

Radio- Electronics

**HOW TO IMPROVE
HOME VIDEO SOUND**

\$1.25 MAY 1982

Build this
SATELLITE TV RECEIVER
for under \$500

How to
DESIGN ANALOG CIRCUITS
New back-to-basics series

Easy to build
AC POWER SWITCHER
for automatic control

Better TV reception
UHF PREAMP
you can build

What's inside
DIGITAL FILTERS
they work
OWN
BITLER
video movies



390736 DHM 0997G093 GV A NOV82
MR ROBERT DAHM 05
997 GRAND AV
AURORA IL 60505



PLUS:
Hobby Corner
Service Clinic ★ State-Of-Solid State
Communications Corner ★ Equipment Reports

THE NEW TRIPLETT DMM FAMILY

performers.

New

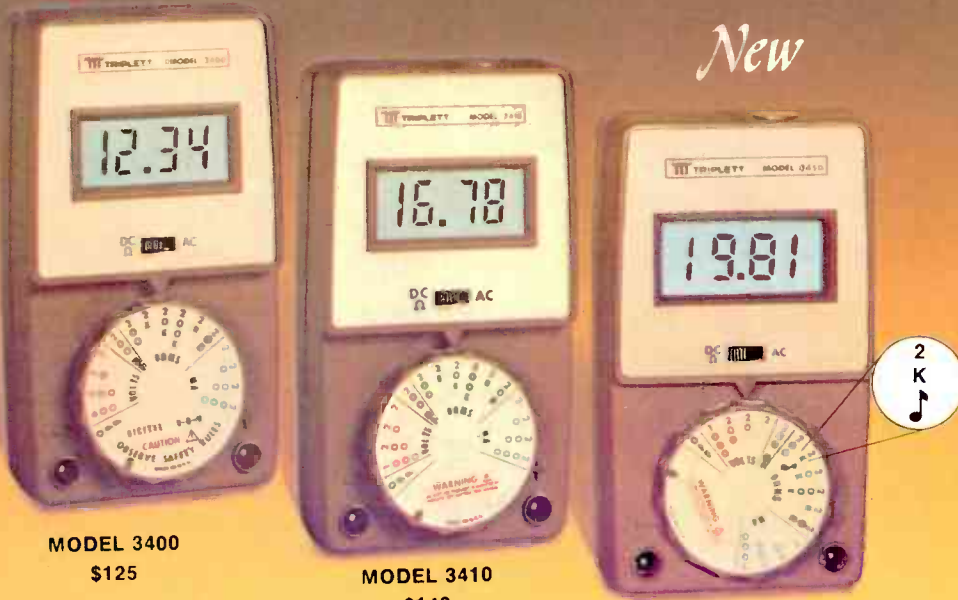

MODEL 3400
\$125

MODEL 3410
\$140

MODEL 3450
\$150

**GO DIGITAL . . .
CHOOSE FROM
3 HANDSIZE
MODELS**

When you're shopping for digitals, be sure to check out these Triplett Digital Multimeters. They're loaded with extras that extend multimeter life and make your job a lot easier and safer.

MODEL 3400 . . . Overload protected to 600 volts on ALL ranges, Typical DC accuracy 0.2%, Hi/Low Power Ohms, Typical battery life 500 hours with low battery indication. Price only \$125.

MODEL 3410 . . . Overload protected to 1000 volts on volts and ohms with no fuse blow, Typical DC accuracy 0.2%, other features similar to Model 3400. Price only \$140.

MODEL 3450 . . . Audible continuity plus actual resistance reading, Overload protected to 1000 volts on volts and ohms with no fuse blow, Typical DC accuracy 0.15%, Hi/Low Power Ohms, Typical battery life 500 hours with low battery indication. Only \$150.

Triplett's over 75 years experience is evident in the engineering firsts included in these digital testers. Plus a full **ONE YEAR WARRANTY**. For a free no-obligation demonstration, contact your Triplett distributor, Mod-Center or Representative.



Triplett Corporation, Bluffton, OH 45817
(419) 358-5015, TWX (810) 490-2400



**Triplett performance . . .
a tough act to follow**

CIRCLE 30 ON FREE INFORMATION CARD
CIRCLE 31 FOR in-Plant Demonstration

SAVE \$10.00

Purchase one of the Model 3400 Series DMM between March 15, 1982 and June 15, 1982 and receive a \$10.00 rebate.

TO RECEIVE REBATE, YOU MUST

- SEND**
1. Distributor identified, dated sales receipt (Non-returnable)
 2. Warranty Card from back of Instruction Manual.
 3. This completed form.

TO: Model 3400 Series Rebate Offer
Triplett Corporation
Bluffton, OH 45817

ADDITIONAL TERMS

Rebate requests must be postmarked by July 1, 1982, or returned refused. Offer good only in U.S.A. and void where prohibited, taxed or restricted by law. Distributors not eligible for rebate.

Allow 6-8 weeks for your rebate check.

REBATE OFFER

RES

NAME _____
COMPANY _____
ADDRESS _____
CITY _____ STATE _____ ZIP _____

There's money up there.

Here. Use our dish to catch it.

The satellites are there. And all you need is an earth station to put the signals to work for you.

We have a complete new selection of packages—dishes, electronics, associated MATV equipment, and all—that you can sell and install wherever you've put in MATV systems. Hotels. Motels. Nursing homes. Hospitals. Condos. Apartments.

The packages are priced very attractively. It's a very real opportunity for you and your customers to make a good profit.

If it sounds good, call us toll-free for more information.

800-631-5491 In New Jersey 201-679-4000

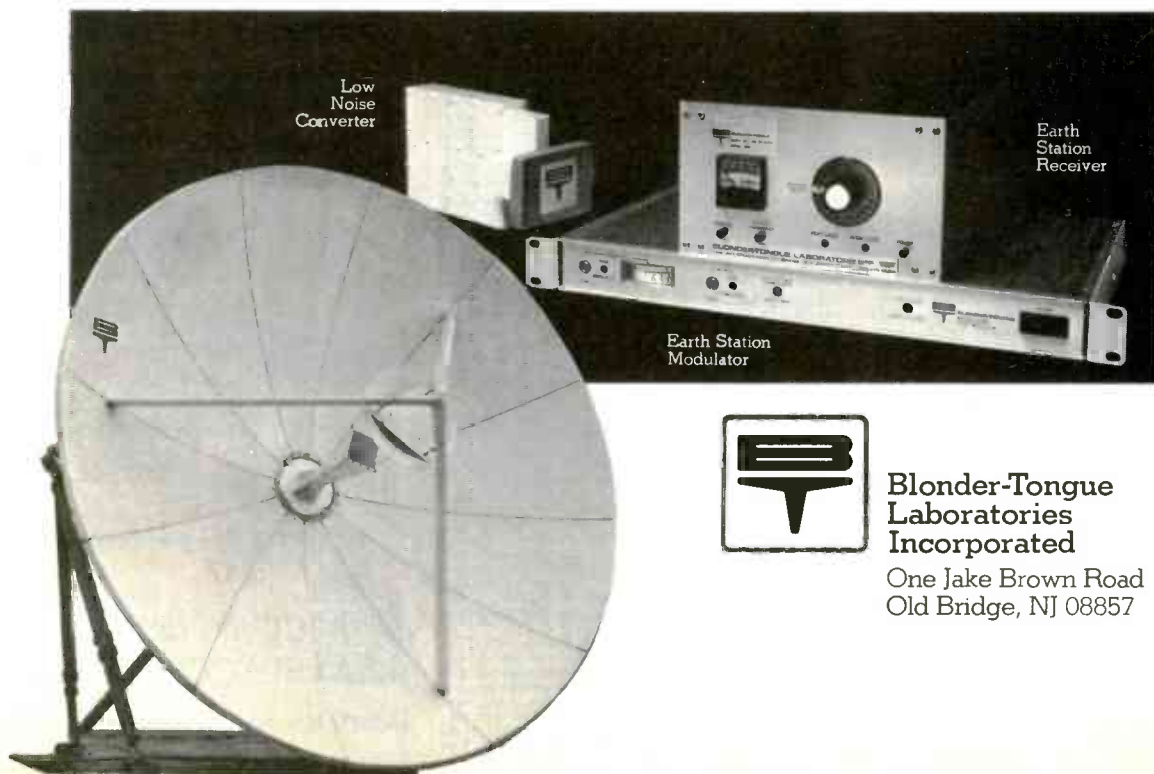

**Blonder-Tongue
Laboratories
Incorporated**

One Jake Brown Road
Old Bridge, NJ 08857

CIRCLE 28 ON FREE INFORMATION CARD

Why use their flexible discs:

Athana, BASF, Control Data, Dysan, IBM, Maxell, Nashua, Scotch, Shugart, Syncom, 3M, Verbatim or Wabash

when you could be using

MEMOREX

high quality error free discs?

Product Description	Part #	CE quant. 100 price per disc (\$)
8" SSSD IBM Compatible (128 B/S, 26 Sectors)	3062	2.09
8" SSSD Shugart Compatible, 32 Hard Sector	3015	2.09
8" SSDD IBM Compatible (128 B/S, 26 Sectors)	3090	2.74
8" DSDD Soft Sector (Unformatted)	3102	3.14
8" DSDD Soft Sector (128 B/S, 26 Sectors)	3115	3.34
8" DSDD Soft Sector (1024 B/S, 8 Sectors)	3104	3.34
8" DSDD Burroughs B-80 Comp., 32 Hard Sector	3092	3.34
5 1/4" SSSD Soft Sector (Unformatted)	3401	1.94
5 1/4" SSDD Soft Sector w/Hub Ring	3481	2.34
5 1/4" SSDD 10 Hard Sector w/Hub Ring	3483	2.34
5 1/4" SSDD 16 Hard Sector w/Hub Ring	3485	2.34
5 1/4" DSDD Soft Sector w/Hub Ring	3491	3.09
5 1/4" DSDD 10 Hard Sector w/Hub Ring	3493	3.09
5 1/4" DSDD 16 Hard Sector w/Hub Ring	3495	3.09

SSSD = Single Sided Single Density; SSDD = Single Sided Double Density
DSDD = Double Sided Double Density

Memorex Flexible Discs...The Ultimate in Memory Excellence

Quality
Memorex means quality products that you can depend on. Quality control at Memorex means starting with the best materials available. Continual surveillance throughout the entire manufacturing process. The benefit of Memorex's years of experience in magnetic media production, resulting for instance, in proprietary coating formulations. The most sophisticated testing procedures you'll find anywhere in the business.

100 Percent Error Free

Each and every Memorex Flexible Disc is certified to be 100 percent error free. Each track of each flexible disc is tested, individually, to Memorex's stringent standards of excellence. They test signal amplitude, resolution, low-pass modulation, overwrite, missing pulse error and extra pulse error. They are torque-tested, and competitively tested on drives available from almost every major drive manufacturer in the industry including drives that Memorex manufactures. Rigid quality audits are built into every step of the manufacturing process and stringent testing result in a standard of excellence that assures you, our customer, of a quality product designed for increased data reliability and consistent top performance.

Customer-Oriented Packaging

Memorex's commitment to excellent does not stop with a quality product. They are proud of their flexible discs and they package them with pride. Both their packaging and their labeling have been designed with your ease of identification and use in mind. The desktop box containing ten discs is convenient for filing and storage. Both box labels and jacket labels provide full information on compatibility, density, sectoring, and record length. Envelopes with multi-language care and handling instructions and color-coded removable labels are included. A write-protect feature is available to provide data security.

Full One Year Warranty—Your Assurance of Quality
Memorex Flexible Discs will be replaced free of charge by Memorex if they are found to be defective in materials or workmanship within one year of the date of purchase. Other than replacement, Memorex will not be responsible for any damages or losses (including consequential damages) caused by the use of Memorex Flexible Discs.

Quantity Discounts Available

Memorex Flexible Discs are packed 10 discs to a carton and 10 cartons to a case. Please order only in increments of 100 units for quantity 100 pricing. We are also willing to accommodate your smaller orders. Quantities less than 100 units are available in increments of 10 units at a 10% surcharge. **Quantity discounts** are also available. Order 500 or more discs at the same time and deduct 1%; 1,000 or more saves you 2%; 2,000 or more saves you 3%; 5,000 or more saves you 4%; 10,000 or more saves you 5%; 25,000 or more saves you 6%; 50,000 or more saves you 7% and 100,000 or more discs earns you an 8% discount off our super low quantity 100 price. Almost all Memorex Flexible Discs are immediately available from CE. Our warehouse facilities are equipped to help us get you the quality product you need, when you need it. If you need further assistance to find the flexible disc that's right for you, call the Memorex compatibility hotline. Dial 800-538-8080 and ask for the *flexible disc hotline* extension 0997. In California dial 800-672-3525 extension 0997. Outside the U.S.A. dial 408-987-0997.

Buy with Confidence

To get the fastest delivery from CE of your Memorex Flexible Discs, send or phone your order directly to our Computer Products Division. Be sure to calculate your price using the CE prices in this ad. Michigan residents please add 4% sales tax. Written purchase orders are accepted from approved government agencies and most well rated firms at a 30% surcharge for net 30 billing. All sales are subject to availability, acceptance and verification. All sales are final. Prices, terms and specifications are subject to change without notice. Out of stock items will be placed on backorder automatically unless CE is instructed differently. Minimum order \$50.00. International orders are invited with a \$20.00 surcharge for special handling in addition to shipping charges. All shipments are F.O.B. Ann Arbor, Michigan. No COD's please. Non-certified and foreign checks require bank clearance.

Mail orders to **Communications Electronics**, Box 1002, Ann Arbor, Michigan 48106 U.S.A. Add \$8.00 per case or partial-case of 100 8-inch discs or \$6.00 per case or partial case of 100 5 1/4-inch mini-discs for U.P.S. ground shipping and handling in the continental U.S.A. If you have a MasterCard or Visa card, you may call anytime and place a credit card order. **Order toll-free** in the U.S. Call anytime 800-521-4414. If you are outside the U.S. or in Michigan, dial 313-994-4444. Order your high quality, error free Memorex discs today.
Copyright ©1982 Communications Electronics™

High Quality Error Free



Order Toll-Free!
(800) 521-4414
In Michigan (313) 994-4444

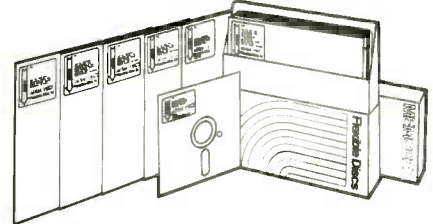

For Data Reliability—Memorex Flexible Discs

**COMMUNICATIONS
ELECTRONICS™**

Computer Products Division

854 Phoenix □ Box 1002 □ Ann Arbor, Michigan 48106 U.S.A.
Call TOLL-FREE (800) 521-4414 or outside U.S.A. (313) 994-4444

SPECIAL FEATURE	57 DESIGN ANALOG CIRCUITS A new 11-part back-to-basics series. Each month we'll cover analog components and tell you how to apply them. This month, its thermistors and varistors. Mannie Horowitz
BUILD THIS	49 SATELLITE TV RECEIVER A high quality receiver for under \$500. Add an antenna and an LNA for a complete satellite earth station. David Becker
	54 AUTOMATIC POWER SWITCHER An easy-to-build elegant solution to having to throw multiple power switches. Gary McClellan
	64 UHF-TV PREAMP Part 2. Improve UHF reception with this 2-stage amplifier. Ray Pichulo
	71 VIDEO TITLER Part 2. Add titles to your home video movies with this alphanumeric character and graphics generator. Michel Champagne
TECHNOLOGY	4 VIDEO ELECTRONICS Tomorrow's news and technology in the quickly changing industry. David Lachenbruch
	22 SATELLITE TV NEWS The latest happenings in Communications technology. Gary H. Arlen
	91 STATE OF SOLID STATE One IC voltage conversion. Robert F. Scott
CIRCUITS AND COMPONENTS	67 DIGITAL FILTERS Here's a look at how analog signals are filtered using digital techniques. Arthur Makosinski
	80 HOBBY CORNER A new contest and notes from the mailbag. Earl "Doc" Savage, K4SDS
	102 NEW IDEAS A word counter for your typewriter.
VIDEO	61 IMPROVE VIDEO SOUND A look at several methods to improve the sound quality of your home video movies. Len Feldman
	94 SERVICE CLINIC Troubleshooting IC's. Jack Darr
	96 SERVICE QUESTIONS R-E's Service Editor solves technicians' problems.
TEST EQUIPMENT	77 TESTING FOR SAFETY Here's a look at how the Underwriters Laboratories check the safety of test equipment and what the UL label means. Jack Darr
COMPUTERS	88 COMPUTER CORNER Microcomputer memory devices. Les Spindle
RADIO	84 COMMUNICATIONS CORNER Shortwave listening on a budget. Herb Friedman
EQUIPMENT REPORTS	37 Radio Shack MG-1 Synthesizer 42 Microtek Byewriter-1 Printer
DEPARTMENTS	16 Advertising and Sales Offices 26 Letters 130 Advertising Index 108 Market Center 106 Books 100 New Products 131 Free Information Card 6 What's News

ON THE COVER

Build this high-quality satellite TV receiver for under \$500. Add a satellite TV antenna and LNA for a complete TV earth station. The kit comes with a pre-aligned IF strip and LNA power supply. Get started building your satellite receiver today. Turn to page 49.

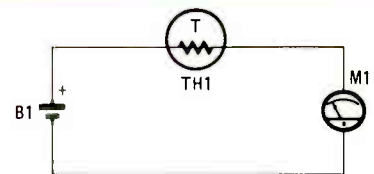

HOW TO DESIGN analog circuits is a new 11-part series on analog components and how to apply them. This month, thermistors and varistors are covered. The story starts on page 57.



AUTOMATIC POWER SWITCHER solves the problem of having to turn on multiple power switches in your hi-fi or computer system. Throw one switch and the power switcher does the rest automatically. Construction starts on page 54.

Radio-Electronics, (ISSN 0033-7862) Published monthly by Gernsback Publications, Inc., 200 Park Avenue South, New York, NY 10003. Second-Class Postage Paid at New York, N.Y. and additional mailing offices. One-year subscription rate: U.S.A. and U.S. possessions, \$13.00. Canada, \$16.00. Other countries, \$20.50 (cash orders only, payable in U.S.A. currency.) Single copies \$1.25. © 1982 by Gernsback Publications, Inc. All Rights reserved. Printed in U.S.A.

Subscription Service: Mail all subscription orders, changes, correspondence and Postmaster Notices of undelivered copies (Form 3579) to Radio-Electronics Subscription Service, Box 2520, Boulder, CO 80322.

A stamped self-addressed envelope must accompany all submitted manuscripts and/or artwork or photographs if their return is desired should they be rejected. We disclaim any responsibility for the loss or damage of manuscripts and/or artwork or photographs while in our possession or otherwise.

As a service to readers, Radio-Electronics publishes available plans or information relating to newsworthy products, techniques and scientific and technological developments. Because of possible variances in the quality and condition of materials and workmanship used by readers, Radio-Electronics disclaims any responsibility for the safe and proper functioning of reader-built projects based upon or from plans or information published in this magazine.

VIDEO ELECTRONICS

DAVID LACHENBRUCH
CONTRIBUTING EDITOR



DISC REALIGNMENT

Growing pains and early problems have caught up with the infant videodisc industry, resulting in some major changes and realignments. In the optical LaserVision camp, the two early prime movers—IBM and MCA—now are out of the action so far as manufacturing is concerned, and Pioneer is in the driver's seat, along with Philips. Plagued by slow deliveries and a high reject rate, DiscoVision Associates, a jointly owned IBM-MCA venture, closed its Carson, CA plant, and now exists only as a patent-licensing company.

Pioneer Electronics (Japan) purchased DiscoVision's 50% interest in Universal-Pioneer, which masters and presses optical discs in Kofu, Japan. With the closing of the Carson plant, the only major source of optical videodiscs was Japan, where Pioneer is pressing consumer and industrial discs and Sony is pressing industrial discs only. However, a new U.S. facility for optical discs has just been opened by 3M in Menomonie, WI, and a new firm—Vidisco, headed by David Paul Gregg, an engineer who led the early development of the optical disc—at press time was bidding for the Carson facility. Another company, Quixote Corp., plans to press industrial optical discs using a new fast process. Philips expects to open a disc plant in Blackburn, England this year.

North American Philips isn't giving up on the disc. Its Magnavox Magnavision player, which has come in second to Pioneer's unit in features, will be replaced temporarily by one made in Japan by Pioneer around midyear. Probably it will be sold under Philips' Magnavox, Sylvania, and Philco brand names, until a completely new Philips-developed model is ready in 1983.

RCA DISC PRICE SLASHED

Meanwhile, RCA's CED system has also been having its share of troubles. Player sales last year simply failed to meet projections, and competitive compatible players have been for sale at extremely low prices. However, RCA was surprised by the almost insatiable demand for discs from people who did buy its players; those who owned them for eight months or more purchased an average of 23 discs. As a result, RCA's marketing philosophy seems to have changed to one of wooing disc sales by offering players at low prices. RCA introduced a new model of its basic (monophonic) player with a suggested list price of \$349.95, down \$150 from its original model (which is virtually the same as the new one), and offered the older model to dealers at an even sharper discount. RCA plans to introduce a stereo-sound model during this spring and a wireless remote version in the fall.

LOOKMAN

Sony has introduced a sort of "video Walkman" in Japan, and probably will market it in the U.S. later this year. The 2-inch picture is provided by the first flat TV tube to be sold on the consumer market. The "FD" (Flat Display) tube resembles a small table-tennis paddle, its electron gun being parallel to the screen rather than perpendicular. The tube itself is about 5/8-inch thick, 2.17 inches wide, 5.24 inches deep; the TV set is smaller than a paperback book, and can be operated for 2½ hours on four AA alkaline cells. Another flat TV, using a 3-inch tube based on the same principle, has been developed by Sinclair Research of the U.K. and is to be built by Timex in Scotland for introduction here this year. Sony's Flat TV sells for about \$240 in Japan. R-E

"No one else gives you as many functions in a handheld DMM."

Now you can move up to Fluke."

We've got great news for people who've been holding out for a high quality, high performance DMM at a moderate price: Fluke's new nine-function model D 804 is now available at select electronics supply stores.

With a suggested U.S. price of only \$249 and features you won't find in any other handheld DMM, the D 804 is an exceptional value. Here's why.

Logic level and continuity testing: A real time-saver for troubleshooting passive circuits in pcb's, cables, relay panels and the like. The D 804 has a switch-selectable audible tone and visual symbols to indicate continuity or logic levels.

Direct temperature readings in °C: Used with any K-type

thermocouple, the D 804 delivers fully-compensated readings in °C from -20°C to +1265°C, for checking heating and refrigeration systems.

Peak hold feature captures transients: A short-term memory in the D 804 captures and holds the peak reading of a motor starting current.

And more: 0.1% basic dc accuracy, conductance, 26 measurement ranges, battery, safety-designed test leads and a one year parts and labor warranty. A full line of accessories is also available to extend the measurement capabilities of your DMM.

Ask your dealer about the powerful, versatile D 804 and the rest of Fluke's new Series D line of low-cost digital multimeters.



From the world leader in DMM's. Now we've designed one for you.



Suggested U.S. list price
technical data circle No. 24
1187-4/D804
RE 5/82

If your dealer doesn't carry Series D
Multimeters yet, call this number. We'll be
happy to tell you who does. 1-800-426-9182

FLUKE[®]

WHAT'S NEWS

U.S. semiconductors now equal Japan's

The quality of American 16K RAM semiconductors is now running neck-and-neck with that of their Japanese counterparts, reports Richard W. Anderson, general manager of the Hewlett-Packard Computer Systems division. "So far as 16K memory parts are concerned, the contest is now more nearly company-versus-company than country-versus-country, though we have yet to find a U.S. supplier who consistently matches the best of the Japanese," he says.

Failure rates among units from six suppliers—three of those Japanese and three were American—ran from 7 to 30 failures per 10,000 units, says Anderson. Both the highest and lowest failure rates were in semiconductors from Japanese suppliers, he said.

United States Mail goes electronic

Electronic Computer-Originated Mail (E-COM) became part of the postal technology last January. It offers large mailers considerable economy in distributing their computer-originated mail.

E-COM mail starts in a computer, as does much of the other mail today. It is transferred to magnetic tape and transmitted by telephone line (or other communications carrier) to one of the 25 "Serving Post Offices" of the system. From there it is transmitted electronically to any of the other 24 post offices in the net. The electronic message is then printed out, trimmed, folded, and placed in envelopes with the address showing through a window in the front. Delivery is by first-class mail.

Twenty-five post offices began the service. Others will be added as expedient.

Casio is now making a personal computer

Casio Inc. has added to its line a new sophisticated personal desktop computer, which can be expanded up to 32K bytes of Random-Access Memory (RAM). A unique feature is the 4K CMOS (Complementary Metal Oxide Semiconductor) RAM cartridges, on which programs can be stored for quick access for up to three years.

A high-resolution graphic function can express various tables, patterns, and graphs,



THE CASIO FX-9000P personal computer. The basic unit comes with a 4K RAM, a 5.5-inch built-in CRT, very extensive high-resolution graphics, and powerful mathematical functions for scientific, engineering and statistical operations.

thus simplifying analysis of experimental results or business data. Hard copies can be obtained with an optional graphic printer.

Powerful mathematical functions include standard deviation, regression analysis, and correlation coefficient.

The system uses a high-level, semi-compiled, problem-solving basic language, CBASIC. An easily understood grammar and versatile command group make it easy to master.

Suggested list price for the Casio FX9000P is \$1,199. Numerous options are also available for the computer.

RCA videocassette now plays 8 hours

A new RCA long-play tape expands the recording capability of the "SelectaVision" video cassette recorder to a full eight hours. The new videotape permits packaging one-third more tape in a standard VHS cassette, resulting in an extension of playing time from six to eight hours in the SLP mode.

The deluxe 8-hour tape cassette, VK330, carries an optional retail price of \$32.95. Two previous blank-tape cassettes, the VK125 and VK250, with recording times of three and six hours respectively, will remain in the line.

Five new standards published by EIA

The Engineering Department of the Electronic Industries Association announces five new or updated standards.

RS-483, "Standard Method of Test for Effective Series Resistance (ESR) and Capacitance of Multilayer Ceramic Capacitors at High Frequencies," is the first of its kind for such measurements. A low-ESR transmission line has been constructed, and a mathematical system devised for using it in a resonant mode to determine capacitor parameters, particularly ESR, up to microwave frequencies. Copies of RS-483 are priced at \$10.00.

RS-311-A, "Measurement of Transistor Noise Figure and Effective Noise Temperature at MF, HF and VHF" revises RS-311, adding information necessary for "effective input noise temperature" measurements. Copies of RS-311-A are priced at \$6.00 each.

RS-381-A updates RS-381, clarifying the method used to measure "Q" of a voltage-variable-capacitance diode in the low VHF range, using an RF admittance bridge. It is available at \$6.50 each.

RS-490, "Standard Test Methods of Measurement for Audio Amplifiers," replaces EIA

continued on page 12



E-COM EQUIPMENT UNDER TEST at the RCA Government Communications Systems, Camden, NJ. (RCA supplied the equipment for the new system, on a \$31-million contract.) The system accepts inputs from a customer's computer-generated magnetic tape or from a computer via private telecommunications carriers and transmits it to the electronic center designated by the customer, where it is printed, trimmed, folded, placed in envelopes, and delivered by first-class mail.

COMPARE HITACHI TO TEKTRONIX THEN DECIDE!

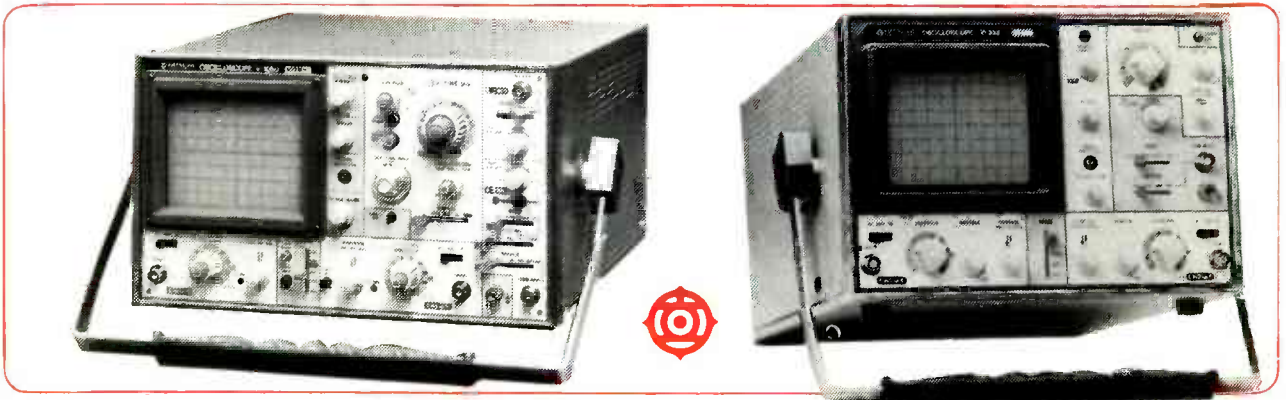

No one can match the features or performance at our
MARKET-SHATTERING PRICES!
Buy with confidence from the nation's largest Hitachi distributor

REHITV1050 100 MHz, List \$2375.00

Sale \$1595.00

REHITV550B 50 MHz, List \$1745.00

Sale \$1250.00

REHITV352 35 MHz, List \$1150.00

Sale \$795.00

REHITV202 20 MHz, List \$850.00

Sale \$595.00

All HITACHI Scopes come with 2, 10 to 1 Probes

SPEC	TEK 2210	HITV1050	HITV550B	HITV352	HITV202
PRICE	\$1600.00	\$1000.00	\$1200.00	\$700.00	\$600.00
BANDWIDTH	50 MHz/50 MHz	100 MHz	50 MHz	35 MHz	20 MHz
SENSITIVITY	20 mV/DIV-5mV/DIV	5mV/DIV	5mV/DIV	5mV/DIV	5mV/DIV
SWEEP SPEED SELECTION	00 0.2/DIV 10 5 1/DIV 1 10 10/DIV	20 0.2/DIV 10 5 1/DIV 1 10 10/DIV	00 0.2/DIV 10 5 1/DIV 1 10 10/DIV	2 2 0.2/DIV 10 5 1/DIV 1 10 10/DIV	2 2 0.2/DIV 10 5 1/DIV 1 10 10/DIV
VERTICAL MODES	CH 1, CH 2, ALT COMP. ADD	CH 1, CH 2, ALT COMP. ADD TRIG. & VIEW	CH 1, CH 2, ALT COMP. ADD TRIG. & VIEW	CH 1, CH 2 MAGN. ADD OFF	CH 1, CH 2 MAGN. ADD OFF
WIRE RANGE	2 mV to 100 V	500 20 1 to 500	1 mV to 100 V	1 mV to 100 V	1 mV to 100 V
VERT. SENSITIVITY	/DIV	/DIV	/DIV	/DIV	/DIV
RELATED OR INTERFACED SWEEP	YES	YES	YES	NO	NO
DELAY TIMER	5 10 15 20 4 ms	10 ns to 5 1/2 DIV	20 ns to 5 1/2 DIV	FIXED	---
DUAL TRACE MODE MEASUREMENTS	A, B, ALT w/B INTERSECTION	A, B, ALT w/B INTERSECTION	A, B, ALT w/B INTERSECTION	---	---
TRIGGER "A" MODES	AUTOMATIC TV FIELD TV VERTICAL LINE EXTERNAL	AUTOMATIC TV VERTICAL TV HORIZONTAL LINE EXTERNAL	AUTOMATIC TV VERTICAL TV HORIZONTAL LINE EXTERNAL	AUTOMATIC TV (-), - LINE EXTERNAL	AUTOMATIC TV (-), - LINE EXTERNAL
TRIGGER "B" MODES	- SLOPE INTERNAL ONLY	- SLOPE INTERNAL EXTERNAL	- SLOPE INTERNAL EXTERNAL	---	A, B CHANNEL DATE INPUT
ALTERNATE SWEEP SEPARATOR	YES	YES	NO	---	---

* USING X10 PROBE

† USING X10 PROBE WITH MAGNIFIER

‡ We had to obtain this specification by phone from Tektronics because it was not listed in the literature.

SPEC	TEK 2210	HITV1050	HITV550B	HITV352	HITV202
GBT	0 to 10 DIV INT. ABATICLE POST POSITION TRIG. ACCEL. V	0 to 10 DIV INT. ABATICLE POST POSITION TRIG. ACCEL. V	0 to 10 DIV INT. ABATICLE POST POSITION TRIG. ACCEL. V	0 to 10 DIV INT. ABATICLE POST POSITION TRIG. ACCEL. V	0 to 10 DIV INT. ABATICLE POST POSITION TRIG. ACCEL. V
GBT CONTROLS	BRIGHTNESS AUTO FOCUS REAR FOCUS TRACE ROTATION	BRIGHTNESS AUTO FOCUS REAR FOCUS TRACE ROTATION	BRIGHTNESS AUTO FOCUS REAR FOCUS TRACE ROTATION	BRIGHTNESS AUTO FOCUS REAR FOCUS TRACE ROTATION	BRIGHTNESS AUTO FOCUS REAR FOCUS TRACE ROTATION
SCALE ILLUMINATION	---	YES	YES	YES	YES
CHARACTER Z	---	YES	YES	YES	NO
INVERT	YES	YES	YES	YES	NO
TRIGGER VIEW	NO	A, B	A	NO	NO
HF REJECTION	NO	SWITCHABLE	SWITCHABLE	NO	NO
LF REJECTION	NO	SWITCHABLE	SWITCHABLE	NO	NO
BAND WIDTH LIGHT	NO	YES 50 MHz	NO	NO	NO
X-Y MEASUREMENTS	---	YES	YES	YES	YES
CAMERA READY	YES	YES	YES	NO	NO
SOFT POSITION HANDLE	YES	YES	YES	YES	YES
SETTLING	10,000:1	10,000:1	10,000:1	---	---
2 AXIS BANDWIDTH	50 MHz	50 MHz	50 MHz	50 MHz	50 MHz
0-500	5.5 MHz	5.5 MHz	5.5 MHz	---	---
POWER CONSUMPTION	60 WATTS	60 WATTS	60 WATTS	60 WATTS	60 WATTS
PROBE CALIBRATION	YES	YES	YES	YES	YES
INPUT	50 100 500	50 100 500	50 100 500	50 100 500	50 100 500
A, B CHANNEL DATE INPUT	---	YES	NO	NO	NO
POWER ON INDICATOR	---	YES	YES	YES	YES
WARRANTY	1 YEAR	2 YEARS	2 YEARS	2 YEARS	2 YEARS

Until now, if you wanted a 50MHz or 100MHz dual trace oscilloscope of uncompromising quality, there was only one choice. Now there is a second... outstanding new delay sweep with an established name — the Hitachi V550B and the V1050

The HITACHI V550B (50MHz) and V1050 (100MHz) offer all the capabilities you might demand from a lab grade oscilloscope. Capabilities such as a max. sweep rate of 2ns/div (V1050) 5ns/div (V550B). Also features you may not expect, like sensitivity of 1 mv/div (V550B) 5mv/div (V1050) @ 10MHz, automatic focus correction, and a built-in TV sync separator circuit.

The cost? Remarkably reasonable, especially when you compare it to the other leading 50MHz or 100MHz Dual trace oscilloscopes. It's a price breakthrough made possible by using up-to-date production techniques and a design backed up by over 20 years of oscilloscope experience.

HITACHI Oscilloscopes are innovative oscilloscopes designed and manufactured by Hitachi Denshi Ltd. The wide experience gained by HITACHI electronic specialists in producing oscilloscopes has resulted in this line of modern oscilloscopes featuring wider band width, more compact design and light weight. Through adopting circuitry with linear IC's and logic IC's plus modern manufacturing techniques, including automatic component-insertion machines. These oscilloscopes offer increased stability, improved reliability, excellent performance and enhanced operating ease.

The panel layout is designed to create maximum operating ease by considering measuring processes and operation frequency. The layout is divided into three blocks according to respective functions identified by different colors. This convenience-oriented design for users improves daily controllability and drastically reduces operating errors.

PRIORITY ONE ELECTRONICS

9161 R Deering Ave., Chatsworth, CA 91311

ORDER TOLL FREE (800) 423-5922
CA, AK, HI CALL (213) 709-5464

CIRCLE 22 ON FREE INFORMATION CARD

www.americanradiohistory.com

TERMS U.S. VISA, MC, BAC, Check, Money Order, U.S. Funds Only. CA residents add 6% Sales Tax. INCLUDE \$15.00 FOR EACH OSCILLOSCOPE for UPS Surface Shipping and Handling. Just in case, include your phone number. Prices subject to change without notice. We will do our best to maintain these prices through April, 1982. For complete specifications, see our 60 page catalog in the November issue of BYTE or send \$1.00 for your copy, today. Sale Prices are for prepaid orders only.

Everybody's making money selling microcomputers. Somebody's going to make money servicing them.

New NRI Home-Study Course Shows You How to Make Money Servicing, Repairing,
and Programming Personal and Small Business Computers





Training includes the new TRS-80 Model III microcomputer, 6-function LCD Beckman multimeter, and the NRI Discovery Lab with hundreds of tests and experiments.

Seems like every time you turn around, somebody comes along with a new computer for home or business use. And what's made it all possible is the amazing microprocessor, the tiny little chip that's a computer in itself.

Using this new technology, the industry is offering compact, affordable computers that handle things like payrolls, billing, inventory, and other jobs for businesses of every size...perform household functions including budgeting, environmental systems control, indexing recipes. And thousands of hobbyists are already

owners, experimenting and developing their own programs.

Growing Demand for Computer Technicians

This is only one of the growth factors influencing the increasing opportunities for qualified computer technicians. The U.S. De-

partment of Labor projects over 100% increase in job openings for the decade through 1985. Most of them *new* jobs created by the expanding world of the computer.

Learn at Home in Your Spare Time

NRI can train you for this exciting, rewarding field. Train you at home to service not only microcomputers, but word processors and data terminals, too. Train you at your convenience, with clearly written "bite-size" lessons that you do evenings or weekends, without going to classes or quitting your present job.

Your training is built around the latest model of the world's most popular computer. It's the amazing TRS-80™ Model III, with capabilities and features to perform a host of personal and business functions. No other small computer has so much software available for it, no other is

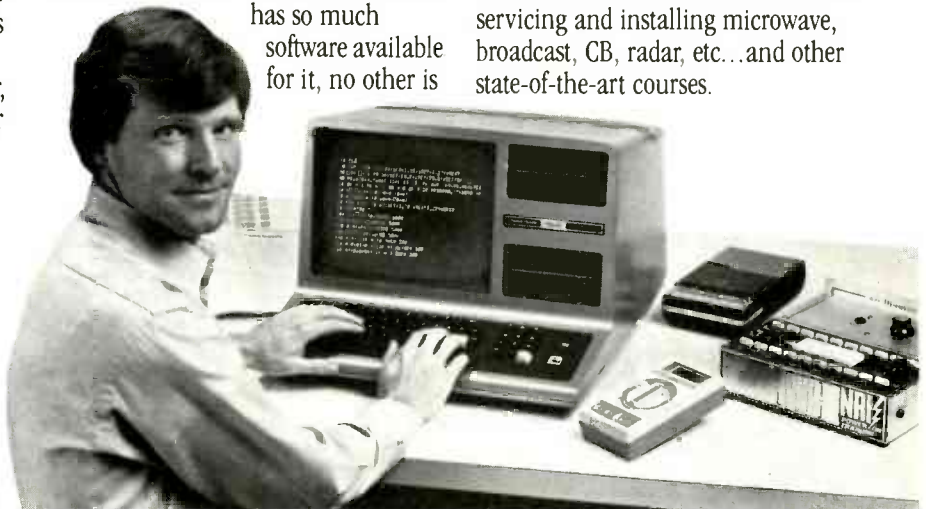

used and relied on by so many people. And it's yours to keep for personal or business use.

You get plenty of practical experience. Using the NRI Discovery Lab® that also comes as part of your course, you build and study circuits ranging from the simplest to the most advanced. You analyze and troubleshoot using the professional Beckman LCD digital multimeter you keep to use later in your work. Then you use the lab and meter to actually access the interior of your computer...build special circuits and write programs to control them. You "see" your computer at work and demonstrate its power.

Become the Complete Computer Person

You're also trained in writing and debugging both BASIC and advanced machine language programs...gain hands-on experience in the operation and application of computers to business and personal jobs. You're trained to become the fully rounded, new breed of technician who can interface with the operational, programming, and service facets of today's computers. You're ready to take your place in the new electronic age.

Other Opportunities

NRI has been giving ambitious people new electronic skills since 1914. Today's offerings also include TV/Audio/Video Systems servicing with training on our exclusive computer-programmable 25" diagonal color TV...Communications Electronics for servicing and installing microwave, broadcast, CB, radar, etc...and other state-of-the-art courses.

Free Catalog...Mail Card No Salesman Will Call

Send the postage-paid card for our 100-page catalog showing all courses with equipment and complete lesson plans. There's no obligation other than to yourself. See how NRI can help you grow with the most exciting and important new field of the 80's. If card has been removed, please write to us.



NRI SCHOOLS
McGraw-Hill Continuing
Education Center
3939 Wisconsin Ave.
Washington, DC 20016

We'll give you tomorrow.

(TRS-80 is a trademark of the Radio Shack division of Tandy Corp.)

WHAT'S NEWS

continued from page 6

Interim Standard No. 2, which replaced IHF-A-202 published in 1978 by the Institute of High Fidelity. Copies are \$8.00 each.

RS-475, "Generic Specifications for Fiber Optic Connectors," covers all fiber-optic connector types. Price is \$7.00 each.

Copies of all the above are available from the Standard Sales Office, Electronic Industries Association, 2001 Eye St. N.W., Washington, DC 20006. A free catalog of EIA and JEDEC standards and engineering publications is also available.

Domestic satellites now number fourteen

With the launching of RCA's Satcom IV on January 14, there were the equivalent of 14 U.S.

domestic satellites in orbit. Like its predecessors, Satcoms, I, II, and III-R, Satcom IV has 24 channels, each of which can carry 1,400 voice circuits, one FM/color-TV transmission, or 64 megabits of computer data per second. The satellites cover all 50 states and Puerto Rico.

With Satcom IV, RCA Americom has two satellites dedicated to cable TV. They have a combined programming capacity of more than 1,000 hours per day. There are now 22 million U.S. homes served by cable TV, and nearly all of them receive at least one satellite-relayed channel of programs.

Interference cut by new GE device

At the recent International Solid State Circuits Conference

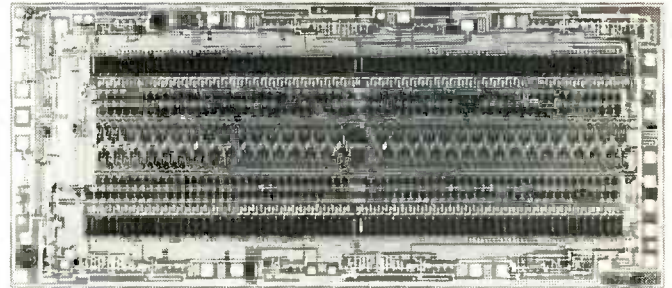

HEART OF GE'S NEW CIRCUIT for detecting radio signals through extreme interference is a pair of 128-point binary-analog computers in the central part of the chip. That chip was developed by scientists at the GE Research and Development Center at Schenectady, NY.

of the IEEE in San Francisco, General Electric scientists described microelectronic device that improves radio communications where there's extreme noise or interference.

The device—called a surface-charge correlator—is intended for military applications. It will allow effective communication under combat conditions where the frequencies are jammed by the enemy.

The tiny (0.110 × 0.265 inch) circuit chip will recognize and amplify specially-coded signals containing voice communications, while discarding jamming noise. It does that by a series of multiplying and adding operations—at the rate of over a billion calculations a second. Through those calculations, the device can judge the degree of correlation between incoming signals and a special code programmed into its memory.

If the degree of correlation is high, the device concludes that the radio signal contains the desired voice data. Signals with a low degree of correlation are dismissed as noise. The desired data, containing the voice material, is amplified and passed on to a decoder, which reassembles them into recognizable words.

Ford moving toward semiautomatic travel?

This year selected car models in the Ford lineup will carry the company's second-generation Message Center that seems to

some to be an approach toward the automatic road control system of the future. The Message Center is part of the standard instrument panel on the new Continental. Another version, the "Trip minder," is optional on the Mercury-Marquis, Cougar XR-7, and Ford LTD and Thunderbird. The optional "Trip Computer" will be available on the European Ford Granada.

All three will show the day, date, elapsed trip time, distance travels, average speed, and instantaneous and average fuel consumption. The Continental's Message Center can also be programmed to show the estimated time of arrival and distance to destination. It also shows the distance that can be traveled on the fuel remaining in the tank, as does the Trip Computer.

The systems are produced by Philco-Ford of Canada Ltd., use National Semiconductor's 8050 microprocessors.

3M's videodisc plant is now in operation

3M has opened a complete videodisc mastering and replication facility in Menomonie, WI, (about 50 miles from the company's St. Paul headquarters.) The plant was in a modified start-up mode for several months before the opening, while testing the sophisticated equipment used in 3M's proprietary replication process.

The discs are compatible with Magnavox, Pioneer, Sony, and Discovision players. **R-E**

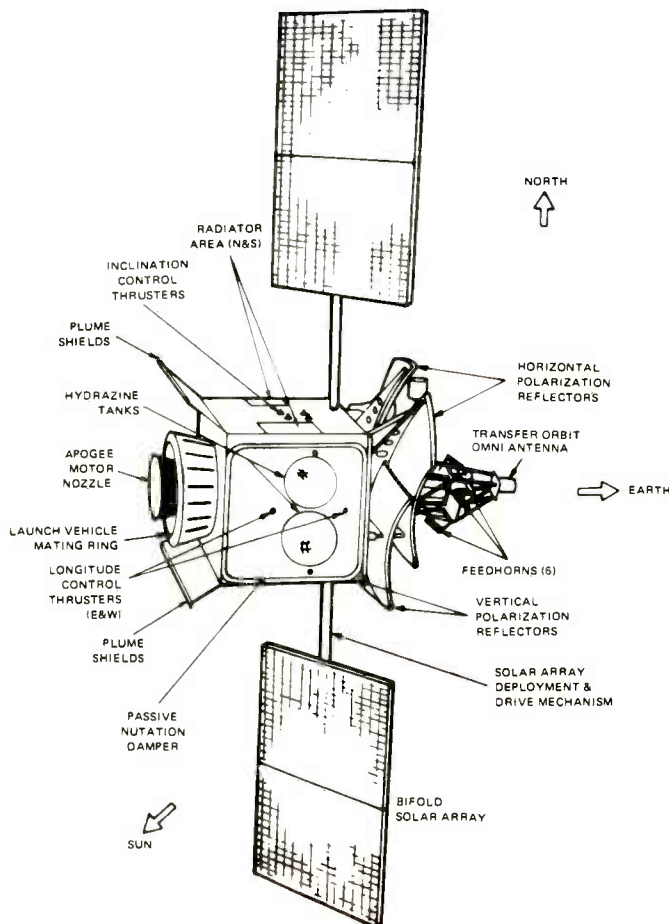

AN RCA SATCOM, with the various parts identified.

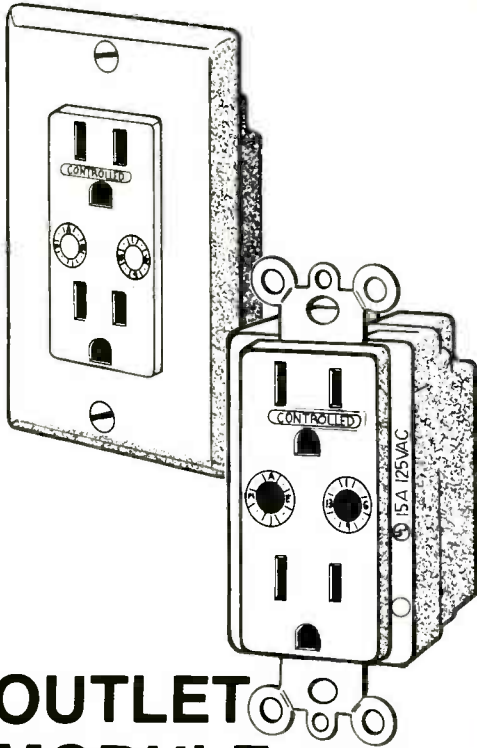

OUTLET MODULE

NEW!
NOW AVAILABLE

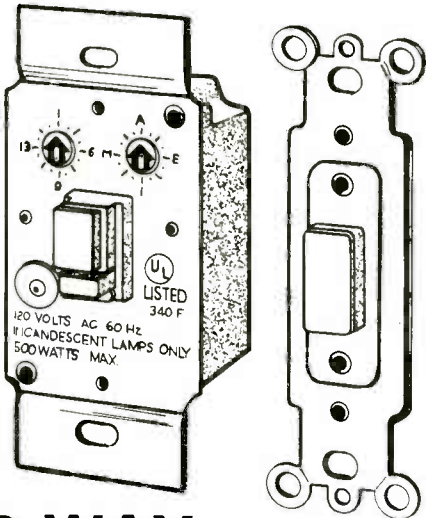

3-WAY WALL SWITCH

*Prices subject to change without notice.
Please add \$3.00 shipping.

BURGLARY INSURANCE SALE

SAVE \$\$ ON BSR SECURITY SYSTEMS.

\$49.95

QUANTITIES LIMITED

THE TIMER. Most burglars stay away if they think someone is home.

The BSR System X-10 Security Timer plugs in anywhere and automatically turns lights, TV sets, hi-fis, and appliances on and off. At preset times during the day and night, or instantly at the touch of a button. So your house not only looks but sounds lived-in, even when you're not home.

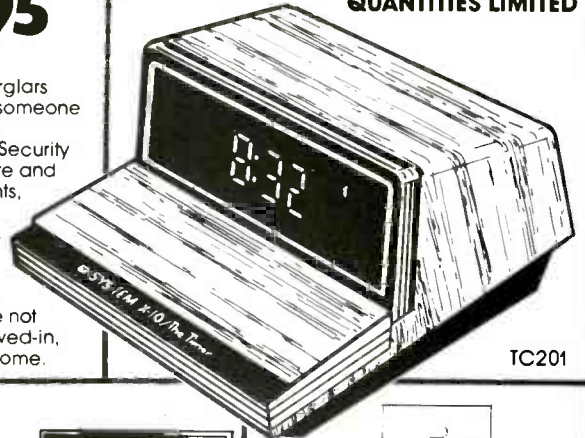

TC201

**SPECIAL
PURCHASE**



\$11.95* **LAMP MODULE.** Plug-in units receive signals from Timer or Mini Controller to control lamps anywhere in the house. Turn them on, off, dim, or brighten them. All by remote control. LM501

\$11.95* **APPLIANCE MODULE.** Plug-in units receive signals to turn appliances on and off anywhere in the house. Limit 3 per customer. AM601

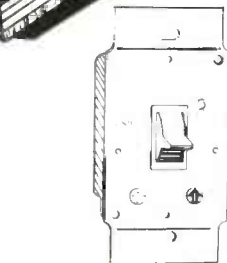

\$11.95* **WALL SWITCH MODULE.** Replace existing indoor wall switches with these modules to control important indoor and outdoor overhead lights. Hallway lights. Porch lights. Flood lights. WS701

*Modules shown are \$14.95 each with the purchase of Timer, Console or Cordless Controller.



\$29.95 **ULTRASONIC COMMAND CONSOLE.** Simply press the buttons on the keyboard, and control lights and appliances throughout the house. Also receives signals from Cordless Controller.

\$12.95 **CORDLESS CONTROLLER.** Transmits signals to the UC301 Console from up to 30 feet away.

BSR SYSTEM X-10®

THE TEST EQUIPMENT SPECIALISTS

TOLL FREE HOT LINE
800-223-0474

54 WEST 45th STREET, NEW YORK, N.Y. 10036 212-687-2224

**ADVANCE
ELECTRONICS**

**A STEP BEYOND
EXTRAORDINARY**

SHURE



**INTRODUCING THE
V15 TYPE V**



**SIDE-GUARD
PROTECTION
SYSTEM**



**MASAR™-POLISHED
HYPERELLIPTICAL
STYLUS TIP**



**BERYLLIUM
MICROWALL/BE
STYLUS SHANK**



**DYNAMIC STABILIZER/
DESTATICIZER**

FEATURING MICROWALL/Be TECHNOLOGY™

This revolutionary new phono cartridge is not just an advance in design... it's a quantum leap forward resulting in superior sound reproduction. The V15 Type V not only re-creates the music... it brings back the emotion of the performance! It solves such ever-present, record playback problems as "Superdisc" hot signals, record warp, static electricity, record wear, cartridge misalignment, and stylus breakage.

The Type V is totally optimized for flawless performance at 1.0 gram tracking force. Its trackability in the critical 5 kHz-plus region is double that of the nearest competitor; and its high frequency mechanical resonance is well beyond the audible range. All of this is due to the incredible Beryllium Microwall Technology Shure developed specifically for this cartridge.

A MASAR™ polished stylus tip contributes far less to record wear than any other high performance cartridge. This impressive array of features combines to give performance that goes far beyond what was —until now— considered the best. The performance is so improved that an entirely new, landmark system of measurement was developed: the Total Trackability Index (TTI).

PLUS! With the V15 Type V you'll receive a certificate good for Shure's newly developed TTR117 Trackability Test Record. Valued at \$15.00, this new standard-setting test record is yours **FREE!**
Send for our fact-filled brochure on this remarkable new cartridge. Ask for AL694.

No other cartridge, at any price, offers all these benefits:

- Incredibly accurate high frequency trackability due to the revolutionary new high stiffness, low mass Beryllium MICROWALL/Be™ stylus shank.
- Exclusive DYNAMIC STABILIZER that functions like a miniature shock absorber to eliminate warp-related problems such as groove skipping, cartridge bottoming, and signal wow. Simultaneously discharges surface static electricity.
- Accurate, distortion-free tracking—a result of the HYPERELLIPTICAL stylus tip.
- Reduced record-wall friction, stylus and record wear with the first MASAR™ polished stylus tip on a consumer cartridge.
- Unique SIDE-GUARD stylus protection system prevents accidental stylus damage.
- Highest performance with lowest record wear due to optimizing for 1.0 GRAM TRACKING FORCE.
- Designed with an ULTRA-FLAT FREQUENCY RESPONSE resulting in natural, uncolored sound.
- LEVELING ALIGNMENT STYLUS included to minimize crosstalk and maximize channel separation.
- DUO-POINT ALIGNMENT GAUGE included to minimize lateral tracking error distortion.
- A serialized, individual COMPUTER PRINT-OUT that verifies your cartridge's performance.



SHURE

YOU'LL HEAR MORE FROM US

Shure Brothers Inc., 222 Hartrey Ave., Evanston, IL 60204

CIRCLE 17 ON FREE INFORMATION CARD

EDITORIAL

Cable-TV Interference

You may feel that subscribing to a cable-TV service, will put an end to your TV reception and interference programs. Unfortunately, that is not always true. As it turns out, midband cable-TV channels overlap VHF amateur radio bands and, among other sources, offending interference could be from your neighbor's ham rig. But before you decide to expand your junk box with parts from your neighbor's rig, let's take a closer look at the problem.

The cable-TV company transmits over shielded coaxial cable lines. A "leaky" cable will not only "receive" interference, but will also permit the cable signal to escape and be transmitted as interference. If your cable turns out to be leaky, it's unusually the result of poor installation.

If you should track the source of your cable interference to your neighbor's rig, remember that at the same time you are probably interfering with his amateur transmissions. To control that sticky situation, the FCC has restricted the maximum allowable leakage level from the cable to 20 μ V-per-meter measured at a distance of 10 feet from the cable over a frequency range of 54 MHz to 216 MHz. Unfortunately, the FCC hasn't aggressively tracked down or taken action against offending cable companies. If you find interference in your cable-TV reception, report it to the cable company; they're responsible!

Recently, the FCC has proposed to increase the maximum allowable leakage level from 20 μ V to 100 μ V. In response, the ARRL (American Radio Relay League) has filed a petition against the proposed change. In its petition, the ARRL argues that "the Committee's recommendation constitutes acceptance of poor engineering practices of the cable industry and encourages expansion of an existing problem." We fully agree and support the ARRL in its petition. We hope that the FCC decides against this latest proposal and acts to enforce the existing regulation.



ART KLEIMAN
Editor

Radio- Electronics

Hugo Gernsback (1884-1967) founder
M. Harvey Gernsback, editor-in-chief
Larry Steckler, CET, publisher
Arthur Kleiman, editor
Josef Bernard, K2HUF, technical editor
Carl Laron, WB2SLR, assistant editor
Jack Darr, CET, service editor
Leonard Feldman
contributing hi-fi/video editor
Robert F. Scott, semiconductor editor
Herb Friedman, communications editor
Gary H. Arlen, contributing editor
David Lachenbruch, contributing editor
Earl "Doc" Savage, K4SDS, hobby editor
Ruby M. Yee, production manager
Robert A. W. Lowndes, production
associate
Stefanie A. Mas, production assistant
Joan Roman, circulation director
Arline R. Fishman,
advertising coordinator

Cover photo by Robert Lewis

Radio-Electronics is indexed in *Applied Science & Technology Index* and *Readers Guide to Periodical Literature*.

Gernsback Publications, Inc.
200 Park Ave. S., New York, NY 10003
President: M. Harvey Gernsback
Vice President: Larry Steckler

ADVERTISING SALES 212-777-6400

Larry Steckler
Publisher

EAST

Stanley Levitan
Radio-Electronics
200 Park Ave. South
New York, NY 10003
212-777-6400

MIDWEST/Texas/Arkansas/Okla.

Ralph Bergen
The Ralph Bergen Co., Inc.
540 Frontage Road—Suite 325
Northfield, Illinois 60093
312-446-1444

PACIFIC COAST Mountain States

Marvin Green
Radio-Electronics
413 So. La Brea Ave.
Los Angeles, Ca 90036
213-938-0166-7

SOUTHEAST

Paul McGinnis
Paul McGinnis Company
60 East 42nd Street
New York, N.Y. 10017
212-490-1021



For under \$1095, these troubleshooters from Non-Linear Systems can handle virtually every test situation.

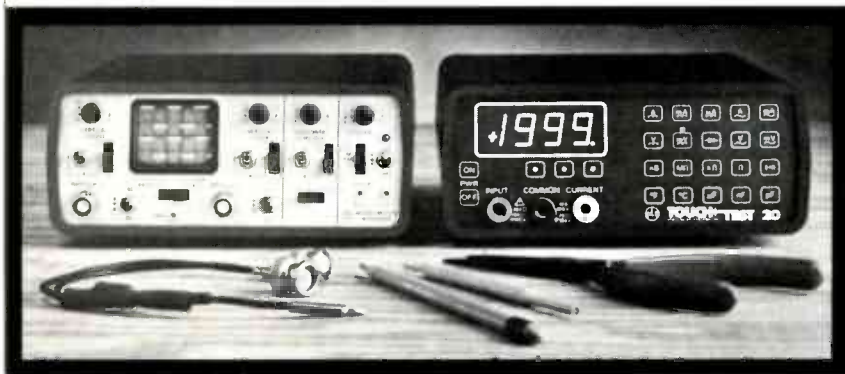

An unbeatable combination. The all-purpose MS-215 miniscope (left), and the remarkable Touch Test 20 DMM (right), which puts 20 key test functions at your fingertips. Now take the lab to the problem. Or the problem to the lab.

Together, the remarkable Touch Test 20 DMM and MS-215 miniscope from Non-Linear Systems give you one portable lab instead of a cumbersome collection of individual testers. They come with a trim price, too. Under \$1095. Whatever your troubleshooting problems, chances are the Touch Test 20 and MS-215 can supply the answer.

Touch Test 20. Small wonder. The Touch Test 20 weighs barely 2 lbs., 4 oz. Yet it puts 20 key test functions at your fingertips. Plus the ability to measure 10 electrical parameters and 44 ranges. Operation's a snap. No dials. Now a light touch chooses the function. Large 0.55 LED numbers show the reading.

Most innovative portable/bench-type DMM available. The Touch Test 20 performs a variety of mainline tests and measures, nimbly and accurately. From AC and DC voltage checks to diode and transistor tests and continuity analysis. And dozens of tests in between.

A shop-proven, field-proven performer, the Touch Test 20

comes with test leads, temp probe and resistor/capacitor test adapter. Features automatic polarity and overload indications plus in-circuit test capabilities.

Touch Test 20 at a glance.

Measurements

AC Voltage	10 μ V to 750 VRMS, 6 ranges
DC Voltage	10 μ V to 1000 VDC, 6 ranges
AC Current	10 μ A to 10 A, 4 ranges
DC Current	0.01 μ A to 10 A, 7 ranges
Resistance	10 milli Ω to 20 meg Ω , 7 ranges
Temperature	-40°C to 150°C, -40°F to 302°F, 2 ranges
Conductance	0.01 nS to 200 nS (equivalent to 5 megohms to 100,000 megohms.) 2 ranges
Capacitance	1 pF to 200 μ F, 6 ranges

Tests

Diode	Diode and transistor junctions in conducting and non-conducting directions.
Continuity	Audible signal.

Size

2.9" H x 6.4" W x 7.5" D (74 mm x 163 mm x 191 mm)

Weight

2 lb. 4 oz. (1.02 kg)

Price

\$495.00 with batteries

\$537.00 without batteries

MS-215. A whale of a miniscope.

With the MS-215, 15-megahertz, battery/line-operated, dual-trace miniscope, versatility and portability come in a 3 lb. package.

MS-215 at a glance.

Vertical Bandwidth	15 MHz
Deflection Factor	10mV/div to 50V/div, 12 calibrated ranges
Input Impedance	1 megohm in parallel with 50 pF
Time Base	0.1 μ Sec/div to 0.5 Sec/div, 21 calibrated ranges
Horizontal Bandwidth	200 kHz
Trigger Modes	Automatic, Internal, External and Line
Power Sources	
Internal	Rechargeable lead acid batteries
External	115 VAC or 230 VAC, 50-60 Hz via plug-in transformer
Size	2.9" H x 6.4" W x 8.0" D (74 mm x 163 mm x 203 mm)
Weight	3 lbs. (1.36 kg)
Price	\$596.00

Works wonders. On-site. In the field. Repairmen use it to troubleshoot DMMs, counters, power supplies and signal generators. Analyze calculators, microprocessors and electronic games. Test C-MOS, OP AMPS, oscillators, shift registers. And it simplifies measurement of propagation delays, phase shift and waveform testing.

Both warranted a full year. If your work demands test equipment that handles virtually all normal applications, at a price you can live with, road test the Touch Test 20 DMM and MS-215 miniscope. Just two of the many exceptional electronic test products we've developed in the past 30 years. From the specialists in the science of staying ahead.



Non-Linear Systems, Inc.

Originator of the digital voltmeter.
Box N, Del Mar, California 92014
Telephone (714) 755-1134 TWX 910-322-1132

If you have put off learning more electronics for any of these reasons, act now!

- I don't have the time.
- High school was hard for me and electronics sounds like it may be hard to learn.
- I can't afford any more education.
- I have a family now.
- I'm here. You're there. I've never learned that way before. I'm not sure it will work for me.

Read the opposite page and see how you can get started today!

Be honest with yourself. Are the reasons really excuses? You already know enough about electronics to be interested in reading this magazine. So why not learn more? If you need encouragement, read on and see how excuses can be turned into results.

You don't have the time. Be realistic. All you have in life is a period of time. Use it. Try to know more tomorrow than you do today. That's the proven way to success. CIE studies require just about 12 hours of your time a week, two hours a day. You probably do have the time.

Electronics sounds like it may be hard to learn. You already know something about electronics or you wouldn't be reading this. Now, build on that. CIE Auto-Programmed® Lessons help you learn. Topics are presented in simple, logical sequence. All text is clear and concise for quick, easy understanding. You learn step by step, at your own pace. No classes to attend. Nobody pressures you. You can learn.

You can't afford any more education. Actually, you can't afford NOT to gain the skills that can put you ahead of the others. You know what inflation is doing to you now. Education—learning a skill—is an inflation-fighter that can be yours. If you are not able to pay full tuition now, CIE will lend you funds on a monthly payment plan.

You have a family now. All the more reason why you have the responsibility to advance yourself. For the sake of your family. Do you want them to have what you had or have more than you had? The choice is yours. Electronics is a rewarding career choice. CIE can help you to get started on that career.

You're there. We're here. How does CIE help you learn? First, we want you to succeed. You may study at home, but you are not alone. When you have a question about a lesson, a postage stamp gets you your answer fast. You may find this even better than having a classroom teacher. CIE understands people need to learn at their own pace. When CIE receives your completed lesson before noon any day of the week, it will be graded and mailed back the same day with appropriate instructional help. Your satisfaction with your progress comes by return mail. That's how CIE helps you learn.

NOW, IF YOU AGREE CIE TRAINING CAN WORK FOR YOU, HOW ELSE CAN CIE HELP YOU?

Cleveland Institute of Electronics is the largest independent home study school in the world that specializes exclusively in electronics. Although "big" does not always mean "best," it is evidence that CIE is a strong, successful institution with the people and resources to help you succeed.

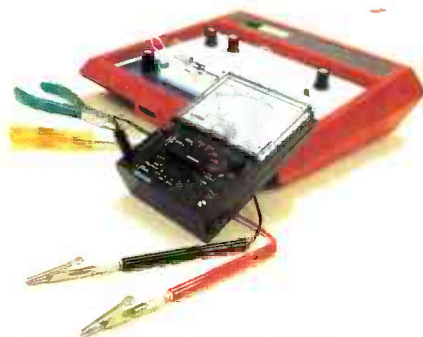

Step-by-step learning includes "hands-on" training.

The kind of professional you want to be needs more than theory. That's why some of our courses include the Personal Training Laboratory, which helps you put lesson theory into actual practice. Other courses train you to use tools of the trade such as a 5MHz triggered-sweep, solid-state oscilloscope you build yourself—and use to practice troubleshooting. Or a Digital Learning Laboratory to let you apply the digital theory that's essential today for anyone who wants to keep pace with electronics in the eighties.



Your FCC License can impress employers.

For some electronics jobs, you must have your FCC License. For others, employers usually consider it a mark in your favor. Either way, your License is government-certified proof of your knowledge and skills. More than half of CIE's courses prepare you to pass this exam. Surveys show that some 80% of CIE graduates who take the exam are successful.

Find out more! Today. Now.

There's a card with this ad. Fill it in and return. If some other ambitious person has already removed it, use the coupon.

You'll get a copy of CIE's free school catalog, along with a complete package of personal home study information.

For your convenience, we'll try to arrange for a CIE representative to contact you to answer any questions you may have.

If you are serious about a rewarding career, about learning electronics or building on your present skills, your best bet is to go with the electronics specialists—CIE. Mail the card or coupon today or write CIE (please mention the name and date of this magazine), 1776 East 17th Street, Cleveland, Ohio 44114.

This could be the best decision you've made all year.

Associate Degree

Now, CIE offers an Associate in Applied Science Degree in Electronics Engineering Technology. In fact, all or most of every CIE Career Course is directly creditable towards the Associate Degree.

"If you're going to learn electronics, you might as well learn it right!"

*John Cunningham
Senior Technical Director*



CIE Cleveland Institute of Electronics, Inc.

1776 East 17th Street, Cleveland, Ohio 44114
Accredited Member National Home Study Council

YES... I want to learn from the specialists in electronics—CIE. Send me my FREE CIE school catalog...including details about the Associate Degree program...plus my FREE package of home study information.

Print Name _____

Address _____ Apt. _____

City _____

State _____ Zip _____

Age _____ Phone (area code) _____

Check box for G.I. Bill bulletin on Educational Benefits: Veteran Active Duty

MAIL TODAY!

RE-36

SATELLITE/TELETEXT NEWS

GARY ARLEN
CONTRIBUTING EDITOR

QUASI-TELETEXT SERVICES

A new hybrid teletext service that offers electronic listings of tonight's TV programs is now being delivered via the vertical blanking-interval of United Video's transponder 3 on Satcom III, the circuit that carries superstation WGN. "Electronic Program Guide"—EPG—carries hour-by-hour listings of shows appearing on cable-TV channels of cable systems that subscribe to the service. The EPG line-up is formatted specifically for each cable system, then beamed down the vertical interval, addressed so that each cable system picks up only the listings for its own programming. That makes it possible for systems to tailor the directories—and the ads—to their local needs since each system carries different pay TV channels and other services.

Another text service is available on the vertical interval of Satcom III Transponder 6, the circuit that carries superstation WTBS. Dow Jones Cable News, a continuous read-out of business and financial news, is the latest addition to the CableText package developed by Satellite Syndicated Systems.

NEW TVRO EQUIPMENT

New home-satellite reception equipment seems to be stabilizing in the price range under \$3,000, according to indications at the latest Consumer Electronics Show where dozens of devices were on display. Sizable new companies are also getting into the business which could lead to more research, industry clout, and innovation.

For example, Boman Industries, a familiar name in the car-stereo market, has plunged into the home-satellite business, offering several packages of equipment that will retail for under \$3,000. Its new 3.3-meter antennas can be put on several new mounts, including a 4-point AZ/EL mount that permits precision settings for azimuth and elevation positions. Boman is offering three receivers, with its top-of-the-line model *SR-1000* including automatic frequency control, pushbutton controls for satellite-search antenna motor drive, plus a maximum noise of 12 dB. (Boman, 9300 Hall Road, Downey, CA 90241.)

Also at CES, the new Downlink 2001 home-satellite system made its debut. The system, being promoted by Interglobal Satellite Systems Inc. (ISSI), includes a motorized antenna, LNA, receiver, and remote control unit—with the package priced at nearly \$5,000. (That is about half the price of other fully motorized systems.) ISSI is located at 30 Park Street, Putnam, CT 06260.

There's also an increasing market for satellite accessories. For example, Arunta Engineering Corp. has introduced its first receiver intended to pick up the increasing number of stereo-sound programs being distributed via satellite. The Arunta *DD-3000* stereo receiver and downconverter carries a \$2995 list price, has a noise figure of about 9-dB maximum, plus several audio metering indicators. (Arunta, PO Box 15082, Phoenix, AZ 85060.)

AROUND THE SATELLITE CIRCUIT

Video News Conferences: A popular new use of satellite teleconferencing is the "video press conference," which permits reporters around the country to take part in coverage of an event even if they are in a distant city. One of the first such applications involved MGM/United Artists and their recent movie "Pennies from Heaven." Stars Steve Martin and Bernadette Peters, plus the film's director and screenwriter, were in New York answering questions from columnists and critics in 14 cities around the country. The feed, which was part of the new teleconferencing service of Hilton Hotels, may be the first of a number of similar satellite-fed press conferences run by movie studios.

RCA Americom has requested FCC permission to launch Satcom VI. The RCA proposal calls for its sixth bird to go up in January 1985; it will cost \$80 million and be the most advanced satellite design, with 24 transponders capable of handling digital audio and video, packet switching, and other services.

Meanwhile the saga of Satcom IV, which was launched successfully in mid-January, continues. The FCC declared that RCA's auction to distribute Satcom IV transponders (R-E, March) was not permissible, thus forcing RCA into another plan to allocate the circuits. In other developments, RCA is planning to put up replacements for aging Satcoms I and II during the next 18 months; the FCC has approved one of those launches.

R-E

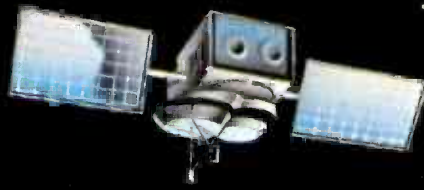

Enter the new age of TV entertainment with the state-of-the-art
Heathkit®
HOME EARTH STATION SYSTEM

The stars are now within your reach — and within the reach of your budget. Priced as low as \$6,995, the Heathkit SRS-8100 Home Earth Station System puts a wide variety of TV entertainment at your fingertips. Geosynchronous satellites offer many channels programming movies, nightclub acts, concerts, musical specials, Broadway plays, news and more* — most free of cuts, censorship and commercial interruptions.



Simulated TV picture

This home earth station system comes with the Heathkit trademark of quality and reliability.

The specially-prepared, do-it-yourself SRA-8100-10 Site Survey Kit helps find the correct location for the satellite receiving antenna. Step-by-step assembly manuals and technical assistance from Heathkit Electronic Centers make our Earth Station System easy to assemble and install. The SRA-8100-2 Integrated Low-Noise Amplifier/Down-Converter, SRA-8100-1 Three-Meter Satellite Receiving Antenna and satellite receiver electronics are made by Scientific-Atlanta, one of the world's foremost manufacturers of satellite telecommunications equipment.

The Heathkit SRA-8100-3 Satellite Receiver Kit features a special Zenith Space Command Remote Control. It features 24-channel electronic tuning, drift-free reception, built-in memory, a built-in security circuit (alarm not included) and an attractively-styled walnut-finish cabinet.

View exciting satellite programs on the new, state-of-the-art Heathkit GR-2500 Color Television. It features maximum picture sharpness with 330 lines of resolution, exceptional 112-channel tuning capability (for cable signals), rich four-speaker sound, remote control, optional Space Phone, easy 15-hour kitbuilding and a great low kit/cabinet system price.

**SEE THE LATEST IN HIGH-TECHNOLOGY,
 EASY-TO-BUILD KIT-FORM ELECTRONICS**

— It's all in our new, 104-page Heathkit Catalog.

For your FREE Catalog, write:
 Heath Company, Dept. 020-896, Benton Harbor, MI 49022
 -or pick up your copy at any of the conveniently-located
 Heathkit Electronic Centers throughout the U.S.



*Federal Communications Commission equipment authorization relating to the sale of the Heathkit Earth Station requires the following disclosure: "Use of this device may violate Section 605 of the Communications Act of 1934, as amended, through the unauthorized interception and divulgence of radio communications for one's own benefit where there is no entitlement to its receipt."

Viewing of some satellite TV channels may require the customer to obtain permission from, or make payments to, the programming company. Some programmers may not grant permission. Some local, state and foreign laws may now or in the future limit the use of this device. The customer is responsible for compliance with all applicable laws and regulations.

Heath and Heathkit are registered trademarks of Heath Company. Zenith is a registered trademark of Zenith Radio Corporation. Heath Company and Veritechnology Electronics Corporation are wholly-owned subsidiaries of Zenith Radio Corporation. Heathkit Electronic Centers are operated by Veritechnology Electronics Corporation.

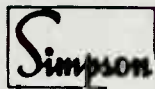

TRIPLETT

KEITHLEY

LEADER



Non-Linear Systems

FLUKE DIGITAL MULTIMETERS

- Six functions • 3½-digit resolution
- dc voltage
- ac voltage
- dc current
- ac current
- resistance
- diode test
- 0.25% basic dc accuracy
- LCD display
- Overload protection

Model 8022B:
The Troubleshooter

\$139



Model 8020B:
The Analyst

\$189

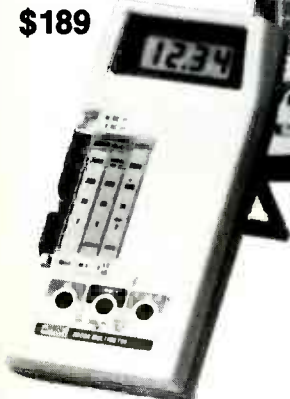

Model 8024B:
The Investigator

\$239

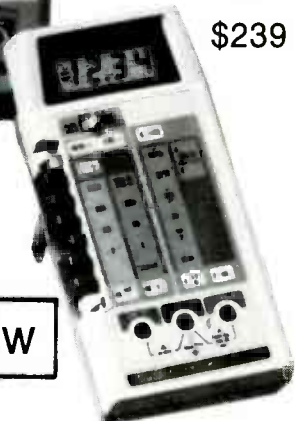

NEW

• Seven functions

- dc voltage
- ac voltage
- dc current
- ac current
- resistance
- diode test
- conductance (1/R)
- 3½-digit resolution
- 0.1% basic dc accuracy
- LCD display
- Overload protection
- Two year parts and labor warranty

• Nine functions

- dc voltage
- ac voltage
- dc current
- ac current
- resistance
- diode test
- conductance (1/R)
- logic level and continuity detect
- temperature (K-type thermocouple)
- Peak hold on voltage and current functions
- Selectable audible indicator for continuity or level detection
- 3½-digit resolution
- 0.1% basic dc accuracy
- LCD display
- Overload protection

THESE 1981 B&K OSCILLOSCOPES ARE IN STOCK AND AVAILABLE FOR IMMEDIATE DELIVERY



- 1479A Dual-Trace 30 MHz
- 1477 Dual-Trace 15 MHz
- 1432 Dual-Trace 15 MHz Portable
- 1476 Dual-Trace 10 MHz
- 1466 Single-Trace 10 MHz
- 1405 Single-Trace 5 MHz
- 1420 Dual-Trace 15 MHz Portable

CALL FOR OUR EARLY BIRD SPECIAL LOW PRICE

New Low Distortion Function Generator



- MODEL 3010
- Generates sine, square and triangle waveforms
 - Variable amplitude and fixed TTL square-wave outputs
 - 0.1 Hz to 1MHz in six ranges
 - Push button range and function selection
 - Typical sine wave distortion under 0.5% from 0.1Hz to 100kHz
 - Variable DC offset for engineering applications
 - VCO external input for sweep-frequency tests

Call For Our Price

DATA PRECISION Model 938 0.1%, 3½-Digit, LCD DIGITAL CAPACITANCE METER



\$219

- WIDE RANGING — from 199.9 pF full scale (0.1 pF resolution) up to 1999 µF full scale, in eight ranges, virtually every capacitance you'll ever need to measure.
- FAST AND EASY TO USE — Direct reading, pushbutton ranges. Just plug in and read.
- EXCEPTIONALLY ACCURATE — provides ±0.1% basic accuracy.
- TOUGH AND COMPACT — Built to take rough usage without loss of calibration accuracy. Fits and goes anywhere, takes very little bench space, always handy for quick capacitance checkout, matching, calibration, and tracking.
- PORTABLE — Palm-sized, light-weight, operates up to approximately 200 hours on a single 9V alkaline battery
- EASY READING — big, clear, high-contrast 3½-digit LCD display, a full 0.5" high, readable anywhere.
- VALUE PACKED — Outstanding measurement capability and dependability. Outperforms DC time-constant meters, and even bridges costing 2 to 5 times as much.
- RELIABLE — warranted for 2 full years.

80MHz Counter with Period Function



- MODEL 1820
- 5Hz to 80MHz reading guaranteed—100MHz typical
 - Period measurements from 5Hz to 1MHz.
 - Period average, auto and manual positions
 - One PPM resolution
 - Totalizes to 999999 plus overflow
 - Elapsed time measurements from 0.1 to 9999.99 seconds plus overflow
 - One-megohm input resistance
 - Bright 43' high LED readouts

Call For Our Price

We carry a full line of multimeters, oscilloscopes, frequency counters, audio and RF generators, power supplies and accessories. Just call our Toll-Free number and one of our experts will answer all your questions about test equipment.

BK PRECISION**HITACHI****FLUKE****VIZ****HICKOK****DATA PRECISION****DORIC**

WESTON

The Roadrunner Model 6100

- 5 Range audible signaling function
- 0.5" LCD display
- 6 Functions
- 29 Ranges

SPECIAL

KEITHLEY MODEL 130 DIGITAL MULTIMETER

	RANGE	ACCURACY
DC VOLTAGE	200mV, 2V, 20V, 200V, 1000V	.5%
AC VOLTAGE	200mV, 2V, 20V, 200V, 750V	1%
DC CURRENT	2mA, 20mA, 200mA, 2000mA, 10A	2%
AC CURRENT	2mA, 20mA, 200mA, 2000mA, 10A	3%
RESISTANCE	200Ω, 2kΩ, 20kΩ, 200kΩ, 20MΩ	.5%

\$125.**HITACHI****SAVE UP TO \$500**

- V-151B 15 MHz Single Trace
- V-152B 15 MHz Dual Trace
- V-202 20 MHz Dual Trace
- V-301 30 MHz Single Trace
- V-302B 30 MHz Dual Trace
- V-352 35 MHz Dual Trace
- V-550B 50 MHz Dual Trace, Dual Time Base
- V-1050 100 MHz Dual Trace, Dual Time Base



Call For
Special
REBATE OFFER

PORTABLE OSCILLOSCOPES

BATTERY OPERATED



Non-Linear Systems

Call For Our Prices

MS-15

Single Trace 15MHz

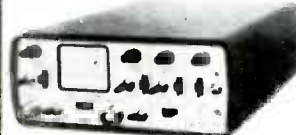
MS-215

Dual Trace 15 MHz

MS-230

Dual Trace 30MHz

KEITHLEY

Model 169 BENCH/PORTABLE DMM

- 3½ Digit liquid crystal display
- 0.25% basic accuracy
- 26 Ranges

\$189.00

New Sweep/Function Generator

BK PRECISION**MODEL 3020**

- Four instruments in one package—sweep generator, function generator, pulse generator, tone-burst generator.
- Covers 0.02Hz-2MHz
- 1000:1 tuning range
- Low-distortion high-accuracy outputs

Call For Our Price

- Three-step attenuator plus vernier control
- Internal linear and log sweeps
- Tone-burst output is front-panel or externally programmable



TOLL FREE HOT LINE
800-223-0474

THE TEST EQUIPMENT SPECIALISTS

54 WEST 45th STREET, NEW YORK, N.Y. 10036 212-687-2224

ADVANCE ELECTRONICS

LETTERS

Address your comments to: Letters, **Radio-Electronics**,
200 Park Avenue South, New York, NY 10003

LOOKING FORWARD

While looking through the February 1982 issue of **Radio-Electronics**, I found the "Computer Corner" department to have a very positive view of computer technology today.

Other people refer to the advances in computer science as a threat to workers. I thought that the advantages mentioned in that department show just how much we need those machines. I do not think that they could harm us very much, based on our economy.

Soon, I believe, people will be ready to accept computers as a part of their lives.
K. LYNN BELL,
Edwards, MS

THE SINCLAIR ZX81

Recently, I purchased and assembled a Sinclair ZX81 computer, but it wouldn't

work when I had finished, and I had followed the instructions religiously, with certain exceptions. I am not a novice at soldering, or at reading diagrams, and accordingly must lay the blame on the kit designer—or the packer. Since what happened to me could happen to anyone else, I am writing this with the hope that you will make this information available to your subscribers.

I ordered the kit and received it within the 30-60 days purchasers were asked to allow. On reading the instructions, I saw references to variations in wiring for the UK, USA, and France, with the statement "not used, USA only" applying to the RF modulator. Apparently the instruction sheet was one for use in France and the UK. Nevertheless, I proceeded to the assembly.

The PC board differed from the diagram of parts locations, and that should have cautioned me immediately to be

careful, but I proceeded and installed all components successfully, with the exceptions of those that were marked "not used, USA only" because they had not been supplied, nor were their values mentioned anywhere. As a result, one wire of the modulator was left adrift. Extra parts had been furnished, but there were no instructions concerning them.

I thought that a telephone call to Nashua, which is not far from me here, would clear things up in a jiffy. But when I asked the operator for the number of Sinclair Research, Ltd at their address there, she told me, without hesitation, that many people have asked for their number, but they do not have a telephone.

My point in writing to you is to inform any future buyers to examine their instruction sheets; and if they find that certain parts are listed as "not used, USA only"—specifically R32, R33, and D9—

continued on page 32

An enclosure as good as your idea.

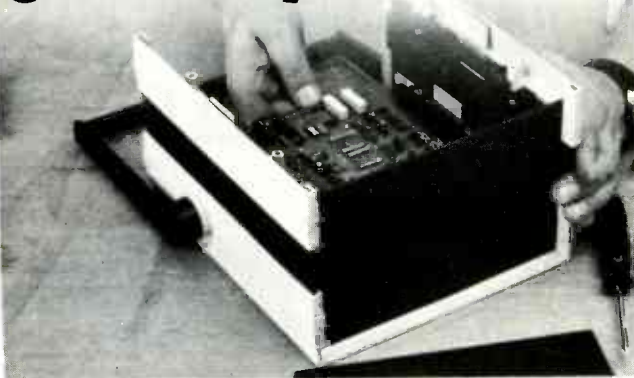

You've turned a good idea into a piece of equipment—now you need a good enclosure. Here's how PacTec can help you with our versatile enclosures:

- Attractive yet inexpensive.
- Durable ABS construction.
- Many sizes, colors, accessories.
- Built in bosses and slots speed component mounting.
- Available off-the-shelf from single unit to production quantities. **See them at your PacTec Distributor.** And ask him for your free catalog.

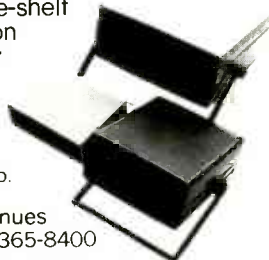

PACITEC™ Corp.
subsidiary of La France Corp.
Enterprise and Executive Avenues
Philadelphia, PA 19153 (215) 365-8400

CIRCLE 43 ON FREE INFORMATION CARD

Aaron-Gavin Kits

STEREO GRAPHIC EQUALIZERS

31 Band EQ KIT \$328.
21 Band EQ 235.



11 Band EQ 119.



LED METER



FEATURES
PRODUCTION RANGE
MULTI-SCALE
30dB

Special Multi-Purpose MIXER



All components are...
Dual components...
Dip switches...

EQUALIZERS PRICED FROM \$119. to \$690.

LED METERS PRICES FROM \$48. to \$219.



11 Band High-Low Mixer Equalizer

PROFESSIONAL QUALITY
THAT YOU CAN
BUILD YOURSELF.

A Unique MIXER for DJ's—Studio's—Broadcaster's

- Two MIC Inputs
- Two AUX channels
- 3 Turntable Inputs
- Tapeover Switch
- Crossfade
- Beat Match
- Subsonic Filters
- Even Band Stereo EQUALIZER
- Headphones
- Dual LED Meter

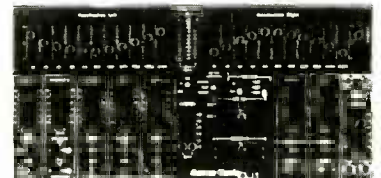

Call or write for full product information, specifications and pricing to: Aaron-Gavin,
123 South McClay Street, Unit F, Santa Ana, CA 92701, (714) 957-8710.



Introducing a direct line to a 60 MHz Tektronix scope built for your bench!

From the world's most respected name in oscilloscopes: a new scope, plus a new direct order number, that finally makes it practical to put Tektronix quality on your bench... at work or home.

Among professional engineers and technicians there is no substitute for the performance and reliability of Tektronix oscilloscopes.

Now, for the first time, Tektronix is offering an advanced scope at an unprecedented low price—and has a direct order line that lets you get your order processed today!

The scope: the 2213. Its radical new design brings you Tektronix quality for well below what you would pay for

lesser-name scopes.

The 2213's practical design includes 65% fewer mechanical parts, fewer circuit boards, electrical connectors and cabling. Result: a lower price for you plus far greater reliability.

Yet performance is pure Tektronix: there's 60 MHz bandwidth for digital and high-speed analog circuits. The sensitivity for low signal measurements. The sweep speeds for fast logic families. A complete trigger system for digital, analog or video waveforms. And new high-performance Tektronix probes are included!

2213 PERFORMANCE DATA

Bandwidth: Two channels, dc—60 MHz from 10 V/div to 20 mV/div. (50 MHz from

2 mV/div to 10 mV/div).

Sweep speeds: Sweeps from 0.5 s to 50 ns (to 5 ns/div with X10 mag).

Sensitivity: Scale factors from 100 V/div (10X probe) to 2 mV/div (1X probe). Accurate to $\pm 3\%$. Ac or dc coupling.

Delayed sweep measurements: Standard sweep, intensified after delay, and delayed.

(Need dual time-base performance and timing accuracy to $\pm 1.5\%$? Ask about our 2215 priced at \$1400.)

Complete trigger system: Modes include TV field, normal, vertical mode, and automatic; internal, external, and line sources; variable holdoff.

Probes: High perform-

ance, positive attachment, 10-14 pF and 60 MHz at the probe tip.

The price: Just \$1100 complete*. Order direct from Tektronix National Marketing Center. Phones are staffed by technical people to answer your questions about the 2213. Your direct order includes a 15-day return policy and full Tektronix warranty.

Now it's easier than ever to get your hands on a Tek scope!

**ORDER TOLL-FREE
800-547-1845**

Ask for Department A01

(In Oregon, Alaska and Hawaii: 1-503-627-5402 collect.) Lines are open from 8 am EST to 5 pm PST.

*Price F.O.B., Beaverton, OR.

Replace Your Conventional Scope With The Sencore SC61. The First Scope With Pushbutton, Automatic Readout.

\$3275

GSA # GS002S27505

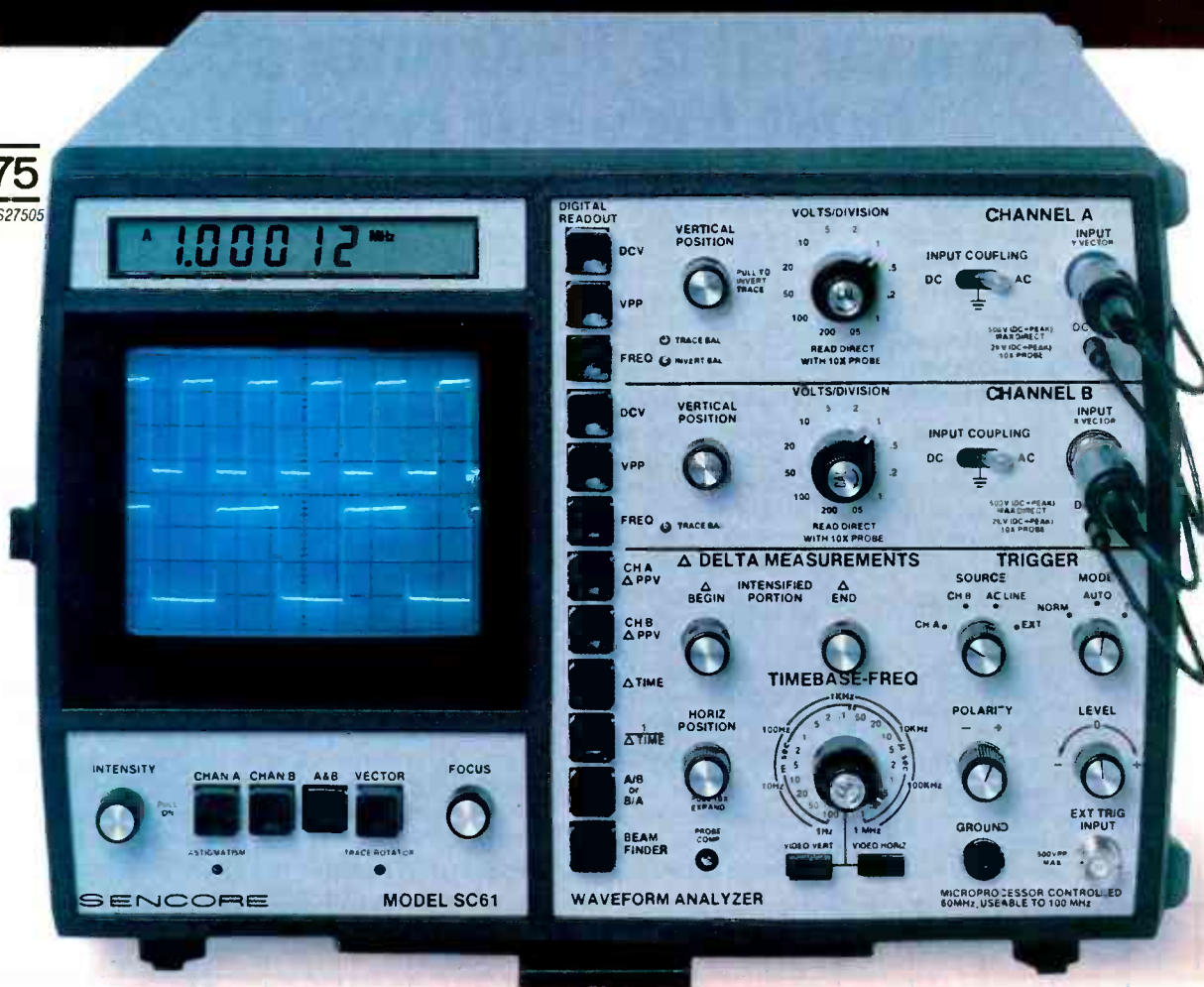

Sencore SC61 60 MHz Waveform Analyzer.

Cut Your Scope Time In Half Or Your Money Back.

Cut your scope time in half? We know that's a bold claim. But once you've tried the SC61 we know you'll agree it's a conservative claim. Why? Because the speed, accuracy, and ease of operation of the SC61 makes every conventional oscilloscope as outdated and cumbersome as the analog meter. Now all you do is just push a button and read.

The First Scope With Automatic Readout At last the oscilloscope has gone digital. No more graticule counting, calculating, or estimating your measurements. You can now make waveform measurements digitally accurate, digitally fast, at the push of a button.

Make All Measurements With One Probe Make no mistake. The SC61 is not a "piggyback" unit, but a completely integrated waveform monitoring system. You connect only one probe and the Autotracking™ display digitally tracks the waveform on the screen. You just push a button when you want to read DC volts, P-P volts, or frequency.

An Exclusive Breakthrough It took four patent pending circuits to completely integrate the scope and digital display. The end result is a breakthrough in scope technology that virtually obsoletes conventional scopes. Here's why.

It's 10 Times Faster The SC61 is 10 to 100 times faster than any conventional scope. How? Because all you do is push a button instead of counting graticules, calculating, or switching probes. Increased speed means increased productivity.

It's 10 Times More Accurate No matter how carefully you try to measure a waveform with a conventional scope, you will only be 5% to 15% accurate due to parallax and interpretation errors. Today's circuits demand greater accuracy than that. The SC61's digital readout is 10 to 1000

times more accurate to meet these testing needs.

It's Easier To Use The digital readout is simplicity itself. Just push and read. You'll make fewer errors because every measurement now becomes exact. Now you can concentrate on the circuit rather than the scope.

Measure Part Of A Waveform Intensify any waveform portion with the exclusive "Delta Bar," push the button, and read PPV, time, or frequency for just that portion of the waveform. Ideal for measuring timed circuits, signal delays, pulse widths, and more.

Guaranteed To Cut Your Scope Time In Half When we say the SC61 will cut your scope time in half, we're being conservative. It's possible to reduce your scope time 75%, even 90% with this first-of-its-kind oscilloscope. But don't take

our word for it. Try an SC61 and judge for yourself. Here's our offer.

30 DAY MONEY BACK GUARANTEE

If the SC61 does not at least double your scope productivity during the first 30 days, you may return it for a full refund, including freight both ways.

Update Today Just like DVM's have replaced analog meters, the SC61 will replace conventional scopes (under 100MHz) and for the same reasons: increased speed, accuracy, and reliability. Update today with this new automated scope technology. It's the scope you've been waiting for.

To Order Or To Receive
A Complete Color Brochure,
Phone Toll-Free Today.

800-843-3338

Qualified Sales Engineers are ready to talk with you about SC61 performance and applications. Ask for Dept. 130.

SENCORE

3200 Sencore Drive, Sioux Falls, SD 57107 605/339-0100 TWX: 910-660-0300

Alaska, Hawaii, and Canada call collect at 605/339-0100

LETTERS

continued from page 26

they will have little success in getting the computer to work, and they might as well send the whole package back.

JOHN K. MITCHELL,
Westwood, MA

The following is a reply to Mr. Mitchell's letter from Sinclair.

Dear Mr. Mitchell:

We regret any confusion that you may have been caused by the assembly instructions for our model ZX81 personal computer kit. However, we can assure

you that the kit that you received will operate in the United States if properly assembled. If you will return it to us, we will be pleased to repair it free of charge.

NIGEL H. SEARLE,
Sinclair

THE PROFEEL

I enjoyed your articles on video entertainment, but I think that you have misinterpreted Sony's specs on the Profeel. According to Bell Laboratories, 340-350 lines of resolution is not that great—175/52.4 μ sec \Rightarrow 3.3 MHz. Actually, that spec is for horizontal lines, not resolution; horizontal lines make up vertical resolution, and 340-350 is a typical picture.

C.C. WHITNEY,
Miami, FL

The article that you are referring to is entitled "The Home Entertainment Center" that appeared in the January 1982 issue. The 8-MHz bandwidth specification, as pointed out in the article, was based on the assumption that since the Profeel monitor is capable of displaying 80 characters-per-line as opposed to the 40 character-per-line capability of the standard TV set, the bandwidth capability of the Profeel monitor is twice that of a standard TV receiver—or 8 MHz. The 8-MHz bandwidth specification was confirmed in a conversation with a Sony engineer involved in the Profeel project.

ART KLEIMAN
Editor

OOOOOOPS!

There are several errors in the schematic (Fig. 1) that appeared with my article "Telephone In-Use Monitor" in the March 1982 issue of **Radio-Electronics**.

First, the values of resistors R1 and R3 should be 2.2 megohms, not kilohms (the values are correct in the parts list). Second, capacitor C1 should have its positive end connected to pin 2 of IC1 and its other end to the line joining pin 1 of the IC and the cathode of LED1. The way it is shown, the LED will not light.

Thank you for allowing me to bring those facts to the attention of your readers.

CHRISTOPHER M. DUNN

An error crept into the theory-of-operation section of the "chug-chug" toy described in our article entitled "4 Toys for the Holiday Season" in the December 1981 **Radio-Electronics**.

It should have stated that "...the op-amp noise current (bias noise-current), if any, would not be converted to a voltage due to the low impedances chosen to eliminate hum pickup. Thus, FET-input op-amp types *must* be used, because they exhibit voltage noise, whereas bipolar-transistor input op-amps exhibit more current than voltage noise...MOSFET op-amps have the highest input noise-voltages (higher than JFET's), but almost no input bias-current—hence, almost no input fluctuation current or 'current noise.'"

Thank you for printing this correction.

DAN & DIANE TALBOT

POOR PICTURES

I happen to be one of those unfortunate Americans who live next to the local power company's high-tension, distribution power-lines. After enjoying another evening of good old American AM-modulated television pictures, including car ignitions, arcing insulators, overhead aircraft, and the like, I have to ask an important question: *Why?*

Why in this day of fast-moving electronics technology are we still strapped to noisy, degraded TV pictures?

The satellite industry has already proven FM television far superior to AM, and I for one would like to see it a reality. With all of the new low-power UHF-AM stations to start springing up all over the country, it seems that, as times goes on,

continued on page 36

Vector
introduces ~
New & More Versatile
Slit-N-Wrap® Tools
for Wire-
wrapping.

Count Wire Wraps Electronically
Get 3 to 9 Wraps

Eliminate Hand-Held Wire End
at Wrap Start with New Wire Grip Housing!

300 Foot Wire Spool
with Tension Regulator to Reduce Wire Breakage
Six Wire Colors available

Advantages:
Faster and Easier Wrapping
No Stripping
No Precutting
No Premeasuring
No Loading
Daisy Chain Wraps
Quick Change Bits
Reliable Wraps Meet MIL-STD 1130A, par. 5.6

Battery & Manual Models Available

P184-7
\$198.00
110V A.C.
60Hz

U.S. & Foreign Patents

Vector Electronic Company
INCORPORATED

12460 Gladstone Ave., P.O. Box 4336, Sylmar, CA 91342-0336, phone (213) 365-9661
Price Subject to Change Without Notice. 828108
See us at Electro Booth No. 1510

CIRCLE 42 ON FREE INFORMATION CARD

VIDEO 100

12" Black and White Monitor

- Economical favorite for personal computing
- Light-weight cabinet with built-in handle.
- 12 MHz band width
- Plug-in compatible with most personal computers
- 90° deflection for clear, sharp characters
- 80 x 24 character display

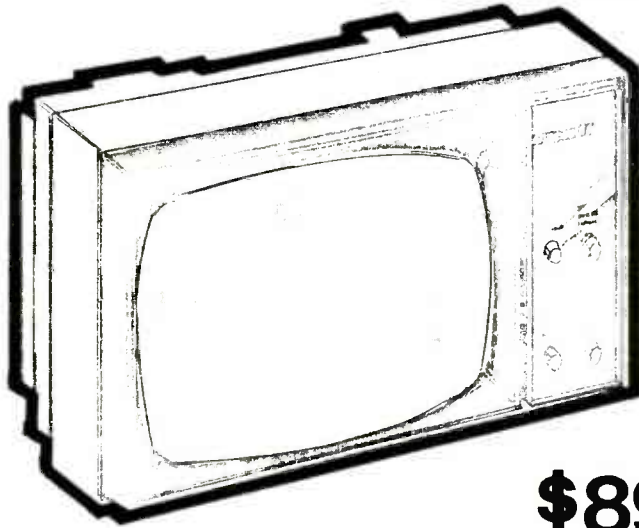

\$8950

ITEM	SPECIFICATIONS
CRT.....	12" diag. 90° defl.
CRT Phosphor.....	P-4
Signal.....	Composite video input
Input Signal.....	1.0Vp-p, sync negative
Input Impedance.....	75 ohms
Scan Frequencies.....	Horizontal: 15600Hz Vertical: 50/60Hz
Display Size.....	210 (W) x 158 (H) mm
Deflection Linerity.....	Horizontal: 10% Max. (refer to EIA ball Chart and dot Pattern.) Vertical 8%
Video Response.....	12MHz (± 6dB)
Resolution.....	Center: 650 Corners: 550

Power Source..... 120V Ac, 50/60 Hz
 Dimensions..... 11.375" (H) x 16.25" (W) x 11.25 (D)
 Weight..... 6.5Kg (14.3 Lbs.) net

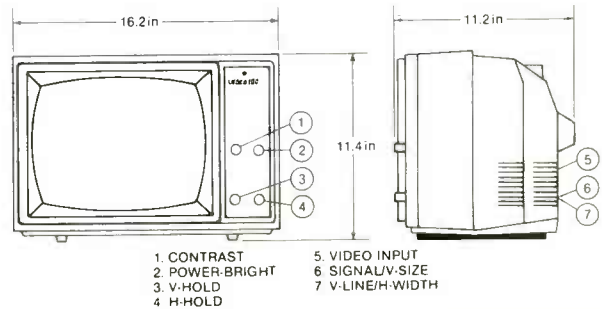

DISKETTES
 5 1/4" BULK "OEM" PACK
 FOR YOUR
 APPLE
 Box of 100
\$149

**16K APPLE II EXPANSION
 CARD \$79⁹⁵**

**MICROWAVE RECEIVER
 SYSTEM**

**1.8GHZ to 2.4 GHZ
 BROAD BAND**  **only \$295.00**

**80 COLUMN APPLE II
 CARD \$249⁹⁵**

**TRACTOR
 FEED**

**120 COLUMN FOR THE
 DIABLO PRINTERS BI-
 DIRECTIONAL BUILT
 BY RUTISHAUSER**

\$149^{new}

**With built-in-converter to channel
 2, 3, or 4 of any standard TV set.**

RANGE: Line of sight to 250 miles.

SCOPE: Will receive within the frequency band from satellites, primary microwave stations, and repeater microwave booster stations.

CONTENTS: Packaged in 19"x19"x4 1/2" corrugated carton complete with:

- 24" Dish
- Feed-Horn Receiver
- Mounting Bracket
- Mounting Clamp
- Instructions
- 300 Ohm to 75 Ohm Adapter
- 750 Ohm to 300 Ohm Adapter
- 60 Feet Coax Cable with Connectors
- 3 Feet Coax Cable with Connectors

MUFFIN FAN
 120 VOLTS
\$995



"HAVE YOU KISSED
 YOUR COMPUTER LATELY?"

Components Express, Inc.

1380 E. Edinger, Santa Ana, CA 92705 (714) 558-3972

WE WILL BEAT ANY

This offer applies only to items in this ad. Ad showing advertised price must accompany your order.

BK PRECISION
CRT Restorer Analyzer
 With High Speed Multiplex Technique
Model 467
 • Restores color and B/W picture tubes like new! Uses the most powerful restoration method known with minimal danger to the CRT. • Exclusive multiplex test technique



Portable Digital Capacitance Meter
Model 820
 • Measures capacitance from 0.1 pF to 1 Farad. • Resolves to 0.1 pF. • 10 ranges for accuracy and resolution. • 4 digit easy to read LED display. • 0.5% accuracy. • Special lead insertion jacks or banana

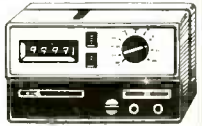

Sweep/Function Generators
Model 3015
 • Frequency: 2 Hz to 200 kHz, in 3 ranges. • Outputs: Sine, square or triangle. • Variable Amplitude: 15 V p-p, open circuit, 7.5 V p-p into 600 ohms. • Pulse Output: Fixed amplitude TTL level, logic high greater than 3 volts. • Accuracy: ±5% F.S., to 20 kHz.

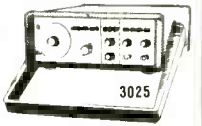

Model 3025
 • Frequency: 0.005 Hz to 5 mHz in 7 ranges. • Outputs: Sine, square, triangle or haversine. • Variable Amplitude: 20 V p-p, open circuit, 10 V p-p, into 50 ohms. • Accuracy: ±5% F.S.

Model 3030
 • Frequency: 0.001 Hz to 5 mHz in 8 ranges. • Outputs: Sine, square, triangle, pos/neg square, pos/neg ramp. • Variable Amplitude: 20 V p-p, open circuit, 10 V p-p, into 50 ohms. • Accuracy: ±(1.5% setting + 1% F.S.), 0.001 Hz to 1 mHz; ±(2% setting + 2% F.S.), 1 mHz to 5 mHz.

Four Instruments in One
Model 3020
 Four instruments in one package—sweep generator, function generator, pulse generator, tone-burst generator • Covers .02 Hz to 2 MHz • 1000:1 tuning range • Low-distortion high-accuracy outputs • Three-step attenuator plus vernier control • Internal linear and log sweeps

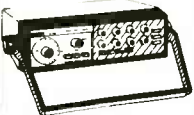

Low Distortion Function Generator
Model 3010
 • Generates sine, square and triangle waveforms • Variable amplitude and fixed TTL square-wave outputs • 0.1 Hz to 1 MHz in six ranges • Typical sine wave distortion under 0.5% from 0.1 Hz to 100 kHz.

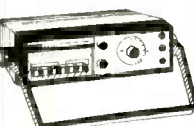

Dual-Trace 30 MHz Delayed Sweep Scope
Model 1530
 • Delayed sweep operation for sweep expansion up to 1000x. • 30 MHz response, usable to 50 MHz. • 5 mV/division sensitivity, selectable 2 mV to 20 mHz. • Variable hold-off for pulse train display. • Single-sweep for nonrepetitive waveforms. • Built-in triggering filters.

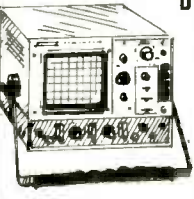

BECKMAN
TECH 350
 Bright, 0.5% LCD display. Single easy-to-use switch. Separate diode test function. Low power resistance range. 22 megohms input resistance. 12,000 hour battery life.



BECKMAN
3 1/2 Digit Multimeters
TECH 310
 Has 7 functions and 29 ranges, plus 0.25% VDC accuracy.

TECH 330
 Has 7 functions and 29 ranges, plus 0.1% VDC accuracy and true RMS capability (AC + DC).

TECH 300
 Has 0.5% VDC accuracy and all the features of TECH 310, except the continuity test function and 10-amp current ranges.

TECH 360
 Input jack for a standard K-type thermocoupling, enabling user to measure temp from -20°C to +1265°C. Switch selectable measurement of true RMS (AC + DC) or AC only voltages and currents.

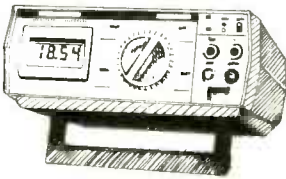

FLUKE
Multimeter
 • Free 10 amp current shunt. • General purpose True RMS multimeters with identical features except for power sources.

Model 810
 Operates on line voltage

Model 811
 Operates on line voltage and with rechargeable Ni-Cad batteries.

Model D810



Hand Held DMM with free case
Model D800
 Fluke's lowest priced DMM. An all purpose instrument for basic measurement needs. Five ranges for AC and DC voltage measurements. Four ranges for AC and DC current tests. Six resistance ranges.



Model D802
 Same as Model D800 but has a basic DC accuracy of 0.1% and Fluke conductance function for accurate high resistance measurement.

Model D804
 The most powerful in the series. All features of Model D802 plus capability to check continuity and logic levels, measure temp with K-type thermocouples and capture peak readings of transients.

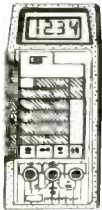
Simpson
Meter
Model 260-7
 • 28 time-proven ranges. • Direct dial reading of Amp-Clamp ranges. • Only 2 batteries... one 9-volt and one 1.5 volt "D" cell
 • 260-7 complete with batteries, test leads and manual.
 • 260-7M with mirror scale
 • 260-7MT in roll case
 • 260-7MRT with mirror scale, in roll top case
 Available with reset pushbutton releases when overload exists.



3 1/2 Digital Multimeter
Model 467
 • LCD analog bargraph to indicate nulls, peaks and trends. • Differential peak hold captures maximum (peak) and minimum values of complex waveforms. • 50 u/sec pulse detection. • True RMS measuring capability.



MLS
Touch/Test 20 Multimeter
 • Touch selection and control of functions, ranges and power. • Large (0.55" high) LED readout. • Automatic polarity and overload indication. • In-circuit test capabilities.

Model TT-20
Model TT-20B With batteries and charger
Model TT-21 With LCD readout
Model TT-21B With LCD readout, batteries and charger

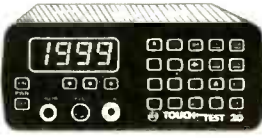

Portable Triggered Miniscopes
Model MS-15 15 MHz
Model MS-215 15 MHz, Dual Trace
Model MS-230 30 MHz, Dual Trace

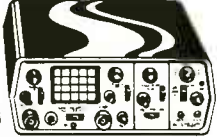

FORDHAM
 855 Conklin St., Farmingdale, N.Y. 11735

Master Charge Money Order
 VISA COD Check
 N.Y. State residents add appropriate sales tax.
 \$25.00 minimum order
 COD's extra (requires 25% deposit)

ADD FOR SHIPPING AND INSURANCE
 to \$250.00 \$ 4.50
 \$251.00 to 500.00 6.00
 501.00 to 750.00 8.50
 751.00 to 1000.00 12.00
 over 1000.00 12.50

VISA master charge

ADVERTISED PRICE

GLOBAL SPECIALTIES CORP

**3 1/2 Digit
0.1% Digital
Capacitance Meter**



Model 3001

Universal Counter-Timer



Model 5001

For the electronic measurement and display of frequency, period, interval and counted events. Unique full input signal conditioning.

Frequency Counter



Model 6001

• 5 Hertz to 650 MHz • 10 MHz crystal oven timebase input • Selectable 0.1, 1.0, 10 sec gate • Switchable low pass 50 KHz filter • True TTL compatibility at input

KEITHLEY

Hand-Held Beeper Digital Multimeter

Model 128

• LCD display • 0.5% basic accuracy • 3 1/2 digit resolution • "Beeper" operates on all ranges and functions.

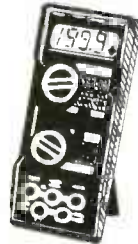

Hand-Held Digital Multimeter

Model 130

• 0.5% basic accuracy • 3 1/2 LCD display.

4 1/2 Digit Multimeter

Model 135

• 0.5% basic accuracy • 4 1/2 digit resolution provides wide dynamic range • LCD display

HITACHI
Hitachi Denki, Ltd.

Dual Trace Oscilloscopes

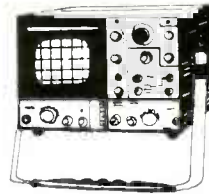

Economically priced, general-purpose oscilloscopes. Square, 5 1/2" CRT with internal graticule (illuminated scale). High accuracy voltage axis and time axis set at ±3% (certified at 10°C and 35°C). High-sensitivity design; vertical sensitivity of 1 mV/div available. 8-div. dynamic range ensures accurate measurement of waveforms without distortion. TV sync-separator circuit.

20 MHz
Model V-202

35 MHz
Model V-352

100 MHz
Model V-1050

LEADER

**10 MHz at 1 mV
5" Scopes**

Model LBO-513

Single Trace with probe

Model LBO-514

Dual Trace with probes

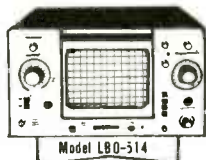

20 MHz Oscilloscopes

• Add and subtract modes (with CH-2 invert), permits differential measurements (Model LBO-508A only). • Front panel X-Y operation ideal for phase-shift analysis, sweep alignment and vectorscope service (Model LBO-508A only). • 17.5 nanosecond rise time for easy viewing of high speed pulses and wave forms.

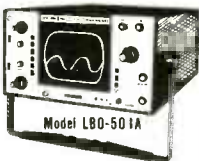

Model LBO-507A

Single Trace with probe

Model LBO-508A

Dual Trace with probes

LUXO

Magnifier Lamp

Model LFM-1A

Offers large viewing area for fine details, component assembly and other close work. Has unique double tension control. In grey, black, white and tan. Three diopter, 13" focus standard on all models. (45" reach).



Magna-Lux Lamp

Model LUX-2A

Magnifier utility lamp. The 3 3/4" diameter lens supplemented by a 40-watt standard appearance black A-15 incandescent bulb. Sold in black only, has an arm reach of 39" and includes a factory installed 3-diopter lens. Same magnification as LFM-1A.



Weller

Non-Burnable
Silicone Cord

Controlled Output Soldering Station

Model WTCP-N

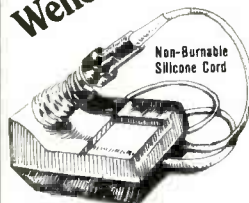

Portable Desoldering Stations

Model DS-600

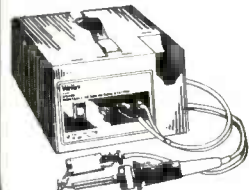

Weller Xcelite

Attache Style Tool Cases

Model TC-150/ST

Contains 23 individual tools, 24 Series 99 interchangeable screwdriver/nutdriver blades and handles, 2 measuring tapes, soldering iron, recharger, solder.



Model TC-100/ST

53 individual screwdrivers, nutdrivers, pliers and wrenches, 31 Series 99 interchangeable screwdriver/nutdriver blades and handles, and two screwdriver/nutdriver sets.



Model TC-200/ST

Smaller version of the TC-100 case. 27 interchangeable Series 99 screwdrivers and nutdrivers, for use with the straight or tee handle, plus 10 assorted snips, pliers, wire cutters and wrenches.

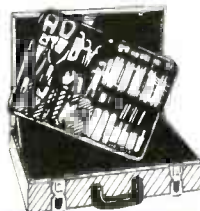

Service Master Tool Kit

Model 99-SM
24-piece kit

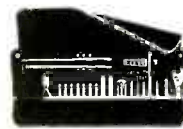

VIZ

DC Power Supply
Model WP-708

It's a dual DC Voltmeter
It's a triple DC Power Supply

• Three separate completely isolated DC power supplies: two 0-20V @ 0-2A, one fixed 5V @ 4A • Excellent line and load regulation • Fully adj. current limiting on the two variable supplies



TOLL FREE (800) 645-9518 in N.Y. State call **(516) 752-0050**

RCA's Newest See and Do VCR Video Tape Program...

"Familiarization and Servicing The VGP170/TGP1500 Convertible VCR System"



- Video Tape . . . 80-Minutes, Full Color
- Workshop Manual . . . Fully Illustrated Step-by-Step Servicing Procedures
- Training Workbook . . . Reinforces Your Learning with "Hands-On" Exercises

Complete Package only \$89.95

This full-color Technical Training Video Tape (VHS Format) is invaluable for technician training or for use at the bench when the VCR or Tuner/Timer is being serviced. Includes visual instruction with audio narration on Tuner/Timer, IR Remote, Cylinder and Capstan Servo servicing, plus Sound-on-Sound operation and much more.

Systems and circuits are referenced to the VCR counter number so that technicians can proceed directly to the related subject matter.

Yes!

Send the number of tapes I have indicated to address below:

Enclosed is my check or money order payable to RCA Corp.

Quantity _____ @ \$89.95 Each

\$ _____ Total Enclosed

Allow 4-6 Weeks Delivery



THIS IS YOUR SHIPPING LABEL — PLEASE PRINT

NAME _____

STREET ADDRESS _____

CITY _____ STATE _____ ZIP _____

MAIL TO: RCA Technical Training 1-450

600 N. Sherman Drive, Indianapolis, IN 46201

8204-4-RE

LETTERS

continued from page 32

the harder the situation would be to change.

Let's see some of those "off-the-air Pay-TV" stations start experimenting with FM modulation. For those who choose not to subscribe, the distorted, out-of-sync pictures would prove just as unwatchable as those you get from present scrambling techniques. A simple FM-converter/AM-remodulator box could then be provided to subscribers. The only place AM interference could enter would be on the cable from the converter to the TV set. That could be a perfect way to test FM-TV in this country. Stations could forward their results to the FCC and, if successful, we could soon see FM-perfect stations popping up all over.

"Bandwidth too broad," you say? Well, how about some form of frequency-companding technique?

Come on, all you electronics engineers: Show us what you can do! Remember when FM radio was only a dream on the part of E.H. Armstrong? Just think: People could say, "I subscribed to that new pay-TV station, and the picture is so great that it's worth the \$18 a month."

GARY N. SMITH,
Sinking Spring, PA

AUTOMOBILE IGNITION SUBSTITUTE

With respect to the "New Ideas" column in the February 1982 **Radio-Electronics**, I think that with a little close examination you will find that the author, Stan K. Stephenson II, knows very little about electronics, still less about gasoline engines, and needs to go back to school for his math.

The 2N6384 power darlington transistor has a collector-to-base breakdown voltage of 60 volts. The reason for the capacitor across the coil is to create a flywheel effect, causing a reverse emf of up to 450 volts; therefore, a power-transistor with a breakdown rating of at least 400-volts should be used, then a Zener diode of about 350 volts should be placed collector-to-base to clamp any spikes exceeding 350 volts. It is not good practice to use the voltage rating of a capacitor for a clamp, such as the .05/100 that he is using collector-to-emitter.

The frequency at which he is running his oscillator, 1-kHz, is equivalent to 15,000 rpm, not 650 rpm. I think that is a little too fast for a car engine to idle.

$1 \text{ kHz} \times 60 = 60,000$ sparks per minute. An eight-cylinder engine fires 4 times per revolution. Thus, 60,000 divided by 4 equals 15,000 rpm.

As for the neon lamp, who is going to hold a small NE2 neon lamp, with 30,000 volts across it, one eighth of an inch away from a pulley, fan, and a bunch of belts turning at 15,000 rpm?

In conclusion, it is my hope that anybody who tries that gadget is lucky enough to have the .05/100-volt capacitor short the first time the coil fires, thereby eliminating all of the aforementioned problems.

GORDON HENDRIX

R-E

EQUIPMENT REPORTS

Radio Shack Model MG-1 Music



CIFCLE 101 ON FREE INFORMATION CARD

FOR YEARS, THE MOOG SYNTHESIZER HAS been synonymous with modern electronic music and rock bands. Early versions of that device, however, were very expensive and were regarded as status symbols for the rock musicians.

RAD O SHACK		MG-1											
OVERALL PRICE													
EASE OF USE													
INSTRUCTION MANUAL													
PRICE / VALUE													
		1	2	3	4	5	6	7	8	9	10		
		Poor		Fair			Good			Excellent			

Now Radio Shack (One Tandy Center, Ft. Worth, TX 76102) has entered the market with their *model MG-1* from Moog.

The instruction manual that accompanies the instrument provides excel-

lent graphic examples to acquaint the user with the wide variety of sounds available. Some of those sounds include musical instruments and sound effects. The manual also includes a section on basic music theory for those with little or no music background.

The 2½-octave full-chromatic keyboard is used in combination with a wide variety of tone-controlling features: a 2:1 sync selector, 3 position octave selector, square or triangular wave-shape selector and even a mixer that will let you mix two tones, a noise source, bell tone, or polyphony (which allows you to play chords).

Modulation capabilities include vibrato, tremolo, random, and glide sequences. A separate filter permits cutoff and peak emphasis, while a contour section adjust rise and fall times.

continued on page 42

VIDEO DISCOUNTS

TEKNIKA WIRELESS REMOTE CONTROL TV TUNER
\$110.00 ea.

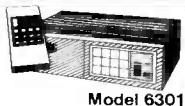

Model 6301

REMOTE TV CONVERTER
Wireless Remote Control 40 Channels
4 or more
\$139.95 ea. \$125.00 ea.



Model CTC5R

36 CHANNEL UP CONVERTER FOR TV & VTR Cable VHF to UHF
Model V5736
1-3 pieces \$29.95 ea.
4 pieces & up \$24.95 ea.



VIDEO SWITCHER
Model V 4801 \$29.95 ea.
Flip a switch to watch a program on any channel, while simultaneously recording a program on any cable or pay TV channel - or vice versa. Plus, you can use your recorder's programming feature to record TV programs while you're away.



VIDEO CONTROL CENTER
Model V 4802 \$39.95 ea.
Provides remote control access of all your Video, TV or Cable inputs to your TV set or Big Screen TV from one convenient location by merely flipping a switch.

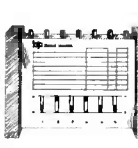

COAXIAL SWITCHING FOR TV VIDEO CASSETTE RECORDERS
Model AB-370 \$6.95 ea.
3-position coaxial push-button switch.

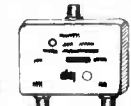
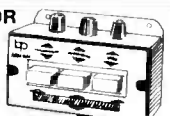

COAX AB SWITCHES
Model AB-27 \$2.95 ea.
• Input: 75 ohm. • Output: 75 ohm.

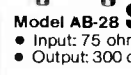

Model AB-28 \$2.95 ea.
• Input: 75 ohm.
• Output: 300 ohm.



Model AB-29 \$2.95 ea.
• Input: 75 & 300 ohm.

ANTENNA/CABLE TV SWITCH
Model AB-400 \$10.95 ea.



ANTENNA/CABLE TV SWITCH
Model AB-410 \$9.95 ea.
• Switches from cable to antenna system instantly. • Accepts 75 or 300 ohm inputs.

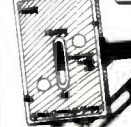

TV GAME SWITCH
Model V 450 \$2.95
300 ohm in and out with RCA plug.

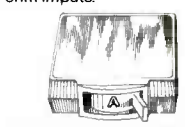

COAXIAL SWITCH
Model DCSA/B \$7.95
A versatile product, with a range of consumer and MATV applications.

VHF/FM AMPLIFIERS

Model 7002 \$9.95 ea.
• All solid state signal amplifier boosts weak signals. For 2 sets.



Model 7004 \$12.95 ea.
• For up to 4 sets • Signal gain 3 dB



DISTRIBUTION AMPLIFIER VHF/UHF FM
With FM Trap
Model DA-425 \$29.95 ea.
• Designed for TV/VCR multiple-set installations.

QUICK CONNECT "F" PLUG & BALUN

Model V 400 \$1.50 ea.
10 for \$12.50



QUICKCONNECT "F" PLUG
Model V 403 .75
10 for \$6.00
For 75 ohm cable. No wiring necessary.



QUICK CONNECT "F" PLUG RG 59U
Model V 4036 \$2.50 ea.
6 ft.



VHF/UHF MATCHING TRANSFORMERS

Model MT-1 \$.75 ea.
10 for \$6.00
VHF/UHF 75-300 ohm matching unit. Miniature size completely shielded and balanced for reduction of direct pick-up.

Model MT-2 \$1.10 ea.
10 for \$9.00
Completely plastic molded construction for weather-proofing. Supplied with rubber boot.



FORDHAM
355 Conklin St., Farmingdale, N.Y. 11735

Master Charge
VISA
COD
Money Order
Check
\$25.00 minimum order
COD's extra (requires 25% deposit)

N.Y. State residents add appropriate sales tax.

ADD FOR SHIPPING AND INSURANCE
to \$250.00 \$ 4.50
\$251.00 to 500.00 6.00
501.00 to 750.00 8.50
751.00 to 1000.00 12.00
over 1000.00 12.50

TOLL FREE (800) 645-9518
in N.Y. State call (516) 752-0050

EQUIPMENT AND TRAINING NO OTHER SCHOOL CAN MATCH.

**NTS HOME TRAINING INVITES YOU TO EXPLORE MICROCOMPUTERS,
DIGITAL SYSTEMS AND MORE, WITH STATE-OF-THE-ART EQUIPMENT
YOU ASSEMBLE AND KEEP**

Without question, microcomputers are the state of the art in electronics. And NTS is the only home study school that enables you to train for this booming field by working with your own production-model microcomputer.

We'll explain the principles of troubleshooting and testing your microcomputer and, best of all, we'll show you how to program it to do what you want.

You'll use a digital multimeter, a digital logic probe and other sophisticated testing gear to learn how to localize problems and solve them.

Send for the full color catalog in the electronics area of your choice—discover *all* the advantages of home study with NTS!

NTS also offers courses in Auto Mechanics, Air Conditioning and Home Appliances. Check card for more information.



We believe that training on production-model equipment, rather than home-made learning devices, makes home study more exciting and relevant. That's why you'll find such gear in most of NTS's electronics programs.

For instance, to learn Color TV Servicing you'll build and keep the 25-inch (diagonal) NTS/HEATH digital color TV.

In Communications Electronics you'll be able to assemble and keep your own NTS/HEATH 2-meter FM transceiver, plus test equipment.

But no matter which program you choose, NTS's Project Method of instruction helps you quickly to acquire practical know-how.



Simulated TV Reception

4.



3.

1. **The NTS/Rockwell AIM 65 Microcomputer** A single board unit with on-board 20 column alphanumeric printer and 20 character display. A 6502-based unit 4K RAM, expandable.
2. **The NTS/KIM-1 Microcomputer** A single board unit with 6 digit LED display and on-board 24 key hexadecimal calculator-type keyboard. A 6502 based microcomputer with 1K RAM, expandable.
3. **The NTS/HEATH H-89 Microcomputer** features floppy disk storage, "smart" video terminal, two Z80 micro-processors, 16K RAM memory, expandable to 48K.
4. **The NTS/HEATH GR-2001 Digital Color TV (25" diagonal)** features specialized AGC-SYNC muting, filtered color and new solid-state high voltage tripler rectifier.

NTS NATIONAL TECHNICAL SCHOOLS

TECHNICAL-TRADE TRAINING SINCE 1905
Resident and Home-Study Schools
4000 SO. FIGUEROA ST., LOS ANGELES, CA. 90037



NATIONAL TECHNICAL SCHOOLS

4000 South Figueroa Street. Dept 206-582
Los Angeles, California 90037

Please rush FREE color catalog on course checked below

- | | |
|---|---|
| <input type="checkbox"/> MicroComputers/MicroProcessors | <input type="checkbox"/> Auto Mechanics |
| <input type="checkbox"/> Communications Electronics | <input type="checkbox"/> Air Conditioning |
| <input type="checkbox"/> Digital Electronics | <input type="checkbox"/> Home Appliances |
| <input type="checkbox"/> Industrial Technology | <input type="checkbox"/> Color TV Servicing |

Name _____ Age _____

Address _____

Apt. _____ City _____

State _____ Zip _____

- Check if interested in G.I. information.
 Check if interested ONLY in classroom training in Los Angeles.

EQUIPMENT REPORTS

continued from page 37

Above the keyboard is a cluster of switch controls that are used to "program" the synthesizer. Two waveform generators (sawtooth and square wave) provide the basic sound source; the modulation controls, filters, and mixers shape the final sound.

The synthesizer has a low-level, high-impedance output that is designed to be used with an existing amplifier, handy for home or "concert" use. In addition a headphone jack permits the unit to be used in a noisy environment, or without disturbing others. The unit also includes a built-in AC power supply.

Rear-panel jacks provide pitch and trigger interface ports for computer control. Another rear-panel jack allows you to input an external sound source, such as a tape recorder.

The lightweight instrument has a professional look: basic black vinyl with color accents grouping the controls by common function. The "feel" of the keys is quite conventional and the spacing is standard.

The *model MG-1* provides an economical alternative to more expensive electronic sound generating equipment. It sells for \$499.95, and is available from Radio Shack outlets. **R-E**

Microtek Bytewriter-1 Matrix Printer



CIRCLE 102 ON FREE INFORMATION CARD

Microtek	Bytewriter-1									
OVERALL PRICE	[Red bar]									
EASE OF USE	[Red bar]									
INSTRUCTION MANUAL	[Red bar]									
PRICE/VALUE	[Red bar]									
	1	2	3	4	5	6	7	8	9	10
	Poor			Fair			Good			Excellent

THE *BYTEWRITER-1* MATRIX PRINTER, by Microtek Inc., is a 7 x 5 dot-matrix printer for the *TRS-80*, *Apple* and *Apple II*, and *Atari 400/800* computers that specifically answers the need for an inexpensive printer capable of accommodating standard letter-size sheets and paper rolls.

Priced at only \$299, the *Bytewriter-1*

OOOOOOPS!

If you had trouble following our report on Microtek's *Bytewriter-1* last month, there was a good reason. It seems gremlins played an April-Fool trick on us and moved around some type when we weren't looking. Here is how it should have appeared.

has three individual internal connectors for the three computer systems. It is almost impossible to mix up the connections if you move the printer from one computer system to another because the required interface cable from the computer to the printer will attach only to the appropriate connector.

The *Bytewriter-1* prints both upper and lower case—without lower-case descenders—at 10 characters-per-inch, 6 lines to the inch. It accepts 95 of the 96 standard ASCII printable character codes and three control codes.

In the ASCII "standard", the characters start at decimal code 33 and run through decimal 127. Code 127, however, is not really a character; it is the delete function. Some printers, on receiving a code 127 from the computer, will do nothing. The *Bytewriter-1*, however, translates code 127 into an open

BBC
BROWN BOVERI

GOERZ
METRAWATT



INTRODUCTORY OFFER

MA 1H A Professional Tool for **only \$49.00**

Safety Test Leads \$ 7.90
Case for Meter and Leads \$12.00

Black molded high impact thermoplastic case.

Large mirror scale, 83mm

Meter movement: Coil core magnet mounted on shock-proof jeweled bearings. Overload protected.

Dimensions: 92 x 126 x 45mm, Battery AA size 1.5V

Input impedance: 20k Ω /V DC, 4k Ω /V AC

Accuracy: 3% V DC, 4% V AC

Measuring ranges

Voltage	Current	Resistance	Capacitance
0.15 V dc	50 μ A dc	1 Ω ... 1 k Ω	2000 ... 200000 μ F
0.5 V dc	0.5 mA ac/dc	10 Ω ... 10 k Ω	200 ... 20000 μ F
1.5 V ac/dc	5 mA ac/dc	100 Ω ... 100 k Ω	20 ... 2000 μ F
5 V ac/dc	50 mA ac/dc	1 k Ω ... 1 M Ω	2 ... 200 μ F
15 V ac/dc	500 mA ac/dc		
50 V ac/dc	5000 mA ac/dc		
150 V ac/dc			
500 V ac/dc			
1000 V dc			

MA 2H

Accuracy: 1.5% V DC, 2.5% V AC

Current range: 15 A AC/DC

Other specs same as MA1H

\$79.00

1 YEAR IMMEDIATE EXCHANGE WARRANTY

THE TEST EQUIPMENT SPECIALISTS

TOLL FREE HOT LINE

800-223-0474

**ADVANCE
ELECTRONICS**

54 WEST 45th STREET, NEW YORK, N.Y. 10036 212-687-2224

Burglar Alarm

A computerized burglar alarm requires no installation and protects your home or business. It is the first real alternative to a thousand dollar or more professional system.

The concept is simple. Provide all electronic functions of a professional wired together system. Put sensing and control into one easy-to-use device. Use large scale integration of solid state components to achieve lower cost and greater reliability. Here are some of the exciting features:

Invisible Protection. The Midex 55 protects your home using exactly the same technology that police radars use to catch speeding cars and trucks. When you are not at home, the Midex 55 generates a low energy radar field that detects anyone who moves in a designated area of your house. The protection pattern is an adjustable tear drop shape with maximum dimensions of 50 x 20 feet.

Loud Alarm. When the system detects an intruder, it turns on a loud police type electronic siren. The sound is loud enough to cause pain. It is loud enough to drive a burglar away before he can steal or damage your valuables. It is loud enough to alert your neighbors and, more important, loud enough to warn you not to enter your home before the police arrive.

Computerized Controls. To turn the system on, you punch in your personalized 4 digit access code. You now have 30 seconds to leave your home or office. When you return, you enter and disarm the system with your access code. You have 30 seconds to do that also.

When the Midex senses an intruder, it remains silent for 30 seconds. It then sounds the alarm until 8 minutes after the burglar leaves. The alarm then shuts off and resets, once again ready to do its job. This shut-off feature, not found on many expensive systems, means that your alarm won't go wailing all night long while you're away.

Standby Power. Should AC power fail or a smart burglar cut your AC power lines, the Midex 55 automatically switches to FAIL-SAFE operation using a built-in rechargeable battery pack. You are protected no matter what.



The Midex 55 alarm system measures only 4" x 10½" by 7" yet protects you like much larger and expensive security systems.

EXPANDABLE SYSTEM

You can set up the Midex in your own home in minutes. It looks like a stereo component. Just plug it into a wall socket, aim and adjust its protection pattern and connect two wires to the powerful alarm blast horn SP-30. If you wish, you can connect two alarm blast horns. If you connect 2 blast horns, we recommend one outside and one inside. A test light allows you to easily determine the area of coverage of the protection pattern. A thumb wheel lets you adjust it to your needs.

As an extra security measure, you can connect one or more panic buttons to the Midex. The panic buttons activate the alarm even with the radar protection pattern turned off. But even if you don't use the expansion features, the Midex is complete, ready to protect you, just as it arrives in its well-protected carton.

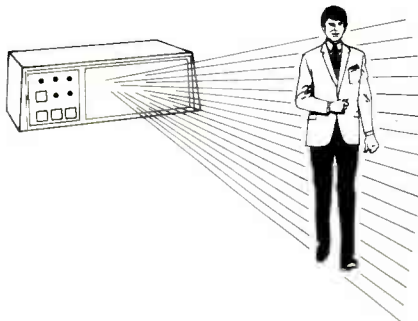

The adjustable pattern has a range up to 50 feet.

NO MORE FALSE ALARMS

Compared with other burglar alarms like ultrasonic systems, the Midex has almost no chance of false alarms, since it is not affected by traffic noise, plane noise, air conditioner turbulence, telephones or strong outside winds. Only the motion of the burglar walking through the radar field can set it off.

COMPARED AGAINST OTHERS

The Midex compares with much more expensive professionally installed systems. Yet it costs no more than do-it-yourself alarms purchased at retail. In a recent article, a leading consumer magazine rated the Midex tops in space protection, alarm siren power and immunity from false alarms. Don't be confused. There is no system under \$1000 that provides you with the same protection.

The powerful blast horn has a 120dB output and makes a sound so loud it causes pain.

U.L. APPROVED SYSTEM

If you have owned a burglar alarm for more than a year, there's a good chance that it has required service. The Midex, however, is solid state and built with the same heavy duty components in industrial systems. The Midex is made by Solfan Systems, Inc., the leader in the production of radar detectors for commercial and industrial security systems. Solfan has made more than half a million industrial radar sensors and over 100,000 Midex 55. Will the Midex ever need service? No product is perfect. If you ever have a problem, call us on our toll free "help line" at (800) 227-8167. The product has a limited 1 year parts and labor warranty.

STANDING BEHIND A PRODUCT

The Midex protects more than 100,000 American homes. But the true test of how it performs is in your home or office. That is why we provide a one month trial period. We give you the opportunity to see how fail safe and easy to operate the Midex system is and how thoroughly it protects you and your loved ones. Decide after one month whether or not you want to keep it. If you decide to keep it, you'll own the best. If you not, return your unit for a full and prompt refund. There is no risk.

Purchase the Midex 55 now for \$199.95 and the SP-30 blast horn for \$39.95. We recommend the purchase of two blast horns. To order, simply send your check to the address shown below. California residents add 6% sales tax. Credit card buyers may call our toll free number below. There are no postage or handling charges. The unit will be sent to you complete with all instructions.

Midex gives you everything you could possibly expect from a burglar alarm: 1) a professional grade system at a very reasonable price, 2) toll free telephone assistance, 3) the chance to buy a unit in complete confidence, knowing that you may return it if it's not exactly what you want. You can't lose.

Computer technology has produced the ultimate security system. Order your Midex 55 without obligation today.

midex

665 Clyde Avenue
Mountain View, CA 94043
(415) 964-7020 in Calif.
(800) 227-8167

CIRCLE 23 ON FREE INFORMATION CARD 43

box of the type used on questionnaires. If you were printing something where you might want to check off each step with a pencil or pen, the open box would be an asset.

The *Bytewriter-1* responds to three ASCII control codes. Those are: CR (carriage return), SO (shift out), and SI (shift in). CR also provides an automatic linefeed. When the printer receives the CR code, all data stored in the print buffer is printed and the paper is advanced one line. If more than 80 characters have been received and stored in the printer's buffer before the CR is sent by the computer, the first 80 are printed on one line and the re-

mainder are "wrapped around" on the next line.

When the printer receives the SO code, all data that follows is printed out in "bold" double-width characters. Reception of the SI code cancels the "bold" characters and all printing that follows the SI code is normal width. The SO and SI codes can be intermixed at will in the same line, permitting individual characters, words, and phrases to be printed "bold." The bold characters do not cancel at the end of a line, but will continue until the SI code is received.

Like some other printers, the *Bytewriter-1* ignores the Line-Feed (LF)

code. A line feed is automatically accomplished as a result of the carriage return. If just a line feed is desired, it is necessary to send a CR code to the printer. While that provides a line feed, it also moves the printhead to the beginning of the next line; that makes it somewhat difficult, if not impossible, to line up columns.

Unlike earlier "budget" printers that used rolls of narrow, adding-machine type paper that permitted lines of perhaps 16 or 30 characters, or that used a somewhat difficult to obtain and expensive heat-sensitive or electrostatic paper, the *Bytewriter-1* uses standard sheets—letter or legal size—or standard paper rolls up to 8½-inches wide. The paper feed is friction only; there are no tractor or pin-feed devices. Single sheets are inserted from the rear. Permanent brackets and a removable spindle are provided for paper rolls. The bracket supports a standard 5-inch diameter teletype paper roll off the table—the user is not limited to one of the new mini-size rolls of approximately 3-inch diameter, which happen to cost more than the standard roll.

The characters are printed by a 7-wire printhead that plugs into a socket and is user-replaceable by simply loosening two screws and unplugging the connecting cable. Unlike most other printheads that are connected to their electronics by a flexible ribbon cable that "rolls" along with the printhead, the *Bytewriter-1* uses discrete, highly flexible wires to connect the printhead to the circuit. The wires flop and twist considerably as the printhead travels. While it does not appear to the eye that the twisting wires would have the life expectancy of "rolling ribbon", there is no previous experience on which to make a judgment as to life expectancy of the wires.

The printhead is driven by a grooved spindle, rather than a drive belt. Again, that is an arrangement we have not seen used in a matrix printer before; but it does work. Again, we have no idea what the life expectancy or reliability might be; but after several weeks of quite severe usage—likely more than done by the average hobbyist—we have had not a single instance of difficulty with any part of the printer's electrical or mechanical assembly.

The printhead's bi-directional drive is the "full line" system commonly found on many lower-cost printers; it is not logic-seeking. That is, the head sweeps from full left to full right, even if it prints just a single letter on the left side. It then sweeps back from full right to full left regardless how much it has to print. The printer speed is 80 characters-per-second (per line), 60 lines-per-minute.

There is no impression adjustment

ADVANCE IS PROUD TO INTRODUCE the KEITHLEY Line of High Quality Digital Multimeters Featuring The New 130 Hand-Held DMM

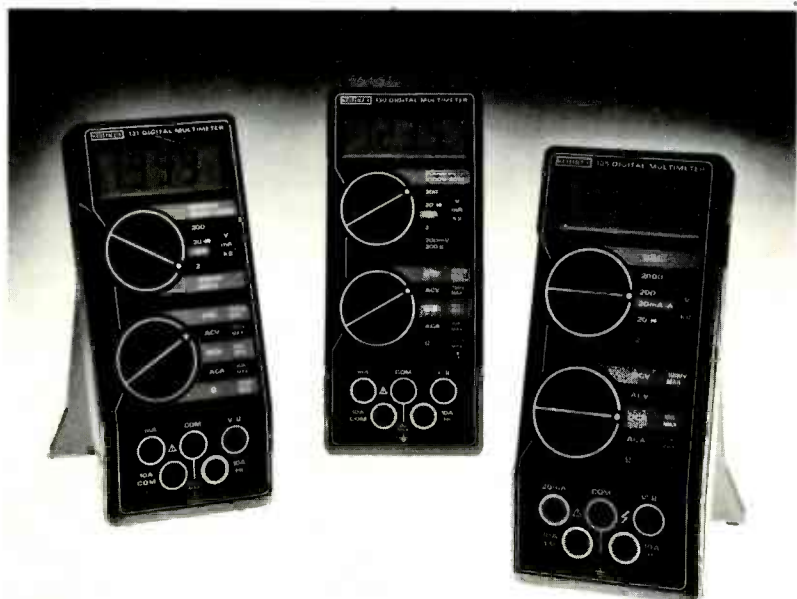

Rugged DMMs from Keithley — all feature large, bright LCD display, easy-to-use rotary switches, externally accessible battery and fuse, 10A current range, diode test capability, low battery indicator, cushioned components.

Model 131. Similar to Model 130, with increased accuracy... **\$139**

Model 130. Our most popular model, the price/performance champ... **\$125**

Model 135. First 4½-digit DMM with hand-held convenience... **\$235**

MODEL	ACCURACY					SENSITIVITY				
	DCV	DCA	ACV	ACA	Ω	DCV	DCA	ACV	ACA	Ω
130	0.5%	1%	1%	2%	0.5%	100μV	1μA	100μV	1μA	100mΩ
131	0.25%	0.75%	1%	2%	0.2%	100μV	1μA	100μV	1μA	100mΩ
135	0.05%	0.5%	1%	1.5%	0.2%	100μV	10μA	100μV	1μA	100mΩ

Case \$10.00 Shipping \$3.00

THE TEST EQUIPMENT SPECIALISTS
TOLL FREE HOT LINE
800-223-0474
ADVANCE ELECTRONICS

54 WEST 45th STREET, NEW YORK, N.Y. 10036 212-687-2224

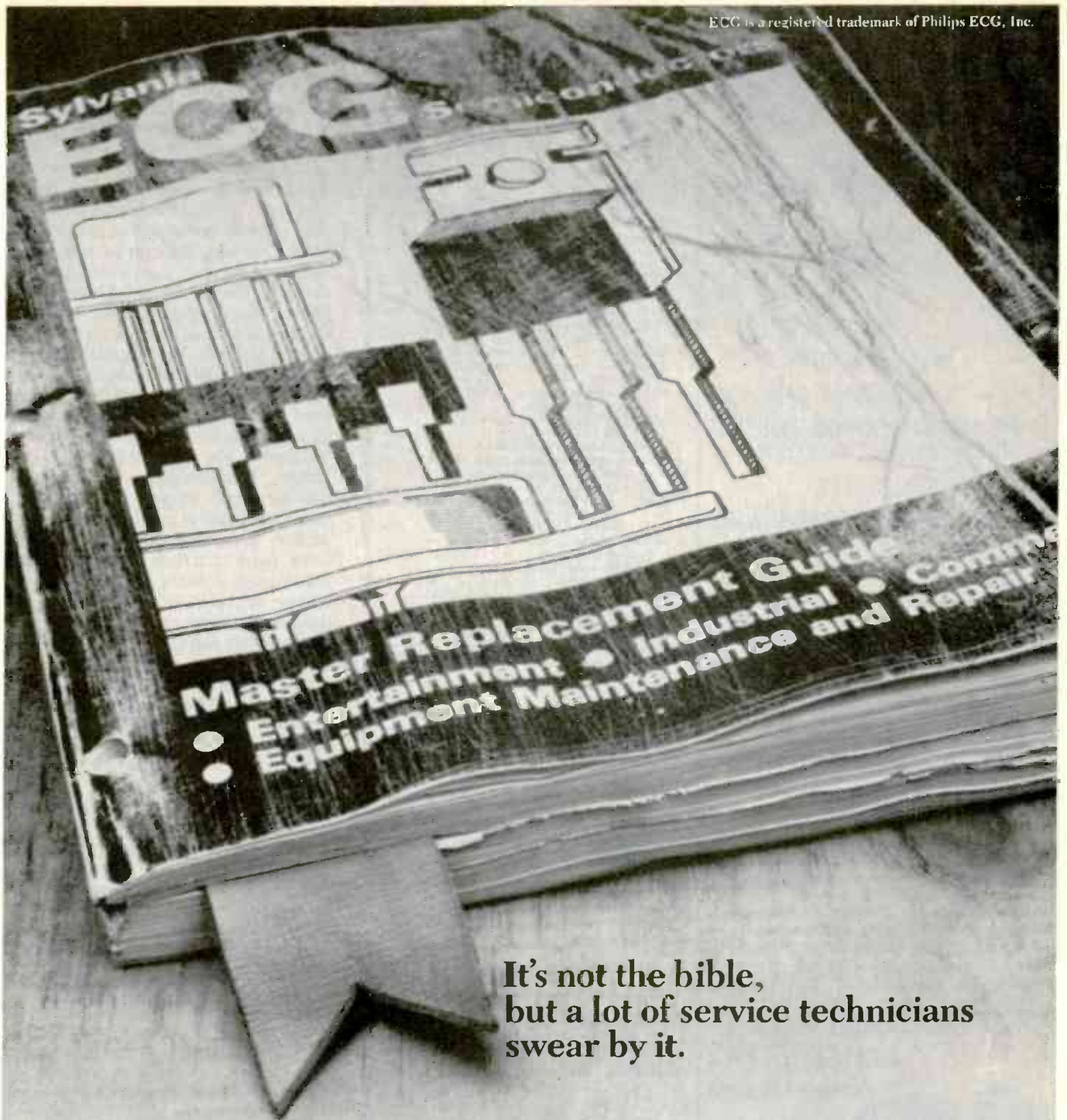

**It's not the bible,
but a lot of service technicians
swear by it.**

Behold! The Sylvania ECG® Master Replacement Guide, the most comprehensive publication of its kind used by the industry.

Inside you will find more than 170,000 industry part numbers cross referenced to over 2,500 ECG numbers, including most of the hard-to-find foreign parts that are plaguing more and more repairmen every day.

If the part number is illegible, there are also easy to use comprehensive selection tables to help you identify and replace

transistors and linear ICs by application. You will find clear, concise descriptions and illustrations on each type from diodes to ICs with specifications, applications and package dimensions.

What's more, you also have Philips ECG technical resources ready to help you with any questions you might have regarding particular situations or applications; and as always, all ECG parts you will receive come with the knowledge that they've met specifications which are equal to

and usually exceed those of the original parts and that they've been tested using stringent procedures established by the U.S. Military.

To find out more, seek your nearest authorized Philips ECG distributor.

If you are not already a believer, one look at our catalog should convert you.

Philips ECG

A North American Philips Company

"For your nearest ECG distributor, please call 1-800-225-8326, in Mass., call 1-800-342-8736."

CIRCLE 19 ON FREE INFORMATION CARD

**INTRODUCING
OUR
MDS - AMATEUR - ETV
32 ELEMENT YAGI ANTENNA**



- NOT A KIT
- 1.9-2.5 GHz
- 38½" LENGTH
- 23 dB AVERAGE GAIN
- DIE CAST WATERPROOF HOUSING FOR ELECTRONIC CIRCUITRY
- COMMERCIAL GRADE
- INCLUDES MOUNTING HARDWARE

MODEL NO. **MAE-1** ONLY **\$19.95**

VTR ACCESSORIES

SIMPLE SIMON VIDEO STABILIZER



Model **VS-125**

Simple Simon Video Stabilizer, Model VS-125, eliminates the vertical roll and jitter from "copy guard" video tapes when playing through large screen projectors or on another VTR. Simple to use, just adjust the lock control for a stable picture. Once the control is set, the tape will play all the way through without further adjustments. Includes 12V power supply.

VS-125 Video Stabilizer wired \$54.95

SIMPLE SIMON VIDEO SWITCHING BOX



Model **VSB-300**

The **Affordable Video Control Center!**

Excellent in isolation and no loss routing system. Simple Simons VSB-300 Video Switching Box enables you to bring a variety of video components together for easy viewing/dubbing. Also you gain the ability to record one channel while viewing another. Unit includes two F-type quick connector ended cables.

VSB-300 Video Switching Box wired \$19.95

SIMPLE SIMON ELECTRONIC KITS, Inc.

7 + 11 SWD PARTS KITS

MITSUMI VARACTOR UHF TUNER
Model UES-A56F
\$34.95

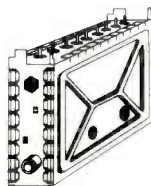

Freq. Range UHF470 - 889MHz
Antenna Input 75 ohms
Channels 14-83 Output Channel 3

KIT NO	PART NO	DESCRIPTION	PRICE
1	VT1-SW	Varactor UHF Tuner, Model UES-A56F	\$34.95
2	CB1-SW	Printed Circuit Board, Pre-Drilled	18.95
3	TP7-SW	P.C.B. Potentiometers, 1-20K, 1-1K, and 5-10K ohms, 7-pieces	5.95
4	FR35-SW	Resistor Kit, ¼ Watt, 5% Carbon Film, 32-pieces	4.95
5	PT1-SW	Power Transformer, PRI-117VAC, SEC-24VAC, 250ma	6.95
6	PP2-SW	Panel Mount Potentiometers and Knobs, 1-1KBT and 1-5KAT w/Switch	5.95
7	SS14-SW	IC's 7-pcs, Diodes 4-pcs, Regulators 2-pcs Heat Sink 1-piece	29.95
8	CE9-SW	Electrolytic Capacitor Kit, 9-pieces	5.95
9	CC33-SW	Ceramic Disk Capacitor Kit, 50 W.V., 33-pieces	7.95
10	CT-SW	Variable Ceramic Trimmer Capacitor Kit, 5-65pfd, 6-pieces	5.95
11	L4-SW	Coil Kit, 18mhs 2-pieces, 22µchs 1-piece (prewound inductors) and 1 T37-12 Ferrite Torroid Core with 3 ft. of #26 wire	5.00
12	ICS-SW	I.C. Sockets, Tin Inlay, 8-pin 5-pieces and 14-pin 2-pieces	1.95
13	SR-SW	Speaker, 4x6" Oval and Prepunched Wood Enclosure	14.95
14	MISC-SW	Misc. Parts Kit Includes Hardware, (6/32, 8/32 Nuts, & Bolts), Hookup Wire, Ant. Terms, DPOT Ant. Switch, Fuse, Fuseholder, etc.	9.95
When Ordering All Items, (1 thru 14), Total Price			139.95

UHF ANTENNAS and ACCESSORIES

ZYZZX

VHF-UHF WIDEBAND ANTENNA AMPLIFIER

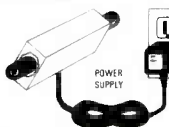
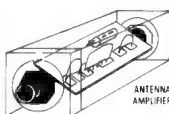

MODEL ALL-1
50 MHz — 900 MHz
12 dB GAIN ± 0.5dB

A Revolutionary New One Stage HYBRID IC Broadband Amplifier

This unit is not available anywhere else in the world. One unit serves many purposes and is available in Kit or Assembled form. Ideal for outdoor or indoor use. Input-output impedance is 75 ohms. Amplifier includes separate co-ax feed power supply. Easily assembled in 25 minutes. No coils, capacitors etc. to tune or adjust.

ALL-1 Complete Kit with power supply \$24.95
ALL-1 Wired and Tested with power supply \$34.95

Our New STVA 14.5 dB GAIN, 14 ELEMENT CORNER REFLECTOR YAGI ANTENNA



STVA-3 Yagi Antenna, 14.5 dB, 75 ohm, Chan. 60-68 \$16.95
STVA-4 Yagi Antenna, 14.5 dB, 75 ohm, Chan. 44-52 \$16.95
STVA-1 Yagi Antenna, 11.5 dB, 75 ohm, Chan. 42-54 \$9.95

RG-59/U	75 ohm Low Loss Coax Cable \$ 12 p/ft
F-59	Coaxial Connectors, ea.39
MT-1	Special UHF 75-300 ohm Matching Transformer, ea. 1.45
ALL-1	HYBRID IC Wideband VHF-UHF-FM Antenna Amplifier Kit 24.95
ALL-1	HYBRID IC Wideband VHF-UHF-FM Ant. Amp. Assembled 34.95

Available by Mail Order Only — Send Check or Money Order To:

SIMPLE SIMON ELECTRONIC KITS, Inc.

Calif. Orders: 3871 S. Valley View, Suite 12
Las Vegas, Nevada 89103
Tel: (702) 322-5273

All Other Orders: 11850 S. Hawthome, Blvd.
Hawthome, Calif. 90250
Tel: (213) 675-3347

Minimum Order: \$16.95. Add 10% Shipping and Handling on orders under \$40.00. For orders over \$40.00, add 5%. Minimum Shipping and Handling \$2.00. Catalog \$1.00.

— VISA and Mastercard Acceptable —

for the printhead; it is set at the factory and will print up to the original and three copies. Our experience showed a somewhat irregular impression impact-density where a substantial part of the character was reproduced by a string of dots, such as the small letter "e", or the parenthesis symbols [()]. While the "top" (original) copy was legible, the copies—particularly the third—were somewhat difficult to read. Also, bear in mind that "copy does *not* mean carbon. Using sheets of letter-size paper, the original and two NCR (No Carbon Required) copies just barely slipped through. The original and three NCR's required considerable care to load. Unless a Mylar carbon film was used it was somewhat difficult to make "carbon copies" using single sheets because it was difficult to load single sheets interspersed with ordinary carbon paper. Paper rolls that consisted of factory interleaved original, carbon and "second sheet" (copy) were more convenient because they fed through smoothly and without any bother. Actually, roll paper proves the most convenient to use; and it's certainly inexpensive if you purchase the ordinary teletype-paper grade.

One nice feature is that the paper can be rolled backwards or forwards whether the power is on or off. Typical of matrix printers, the print line is low, out of sight. If you print one line you can roll the paper forward to check copy and then roll it back for additional printing; it's not necessary to turn off the printer to roll the paper backwards.

The ribbon is supplied in a cartridge that spans almost the full length of the printer. It simply drops into place; there is no threading or positioning. It is one of the easiest ribbons to install, even for someone who is all thumbs. Replacements are priced at \$7.95.

The printer is rather small. Without the paper-roll adapter, it measures 15 × 9¼ × 3-inches. (You must allow some room at the rear for loading paper.) The power switch is located at the left rear outside the paper path. The interface cable comes out the right rear, also outside the paper path. (Even some of the best of other printers are known to get their cables tangled up with the paper because the cables are right in the feed path.) On the top right is a recessed, toothed knob for manual paper positioning.

While the *Bytewriter-1* has some obvious limitations, such as variable impact density and lack of direct line feed, it does quite a creditable job for its price. Certainly, at \$299 (plus \$19.95 for the interface cable and \$15 for shipping) it is one of the least expensive "full size" printers around. For information, or to order a *Bytewriter-1*, write to Microtek Inc., 9514 Chesapeake Dr., San Diego, CA 92123. **R-E**

ADVANCE IS PROUD TO INTRODUCE
The  HITACHI Line
of High Quality Oscilloscopes
All Hitachi Instruments
Are Backed by
A Two-Year Warranty

V-202 & V352
20MHz & 35MHz DUAL TRACE
OSCILLOSCOPES



NEW

1. Square CRT with internal grid (illuminated scale)
2. High-accuracy voltage axis and time axis set at $\pm 3\%$ (certified at 10° to 35°C)
3. High-sensitivity 1mV/div
4. Low drift
5. Dynamic range 8 div.
6. TV sync-separator circuit
7. Built-in signal delay line (V-352)
8. X-Y operation
9. Sweep-time magnifier (10 times)
10. Trace rotation system
11. Fine-adjusting, click-positioning function

AT LAST A 100MHz OSCILLOSCOPE
WORTH WAITING FOR
WITH NO WAITING



CALL FOR
INTRODUCTORY
OFFER

HITACHI
100MHz
OSCILLOSCOPE
MODEL V-1050

- 20kV CRT supply
- Large, bright 8 x 10 cm screen
- Four-trace operation (Ch1; Ch2, A trigger, B trigger)
- High sensitivity 500 uV/div (5MHz)
- High accuracy $\pm 2\%$ (+10°C to 35°C)
- Alternate timebase operation
- Full TV triggering

IN STOCK FOR
IMMEDIATE DELIVERY

C.R.T.

Type Hitachi 150BNB31 rectangular mesh type tube with 20kV acceleration potential and metal backed phosphor

VERTICAL DEFLECTION (Identical Channels)

Bandwidth and Rise Time DC to at least 100MHz and rise time 3.5ns or less. DC to at least 5MHz and rise time 70ns or less at 10 X magnification. Lower -3db point, AC coupling 10Hz or less. 10x probe: 1Hz or less.

HORIZONTAL DEFLECTION

Time Base A 20ns/div. to 0.5s/div. in 23 calibrated steps, 1-2-5 sequence. Uncalibrated continuous control between steps 1: < 2.5
 Time Base B 20ns/div. to 50ms/div. in 20 calibrated steps 1-2-5 sequence. 10x mag extends fastest sweep rate to 2ns/div.
 Calibrated Sweep Delay Continuous calibrated control between 0.5 and 10x time base A setting.

V-550B 50MHz, DUAL TRACE DELAYED SWEEP
PORTABLE OSCILLOSCOPE



Delayed sweep permits 1,000 X Magnification

Variable Hold-off Circuitry Facilitates Pulse Measurement

- Large, Bright 8 x 10cm Screen
- High Sensitivity 1mv/div (10MHz)
- 5 ns/div Sweep Rate
- 3rd Channel Display (Trigger View)
- Variable Trigger Hold-off
- Full TV Triggering
- Single Sweep
- Automatic Focus Correction

ADVANCE ELECTRONICS

THE TEST EQUIPMENT SPECIALISTS

TOLL FREE HOT LINE
800-223-0474



54 WEST 45th STREET, NEW YORK, N.Y. 10036 212-687-2224

Power play.

Six ways to handle your power supply needs ...from B&K-PRECISION

Now you can choose from six B&K-PRECISION lab power supplies and have the supply that's exactly right for your needs.

For high TTL loads, choose the new 1654. With an output that's variable from 2-6 Vdc, the 1654 packs 10 amps in reserve. Features include remote sensing, to measure and regulate output voltage directly at the load, and overvoltage protection. For CMOS and linear circuitry the 1652 dual-output supply provides two 0-25 Vdc outputs at 1.5 amps. With opto-isolator controlled auto-tracking, it's even more versatile than two separate supplies.

The B&K-PRECISION 1650 is one supply that can replace three. It features a 5 Vdc, 5 amp output for digital needs and two auto-tracking 0-25 Vdc outputs. The outputs are fully isolated.

The popular 1601 is ideal for a wide range of solid-state applications. It supplies 0-50 Vdc with up to 2 amps. It's high voltage counterpart is the 1602. The 1602's primary output is 0-400 Vdc at 200 mA, complemented by a 0 to -100 Vdc bias supply and 12.6/6.3Vac outputs.

Rounding out the field is the compact 1640. Designed specifically to power mobile equipment, it delivers 11-15 Vdc at 0-3 amps.

All B&K-PRECISION power supplies feature voltage and current metering, full overload protection and floating outputs. They're all designed for cool power, so you won't be buying a bench warmer. The prices are attractive too.

If you need a power supply fast, you can score with immediate delivery at your local B&K-PRECISION distributor. For details, call toll-free **1-800-641-4627** (in Illinois 312-889-8870).



BK PRECISION DYNASCAN CORPORATION

6460 W. Cortland • Chicago, IL 60635 • 312/889-9087 TELEX: 25-3475

International Sales, 6460 W. Cortland Street, Chicago, IL 60635 USA: TELEX: 25-3475

Canadian Sales, Atlas Electronics, Ontario

CIRCLE 26 ON FREE INFORMATION CARD

BUILD THIS

DAVID BECKER

HOME SATELLITE-TV RECEPTION, ONCE A dream, is now a reality. Thousands of enthusiasts have installed their own "backyard" earth stations and the simple, inexpensive receiver that will be described here will allow you to do the same. To understand how satellite TV works, let's look at why and how it developed.

In the early days of TV, transmissions were strictly local, using the standard VHF-frequencies. Later, as networks were formed, there came a need for nationwide video-distribution systems. Coaxial-cable lines and multiple copies of films or kinescopes (films taken from a video monitor) were used initially, but they were costly and were gradually replaced by microwave-relay links.

By 1980, satellite communications had progressed far enough to allow the use of a single satellite as a relay point, broadcasting to TVRO (TV Receive-Only) terminals across the U.S. Although TVRO terminals were expensive, the system was adopted quickly because its overall cost was less than that of a ground-link system.

Communications satellites have *geosynchronous* orbits. A geosynchronous (or *geostationary*) orbit is one in which the satellite orbits directly above the equator and has an orbital velocity that precisely matches that of Earth's rotation. An observer on Earth sees the satellite as a stationary point in the sky (see Fig. 1). A satellite-communications link has three points: the signal source on the ground, the satellite relay in orbit, and any number of ground-based TVRO terminals. We will examine each of those three points in a moment, but first let's see what type of programming the satellites carry.

Presently, as shown in Fig. 2, there are about a dozen U.S. and Canadian satellites within view from this country, with many more due to be launched in the near future. Each satellite carries 12 or 24 *transponders* (receiver/transmitters)—each one using a different frequency-pair—with programming that includes movies, sports, news, and almost anything else imaginable.

The domestic satellites can provide up to 228 separate TV channels, or over 200,000 telephone voice-channels, simultaneously. The most popular satellite is RCA's Satcom F1 (located at 135° west latitude) which is used by cable-TV companies to relay their programs. As an example of the diverse programming it carries, services available on Satcom F1 include: Home Box Office

SATELLITE TV RECEIVER

Here are the complete plans for a satellite-TV receiver to go with the 8-Ball antenna we presented in 1981. Add an LNA for a complete satellite-TV earth station.

(HBO) and Cinemax, a 24-hour news channel, daily live coverage of the House of Representatives, a channel devoted entirely to sports, "superstations" WOR-TV in New York and WGN-TV in Chicago, and many others. And, if all of that programming isn't enough, there are plenty of other satellites to choose from.

The satellite link

We said earlier that a satellite-communications link is made up of three parts: the ground transmitting-station, the satellite, and the ground receiving-station. They are shown in Fig. 3. Let's first study the ground sending-station, or *uplink* transmitter.



The job of the uplink transmitter is to send a frequency-modulated video signal (as opposed to the amplitude-modulated video signals used in broadcasting) and an FM-audio signal to the satellite using a carrier in the 5.9-6.4-GHz range. Since the satellite is over 22,000 miles away, the signal must be aimed

very accurately to insure that it reaches the "bird" with maximum strength. A signal of at least 500 watts is fed to a parabolic-dish antenna. That antenna provides gain by reflecting energy that would normally be radiated away from the satellite and focusing it into a concentrated beam toward it.

An uplink station can beam up more than one video channel at a time by using special signal-combiners. The most recent development in uplinks is mobile transmitters; an antenna and transmitter mounted on a trailer and in a van are transported from place to place for on-location broadcasting. That allows live video-broadcasts to be beamed from and to virtually anywhere in the world.

The next part of the communications link is the satellite itself. It uses a parabolic dish to receive the 6-GHz uplink signal, and then retransmits it back to Earth on a lower 3.7-4.2-GHz carrier. Using two separate frequencies allows simultaneous reception and transmission. Both the uplink and the *downlink* (satellite-to-earth signal) paths have a 500-MHz wide frequency-range (5.9-6.4 GHz and 3.7-4.2 GHz) which means that there is room for 12 channels, each

40 MHz wide.

That's fine for a 12-transponder satellite, but how do you fit 24 channels in the same space? A combination of two systems is used. First, the channels are staggered so that the center of one channel is at the upper and lower edges of the adjacent ones, as shown in Fig. 4. The channels overlap, though, and normally would interfere with one another. To avoid that interference, the signals are cross-polarized. At microwave frequencies such as those used for satellite transmissions, signals polarized at right angles to one another are isolated by about 30 dB. Odd-numbered channels are vertically polarized; even-numbered ones horizontally polarized. In that way, the channel being received is 30-dB stronger than its oppositely polarized neighbors—more than enough to mask the undesired signals.

The biggest problem with the downlink signal transmitted by the satellite is that it is quite weak. Since the satellite is expected to perform without any maintenance during its expected life, it must be solar powered. Even with the most efficient solar panels, it can only produce about 5 watts of output power per transponder. That means that after the signal travels 22,000 miles to Earth, losing 196 dB of its initial strength (dropping to almost 5×10^{-20} watts), the ground receiving-station is not left with much to work with.

The first component of a TVRO terminal is a large parabolic or spherical-reflector antenna, typically 10 or 12 feet in diameter. (Construction of a spherical antenna, the "8-Ball," was described in the August, September, and October 1981 issues of *Radio-Electronics*.) The antenna gathers all the signal that falls on its surface area and reflects it to its focal point where an LNA (Low Noise Amplifier) is positioned. Using cascaded GaAsFET and bipolar transistors, the LNA amplifies the 4-GHz signal by about 40 dB while adding only one or two dB of noise. It is important to introduce as little noise at this stage as possible, since any that does creep in will be carried and amplified through the rest of the system.

Once the signal leaves the LNA, it travels down a heavy coaxial cable to the receiver, the heart of the TVRO terminal.

Receivers

The receiver—the final part of the satellite-communications link—takes the 4-GHz RF signal from the LNA and transforms it into standard composite-video and audio. Receivers can be designed in a variety of ways and a discussion of some of the features desirable in a receiver will demonstrate what a quality unit should be capable of doing.

A receiver should be fully *frequency-*

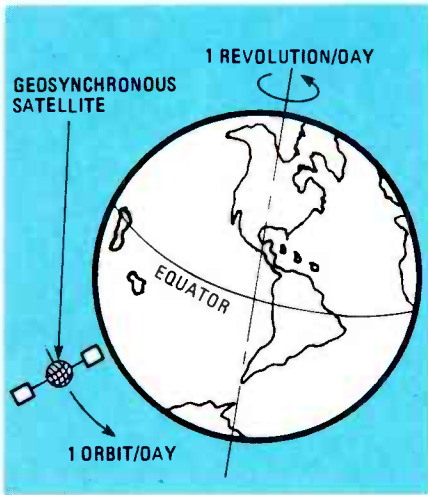

FIG. 1—THE ORBITAL VELOCITY of a geosynchronous satellite matches the rotational speed of Earth exactly, making it appear to be stationary in the sky.

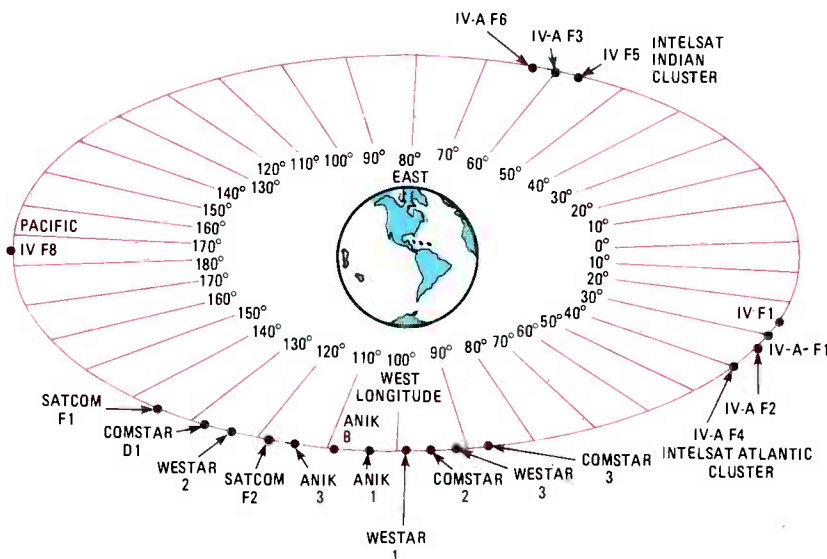

FIG. 2—U.S. AND CANADIAN communications satellites lie between 80° and 140° west longitude.

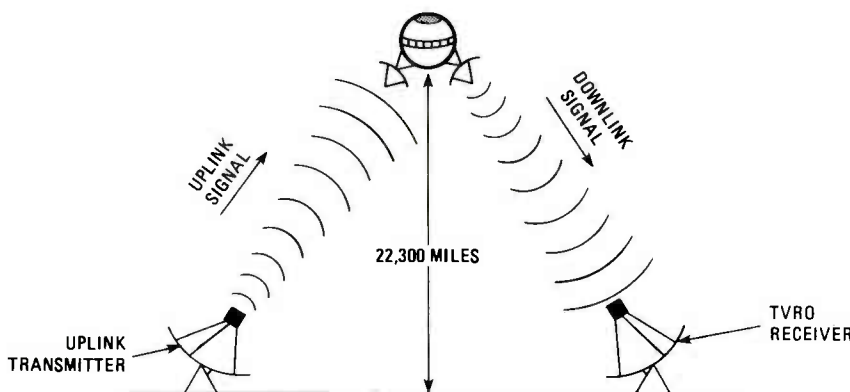

FIG. 3—THE UPLINK TRANSMITTER sends a 6-GHz signal up to the satellite, which retransmits the video and audio information back to Earth on a frequency in the 4-GHz band.

agile; that is, it should be able to be tuned over the entire 3.5–4.5-GHz band. That will allow 24-channel use, as well as the reception of transmissions from foreign satellites. Its sound-subcarrier demodulator should be tunable over the full range of 5.5–7.5 MHz. The various transponders transmit their audio information on sub-carrier frequencies located within that range and the receiver should, of course, be able to demodulate any of them.

Another important feature to consider is dual conversion, where the incoming signal is converted to a lower frequency in two steps rather than one. The advantage of dual-conversion receivers is that they do not interfere with one another, allowing multiple units to be operated in the same vicinity. A single-conversion receiver, on the other hand, can cause (and suffer from) interference problems because of an oscillator that would necessarily be operating within the 4-GHz band. A quality receiver should also incorporate an AFC (Automatic Frequency Control) circuit, and, of course, be easy to assemble and align. The R2B receiver presented here uses a dual-conversion design and provides the features just described.

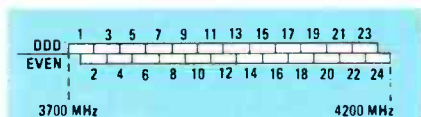

FIG. 4—HOW TO FIT 24 channels in a 12-channel bandwidth. Adjacent channels are overlapped, and odd-numbered channels vertically polarized; even-numbered ones horizontally polarized.

How it works

Figure 5 shows a block diagram of the R2B receiver. Figure 6 is a schematic of the mixer section of the receiver, and Fig. 7 is an overall schematic of the unit.

The input to the receiver is the amplified 4-GHz signal from the LNA. Circuits to handle signals in that frequency range are both critical and expensive, so the 4-GHz signal is immediately converted down to an 1100-MHz intermediate frequency (IF) by the first-mixer stage of the receiver.

First mixer

This stage is probably the most exotic part of the R2B receiver. Although it is simple in design, it is quite complex in the way it works.

A double-balanced design is used for impedance matching and to provide good local-oscillator rejection characteristics. The input signal from the LNA is split in phase by a quarter-wave transmission-line balun, L11, and coupled to the other side of the PC board through capacitors C72 and C73, which are actually formed by the PC-board material—the board itself acting as a dielectric between the two tinned-copper surfaces. The phase-split signal is then fed to a diode quad made up of D10–D13.

Similarly, the signal from the local oscillator is split using another transmission-line balun, L10, and then fed to the quad. The local-oscillator signal switches the diode quad on and off, thus producing the mixer products. (In superhetrodyne receivers, mixing two

signals produces the sum and difference of the two. The R2B mixes signals in the 3.7–4.2-GHz range with 2.6–3.1-GHz signals from the local oscillator to produce a difference frequency of 1100 MHz.) Small wire loops, L12 and L13, act as chokes and couple the 1100-MHz signal-bearing intermediate frequency to the main receiver-board.

The tunable local oscillator, IC10, is a thin-film MIC (Microwave Integrated Circuit). It is difficult to build voltage-tuned oscillators from discrete components that will operate reliably at microwave frequencies and that IC does the job nicely.

1100-MHz first IF

The first-IF stage, which follows the first mixer, uses three stripline transistors, Q1–Q3, to provide 5–10 dB of gain at 1100 MHz. The primary function of that stage, though, is not to provide gain, but to provide bandpass filtering. Properly tuned, the first-IF stage gives excellent image-rejection as well as limiting the total power (both signal and noise) of the signal for the second-IF stage.

Each stage is biased for class-A operation at about 5 mA of collector-current. Small (5 pF) capacitors couple the inputs and outputs of the stages. Miniature resonators are formed by piston capacitors. Proper impedance-matching is obtained by the placement of the coupling capacitors on the lead-straps of the piston trimmers. Carefully controlled spacing of the resonator sections makes possible a composite, double-tuned filter assembly. The 1100 MHz IF-stage is made up of two such assemblies; each one is isolated by a buffer/gain stage.

Second oscillator and mixer

The next stage encountered is the second mixer, which heterodynes the 1100-MHz signal with an 1170-MHz one, giving an output at 70 MHz. Since the R2B receiver has an excellent AFC range (greater than 20 MHz), a simple, fundamental-frequency, single-transistor (Q6) oscillator can be used to make a base-tuned 1170-MHz oscillator. Its output is buffered by Q5 before driving the second mixer, IC1. Once again, the piston capacitor/resonator arrangement is used. To provide a little more gain at the high end, resistor R51's lead inductance (that resistor's lead inductance is represented as L7 in the schematic) is used for peaking.

Transistor Q5 provides a signal having a level of about +7 dBm to mixer IC1's local-oscillator port; that level insures low conversion-loss as well as keeping the generation of spurious signals to a minimum. The mixer's output is filtered through a pi-network to provide a clean 70-MHz signal for processing by the second-IF stage.

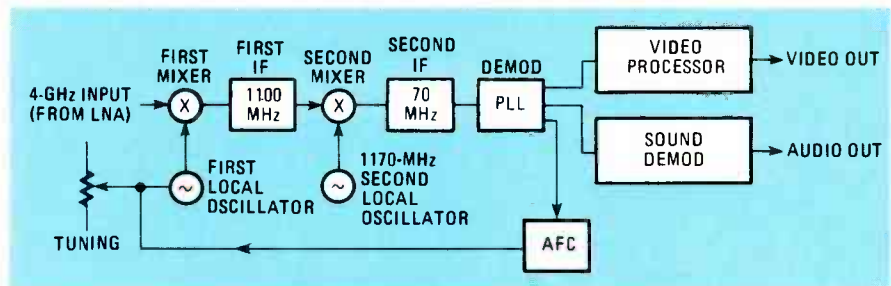

FIG. 5—BLOCK DIAGRAM of R2B satellite-TV receiver. Function of each block is discussed in text.

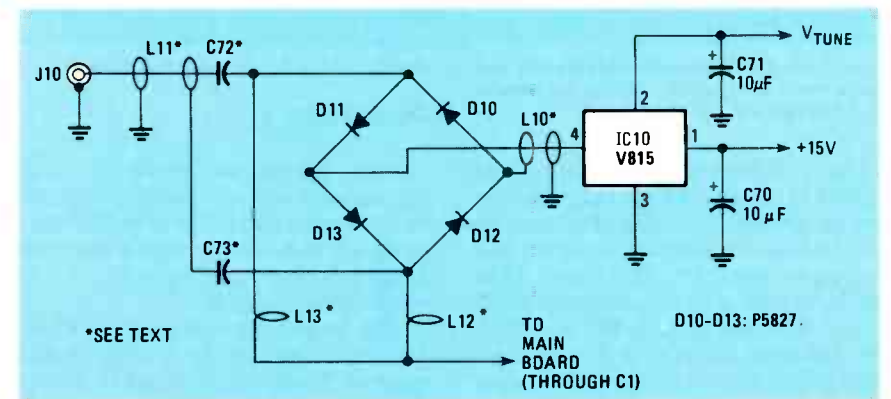

FIG. 6—FIRST-MIXER stage uses a thin-film MIC (Microwave Integrated Circuit), IC10, for a stable tunable local-oscillator. See text for explanation of L10–L13, and C72 and C73.

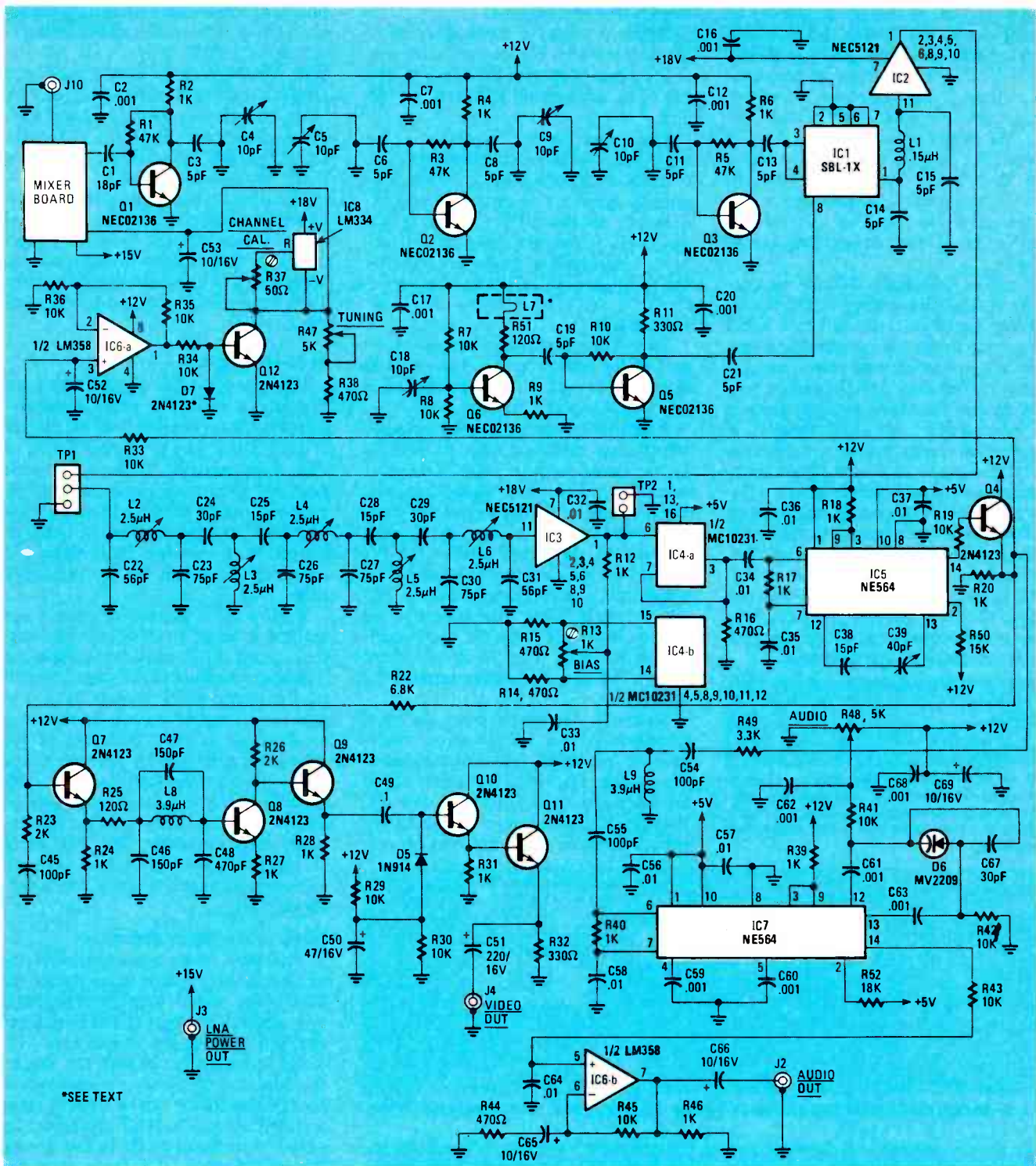

FIG. 7—RECEIVER uses two PLL's (Phase-Locked Loops), IC5 and IC7, to demodulate FM video and audio signals. Because those IC's can operate only up to about 50 MHz, IC4-a divides the 70-MHz second-IF frequency by two, generating a 35-MHz signal that they can handle.

Second-IF stage

The second-IF (or low IF) stage is responsible for most of the selectivity and gain of the receiver. Prepackaged gain-block modules, IC2 and IC3, provide about 60 dB of gain, and simplify the design and construction of the wideband (25 MHz) IF amplifier. The second-IF stage sets the noise bandwidth of the receiver and is optimized for low-threshold performance.

The bandpass-filter section of the second-IF stage is located between the two gain-block modules and is made up of a series of cascaded low-pass and high-pass networks. The 5-pole filter has input and output impedances of 75 ohms. Two test points, TP1 and TP2, are provided for use in sweep-alignment of the filter. Molded-plastic, slug-tuned inductors are used as tuning elements because they are temperature-

stable and offer repeatable results.

Demodulator

After leaving the second-IF stage, the signal is at a low enough frequency to be demodulated. The demodulator is designed to extract as much video and audio information as possible from the weak satellite-signal.

The design uses a simple PLL (Phase-Locked Loop), but in a rather unusual manner. Most PLL IC's have a difficult time tracking wide swings—especially at 70 MHz—and the satellite signal is

PARTS LIST

All resistors 1/4-watt, 5% unless otherwise specified

R1, R3, R5—47,000 ohms
 R2, R4, R6, R9, R12, R17, R20, R24, R27, R28, R31, R39, R40, R46, R50—1000 ohms
 R7, R8, R10, R19, R29, R30, R33-R36, R41-R43, R45—10,000 ohms
 R11, R32—330 ohms
 R13—1000 ohms, trimmer potentiometer, PC-mount
 R14-R16, R38, R44—470 ohms
 R18—15,000 ohms
 R21—1000 ohms, 1 watt
 R22—6800 ohms
 R23, R26—2000 ohms
 R25, R51—120 ohms
 R37—50 ohms, trimmer potentiometer, PC-mount
 R47, R48—5000 ohms, potentiometer, linear taper
 R49—3300 ohms
 R52—18,000 ohms

Capacitors

C1—18 pF, ceramic disc
 C2, C7, C12, C17, C20, C59, C60-C63, C68—.001 μ F, ceramic disc
 C3, C6, C8, C11, C13-C15, C19, C21—5 pF, ceramic disc
 C4, C5, C9, C10, C18—10 pF, piston-type trimmer (Stettner 120-05—do not substitute!)
 C16, C32-C37, C56-C58, C64—.01 μ F, ceramic disc
 C22, C31—56 pF, ceramic disc
 C23, C26, C27, C30—75 pF, ceramic disc
 C24, C29, C67—30 pF, ceramic disc
 C25, C28, C38—15 pF, ceramic disc
 C39—4-40 pF, trimmer
 C40—not used
 C41—2200 μ F, 25 volts, electrolytic

C42-C44, C52, C53, C65, C66, C69-C71—10 μ F, 25 volts, electrolytic
 C45, C54, C55—100 pF, ceramic disc
 C46, C47—150 pF, ceramic disc
 C48—470 pF, ceramic disc
 C49—.1 μ F, Mylar
 C50—47 μ F, 16 volts, electrolytic
 C51—220 μ F, 16 volts, electrolytic
 C72, C73—see text

Semiconductors

IC1—SBL-1X, 1-GHz double-balanced mixer
 IC2, IC3—MC5121 broadband amplifier (NEC or other)
 IC4—MC10231 dual flip-flop
 IC5, IC7—NE564 phase-locked loop
 IC6—LM358 dual op-amp
 IC8—LM334 constant-current source
 IC9—not used
 IC10—V815 voltage-controlled oscillator (Watkins-Johnson or other)
 IC11—7815 15-volt positive regulator
 IC12—7812 12-volt positive regulator
 IC13—7805 5-volt positive regulator
 Q1-Q3, Q5, Q6—02136 microwave transistor (NEC—do not substitute!)
 Q4, Q7-Q12—2N4123 NPN transistor or equivalent
 LED1—Jumbo red LED
 D1-D4—1N4004, 1 amp, 400 PIV
 D5—1N914
 D6—MV2209 20-80 pF varactor diode
 D7—2N4123 or 2N2222, modified (see text)
 L1—.33 μ H choke
 L2-L6—2.5 μ H 4 1/2-turn variable slug-tuned inductor with shield can (Coilcraft 104-1 1/2T-3/4J-POS3 or equivalent)
 L7—see text
 L8, L9—3.9 μ H choke
 L10—1-inch length Teflon coaxial cable (see next part)

L11—1 inch length .141-inch diameter Teflon coaxial hardline (see next part)
 L12, L13—single loop 28-gauge enameled wire
 F1—3/8-amp slow-blow fuse
 J1—RCA phono jack, panel-mount
 J2-J4—RCA phono jack, PC-mount
 J5—2-pin molex plug, PC-mount
 J10—RG58U type "N," female
 JU1—28-gauge wire with 1-inch insulating sleeving
 JU2—Berg jumper clip (for TP1)
 TP1—3-pin Berg mini jack, PC-mount
 TP2—2-pin Berg mini jack, PC-mount
 S1—DPDT push-on, push-off, PC-mount
 T1—18 volts, 1 amp

Miscellaneous: PC boards (Mixer board to be made from .062-inch FR-4 material with 2/2-ounce copper and tin-lead plating not to exceed .0015-inches in thickness. Dielectric constant must be $4.83 \pm .15$), IC sockets, TO-220 heat sink, wire, 28-gauge sheet metal, enclosures, knobs, line cord, fuseholder, hardware, etc.

The following are available from Ramsey Electronics, 2575 Baird Rd., Penfield, NY 14526: Complete Sat-tec R2B satellite-TV receiver kit with pre-aligned 70-MHz IF and 1170-MHz oscillator sections, \$495.00; completely wired and tested Sat-tec R2B satellite-TV receiver, \$749.95; RM3 RF modulator, \$69.95; Watkins-Johnson V815 oscillator IC (IC10), \$125.00; AvanteK 120°K, 50-dB gain LNA, \$595.00.

The above prices include shipping and insurance charges to points in the U.S. and Canada. Overseas orders please add 15% to cover shipping. MC and Visa accepted.

wideband. Since the PLL, IC5, has a typical maximum working frequency of only 50 MHz, a way has to be found around that limitation for 70-MHz operation.

The solution is to use an ECL (Emitter-Coupled Logic) divider to divide the frequency of the input signal by two. That is done by IC4, a high-speed dual flip-flop. One half of that IC (IC4-a) is used as a divider, and the other half (IC4-b) as a bias source. Pins 14 and 15 of the IC are complementary logic-level outputs. Bias pot R13 is across those outputs and can be adjusted to provide any voltage between the logic-high and logic-low levels. When correctly adjusted, it biases the input to the flip-flop at a level that makes the 70-MHz signal cause the flip-flop to toggle, providing a 35-MHz output. Since both the bias source and the flip-flop are on the same chip, the bias source is temperature compensated.

The 35-MHz output from IC4-a can be tracked easily by the PLL. The only penalty is that the demodulated signal has only half its original deviation, but that can be compensated for later. A simple FM demodulator with a center

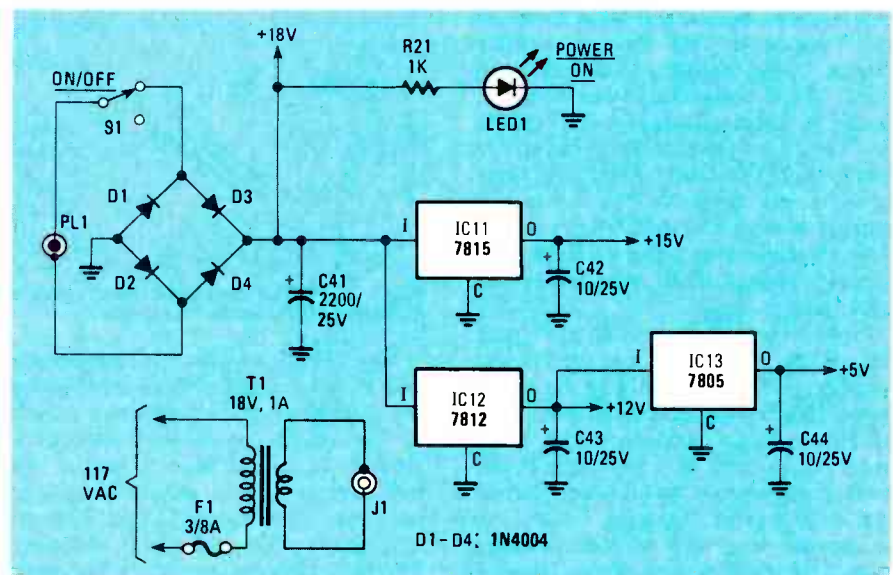

FIG. 8—POWER SUPPLY provides unregulated 18-volts DC, and regulated 5, 12, and 15-volts DC for receiver. Transformer is physically isolated from receiver to avoid drift due to component heating.

frequency of 35 MHz (determined by C38 and C39) is built around IC5. Transistor Q4, an emitter-follower stage, buffers the video and audio-subcarrier information from the PLL for the next stages of the receiver.

Video processor

The video output by the demodulator is "raw" video and must be processed before it can be viewed. The processing involves *de-emphasis* and *de-dithering*.
continued on page 104

BUILD THIS

AUTOMATIC Power Switcher

How many switches do you have to throw to get your computer or stereo system up and running? Build this power switcher and you'll need only one.

GARY McCLELLAN

ANY ELECTRONIC OR ELECTRICAL SYSTEM that uses a number of separately switched components can be a nuisance to power-up...all those switches to turn on, and then, having to remember to turn them all *off*! I had that problem with my Radio Shack TRS-80 computer system.

As it grew, I quickly realized what a headache powering-up can be, and tried all sorts of solutions, such as extension cords and outlet strips. They did the job, but lacked what I like to call "elegance," for there is nothing elegant about plugging in an extension cord! The solution is a power switcher. It can be used with computers, on the test bench, and even with stereo equipment where there are many things to be powered up. Basically, the device is a current-operated switch: when current-flow through one of the computer devices is sensed, that turns on all the other equipment.

In my computer application, I plug the video monitor into the power switcher. Then I plug each of the accessories into the outlets on the unit. Now all I have to do to power-up my computer is to turn on the monitor and everything springs to life! Not only is the arrangement "elegant," but I no longer forget to turn off the computer after a late-night session. Other bonuses include the fact that no warranty-voiding modifications have to be made to the computer or accessories, and that the power switch on each accessory still works. For example, the printer isn't used all the time, so it is simply shut off until it's needed. That's great for saving wear and tear on expensive mechanical components.

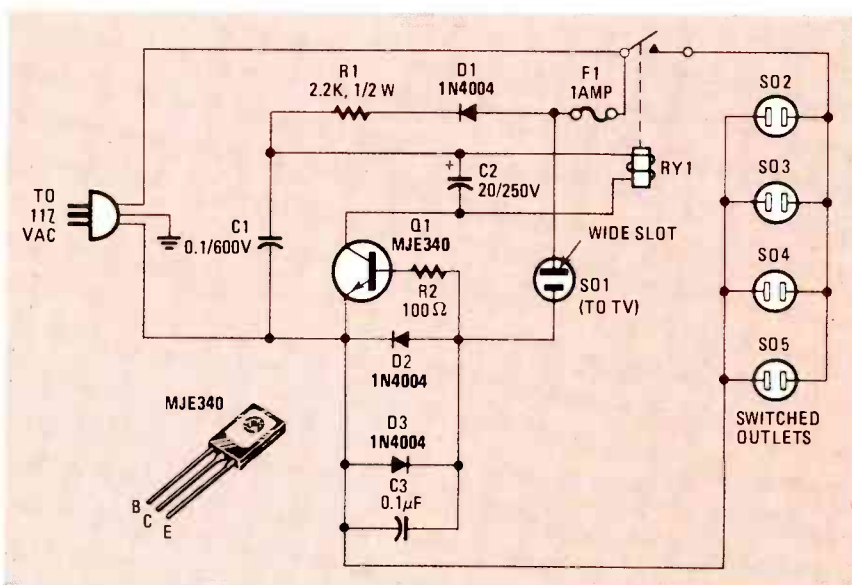

FIG. 1—IF POWER SWITCHER doesn't work with the Radio Shack video monitor, reverse the connections to SO1. See text for details.

The power switcher is inexpensive and easy to build. I built my version using junkbox parts, but I was careful to use readily available components. And, even if you have to go out and buy the parts, you should be able to keep the cost between \$10 and \$20 with reasonable effort and care in shopping. The switcher contains only a few parts, so construction should go quickly and easily. Building it should be a one-afternoon project.

How it works

Figure 1 shows a schematic of the power switcher. Note that diodes D2 and D3 are in series with the line to the monitor socket. That's because we

want the monitor to do the power switching. When it is turned on, it draws current, causing the diodes to conduct. That applies a 0.7-volt P-P signal to the transistor, causing it to conduct, and close the relay. Don't be concerned about the 0.7-volt drop to the monitor—that value is negligible when compared to the full 117-volt line voltage.

The rest of the circuit is used to power the relay, and for glitch suppression. Diode D1 and resistor R1 make up the relay power-supply. Capacitor C2 across the relay coil filters the voltage, and prevents chatter. Capacitors C1 and C3 are included to keep power-line glitches from the transistor, and to pre-

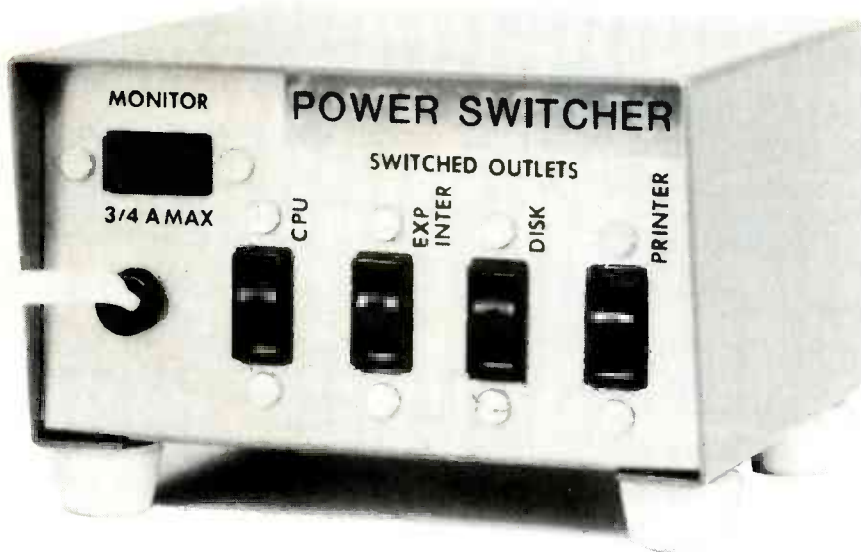

vent damage to the device. Finally, fuse F1 was included as a protective device for the video monitor, even though the monitor already has its own fuse. A little extra protection never hurt anyone.

Parts substitutions

One of the nice things about this device is that parts values are not critical and a wide range of substitutions are possible. That can reduce your cost dramatically if you have a well-stocked junkbox. Of course, there are reasonable limits as to how far you can go; those are dictated mainly by safety and reliability, which are the most important factors. Let's look at some areas where you may make substitutions—and then a few where you shouldn't.

The first thing that most people will probably want to find a substitute for is relay RY1, a 117-volt-AC relay with contacts rated at five amps. The original part used was designed for vacuum-tube circuits, and is known as a "plate-circuit relay". Those devices are still in use, and are sometimes available at surplus-electronics stores or by mail order. If you can't find a relay with a 10,000-ohm coil, you may substitute one with a 5000, or even 2500-ohm coil. If you happen to have a 117-volt-DC relay, and the coil resistance is 2000 ohms or higher, it may also be used. In any case, adjust the value of R1 so that the relay closes any time a load is connected to SO1. One thing you should make sure of when you select a relay is that its contacts are heavy enough to switch at least five amps of current. Although it is doubtful that you will draw that much current with a TRS-80 computer and its accessories, the extra capacity insures

safety and longer component-life. Relays in the five- to ten-amp range are easy to find.

Another part that many people will want to use a substitute for is transistor Q1. The original part is an NPN, 250 mA, 350-volt-CE (Collector-to-Emitter) breakdown-voltage devices, and is sometimes found in the audio output-stages of radios and TV's. Thus, you may be able to scrounge a usable transistor from such sources. Generally, the substitute transistor should have at least a 200-volt CE breakdown-rating, and be able to handle at least 100 mA of current. The gain really isn't important, since the device is used only as a switch. In fact, it might be possible to use an SCR, if you have one, in place of the transistor. Just be sure to replace C2 with a 1N4004 diode to suppress back-EMF, and make sure that the relay is an AC type. (Otherwise, the SCR will latch up when a load is applied to SO1, and you'll have to unplug the switcher to turn off the computer!) There are many substitutes for the MJE-340, though, if you don't have one.

There are other components for which substitutes are available. The diodes may be replaced by devices with a higher current-capacity or PIV rating. Diode D1 should have at least a 200-PIV rating though. The ratings of the other two diodes, D2 and D3, aren't as important because neither diode will see more than 0.7 volts.

Some substitutions are permissible for the capacitors, although it is suggested that C1 be a Mylar type; they handle line-voltage glitches better than ceramic discs. The other capacitors aren't critical.

If any of your equipment has three-prong plugs, you will want to change SO2-SO5 to 3-pin receptacles as required. That way you can avoid the headaches that adaptor plugs tend to cause, and still have your equipment grounded properly.

If you do make any substitutions, make sure that all parts you use are in good condition for maximum safety and reliability. If there's any doubt, spend the little extra cash necessary to get parts that you know you can trust!

Construction

Caution: The switcher is connected directly to the power line and can present a shock hazard if assembled incorrectly. It is suggested that you use extra care in assembling it. Also, it is recommended for safety reasons that you do not substitute for the three-wire power cord and metal cabinet.

Let's start construction. The layout, which is not critical, will depend to a large extent on the components you are using. The first step (after obtaining the parts) is to lay them out in the box to determine where they should be mounted. In the prototype, the line cord and sockets were mounted on one end of a box that measured $4\frac{1}{2} \times 4 \times 2\frac{1}{2}$ inches. The relay and fuse were attached to the bottom of the case. The rest of the circuit, mounted on a long terminal-strip, was then attached to the bottom of the box. Figures 2 and 3 show details of the layout.

Drill the holes for the power cord and sockets. Then turn to the installation of the relay and circuitry. Generally, those components can be mounted on the bottom of the box, unless you have a plug-in type relay; in that case, mount

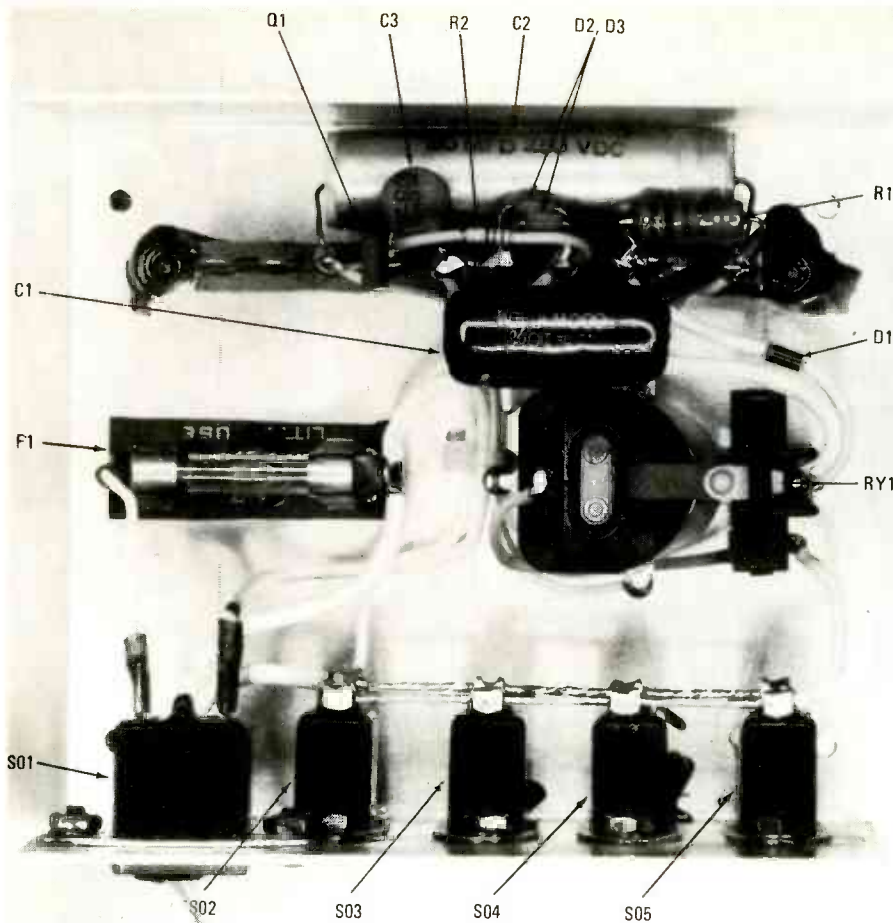

FIG. 2—MAJORITY OF COMPONENTS can be mounted on an 8-lug terminal strip. Be sure to use heavy-gauge wire to handle line voltage and current safely.



FIG. 3—THIS PARTICULAR VERSION of power switcher did not require 3-wire line cord, but yours probably will. Make sure that the ground wire makes good contact with case.

the relay socket on an "L" bracket. Locate the terminal strip near the relay. The fuseholder should go near SO1, to which it will be connected. After component locations have been determined, drill the mounting holes for them. If you like, the outlets can be labelled with press-on letters, which will make them more convenient to use.

All the electronic components (resistors, capacitors, diodes, etc.) can be mounted on the terminal strip. Use "spaghetti" insulating tubing to keep component leads from shorting together. Be sure to observe polarities, especially in the case of the transistor (see the inset in Fig. 1). When the terminal strip

PARTS LIST

All resistors 1/4-watt, 5% unless otherwise specified

R1—2200 ohms, 1/2-watt, 10%

R2—100 ohms

Capacitors

C1—0.1 μ F, 600 volts, Mylar

C2—20 μ F, 250 volts, electrolytic

C3—0.1 μ F, 25 volts, ceramic disc

Semiconductors

Q1—MJE-340 or equivalent (see text)

D1-D3—1N4004 (1 amp, 400 PIV)

F1—1 amp fuse

SO1—polarized chassis-mount socket

SO2-SO5—nonpolarized chassis-mount socket

RY1—10,000-ohm plate-circuit type with SPST, 5-amp contacts (see text)

Miscellaneous: aluminum box, 3-wire power cord with plug, strain relief for cord, clip-type fuse holder, 8-lug terminal strip, relay socket and bracket (if required), wire, solder, etc.

is finished, mount it on the bottom of the enclosure.

The next step is the chassis wiring. Remember that it will be carrying fairly high voltages and currents, so be sure to do the best job that you can. Mount the line cord and strain-relief, sockets, relay, and fuseholder. Then start the wiring by busing together the lower terminals of SO2-SO5 with a piece of No. 18 solid wire (or tinned No. 18

stranded wire). Do the same with the upper terminals. Then connect the line cord as shown in the schematic. Finally make the appropriate connections to the terminal strip and relay. Finish up by checking over your wiring for errors and correcting any that you find.

Safety checks

Naturally, you are in a hurry to try this power switcher—but **check it out first**. Since it connects directly to the AC power-line, it is a good idea to take the time to be sure that the unit is safe for use. First, inspect the wiring to be sure that there are no shorts to ground (the case) or between adjacent wiring. Correct any shorts that you may find.

Then make sure that all connections are properly soldered: it's easy to miss a joint, especially on the terminal strip. While you're checking the wiring, make certain that the line-cord's ground wire (from the round prong on the plug) is in good contact with the case. Finish up by checking continuity between the case and the prongs of the line-cord plug. The resistance should be infinite on any ohmmeter range, except in the case of the round ground-prong, where you should see no resistance. If any of the readings are incorrect, recheck your solder connections, and look for any dirt or contamination between a connection and ground.

Operation

Assuming that you're using the power switcher with a computer, plug it and its accessories into SO2-SO5. Then plug the monitor into SO1 and the switcher's line cord into a wall outlet. Turn on the computer and accessory power switches, and then turn on the monitor. The entire system should spring to life, and you'll be all set to enjoy a computer system that's easier to use. To finish up, you may want to install the switcher under your operating table, as I did with the prototype, or conceal it some other way.

If you have trouble getting the switcher to turn on with the monitor, simply reverse the connections to SO1. The Radio Shack monitor has a half-wave rectifier in it that draws current on half cycles of the line-current, and reversing the connections causes the monitor to draw current on the same half cycle that is used to trigger the switcher. (That should not be a problem with the other accessories.)

You can also use the power switcher to operate other devices. One application that comes to mind is using a turntable to control an entire sound-system. Simply plug the turntable into SO1, and the other components of the system into the other sockets. That's all there is to it! Once you've built it, I'm sure you'll find many uses for this power switcher.

R-E

HOW TO DESIGN ANALOG CIRCUITS



If a circuit is not designed properly, the likely result will be a device that does not work, or a pile of charred components. Learn the right way to design analog circuits that use semiconductor components in this new series.

MANNIE HOROWITZ

AT ONE TIME OR ANOTHER, ANYONE interested in electronics (either as a hobby or on a professional basis) has needed a circuit to perform some special function. Most of us have found, however, that it is almost impossible to design a circuit properly using haphazard techniques. That is especially true of circuits that use semiconductors. If proper techniques and procedures are not followed, the end result is likely to be either nothing or a bunch of charred components.

In this series of articles our goal will be to teach you how to design analog circuits that use semiconductors. Each article will cover one or more specific semiconductors. As we will be starting from scratch, some of the things we'll be talking about may seem ridiculously simple to some of you. That material will be presented for the sake of the novice, as well as for continuity. The

only things we will assume is that you have a basic knowledge of such things as current and voltage, as well as some familiarity with components such as resistors, capacitors, and inductors. (If you do *not* have a background in those subjects, we suggest that you read a book on basic electronics first. Your local library is an excellent place to look for one.)

Only what you need to know to do actual designs will be covered here. Derivations of formulas will be avoided except where they help make the design procedure clear. When a formula is presented, an example showing you how to apply the formula will also be provided. Do not try to memorize any of the formulas or derivations; simply make a note of where they are so that you can refer to them when you need them.

Before we get much farther, let's

speak briefly about some of the numbers we will be using. Many of the numbers used in electronics are either very large or very small. Writing numbers such as 100,000 or 0.000001 continuously can get tedious. It is a lot easier to write those numbers using scientific notation or *exponents*. In scientific notation, 1000 becomes 10^3 and 0.001 becomes 10^{-3} .

Special prefixes are also used to denote powers of 10. Some of the most common are kilo (10^3), mega (10^6), giga (10^9), milli (10^{-3}), micro (10^{-6}), nano (10^{-9}), and pico (10^{-12}). As an example, 0.001 volts would be written as 1 millivolt.

Conductors, insulators, and semiconductors

When the electrical characteristics of different materials are considered, they can be divided into three not-so-exacting

groups. Those are conductors, semi-conductors, and insulators. Most of us are familiar with conductors and insulators—but what about semiconductors? A semiconductor is defined as a material whose conductivity falls somewhere between that of an insulator and a conductor.

Most semiconductors use either germanium or silicon as the base element. Because those elements are good insulators in their pure form, they are mixed with another material to form the useful semiconductor; that mixing is called *doping*. Doping the base material has two consequences: The conductivity of the base material is increased and, depending on what is used for the doping, the base material picks up either an excess or shortage of negative charge. A semiconductor with an excess of negative charge is called *n-type*; a semiconductor with a shortage of negative charge is called *p-type*.

Semiconductor materials have a wide variety of properties. Their resistance varies with the voltage across them, with changes of temperature, and with the amount of light that strikes them. In addition, any device made up of a semiconductor material is to some extent sensitive to magnetic fields and can be considered to be a *Hall-effect* device. (We'll talk more about Hall-effect devices later.)

Varistors

A semiconductor device whose resistance varies with the voltage across it is called a *varistor* or voltage-dependent resistor. Because of their structure, those devices are often called varistor diodes or current-limiting diodes.

The difference between an ordinary resistor and a varistor is that while the resistance of an ordinary resistor is constant, the resistance of a varistor changes with voltage. In that device, the resistance is very low at high voltages. As the voltage decreases, the resistance increases. Ohm's law, of course, applies here—just the resistance of the device changes. In most varistors, the polarity of the signal is unimportant, although there are some devices where it is. Just like a resistor, a varistor dissipates power and, as with any other device, the maximum ratings of a varistor should not be exceeded.

Let's see how we can make use of the characteristics of a varistor. The circuit shown in Fig. 1-a consists of a power source, switch, resistor, and inductor. When the switch is closed, current flows through the resistor and inductor. Steady-state current is limited to safe levels because of the presence of the resistor. When the circuit is broken by opening the switch, a high voltage is developed across the inductor because of the rapid change in cur-

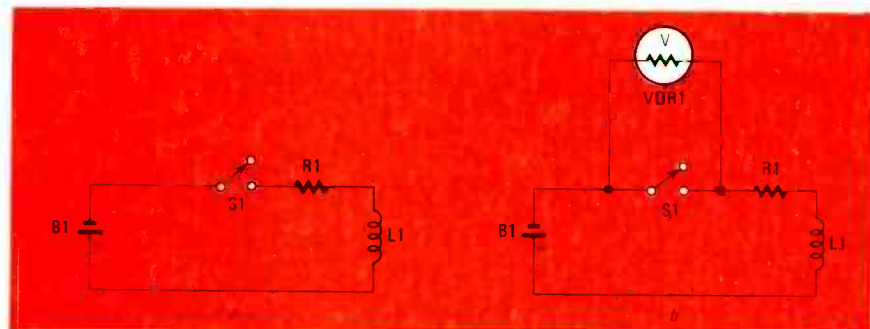

FIG. 1—A VARISTOR can be used as a current limiter. Opening the switch in the circuit shown in a would cause a current surge (due to the presence of the inductor) that could damage the switch contacts. Placing a varistor in the circuit as shown in b would protect the contacts.

rent through that inductor. Since that high voltage is also across the switch, the switch contacts could be damaged if they are not protected. One way to protect the contacts would be to wire a varistor across the switch as shown in Fig. 1-b. In that circuit, the resistance of the varistor is very small when the switch is first opened, because the high-voltage developed by the inductor is applied across the device. That low resistance keeps the instantaneous voltage across the switch low, protecting the switch contacts. The varistor has no effect on the circuit with the switch closed, because the switch shorts out that device.

If you wish, the varistor could have been wired across the inductor instead. Despite the fact that it would be in the circuit even while the switch is closed, it would not affect the circuit's operation because the steady-state DC voltage across the inductor is low. As that low voltage would also be across the varistor, its resistance would be extremely high and thus negligible when compared to the resistance of the inductor.

Thermistors

A thermistor is a semiconductor device whose resistance changes with changes in temperature. A thermistor whose resistance increases with increasing temperature is called a positive-coefficient device; one whose resistance decreases with increasing temperature is called a negative-coefficient device. For the sake of simplicity, we will deal exclusively with negative-coefficient thermistors in this discussion, although most of what we will say can also be applied to positive coefficient devices.

How much the resistance decreases with temperature is a function of the particular device used. As a general rule, however, the resistance decreases by about 4% for each degree Celsius that the temperature rises (above 25°C). Once you know the resistance of 25°C, it is a fairly simple matter to calculate the resistance at any higher temperature—simply multiply the resistance by 96% for each degree over that temperature. For example, if the resistance is

250 ohms at 25°C, it is $250 \times 0.96 = 240$ ohms at 26°C, $240 \times 0.96 = 230.4$ ohms at 27°C, $230.4 \times 0.96 = 221.2$ ohms at 28°C, and so on. Another characteristic of a thermistor is that there is a time delay from when heat is first applied to the device until it reaches its final temperature, again assuming that all of the heat is supplied by an external source. That "thermal time constant" rating indicates the amount of time it takes for the temperature of the thermistor to rise to about $\frac{5}{8}$ of its final value.

So far, we've assumed that all the heat is supplied by an outside source and none is developed by the thermistor itself. Of course, if you apply enough voltage to a thermistor, some heat will be generated. Assuming this time that there is no external source of heat, the resistance of a thermistor will remain constant up until the applied voltage exceeds a certain critical point. With no change in resistance, the current through the device increases linearly with increasing voltage. Once the critical point is reached, however, the device begins to heat up and the resistance begins to drop. When that happens, the current will increase at a faster rate than the voltage. That critical point is called the *self-heating voltage*.

The last characteristic that we'll look at is the thermistor's dissipation constant. That constant indicates how much power must be dissipated by the device to increase its temperature by 1°C. If, for example, the constant is 0.6 mW-per-°C, the thermistor must dissipate $0.6 \times 20 = 12$ mW if its body temperature is to rise by 20°C.

Sometimes you may find that you need to alter the thermal characteristics of a thermistor you have on hand to make it useful for some particular application. That would not be necessary if an infinite number of different types of thermistors were available, but that is rarely the case. The circuit in Fig. 2 is used for that. Just determine the minimum and maximum resistance that you require in your application and choose a device where the cold resistance is higher than the maximum resistance you require and the hot resistance is lower than the minimum resistance you

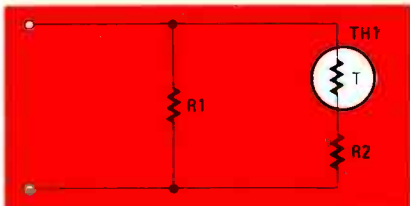

FIG. 2—THE RESISTANCE of a thermistor at different temperatures can be altered to fit the requirements of a particular application by properly choosing the values for R1 and R2.

need. Letting R_{TH} be the hot resistance of the thermistor and R_{TC} be its cold resistance, R1 and R2 in Fig. 2 can be determined from the following relationship:

$$R_H = \frac{(R_{TH} + R_2) R_1}{R_{TH} + R_2 + R_1}$$

$$R_C = \frac{(R_{TC} + R_2) R_1}{R_{TC} + R_2 + R_1}$$

Where R_H is the hot resistance required by the circuit and R_C is the cold resistance required.

As an example, let's assume that for a particular application you need a thermistor with a resistance that is 440 ohms at 25°C and 240 ohms at 50°C. You have a thermistor on hand with a resistance specified as 600 ohms at 25°C and 210 ohms at 50°C. Substituting into equations 1 and 2, you end up with:

$$240 = \frac{(210 + R_2) R_1}{210 + R_2 + R_1}$$

$$440 = \frac{(600 + R_2) R_1}{600 + R_2 + R_1}$$

Solving for R1 and R2 we get:

$$R_1 = 1218 \text{ ohms}$$

$$R_2 = 89 \text{ ohms.}$$

Because those values are not standard, they will be expensive to buy, if you can find them at all. But using standard, readily available values such as 1200 ohms for R1 and 91 ohms for R2 will be acceptable for most applications.

There are quite a number of practical applications for the thermistor. Among the more common is in a temperature-measuring circuit, as shown in Fig. 3. Here, the device is connected in series with a milliammeter and a voltage source. The current flowing through the meter is, by Ohm's law, equal to the voltage divided by the resistance of the thermistor. As heat is applied, however, the resistance of the thermistor

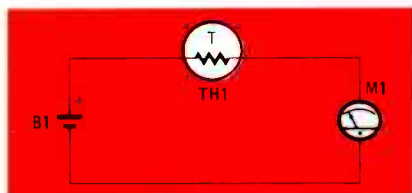

FIG. 3—A THERMISTOR can be used to measure temperatures. This simple circuit shows one way to do that.

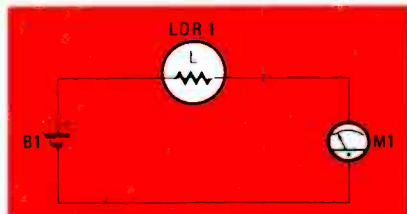

FIG. 4—A SIMPLE LIGHTMETER can be made using a photoresistor. For such an application, the photoresistor should be equally sensitive to all visible wavelengths of light.

changes. Thus the current flowing through the circuit and the meter changes with temperature. It is a simple matter to calibrate the meter's scale in order to indicate the temperature at the thermistor.

Another important application of the thermistor is in limiting current surges. The life of light bulbs, rectifiers, etc. would be shortened if a large current flowed through any of those devices at the instant power was applied. If a thermistor were placed in series with any device, its high cold resistance would limit that surge current. If the thermistor is properly chosen, its resistance will be large enough to limit the surge to reasonable and safe currents when it is cold, and be low enough not to affect the circuit when it is hot.

Photoresistors

As we noted earlier, not only is the resistance of semiconductor material dependent upon temperature and applied voltage, but it also varies with the amount of light that hits it. The photoresistor takes advantage of the fact that semiconductor materials are sensitive to light. The resistance of the device varies *inversely* with the intensity of the light striking it. (The more intense the light, the less resistance.)

The wavelengths of visible light vary from about 330 to 800 nanometers (3300 to 8000 angstroms). Different photoresistors respond to different wavelengths—the wavelength to which a particular device is most sensitive, depends upon the basic material used for the semiconductor, and upon the percentage of impurities added to the basic material. Because the device is made from semiconductor particles, the wavelength sensitivity also depends upon the size of those particles. In-

ciently, most photoresistors will respond to a wide variety of wavelengths, including wavelengths in the infrared and ultraviolet regions; those wavelengths are beyond the range of the human eye and are thus invisible.

Without getting into the physics involved, there are two units commonly used for light intensity: those are *foot-candles* and *lux*. The greater the number of foot-candles or lux hitting the photoresistor, the greater the intensity of the light source, and the lower the resistance of the photoresistor. You should also note that the intensity varies with the inverse square of the distance from the light source. For a fixed light source at 5 feet from a surface, let us assume that the intensity of light at the surface is I. Now increase that distance to 10 feet. Because the distance from the source has doubled, the intensity is now $I/2^2 = I/4$. If the distance were tripled to 15 feet, the relative intensity is $I/3^2 = I/9$, and so on.

Photoresistors are used in many different types of devices. The obvious one is its application in measuring light intensity when taking photographs. Because color is an important factor in that application, semiconductor devices that respond to the entire visible spectrum should be used. A circuit for that application is shown in Fig. 4. In the absence of light, the resistance of the photoresistor is high; thus very little current from the battery will reach the meter. If the sensitivity of the meter is low, the pointer will not be noticeably deflected. With increasing light intensity, the resistance of the photoresistor drops. Now more current can flow in the circuit; that will be indicated by the meter. The higher the intensity, the greater the deflection of the pointer. Calibrating the meter is simple.

Another, more common use for the photoresistor is to control a relay, that in turn is used to control some device or appliance. A circuit that can be used to turn a lamp on at night is shown in Fig. 5. Here the photoresistor is across the relay. The photoresistor and R1 form a voltage divider. During daylight hours, the resistance of the photoresistor is low, and therefore most of voltage is across R1. The voltage across the relay coil is too low to establish the magnetic field necessary for the contacts to close. As night falls, the re-

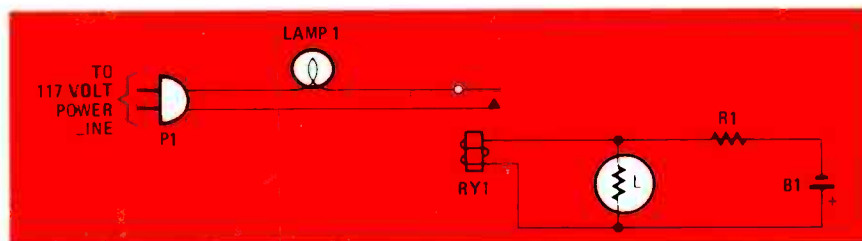

FIG. 5—A PHOTORESISTOR and a relay can be used to turn a lamp on at nightfall. The circuit will turn the lamp off at dawn.



THERMISTORS ARE HOUSED in a wide variety of enclosures for different applications. Among the enclosures shown here are ones for air, water, and surface temperature measurement.

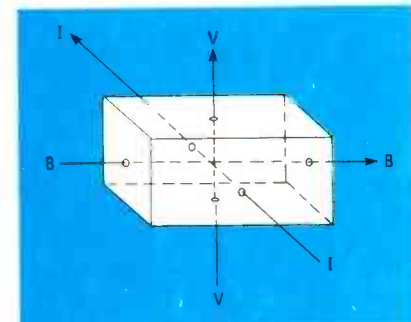

FIG. 6—THE HALL EFFECT is shown here. With a magnetic field B , and a current I as shown, a voltage V will be generated that is perpendicular to both B and I .

The Hall effect

Perhaps the easiest way to describe the Hall effect is with an illustration, such as the one in Fig. 6. In that figure, the cube is a piece of semiconductor material. If the cube were placed in a magnetic field B , and a current I flowed through it, then a voltage V , perpendicular to I and B would be generated. The voltage that is generated is proportional to the product of I and the magnitude of B . If either the current or the magnetic field are missing, no voltage will be generated.

One of the most important applica-

tions of the Hall effect is to measure the field strength of a magnet. In that application, a voltmeter is connected so it can measure the voltage generated. If the current is held constant, the voltage will be *directly* proportional to the magnitude of the magnetic field. (The higher the voltage, the greater magnitude.) Again, it is relatively easy to calibrate the meter to give a direct readout of the magnitude of the magnetic field. That application may seem unimportant, but its principles can be extended to give you a way to measure a DC current flowing in a conductor. As the magnitude of a magnetic field is related to the DC current in the conductor, if the voltage across the conductor is known (measured from end to end), the Hall effect lets you determine the current through it—without breaking the wire—simply by measuring the magnetic field.

Note that the output voltage due to the Hall effect has a specific polarity. That polarity depends upon the directions of the magnetic field and the current. The polarity is also a function of the type of semiconductor material used. If it is n-type, the polarity will be opposite from the polarity when p-type material is used. Thus the Hall effect can be used to determine the type of semiconductor material. The easiest way to apply that is to note first the polarity of the voltage when a known type of material is used. Next substitute any unknown semiconductors. Compare the polarity of the voltage. If it is the same, the semiconductors are the same type; if it is different, the semiconductor is of the opposite type.

The devices we've looked at this month have been relatively simple, yet they are quite useful in analog circuits. Be sure to include those devices in your arsenal. When we continue this series, we'll look at a device that is used in a wide variety of applications—the diode. **R-E**

sistance of the photoresistor increases, as does the voltage across the relay's coil. Once the voltage across the coil is high enough, the contacts close, turning on the lamp. The procedure is reversed at dawn, turning the lamp off again. Of course, safety should be a prime concern when building that, or any other, circuit. Wires should be rated high enough to handle the currents that they will be carrying. The relay's contacts should be capable of handling the switching that will be required without pitting, and be rated high enough so that there will be no breakdown or arcing.

Just as with any other device, a photoresistor has certain ratings that should not be exceeded. Never exceed the specified limits of voltage, current, or power; doing so will destroy the device, at the very least.

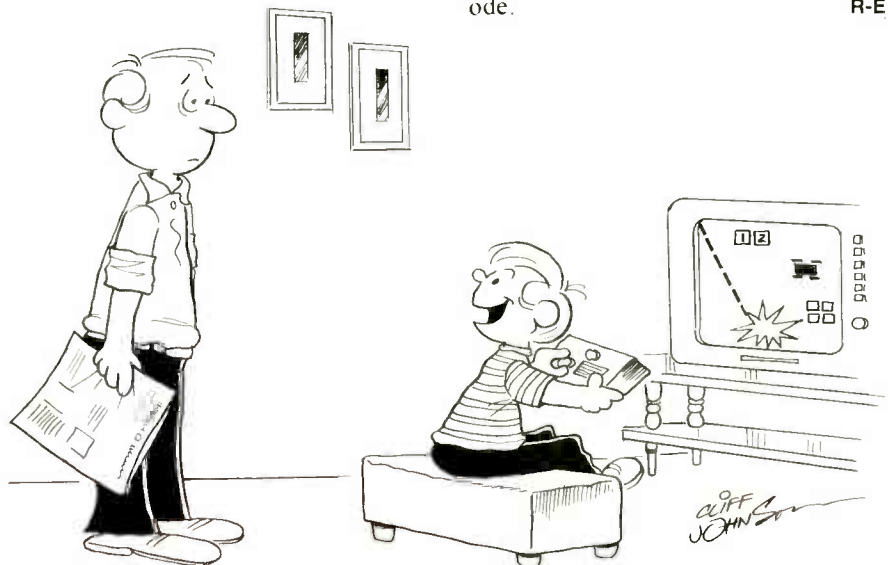

"These video war games sure are fun, Dad. ... I'll bet you didn't have this much fun in the real war!"

HOW TO

IMPROVE VIDEO SOUND



*Dissatisfied with the sound quality of the videotapes you make?
Here are several ways to improve it.*

LEN FELDMAN
CONTRIBUTING HI-FI/VIDEO EDITOR

HOME VIDEOCASSETTE RECORDERS, LIKE TV receivers, tend to place more emphasis on the quality of the picture than on that of the sound. While the color pictures reproduced from videotape are often indistinguishable from those obtained from good, off-the-air TV reception. The sound portion of those recordings, however, seem almost to have been tailored for reproduction by the small speakers and minimal-power amplifiers found in most table-top TV receivers.

If, however, you have ever connected the audio-output jack from your home

or portable VCR directly to your component stereo-system, you know that the frequency response of the soundtrack on a videotape is not all that bad. When VCR's are operated at their fastest speeds (0.79 ips for Beta-format machines or 1.31 ips for VHS machines) the audio response often extends to beyond 10 kHz, while the signal-to-noise ratio may be as high as 45 dB or more if high-grade tape is used. While those specifications are not outstanding in high-fidelity terms, they would be more than adequate for general use were it not for some steps that makers

of VCR's take to "simplify" the audio sections of their products.

Live-taping situations

Most VCR's are equipped with a single microphone-input and, in some cases, another high-level input. Home-video cameras usually have built-in omnidirectional microphones that are connected to a VCR by the multi-pin camera cable that has become fairly standard on this type of equipment. In any case, there is no means of controlling audio gain at the camera, nor is there a master level-control at the

VCR. The VCR is equipped with an ALC (Automatic Level Control) circuit that restricts the dynamic range of the audio severely.

The ALC can cause problems when the built-in camera microphone is used as the sole sound-pickup device in a home-videotaping setup. The reason is that, more often than not, the camera and microphone are several feet away from the subject being taped, and the resulting soundtrack has an echo-laden, reverberant quality that is incongruous when heard together with close-up views of the subject (taken with the aid of a zoom lens).

Background noise also increases, because the ALC circuit is doing what it was intended to do (maintaining a constant audio level—even if the only audio is irrelevant background-noise), and the effect is anything but natural-sounding. In addition, if the camera is hand-held or shoulder-supported (rather than being mounted on a tripod), one can often hear the sound of "heavy breathing" from the camera operator because of his proximity to the camera-mounted microphone and the "wide open" gain that is provided by the ALC circuitry.

The solution to the problem, obviously, is to use an off-the-camera microphone (or microphones), preferably of the directional or cardioid type. It can be kept just out of camera range, but still be positioned close enough to the subject or subjects being taped to give good solid audio.

Whether you choose a dynamic microphone or a condenser type, the plugs found on the higher quality, low-impedance microphones are not likely to fit directly into the miniature jacks found on most portable and home VCR's. However, adaptors that convert from one type of plug to another are readily available from electronics-parts stores.

Audio mixing

It's just one step from using a single external microphone to using several microphones and even some line-level program-sources (like music from records or tapes). Using multiple sources instead of the single-microphone approach is also preferable when dubbing a new audio-track onto your existing videotapes.

Shure Bros. (222 Hartrey Ave., Evanston, IL 60204), a well known manufacturer of phono pickups, microphones, and professional audio equipment and accessories, has introduced recently a small, 4-input audio mixer, the *model M267*. While it is intended for use primarily in audio-recording applications, the versatile, relatively inexpensive (\$395.00) mixer can also solve a lot of problems for serious videophiles who want better-quality soundtracks



FIG. 1—A MIXER, such as the Shure M267, allows you to use several microphones or other audio sources.

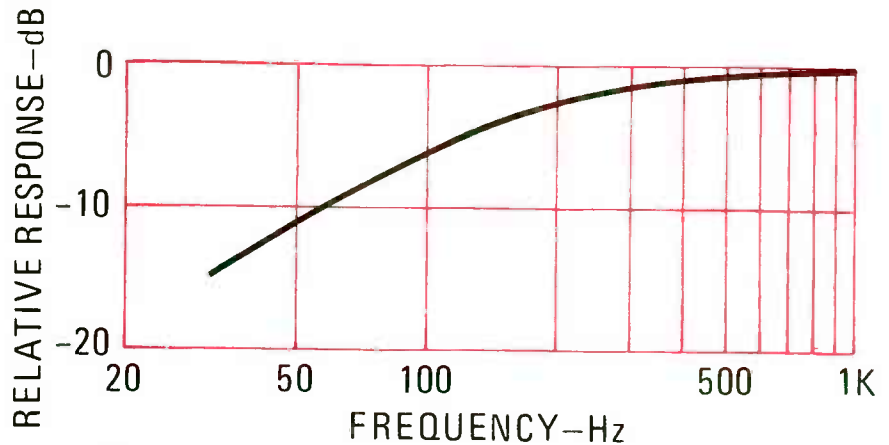

FIG. 2—LOW-CUT FILTERS can reduce the annoying effects of wind noise, turntable rumble, and other low-frequency sounds by decreasing low-frequency response.

on their tapes. (Shure also manufactures a *model M268* mixer that includes many of the features of the *model M267*, but sells for \$250.00.)

The *model M267*, shown in Fig. 1, has wide frequency-response (30 Hz to 20 kHz, ± 2 dB) and low distortion up to +18-dBm output (less than 0.35% at +15 dBm at any frequency within its passband), extremely low noise, and very low susceptibility to RF interference—a problem that can often crop up in an untested "field" environment.

Four switchable microphone or line-level balanced inputs with individual gain controls and low-frequency rolloff switches are provided, and the output is switchable for either line or microphone levels. Thus, if your video camera is equipped with only an external-microphone input (and there is no line-level input on your VCR), you can still get the benefit of good signal-to-noise ratios.

There's a built-in peak limiter—together with an LED peak-indicator—that can cut distortion due to overload; it can be switched in or out. The sensitivity of a small VU meter can be set for +4 or +8 dBm with a VU RANGE switch (normally, 0 dB on the meter is equal to +4 dBm; the +8-dBm setting is used to reduce sensitivity). The

meter is illuminated for easy reading when the mixer is AC-operated.

However, the *model M267* will operate either from AC or from an external battery pack. In case of an AC-line failure or power interruption, noiseless automatic switchover to the batteries takes place. Battery-charge condition can be checked at any time. A front-panel monitoring-jack will drive just about any mono or stereo headphones, and a separate level control is provided for the phones. Finally, a built-in 1000-Hz tone oscillator is incorporated for line tests and level checks.

The low-cut filters associated with each of the four LINE/MIC inputs provide a low frequency roll-off that follows the response curve shown in Fig. 2. The filters can be used individually with each input control to reduce wind noise or undesirable low-frequency signals, such as turntable rumble, or overly bassy voices caused by speakers or singers holding microphones too close to their mouths.

Better audio dubbing

Most of the owner's manuals supplied with VCR's suggest that the proper way to do audio dubbing (the process whereby a new soundtrack is substituted for the original one) on a videotape is

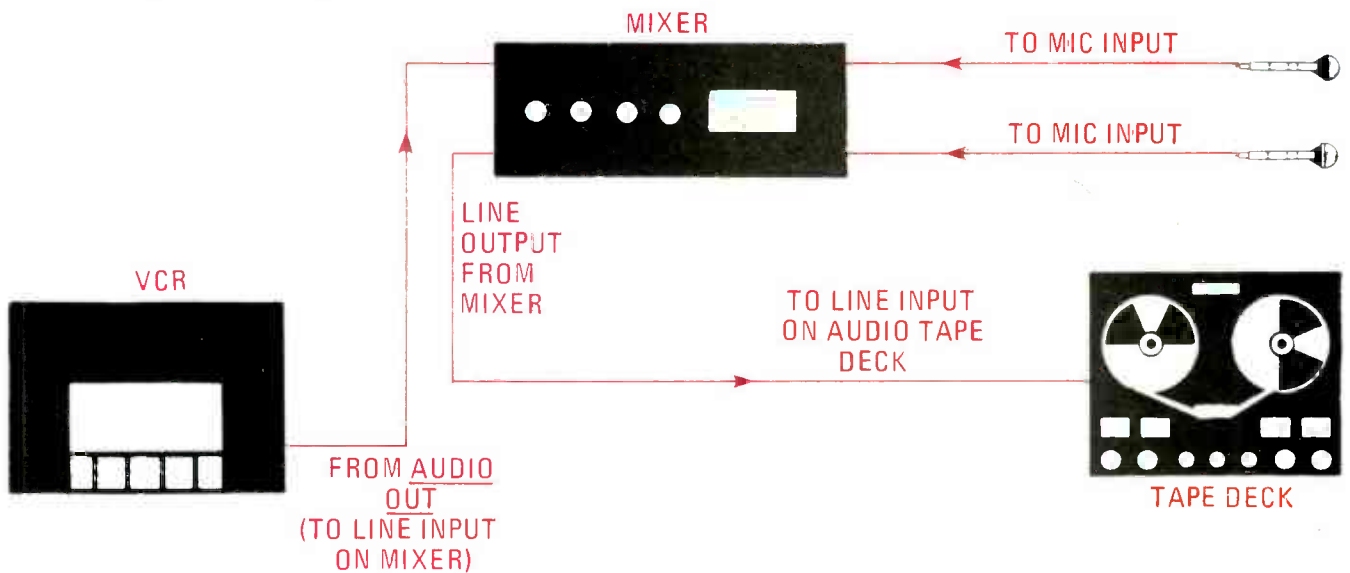

FIG. 3—A MASTER AUDIO TAPE is prepared by using a mixer to combine the original video soundtrack with new material.

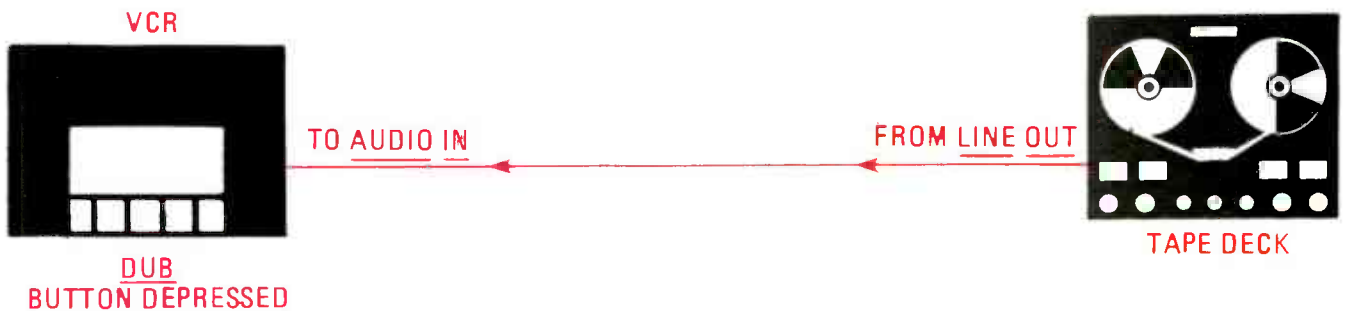

FIG. 4—THE ORIGINAL SOUNDTRACK is replaced by the new one by transcribing the master audio tape to videotape using the VCR's "dub" function.

simply to plug a microphone (or a mixer such as the one we have been describing) into the external-microphone jack of the VCR, hit the AUDIO DUB button, and substitute new audio for the old.

There are several disadvantages to that procedure. For one thing, it erases the original soundtrack, which you may want to include in the new sound mix. Secondly, working in "real time" and getting all the musical and voice portions to fit together, on cue, during the very first "take" is a rarity—if you've ever tried it, you know that the task can be extremely frustrating.

A much better technique involves transcribing the existing audio soundtrack from the videotape onto audio tape and, with the aid of a mixer, adding the additional microphone or line-level contributions, as shown in Fig. 3. If you don't get the "perfect" mix the first time, you have not destroyed the original videotape soundtrack and can try again—as many times as you need to get it right.

Figure 4 shows the hookup for the final audio-dubbing process. In that step, of course, it is necessary to synchronize the newly mixed audio master-tape with the VCR program using the audio-dubbing feature on your

VCR. The synchronization process is not as difficult as you may think, at least for scenes of relatively short duration. After all, the final mixed tape contains the original "live" soundtrack, which is already perfectly synchronized with the video. Since the same audio-tape deck is used both to record and playback the final mix, tape speed—even if not perfectly accurate—will be consistent for the brief periods needed to transcribe the new audio mix back onto the videotape via the audio-input jack on the VCR.

With practice, the PAUSE control on the VCR (which, in most cases, pro-

duces a still-frame picture on the screen), used in conjunction with the PAUSE button on your audio tape-deck, should permit a close-to-perfect audio-dubbing operation. (As for the VCR's speed stability, you don't have to worry because its tape-transport system is synchronized to the standard NTSC 30-frames-per-second picture rate.)

Imaginative use of a microphone/line mixer, together with playback through your sound system rather than through your TV set, can give your home-video productions near-professional audio quality.

R-E



"My Mom says it's a radio. ... Boy, it must take a lot of batteries to run one that size!"

BUILD THIS

UHF-TV PREAMPLIFIER

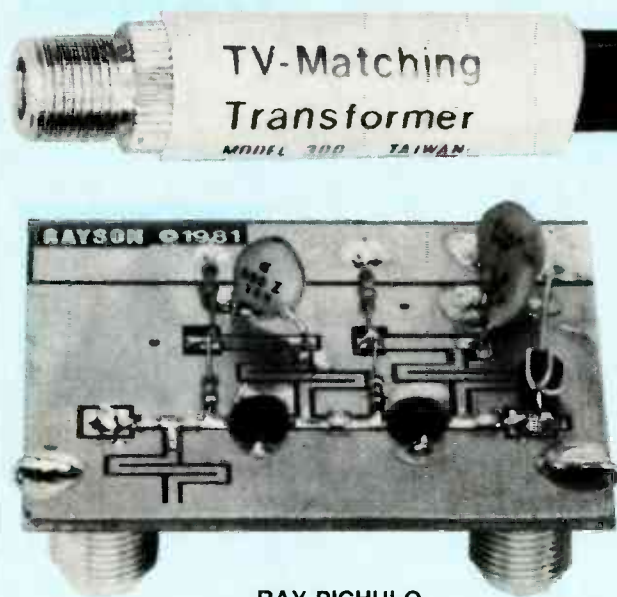

RAY PICHULO

This inexpensive UHF preamplifier can give you reception you never thought possible, especially if is used with a good antenna system and feedline.

Part 2 LAST MONTH, WE looked at the preamplifier that could improve your UHF reception. We'll finish up by showing you a balun for use with coaxial cable, but first, let's look at other factors that can affect your reception.

Today we find that, in most urban areas, receiving antennas are disappearing from rooftops. Indeed, many viewers are getting satisfactory results on VHF channels 2 through 13 using just built-in "rabbit ears." There may be several reasons for that: better VHF tuners, higher transmitter powers, better-located transmitting antennas, and—regrettably—the fact that many people just don't recognize poor picture-quality or know how to correct it.

Many of those viewers usually use a simple loop antenna attached to their TV sets' antenna terminals for UHF and don't care whether or not they get more than one or two channels—or even if they get anything at all.

As you travel out through the suburbs and into the near-fringe areas where an external antenna is still a necessity, you will probably notice that most of the installations use a single "combina-

tion" VHF/UHF antenna. While that may seem at first to be a good solution, the results are little different from those obtained by city dwellers with their "rabbit ears" and loops—while the VHF quality may be good, that of the UHF is, generally, fair or poor. A look at combination-antenna specifications will usually show that the performance of the antenna at UHF frequencies is poor, with little or no gain.

Let's take a moment to consider TV design-practices. Until recently, UHF tuners never even had an RF-amplifier stage. Even with the addition of such a stage in most of the UHF varactor tuners, sensitivity is lower and the noise figure higher than with VHF tuners. In many parts of the world, most TV broadcasting takes place at UHF frequencies and the receivers sold must meet certain UHF sensitivity and noise-figure criteria. (In simple terms, "noise figure" is the decrease in apparent signal-to-noise ratio caused by inherent system-noise.) Such needs don't exist for TV sets sold in the U.S.

The reception problem is compounded by the higher transmission-line and propagation losses inherent in UHF

transmission. Smaller antenna size, and therefore a smaller signal capture-area, is another factor contributing to poor UHF reception.

Improving the antenna system

Let's take the advice of the FCC and industry committee and see how an antenna system can be improved. The July 1981 issue of *Radio-Electronics* contains an excellent article with a comprehensive rating of many antennas with UHF capability that are now on the market. The first step is to get away from the ineffective ones, so we'll forget about loop antennas and take a close look at the UHF gain-specifications of the "combo" antennas. Unless the gain of those antennas is in the neighborhood of 7 dB or better on the UHF channels we are interested in, we should consider using separate UHF and VHF receiving antennas in areas where signal strength is not classified as "strong."

Probably the simplest effective UHF receiving antennas are the corner reflectors. Most of them will give at least 7 dB of gain. If more gain is required, either a combination corner reflector/

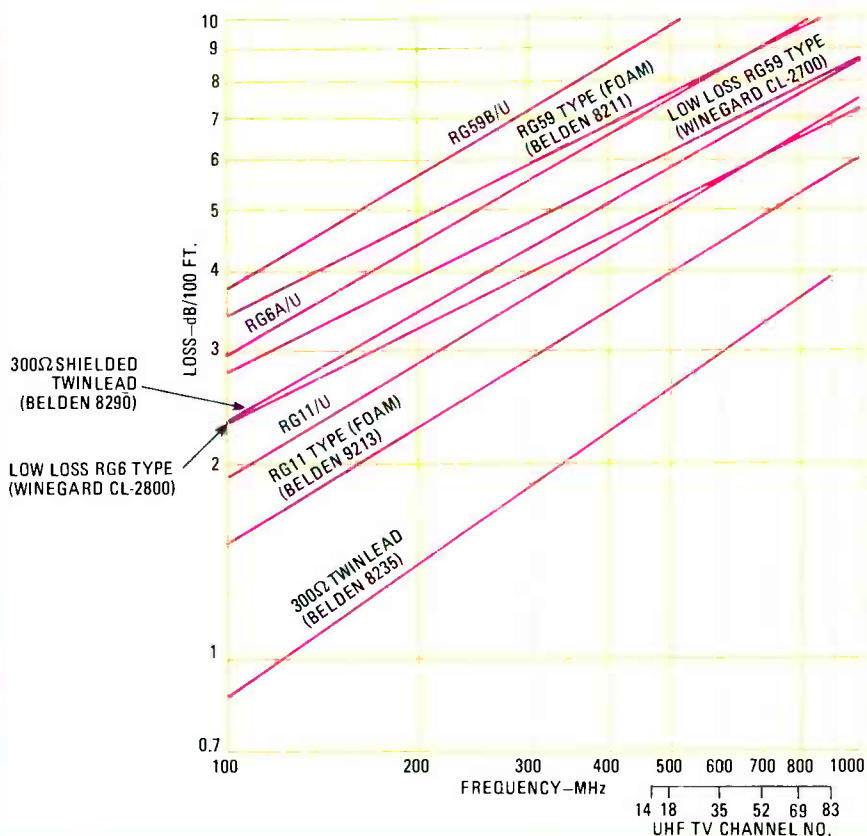

FIG. 12—LOSSES IN VARIOUS TYPES OF CABLE measured in dB/100 feet. Ordinary twinlead would seem to be best, but has serious shortcomings (see text).

yagi or a stacked 4-bay antenna can be used. Either can provide gains ranging from 8 to 15 dB, depending on their size and number of elements. Examples of corner reflector/yagi antennas are the Radio Shack *U-100* or the Winegard *CH-9085*. A good stacked 4-bay antenna that was recommended in the article is the Winegard *KU-420*. Antennas having even higher gains—on the order of 15 to 20 dB—are also available. They are of the parabolic-reflector type and are usually between 3 and 6 feet in diameter.

Before you buy any antenna, though, you should check the manufacturer's published gain-vs.-frequency data. Some of the curves may surprise you.

For example, most UHF antennas do not cover the full 70 channels (14 through 83). Instead, you will probably find that their best performance is in the range of channels 20 to 55, with a gradual dropoff above and below them. The reason is that channels 70 through 83 are allocated as translator-band channels, and channels 60 through 69 were originally reserved for subscription-TV use. At the low end of the band, channels 14 through 20, in many areas, are shared with the land mobile radio service. So, the design of most

antennas was optimized for the best gain on the middle channels.

In many cases, that won't be a major problem, but if you're interested in receiving high-end channels, you may want to look further into the catalogs. You'll probably discover that there are antennas optimized for the high end as well. They are usually called "T-band" or "translator band" antennas, and should be suitable for high-end channels.

Installation

After you've chosen an antenna, the next step is its installation. There are several considerations unique to UHF. The line-of-sight principle is the main concern; if it is at all possible, try to select an antenna site where the antenna has a clear shot at the horizon. Ideally, the elevation angle to the horizon should be 0 degrees; however, satisfactory performance can still be obtained with an angle to the horizon of up to ten degrees. Close-by obstructions are to be avoided. Buildings, trees, hills, or similar obstructions will seriously degrade the received signal. In some cases a mast or tower can provide the necessary extra height to clear obstructions. While the effects of steel-frame structures and hills is pretty

obvious, the effect of trees and foliage is not. Dense foliage can create a path loss of 20 dB or more.

Sometimes it may be impossible to get a clear line-of-sight shot to the transmitting antenna. Reception may still be possible using reflected or scattered signal. When that technique is used, though, the actual physical placement of the antenna becomes extremely critical because the signal is arriving via several different paths. Remember, we are dealing with wavelengths measured in inches, so a lateral or vertical move of only six inches can result in a change in signal quality.

Feedlines

The next item to consider is the feedline. Several types of feedline are available and most installers know that good quality, low-loss, feedline is important for UHF. Many, though, do not know what makes a feedline low-loss.

For example, many installers insist that you should never use coaxial cable at UHF frequencies because it is lossier than twinlead. Few people are aware, however, that the biggest contributor to coaxial cable's lossiness is its woven braid. UHF signals travel most efficiently in a straight line, something they can't do in a woven-braid conductor. However, low-loss coaxial cable using an aluminum foil or aluminized Mylar as a shield *does* permit the signal to travel in a straight line and has a significantly lower loss than the equivalent conventional coaxial cable (RG-59/U or RG-6/U).

The other major factor contributing to coaxial cable's loss figure is dielectric loss. That can be reduced by using

A kit of all parts for the UHF preamp, including power supply and balun (the balun will be discussed next month), is available for \$34.50 plus \$2.00 for shipping and handling. An assembled version is available for \$57.50 plus \$2.00 for shipping and handling. Both are available from:

RaySon Electronics Corp.
1010 12th St., Suite 5
Sparks, NV 89431

Micromart
508 Central Avenue
Westfield, NJ 07090
(201) 654-6008

Quest Electronics
P.O. Box 4430
Santa Clara, CA 95054
(800) 538-8196 (except CA)
(408) 988-1640

All suppliers accept MC and VISA. Please add sales tax where applicable.

foamed rather than solid dielectric-material in the cable. The effects of both factors can be seen in Fig. 12, which shows a comparison of the losses of various types of feedline used for UHF. At 470 MHz (channel 14) conventional RG-59 coaxial cable has a loss of 9 dB per 100 feet; the Belden 8211 foam-dielectric version of the same cable has a loss of 7 dB per 100 ft., while the Winegard CL-2700 low-loss cable (foam dielectric and solid shield) has a loss of 5.8 dB per 100 feet. Since a 3-dB loss represents a 50% power loss, the low-loss cable has more than twice the power-transmission efficiency of RG-59 cable. Larger diameter cable such as RG-6 or RG-11 has even greater efficiency because of the greater conductor spacing and the resultant lower dielectric-loss. Low-loss RG-6 type cable (CL-2800) is more efficient than shielded twinlead (type 8290).

So far, we've been talking about dry cable or twinlead. While moisture doesn't affect coaxial cable, because the dielectric is sealed in by the outer jacket, it *does* affect twinlead greatly. To see just how much, consider some figures supplied by Channel Master. At the low end of the UHF band (500 MHz) their best twinlead, type 9555 is twice as lossy wet as it is dry. The feedline has foam-clad conductors encased in a polyethylene jacket. As you go down the list, the feedlines listed have progressively less foam around the conductors, until you get to type 9561, which is more or less conventional twinlead with just a solid polyethylene web. The wet attenuation-factor of that feedline is 100 times or more greater than the dry attenuation-factors. (Remember: -20 dB represents a power reduction of 99%!)

That data should convince you that wet twinlead is to be avoided if at all possible. You should also bear in mind that the figures are for *new* cable. Exposure to the elements causes polyethylene to become contaminated, increasing its dielectric loss and, therefore, the loss of the cable.

On the other hand, coaxial cable is protected by an outer jacket, and degradation of the cable occurs much more slowly. Before the dielectric can become contaminated, the protection provided by the outer jacket has to fail. So although, at first, the lower losses of twinlead would seem to favor its use over coaxial cable, when you consider the life of an installation, coaxial cable gives better results.

Installing feedline

Many an otherwise good installation is ruined by poor feedline-installation. No matter which type of feedline you use, care must be taken to keep it away from power and telephone cables. At

least two inches separation should be maintained for coax; more in the case of twinlead. That precaution reduces the possibility of hum or noise pickup.

Where cables enter a building, feed-through bushings should be used—the cables should not be jammed under windows or doors!

If you are using twinlead, it is especially important to keep the cable at least four inches away from *all* metallic surfaces—gutters, downspouts, aluminum siding, the antenna mast, rotor cable, power cables, etc. In many cases that will prove to be a difficult or impossible task; that is when coax *should* be used.

Excess cable-lengths should be cut off, not wound into a coil or bunched up. That is particularly important in the case of twinlead, for you can end up unwittingly creating an RF choke. (Running twinlead down through a metal conduit, such as the mast, can have the same effect.)



FIG. 13—BOARD FOUND INSIDE balun, showing addition of 10 μ H choke and power leads.

Baluns

If you are using coaxial cable you will need two impedance-matching transformers, known as *baluns*. One must be of the outdoor type, because it is mounted between the outdoor preamp and the antenna. The other is used indoors, at the TV set. It must be modified slightly to form a "bias-T," which will permit both the TV signal and the current that powers the preamp to travel along the coax, while providing separate terminations for both at the set-end of the cable.

There are several baluns available that lend themselves very nicely to that application. Among the ones you might wish to use are the MCM Audio TVT-1, the RMS Electronics MA 1000UV, the Channel Master 0782 and the Arista 267A.

All the baluns mentioned have an "F" connector pressed into a short length of aluminum tubing with a pigtail of 300-ohm twinlead sticking out the other end. The aluminum tubing is covered with shrink tubing. To open a balun for modification, cut away the shoulder of the shrink tubing at the base of the "F" connector and then remove the connector, and the board attached to it, by pulling it out of the aluminum tubing. It may be necessary to use pliers for that operation; if so, thread a male connector on temporarily and grasp it

OOOPS!

The parts placement diagram (Fig. 8) that appeared in Part I of this article (March 1982) was inadvertently reversed. The correct diagram appears below.

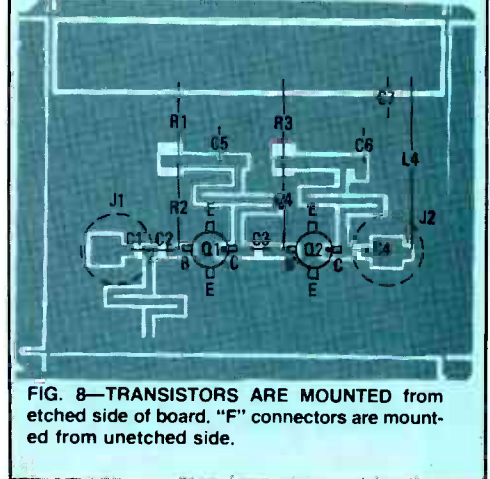

FIG. 8—TRANSISTORS ARE MOUNTED from etched side of board. "F" connectors are mounted from unetched side.

with the pliers. That will prevent any possible damage to the threads of the female "F" connector from taking place. (You may want to purchase a male-to-male connector for the purpose, since you will probably need it later when you connect the antenna balun to the preamp.)

All the baluns have three DC blocking-capacitors already built into them, so all that is necessary is to add a small choke. The choke, L1 in Fig. 11 (see last month's issue), is the same as choke L4 used in the preamp—3½ turns of No. 30 wire-wrap wire wound through a small ferrite bead. The bead is small enough to fit inside the transformer's housing. As shown in Fig. 13, one end of the No. 30 wire is soldered directly to the center pin of the "F" connector, while the other end is soldered to the rivet that secures the twinlead pigtail to the balun's circuit board. The rivet becomes the +V terminal and the positive lead from the power supply is soldered to it. The body of the "F" connector becomes the ground terminal and the ground lead from the power supply is connected to the connector by being soldered to the ground foil on the small circuit board.

The UHF preamp is easy to build and, when used with the type of antenna installation described, will do a lot to improve the quality of your UHF-TV reception. **R-E**

WHAT'S INSIDE

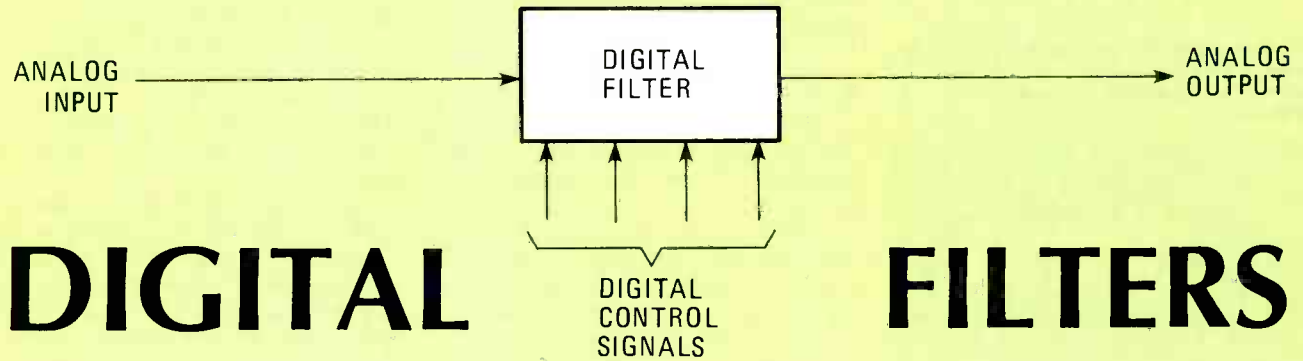

DIGITAL FILTERS

Filtering an analog signal using digital techniques is becoming more and more commonplace. Here is a look at digital filters and how they work.

ARTHUR MAKOSINSKI

TRADITIONALLY, ACTIVE AUDIO-FILTER designs have used either L-C or R-C networks in combination with phase- or gain-compensating amplifiers. While such filters are relatively simple and economical when designed for one or two frequencies, they become complex and expensive if required in large numbers, as, for instance, in a $\frac{1}{3}$ octave audio-spectrum analyzer. A device with a 20-Hz to 20-kHz range would require over 30 separate bandpass filters, or 360 precision capacitors and resistors for filter-tuning alone. That is in addition to the problems of achieving adequate temperature and amplitude stability, as well as maintaining acceptable reliability.

With the development of digital IC's in the late 60's, designing digitally controlled audio filters became possible. One of the first designs considered, was the digitization of the old mechanical commutating-filter; that filter is shown in Fig. 1.

Commutating filter

How the commutating filter works can best be understood by considering the simple low-pass section of Fig. 2 as an integrator with a time constant $\tau = RC$. If n such sections are cascaded and sequentially switched at a rate of f times per second, the net time-constant increases by n , so that the new time-constant $\tau = nRC$. That will yield a 3 dB low-pass response at $f_{LOW PASS} = 1/(2nRC)$.

If a signal at the commutating frequency, f_c , is now applied to the filter, each individual capacitor sees a particular—and fixed—average voltage (the voltage is dependent on the phase of the input frequency) each time it is switched into the circuit. Each capaci-

tor therefore charges to a fixed voltage, and as the individual capacitors are switched in, or commutated, the original signal is reproduced as a series of discrete values or steps.

The commutating filter is often called a comb filter because it will only pass signals with a frequency of f_c —the resonant frequency of the filter—and its harmonics. That response is shown in the graph of Fig. 3. If, however, only the resonant frequency is desired, low-pass filters can precede or follow the commutating filter, attenuating the other "teeth" of the comb.

In modern commutating filters, the commutating is done by shift registers or counters. Standard transistors, or FET's, can be used to switch the capacitors. Figure 4 shows an eight-section commutating filter in which the necessary sequential switching is done by a combination of a CD4040 BCD ripple counter and a CD4051 BCD-to-decimal decoder. The CD4040 counter is triggered by a squarewave clock signal. As the counter advances, on the negative-going clock transitions, the first 3 bits of its 12-bit BCD output are connected to the BCD input-lines of the CD4051 decoder. That IC translates the BCD code into sequential decimal steps that switch the internal CMOS transistors on and off; those transistors, in turn, switch the connected capacitors. In that circuit, the filter's frequency is a function of the clock rate, and the number of poles, or sections, in the filter. In

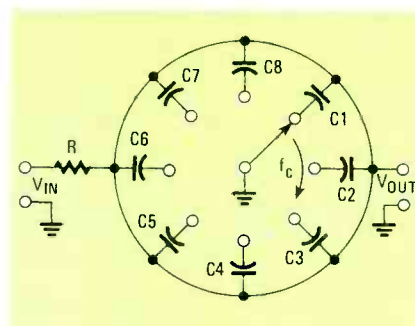

FIG. 1—A MECHANICAL commutating filter. If the input signal is equal to the switching frequency, the filter would reproduce the input signal at the output as a series of steps.

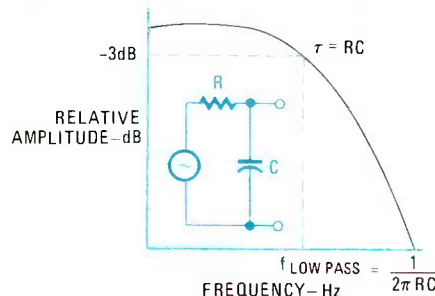

FIG. 2—THE RESPONSE of a simple low-pass filter is shown here. The time constant of the curve is determined by the values of R and C.

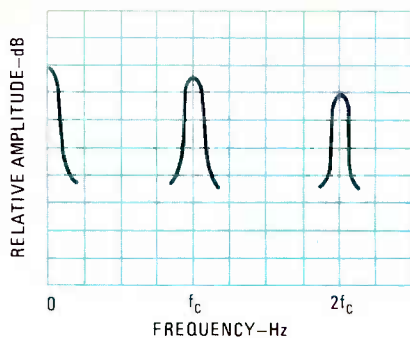

FIG. 3—A COMMUTATING FILTER can also be called a comb filter since, at resonance, it passes the fundamental frequency and its harmonics.

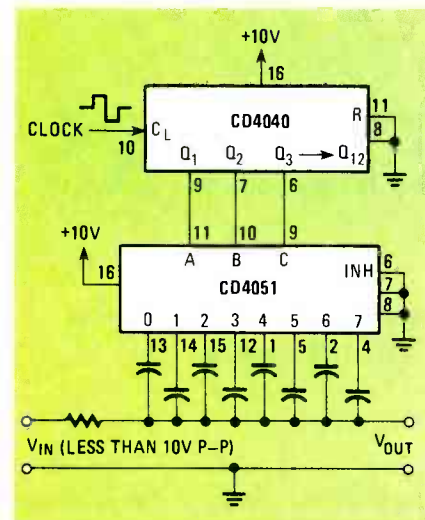

FIG. 4—USING A BCD COUNTER and 8-channel decoder IC's to control a commutating filter. The filter is tuned by changing the clocking frequency.

Fig. 4, since there are 8 poles, the filter's primary response frequency, in Hz, will be:

$$f_c = \text{clock frequency} \div \text{number of poles}$$

The filter will also pass the harmonics of f_c , and its bandwidth will be 2 divided by the number of poles, times the bandwidth of the single, original low-pass section. If the resistor's value is 10,000 ohms, and the capacitors are .01 μ F each, the filter in Fig. 4 will have a practical, continuous turning range of from 10 kHz to over 1 MHz, and a Q of 80.

One problem is that the CD4051 is not exactly an ideal switch. Its typical "on" resistance, with a supply voltage of 10 volts, is 180 ohms, and it increases as the supply voltage is lowered. While that will rarely affect performance, since the other resistances in the filter are generally much greater (consider the 10,000-ohm resistor we just mentioned), in some cases individual transistors would be better.

If you wish, additional decoders can be added to the other BCD outputs of the CD4040 ripple counter—altogether the CD4040 can drive five decoders. As more decoders are added, the filter's output becomes smoother

and its bandwidth becomes sharper. To minimize the filter's step non-linearity, the capacitors that are used should have a tolerance of less than 10%. An R-C low-pass filter at the output of the commutating filter can attenuate substantially any of the clock signal at the output and improve linearity. Precautions should also be taken so not to overload the input of the filter; that happens if the peak-to-peak input voltage exceeds the positive supply voltage to the decoder.

Switched-capacitor filters

Although this sounds suspiciously like the commutating filter, the switched-capacitor filter works in quite a different way.

In its simplest form, it is an R-C low-pass filter where the capacitive elements are fixed, and the resistive elements are substituted by "switched-capacitor" resistors. Later on, we will see how the switched-capacitor circuit can even simulate an L-C filter, but first, to understand this odd resistor substitution, let's take a look at Fig. 5. In Fig. 5-a, when the switch is in position A, the capacitor charges up to voltage V_1 . When the switch is flipped to position B, the capacitor will discharge to voltage V_2 . The amount of charge flowing into (or from) V_2 therefore equals $C(V_2 - V_1)$.

Now, let's replace the analog switch with a pair of FET's, and drive the circuit with a clock pulse, as shown in Fig. 5-b. If the capacitors are switched at a clock rate, f_c , then the average current flow I from V_1 to V_2 will be $I = C(V_2 - V_1)f_c$. Since $R = V/I$, a resistor that would give the same average current I as a switched capacitor could be calculated from $R = 1/Cf_c$.

Therefore, it would seem that any resistor in an R-C filter could be replaced by a switched-capacitor. That, however, turn out not to be a practical approach when working with IC's because of the internal cross-coupling that is caused by self- and parasitic-capacitances.

The most widely used type of IC low-pass filter is an op-amp integrator. If the switched-capacitor filter shown in Fig. 6 seems to resemble an integrator, there is a good reason: It *is*—but in that cir-

cuit the input resistor has been replaced by a switched capacitor. For those of you that are unfamiliar with integrators, and as a review for the others, let's take a brief look at how that circuit is used as a low-pass filter.

Due to the action of the capacitor in the feedback loop, if the input signal to the circuit has a relatively low frequency, the output will be the integral of the input—hence the name integrator. But if the input frequency is high enough, the feedback capacitor does not have time to charge, and the op-amp's output remains constant (i.e. DC). The filter's cut-off frequency is determined by the values of the resistor and capacitor.

Since the resistor in Fig. 6 has been replaced by switched capacitors, that filter can be tuned by simply altering the frequency at which the capacitors are switched (clocked). As an additional precaution against internal parasitic capacitances, the configuration shown in Fig. 7 is used. If that circuit is clocked properly, it can also be used to simulate the inductor currents and capacitor voltages of a passive L-C circuit. Here is what happens:

The ϕ clock signal is 180° out of phase with respect to the $\bar{\phi}$ clock signal. Let's feed the ϕ clock signal to Q1 and Q3, and the $\bar{\phi}$ signal to Q2 and Q4. During the first half cycle of the clock pulse, only Q1 and Q3 will be "on" and capacitor C1 will charge up to the value of V_{IN} . Assuming V_{IN} to be positive, C1 will charge up so that point *b* will be positive with respect to point *a*. During the second half cycle, only Q2 and Q4 will be "on" and the voltage across capacitor C1 is applied to the inverting input of the integrator. However, since point *a* is negative with respect to point *b*, the overall affect is that of a non-inverting integrator. The output will have some phase lag, in addition to the 90° phase lag of an ideal integrator, caused by internal delays.

Now, let's change the clock inputs to the filter. The ϕ clock signal is now fed to Q2 and Q3 and $\bar{\phi}$ is fed to Q1 and Q4. During one half of the clock cycle, only Q1 and Q4 will be "on" and capacitor C1 is shorted through ground and discharges to zero. During the other half of the clock cycle, Q2 and Q3

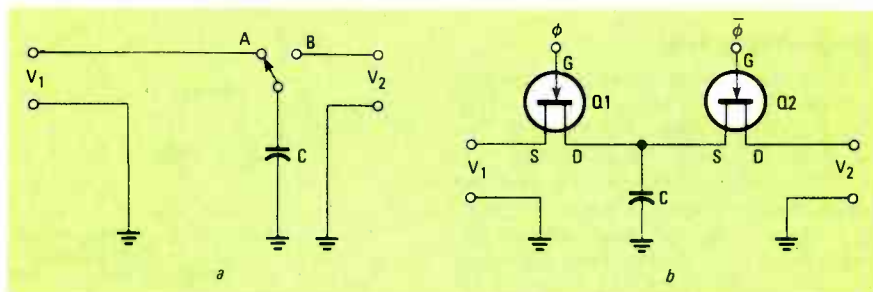

FIG. 5—THE SWITCHED-CAPACITOR technique shown in a is realized in an IC by using the circuit shown in b. In b, the two FET's replace the mechanical switch.

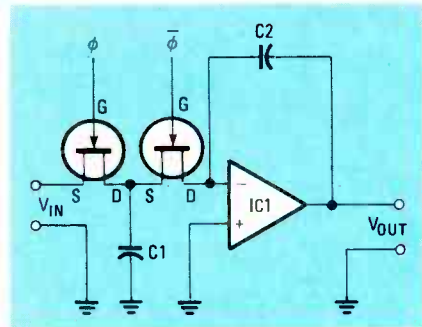

FIG. 6—AN INTEGRATOR is often used as a low-pass filter in IC's. In the circuit shown here, the input resistor has been replaced by a switched capacitor.

are "on" and since the capacitor is discharged, it appears as a short and V_{IN} is applied directly to the inverting input of the integrator. The circuit shown in Fig. 7 now behaves just like an inverting integrator whose output has slightly less lag than 90° .

It is a simple matter to connect the integrators in series and clock them so that every other integrator is of the same type. If that is done, the slight variations in phase angle will be cancelled. The resulting circuit will behave just like a low selectivity L-C network. As the differences in phase will be cancelled regardless of the clocking frequency, that switched-capacitor filter can be tuned by simply changing the clocking frequency.

By using the techniques we've discussed, it is possible to simulate complete networks of various types of single- and multi-pole filters. What's important from a manufacturing viewpoint is that switched-capacitor resistors require very little silicon area—in fact the area decreases as the value of the resistor increases. In practice, a 10-megohm resistor is needed if the filter's capacitor is to be kept to a reasonable 10 picofarads. A resistance of 10 megohms is obtained if a 1-picofarad capacitor is switched at a frequency of 100 kHz. If, in place of the switched capacitor, a 10-megohm resistor were actually used in the IC, it would require 100 times more space.

Though the switched-capacitor tech-

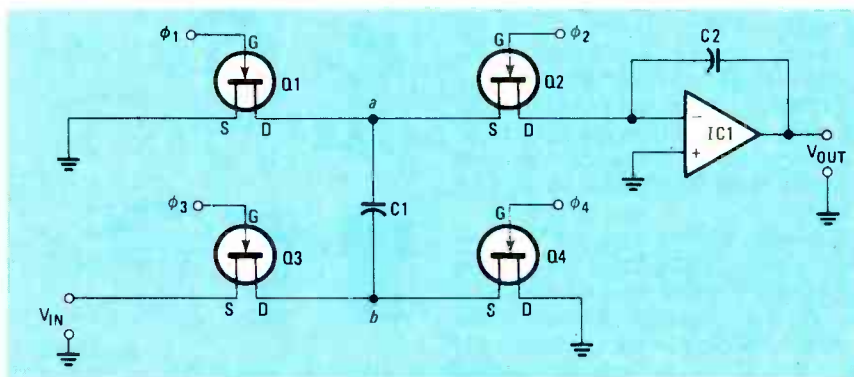

FIG. 7—PARASITIC CAPACITANCES can be reduced further by using this circuit. If clocked properly, several of them could also be combined to simulate a passive L-C filter.

TABLE 1

Digital Filter Type	Commutating	Switched-Capacitor	Transversal
Filter response	comb	bandpass high pass low pass Notch	bandpass low pass chirp
Frequency range	< 5 Hz - 10 MHz higher with ECL	.5 Hz-25 kHz	1 kHz-1 MHz
Dynamic range	depending on types of switching elements, etc.	> 80 dB	> 40 dB
Distortion		< .1%	< .1%
Clock residue	high high depending on number of sections & switching elements	≈ 6 mV	not specified
Input signal maximum		10 V p-p	3 V p-p
Input impedance	high depending on number of sections & switching elements	≥ 100 kilohms	≥ 200 kilohms
Output impedance		< 1 kilohms	≤ 1 kilohms
Stopband	80 dB	60 dB/octave	150 dB/octave
Skirt steepness		< ± 2 dB	≥ 15 dB
Insertion loss	≈ 20 dB	better than .5%	better than .1%
Center Frequency accuracy	absolute	MOS	MOS
Technology used	any: TTL, CMOS, ECL, transistors		
Parts cost/filter (quantities of 1 - 9)	≈ \$3.00	> \$28.00	≈ \$40.00

nique is still relatively new, several manufacturers are beginning to use it. Among the IC's using that technique are American Microsystem's (3800 Homestead Road, Santa Clara, CA 95051) S3505 and Mostek's (1215 W. Crosby Road, Carrollton, TX 75006) MK5912. Those IC's are telephone-system coder-decoders; both make extensive use of switched-capacitor filters.

EG&G Reticon (345 Potero Ave., Sunnyvale, CA 94086) uses switched-capacitors in three general purpose, digital-filter IC's—the R5604, R5605, and R5606. The R5604 contains three 6-pole Chebyshev 1/3-octave ANSI Class III filters that together cover an entire octave with one external input-clock trigger. The R5605 contains two 6-pole Chebyshev 1/2-octave ANSI class III filters that, like the R5604, cover a full octave with one external input-clock trigger. The R5606 contains one 6-pole Chebyshev full-octave ANSI class II

filter. Each IC is housed in a 16 pin DIP and requires minimum of +5 volts for operation. Reticon is extending their high-end usable frequency to 20 kHz, and the low end to .5 Hz. The clock to center-frequency ratio of the R560x family is approximately 108:1, and the insertion loss is typically 0 dB. An on-chip flip-flop divides the clock frequency by two so that the switched-capacitor is switched at 1/2 the clock frequency.

One problem with most sampled data systems is that input frequencies at rates about 1/2 of the switching frequency may be mistaken for the filter's center frequency (aliased) and may appear at the filter's output. Reticon recommends using an external R-C network at the IC's input, if input signals greater than 27 times the center frequency are expected.

Another small drawback with those IC's—at least at present—is cost. Reticon sells the R560x series IC's at prices that range from \$28.00 to \$48.00 each, in small quantities.

Transversal filters

Another monolithic digital-filter that is beginning to be used in some applications uses a novel combination of a simulated multi-tap delay line and synchronized periodic sampling. Like the previously discussed filters, the transversal filter uses a trigger clock to "tune it" to the desired frequency. While its exact operation is quite complex, and beyond the scope of this article (if you are interested in a more complete discussion, see Reticon's

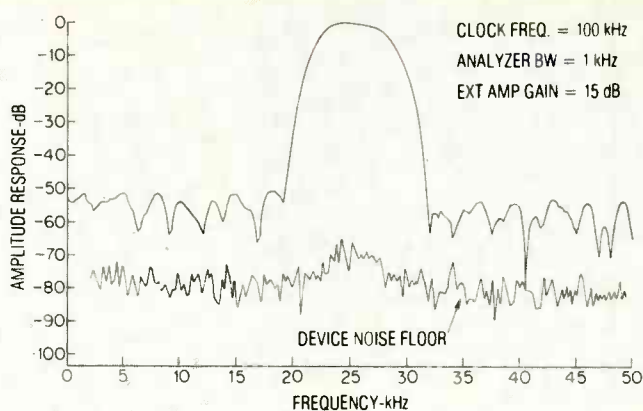
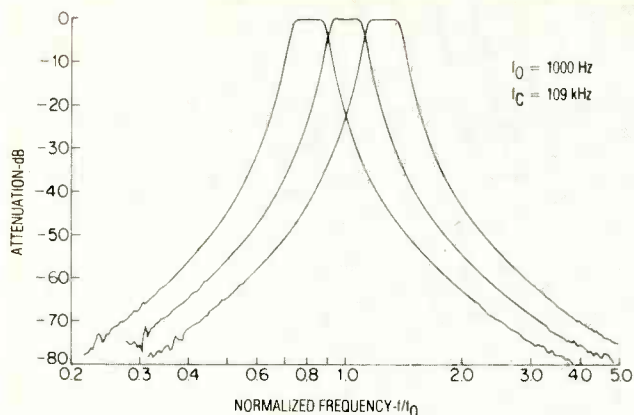

THE BANDPASS CHARACTERISTICS of a Reticon R5604 switched-capacitor filter is shown in a. Contrast that to the frequency response of the Reticon R5602-3 transversal filter, shown in b.

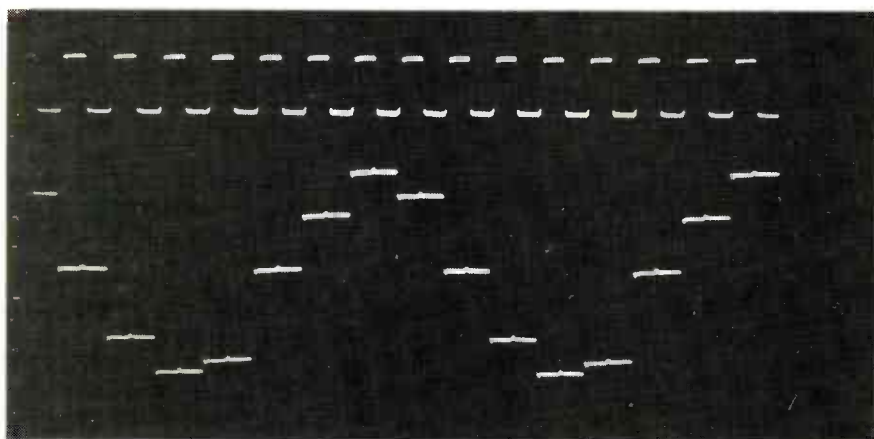

THE CLOCK INPUT to a commutating filter, and the resulting output is shown here. The signal input to the device is a sine wave.

R5602 Transversal Filter Family Data Sheet for details), let's take a brief look at how it works.

Basically, the IC uses a new MOS charge transfer technique to form a monolithic bucket brigade. The bucket brigade is a chain of N-channel MOS transistors connected to small monolithic storage capacitors. The input signal is sampled, and the sampled charge is transferred from one capacitor to the next by alternately switching the MOS transistors.

As the sampled charge is transferred, it is simultaneously summed with a fixed analog reference. Thus, at every clock transition an alternate pattern of signal samples and reference charges are shifted forward. By multiplying the sampled and reference values by pre-programmed weighting factors and combining them at the output, various responses can be simulated.

The Reticon transversal filters contain a 64-section bucket brigade, as well as timing and output circuitry. Like the switched-capacitor filters, transversal filters are available in several configurations including low-pass and bandpass filters.

The filters have linear phase response

and skirts, with a 150 dB-per-octave roll-off rate. The same aliasing problems found in switched-capacitor filters can impair the transversal filter's performance if input circuitry is not carefully designed. The Reticon R5602 family requires more outboard circuitry than their switched-capacitor counterparts, as well as a +15-volt power source. They cost \$40.00 each in quantities of less than 10.

Presently, a general limitation with the transversal filters is their poor low-frequency response, which, in turn, is a function of the minimum sampling (clock) frequency required to shift the capacitor voltage levels along the bucket brigade. That "refresh" rate must be fast enough not to allow loss of charge in the capacitors due to leakage. Currently, those filters can be used down to input frequencies of at least 1 kHz.

Recently, Reticon reported work on a transversal filter IC that uses double polysilicon low-loss capacitors, extending the low-frequency response down to 50 Hz; the high-frequency limit is 125 kHz. The IC has a dynamic range of over 65 dB and, what is perhaps most remarkable, it offers digitally pro-

grammed characteristics. Texas Instruments (PO Box 225474, Dallas, TX 75265) has also developed an advanced 1024-stage transversal filter with an 8-bit programmable response-characteristic and Q, in addition to a 60-dB dynamic range, 50-dB stopband attenuation, and a 1-MHz maximum filter frequency. No mention was made of the low-frequency capability. At the time of writing, neither the Reticon nor the Texas Instruments filters were commercially available.

Applications

With features like broad frequency-capability, digitally programmable center frequency, and, in the near future, programmable response characteristics, digital audio filters—and especially the switched-capacitor and transversal types—are a natural for use in computer-controlled networks. With those devices, a 1/3-octave spectrum analyzer could be built using only one filter IC to cover the whole range from 20 Hz to 20 kHz. If proper anti-aliasing measures are taken at the filter's input, switching the clock frequency will be all that's needed to sweep the filter through the entire range. Some other applications could include harmonic analyzers, programmable noise analyzers, modems, and any kind of audio or sub-audio filter.

R-E



"Oh! You mean you wanted me to clean the videodiscs with the disc-washer?"

BUILD THIS

Part 2 THE FIRST PART OF this article, in the April 1982 issue of *Radio-Electronics*, described the theory of operation and construction of a 6802 microprocessor-based video titler for your VCR. This part will discuss, in general terms, some of the programming techniques that are used to make the device operate.

The purpose of any computer program is to accept data, process it, and produce an output based on the results of processing that data.

In the case of the video titler, the input comes from the keypad. The processing consists of recognizing which keys have been pressed, and the output is a series of instructions to the VDG (Video Display Generator) that results, ultimately, in a video signal.

Keypad

The program, located in an EPROM (Erasable Programmable Read-Only Memory), that controls the video titler has three sections that deal with the keypad: recognizing when a key has been depressed, recognizing which key has been depressed, and debouncing (turning into a clean pulse) the "key-pressed" signal.

The 40-key keypad is arranged as five rows of eight columns each. It uses two microprocessor ports—one for input to the microprocessor located at 1000 (hex) and one for output at 800 (hex). Note that only five of the eight bits available at the output port are used for keypad control (one for each row of the keypad); the others are for VDG mode-selection.

Determining the status of a key (pressed or unpressed) is done by *scanning* the keypad. That is done in two steps. First, a bit-pattern is written to the output port to select a specific row. A logic-0 represents a selected row. A logic-1 a non-selected one. Then, the status of every key in the row selected is read through the input port. A logic-0 indicates that a key has been depressed.

Since there are eight columns in each row, and since each column is represented by a bit, a column with no keys depressed will be read as FF (hex), which represents a bit-pattern consisting entirely of logic-1's. Any column that has a value less than FF (hex) has a key depressed, and the position of the logic-0 within the bit pattern tells which key in the column it is.

VIDEO TITLER FOR HOME VIDEO MOVIES

MICHEL
CHAMPAGNE

Last month we showed you how to build and use a video titler for your VCR. Now we'll take a look at how it works.



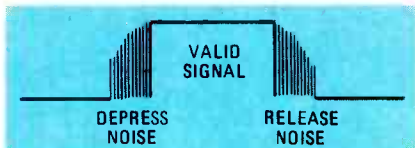

FIG. 12—KEY BOUNCE generates noise that can confuse the microprocessor when a key is pressed and released. The text explains how the valid signal is extracted.

Mechanical switches, such as the keys of the keypad, present a problem for logic circuits. Even though you may have pressed the key only once, its contacts can continue to bounce against each other after you press it and after you release it (see Fig. 12). That bounce is confusing to the microprocessor, since it sees each one as a separate key closure—not what you intended at all. To “debounce” the keys, it is necessary to wait until the contacts are stable, and then read their status. That is done by making the assumption that typically a key will be depressed for about 300 milliseconds and that the maximum bounce duration is about 20 milliseconds. The sequence of instructions the microprocessor follows in debouncing and in determining which key has been pressed is as follows:

1. Select a row.
2. Read the input port.
3. If the value equals FF (hex) then read the value of the next row (and so on, until finished).
4. If the value is not FF (hex), then wait 100 milliseconds (that is a check for key bounce).
5. Select the same row.
6. Read the input port.
7. If the value equals FF (hex) then it was key bounce, so go back to step one and start again.
8. Check all the other rows to make certain that there is only one key depressed (value less than FF (hex)).
9. Read the input port.
10. If the value is not equal to FF (hex), then more than one key is depressed. Go back to step one and start over.
11. Execute the function determined by the value of the depressed key.
12. Wait for the key to be released. Check all lines until only FF (hex) is read.
13. Delay about 30 milliseconds.
14. Go back to step one and start again.

Display

The video display is generated by an MC6847 video-display generator IC. Its pinout is shown in Fig. 13. It can operate in 12 different modes, but the video titler uses only two of them—the “internal alphanumerics” mode and what’s called the “semigraphics-4” mode. The alphanumeric mode is used to display characters, while the semigraphics mode is used to generate

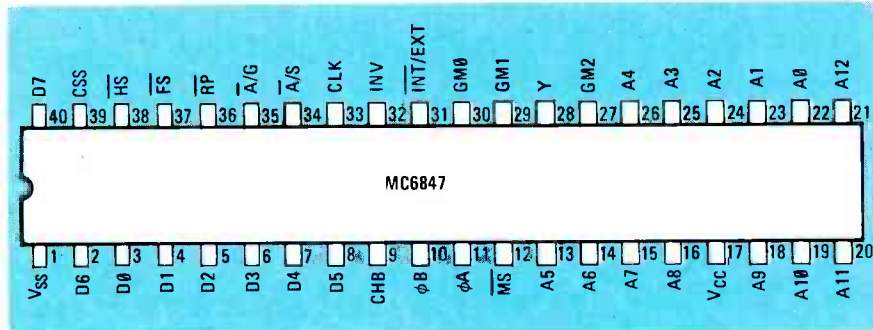

FIG. 13—MOTOROLA'S MC6847 video-display generator IC is the heart of the video titler.

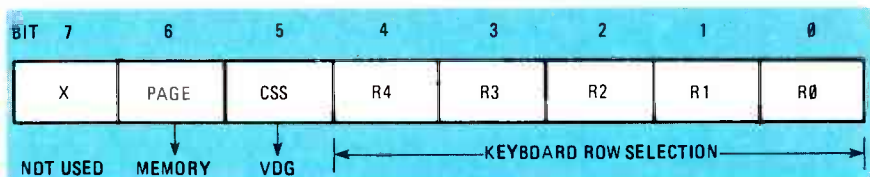

FIG. 14—A DATA BYTE contains information describing the character to be displayed, which page it is to be taken from, and what its background color (CSS) will be.

blocks of color (a full screen would consist of a 64 × 32 array of colored display elements, each one made up of an 8 × 12 array of dots).

The VDG receives its instructions from the display memory (located from 2000 (hex) to 23FF (hex)). Each memory address contains a byte representing the information to be displayed. If the most significant bit (bit 7) of the byte is a logic-0, then a graphics character will be displayed; if it is a logic-1, the result will be an alphanumeric character. The memory is divided into two sections (2000 (hex) through 21FF (hex) and 2200 (hex) through 23FF (hex)), to provide two separate “pages,” or displays. Page selection is made by setting or clearing the page bit (bit 6), as shown in Fig. 14. The “CSS” bit (bit 5) is used to select the background color—red or green—for an alphanumeric character.

Note: Each byte presented to the VDG must contain the keypad-scan information, the page bit, and the CSS bit.

It is important to remember that the display memory is accessed by both the microprocessor for inputting data and by the VDG for retrieving data to

create the display. If both sections try to access the memory simultaneously, the VDG will miss some data, and the display will be incomplete.

To keep that from happening, a synchronizing signal is provided through an input port located at 1800 (hex). Bit 6 of that port, when cleared, means that the microprocessor can access the memory: when it is set, the VDG is using it. A routine that guarantees a period of 2 milliseconds during which the microprocessor can access the memory is shown in Table 1.

Programming

This section will describe, in general terms, how the video titler is programmed.

First, two tables relating specific keys to specific characters have to be created. One table is for the alphanumeric mode; the other for the graphics mode. The values for the tables are derived by multiplying the row number (0-4) by eight and adding it to a column number (0-7). Each value corresponds to a particular alphanumeric or graphic

continued on page 76

TABLE 1

```

: WAITS FOR THE END OF CURRENT "MEMORY ACCESSIBLE PERIOD"
WAITLO    LDA A      $1800    ; READS VDG FS SIGNAL
           AND A      $40      ; TEST BIT 6
           BNE       WAITLO

: WAITS FOR THE END OF VDG SCAN.
WAITHI    LDA A      $1800
           AND A      $40
           BEQ       WAITHI

: NOW YOU ARE SURE THAT YOU HAVE A MAXIMUM PERIOD FOR USING
: DISPLAY MEMORY.

```



Courses in Computers and Programming



Disk Drives and Peripherals



All-in-One Computer



High-Speed Dot Matrix Printer



Superior Software Tools



Fully Portable Test Instruments



Hand-held Digital Multimeter



Programmable Automobile Horn



Emergency Power System



Hydraulic Log Splitter



Domestic Solar Water Heater



Space Phone Television



Home Earth Station Receiver

FREE Heathkit® CATALOG



Educational Self-Study Courses



Pro-Series Audio Components



Digital Marine Depth Sounder



Amateur Radio Gear



Computerized Weather Station

450 kits and products: solar hot water systems, satellite TV, all-in-one computers, test instruments, amateur radio gear, self-study courses in computer literacy and state-of-the-art electronics, energy conservation and home security devices, fine stereo components, color televisions, automotive or marine aids, home conveniences and more – things you've always wanted and needed, right now at low kit prices from Heath.

For people with imagination, there's nothing to compare with the exclusive thrill of hand-built satisfaction.

Discover the fun of kitbuilding – it's a great way to relax in your spare time and share a rewarding pastime with your whole family. The great kits you build will reflect the pride of your craftsmanship, too. The famous Heathkit illustrated manuals make it easy for *anyone* to build reliable, professional-quality kits.

SEND FOR FREE CATALOG

Our 104-page catalog is Free! If coupon is missing write: Heath Company, Dept. 020-892, Benton Harbor, MI 49022

Heathkit Heath Company, Dept. 020-892
Benton Harbor, MI 49022

Send me the latest free Heathkit Catalog now. I want to "build in" the quality difference.

Name _____

Address _____

City _____ State _____

CL-727-RI Zip _____

FREE CATALOG

Heathkit products are also displayed, sold and serviced at 60 Heathkit Electronic Centers* nationwide. Consult telephone directory white pages for location. *Operated by Veritechnology Electronics Corporation, a wholly owned subsidiary of Zenith Radio Corporation. Some retail prices may be slightly higher.

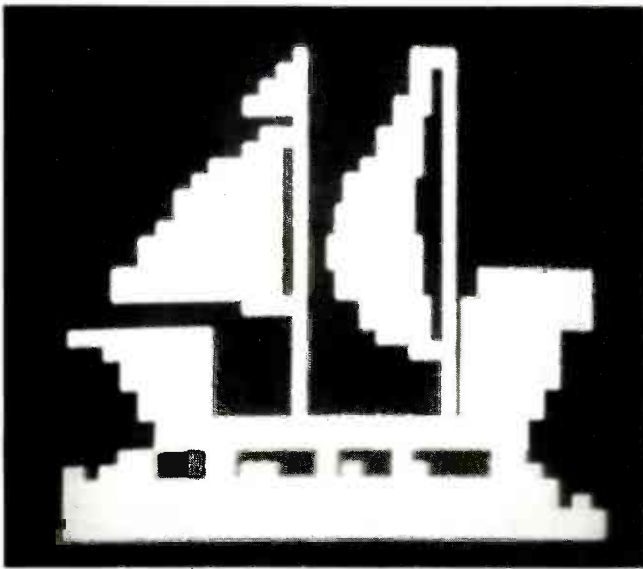

HERE ARE TWO DIFFERENT DISPLAYS that can be created using the video titler. The one on the right uses both the graphic and alphanumeric modes.

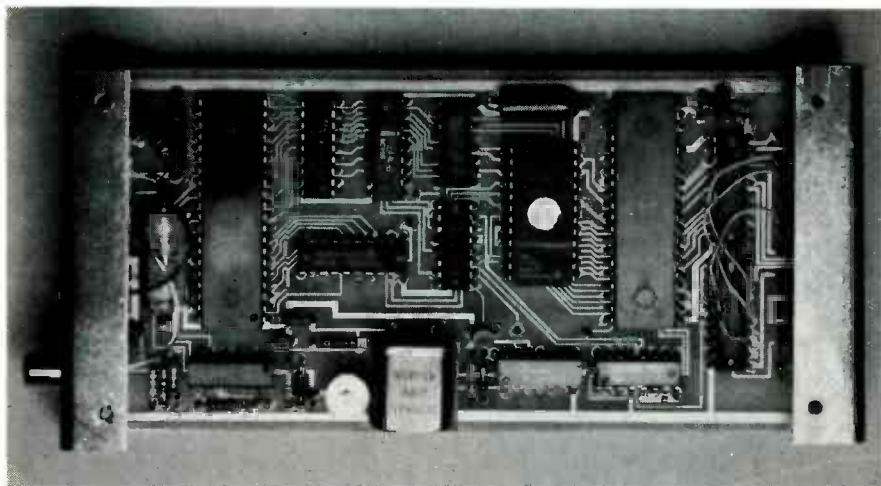

THE PROGRAM that controls the video titler is located in an EPROM. That IC is easy to spot here—it is the one with a round quartz window.

continued from page 72

character and is written into memory when the appropriate key is depressed. (The correspondence between the keys and the values assigned them is stored in the EPROM.)

Second, two blocks of variables, each containing the current status of one of the two display pages, are required. Each block contains the fol-

ORDERING INFORMATION

The following are available from Scriptovision, Inc., P.O. Box 535, Snowdown Station, Montreal, Quebec, CANADA H3X 3T7 (all prices shown are in U.S. dollars); assembled and tested titler, \$169.00; partial kit (PC board, programmed EPROM, keyboard, enclosure, keyboard label), \$69.00; PC board and programmed EPROM, \$49.00; programmed EPROM only, \$35.00. U.S. residents must add 4.7% to those prices for import duty. Please add \$3.85 to each order for shipping and handling. Allow 4-6 weeks for delivery.

lowing information:

- Cursor position (two bytes representing an address in the display memory).
- Contents of memory at the cursor position (one byte).
- Page number (one byte equal to 40 (hex) or 00 (hex)—see Fig. 14).
- CSS (one byte equal to 20 (hex) or 00 (hex)—see Fig. 14.)
- Row number (one byte).
- Column number.
- Flag indicating "cursor on" or "cursor off."
- Flag indicating alphanumeric or graphic mode.
- Flag indicating whether shift lock is on or off.
- Flag indicating direction of cursor movement (vertical or horizontal)

There are two types of keys on the video titler's keypad: those are the data keys and function keys. The data keys are used to select the characters that will be displayed; the function keys are used to move the cursor, erase, select modes, etc.

The cursor takes the form of a rectangular cyan picture-element. Every time a data key is depressed, the key number is computed and given a value between 0 and 39 if the shift lock is not set, and between 40 and 79 if it is. (The shift lock is used only in the CHARACTER mode.) That value represents a memory location in the character table or graphics table stored in the EPROM. The contents of that memory location are moved into the display memory at the cursor position after waiting for VDG synchronization. The cursor is then advanced one position (in the HORIZONTAL mode) or 64 positions (one entire line, so it is directly above or below the previous position) in the VERTICAL mode. If the cursor is to be displayed, the contents of the display memory at the new position are saved, but not seen until the cursor moves on.

If a function key is depressed, things get a bit more complicated. The program has to test the key number and, depending on the key, jump to the section of the program that contains instructions for performing its function. That portion of the program has to be executed before the keyboard scan can be resumed.

The video-titler program has a starting location of F800 (hex) and memory locations FFFE and FFFF, which are the reset interrupt-vector, must contain the address of the first instruction that the program will execute on reset.

One last thing, don't forget that the stack pointer has to be initialized, and the screen cleared (by writing 80 (hex)) into each address of the display memory.

That should give you some idea of what makes the video titler tick. Much more information can be found in Motorola's data sheet on the MC6847 video-display generator IC. **R-E**

TEST EQUIPMENT



Have you ever wondered how a manufacturer gets the right to use the Underwriters Laboratories' symbol, and what that symbol means to you? In this article we'll look at some of the provisions of UL's electronic test equipment standard, and see what they do to find out if a piece of equipment meets it.

JACK DARR
SERVICE EDITOR

MOST OF US KNOW ABOUT UNDERWRITERS Laboratories, and the product-testing that that non-profit organization does. They test all kinds of products that, if poorly designed, could cause injury. Among the kinds of products they look at is electronic test equipment. Recently, we received a copy of their Standard for Electrical and Electronic Measuring and Testing Equipment (UL-1244), and we thought you might like to know about some of its provisions.

The purpose of the Standard is to make sure that each unit is as safe as possible for the user. Samples of each instrument are tested, under operating conditions, in one of the four UL labs. They look for more than just shock hazard, and some of the tests may surprise you; they did surprise me!

Shock hazard

Of course, one of the things they *do* look for is potential shock hazards. For all AC-power instruments in metal cases, the AC line-cord must be of the 3-conductor type: black (hot), white (grounded side of the AC line) and green (earth ground). The green wire must be

connected to the metal case of the instrument. All line cords must have a strain-relief clamp at the point where it enters the case. One of the tests UL performs is to apply a 35-pound pull to that cord: The case must not cut the cord, and the cord must not come loose or break.

Another provision is that the fuse device used must not break the "safety-ground" circuit. It should be placed so that it opens the black wire—the hot side of the line.

Testing for leakage current is also done. If you've done TV service work, the test should be familiar to you—we've had to use it on line-connected

chassis for some time now. An AC-current meter is placed in series with a 1500-ohm resistor that is bypassed by a 0.15 μ F capacitor as shown in Fig. 1. Using that setup, the leakage current between the case and the AC hot-line must not read more than 0.5 mA AC, or 3.5 mA for equipment with RFI filters in their AC inputs.

Another thing they look for is whether any user-accessible parts could possibly give an electric shock. They define a "user-accessible part" as anything an operator might touch accidentally while he is using or adjusting the device. Figure 2 shows a UL technician checking an oscilloscope for just such a hazard.

Drop tests

The "drop test" has long been an electronics joke—but that is a test that UL takes seriously. The equipment they test is "dropped" a few times to see if it can withstand "reasonable abuse." In fact, each of three samples of a piece of hand-held equipment is dropped three separate times from a distance of three feet. Each time, it is turned so that a different part of the in-

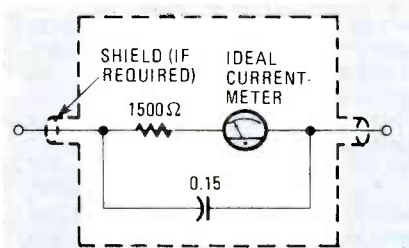

FIG. 1—SCHEMATIC DIAGRAM of the test setup used by the UL to test for leakage current.

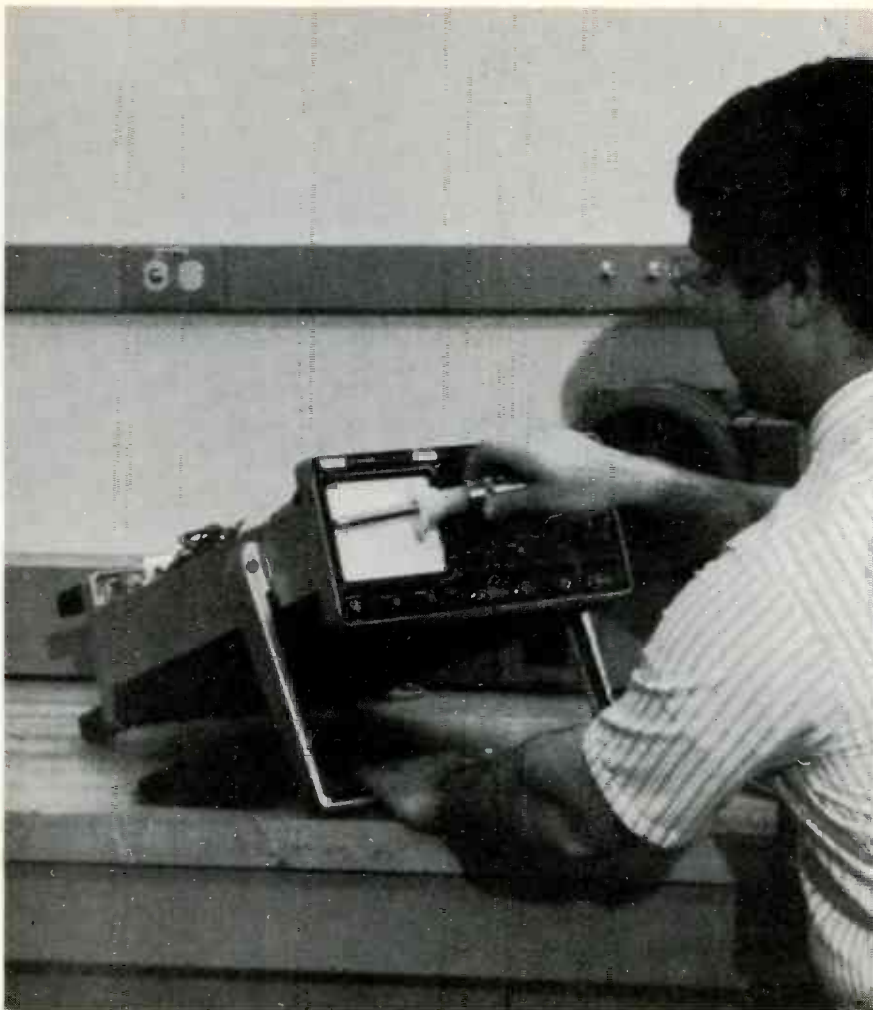

FIG. 2—A PIECE OF EQUIPMENT will not meet the UL Standard if any part that could give an electric shock is accessible to the user. Here, a UL technician is examining an oscilloscope for a potential shock hazard.

strument is faced down, and the result of each fall is examined.

For bench, portable, and floor-mounted equipment, each unit is tilted up until the bottom is $3\frac{15}{16}$ inches from the floor/bench, then let go. It must fall back upright, and not fall over "on its next face." That is done for each of the four edges of the bottom.

Impact tests

Providing that the unit survives the drop test, an impact test is done on all equipment except hand-held units. The test involves hitting the instrument with a steel ball weighing 1.2 pounds. For the top, the ball is dropped from whatever height is needed to produce an impact of 2 newton-meters (1.5 foot-pounds). For the sides, the ball is suspended on a cable, and swung down like a pendulum to give the same impact-force on each side.

The meter-face doesn't get away, either. It must be subjected to an impact-force of 0.226 newton-meters. A special ball is used and it is dropped onto the meter face from whatever height is required to give the specified impact.

In addition to the drop and impact tests done on their cases, oscilloscope CRT's are also checked. For CRT's with a diameter of 6 inches or less, a special device called an impact-hammer is used. That has a spring-loaded cylinder with a ball-shaped end. The device is cocked, then tripped so that the end of the cylinder delivers an impact of 0.5 newton-meters (0.37 foot-pounds) to the CRT's screen. For larger scopes, the screen must withstand an impact of 2 newton-meters (1.5 foot-pounds). To perform the test, the scope is turned screen up, and a steel ball is dropped on it from the required height.

Implosion protection

CRT's, of course, should provide adequate protection from the effects of an implosion. To test that, UL breaks the CRT and looks closely at the results.

The implosion is caused in one of two ways. The "thermal-shock" method involves scratching the neck or funnel of the tube with a glass cutter in one of three prescribed patterns. The scratched areas are then either heated by applying repeatedly a glass rod that has been warmed almost to its melting point, or cooled by applying liquid nitrogen repeatedly.

The other way is called the "impact" method: A hole is made in the top of the case, and the end of a 1-inch metal rod is rested at the junction of the funnel and the screen. An 11-pound weight is then dropped through a five-foot guide tube and hits the top end of the rod. (If the CRT doesn't break, they add more weight!)

The scattering of glass from the im-

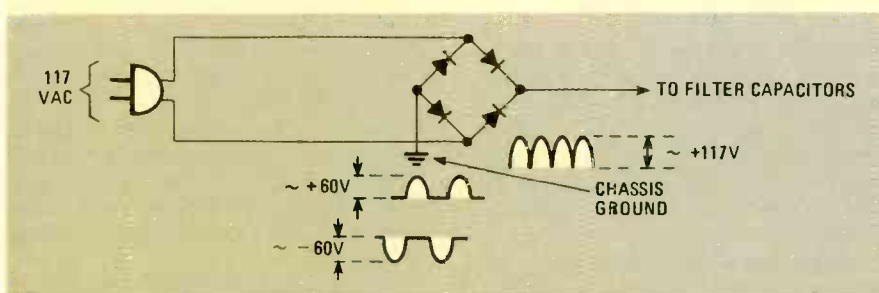

WITH A "HOT" CHASSIS, the chassis ground is always about 60 volts above or below true ground, depending on which side of the AC line is "hot."

SHOCK PREVENTION

HERE'S SOMETHING THAT THE UL STANDARD does *not* cover—and it's not intended to—but that I think I should mention because we are talking about safety. A great many of the newer TV sets use a full-wave bridge rectifier connected directly across the AC line (see above) for the primary DC supply. That means that the chassis ground is *ALWAYS* at least at 60 volts above or below true ground! If your test equipment uses the line ground as a common, you can cause damage just by hooking up the ground lead of the instrument. (You do not have to ask me how I found

out!) Reversing the line plug does no good at all.

I recommend using a 1:1 isolation transformer at all times. The transformer should have a high enough rating to handle the highest load you might expect; usually something like 200 watts is ample. I've had one of those on my own bench for years; it feeds a separate AC receptacle that I've labeled ISOLATED. (On my bench it also goes through a true wattmeter, which I've found helpful in dealing with power-supply problems, but such a set-up is not required.) R-E

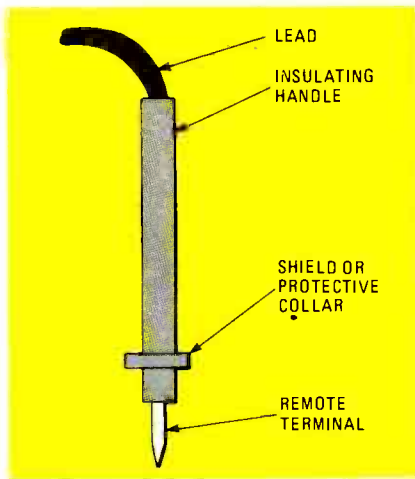

FIG. 3—TO PREVENT YOUR fingers from accidentally slipping down to the uninsulated part of the probe, the handle should have a collar such as the one shown here.

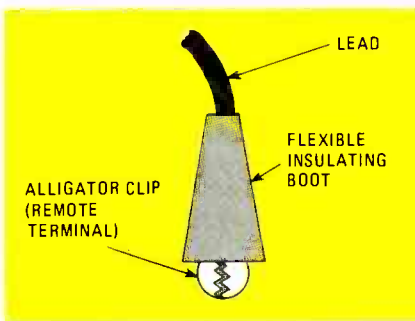

FIG. 4—A FLEXIBLE INSULATING BOOT located over an alligator clip will not make the clip any harder to use, but will protect against accidental shocks.

plosion is observed. The equipment under test is placed in its normal operating position, on a support that is about 30 inches high (equipment that normally stands on the floor is tested standing on the floor). Two barriers, each 9½ inches high, are placed on the floor at 1½ and 6 feet from the front of the CRT. The floor is covered with non-skid material. The Standard requires that no piece of glass heavier than 0.007 ounces pass the first barrier, and no glass at all pass the second. The total mass of all glass particles between the two barriers must not weigh more than 1.5 ounces. Two samples of each piece of equipment are tested.

X-ray emissions

All devices are tested for excessive X-ray emissions. That is done by setting up the equipment for normal use and adjusting the line voltage to the highest permissible value (for a device rated at 105-130 volts AC, the line-voltage is set at 130 volts AC). For the test, the unit is set up in such a way so that the maximum possible amount of X-rays are produced. In the case of oscilloscopes, the beam pattern must not exceed 1⅓/16 × 1⅓/16 inches, or the smallest possible display, whichever is larger. In addition, for dual-track scopes, both

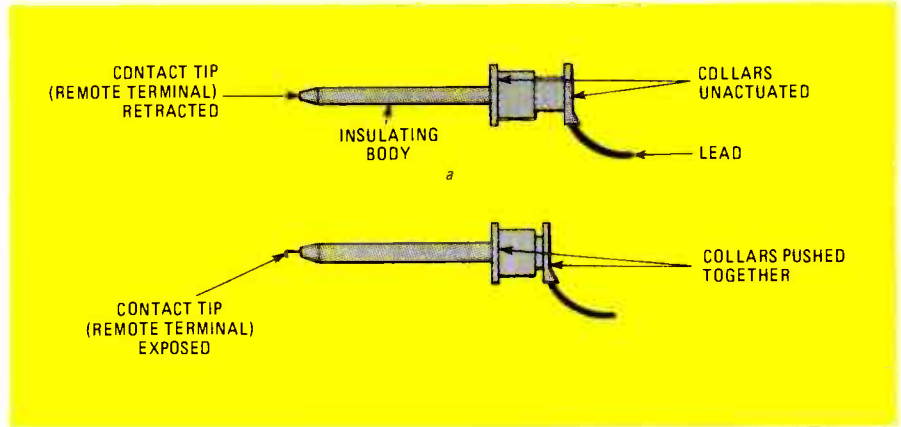

FIG. 5—THE REMOTE TERMINAL is completely insulated in the probe (a) until the handle's collars are pushed together as shown in (b).

beams must be on, and they must be positioned so that they generate the maximum amount of X-rays.

After the equipment is set up as described, X-ray levels are checked at a distance of 2 inches from the surface of the unit. The X-ray levels are averaged over an area of 1.55 square inches and must not exceed 0.5 milliroentgens-per-hour. The test is performed with any doors or covers that would be open during normal use open or removed; a second test is performed with any doors or covers that would be open or removed when servicing the instrument open or removed.

Test probes

One thing that is common to many types and brands of test equipment is test probes. The UL Standard calls for insulating all types of probes to minimize any possibility of shock. In addition, all connectors and terminals should be designed so that no area that could give an electrical shock is exposed when they are fully mated. That is one standard that has been met in most instruments for quite some time. Instead of the old-style banana jacks, most instruments use recessed jacks. The plugs on the test leads are insulated with soft rubber or plastic. (Remember the old banana plugs with a set-screw on the side to hold the wire? Those could, and did, "bite" you if you touched the end of the screw!) No metal is exposed when the leads are plugged into the device. One fringe-benefit from that setup is that the rubber or plastic acts as a strain-relief for the test leads, making it considerably harder to break them right at the plug.

The test-probes have always been insulated, at least to some extent. The Standard requires, however, that the construction of the probe minimize the possibility of accidentally touching the remote terminal (the part of the probe that touches the circuit). That means using a protective "collar" at the lower end of a probe as shown in Fig. 3. The collar is there so that your fingers can't

accidentally slip down to the remote terminal, with rather nasty consequences. While, strictly speaking, the collar is required only on probes used to measure peak voltages of 1000 volts or more, it is a good thing to have on any probe—even a few hundred volts can smart! Alligator clips must also be properly insulated; one method for that is shown in Fig. 4.

Another type of probe that meets the UL Standard is the spring-loaded type shown in Fig. 5. In that type of probe, the remote terminal is not exposed until the two collars on the handle are pushed together. The remote terminal can either be bent, as shown, or straight.

All probes and test leads, of course, must be adequately insulated. The lead's insulation must have a rating at least as high as any voltage that it might be connected to. That is checked by inspection. In addition, a high voltage is applied to the probe assembly to see if the insulation might break down under those conditions.

The mechanical strength of the probes is also tested. That is done with a machine. The probe is hung by the end, and an arm on the machine pulls it up and then releases it. The probe hits a hardwood surface at the end of the drop, which simulates what happens when you drop a probe against a bench-leg or the floor. The test is repeated 50 times!

There you have some of the things that the UL does to make sure our test equipment is not just useful, but safe. Of course, there is a lot more to it (the Standard itself is a 60-page document), but that should give you some idea of what a piece of equipment must go through before the manufacturer has the right to use the UL label. Incidentally there is a difference between the statements "UL listed," and "meets UL specifications." Only equipment that has been tested by UL can be called UL listed. The statement "meets UL specifications" does not necessarily mean that UL has tested a piece of equipment.

R-E

HOBBY CORNER

A new "contest," and notes from the mailbag

EARL "DOC" SAVAGE, K4SDS, HOBBY EDITOR

THE OTHER DAY, I WAS ASKED HOW TO build the smallest possible audio oscillator. It seems that my neighbor was trying to squeeze an oscillator into a case that was already overcrowded.

My first thought was that a transistor is smaller than an IC, so the oscillator should use one. Well, the smallest circuit I could come up with is the simple device shown in Fig. 1. Of course, it turned out that the output transformer is larger than the rest of the components. Perhaps using an IC would not be such a bad idea after all.

That brought me to the circuit shown in Fig. 2. Excluding the speaker, the circuit still requires four components. In its favor, however, is the fact that no output transformer is required.

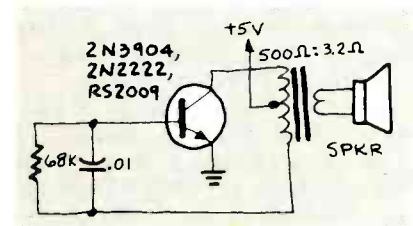

FIG. 1

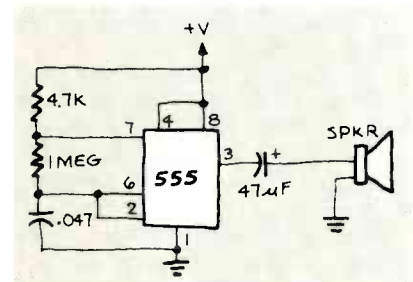

FIG. 2

I fooled around a bit with the design and managed to come up with a circuit that used just three parts, but the results were not satisfactory.

We have not given up. Sooner or later we'll stuff a tiny oscillator into that case. In the meantime, let's have a contest—we'll see who can come up with a design that takes up the least amount of space. In a later column, I'll publish the smallest that I receive (schematic only, please) before midnight June 1, 1982.

When writing

Certainly, I want to do nothing to make it more difficult for you to write

to me about problems, answers, or whatever. Your letters are appreciated, especially when you come up with a solution to another reader's problem.

There are a couple of things, however, that will make things better for both of us. Send your letters to me at the New York office. Use this address:

Radio-Electronics
200 Park Avenue South
New York, NY 10003

If you mail anything except subscription information to the Subscription Department in Colorado, it is not only delayed but it may be misdirected. In addition, please take special care to identify each sheet of your correspondence. Perhaps the easiest way to do that is to stick a return address label on each page. Unless the pages are marked in some way, they may become separated, never to be rejoined. There are two reasons why that may happen:

First, your letter may go to/through several people before it gets to me. In spite of our best efforts, things sometimes get separated—especially envelopes from their contents. Second, and perhaps more important, is the fact that my filing system leaves a great deal to be desired. Well, the system itself is not so bad—it's just that I forget to use it until things begin to fall off the stacks that I toss them onto. Repeated New Years' resolutions have not resulted in any lasting improvement.

The little problem was brought to mind by a package I received recently—without envelope, of course. Someone named Bob sent me three issues of a magazine from the 1930's. The accompanying note thanked me for sending him something (What?), indicated that the unwanted magazines could be returned (Where?), and that those I kept would be deducted from the amount(????).

Well, I am completely in the dark. It's like starting to read a book in the middle. So, Bob, write again and let me know what to do with the magazines. They must have some special value, and it would be a shame for them to hang around here until they get lost.

Universal language

The most interesting things turn up in the mail. Noel Nyman of Seattle, WA works for a company that receives

items from Thailand. Just as we do, the Thais use newspapers as packing material. Noel sent along a couple of pages from a Thai newspaper.

Now, I don't read a word of Thai. In fact, it might as well be written in Greek. To be accurate, Greek would be better—I might be able to recognize something. In this case, I could only read occasional things like "30K," "BACK E.M.F.," and some digits.

Nevertheless, I was fascinated by the Thai newspaper because when I turned the page, I found that I could read part of it! There at the bottom of the page was a schematic with the same symbols and numbers that we all know.

That Thai writer was communicating with me halfway around the world, and in his own language. As Noel pointed out, the schematic was unmistakably a capacitance-operated switch. Any of us could have built that circuit from the article.

Adjustable LED indicator

In the December Hobby Corner, Leonard Eisner asked for help in designing a circuit that would turn on an LED at selectable voltage levels.

Leonard Dennis of Atchison, KS sent a very good circuit that uses one-fourth of an LM3900. It can be adjusted over a very wide range and turns on an LED when the voltage exceeds the selected level.

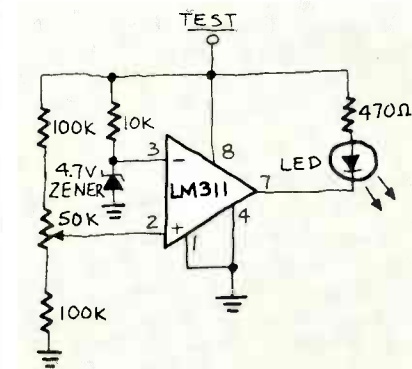

FIG. 3

I want to show you a circuit (Fig. 3) that was sent to me by Ronald Holder of Bridgman, MI. It is unusual because the voltage that is measured is also

Introducing incredible tuning accuracy at an incredibly affordable price: The Command Series RF-3100 31-band AM/FM/SW receiver.* No other shortwave receiver brings in PLL quartz synthesized tuning and all-band digital readout for as low a price.† The tuner tracks and "locks" onto your signal, and the 5-digit display shows exactly what frequency you're on.

There are other ways the RF-3100 commands the airways: It can travel the full length of the shortwave band (that's 1.5 to 30 MHz). It eliminates interference when stations overlap by narrowing the broadcast band. It improves reception in strong signal areas with RF Gain Control. And the RF-3100 catches Morse

communications accurately with BFO Pitch Control.

Want to bring in your favorite programs without lifting a finger? Then consider the Panasonic RF-6300 8-band AM/FM/SW receiver (1.6 to 30 MHz) has microcomputerized preset pushbutton tuning, for programming 12 different broadcasts, or the same broadcast 12 days in a row. Automatically. It even has a quartz alarm clock that turns the radio on and off to play your favorite broadcasts.

The Command Series RF-3100 and RF-6300. Two more ways to roam the

globe at the speed of sound. Only from Panasonic.

*Shortwave reception will vary with antenna, weather conditions, operator's geographic location and other factors. An outside antenna may be required for maximum shortwave reception.

†Based on a comparison of suggested retail prices.



RF-6300 8-band AM/FM/SW

This Panasonic Command Series™ shortwave receiver brings the state of the art closer to the state of your pocketbook.



With PLL Quartz Synthesized Tuning and Digital Frequency Readout.

Panasonic
just slightly ahead of our time.

used to power the circuit.

The measured voltage (from 5 to 36 volts) is applied to the point marked TEST. The LED is turned on if the voltage exceeds the level set by adjusting the 50,000-ohm pot. Of course, the circuit will also drive a small relay or audio buzzer, if desired.

More on the rain gauge

Kent McSwain of Albemarle, NC, sent a great improvement on the rain gauge discussed in the November issue. He did not like the idea of having the weight of the water turn a potentiometer.

Kent suggests using a regular water-alarm circuit to measure the amount of

rain in the gauge. Several sensors are attached to the inside of the gauge's tube, at appropriate levels, and the leads from them are run into the house using a multi-conductor telephone cable. Inside the house, each sensor (one at a time) is connected by a switch to the alarm circuit. Mark the switch so that you know which sensor is connected by each position; when the alarm sounds you will know the water level in the gauge. Thanks for sharing that idea with us, Kent.

It is "time" again

L.V. Clifford of New Port Richey, FL wrote in to say that he is tired of re-

setting his digital clocks. He wants a battery circuit that will take over, at least for a short period of time, when the AC power fails.

I agree that the situation is annoying, especially when the power is off for just a second or so. After all, even the old electric clocks had to be reset after they were off for a few minutes. But to have to reset it after a few flickers?—that is exasperating!

Let's help Clifford out. What kind of a battery circuit can you come up with to run your clock for short periods of time? Remember, that your circuit has to be small enough to fit into the clock's case. **R-E**

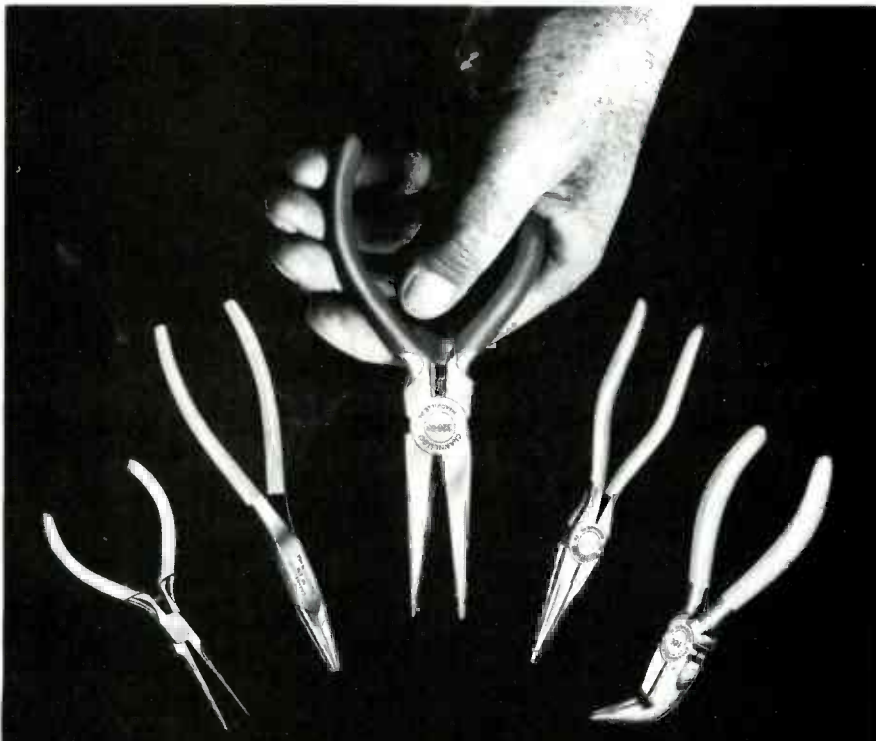

Sometimes It Pays To Have Nosey Friends

... friends that give you a firm grip on fine work in tight places. That make it easy to reach the hard to reach. Long nose pliers by CHANNELLOCK. Slender, perfectly mated jaws with no side wobble. Sharp, hand honed cutters. Beautiful high polished finish. Blue dipped plastic comfort grips. Quality in every detail (at no premium in price). CHANNELLOCK. Be sure that name is on the pliers YOU buy.

CHAN NEL LOCK

CHANNELLOCK, INC. • Meadville, Pennsylvania 16335

Meet The Rest Of The Family. Send For Free Catalog.



A 10 HOUR TAPE RECORDER WAS \$125.00
NOW only \$95.00* **LONG PLAY**

Modified Panasonic Slimline high quality AC-DC Recorder provides 5 continuous hrs. of recording & play back of top quality sound on each side of cassette for a total of 10 hrs. Built-in features include:

- Voice level control
- Digital counter, etc.
- TDK DC-180 Cassette included.

PHONE RECORDING ADAPTER

Records calls automatically. All Solid state connects to your telephone jack and tape recorder. Starts recording when phone is lifted. Stops when you hang up. **\$24.50*** **FCC APPROVED**

VOX VOICE ACTIVATED CONTROL SWITCH

Solid state. Self contained. Adjustable sensitivity. Voices or other sounds automatically activate and control recorder. Uses either recorder or remote mike. **\$24.95***

*Add for ship. & hdg. Phone Call Adapter & VOX \$4.00. Cal. Res. add tax. Mail order. VISA, M/C, cod's ok. Qty. disc. avail. Money back guar. Free data. Dir. inq. inv. AMC SALES, Dept. 19, 9335 Lubec St., Box 928, Downey, CA (213) 90421 Phone 869-8519

PEOPLE WHO OWN A FOX SCANNER...



LOVE ITS SIZE

The Fox BMP 10/60 is the smallest, lightest base station on the market today.



USE IT ANYWHERE

The Fox BMP 10/60 is the most versatile scanner in the world. With our optional Porta-Pac, it can be easily carried over your shoulder. * With our optional Mobile Mounting Bracket, it's a snap to attach it to your car.



TURN ON TO ADVENTURE

The Fox BMP 10/60 is packed with professional features—Skip, Action and Pause capabilities, two full watts of audio, complete 10 channel programmability and lots more. Scanning has never been easier, or more fun.



GET A FREE \$15 SPEAKER

Buy the BMP 10/60 now, and we'll send you a 4 watt Mini-Speaker free. Offer expires June 30, 1982.

Ask your dealer for full details.

Call 800-543-7892 for the dealer nearest you, or ask about ordering directly from our factory.



Fox Marketing, Inc.

4518 Taylorsville Road • Dayton, Ohio 45424

*Some states may prohibit use of scanners in mobile or portable applications. Check your local laws.

CIRCLE 18 ON FREE INFORMATION CARD

COMMUNICATIONS CORNER

Shortwave listening on a budget

HERB FRIEDMAN, COMMUNICATIONS EDITOR

THE WAY IT LOOKS THESE DAYS. WE ARE living in the age of two computers in every garage and a microprocessor in everything else. Communications devices are not any different. Just browsing through any of the magazines devoted to our hobby would lead one to believe that nearly all communications receivers use at least some digital circuitry, if not a microprocessor.

In fact, that is just about right. But there are still some of us around that don't have the means, or the desire, to spend the equivalent of a couple of months salary for the latest "break-through." There are still some hams who haven't traded in their old gear just so they can listen to the new amateur bands. And there are many newcomers to our country who might like to listen to a shortwave broadcast from their old homeland, but can't afford even the least expensive non-digital receiver.

For those hobbyists, there's little value in the new—and expensive—"computerized" receivers. In fact, they would probably get more out of an old but reliable device called a crystal-controlled converter. To bring it up to date, we'll simply substitute solid-state technology for the old tube-design.

A crystal-controlled converter is a rather unsophisticated, low-cost device that converts SW signals to the tuning range of any available receiver. Figure 1 shows how it works. Assume that the desired signal is on 7.05 MHz, and all that's available to the listener is a broadcast-band radio with a tuning range of 550 to 1600 kHz. The signal from the antenna is fed into the mixer through a tank circuit that is resonant at 7.05 MHz. The output of an 8.05-MHz crystal oscillator is also fed into the mixer. The output of the mixer consists of the original 7.05-MHz signal, the sum of the signal and output of the crystal oscillator (7.05 MHz + 8.05 MHz = 15.1 MHz), and the difference between the signal and output of the crystal oscillator (8.05 MHz - 7.05 MHz = 1 MHz); the output of the mixer is fed to the broadcast-band radio. If the radio is tuned to 1 MHz (1000 kHz) it will actually receive the 1-MHz component of the mixer's output—the 7.05-MHz signal. The other components of the mixer's output will be attenuated by

the radio's tuned antenna-input circuit.

Unfortunately, frequency converters are subject to image-frequency interference. The best way to explain image-frequency interference is with an example. In Fig. 1, we beat the desired 7.05-MHz signal against an 8.05-MHz oscillator to get the desired 1-MHz output. But if there is a signal at 9.05 MHz, (the image frequency), it will also beat against the oscillator, producing a 1-MHz output from the mixer. That is image-frequency interference. The only way to eliminate the problem is to select an oscillator frequency so that there is no signal on the image frequency. (Keep in mind that the output can be anywhere in the broadcast band.)

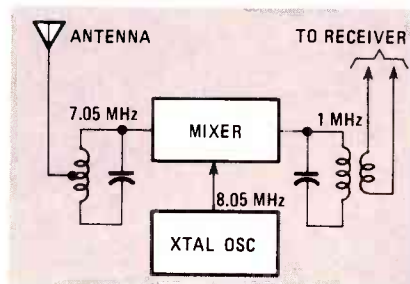

FIG. 1

Let's take a closer look at how a converter works. For this example, assume you've reworked a surplus Navy receiver that has a tuning range of 1.5-12 MHz, but you want to monitor 15 MHz with a minimum of image interference. We'll use a 25-MHz crystal oscillator in our converter. The 15-MHz signal is beat against the oscillator to produce a mixer output of 10 MHz. That output is fed into the receiver, letting you hear the 15-MHz signal when you tune to 10 MHz. As for the image, it's at 35 MHz, a little-used frequency that's sharply attenuated by the converter's tuned input-circuit.

While this is essentially a fixed-frequency device that is tuned by changing the oscillator's frequency, depending on the "Q" of the converter's tuned circuits, you should be able to tune through a narrow range of approximately 500 kHz by simply adjusting the receiver's tuning control. For example, if the receiver is tuned to 10.0 MHz it will receive a 15-MHz signal; but if it were tuned to 10.1 MHz, it would re-

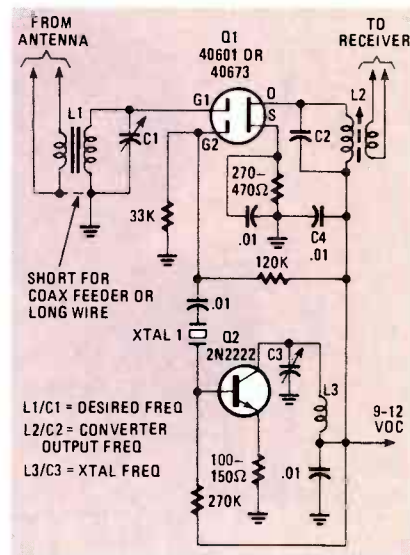

FIG. 2

ceive a 14.9-MHz signal. Are you confused about why tuning the receiver to a higher frequency would let you receive signals that are lower in frequency? It is because the frequency of the converter's crystal oscillator is higher than the frequency of the desired signal. Thus, the output of the mixer is 25 MHz - 14.9 MHz, or 10.1 MHz. If the oscillator's frequency were below the SW-signal's frequency, tuning the receiver to a higher frequency would let you receive signals that were also higher in frequency.

The preceding examples are the primary uses for crystal-controlled converters. While it's difficult to locate a shortwave converter these days, if you have had any experience with winding your own coils, and you own or can borrow some form of dip meter (that device is used to determine the resonant frequency of a tuned circuit), you can probably use "junk-box" parts to throw together a converter for the frequencies below 30 MHz, such as the one shown in Fig. 2.

That circuit has not been optimized for performance; it's strictly an experimental project whose values have been selected to provide some level of operation using, within reason, almost any components. For instance, you can trim the performance for the specific transistors you use. Don't hesitate to make changes; it's almost impossible to



formula-1™

the antenna specialists co. presents the latest advance in high-performance antennas for professional CB communications



A formula race car and A/S's new Model M-710 *Formula-1* are more alike than you'd guess. The engineering strategy is identical: continually refine a proven basic design, within a set of strict operating parameters such as electromagnetic propagation and transmitter power, with one objective: MAXIMUM POSSIBLE PERFORMANCE.

That's *Formula-1*, the direct descendant of A/S's original classic base-loaded low-band mobile police antennas, and the culmination of over 25 years of continuous design development. Born for performance, built to last. *Formula-1* is today's new state-of-the-art in mobile CB antennas.



- Precision-wound, water-proof "Big Momma" type coil. Cool running — x100 reserve power factor. Lifetime burnout guarantee.
- Factory tuned for general use; set-screw ultra-fine tuning.
- Longer whip for more "reach".
- 17-7 PH stainless steel whip. Taper-ground to minimize range-robbing wind deflection at highway speeds.
- Anti-static whip ball-tip for less noise, better safety.
- New quarter-turn quick-disconnect. Life tested over 2,500 times.
- 17' pre-assembled cable, miniature in-line connector for easy installation.
- Contour-forming protective mounting gasket for finished appearance.
- Complete hardware for both roof-top or trunk-lip mounting.
- 5-year limited warranty.

Formula-1 performs like a formula should... and overtakes anything else on the roads. Available now from your CB dealer.

the antenna specialists co.



Support your local REACT Team... We do!

CIRCLE 34 ON FREE INFORMATION CARD



© "Stripes of Quality"
 a member of **The Allen Group**
 12435 Euclid Avenue, Cleveland, Ohio 44106
 Export: 2200 Shames Drive
 Westbury L.I., New York 11590
 Canada: A.C. Simmonds & Sons, Ltd.

“blow” anything.

Transistor Q1 is a diode-protected dual-gate FET. A 4060 is suggested because it's specifically intended for use in a mixer circuit. But if all you have around is an RF amplifier such as a 40673, give it a try. Transistor Q2 is a small-signal high-frequency NPN transistor. Any general-replacement type (such as a 2N2222, etc.) should work.

The tank circuit made up of C1 and L1 is tuned to be resonant at the desired frequency; C1 can be a variable unit as shown; or, if you wish, a slug-tuned unit can be used for L1. (As we said nothing is critical; that also holds

true for the other tank circuits.) A second tank circuit, made up of C2 and L2, is tuned to be resonant at the converter's output frequency (for example, 1000 kHz). A third tank circuit, made up of C3 and L3, is tuned to be resonant at the crystal's frequency; tune that tank circuit so that the oscillator “starts” reliably each time power is applied to the converter. The adjustment of C3 (or L3, if you chose to make it adjustable) will have a slight effect on the crystal's operating frequency; you can “zero” the crystal frequency to within a few hundred Hz by fudging the adjustment of C3 (or L3).

The crystal can be either a funda-

mental or overtone type. If it is an overtone type, the output frequency will be slightly different from the marked or calculated value; again, you can compensate for that by adjusting either C3 or L3.

Please keep in mind that the converter we've described is intended as a “junk box” or “experimental” project. Even so, while it won't perform miracles, it will do a creditable job. **R-E**

ADVANCE IS PROUD TO INTRODUCE
NLS Non-Linear Systems

High Quality Oscilloscopes Backed by A One-Year Warranty

* (Exception: model MS-230 is slightly deeper, at 8.6", and heavier, at 3.6 lbs.)

MODEL	VERTICAL BANDWIDTH	DEFLECTION FACTOR	TIME BASE
MS-230	30MHz	10mV to 50V/div 12 Ranges	0.05µ Sec to 0.2 Sec/div 21 Ranges
MS-215	15MHz	10mV to 50V/div 12 Ranges	0.1µ Sec to 0.5 Sec 21 Ranges
MS-15	15MHz	10mV to 50V/div 12 Ranges	0.1µ Sec to 0.5 Sec 21 Ranges

MS 230



MS 215



Non-Linear Systems' trio of mini-oscilloscopes are accurate, affordable, portable. And there's one to match nearly every budget and need. Standard features on all models include an input impedance of 1 megohm with 50 pF; maximum input voltage of 350 V; trigger modes in auto, internal, external and line; slope that's + or - selectable; graticule (4x5 division of 0.25" each); dual power sources operating either internally from rechargeable lead acid batteries or externally from 115 VAC or 230 VAC (50-60 Hz) via plug-in transformer; handy size (2.9"H x 6.4"W x 8.0"D) and weighs just 3 lbs.*

Check the chart below for details of model features and specifications.

MS 15



The remarkable Touch Test 20 DMM. With the Touch Test 20 Non-Linear Systems introduces the 2 lb. 4 oz. test lab. Now, with 20 key test functions at your fingertips (plus the ability to measure 10 electrical parameters and 44 ranges), you can take one lab to the field instead of a cumbersome collection of individual testers.

The new Touch Test 20 D M M features:

- Built in temperature measurement (including probe, F° and C°)
- Capacitance measurement
- DC Voltage (200 MV - 1000V)
- AC Voltage (200 MV - 1000V)
- DC Current (200 µA - 10A)
- AC current (200 µA - 10A)
- Resistance (200 Ω - 20MΩ)
- Diode Test

ADVANCE ELECTRONICS

THE TEST EQUIPMENT SPECIALISTS

TOLL FREE HOT LINE 800-223-0474



54 WEST 45th STREET,
 NEW YORK, N.Y. 10036 212-687-2224



Call For Special Introductory Price Offer



"We're compatible on religion, love, and politics, but not on important issues—such as videotape versus video-disc!"

INTERNATIONAL FM-2400CH FREQUENCY METER FOR MOBILE TRANSMITTERS/RECEIVERS

Portable • Solid State • Rechargeable Batteries

The **FM-2400CH** provides an accurate frequency standard for adjustment of mobile transmitters and receivers at predetermined frequencies.

The FM-2400CH with its extended range covers 25 to 1000 MHz.

The frequencies can be those of the radio frequency channels of operation and/or the intermediate frequencies of the receiver between 5 MHz and 40MHz.

Frequency stability: ± .0005% from +50° to +104°F.

Frequency stability with built-in thermometer and temperature corrected charts: ± .0025% from +25° to +125° (.000125% special 450 MHz crystals available).

- Tests Predetermined Frequencies 25 to 1000 MHz
- Pin Diode Attenuator for Full Range Coverage as Signal Generator
- Measures FM Deviation



FM-2400CH (meter only) . 690.49
 RF crystals (with temp. correction) \$28.89 ea.
 RF crystals (less temp. correction) \$21.92 ea.
 IF crystals catalog price

Write for catalog



INTERNATIONAL CRYSTAL MFG. CO., INC.
 10 North Lee Oklahoma City, Okla. 73102

28K

PERSONAL COMPUTER

Only

\$299⁰⁰

Special Sale Price

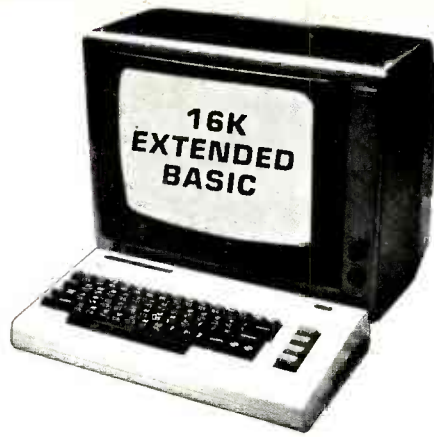

WHAT A SMART INVESTMENT!!!

- For Students and Schools
- Learn to program a computer
- Learn to operate a computer
- For Programmers & Teachers
- For Labs, Engineers, Etc.
- For Small Businesses
- For The Home Owner

PLUG IN EXPANSION

GREATEST BUY IN AMERICA

It has color, sound and music with a powerful 6502 microprocessor (Like Apple). 20,000 Bytes ROM with a 16K microsoft extended Level II Basic built in, 8,000 Bytes RAM plug in expandable to 32K RAM, Cursor, Real time, Full size easy to use 66 key professional typewriter keyboard, 62 keys with graphics symbols, 4 programmable function keys. High resolution graphics, 512 displayable characters, Text display is 23 lines 22 characters, 16 colors. Will accept Tape, Disk-Plug In Cartridges. Has low priced plug in peripherals, Connects to any TV or monitor, Includes AC adapter, RF modulator, Switch box, Cables and self teaching instruction book - all in a beautiful Creme Colored Console Case. This is a powerful-full sized-extra featured computer for only \$299.00

WHY SUCH A LOW PRICE

Selling on a direct to customer basis, we save you the profit margin normally made by computer stores and distributors. We are willing to take a small margin to develop volume to cut our cost of operation.

COMPETITIVE LIST PRICES

APPLE \$1125, T. I. \$525, ATARI \$399.95, RADIO SHACK TRS 80 color with only 12K memory sells for \$399.50.

LOW COST PLUG IN EXPANSION

Expansion accessories plug directly into this computer, extra RAM memory, Controllers, a Cassette, A Telephone Modem for only \$109.00, an 80 Column Printer for \$375.00, even the 170K Disk Drive plugs in direct. You do not have to buy an expensive expansion interface.

GET JOB OPPORTUNITIES NOW

Every newspaper has several pages of want ads for computer people. You can learn to operate and program a computer for these opportunities available to those who prepare for the computer revolution. This computer has extended Level II Basic with floating point decimal, Integer and String Arrays, Trig functions, Direct Statement Execution, Multi-statement Lines, Cursor, Full screen editing, Color Command Keys, Graphics, Scrolling, File Management, Upper-Lower Case, Direct Memory Access, Peek and Poke and much more! Assembly machine language is

available. We have easy to follow self teaching books and programs.

INVEST IN YOUR CHILDREN

Educate your children while they play. Every kid wants to play electronic games. (We have some of the best). The next natural step for their curiosity is to try simple programming. They can do this in 20 minutes with our simple self teaching instruction book. High schools are teaching computer math, science and programming - some start in grammar school. If you provide this computer as a Teacher and Tutor at home, before you know it your child will be writing computer programs. You can use your T.V. to EDUCATE not frustrate your family and eliminate T.V. boredom with programs that challenge, stimulate and entertain the whole family. We have a wide variety of games, recreational, home finance and educational programs to choose from. Why pay \$140.00 to \$295.00 for an electronic game when you can buy this powerful computer for only \$299.00.

COMMUNICATE WITH THE WORLD

Plug in your VIC telephone modem. Now you can get a world of information through your telephone, plus electronic mail. Just dial up the information you want. UPI wire service, stock market, historical information by topic from over 60 magazines, including New York times. Airline information, order tickets, get weather information anywhere in the world, restaurant and hotel information, thousands of categories are on line for you, business, finance, education, entertainment, games etc. YOU'LL BE THE TALK OF YOUR NEIGHBORHOOD. Our telephone modem price is by far the lowest available.

IMMEDIATE REPLACEMENT WARRANTY

If your computer fails because of warranty defect within 90 days from date of purchase, you simply send your computer to us via United Parcel Service prepaid. We will "immediately" send you a replacement computer at no charge via United Parcel Service prepaid. No one we know gives you this kind of warranty service. Most computer warranty service takes 30 to 90 days to handle - this fantastic "immediate replacement warranty" is backed by COMMODORE COMPUTER, a MAJOR national brand electronics manufacturer.

SPECIAL SALE PRICE \$299.00

For only \$299.00 you get the powerful 28K COMMODORE VIC with 20K ROM, 8K RAM and Extended Level II Basic, The professional 66 keyboard, color, sound, music, self teaching instruction book, AC adapter, RF modulator, TV switch box, owners manual, plus all of the other extra features listed, in a beautiful Creme Colored Console Case.

SPECIAL SALE PRICE \$379.00

For only \$379.00 you get the more powerful 41K COMMODORE VIC with 20K ROM, 21K RAM and Extended Level II BASIC, plus all of the extra features shown for the 28K COMMODORE VIC!

"15-DAY FREE TRIAL"

DON'T MISS THIS SALE - ORDER NOW

- Please send me the 28K Commodore VIC Computer for \$299.00
- Please send me the 41K Commodore VIC Computer for \$379.00
- Special Data Cassette \$69.00

We ship C.O.D. and honor Visa and Master Card.

Name _____

Address _____

City _____

State _____ Zip Code _____

VISA MASTER CARD C.O.D.

Credit Card No. _____

Expiration Date _____

Add \$10.00 for shipping, handling and insurance. Illinois residents please add 6% tax. Add \$20.00 for CANADA, PUERTO RICO, HAWAII orders, WE DO NO EXPORT TO OTHER COUNTRIES.

Enclose Cashiers Check, Money Order or Personal Check. Allow 14 days for delivery (21 days for Personal Check orders.) 2 to 7 days for phone orders. Canada orders must be in U.S. dollars.



we are
commodore VIC
experts!!

VIC 20
owners register with
us for new product
and program information.

PROTECTO ENTERPRIZES (FACTORY-DIRECT)

BOX 550, BARRINGTON, ILLINOIS 60010
Phone 312/382-5244 to order

CIRCLE 27 ON FREE INFORMATION CARD

20M282

MAY 1982

87

COMPUTER CORNER

Microcomputer memory devices

LES SPINDLE*

AN IMPORTANT CONSIDERATION IN planning your computer system is making sure that it has enough memory capacity to meet your needs—present and future. The amount of data that can be stored, and the speed with which it can be accessed, will play an important role in the efficiency of the system in handling your home or business applications. You should not only have enough memory to take care of your immediate requirements, but also have provision for expanding that memory as your use of the computer increases.

Memory comes in two basic forms. The first is *resident* memory—the memory that is usually located inside the computer and that is used to hold programs and variables when they are in use. The other form, *external* memory, is used for storing programs and data. Those programs and data, however, cannot be used by the computer until they are loaded into the resident (or *working*) memory.

Resident memory

Let's take a look at the memory options available to you, beginning with the internal memory capacities of your computer. All microcomputers have a certain amount of resident memory in the form of integrated circuits, classified either as ROM (Read-Only Memory) or RAM (Random Access, or Read-And-write, Memory). Both allow the microprocessor virtually instantaneous access to the data they contain.

ROM can be compared to a phonograph record—the data is fixed, and cannot be added to or subtracted from. It is used to store such things as the computer's operating system or a language (like BASIC) that will be used over and over, and which should be available to the user as soon as the computer is turned on.

The ROM's that are supplied with a computer are usually designed from the ground up to contain specific data; it is, literally, built in. There are several types of ROM, though, that a computer user—with the appropriate equipment—can program himself. The first is called PROM (Programmable Read-Only Memory). It can be programmed

only one time and, if a programming error is made, a new PROM has to be "burned." An EPROM (Erasable Programmable Read-Only Memory), however, can be erased if an error is made, and the program reloaded. Even more valuable is the fact that, if the program contained by an EPROM is no longer needed, the IC can be erased and reused for a completely different purpose.

RAM, on the other hand, is designed for temporary data storage. Its contents can be changed or read at any time and without it a computer would be useless. RAM is used to hold programs and data.

It is important to know that there are two types of RAM—*static* and *dynamic*. Dynamic RAM's are easier to design and manufacture, and new large-capacity RAM IC's first appear in dynamic form; the static versions follow later. Among the advantages of dynamic RAM is its low power-consumption and lower price, when compared to static memory. The disadvantage of dynamic RAM is that it is "leaky," and quickly loses its contents unless it is frequently refreshed. In the early days, refresh circuitry was quite complicated, and dynamic-memory systems were regarded as somewhat unreliable. Current dynamic RAM's and the IC's used

to refresh them have been considerably improved and simplified; those are now widely used.

Static RAM's, on the other hand, require no refreshing. They will keep their contents intact until the computer is shut off. Static memories are more complex and expensive than their dynamic counterparts, and—generally—consume more power. Still, many computerists feel more comfortable with them than with dynamic memories.

Adding memory

There are several things to bear in mind when selecting add-on memory to extend your computer's capabilities. The first, of course, is whether it is compatible with the computer. If the computer uses memory boards or cartridges, they must fit. That sounds obvious, but is still something to watch. Also, if your memory is expandable simply by adding more RAM IC's, make sure that they are the proper type. Finally, make sure that the new memory does not take up physical space that may be needed for peripheral boards that may be added later, and that your computer's power supply can handle the memory *plus* whatever else it may be called upon to run.

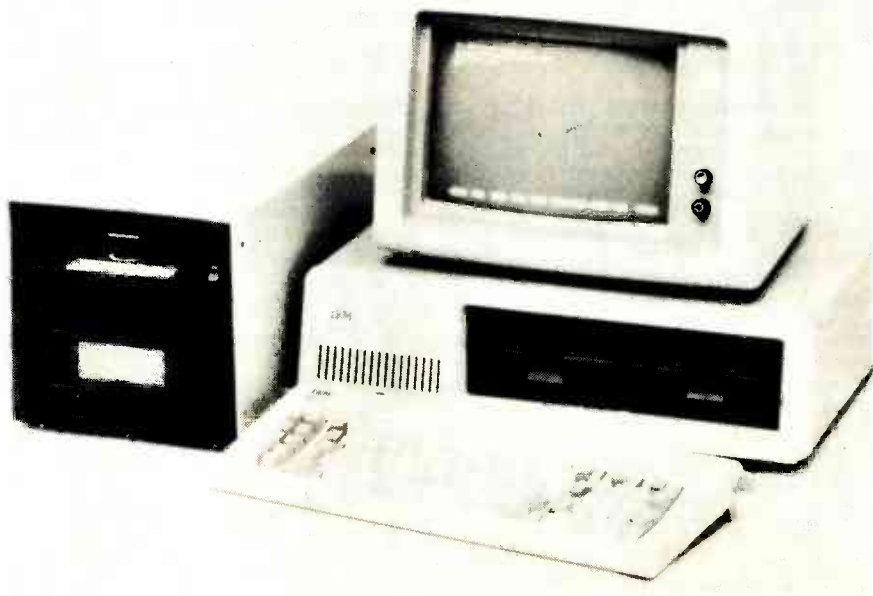

FIG. 1

*Managing Editor, *Interface Age* magazine.

\$695⁰⁰

FREE



Gould Oscilloscope Factory Sale.

The 20 MHz, dual trace oscilloscope that would normally cost \$1,000 from someone else, now costs just \$695 from Gould. So it's like getting part of it free.

How can we do it? With a special factory sale from us direct to you.

No catches either. The OS300 provides everything you need in a quality oscilloscope.

Check these features

- 20 MHz bandwidth
- 2 mV sensitivity
- Active TV trigger
- DC trigger
- Channel sum or difference
- 12 lbs. overall weight
- X-Y Mode
- Z axis input
- Color grouped controls
- Triggers on frequencies up to 50 MHz

The Gould OS300 is a compact, portable 20 MHz dual trace oscilloscope weighing only 12 lbs. The scope is enclosed in a rugged metal housing that has a convenient carrying handle. The case size is only 5½" x 12" x 18", yet the display area is a large, bright 8 x 10 cm rectangular CRT.

This instrument offers features usually found in more expensive oscilloscopes including channel sum and difference, switched X-Y and 2mV/cm sensitivity across the full bandwidth. A 2-volt DC coupled Z-mod input facilitates use with logic analyzer outputs.

Triggering facilities include AC, DC coupling plus an active TV synch separator which automatically se-

lects line/field triggering as the time-base speed is adjusted.

Service and warranty

The OS300 is covered by Gould's one year warranty on parts and labor exclusive of fuses, minor maintenance and calibration. And can be serviced at any of Gould's more than 20 service centers across the country.

Order before June 30, 1982 and get two sets of x10 probes at no extra cost

What could be better? Order 10 or more OS300's and you can get an even lower price of \$643 per unit.

How to order

To order, simply call our toll free number, and use your MasterCard, VISA or American Express card.

To order by mail, please use the coupon. And send your check, money order or purchase order. We regret that we cannot accept C.O.D.'s.

Call 800-321-3035 and ask for operator #300

Phones open Monday through Friday, 8:30 a.m. to 4:30 p.m., EST. Have your MasterCard, VISA or American Express card ready. This number is for orders only. For information, you must write to Gould Inc., Instruments Division, 35129 Curtis Blvd., Eastlake, OH 44094.

 **GOULD**

Electronics & Electrical Products

CIRCLE 20 ON FREE INFORMATION CARD

FREE TRIAL. Return in 15 days for a complete refund if not entirely satisfied.

OS300 OSCILLOSCOPE

PRICE \$695.00 ea.*

QTY _____

AMOUNT _____

add applicable sales tax _____

INSURANCE SHIPPING _____

\$6.95 ea.* _____

*U.S. Dollars

TOTAL _____

Name _____

Address _____

City _____

State _____

Zip _____

MAIL TO: Gould Inc.,
Instruments Division
35129 Curtis Blvd.
Eastlake, OH 44094

External storage devices

Once you've decided about memory, it's time to decide what external storage device you're going to use to hold your languages, programs, and data when they are not resident in the computer.

Audio-cassette type is the medium that seems to be most popular (and affordable) for home and hobby applications. Its storage capacity is high, and its cost is low. A reasonably priced (\$50-\$100) cassette recorder and several cassettes will start you on your way. Problems will quickly arise, however, when you start trying to use cassettes for larger-scale applications.

The major disadvantage of cassettes

is that all the data on them is recorded serially. Just as one byte follows another onto the tape, so do whole files. Just trying to locate a particular file can be a time-consuming task, and updating it can be a nightmare. Cassettes are also slow—it can take several minutes to load in a file *after* you've managed to find it!

In a business environment, you can't afford to spend time searching through cassettes and waiting for them to load their contents into the computer's memory; you need something faster.

The answer is a disk system. There are two types of disk systems: *floppy* and *hard*. Let's look at the floppy disk

first, since it is more widely used.

Floppy disks are a sort of cross between phonograph records and magnetic recording-tape. They come in two diameters: 5¼ inches and 8 inches and are enclosed in a square cardboard or plastic jacket to protect them (the disk surfaces are very delicate). Data is recorded as magnetic pulses on the surface of the disk.

The beautiful thing about disks, as compared to cassettes, is that it is possible to find and load anything that's on a disk in a matter of seconds. A directory is automatically maintained on each disk, indicating where everything is stored, and the disk drive's read/write head can position itself anywhere on the disk in milliseconds. The speed, plus the conveniences offered by the software—known as the DOS (*Disk Operating System*)—that controls the comings and goings of data to and from the disk, make floppy disks ideal for the kind of situations encountered in small and medium-sized business—or even in serious personal computing.

It is possible to increase the storage capacity of a disk system. Initially, it will probably be "single-sided, single-density," which means that a 5¼-inch disk will be able to hold approximately 90 kilobytes (the figure will vary depending on the design of the circuit that

continued on page 99

Take a good look at VACO.



THE SUPER CASE
70260

The world famous Super Case. Complete with 48 of the most popular and professional problem-solving tools. From screwdrivers and nutdrivers to pliers, wrenches, crimping tools and more. A super variety and super value. All unconditionally warranted from Vaco, of course. The Super Case and all the other fine Vaco tools can be seen in our new 1982 catalog. It's free, just write. Say you want to take a good look at VACO.

Vaco Products Company, 1510 Skokie Blvd.
Northbrook, IL 60062 U.S.A.

VACO

Power Line Filters

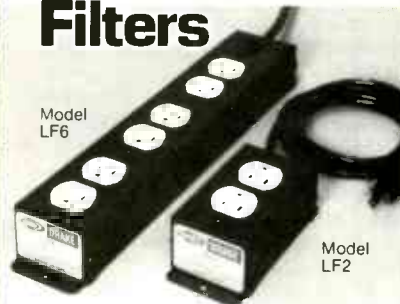

Model
LF6

Model
LF2

These filters protect any sensitive electronic equipment from power line transient damage and radio frequency interference. Both models offer common mode and differential mode surge suppression for power line "spikes". Rf interference is suppressed using both inductive and capacitive components. Ideal for computers, test equipment or TV.

LF2 a duplex outlet, 120V, 8 amps max. . . \$39.95

LF6 three separately filtered duplex outlets, 120 V, total fused capacity 15 amps, power switch and indicator lamp . . . \$59.95

Add \$2.50 shipping and handling per order.

Send check with order and provide street address for UPS shipment. Ohio residents add Sales Tax. Charge card buyers may call toll free:

1-800-543-5612



In Ohio, or for information call: 1-513-866-2421

R. L. DRAKE COMPANY

540 Richard Street, Miamisburg, Ohio 45342

INSTITUTIONAL AND DEALER INQUIRIES INVITED.

STATE OF SOLID STATE

One IC voltage conversion

ROBERT F. SCOTT, SEMICONDUCTOR EDITOR

WHILE EXPERIMENTING WITH SOLID-state circuits, have you ever wished that you could power analog circuits from the supply you are using for digital circuits? Well, it's not impossible. In fact, it's simple when you use the Intersil CMOS ICL7660 voltage converter connected as shown in Fig. 1. Apply a positive voltage between pins 8 and 3 and you'll get a negative voltage of the same value between pins 5 and 3. Both voltages are measured with respect to pin 3, which is ground or the negative terminal of the battery or driving power supply.

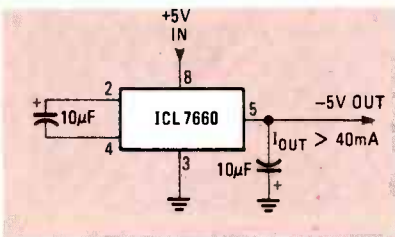

FIG. 1

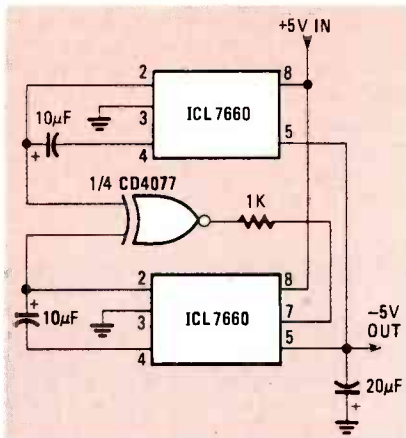

FIG. 2

Thus, in the 7660, we have a unique device that converts a positive-input voltage to a negative-output voltage with a conversion efficiency of 98% when $R_L = \infty$. Power-conversion efficiency is 98% when R_L is 5000 ohms. Output current is greater than 40 mA into a 55-ohm load.

If you need a higher supply voltage for a portion of your circuitry, simply cascade two or more 7660's. Need more current? Connect two 7660's in parallel as shown in Fig. 2. That circuit

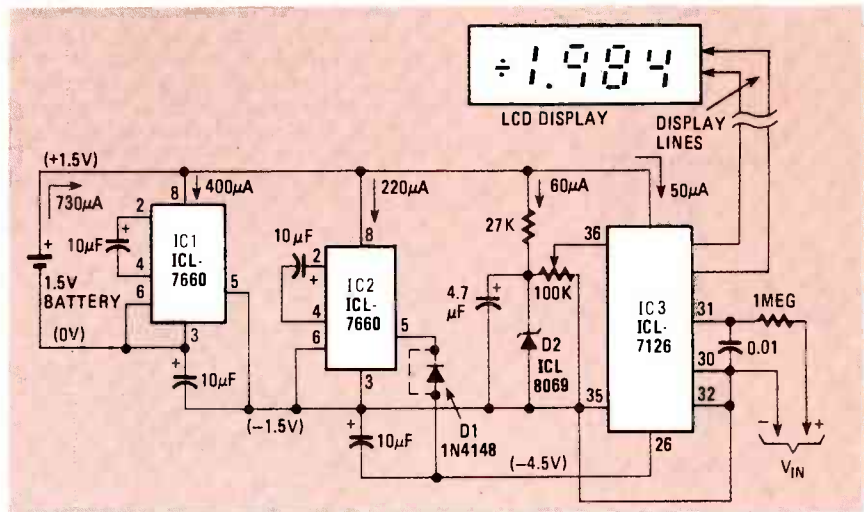

FIG. 3

is useful when the load on a single 7660 causes an excessive voltage drop.

Normally, simple power supplies cannot be paralleled with any degree of efficiency because the output voltages and internal impedances of the individual sources are never precisely equal. Thus, when two such supplies are paralleled, the one with the higher output will carry most of the load. In Fig. 2, each device sees the same input voltage and, since conversion efficiency is nearly ideal, the devices share the load equally.

Each device has a separate "pump" capacitor (10 µF in this application). The CD4077 exclusive NOR gate compares the device outputs at pin 2 and clocks one to maintain sync with the oscillator in the other. The scheme can be extended to deliver around 160 mA by paralleling four devices and using an extra logic gate.

In an interesting circuit innovation described by Intersil, a 1.5-volt cell and a pair of 7660's were used as cascaded voltage doublers to deliver 6-volts DC to a 7126 3 1/2-digit micropower analog/digital converter driving a liquid-crystal display. The circuit is shown in Fig. 3.

With 1.5 volts applied to the input of IC1, the first voltage converter, a negative 1.5 volts is developed at pin 5. Converter IC2 sees a total of 3 volts at its input (1.5 volts from the battery and 1.5 volts from IC1) and produces -3 volts with respect to the output of IC1. The total voltage across IC2 pins 8 and

5 is four times the battery voltage, or 6 volts. That is high enough to supply the 7126 A/D converter and the 8069 voltage reference. The external voltage reference is needed because the A/D converter's internal reference works best with a power supply of over 6.5 volts. The 1.2-volt external reference insures that the A/D converter will work correctly even when the battery voltage is low.

Total battery drain is typically only 750 µA. Battery voltages up to 3.5 may be used. Diode D1 should be used whenever battery voltage can be expected to exceed 3 volts.

The ICL7660 is an inexpensive solution to many voltage-conversion problems. It's only \$1.95 in lots of 100. Your Intersil distributor or favorite mail-order supply house should have it in stock.

VMOS power devices

Field-effect transistors (FET's) have been around as practical devices since about 1952. But for the next twenty years or so, they were strictly low-power devices capable of handling only loads of less than 1 watt. Thus, they were not able to compete with bipolar transistors and SCR's in power-handling applications. The reason for that is that in a typical FET, the current travels horizontally, just below the surface of the chip, and the maximum current density is much lower than that of

continued on page 97

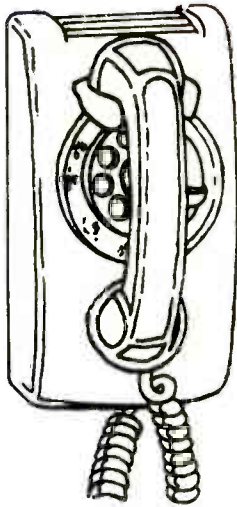

CALL NOW

AND RESERVE YOUR SPACE

- 6x rate \$550 per each insertion.
- Reaches 220,500 readers.
- Fast reader service cycle.
- Short lead time for the placement of ads.
- We typeset and layout the ad at no additional charge.

Call 212-777-6400 to reserve space. Ask for Arline Fishman. Limited number of pages available. Mail materials to: mini-ADS, RADIO-ELECTRONICS, 200 Park Ave. South, New York, NY 10003



ONE MAN CRT FACTORY, easy operation. Process new or rebuild old CRT's for tv's, bus. machines, monitors, scopes, etc. Color, b&w, 20mm, foreign or domestic. 3x6 ft. space required. Profits???. Average CRT rebuilding cost — \$5. Sell for \$100 = \$95 profit; x 5 CRT's = \$475 daily; x 5 days = \$2375 weekly profit. Higher profits outside U.S.A. Investigate this opportunity today. We service the entire world. Write or call:

CRT Factory, 1909 Louise St., Crystal Lake, Il. 60014, (815) 459-0666.

CIRCLE 7 ON FREE INFORMATION CARD



This **DYNAMIC NOISE REDUCTION SYSTEM** is a significantly improved version of the NR-2 (featured in R.E. Aug./Sept. 79) employing the most advanced IC's to reduce the noise in your stereo system by up to 14dB. Works with all program sources (including Dolby® tapes) to make your sounds virtually noise free. **AAS-450, \$189.00, VISA, M/C welcome. Advanced Analog Systems Inc., 790 Lucerne Dr., Sunnyvale, CA 94086, (408) 730-9786.**

Dolby® is T.M. of Dolby Licensing, S.F. CA
CIRCLE 10 ON FREE INFORMATION CARD

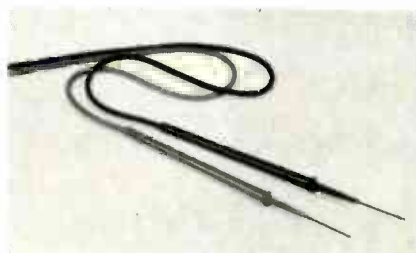

AT LAST! COMPLETELY REPAIRABLE TEST PROBES. MICROPROBES from Huntron Instruments feature a needle-sharp stainless steel point on a telescoping, length adjustable electrode insulated to withstand 1KV right down to the ground tip. Super-Slim valox probe bodies and 5 foot superflex leads. **All parts are replaceable! \$9.95 + \$3.50 handling.** Add CALIF. or WASH. tax. **Visa/Mastercharge accepted.** Huntron Instruments, 15123 Hwy. 99 North-Lynnwood, WA 98037 (800) 426-9265.

CIRCLE 3 ON FREE INFORMATION CARD

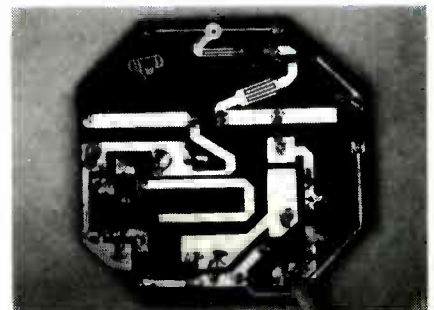

2300 MHz DOWNCONVERTER kit for Amateur microwave reception. \$35.00 postpaid. Highest quality components. Send SASE for information filled catalog of other converter kits, preamps, accessories and parts. VISA and MASTERCARD accepted.

SMP - Superior Microwave Products, Inc. PO Box 1241 Vienna, VA 22180 1-800-368-3028 1-703-255-2918

CIRCLE 2 ON FREE INFORMATION CARD

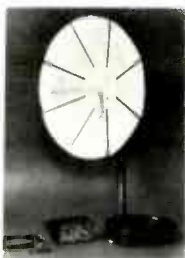

AMATEUR MICROWAVE RECEIVER SYSTEM (pictured) provides wide-band, high gain reception of amateur television transmissions from 2.1 GHz to 2.6 GHz. View on your television. Order MA1: **\$169.95. MICROWAVE TELEVISION EDUCATION MANUAL** includes detailed microwave downconverter, power-supply, and antenna plans: **\$16.25. SUBSCRIPTION TELEVISION EDUCATION MANUAL: \$14.95.** Add 5% shipping and handling. *Informative catalog: \$2.00. ABEX, P.O. Box 26601-RE, San Francisco, CA 94126-6601.*

CIRCLE 5 ON FREE INFORMATION CARD



AUDIO DELAY LINE, Make your listening room sound like a concert hall. The **ARS-977** adds the effect of spacial dimension to your sounds; that big real life feeling. Featured in R.E. (Sept./Oct. 81) **ARS-977 Kit only \$149.95. VISA, M/C welcome.**— **Advanced Analog Systems Inc., 790 Lucerne Dr., Sunnyvale, CA 94086, (408) 730-9786.**

CIRCLE 11 ON FREE INFORMATION CARD

Heart disease and stroke will cause half of all deaths this year.



American Heart Association

WE'RE FIGHTING FOR YOUR LIFE

CALL NOW AND RESERVE YOUR SPACE

- 6x rate \$550 per each insertion.
- Reaches 220,500 readers.
- Fast reader service cycle.
- Short lead time for the placement of ads.
- We typeset and layout the ad at no additional charge.

Call 212-777-6400 to reserve space. Ask for Arline Fishman. Limited number of pages available. Mail materials to: mini-ADS, RADIO-ELECTRONICS, 200 Park Ave. South, New York, NY 10003.

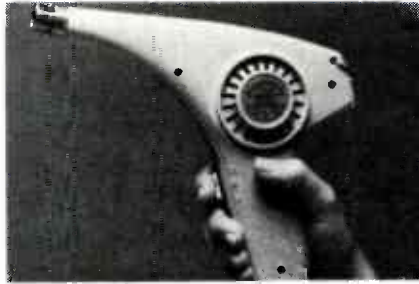

UNGAR HEAT GUN weighs 13 ounces, including 6' full length 3 wire cord. Positive control where precise hot air direction is required. Ideal For... • Solder Preforms • Shrink Tubing • Reflow soldering • Epoxy curing • Expanding frozen fasteners. UL Listed. 250 W, 120V AC. Suggested Resale: **\$70.00 Each. Available through your Ungar Distributor or contact... UNGAR, Division of Eldon Industries, Inc., P.O. Box 6005, Compton, CA 90220, (213) 774-5950, (800) 421-1538. CIRCLE 4 ON FREE INFORMATION CARD**



Digital logic probe DLP-50 is one of the most sophisticated logic probe. It's features are: 50 MHz frequency range, high input impedance of 10 MSL, wide range of power supply 4.5 to 30 VDC, Hi, Lo, Open/Bad, and pulse LED indicators Audible warning, and much more at unbelievable price of **\$54.95**, plus **2.95** shipping and handling, Calif. add tax. Send for your free catalogue on our other products. **Masco Electronics, P.O. Box 45922, Los Angeles, Calif. 90045**, (Check, M/O, VISA, and M/C are accepted.) **CIRCLE 9 ON FREE INFORMATION CARD**

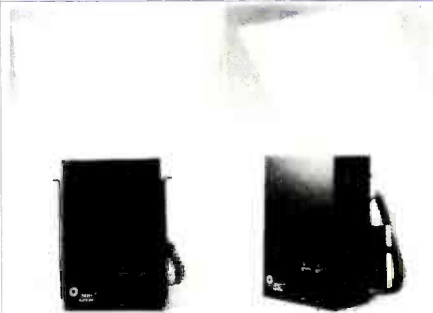

WAKE UP to a sunrise every morning. The new elarm[™] sunrise is a revolutionary alarm that wakes you slowly and gently with a special sequence of lights and sound. Several models are available starting at only **\$89.95**. Write for more information: **Lour Sales Group, Dept. 12, P.O. Box 94728, Schaumburg, IL. 60194.**

CIRCLE 6 ON FREE INFORMATION CARD

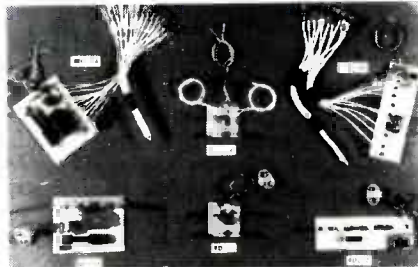

NOVEL QUALITY KITS RDU-1: Alternately flashes 2 (or more) LEDs **\$3.95**. **RDU-1A:** Alternately flashes 2 (or more) lamps specify 6 or 12 VDC **\$3.95**. **RDU-2:** 10-LED chaser **\$6.95**. **RDU-2A:** 10-lamp chaser specify 6 or 12 VDC **\$9.95**. **RDU-3:** 16-LED back & forth chaser **\$11.95**. **RDU-3A:** 14-lamp back & forth chaser specify 6 or 12 VDC **\$14.95**. **RD Unlimited, GPO Box 1879, New York City, N.Y. 10116.** Min. order **\$15.00** add **\$3.00** for shipping NYC/NYS residents add appropriate tax. **CIRCLE 92 ON FREE INFORMATION CARD**

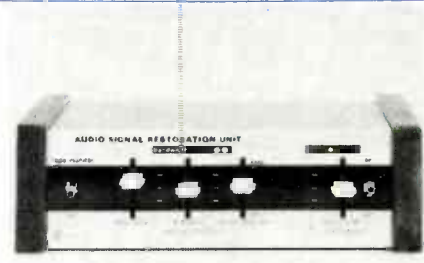

Digital sound from your analog recordings? The ASRU improves the dynamic range of records and tapes by 18dB. See R-E cover story 3-4/81 or send for free catalog. Kit: **\$110** postpaid. M/C, VISA. Orders only 800-227-1617, Oper. 191. **Symmetric Sound Systems, Inc., 912B Knobcone Pl., Loveland, CO 80537.**

CIRCLE 93 ON FREE INFORMATION CARD



YES, 300 Watts RMS... build this "BRUTE" amp easily with our special HEATSINK and PCB kit ... complete with instructions ... only **\$24.95** US/PPD. For fast delivery, send a cashier's check or money order only **NO COD PLEASE**, to: **DACOR LIMITED, P.O. Box 683, Station Q, Toronto, CANADA M4T 2N5.**

CIRCLE 12 ON FREE INFORMATION CARD

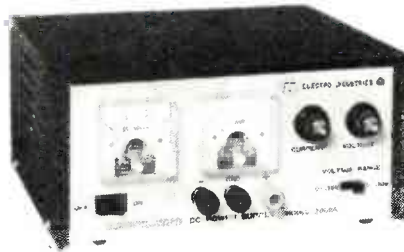

VERSATILE LABORATORY POWER SUPPLY delivers a fully regulated output from 0 to 30 VDC at 0 to 2A. Ripple and noise is less than 250 uV RMS. Model 3002A features continuously adjustable current limiting and precision constant voltage/constant current operation with "automatic crossover." Unit can also be used as a current regulated power source. Only **\$119.95**. **Electro Industries, 4201 W. Irving Park Rd., Chicago, IL 60641, (312) 736-0999. CIRCLE 8 ON FREE INFORMATION CARD**

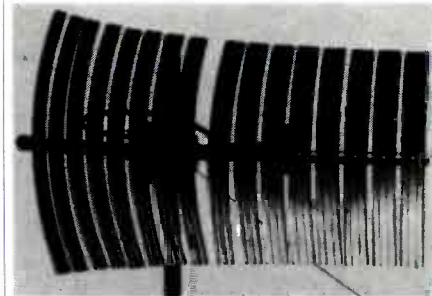

AMATEUR MICROWAVE RECEIVER SYSTEM 36" Parabolic antenna, receives 2.1-2.5 GHz with over 55 db system gain, **\$199.95**. **REPAIR**, we repair all makes of communications equipment, including amateur microwave. Large line of electronic kits and parts. Send **\$2.00** for catalog, refundable on first purchase. **VISA & MASTERCARD ACCEPTED. SRS PO BOX 50, East Detroit, MI 48021 (313) 791-5551.**

CIRCLE 13 ON FREE INFORMATION CARD

SERVICE CLINIC

Troubleshooting IC circuits

JACK DARR, SERVICE EDITOR

INTEGRATED CIRCUITS ARE STRANGE and mysterious things to many of us. However, as times change, so must we; and because IC's appear to be with us to stay, we're going to have to learn to troubleshoot the circuits they appear in. The question is: *How* do you troubleshoot something that looks like a black bug with 24 legs?

The answer is to determine what the function of the IC is supposed to be, and then to see whether it is doing what it's supposed to. Check the inputs and the outputs. If it's a demodulator, is it demodulating? If it's an amplifier, is it amplifying? And so on...

Taking a comparatively simple device, an audio-preamp driver IC, we should see low-level audio signals at the input, and the same signals, at a much higher level, at the output. The output drives the base of the audio-output transistor. (Some IC's have the output transistor built in, in which case they drive the speaker directly.) To test the IC, feed a low-level—about one-volt peak-to-peak—audio signal to the input. Then, check for the normal signal-level at the output. That can be as simple as listening for it. If you don't hear anything, scope the output of the IC. If there's a signal there, the output transistor isn't working; check it. Input and output pins of an IC, as well as normal signal-levels, can usually be found on the schematic of the device giving you trouble.

If there's no output from the IC, check the DC voltages around it, starting with the DC-supply pin. It is connected to the DC power-supply, usually through a dropping resistor. If the voltage is off, check the resistor, and any bypass capacitors that may be connected to the power-supply pin. If the resistor shows signs of overheating, you may have found the problem. The chances are that the IC is internally shorted, or a bypass capacitor is bad. If the supply voltage is present but incorrect, check all the other pins of the IC. Some may have no connection, or go directly to another IC, but others may have small resistors to ground, or capacitors, on them; check them out, and make sure that the DC voltages are correct. They are produced by the IC and, if one or more is not there, the IC is probably bad. Be sure to check all the external

components before condemning the IC, though! Some sets use the audio-preamp driver IC as a volume control—its output level is determined by a variable control-voltage. Make sure that the control voltage is normal, and varies as it should when the volume control is turned.

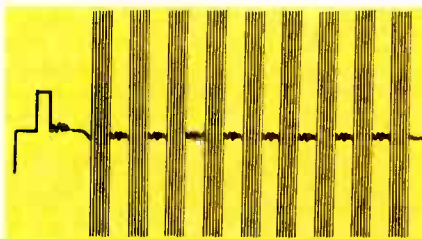

FIG. 1

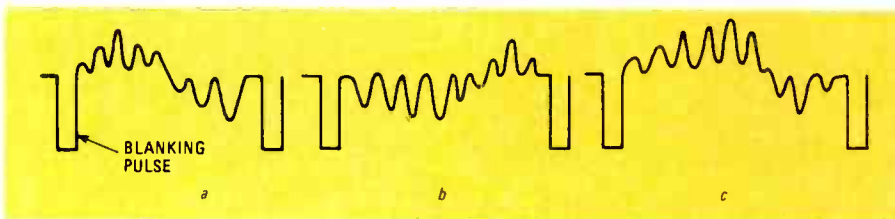

FIG. 2

We can still use the same basic tests with a much more complex but basically similar type of IC, such as a color demodulator. Feed a known input-signal to the IC and check its three outputs (in this case) to see whether or not there's a signal present at each. The input signal can be the video output of a color-bar generator, and will show a "comb" pattern (see Fig. 1). Use your scope to set the input level indicated on the schematic. The three outputs should bear the familiar "lazy-S", or "rocker" shape shown in Fig. 2. Each output feeds the input of one of the three color-amplifier transistors. Your schematic should indicate the correct peak-to-peak voltage for each IC output. Normally, the red and blue outputs will be stronger than the green one.

If you see an input but no output, read all of the DC voltages developed on the IC pins. If one pin is supposed to have +3.6-volts DC, for example, with a small resistor to ground, and the resistor is OK but the voltage is missing, the IC may be bad. Check DC voltages at other pins; you may find more of them off, and if that's the case, it's a good sign that the IC is bad.

If the DC-voltage tests don't produce

results and the trouble is still present, look for pins with only a bypass capacitor, or something else, on them. If you see a signal on any pin with a bypass capacitor, the capacitor is very likely open. Also, the 3.58-MHz reference-oscillator signal is often brought out to an external tint-control; check all the components in that circuit, too. Open or leaky capacitors can cause feedback and some very strange symptoms!

Troubleshooting circuits containing IC's is really very simple: Any circuit has an input and an output. If signal is OK on the input, but not on the output, and all the external parts are good, then there's nothing left between those two points but the IC.

If the problem is intermittent, don't ignore the IC's when you're hunting for it! IC's can develop thermal intermittents just like other components. In one situation that came up some time ago (and has cropped up several times since) the 3.58-MHz reference signal of a well-known make of receiver dropped out intermittently. The oscillator was made up of a simple op-amp and a crystal. The IC would get hot, and the signal would disappear. (By the way, the best cure we found for that was to use an IC of a different make from the original! Sylvania, GE, and RCA all had exact substitutes for it.)

Audio distortion showed up in a small black-and-white set that had an audio IC with a built-in output transistor. Cooling the IC cleared up the distortion, so the IC was replaced. Unfortunately, the same symptoms showed up with the new one! The final "fix" was to cement a small heat sink, made of a shallow U-shaped piece of thin aluminum, to the IC case. That kept it cool enough so that it didn't act up.

Replacements for some "unknown" IC's are hard to find, especially in the case of some of the imports. Sometimes we have been able to find a substitute

Economy. Accuracy. Portability. Versatility. Whatever's important to you, count on us.



When it comes to frequency counters, we've cut the industry giants down to size. Whatever and wherever you're counting, we offer you far more performance for far less money.

Start with our portable handheld MAX-50 counter. At just \$77*, it delivers precision six-digit frequency readings to 50 MHz. It features easy, instant operation, ideal for audio, VHF and UHF applications and is available with a complete line of accessories and input cables.

For a larger (0.43") display, greater accuracy or TTL compatibility, our portable eight-digit MAX-100 is the natural choice. With a range of 5Hz to 100MHz, it's perfect for audio, video, microprocessor and RF applications, in lab, production line or field. Especially when you consider its ± 4 ppm accuracy, versatility and complete line of accessories at a low \$149* price.

For more demanding challenges in process control, audio applications and low frequency counting, our remarkable Model 5001 Universal Counter-Timer, priced at only \$360*, offers a range of DC through 10MHz. Measuring frequency (selectable gate

times .01, .1, 1.0, 10 sec), frequency ratio, period, multiple period average, time interval, time interval average and event count—on a bright, 0.43" eight-digit LED display. All, with full input signal conditioning on two input channels, and variable display sampling rate.

For the ultimate in high-precision, our Model 6001 is your best value. It covers a range of 5Hz to 650MHz with a unique NBS-traceable 10MHz TCXO with 0.5ppm accuracy. And boasts selectable gate times, switchable low-pass filter, external timebase input, buffered timebase output and a bright 0.43" eight-digit LED display. Priced at just \$489*, its performance is unequalled by counters at twice the price!

When you consider that all our counters are guaranteed to meet or surpass published specifications, isn't it time you had a Global Specialties' counter on your bench?

70 Fulton Terr. New Haven, CT 06509 (203) 624-3103, TWX 710-465-1227
OTHER OFFICES: San Francisco (415) 648-0611, TWX 910-372-7992
Europe: Phone Safron-Walden 0799-21682, TLX 817477
Canada: Len Finkler Ltd. Downsview, Ontario

GLOBAL SPECIALTIES CORPORATION

Call toll-free for details
1-800-243-6077
During business hours

*Suggested U.S. resale. Prices, specifications subject to change without notice. © Copyright 1981 Global Specialties Corporation.

See us at EDS booth nos. K26, 28; L25, 27

CIRCLE 29 ON FREE INFORMATION CARD

www.americanradiohistory.com



NEVER BUY BATTERIES AGAIN!

WITH OUR PATENTED "SLEEVE ADAPTER"
RECHARGEABLE BATTERY SYSTEM
COMPLETE WITH 4 SANYO "AA" SIZE
RECHARGEABLE BATTERIES, 4 SETS OF "C" &
"D" ADAPTERS AND THE CHARGER.

The "AA" cell with ADAPTER'S will power most products that require "C" or "D" batteries. Rechargeable over and over again, indefinitely. **One size fits all. SAVE MONEY 2 WAYS.** End repeated purchases of costly throwaways. Eliminates need to buy rechargeable "C" & "D" cells. **Complete System \$19.95** • NEED MORE? "AA" batteries \$2.10 each • Adapter sleeves \$1.50 "C" & "D" set • 9 V rechargeable \$8.49 each • Additional chargers \$6.95 (will charge 2 or 4 "AA" or one 9 volt)
 MC/VISA Accepted. Give card number and expiration date.
 Postage and Handling \$2.50 N.Y. State add 7¼%. Send check/Money Order
BURTON PRODUCTS Corp. Dept. Ra-5 P.O. DRAWER E. CORAM, N.Y. 11727

CIRCLE 62 ON FREE INFORMATION CARD

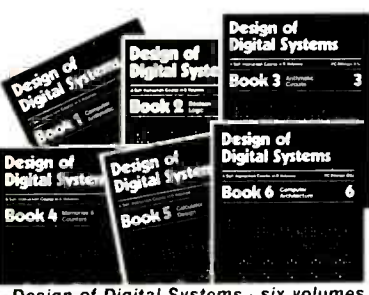

Designing Digital Systems

Two programmed learning courses:
 hardware and software; theory
 and application.

ADVANCED COURSE DESIGN OF DIGITAL SYSTEMS

Six large format volumes — each 11¼ x 8¼"

CONTENTS

The contents of Design of Digital Systems include:
 Book 1: Octal, hexadecimal and binary number systems; representation of negative numbers; complementary systems; binary multiplication and division.
 Book 2: OR and AND functions; logic gates; NOT, exclusive-OR, NAND, NOR and exclusive-NOR functions; multiple input gates; truth tables; DeMorgan's Laws; canonical forms; logic conventions; Karnaugh mapping; three-state and wired logic.
 Book 3: Half adders and full adders; subtractors; serial and parallel adders; processors and arithmetic logic units (ALUs); multiplication and division systems.
 Book 4: Flip-flops; shift registers; asynchronous counters; ring, Johnson and exclusive-OR feedback counter; random access memories (RAMs); read-only memories (ROMs).
 Book 5: Structure of calculators; keyboard encoding; decoding display data; register systems; control unit; program ROM; address decoding; instruction sets; instruction decoding; control program structure.
 Book 6: Central processing unit (CPU); memory organization; character representation; program storage; address modes; input/output systems; program interrupts; interrupt priorities programming; assemblers; executive programs, operating systems, and time-sharing.

OUR CUSTOMERS

Design of Digital Systems has been bought by more than half the 50 largest corporations in America, and by Motorola, Intel, DEC, National Semiconductor, Fairchild, General Instrument, Hewlett-Packard, Heath Co., M.I.T., NASA, Smithsonian Institute, Bell Telephone Labs. And many, many more, as well as corporations and individuals in over 50 countries.

BASIC COURSE



Digital Computer Logic & Electronics

CONTENTS

Digital Computer Logic and Electronics is designed for the beginner. No mathematical knowledge other than simple arithmetic is assumed, though you should have an aptitude for logical thought. It consists of 4 volumes — each 11¼ x 8¼" — and serves as an introduction to the subject of digital electronics.
 Contents include: Binary, octal and decimal number systems; conversion between number systems; AND, OR, NOR and NAND gates and inverters; Boolean algebra and truth tables; DeMorgan's Laws; design of logical circuits using NOR gates; R-S and J-K flip-flops; binary counters, shift registers and half-adders.

NO RISK GUARANTEE

There's absolutely no risk to you. If you're not completely satisfied with your courses, simply return them to CLT within 30 days. We'll send you a full refund, plus return postage.

TAX DEDUCTIBLE

In most cases, the full cost of CLT courses can be a tax deductible expense.

PHONE ORDERS - FREE

To order by phone, call (617) 664-3657 with your credit card information. It won't cost you a dime, because we'll deduct the cost of your call from the price of the courses you order.

TO ORDER BY MAIL

You may use the order form below if you wish, but you don't need to. Just send your check or money order (payable to Cambridge Learning, Inc. to the address below. If you don't use the order form, make sure your address is on your check or the envelope, and write "DDS" (Design of Digital Systems), "DCLE" (Digital Computer Logic & Electronics), or "both" (both courses) on your check.
 Mass. Residents add 5% sales tax. We pay all shipping costs.
 We also accept company purchase orders.

AIR MAIL

The prices shown include surface mail postage anywhere in the world. Air mail postage costs an extra \$10 for both courses (10 volumes).

DISCOUNTS

Call or write for details of educational and quantity discounts, and for dealer costs.

SAVE \$5

If you order both courses, you save \$5. Order at no obligation today.

To: Cambridge Learning Inc., 1 Judith Drive, North Reading, MA 01864

Please send me

— sets of Design of Digital Systems.....	\$19.95	\$
— sets of Digital Computer Logic & Electronics.....	\$14.95	
— sets of both courses.....	\$29.90	
Enclosed is check/money order (payable to Cambridge Learning Inc.) for total.....	\$	

NAME.....

ADDRESS.....

CITY/STATE/ZIP..... R10

CIRCLE 40 ON FREE INFORMATION CARD

part by determining the function of the IC and then looking through the list of IC drawings in the front pages of replacement part guides. They show functions, pinouts (a description of what each pin of the IC does) and so on. There's no guarantee that that method will work in all cases, but it's a good place to start. If there are any numbers on the IC, check them against those in the guides, and also take into account the letters at the start of the number—they can be important. R-E

SERVICE QUESTIONS

HELPFUL HINTS

Douglas Hoff of Vacaville, CA sends these hints for the GE AC-B chassis:

The set was dead, with no voltage on horizontal driver Q551. I ran a jumper wire from the junction of C551/R551 to the cathode of Q980, the start-up SCR.

After that, vertical deflection was poor, with jagged edges on the raster. Resistor R650 was burning up. I added more jumpers through eyelets W41A and B and soldered them together, then did the same for eyelets W42A and B. (You'll find the eyelets clearly marked on the bottom of the board.) With the jumpers, normal operation was restored.

Thanks very much Douglas! That's the kind of field feedback a lot of us need.

NO HIGH-VOLTAGE

This RCA CTC-81 has no raster and noise in the sound. I've got DC voltage on T402 (the driver transformer for the trace switch) and there is a gate pulse on the retrace switch, but no waveforms on the transformer! Sometimes the set will kick on and play; when that happens, everything tests out normal! I need advice!—G.K., Massillon, OH

From the reaction when the fault is present, it sounds as if the retrace switch isn't doing anything—it could be open, and also apparently intermittent! Try checking it, or changing it. If it were shorting, it would blow the fuse; but if it's open, you'd get exactly what you see.

(Feedback: You were right—the retrace switch was open. Thanks.)

NO HORIZONTAL SWEEP

A Sony TV-740 came in with just a vertical line in the center of the screen. The solution seemed easy—find the break in the yoke circuit. It turns out that C810, 3.5 µF, was open. Since I didn't have an exact replacement, I used a 3.0 µF, 500-volt-DC capacitor and a 0.47 µF, 100-
continued on page 98

**15MHz DUAL TRACE
PORTABLE OSCILLOSCOPE**

PORTABLE

Soar Corp's new Model MS-3015 small scope (4 3/8 x 8 3/4 x 11 3/4) comes complete with FOUR operating power choices **built-in!**

1. Internal NiCad batteries and auto re-charge system.
2. AC 90 to 130V,
3. AC 180V to 260V all at 48 to 440 Hz and
4. external DC 11V to 30V (runs on your car/boat battery).

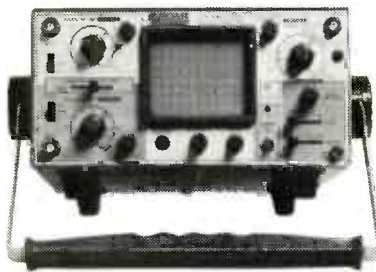

MODEL 3015

VERSATILE

Dual Trace DC to 15MHz with sensitivity of 2mV to 10V/Div on 12 ranges, your choice of 5 operating modes, plus X-Y, add, subtract. 19 sweep ranges from 0.5 μ sec thru 0.5 sec. with X5 mag. choice of four trigger modes plus Auto Free run and preset TV/H. 3.7" rect. CRT with internal graticle. Comes complete with two 10:1 probes, detachable 3 conductor AC cord. **FULL ONE YEAR LTD. WARRANTY.**

AFFORDABLE

Quantities of:

- 1-9 \$749.00 each
10 & up 675.00 each

Available at selected distributors or write/phone:

NORTH AMERICAN  **SOAR corporation**
1126 Cornell Avenue, Cherry Hill, NJ 08002
Tel. (609) 488-1060

CIRCLE 45 ON FREE INFORMATION CARD

STATE OF SOLID STATE

continued from page 91

a bipolar device that uses vertical current flow.

Around 5 years ago, a new FET technology was developed to increase the current density of the devices. That in turn, led to the development of high-power FET's that feature both high-voltage and high-current capability. The technological improvement on the basic MOSFET. Vertical MOS or VMOS (also called V-groove MOS) owes its greatly improved characteristics and high-power capability to a "V" groove channel that promotes vertical current flow.

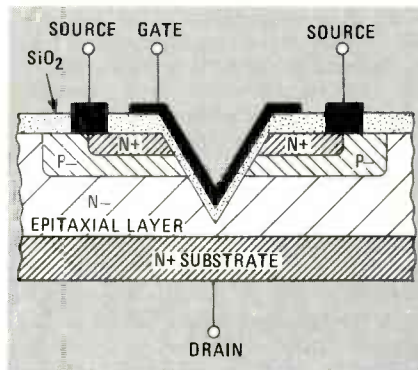

FIG. 4

Figure 4 shows a cross section of a VMOS channel. The device is fabricated on an n+ substrate that becomes the drain and provides a low-resistance current path. An n- epitaxial layer is added to increase the drain-to-source breakdown voltage and to reduce feedback capacitance.

Lightly doped p- bodies are diffused into the epitaxial layer to form channel regions. Smaller n+ regions are diffused into the p- island to form source regions. The n- epitaxial layer and substrate now become drain regions.

The V-shaped groove is etched through the source and channel regions into the epitaxial layer. A silicon oxide layer is then grown on the surface and in the groove and then aluminum metallization is added to form source and gate connections. Finally, the entire chip is passivated (coated with an inert protective material) to keep contaminants from entering the gate material.

The vertical design of the VMOS technology gives it the following advantages over the conventional MOS structure:

1. The length of the current channel is determined by the depth of the diffusion—a much more easily controlled factor than mask spacings used to define channel lengths in conventional MOS. That makes it possible to obtain a better width/length ratio and al-

**GET TO THE
CORE OF
YOUR APPLE®**

Sams wants to introduce you to the syntax and programming techniques of Applesoft with APPLESOFT LANGUAGE, a complete, easy-to-understand handbook written in a self-teaching format. Several ready-to-use programs are included which demonstrate most of the concepts covered.

APPLE® INTERFACING from the popular Blacksburg group helps you understand the important task of successfully interfacing your Apple to a variety of peripheral devices. Experiments are included to illustrate Apple interfacing fundamentals.

Order both from Sams today and save more than 15%!

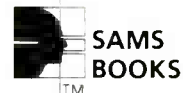
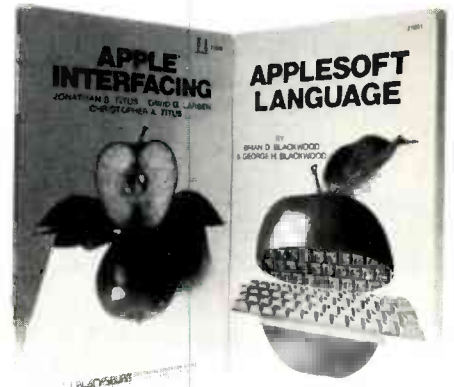

APPLESOFT LANGUAGE, No. 21811, \$10.95 _____
 APPLE® INTERFACING, No. 21862, \$10.95 _____
 Set of both books, No. 21962 \$17.95 _____
 Amount of Order \$ _____
 Add local sales tax where applicable \$ _____
 Add Handling Costs \$2.00 _____
 Total Amount of Order \$ _____

Check Money Order VISA
 MasterCard (Interbank No. _____)
 Account No. _____ Expiration Date _____

Full payment by check, money order, or charge card must accompany your order.

Name (print) _____
 Signature _____
 Address _____
 City _____ State _____ Zip _____

Call 800-428-3696 toll-free, or 317-298-5566 for the name of your local Sams Book outlet or to order by phone (give Sams Operator the code number in the box below). Offer good in USA only and expires 8/31/82. Prices subject to change without notice.

AD 184

CIRCLE 46 ON FREE INFORMATION CARD

WINNER

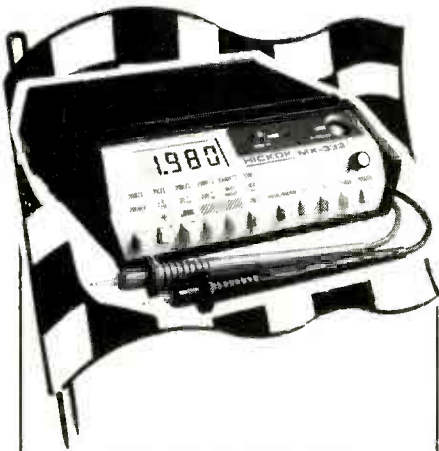

Hickok's MX333 with VARI-PITCH® and LOGI-TRAK®

Instantaneous VARI-PITCH speeds:

- Voltage tracing
- Troubleshooting in hard-to-reach locations
- Tuning type adjustments
- Resistance checks
- Digital logic troubleshooting

And . . . Detects signal characteristics and abnormalities not possible with digital or analog meters.

LOGI-TRAK replaces the best 100MHz logic probes and offers:

- Eyes on the probe tip, HI/LO indication
- Instant identification of marginal states and fault conditions
- 100MHz response
- 5n sec pulse detection

LISTEN to what the MX333 can do for you. Ask about our NO RISK 30 day Free Trial.



THE HICKOK ELECTRICAL INSTRUMENT CO.
10514 Dupont Avenue • Cleveland, Ohio 44108
(216) 541-8060

- lows higher current densities to be obtained.
2. Each groove creates two parallel channels so the current density is inherently doubled.
3. The substrate forms the drain contact so that there is no need to provide space for a metal drain contact on top of the chip. That reduces chip area and thus keeps saturation resistance low.
4. The high-current density results in low gate-to-drain (feedback) capacitance because the portion of the gate nearest the drain (called the overlap) is in the bottom of the V groove. In a conventional MOSFET, extra drain-gate overlap must be provided to allow for possible mask misalignment. That increases the gate-to-drain and gate-to-source capacitances.
5. The epitaxial layer of the VFET is lightly doped so it absorbs the depletion area from the reverse-biased drain-to-body PN diode. That greatly increases the breakdown voltage while having little or no effect on other device parameters.

Various designs of VMOS transistors have been developed by different manufacturers to increase such parameters as speed, power-handling capacity, and voltage and current ratings. Names given those technologies include DMOS, VDMOS, TMOS, ZMOS, HEXFET and SuperFet. We'll get to them in a future column. R-E

SERVICE QUESTIONS

continued from page 96

volt-DC one in parallel. That caused more problems! Now the sweep stops about 1½ inches from the right, with bad foldover. Everything around the yoke checks out OK. Any ideas?—G.H., Alplaus, NY

You had the right idea, but the wrong part! Since that capacitor is in the horizontal circuit, the original must have been a special type, with a special dielectric made to withstand the high-frequency pulses (like the familiar 4-legged capacitors).

You'll probably have to get an exact duplicate. Sony's address is Sony Corp. of America, 8281 N.W. 107th Terrace, Kansas City, MO 64195. Look up the New York State distributor and try him, too.

HIGH-VOLTAGE PROBLEM

I wrote you recently about a HV problem in an RCA CTC-68. One of the things you suggested was the HV-regulator transformer. That was it! The solder joints were bad. Thanks.

Thanks to Jim L. Webb, Fox, OK, for the feedback. R-E

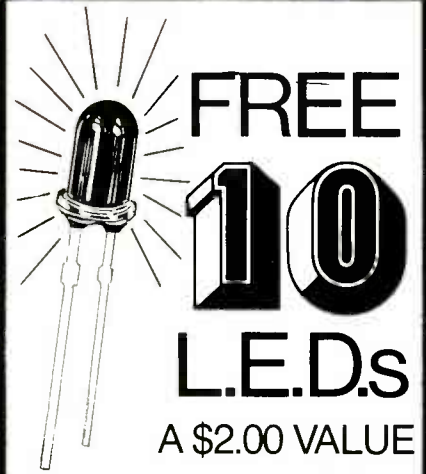

You can now receive ten prime T-1¼ or T-1 red LEDs absolutely free. It is our way of introducing you to the quality parts we offer.

ETRONIX

14803 NE 40th Dept. RE052
Redmond, WA 98052

Yes, Please send me 10 Free LEDs, plus your brochures on additional products available. I prefer T-1 T-1¼.

NAME _____

ADDRESS _____

CITY _____ ST. _____ ZIP _____

Please include \$1.00 to help cover postage and handling.

CIRCLE 54 ON FREE INFORMATION CARD

Put Professional Knowledge and a COLLEGE DEGREE

in your Electronics Career through

HOME STUDY

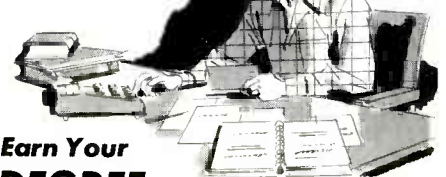

Earn Your DEGREE

No commuting to class. Study at your own pace, while continuing your present job. Learn from easy-to-understand lessons, with help from your home-study instructors whenever you need it.

In the Grantham electronics program, you first earn your A.S.E.T. degree, and then your B.S.E.T. These degrees are *accredited* by the Accrediting Commission of the National Home Study Council.

Our *free* bulletin gives full details of the home-study program, the degrees awarded, and the requirements for each degree. Write for *Bulletin R-82*.

Grantham College of Engineering
2500 So. LaCienega Blvd.
Los Angeles, California 90034

COMPUTER CORNER

continued from page 90

controls the disk drive) and an eight-inch one about 250 kilobytes.

Changing the disk-controller board can allow you to have twice the capacity on the same disk and drive you have been using by going to a *double density* format. In that format, the amount of data that can be stored on one side of a single disk is doubled.

The latest in floppy-disk technology is *quad density*, or *double-sided, double-density*. There, two read/write heads are used, one for each side of the disk, and a single eight-inch disk can hold up to a megabyte of data.

Most disk systems can be expanded by adding extra drives. They usually come set for single-sided, single density operation, but many can be reconfigured to take advantage of the more advanced recording techniques.

Beyond floppy disks are hard disks. They are usually aluminum platters coated with a metallic oxide and they rotate at very high speeds. Because of the high speeds involved, the read/write head, unlike that of floppy-disk systems, does not touch the disk, but floats very close to its surface on a cushion of air. Hard-disk capacities start at 5 megabytes and go on from there. Hard

disks are usually found in elaborate business systems.

A recent—and more affordable—hard-disk system appeared several years ago and is rapidly finding popularity in the microcomputer market. The *Winchester-technology* disk ("Winchester" was its code name when it was under development) typically uses 8- or 5¼-inch platters to give capacities starting with several megabytes and going up. Winchester drives are now available that can fit in the same space previously occupied by a standard 5¼-inch floppy-disk drive, but provide many times more storage capacity. (A representative Winchester-technology system with floppy-disk backup is shown to the left of the computer in Fig. 1.) Prices start out around \$3000.00, but, when all the factors are considered, that is not a big price to pay if you are going to make extensive use of the system.

The memory market—both resident and external—offers a staggering variety of choices. Those choices involve not only the medium, but also the quality of the product. It's a good idea to consult other computer users and to search through the ads, catalogs, and computer stores before making a decision. A computer cannot perform efficiently if it doesn't have sufficient memory. What it doesn't need, though, is premature senility.

R-E

Get A GNOME the original micro-synthesizer

Every day more people discover that PAIA's GNOME is the most versatile, cost effective special effects device on the market today.

John Simonton's time-proven design provides two envelope generators, VCA, VCO and VCF in a low cost, easy to use package. Use alone with it's built in ribbon controller or modify to use with guitar, electronic piano, polytonic keyboards, etc.

The present introduction to electronic music and best of all, the Gnome is only \$69.95 in easy to assemble kit form. Is it any wonder why we've sold thousands?



CHARGE TO VISA OR MC TOLL-FREE
1-800-654-8657 9AM to 5PM CST MON-FRI

DIRECT INQUIRIES TO
PAIA Electronics, Inc.

Dept. 5R, 1020 W. Wilshire Bv. Oklahoma City, OK 73116 (405) 843-9626

- Send GNOME MICRO-SYNTHESIZER Kit . . . (\$69.95 plus \$3.00 postage)
- Send FREE CATALOG

name _____

address _____

city _____ state _____ zip _____

CIRCLE 52 ON FREE INFORMATION CARD

HAMEG

PRESENTS

THE NEW

HM 203



High performance
at
low cost.

\$580
(PROBES INCLUDED)

A quality scope,
made in the U.S.A.,
by a company with
over 23 years
experience.

HAMEG

88-90 Harbor Rd.

Port Washington, N.Y., 11050

Tel: (516) 883-3837



Hameg introduces high performance at low cost in the HM 203, a full featured, highly reliable, dual trace 20 MHz oscilloscope. For only \$580, the HM 203 has specifications normally associated with higher priced scopes. Bandwidth - DC → 20 MHz • Risetime 17.5 ns • Overshoot 1% max. • Y amp range 5 mv/cm to 20 v/cm • Max. input voltage 500V • Timebase .5 µs/cm to .2s /cm • Sweep mag. x5 • Trigger 5 Hz to 30 MHz • X-Y plot • Built-in probe calibrator and more. Its sturdy construction and light weight (13.2 lbs.) make the HM 203 equally at home in the field and on the test bench.

CIRCLE 38 ON FREE INFORMATION CARD

NEW PRODUCTS

For more details use the free information card inside the back cover.

Digital Multimeter

The Drake DM2350 Digital Multimeter is a convenient, small handheld liquid crystal display meter ideal for the serviceman or hobbyist. This 3½ digit meter is auto-ranging, auto-zeroing, has polarity indication, and an over-range warning signal. Battery life is greater than 300 hours with a "low battery" indicator. A continuity test sounds a signal when circuit resistance is less than 20 ohms. Dc accuracy is a basic 0.8%.

Batteries, probes, 20 amp current shunt, spare fuse and soft carrying case all included at \$95.95

Add \$2.50 shipping and handling per order.

Send check with order and provide street address for UPS shipment. Ohio residents add Sales Tax. Charge card buyers may call toll free.

1-800-543-5612



DRAKE

In Ohio, or for information call: 1-513-866-2421

R. L. DRAKE COMPANY

540 Richard Street, Miamisburg, Ohio 45342

INSTITUTIONAL AND DEALER INQUIRIES INVITED

CIRCLE 51 ON FREE INFORMATION CARD



In general, spring reverbs don't have the best reputation in the world. Their bassy "twang" is only a rough approximation of natural room acoustics. That's a pity because it means that many people will dismiss this exceptional product as "just another spring reverb". And it's not. In this extraordinary design Craig Anderton uses double springs, but much more importantly "hot rods" the transducers so that the muddy sound typical of most springs is replaced with the bright clarity associated with expensive studio plate systems.

Kit consists of circuit board, instructions, all electronic parts and two reverb spring units. User must provide power (±9 to 15 V) and mounting (reverb units are typically mounted away from the console).

CHARGE TO VISA OR MC TOLL-FREE
1-800-654-8657 9AM to 5PM CST MON-FRI

DIRECT INQUIRIES TO:

RAA Electronics, Inc.

Dept. 5 AR 1020 W. Wilshire Bv. Oklahoma City, OK 73116 (405) 843-9626

1 Send the 6740 REVERB KIT \$59.95 plus shipping (\$3) enclosed or charged.

1 Send Free Catalog

name _____

address _____

city _____ state _____ zip _____

CIRCLE 53 ON FREE INFORMATION CARD

DESKTOP COMPUTER, the *Advantage*, is the first completely integrated desktop stand-alone system to offer minicomputer-grade graphics capabilities. It includes a 12-inch display, two 5¼-inch high-capacity



CIRCLE 131 ON FREE INFORMATION CARD

floppy-disk drives, an 87-key *Selectric*-style keyboard, and a choice of optional broad-ranging operations and applications software.

The *Advantage* is built around a 4-MHz Z80A and includes 64 kilobytes of random-access memory (RAM). It features a 12-inch bit-mapped CRT display to produce bar charts, pie diagrams, plotted graphics, and 3-dimensional visuals, driven by an additional 20 kilobytes of RAM that support the bit-mapping feature. With the *Advantage*, small-business computer owners will be able to integrate graphics into their everyday business without paying a premium. The *Advantage* is priced at \$3999.00.—**North Star Computers, Inc.**, 14440 Catalina Street, San Leandro, CA 94577.

PHONO CARTRIDGE, model *MV30HE*, is designed exclusively for model *SME 3009 Series III* and model *SME 3009 Series IIIS* tone arms. It is a high-performance, miniature cartridge that is integrated with an SME carrier-arm. The integrated design results in significantly reduced effective mass; it virtually eliminates headshell resonances, and provides easy-to-mount convenience.

The model *MV30HE* features a distortion-reducing hyperelliptical stylus, the tip of which provides as much as a 25%

reduction of distortion over a conventional bi-radial (elliptical) stylus. Its low mass allows the stylus assembly to follow the record groove not only up to, but beyond, the theoretical cutting velocities of today's recordings. The "HE" stylus assembly also incorporates a telescoped stylus-shank structure for reduced effective mass, without sacrificing stiffness.

Installation of the model *MV30HE* simply requires plugging the carrier arm into the tone-arm pivot of a turntable. The integrated design eliminates the nuts, screws, and terminal-pin wires usually needed to mount phono cartridges. The model *MV30HE* has a suggested retail price of \$230.00.—**Shure Brothers Incorporated**, 222 Hartrey Avenue, Evanston, IL 60624.

MICROPHONE, model *PL88*, is a dynamic cardioid vocal microphone, featuring voice-tailored frequency-response char-



CIRCLE 133 ON FREE INFORMATION CARD

acteristics; it is resistant to handling-noise. Designed for the vocalist on a tight budget who is unwilling to compromise his or her standards of quality, the model *PL88* features an on/off switch and, for additional flexibility, is available in both high- and low-impedance models. The model *PL88* is priced at under \$70.00.—**Electro-Voice, Inc.**, 600 Cecil Street, Buchanan, MI 49107.

STEREO CASSETTE DECK, model *KX-70*, uses metal tape and has an exclusive computerized memory that provides fast, automatic program access, as well as repeat operation.

Called the *Direct Program Search System (DPSS)*, the microprocessor-controlled memory expands the deck's normal functions to include fast-forward and rewind search of up to 15 music selections on each side, as well as single-select-



CIRCLE 132 ON FREE INFORMATION CARD



CIRCLE 134 ON FREE INFORMATION CARD

tion and full-side repeat and re-record/standby. The DPSS is easy to operate and features a multicolored LED display and lighted arrows as mode indicators.

Electronic full-logic controls give instant response at the touch of a button, and allow the listener to change modes without an intervening "stop" action, and without tape stretch. Operation is simplified further by smooth-action pocket loading, and the pocket is removable for easy head-cleaning and demagnetizing. A dual-motor system insures minimal wow and flutter, and provides fast handling of the tape.

Other features include Dolby noise-reduction; a newly developed amorphous-alloy magnetic head for optimum metal-tape performance; three tape-selector positions with automatic equalization and bias-matching; seven-LED peak-level meters; a timer/standby switch; single-operation recording; MIC mixing; automatic jacks, and a headphone jack. The *model KX-70* has a suggested retail price of \$349.00.—**Kenwood Electronics**, Dept. P., 1315 E. Watsoncenter Road, Carson, CA 90745.

SPEAKERS, *model Micro 10*, are 13½ × 9½ × 9½ inches, and have cabinets made from American black walnut. They feature



CIRCLE 135 ON FREE INFORMATION CARD

new 6½-inch modified polypropylene woofers with 1¼-inch high-temperature aluminum voice-coils; leaf tweeters, cases lined with lead, and hand-rubbed oiled walnut cabinets. The *model Micro 10* is priced at \$500.00 a pair.—**Soundmates**, 796 29th Avenue S.E., Minneapolis, MN 55414.

AMBIENCE ACCESS SYSTEM, *model ARU*, offers a unique time-delay system that adds nothing of its own to sound reproduction. The listener receives the ambience that is present in the recording; there is no extra reverberation, and the effect is that of being in the concert hall. The original signal is transmitted without modification to the front speakers, while the same signal is fed to the side speakers, with a time delay of .03 seconds. In addition, a pair of rear speakers receives an uncorrelated signal that consists of the difference between left and right front

channels, also delayed by .03 seconds.

In most recordings, the extreme low-frequency signals are cut in mono; thus the difference signal tends to be bass-shy. To fill in the missing bass, a mono signal made up of the sum of the left and right front channels is added to the rear speaker at frequencies below 60 Hz. High frequencies are contoured for the side and rear speakers as they would be in the concert hall. A remote-control unit with a 25-foot cord permits sound levels for the front, side, and rear speakers to be adjusted from a distance.



CIRCLE 136 ON FREE INFORMATION CARD

The *model ARU* allows the user to take charge of his total music system far more easily than any other system of its kind because all key functions are available through the remote-control section. It will function with any stereo system the user now has, and with any kind of music, as well as interface with virtually anything the user might acquire in the future. The *model ARU* is priced at \$829.00.—**Benchmark Acoustics**, 201 West 89th Street, New York, NY 10024.

CORDLESS TELEPHONE, *model FF-4000*, is microprocessor-based; the user can

JAN CRYSTALS
HOLD THE FREQUENCY

- CB
- CB standard
- 2 meter
- Scanners
- Amateur Bands
- General Communication
- Industry
- Marine VHF
- Micro processor crystals

Send 10¢ for our latest catalog. Write or phone for more details.

JAN CRYSTALS **master charge** **BankAmericard** **VISA** easy to charge

P.O. Box 06017
Ft. Myers, Florida 33906
all phones (813) 936-2397

CIRCLE 57 ON FREE INFORMATION CARD

Audio Modules

MOSFET Power Amplifiers

*BUILT-IN HEATSINKS *ONLY 5 CONNECTIONS REQUIRED * 5 YEAR WARRANTY

Choose ILP MOSFET power amps when you need the ultimate in performance without spending big money. They provide the fastest possible slew rate, low distortion at high frequencies, + better thermal stability. MOSFET power amps work with complex loads without difficulty and without crossover distortion. Three models are available, with integral heatsink to mount on your own chassis (optional rack mount cabinet available). Connection is simple — via 5 pins. MOSFETs can be combined with other ILP modules to create almost any audio system, whatever your age or experience.

Ultra-fi specifications. Slew rate 20V/us. Rise time 3 us. S/N ratio 100 db. Frequency response (-3 db) 15 Hz - 100 kHz. THD (Typical at 1kHz) < 0.005%. IMD (50Hz/7kHz 4:1) < 0.006%.

MOS120 60W/4-8Ω (requires ± 45V)	\$79.95
MOS200 120W/4-8Ω (requires ± 55V)	\$129.95
MOS400 240W/4Ω (requires ± 55V)	\$199.95

WRITE FOR FREE CATALOGUE LISTING:
*BIPOLAR POWER AMPLIFIERS *HI-FI PREAMPS
*MIXERS *POWER SUPPLY UNITS *CABINETS
*GUITAR PREAMP and more

GLADSTONE

Electronics 901 Fuhrmann Blvd., Buffalo, NY 14203
CALL (716) 849-0735 to order. Have your VISA or MasterCard ready. For information call (416) 787-1448 or circle reader number. Dealer/OEM enquiries (416) 787-1488. In Canada: Gladstone Electronics, Toronto.

CIRCLE 59 ON FREE INFORMATION CARD

64K \$159.

For Sinclair ZX81

Memotech 64K Memopak

The Memopak is a 64K RAM pack which extends the memory of the ZX81 by a further 56K. Designed to be in the price range expected by Sinclair owners. Plugs directly into the back of the ZX81 and does not inhibit the use of the printer or other add-on boards. There is no need for additional power supply or cables. The Memopak together with the ZX81 gives a full 64K, which is neither switched nor paged, and is directly addressable. The unit is user transparent, and accepts such basic commands such as 10DIM A(9000).

With the Memopak extension the ZX81 is transformed into a powerful computer, suitable for business, leisure and educational use, at a fraction of the cost of comparable systems.

GLADSTONE

Electronics, 901 Fuhrmann Blvd., Buffalo, NY 14203.
Call (716) 849-0735 to order. Have your VISA or MasterCard ready. \$3.00 shipping and handling.
In Canada, call (416) 787-1448.
Mail orders send check or money order. Sorry no CODs. Circle reader service card for Sinclair software catalogue.

CIRCLE 60 ON FREE INFORMATION CARD

choose rotary pulse or pure tone-activated dialing, making this the first cordless telephone capable of full central-telephone-equipment interface. Features offered by the phone company such as call waiting, call forwarding, three-way calling, and speed calling can be used, via a special "hook" key.

The model FF-4000 has automatic dialing capability, which means that the user can store up to three numbers in memory and dial any one of them by just pushing a button. The auto-dial feature is protected against power outages by an easily changeable 9-volt battery. There is also a security system, programmable by the owner, to prevent unauthorized use of the system.

Very low power-level operation allows



CIRCLE 137 ON FREE INFORMATION CARD

longer performance from a single charge than possible with any other cordless telephone. Special circuitry permits the handset to be recharged fully in under four

hours. There is also a re-dial button, which permits one-button re-dialing of the last number called; a "battery-low" light, which indicates when the handset is in need of recharging; a "charge" light on the base, which indicates that the handset's batteries are being recharged, and a "power" light on the base to indicate that power to the base station is on. Other features include volume control on the handset and double modular external jacks on the base station (one for regular phone-line hookup, the other for any telephone accessories, such as phone-answering devices, etc.)

The model FF-4000 has a suggested retail price of \$349.95.—**Electra Company**, 300 E. Country Line Road, Cumberland, IN 46229.

If you're looking for trouble, you came to the right place.

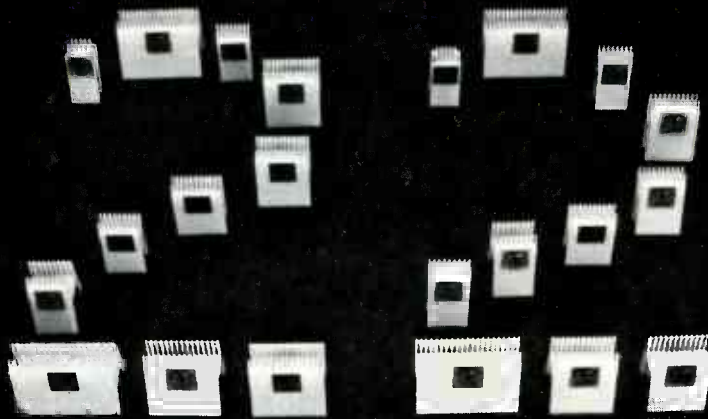

When you're testing circuitry, you need the best troubleshooter around: The AP Test Clip.

It's made with a narrow nose shape that allows for easy attachment on high density boards. Nailhead pins that keep probe hooks from sliding off ends. Open nose design that permits probe tip access to DIP leads. And a contact comb that fits between DIP leads, eliminating any possibility of shorts. All these little design differences add up to the ultra-reliable, safe, quick DIP troubleshooting you need.

You can buy AP Test Clips in 22 standard or connector-

compatible models in 11 sizes. (They're also available with long, headless test lead pins for

attachment to AP jumper cable assemblies.) And every one is made with highest quality engineering-and industrial-grade materials for long life and reliability.

So don't go looking for trouble until you've contacted your AP PRODUCTS distributor and ordered AP Test Clips—the best little troubleshooters around.

Call TOLL FREE, 800-321-9668, for the name of the distributor nearest you. (In Ohio, call collect: (216) 354-2101.)



AP PRODUCTS
INCORPORATED
9450 Pineneedle Drive
P.O. Box 603
Mentor, Ohio 44060
(216) 354-2101

In Europe, contact A P PRODUCTS GmbH • Baumlesweg 21 • D-7031 Weil 1 • W. Germany

CIRCLE 36 ON FREE INFORMATION CARD

www.americanradiohistory.com

TOOL CASES. model 800T and model 805T, are ruggedly constructed injection molded cases, made of high-impact polypropylene, combined with molded polyurethane pallets.



CIRCLE 138 ON FREE INFORMATION CARD

Model 800T (shown) measures 18 × 13½ × 6 inches, and has two pallets; it is priced at \$107.00. The slightly smaller model 805T measures 18 × 13½ × 5 inches, and has one pallet; its price is \$87.00.—**Platt Luggage, Inc.**, 2301 S. Prairie Avenue, Chicago, IL 60616.

CONSOLE. The P/C Desk Console, has been introduced for the Sharp PC-1211 and the Radio Shack TRS-80 pocket computers with printer. Constructed of black plastic and measuring 8.5 × 16 × 2.75 inches, it has room for three cassette

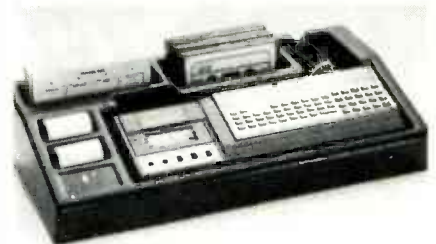

CIRCLE 139 ON FREE INFORMATION CARD

boxes, a full set of 3 × 5-inch cards, two paper rolls, a spare print ribbon, and the interface cable. The P/C Desk Console is priced at \$19.95, plus \$2.50 shipping, and 6% tax for CA residents.—**Fox/Walker**, 4650 Arrow Hwy., Bldg. G-17, Montclair, CA 91763.

R-E

NEW IDEAS

Typewriter word counter

HERE'S A PROJECT THAT CAN SAVE YOU some time when you need a manuscript of a specific length, such as for a school project, a classified advertisement, etc. It will keep track of how many words you've typed, and display the total. The circuit uses Hall-effect switches (Sprague UGN-3020T, or equivalent) to detect keystrokes and spaces.

The Hall-effect switches are sensitive to the presence of a magnetic field. In this project, permanent magnets are used to turn the switches on and off. When the magnet is near the switch, the output from the switch is logic 0; when the magnet moves away, the switch opens and, because of the 10,000-ohm pull-up resistor, the output goes to logic 1.

The switches are connected to $\frac{1}{4}$ of a 4043 RS flip-flop. After the circuit has been reset, the output from that flip-flop is at logic 1. At the first keystroke, the output from the Hall-effect switch goes to logic 0, pulling the flip-flop's output to logic 0. The output from the flip-flop drives the MC14553 three-decade counter. That counter is negative-edge triggered, so the transition of the flip-flop's output from logic 1 to logic 0 increments the counter. The counter's BCD output is then fed to the 4511, a BCD-to-7-segment display decoder/driver, which in turn controls the $3\frac{1}{2}$ -digit LED display.

Each subsequent key stroke is ignored until the space bar is hit. Hitting the space bar opens the space-bar Hall-

effect switch, which in turn resets the RS flip-flop. Subsequent spaces are ignored until the next keystroke is entered, and the entire cycle is repeated. If the space bar and a key are struck at the same time, the flip-flop's output is logic 1, and the next keystroke increments the counter.

When the count reaches 999, the next negative transition will clear the counter but set its overflow high. That overflow output is latched by a second flip-flop, $\frac{1}{4}$ of the 4043, driving the display's most significant digit (the 1 on the display) on. The procedure then repeats, for a maximum count of 1999 words.

For this circuit to work, the Hall-effect switches and the magnets must be mounted inside the typewriter itself. One switch and magnet should be mounted so that they are close together normally, but move apart when any key is struck. The second switch and magnet should be mounted so that they move apart when the space bar is hit. The switches and magnets are mounted using epoxy glue. Both sets of switches and magnets should be positioned so that the thick side of the switch (the side opposite the dot) is normally near the magnet's south pole.

You can power the circuit any way you wish. One good way would be to use a wall-plug transformer with a 9-volt output. You could also use a 9-volt battery. If you do that, you may want to devise a display blanking circuit to extend battery life. —Larry Dighera

NEW IDEAS

This column is devoted to new ideas, circuits, device applications, construction techniques, helpful hints, etc.

All published entries, upon publication, will earn \$25. In addition, Panavise will donate their model 333—The Rapid Assembly Circuit Board Holder, having a retail price of \$39.95. It features an eight-position rotating adjustment, indexing at 45-degree increments, and six positive lock positions in the vertical plane, giving you a full ten-inch height adjustment for comfortable working. (See photo below.)

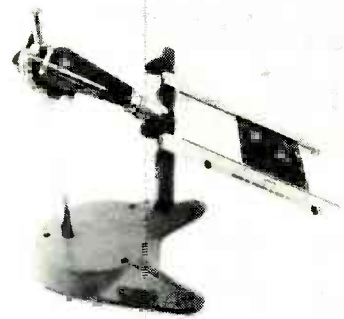

I agree to the above terms, and grant **Radio-Electronics** Magazine the right to publish my idea and to subsequently republish my idea in collections or compilations of reprints of similar articles. I declare that the attached idea is my own original material and that its publication does not violate any other copyright. I also declare that this material had not been previously published.

Title of Idea

Signature

Print Name

Date

Street

City

State

Zip

Mail your idea along with this coupon to: **New Ideas Radio-Electronics**, 200 Park Ave. South, New York, NY 10003

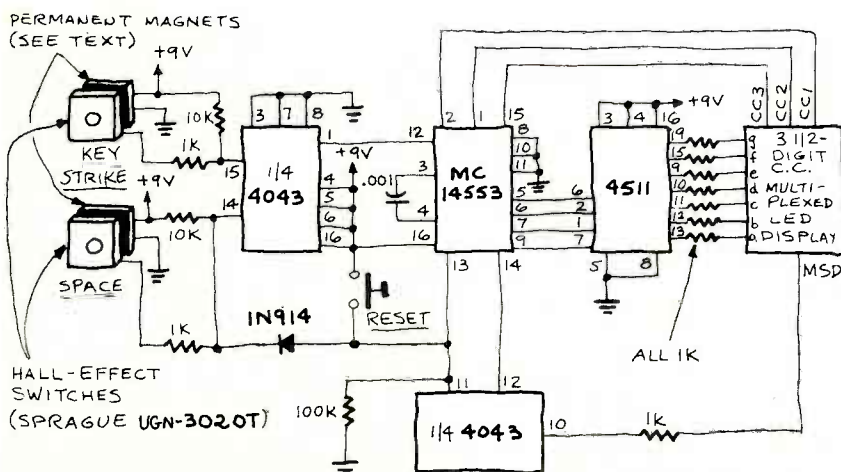
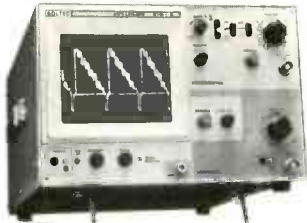

FIG. 1

Pana Scopes

from **SOLTEC**[®] CORPORATION



\$495

w/probe 15MHz, Single Trace.
1mV/Div to 2V/Div.,
11 Ranges, Auto Fix Triggering

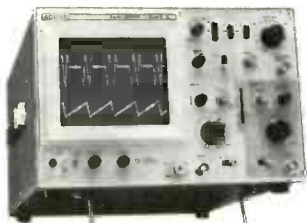

\$595

w/probes 15MHz, Dual Trace.
1mV/Div to 2V/Div.,
11 Ranges, Auto Fix Triggering

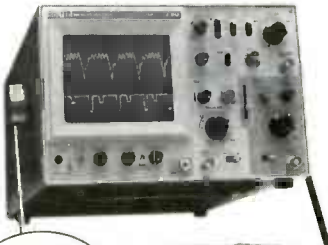

\$695

w/probes 20MHz, Dual Trace.
1mV/Div to 2V/Div.,
11 Ranges, Auto Fix Triggering

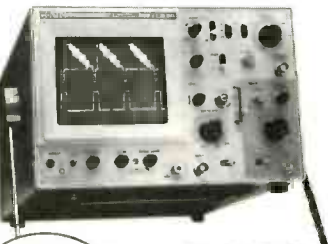

\$895

w/probes 30MHz, Dual Trace.
1mV/Div to 2V/Div.,
11 Ranges, Auto Fix Triggering

... in stock now at your local

SOLTEC[®] DISTRIBUTOR
SOLTEC[®]
CORPORATION

11684 Pendleton St., Sun Valley, CA 91352
Toll Free: 1-800-423-2344
or, in Calif. 1-213-767-0044

SATELLITE TV RECEIVER

continued from page 53

(At the uplink transmitter, the video is pre-emphasized to reduce degradation in quality during transmission and is dithered—or dispersed—at a 30-Hz rate to prevent interference to ground-based microwave links. The two processes must be "undone" to recover the original video information.)

A de-emphasis network after Q4 made up of R22, R23 and C45 removes the pre-emphasis that was added at the uplink source. Transistor Q7 isolates the de-emphasis network from the video low-pass filter formed by C46-C48 and L8. That filter is needed to remove the audio-subcarrier components from the video; sometimes they can wreak havoc with devices like external RF-modulators. It should be noted that all stages so far have been direct-coupled to allow frequency response down to DC—an important factor for good video. Transistors Q8 and Q9 form a $\times 2$ -gain amplifier/buffer stage that drives C49 and D5, a simple clamp-stage that removes the 30-Hz dither that would otherwise cause the picture to flicker. Following the clamp stage, emitter-followers Q10 and Q11 provide enough gain to produce a one-volt peak-to-peak video signal into a 75-ohm load.

Audio demodulator

FM audio from the satellites is transmitted on subcarriers in the 5.5–7.5-MHz range (with 6.8 MHz being typical), making a tunable audio-demodulator a must. A high-pass filter consisting of C54, C55, and L9 couples the audio subcarrier to a second PLL stage, IC7, similar to that used in the video section with the exception that it operates only over a 5–8-MHz range. Its center frequency is determined by the capacitance across pins 12 and 13. That capacitance is formed by a varactor diode (D6) and C67. The bias on the varactor is adjusted by the front-panel AUDIO potentiometer; increasing the voltage increases the frequency of the PLL. The PLL follows the FM subcarrier and outputs demodulated audio at pin 14. That audio is low-pass filtered by R43 and C64, and applied to a $\times 20$ gain stage made up of half of IC6, a dual op-amp. The output of IC6 is 1-volt peak-to-peak and is capable of driving a 600-ohm load.

AFC

The AFC (Automatic Frequency Control) stage performs the important function of keeping the 4-GHz signal centered in the 25-MHz wide 70-MHz IF. Although that task sounds complicated, the AFC circuit is really quite

Quietrole

The Original...

A First in the industry, with over thirty years of use by satisfied customers.



Spray Pack Mark II gets into places of close tolerance and washes out the dirt, leaving a thin film of lubricant which lasts indefinitely, with zero effect upon current capacity and resistance.

Spray Pack Mark II has been tested and proven in the Space Age and is still the finest lubri-cleaner available. It is quick, safe, effective - a MUST for every tool caddy.

Spray Pack Mark II is the best-priced lubri-cleaner.

Available at Leading Distributors



CIRCLE 58 ON FREE INFORMATION CARD

COMPUTERS

Complete Microprocessors line, peripherals & Terminals		
Green 12" Monitor	\$129.00	SOROC IQ 135 795.00
B/W 12" Monitor	109.00	TI-99/4 379.00
Visicalc	200.00	Epson MX-80 call us
Microsoft Z/80	320.00	Color Monitor call us
IDS PRISM 80	call us	TI-810 1395.00
TI-745	1440.00	80 Column Board 299.00

Texas Instruments

Invest. Anal.	\$ 42.00	TI-59	\$175.00
Accessories	Call us	TI-55 II	39.95
TI-58C	80.00	Speak & Spell	49.95
PC100C	155.00	TI Programmer LCD	54.95
TI BAIL	39.00	MBA	49.95

HEWLETT-PACKARD

HP/125 Computer	call us	HP-11C NEW	call us
HP/37E	72.00	HP-12C NEW	call us
HP-33C	85.00	HP-41C Mem Module	26.00
HP-34C	115.00	HP-41CV	243.00
HP-38C	114.99	HP-67	295.00
HP-41C Prog	188.00	HP-97	570.00
HP-41C Printer	285.00	Quad Ram	call us
HP-41C CRD RDR	169.00	Application Pac	call us
HP/85	1995.00	HP/83	1670.00

SCM TYPEWRITER SPECIALS

SCM 2200	\$284.00	INTREPID	\$274.00
SCM 2500	294.00	CLASSIC 12	164.00

All units shipped in original cartons with accessories according to manufacturer's specification. Send money orders, personal check 2 weeks to clear. In Illinois add 6% sales tax. Add \$6.95 minimum shipping & handling charges per unit. We ship UPS. Subject to availability. Written warranty for specific products can be obtained free upon request. Above prices are for mail order and prepaid only. Prices and specifications subject to change without notice. Send mail orders.

Nabik's, Inc.

519 DAVIS EVANSTON, ILL. 60201 TEL 312-869-6144

simple. Its heart is the TUNING potentiometer, R47, and a constant-current source, IC8. That IC provides a current to the potentiometer, where a voltage drop takes place. The output of the constant-current source is modified by a current mirror formed by D7 (a 2N4123 transistor with its base and collector leads tied together) and Q12. By varying the current applied to that current mirror, we can vary the current through the front-panel tuning potentiometer, and thus the voltage drop across it.

In effect, we "steal" some of IC8's constant current; that tends to linearize the tuning characteristics of the first local-oscillator. Integrated circuit IC6-a is used to drive the current mirror and the circuit performs a voltage-to-current translation.

The output voltage from the demodulator (taken from the emitter of Q4) is filtered by R33 and C52 to remove any trace of video signal, so that all that's left is a control voltage representing a frequency. That voltage is applied to the non-inverting input of IC6-a and controls the voltage to the current translator, causing an AFC action to take place. If the signal drifts higher, the AFC circuit steals more current

from IC8, causing the voltage drop across the tuning potentiometer to decrease and pulling the receiver back on frequency.

Power supply

A simple full-wave bridge rectifier-type power supply, shown in Fig. 8, provides unregulated 18-volts DC for the receiver, and IC11, IC12, and IC13 provide regulated 15, 12, and 5-volts, respectively. The 18-volt, 1-amp, power transformer is housed in a separate enclosure to reduce heat drift in the receiver.

In the next part of this article we'll present foil patterns and parts-placement diagrams for the receiver, along with assembly instructions. **R-E**

Support the
March of Dimes
BIRTH DEFECTS FOUNDATION



THIS SPACE CONTRIBUTED BY THE PUBLISHER

IC RECIPES

Author Don Lancaster takes a unique and innovative approach to CMOS and TTL with these two great books from Sams!

In CMOS COOKBOOK, he outlines the differences between CMOS and other MOS designs and describes CMOS' many advantages. An actual mini-catalog lists pinouts and applications for more than 100 different devices.

In TTL COOKBOOK, Don takes a look at TTL logic circuits and demonstrates many kinds of practical applications for this most inexpensive and most widely applicable form of electronic logic.

Help satisfy your basic electronics appetite with these easy-reading, information-packed Sams cookbooks! Order both of them today and save over 15%!

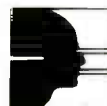
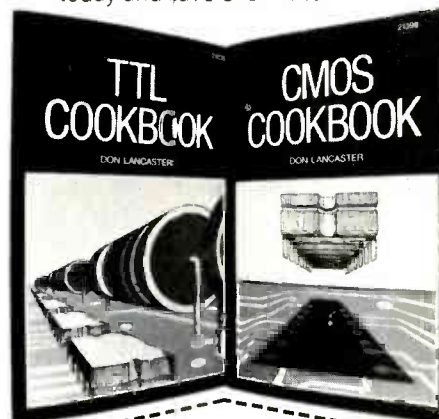

SAMS BOOKS

	No.	Price	Quantity
CMOS COOKBOOK,	No. 21398	\$12.95	_____
TTL COOKBOOK,	No. 21035	\$11.95	_____
Set of both books,	No. 21958	\$19.95	_____

Amount of Order \$ _____
Add local sales tax where applicable \$ _____
Add Handling Costs \$ _____
Total Amount of Order \$ _____

Check Money Order VISA
 MasterCard Interbank No. _____

Account No. _____
Expiration Date _____

Full payment by check, money order, or charge card must accompany your order.

Name (Print) _____

Signature _____

Address _____

City _____ State _____ Zip _____

Call 800-428-3696 toll-free, or 317-298-5566 for the name of your local Sams Book outlet or to order by phone (give Sams Operator the code number in the box below). Offer good in USA only and expires 8/31/82. Prices subject to change without notice.

AD167

MAY 1982

TOTAL CONVENIENCE

Model 324
THE ELECTRONIC WORK CENTER

SUGGESTED RETAIL PRICE
\$49.95

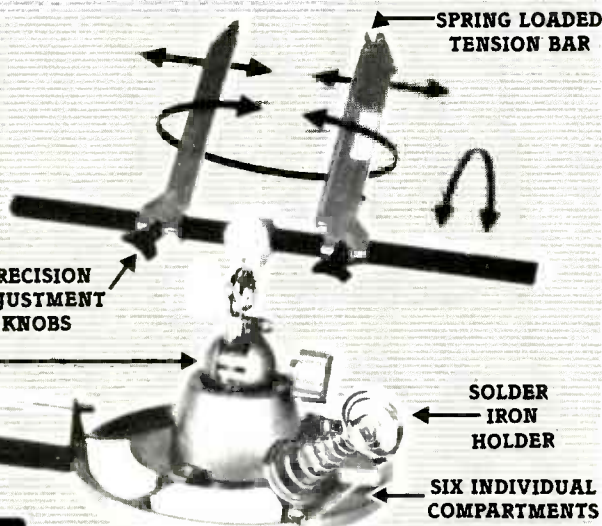

TILTS, TURNS & ROTATES

SOLDER HOLDER

PRECISION ADJUSTMENT KNOBS

SOLDER IRON HOLDER

SIX INDIVIDUAL COMPARTMENTS

SPRING LOADED TENSION BAR

PANAVISE

Contact your local dealer today.

PANAVISE PRODUCTS, INC.-2850 E. 29th St., Long Beach, Ca. (213) 595-7621

CIRCLE 49 ON FREE INFORMATION CARD

CIRCLE 47 ON FREE INFORMATION CARD 105

NEW

YOUR TOOLS FOR TOMORROW'S TECHNOLOGY

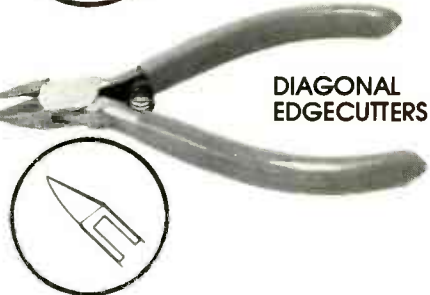

AVAILABLE AT YOUR DISTRIBUTOR

ATT ADVANCED™
TOOL
TECHNOLOGY inc.

18217 PARTHENIA ST • NORTHRIDGE, CA 91325
(213) 993-1202

CIRCLE 39 ON FREE INFORMATION CARD

NEW BOOKS

For more details use free information card inside back cover.

INSIDE BASIC GAMES, by Richard Mateosian. Sybex, 2344 Sixth Street, Berkeley, CA 94710. 325 pp including appendix and index; 7 x 9 inches; softcover; \$13.95.

Assuming that the reader has some knowledge of BASIC programming, this book teaches him or her how to design error-free interactive BASIC programs, including games and other "real time" situations. Eight different kinds of computer games (a total of 14 games) are described in detail, then completely analyzed to illustrate how the games were designed and developed in BASIC. All aspects of game-program design, including program structuring, cursor positioning, randomization, and other concepts are discussed. Programs for games such as Hangman, Ten-Key Flicker, and Taxman are coded in Microsoft BASIC, and versions are provided for the PET/CBM, APPLE II, and TRS-80.

CIRCLE 121 ON FREE INFORMATION CARD

EXPERIMENTS IN TELECOMMUNICATIONS, by Morris Tischler. Gregg Division, McGraw-Hill Book Company, 1221 Avenue of the Americas; New York, NY 10020; 186 pp; 8½ x 11 inches; softcover; \$7.95. **EXPERIMENTS IN GENERAL AND BIOMEDICAL INSTRUMENTATION**, by Morris Tischler; same publisher and format; 201 pp; \$8.95.

These two books are part of a series presenting linear IC's in a variety of circuit applications, and are written for use by electronics technicians who have a basic knowledge of transistors and test instruments. Each volume covers theory and application through laboratory experiments and tracks with standard electronics-course coverage. Step-by-step lab procedures reinforce learning with hands-on activities using common lab equipment and devices presently used in industry.

CIRCLE 122 ON FREE INFORMATION CARD

HANDBOOK OF OSCILLOSCOPES: Theory and Application, by John D. Lenk. Prentice-Hall, Inc., Englewood Cliffs, NJ 07632. 340 pp including index; 6¼ x 9¼ inches; cloth; \$19.95.

This new and revised edition carries through all the features of the first edition, bridging the gap between oscilloscope theory and practical applications. It is designed as a basic textbook for student technicians, hobbyists, and experimenters, and as a guidebook for experienced working technicians and engineers. Each chapter has been expanded to include new material, and existing information has been updated to reflect present-day trends, especially in the extensive use of curve tracers. The revision also simplifies much of the material in the first edition.

Assuming that readers are not familiar with the operating principles of oscilloscopes, the opening chapters present simplified details. Chapter one through four cover oscilloscope basics—typical operating controls and characteristics, specifications and performance—as well as a brief description of oscilloscope accessories. Throughout, the descriptions are kept to the block-diagram or simplified level; unnecessary and elaborate circuit descriptions are avoided.

CIRCLE 123 ON FREE INFORMATION CARD

HANDBOOK OF MICROPROCESSOR APPLICATIONS, by John A. Kuecken. TAB Books, Inc., Blue Ridge Summit, PA 17214. 308 pp including index; 5½ x 8½ inches; softcover; \$8.95.

"What can a microprocessor *not* be used for? It will not mend a broken heart. It will not ensure justice among all men. It will not bring happiness to the lonely. It will not perform its functions instantaneously. Outside of those constraints, there is very little that it cannot do or assist in doing."

So starts this book, whose object is to show the principles of microcomputers and to demonstrate some of the nearly infinite numbers of ways in which the microcompressor can be applied to measurement, process sequencing, "smart" instruments, and some of the more traditional computer applications.

The book is written with the assumption that the reader has no familiarity with binary arithmetic, BCD, hexadecimal or octal notation; because of that, those subjects are all treated early in the discussion.

Emphasis is placed upon the use of the microprocessor in the control, sequencing, and measurement functions and the manipulations of bits and bytes at the machine or assembly-language level in which most of the simple evaluation kits operate. It is not assumed that any of the extensive "development systems" are available to the reader.

The basic aim of the text is to render the use of microprocessors as simple as possible in the widest span of applications. The same subjects have been treated in different locations in the text from different viewpoints, so that a second and perhaps third encounter with the same topic will generate greater familiarity and understanding of the less-familiar concepts.

CIRCLE 124 ON FREE INFORMATION CARD

HANDBOOK OF SIMPLIFIED RADIO, PHONO, AND TAPE RECORDER REPAIRS, An Illustrated Troubleshooting Guide, by James Edward Keogh and Ben Suntag. Parker Publishing Company, Inc., West Nyack, New York 10994. 236 pp including appendices and index; 6 x 9 inches; softcover, spiral binding; \$16.95.

The car radio keeps fading in and out...the tape-recorder playback is on the blink...the pickup arm on the stereo refuses to lift. For most people, repairs on three items like those would come to considerable expense at a repair shop.

This book is a simplified, time-saving guide that shows you how to troubleshoot radios, phonographs, and tape recorders quickly. Through step-by-step troubleshooting charts, you will find the source of the problem. Locate the symptom in the appropriate chapter and simply follow the troubleshooting chart. The malfunctions are listed according to the most likely occurrences. Not only are you told *what* component to check, but also *how* to make the necessary tests so that you can narrow the problem down to its primary cause. Succeeding steps are then outlined.

Once you know what the trouble is, it's a matter either of repairing or replacing the component. This book shows you how to make simple repairs, when that is possible, as well as indicating at what point a replacement is the only solution to the problem.

CIRCLE 125 ON FREE INFORMATION CARD

TELECOMMUNICATION TRANSMISSION HANDBOOK, 2nd Edition, by Roger L. Freeman. John Wiley & Sons, Inc., One Wiley Drive, Somerset, NJ 08873. 707 pp including appendices and index; 6 1/2 x 9 1/2 inches; hardcover; \$49.50.

For practicing telecommunications engineers and advanced students, this standard handbook—now fully revised and updated—provides the practical and real-world information needed for telecommunication design for single links or for complete networks. It treats the technical expertise of 14 transmission disciplines with a unified telecommunications-system approach.

Because many engineers are unfamiliar with some aspects of transmission technology, each chapter begins with an examination of key concepts, which are then applied to the specific engineering situations. That integrative approach makes available a wealth of on-the-job techniques that can be used in any area of transmission-problem solving, whatever the engineer's specialty. Many tables, nomograms, and curves illustrate basic principles and suggest additional applications.

CIRCLE 126 ON FREE INFORMATION CARD

INTERFERENCE HANDBOOK, by William R. Nelson, WA6FQG. Radio Publications, Inc., Box 149, Wilton CT 06897. 247 pp including index and data on other recommended handbooks; 5 1/2 x 8 1/2 inches; softcover; \$8.95 plus \$1.00 for postage and handling.

This book tells how to locate and cure RFI (Radio Frequency Interference) relating to TV, stereo, radio, power lines, and telephones. Problems in all of those areas are analyzed and solved. There are many photos, diagrams, and charts. Suppression circuits for interfering devices are discussed in detail, as well as protection techniques for home-entertainment equipment.

Interference is a fast-growing problem, and there will be more tomorrow than there is today. This handbook is designed to be of service to those confronting that world-wide obstacle to clear, reliable electronic communication.

R-E

CIRCLE 127 ON FREE INFORMATION CARD

ANNOUNCING TWO NEW TERMINALS

Smart • Fast • Graphics • Matching Modem and \$295 Printer

Netronics announces a state of the art breakthrough in terminals, now at prices you can afford, you can go on-line with data-bank and computer phone-line services. It's all yours: "electronic newspapers," educational services, Dow-Jones stock reports, games, recipes, personal computing with any level language, program exchanges, electronic bulletin boards... and more every day!!!



Netronics offers two new terminals, both feature a full 56 key/128 character typewriter-style keyboard, baud rates to 19.2 kilobaud, a rugged steel cabinet and power supply. The simplest one, FASTERM-64, is a 16 line by 64 or 32 character per line unit, with a serial printer port for making hard copy of all incoming data, and optional provisions for block and special character graphics. The "smart" version, SMARTERM-80, features either 24 line by 80 characters per line or 16 by 40 characters per line. It offers on-screen editing with page-at-a-time printing, 12,000 pixel graphics, line graphics, absolute cursor addressing, underlining, reverse video, one-half intensity and much more... simply plug them into your computer or our phone modem and be on-line instantly. Use your TV set (RF modulator required) or our deluxe green-phosphor monitor pictured above. For hard copy just add our matched printer.

Price breakthrough!!! Own the FASTERM-64, a complete terminal kit, ready to plug in for just \$199.95 or order the SMARTERM-80 kit for just \$299.95, (both available wired and tested.) Be on-line with the million-dollar computers and data services today... we even supply the necessary subscription forms.

More good news: All the components in our terminals are available separately (see coupon), so you buy only what you need!!!

FASTERM-64 ... DISPLAY FORMAT: 64 or 32 characters/line by 16 lines ... 96 displayable ASCII characters (upper & lower case) ... 8 baud rates: 150, 300, 600, 1200, 2400, 4800, 9600, 19,200 (switch sel.) ... LINE OUTPUT: RS232C or 20 ma current loop ... VIDEO OUTPUT: 1V P/P (EIA RS-170) ... CURSOR MODES: home & clear screen, erase to end of line, erase cursor line, cursor up & down, auto carriage return/line feed at end of line & auto scrolling ...
REVERSE VIDEO ... BLINKING CURSOR ... PARITY: off, even or odd ... STOP BITS: 1, 1.5, 2 ... DATA BITS PER CHARACTER: 5, 6, 7 or 8 ... CHARACTER OUTPUT: 5 by 7 dot matrix in a 7 by 12 cell ... PRINTER OUTPUT: prints all incoming data ... 1K ON BOARD RAM ... 2K ON BOARD ROM ... CRYSTAL CONTROLLED ... COMPLETE WITH POWER SUPPLY ...
OPTIONAL GRAPHICS MODE: includes 34 Greek & math characters plus 30 special graphics characters ... ASCII ENCODED KEYBOARD: 56 key/128 characters ...
SMARTERM-80 ... DISPLAY FORMAT: 80 characters by 24 lines or 40 characters by 16 lines 128 displayable ASCII characters (upper & lower case) 8 baud rates: 110, 300, 600, 1200, 2400, 4800, 9600, 19,200 ... LINE OUTPUT: RS232C or 20 ma current loop ... VIDEO OUTPUT: 1V P/P (EIA RS-170) ... EDITING FEATURES: Insert/delete line, Insert/delete character, forward/back tab ... LINE OR PAGE TRANSMIT ... PAGE PRINT FUNCTION ... CURSOR POSITIONING: up, down, right, left, plus absolute cursor positioning with read back ... VISUAL ATTRIBUTES: underline, blink, reverse video, half intensity, & blank ... GRAPHICS: 12,000 pixel resolution block plus line graphics ... ON-SCREEN PARITY INDICATOR ... PARITY: off, even or odd ... STOP BITS: 110 baud, 2, all others 1 ... CHAR. OUTPUT: 7 by 11 character in a 9 by 12 block ... PRINTER OUTPUT: 60 OR 50 Hz VERTICAL REFRESH ... BLINKING BLOCK CURSOR ... CRYSTAL CONTROLLED ... 2K ON BOARD RAM ... ASCII ENCODED KEYBOARD: 56 key/128 character ... 4K ON BOARD ROM ... COMPLETE WITH POWER SUPPLY ...
TELEPHONE MODEM 103 O/A ... FULL DUPLEX, FCC APPROVED ... DATA RATE: 300 baud ... INTERFACE: RS232C and TTY ... CONTROLS: talk/data switch (no need to connect and disconnect phone), originate/answer switch on rear panel ... NO POWER SUPPLY REQUIRED ...
ASCII KEYBOARD ASCII-3 ... 56 KEY/128 CHARACTER ASCII ENCODED ... UPPER & LOWER CASE ... FULLY DEBOUNDED ... 2 KEY ROLLOVER ... POS OR NEG LOGIC WITH POS STROBE ... REQUIRES +5 & -12V DC (SUPPLIED FROM VIDEO BOARDS) ...
PRINTER COMET I ... SERIAL I/O TO 9600 BAUD ... 80 CHARACTER COLUMN (32 COMPRESSED) ... 10" TRACTOR FEED ... UPPER/LOWER CASE ... INDUSTRY STANDARD RIBBONS ... 4 CHARACTER SIZES ... 9 BY 7 DOT MATRIX ... BI-DIRECTIONAL PRINTING



Continental U.S.A. Credit Card Buyers Outside Connecticut
CALL TOLL FREE 800-243-7428

To Order From Connecticut Or For Tech. Assist. Call (203) 354-9375

NETRONICS R&D LTD. Dept. RE
333 Litchfield Road, New Milford, CT 06776

Please send the items checked below:

- COMPLETE FASTERM-64 TERMINAL (includes FASTVID-64 video board ASCII-3 keyboard, steel cabinet and power supply) ... kit \$199.95 plus \$3 P&I ... wired & tested \$249.95 plus \$3 P&I ... graphics option: add \$19.95 to each of above
- COMPLETE SMARTERM-80 TERMINAL (includes SMARTVID-80 video board, ASCII-3 keyboard, steel cabinet and power supply) ... kit \$299.95 plus \$3 P&I ... wired and tested \$369.95 plus \$3 P&I
- FASTVID-64 VIDEO BOARD (requires +5 & -12V DC) ... kit \$99.95 plus \$3 P&I ... graphics option add \$19.95 ... wired & tested \$129.95 plus \$3 P&I ... graphics option add \$19.95
- SMARTVID-80 VIDEO BOARD (requires +5 & -12V DC) ... kit \$199.95 plus \$3 P&I ... wired & tested \$249.95 plus \$3 P&I
- DELUXE STEEL TERMINAL CABINET ... \$199.95 plus \$3 P&I
- ASCII-3 KEYBOARD (requires +5 & -12VDC) ... kit \$69.95 plus \$3 P&I ... wired and tested \$89.95 plus \$3 P&I
- POWER SUPPLY (powers ASCII-3 keyboard & video boards) ... kit only \$19.95 plus \$2 P&I
- ZENITH VIDEO MONITOR (high resolution green phosphor) ... wired & tested \$149.95 plus \$6 P&I
- TELEPHONE MODEM MODEL 103 O/A ... wired & tested \$189.95 plus \$3 P&I
- DOT MATRIX PRINTER Comet I ... wired & tested \$299.95 plus \$10 P&I
- RF MODULATOR MOD RF-1 ... kit only \$8.95 plus \$1 P&I
- 3FT-25 LEAD MODEM/TERMINAL OR PRINTER/TERMINAL CONNECTOR CABLE ... \$14.95 ea plus \$2 P&I

For Canadian orders, double the postage. Conn. res. add sales tax.

Total Enclosed \$ _____

Personal Check Cashier's Check/Money Order

VISA MasterCard (Bank No. _____)

Acct. No. _____ Exp. Date _____

Signature _____

Print Name _____

Address _____

City _____ State _____ Zip _____

CIRCLE 41 ON FREE INFORMATION CARD

MARKET CENTER

WANTED

RECEIVING tubes, obsolete types, unused and boxed. But, no brokers. **VAN DATA SYSTEM CO.**, 1-12-8 Kyomachibori, Nishi-ku, Osaka 550, JAPAN.

BUSINESS OPPORTUNITIES

MECHANICALLY inclined individuals desiring ownership of Small Electronics Manufacturing Business - without investment. Write: **BUSINESSES**, 92-R, Brighton 11th, Brooklyn, NY 11235

LAWYER Business litigation, patents, appeals. **JEROME FIELD**, B 292, Brooklyn 11230. Phone (212) 434-0781. Eves. 434-1825

PROJECTION TV ... Make \$200.00+ per evening assembling projectors ... Easy ... Results equal to \$2,500 projectors ... Your total cost less than \$15.00 ... **Plans, lens, & dealer's information \$14.00** ... Illustrated information free ... **MACRO-COMGIX**, Washington Crossing, PA 18977. Credit card orders 24 hour. (215) 736-2880.

HIGHLY PROFITABLE ONE-MAN ELECTRONIC FACTORY

Investment unnecessary, knowledge not required, sales handled by professionals. Ideal home business. Write today for facts!

Postcard will do, **Barta-RE-X**, Box 248, Walnut Creek, CA 94597.

ELECTRONIC TOOLS

NOW you can bend light to reach areas never before possible. A new and totally unique device. Send for free info. today. **H AND M PRODUCTS**, P.O. Box 3483, Quincy, IL 62301

To run your own classified ad, put one word on each of the lines below and send this form along with your check for \$1.65 per word (minimum 15 words) to:

Radio-Electronics, 200 Park Avenue South, N.Y., N.Y. 10003

ORDER FORM

PLEASE INDICATE in which category of classified advertising you wish your ad to appear. For special headings, there is a surcharge of \$10.

() Plans/Kits () Business Opportunities () For Sale
() Education/Instruction () Wanted ()

Special Category: \$10

(PLEASE PRINT EACH WORD SEPARATELY, IN BLOCK LETTERS.)

1	2	3	4	5
6	7	8	9	10
11	12	13	14	15
16	17	18	19	20
21	22	23	24	25
26	27	28	29	30
31	32	33	34	35

PLEASE INCLUDE FOR OUR FILES YOUR PERMANENT ADDRESS AND PHONE NUMBER.

COMPUTERS

SAVE 90%. Build your own computer, CRT, and interfaces. Free details. **DIGATEK CORPORATION**, Suite E, 2723 West Butler Drive, Phoenix, AZ 85021

CORDLESS TELEPHONES

LOW prices, all major brands. Inquiries or Visa/MasterCard orders—(206) 743-3977. **TRINETICS**, Box 6005, Lynnwood, WA 98036

SATELLITE TELEVISION

SATELLITE TV antenna, 10 ft. fiberglass, complete, polar mount, \$1950.00, electronics at cost also. **TRI-STAR COMMUNICATIONS**, Box 843, Erie, MI 48133 (419) 726-1095

FREE \$200 value TVRO P.C. board set, when you join our development group. Complete systems as low as \$700. Newest low cost designs, antennas, group purchasing, more. Info \$1.00, membership \$50. 509-534-8088 6-9 PM PST. **COMPUTER SATELLITE SERVICES**, 1604 N. Smith St., Spokane WA 99207

SATELLITE TV. Books, parts, low-noise microwave transistors. Specs and catalog \$2.00. **ELITE ELECTRONICS**, RR1, St. George, Ontario, Canada N0E 1N0

GEOSTATIONARY satellite TV antenna aiming angles. Azimuth and elevation (true and magnetic) coordinates calculated by digital computer for your location. 23 satellites. Send name, address, your location's latitude and longitude (deg. min. sec.); or distance and direction from nearby town; or explicit geographical location in your city; plus \$6.50 to: **HUTSON INDUSTRIES, INC.**, P.O. Box 155, Scooba, MS 39358

INTERESTED in Home Satellite Television — Don't buy anything until you've read the **HOME-SAT HANDBOOK & BUYERS GUIDE**. Our book tells everything about home satellite TV and may save you hundreds, even thousands of dollars in your selection and installation of a system! \$7.50. **H & G HOMESAT SERVICES**, Box 422, Seaford, NY 11873

SATELLITE super-mixer; DBM-4150A. Clean up your **TVRO receiver!** Near-theoretical performance; flat response, DC-1500IF, SMA connectors; \$69.50 — CK/MO/COD. **RIGEL SYSTEMS**, 2974R Scott Blvd., Santa Clara, CA 95050 (408) 727-4231.

SATELLITE television feed horn (brass), fits standard CPR229 flange, for parabolic dish f/d 3-.45. Frequency 3.30-4.90GHz. \$30.00 Post-paid USA MasterCard—money order—cashier check. **FRIEDSAM TV HARDWARE**, 112 West Main, Marshallville, GA 31057 (912) 967-2828.

SATELLITE, complete programs listings, 12 monthly issues \$65.00. **SATELLITE TV GUIDE**, Box 53, Ayden, NC 28513

SATELLITE Television: Now buy directly from national manufacturer, complete receiver kit \$595.00—entire system for under \$1,000.00. Forward \$4.95 for information and satellite study package to: **NATIONAL TELECOMMUNICATION SYSTEMS CORP.**, 1048 Mt. Gallant Rd., Rock Hill, SC 29730 (Visa-Master Charge).

FREE SATCOM
IN 15 MINUTES
BY VISA/MASTERCARD

SATELLITE TV

FANTASTIC 80 TV CHANNELS

New antenna construction plans plus big 8 x 11 book loaded with aiming info, kits, LNAs and receivers at wholesale prices. Far better than cable TV! Enjoy crystal clear reception. Send \$9.95 today. Add \$2.00 for 1st class (air mail) or call our 24 hr. COD order line (305) 862-5068 Now.

Global TV Electronics, P.O. Box 219-F, Maitland, FL 32751

SATELLITE TV WEEK

The most complete weekly listings. We cover more than just SATCOM 3. Send \$1 for sample copy.

Satellite TV Week

P.O. Box 306, Fortuna, California 95540
Call toll free: (800) 358-9997 • California (707) 725-2476

Satellite TV

FOR THE HOME

Sick of Network TV?

Our receiver lets you get over 75 channels of television directly from earth-orbiting cable TV satellites! HBO, Showtime, super stations, sports and movies worldwide.



We don't just sell information! We Manufacture Hardware!

From offshore oil rigs, data links to hotels and backyard installations, we wrote the book. Constantly updated, our **94 Page** technical information book and catalog gives you all the facts. Inexpensive dishes, feeds, telemetry software, kits and more. Recommended reading by NASA, The Office of Consumer Affairs and quality companies like Rockwell/Collins. Send \$7.95 today!

CALL
24-hrs. C.O.D. Hotline
(305) 339-7600

SPACECOAST
RESEARCH CORPORATION
P.O. Box 442-E, Altamonte Spgs, FL 32701



TTL 7400 SERIES

7400N	23	7438N	.42	74100N	1.38	74154N	1.25	74193N	.75
7401N	25	7440N	.25	74104N	.64	74155N	.58	74194N	.55
7402N	24	7442N	.52	74107AN	.40	74157N	.58	74195N	.75
7403N	24	7444N	.89	74109N	.40	74159N	1.52	74196N	.79
7404N	26	7446N	.79	74110N	.52	74160N	.60	74197N	.79
7405N	26	7447AN	.79	74111N	.72	74161AN	.69	74198N	1.39
7406N	.36	7450N	.75	74112N	1.38	74162N	.69	74199N	1.39
7407N	.41	7451N	.29	74120N	1.38	74163AN	.69	74221N	.68
7408N	.26	7453N	.29	74121N	.39	74164AN	.69	74246N	1.70
7409N	.28	7454N	.29	74122N	.48	74165AN	.69	74247N	1.50
7410N	26	7455N	.89	74123N	.48	74166N	.69	74253N	1.28
7412N	35	7473N	.35	74125N	.48	74170N	1.75	74259N	1.89
7413N	.42	7474N	.35	74126AN	.48	74172N	3.95	74273N	1.99
7414N	.44	7475N	.45	74128N	.64	74173N	.79	74276N	2.38
7416N	.36	7476N	.35	74132N	.48	74174AN	.69	74278N	2.38
7417N	.36	7483AN	.48	74136N	.52	74175N	.66	74279N	.76
7420N	.25	7484AN	1.99	74141N	.95	74176N	.77	74283N	1.10
7422N	.45	7485N	.66	74142N	2.95	74178AN	1.17	74305N	.84
7423N	.29	7486N	.35	74143N	3.84	74179N	1.35	74298N	.84
7425N	.32	7490AN	.36	74144AN	3.44	74180N	.75	74351N	2.20
7426N	.32	7491AN	.50	74145AN	.67	74182N	.52	74365AN	.59
7427N	.32	7492AN	.42	74147AN	1.50	74184N	2.39	74366N	.59
7428N	.43	7493AN	.68	74148AN	.99	74185N	2.36	74367AN	.58
7430N	.23	7494AN	.65	74150N	1.25	74190N	.75	74368AN	.59
7432N	.36	7495AN	.64	74151N	.54	74192AN	.75	74369AN	.96
7433N	.42	7496AN	.59	74153N	.49	74192N	.75	74393N	1.49
7437N	.38	7497N	1.89						

TTL 74LS SERIES

74LS00N	21	74LS73N	.35	74LS417N	1.96	74LS221N	.89	74LS321N	3.95
74LS01N	22	74LS74N	.35	74LS418N	1.43	74LS240N	1.25	74LS322N	4.95
74LS02N	24	74LS75N	.45	74LS419N	.43	74LS241N	1.25	74LS323N	4.95
74LS03N	24	74LS76N	.44	74LS419N	.43	74LS242N	1.25	74LS324N	4.95
74LS04N	25	74LS78N	.39	74LS455N	.87	74LS243N	1.25	74LS348N	1.65
74LS05N	25	74LS83N	.69	74LS456N	.87	74LS244N	1.25	74LS352N	1.28
74LS06N	25	74LS85N	.69	74LS457N	.87	74LS245N	1.59	74LS374N	1.95
74LS07N	25	74LS86N	.38	74LS458N	.48	74LS247N	.84	74LS362N	9.95
74LS10N	24	74LS90N	.42	74LS460N	.79	74LS248N	1.09	74LS365N	.59
74LS11N	28	74LS91N	.99	74LS461N	.75	74LS249N	1.10	74LS366N	.59
74LS12N	27	74LS92N	.64	74LS462N	.84	74LS251N	.69	74LS367N	2.34
74LS13N	.36	74LS93N	.54	74LS463N	.69	74LS252N	.69	74LS368N	.59
74LS14N	.48	74LS94N	.52	74LS464AN	.58	74LS257N	.69	74LS373N	1.95
74LS20N	24	74LS95N	.72	74LS465AN	.69	74LS258N	.69	74LS374N	1.95
74LS21N	27	74LS96N	.42	74LS466N	1.64	74LS259N	1.49	74LS375N	1.44
74LS26N	25	74LS109N	.36	74LS470N	1.59	74LS260N	1.25	74LS377N	1.25
74LS27N	29	74LS112N	.66	74LS473N	.72	74LS266N	.42	74LS378N	.99
74LS28N	29	74LS113N	.45	74LS474N	.44	74LS273N	1.19	74LS379N	1.44
74LS32N	27	74LS123N	.39	74LS475AN	.44	74LS275N	3.39	74LS390N	1.44
74LS37N	.29	74LS125N	.49	74LS478N	1.99	74LS279N	.44	74LS393N	1.44
74LS38N	.29	74LS126AN	.49	74LS478N	1.99	74LS280N	1.96	74LS394N	1.19
74LS42N	.44	74LS132N	.48	74LS479N	.58	74LS283N	.86	74LS447N	.89
74LS47N	.72	74LS133N	.42	74LS479N	.58	74LS290N	.79	74LS490N	1.89
74LS48N	.72	74LS136N	.49	74LS491N	.85	74LS290N	.79	74LS630N	54.90
74LS51N	24	74LS138N	.44	74LS492N	.74	74LS293N	.99	74LS669N	.84
74LS54N	24	74LS139N	.55	74LS494N	.74	74LS320N	2.75	74LS670N	1.99
74LS55N	24	74LS145N	1.09	74LS497N	.88				

CMOS

CD4001BE	25	CD4024BE	.53	CD4052BE	.85	CD40520BE	.70	CD4085BE	.75
CD4002BE	25	CD4025BE	.55	CD4053BE	.75	CD40522BE	.70	CD4086BE	.75
CD4006BE	29	CD4026BE	1.95	CD4060BE	.99	CD40526BE	.99	CD4093BE	.56
CD4007BE	24	CD4027BE	.45	CD4066BE	.49	CD40527BE	.47	CD4099BE	1.25
CD4008BE	25	CD4028BE	.58	CD4069BE	.35	CD40528BE	.85	CD4104BE	2.34
CD4009BE	35	CD4029BE	.75	CD4069BE	.35	CD40529BE	.99	CD4097PC	.83
CD4010BE	39	CD4030BE	.58	CD4070BE	.35	CD40532BE	.99	CD4098PC	.97
CD4011BE	25	CD4033BE	1.67	CD4071BE	.25	CD40539BE	.99	74C00N	.34
CD4012BE	25	CD4034BE	1.99	CD4072BE	.25	CD40543BE	1.21	74C14N	.65
CD4013BE	30	CD4035BE	.65	CD4073BE	.35	CD40732N	.39	74C15N	.99
CD4014BE	75	CD4040BE	.64	CD4075BE	.28	CD40555BE	.75	74C76N	.41
CD4015BE	.75	CD4041BE	.79	CD4076BE	.59	CD40556BE	.75	74C85N	.79
CD4016BE	.39	CD4042BE	.58	CD4077BE	.28	CD40581BE	.89	74C107N	.53
CD4017BE	.70	CD4043BE	.65	CD4078BE	.64	CD40582BE	.89	74C161N	.99
CD4018BE	.70	CD4044BE	.55	CD4079BE	.35	CD40584BE	.42	74C163N	.99
CD4019BE	.39	CD4046BE	.79	CD4512BE	.99	CD40585BE	.79	74C173N	1.15
CD4020BE	.70	CD4047BE	.85	CD4514BE	1.50	CD40702BE	15.95	74C175N	.75
CD4021BE	.75	CD4049BE	.38	CD4515BE	1.68	CD4081BE	.25	74C192N	1.03
CD4022BE	.79	CD4050BE	.38	CD4516BE	.75	CD4082BE	.25	74C193N	.99
CD4023BE	.25	CD4051BE	.79	CD4519BE	.45				

PLASTIC POWER TRANSISTORS

TIP29B	48	TIP41C	.69	TIP125	.74
TIP30C	48	TIP42B	.69	TIP126	.82
TIP30B	48	TIP42C	.74	TIP127	.89
TIP30C	48	TIP110	.58	TIP140	1.54
TIP31A	49	TIP111	.64	TIP141	1.84
TIP31B	49	TIP112	.72	TIP142	2.05
TIP31C	52	TIP115	.56	TIP145	1.99
TIP32A	.46	TIP116	.64	TIP146	1.99
TIP32B	.50	TIP117	.75	TIP147	2.45
TIP32C	.56	TIP120	.74	TIP295S	.93
TIP41A	.65	TIP121	.64	TIP305S	.75
TIP41B	.65	TIP122	.74		

SCR'S and TRIAC'S

TIC1060	SCR	5 amp	400V T0-202	.39
TIC1168	SCR	8 amp	200V T0-220	1.06
TIC1168	SCR	8 amp	400V T0-220	1.19
TIC1268	SCR	12 amp	200V T0-220	1.18
TIC1268	SCR	12 amp	400V T0-220	1.48
TIC2168	Triac	6 amp	200V T0-220	1.12
TIC2168	Triac	6 amp	400V T0-220	.94
TIC2268	Triac	8 amp	400V T0-220	1.10
TIC2368	Triac	12 amp	400V T0-220	1.30
TIC2468	Triac	16 amp	400V T0-220	1.60
2N1595	SCR	1 amp	50V T0-220	.65
2N4442	SCR	8 amp	200V T0-127	1.29

LINEAR IC'S

LM309K	1.35	LM741CH	.59
LM323K	4.50	LM741CN	.29
LM324CN	.48	LM747CN	.50
LM339CN	.48	LM1488CN	.64
LM348CN	.99	LM1489CN	.64
LM558N	.29	LM2240CN	1.80
LM556CN	.68	LM3403CN	1.19
LM567N-8	.99	LM4136CN	.88
LM723CN	.45	LM4558CN	.44
		ULN2003AN	.79

OPTOELECTRONICS L.E.D.

LED 209 T-1 3mm Red	.10
LED 211 T-1 3mm Green	.19
LED 212 T-1 3mm Yellow	.14
LED 220 T-1 3/4 5mm Red	.11
LED 222 T-1 3/4 5mm Green	.24
LED 224 T-1 3/4 5mm Yellow	.16
7 SEGMENT DISPLAYS	
FND 507 / TIL 322	.99
FND 507 / TIL 321A	.99
MAN 71A / DL 707R	1.25
MAN 72A / DL 707	1.25

*** BONUS ***

Any order received over \$100 - we will send you at no extra charge
Zilog Software Manual
Unitrode Data book
Low Power Schottky Data book
MOS Memory Data book
TOTAL VALUE OVER \$30

1 AMP VOLTAGE REGULATORS

78XXUC POSITIVE	.69
79XXUC NEGATIVE	.79
VOLTAGES 5, 6, 8, 12, 15, 18, 24.	
78XXKC POSITIVE	1.57
79XXKC NEGATIVE	1.79
VOLTAGES 5, 8, 12, 15, 18, 24.	

MICRO COMPUTER SUPPORT CENTRE

UNBEATABLE!
MEMORY RAM SPECIALS

2114-30 4K STATIC 8/17.95
4116-30 16K DYNAMIC 8/14.95

WITH SHUNTS AND INSTRUCTION FOR TRS 80 UPGRADE.

STATIC RAM'S

2101-35	1K (256 x 4)	350NS 22 PIN	2.95
2102-25	1K (1K x 1)	250NS 16 PIN	1.75
P2111-45	1K (256 x 4)	450NS 18 PIN	2.65
P2112-35	1K (256 x 4)	350NS 16 PIN	3.25
P2016-10	16K (2K x 8)	100NS 24 PIN	29.95
P2016-15	16K (2K x 8)	150NS 24 PIN	15.95
P2016-20	16K (2K x 8)	200NS 24 PIN	13.95
Z6132-6PS	32K (4K x 8)	450NS 28 PIN	36.95

DYNAMIC RAM'S

P4060-30	4K (4K x 1)	300NS 22 PIN	2.65
P4116-20	16K (16K x 1)	200NS 16 PIN	2.65
P4164-25	64K (64K x 1)	250NS 16 PIN	19.95
P4164-20	64K (64K x 1)	200NS 16 PIN	17.95

EPROM'S

C2708-45	8K (1K x 8)	450NS 24 PIN	4.50
C2716-17	16K (2K x 8)	450NS 24 PIN	4.95
TMS2151	Single 5 Volt Supply, Intel Pin Out		4.95
TMS2716	16K (2K x 8)	450NS 24 PIN 3 Power Supply, T Pin Out	12.95
C2532	32K (2K x 8)	450NS 24 PIN T Pin Out	13.95
C2732	32K (4K x 8)	450NS 24 PIN Intel Pin Out	13.95
C2564	64K (8K x 8)	450NS 24 PIN T Pin Out	29.95
C2764 A	64K (8K x 8)	300NS 28 PIN Intel Pin Out	29.95

BI-PROMS

74S188N	32 x 8	16 PIN	1.98
74S288N	32 x 8	16 PIN	1.98
93417/82S126	256 x 4	16 PIN	2.45
93427/82S129	256 x 4	16 PIN	2.45
93436/7620	512 x 4	16 PIN	4.95
93446/7621	512 x 4	16 PIN	4.60
93448/7641	512 x 8	24 PIN	7.95
93453/7643	1024 x 4	18 PIN	6.95
93451/82S181	1024 x 4	24 PIN	17.95
932S185/7128	2048 x 4	18 PIN	14.95
92S191/7138	2048 x 8	24 PIN	78.00

THEY TALK - YOU LISTEN!

MONITORING ACCESSORIES

GROVE

1982 Catalog

Improve your monitoring receivers with unique accessories. Preamps, descramblers, notch filters, active antennas, preselectors, multi-couplers, frequency lists, beam antennas and more.

FREE CATALOG FREE

GROVE ENTERPRISES, INC. Dept. J. Brasstown, NC 28902

WERSI KEYBOARD KITS



WERSI Organs are demonstrably superior in overall performance, to ALL commercially built instruments, regardless of price. Best of all, you save 1/2 to 2/3 the cost with our easy to build kits. (Also factory assembled).

And now - after 3 years in research, the totally unprecedented "Pianostar" electronic piano (and much more!) has been unveiled to international raves! You have to hear it to believe it!

Explore the exciting world of WERSI, Free information package.
Call free, 24 hrs., 1-800-233-3865
(in PA call: 717/299-4327, 9-5)
Ask for "WERSI DATA PAK #M33"
Please specify Piano or Organ

MICROWAVE HORN ANTENNA KIT

1.7-2.6 GHz Frequency Range 17-19 db Gain. Kit w/Assembly Instructions \$39.95*
Down Converter Board \$19.95* (w/Antenna Kit \$14.95)
Parts Kit for Board \$29.95* (w/Antenna or Board \$24.95)
Complete Package (Antenna, Board & Parts Kit) \$79.95



MICROTENNA ASSOCIATES

2335 South 2300 West, Salt Lake City, Utah 84119
Check or M.O. only - Allow 2-4 Weeks Delivery (Cost includes shipping)
*Utah Residents Please Add 5% Sales Tax

PLANS & KITS

FREE catalog 99 cent kits. Buy 2 get 1 free. Parts, bargains galore. ALLKIT, 434 West 4th St., West Islip, NY 11795

OSCILLOSCOPE performance from your unmodified television for less than \$25. Super simple, accurate, practical. Order Tele-Scope circuit board and plans \$8.50. Get two for dual trace \$15. MICROGRID, Box 613, Ithaca, NY 14850

SATELLITE TVRO parabolic aluminum dish, local materials \$500. Plans, formulas \$10.00. WARD MICROWAVE, Box 100, Conway, NC 27820

DECODE Morse, RTTY, and ASCII signals from airwaves with new Code*Star. LED readout or connect with your computer/printer. Keyboard, other items also available. Kits or assembled. MICROCRAFT, Box 513R, Thiensville, WI 53092 (414) 241-8144

MUSICAL car horn 64 tunes. No chips to buy. Kit with case less horn, \$31.95. Factory assembled with horn, \$41.95. Add \$2.50 shipping. ELECTRONIC SOUND, P.O. Box 401951, Garland, TX 75040

PRINTED circuit boards from sketch or artwork. Kit projects. Free details. DANOCINTHS INC., Box 261, Westland, MI 48185

CABLE TV converters and equipment. Plans and parts. Build or buy. For information send \$2.00. C & D ELECTRONICS, PO Box 21, Jenison, MI 49428

ELECTRONIC catalog. Over 4,500 items. Parts & components. Everything needed by the hobbyist or technician. \$2.00 postage & handling (United States only). refundable with first \$15.00 order. T & M ELECTRONICS, 474 East Main Street, Patchogue, NY 11772 (516) 289-2520

MINI FM MIC



Compact size, only 2" x 1" x 3/4". Transmit to FM radio 88-108 MHz. Exceptional audio quality. Transmits stable signal up to 900 ft. Complete kit incl. case, battery & instructions. Only \$13.95 Assembled \$18.95. Add \$1.55 S&H ea. Send 18¢ stamp for brochure.

S.E. Corp., Box 16699-R
Temple Terrace, FL 33687

FREE KIT Catalog

FUNCTION GENERATOR KIT \$59.95 contains TEST & EXPERI-MENTER'S EQUIP.
Auto-Ranging Cap-meter kit \$79.95

Phone 415 - 447 - 3433

Write or Phone for FREE CATALOG. Average 1 minute Saturday call is 21¢.

DAGE SCIENTIFIC INSTRUMENTS

BOX 1054R LIVERMORE CA 94550

BEND-A-LIGHT™



CAST SHADOWS AND REFLECTED GLARE MAKE THE JOB MISERABLE! NOT WITH BEND-A-LIGHT. A HIGH INTENSITY LIGHT SOURCE WITH A FLEXIBLE SHAFT. GETS LIGHT INTO THE SMALLEST HOLES! SEND \$25 TODAY (IL & MI RESIDENTS ADD TAX) TO:

M.H. ENTERPRISES, P.O. Box 1226, Dept. 13631, Northbrook, IL 60062

SINTEC COMPANY

Drawer Q, Milford, N.J. 08848

"Quality Electronic Parts by Mail"

Free Sinter Catalog - Over 1000 Items
\$10.00 Min. Order - N.J. Residents add 5% sales tax.
Postage. Add \$5.00 plus \$1.00 Insurance.
Sinter accepts Check, Money Order.
VISA, Master Charge, C.O.D.
Phone Orders Welcome
Toll Free Call 1-800-526-5960
N.J. Residents (201) 996-4093

ELECTRO SPACE PRINTED CIRCUIT CARD EJECTORS				ELECTRO SPACE PRINTED CIRCUIT CARD INJECTOR/EJECTORS FOR 1/16 THICK CARDS					
Stock No.	Color	1-24	24-19	50-Up	11452	White	5-27	\$ 23	\$ 20
11450	White	5.25	\$ 21	\$ 19	11453	Red	27	23	20
11451	Red	.25	.21	.19					

Texas Instruments Low Profile Sockets, In plated phosphor bronze contact pins with gold light seal

Stock No.	No. Pins	1-24	25-99	100-Up
11201	8	\$ 15	\$ 13	\$ 12
11202	14	18	15	14
11203	16	20	17	16
11204	18	24	21	19
11205	20	27	24	21
11206	22	30	27	23
11207	24	33	30	25
11208	28	38	34	29
11209	40	45	40	35

SUBSCRIPTION TV PLANS: 2300 MHz Microwave Downconverter plus BONUS UHF system, both for \$15.00! Best systems available, no internal connections to TV. Parts, PCB's, Kits available, MC/VISA accepted. Other plans: Negative Ion Generator, Telephone Memory Dialer, UHF/VHF Antenna Amplifier, Wireless FM Intercom, \$4.00 each. Send SASE for more information. COLLINS ELECTRONICS, Box 6424, San Bernardino, CA 92412

AMATEUR microwave downconverter new 4 stage design out performs all the others. Down-converter kit \$59.95, assembled \$89.95, 6 month warranty. \$2.00 for details. Send check or money order to: MINIATURE COMMUNICATION, P.O. Box 114, Cudahy, WI 53110

BROADCASTING! Start your own station! AM, FM, cable, licensed, unlicensed. Low cost transmitters, plans, instruction books. Free information. BROADCASTING, Box 130F5, Paradise, CA 95969

PEAK expander and CX decoder kit model SX-80 \$76.00 plus \$2.00 shipping. Complete plans \$1.00. See Radio Electronics Dec. '81. SOUND CONCEPTS, Box 135R, Brookline, MA 02146

PCB'S five day service! Kit projects or artwork, no drilling charge, guaranteed quality. DITEK CORPORATION, 6244 Colby, Lincoln, NE 68505.

PROJECTION TV ... Convert your TV to project 7 foot picture. Results equal to \$2,500 projector. Total cost less than \$20.00. Plans & lens \$16.00. Illustrated information free. Credit card orders - 24 hours. (215) 736-3979. MACROCOMII, Washington Crossing, PA 18977.

CONVERTERS, inexpensive satellite TV, complete TV descramblers, and instruction manuals. Stereo reverbs, power supplies, burglar alarm systems, VCR's, synch stabilizers, electronic games, and more. Send \$1.00, refundable. J.D.'s ELECTRONICS, Box 2728, San Bernardino, CA 92406.

HEX-WIK SUPERIOR SOLDER REMOVAL BRAID

Stock No.	Size	Ft/Spool	Price
50041	1/16	6	\$2.10
50042	5/64	6	2.25

ARIES ZERO INSERTION FORCE SOCKETS

- Cam actuated, true zero insertion force - tin plated solder tail pins - capable of being plugged into DIP sockets

Stock No.	No. Pins	1-24	25-49	50-Up
11058	24	34.00	\$3.80	\$3.25
11056	28	4.25	3.77	3.40
11057	32	4.50	4.34	3.91
11058	64	9.89	8.76	7.90

Pin Straightening Tool puts devices on their true row to row spacing. One side is for .300 center devices, flip tool over for devices on .600 centers. Put device in tool, slide, bowed leads come back to proper spacing



Stock No. 11059 \$12.95

RCA C/MOS

Stock No.	RCA No.	1-24	25-Up
44001	CD4001BE	5.36	\$ 3.33
44002	CD4001UBE	36	33
44007	CD4007UBE	36	33
44011	CD4011UBE	36	33
44012	CD4011UBE	36	33
44013	CD4013BE	56	52
44015	CD4015BE	1.07	1.01
44016	CD4016BE	59	55
44017	CD4017BE	1.07	1.01
44019	CD4019BE	59	55
44020	CD4020BE	1.18	1.12
44023	CD4023BE	36	33
44024	CD4024BE	92	87
44025	CD4025BE	36	33
44027	CD4027BE	68	64
44030	CD4030BE	59	55
44040	CD4040BE	1.18	1.12
44046	CD4046BE	1.36	1.48
44049	CD4049BE	57	54
44050	CD4050BE	57	54
44051	CD4051BE	1.18	1.12
44052	CD4052BE	1.18	1.12
44053	CD4053BE	1.18	1.12
44054	CD4054BE	1.96	1.85
44056	CD4056BE	1.96	1.85
44060	CD4060BE	1.48	1.40
44066	CD4066BE	78	74
44069	CD4069BE	36	33
44070	CD4070BE	44	41
44071	CD4071BE	1.26	1.20
44076	CD4076BE	36	33
44081	CD4081BE	36	33
44082	CD4082BE	78	74
44083	CD4083BE	78	74
44084	CD4084BE	1.56	1.48
44092	CD4502BE	1.72	1.64
44511	CD4511BE	1.26	1.20
44512	CD4512BE	1.18	1.12
44530	CD22100E	2.49	2.35
44539	CD4010BE	1.96	1.85
44592	CD4010BE	1.84	1.80

RCA POWER

SINTEC RCA No.	1-24	25-49	SINTEC RCA No.	1-24	25-49		
40122	C122D	51.22	51.16	44037	2N4037	\$.86	\$.82
42322	T232D	1.85	1.38	45294	2N5294	80	76
42700	T2700	2.07	1.96	45296	2N5296	80	76
42800-1	T2800B	2.08	1.96	45320	2N5320	1.25	1.19
42800-2	T2800C	1.56	1.50	45321	2N5321	1.02	.96
42850	T2850	1.90	1.79	45322	2N5322	1.61	1.53
40029-1	TIP29A	60	57	45415	2N5415	1.60	1.52
40031	TIP31A	74	70	45416	2N5416	2.17	2.06
40121	TIP121	1.43	1.35	45784	2N5784	2.27	2.19
40125	TIP125	1.37	1.29	46044	2N6044	2.04	1.93
42955	MJ2955	1.16	1.10	46101	2N6101	1.25	1.19
43055	RCA3055	1.03	.97	46102	2N6102	82	73
43439	2N4339	1.73	1.65	46387	2N6387	1.15	1.09
42270	2N2270	.82	.78	46111	2N6111	80	76
43053	2N3053	.61	.58	46254	2N6254	2.16	2.05
43054	2N3054	1.37	1.29	46290	2N6290	80	76
43055-1	2N3055	1.03	.97	46292	2N6292	80	76
43055-2	2N3055SHOM	1.62	1.54	46386	2N6386	1.05	.99
43440	2N3440	1.25	1.19	46387	2N6387	1.15	1.09
43771	2N3771	2.92	2.76	46388	2N6388	1.28	1.22
43772	2N3772	3.18	3.00	46474	2N6474	1.03	.97
43773	2N3773	3.22	3.04	46667	2N6667	1.49	1.44
44036	2N4036	1.08	1.02	46668	2N6668	1.80	1.52
				40347	40347	1.22	1.16

ELPAC POWER SUPPLIES SOLV SERIES FULLY REGULATED

Stock	Output Voltage (VDC)	Output Current (mA)	Dimensions (HxWxD) Inches	Price
13802	12	0.25	4.71/16x4.2	\$38.00
13803	12	1.5A	4.71/16x4.2	38.00
13804	15	1.2A	4.71/16x4.2	38.00
13806	24	0.75A	4.71/16x4.2	38.00
13808	5	60A	5.5/8x4.7/8x3-3/16	57.00
13809	12	4.0A	5.5/8x4.7/8x3-3/16	57.00
13810	15	3.3A	5.5/8x4.7/8x3-3/16	57.00
13812	24	2.0A	5.5/8x4.7/8x3-3/16	57.00

ELPAC POWER SUPPLIES DC/DC CONVERTERS

Stock	Input Voltage (VDC)	Output Voltage (VDC)	Output Current (mA)	Dimensions (HxWxD) Inches	Price
13825	3-7.0	12-20.6	125	.651x1.2x1.77	23.00
13826	3-7.0	12-20.6	0.25	.651x1.2x1.77	23.00
13827	3-7.0	15-20.7	0.25	.651x1.2x1.77	23.00
13828	3-7.0	15-20.7	0.25	.651x1.2x1.77	23.00
13829	3-7.0	28-27.0	1.0	.651x1.2x1.77	23.00
13830	3-7.0	28-27.0	0.10	.651x1.2x1.77	23.00

Floppy Disc power supply for 8 drive, as built by Shugart, CDC, Wang, etc. three outputs (+5V, +24V, -5V). Output current max 2.5A. 3.0x3.4x.4A. PK. O.SA. Stock No. 13801 \$109.00

MOTUEC

- VOLT/OHM Milliammeter (Stock No. 13725) \$34.75
- Battery Tester for small batteries from 1.35V to 4.5V (Stock No. 13733) \$13.95
- Miniamp AC Volt-Ammeter

Stock No.	AC Amperes Ranges	Price
13730	0-25A	\$39.50
13731	0-50A	39.50
13732	0-100A	39.50

Bow Rosin Core Solder (60/40 Alloy)

Stock No.	Dia. (Inch)	Length (Oz)	Weight
50075	.062	9	\$3.28
50076	.062	25	4.36
50077	.062	50	8.62
50078	.032	33	5.40
50079	.032	89	4.16
50080	.032	175	8.62

LINE SPLITTER allows fast & accurate readings of AC power consumption (Stock # 13727) \$ 9.95
VOL-MULTITESTER Versatile Volt-Ohm-Milliammeter (Stock # 13729) \$13.95

Radio Shack Parts Bring Your Ideas to Life!

No Waiting! • No Minimum Order! • Low Prices!

Solar Power Demo Kit

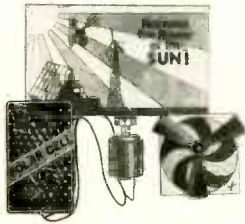

NEW!

995

- Ready to Use
- Ideal for Models

A top-quality solar cell pre-wired to a precision DC motor—ready for your creative ideas! Great for building into model windmills, boats, radiometers and more. Includes miniature propeller, color wheels, illustrated booklet. 277-1201 . . . 9.95

Now That It's Working . . .

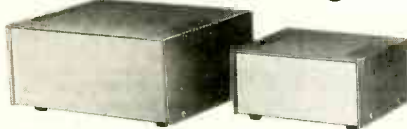

A 995 NEW! B 695

Dress up that special project! Both of these deluxe enclosures feature vented steel top, easy-to-work aluminum chassis, removable rubber feet and great-looking "TRS-80 gray" styling.

Fig.	Size	Cat. No.	Each
A	3 1/4 x 7 1/2 x 5 7/8"	270-229	9.95
B	2 1/2 x 5 1/8 x 4 9/16"	270-228	6.95

Here's a Fast, Easy Way To Design and Build!

Design and Debug Your Circuit On a Socket, Transfer It to the PC Board

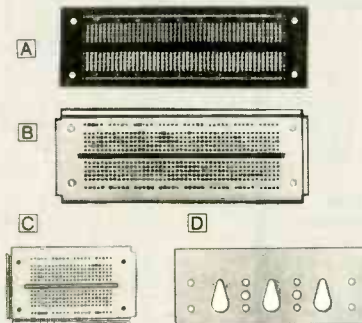

- A Pre-Drilled PC Board.** Holes match sockets (B and C) for easy transfer. 2 1/16 x 5 7/16 x 1/16", with 0.3" DIP center. 550 connection points. 276-170 . . . 3.29
- B Modular IC Breadboard Socket.** DIP center. These boards snap together for larger projects and accept 30 to 22-gauge solid wire. Two busses, 550 indexed connection points. 2 1/8 x 6". 276-174 . . . 10.95
- C Modular IC Breadboard Socket.** As above, but with 270 indexed connection points. 2 1/8 x 3 3/8". 276-175 . . . 6.49
- D Accessory Panel.** Snaps into interlock groove of B. Allows you to mount controls, switches and read-outs. 5 3/8 x 2 1/4". 276-171 . . . 1.99

Engineer's Notebook II

NEW!

Only

249



By Forrest Mims III

Gives you practical circuits for most analog and digital ICs. A wealth of information, presented in an easy-to-read format. 128 pages. Punched for three-ring binder. 276-5002 . . . 2.49

Computer Connectors

Solderless, Reusable Type

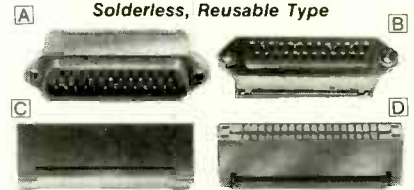

Fig.	Description	Cat. No.	Each
A	D-Sub Male for RS-232	276-1559	4.99
B	25-Pin D-Sub Female	276-1565	4.99
C	40-Position Card-Edge	276-1558	4.95
D	34-Position Card-Edge	276-1564	4.95

TV Horizontal Output Transistor



NEW!
795

25C1308. Top-quality NPN replaces ECG-238, GE-38, SK-3115 in many 19" color sets. With insulator, bushings. Why pay more? 276-2055 . . . 7.95



Joystick Pot

495

Includes Mounting Template

Great for video games, computers, radio control and more! Twin 100,000-ohm linear pots. 1"-long control. 271-1705 . . . 4.95

SPDT DIP Relay



299

Contacts Rated 1 Amp at 125VAC

5VDC, 56-Ohm Coil. Sensitive. Sub-mini size and ideal for PC board or DIP socket mounting. 3/8 x 5/8 x 7/16". 275-216 . . . 2.99

Photo Bargains!

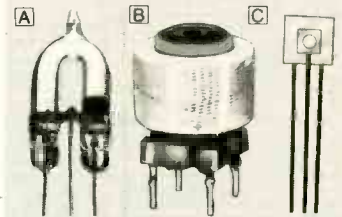

- A Xenon Strobe Flashtube.** Bright, long-life. Great for projects or replacement use. Trigger voltage: 4kV. Anode: 300V maximum. 200V min. With specs. 272-1145 . . . 2.99
- B 4kV Trigger Coil.** Use with flashtube (above). Requires 200-300VDC primary source. With wiring diagrams. 272-1146 . . . 1.49
- C LASCR Photo Detector.** Fast response makes it ideal for "slave" photoflash units. TO-92 case. 276-1095 . . . 1.99

Mercury Switch



89¢

This submini gravity-actuated switch is ideal for tamper alarms, position detecting and more. Rated 100 milliamps at 24VDC. 275-025 . . . 89¢

Micronta® Test Equipment Values



A 1995

B 3495

- A Digital Logic Probe.** Simplifies digital troubleshooting by indicating high, low or pulsed logic states with LEDs. Powered by circuit under test. 22-301 . . . 19.95
- B 27-Range VOM.** Measures AC/DC volts, ohms, DC milliamps, decibels. Big 4" mirrored scale. 30,000 ohms per volt DC sensitivity. With leads, manual. Requires "AA" and 9V batteries. 22-203 . . . 34.95

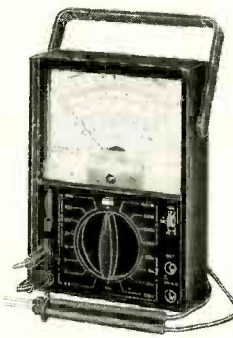

Micro Test Clips



149

Pkg. of 2

Insulated

Spring-action—ideal for testing on hi-density PC boards. 1 1/2" long. Solder type. One red, one black. 270-370 . . . Pkg. of 2/1.49

Binding Post Set



139

Pkg. of 2

Secure contact with push to release. Accept up to 14-gauge wire. Includes one red, one black. 274-660 . . . Pkg. of 2/1.39

IC Protector Mat



NEW!

Only **89¢**

5 x 5" conductive foam mat protects sensitive ICs from static charges. Pays for itself with the first chip it saves! 276-2400 . . . 89¢

'Phone Adapters



- A 1/4" Stereo Phone Jack to 1/8" Stereo Phone Plug.** Use standard stereo headphones with the new mini portables. 274-366 . . . 2.59
- B 1/8" Stereo Jack to 1/4" Stereo Plug.** Use "mini" headphones with std. jacks. 274-367 . . . 2.39

5-Volt Reed Relay

Only

99¢

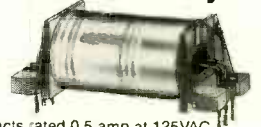

DPST contacts rated 0.5 amp at 125VAC. 5-volt, 180-ohm coil. PC board mountable. 275-228 . . . 99¢

DC Microammeter

Cut 33%

Reg. 8.95

595



0 to 50 Microamps DC. Precision jeweled movement and easy-to-read face. 270-1751 . . . Sale 5.95

Radio Shack®

A DIVISION OF TANDY CORPORATION • OVER 8200 LOCATIONS IN 76 COUNTRIES

Retail prices may vary at individual stores and dealers

CIRCLE 66 ON FREE INFORMATION CARD

CPU'S & SUPPORT CHIPS

Table listing various CPU and support chips with their part numbers and prices.

RAM's

Table listing RAM chips with their part numbers and prices.

ROM's

Table listing ROM chips with their part numbers and prices.

UART's

Table listing UART chips with their part numbers and prices.

INTERFACE & DRIVERS

Table listing interface and driver chips with their part numbers and prices.

Table listing 14 PIN HEADERS, 16 PIN HEADERS, and other connector components.

Table listing 50 PIN RIBBON CONNECTORS, 40 PIN RIBBON CABLE CONN, etc.

EPOXY GLASS VECTOR BOARD

Table listing epoxy glass vector board specifications and prices.

DATL'S DAC-08CQ

Table listing DATL's DAC-08CQ specifications and prices.

CRYSTALS

Table listing various crystal specifications and prices.

7 WATT LD 65 LASER DIODE

Table listing 7 WATT LD 65 LASER DIODE specifications and prices.

DISC CAPACITORS

Table listing disc capacitor specifications and prices.

TANTALUM CAPACITORS

Table listing tantalum capacitor specifications and prices.

SANKEN AUDIO POWER AMPS

Table listing SANKEN audio power amplifier specifications and prices.

RS232 CONNECTORS

Table listing RS232 connector specifications and prices.

POSTAGE RATES

Table listing postage rates for different order values.

C/MOS

Table listing C/MOS chips with their part numbers and prices.

SPECIALS

Table listing special offers on various components.

DOUBLE SIDED DIP RIBBON CABLE JUMPER ASSEMBLIES

Table listing double sided dip ribbon cable jumper assemblies.

RS 232 CABLE

Table listing RS 232 cable specifications and prices.

MINIATURE MULTI-TURN TRIMMING POTS

Table listing miniature multi-turn trimming pots.

DIP SWITCHES

Table listing dip switch specifications and prices.

TOGGLE SWITCHES

Table listing toggle switch specifications and prices.

SCR's

Table listing SCR specifications and prices.

TRIAC's

Table listing TRIAC specifications and prices.

SFC 3301 - 50 PRV 30A

Table listing SFC 3301 specifications and prices.

FAST RECOVERY DIODE (35ns)

Table listing fast recovery diode specifications and prices.

20KV 250MA DIODE

Table listing 20KV 250MA diode specifications and prices.

SILICON POWER RECTIFIERS

Table listing silicon power rectifier specifications and prices.

CLOCK CHIPS

Table listing clock chip specifications and prices.

.5V at 800ma SOLAR CELLS

Table listing .5V at 800ma solar cell specifications and prices.

7 SEGMENT DISPLAYS

Table listing 7 segment display specifications and prices.

TRANSISTOR SPECIALS

Table listing transistor special offers with their part numbers and prices.

TTL IC SERIES

Table listing TTL IC series with their part numbers and prices.

FULL WAVE BRIDGE

Table listing full wave bridge specifications and prices.

DIP SOCKETS

Table listing dip socket specifications and prices.

74LS SERIES

Table listing 74LS series chips with their part numbers and prices.

LINEAR CIRCUITS

Table listing linear circuit components with their part numbers and prices.

REGULATORS

Table listing regulator specifications and prices.

MICROWAVE KIT advertisement featuring a large price tag of \$89.95 and details about converting microwave ovens to VHF television.

MICROWAVE television "downconverters" under \$50.00. Highest quality, easily assembled. Catalogue: \$2.00 (refundable).

HOW to build data splitter, wye cable, line driver, ASCII character generator, and their power supplies.

SUBSCRIPTION Television Microwave Downconverters; UHF Sinewave Systems using Advanced Circuitry and Technology.

ELECTRONIC items and kits, for free catalog write: DAC INDUSTRIES, 6005 Musket Road, Fort Washington, PA 19034.

HUNDREDS of telephone, surveillance, transmitter, receiver, and other products, kits, and plans.

PRINTED circuit handbook, sixty pages. Nine dry methods. Send \$12.00 plus \$1.75 shipping.

SUBSCRIPTION television education manual. Complete theory and circuits \$9.95. Parts and kits available.

REPAIRS

ATARI games repaired within 48 hours. Mail in with your check for \$34.95. Return postage included.

FOR SALE

MICROWAVE receiver system. Write: "Dealers Wanted," Dept. RE, POB 4181, Scottsdale, AZ 85258.

SCANNER/monitor accessories—kits and factory assembled. Free catalog. CAPRI ELECTRONICS, Route 1R, Canon, GA 30520

POLICE/fire scanners, scanner crystals, antennas, radar detectors. HPR, Box 19224, Denver, CO 80219

TEST equipment, new and used. Catalog \$1.00. PTI, Box 8756, White Bear Lake, MN 55110.

THE Intelligence Library. Restricted technical secrets—books on electronic surveillance, lock-picking, demolitions, investigation, etc.

MICROWAVE 2 GHz. Best in the West! Downconverter kits \$39.00. Complete with antenna and control box \$99.00.

CHEMICALS, apparatus, project boxes, wide selection. Catalog \$1.00 send to: PIONEER LTD, IND, 14a Hughey St., Nashua, NH 03060

RESISTORS 1/4W, 1/2W 5% carbon films 3c ea. NO MINIMUMS. Cabinet assortments 1% metal films.

TTL

7400	2/.85	7490	.85
7402	2/.85	7493	.85
7404	2/.85	74100	2.25
7406	2/1.19	74109	2/1.19
7407	2/1.19	74121	.69
7408	2/.89	74123	.99
7410	2/.85	74150	1.95
7414	.99	74154	1.95
7417	2/1.10	74157	.99
7420	2/.85	74161	1.19
7447	1.19	74164	1.59
7474	.69	74174	1.59
7475	.79	74175	1.49
7476	.69	74192	1.19
7485	1.19	74193	1.19
7486	2/1.19	74367	.99
7489	2.99	74393	1.95

POTENTIOMETERS

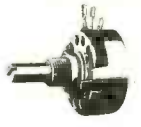

2 Watt @ 70°C
7/8" Slotted Shaft
Linear Taper
1K, 5K, 10K, 25K, 50K,
100K, 1 Meg
CMU\$2.95



3/4 Watt @ 70°C
15 Turn Pot.
Linear Taper
100 Ohm, 500 Ohm,
1K, 5K, 10K, 50K,
100K, 500K, 1M eg
830P\$1.79

DATA BOOKS

JPTTL	Jim-Pak 7400/74LS TTL	\$3.95
JPCML	Jim-Pak CMOS/Linear	4.49
JMPMP	Jim-Pak Micro./Display	3.95
30001	National CMOS	6.95
30003	National Linear	9.95
30005	National TTL Logic	9.95
30009	Intersil	7.95
10400	Intel Component	10.95

CMOS

4000	.55	4030	.75
4001	.55	4040	1.79
4002	.59	4044	1.39
4006	1.49	4046	1.95
4009	.79	4047	2.75
4010	.79	4049	.79
4011	.55	4050	.89
4013	.79	4051	1.59
4016	.79	4066	.95
4017	1.39	4069	.69
4018	1.39	4070	.75
4020	1.39	4071	.69
4023	.49	4081	.59
4024	1.19	4093	1.19
4027	.79	4511	1.95

CONNECTORS



DB25P	D-Subminiature Plug	3.95
DB25S	D-Subminiature Socket	4.95
DB51226	Cover for DB25P/S	2.25
22/44SE	P.C. Edge	2.95
UG88/U	BNC Plug	2.19
UG89/U	BNC Jack	3.95
UG175/U	UHF Adapter	.59
SO239	UHF Panel Recp.	1.49
PL258	UHF Adapter	1.95
PL259	UHF Plug	1.95
UG260/U	BNC Plug	2.39
UG1094/U	BNC Bulkhead Recp.	1.49

LINEAR

LM301N	.59	LM7805T	1.75
LM305H	1.39	LM7812T	1.75
LM307N	.75	LM7815T	1.75
LM308N	1.19	LM380N	1.49
LM309K	2.25	LM384N	2.49
LM310N	2.69	LM555N	.69
LM311N	1.49	LM556N	1.49
LM317T	2.29	LM565N	1.95
LM318N	2.95	LM566N	1.95
LM319N	2.95	LM567N	1.79
LM320K-5	2.25	LM723N	.79
LM7905T	1.75	LM741N	.65
LM7912T	1.75	LM1310N	2.95
LM7915T	1.75	LM1458N	.99
LM323K	5.95	LM1488N	1.59
LM324N	1.29	LM1489N	1.59
LM337T	2.29	LM1800N	4.49
LM339N	1.29	76477N	3.95

DIP JUMPERS AND CABLE ASSEMBLIES



DJ-14-1	14-Pin 1-Foot Single-End (Dip Jumper)	\$2.95
DJ-16-1	16-Pin 1-Foot Single-End (Dip Jumper)	3.25
DJ-24-1	24-Pin 1-Foot Single-End (Dip Jumper)	3.95
DJ-40-1	40-Pin 1-Foot Single-End (Dip Jumper)	7.95
DJ-14-1-14	14-Pin 1-Foot Double-End (Dip Jumper)	4.25
DJ-16-1-16	16-Pin 1-Foot Double-End (Dip Jumper)	4.95
DJ-24-1-24	24-Pin 1-Foot Double-End (Dip Jumper)	5.95
DJ-40-1-40	40-Pin 1-Foot Double-End (Dip Jumper)	11.95
DJ-14-3-14	14-Pin 3-Foot Double-End (Dip Jumper)	5.49
DJ-16-3-16	16-Pin 3-Foot Double-End (Dip Jumper)	5.95
DB25P-4-P	DB25P - 4 Foot - DB25P (Cable Assembly)	16.95
DB25P-4-S	DB25P - 4 Foot - DB25S (Cable Assembly)	17.95
DB25S-4-S	DB25S - 4 Foot - DB25S (Cable Assembly)	18.95

NEW! JE215 Adjustable Dual Power Supply

General Description: The JE215 is a Dual Power Supply with independent adjustable positive and negative output voltages. A separate adjustment for each of the supplies provides the user unlimited applications for IC current voltage requirements. The supply can also be used as a general all-purpose variable power supply.

FEATURES:

- Adjustable regulated power supplies, pos. and neg. 1.2VDC to 15VDC.
- Power Output (each supply): 5VDC @ 500mA, 10VDC @ 750mA, 12VDC @ 500mA, and 15VDC @ 175mA.
- Two, 3-terminal adj. IC regulators with thermal overload protection.
- Heat sink regulator cooling
- LED "on" indicator
- Printed Board Construction
- 120VAC input
- Size: 3-1/2" w x 5-1/16" L x 2" H



JE215 Adj. Dual Power Supply Kit (as shown) . . \$24.95

JIM-PAK KITS



JE730



JE701

JE200	5V 1 Amp Regulated Power Supply Kit	\$14.95
JE205	Multi-Voltage Board Kit (Adapts to JE200)	12.95
JE210	5-15V / .5-1.5 Amp Regulated Power Supply Kit	19.95
JE212	Neg. 12VDC Adapter Board Kit (for JE610)	9.95
JE215	Adjustable Power Supply Kit (Pictured above center)	24.95
JE300	Digital Thermometer Kit	39.95
JE305	Solar Cell Panel Kit	39.95
JE600	Hexadecimal Encoder Kit	59.95
JE610	ASCII Encoded Keyboard Kit	79.95
JE701	6-Digit (.300") Clock Kit (Pictured above right)	19.95
JE730	4-Digit (.357") Clock Kit (Pictured above left)	14.95
JE747	6-Digit (.630") Clock Kit	29.95
JE2206B	Function Generator Kit (Pictured below right)	19.95

GRAB BAGS

GB100	Ceramic Disc. Capacitors	(100)	\$2.95
GB101	Mylar Capacitors	(60)	4.95
GB102	Electrolytic Capacitors	(60)	4.95
GB103	Tantalum Capacitors	(40)	4.95
GB107	Silicon Diodes (1N914/1N4148)	(100)	2.95
GB108	TTL Series Integrated Circuits	(50)	4.95
GB109	Linear Integrated Circuits	(30)	4.95
GB110	Assorted LEDs	(100)	5.95
GB113	Miniature Trimmer Pots.	(30)	4.95
GB116	1/4 Watt Resistor Assortment	(200)	2.95
GB117	1/2 Watt Resistor Assortment	(200)	2.95
GB120	Miniature Slide Switches	(25)	3.95
GB123	Heat Sinks Assortment	(30)	3.95
GB127	Transistors Plastic/Power	(100)	3.95
GB137	Chokes, Coils and Inductors	(50)	3.95
GB139	3-8 Terminal Solder/Screw Type	(40)	3.95
GB140	Spacers, Standoffs, Insulators	(150)	2.95
GB141	Washers and Spacers	(200)	2.95
GB145	Lugs, Crimp On	(100)	2.95
GB147	Hardware Mix - Nuts, Screws, etc.	(500)	5.95
GB154	1 & 2 Watt Resistor Assortment	(100)	2.95
GB162	7-Segment Displays	(50)	6.95
GB165	Toggle, Rocker, Push Button Switches	(40)	10.95
GB173	U Test & Sort 3/8" Potentiometers	(100)	5.95
GB175	1 & 3 Amp Silicon Rectifiers (Diodes)	(100)	3.95
GB177	Shrink Tubing - Assorted 1" pieces	(200)	3.95

LS Schottky

74LS00	.55	74LS109	.75
74LS02	.55	74LS123	1.49
74LS04	.69	74LS138	1.29
74LS08	.55	74LS139	1.29
74LS10	.55	74LS154	1.95
74LS14	1.09	74LS157	1.19
74LS30	.55	74LS161	1.29
74LS32	.69	74LS174	1.19
74LS38	.69	74LS175	1.19
74LS42	1.29	74LS192	1.49
74LS47	1.29	74LS193	1.49
74LS48	1.79	74LS221	1.49
74LS73	.75	74LS244	1.89
74LS74	.69	74LS245	3.49
74LS75	.75	74LS367	.89
74LS85	1.49	74LS374	1.95
74LS90	.89	81LS97	2.29

SOCKETS

Low Profile		Wire Wrap	
8 pin LP	2/.59	14 pin WW tin	.75
14 pin LP	2/.69	14 pin WW gold	1.09
16 pin LP	2/.79	16 pin WW tin	.79
18 pin LP	2/.89	16 pin WW gold	1.19
20 pin LP	2/.99	24 pin WW gold	1.69
22 pin LP	2/1.09	40 pin WW gold	2.75
24 pin LP	.79	14 p. plug/cover	1.29
28 pin LP	.82	16 p. plug/cover	1.39
36 pin LP	.99	24 p. plug/cover	1.95
40 pin LP	1.19	Also, The Molex Line	

DIODES & TRANSISTORS

IN751	2/.59	2N2219A	2/1.19
IN757	2/.59	2N2222A	2/.89
IN1188	2.69	2N2907A	2/.89
IN3600	5/.99	2N3055	.99
IN4001	4/.59	2N3772	2.25
IN4004	4/.69	2N3904	2/.69
IN4007	4/.79	2N3906	2/.69
IN4148	10/.99	2N4401	2/.79
IN4733	2/.69	2N4403	2/.79
IN4734	2/.69	2N5129	2/.69
IN4735	2/.69	2N5139	2/.69
IN5401	3/1.19	TIP29A	.89
IN5408	3/1.99	TIP31A	.99

CAPACITORS

Dipped Tantalum		ELECTROLYTIC	
.1mf @ 35V	2/.89	1mf @ 50V	3/.65
.47mf @ 35V	2/.89	4.7mf @ 50V	2/.59
1mf @ 35V	2/.89	10mf @ 50V	2/.69
2.2mf @ 25V	2/1.09	22mf @ 50V	2/.79
3.3mf @ 25V	2/1.19	47mf @ 50V	2/.89
4.7mf @ 25V	2/1.39	100mf @ 50V	.59
10mf @ 25V	1.19	220mf @ 50V	.69
33mf @ 25V	3.95	1000mf @ 25V	1.19
		2200mf @ 16V	1.39
100V MYLAR		50V CERAMIC	
.001-.01mf	4/.79	10pf-.02mf	4/.59
.02mf	4/.89	.047mf	4/.69
.047mf	4/.99	.1mf	4/.79
.1mf	4/1.19		
.22mf	4/1.29		

MICROPROCESSORS

Z80A	CPU (4MHz)	13.95
1173AN-1	30 Tune Musical MPU Chip	8.95
8080A	CPU	6.95
8216	8 Bit I/O Port	3.95
8218	Bi-Directional Bus Driver	4.49
2513/2140	Character Generator	12.95
8T97	Tri-State Hex Buffer	2.25
AY-5-1013	30K Baud UART	6.95
AY-5-2376	88-Key Keyboard Encoder	11.95
2114-2	4K Static RAM (200ns)	3.95
MK4116	16K Dynamic RAM (250ns)	3.95
2708	8K EPROM	5.95
2716	16K EPROM (+5V)	9.95

Function Generator Kit

Provides 3 basic waveforms: sine, triangle and square wave. Freq. range from 1 Hz to 100K Hz. Output amplitude from 0 volts to over 6 volts (peak to peak). Uses a 12V supply or a ±6V split supply. Includes chip, P.C. Board, components & instructions.



JE2206B . . . \$19.95

SUBSCRIPTION TV KITS

UHF Gated Pulse Kit...\$39.00
UHF Sinewave Kit...\$37.00

Kits include parts, manual and etched pc board.

Informative Catalog...\$2.00

J & W ELECTRONICS
P. O. BOX 61-B
CUMBERLAND, RI. 02864



WRITE FOR MCGEE'S SPEAKER & ELECTRONICS CATALOG

1001 BARGAINS IN SPEAKERS

Tel.: 1 (816) 842 5092

1901 MCGEE STREET KANSAS CITY, MO. 64108

REVERBERATION for organs and keyboards — Simply connected to any electronic organ, even those with multiple outlet channels. Room size and reverberation time adjustable. Nothing comparable in this price range is offered on the market. Send for free brochure. **DEVTRONIX ORGANS, INC.**, Dept. 60, 6101 Warehouse Way, Sacramento, CA 95826

SATELLITE Buffs: used 6, 10, and 16 ft. parabolic antennas for sale. Muchmisc. Call days: (216) 871-5552; evenings (216) 779-8539.

MICROWAVE and other TV equipment. Catalog 20c, manual \$1. **TROJAN ENTERPRISES**, 2920 Shelby, Indianapolis, IN 46203

SUPER SALE

EPROM

	1-7	8 up	50 up
2716	4.15	3.90	CALL
2732	9.70	8.85	CALL

16K RAM EXPANSION KIT

For TRS-80 Model III
Set of 8 pieces UPD416-2 (200nS)

Data furnished with purchase on request. **\$13.95**

WRITE FOR FREE CATALOG



SUNTRONICS CO., INC.

12621 CRENSHAW BOULEVARD
HAWTHORNE, CALIFORNIA 90250

(LOCATED NEXT TO FORMULA INTERNATIONAL)

STORE HOURS: Mon-Fri, 10am to 8:30pm — Sat 10am to 5pm

IN CALIFORNIA OUTSIDE CALIFORNIA TOLL FREE

(213) 644-1149 1-800-421-5775

Mail Order—Minimum Order: \$10. Send Money Order or Check to: P.O. BOX 1957—Dept. R, HAWTHORNE, CA 90250. Use your VISA or Mastercard (please include expiration date). Add \$2.00 postage and handling to order. California residents add 6% sales tax.

Govt. SURPLUS ELECTRONIC EQUIPMENT CATALOG

New ITEMS . . . New BARGAINS!

FREE UPON REQUEST!

Send today for FREE copy of
NEW CATALOG WS-82 Address: Dept. RE

FAIR RADIO SALES

1016 E. EUREKA - Box 1105 - LIMA, OHIO - 45802

LONG-PLAY cassette recorder, 1 1/2 pounds, with two slow speeds for recording up to 15 hours on a single standard C-180 tape! Unbelievable sensitivity and voice fidelity. Takes telephone recording and voice activator accessories. Perfect for professionals, students, security personnel. Excellent for radio and TV, security monitoring, home surveillance, lectures. Free brochure. **EXTENDO-TAPE SYSTEMS**, Box 16000LC, Temple Terrace, FL 33687

ADVANCED technological devices. Computer to human brain interfaces, talking watches, satellite home earth stations, lasers and many more amazing products. Send \$2.00 for catalog to: **TECHNORONICS**, PO Box 2643, Winter Park, FL 32790

CAR stereo graphic equalizer amplifier. 110 watt, 7-band equalizer, with LED power meters. Factory fresh and pretested, \$45.00. Free acknowledgment of delivery. Send money order to **J. COOK**, 1381 North Sereno Circle, Bountiful, UT 84010. Plus \$2.70 shipping.

BOB'S TV does it again! Six hour VHS taps only \$130 for a box of ten. **BOB'S TV**, 93-15 86 Drive, Woodhaven, NY 11421

TERMINALS

★ ADDS ★
VIEWPOINT
\$579.00

SOROC
IQ 120
\$689.00

82 I.C. MASTER
\$59.85

CARDS
MICROSOFT
Z80 \$295.00
16K RAM \$160.00
VIDEO X
VIDEOTERM 80 columns \$295.00

COMPUTERS

ATARI® 800™
COMPUTER SYSTEM

400w/16K \$350.00
800w/16K \$699.00
★ 800 Computer w/48K
★ BEST BUY \$825.00

ATARI PERIPHERALS:
Printer 825- 650.00 Asteroids
Disk Dr. 810- 485.00 Missile Com. 32.50
Record 410- 820.00 Sup. Brk. Out
Paddle (pr.) > 16.95 Assm. Edit- 49.00
Joystick (pr.) Star Raiders- 45.00
32k RAM- 179.95 Basketball- 28.00
Basic Cart- 49.00 Chess- 32.00

COMPONENTS 74 S00

SN7400N 18	SN7482M 30	74S00 39	74S138 7.00
SN7402N 21	SN7482N 49	74S02 45	74S140 1.00
SN7404N 22	SN7483N 45	74S04 38	74S158 7.75
SN7408N 22	SN7485N 50	74S08 69	74S174 1.35
SN7410N 18	SN7486N 60	74S10 39	74S182 7.75
SN7412N 20	SN74122N 39	74S15 45	74S189 4.25
SN7413N 22	SN74130N 95	74S20 55	74S201 5.75
SN7414N 29	SN74141N 65	74S22 55	74S240 2.75
SN7416N 27	SN74151N 65	74S30 75	74S244 2.95
SN7417N 29	SN74153N 55	74S37 55	74S251 2.75
SN7420N 17	SN74154N 125	74S50 65	74S287 2.95
SN7425N 20	SN74155N 75	74S51 49	74S288 2.95
SN7430N 17	SN74157N 58	74S64 55	74S299 5.75
SN7437N 26	SN74160N 89	74S74 65	74S470 9.25
SN7438N 24	SN74161N 65	74S95 95	74S471 9.50
SN7440N 16	SN74163N 85	74S12 1.95	74S473 9.50
SN7442N 45	SN74164I 87	74S132 1.45	74S474 9.50
SN7443N 42	SN74165N 55		
SN7445N 64	SN74174N 88		
SN7451N 19	SN74175N 79		
SN7454N 19	SN74180N 75		
SN7474N 27	SN74181N 1.15		
SN7475N 35	SN74393N 1.65		

2708 3.25ea 8 for 2.95ea
5.50ea 8 for 5.00ea
2732 12.95ea 4 for 11.00ea
4116 200ns. 8/
\$1.85ea \$14.00

214L 300NS 2.25ea 4 for 1.90ea
200NS 2.45ea 4 for 2.00ea
2111 450NS 2.50ea 10 for 2.00ea

74LS00

74LS00 28	74LS158 60	2102 85	5408NS 95
74LS02 28	74LS181 28	8038 2.95	1103A .75
74LS03 28	74LS182 80	ME565 2.26	UPD765 10.65
74LS04 28	74LS183 98	95-1013A 4.25	floppy disk w. tape
74LS06 22	74LS184 85	1488 95	ULN2001 1.95
74LS08 28	74LS185 85	1489 95	TM89-400 1.40
74LS09 28	74LS189 1.55	1672 1.30	MC4008P 1.50
74LS10 26	74LS170 1.75	8728 1.30	MM4026 1.55
74LS14 90	74LS174 85	8729 1.30	MM4028 1.95
74LS16 22	74LS175 85	7805 45	85 1.95
74LS21 26	74LS190 85	7908 85	
74LS26 40	74LS191 1.25	7915 85	
74LS27 27	74LS195 95	7916 85	
74LS28 37	74LS197 78	7905 85	
74LS30 29	74LS221 1.25	1489 95	
74LS32 31	74LS240 1.65	8728 1.30	
74LS38 31	74LS241 1.65	8729 1.30	
74LS42 63	74LS243 1.55	8212 1.06	
74LS48 77	74LS244 1.55	8216 1.95	
74LS74 38	74LS245 2.45	IS410SCR 85	
74LS75 55	74LS251 1.25	IT410TRIAC 85	
74LS86 45	74LS253 85	7908 85	
74LS90 59	74LS257 85	7908 85	
74LS93 65	74LS259 1.95	7915 85	
74LS98 90	74LS290 55	7916 85	
74LS107 43	74LS273 1.55	7905 85	
74LS113 45	74LS279 45	7908 85	
74LS122 45	74LS290 1.25	7908 85	
74LS123 90	74LS293 1.65	7912 85	
74LS125 99	74LS305 85	MC1330AIP 1.60	
74LS128 79	74LS367 75	MC1350P 1.15	
74LS138 64	74LS373 1.45	MC1388P 1.50	
74LS139 59	74LS378 1.45	LM390 1.10	
74LS151 49	74LS379 1.25	LM655N 95	
74LS153 49	74LS669 1.55	LM741 25	
74LS157 60	74LS670 1.85	MC1458P 55	

2-80 CPU's 7.95
2-80A CTC 10.50
2-80A CPU 10.50
2-80 002 16-64K 120.00
8086A 13.50
2901A 7.50
MC8800 9.50

DISKETTE «SALE»

Wabash:
5 1/4 → 10/
8inch → \$24.90
SS/SD: More Avail.
QTY. PRICE AVAIL

REAL-TIME CLOCK CALENDAR (MSM 5832)

Description: Mono Metal Gate CMOS I.C.
Features:
Time, Month, Date, Year, & Day of Week
Bus Oriented
4 Bit Data Bus
4 Bit Address
R/W Hold Select.
Inter. Signal
32.768KHz xtal Control
5v Pow Sup
Low Power Dissipation

XTAL \$7.45
I/PTC \$2.85

SPECIALS

ZENITH ZVM-121
12 inch 15 MHz
\$118.50
8255 → \$5.95
8748-B → \$31.00
3341PC → \$2.00
MMS060 → 35c
MC6800 → \$7.75
MC6802 → \$14.95
MC6850 → \$4.50
MC6821 → \$4.95

GLOBAL LPK-1:

Logic Probe Kit - complete nothing extra to buy. Min. pulse width 300nsec.
\$18.95

THE MPD 117

turns an ordinary outlet into a controlled power source
\$79.50

*** MONITORS ***

ZENITH 1 12in. 15MHz. 1. Green Phos. Hi-Res. → \$118.50 ☆
J.C.S. 2 12in. 18MHz. 2. Green Phos. Hi-Res. → \$169.50 ☆
AMDEK 3 12in. 12MHz. 3. Green Phos. Hi-Res. → \$155.50 ☆
13in Color 3a 3a. Lo-Res. → \$375.50 ☆

CONCORD COMPUTER PRODUCTS

1971 SO. STATE COLLEGE ANAHEIM, CALIF. 92806
(714) 937-0637
CHECK - M/O NO COD
\$10 MIN ORDER, CA RES ADD 6% FRT
10 20 50 100 200 800 1000 UP CALL

send \$1.00 for catalog

Bare Bones APPLE II

W/O Keyboard \$450
W/O Pwr. Supply

RADIO-ELECTRONICS

ramsey

the first name in Counters!



9 DIGITS 600 MHz \$129⁹⁵ WIRED

PRICES:

CT-90 wired, 1 year warranty	\$129.95
CT-90 Kit, 90 day parts warranty	109.95
AC-1 AC adapter	3.95
BP-1 Nicad pack + AC Adapter/Charger	12.95
OV-1, Micro-power Oven time base	49.95
External time base input	14.95

The CT-90 is the most versatile, feature packed counter available for less than \$300.00! Advanced design features include; three selectable gate times, nine digits, gate indicator and a unique display hold function which holds the displayed count after the input signal is removed! Also, a 10MHz TCXO time base is used which enables easy zero beat calibration checks against WWV. Optionally, an internal nicad battery pack, external time base input and Micro-power high stability crystal oven time base are available. The CT-90, performance you can count on!

SPECIFICATIONS:

Range:	20 Hz to 600 MHz
Sensitivity:	Less than 10 MV to 150 MHz Less than 50 MV to 500 MHz
Resolution:	0.1 Hz (10 MHz range) 1.0 Hz (60 MHz range) 10.0 Hz (600 MHz range)
Display:	9 digits 0.4" LED
Time base:	Standard-10.000 MHz, 1.0 ppm 20-40°C Optional Micro-power oven-0.1 ppm 20-40°C
Power:	8-15 VAC @ 250 ma

7 DIGITS 525 MHz \$99⁹⁵ WIRED



SPECIFICATIONS:

Range:	20 Hz to 525 MHz
Sensitivity:	Less than 50 MV to 150 MHz Less than 150 MV to 500 MHz
Resolution:	1.0 Hz (5 MHz range) 10.0 Hz (50 MHz range) 100.0 Hz (500 MHz range)
Display:	7 digits 0.4" LED
Time base:	1.0 ppm TCXO 20-40°C
Power:	12 VAC @ 250 ma

The CT-70 breaks the price barrier on lab quality frequency counters. Deluxe features such as; three frequency ranges - each with pre-amplification, dual selectable gate times, and gate activity indication make measurements a snap. The wide frequency range enables you to accurately measure signals from audio thru UHF with 1.0 ppm accuracy - that's .0001%! The CT-70 is the answer to all your measurement needs, in the field, lab or ham shack.

PRICES:

CT-70 wired, 1 year warranty	\$99.95
CT-70 Kit, 90 day parts warranty	84.95
AC-1 AC adapter	3.95
BP-1 Nicad pack + AC adapter/charger	12.95

7 DIGITS 500 MHz \$79⁹⁵ WIRED



PRICES:

MINI-100 wired, 1 year warranty	\$79.95
AC-Z Ac adapter for MINI-100	3.95
BP-Z Nicad pack and AC adapter/charger	12.95

Here's a handy, general purpose counter that provides most counter functions at an unbelievable price. The MINI-100 doesn't have the full frequency range or input impedance qualities found in higher price units, but for basic RF signal measurements, it can't be beat! Accurate measurements can be made from 1 MHz all the way up to 500 MHz with excellent sensitivity throughout the range, and the two gate times let you select the resolution desired. Add the nicad pack option and the MINI-100 makes an ideal addition to your tool box for "in-the-field" frequency checks and repairs.

SPECIFICATIONS:

Range:	1 MHz to 500 MHz
Sensitivity:	Less than 25 MV
Resolution:	100 Hz (slow gate) 1.0 KHz (fast gate)
Display:	7 digits, 0.4" LED
Time base:	2.0 ppm 20-40°C
Power:	5 VDC @ 200 ma

8 DIGITS 600 MHz \$159⁹⁵ WIRED



SPECIFICATIONS:

Range:	20 Hz to 600 MHz
Sensitivity:	Less than 25 mv to 150 MHz Less than 150 mv to 600 MHz
Resolution:	1.0 Hz (60 MHz range) 10.0 Hz (600 MHz range)
Display:	8 digits 0.4" LED
Time base:	2.0 ppm 20-40°C
Power:	110 VAC or 12 VDC

The CT-50 is a versatile lab bench counter that will measure up to 600 MHz with 8 digit precision. And, one of its best features is the Receive Frequency Adapter, which turns the CT-50 into a digital readout for any receiver. The adapter is easily programmed for any receiver and a simple connection to the receiver's VFO is all that is required for use. Adding the receiver adapter in no way limits the operation of the CT-50, the adapter can be conveniently switched on or off. The CT-50, a counter that can work double-duty!

PRICES:

CT-50 wired, 1 year warranty	\$159.95
CT-50 Kit, 90 day parts warranty	119.95
RA-1, receiver adapter kit	14.95
RA-1 wired and pre-programmed (send copy of receiver schematic)	29.95

**NEW
READ
RECEIVER
FREQUENCY**



DIGITAL MULTIMETER \$99⁹⁵ WIRED

PRICES:

DM-700 wired, 1 year warranty	\$99.95
DM-700 Kit, 90 day parts warranty	79.95
AC-1, AC adaptor	3.95
BP-3, Nicad pack + AC adapter/charger	19.95
MP-1, Probe kit	2.95

The DM-700 offers professional quality performance at a hobbyist price. Features include; 26 different ranges and 5 functions, all arranged in a convenient, easy to use format. Measurements are displayed on a large 3 1/2 digit, 1/2 inch LED readout with automatic decimal placement, automatic polarity, overrange indication and overload protection up to 1250 volts on all ranges, making it virtually goof-proof! The DM-700 looks great, a handsome, jet black, rugged ABS case with convenient retractable tilt bail makes it an ideal addition to any shop.

SPECIFICATIONS:

DC/AC volts:	100uV to 1 KV, 5 ranges
DC/AC current:	0.1 uA to 2.0 Amps, 5 ranges
Resistance:	0.1 ohms to 20 Megohms, 6 ranges
Input impedance:	10 Megohms, DC/AC volts
Accuracy:	0.1% basic DC volts
Power:	4 'C' cells

AUDIO SCALER

For high resolution audio measurements, multiplies UP in frequency.

- Great for PL tones
- Multiplies by 10 or 100
- 0.01 Hz resolution!

\$29.95 Kit \$39.95 Wired

ACCESSORIES

Telescopic whip antenna - BNC plug	\$ 7.95
High impedance probe, light loading	15.95
Low pass probe, for audio measurements	15.95
Direct probe, general purpose usage	12.95
Tilt bail, for CT 70, 90, MINI-100	3.95
Color burst calibration unit, calibrates counter against color TV signal	14.95

COUNTER PREAMP

For measuring extremely weak signals from 10 to 1,000 MHz. Small size, powered by plug transformer-included.

- Flat 25 db gain
- BNC Connectors
- Great for sniffing RF with pick-up loop

\$34.95 Kit \$44.95 Wired

ramsey electronics, inc.

2575 BAIRD RD. • PENFIELD, NY 14526



PHONE ORDERS
CALL 716-586-3950

TERMS

Satisfaction guaranteed - examine for 10 days, if not pleased, return in original form for refund. Add 5% for shipping insurance to a maximum of \$10. Overseas add 15%. COD, add \$2. Orders under \$10 add \$1.50. NY residents add 7% tax.

CIRCLE 69 ON FREE INFORMATION CARD

FUJITECH AUDIO KITS

LATEST AUDIO TECHNOLOGY FROM JAPAN

Model A1033 Integrated Tube Amplifier

- Latest Japanese Design
- Distortionless Output Transformer using special winding techniques
- Most circuitry on PCB for easy assembly and humfree performance
- Output 30W x 2 Ultra Linear (Switchable to Triode) 15W x 2 Triode Output (near class A performance)
- THD under 0.4%
- Frequency Response 30~30,000 Hz (-1dB)
- Separate Pre-Out and Main-In

KIT ONLY
\$499.00

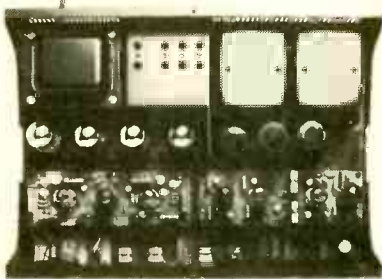

\$499.00

Send \$5.00 for each assembly manual, refundable with order.

Monarchy Engineering, Inc.
380 Swift Avenue, Unit 21
South San Francisco, CA 94080

Visa or Mastercharge acceptable.

Model A501 Power Amp

- Pure Class A 25W + 25W
- Switchable to Class AB 100W + 100W
- Switchable to Bridge Class A 100W mono
- Switchable to Bridge Class AB 300W mono
- Frequency Response 5-200KHz (-1dB)
- Signal-to-Noise Ratio 120dB
- Non-magnetic Chassis
- "Out-board" comprehensive protection circuitry
- DC circuitry with limited use of NFB
- High Efficiency Fluid Convection Cooling
- THD under 0.007%

KIT ONLY
\$299.00

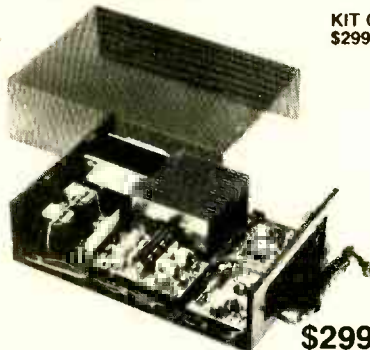

\$299.00

Model A502 DC Stereo Control Center

- Direct DC coupling from Input to Output
- DC servo circuitry
- Cascade FET Input in all stages
- Separate Moving Coil RIAA amplifier
- Distortion below 0.005% (3V)
- Max Output 15V
- Frequency Response 20Hz-20KHz ±0.2 dB
- Maximum Phono Input
MC = 16mv RMS (1KHz)
MM = 270mv RMS (1KHz)
- Built-in Headphone amplifier
- Relay Output Muting

KIT ONLY
\$349.00



\$349.00

BULLET ELECTRONICS

P.O. BOX 401244R
GARLAND, TX. 75040
(214) 278-3553

Sound Effects Kit \$18.50



The SE-01 is a complete kit that contains all the parts to build a programmable sound effects generator. Designed around the new Texas Instruments SN76477 Sound Chip, the board provides banks of MMU DIP switches and pots to program the various combinations of the SFG Oscillator, VCO, Noise, One Shot and Envelope Controls. A Quad Op Amp IC is used to implement an Adjustable Pulse Generator, Level Comparator and Multiple Oscillator for even more versatility. The 3" x 5" PCB board features a prototype area to allow for user added circuitry. Easily programmed to duplicate Explosions, Phasor Guns, Steam Trains, or almost an infinite number of other sounds. The unit has a multiple of applications. The low price includes all parts,

assembly manual, programming charts, and detailed 76477 chip specifications. It runs on a 9V battery (not included). On board 100mA amp will drive a small speaker directly or the unit can be connected to your stereo with incredible results! (Speaker not included). 76477 is included. Available separately for \$3.15 each.

7 Watt Audio Amp Kit \$6.95

SMALL, SINGLE HYBRID IC AND COMPONENTS FIT ON A 2" x 3" PCB BOARD (INCLUDED). RUNS ON 12VDC. GREAT FOR ANY PROJECT THAT NEEDS AN INEXPENSIVE AMP, LESS THAN 3% THD @ 5 WATTS. COMPATIBLE WITH SE-01 SOUND KIT.

Doomsday Alarm Kit \$9.95

If you have trouble sleeping and you would like the rest of the neighborhood to share your misery then this little kit will be for you! There is no way to accurately describe the unearthly howls, screams and tones that come out of this kit. Four separate tone oscillators are mixed, cancelled and stepped at a varying rate. 10 Watts of crazy sounds. A great fun kit or a practical burglar alarm. Complete with PCB board and all necessary components less speaker. For 6-12 VDC. ORDER DA-02.

New! 3TZ Time Zone Clock Kit

Microprocessor/ROM clock kit keeps local time (12 hour format), and 2 world time zones (24 hour format). Large 6" ORANGE readouts 10 min. ID timer for HAMS. Comes complete with attractive plastic case and wallplug XFMR.

- 6 Digit (hrs., min., sec.)
- 3 Time Zones (Selectable)
- Feather-tough front panel switches
- Quartz XTAL Timebase
- Battery backup
- Quality solder masked and plated PCB boards
- Seconds Reset/Hold feature

\$54.40

SEE SPECIAL WINTER PRICES BELOW

The Super Music Maker

REVISION 2
\$24.95

(Basic Kit)

Does not include speaker switches or 2708 ROM

Now you can play hundreds of songs using the Bullet Super Music Maker. The unit features a single factory programmed microprocessor IC that comes with 20 pre-programmed short tunes. By adding the additional PROMS (2708's) the system can be expanded to play up to 1000 notes per PROM. Just think—a compact electronic instrument that will play dozens, hundreds or even thousands of selections of music. The kit comes with all electronic components (less the PROM), and a drilled, plated and screened PCB board which measures 4" x 4". The 7 watt amplifier section is on the same PCB board and drives an 8 ohm speaker (not included), from a whisper to ear splitting volume. Since the unit works on 12 VDC or 12 VAC, vehicle or portable operation is possible. What do you get for \$24.95? Everything but a speaker, transformer, case, switches, and PROM. Additional 2708 albums containing popular tunes are available for \$9.95 each or you can program your own PROMS using information provided with the kit instructions. Lists of available PROM albums are available on request. (Note: Unit plays electronic music one note at a time. It is not possible to play chords or a melody with harmony simultaneously.)

- Envelope control gives decay to notes.
- On board inverter allows single voltage (+12) operation.
- ADD 9% FOR SHIPPING AND ACCESSORIES
- DIP Switches (One 8 pos., One 5 pos.) 2.00/set (Can be directly soldered to PCB. to access tunes)
- Rotary Switches Two 5 position 2.50/set (For remote wiring to PCB. to access tunes)
- Attractive Tan Plastic Case 6.50
- Wallplug Transformer (For operation on 117VAC house voltage) 3.00

SPECIAL WINTER PRICES

1. Super Music Maker with case and two 5-position rotary switches \$32.00
2. Super Music with one 2716 2K x 8 PROM filled with over 50 selections of additional music (1500 notes) \$32.00
3. The Whole Ball of Wax #2 - case and switches. \$39.95

ORDERING INFORMATION: Call or Write For Free Catalog

- COD MINIMUM \$20.00 • ADD \$2.50 FOR COD'S
- UPS DELIVERY ADDRESS MUST ACCOMPANY ALL COD ORDERS
- \$1.00 HANDLING ON ORDERS UNDER \$10.00
- VISA, MC CARDS OR CHECK
- ADD 9% FOR SHIPPING
- TEXAS RESIDENTS ADD 5% STATE SALES TAX
- ALL FOREIGN ORDERS ADD 25% FOR SHIPPING (CANADA 15% NO FOREIGN COD'S)
- CALL (214) 278-3553 TO PLACE CREDIT CARD OR COD ORDER

- A FEW THINGS ON THE SIDE**
- CA3080 TRANS COND AMP .88
 - TLO-82 DUAL BI-FET AMP .88
 - GD4586 CMOS - 50/60 CNTR .88
 - MC3301 QUAD OP AMP (HSE #) .44
 - FPT500 PHOTO TRANSISTOR .44
 - TIP 100 NPN DARL 2A IC .88
 - DUAL PHOTO RESISTOR 3/8" DIA. 3/4, 88
 - 2" 8 OHM SPKR. 25 W 2/1, 88
 - AT 3-8910 SOUND EFFECTS 11, 88
 - 60 PAGE MANUAL FOR ABOVE 20/1, 88
 - JUMBO RED LED ASST. STYLES 20/1, 88
 - 10103 SENSITIVE GATE SCR 3/1, 88

SUPER SPECIAL DEAL!
STANDARD C-90 CASSETTE, NEW, IN PLASTIC CASES, TOP QUALITY ORIG. USED IN DIGITAL APP. FREQ RESPONSE 300HZ - 10KHZ
1.30 ea. 3/3, 50

SAVE up to 50% on name brand test equipment. Free catalog and price list. SALEN ELECTRONICS, Box 82-G, Skokie, IL 60077

TELEVISION cable converters—video accessories, discount electronic products and parts. \$1.00. ELECTRONICS ETCETERA, P.O. Box 826, Solvang, CA 93463

POWER supply -12v @ 1 amp +12v @ 2 amps +5v @ 1.5 amps +24v @ 3 amps. All used. Used 16 x 7 x 5 1/2 encased, molded plug. \$21.95 ppd. Perfect for disc drives. F. G. STEVPENS CO., P.O. Box 781, Norwalk, CT 06856

TEKTRONIX 585, three plug-ins, cart. 105 generator. \$695.00 lot. (813) 494-3118, P.O.B. 1823, Arcadia, FL 33821

BOOTLEGGERS Bible for CB modifications \$12.95. CB Radio Repair Manual, \$8.95. Linear Planbook \$11.95. Also kits, complete units, and more! Catalog \$1.00 at: A.P. SYSTEMS, POB 263 RE, Newport, RI 02840

SYNTHESIZER module. PLL, 100 continuous direct binary coded channels at 100 KHz steps. 38 MHz out; with schematic, specs, application notes. Send \$9.98 ppus to PRESTON, 7 Doris Place, East Islip, NY 11730

SPEAKERS by Electro-Voice and others. Build your own speaker system and save. Also microphones, mixers, amps, etc. Free list. SONIX CO., Box 58-RE, Indian Head, MD 20640. Phone (301) 753-6432.

ENJOY commercial free television. Experimental frequency control module is the finest available today. Sine wave or gated pulse in kit or factory built. Information package \$2.00, refundable on first order. LEE-TRONICS, P.O. Box 253, Taylor, MI 48180

ATARI, Commodore computers, accessories, software, lowest prices, information \$1.00. (714) 783-0556. SPORT 'N' SOUND, 21999 Van Buren, Grand Terrace, CA 92324

UHF sinewave converters: complete kits \$175.00, etched/drilled PCB \$25.00. UHF varactor tuner \$40.00, toroid kit \$7.50. MC/VISA accepted. Information \$1.00. (714) 783-0556. SPORT 'N' SOUND, 21999 Van Buren, Grand Terrace, CA 92324

SATELLITE system, \$1950.00. Complete receiver kits available. WESTCOM, 715 Washington, Ayden, NC 28513. Dealers welcome.

THE Tranny Caddy—tough, roomy lightweight carrying case for tools, components, PCB's, etc.—full details: MHP Co., Room 1042, 485 Fifth Avenue, New York, NY 10017.

P.O. Board Material. Free info. BOYD ELECTRONICS, 1998 Southgate Way, Grants Pass, OR 97526

39% OFF ADD \$2.50 FOR POSTAGE

30 CHANNEL CABLE TV CONVERTER

ORDER No. 171AE047

IBCO ROUTE 9N, PLATTSBURGH, N.Y. 12901 Tel.: (518) 561-8700.

FREE! UNUSUAL 96 PAGE ELECTRONIC PARTS & IDEAS CATALOG!

EDUCATION & INSTRUCTION

UNIVERSITY degrees by mail! Bachelors, Masters, Ph D's... Free revealing details. COUNSELING, Box 317-RE5, Tustin, CA 92680.

Be an FCC LICENSED Electronic Technician

Earn up to \$600 a Week & More!

No costly school — The Original FCC Tests. Answers exam manual that prepares you at home for FCC General Radiotelephone License. Newly revised multiple-choice exams cover all areas tested on the actual FCC Govt exam! No previous experience required. \$12.95 post-paid. Moneyback Guarantee.

Dept. E P.O. Box 26348, San Francisco, CA 94126

COMMAND PRODUCTIONS

ATTENTION ELECTRONIC TECHNICIANS

Highly Effective Home Study BSEE Degree Program for Experienced Electronic Technicians. Our New Advanced Placement Program grants Credit for previous Schooling & Professional Experience. Advance Rapidly! Our 36th Year!

FREE DESCRIPTIVE LITERATURE!

Cook's Institute of Electronics Engineering
DESK 15, P.O. BOX 20345, JACKSON, MS 39209



ARIZONA ELECTRONIC SURPLUS
6835 North 16th Street
Phoenix, Arizona 85016

****TV BOX BUILDERS****

LM 7812 ... \$1.35	LM 301 ... \$0.90
LM 7815 ... \$1.15	LM 1458 ... \$1.00
78L15 ... \$1.05	LM 380 ... \$1.90
LM1800 ... \$2.45	NE 565 ... \$1.90
LM1889 ... \$2.75	MC1330 ... \$2.40
	MC1350 ... \$1.90
74123 ... \$1.80	MC1358 ... \$2.10

CH3/CH4 Modulator
\$1795

9 V. BATTERY CLIPS

W/9" LEADS

8/\$100

UHF VARACTOR TUNER

\$1795

15-24 V.

INTERTELL PHONES

Model 2160
21 Button
W/Intercom

\$2495

MULTI-VOLTAGE SWITCHING POWER SUPPLY

\$3495

INPUT 110 V.A.C. OUTPUT +5 -5, +12 -12, +24, & +46

HMR II*

6 MO. WARRANTY

HAM MICROWAVE RECEIVER
w/Cable & Power Supply

\$14995

ORDERING INSTRUCTIONS

Minimum order \$10.00
C.O.D. Payment by cash or money order, company check.
C.O.D. — \$2.25 + \$2.35 shipping.
CREDIT CARDS — Master Charge & Visa.
SHIPPING MINIMUM \$2.35 + 35¢ per \$100.00 for insurance.

*We do not sell these items for the use of receiving subscription type TV transmissions.

CIRCLE 78 ON FREE INFORMATION CARD

HITECH KITS EDUCATIONAL IN NATURE FUN TO BUILD AND USE

LCD Multimeter

The affordable LCD Multimeter. High accuracy 19 range large 3 1/2 digit DVM with diode test, auto polarity and LO Batt. indicator.

Model 101 Fully Assembled \$59.95

0-35V 1.5A Quality Power Supply

Provides 4 ranges of current limiting up to 1.5A. Uses precision regulator and power transistor booster.

HKIT-83A Kit \$19.50

0-50V 3A Regulated Adjustable Power Supply

With overload protection and LED power on indicator. Assm \$28.50
HKIT-503 Kit \$24.50



30W Single Channel Power Amp.
Compact power amp with volume, treble and bass control. Excellent for boosting the power of your portable radio, or cassette. Connect to your TV audio and experience the real sound of your TV program.

HKIT-300 Kit \$16.95

Programmable Music Door-bell

Electronic door-bell that has 9 programmable tones. Uses CMOS for low power consumption and has auto shut-off feature.

HKIT-47A Kit \$14.50



5 Function LCD Pen Watch

High Quality ball point pen with built-in 5 function LCD watch. Comes as finished product only with gift box.

\$9.99

7 Digit Universal Counter

Universal Counter counts up to 80 MHz and 10 million events. 7 large 0.5" digits. Crystal time base. High performance.

HKIT-86A Kit \$49.50

C & K Style Toggle Switches

DPDT ON-OFF-ON \$2.00
DPDT ON-OFF \$1.60
SPDT ON-OFF-ON \$1.40
SPDT ON-OFF \$1.10

32.768 MHz Xtal. \$2.50

Function Generator

Generates triangle, square or sine wave. 1 Hz to 100 KHz. Ideal for testing audio amps.

HKIT-55 Kit \$35.50

We also specialize in high quality custom PCB manufacturing. Please send inquiry.

Kits do not include solder/batteries.

To Order, send check or money order to:

Hitech Electronics
4425 W. Sepulveda Blvd., Torrance CA 90505

Phone Orders: (213) 371-2160

VISA and M/C welcomed. Minimum Order \$9.00
Shipping and Handling \$2.00, CA resident add 6% tax.

PLEASE VISIT OUR STORE. Open 10:00-6:00 Mon. thru Sat.
Special discounts available to educational institutions. Dealer inquiries invited.

CIRCLE 85 ON FREE INFORMATION CARD

CB RADIO

GET more CB channels and range! Frequency Expanders, boosters, speech processors, FM converters, ignition noise blankers, how-to books, plans, modifications. Catalog \$2. CB CITY, Box 31500RE, Phoenix, AZ 85046

COMPUTER ACCESSORIES

LEMON-AID Loader. Plug in. Ends touchy cassette loading TRS-80. Guaranteed. \$12.99 post-paid. WAYNE LEMONS TECH SERVICES, PO Box 429, Buffalo, MO 65622 (417) 345-7643.

CABLE

POLYETHYLENE DIELECTRIC

RG213 noncontaminating 95% shield mil spec	36c/ft.
RG58AU stranded MIL SPEC	12c/ft.
RG8U 95% shield MIL SPEC	31c/ft.

LOW LOSS FOAM DIELECTRIC

RG8X (mini 8) 95% shield	17c/ft.
RG8U 97% shield	30c/ft.
RG58U 95% shield	10c/ft.
RG58AU stranded center 80% shield	11c/ft.
RG59/U 100% foil shield TV type	19c/ft.
Rotor Cable 2-18 ga 6-22 ga	
Cable-shipping \$3.00 1st 100 ft., \$2.00 each add'l 100 ft.	

CONNECTORS

PL-259 & SO-239	10/\$3.89
Reducer UG-175 or 174	10/\$1.99
UG-255 (PL-259 to BNC)	\$3.50

Connectors—shipping 10% add'l. \$1.50 minimum

FREE CATALOG

COD add \$1.50 — FLA. Res. add 4% Sales Tax

NEMAL ELECTRONICS

Dept 42
5685 SW 80th Street, Miami, FL 33143
Call (305) 661-5534

CHANEY electronics inc.

P.O. BOX 27038, DENVER, COLO. 80227 PHONE ORDERS: 303-781-5750

TEACHERS AND HOBBYISTS

- Minimum Order \$9.00
- Please include \$1.50 for shipping (UPS)
- We accept VISA and MASTERCHARGE
- EXTRA FAST SERVICE

Chaney Electronics has been providing quality electronic kits for high schools, tech schools, universities and hobbyists for over 10 years and we hope you will join the thousands of satisfied Chaney Electronics kit builders. All of our kits contain a quality etched and drilled glass epoxy pc board, all necessary electronic parts (except as noted on a few kits) and easy to understand assembly instructions. You provide a battery for the battery operated kits and if desired you may wish to provide a case. We recommend that you use a low wattage soldering iron and good quality rosin core solder when assembling your kits. Building our kits is both rewarding and fun because they are thoroughly tested and designed so that with proper assembly they work the first time! If you have any questions please call or write, we are here to assist you.

SEND FOR OUR COMPLETE CATALOG OF KITS AND PARTS.

<p>120VAC VARIABLE STROBE LIGHT KIT Complete variable rate strobe light kit produces brilliant flashes of light. Operates from standard 120VAC. Reliable design—thousands of these are in use throughout the world. Overall size of completed board, 3"L x 2"W x 3"H. C3071 \$7.50</p>	<p>ELECTRONIC WHEEL OF FORTUNE KIT Push the start button and a bright red ball (LEDS) appear to spin around ten numbers. When you release the button the electronic ball appears to slow down and finally comes to a stop on one number. As the ball spins a small speaker emits a ticking sound in synchronization. Unit operates from 9V battery. Size of board: 2.9" x 2.6". C3806 \$9.99</p>
<p>3VDC ELECTRONIC WARNING FLASHER KIT This portable battery operated device continuously emits bursts of intense light at a fixed repetition rate. Can be seen for great distances making it a great safety device. Features xenon flash tube. Operates on 3VDC (two 1.5V Batteries). Size of board: 2 1/2" L x 2" W. C3207 \$7.95</p>	<p>AC FAILURE ALARM KIT Have you ever been late because the AC went off and your clock radio didn't work? Well, that need not happen again! Simply plug this unit into the wall outlet and if the AC goes off the unit emits a tone. Features green ready light and piezoelectric tone device. Operates on 9V battery. Size of board: 2.8" x 2.3". C4483 \$4.75</p>
<p>STROBOSCOPE KIT Reliable IC design kit for use in physics experiments or troubleshooting. Optically stops motion of fans, wheels, pulleys, flywheels, etc. The stroboscope operates from standard 120VAC and features bright xenon flash tube and IC design. Size of board: 3.5" x 4.75". C4070 \$29.95</p>	<p>10 WATT SIREN KIT Kit provides a loud alternating tone output. Uses two IC's and a power transistor to provide a reliable performance. Features variable sound control and 6 to 120VAC operation. Requires 8 ohm speaker. Size of board: 3.5" x 1.5". C4068 \$5.00</p>
<p>PHOTO SLAVE TRIGGER KIT Probably the most sensitive slave trigger kit on the market. Simply connect to the strobe that will be used as the slave. When the master strobe is fired the slave strobe will also flash. Size of board: 1.5" x 1". C4630 \$6.00</p>	<p>SOUND EFFECTS GENERATOR KIT Exciting sound effects kit uses the popular TI76477 chip to develop phasor, locomotive, siren, tweeting bird, organ, Model T, etc. sounds. Uses dip switch for simple programming of the generator. Operates from 9V battery. Size of board: 3.25" x 2". C4422 \$12.95</p>
<p>FASCINATION STAR KIT Produces an "exploding star" visual effect using 25 LEDs and IC circuitry. The center LED lights first then the next group of LEDs light and then another set of lights until the outer edge of the star lights up. The process then reverses itself. Operates from 9V battery. C4432 \$10.95</p>	<p>PHASOR GUN SOUND AND LIGHT KIT Here's a simple kit which makes an excellent first project. Uses special IC, darlington transistor and LED to produce "outer space phasor gun" sound and flashing red light. Operates from 9V battery. Size of board: 1" x 1.2". C4484 \$4.00</p>
<p>SEQUENTIAL LED FLASHER KIT This kit combines IC circuitry and 10 jumbo red LEDs to produce a unique visual display. LEDs continuously light sequentially from right to left. Easy to build kit. Operates from 9V battery. Size of board: 5.25" x 1.5". C4431 \$6.75</p>	<p>3CHANNEL COLOR ORGAN Very popular 3 channel color organ causes lights of your choice to flash to beat of music. Features level control and 3 separate AC outlets to connect Christmas lights, lamps, etc. Operates from 120VAC. Size of board: 3" x 5". C4530 \$8.50</p>

CIRCLE 76 ON FREE INFORMATION CARD

SURPLUS ELECTRONICS CORP.

WHOLESALE/RETAIL

EQUIPMENT/COMPONENTS/WIRE & CABLE/ACCESSORIES

7294 N.W. 54th Street
Miami, Florida 33166

We accept MasterCard and Visa.

Phone: (305) 887-8228
TWX: 810-848-6085

"TANK BATTLE" TV GAME

In just a short time and with a few minor parts, the most novice hobbyist can complete this exciting Tank Battle game. Create a fun-filled evening for the whole family. Two independent tanks rumble thru land mine fields, shoot shells and fragment when hit. Four distinct engine sounds are produced for the different speeds. Sounds of gunfire, shell bursts and tank explosions are realistic. Automatic on-screen scoring. Supplied with schematic drawing.

SOLD AS IS \$9.95 ea.

C.B. SPECIAL

CONVERT THESE TO 10 METER FM

New HY-GAIN printed circuit board assembly with PLL02A chip and 3 crystals. (Squelch pot, volume control and channel switch not included.) Boards sold as is, the way we bought them from the manufacturer. Board dimensions 6" x 6 1/2"

1-9 \$7.50
10-49 \$6.50
50-99 \$6.00
100-UP \$5.50

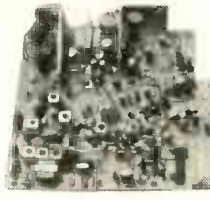

COPPER CLAD BOARD

(Double Side)
Size 9.25 x 10.75
Thickness .062
\$2.00 ea.

ERIE TRIMMER CAP

513-002
.196" Dia. .080" High
3.5-20pf
\$1.75 ea.

SMALL ENOUGH TO FIT IN YOUR WATCH

AMP METERS

\$2.50 ea.

2 1/4" square, no shunt required. Easy-to-read dial.
Movements: 0-6, 0-10, 0-17

COAX CONNECTORS

UG-273/U BNC-F/UHF-M \$2.50
UG-255/U BNC-M/UHF-F \$3.00
UG-146 A/U N-M/UHF-F \$4.50
UG-83B/U N-F/UHF-M \$4.50
UG-175 RG-58 Adapt \$.20
UG-176 RG-59 Adapt \$.20
UG-1094 BNC-F/Panel \$1.00
SO239 50c
PL259 60c

COAXIAL CABLE

50 OHM-RG 174
\$4.95/100' \$3.00/50'

TEXAS INSTRUMENT KEYBOARD

\$1.95 ea.
5/\$8.00

Has 3 slide switches, 26 different keys, key pad removable by 4 screws

MODEM CABLE ASSEMBLIES

\$5.50 ea.

Conn & Hood	22 AWG # Cond	Length
25 P	14	15'
25 S	10	17'

7' POWER CORD

HEWLETT PACKARD TYPE

Molded 3 Prong Plug with molded receptacle
Belden 16 AWG
\$3.00 ea.

9 VOLT NiCd RECHARGEABLE BATTERY

NEW. Replaces the popular 9V Transistor Battery.
\$4.75 ea.

MAHOGANY PROJECT BOX

\$1.50 ea.

4 3/8" w x 7 3/8" l x 3/4" to 1 1/2" h
Has a lip for recessed face plate and a felt bottom

SCREW DRIVER KIT

Handle stores four blades
2 single slot 5/32" & 3/32"
1 phillips 1 scratch awl
6" long with one blade inserted
\$1.00 ea.

SUPER SMALL PHOTO FLASH

170 MFD 330 VOLT
1 1/4" x 7/8"
2 for **\$1.50**
10 for **\$7.00**

750 MFD 330V PHOTO FLASH

2" HIGH x 1 1/4" DIA.
\$1.25 each
10 for **\$11.00**

MUFFIN FANS

MFG By Rotron Inc.
3 Blades 4 3/4" Square USED
110 VAC **\$5.95 ea.**
NEW
110 VAC Model MU2A1
\$12.00 ea.

DIP SWITCH

5 POSITION **\$1.00 ea.**
8 POSITION **\$1.50 ea.**
10 POSITION **\$2.00 ea.**
12 POSITION **\$2.50 ea.**

WHISTLE ACTIVATED SWITCH

\$2.50 ea.

Your whistle from a distance of 30' max. is picked up by an FET condenser mic. which turns on the switch. (Sensitivity can be adjusted.) Match your whistle again and turns off.
Schematic Diagram Supplied

POWER TRANSFORMER

\$14.95 ea.

Primary - 115 vac
Secondary - 32 v with 24 v tap at 15 amps
Dim. 4 1/2" h x 3 3/4" w x 4" deep

SOLID GEL BATTERY

6 volt @ 8 a.h. with Charger
\$14.95

Elpower EP 680 may be charged constant voltage or constant current. Battery is self-contained and requires no maintenance. Connections made with quick connect lugs. All plastic case size 5 1/2 h x 2 3/4 w x 4 1/2 l, weight 4 lbs.

TELEPHONE & TTY INTERFACE MODEM

MFG by Anderson Jacobson
OAA Modern Model DC 230 with A-36 Telephone Coupler
\$69.95

Rated 300 Baud, half or full duplex. OAA level adjustable 0 to -3, -4 to -6, -7 to -10 TTY and DAA outputs brought out to 15 pin Molex connectors. FSK oscillator sends 1070 Hz space and 1270 Hz mark. Receives 2025 Hz space and 2225 Hz mark. Telephone coupler has 4-ft. cord and plug. Size 4 1/4" W x 15 L x 3" H. Op. designed to be recessed in desk or panel. Electronics in case, 6 1/2 W x 12 x 2 3/4" Dp. with 8-ft. 3-wire U-ground cord and plug. Operates on 115 vac, 50/60 Hz. 1/2 Amp. Supplied with connection sheet. Removed from equipment, excellent condition, guaranteed.

DB CONNECTORS

25 P **2.50**
25 S **3.50**

COVER FOR DB2 SP/S (PLASTIC) **1.25**

C & K SWITCHES

Part #	Movement
J-60	7101 SPDT
L-3	7108 SPDT (momentary)
J-3	7201 DPDT (special large rocker)

\$1.00 ea. 6/\$5.00

COMPUTER GRADE ELECTROLYTICS

VALUE/MFD	VOLTS	DIAM./LGTH.	PRICE
63,000	@ 15V	3" x 5 1/2"	\$4.00 ea.
10,000	@ 20V	1 1/2" x 5 3/4"	\$3.00 ea.
2,700	@ 25V	1 1/4" x 2 1/4"	\$2.00 ea.
2,900	@ 25V	1 1/4" x 2"	\$2.00 ea.
100,000	@ 30V	3" x 5 1/2"	\$6.00 ea.
39,000	@ 30V	1" x 5 3/4"	\$4.00 ea.
34,000	@ 30V	3" x 5 1/2"	\$3.00 ea.
450	@ 75V	1 1/4" x 2 1/4"	\$2.00 ea.
500	@ 100V	1 1/2" x 3 1/4"	\$2.00 ea.
50	@ 450V	1 1/4" x 2"	\$2.00 ea.

AXIAL LEAD ELECTROLYTIC CAPACITORS

2 uF @ 15V 12	\$1.00
10 uF @ 15V 12	\$1.00
20 uF @ 15V 12	\$1.00
50 uF @ 15V 12	\$1.00
2.2 uF @ 25V 12	\$1.00
3.3 uF @ 25V 12	\$1.00
1 uF @ 35V 12	\$1.00
2 uF @ 150V 12	\$1.00
25 uF @ 25V 15	\$2.00
3 uF @ 50V 15	\$2.00
5 uF @ 50V 15	\$2.00
10 uF @ 50V 15	\$2.00
250 uF @ 25V 10	\$2.00

SUB-MINI 10K POT

with On-Off 1/4" hole mount, 1/8" D shaft, 3/4" thread section.
5/\$1.00

24-Volt POWER SUPPLY

5.4 AMPS
MFG by ACDC Electronics Inc.
Model OEM 24N5.4-1
10" x 5" h x 5" w
\$45.00

Input 105-125 vac 50/60 Hz. Has volt adj and O.L. adj. Output terminals contain + out, + sen, - sen, - out, ac neut, ac line and GND. 13 LBS.

SAME AS ABOVE EXCEPT 24 VOLT 7 AMP **\$65.00**

REMOTE 40 CH. C.B. SPECIAL

NEW HYGAIN 16 MODEL 2716 HANDSET HAS DIGITAL CLOCK. PLASTIC CASE FOR REMOTE NOT INCLUDED. SOLD AS IS **\$29.95**

EDGE CONNECTORS

Double Row / Wire Wrap .100
22 pins **\$3.49 10/\$30.00**
30 pins **\$3.96 10/\$32.00**
50 pins **\$5.43 10/\$45.00**

Double Row / Solder Eyelet .156
6 pins **\$1.10 10/\$ 9.00**
15 pins **\$1.65 10/\$12.50**
22 pins **\$2.08 10/\$17.00**
43 pins **\$3.66 10/\$30.00**

SPEAKER

3" Diam., 8 OHM, 5 Watts.
\$2.00 ea.

POWER SUPPLY

\$3.95 ea.
+ 12 vdc .1 amps
+ 5 vdc .4 amps

E. F. JOHNSON "S" METER

Edge Meter 250 UA, fits in 5/8" x 1 3/8" hole. Black background. Scale 1-20 Top, 0-5 Bottom.
\$1.25 ea. 5/\$5.00

TRIMMER CAP

1.5-20pf (ARCO PC-402) **50c ea.**

DIP SOLDER IC SOCKETS

14 pin	\$1.14
16 pin	.16
18 pin	.18
20 pin	.20
24 pin	.24
40 pin	.40

IC SOCKETS GOLD-PLATED WIRE WRAP

14 pin	40c ea.
16 pin	45c ea.

TERMS: All material guaranteed unless otherwise stated. If you are not satisfied with our product, it may be returned within 10 days for a refund (less shipping). Please add \$4.00 for shipping and handling on all orders. COD's accepted for orders totaling \$50 or more. All orders shipped UPS unless otherwise specified. Florida residents please add 4% sales tax. Minimum order, \$15.00. Foreign orders - US funds only, add 20% for shipping and handling.

7400 - SN7400N .20 SN7401N .25 SN7402N .25 SN7403N .25 SN7404N .25 SN7405N .25 SN7406N .25 SN7407N .25 SN7408N .25 SN7409N .25 SN7410N .25 SN7411N .25 SN7412N .25 SN7413N .25 SN7414N .25 SN7415N .25 SN7417N .25 SN7420N .25 SN7421N .25 SN7422N .25 SN7423N .25 SN7426N .25 SN7427N .25 SN7428N .25 SN7430N .25 SN7432N .25 SN7437N .25 SN7438N .25 SN7439N .25 SN7440N .20 SN7441N .25 SN7442N .25 SN7443N .25 SN7444N .25 SN7445N .25 SN7446N .25 SN7447N .25 SN7448N .25 SN7449N .25 SN7450N .25 SN7451N .25 SN7452N .25 SN7453N .25 SN7454N .25 SN7455A .25 SN7460N .25 SN7470N .25

Bulova Quartz Ladies Watches ONE YEAR FACTORY WARRANTY

Your Choice — \$69.95 ea. any Model CALL OR SEND ORDER IN REFERENCE TO THIS AD FOR SPECIAL PRICE Because of Limited Supply, please provide a second and third choice

LITRONIX Stick Display Sale MULTI-DIGIT REFLECTOR ARRAYS FOR CLOCK SALE!

NATIONAL Stick Display Sale LED NUMERIC ARRAYS SALE!

74LS - 74LS00N .20 74LS01N .20 74LS02N .20 74LS03N .20 74LS04N .20 74LS05N .20 74LS06N .20 74LS07N .20 74LS08N .20 74LS09N .20 74LS10N .20 74LS11N .20 74LS12N .20 74LS13N .20 74LS14N .20 74LS15N .20 74LS16N .20 74LS17N .20 74LS18N .20 74LS19N .20 74LS20N .20 74LS21N .20 74LS22N .20 74LS23N .20 74LS24N .20 74LS25N .20 74LS26N .20 74LS27N .20 74LS28N .20 74LS29N .20 74LS30N .20 74LS31N .20 74LS32N .20 74LS33N .20 74LS34N .20 74LS35N .20 74LS36N .20 74LS37N .20 74LS38N .20 74LS39N .20 74LS40N .20 74LS41N .20 74LS42N .20 74LS43N .20 74LS44N .20 74LS45N .20 74LS46N .20 74LS47N .20 74LS48N .20 74LS49N .20 74LS50N .20 74LS51N .20 74LS52N .20 74LS53N .20 74LS54N .20 74LS55A .20 74LS56N .20 74LS57N .20 74LS58N .20 74LS59N .20 74LS60N .20 74LS61N .20 74LS62N .20 74LS63N .20 74LS64N .20 74LS65N .20 74LS66N .20 74LS67N .20 74LS68N .20 74LS69N .20 74LS70N .20 74LS71N .20 74LS72N .20 74LS73N .20 74LS74N .20 74LS75N .20 74LS76N .20 74LS77N .20 74LS78N .20 74LS79N .20 74LS80N .20 74LS81N .20 74LS82N .20 74LS83N .20 74LS84N .20 74LS85N .20 74LS86N .20 74LS87N .20 74LS88N .20 74LS89N .20 74LS90N .20 74LS91N .20

COMPUTER GRADE CAPACITORS

LOW PROFILE (TIN) SOCKETS SOLDERTAIL STANDARD (TIN) WIRE WRAP SOCKETS (GOLD) LEVEL #3 SOLDERTAIL (GOLD) STANDARD

INTERFIL Part No. Function Price

74C - 74C00N .39 74C01N .39 74C02N .39 74C03N .39 74C04N .39 74C05N .39 74C06N .39 74C07N .39 74C08N .39 74C09N .39 74C10N .39 74C11N .39 74C12N .39 74C13N .39 74C14N .39 74C15N .39 74C16N .39 74C17N .39 74C18N .39 74C19N .39 74C20N .39 74C21N .39 74C22N .39 74C23N .39 74C24N .39 74C25N .39 74C26N .39 74C27N .39 74C28N .39 74C29N .39 74C30N .39 74C31N .39 74C32N .39 74C33N .39 74C34N .39 74C35N .39 74C36N .39 74C37N .39 74C38N .39 74C39N .39 74C40N .39 74C41N .39 74C42N .39 74C43N .39 74C44N .39 74C45N .39 74C46N .39 74C47N .39 74C48N .39 74C49N .39 74C50N .39 74C51N .39 74C52N .39 74C53N .39 74C54N .39 74C55N .39 74C56N .39 74C57N .39 74C58N .39 74C59N .39 74C60N .39 74C61N .39 74C62N .39 74C63N .39 74C64N .39 74C65N .39 74C66N .39 74C67N .39 74C68N .39 74C69N .39 74C70N .39 74C71N .39 74C72N .39 74C73N .39 74C74N .39 74C75N .39 74C76N .39 74C77N .39 74C78N .39 74C79N .39 74C80N .39 74C81N .39 74C82N .39 74C83N .39 74C84N .39 74C85N .39 74C86N .39 74C87N .39 74C88N .39 74C89N .39 74C90N .39 74C91N .39 74C92N .39 74C93N .39 74C94N .39 74C95N .39 74C96N .39 74C97N .39 74C98N .39 74C99N .39

LINEAR - LM102H .79 LM103H .79 LM104H .79 LM105H .79 LM106H .79 LM107H .79 LM108H .79 LM109H .79 LM110H .79 LM111H .79 LM112H .79 LM113H .79 LM114H .79 LM115H .79 LM116H .79 LM117H .79 LM118H .79 LM119H .79 LM120H .79 LM121H .79 LM122H .79 LM123H .79 LM124H .79 LM125H .79 LM126H .79 LM127H .79 LM128H .79 LM129H .79 LM130H .79 LM131H .79 LM132H .79 LM133H .79 LM134H .79 LM135H .79 LM136H .79 LM137H .79 LM138H .79 LM139H .79 LM140H .79 LM141H .79 LM142H .79 LM143H .79 LM144H .79 LM145H .79 LM146H .79 LM147H .79 LM148H .79 LM149H .79 LM150H .79 LM151H .79 LM152H .79 LM153H .79 LM154H .79 LM155H .79 LM156H .79 LM157H .79 LM158H .79 LM159H .79 LM160H .79 LM161H .79 LM162H .79 LM163H .79 LM164H .79 LM165H .79 LM166H .79 LM167H .79 LM168H .79 LM169H .79 LM170H .79 LM171H .79 LM172H .79 LM173H .79 LM174H .79 LM175H .79 LM176H .79 LM177H .79 LM178H .79 LM179H .79 LM180H .79 LM181H .79 LM182H .79 LM183H .79 LM184H .79 LM185H .79 LM186H .79 LM187H .79 LM188H .79 LM189H .79 LM190H .79 LM191H .79 LM192H .79 LM193H .79 LM194H .79 LM195H .79 LM196H .79 LM197H .79 LM198H .79 LM199H .79 LM200H .79

74S - 74S00N .45 74S01N .45 74S02N .45 74S03N .45 74S04N .45 74S05N .45 74S06N .45 74S07N .45 74S08N .45 74S09N .45 74S10N .45 74S11N .45 74S12N .45 74S13N .45 74S14N .45 74S15N .45 74S16N .45 74S17N .45 74S18N .45 74S19N .45 74S20N .45 74S21N .45 74S22N .45 74S23N .45 74S24N .45 74S25N .45 74S26N .45 74S27N .45 74S28N .45 74S29N .45 74S30N .45 74S31N .45 74S32N .45 74S33N .45 74S34N .45 74S35N .45 74S36N .45 74S37N .45 74S38N .45 74S39N .45 74S40N .45 74S41N .45 74S42N .45 74S43N .45 74S44N .45 74S45N .45 74S46N .45 74S47N .45 74S48N .45 74S49N .45 74S50N .45 74S51N .45 74S52N .45 74S53N .45 74S54N .45 74S55N .45 74S56N .45 74S57N .45 74S58N .45 74S59N .45 74S60N .45 74S61N .45 74S62N .45 74S63N .45 74S64N .45 74S65N .45 74S66N .45 74S67N .45 74S68N .45 74S69N .45 74S70N .45 74S71N .45 74S72N .45 74S73N .45 74S74N .45 74S75N .45 74S76N .45 74S77N .45 74S78N .45 74S79N .45 74S80N .45 74S81N .45 74S82N .45 74S83N .45 74S84N .45 74S85N .45 74S86N .45 74S87N .45 74S88N .45 74S89N .45 74S90N .45 74S91N .45 74S92N .45 74S93N .45 74S94N .45 74S95N .45 74S96N .45 74S97N .45 74S98N .45 74S99N .45 74S00N .45

1/4 WATT RESISTOR ASSORTMENTS - 5% CAPACITOR CORNER 50 VOLT CERAMIC DISC CAPACITORS 100 VOLT MYLAR FILM CAPACITORS MINI. ALUMINUM ELECTROLYTIC CAPACITORS

CA-LINEAR - CA301H .59 CA301B .215 CA302H .325 CA303H .249 CA303H .135 CA304N .130 CA305N .325 CD-CMOS - CD4001 .39 CD4002 .39 CD4003 .119 CD4004 .25 CD4005 .49 CD4006 .49 CD4007 .25 CD4008 .49 CD4009 .49 CD4010 .49 CD4011 .39 CD4012 .25 CD4013 .49 CD4014 .49 CD4015 .119 CD4016 .59 CD4017 .119 CD4018 .119 CD4019 .119 CD4020 .119 CD4021 .119 CD4022 .119 CD4023 .119 CD4024 .79 CD4025 .23 CD4026 .25 CD4027 .25 CD4028 .25 CD4029 .149 CD4030 .49 CD4031 .49 CD4032 .49 CD4033 .49 CD4034 .49 CD4035 .49 CD4036 .49 CD4037 .49 CD4038 .49 CD4039 .49 CD4040 .49 CD4041 .49 CD4042 .49 CD4043 .49 CD4044 .49 CD4045 .49 CD4046 .49 CD4047 .49 CD4048 .49 CD4049 .49 CD4050 .49 CD4051 .49 CD4052 .49 CD4053 .49 CD4054 .49 CD4055 .49 CD4056 .49 CD4057 .49 CD4058 .49 CD4059 .49 CD4060 .49 CD4061 .49 CD4062 .49 CD4063 .49 CD4064 .49 CD4065 .49 CD4066 .49 CD4067 .49 CD4068 .49 CD4069 .49 CD4070 .49 CD4071 .49 CD4072 .49 CD4073 .49 CD4074 .49 CD4075 .49 CD4076 .49 CD4077 .49 CD4078 .49 CD4079 .49 CD4080 .49 CD4081 .49 CD4082 .49 CD4083 .49 CD4084 .49 CD4085 .49 CD4086 .49 CD4087 .49 CD4088 .49 CD4089 .49 CD4090 .49 CD4091 .49 CD4092 .49 CD4093 .49

Jameco ELECTRONICS 1355 SHOREWAY ROAD, BELMONT, CA 94002 PHONE ORDERS WELCOME - (415) 592-8097

Table with columns for Part No., Function, and Price, listing various electronic components and their specifications.

UTIC MINI STEREO FM RECEIVER WITH HEADPHONES

For Joggers, Cyclists, and Skaters!

FEATURES: Lightweight headphones. Left/right balance control. Full fidelity stereo sound. Additional black soft carrying case & shoulder strap. Belt clip (hands free). Operates on 3 AA cell batteries (not incl.). Compact size: 3 1/2" x 4 1/4" x 1". WL 6 oz.

Model 1810 List Price \$89.95 ... \$29.95

SPEAKERS

Part# A0201 1.25 99
2 1/2" Round - 8 Ohm
25 Watt (4" Leads)
Size: 2 1/4" x 1 1/4"

Part# SF-25016 1.39 1.25
2 1/2" Square - 16 Ohm
25 Watt (4 mount holes)
Large Ceramic Magnet
Size: 2 1/4" x 2 1/4" x 3/4"

National Semiconductor RAM SALE

STATIC RAMS

MM214N-2 4K (200NS) ... \$2.49 each
(8 EACH \$16.95/lot) (100 EACH \$195.95/lot)

MM214N-2L 4K (200NS) Low Power ... \$2.95 each
(8 EACH \$18.95/lot) (100 EACH \$225.00/lot)

MM214N 4K (70NS) ... \$4.95 each
(8 EACH \$34.95/lot) (100 EACH \$418.95/lot)

MM616P-4 16K (200NS) ... \$14.95 each
(8 EACH \$99.95/lot) (100 EACH \$1195.00/lot)

DYNAMIC RAMS

MM164N-20 64K (200NS) ... \$14.95 each
(8 EACH \$99.95/lot) (100 EACH \$1195.00/lot)

MM5290N-2 16K (150NS) 4116 ... \$2.95 each
(8 EACH \$19.95/lot) (100 EACH \$225.00/lot)

MM5290N-4 16K (200NS) 4116 ... \$1.95 each
(8 EACH \$14.95/lot) (100 EACH \$175.00/lot)

EPROM Erasing Lamp

• Erases 2708, 2716, 1702A, 5203Q, 5204Q, etc.
• Erases up to 4 chips within 20 minutes.
• Maintains constant exposure distance of one inch.
• Special conductive foam liner eliminates static build-up.
• Built-in safety lock to prevent UV exposure.
• Compact - only 7 1/8" x 2-7/8" x 2".
• Complete with holding tray for 4 chips.

UVS-11E Replacement Bulb ... \$16.95

UVS-11E ... \$79.95

JOYSTICKS

JS-5K 5K Linear Taper Pots ... \$5.25
JS-100K 100K Linear Taper Pots ... \$4.95
JVC-40 40K (2) Video Controller in case ... \$4.95

MUFFIN FAN

The dependable, low cost, largest selling fan for commercial cooling applications.

• 105cfm free air delivery
• 4.65" sq. x 1.50" depth. Weight - 17 oz.
• acoustical rating as low as NC-38
• more than 10 yrs. cont. duty at 10°C
• Impedance protected
• for ambient to 70°C
• UL yellow card recognized & CSA approved

115V, 50/60Hz, 14 Watts, 105cfm - Ultrasonically cleaned & tested.

MUZA1 ... \$9.95 ea.

JE215 Adjustable Dual Power Supply

General Description: The JE215 is a Dual Power Supply with independent adjustable positive and negative output voltages. A separate adjustment for each of the supplies provides the user unlimited applications for IC current voltage requirements. The supply can also be used as a general all-purpose variable power supply.

FEATURES:

- Adjustable regulated power supplies, pos. and neg. 1.2VDC to 15VDC.
- Power Output (each supply): 5VDC @ 500mA, 10VDC @ 750mA, 12VDC @ 500mA, and 15VDC @ 175mA.
- Two, 3-terminal adj. IC regulators with thermal overload protection.
- Heatsink regulator cooling.
- LED "on" indicator.
- Printed Board Construction.
- 120VAC input.
- Size: 3-1/2" w x 5-1/16" h x 2" L

JE215 Adj. Dual Power Supply Kit (as shown) ... \$24.95
(Picture not shown but similar in construction to above)

JE200 Reg. Power Supply Kit (5VDC, 1 amp) ... \$14.95
JE205 Adaptor Brd. (to JE200) \$5.29 & 12V. \$12.95
JE210 Var. Pwr. Sply. Kit, 5-15VDC, to 1.5amp ... \$19.95

MICROPROCESSOR COMPONENTS

8080A/8080A SUPPORT DEVICES

INS480A	CPU	4.95
DP8212	8-Bit Input/Output	3.25
DP8214	Priority Interrupt Control	3.25
DP8216	Bi-Directional Bus Driver	3.49
DP8224	Clock Generator/Driver	3.95
DP8226	Bus Driver	3.49
DP8228	System Controller/Bus Driver	4.95
DP8238	System Controller	5.95
INS4243	I/O Expander for 48 Series	9.95
INS4250	Asynchronous Counter Element	9.95
DP8251	Prog. Comm. I/O (USART)	6.95
DP8253	Prog. Interval Timer	6.95
DP8255	Prog. Peripheral I/O (PPI)	9.95
DP8257	Prog. DMA Controller	9.95
DP8259	Prog. Interrupt Control	9.95
DP8275	Prog. CRT Controller	9.95
DP8279	Prog. Keyboard/Display Interface	9.95
OP8303	System Timing Element	6.95
DP8304	8-Bit Bi-Directional Receiver	3.95
DP8307	8-Bit Bi-Directional Receiver	3.95
DP8308	8-Bit Bi-Directional Receiver	3.95
DP8310	Octal Latched Peripheral Driver	5.25
DP8311	Octal Latched Peripheral Driver	5.25

6800/6800A SUPPORT DEVICES

MC6800	MPU with Clock and RAM	7.95
MC6801A	Peripheral Inter. Asst. (MC6800)	7.49
MC6802	128K Static RAM	17.95
MC6803	128K Static RAM (MC6803B)	14.95
MC6804	Any-Order ROM - Comm. Adapter	6.95
MC6805	4000ops Serial Data Adapter	6.95
MC6860	4000ops Digital MODEM	12.95
MC6862	2400ops Modulator	12.95
MC6880A	Quad 1-Static Bus Trans (MC6880)	2.95

MICROPROCESSOR CHIPS

Z80 (780C)	CPU (MK3800T) (1MHz)	11.95
Z80A (780-1)	CPU (MK3800T-1) (4MHz)	13.95
CDP1802	CPU	16.95
2650	MPU	16.95
IDM2901A	CPU - 4-Bit Slice (Com. Temp. Grade)	11.95
MC5502	MPU w/Clock (80K Bytes Memory)	18.95
INS4803V4	CPU - 8-Bit (80K Bytes Mem)	7.95
INS4803N4	CPU - 8-Bit (128K Bytes RAM)	9.95
INS4804N4	CPU (256 Bytes RAM)	24.95
INS4807N	CPU - 8-Bit (80K Bytes Mem)	7.95
INS4807JN	CPU w/Basic I/O Interpreter	29.95
PM05	CPU	9.95
TM5990V-L	MPU - 16-Bit	39.95

PROMS/EPROMS

1702A	2K 1702 Static PROM	2.95
2708	8K EPROM	2.95
TM5217	16K EPROM (5V, +5V, +12V)	3.95
27161(2517)	16K EPROM (Single +5V)	3.95
27C101	32K EPROM	17.95
2758	8K EPROM (400ns) (Single +5V)	7.45
2764	16K EPROM (Hitachi HM62764)	3.95
5203	32K EPROM (Hitachi HM62764)	14.95
82523(4518)	32K PROM (Open Collector)	3.95
82515	4096 Bipolar PROM	14.95
82512(4528)	2048 Bipolar PROM	14.95
82516	8K PROM	14.95

--- Over 30 More PROMS Listed in Our Catalog ---

ROMS

26121(201)	Character Generator (Upper Case)	9.95
26121(201)	Character Generator (Lower Case)	9.95

NMOS READ ONLY MEMORIES

MC68670P	128Kx7 ASC11 Shiftreg w/Green	13.50
MC68660P	128Kx7 Memory Symbols & Pictures	13.50
MC68667P	128Kx7 Alpha, Character Char. Gen.	13.50

MICROPROCESSOR MANUALS

M-280	User Manual	7.50
MC68010	CMOS 7-Bit Counter	7.50
M-2650	User Manual	5.00

SPECIAL FUNCTION

D5008CN	Quad MOS Clock Driver (5MHz)	1.50
D5008CN	Dual MOS Clock Driver (5MHz)	1.95
INS173N-1	Floppy Disc Controller	24.95
INS626N	Communication Chip	11.95
INS627N	Microprocessor Real Time Clock	6.95
CP042N	Microcontroller with 8-Digit RAM	6.95
CP042N	Microcontroller with 8-Digit RAM & Direct LED Drive w/Bus Int.	7.49

TELEPHONE/KEYBOARD CHIPS

AV-9100	Push Button Telephone Dialer	14.95
AV-9200	Rotary Dialer	14.95
A-V-9200	A-V-9200 Chip	14.95
HD065-5	Keyboard Encoder (16 keys)	7.95
HC929	Keyboard Encoder (16 keys)	7.95
MC5293	Keyboard Encoder (20 keys)	5.95
MS3190N	Push Button Pulse Dialer	5.49
MS3199N	96/144-Key Serial Keyboard Encoder	6.95

EEPROM Rocker Dip Switch - "Mini-Dipm" 2400 Series

THE MOST UNIQUE DIP SWITCH AVAILABLE!

Mini-DIP is designed to retrofit all major brands of Dip switches. Unique features include locking and design to prevent accidental activation and/or deactivation contact. One-piece housing and press-in terminals prevent contamination. 2-10 station Form 'A' and 1-5 station Form 'C'.
• Terminals on 100 x 300 (.254 x 1.52) centers • PCB or 1-socket mountable • Positive latching/wiping action with gold contact • Total and bottom size .75" x .75" x .25"

Part No.	Pos.	Configuration	Socket	Price
2400-10	2	12	8 pin	7.00 / 6.95
2400-3	3	123	8 pin	8.00 / 7.95
2400-4	4	1234	8 pin	9.00 / 8.95
2400-4BCA	4	1234	8 pin	10.00 / 9.95
2400-5C	6	CS4321	14 pin	1.00 / 10.95

GRAB BAG SPECIALS

GB180 (Pictured Above)

Part No.	Description	Price
GB176	200 1/2 watt resistor assortment	\$3.00
GB177	200 1/2 watt 1/2 watt resistor assortment	\$3.00
GB178	200 1/2 watt 1/2 watt resistor assortment	\$3.00
GB179	200 1/2 watt 1/2 watt resistor assortment	\$3.00

Capacitors

Part No.	Description	Price
GB170	100 each Ceramic Disc - 100pF - 10V	\$2.00
GB171	60 each Paper	4.00
GB172	60 each Electrolytic	4.00
GB173	40 each Tantalum (Rubber & Epoxy)	4.00
GB174	40 each Copper Metal (1000pF @ 50-500V)	4.00

INTEGRATED CIRCUITS

GB108	90 each TTL Series - marked (1000) 74123 8 pin	\$4.00
GB109	30 each Linear - marked (1000) 201 740 300 300 300	4.00
GB110	30 each 7400 - marked (1000) 310 4100 4100 4100	4.00
GB111	30 each 7410 - marked (1000) 310 4100 4100 4100	4.00
GB112	30 each 7411 - marked (1000) 310 4100 4100 4100	4.00
GB113	30 each 7412 - marked (1000) 310 4100 4100 4100	4.00
GB114	30 each 7413 - marked (1000) 310 4100 4100 4100	4.00
GB115	30 each 7414 - marked (1000) 310 4100 4100 4100	4.00
GB116	30 each 7415 - marked (1000) 310 4100 4100 4100	4.00
GB117	30 each 7416 - marked (1000) 310 4100 4100 4100	4.00
GB118	30 each 7417 - marked (1000) 310 4100 4100 4100	4.00
GB119	30 each 7418 - marked (1000) 310 4100 4100 4100	4.00
GB120	30 each 7419 - marked (1000) 310 4100 4100 4100	4.00
GB121	30 each 7420 - marked (1000) 310 4100 4100 4100	4.00
GB122	30 each 7421 - marked (1000) 310 4100 4100 4100	4.00
GB123	30 each 7422 - marked (1000) 310 4100 4100 4100	4.00
GB124	30 each 7423 - marked (1000) 310 4100 4100 4100	4.00
GB125	30 each 7424 - marked (1000) 310 4100 4100 4100	4.00
GB126	30 each 7425 - marked (1000) 310 4100 4100 4100	4.00
GB127	30 each 7426 - marked (1000) 310 4100 4100 4100	4.00
GB128	30 each 7427 - marked (1000) 310 4100 4100 4100	4.00
GB129	30 each 7428 - marked (1000) 310 4100 4100 4100	4.00
GB130	30 each 7429 - marked (1000) 310 4100 4100 4100	4.00
GB131	30 each 7430 - marked (1000) 310 4100 4100 4100	4.00
GB132	30 each 7431 - marked (1000) 310 4100 4100 4100	4.00
GB133	30 each 7432 - marked (1000) 310 4100 4100 4100	4.00
GB134	30 each 7433 - marked (1000) 310 4100 4100 4100	4.00
GB135	30 each 7434 - marked (1000) 310 4100 4100 4100	4.00
GB136	30 each 7435 - marked (1000) 310 4100 4100 4100	4.00
GB137	30 each 7436 - marked (1000) 310 4100 4100 4100	4.00
GB138	30 each 7437 - marked (1000) 310 4100 4100 4100	4.00
GB139	30 each 7438 - marked (1000) 310 4100 4100 4100	4.00
GB140	30 each 7439 - marked (1000) 310 4100 4100 4100	4.00
GB141	30 each 7440 - marked (1000) 310 4100 4100 4100	4.00
GB142	30 each 7441 - marked (1000) 310 4100 4100 4100	4.00
GB143	30 each 7442 - marked (1000) 310 4100 4100 4100	4.00
GB144	30 each 7443 - marked (1000) 310 4100 4100 4100	4.00
GB145	30 each 7444 - marked (1000) 310 4100 4100 4100	4.00
GB146	30 each 7445 - marked (1000) 310 4100 4100 4100	4.00
GB147	30 each 7446 - marked (1000) 310 4100 4100 4100	4.00
GB148	30 each 7447 - marked (1000) 310 4100 4100 4100	4.00
GB149	30 each 7448 - marked (1000) 310 4100 4100 4100	4.00
GB150	30 each 7449 - marked (1000) 310 4100 4100 4100	4.00
GB151	30 each 7450 - marked (1000) 310 4100 4100 4100	4.00
GB152	30 each 7451 - marked (1000) 310 4100 4100 4100	4.00
GB153	30 each 7452 - marked (1000) 310 4100 4100 4100	4.00
GB154	30 each 7453 - marked (1000) 310 4100 4100 4100	4.00
GB155	30 each 7454 - marked (1000) 310 4100 4100 4100	4.00
GB156	30 each 7455 - marked (1000) 310 4100 4100 4100	4.00
GB157	30 each 7456 - marked (1000) 310 4100 4100 4100	4.00
GB158	30 each 7457 - marked (1000) 310 4100 4100 4100	4.00
GB159	30 each 7458 - marked (1000) 310 4100 4100 4100	4.00
GB160	30 each 7459 - marked (1000) 310 4100 4100 4100	4.00
GB161	30 each 7460 - marked (1000) 310 4100 4100 4100	4.00
GB162	30 each 7461 - marked (1000) 310 4100 4100 4100	4.00
GB163	30 each 7462 - marked (1000) 310 4100 4100 4100	4.00
GB164	30 each 7463 - marked (1000) 310 4100 4100 4100	4.00
GB165	30 each 7464 - marked (1000) 310 4100 4100 4100	4.00
GB166	30 each 7465 - marked (1000) 310 4100 4100 4100	4.00
GB167	30 each 7466 - marked (1000) 310 4100 4100 4100	4.00
GB168	30 each 7467 - marked (1000) 310 4100 4100 4100	4.00
GB169	30 each 7468 - marked (1000) 310 4100 4100 4100	4.00
GB170	30 each 7469 - marked (1000) 310 4100 4100 4100	4.00
GB171	30 each 7470 - marked (1000) 310 4100 4100 4100	4.00
GB172	30 each 7471 - marked (1000) 310 4100 4100 4100	4.00
GB173	30 each 7472 - marked (1000) 310 4100 4100 4100	4.00
GB174	30 each 7473 - marked (1000) 310 4100 4100 4100	4.00
GB175	30 each 7474 - marked (1000) 310 4100 4100 4100	4.00
GB176	30 each 7475 - marked (1000) 310 4100 4100 4100	4.00
GB177	30 each 7476 - marked (1000) 310 4100 4100 4100	4.00
GB178	30 each 7477 - marked (1000) 310 4100 4100 4100	4.00
GB179	30 each 7478 - marked (1000) 310 4100 4100 4100	4.00
GB180	30 each 7479 - marked (1000) 310 4100 4100 4100	4.00
GB181	30 each 7480 - marked (1000) 310 4100 4100 4100	4.00
GB182	30 each 7481 - marked (1000) 310 4100 4100 4100	4.00
GB183	30 each 7482 - marked (1000) 310 4100 4100 4100	4.00
GB184	30 each 7483 - marked (1000) 310 4100 4100 4100	4.00
GB185	30 each 7484 - marked (1000) 310 4100 4100 4100	4.00
GB186	30 each 7485 - marked (1000) 310 4100 4100 4100	4.00
GB187	30 each 7486 - marked (1000) 310 4100 4100 4100	4.00
GB188	30 each 7487 - marked (1000) 310 4100 4100 4100	4.00
GB189	30 each 7488 - marked (1000) 310 4100 4100 4100	4.00
GB190	30 each 7489 - marked (1000) 310 4100 4100 4100	4.00
GB191	30 each 7490 - marked (1000) 310 4100 4100 4100	4.00
GB192	30 each 7491 - marked (1000) 310 4100 4100 4100	4.00
GB193	30 each 7492 - marked (1000) 310 4100 4100 4100	4.00
GB194	30 each 7493 - marked (1000) 310 4100 4100 4100	4.00
GB195	30 each 7494 - marked (1000) 310 4100 4100 4100	4.00
GB196	30 each 7495 - marked (1000) 310 4100 4100 4100	4.00
GB197	30 each 7496 - marked (1000) 310 4100 4100 4100	4.00
GB198	30 each 7497 - marked (1000) 310 4100 4100 4100	4.00
GB199	30 each 7498 - marked (1000) 310 4100 4100 4100	4.00
GB200	30 each 7499 - marked (1000) 310 4100 4100 4100	4.00

POTENTIOMETERS

GB113	30 each 10K Linear - 1000 Ohm (1000) 1000	\$4.00
GB114	30 each 10K Linear - 1000 Ohm (1000) 1000	4.00
GB115	30 each 10K Linear - 1000 Ohm (1000) 1000	4.00
GB116	30 each 10K Linear - 1000 Ohm (1000) 1000	4.00
GB117	30 each 10K Linear - 1000 Ohm (1000) 1000	

QUALITY parts at DISCOUNT PRICES!

4 CHANNEL 8 TRACK HOME UNIT

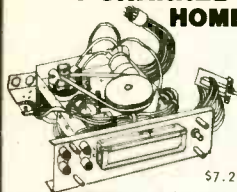

BRAND NEW UNITS... ASSEMBLY INCLUDES; TAPE HEAD, MOTOR BELT, 110VAC MOTOR, PRE-AMP, LIGHTS, SWITCHES, SOLENOID AND OTHER USEFUL PARTS... AN EXCEPTIONAL BUY! \$7.25 PER ASSEMBLY

4PDT RELAY

• 14 pin style
• 3 amp contacts
• 24 volt d.c. or 120 volt a.c. Coil
• Used but fully tested
\$1.70 EACH
specify coil voltage
LARGE QUANTITIES AVAILABLE
SOCKETS FOR RELAY 50¢ each



BLACK PLASTIC CASE



PAC-TEC SERIES C
BLACK PLASTIC ENCLOSURE ADJUSTABLE HEIGHT FROM 1.63" TO 2.93"; WIDTH 6.85"; DEPTH 8". BUILT-IN STAND OFFS FOR P.C. BOARDS... FRONT AND BACK PANELS NOT INCLUDED... \$5.25 PER CASE

MINI SIZE BUZZERS

1 1/2 to 3 volts 75¢ ea WITH WIRE LEADS
1 1/2 to 3 volts 75¢ ea WITH PIN TERMINALS
3 to 7 volts WITH PIN TERMINALS 75¢ each



JOYSTICK

PRECISION DEVICE... CONTAINS 4 50K CENTER TAPPED ALPS POTS... \$4.75 each



MITSUMI MODEL UES-A55F VARACTOR UHF TUNER

FREQ. RANGE 470 - 889 MHZ
ANTENNA INPUT 300 OHMS
\$25.00 each
10 for \$220.00



FLAT LEVER MINI-TOGGLE SMD-T (ON-ON)

5 AMP @ 120 VAC
C & K 7101
\$1.00 EACH
10 for \$8.50
100 for \$75.00



SEND FOR NEW 1982 Free! 40 PAGE CATALOG Free!

COMPUTER GRADE CAPACITOR

1700 mfd. 150VDC \$2.00
2 1/2" DIA X 4 3/4" HIGH
3,600 mfd. 40VDC \$1.00
1 3/8" DIA. X 3" HI
6,400 mfd. 60VDC \$2.50
1 3/8" DIA. X 4 1/4"
12,000 mfd. 40VDC \$3.00
2 1/2" DIA X 4 1/4" HIGH
18,000 mfd. 75VDC \$4.00
2 1/2" DIA X 4 1/2" HIGH \$2.00
20,000 mfd. 25VDC
2" DIA. X 2 1/2" HIGH
22,000 mfd. 15VDC
2" DIA X 2 1/2" HIGH \$2.00
22,000 mfd. 40VDC
2" DIA. X 6" HIGH \$3.00
25,000 mfd. 75VDC \$4.50
3" DIA X 4 3/8" HIGH
45,000 mfd. 25VDC \$3.50
2" DIA. X 4" HIGH
72,000 mfd. 15VDC
2" DIA. X 4" HIGH \$3.50
CLAMPS TO FIT CAPACITORS 50¢ ea.



L.E.D.'s STANDARD JUMBO DIFFUSED

RED 10 FOR \$1.50
GREEN 10 FOR \$2.00
YELLOW 10 FOR \$2.00
FLASHER LED
5 VOLT OPERATION JUMBO SIZE.
2 FOR \$1.70
BI POLAR LED
2 FOR \$1.70
SUB MINI LED
.079" X .098"
20mA at 1.75v
10 FOR \$1.00
200 FOR \$18.00
QUANTITY PRICES AVAILABLE

CANNON XLRA-313 CONNECTOR
3 PRONG CHASSIS MOUNT CONNECTOR
\$2.00 EACH
10 for \$19.00

BLACK LIGHT (ULTRAVIOLET)
G.E. # F675BL \$2.50 each

TRANSFORMERS

120 volt primaries
6 VOLTS at 150 mA \$1.25
12 V.C.T. at 500 mA \$2.50
16.5 V. at 3 AMPS \$6.50
18 VOLTS at 350 MA \$2.00
18 VOLTS at 1 AMP \$4.50
25.2 V.C.T. at 2.8 AMP \$5.50

SPECIAL MRF 901
MICROWAVE TRANSISTOR \$2.50 EA.

SUPER SMALL PHOTO-FLASH
170 MFD 330 V
1 1/4" X 7/8"
2 FOR \$1.50
10 FOR \$7.00

750 MFD 330 V PHOTO FLASH
2" HIGH X 1 1/4" DIA.
\$1.25 EACH
10 FOR \$11.00

500K LINEAR SLIDE POT
2 7/8" LENGTH
1 3/4" TRAVEL
75¢ EACH

2" ALLIGATOR CLIPS
7 clips for \$1.00
100 clips for \$12.00
500 clips for \$50.00

ALL ELECTRONICS CORP.
905 S. Vermont Ave.
P.O. BOX 20406
Los Angeles, Calif. 90006
(213) 380-8000
Mon. - Fri. Saturday
9 AM - 5 PM 10 AM - 3 PM

TERMS
• Quantities Limited
• Min. Order \$10.00
• Add \$2.50 Shipping USA
• Calif. Res. Add 6%
• Prompt Shipping

AMAZING DEVICES

PHASORS/SHOCKWAVE

PPF-1. PHASOR PAIN FIELD — Is being tested by Gov't for riot control. Soon to come under weapons restrictions as an infernal machine. Easily hand-held Hazardous — Use with discretion SOLO ONLY FOR ANIMAL CONTROL
PPF-1 PLANS \$15.00
IPG-3. INVISIBLE PAIN FIELD GENERATOR — Produces directional field of moderately intense pain to lower back of head up to 50 ft. Cigarette pack sized enclosure is easily hidden.
IPG-3 PLANS \$7.00 IPG-3K KIT \$39.50
IPG-30 ASSEMBLED FOR ANIMAL CONTROL \$49.50
HUG-1. HIGH POWERED ULTRASONIC GUN — Produces directional 130 db of sound pressure energy at 20-24 kHz. Hand-held, intended for lab use.
HUG-1 PLANS \$10.00

LASERS
PARTICLE BEAM WEAPON PLANS \$15.00
LHP-2 BEGINNER VISIBLE RED NON-HAZARDOUS OPTICAL LASER. Adjustable pulse.
LHP-2 PLANS \$7.00 LHP-2K KIT \$39.50
LP-3/LRG-3 LASER PISTOL AND RIFLE COMBINATION — 7-24 watts of infrared energy.
LP-3/LRG-3 PLANS \$10.00
LGU-1 VISIBLE RED LASER GUN for holography, special effects, cloud writing, etc.
LGU-1 PLANS \$10.00
LC-1 BURNING/CUTTING CO2 LASER — 10-40 watts continuous.
LC-1 PLANS \$15.00

RUB-1 WELDING/DRILLING RUBIYAG LASER, intense red.
RUB-1 PLANS \$15.00
HPS-1 HIGH POWERED PORTABLE ENERGY SOURCE FOR LASERS & MAGNETIC WEAPONS: exploding wires, stock waves, etc.
HPS-1 PLANS \$8.00 HPS-1K KIT \$49.50

SECURITY/PERSONAL PROTECTION
INF-1. INFINITY TRANSMITTER — Uses telephone lines for selective home or office listening while away on business or vacation.
INF-1 PLANS \$15.00
SD-4. SEE IN THE DARK — Device, long range.
SD-4 PLANS \$10.00
VWPM-5. WIRELESS TELEPHONE TRANSMITTER — Long range.
VWPM-5 PLANS \$10.00 VWPM-5K KIT \$34.50

FBT-7. WIRELESS MICROPHONE — Extended range.
FBT-7 PLANS \$7.00 FBT-7K KIT \$34.50
HOD-1/TIT-6. ELECTRONIC TRACKING AND HOMING DEVICE — LASERS & MAGNETIC WEAPONS: exploding wires, stock waves, etc.
HOD-1/TIT-6 PLANS \$6.00 HOD-1/TIT-6K KIT \$39.50

TAT-2. TALK AND TELL — Device records telephone when in use.
TAT-2 PLANS \$5.00 TAT-2K KIT \$14.50
PSW-3. PHASOR STUN WAND — Produces energy capable of burning flesh intended as a last resort personal defense weapon.
PSW-3 PLANS \$8.00 PSW-3K KIT \$59.50

Send for free catalog descriptions of above items, kits and parts, plus hundreds more. We accept, Master Charge and VISA or when ordering send check or money order to:
SCIENTIFIC SYSTEMS
DEPT. R8 BOX 716, AMHERST N.H. 03031

CIRCLE 87 ON FREE INFORMATION CARD

30 TUNE MELODY MICROPROCESSOR

FEATURES
• 30 Melodies
• Variable Tune Speed
• Variable Volume
• Direct Output To Speaker
• Auto or Manual Tune Change
• Low Power
• Operated By Two 9V Batteries

APPLICATIONS
• Electronic Door-chimes
• Musical Car-horn
• Entrance Warning
• Music Box
Spec Sheet & Typical Circuit Schematic Included

- | | | |
|-----------------------------|---------------------------|--------------------------------|
| 1 Pomp & Circumstances | 11 La Marseillaise | 21 Wilhelmus |
| 2 Auld Lang Syne | 12 Happy Birthday | 22 Wedding March |
| 3 Charge! | 13 Jingle Bells | 23 Sailor's Hornpipe |
| 4 Rue Britannia | 14 Soldiers Chorus (Fest) | 24 Shave and a Haircut |
| 5 Westminster Chimes | 15 Close Encounters Theme | 25 Colonel Bogey March |
| 6 Deutschland | 16 O Canada | 26 Turkish Lullaby Little Bear |
| 7 Greensleeves | 17 Mexican Hat Dance | 27 William Tell Overture |
| 8 Star Spangled Banner | 18 God Save The Queen | 28 Eyes of Texas |
| 9 Mozart Sonata | 19 Orange & Lemons | 29 Bach Toccata in D Minor |
| 10 Beethoven's 5th Symphony | 20 Blue Danube Waltz | 30 Lullaby |

Special Offer **\$6.95** Two For **\$13.00**
Ca. Res. Add 6% Tax Postage & Handling Add \$1.50

LIMITED QUANTITY CLEARANCE Electronic Door-Tunes

These units are complete with all parts including microprocessor described above. Minor problems require troubleshooting.

Schematic included, as is... only **\$14.95**
Shipping & Handling... \$ 3.00
500K Lin. Pots. 65¢ ea. or 4/\$2.00
6Ft. Coax with RCA plugs: 3/\$2.00
Ca. Res. Add 6% Tax. Postage 50¢
Check or M.O. • Visa & Master Card Accepted
SRJ INTERNATIONAL CORP.
1936 Hillman Avenue
Belmont, Calif. 94002

CIRCLE 86 ON FREE INFORMATION CARD

ELECTRONIC KITS FROM HAL-TRONIX

2304 MHZ DOWN CONVERTERS. TUNES IN ON CHANNELS 2 TO 7 ON YOUR OWN HOME T.V. HAS FREQUENCY RANGE FROM 2000 MHZ TO 2500 MHZ. EASY TO CONSTRUCT AND COMES COMPLETE WITH ALL PARTS INCLUDING A DIE-CAST ALUM CASE AND COAX FITTINGS, REQUIRE A VARIABLE POWER SUPPLY AND ANTENNA (Antenna can be a dish type or coffee can type depending on the signal strength in your area.)

- 2304 MOD 1 (Basic Kit) \$49.95
(Less case & fittings)
2304 MOD 2 (Basic / Pre-amp) \$59.95
(Includes case & fittings)
2304 MOD 3 (Hi-Gain Pre-amp) \$69.95
(Includes case & fittings)
POWER SUPPLY FOR EITHER MODEL ABOVE IS AVAILABLE. COMES COMPLETE WITH ALL PARTS. CASE, TRANSFORMER, ANTENNA SWITCH AND CONNECTORS (Kit) \$24.95
Assembled \$34.95
Slotted Microwave Antenna For Above Downverters... \$39.95

PREAMPLIFIERS
HAL PA-19—1.5 mhz to 150 mhz. 19db gain operates on 8 to 18 volts at 10ma. Complete unit \$8.95.
HAL PA-1.4—3 mhz to 1.4 ghz. 10 to 12 db gain operates on 8 to 18 volts at 10ma. Complete unit \$12.95.
(The above units are ideal for receivers, counters, etc.)

- 16 LINE TOUCH TONE DECODER KIT WITH P.C. BOARD AND PARTS \$69.95
12 LINE TOUCH TONE DECODER KIT WITH P.C. BOARD AND PARTS \$39.95
16 LINE ENCODER KIT, COMPLETE WITH CASE, PAD AND COMPONENTS \$39.95
12 LINE ENCODER KIT, COMPLETE WITH CASE, PAD AND COMPONENTS \$29.95

MANY, MANY OTHER KITS AVAILABLE

Send 20 cents stamp or S.A.S.E. for information and flyer on other HAL-TRONIX products. To order by phone: 1-313-285-1782.

HAL-TRONIX
P.O. Box 1101
Southgate, MI 48195

ORDERS OVER \$25.00 WILL BE SHIPPED POSTPAID EXCEPT ON ITEMS WHERE ADDITIONAL CHARGES ARE REQUESTED. ON ORDERS LESS THAN \$25.00 PLEASE INCLUDE ADDITIONAL \$2.00 FOR HANDLING AND MAILING CHARGES.

CIRCLE 91 ON FREE INFORMATION CARD

over 1600 products!
includes technical tips & information

FREE CATALOG

Burglar/Fire Alarms Security Products



Alarm Controls • Remote Stations
Infrared • Motion Detectors • Sirens
Microwave • CCTV • Fire Detectors
Vehicle Alarms • Phone Dialers
Key Locks • Wireless Components
Magnetic Contacts • Glass Protection
Lights • System Parts • Tools • Books
Bells • Ionization Smoke Detectors

mountain west
4215 N. 16th Street Dept. RE-5
Phoenix, AZ 85016
1-800-528-6169

CIRCLE 89 ON FREE INFORMATION CARD

RADIO-ELECTRONICS

PAT. # 4,259,705

WARNING!

Electric Power Pollution, Spikes, Interference & Lightning HAZARDOUS to HIGH TECH EQUIPMENT!!



MicroComputers, VTR, Hi-Fi, Lasers, Spectrometers are often damaged or disrupted due to Power Pollution.

High Tech components may interact!

Our patented ISOLATORS eliminate equipment interaction, curb damaging Power Line Spikes, Tame Lightning bursts & clean up interference.

Isolated 3-prong sockets; integral Spike/Lightning Suppressor. 125 V, 15 A, 1875 W Total, 1 KW per socket.

ISO-1 ISOLATOR. 3 Isolated Sockets; Quality Spike Suppression; Basic Protection \$69.95

ISO-3 SUPER-ISOLATOR. 3 DUAL Isolated Sockets; Suppressor; Commercial Protection \$104.95

ISO-17MAGNUM ISOLATOR. 4 QUAD Isolated Skts; Suppressor; Laboratory Grade Protection \$181.95

Master-Charge, Visa, American Express

TOLL FREE ORDER DESK 1-800-225-4876 (except AK, HI, MA, PR & Canada)

SATISFACTION GUARANTEED!

Electronic Specialists, Inc.

171 South Main Street, Natick, MA 01760

Technical & Non-800: 1-617-655-1532

CIRCLE 88 ON FREE INFORMATION CARD



FREE!

1982 DISCOUNT ELECTRONICS CATALOG

JOIN THE PAK!

Send for our Free catalog and become a member of our exclusive Pak. Our members receive Poly Paks' exciting catalog several times a year. We offer:

- Penny Sales, Free Premiums and Low, Low Prices on a wide variety of

Electronic Products such as Computer Peripherals, Integrated Circuits, Speakers, Audio Equipment, Rechargeable Batteries, Solar Products, Semiconductors, and much, much more!

Take advantage of our 25 years as America's foremost Supplier of discount electronics.

RUSH ME YOUR FREEDISCOUNT CATALOG!

NAME: _____

ADDRESS: _____

CITY: _____

STATE: _____ ZIP: _____

CLIP AND MAIL COUPON TODAY TO:

POLY PAKS, INC.

P.O. Box 942, RA-5

S. LYNNFIELD, MA. 01940

(617) 245-3828

CIRCLE 90 ON FREE INFORMATION CARD

HOBBYISTS & EDUCATORS



ELECTRONICS CO., INC.

SEND OR CALL

for your **FREE** 1982

PPG Electronics

Projects

Handbook/

catalog.

A 48 page Handbook with 48 SUPER exciting, low cost, electronic projects. (Some projects as low as \$2.50).

EACH PROJECT is shown with:

- Complete schematic
- Complete parts list
- Project description
- Kit prices

RECEIVE full information on projects such as:



TELEPHONE HOLE BUTTON



DUAL BURGLAR ALARM



STROBE LIGHT



NERVE TESTER



ROBOT BLINKER



3-CHANNEL COLOR ORGAN



DIGITAL SLOT MACHINE



COMBINATION LOCK

Also available, complete Basic Electronics Course

DEALERS

Cash in on the electronics revolution now. PPG has sold hundreds of thousands of these electronic kits to schools and training institutions. We are offering these exciting kits through electronics stores across the nation.

Contact us immediately for your Dealer's Free Information Package. Find out how you can get started in this exciting and fast growing retail market.

CALL THIS TOLL-FREE NUMBER FOR YOUR FREE HANDBOOK AND THE NAME OF THE DEALER NEAREST YOU.

Toll-Free 1 (800) 453-1708

Utah residents 1 (801) 628-3627

PPG Electronics Co., Inc.

791 Red Rock Road,

St. George, Utah, 84770

PPG GATEWAY TO THE ELECTRONIC AGE

Special Prices For Educators

CIRCLE 81 ON FREE INFORMATION CARD

B. G. MICRO

P. O. Box 280298 Dallas, Texas 75228

(214) 271-5546

Visa • MasterCard • American Express

STATIC RAM

*21L02-1KX1 250 n.s. Low Power 95	
2114L-3 1KX4 300 n.s. Low Power 2.75 8/17.95	
HM6116P-4-2KX8 + 5v-200 n.s. CMOS Low Power 2716 Style Pin Out 13.50 8/95.00	
TMM2016-2KX8 + 5v-NMOS 200 n.s. - 2716 Style Pin Out 13.50 8/95.00	
MK4104J-4 250NS 4K x 1 STATIC 18 PIN CERAMIC Computer Mfg. Surplus. PRIME. Fully Static. Easy to Use. Has Same Pin Out as TMS4044, but slightly different timing. With Specs. (Mostek)	
8 for 12.00 32 for 39.95 VERY LOW POWER!	

SOCKETS

Low Profile Solder Tail	
14 Pin 10/1.00	
16 Pin 8/1.00	
18 Pin 8/1.00	
20 Pin 7/1.00	
24 Pin 6/1.00	
40 Pin 5/1.00	

Buy \$10 Get \$1.00
FREE CHOICE

74LS

LS00 .24	LS125 .95	LS243 1.49
LS02 .24	LS138 .79	LS244 .99
LS04 .24	LS139 .79	LS245 1.95
LS05 .24	LS151 .79	LS257 .79
LS08 .24	LS153 .79	LS266 .59
LS10 .24	LS154 1.75	LS283 .99
LS14 .89	LS157 .79	LS290 .99
LS20 .24	LS161 .99	LS293 1.75
LS27 .24	LS164 .99	LS298 .89
LS30 .24	LS166 .99	LS367 .79
LS32 .36	LS175 .89	LS368 .79
LS42 .49	LS181 1.99	LS373 .99
LS74 .44	LS192 .89	LS374 1.49
LS85 .95	LS193 .89	LS375 1.19
LS86 .39	LS221 1.10	LS377 1.49
LS90 .69	LS240 .99	LS390 1.19
LS109 .39	LS241 .99	LS393 1.19
LS123 .99	LS242 1.49	LS399 .99

DYNAMIC RAM

2107B-4 (MM5280N-5) 4KX1 22 Pin 1.59	
4027-4KX1-250 n.s. 1.75	
*4116-16KX1-300 n.s. 8/12.95	
*4116-16KX1-200 n.s. 8/15.95	
HM4164- +5v 64K Dynamic 12.95 8/95.00	

MISCELLANEOUS

*TR1602-UART same as AY5-1013 1.99	
*IM6402-+5v High speed UART-AY5-1013 pin out 2.00	
*MC1488-1489-RS232 Receiver and drive H.# 1.19	
AY3-8910-Sound Chip with 60 page data manual 12.95	
82S123-32X8 Tri State Bi polar PROM 3.99	
4.916MHZ Baud Rate Crystal 1.99	
1771 Single Density Floppy Disc Controller 22.50	
1791 Double Density FDC 29.95	
DM8131 6 Bit Unified Bus Comparator 2.99	
8 Pin Dip Jumpers 3/1.00	
82S129 Tri State Bi Polar Prom SPECIAL 2.59	

EPROM

*1702A 256X8 1 us 2708 1KX8 450 n.s. 2.95	
27A08 1KX8 350 n.s. 3.95	
*2716 2KX8+5v 450 n.s. 5.95	
*2716-1 2KX8+5v 350 n.s. 9.95	
*2732 4KX8 450 n.s. 9.95	
Intel Pin Out	
*2532 4KX8 450 n.s. 9.95	
T.I. Pin Out	
2732A-3 4K x 8 350 n.s. 9.95	
Intel Pin Out Low Power 12.95	

Z80

Z80A-4MHZ CPU 8.95	
Z80P10 - Parallel 5.95	
Z80S10/O Chan. Ser. 24.95	
Z80A-SIO/O 29.95	
*Z80DMA-DMA Controller 9.95	
Z80 2.5 MHZ CPU 6.95	

CALL OR WRITE FOR PRICES ON CMOS-8080 - BIT SLICE - TTL - 74S

TERMS: Add \$1.50 postage, we pay balance. Orders over \$50.00 add 8% for Insurance. No C.O.D. Texas Res. add 6% Tax, 90 Day Money Back Guarantee on all items. All items subject to prior sale. Prices subject to change without notice. Foreign order - U.S. funds only. We cannot ship to Mexico. Countries other than Canada, add \$3.50 shipping and handling.

LOW TIM DC STEREO PRE-AMP KIT TA-10-20

Incorporates brand-new D.C. design that gives a frequency response from 0Hz-100KHz ± 0.5dB! Added features like tone defeat and loudness control let you tailor your own frequency supplies to eliminate power fluctuation! Specifications: • T.H.D.: less than .005% • T.I.M. less than .005% • Frequency response: DC to 100KHz ± 0.5dB • RIAA deviation: ± 0.2dB • S/N ratio: better than 70dB • Sensitivity: Phono 2MV 47K/Aux. 100MV 100K • Output level: 1.3V • Max output: 15V • Tone control: bass ± 10dB @ 50Hz/treble ± 10dB @ 15Hz • Power supply: ± 24 D.C. @ 0.5A
Kit comes with regulated power supply, all you need is a 48V C.T. transformer @ 0.5A.

ONLY \$44.50
X'former
\$4.50 ea.



100W CLASS A POWER AMP KIT

Dynamic Bias Class "A" circuit design makes this unit unique in its class. Crystal clear, 100 watts power output will satisfy the most picky fans. A perfect combination with the TA-1020 low T.I.M. stereo pre-amp.

- Specifications:
- Output power: 100W RMS into 8-ohm 125W RMS into 4-ohm
 - Frequency response: 10Hz-100KHz
 - T.H.D.: less than 0.008%
 - S/N ratio: better than 80dB
 - Input sensitivity: 1V max.
 - Power supply: ± 40V @ 5 amp
 - One channel, needs two for stereo



TA-1000KIT \$51.95
Power transformer
\$24.00 each

50 WATTS AUTO STEREO BOOSTER BY VERTRONIX

- Specifications:
- 50 watts RMS total (25W + 25W)
 - Frequency Response: ± 0.5dB, 20Hz~20KHz
 - T.H.D.: 0.2% at full rated output
 - Input Impedance: 20K ohms
 - Crosstalk: Better than 90dB
 - Sensitivity: 1.5V for full rated output
 - S/N Ratio: Greater than 95dB
 - Speaker Load: 2~8 ohms
 - Voltage Supply: 9~18VDC

Model V-Amp 500
REG. PRICE \$119.00 EACH
OUR SPECIAL PRICE \$55.00 EACH

"FISHER" 30 WATT STEREO AMP

Kit includes 2 pcs. Fisher PA 301 Hybrid IC all electronic parts with PC Board. Power supply ± 16V DC (not included). Power bandwidth (KF 1% ± 3dB). Voltage gain 33dB 20Hz-20KHz.

Super Buy
Only **\$18.50**

5W AUDIO AMP KIT

2 LM 380 with Volume Control
Power Supply 6 18V DC
ONLY \$6.00 EACH



2 WATT AUDIO AMP

Pre assembled units. All you need is to hook up the speaker and the volume control. Supply voltage from 9V 15V D.C. measures only 2" x 3 1/2", making it good for portable or discrete applications. Comes with hook up data.



BUY 2 FOR \$4.99

1 WATT AUDIO AMP

All parts are pre-assembled on a mini PC Board. Supply Voltage 6~9V D.C.
SPECIAL PRICE \$1.95 ea.



NEW MARK III 9 Steps 4 Colors LED VU

Stereo level indicator kit with arc-shape display panel!!! This Mark III LED level indicator is a new design PC board with an arc-shape 4 colors LED display (change color from red, yellow, green and the peak output indicated by rose). The power range is very large from -30dB to +5dB. The Mark III indicator is applicable to 1 watt - 200 watts amplifier operating voltage is 3V-9V DC at max 400 MA. The circuit uses 10 LEDs per channel. It is very easy to connect to the amplifier. Just hook up with the speaker output!

IN KIT FORM \$18.50

MARK IV 15 STEPS LED POWER LEVEL INDICATOR KIT

This new stereo level indicator kit consists of 36 4-color LED (15 per channel) to indicate the sound level output of your amplifier from -36dB +3dB. Comes with a well-designed silk screen printed plastic panel and has a selector switch to allow floating or gradual output indicating. Power supply is 6 12V D.C. with THG on board input sensitivity controls. This unit can work with any amplifier from 1W to 200W!

Kit includes 70 pcs. driver transistors, 38 pcs. matched 4-color LED, all other electronic components, PC board and front panel.



MARK IV KIT \$31.50

MARK V 15 STEPS LED POWER OUTPUT INDICATOR KIT

All functions same as Mark IV but this is with heavy duty aluminum front plate and case. Can be easily slot into the front panel of your auto, truck or boat. Operates on 12V DC.



\$41.50 EACH KIT

SOLID STATE STEREO GRAPHIC EQUALIZER PRE AMP KIT TA-2500

- Specifications:
- Total Harmonic Distortion: Less than 0.05%
 - Intermodulation Distortion: (70Hz:7KHz = 4:1 SMPTE Method) Less than 0.03%
 - Frequency Response: Overall 10Hz ~ 100KHz +0.5dB, -1dB
 - RIAA Curve Deviation: (Phono) +0.2dB, -0.2dB (30Hz~15KHz)
 - Channel separation (at rated output 1KHz)
 - Phono, Tuner, Aux and Tape Monitor better than 70dB
 - Input sensitivity and impedance (1KHz for rated output) Phono: 2MV 47K ohms Aux: 130MV 50K ohms Tuner: 130MV 50K ohms Tape: 130MV 50K ohms
 - Graphic Equalizer control: 10 Band Slide Control
 - Frequency Bands: 31 5Hz; G3Hz; 125Hz; 250Hz; 500Hz; 1KHz; 2KHz; 4KHz; 8KHz; 16KHz also with on panel selector for Phono, Tuner, Aux 1 and Aux 2.
 - Power Supply: 117 VAC

Kit comes with all electronic components, transformer, instructions and a 19" rack mount type metal cabinet.



MODEL TA-2500 \$119.00 PER KIT

ELECTRONIC DUAL SPEAKER PROTECTOR

Cut off when circuit is shorted or over load to protect your amplifier as well as your speakers. A must for OCL circuits.



KIT FORM \$8.75 EA.

PROFESSIONAL REGULATED VARIABLE D.C. POWER SUPPLY KIT

All solid state circuitry with high efficiency power transistor 2SD388 and I.C. voltage regulator MC1733. Output voltage can be adjusted from 0-30V at 1 amp current limited or 0-15V at 2 amp current limited. Internal resistance is less than 0.005 ohm; ripple and noise less than 1 mV, dual on panel meter for voltage and amp reading, also with on board LED and audible over load indicator. Kit comes with predrilled P.C. board, instructions, all necessary electronic components, transformer and a professional look metal cabinet. The best project for school and the most useful instrument for repairman.

Build one today!
MODEL TR 88A 0~15V D.C. 2 amp
MODEL TR 88B 0~30V D.C. 1 amp

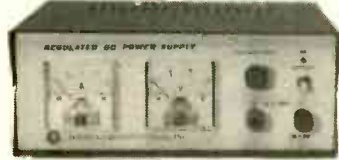

\$59.50 PER KIT

REGULATED DUAL VOLTAGE SUPPLY KIT

± 4~30V DC 800 MA adjustable, fully regulated by Fairchild 78MG and 79MG voltage regulator I.C. Kit includes all electronic parts, filter capacitors, I.C., heat sinks and P.C. board.



\$12.50 PER KIT

POWER SUPPLY KIT

0-30V D.C. REGULATED
Uses UA723 and ZN3055 Power TR output can be adjusted from 0-30V, 2 AMP. Complete with PC board and all electronic parts. Transformer for Power Supply, 2 AMP 24V x 2 **\$9.50**



0-30 Power Supply
\$10.50 each

TA-323 6 WATTS TOTAL 30W + 30W STEREO AMP KIT

This is a solid state all transistor circuitry with on board stereo pre-amp for most microphone or phone input. Power output employs 2 pairs matching Darlingtons Transistors. Driven by the popular ZN3053 Driver Transistors. Four built on board controls for: volume, balance, treble and bass. Power supplies requires 48 VET 2.5 amp transformer. T.H.D. of less than 0.1% between 100 Hz and 10KHz at full power. (30 Watts + 30 Watts loaded by 8~).

★ SPECIAL ★ EXCELLENT PRICE!

MODEL 001-0034
Transformer (Optional)
\$29.50 PER KIT
\$10.50 EACH

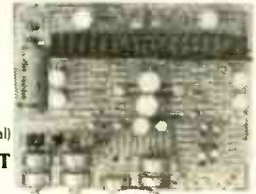

200 WATTS CLASS 'A' STEREO POWER AMP KIT TA-2600 (WITH LED POWER LEVEL DISPLAY AND RACK MOUNT TYPE CABINET)

TA-2600 is a kit that combines two sets of TA-1000 class A power amplifiers that can give you 100 watts of true power per channel. The kit also has the latest "V" shape LED power level display with memory Peak Hold on the front panel. For speaker protection it also has separate electronic speaker protection circuits. Kit comes with the 19" rack mount type metal cabinet with a professional quality black anodized front panel: all electronic parts and components: P.C. boards; filter capacitors and a heavy duty transformer. Specifications:

- Power Level Display: Electronic LED type, 12 LED per channel from -18 dB to 0 dB with Peak Hold memory
- Power Amplifier: Output power: 100 Watts per channel into 8 Ohm load. 125 Watts into 4 Ohm load. Total Music power output 250 Watts Max
- Frequency Response: 10 Hz to 100 KHz
- Total Harmonic Distortion: Less than 0.008% at full power
- Signal/Noise Ratio: better than 80 dB
- Input Sensitivity: 1V Max



MODEL TA-2600 \$285.00 FULLY ASSEMBLED
\$225.00 KIT FORM



FORMULA INTERNATIONAL INC.

	SHIPPING AND HANDLING CHARGES	
	Under \$20.00 purchase	Over \$20.00 purchase
Inside California	10%	5%
Outside Calif. (includes Mexico & Canada)	15%	10%
Overseas	25%	20%

Minimum Order \$10.00/Calif. Residents Add 6% Sales Tax
Phone Orders Accepted on Visa or MC ONLY. NO C.O.D. Store Hours 10-7 Mon-Thu-Sat

12603 CRENSHAW BLVD. HAWTHORNE, CA 90250
PHONE: (213) 973-1921 • (213) 679-5162

Send \$1.00 For Detailed Catalogue



FOR COMMERCIAL FREE TV BOX BUILDERS

MC 1358	\$2.50	LM 7815	\$1.20
MC 1350	\$2.00	NE 565	\$2.00
MC 1330	\$3.00	Connectors Set	\$1.00
LM 1458	\$1.00	I.C. Socket Set	\$2.00
LM 380	\$2.00	Matching Transformer	\$1.40
Sanyo UHF Tuner	\$35.00	Tolriod Coils (Set of 4)	\$3.00
Capacitors Set	\$12.50	Speaker Cabinet	\$12.95
Resistors Set	\$2.00	Transformer	
Trim Pots:		18V 800MA	\$3.00
Trim Caps Set	\$13.50		
Pots and Knobs	\$2.00		

We sell you all the above components in a package for **\$125.00** and you will receive a free predrilled P.C. board and instructions at no charge!

SANYO UHF VARACTOR TUNER
For UHF CH 14 83

Tuning voltage +1V ~ +28V D.C. Input impedance 75 OHM. I.F. band width 7 ~ 16 MHz. Noise figure 11.5dB MAX. Size 2 3/8" x 1 1/4" x 3/4". Supply voltage 15V D.C. Sound I.F. = 58.0 MHz. Video I.F. = 62.5 MHz.



All units are brand new from Sanyo.
MODEL 115-B-405A
\$35.00 EACH

Tuner is the most important part for the circuit. Don't let those \$19.00 tuners fool you!

TV GAME BOARD

PLAYS 4 GAMES: TENNIS; HOCKEY; HANDBALL AND JAI-ALAI.

All boards complete with all parts ready to play. Requires 6C size batteries and a small speaker for sound effects. The boards were surplus from a famous game manufacturer. They will play on all US standard black and white or color TV sets. (Regular price for these games were \$39.50 each)
OUR PRICE ONLY \$6.50 EACH



PART #57456

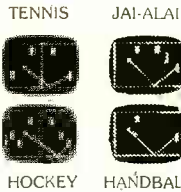

TENNIS JAI-ALAI
HOCKEY HANDBALL

ELECTRONIC PIN BALL MACHINE



That sounds and plays like the real thing. All units are brand new but without the case. Functions of the game include double flipper control, kicker control, 1-4 players, 3 speed ball control, tilt switch, automatic score, extra bonus cave and many more. All solid state with LED panel, no moving parts. Requires 9V battery to operate, speaker not included.

A perfect gift for yourself or friends.
SPECIAL **\$8.99 EACH** SPEAKER **\$1.25 EACH**

ELECTRONIC MUSICAL TELEPHONE REST KIT

This telephone rest can be used as a door charm, an audible indicator and for many other sound projects. The special custom made I.C. is pre programmed with 4 musical tunes. Kit comes with a nice looking plastic case, pre-drilled P.C. board, volume control, special sound I.C. speakers and all electronic components and instructions. Ideal for home or school projects.



MODEL FIH-3000

BUY NOW!

SPECIAL PRICE! ONLY

\$15.50 PER KIT

DIGITAL TIMER/CLOCK

- 24 Hour preset time to turn on or off
- 12 Hour green 0.5" display for time
- operated on 12 ~ 16V A.C.

The whole timer is self contained in a compact plastic case (as seen in photo). Designed for VTR with push button switch for easy setting. Limited quantity available.



NOW ONLY \$12.94 MODEL VEQ 0143

SANYO ANTENNA SIGNAL BOOSTER

This Booster is specially designed for UHF Channels (14-83). After installed this unit (between the antenna input cable and the UHF tuner) will have a minimum of 10dB gain, that is approximately 2 times better than what you are seeing now. Ideal for those who live in apartments that cannot put up an outdoor antenna. Size is so small: only 2" x 1 1/2" x 1". Supply voltage is 15 VDC.



★ NEW ITEM ★

MODEL 001-0076

\$12.50 EACH

13 FUNCTIONS LCD TIME MODULE



MODEL 001-0062

\$7.94 EACH

- Displays month, date and day of the week
- Displays hour, minute and second
- AM, PM Indicator
- Alarm 1 and Alarm 2 (Independent)
- 10 Hours Stop Watch
- 12 Hours presettable count down time
- Hour Charm Indicator
- Back light by touch of the switch

These modules are brand new and made by LITRONIX. Designed for a man's watch. Can be used for many applications. Comes with 2 silver batteries and the ceramic round transducer.

MATCHED PAIR POWER TRANSISTORS BY MOTOROLA

MJ2955 PNP 150 Watts BV=60 V	\$3.50
2N3055 NPN I.C.=15 A	per pair
MJE2955 PNP 90 Watts BV=60 V	\$3.00
MJE3055 NPN I.C.=10 A	per pair
MJ15003 NPN 250 Watts BV=140 V	\$12.00
MJ15004 PNP I.C.=20 A	per pair

All above parts guaranteed to be prime and come with data sheets.

MUFFIN FANS FOR EQUIPMENT COOLING



These fans are pulled out from used computers. But carefully cleaned by ultrasonic cleaner. All in "like-new" condition. Size 4 11/16" x 1-1/2" x 4 11/16"
MODEL MF505
\$9.50 EACH

FLUORESCENT LIGHT DRIVER KIT 12V DC POWERED



Lights up 8 ~ 15 Watt Fluorescent Light Tubes. Ideal for camper, outdoor, auto or boat. Kit includes high voltage coil, power transistor, heat sink, all other electronic parts and PC Board, light tube not included!

\$6.50 Per Kit

PRESS-A-LIGHT SELF GENERATED FLASHLIGHT

Never worry about battery, EXCLUSIVE! **\$3.95 ea.** because it has none! Easy to carry in pocket! and handy to use. Ideal for emergency light. It generates its own electricity by squeezing grip lever. Put one in your car, boat, camper or home. You may need it some time!



Model F-179

No FCC license required.
OUR PRICE \$49.50
ADDITIONAL MICROPHONE (TRANSMITTER) AVAILABLE AT **\$28.00 EACH**



CRYSTAL CONTROLLED WIRELESS MICROPHONE SYSTEM

Transmitter: FET mic for flat 30 ~ 18 KHz response extra controlled 49MHz AM Band for drift-free performance. 100 MW output (range approx. 1/4 mile) for reliable long range transmission. Powered by a 9V radio battery (included).

Receiver: Extra controlled locks on 49MHz transmitter signal. With on panel VU meter

MURA WMS-49

monitors the signal strength from the microphone. Standard phone jack outlet connection to a P.A. or other phone input. 9V battery included. This professional set is ideal for on stage, in field, church, in house or outdoor use.

SUPER FM WIRELESS MIC KIT—MARK III



This new designed circuit uses high FEQ. FET transistors with 2 stages pre amp. Transmits FM Range (88-120 MHz) up to 2 blocks away and with the ultra sensitive condenser microphone that comes with the kit, allows you to pick up any sound within 15 ft. away! Kit includes all electronic parts, OSC coils, and P.C. Board. Power supply 9V D.C.

FMC-105

\$11.50 PER KIT

WEM-36 FM WIRELESS MICROPHONE

TEET MODEL WEM-36 is a factory assembled FM wireless microphone powered by two AA size batteries. Transmits in the range of 88-108 MHz with 3 transistor circuits to meet with F.C.C. part 15 regulations. Element is built in a plastic tube type case with an omni-directional electret condenser microphone unit. By using a standard FM radio, signal can be heard anywhere on a one-acre lot. Sound quality was judged "very good."



MODEL WEM-36

\$16.50 EACH

WHISTLE ACTIVATED SWITCH BOARD

All boards are pre-assembled and tested. Your whistle to its FET condenser microphone from a distance, as far as 30 feet away (sensitivity can be easily adjusted) will turn the switch on, then match your whistle to it again, then it turns off. Ideal for remote control toys, electrical appliance such as lights, coffee pots, TV, Hi-Fi, radio or other projects. Unit works on 9V D.C.



MODEL 968

\$4.50 EACH

ULTRASONIC SWITCH KIT



Kit includes the Ultra Sonic Transducers, 2 PC Boards for transmitter and receiver. All electronic parts and instructions. Easy to build and a lot of uses such as remote control for TV, garage door, alarm system or counter. Unit operates by 9-12 DC.

\$15.50

ELECTRONIC SWITCH KIT

CONDENSER TYPE Touch On Touch Off uses 7473 I.C. and 12V relay

\$5.50 each

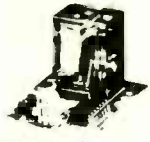

FORMULA INTERNATIONAL INC.

	SHIPPING AND HANDLING CHARGES	
	Under \$50.00 purchase	Over \$50.00 purchase
Inside California	10%	5%
Outside Calif (includes Mexico & Canada)	15%	10%
Overseas	25%	20%

Minimum Order \$10.00, Cash Reservations And 6% Sales Tax
Phone Orders Accepted on Visa or MC ONLY. NO C.O.D./Store Hours 10-7 Mon-Thu-Sat

12603 CRENSHAW BLVD. HAWTHORNE, CA 90250
PHONE: (213) 973-1921 • (213) 679-5162



Send \$1.00 For Detailed Catalogue

4 one \circ CAPACITANCE METER .1pF to 999K μ F
 in \circ FREQUENCY COUNTER 35MHz
 kit \circ SQUARE WAVE GEN. 1Hz to 99KHz-
 \circ OHMMETER - 3.58MHz Xtal - Regulated PS - Five
 .8" Readouts - Low cost TTL Circuits - Automatic
 Decimal Placement - Be AMAZED - Build it for
 \$60 or less. (Purchase the plans, drilled P.C.
 board 4-3/4" by 6-3/4" and front panel decal
 for \$27.99) BAGNALL ELECTRONICS, ReIncl-
 179 May Street, Fairfield, Conn. 06430 able

● THE SYSTEM 20 ●
 MICROWAVE TV RECEPTION
 AT IT'S BEST!!

- RX-2300 Assembled Down Converter
- Power Supply / Antenna Switch
- 25" Parabolic Antenna
- All Coaxial Cables
- Full Year Warranty

\$299.95
 + \$5.00 shipping

TEM MICROWAVE CORPORATION
 22518 - 97th Avenue North
 Corcoran, Minnesota 55374



Thanks to you... it works...
 for ALL OF US

United Way

A Public Service of This Magazine & The Advertising Council

LEARN ABOUT S-100 COMPUTERS.

S-100 computers are the next logical step up after 'personal' computers, whether for business, professional, or scientific applications. These three books are a must for technicians, students, systems integrators, or anyone who wants to know more about S-100 computers.

'Interfacing to S-100/ IEEE 696 Microcomputers', by Sol Libes and Mark Garetz. Spells out operating requirements and characteristics with clarity and precision. 17 chapters cover busing techniques, parallel and serial interfacing, handshaking, bus signals and timing relationships, I/O ports, interrupts, A/D and D/A conversion, much more. Osborne/McGraw-hill; softcover; 321 pages. \$15.00

'Product User Manuals 1975-1980, Volume 1', by CompuPro. With schematics, test routines, operating information for 29 CompuPro products (RAM and ROM memories, motherboards, CPU 8085/8088 dual processor board, CPU-Z, interfacers, etc.). Also defines and explains the S-100 bus. Excellent reference on memories and CPU boards. Softcover; 8.5in x 11in. format; 256 pages; \$20.

'Product User Manuals, Volume 2', by CompuPro. Similar to above, but covers System Support 1, Disk 1, RAM 17 CMOS memory, Interfacer 3, STD RAM, STD CPU, STD motherboard, and more. Softcover; 8.5in. x 11in. format; 307 pages; \$25.

CompuPro™
 OAKLAND AIRPORT, CA 94614-0355

division
 GODBOUT
 ELECTRONICS

TERMS: Cal res add tax. Allow 10% shipping; excess refunded. VISA® and Mastercard® orders (\$25 minimum) call (415) 562-0636, 24 hrs. Include street address for UPS. Prices subject to change without notice.

CIRCLE 77 ON FREE INFORMATION CARD

Electronics Paperback Books

Quality Books on Computers and Other Subjects
 Check Off The Ones You Want!



- BEGINNERS GUIDE TO MICROPROCESSORS AND COMPUTING \$4.75
- A MICROPROCESSOR PRIMER \$4.50
- PRACTICAL COMPUTER EXPERIMENTS \$4.75
- BEGINNERS GUIDE TO DIGITAL TECHNIQUES \$3.25
- ELEMENTS OF ELECTRONICS, VOLUME 4 - Micro-Processing Systems And Circuits \$7.50
- PRACTICAL COMPUTER EXPERIMENTS \$4.75
- DIGITAL IC PROJECTS \$4.95
- ELECTRONIC SYNTHESIZER PROJECTS \$4.50
- PRACTICAL INTRODUCTION TO DIGITAL IC'S \$3.50
- COUNTER DRIVER AND NUMERICAL DISPLAY PROJECTS \$4.50
- INTERNATIONAL TRANSISTOR EQUIVALENTS GUIDE
- INTERNATIONAL TRANSISTOR EQUIVALENTS \$7.50
- SIMPLE LED CIRCUITS, Book 2 \$3.75
- POWER SUPPLY PROJECTS \$4.95
- AUDIO PROJECTS \$5.00
- INTRODUCTION TO BASIC PROGRAMMING TECHNIQUES \$5.00
- INTRODUCTION TO RADIO DX'ING \$5.00

PRICES GOOD UNTIL JULY 30, 1982

ELECTRONIC TECHNOLOGY TODAY INC. 5/82
 P.O. Box 83, Massapequa Park, NY 11762

Number of books ordered

Total Price of Books _____

Sales Tax (NY State Residents only) _____

Shipping and Handling (60c 1 or 2 books 25c each add'l book) _____

TOTAL ENCLOSED _____

Name _____

Address _____

City _____ State _____ Zip _____

RADIO-ELECTRONICS

MICROWAVE EQUIPMENT and KITS

ANTENNA parabolic fiberglass antenna 20", approx. 20db gain	\$49.95
HANVERT II hi-gain 4 transistor 2.1-2.4 GHz to VHF TV ch. 2-6, down converter w/metal case. KIT	39.95
	ASSEMBLED & TESTED 59.95
POWER II precision 8-15VDC power supply for down converters. KIT	24.95
	ASSEMBLED & TESTED 39.95
MICROWAVE RECEIVING SYSTEM - ALL THREE - ASSEMBLED AND TESTED	124.95

SUPER LED's

2 amp. rating w/heat sink
ME2 IR 25A pulse
ME5 IR
MM4 RED

\$4.95 each

6-32 stud

RESISTOR SALE

.25W 5% carbon film - \$1.50 per 100 (one value)
all standard values from \$12 per 1000
2.7 to 4.7M ohms

SPECIALS

8085 NEC CERAMIC 40 PIN CPU CHIP	\$6.95
MM5290J NSC 16K/1 DYNAMIC RAM(4116)	2.95
B2758 INTEL EPROM 1K/8	8.95
TRIAIC 8A-600V TO220 RCA	.75
VOX- MICROPHONE, AMP, 2A SCR, PC BD	.95
H11A2 G.E. OPTO ISOLATOR 6 PIN DIP	.25
5101 256X4 CMOS RAM 22 PIN DIP	4.95
TRIAIC 25AMP 400V ON 3X6" HEAT SINK	2.95
7402 TTL QUAD 2 IN NOR GATE DIP	.10
7430 TTL 8 IN NAND GATE DIP	.10
7440 TTL DUAL 4 IN NAND BUFFER DIP	.10
TO-92 PNP TRANSISTOR PAK 100 PRIME	5.00
747 DUAL 741 OP-AMP 14 PIN DIP	.50
LH0021 NSC 1 AMP OP-AMP 8 PIN TO-3	5.00
2504T 1024 BIT DYN. SHIFT REG. TO-5	1.00
2416 INTEL 256X64 CCD SERIAL MEM.	2.50
5244 INTEL CCD DRIVER	3.00

BOX 41778 Sacramento, Ca. 95841
916 334 2161 4811 MYRTLE AVE

we pay post on orders for \$10 or more. All payment must be in U.S. funds. Foreign orders must include post. BAC & MC are not prepaid orders and shipping is added.

BABYLON ELECTRONICS

CIRCLE 88 ON FREE INFORMATION CARD

OSCILLOSCOPE

SUPER SALE

HITACHI	Single	15MHz/1mV	Reg.	Sale
V-151B	Single	15MHz/1mV	570	480
V-152B	Dual	15MHz/1mV	735	599
V-202	Dual	20MHz/1mV	850	697
V-302B	Dual	30MHz/1mV	995	815
V-352	Dual	35MHz/1mV	1150	950
V-550B	Dual	50MHz/1mV	1745	1495
V-1050	Quad	100MHz/0.5mV	2390	1995

SOLTEC	Single	15MHz/1mV	Reg.	Sale
515-1	Single	15MHz/1mV	495	Call
515-2	Dual	15MHz/1mV	595	Call
520	Dual	20MHz/1mV	695	Call
530	Dual	30MHz/1mV	895	Call

LEADER	Single	10MHz/1mV	Reg.	Sale
LBO-513	Single	10MHz/1mV	550	Call
LBO-514	Dual	10MHz/1mV	695	Call
LBO-508A	Dual	20MHz/10mV	880	Call
LBO-520A	Dual	35MHz/5mV	1250	Call
LBO-515B	Dual	30MHz/5mV	1580	Call

FREE FREIGHT for order paid with cashier's check or money order. Above prices are for prepaid order only. VISA/MC accepted. Allow 2 weeks to clear personal checks. California residents, add 6% sales tax. Prices and specifications subject to change without notice.

testek (213) 786-6890
TESTEK CORPORATION
6910 Hayvenhurst Ave., Van Nuys, CA 91406

Hobbyists, "Users", Small System Houses...

We offer top line, pro quality off lease, used & refurbished equipment formerly available only to giant corporations...

- High Speed Chain, Drum, Band & Matrix Line Printers & Terminals
- Quality Mini-Diskette, Diskette, Disk & Storage Module Drives 1/4 to 300 mbytes
- CRT Terminals, Printing Terminals, CRT Monitors
- Small & Medium Size Minicomputer, Word Processors & Peripherals

THIS MONTH'S SPECIALS!

Complete WANG PCS-IIA MINICOMPUTER SYSTEM!

Off-lease, refurbished & eligible for Mfr.'s maintenance. Many exciting features and capabilities include:

- 80x24 U/L Display
- 32 Special Function Keys
- 48K Basic in Rom, 16K Ram
- Dual Shugart Mini Floppy's
- Compact, Self-Contained
- Wang "Basic" Operating System
- Dual Printer Ports (Centronics I/O)

• Basic "keyword" Keyboard
• List Over \$6000.
• 110 VAC, 60 Hz

\$2790 ea.
Add \$20.00 for Shipping Crate. Pay Shipping on Delivery

WANG/DIABLO "WP" DAISY PRINTER

Featuring the Diablo 1355 WP metal wheel daisy printer with Wang-built power supply & interface. Fully Wang serviceable, recovered pristine, excellent condition. Combine with the above mini to complete excellent WP system. 15" frame, dual pitch (10 & 12), 40 char./second. Includes metal daisy wheel & cable.

Wang 2281 Daisy Printer (List \$4500) **\$2600 ea.**
Add \$20.00 for Crate. Pay Shipping on Delivery

Adjustable Forms Tractor (Diablo) for above **\$125 ea.**
Plus Shipping

Acoustic "Hood" for 2281 Wang/Diablo Printer **\$90 ea.**
Manufactured by Gates Plus Shipping

General Electric "TERMINET 1200"

150, 300 & 1200 baud RS-232. ASCII, receive only. 120 columns UPPER & LOWER case. 120 characters per second (60 LPM) max. print rate. Fast, fully-formed characters, continuous character band mechanism. Service & support in most major cities in USA. Highly reliable, current list price near \$6000

Tested & Operational **\$595 ea.**
WHILE THEY LAST!!!

GE "TERMINET 340"

Over 230 LPM. band printer, 132 columns, 64 characters. Very reliable! Parallel interface included, other interfaces available from G.E. Self-test feature, stand included 110 VAC, 60 Hz. G.E. service nation-wide

Tested & Operational **\$895 ea.**
Add \$30 for Pkg. & Hdgl. Pay Shipping on Delivery

MPI Model 52 5 1/4" MINI-FLOPPY

Used, good physical appearance, removed from used equipment. Fully SA-400 pin for pin compatible—features DSDD for 1/2 mbyte per drive!!!

Used, Untested, w/Data **\$199 ea.**
Plus Shipping

Write or Call for Our Latest BARGAIN-PACKED FLYER!

CPU

WAREHOUSE
18 Granite St. Haverhill, Mass 01830

MAIL ORDER:
Box 204 - Newton, New Hampshire 03858

TELEPHONE ORDERS
617/372-8637
Sorry No Collect Calls
MasterCard & VISA Accepted

DON'T FORGET

USE YOUR READER SERVICE CARD

MICROWAVE TV CONVERTERS

MODEL DCV-1-A

DOWN CONVERTER/ANTENNA COMBINATION

- 2 MICROWAVE PREAMP STAGES for maximum gain
- ONE PIECE CONSTRUCTION simplifies installation
- ALUMINUM AND ZINC PLATED STEEL for durability
- BUILT IN A/B SWITCH with more than 95dB isolation
- 2.1-2.6 GHz Covers all ham, commercial and ITFS channels

Years of enjoyment are yours with our model DCV-1-A. Two preamp stages coupled with the yagi antenna/housing provide a typical system gain of 53dB.

ASSEMBLED & TESTED
LIST - \$175.00

YOU GET: 75' downlead
3' jumper
300 ohm matching transformer
detailed instructions

ONLY \$149.95
INTRODUCTORY PRICE

WE CARRY A COMPLETE LINE INCLUDING PARABOLICS

DEALER INQUIRIES INVITED

TRITON MARKETING CORP. 1933 ROCKAWAY PARKWAY BROOKLYN, N.Y. 11236 **212-531-9004**

16K Memory

ALL MERCHANDISE 100% GUARANTEED!

8/15.95

4116-200ns

CALL US FOR VOLUME QUOTES

EPROMS

			Each	8 pcs
1702	256 x 8	(1ns)	4.95	4.50
2708	1024 x 8	(450ns)	2.99	2.75
2758	1024 x 8	(5V) (450ns)	9.95	8.95
TMS2516	2048 x 8	(5V) (450ns)	6.95	5.95
2716	2048 x 8	(5V) (450ns)	5.50	4.95
2716-1	2048 x 8	(5V) (350ns)	9.00	8.50
TMS2716	2048 x 8	(450ns)	9.95	8.95
TMS2532	4096 x 8	(5V) (450ns)	12.95	11.95
2732	4096 x 8	(5V) (450ns) (200ns)	CALL	CALL
2764	8192 x 8	(5V) (450ns)	CALL	CALL

DYNAMIC RAMS

				100 pcs
4027	4096 x 1	(250ns)	2.50	2.00
4116-120	16,384 x 1	(120ns)	8/29.95	CALL
4116-150	16,384 x 1	(150ns)	8/18.95	1.95
4116-200	16,384 x 1	(200ns)	8/15.95	1.80
4116-300	16,384 x 1	(300ns)	8/14.95	1.75
4164	64,536 x 1	(200ns)	CALL	CALL

STATIC RAMS

				100 pcs
2101	256 x 4	(450ns)	1.95	1.85
2102-1	1024 x 1	(450ns)	.89	.85
21L02-4	1024 x 1	(LP) (450ns)	1.29	1.15
21L02-2	1024 x 1	(LP) (250ns)	1.69	1.55
2111	256 x 4	(450ns)	2.99	2.49
2112	256 x 4	(450ns)	2.99	2.79
2114	1024 x 4	(450ns)	8/16.95	1.95
2114L-2	1024 x 4	(LP) (200ns)	8/19.95	2.35
2114L-3	1024 x 4	(LP) (300ns)	8/18.95	2.25
2114L-4	1024 x 4	(LP) (450ns)	8/17.95	2.10
2147	4096 x 1	(55ns)	9.95	CALL
TMS4044-4	4096 x 1	(450ns)	3.49	3.25
TMS4044-3	4096 x 1	(300ns)	3.99	3.75
TMS40L44-2	4096 x 1	(LP) (200ns)	4.49	4.25
MM2016	2048 x 8	(200ns) (150ns)	CALL	CALL
HM6116	2048 x 8	(200ns) (150ns) (120ns)	CALL	CALL

LP = LOW POWER

CRYSTALS

32.768 KHZ	3.95
1.0 MHZ	4.95
1.8432	4.95
2.0	3.95
2.097152	3.95
2.4576	3.95
3.2768	3.95
3.579545	3.95
4.0	3.95
5.0	3.95
5.0688	3.95
5.185	3.95
5.7143	3.95
6.5536	3.95
8.0	3.95
10.0	3.95
14.31818	3.95
18.0	3.95
18.432	3.95
20.0	3.95
22.1184	3.95
32.0	3.95

MISC.

AY5-2376	12.50
11C90	13.95
XR2206	4.95
3242	7.95
3480	9.00
MC4024	3.95
MC4044	4.50
7103	9.50
7106	9.95
7107	12.95
76477	3.95
8038	3.95
95H90	7.99
9602	1.50

DISC CONTROLLERS

1771	24.95
1791	36.95
1793	44.95
1797	54.95
UPD765	39.95

UARTS

AY3-1014	6.95
AY5-1013	3.95
TR1602	4.95
IM6402	7.95

INTERFACE

8T26	1.69
8T28	2.49
8T95	.99
8T96	.99
8T97	.99
8T98	.99
DM8131	2.95
DS8836	1.29

CLOCK CIRCUITS

MM5369	3.95
MM5375	3.95
MSM5832	7.45
7207	7.50
7208	15.95

CONVERTERS

MC1408 L8	4.95
DAC-0800	4.95
ADC-0804	4.95

MAY SPECIALS

16K APPLE* RAM CARD

* Upgrade your 48K Apple II to full 64K.

* Fully software and hardware compatible with Apple language card and microsoft 280 card.

* Eliminates the need for Applesoft or Integer Basic ROM card when used in conjunction with DOS 3.3.

* Allows you to run Apple Fortran or Pascal.

* Available as bare board, kit, or completed and tested board.

BARE BOARD \$ 40.00

KIT 89.95

ASSEMBLED & TESTED 109.95

6883 SAM 24.95

RS232 FEMALE 3.49

RS232 RIGHT ANGLE FEMALE 4.95

RS232 MALE 2.99

RS232 HOOD .99

Specials end May 31, 1982. Please state "May Specials" when ordering.

6502

6502	6.95
6502-A	12.95
6504	6.95
6505	8.95
6507	9.95
6520	4.35
6522	9.95
6532	14.95
6551	11.85

Z80

Z80-CPU	8.95
Z80A-CPU	6.00
Z80-P10	6.50
Z80A-P10	6.00
Z80-CTC	5.95
Z80A-CTC	8.65
Z80-DART	15.25
Z80A-DART	18.75
Z80-DMA	17.50
Z80A-DMA	27.50
Z80-S10/0	23.95
Z80A-S10/0	28.95
Z80-S10/1	23.95
Z80A-S10/1	28.95
Z80-S10/2	23.95
Z80A-S10/2	28.95
Z80-S10/09	17.95
Z80A-S10/9	22.95

Z80B-CPU	18.95
Z80B-CTC	17.95
Z80B-P10	17.95

Z8671	39.95
Z6132	34.95

CMOS

74C00	.35	74C374	2.75	4019	.45	4098	2.49
74C02	.35	74C901	.80	4020	.95	4099	1.95
74C04	.35	74C902	.85	4021	.95	14409	12.95
74C08	.35	74C903	.85	4022	1.15	14410	12.95
74C10	.35	74C905	10.95	4023	.35	14411	11.95
74C14	1.50	74C906	.95	4024	.75	14412	12.95
74C20	.35	74C907	1.00	4025	.35	14419	4.95
74C30	.35	74C908	2.00	4026	1.65	4502	.95
74C32	5.00	74C909	2.75	4027	.65	4503	.65
74C42	1.75	74C910	9.95	4028	.80	4508	1.95
74C48	2.10	74C911	10.00	4029	.95	4510	.95
74C73	.65	74C912	10.00	4030	.45	4511	.95
74C74	.85	74C914	1.95	4034	2.95	4512	.95
74C76	.80	74C915	2.00	4035	.85	4514	1.25
74C83	1.95	74C918	2.75	4040	.95	4515	2.25
74C85	1.95	74C920	17.95	4041	1.25	4516	1.55
74C86	.95	74C921	15.95	4042	.75	4518	1.25
74C89	4.50	74C922	5.95	4043	.85	4519	1.25
74C90	1.75	74C923	5.95	4044	.85	4520	1.25
74C93	1.75	74C925	6.75	4046	.95	4522	1.25
74C95	1.75	74C926	7.95	4047	.95	4526	1.25
74C107	1.00	74C927	7.95	4049	.55	4527	1.95
74C150	5.75	74C928	7.95	4050	.55	4528	1.25
74C151	2.25	74C929	19.95	4051	.95	4531	.95
74C154	3.25	74C930	19.95	4053	.95	4532	1.95
74C157	1.75	4000	.35	4060	1.45	4538	1.95
74C160	2.00	4001	.35	4066	.75	4539	1.95
74C161	2.00	4002	.25	4068	.40	4543	2.70
74C162	2.00	4006	.95	4069	.35	4555	.95
76C163	2.00	4007	.29	4070	.35	4556	.95
74C164	2.00	4008	.95	4071	.30	4581	1.95
74C165	2.00	4009	.45	4072	.30	4582	1.95
74C173	2.00	4010	.45	4073	.30	4584	.95
74C174	2.25	4011	.35	4075	.30	4585	.95
74C175	2.25	4012	.25	4076	.95	4702	12.95
74C192	2.25	4013	.45	4078	.30	4724	1.50
74C193	2.25	4014	.95	4081	.30	80C07	.95
74C195	2.25	4015	.95	4082	.30	80C95	.85
74C200	5.75	4016	.45	4085	.95	80C96	.95
74C221	2.25	4017	1.15	4086	.95	80C97	.95
74C373	2.75	4018	.95	4093	.95	80C98	1.20

HOURS: Mon. - Fri., 9 to 5; Sat., 11 to 3



JDR MICRODEVICES, INC.

1224 So. Bascom Ave.
San Jose, CA 95128
800-538-5000 • 800-662-6279 (CA)
(408) 995-5430 • Telex 171-110

TERMS: For shipping include \$2.00 for UPS ground, \$3.00 for UPS Blue Label air. \$10.00 minimum order. Bay Area residents add 6 1/2 % sales tax. California residents add 6% sales tax. We reserve the right to limit quantities and substitute manufacturer. Prices subject to change without notice. Send SASE for complete list.

2716 EPROMS 450NS (5V)

8/4.95 ea.

ALL MERCHANDISE 100% GUARANTEED!

CALL US FOR VOLUME QUOTES

8000

8035	16.95
8039	19.95
8080A	3.95
8085	12.95
8085A-2	16.95
8086	99.95
8088	39.95
8155	11.95
8156	11.95
8185	29.95
8185-2	39.95
8741	39.95
8748	29.95
8755	44.95

8200

8202	45.00
8205	3.50
8212	1.85
8214	3.85
8216	1.80
8224	2.50
8226	1.80
8228	4.90
8237	19.95
8238	4.95
8239	4.85
8243	4.45
8250	14.95
8251	4.75
8253	9.25
8253-5	9.85
8255	4.75
8255-5	5.25
8257	8.75
8259	6.90
8272	39.95
8275	29.95
8279	9.50
8279-5	10.50
8282	6.65
8283	6.65
8284	5.70
8286	6.65
8287	6.50
8288	25.00
8289	49.95

TV CIRCUITS

MC1330	1.89
MC1350	1.29
MC1358	1.79
LM380	1.29
LM386	1.50
LM565	.99
LM741	.29
LM1310	2.90
LM1800	2.99
LM1889	2.49



APPLE* FAN \$69.00

- EXTRA PLUG-IN CARDS CAN CAUSE YOUR APPLE TO OVERHEAT
- ULTRA-QUIET APPLE FAN DRAWS COOL AIR THROUGH YOUR COMPUTER
- ELIMINATES DOWN TIME
- SAVES REPAIR CHARGES
- INCREASES RELIABILITY
- CLIPS ON — NO HOLES OR SCREWS
- COLOR MATCHES APPLE
- LONG LIFE LOW NOISE MOTOR



*APPLE IS A TRADEMARK OF APPLE COMPUTER INC.

IC SOCKETS

1-99	100
8 pin ST	.13 .11
14 pin ST	.15 .12
16 pin ST	.17 .13
18 pin ST	.20 .18
20 pin ST	.29 .27
22 pin ST	.30 .27
24 pin ST	.30 .27
28 pin ST	.40 .32
40 pin ST	.49 .39

ST = SOLDERTAIL

8 pin WW	.59 .49
14 pin WW	.69 .52
16 pin WW	.69 .58
18 pin WW	.99 .90
20 pin WW	1.09 .98
22 pin WW	1.39 1.28
24 pin WW	1.49 1.35
28 pin WW	1.69 1.49
40 pin WW	1.99 1.80

WW = WIREWRAP

CONNECTORS

RS232 MALE	3.25
RS232 FEMALE	3.75
RS232 HOOD	1.25
S-100 ST	3.95
S-100 WW	4.95

DIP SWITCHES

4 POSITION	.85
5 POSITION	.90
6 POSITION	.90
7 POSITION	.95
8 POSITION	.95

6800

6800	5.70
6802	10.95
6808	9.95
6809	24.95
6809E	29.95
6810	4.60
6820	4.95
6821	4.95
6828	14.95
6834	16.95
6840	14.95
6843	42.95
6844	44.95
6845	16.95
6847	15.95
6850	4.75
6852	5.75
6860	10.95
6862	11.95
6875	6.95
6880	2.95
68B00	10.95
68B21	12.95
68B50	12.95

EPROM ERASERS

PE-14	78.50
PE-14T (with timer)	108.50
PE-24T (with timer)	154.50

ALL ARE HIGH QUALITY UNITS ENCLOSED IN A BLACK ANODIZED ALUMINUM ENCLOSURE.

800-538-5000

800-662-6279

(CALIFORNIA RESIDENTS)

CALL JDR BEFORE YOU BUY!
WE WILL BEAT ANY COMPETITORS' PRICES

TRANSISTORS

PN2222	10/1.00	100/ 8.99
2N2222	.25	50/10.99
2N2907	.25	50/10.99
2N3055	.79	10/ 6.99
2N3904	10/1.00	100/ 8.99
2N3906	10/1.00	100/ 8.99
1N4148 (1N914)		25/ 1.00
1N4004		10/ 1.00

VOLTAGE REG'S

7805T	.79	7905T	.89
7808T	.99	7912T	.89
7812T	.79	7915T	1.19
7815T	.99	7924T	1.19
7824T	.99		

7805K	1.39	7905K	1.49
7812K	1.39	7912K	1.49
7815K	1.39	7915K	.79
78L05	.69	79L12	.79
78L12	.69	79L15	.79
78L15	.69		

LM309K	1.49	LM317K	3.95
LM317T	1.95	LM323K	4.95
		LM337K	3.95

T = TO-220 K = TO-3 L = TO-92

LINEAR

LM301V	.34
LM308V	.98
LM309K	1.49
LM311	.64
LM317T	1.95
LM317K	3.95
LM318	1.49
LM323K	4.95
LM324	.59
LM337K	3.95
LM339	.99
LM377	2.29
LM380	1.29
LM386V	1.50
LM555V	.39
LM556	.69
LM565	.99
LM566V	1.49
LM567V	1.29
LM723	.49
LM733	.98
LM741V	.29
LM747	.79
LM748V	.59
LM1310	2.90
MC1330V	1.89
MC1350V	1.29
MC1358	1.79
LM1414	1.59
LM1458V	.69
LM1488	.99
LM1489	.99
LM1800	2.99
LM1889	2.49
LM3900	.59
LM3909V	.98
LM3914	3.95
LM3915	3.95
LM3916	3.95
75451V	.39
75452V	.39
75453V	.39

7400 SERIES

7400	.19	7451	.23	74136	.50	74186	18.50
7401	.19	7453	.23	74141	.65	74190	1.15
7402	.19	7454	.23	74142	2.95	74191	1.15
7403	.19	7460	.23	74143	2.95	74192	.79
7404	.19	7470	.35	74144	2.95	74193	.79
7405	.22	7472	.29	74145	.60	74194	.85
7406	.22	7473	.34	74147	1.75	74195	.85
7407	.22	7474	.35	74148	1.20	74196	.79
7408	.24	7475	.49	74150	1.35	74197	.75
7409	.19	7476	.35	74151	.65	74198	1.35
7410	.19	7480	.59	74152	.65	74199	1.35
7411	.25	7481	1.10	74153	.55	74221	1.35
7412	.30	7482	.95	74154	1.40	74246	1.35
7413	.35	7483	.50	74155	.75	74247	1.25
7414	.55	7485	.65	74156	.65	74248	1.85
7416	.25	7486	.35	74157	.55	74249	1.95
7417	.25	7489	4.95	74159	1.65	74251	.75
7420	.19	7490	.35	74160	.85	74259	2.25
7421	.35	7491	.40	74161	.70	74265	1.35
7422	.29	7492	.50	74162	.85	74273	1.95
7423	.29	7493	.49	74163	.85	74276	1.25
7425	.29	7494	.65	74164	.85	74279	.75
7426	.29	7495	.55	74165	.85	74283	2.00
7427	.29	7496	.70	74166	1.00	74284	3.75
7428	.45	7497	2.75	74167	2.95	74285	3.75
7430	.19	74100	1.00	74170	1.65	74290	.95
7432	.29	74107	.30	74172	5.95	74293	.75
7433	.45	74109	.45	74173	.75	74298	.85
7437	.29	74110	.45	74174	.89	74351	2.25
7438	.29	74111	.55	74175	.89	74365	.65
7440	.19	74116	1.55	74176	.89	74366	.65
7442	.49	74120	1.20	74177	.75	74367	.65
7443	.65	74121	.29	74178	1.15	74368	.65
7444	.69	74122	.45	74179	1.75	74376	2.20
7445	.69	74123	.55	74180	.75	74390	1.75
7446	.59	74125	.45	74181	2.25	74393	1.35
7447	.69	74126	.45	74182	.75	74425	3.15
7448	.69	74128	.55	74184	2.00	74426	.85
7450	.19	74132	.45	74185	2.00	74490	2.55

HOURS: Mon. - Fri., 9 to 5; Sat. 11 to 3

VISIT OUR RETAIL STORE!



JDR MICRODEVICES, INC.
1224 S. Bascom Ave.
San Jose, CA 95128
800-538-5000 • 800-662-6279 (CA)
(408) 995-5430 • Telex 171-110

TERMS: For shipping include \$2.00 for UPS Ground, \$3.00 for UPS Blue Label Air. \$10.00 minimum order. Bay Area residents add 6 1/2% sales tax. California residents add 6% sales tax. We reserve the right to limit quantities and substitute manufacturer. Prices subject to change without notice. Send SASE for complete list.

ETCO

CABLE TV CONVERTERS AND OTHER GOOD STUFF!

SMASHING ALL SALES RECORDS - OUR NEW 30 CHANNEL CABLE TV CONVERTER!

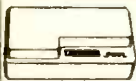

Converts mid & super band cable channels for viewing on your TV set!
No. 349AE047 **39⁹⁵** \$34.95 ea./7.5

HOT NEW IMPORT! REMOTE CONTROL 30 CHANNEL CABLE TV CONVERTER!

89⁹⁵ \$79.95 ea./7.5
\$74.95 ea./10

Includes remote TV on/off switch and fine tuning control!
No. 349VA275



ETCO MKII WIRELESS - THE ULTIMATE CABLE TV CONVERTER!



Set TV to channel 3, and the hand-held remote control does it all!
No. 349ZA008 **189⁰⁰**

VIDCOR 2000 CONVERTER ELIMINATES PROBLEMS WHEN VIDEOTAPE FROM CABLE TV

89⁹⁵

Restores your VCR's capability for programming. Restores remote channel control. Enables videotaping of any cable program while watching another.
No. 349VA950



UNUSUAL FACTORY SURPLUS MID-BAND - SUPER-BAND CABLE TV TUNER

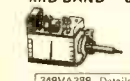

Converts cable channels to a common IF frequency. Experimenters - build cable converters, decoders, etc. With schematic. No. 349VA342 **19⁹⁵** \$17.50 ea./7.10

FACTORY SURPLUS UHF TUNERS

4⁹⁵ \$3.95 ea./10

Brand new production surplus. All solid state. Ideal for experimental work building cable TV converters, etc. No. 349SU099



MINIATURE FM WIRELESS MICROPHONE



Hides in the palm of your hand. Reception on any standard FM radio or receiver. No. 349VA482 **29⁹⁵** \$27.50 ea./7.5
\$24.95 ea./7.10

QUARTER-MILE WIRELESS MICROPHONE & RECEIVER SYSTEM

69⁹⁵ \$49.95 ea./7.5

FCC approved crystal controlled wireless mike & receiver. All battery operated. Electret wide range response. VU meter. No. 349VA093



FACTORY SURPLUS VHF / UHF "TWIN" VARACTOR TUNERS!



Admiral No. NC 3143-1. BRAND NEW! Ideal for building or repairing electronically tuned TV "FRONT ENDS". A hard to find item at a sensational price! No. 349VC308 **39⁹⁵** \$34.95 ea./7.5

DUMPING! NORELCO ENDLESS LOOP CASSETTES!

4⁹⁵ \$4.49 ea./10

Impossible to find at any price!
3 minutes - No. 349VA605
6 minutes - No. 349VA606



IN STOCK - THE MURA CORDLESS TELEPHONE SYSTEM!



Answer & originate calls with this wireless pushbutton 400 Hz. crystal Pkg. rechargeable. Less number recall! Pkg. inc. feature! Use with rotary, touch systems! No. 349VA274 **144⁸⁸** \$129.95 ea./7.5

SALE OF QUARTZ BATTERY OPERATED CLOCK MOVEMENTS!

9⁹⁵ \$8.95 ea./7.5

Accuracy of 1 min./year. up to 4 years operation on 1 alkaline "C" cell. Imported from West Germany. No. 349VA561



20 AMP REGULATED 12VDC POWER SUPPLY!



13.8 vdc no load, 12.5 vdc full load. Car handles ham station marine radio, SSB linears up to 400w P.E.P. Brand new. Factory sealed 110 VAC. No. 349VA394 **69⁸⁸** \$59.98 ea./7.5

FREE

OUR LATEST 98 PAGE FASCINATING CATALOG - jam-packed with unique items, electronic bargains and unusual offers. Write or circle the information card number below.

ETCO ELECTRONICS NORTH COUNTRY SHOPPING CENTER PLATTSBURGH, N.Y. 12901

Check with order, please. Visa & Mastercard OK. (Sorry, no C.O.D.'s. Add 15% for UPS & Handling (Excess refunded). N.Y. State residents add 7% sales tax. Dealer & Export inquiries invited. Our telephone order desk, near closest. Call 1-518-561-8700.

ADVERTISING INDEX

RADIO-ELECTRONICS does not assume any responsibility for errors that may appear in the index below.

Free Information Number Page

55	AMC Sales	82
36	AP Products, Inc.	102
—	Aaron Gavin	26
5	Abex	92
70	Active Electronics	109
10,11	Advance Analog	92
—	Advance Electronics	13,24,25,42,44,47,86
75	All Electronics	122
34	Antenna Specialists	85
78	Arizona Electronics	118
—	B.G. Micro	123
26	B&K Precision Dynascan Corp.	48
83	Babylon Electronics	127
—	Bagnall Electronics	126
—	Karel Barta	108
33	Beckman Instruments	CIV
28	Blonder Tongue	1
—	Bullet Electronics	116
62	Burton Products	96
—	CIE, Cleveland Institute of Electronics	18-21
40	Cambridge Learning	96
76	Chaney Electronics	118
37	Channelock	82
—	Clear-Vue Electronics	112
—	Command Productions	116
32	Communications Electronics	2
—	Components Express	33
80	Computer Peripherals Unlimited	127
73	Concord Electronics	114
—	Cook's Institute	116
57	Jan Crystal	101
12	Dacor Limited	93
—	Dage Scientific	110
—	Data Services Co.	126
67	Digi Key Corp.	117
50,51	RL Drake Company	90,100
8	Electro Industries	93
88	Electronic Specialists, Inc.	123
—	Electronic Technology Today	126
—,79	Etco Electronics	116,130
54	Etronix	98
—	Fair Radio Sales	114
24	Fluke Mfg. Co., Inc.	5
—	Fordham Radio	34-35,37
64	Formula International	124-125
18	Fox	83
59,60	Gladstone Electronics	101
29	Global Specialties Corp.	95
—	Global TV Electronics	108
77	Godbout Electronics	126
20	Gould, Inc.	89
—	Grantham College Of Engineering	98
91	Grove Enterprises, Inc.	110
38	Hal-Tronix	122
—,14	Hameg, Inc.	99
—	Heath	CIII,23,73-75
48	Hickok Electrical Instruments	98
85	Hitech Electronics	118
3	Huntron Instruments	92
87	Information Unlimited	122
61	International Crystal	86
65	JDR, Microdevices	128-129
—	J&W Electronics	114
63	Jameco Electronics	120-121
71	JimPak	113
7	Lakeside Industries	92
6	Lour Sales	93
—	McGee's Radio	114
9	Masco Electronics	93
—	Marsailles Horan	110
23	Microtenna Associates	110
—	Midex	43
89	Monarchy Engineering, Inc.	116
—	Mountain West	122
—	NRI Schools	8-11
—	NTS Schools	38-41
—	Nabih's, Inc.	104
—	Nemal Electronics	118

41	Netronics	107
25	Non Linear Systems	17
45	North American Soar	97
39	ORA Electronics	106
81	P.P.G. Electronics	123
43	Pac-Tec Corp.	26
52,53	Paia Electronics	99,100
21	Panasonic	81
49	Panavise	105
19	N.A. Philips	45
90	Poly Paks	123
22	Priority One Electronics	7
27	Protecto Enterprises	87
58	Quietrole	104
—	RCA	36
92	R.D. Unlimited	93
66	Radio Shack	111
69	Ramsey Electronics	115
84	SCR Electronics, Inc.	130
2	SMP, Inc.	92
86	SRJ International	122
13	SRS	93
—	Sabadia Exports	110
46,47	H.W. Sams	97,105
—	Satellite TV	108
—	Sencore	28-31
—,17	Shure Bros.	14-15
—	Simple Simon Electronics	46
74	Sinewave Mktg. Corp.	127
72	Sintec Co.	110
—	Solid State Sales	112
44	Soltec	104
—	Spacecoast Research	108
—	Suntronics Co., Inc.	114
68	Surplus Electronics	119
93	Symmetric Sound Systems	93
—	Tektronix	27
—	Testek	127
30,31	Triplet Corp.	CII
4	Ungar	93
35	Vaco	90
42	Vector Electronics Co.	32
—	Wersi Electronics	110

SCR SUPER-BUYS

• **UHF-VHF CONVERSION KIT.** Complete with PC board, all required components: cabinet with speaker; and comprehensive brochure incl. schematic, board layout mounting and hook-up diagrams, parts list and assembly and set-up instructions. All parts are industrial prime quality. **Our Own Famous Kit \$119.00**

• **NEW ZENITH ZVM-121 HIGH LEGIBILITY CRT MONITOR.** Features 12" green phosphor CRT, with 15 MHz Bandwidth, 40 or 80 character widths are operator switch-selectable. Fully compatible with 80-column Apple cards, etc. **Our Factory Direct Price \$117.00**

• **MITSUMI - MODEL UES-A55F VARACTOR UHF TUNER** **\$25.00 ea.**
470 - 889 MHz ANTENNA INPUT 10 for **\$220.00**
300 OHMS

• **SPECIAL - 2200 MFD 40 VT CAP** 10 for **\$13.50**

• **I.C. SPECIAL LM 565** 10 for **\$16.00**

• **H.D. TRANSISTORS SPECIALS**
2 N 3055 10 for **\$10.**
2SA 745 \$4.00 ea.
2SA 747B \$4.50 ea.
2S C 1116B \$3.25 ea.
2SC 1403B \$3.00 ea.

OUTSIDE CAL 800-854-8660
INSIDE CAL (714) 527-2554
or (213) 603-9385

SCR ELECTRONICS INC.
VISIT OUR NEW SUPER CENTER
5303 Lincoln Ave., Cypress, CA 90630
Pay by CHECK, M.O., VISA, M/C
\$10.00 MIN. ORDER HANDLING/SHIPPING . \$2.50
UPS ANYWHERE IN CONTINENTAL U.S.

CIRCLE 84 ON FREE INFORMATION CARD

HEATH/ZENITH & YOU, INC. ONE STRONG PARTNERSHIP

A computer purchase is the beginning of a long-term partnership between you and the people you buy from. Your ongoing need for software, peripherals and accessories requires a partner who will stand by you with a growing line of products to meet your needs. Heath/Zenith will be that strong partner for you. Look what we have to offer.

THE ALL-IN-ONE COMPUTER – The heart of the Heath/Zenith line is the stand-alone *89 Computer*. It's a complete system with built-in 5.25-inch floppy disk drive, professional keyboard and keypad, smart video terminal, two Z-80 microprocessors and three RS-232C Serial I/O Ports. It comes with 48K bytes of RAM, expandable to 64K.

PERIPHERALS AND ACCESSORIES – These include the popular *Heath/Zenith 19 Smart Video Terminal*, loaded with professional features. We also offer color and black and white monitors, modems, computer language courses, and high-speed typewriter-quality printers.



SOFTWARE – New software, includes the SuperCalc Spreadsheet and Condor Data Base Management System. *Word processing*, including three different programs. *Small Business Programs*, feature Peachtree's Series 5, Softstuff's General Ledger and Inventory Control. *HUG, Heath Users' Group*, offers members a library of over 500 low-cost programs for home, work or play.

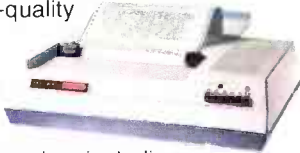

PROGRAMMING LANGUAGES – For your own custom programs, Microsoft languages are available in BASIC (compiler and interpreter), FORTRAN and COBOL.

APPLICATIONS SOFTWARE – Expand the performance range of your computer with a broad selection of software, including the best of *Digital Research* and *Micropro* – as well as the complete line of *Softstuff™* products.

OPERATING SYSTEMS – Three versatile systems give you the capability to perform your specific tasks. *CP/M* by *Digital Research* makes your system compatible with thousands of popular CP/M programs. *UCSD P-System with Pascal* is a complete program development and execution environment. *HDOS, Heath Disk Operating System* gives you a sophisticated flexible environment for program construction, storage, and editing.

DISK SYSTEMS – The new *Heath/Zenith 67 Winchester Disk System*, for commercial use, adds nearly 11 megabytes of storage to your 89 computer. It includes an 8-inch

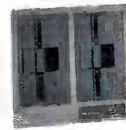

floppy disk drive for data portability. The new 5.25-inch 37 disk system, available with 1 or 2 drives, adds up to 1.28 megabytes of storage. Both plug-in systems have write protection.

SERVICE AND SUPPORT – Prompt and professional service and assistance is available nationally through Heathkit Electronic Centers, Zenith Data Systems for commercial users or through Heath factory servicing and phone-in technical assistance.

Complete, integrated computer hardware and software, designed to serve and grow with you – that's what to look for in a strong partner. And with Heath/Zenith you get it all.

Heath/Zenith computer products are sold nationwide through Heathkit Electronic Centers* (check your white pages for locations). For a FREE catalog and mail order service, write: Heath Co., Dept. 020-894, Benton Harbor, MI 49022.



HEATH/ZENITH

Your strong partner



Product specifications are subject to change without notice.
*Heathkit Electronic Centers are operated by Veritechnology Electronics Corporation, a wholly-owned subsidiary of Zenith Radio Corporation.



Drop-proof

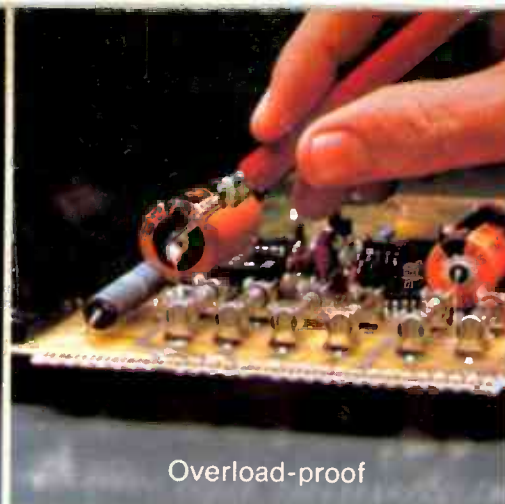

Overload-proof



Contamination-proof

Ooops proof.

Now there's a hand-held DMM tough enough to withstand accidental drops, destructive environments, and input overloads — and still give you superior Beckman performance.

The HD-100 from Beckman is drop-proof, sealed against contam-

ination, and packed with overload protection. You won't find a more rugged meter inside or out.

Drop-proof

Constructed of double-thick thermoplastics, the HD-100 resists damage even after repeated falls. All components are heavy duty and shock mounted.

Water- and contamination-proof

The HD-100 is designed to keep working even around dirt, heavy grime and moisture.

The special o-ring seals, ultrasonically-welded display window and sealed input jacks protect the internal electronics of the HD-100 from any source of contamination. The HD-100 is sealed so tightly, it's even waterproof.

Accidental overload protection

All voltage inputs are protected up to 1500 Vdc or 1000 Vrms. Current ranges are protected to 2A/250V with resistance ranges protected to 600 Vdc. Transient protection extends up to 6KV for 10 micro-seconds.

More meter for the money

For starters you get 2000 hours of continuous use off a common 9V transistor battery. You can run in-circuit diode tests and check continuity. You even get a one year warranty.

The 0.25% basic volt dc accuracy HD-100 serves you with 7 functions and 29 ranges. With one simple turn of the single selector switch, you can go directly to the function and range you need. There's less chance of error.

Feature for feature you can't find a more dependable meter priced at just \$169 (U.S. only).

To locate your nearest distributor write Beckman Instruments, Inc., Instrumentation Products, 2500 Harbor Boulevard, Fullerton, CA 92634 or call (714) 993-8803.



BECKMAN

CIRCLE 33 ON FREE INFORMATION CARD