



Füllstand



Druck



Durchfluss



Temperatur



Flüssigkeits-
analyse



Registrierung



Systeme
Komponenten



Services



Solutions

Operating Instructions

Micropilot S FMR531

Level-Radar

HART/4...20 mA

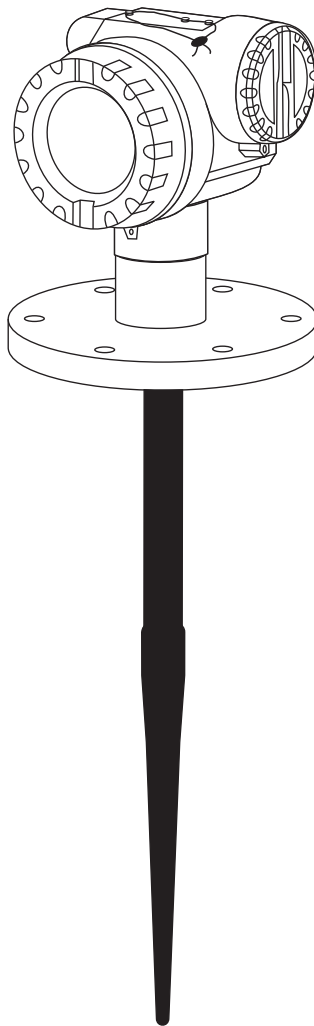

BA207F/00/en/04.09
71093754

Valid as of software version
V 01.03.00 (amplifier)
V 01.03.00 (communication)

Brief overview

For quick and simple commissioning:

Safety Instructions	→ Page 6 ff.
Explanation of the warning symbols You can find special instructions at the appropriate position in the chapter in question. The positions are indicated with the icons Warning ⚠, Caution ⚡ and Note 📌.	
▼	
Installation	→ Page 12 ff.
The steps for installing the device and installation conditions (e.g. dimensions) can be found here.	
▼	
Wiring	→ Page 24 ff.
The device is virtually completely wired on delivery.	
▼	
Display and Operating Elements	→ Page 32 ff.
An overview of the position of the display and operating elements can be found here.	
▼	
Commissioning via Display VU331	→ Page 43 ff.
In the "Commissioning" section, you learn how to switch on the device and check the functioning.	
▼	
Commissioning via Operating Software FieldCare	→ Page 61 ff.
In the "Commissioning" section, you learn how to switch on the device and check the functioning. Additional information on the operation of FieldCare can be found in the operating instructions BA217F/00.	
▼	
Fault Tracking / Trouble Shooting	→ Page 70 ff.
If faults occur during operation, use the checklist to localise the cause. Here you can find measures you can take yourself to take remedial action against the fault.	
▼	
Index	→ Page 96 ff.
You can find important terms and keywords on the individual sections here. Use the keyword index to find quickly and efficiently the information you need.	

Brief operating instructions

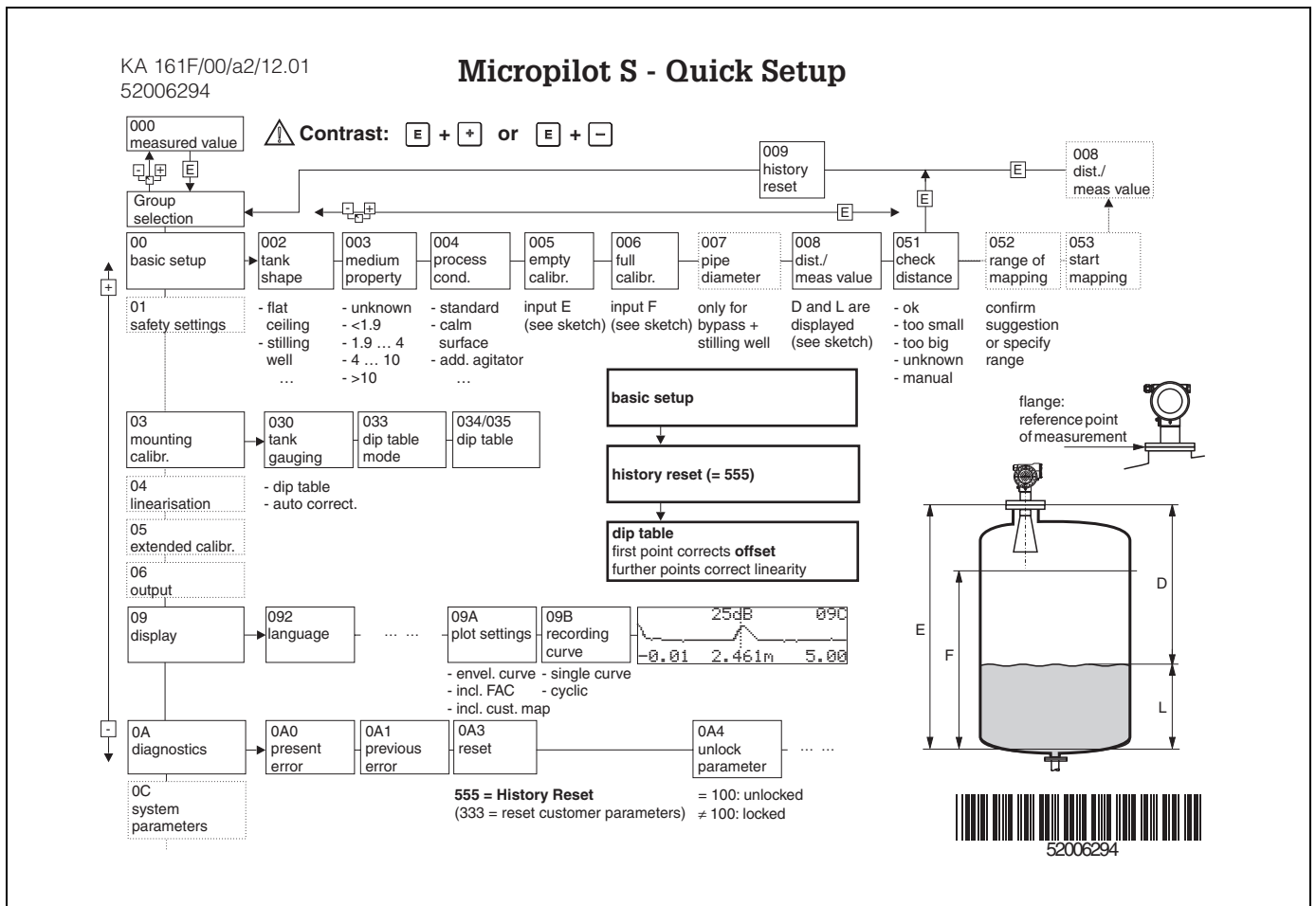

Note!

This operating manual explains the installation and initial start-up for the level transmitter measuring device. All functions that are required for a typical measuring task are taken into account here.

In addition, the Micropilot S provides many other functions that are not included in this operating manual, such as optimising the measuring point and converting the measured values.

An **overview of all device functions** can be found on page 88.

An **extensive description of all device functions** can be found in BA217F - "Description of the instrument functions" on the enclosed CD-ROM.

Operating Instructions can also be found on our homepage: www.endress.com

Table of Contents

1	Safety instructions	6	9.5	Spare parts	77
1.1	Designated use	6	9.6	Return	81
1.2	Installation, commissioning and operation	6	9.7	Disposal	81
1.3	Operational safety	6	9.8	Software history	81
1.4	Notes on safety conventions and symbols	7	9.9	Contact addresses of Endress+Hauser	81
2	Identification	8	10	Technical data	82
2.1	Device designation	8	10.1	Additional technical data	82
2.2	Scope of delivery	11	11	Appendix	88
2.3	Certificates and approvals	11	11.1	Operating menu HART (Display modul), FieldCare	88
2.4	Registered trademarks	11	11.2	Description of functions	90
3	Mounting	12	11.3	Function and system design	90
3.1	Quick installation guide	12	Index	96	
3.2	Incoming acceptance, transport, storage	13			
3.3	Installation Conditions	14			
3.4	Installation instructions	20			
3.5	Post-installation check	23			
4	Wiring	24			
4.1	Quick wiring guide	24			
4.2	Connecting the measuring unit	26			
4.3	Recommended connection	29			
4.4	Degree of protection	29			
4.5	Post-connection check	29			
5	Operation	30			
5.1	Quick operation guide	30			
5.2	Display and operating elements	32			
5.3	Local operation	35			
5.4	Display and acknowledging error messages	38			
5.5	HART communication	39			
6	Commissioning	40			
6.1	Function check	40			
6.2	Switching on the measuring device	40			
6.3	Basic Setup	41			
6.4	Basic Setup with the VU331	43			
6.5	Mounting calibration with VU331	51			
6.6	Basic Setup with FieldCare	61			
6.7	Mounting calibration with FieldCare	65			
7	Maintenance	67			
8	Accessories	68			
9	Trouble-shooting	70			
9.1	Trouble-shooting instructions	70			
9.2	System error messages	71			
9.3	Application errors	73			
9.4	Orientation of the Micropilot	75			

1 Safety instructions

1.1 Designated use

The Micropilot S FMR531 is a compact radar level transmitter for the continuous, contactless measurement of liquids. The device can also be freely mounted outside closed metal vessels because of its operating frequency of about 6 GHz and a maximum radiated pulsed energy of 1 mW (average power output 1 μ W). Operation is completely harmless to humans and animals.

1.2 Installation, commissioning and operation

The Micropilot S has been designed to operate safely in accordance with current technical, safety and EU standards. If installed incorrectly or used for applications for which it is not intended, however, it is possible that application-related dangers may arise, e.g. product overflow due to incorrect installation or calibration. For this reason, the instrument must be installed, connected, operated and maintained according to the instructions in this manual: personnel must be authorised and suitably qualified. The manual must have been read and understood, and the instructions followed. Modifications and repairs to the device are permissible only when they are expressly approved in the manual.

1.3 Operational safety

Hazardous areas

Measuring systems for use in hazardous environments are accompanied by separate "Ex documentation", which is an integral part of this Operating Manual. Strict compliance with the installation instructions and ratings as stated in this supplementary documentation is mandatory.

- Ensure that all personnel are suitably qualified.
- Observe the specifications in the certificate as well as national and local regulations.

FCC-approval

This device complies with part 15 of the FCC Rules. Operation is subject to the following two conditions: (1) This device may not cause harmful interference, and (2) this device must accept any interference received, including interference that may cause undesired operation.















Caution!

Changes or modifications not expressly approved by the part responsible for compliance could void the user's authority to operate the equipment.

1.4 Notes on safety conventions and symbols

In order to highlight safety-relevant or alternative operating procedures in the manual, the following conventions have been used, each indicated by a corresponding symbol in the margin.

Safety conventions	
	<p>Warning! A warning highlights actions or procedures which, if not performed correctly, will lead to personal injury, a safety hazard or destruction of the instrument</p>
	<p>Caution! Caution highlights actions or procedures which, if not performed correctly, may lead to personal injury or incorrect functioning of the instrument</p>
	<p>Note! A note highlights actions or procedures which, if not performed correctly, may indirectly affect operation or may lead to an instrument response which is not planned</p>
Explosion protection	
	<p>Device certified for use in explosion hazardous area If the device has this symbol embossed on its name plate it can be installed in an explosion hazardous area</p>
	<p>Explosion hazardous area Symbol used in drawings to indicate explosion hazardous areas. Devices located in and wiring entering areas with the designation “explosion hazardous areas” must conform with the stated type of protection.</p>
	<p>Safe area (non-explosion hazardous area) Symbol used in drawings to indicate, if necessary, non-explosion hazardous areas. Devices located in safe areas still require a certificate if their outputs run into explosion hazardous areas</p>
Electrical symbols	
	<p>Direct voltage A terminal to which or from which a direct current or voltage may be applied or supplied</p>
	<p>Alternating voltage A terminal to which or from which an alternating (sine-wave) current or voltage may be applied or supplied</p>
	<p>Grounded terminal A grounded terminal, which as far as the operator is concerned, is already grounded by means of an earth grounding system</p>
	<p>Protective grounding (earth) terminal A terminal which must be connected to earth ground prior to making any other connection to the equipment</p>
	<p>Equipotential connection (earth bonding) A connection made to the plant grounding system which may be of type e.g. neutral star or equipotential line according to national or company practice</p>
	<p>Temperature resistance of the connection cables States, that the connection cables must be resistant to a temperature of at least 85 °C.</p>

2 Identification

2.1 Device designation

2.1.1 Nameplate

The following technical data are given on the instrument nameplate:

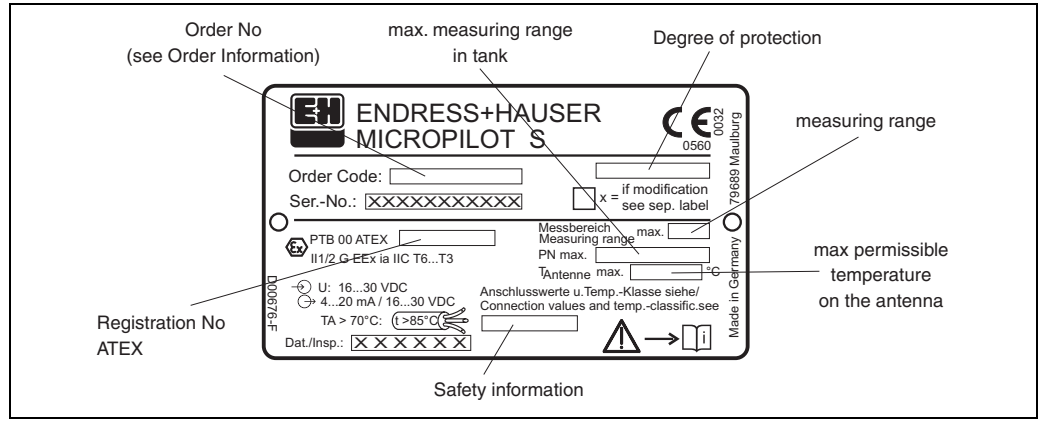

Fig. 1: Information on the nameplate of the Micropilot S FMR531 (example)

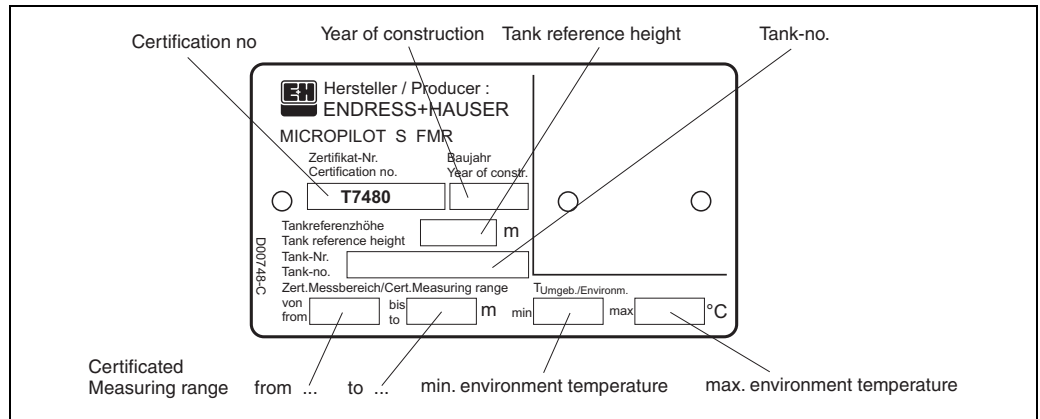

Fig. 2: Information on the NMI type plate for custody transfer applications of the Micropilot S FMR531 (example)

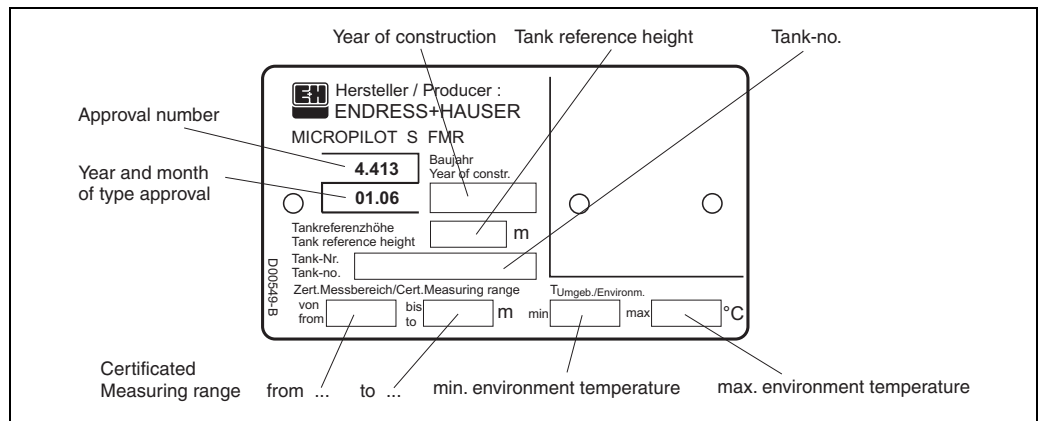

Fig. 3: Information on the PTB type plate for custody transfer applications of the Micropilot S FMR531 (example)

2.1.2 Ordering structure

This overview does not mark options which are mutually exclusive.

10		Approval:	Basic weight
A		Non-hazardous area	7.1 kg
1		ATEX II 1/2G EEx ia IIC T6	
6		ATEX II 1/2G EEx ia IIC T6, WHG	
G		ATEX II 3G EEx nA II T6	
I		NEPSI Ex ia IIC T6 (in preparation)	
S		FM IS Cl.I Div.1 Gr. A-D	
U		CSA IS Cl.I Div.1 Gr. A-D	
K		TIIS Ex ia IIC T3	
L		TIIS Ex ia IIC T6	
Y		Special version	
20		Antenna; Inactive length:	
H		PTFE antistatic 390mm/15", fully insul.; nozzle height max 100mm/4"	0.4 kg
J		PTFE antistatic 540mm/21", fully insul.; nozzle height max 250mm/10"	
E		PTFE 390mm/15", fully insulated; nozzle height max 100mm/4"	0.4 kg
F		PTFE 540mm/21", fully insulated; nozzle height max 250mm/10"	
Y		Special version	
30		Process connection:	Additional weight
		– Clamp-connections –	
TEJ		Tri-Clamp ISO2852 DN40-51 (2"), 316L	0.4 kg
TLJ		Tri-Clamp ISO2852 DN70-76.1 (3"), 316L	
		– EN-Flanges –	
CFJ		DN50 PN10/16 B1, 316L flange EN1092-1 (DIN2527 C)	2.9 kg
CFK		DN50 PN10/16, PTFE >316L flange EN1092-1 (DIN2527)	3.0 kg
CMJ		DN80 PN10/16 B1, 316L flange EN1092-1 (DIN2527 C)	4.8 kg
CNJ		DN80 PN25/40 B1, 316L flange EN1092-1 (DIN2527 C)	5.9 kg
CMK		DN80 PN10/16, PTFE >316L flange EN1092-1 (DIN2527)	4.9 kg
CQJ		DN100 PN10/16 B1, 316L flange EN1092-1 (DIN2527 C)	5.8 kg
CQK		DN100 PN10/16, PTFE >316L flange EN1092-1 (DIN2527)	5.9 kg
CWJ		DN150 PN10/16 B1, 316L flange EN1092-1 (DIN2527 C)	10.6 kg
CWK		DN150 PN10/16, PTFE >316L flange EN1092-1 (DIN2527)	10.8 kg
		– ANSI-Flanges –	
AEJ		2" 150lbs RF, 316/316L flange ANSI B16.5	2.4 kg
AEK		2" 150lbs, PTFE >316/316L flange ANSI B16.5	2.5 kg
ALJ		3" 150lbs RF, 316/316L flange ANSI B16.5	5.0 kg
AMJ		3" 300lbs RF, 316/316L flange ANSI B16.5	6.8 kg
ALK		3" 150lbs, PTFE >316/316L flange ANSI B16.5	5.1 kg
APJ		4" 150lbs RF, 316/316L flange ANSI B16.5	7.0 kg
AQJ		4" 300lbs RF, 316/316L flange ANSI B16.5	11.5 kg
APK		4" 150lbs, PTFE >316/316L flange ANSI B16.5	7.1 kg
AVJ		6" 150lbs RF, 316/316L flange ANSI B16.5	11.3 kg
AVK		6" 150lbs, PTFE >316/316L flange ANSI B16.5	11.5 kg
		– JIS-Flanges –	
KEJ		10K 50 RF, 316L flange JIS B2238	2.1 kg
KEK		10K 50, PTFE >316L flange JIS B2238	2.2 kg
KLJ		10K 80 RF, 316L flange JIS B2238	3.4 kg
KLK		10K 80, PTFE >316L flange JIS B2238	3.5 kg
KPJ		10K 100 RF, 316L flange JIS B2238	4.5 kg
KPK		10K 100, PTFE >316L flange JIS B2238	
KVJ		10K 150 RF, 316L flange JIS B2238	9.9 kg
KVK		10K 150, PTFE >316L flange JIS B2238	10.1 kg
YY9		Special version	
40		Output; Operation:	
A		4-20mA HART; 4-line display VU331, envelope curve display on site	
Y		Special version	
50		Housing:	
C		T12 Alu, coated. IP65 NEMA4X, separate conn. compartment	
Y		Special version	
FMR531-			Product designation (Part 1)

60											Cable entry:
											2 Gland M20 3 Thread G1/2 4 Thread NPT1/2 9 Special version
70											Weight + measure approval:
											A NMi + PTB (<1mm) type approval F NMi witnessed initial verifcat. (<1mm) type approval G PTB witnessed initial verifcat. (<1mm) type approval R Not selected; Inventory control version (3mm) Y Special version
80											Additional option:
											A Basic version S GL/ABS marine certificate Y Special version
FMR531-											Complete product designation

2.2 Scope of delivery



Caution!

It is essential to follow the instructions concerning the unpacking, transport and storage of measuring instruments given in the chapter "Incoming acceptance, transport, storage" on Page 13!

The scope of delivery consists of:

- Assembled instrument
- Endress+Hauser operating program (on the enclosed CD-ROM)
- 2 seals
- Accessories (see Page 68).

Accompanying documentation:

- Short manual (basic setup/troubleshooting): housed in the instrument
- Operating manual (this manual)
- Approval documentation: if this is not included in the operating manual.



Note!

The operating manual BA217F - "Description of Instrument functions" can be found on the enclosed CD-ROM.

2.3 Certificates and approvals

CE mark, declaration of conformity

The device is designed to meet state-of-the-art safety requirements, has been tested and left the factory in a condition in which it is safe to operate. The device complies with the applicable standards and regulations as listed in the EC declaration of conformity and thus complies with the statutory requirements of the EG directives. Endress+Hauser confirms the successful testing of the device by affixing to it the CE mark.

2.4 Registered trademarks

KALREZ[®], VITON[®], TEFLON[®]

Registered trademark of the company, E.I. Du Pont de Nemours & Co., Wilmington, USA

TRI-CLAMP[®]

Registered trademark of the company, Ladish & Co., Inc., Kenosha, USA

HART[®]

Registered trademark of HART Communication Foundation, Austin, USA

ToF[®]

Registered trademark of the company Endress+Hauser GmbH+Co. KG, Maulburg, Germany

PulseMaster[®]

Registered trademark of the company Endress+Hauser GmbH+Co. KG, Maulburg, Germany

PhaseMaster[®]

Registered trademark of the company Endress+Hauser GmbH+Co. KG, Maulburg, Germany

FieldCare[®]

Registered trademark of the Endress+Hauser Process Solutions AG, Reinach, Switzerland

3 Mounting

3.1 Quick installation guide



Observe orientation when installing!

**Installation in tank (free space):
Mark on process connector facing the nearest tank wall!**

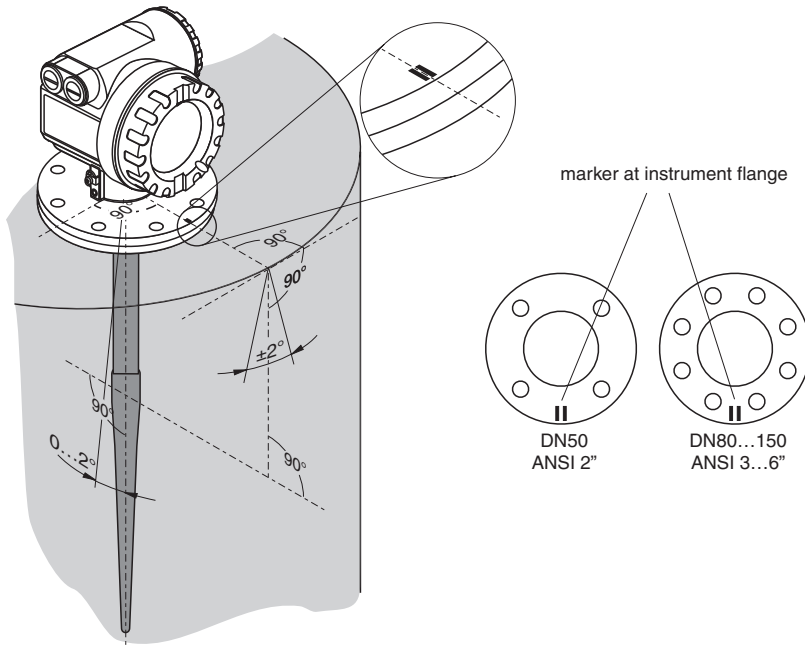

Turn housing

The housing can be turned in order to simplify access to the display and the terminal compartment

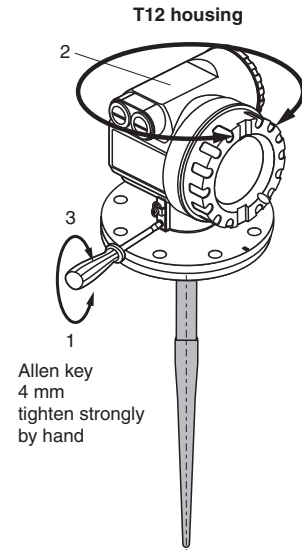

3.2 Incoming acceptance, transport, storage

3.2.1 Incoming acceptance

Check the packing and contents for any signs of damage. Check the shipment, make sure nothing is missing and that the scope of supply matches your order.

3.2.2 Transport



Caution!

Follow the safety instructions and transport conditions for instruments of more than 18 kg.

3.2.3 Storage

Pack the measuring instrument so that is protected against impacts for storage and transport. The original packing material provides the optimum protection for this.

The permissible storage temperature is $-40\text{ °C} \dots +80\text{ °C}$.

3.3 Installation Conditions

3.3.1 Dimensions

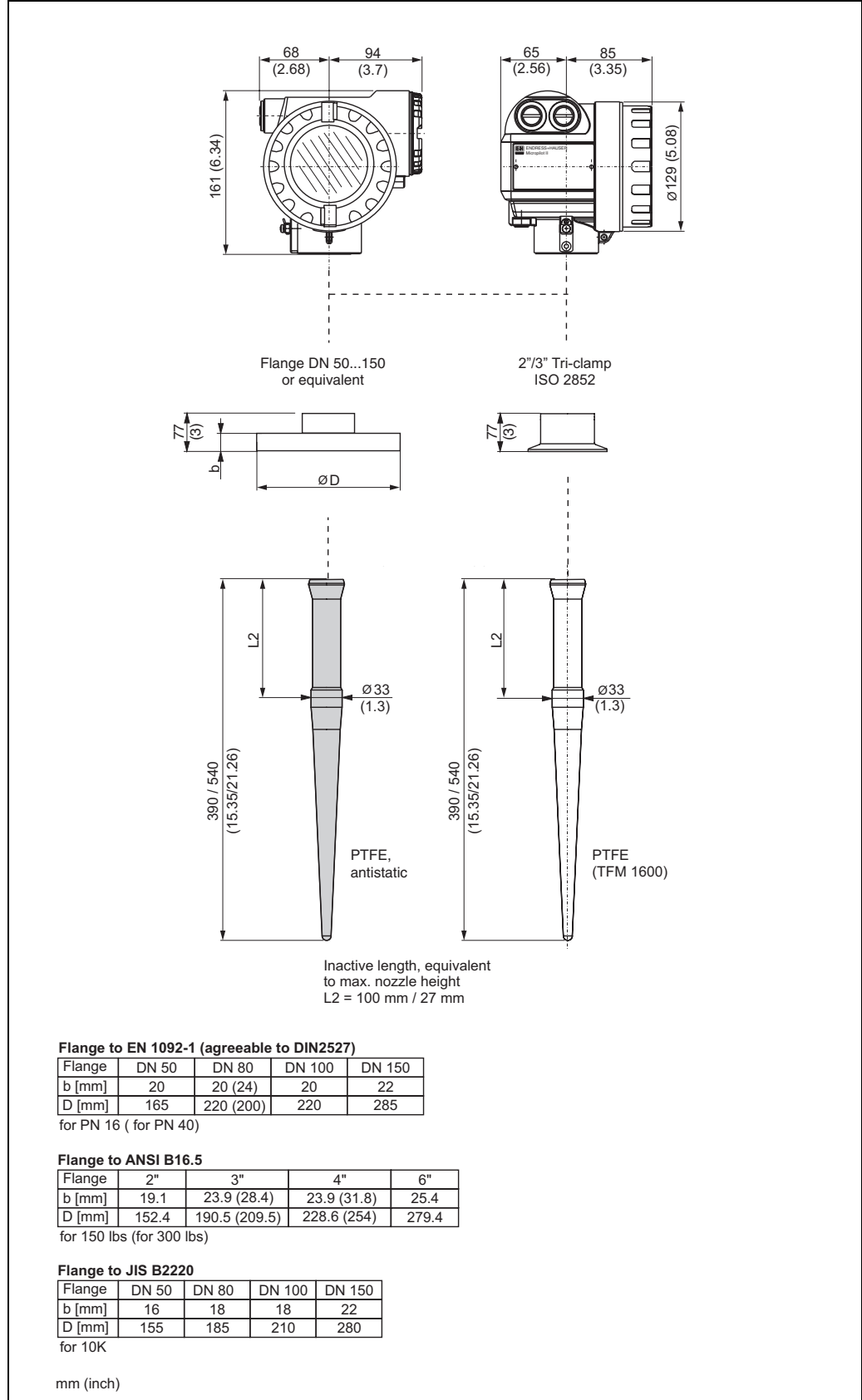

3.3.2 Engineering hints

Orientation

- Recommended distance (1) wall - **outer edge** of nozzle:: $\sim 1/6$ of tank diameter (see Beam angle on Page 16).
- Not in the centre (3), interference can cause signal loss.
- Not above the fill stream (4).
- It is recommended to use a weather protection cover (2) in order to protect the transmitter from direct sun or rain. Assembly and disassembly is simply done by means of a tension clamp (see "Accessories" on Page 68).

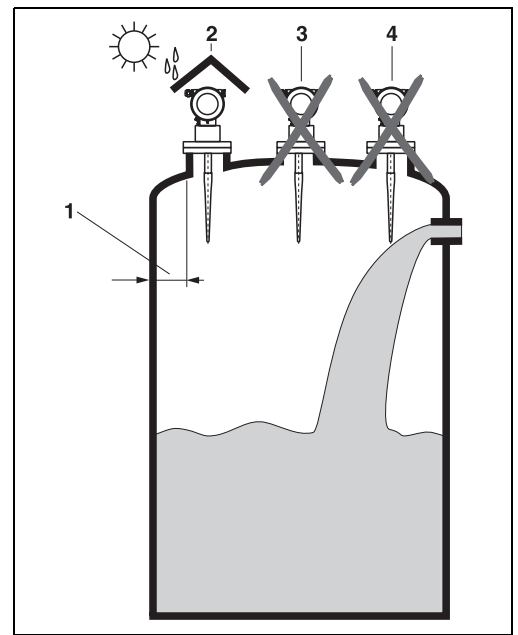

Tank installations

- Avoid any installations (1), like limit switches, temperature sensors, etc., inside the signal beam (refer to beam angle (see "Beam angle" on Page 16).
- It is essential that HiHi alarm is below the blocking distance (BD) and the safety distance (SD).
- Symmetrical installations (2), e.g. vacuum rings, heating coils, baffles, etc., can also interfere with the measurement.

Optimization options

- Antenna size: the bigger the antenna, the smaller the beam angle, the less interference echoes.
- Mapping: the measurement can be optimized by means of electronic suppression of interference echoes.
- Antenna alignment: refer to "optimum mounting position".
- Stilling well: a stilling well can always be used to avoid interference. The FMR532 with planar antenna is recommended for stilling wells with a diameter DN150 (6") and larger.
- Metallic screens (3) mounted at a slope spread theradar signals and can, therefore, reduceinterference echoes.

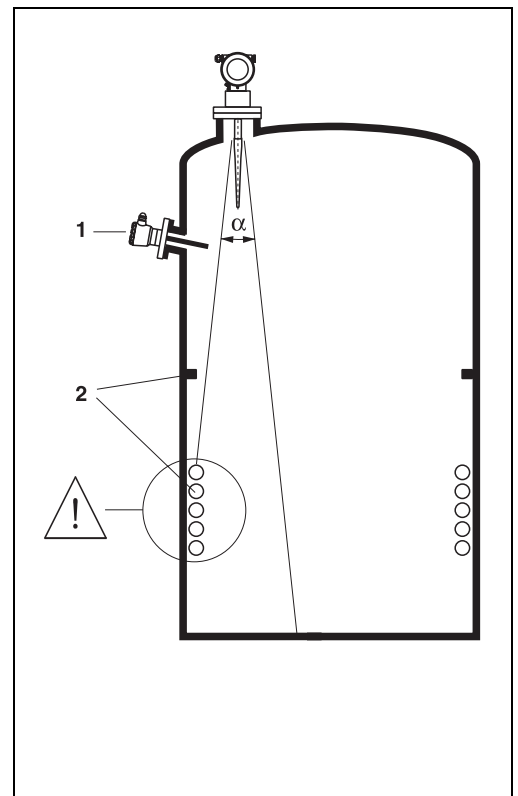

Please contact Endress+Hauser for further information.

Beam angle

The beam angle is defined as the angle where the energy density of the radar waves reaches half the value of the maximum energy density (3dB-width). Microwaves are also emitted outside the signal beam and can be reflected off interfering installations.

Beamwidth diameter **W** as function of antenna type (beam angle α) and measuring distance **D**:

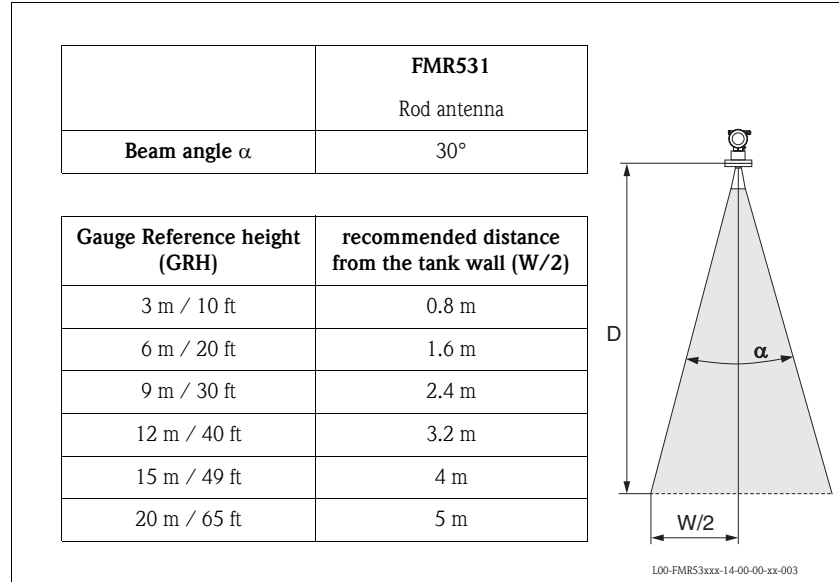

Caution!

Make sure that **only one** tank wall (**not two** tank walls) is directly hit by the radar beam!

Measuring conditions

- The measuring range begins where the beam hits the tank bottom. Particularly with dish bottoms or conical outlets the level cannot be detected below this point.
- For **overspill protection**, it is possible to define a safety distance (**SD**) additionally to the blocking distance (**BD**).
- Depending on its consistence, foam can either absorb microwaves or reflect them off the foam surface. Measurement is possible under certain conditions.
- Distance **B** defined the smallest recommended measurement range.
- Tank diameter and height should be at least dimensioned such that a reflection of the radar signal on both sides of the tank can be ruled out (see »Beam angle« on Page 16).
- In case of media with a low dielectric constant (groups A and B), the tank bottom can be visible through the medium at low levels (low height **C**). Reduced accuracy has to be expected in this range. If this is not acceptable, we recommend positioning the zero point at a distance **C** (see Fig.) above the tank bottom in these applications.
- In principle it is possible to measure with the FMR531 up to the tip of the antenna. However, due to considerations regarding accuracy corrosion and build-up, the end of the measuring range should not be chosen any closer than **A** (see Fig.) to the tip of the antenna.
- The safety distance (**SD**) is set to 0.1 m (4") by default and generating an alarm.

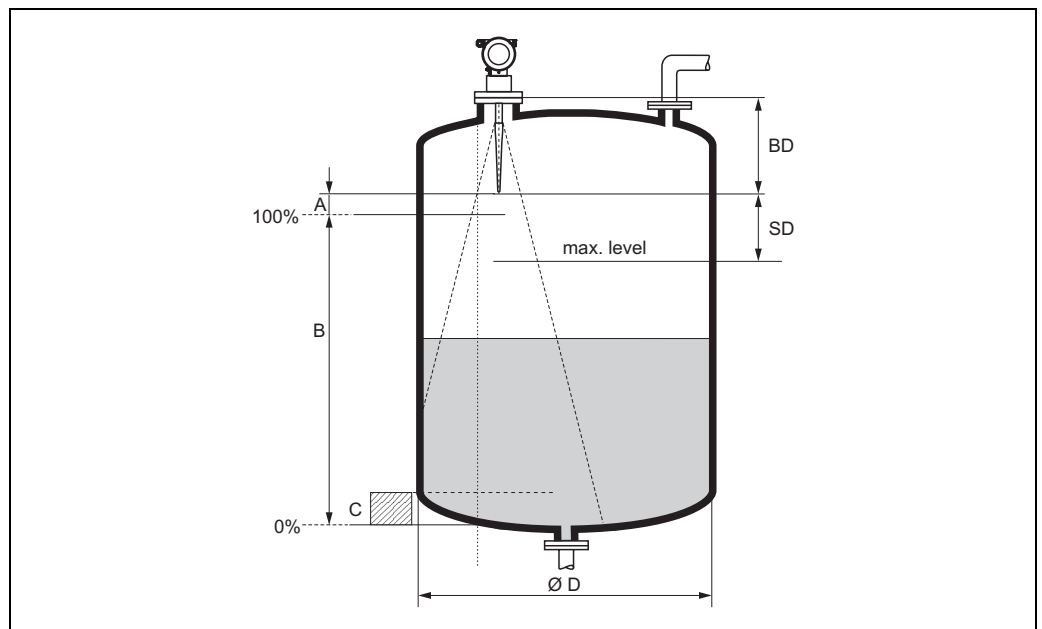

L00-FMR53xxx-17-00-00-en-011

	reference: flange / BD (cf. picture)		reference: antenna tip (cf. picture)		
	Blocking distance	Safety distance	recommended additional settings		
	BD [m / ft]	SD [m / ft]	A [mm / inch]	B [m / ft]	C [mm / inch]
FMR531	0.39/1.3 or 0.54/1.8	0.1/0.3	50 / 2	0.5 / 1.64	150...300/6...12

Behaviour if measuring range is exceeded

The behaviour in case of the measuring range being exceeded can be freely set: the default setting is a current of 22 mA and the generation of a digital warning (E681).

Measuring range

The usable measuring range depends on the size of the antenna, the reflectivity of the medium, the mounting location, and eventual interference reflections.

The following tables describe the groups of media as well as the achievable measuring range as a function of application and media group. If the dielectric constant of a medium is unknown, it is recommended to assume media group B to ensure a reliable measurement.

Media group	DC (ϵ_r)	Examples
A	1.4...1.9	non-conducting liquids, e.g. liquefied gas (LPG). For more information please contact your Endress+Hauser representative.
B	1.9...4	non-conducting liquids, e.g. benzene, oil, toluene, white products, black products, crudes, bitumen/asphalts, ...
C	4...10	e.g. concentrated acids, organic solvents, esters, aniline, alcohol, acetone, ...
D	> 10	conducting liquids, e.g. aqueous solutions, dilute acids and alkalis

Measuring range depending on product class for Micropilot S FMR531

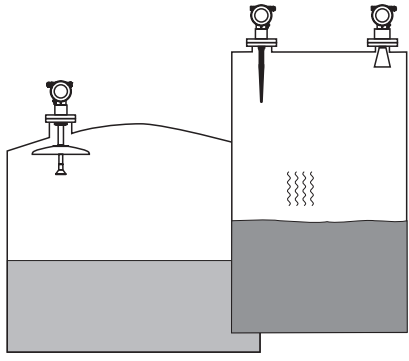
Media group		Free space (Storage tank)
		
		Measuring range
		DN150/200/250
A	DC (ϵ_r) = 1.4...1.9	—
B	DC (ϵ_r) = 1.9...4	10 m/33 ft
C	DC (ϵ_r) = 4...10	DN150: 15 m/50 ft
D	DC (ϵ_r) > 10	DN150: 20 m/65 ft
max. measuring range with custody transfer approvals		NMi and PTB: 10 m/33 ft

Blocking distance

The blocking distance (= BD) is the minimum distance from the reference point of the measurement (mounting flange) to the medium surface at maximum level.

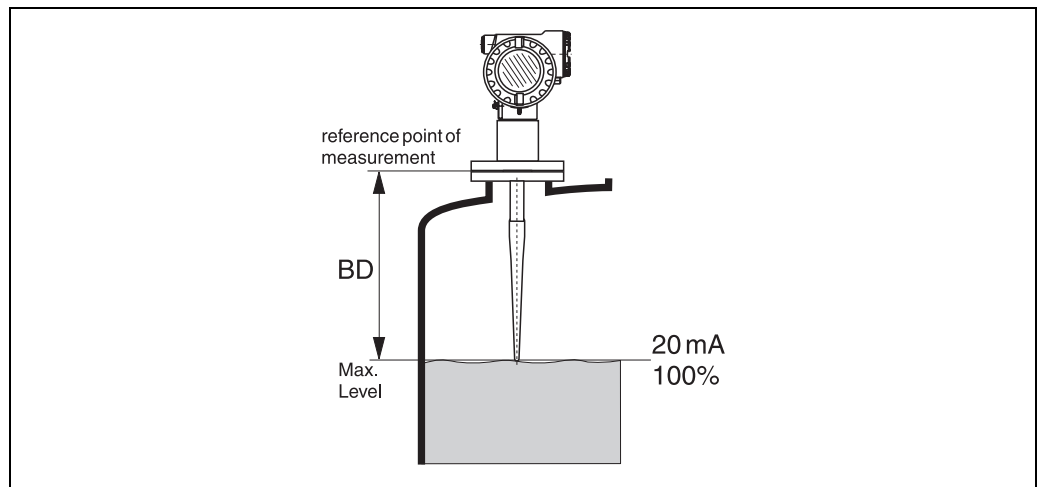

Blocking distance (BD) ¹⁾	Free space (Storage tank)
from flange	390/540 mm 15"/21"

1) 1 mm accuracy under reference conditions

3.4 Installation instructions

3.4.1 Mounting kit

In addition to the tool needed for flange mounting, you will require the following tool:

- 4 mm Allen wrench for turning the housing.

3.4.2 Installation in tank (free space)

Optimum mounting position

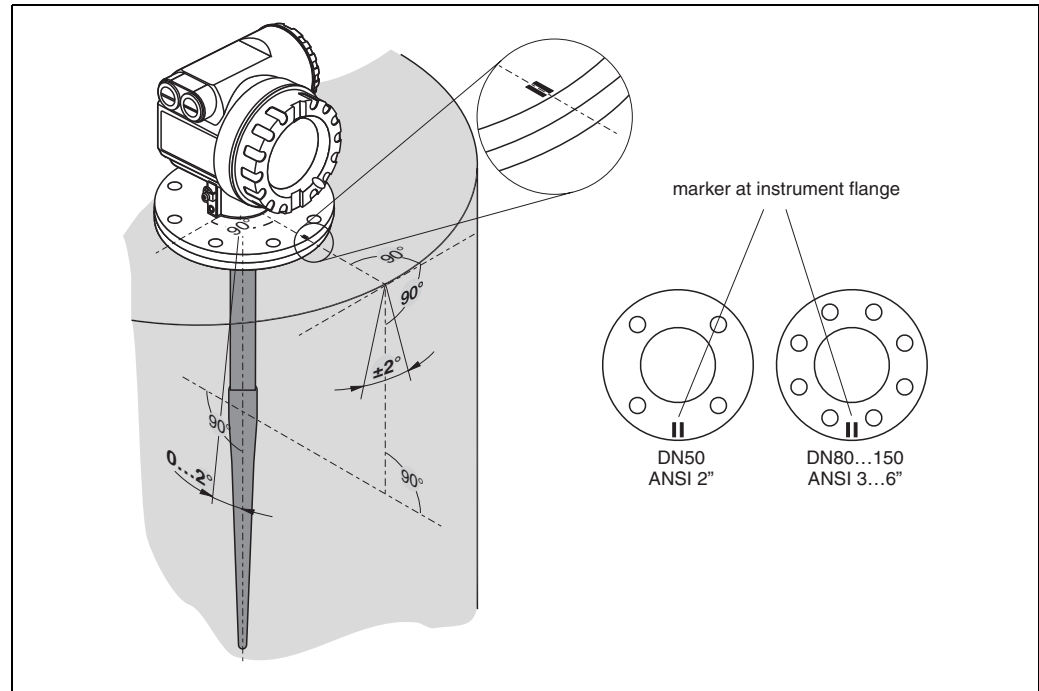

L00-FMR531xx-15-00-00-es-001

Standard installation

- Observe installation instructions on Page 16.
- Marker is aligned towards tank wall.
- The marker is always exactly in the middle between two bolt-holes in the flange.
- The device shall not be mounted in a slant towards the tank wall.
- After mounting, the housing can be turned 350° in order to simplify access to the display and the terminal compartment.
- In order to minimize temperature influences, spring washers should be used in combination with the plated flange of the FMR531.
- The rod antenna must extend below the nozzle.
- Align rod antenna vertically

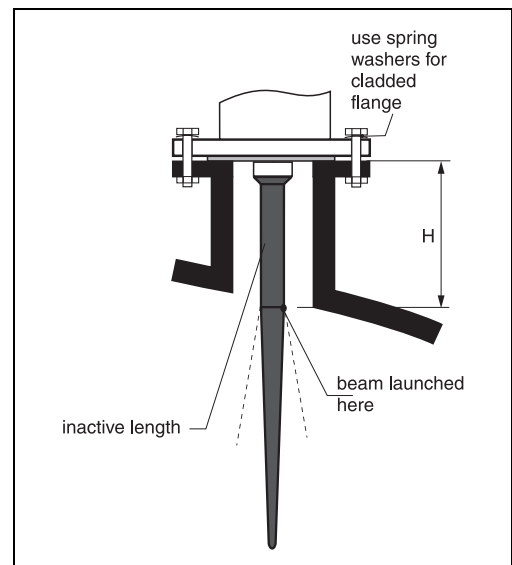

L00-FMR531xx-15-00-00-es-001

Antenna size	390 / 15	540 / 21
H [mm / inch]	< 100 / < 4	< 250 / < 10

3.4.3 Turn housing

After mounting, the housing can be turned 350° in order to simplify access to the display and the terminal compartment. Proceed as follows to turn the housing to the required position:

- Undo the fixing screws (1)
- Turn the housing (2) in the required direction
- Tighten up the fixing screws (1)

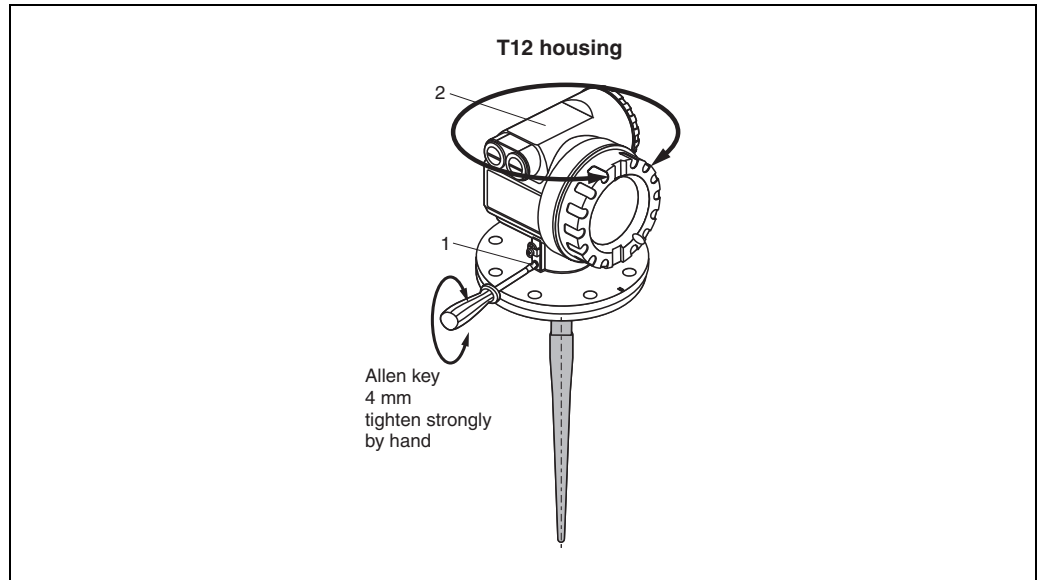

3.4.4 Mounting with Roof reflector

Reflektor

For high precision applications, measurements from a floating roof are inadvisable due to the unsteady movements of the floating roof. For floating roof applications, a special reflector can be used.



Note!

The roof reflector is not part of the standard offering from Endress+Hauser.

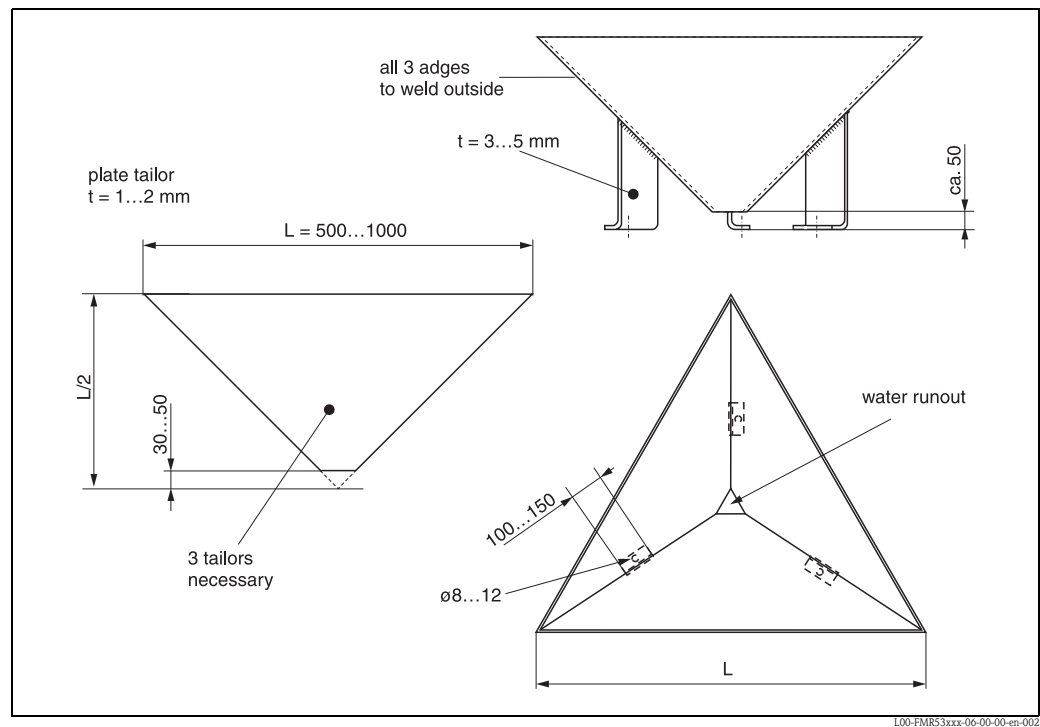

Construction hints

- The construction serves as retroreflector such that a tank roof incline does not influence the measured value.
- The cross-sectional area shouldn't be smaller than specified in the figure above to receive and transmit enough energy.
- The construction should be open in the bottom part to allow rainwater to drop out. Thin stainless steel sheets should be used, to prevent the construction from becoming too heavy.

Optimum mounting position

Positioning of the reflector on a floating roof:

- The upper edges of the reflector have to be aligned horizontally.
- For slanted locations (e.g. dome-shaped floating roof), the feet must be extended accordingly.

Please contact Endress+Hauser for further information.

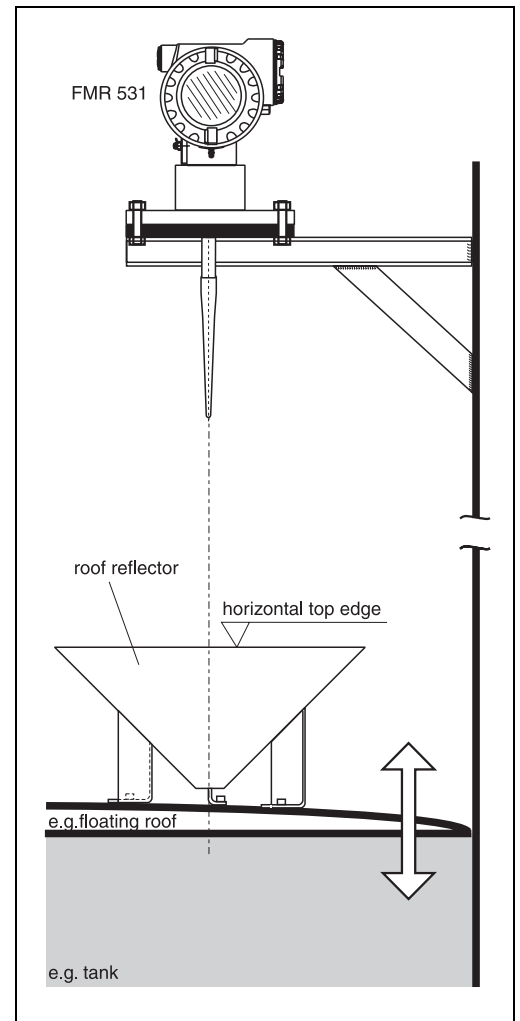

100-FMR531xx-17-00-00-en-005

3.5 Post-installation check

After the measuring instrument has been installed, perform the following checks:

- Is the measuring instrument damaged (visual check)?
- Does the measuring instrument correspond to the measuring point specifications such as process temperature/pressure, ambient temperature, measuring range, etc.?
- Is the flange marking correctly aligned? (see Page 12)
- Have the flange screws been tightened up with the respective tightening torque?
- Are the measuring point number and labeling correct (visual check)?
- Is the measuring instrument adequately protected against rain and direct sunlight (see Page 68)?

4 Wiring

4.1 Quick wiring guide

When grounding conductive screens, the corresponding directives EN 60079-14 and EN 1127-1 must be observed. Recommendation for safe grounding of conductive screens:

Wiring

Caution!

- The power supply must be identical to the data on the nameplate (1).
- Switch off power supply before connecting up the device.
- Connect Equipotential bonding to transmitter ground terminal before connecting up the device.
- Tighten the locking screw: It forms the connection between the antenna and the housing ground potential
- The power supply be delivered by a transmitter supply unit.

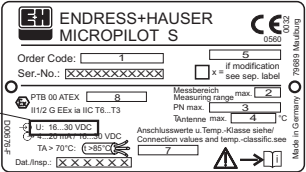

Before connection please note the following:

When you use the measuring system in hazardous areas, make sure you comply with national standards and the specifications in the safety instructions (XA's). Make sure you use the specified cable gland.

Connect up the Microplot S as follows:

EX Before unscrew housing cover (2) at separate connection room turn off the power supply!

- Insert cable (3) through gland (4). Use screened, twisted 2-wire or 4-wire cable.

EX Only ground screening of the line (5) on sensor side.

- Make connection (see pin assignment).
- Tighten cable gland (4).
- Screw off housing cover (2).
- Switch on power supply.

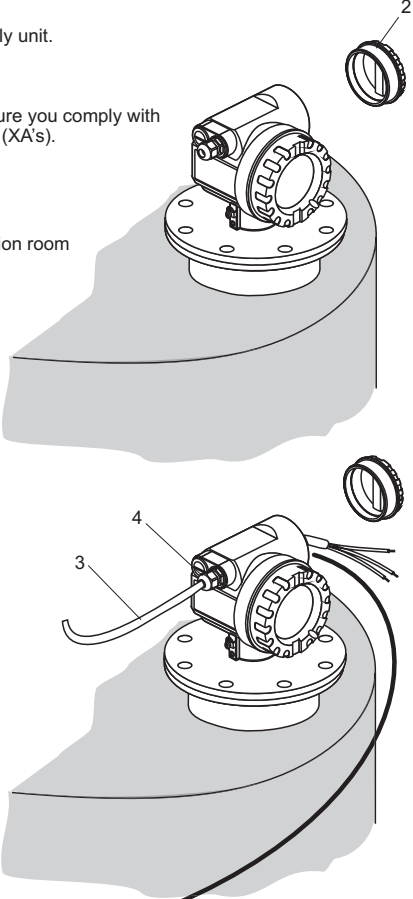

power:
24 VDC
(16...30 V);
from a
transmitter
supply unit

signal:
24 VDC

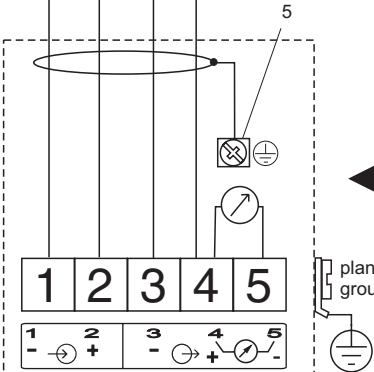

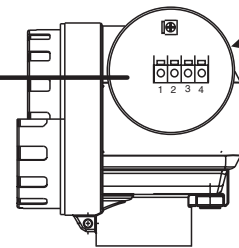

A Microplot S situated in a hazardous area is connected as a **single device** to a **power supply unit and transmitter** situated outside of the hazardous area. In this case, it is recommended that the screen be connected directly to the Microplot at the housing's earth, whereby the Microplot S and the power supply unit are connected to the same potential matching line (PML).

Wiring with Tank Side Monitor NRF590



Before connection please note the following:

- The power supply must be identical to the data on the nameplate (1).
- Switch off power supply before connecting up the device.
- Connect Equipotential bonding to transmitter ground terminal before connecting up the device.
- Tighten the locking screw: It forms the connection between the antenna and the housing ground potential.

When you use the measuring system in hazardous areas, make sure you comply with national standards and the specifications in the safety instructions (XA's). Make sure you use the specified cable gland.

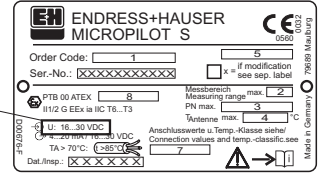

Connect up the Micropilot S as follows:

Before unscrew housing cover (2) at separate connection room turn off the power supply!

- Insert cable (3) through gland (4).
- Use screened, twisted 2-wire or 4-wire cable.
- Make connection (see pin assignment).
- Tighten cable gland (4).
- Screw off housing cover (2).
- Switch on power supply.

Tank Side Monitor NRF590

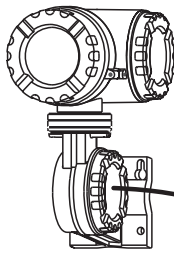

intrinsically safe terminal board

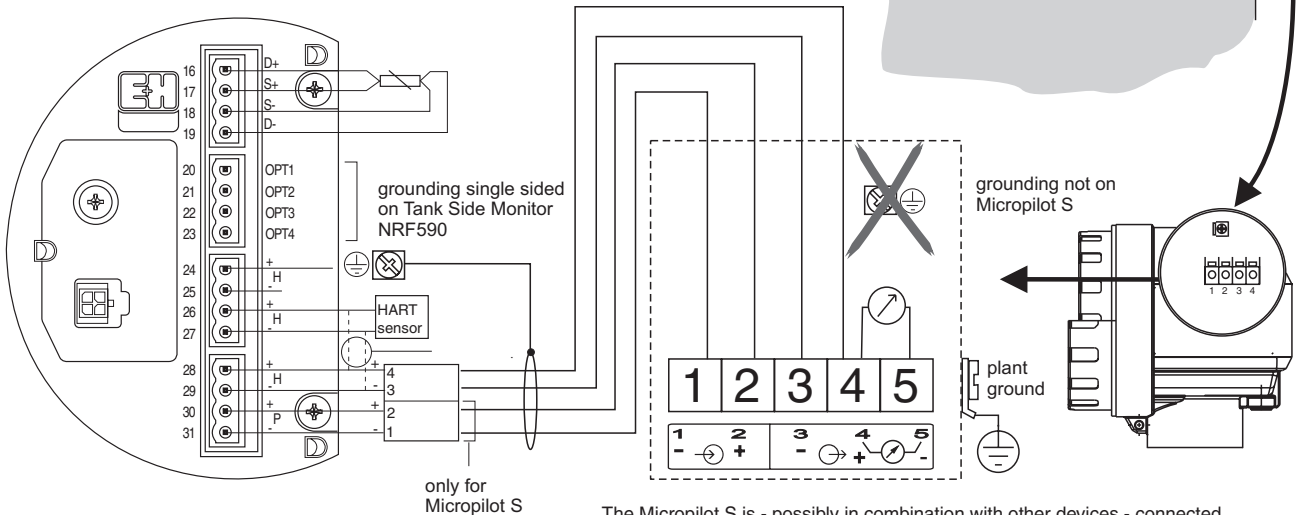

The Micropilot S is - possibly in combination with other devices - connected to a tank side monitor in a hazardous area. In this case, it is recommended that you ground the cable screen centrally at the **Tank Side Monitor** and connect all devices to the same potential matching line (PML). If, for functional reasons, a capacitive coupling is required between local earth and screen (multiple grounding), ceramic condensers with a dielectric strength of min. 1500 V_{eff} must be used, whereby the total capacitance of 10 nF must not be exceeded. Notes on grounding interconnected intrinsically safe devices are provided by the FISCO model.

4.2 Connecting the measuring unit

Terminal compartment

The housing features a separate terminal compartment.

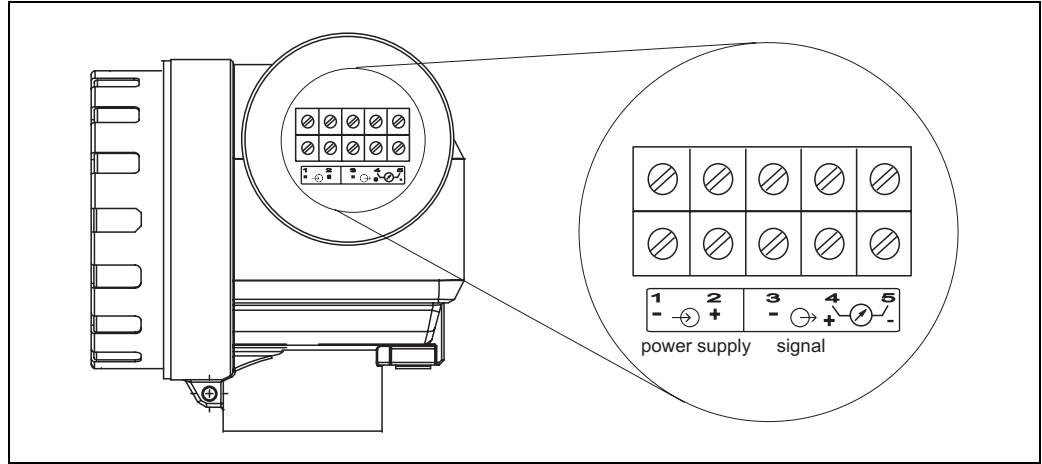

100-FMR53xxx-04-00-00-en-001

Load HART

Minimum load for HART communication: 250 Ω

Cable entry

Cable gland: 2 x M20x1.5

Cable entry: 2 x G 1/2 or 2 x 1/2 NPT

Supply voltage

DC voltage: 16...36 VDC

Communication		Terminal voltage	minimum	maximum
Power supply	Standard	U (20 mA) =	16 V	36 V
	Ex	U (20 mA) =	16 V	30 V
Signal	Ex	U (4 mA) =	11.5 V	30 V
		U (20 mA) =	11.5 V	30 V

Power consumption

Max. 330 mW at 16 V, max. 500 mW at 24 V, max. 600 mW at 30 V.

Current consumption

Max. 21 mA (50 mA inrush current).

Overvoltage protector

- The level transmitter Micropilot S is equipped with an internal overvoltage protector (600 Vrms surge arrester) according to DIN EN 60079-14 or IEC 60060-1 (impulse current test 8/20 μ s, $I = 10$ kA, 10 pulses). Additionally, the instrument is protected by a galvanic insulation of 500 Vrms between the power supply and the (HART) current output. Connect the metallic housing of the Micropilot S to the tank wall or screen directly with an electrically conductive lead to ensure reliable potential matching.
- Installation with additional overvoltage protector HAW262Z/HAW56xZ (see XA081F-A "Safety instructions for electrical apparatus certified for use in explosion-hazardous areas").
 - Connect the external overvoltage protector and the Micropilot S transmitter to the local potential matching system.
 - Potentials shall be equalised both inside and outside the explosion hazardous area.
 - The cable connecting the overvoltage protector and the Micropilot S transmitter shall not exceed 1 m in length;
 - The cable shall be protected e.g. routed in an armoured hose.

Power supply

For stand alone operation recommended via two Endress+Hauser RN221N.

mm accuracy

For measurements with mm accuracy the measured variable must be transmitted using HART protocol to ensure the necessary resolution.

4.2.1 Connection to Tank Side Monitor NRF590

See Page 25.

4.2.2 HART connection with two Endress+Hauser RN221 N

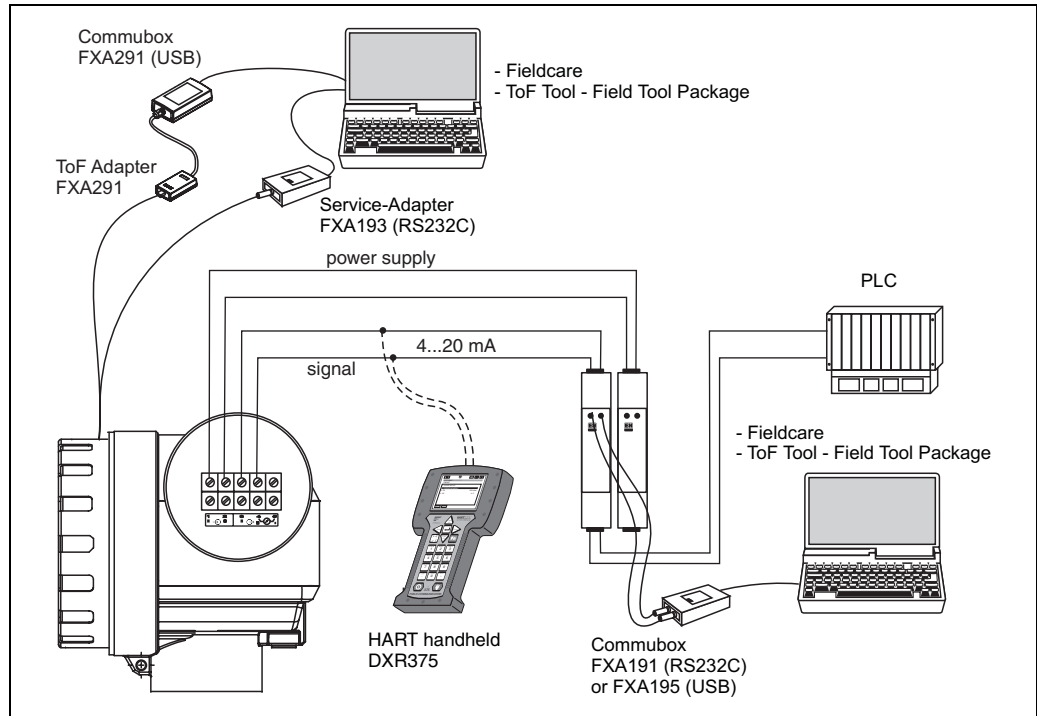

4.2.3 HART connection with other supplies

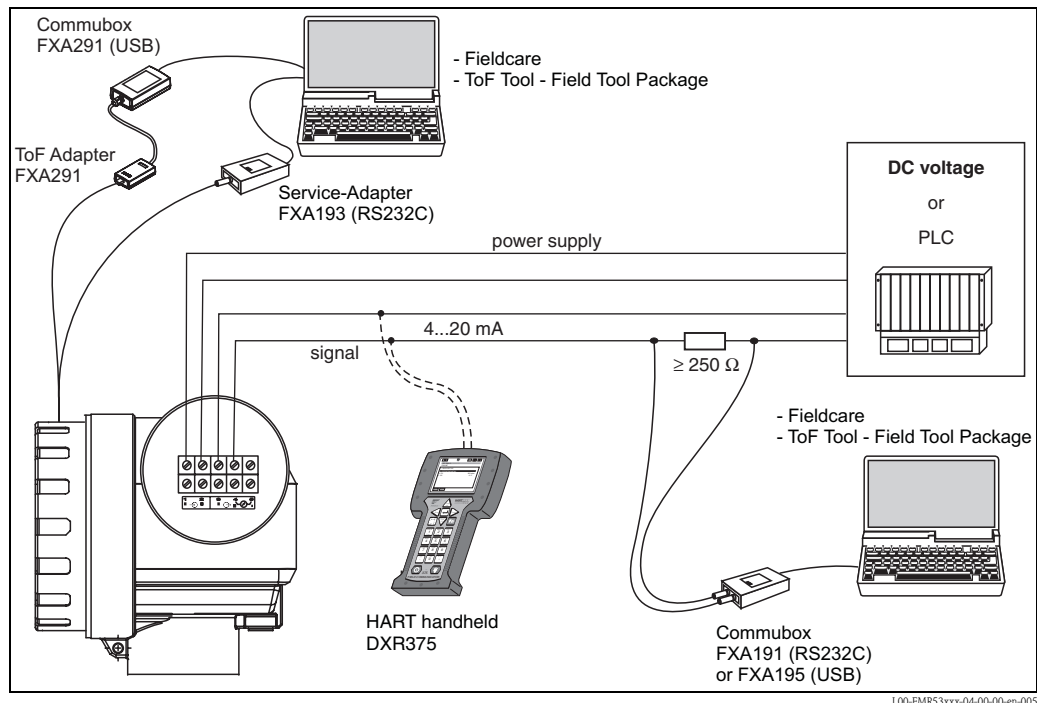

Caution!

If the HART communication resistor is not built into the supply unit, it is necessary to insert a communication resistor of 250 Ω into the 2-wire line.

4.3 Recommended connection

4.3.1 Equipotential bonding

Connect the Equipotential bonding to the external ground terminal of the transmitter.

4.3.2 Wiring screened cable



Caution!

In Ex applications, the instrument must only be grounded on the sensor side. Further safety instructions are given in the separate documentation for applications in explosion hazardous areas.

4.4 Degree of protection

- with open housing: IP 68, NEMA 6P (also ingress protection of the display): IP20, NEMA 1)
- antenna: IP 68 (NEMA 6P)

4.5 Post-connection check

After wiring the measuring instrument, perform the following checks:

- Is the terminal allocation correct (see Page 24 ff.)?
- Is the cable gland tight?
- Is the housing cover screwed tight?
- If auxiliary power is available:
 - Is the instrument ready for operation and does the liquid crystal display show any value?

5 Operation

5.1 Quick operation guide

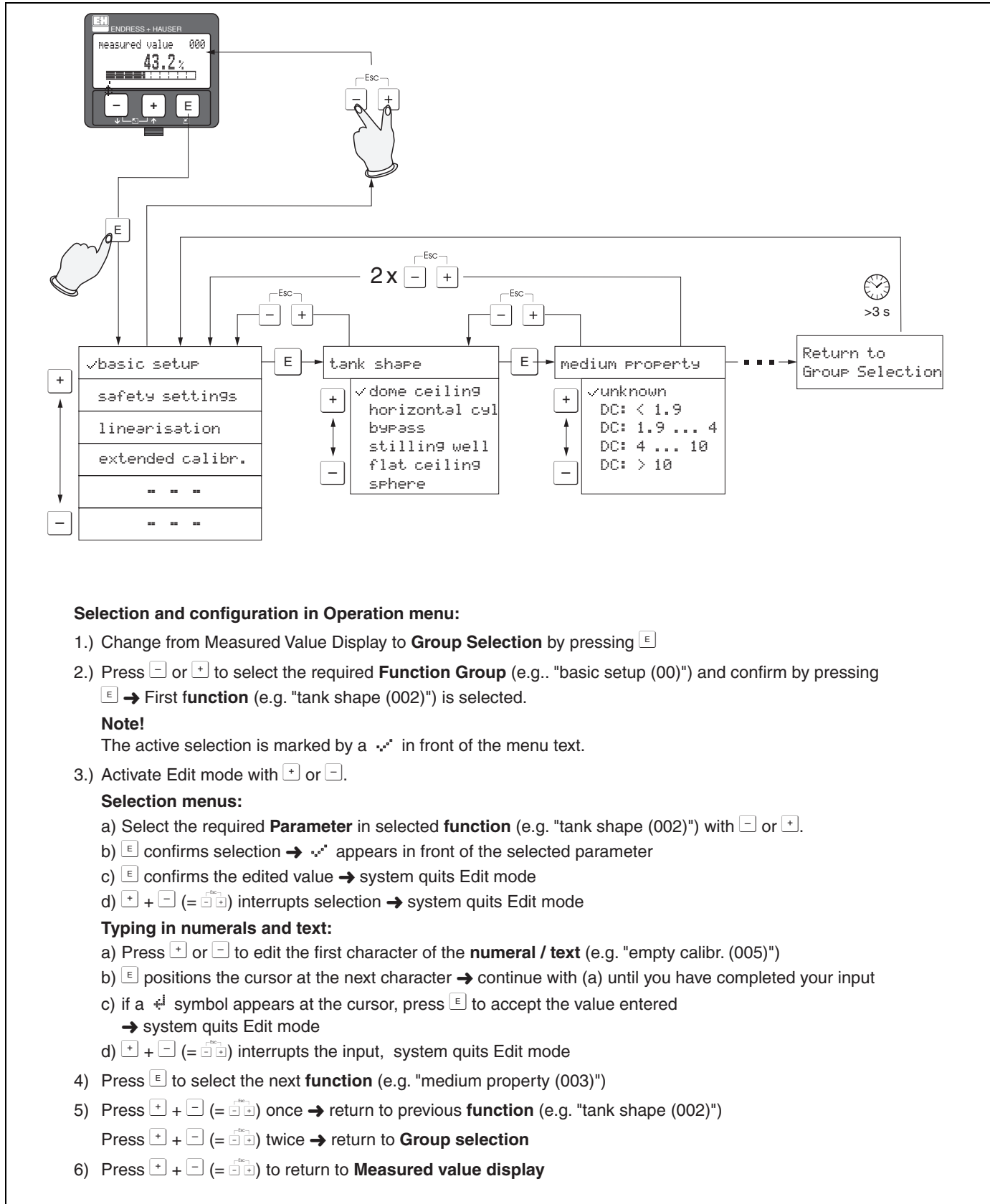

Selection and configuration in Operation menu:

- 1.) Change from Measured Value Display to **Group Selection** by pressing **E**
- 2.) Press **-** or **+** to select the required **Function Group** (e.g.. "basic setup (00)") and confirm by pressing **E** → First **function** (e.g. "tank shape (002)") is selected.

Note!

The active selection is marked by a '√' in front of the menu text.

- 3.) Activate Edit mode with **+** or **-**.

Selection menus:

- a) Select the required **Parameter** in selected **function** (e.g. "tank shape (002)") with **-** or **+**.
- b) **E** confirms selection → '√' appears in front of the selected parameter
- c) **E** confirms the edited value → system quits Edit mode
- d) **+** + **-** (= **Esc**) interrupts selection → system quits Edit mode

Typing in numerals and text:

- a) Press **+** or **-** to edit the first character of the **numeral / text** (e.g. "empty calibr. (005)")
 - b) **E** positions the cursor at the next character → continue with (a) until you have completed your input
 - c) if a **␣** symbol appears at the cursor, press **E** to accept the value entered → system quits Edit mode
 - d) **+** + **-** (= **Esc**) interrupts the input, system quits Edit mode
- 4) Press **E** to select the next **function** (e.g. "medium property (003)")
 - 5) Press **+** + **-** (= **Esc**) once → return to previous **function** (e.g. "tank shape (002)")
Press **+** + **-** (= **Esc**) twice → return to **Group selection**
 - 6) Press **+** + **-** (= **Esc**) to return to **Measured value display**

5.1.1 General structure of the operating menu

The operating menu is made up of two levels:

- **Function groups (00, 01, 03, ..., 0C, 0D):** The individual operating options of the instrument are split up roughly into different function groups. The function groups that are available include, e.g.: "basic setup", "safety settings", "output", "display", etc.
- **Functions (001, 002, 003, ..., 0D8, 0D9):** Each function group consists of one or more functions. The functions perform the actual operation or parameterisation of the instrument. Numerical values can be entered here and parameters can be selected and saved. The available functions of the "basic setup" (00) function group include, e.g.: "tank shape" (002), "medium property" (003), "process cond." (004), "empty calibr" (005), etc.

If, for example, the application of the instrument is to be changed, carry out the following procedure:

1. Select the "basic setup" (00) function group.
2. Select the "tank shape" (002) function (where the existing tank shape is selected).

5.1.2 Identifying the functions

For simple orientation within the function menus (see Page 88 ff.), for each function a position is shown on the display.

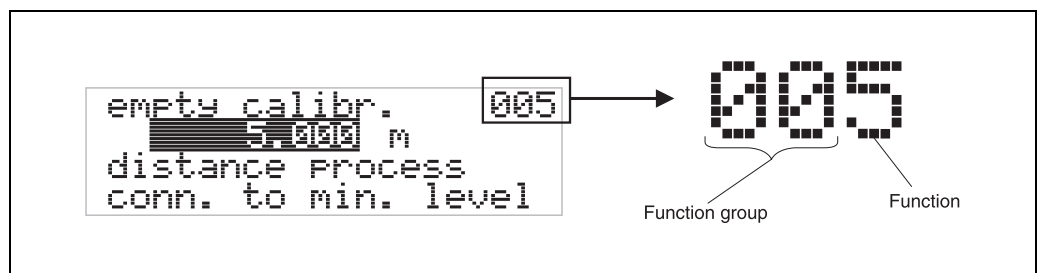

100-FMRxxxx-07-00-00-en-005

The first two digits identify the function group:

- basic setup 00
- safety settings 01
- linearisation 04
- ...

The third digit numbers the individual functions within the function group:

- basic setup 00 → ■ tank shape 002
- medium property 003
- process cond. 004
- ...

Here after the position is always given in brackets (e.g. "tank shape" (002)) after the described function.

5.2 Display and operating elements

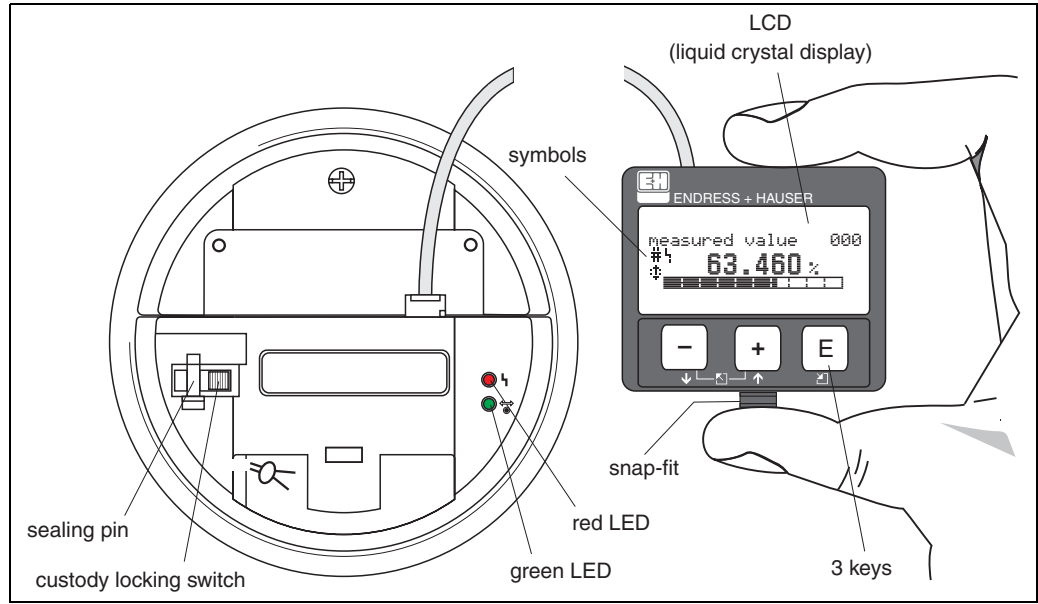

L00-FMR53xxx-07-00-00-en-003



Note!
To access the display the cover of the electronic compartment may be removed even in hazardous area.

5.2.1 Display

Liquid crystal display (LCD)



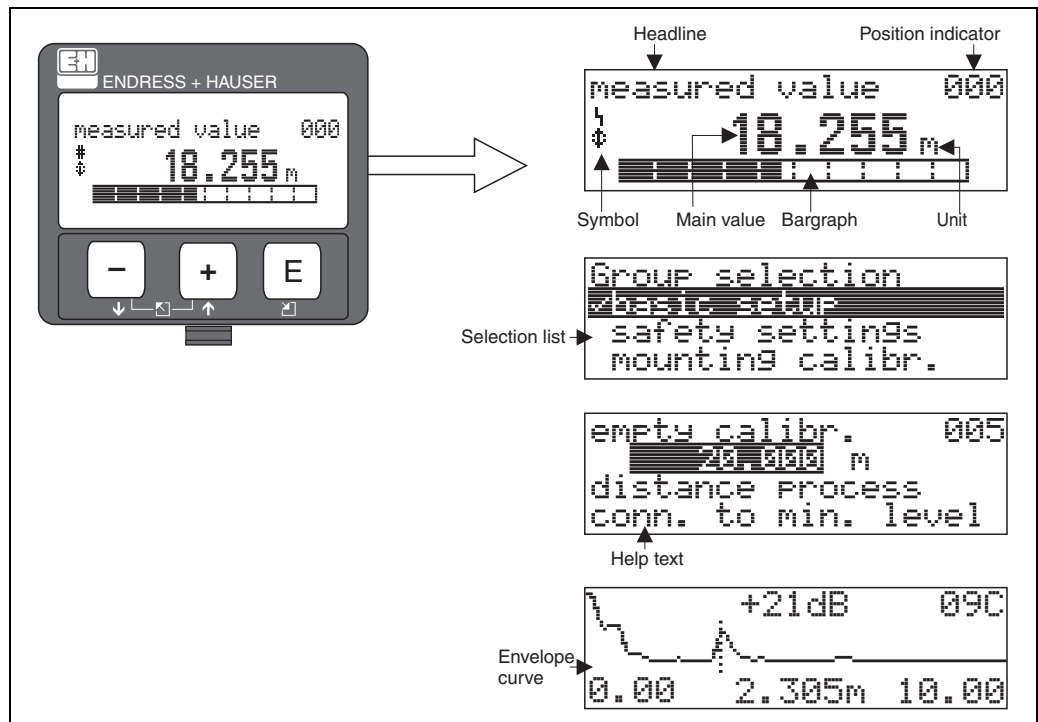

Four lines with 20 characters each. Display contrast adjustable through key combination.



L00-FMR53xxx-07-00-00-en-003

5.2.2 Display symbols

The following table describes the symbols that appear on the liquid crystal display:

Symbols	Meaning
	ALARM_SYMBOL This alarm symbol appears when the instrument is in an alarm state. If the symbol flashes, this indicates a warning.
	LOCK_SYMBOL This lock symbol appears when the instrument is locked, i.e. if no input is possible.
	COM_SYMBOL This communication symbol appears when a data transmission via e.g. HART is in progress.
	Calibration to regulatory standards disturbed If the instrument is not locked or it cannot guarantee the calibration to regulatory standards, the situation will be indicated on the display via the symbol.

Light emitting diodes (LEDs):

















There is a green and a red LED besides the Liquid Crystal Display.

LED (LED)	Meaning
red LED continuously on	Alarm
red LED flashes	Warning
red LED off	No alarm
green LED continuously on	Operation
Green LED flashes	Communication with external device

5.2.3 Key assignment

The operating elements are located inside the housing and are accessible for operation by opening the lid of the housing.

Function of the keys

Key(s)	Meaning
 or 	Navigate upwards in the selection list Edit numeric value within a function
 or 	Navigate downwards in the selection list Edit numeric value within a function
  or 	Navigate to the left within a function group
 or 	Navigate to the right within a function group
 and  or  and 	Contrast settings of the LCD
 and  and 	Hardware lock / unlock After a hardware lock, an operation of the instrument via display or communication is not possible! The hardware can only be unlocked via the display. An unlock parameter must be entered to do so.

Custody locking switch

Access to the electronics can be prevented by means of a custody locking switch that locks the device settings.

The custody locking switch can be sealed for custody transfer applications.

Software reliability

The software used in the radar instrument Micropilot S fulfills the requirements of OIML R85. This particularly includes:

- cyclical test of data consistency
- non-volatile memory
- segmented data storage

The radar instrument Micropilot S continuously monitor the compliance with accuracy requirements for custody transfer measurements according to OIML R85. If the accuracy cannot be maintained, a specific alarm is generated on the local display and via the digital communication (see Page 33).

5.3 Local operation







5.3.1 Locking of the configuration mode

The Micropilot can be protected in two ways against unauthorised changing of instrument data, numerical values or factory settings:

"unlock parameter" (0A4):

A value <> 100 (e.g. 99) must be entered in "unlock parameter" (0A4) in the "diagnostics" (0A) function group. The lock is shown on the display by the  symbol and can be released again either via the display or by communication.

Hardware lock:

The instrument is locked by pressing the  and  and  keys at the same time. The lock is shown on the display by the  symbol and can **only** be unlocked again via the display by pressing the  and  and  keys at the same time again. It is **not** possible to unlock the hardware by communication. All parameters can be displayed even if the instrument is locked.

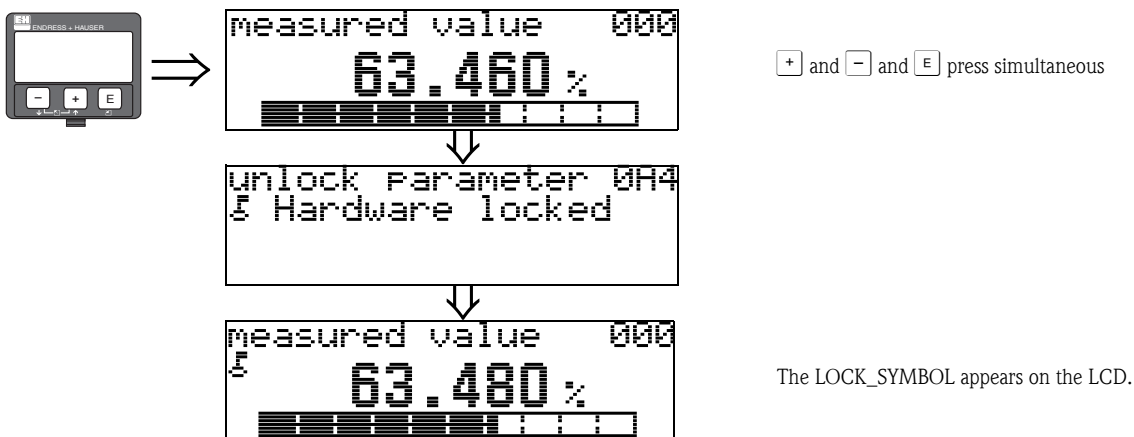

5.3.2 Unlocking of configuration mode

If an attempt is made to change parameters when the instrument is locked, the user is automatically requested to unlock the instrument:

"unlock parameter" (0A4):

By entering the unlock parameter (on the display or via communication)

100 = for HART devices

the Micropilot is released for operation.

Hardware unlock:

After pressing the **+** and **-** and **E** keys at the same time, the user is asked to enter the unlock parameter

100 = for HART devices.

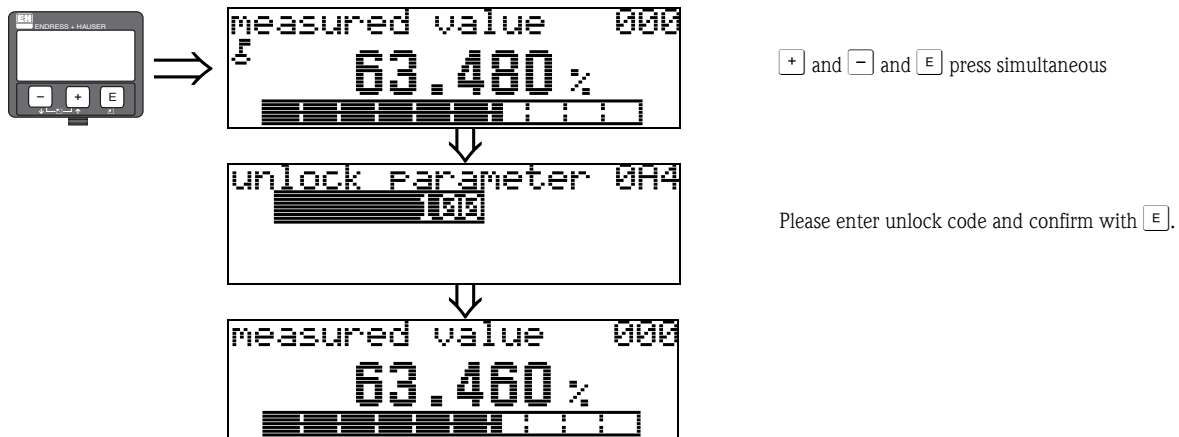

Caution!

Changing certain parameters such as all sensor characteristics, for example, influences numerous functions of the entire measuring system, particularly measuring accuracy. There is no need to change these parameters under normal circumstances and consequently, they are protected by a special code known only to the Endress+Hauser service organization. Please contact Endress+Hauser if you have any questions.

5.3.3 Factory settings (Reset)



Caution!

A reset sets the instrument back to the factory settings. This can lead to an impairment of the measurement. Generally, you should perform a basic setup again following a reset.

A reset is only necessary:

- if the instrument no longer functions
- if the instrument must be moved from one measuring point to another
- if the instrument is being de-installed /put into storage/installed



User input ("reset" (0A3)):

- 333 = customer parameters
- 555 = History

333 = reset customer parameters

This reset is recommended whenever an instrument with an unknown 'history' is to be used in an application:

- The Micropilot is reset to the default values.
- The customer specific tank map is not deleted.
- A linearisation is switched to "**linear**" although the table values are retained. The table can be reactivated in the "**linearisation**" (04) function group.

List of functions that are affected by a reset:

- | | |
|-------------------------|--------------------------|
| ■ tank shape (002) | ■ linearisation (041) |
| ■ empty calibr. (005) | ■ customer unit (042) |
| ■ full calibr. (006) | ■ diameter vessel (047) |
| ■ pipe diameter (007) | ■ range of mapping (052) |
| ■ output on alarm (010) | ■ pres. Map dist (054) |
| ■ output on alarm (011) | ■ offset (057) |
| ■ outp. echo loss (012) | ■ low output limit (062) |
| ■ ramp %span/min (013) | ■ fixed current (063) |
| ■ delay time (014) | ■ fixed current (064) |
| ■ safety distance (015) | ■ simulation (065) |
| ■ in safety dist. (016) | ■ simulation value (066) |
| ■ Tank Gauging (030) | ■ format display (094) |
| ■ auto correction (031) | ■ distance unit (0C5) |
| ■ level/ullage (040) | ■ download mode (0C8) |

The tank map can also be reset in the "**mapping**" (55) function of the "**extended calibr.**" (005) function group.

555 = History Reset



After mounting and aligning the equipment, carry out a history reset.

5.4 Display and acknowledging error messages

Type of error

Errors that occur during commissioning or measuring are displayed immediately on the local display. If two or more system or process errors occur, the error with the highest priority is the one shown on the display.



The measuring system distinguishes between two types of error:

- **A (Alarm):**
Instrument goes into a defined state (e.g. MIN, MAX, HOLD)
Indicated by a constant  symbol.
(For a description of the codes see Page 71 ff.)
- **W (Warning):**
Instrument continue measuring, error message is displayed.
Indicated by a flashing  symbol.
(For a description of the codes see Page 71 ff.)
- **E (Alarm / Warning):**
Configurable (e.g. loss of echo, level within the safety distance)
Indicated by a constant/flashing  symbol.
(For a description of the codes see Page 71 ff.)



5.4.1 Error messages

Error messages appear as four lines of plain text on the display. In addition, a unique error code is also output. A description of the error codes is given on Page 71 ff..

- The "**diagnostics**" (**0A**) function group can display current errors as well as the last errors that occurred.
- If several current errors occur, use  or  to page through the error messages.
- The last occurring error can be deleted in the "**diagnostics**" (**0A**) function group with the funktion "**clear last error**" (**0A2**).

5.5 HART communication

Apart from local operation, you can also parameterise the measuring instrument and view measured values by means of a HART protocol. There are two options available for operation:

- Operation via the universal handheld operating unit, the HART Communicator DXR375.
- Operation via the Personal Computer (PC) using the operating program (e.g. FieldCare) (For connections see Page 28).
- Operation via the Tank Side Monitor NRF590.



Note!

The Micropilot S can also be operated locally using the keys. If operation is prevented by the keys being locked locally, parameter entry via communication is not possible either.

5.5.1 Operation with handheld unit Field Communicator DXR375

All device functions can be adjusted via a menu operation with the handheld unit DXR375.

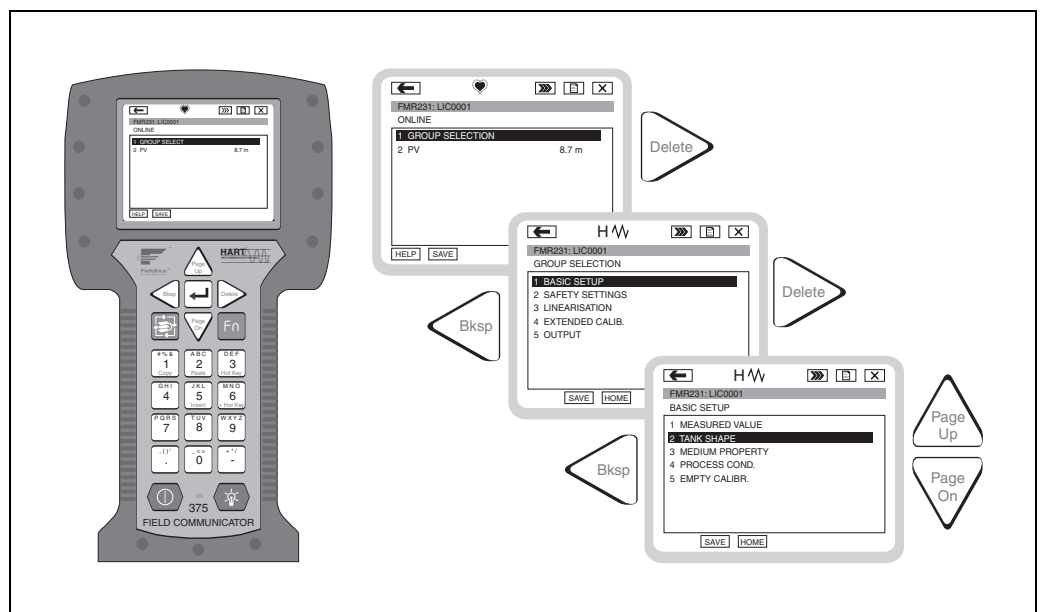

L00-FMR2xxxx-07-00-00-yy-007



Note!

Further information on the handheld unit is given in the respective operating manual included in the transport bag of the DXR375.

5.5.2 Operation with FieldCare

FieldCare is the Endress+Hauser FDT based Plant Asset Management Tool. It can configure all intelligent field devices in your plant and supports you in managing them. By using status information, it also provides a simple but effective means of checking their health.

- Supports Ethernet, HART, PROFIBUS, FOUNDATION Fieldbus etc.
- Operates all Endress+Hauser devices
- Operates all third-party actuators, I/O systems and sensors supporting the FDT standard
- Ensures full functionality for all devices with DTMs
- Offers generic profile operation for any third-party fieldbus device that does not have a vendor DTM

6 Commissioning

6.1 Function check

Make sure that all final checks have been completed before you start up your measuring point:

- Checklist "Post installation check" (see Page 23).
- Checklist "Post connection check" (see Page 29).

6.2 Switching on the measuring device

When the instrument is switched on for the first time, the following messages appear on the display:

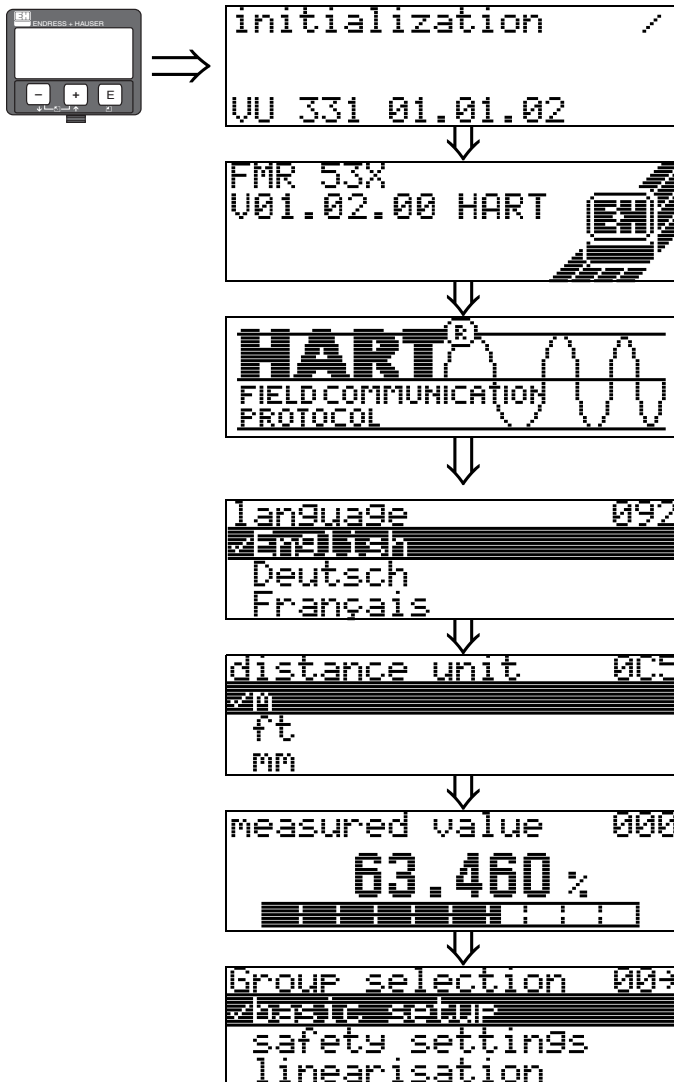

After 5 s, the following message appears

After 5 s, the following message appears

After 5 s or after you have pressed **E** the following message appears

Select the language
(this message appears the first time the instrument is switched on)

Select the basic unit
(this message appears the first time the instrument is switched on)

The current measured value is displayed

After **E** is pressed, you reach the group selection.

This selection enables you to perform the basic setup

6.3 Basic Setup

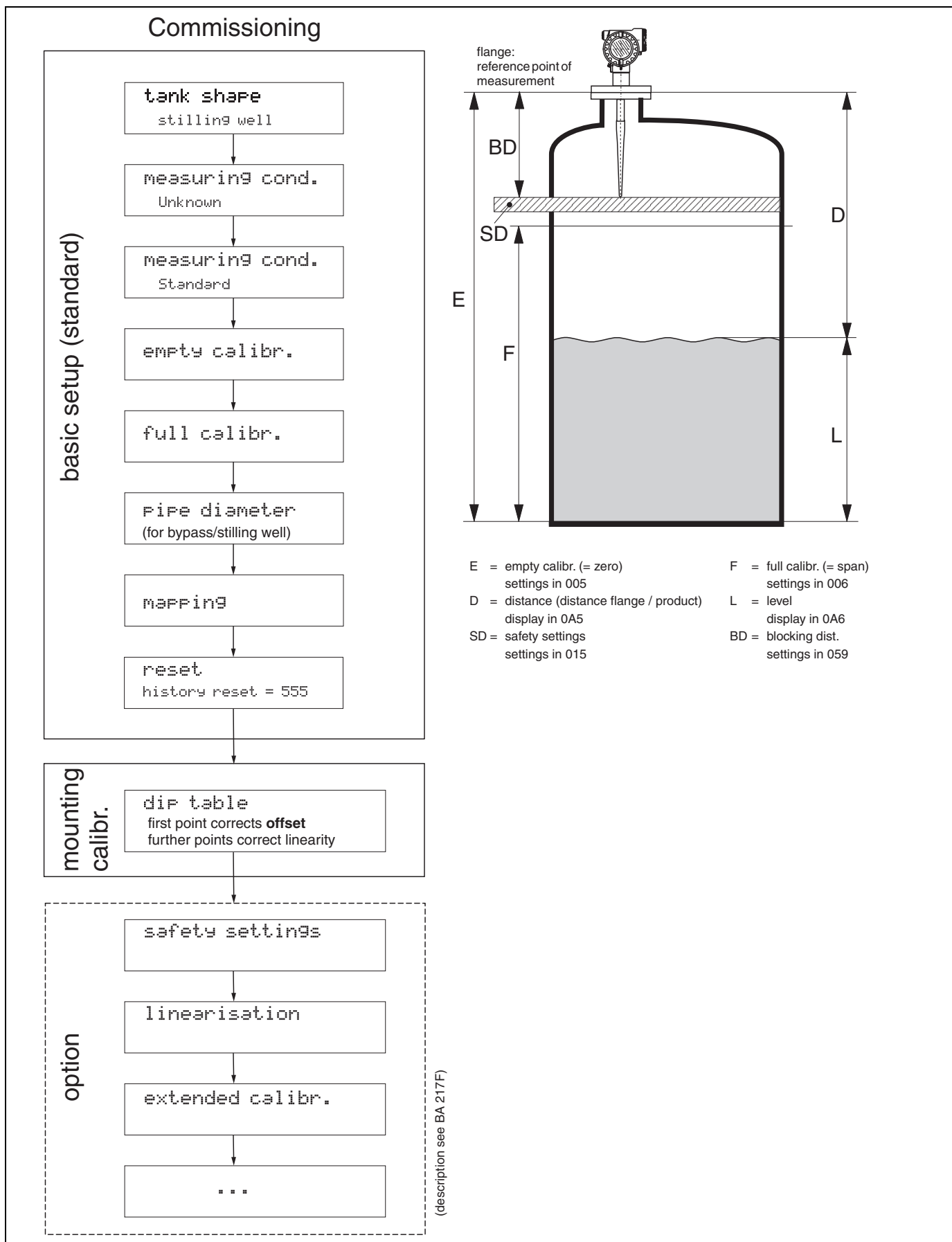

To successfully commission a precise measurement to the nearest mm, it is important you carry out a **history reset on first installation** after mechanical installation and **after** the basic setup of the device (see Page 50). Only after a history reset the **mounting calibration** is carried out. Enter the measurement **offset** as the first point in the dip table for the mounting calibration. When a value is dipped at a later date, make a second entry into the dip table, using the semi-automatic mode. This way, you can easily carry out a linear correction of the measurement.

When configuring the function in "**basic setup**" (**00**) please take into account the following notes:

- Select the functions as described Seite 30.
- Some functions can only be used depending on the parameterisation of the instrument. For example, the pipe diameter of a stilling well can only be entered if "**stilling well**" was selected beforehand in the "**tank shape**" (**002**) function.
- Certain functions (e.g. starting an interference echo mapping (053)) prompt you to confirm your data entries. Press + or - to select "**YES**" and press E to confirm. The function is now started.
- If you do not press a key during a configurable time period (→ function group "**display**" (**09**)), an automatic return is made to the home position (measured value display).



Note!

- The instrument continues to measure while data entry is in progress, i.e. the current measured values are output via the signal outputs in the normal way.
- If the envelope curve mode is active on the display, the measured values are updated in a slower cycle time. Thus, it is advisable to leave the envelope curve mode after the measuring point has been optimised.
- If the power supply fails, all preset and parameterised values remain safely stored in the EEPROM.



Caution!

All functions are described in detail, as is the overview of the operating menu itself, in the manual "**Description of the instrument functions – BA217F**" which is a separate part of this operating manual.



Note!

The default values of the parameters are typed in **boldface**.

6.4 Basic Setup with the VU331

Function "measured value" (000)



This function displays the current measured value in the selected unit (see "customer unit" (042)) function). The number of digits after decimal point can be selected in the "no. of decimals" (095) function. The length of the bargraph corresponds to the percental value of the present measured value with regard to the span.

6.4.1 Function group "basic setup" (00)

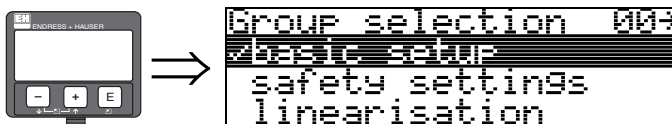

Function "tank shape" (002)



This function is used to select the tank shape.

Selection:

- dome ceiling
- horizontal cyl
- bypass
- stilling well
- **flat ceiling** (Typical ceiling of storage tanks: a slight slope of only a few degrees can be neglected.)
- sphere

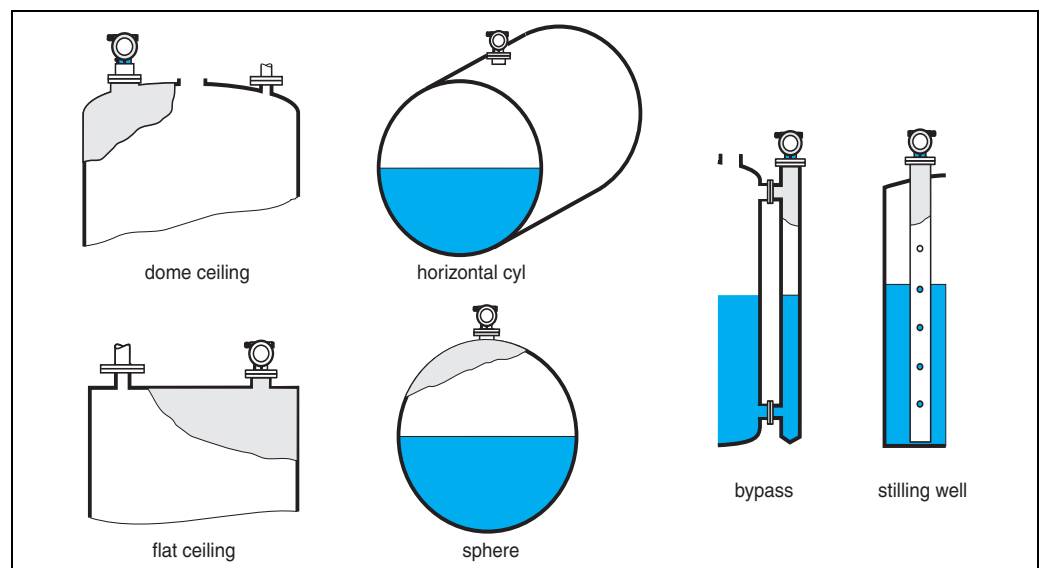

Function "medium property." (003)

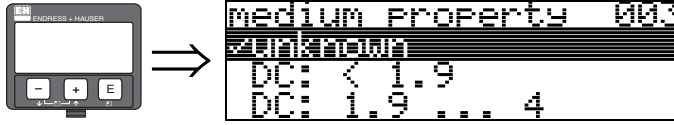

This function is used to select the dielectric constant.

Selection:

- unknown
- DC: < 1.9
- DC: 1.9 ... 4
- DC: 4 ... 10
- DC: > 10

Media group	DC (ϵ_r)	Examples
A	1.4...1.9	non-conducting liquids, e.g. liquefied gas (LPG). For more information please contact your Endress+Hauser representative.
B	1.9...4	non-conducting liquids, e.g. benzene, oil, toluene, white products, black products, crudes, bitumen/asphalts, ...
C	4...10	e.g. concentrated acids, organic solvents, esters, aniline, alcohol, acetone, ...
D	>10	conducting liquids, e.g. aqueous solutions, dilute acids and alkalis

Function "process cond." (004)

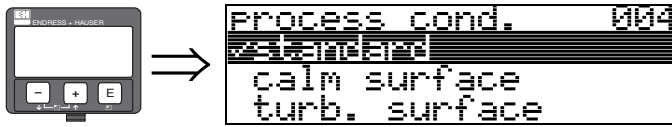

This function is used to select the process conditions.

Selection:

- **standard**
- calm surface
- turb. surface
- agitator
- fast change
- heavy conditions
- test:no filter

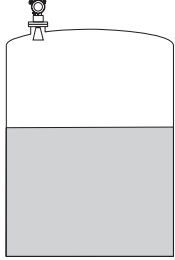
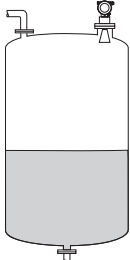
standard	calm surface
For all applications that do not fit into any of the following groups.	Storage tanks with immersion tube or bottom filling
	
The filter and output damping are set to average values.	The averaging filters and output damping are set to high values. → steady meas. value → precise measurement → slower reaction time



Note!

The phase evaluation of the Micropilot S (see Page 51) is only activated if you select the measuring conditions "**standard**", "**calm surface**" or "**heavy conditions**". If, however, "**heavy conditions**" is selected, no index values are stored. We strongly recommend that, in the case of rough product surfaces or rapid filling, you activate the appropriate application parameters.

Function "empty calibr." (005)

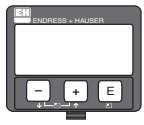

```

empty calibr.      005
██████████ 5.000 m
distance Process
conn. to min. level
  
```

This function is used to enter the distance from the flange (reference point of the measurement) to the minimum level (=zero).

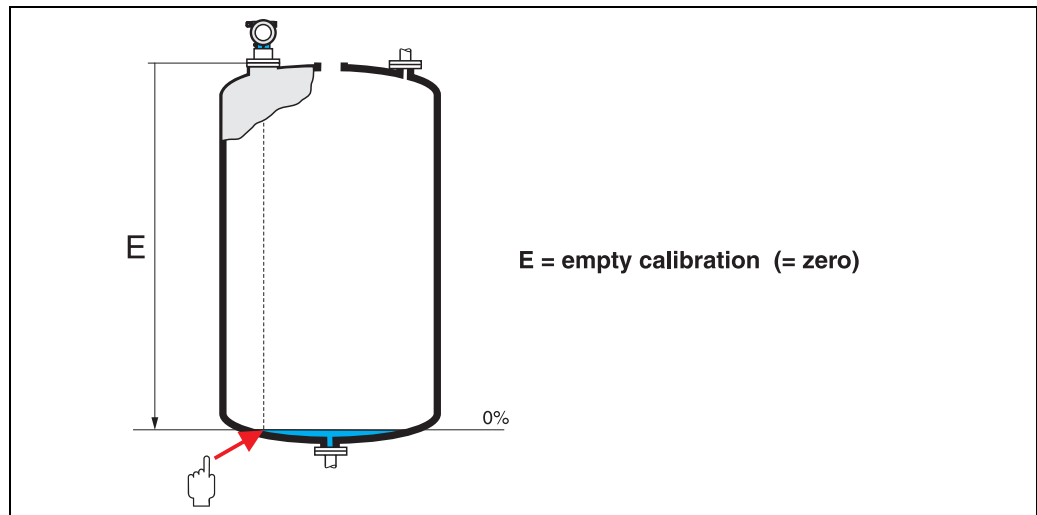

L00-FMR2xxxx-14-00-06-en-008



Caution!

For dish bottoms or conical outlets, the zero point should be no lower than the point at which the radar beam hits the bottom of the tank.

Function "full calibr." (006)

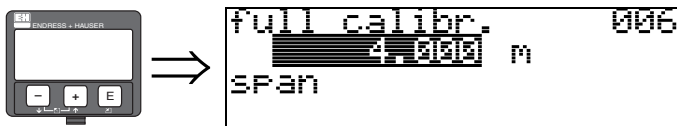

This function is used to enter the distance from the minimum level to the maximum level (=span).

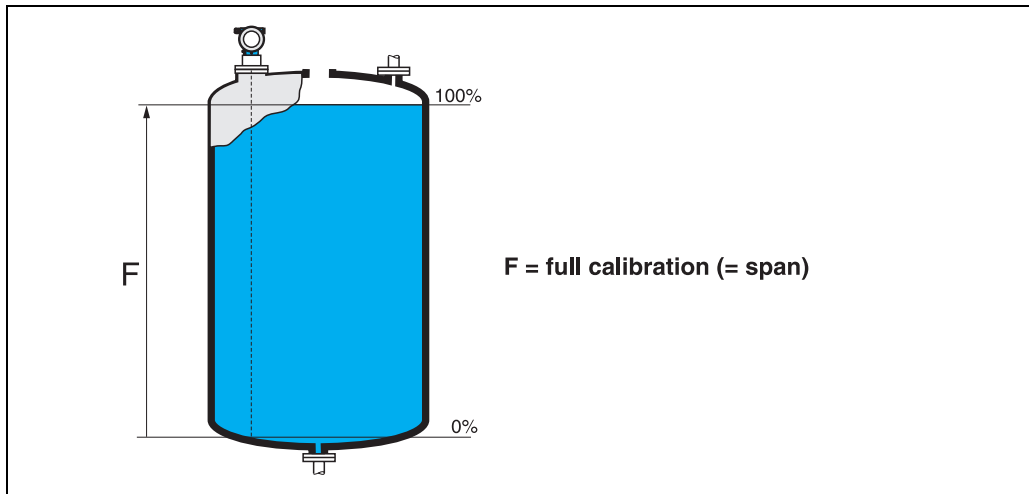

In principle, it is possible to measure up to the tip of the antenna. However, due to considerations regarding corrosion and build-up, the end of the measuring range should not be chosen any closer than 50 mm (2") to the tip of the antenna.



Note!

If **bypass** or **stilling well** was selected in the "tank shape" (002) function, the pipe diameter is requested in the following step.

Function "pipe diameter" (007)



This function is used to enter the pipe diameter of the stilling well or bypass pipe.

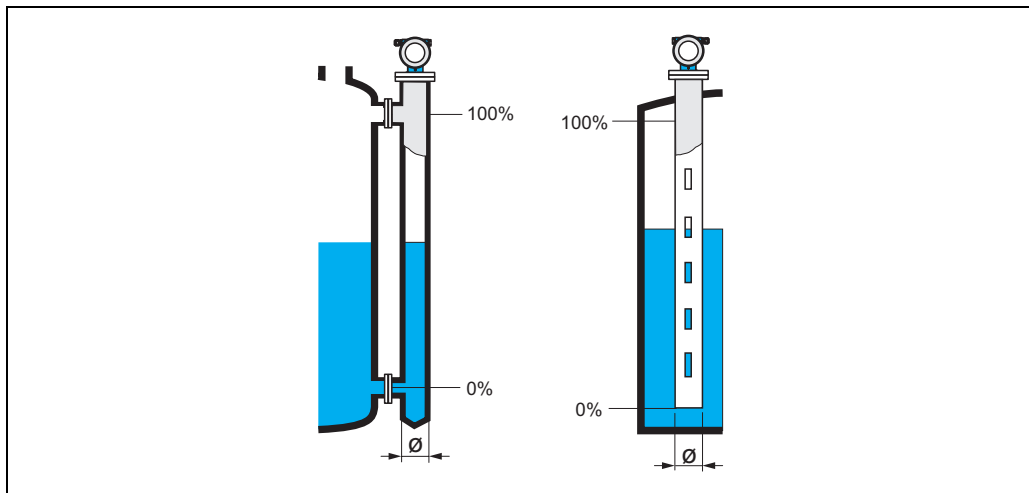

Microwaves propagate slower in pipes than in free space. This effect depends on the inside diameter of the pipe and is automatically taken into account by the Micropilot. It is only necessary to enter the pipe diameter for applications in a bypass or stilling well.

Function "dist./ meas. value" (008)

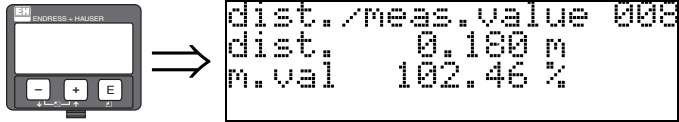

The **distance** measured from the reference point to the product surface and the **level** calculated with the aid of the empty adjustment are displayed. Check whether the values correspond to the actual level or the actual distance. The following cases can occur:

- Distance correct – level correct → continue with the next function, "**check distance**" (051).
- Distance correct – level incorrect → Check "**empty calibr**" (005)
- Distance incorrect – level incorrect → continue with the next function, "**check distance**" (051).

Function "check distance" (051)



This function triggers the mapping of interference echoes. To do so, the measured distance must be compared with the actual distance to the product surface. The following options are available for selection:

Selection:

- distance = ok
- dist. too small
- dist. too big
- **dist. unknown**
- manual

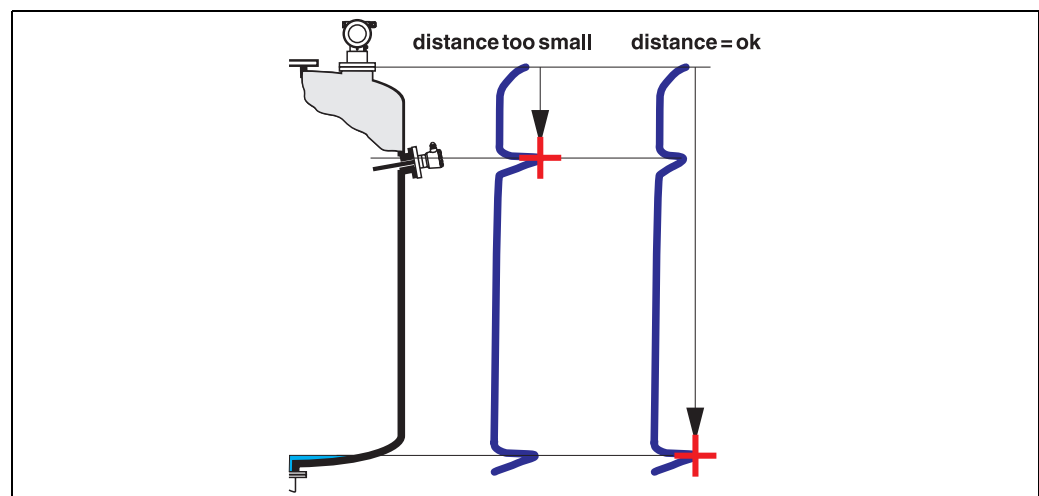

100_FMR2xxxx-14-00-06-es-010

distance = ok

- mapping is carried out up to the currently measured echo
- The range to be suppressed is suggested in the "**range of mapping**." (052) function



Note!

Anyway, it is wise to carry out a mapping even in this case.

dist. too small

- At the moment, an interference is being evaluated
- Therefore, a mapping is carried out including the presently measured echoes
- The range to be suppressed is suggested in the "**range of mapping.**" (052) function

dist. too big

- This error cannot be remedied by interference echo mapping
- Check the application parameters (002), (003), (004) and "**empty calibr.**" (005)

dist. unknown

If the actual distance is not known, no mapping can be carried out.

manual

A mapping is also possible by manual entry of the range to be suppressed. This entry is made in the "**range of mapping.**" (052) function.



Caution!

The range of mapping must end 0.5 m (20") before the echo of the actual level. For an empty tank, do not enter E, but E - 0.5 m (20").

If a mapping already exists, it is overwritten up to the distance specified in "**range of mapping**" (052). Beyond this value the existing mapping remains unchanged.

Function "range of mapping" (052)



This function displays the suggested range of mapping. The reference point is always the reference point of the measurement (see Page 41 ff.). This value can be edited by the operator. For manual mapping, the default value is: 0 m.

Function "start mapping" (053)



This function is used to start the interference echo mapping up to the distance given in "**range of mapping**" (052).

Selection:

- off → no mapping is carried out
- on → mapping is started

During the mapping process the message "**record mapping**" is displayed.



Caution!

A mapping will be recorded only, if the device is not in alarm-state.

Display "dist./meas.value" (008)

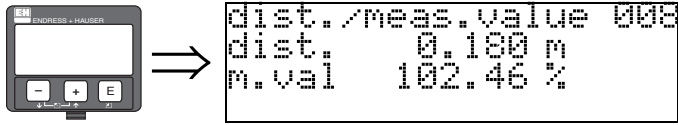

The **distance** measured from the reference point to the product surface and the **level** calculated with the aid of the empty alignment are displayed again. Check whether the values correspond to the actual level or the actual distance. The following cases can occur:

- Distance correct – level correct → continue with the next function, "**check distance**" (051).
- Distance correct . level incorrect → Check "**empty calibr**" (005)
- Distance correct – level incorrect → continue with the next function, "**check distance**" (051).

Function "history reset" (009)

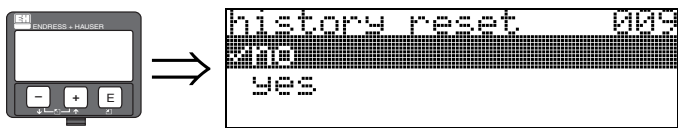

By this function a history reset of the device is performed, i.e. the correspondance table between level an index values is deleted. A new correspondance table will be filled and stored after the history reset, cf. Page 51.



Caution!

A history reset must be performed after:

- first installation or
- change of basic setup or
- change of the installation situation.

In this case also effect a reset of the dip table in function "**dip table mode**" (033).

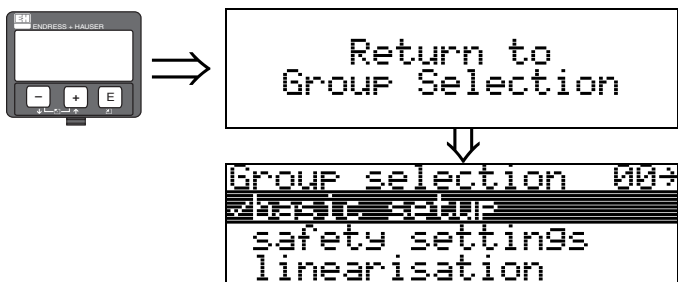

After 3 s, the following message appears

6.5 Mounting calibration with VU331

6.5.1 Function group "mounting calibr." (03)

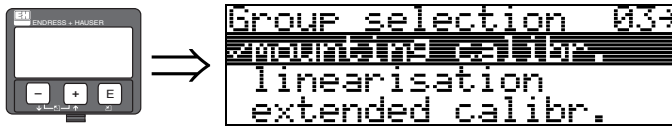

Function "tank gauging" (030)



Using this function, you can either enter a dip table or carry out an auto correction.

Function "auto correction" (031)



When measuring levels with radar systems, so-called "multipath reflections" can affect the level signal giving rise to serious measuring errors. "Multipath reflections" also include radar beams which are received by the radar system, which have not been reflected directly by the medium surface. They may reach the antenna via the basin wall and the medium surface. This phenomenon is particularly noticeable with devices mounted near to walls, as soon as the conical radar beam strikes the basin wall. The Micropilot S can automatically discover and correct measuring errors due to this "multiple path" propagation. This is because it uses two independent sets of information when evaluating reflection signals:

- Firstly, it evaluates the **amplitude** of the reflected energy using the so-called envelope curve system.
- Secondly, it evaluates the **phase** of the reflected energy.

The decisive factor for a constant output signal is to assign the phase values to the associated level values. This assignment is ensured using a correspondence table (index correction table). The Micropilot S learns this for the specific application after installation (learning period). Therefore, after mounting the device, and **after** completing the basic calibration, a **history reset** (must be performed (enter "yes" in the "history reset" (009) function in the "basic setup" (00) function group. Do not switch off the radar system during filling and emptying operations during the teach-in phase. Switching off when there are only negligible level changes produces no error.



Caution!

During the learning period, fast filling/emptying or turbulent surfaces can result in switching off and on the phase evaluation. Subsequently observed measurement errors will disappear as soon as tank levels come back to areas measured by Micropilot S previously with activated phase evaluation. If the observed measurement errors are corrected by dip table entries, the Micropilot S will take care of these corrections and automatically adjust the index correction table. Do **NOT** correct any settings in the basic calibration or the extended calibration.



Note!

Immediately after installation, the Micropilot S measures with the specified mm-accuracy. Until the level range has been completely covered by the medium (setting up the correction table), the

maximum permissible filling speed is 100 mm level change / min. After this, the fill speed has no limitation.

Function "pipe diam. corr." (032) (only relevant for FMR532)

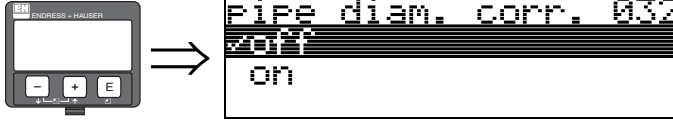

For level measurement in stilling wells, radar systems require highly precise pipe inner diameter data. An mm-exact level measurement cannot be guaranteed for deviations from the actual stilling well inner diameter of more than ± 0.1 mm to the value entered in the function group "**basic setup**" (00). The errors which occur as a result are linear and can be corrected with a dip table containing at least two entries. The Micropilot S also has an automatic pipe inner diameter correction. This adjusts the entered stilling well inner diameter (input in the function group "**basic setup**" (00)) to the actual values. However, this presupposes that the value entered in the function group "**basic setup**" (00) matches the actual pipe inner diameter accurately as possible. The user-defined value entered in the function group "**basic setup**" (00) can be corrected with this value. Then, switch on the "**pipe diam. corr.**" (032) function, after a level change of **at least 5 m** has occurred since start-up. The pipe diameter, which the instrument determines automatically, will then be transmitted to the "**pipe diameter**" (007) function..



Note!

Only if the "**pipe diameter**" (007) function has changed its value, it is necessary to perform a "**history reset**" (009) and to delete the dip table after activation of the "**pipe diam. corr.**" (032) function. Otherwise the level change of 5 m has not yet been exceeded. The "**pipe diam. corr.**" (032) function must be deactivated again and the procedure should be repeated at a later point of time.

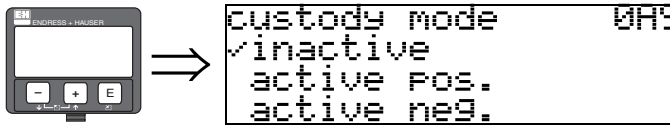
Display "custody mode" (0A9)

This indicates the instrument calibration mode. The calibration mode (active) can be set using the hardware security lock on the electronics (see Page 32).

Selection:

- **inactive**
- active pos.
- active neg.

active pos.

The custody mode (instrument is lead-sealed and accurate to the nearest mm) is active and is held.

active neg.

Custody mode (instrument is lead-sealed and accurate to the nearest mm) is activated and not held, e.g. because the signal-to-noise ratio is less than 5 dB (refer to function "**echo quality**" (056) in the function group "**extended calibr.**" (05)).

**Caution!**

After entering all the values and completing mounting and aligning work, enter the Reset Code "**555**" in the function "**reset**" (0A3) to reset the instrument history for auto-correction or set history reset to "**yes**" in order to reset the instrument history for the auto-correction.

Dip table

The dip table is used to correct the level readings of the Micropilot S using independently taken hand dips. The dip table is used in particular to adapt the level gauge to the specific application conditions as mechanical offset and tank/stilling well design. Depending on national regulations, national inspectors will dip the tank at one to three levels during a calibration run and check the level readings. Only one value pair must be entered into the dip table to correct the measurement **offset**. If a second value pair is entered into the dip table, the Micropilot S accepts the corrected measured values identically for both value pairs. All other measured values are determined by linear extrapolation. If you enter more than two value pairs, the system carries out a linear interpolation between adjacent value pairs. Outside these value pairs, extrapolation is also linear.

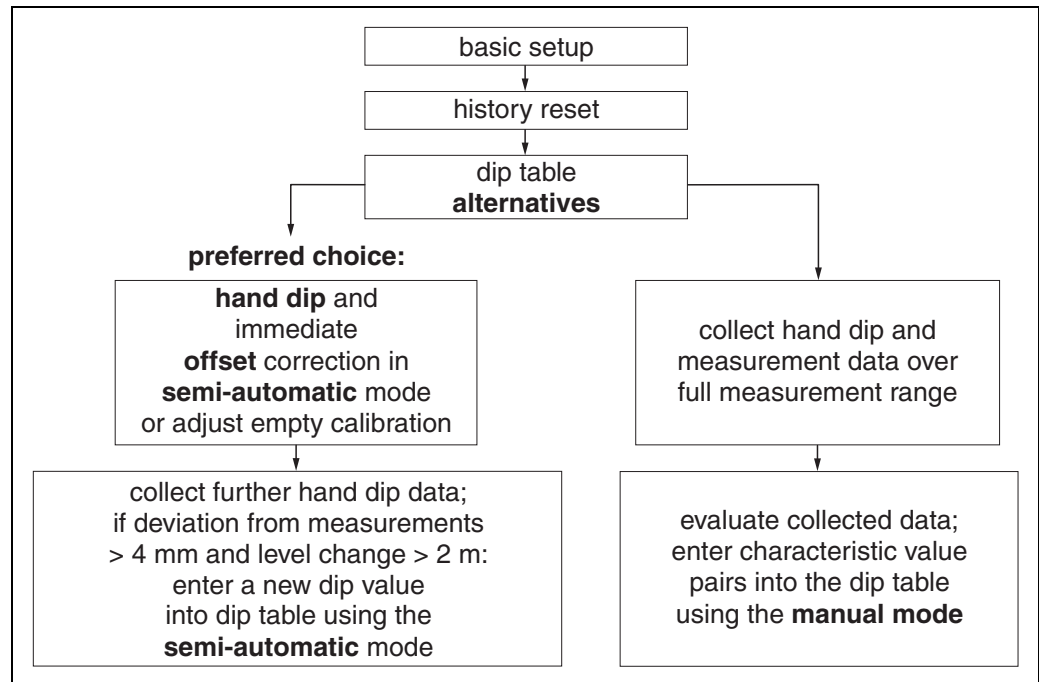

To collect and enter data into the dip table, two alternative procedures may be carried out. In order not to mix up measurement values corrected by the offset or linearisation of the dip table with uncorrected measurement values, it is recommended to use the semi-automatic mode of the dip table to enter new data pairs. In this case, the first dip value should be entered immediately after the basic calibration. Further linearization points should be entered only after a level change of at least 2 m (cf. upper figure, preferred choice) and a deviation between the "uncorrected measurement value" and the hand dip value of at least 4mm. If this procedure can not be followed, then **NO** value pair should be entered into the dip table after basic calibration. Measurement data and hand dip values should be collected over the full measurement range and be evaluated with regard to a good linear fit. Only then characteristic value pairs should be entered into the dip table using the "manual mode" (cf. upper figure, right side). If further linearisation is needed, further hand dip values should be entered **using only the "semi-automatic mode"**.



Note!

- The offset should NOT be determined and entered within the close range of the antenna (conf. definition of the safety distance) or immediately in the range of the tank bottom, because within these ranges interferences of the radar signal may occur.
- The dip table can be printed out using FieldCare. Before doing this, FieldCare must be reconnected to the instrument in order to update the values within FieldCare.
- Make your inputs into the dip table in semi-automatic mode. We advise you to leave "auto correction" (031) activated ("on") while you enter your inputs.



Caution!

After entering one or more points into the dip table, make sure that the dip table is activated and left in the "table on" dip table mode.

Function "dip table state" (037)



```
dip table state 037
✓table off
table on
```

This function displays the dip table status.

Display:

- table on
- **table off**

table on

Indicates whether the dip table is active.

table off

Indicates whether the dip table is not active.

Function "dip table mode" (033)



```
dip table mode 033
✓table off
clear table
view
```

The dip table can be switched on or off using this function.

Selection:

- manual
- semi-automatic
- table on
- **table off**
- clear table
- view

manual

The "manual mode" of the dip table can be used to enter collected data after a series of data pairs taken at different tank levels. The parameter "manual" in the "**dip table**" (033) function can be used to enter data pairs, which have been recorded at different levels, into the dip table. The measured value and the dip value can be entered.

- uncorrected measured value:
This is the measured value supplied by the instrument, **NOT** corrected by the dip table. The choice of measured value, level or remaining fill height is dependent on the instrument setting.
- Dip value:
This is the level or distance to flange respectively, given by the hand dip. This value should be used to correct the measured value.



Note!

The bigger the distance between the different levels while taking hand dips, the more accurate the linearisation of the dip table will be.

semi-automatic

The value pairs in the dip table can be read. You can enter the dip value only. When there are new value pairs, the current uncorrected level or distance is accepted as the measured value.

table on

The dip table is switched on.

table off

The dip table is switched off.

clear table

The complete dip table is deleted. The table is switched off. The number of free table entries is set to the maximum value (= 32).

View

The value pairs in the dip table can **only** be read. You can still select this menu option, even if there is no dip table available. In this case, the number of free table entries is at maximum value (= 32).

Function "dip table" (034)

```
dip table 034
meas.v. 40.000m
dip val 40.000m
remain. 32
```

This function edits measured variable. The number behind the entry "**remain**" indicates the current number of remaining free value pairs. The maximum number of value pairs is 32; after each entry, the remaining number is decremented.



Note!

The **uncorrected** measured value is displayed in the "**dip table**" (034) function. This may differ considerably from the measured values when a dip table is activated.

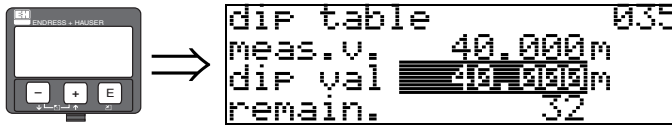
Function "dip table" (035)

This function edits the dip value.

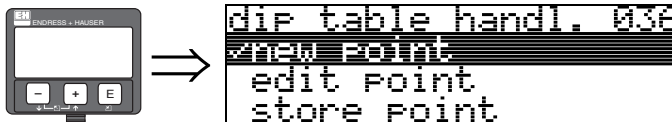
Function "dip table handl." (036)

Use this function to enter the dip value (level or distance) which will correct the measurement values.

Selection:

- new point
- edit point
- store point
- delete point
- return
- next point
- previous point

General procedure:

To enter a new point into the dip table, use "new point" to enter the value (pairs), "store point" to sort the new value (pairs), "return" to go to the dip table mode and "table on" to activate the dip table.

new point

You can enter a new point. Suggested values displayed for the measured value and dip value are the current uncorrected level or remaining fill height. The new value pair can be altered without selecting the "edit point" parameter. If the table is full, you can still select this parameter. In this case, the number of free table entries stands at minimum value (= 0).

edit point

The displayed value pair can be changed. Only the dip value can be changed with semi-automatic input mode.



Caution!

To accept the value pair in the table, confirm it with "store point".

store point

The displayed value pair is sorted in the table.



Note!

For sorting, the following criteria must be met:

- Measured variables may not be equal but have different dip values.
- A measured variable available in the table is recognised as equal when it is closer than 1 mm to the sorting value.
- After successful sorting, the setting remains at "**edit point**" and the number of free table entries is decremented.



Caution!

If the value cannot be sorted, the setting remains at the previous menu option. No warning or error message is generated. However, the number of remaining table entries is not decremented.

delete point

The currently displayed point is deleted from the table. After deletion, the previous point is displayed. If the table only consisted of one point before deletion, then the current measured variable is displayed as a value pair.

return

By selecting this point, you return to the function "**dip table mode**" (033).

next point

This scrolls down in the table. If the table is empty, you can still select this option. However, the displayed value does not change.

previous point

This scrolls up in the table. If the table is empty, you can still select this option. However, the displayed value does not change.



Caution!

After entering one or more points into the dip table, make sure that the dip table is activated in the "**table on**" dip table mode.

6.5.2 Envelope curve with VU331

After the basic setup, an evaluation of the measurement with the aid of the envelope curve ("**display**" (09) function group) is recommended).

Function "plot settings" (09A)

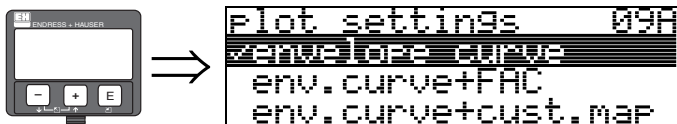

Here you can select which information is shown on the display:

- **envelope curve**
- env. curve+FAC (for FAC see BA217F)
- env. curve+cust.map (i.e. the tank map is also displayed)

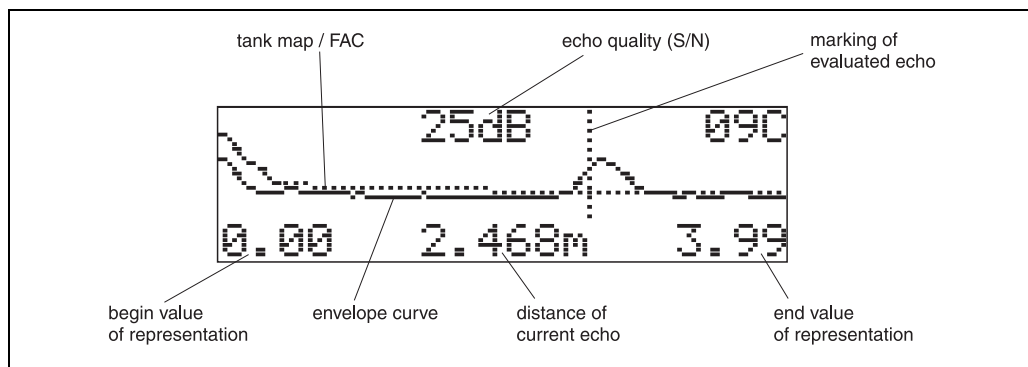

L00-FMRxxxxx-07-00-00-en-004

Function "recording curve" (09B)

This function determines whether the envelope curve is read as:

- **single curve**
- or
- **cyclic**



Note!

If the envelope curve mode is active on the display, the measured values are updated in a slower cycle time. Thus, it is advisable to leave the envelope curve mode after the measuring point has been optimised.



Note!

If the level of echo is very weak or there is a heavy interference echo, an **orientation** of the Micropilot can contribute to an optimisation of the measurement (increase of the level echo/ reduction of the interference echo) (see "Orientation of the Micropilot" on Page 75).

Function "envelope curve display" (09C)

The envelope curve is displayed in this function. You can use it to obtain the following information:

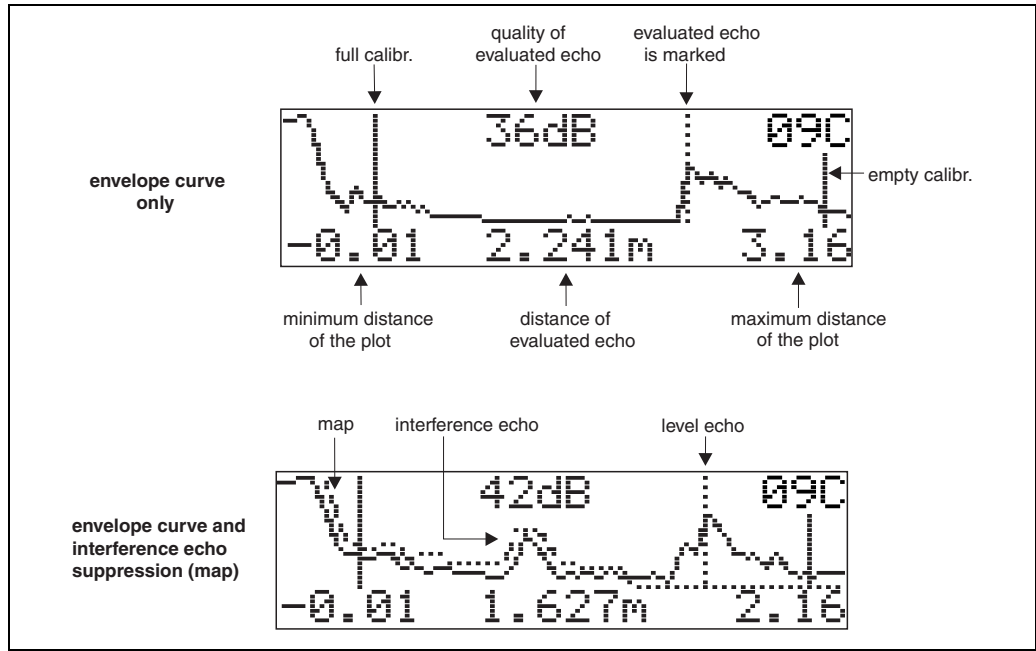

L00-FMR53xxxx-07-00-00-en-003

6.6 Basic Setup with FieldCare

To carry out the basic setup with FieldCare, proceed as follows:

- Start FieldCare and establish a connection
- Select the "**basic setup**" function group in the navigation bar

The following display appears on the screen:

Basic Setup step 1/5:

- Status image
- Enter the measuring point description (TAG number).

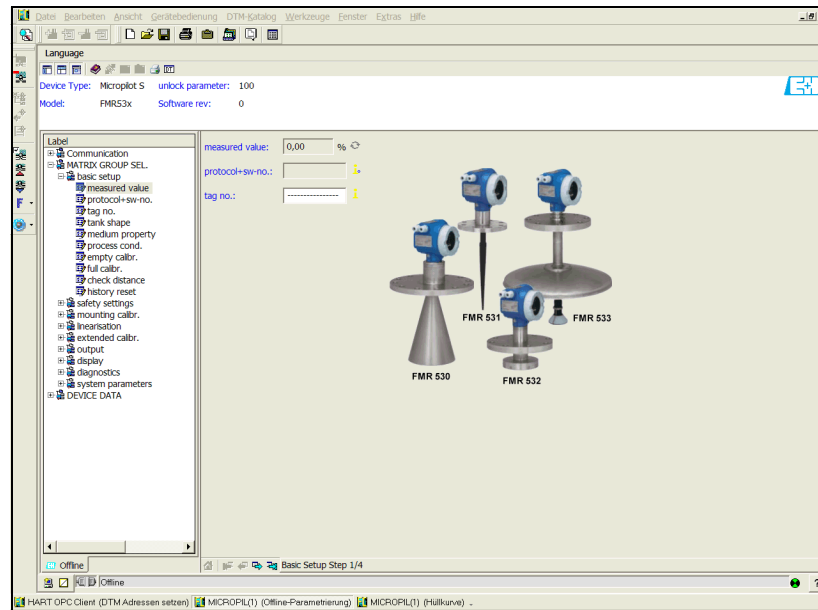

MicropilotS-en-001



Note!

- Each parameter that is changed must be confirmed with the **RETURN** key!!
- The "**Next**" button moves you to the next screen display:

Basic Setup step 2/5:

- Enter the application parameters:
 - tank shape (for a description, see Page 43)
 - medium property (for a description, see Page 44)
 - process cond. (for a description, see Page 45)

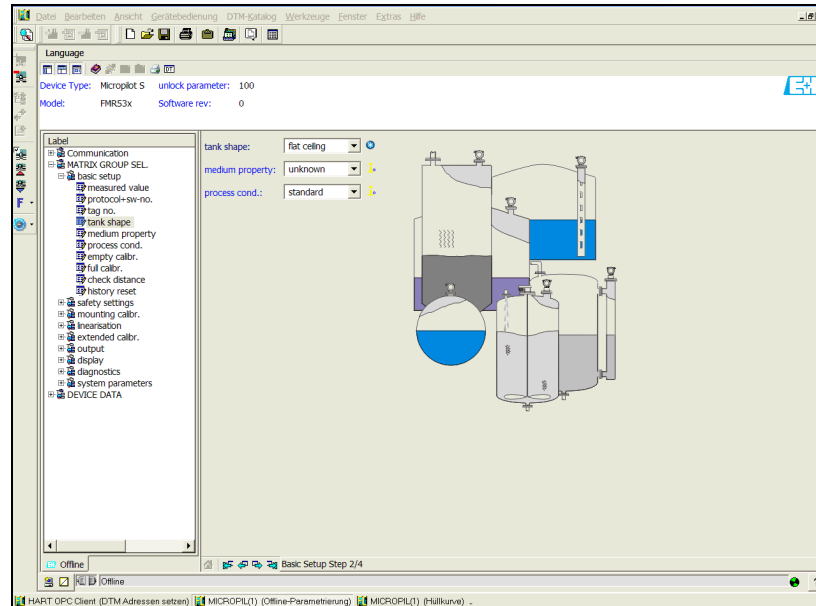

MicropilotS-en-002

Basic Setup step 3/5:

If "**dome ceiling**" is selected in the "**tank shape**" function, the following display appears on the screen:

- empty calibr. (for a description, see Page 46)
- full calibr. (for a description, see Page 47)

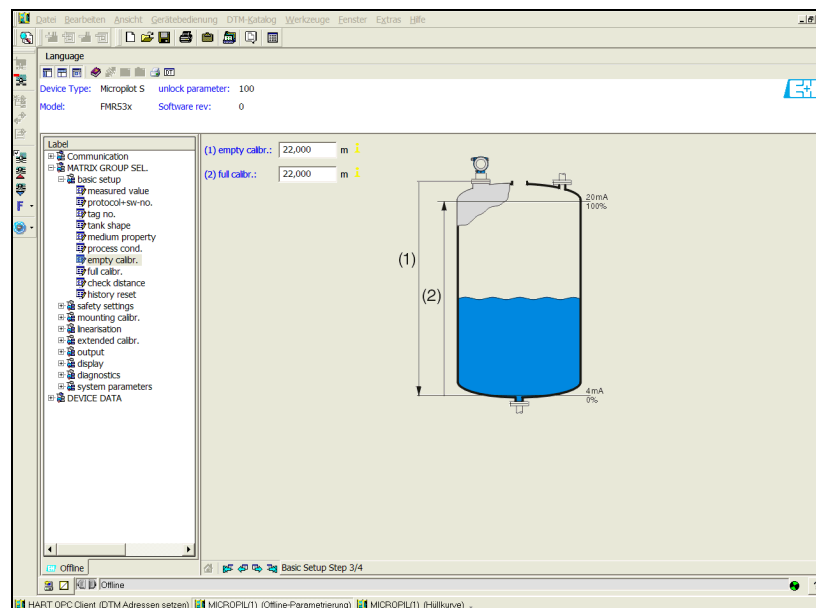

MicropilotS-en-003

If "**horizontal cyl**" or "**sphere**" is selected in the "**tank shape**" function, the following display appears on the screen:

- empty calibr. (for a description, see Page 46)
- full calibr. (for a description, see Page 47)

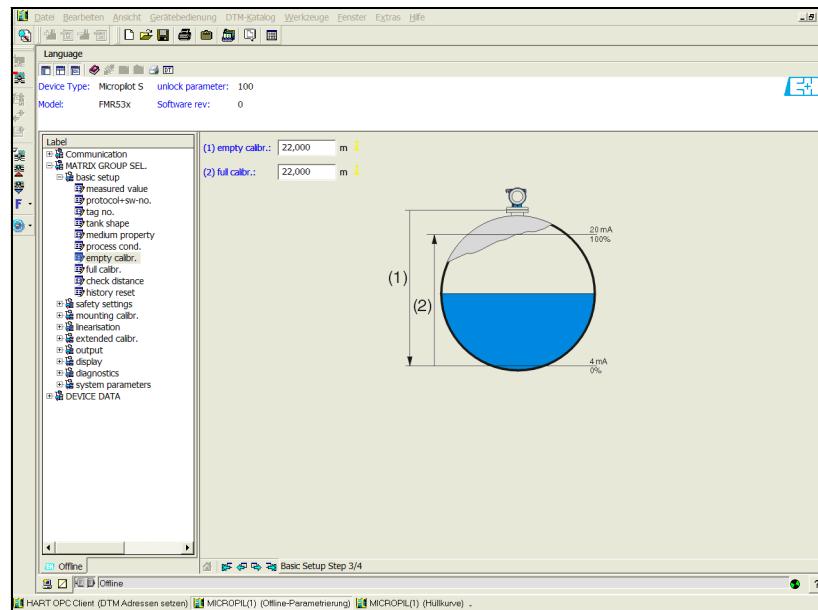

MicroplotS-en-004

If "**stilling well**" or "**bypass**" is selected in the "**tank shape**" function, the following display appears on the screen:

- empty calibr. (for a description, see Page 46)
- full calibr. (for a description, see Page 47)
- Diameter of bypass / stilling well (for a description, see Page 47)

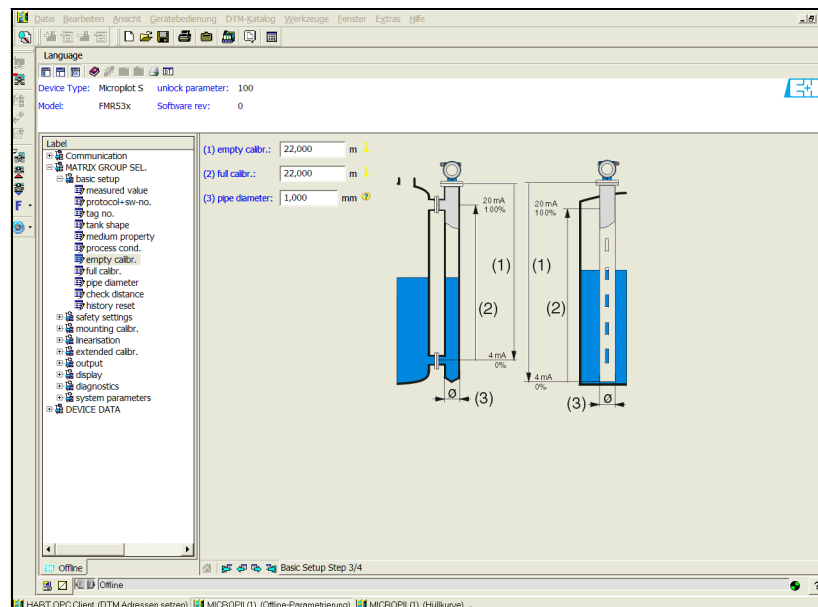

MicroplotS-en-005



Note!
You must also specify the pipe diameter in this display.

If "**flat ceiling**" is selected in the "**tank shape**" function, the following display appears on the screen:

- empty calibr. (for a description, see Page 46)
- full calibr. (for a description, see Page 47)

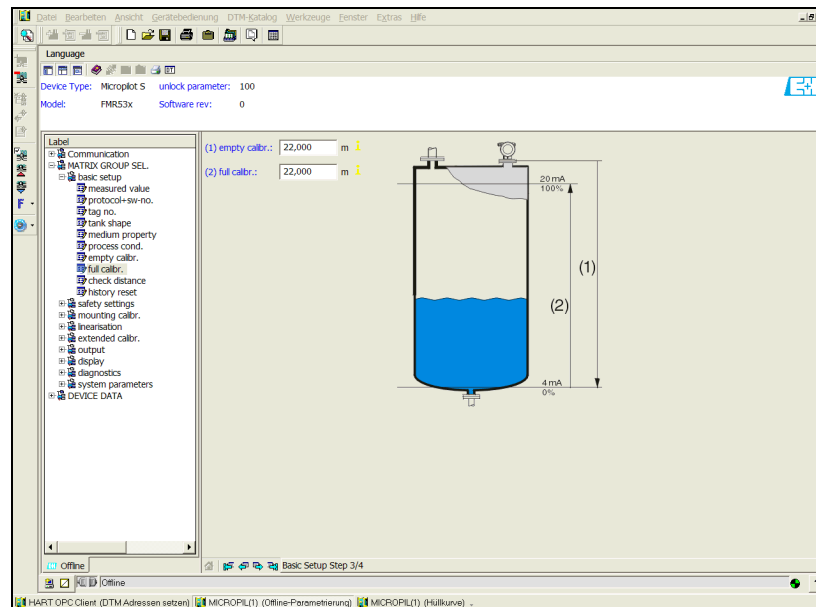

MicropilotS-en-006

Basic Setup step 4/5:

- This step starts the tank mapping
- The measured distance and the current measured value are always displayed in the header
- A description is given on see Page 48

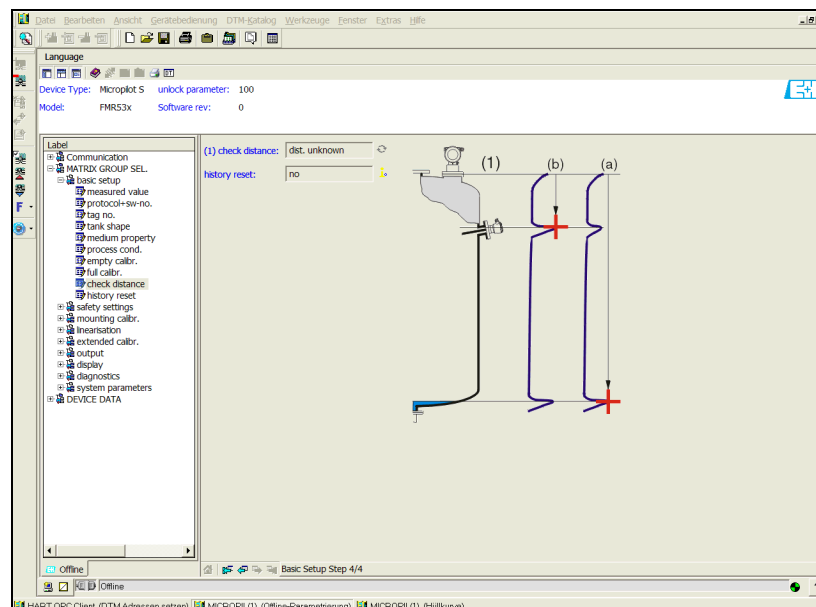

MicropilotS-en-007

Basic Setup step 5/5:

After the first installation of the device, initialise the index correction table. To do so set the history reset to "**yes**".

6.6.1 Envelope curve with FieldCare

After the basic setup, an evaluation of the measurement using the envelope curve is recommended.

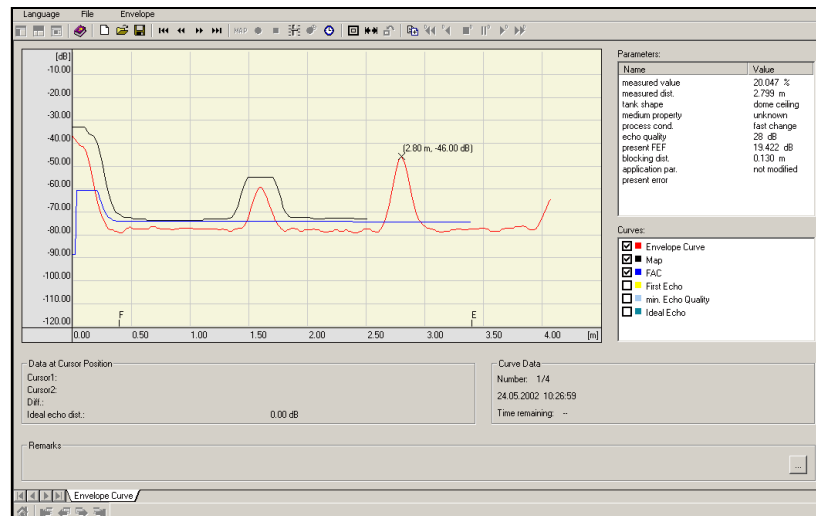

MicropilotM-en-306



Note!

If the level of echo is very weak or there is a heavy interference echo, an orientation of the Micropilot can help optimise the measurement (increase of the useful echo/reduction of the interference echo "Orientation of the Micropilot" on Page 75).

6.6.2 User-specific applications (operation)

For details of setting the parameters of user-specific applications, see separate documentation BA217F/00/en "Description of the instrument functions for Micropilot S" on the enclosed CD-ROM.

6.7 Mounting calibration with FieldCare

To carry out the mounting calibration with FieldCare, proceed as follows:

- Start FieldCare and establish a connection
- Select the "**mounting calibr.**" function group in the navigation bar

The following display appears on the screen:

Mounting calibration step 1/2:

- auto correction (description see Page 51)
- pipe diam. corr. (description see Page 52)

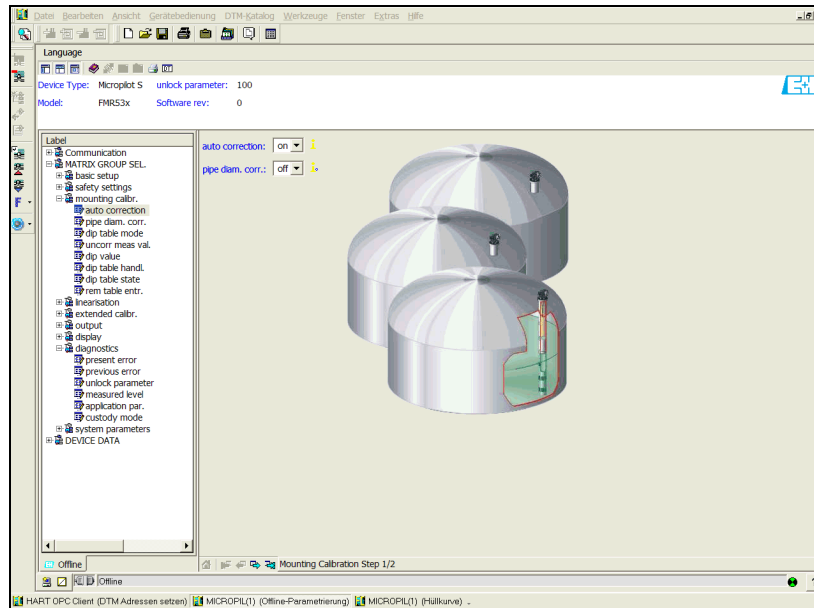

MicropilotS-en-009



Note!

Each parameter that is changed must be confirmed with the **RETURN** key!
The "Next" button moves you to the next screen display::

Mounting calibration step 2/2:

- dip table mode (description see Page 55)
- meas. v. (description see Page 56)
- dip value (description see Page 57)
- dip table handl. (description see Page 57)
- dip table state (description see Page 55)
- left dip t.entr. (description see Page 56)

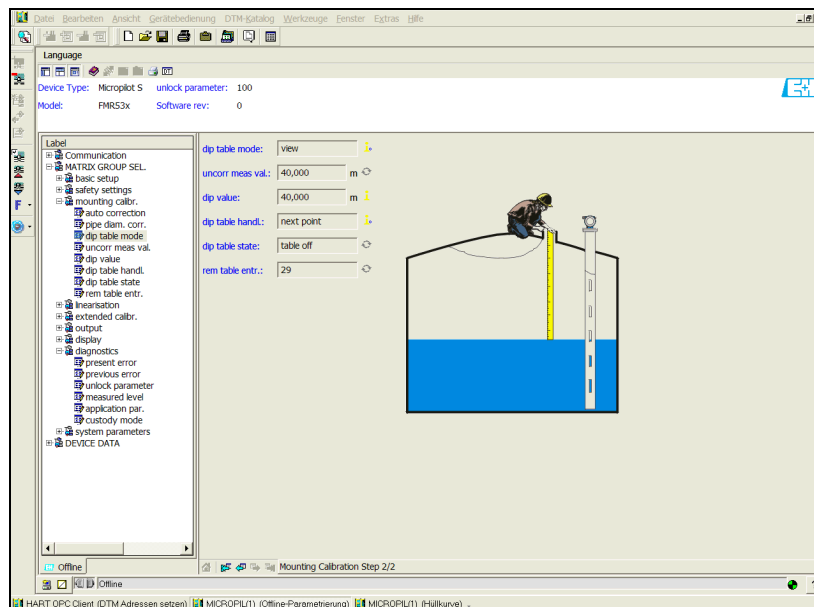

MicropilotS-en-010

7 Maintenance

The Micropilot S measuring instrument requires no special maintenance.

Exterior cleaning

When cleaning the exterior of measuring devices, always use cleaning agents that do not attack the surface of the housing and the seals.

Replacing seals

The process seals of the sensors must be replaced periodically, particularly if molded seals (aseptic construction) are used. The period between changes depends on the frequency of cleaning cycles and on the temperature of the measured product and the cleaning temperature.

Repair

The Endress+Hauser repair concept assumes that the measuring devices have a modular design and that customers are able to undertake repairs themselves. Spare parts are contained in suitable kits. They contain the related replacement instructions. All the spare parts kits which you can order from Endress+Hauser for repairs to the Micropilot s are listed with their order numbers on Page 77 ff.. Please contact Endress+Hauser Service for further information on service and spare parts.

Repairs to Ex-approved devices

When carrying out repairs to Ex-approved devices, please note the following:

- Repairs to Ex-approved devices may only be carried out by trained personnel or by Endress+Hauser Service.
- Comply with the prevailing standards, national Ex-area regulations, safety instructions (XA) and certificates.
- Only use original spare parts from Endress+Hauser.
- When ordering a spare part, please note the device designation on the nameplate. Only replace parts with identical parts.
- Carry out repairs according to the instructions. On completion of repairs, carry out the specified routine test on the device.
- Only Endress+Hauser Service may convert a certified device into a different certified variant.
- Document all repair work and conversions.

Replacement

After a complete Micropilot or electronic module has been replaced, the parameters can be downloaded into the instrument again via the communication interface. Prerequisite to this is that the data were uploaded to the PC beforehand using FieldCare.

Measurement can continue without having to carry out a new setup.

- You may have to activate linearisation (see BA217F on the enclosed CD-ROM.)
- You may need to record the tank map again (see Basic Setup)

After an antenna component or electronic has been replaced, a new calibration must be carried out. This is described in the repair instructions.

8 Accessories

A variety of accessories is available for the Micropilot S. They can be ordered separately from Endress+Hauser.

Weather protection cover

A weather protective cover made of stainless steel is available for outdoor mounting (order code: 543199-0001). The shipment includes the protective cover and tension clamp.

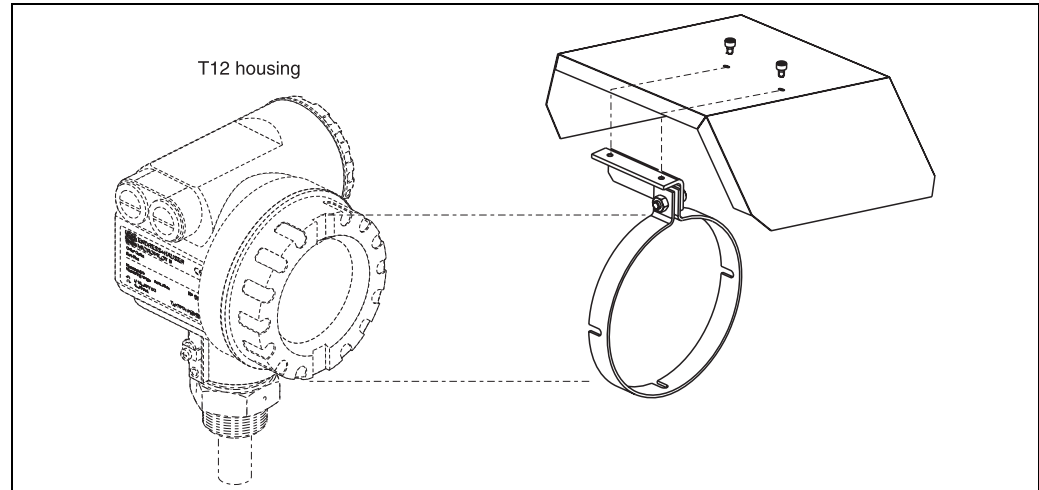

L00-FMR53xxx-00-00-06-en-001

Commubox FXA191 HART

For intrinsically safe communication with ToF Tool/FieldCare via the RS232C interface. For details refer to TI237F/00/en.

Commubox FXA195 HART

For intrinsically safe communication with ToF Tool/FieldCare via the USB interface. For details refer to TI404F/00/en.

Commubox FXA291

The Commubox FXA291 connects Endress+Hauser field instruments with CDI interface (= Endress+Hauser Common Data Interface) to the USB interface of a personal computer or a notebook. For details refer to TI405C/07/en.



Note!

For the following Endress+Hauser instruments you need the "ToF Adapter FXA291" as an additional accessory:

- Cerabar S PMC71, PMP7x
- Deltabar S PMD7x, FMD7x
- Deltapilot S FMB70
- Gammapilot M FMG60
- Levelflex M FMP4x
- Micropilot FMR130/FMR131
- Micropilot M FMR2xx
- Micropilot S FMR53x, FMR540
- Prosonic FMU860/861/862
- Prosonic M FMU4x
- Tank Side Monitor NRF590 (with additional adapter cable)

ToF Adapter FXA291

The ToF Adapter FXA291 connects the Commubox FXA291 via the USB interface of a personal computer or a notebook to the following Endress+Hauser instruments:

- Cerabar S PMC71, PMP7x
- Deltabar S PMD7x, FMD7x
- Deltapilot S FMB70
- Gammapilot M FMG60
- Levelflex M FMP4x
- Micropilot FMR130/FMR131
- Micropilot M FMR2xx
- Micropilot S FMR53x, FMR540
- Prosonic FMU860/861/862
- Prosonic M FMU4x
- Tank Side Monitor NRF590 (with additional adapter cable)

For details refer to KA271F/00/a2.

9 Trouble-shooting

9.1 Trouble-shooting instructions

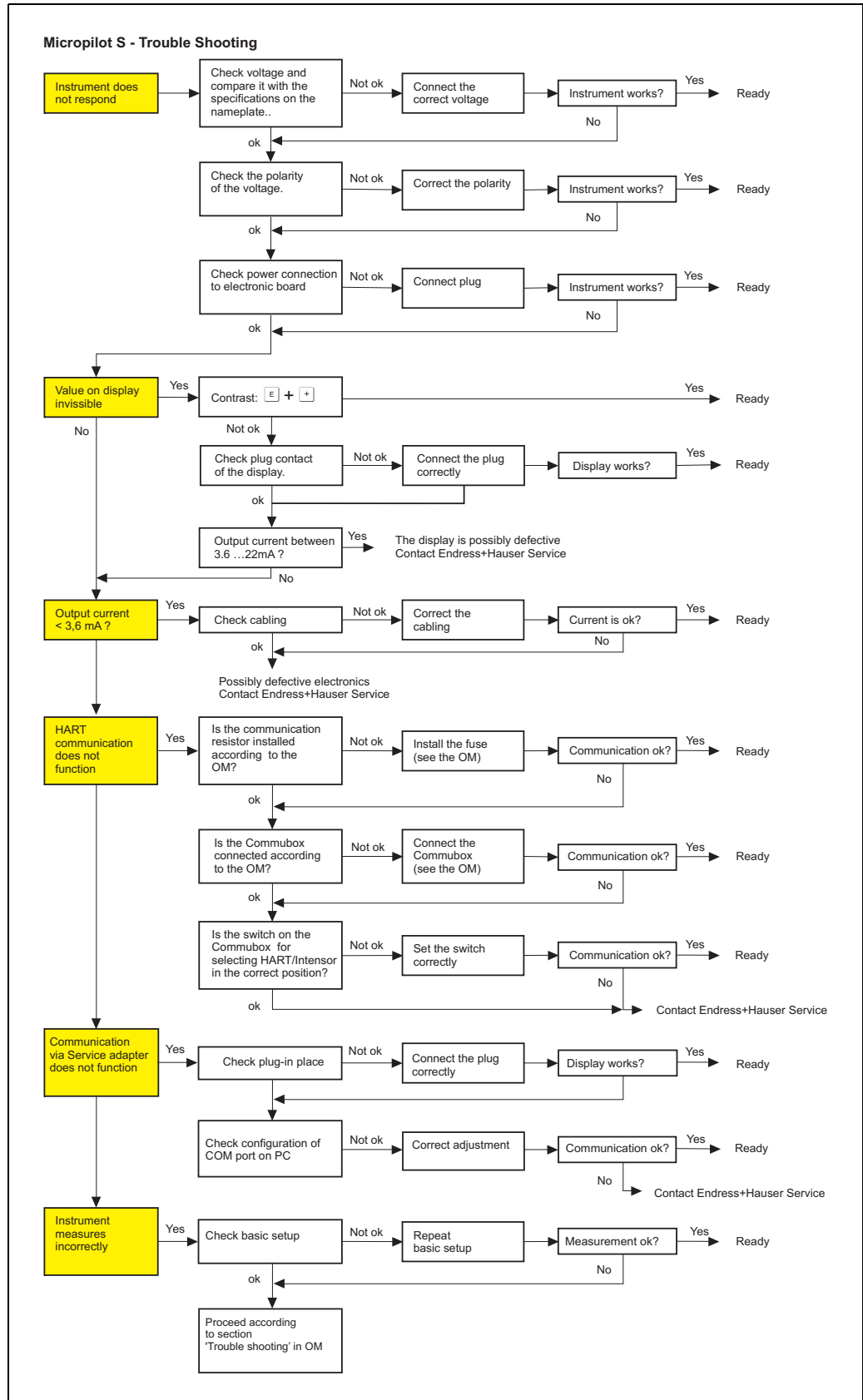

L00-FMR53xxx-19-00-00-es-010

9.2 System error messages

Code	Description	Possible cause	Remedy
A102	checksum error general reset & new calibr.required.	device has been powered off before data could be stored; emc problem E ² PROM defect	reset avoid emc problem; if alarm prevails after reset, exchange electronics
W103	initialising - please wait	E ² PROM storage not yet finished	wait some seconds; if warning prevails, exchange electronics
A106	downloading please wait	processing data download	wait until warning disappears
A110	checksum error general reset & new calibr.required.	device has been powered off before data could be stored emc problem E ² PROM defect	Reset avoid emc problem; if alarm prevails after reset, exchange electronics
A111	electronics defect	RAM defect	Reset if alarm prevails after reset, exchange electronics
A113	electronics defect	RAM defect	Reset if alarm prevails after reset, exchange electronics
A114	electronics defect	E ² PROM defect	Reset if alarm prevails after reset, exchange electronics
A115	electronics defect	general hardware problem	Reset if alarm prevails after reset, exchange electronics
A116	download error repeat download	checksum of stored data not correct	restart download of data
A121	electronics defect	no factory calibration existant E ² PROM defective	contact service
W153	initialising - please wait	initialisation of electronics	wait some seconds; if warning prevails, power off device and power on again
A155	electronics defect	hardware problem	Reset if alarm prevails after reset, exchange electronics
A160	checksum error general reset & new calibr.required	device has been powered off before data could be stored emc problem E ² PROM defect	Reset avoid emc problem; if alarm prevails after reset, exchange electronics
A164	electronics defect	hardware problem	Reset if alarm prevails after reset, exchange electronics
A171	electronics defect	hardware problem	Reset if alarm prevails after reset, exchange electronics
A231	sensor 1 defect check connection	HF module or electronics defective	exchange electronics
A270	custody switch undefcheck position	switch for custody transfer may be defective	check position of custody switchexchange electronics
#	mm - accuracy not ensured	inconsistency between phase and amplitude evaluation inconsistent microfactor inconsistent index mapping	check basic calibrationcheck mounting calibrationcheck echo quality > 10 dB history reset
A272	electronics defect amplifier	inconsistency in amplification	exchange electronics

Code	Description	Possible cause	Remedy
W275	electronics defect factory setting	offset drift of A/D commuter	exchange electronics
W511	no factory calibration ch1	factory calibration has been deleted	record new factory calibration
A512	recording of mapping please wait	mapping active	wait some seconds until alarm disappears
W601	linearisation ch1 curve not monotone	linearization not monotonously increasing	correct linearisation table
W611	less than 2 linearisation points for channel 1	number of entered linearization points < 2	correct linearisation table
W621	simulation ch. 1 on	simulation mode is active	switch off simulation mode
E641	check calibr	echo lost due to application conditions of built up on antenna Antenna defect	check installation optimize orientation of antenna clean antenna (cf. OM)
E651	- risk of overspill	level in safety distance	alarm will disappear as soon as level leaves safety distance.
A671	linearisation ch1 not complete, not usable	linearisation table is in edit mode	activate linearisation table
W681	current ch1 out of range	current out of range 3,8 mA ... 21,5 mA	check calibration and linearisation

9.3 Application errors

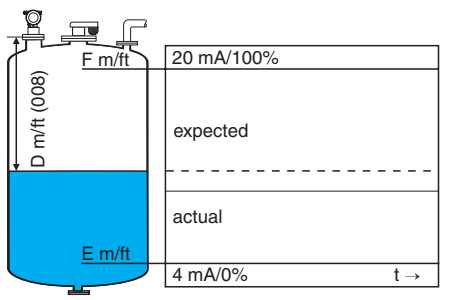
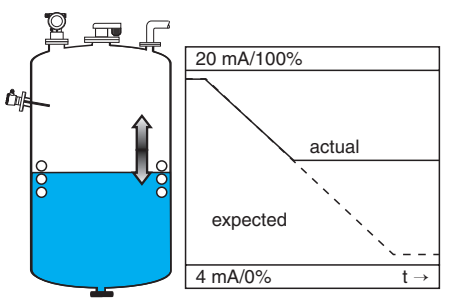
Error	Output	Possible cause	Remedy
<p>A warning or alarm has occurred.</p>	<p>Depending on the configuration</p>	<p>See table of error messages (see Page 71)</p>	<p>1. See table of error messages (see Page 71)</p>
<p>Measured value (00) is incorrect</p>	 <p style="text-align: right; font-size: small;">L00-FMRS3xxx-19-00-00-en-007</p>	<p>Measured distance (008) OK?</p> <p>yes →</p> <p>no ↓</p> <p>Measurement in bypass or stilling well?</p> <p>yes →</p> <p>no ↓</p> <p>Is "offset" (057) active?</p> <p>yes →</p> <p>no ↓</p> <p>An interference echo may have been evaluated.</p> <p>yes →</p>	<p>1. Check empty calibr. (005) and full calibr (006).</p> <p>2. Check linearisation: → level/ullage (040) → max. scale (046) → diameter vessel (047) → Check table</p> <p>3. Check dip table</p> <p>1. Is bypass or stilling well selected in tank shape?</p> <p>2. Is the pipe diameter (007) correct?</p> <p>3. Pipe diameter correction (032) activated?</p> <p>1. offset (057) correctly set?</p> <p>1. Carry out tank mapping → basic setup</p> <p>2. Activate auto correction (031)</p>
<p>No change off measured value on filling/emptying</p>	 <p style="text-align: right; font-size: small;">L00-FMRS3xxx-19-00-00-en-006</p>	<p>Interference echo from installations, nozzle or extension on the antenna</p>	<p>1. Carry out tank mapping → basic setup</p> <p>2. If necessary, clean antenna</p> <p>3. If necessary, select better mounting position (see Page 15)</p>

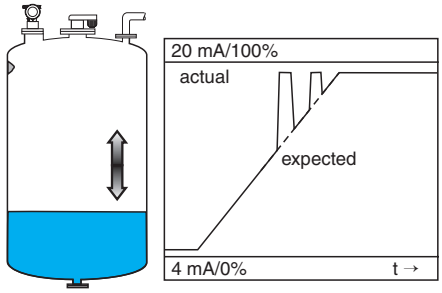
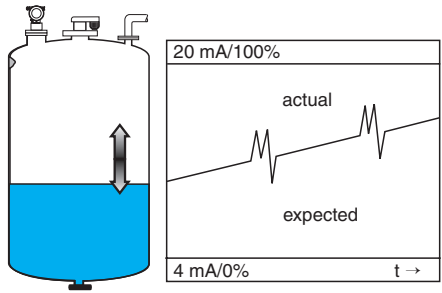
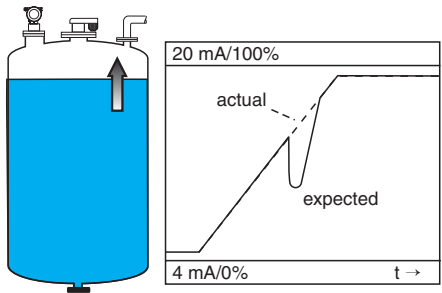
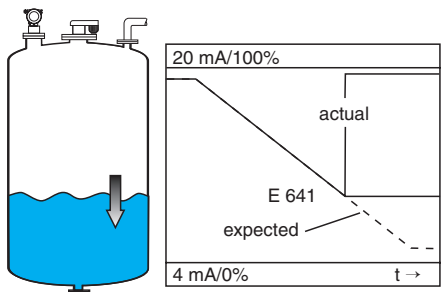
Error	Output	Possible cause	Remedy
<p>If the surface is not calm (e.g. filling, emptying, agitator running), the measured value jumps sporadically to a higher level</p>	 <p style="text-align: right; font-size: small;">L00-FMR53xxx-19-00-00-en-008</p>	<p>Signal is weakened by the rough surface — the interference echoes are sometimes stronger</p>	<ol style="list-style-type: none"> 1. Carry out tank mapping → basic setup 2. Set the process cond. (004) to "turb. surface" or "agitator" 3. Increase the output damping (058) 4. Optimise the orientation (see Page 75) 5. If necessary, select a better mounting position and/or larger antenna (see Page 15)
<p>During filling/emptying the measured value jumps sporadically to a higher/lower level</p>	 <p style="text-align: right; font-size: small;">L00-FMR53xxx-19-00-00-en-009</p>	<p>During definition of the auto correction table the instrument has been switched off and the level has changed.</p>	<ol style="list-style-type: none"> 1. Reset "555" 2. If possible, do not switch off the instrument before the complete measuring range has been passed through.
<p>During filling/emptying the measured value jumps downwards</p>	 <p style="text-align: right; font-size: small;">L00-FMR53xxx-19-00-00-en-004</p>	<p>Multiple echoes</p>	<p>yes →</p> <ol style="list-style-type: none"> 1. Check the tank shape (002), e.g. "dome ceiling" or "horizontal cyl" 2. In the range of the blocking dist. (059) there is no echo evaluation → Adapt the value 3. If possible, do not select central installation position (see Page 15) 4. Activate auto correktion (031)
<p>E 641 ((loss ofecho)</p>	 <p style="text-align: right; font-size: small;">L00-FMR53xxx-19-00-00-en-005</p>	<p>Level echo is too weak.</p> <p>Possible causes:</p> <ul style="list-style-type: none"> ■ Rough surface dueto filling/emptying ■ Agitator running ■ Foam 	<p>yes →</p> <ol style="list-style-type: none"> 1. Check application parameters (002), (003) and (004) 2. Optimise alignment (see Page 75) 3. If necessary, select a better installation position and/or larger antenna (see Page 15)
<p>E 641 (loss ofecho) after turn onthe power supply</p>	<p>If the instrument is configured to Hold by lossof echo the output is set to anyvalue./current.</p>	<p>noise level during theinitialisation phase tohigh.</p>	<p>Repeat once more empty calibr. (005).</p> <p>Caution! Before conformation change with <input type="checkbox"/>+ or <input type="checkbox"/>- to the edit mode.</p>

9.4 Orientation of the Micropilot

For orientation a marker is found on the flange or threaded boss of the Micropilot. During installation this must be oriented (see Page 20):

After commissioning the Micropilot, the "**echo quality**" (056) indicates whether a sufficiently large measuring signal is obtained. If necessary, the quality can be optimised later. Vice versa, the presence of an interference echo can be used to minimise this by optimum orientation. The advantage of this is that the subsequent tank mapping uses a somewhat lower level that causes an increase in the strength of the measuring signal.

Proceed as follows:



Warning!

Subsequent alignment can lead to personal injury. Before you unscrew or loosen the process connection, make sure that the vessel is not under pressure and does not contain any injurious substances.

1. It is best to empty the container so that the bottom is just covered. However, alignment can be carried out even if the vessel is empty.
2. Optimisation is best carried out with the aid of the envelope graph in the display or in FieldCare.
3. Unscrew the flange or loosen the threaded boss by a half a turn.
4. Turn the flange by one hole or screw the threaded boss by one eighth of a turn. Note the echo quality.
5. Continue to turn until 360° is reached.
6. Optimum alignment:

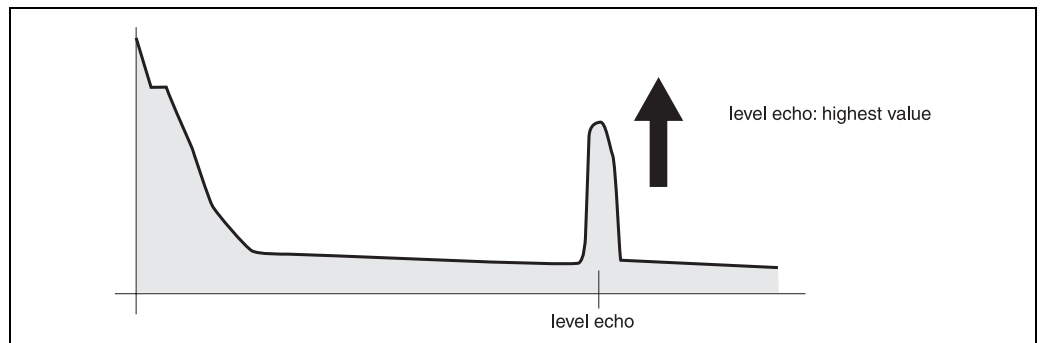

Fig. 4: Vessel partly full, no interference echo obtained

L00-FMRxxxxx-19-00-00-en-002

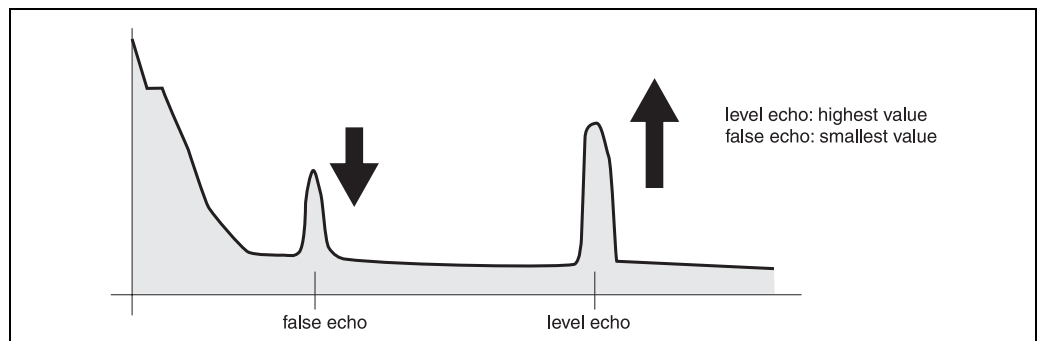

Fig. 5: Vessel partly full, interference echo obtained

L00-FMRxxxxx-19-00-00-en-003

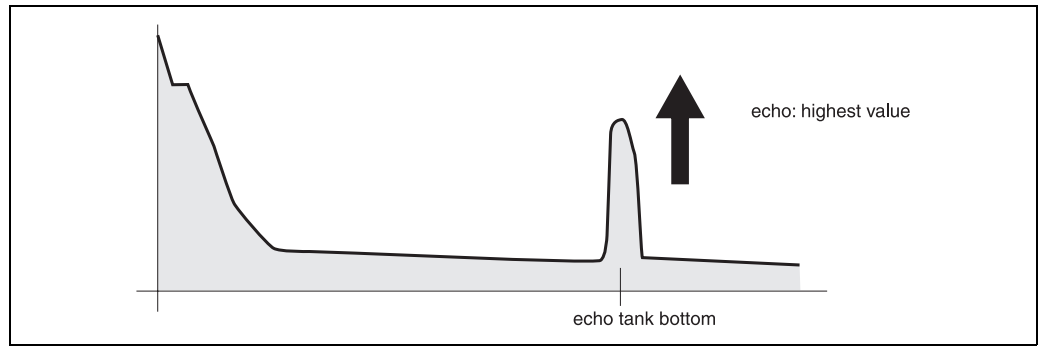

Fig. 6: Vessel empty, no interference echo

L00-FMRxxxxx-19-00-00-es-004

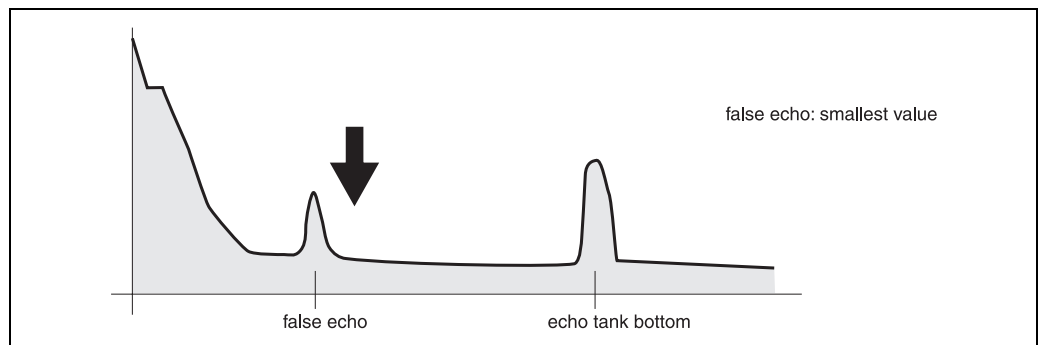

Fig. 7: Vessel empty, interference echo obtained

L00-FMRxxxxx-19-00-00-es-005

7. Fix the flange or threaded boss in this position.
If necessary, replace the seal.
8. Carry out tank mapping, see see Page 48.

9.5 Spare parts



Note!

You can order spare parts directly from your Endress+Hauser service organization by giving the serial number which is printed on the measuring transducer nameplate (see Page 8). The corresponding spare part number also appears on each spare part. Installation instructions are given on the instruction card that is also delivered.



Caution!

If the calibration seal is broken, the national calibration authority should normally be informed within 24 hours.

Spare parts for Micropilot S FMR531, housing T12 with separate terminal compartment

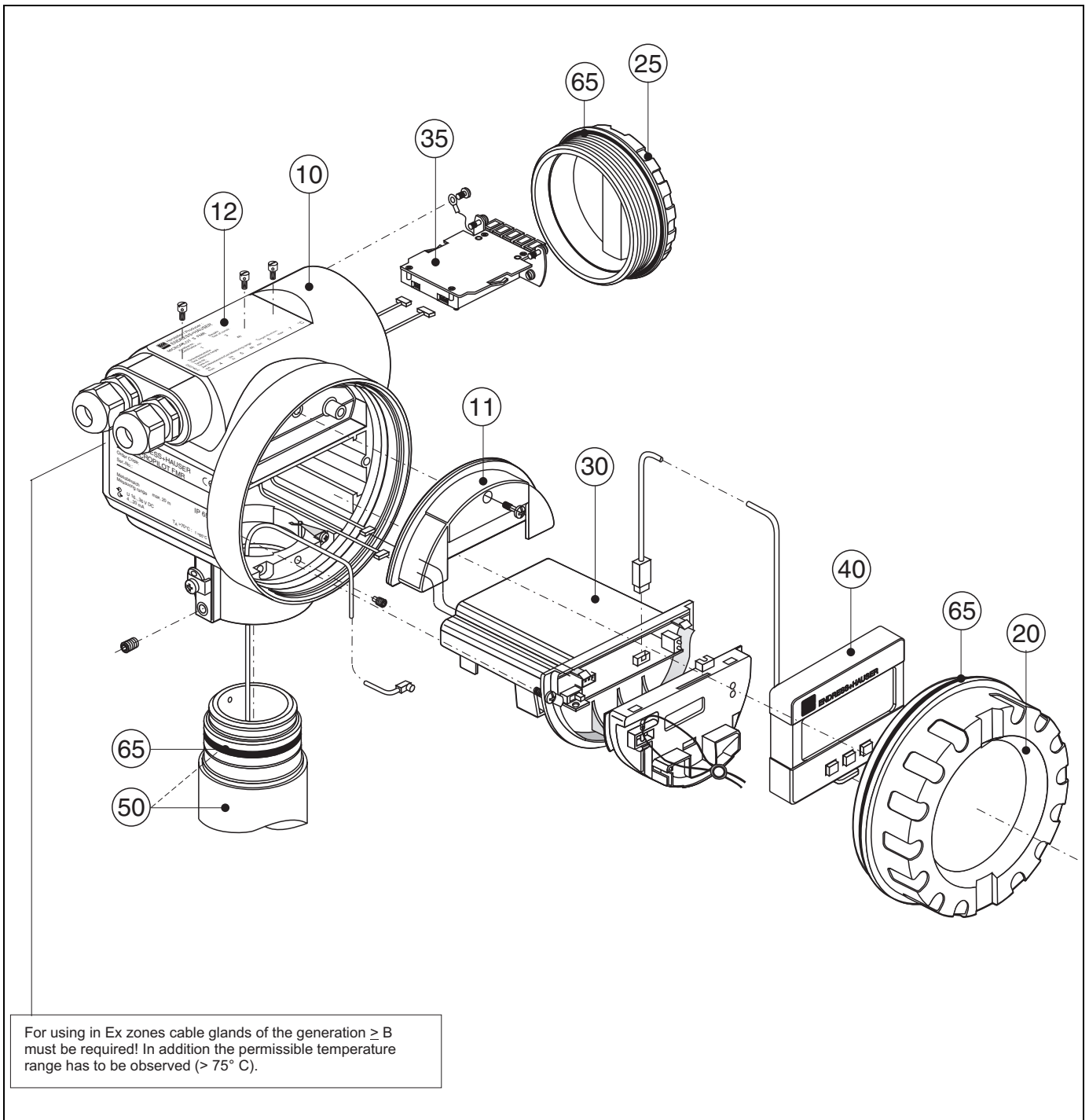

L00-FMR53xxx-00-00-06-en-002

10 Housing

52005682 Housing T12 Alu, coated, G1/2

52005683 Housing T12 Alu, coated, NPT1/2

52005684 Housing T12 Alu, coated, M20

11 Hood for terminal compartment

52005643 Hood T12

12 Nameplates for Custody transfer approvals

52008958 Nameplate Micropilot S, NMi calibratable

52008959 Nameplate Micropilot S, PTB calibratable

20 Cover

52005936 Cover F12/T12 aluminium, inspection glass, seal

25 Cover for the connection compartment

518710-0020 Cover T3/T12, aluminium, coated, seal

30 Electronics

52009431 Electronics Ex HART + HF-module

35 Terminal module / power unit

52005586 Terminal module 5-pole

40 Display

52005585 Display/operating module VU331

Miscellaneous

52005627 Nameplate FMR53* modification

It is our duty to inform you, that after any repair of Ex-certified instruments (replacement of modules), they must be returned to their original condition and a new routine test carried out by an authorised person.

Spare parts for rod antenna Micropilot S, FMR531

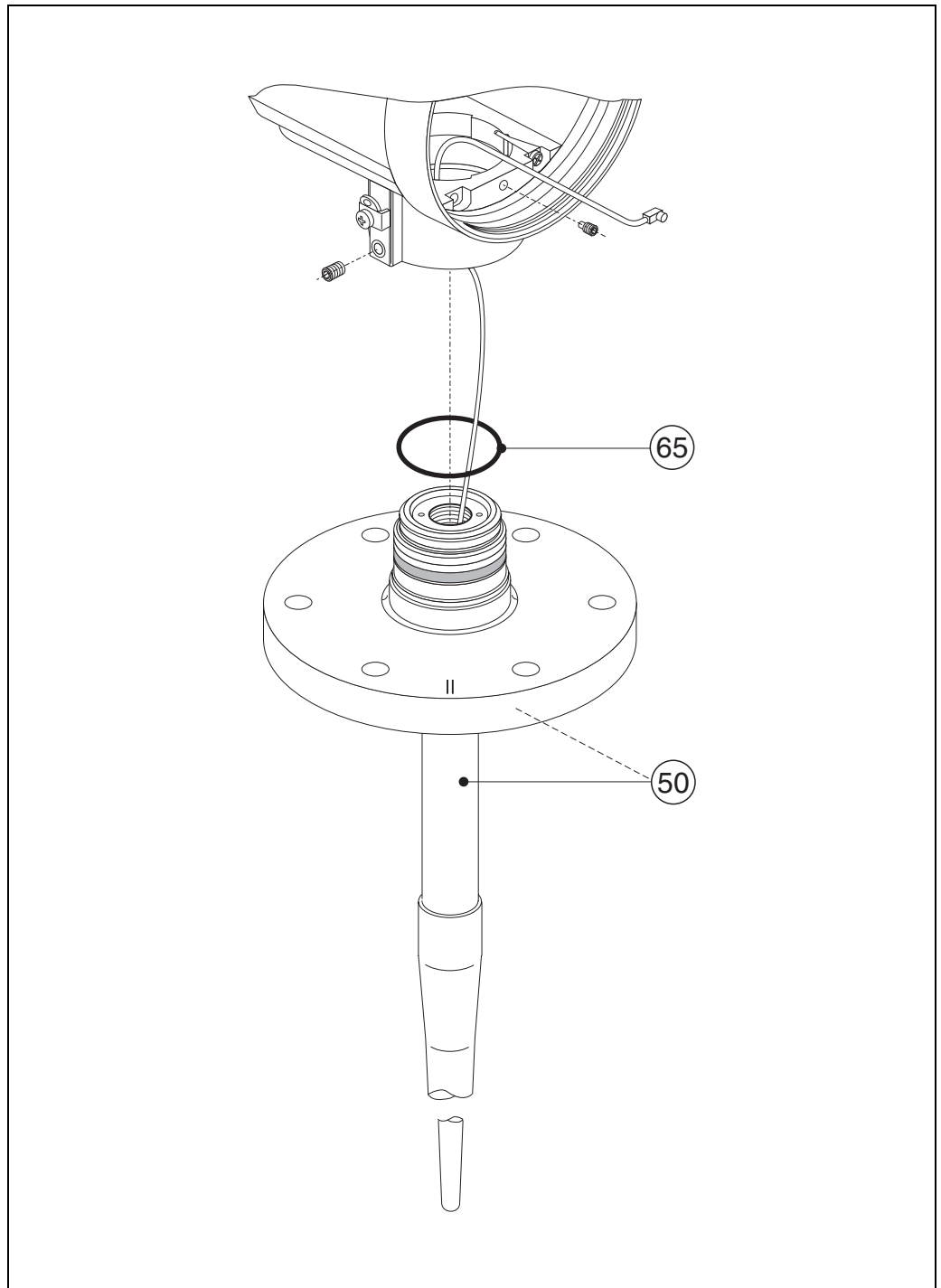

L00-FMRS3xxx-00-00-06-xx-001

50 Antenna assembly

On request.

65 Sealing kit

52005628 Sealing kit

Modification nameplate

When ordering parts that are listed in the product structure (see Page 8) , a check must be made as to whether the instrument description on the nameplate is still valid, e.g. for:

- an antenna component,
- an electronics module

If the instrument designation on the nameplate has changed then a modified nameplate must also be ordered. The information about the new instrument must then be entered on the modified nameplate. This must then be attached to the housing of the Micropilot S. See instructions packed with nameplate.

Housing T12

The complete order code must be specified when ordering the replacement housing so that the correct nameplate can be delivered, e.g.

- FMR531-A4VCW2AA2A

You must label the nameplate yourself.



Caution!

- It is not possible to convert a standard instrument into an Ex instrument by simply exchanging parts.
- When repairing certified instruments, the relevant regulations must be followed.
- For FM approved instruments, it is forbidden to make any changes to the instrument that are not expressly authorised in the operating manual. Contravening this prohibition can invalidate the approval for operation of the instrument.

9.6 Return

The following procedures must be carried out before a transmitter is sent to Endress+Hauser e.g. for repair or calibration:

- Remove all residue which may be present. Pay special attention to the gasket grooves and crevices where fluid may be present. This is especially important if the fluid is dangerous to health, e.g. corrosive, poisonous, carcinogenic, radioactive, etc.
- Always enclose a duly completed "Declaration of contamination" form (a copy of the "Declaration of contamination" is included at the end of this operating manual). Only then can Endress+Hauser transport, examine and repair a returned device.
- Enclose special handling instructions if necessary, for example a safety data sheet as per EN 91/155/EEC.

Additionally specify:

- The chemical and physical characteristics of the product.
- An exact description of the application.
- A short description of the error that occurred (specify error code if possible)
- Operating time of the instrument.

9.7 Disposal

In case of disposal please separate the different components according to their material consistence.

9.8 Software history

Software-version/ Date	Software changes	Documentation changes
V 01.00.00 / 12.2000	Original software. Operated via: – ToF Tool from version 1.5 – Commuwin II (from version 2.05.03) – HART-Communicator DXR375 with Rev. 1, DD 1.	
V 01.02.00 / 03.2002	simplified commissioning history reset in basic calibration ■ Function group: envelope curve display ■ Katakana (japanese) Operated via: – ToF Tool (V 3.0) – Commuwin II (from version 2.05.03) – HART-Communicator DXR375 with Rev. 1, DD 1.	Description of Instrument Functions
V 01.02.02 / 06.2005	Function "echo lost" improved Operated via: – Fieldcare – ToF Tool (from V 3.0) – HART-Communicator DXR375 with Rev. 1, DD 1.	
V 01.03.00 / 04.2009	Enhanced phase evaluation	

9.9 Contact addresses of Endress+Hauser

Contact addresses can be found on our homepage: www.endress.com/worldwide. If you have any questions, please do not hesitate to contact your Endress+Hauser representative.

10 Technical data

10.1 Additional technical data

10.1.1 Application

The Micropilot S is used for highly accurate level measurement in storage tanks and can be applied in custody transfer applications. It meets the relevant requirements according to OIML R85 and API 3.1B.

- The FMR531 with rod antenna is used for highly accurate measurements of very aggressive products and in narrow nozzles.

10.1.2 Input

Measured variable

The measured variable is the distance between a reference point GRH (mounting flange) and a reflective surface (e.g. product surface). The measured value and all parameters are displayed using either metrical SI-units or US/UK-units (inch, ft, ...).

The level is calculated based on the tank height entered.

In order to compensate for non-linear effects like movement of the tank roof, an additional correction table (diptable) can be entered.

Measuring range

see Page 18.

10.1.3 Output

Output signal

- 4...20 mA with HART protocol (e.g. for multidrop connection to the Tank Side Monitor NRF 590): this version can be operated via the PC operating software FieldCare. The instrument supports both point-to-point and multidrop operation.
For measurements with mm accuracy, the measured value must be transmitted via the HART protocol in order to ensure the required accuracy.

Signal on alarm

Error information can be accessed via the following interfaces::

- Local display:
 - Error symbol (see Page 33)
 - Plain text display
 - LED's: red LED continuously on = alarm, red LED flashes = warning
- Current output
- Digital interface

Galvanic isolation

500 V towards ground.
500 V between power supply and signal.

10.1.4 Auxiliary energy

Ripple HART	47...125 Hz: $U_{ss} = 200 \text{ mV}$ (at 500Ω)
Max. noise HART	500 Hz...10 kHz: $U_{eff} = 2.2 \text{ mV}$ (at 500Ω)
Electrical connection	Housing T 12 with separate terminal compartment.
Load HART	Minimum load for HART communication: 250Ω
Cable entry	Cable gland: 2 x M20x1.5 Cable entry: 2 x G $\frac{1}{2}$ or 2 x $\frac{1}{2}$ NPT
Supply voltage	see Page 26.
Power consumption	Max. 330 mW at 16 V, max. 500 mW at 24 V, max. 600 mW at 30 V.
Current consumption	Max. 21 mA (50 mA inrush current).
Power supply	For stand alone operation recommended via two Endress+Hauser RN221N.

10.1.5 Performance characteristics

Note Performance characteristics for instruments that can be calibrated in compliance with OIML R85.

Reference operating conditions **According to OIML R85:**

- Temperature = $-25 \text{ }^\circ\text{C} \dots +55 \text{ }^\circ\text{C}$ ($-13 \dots +131 \text{ }^\circ\text{F}$)
- Atmospheric pressure
- Relative humidity (air) = $65 \% \pm 15\%$
- Medium properties: e.g. medium with good reflectivity and calm surface.
- Tank diameter: signal beam hits the tank wall only at one side.
- No major interference reflections inside the signal beam.

Maximum measured error Absolute accuracy: better than $\pm 1 \text{ mm}$



Note!

Free space Micropilot S radar gauges typically provide accuracy of $\pm 0.5 \text{ mm}$ (2 sigma value).

Depending on the respective national gauging regulations, the admissible errors AFTER installation of the instrument on the tank are $\pm 3 \text{ mm}$ (OIML), $\pm 4 \text{ mm}$ (API),

Proof of accuracy of custody transfer versions The accuracy of each Micropilot S is established through a calibration certificate that records the absolute and relative error at 10 equidistant points during the final test. A Laser Interferometer (Jenaer Messtechnik ZLM 500) with an absolute accuracy of 0.1 mm is used as a reference for the free space measurements with FMR530, 531 and 533. For stilling well measurements with FMR532, a NMI / PTB calibrated tape with an absolute accuracy of 0.25 mm is used. Each Micropilot S is delivered with the PTB and NMi type approval. Additional initial factory verifications for custody applications are available on demand for radar instrument Micropilot S.

Maximum fill speed By the first pass trough of measuring range: 100 mm/min. , thereafter unlimited.

Non-repeatability	0.3 mm (1/64")
Hysteresis	0.3 mm (1/64")
Resolution	<ul style="list-style-type: none"> ■ digital: 0.1 mm ■ analog: 0.03 % of measuring range
Settling time	Typical 15 sec
Long-term drift	The long-term drift is within the specified accuracy.
Influence of ambiente temperature	Within the specified accuracy according to OIML R85
Software reliability	<p>The software used in the radar instrument Micropilot S fulfills the requirements of OIML R85. This particularly includes:</p> <ul style="list-style-type: none"> ■ cyclical test of data consistency ■ non-volatile memory ■ segmented data storage <p>The radar instrument Micropilot S continuously monitor the compliance with accuracy requirements for custody transfer measurements according to OIML R85. If the accuracy cannot be maintained, a specific alarm is generated on the local display and via the digital communication (see Page 33).</p>
Inventory control versions	<p>All device types can be delivered as "Inventory Control Versions" with a reduced accuracy of ± 3 mm (under reference conditions). To these versions, the calibration certificate or custody transfer type approval is NOT attached. The "Inventory Control Versions" can be selected by choosing the option »R« in the order code section »Custody transfer approvals« on Page 9.</p>
Reaction time	The reaction time depends on the parameter settings (min. 1 s). In case of fast level changes, the instrument needs the reaction time to indicate the new value.

10.1.6 Operating conditions: Environment

Ambient temperature range	<p>Ambient temperature for the transmitter:</p> <ul style="list-style-type: none"> ■ Standard: -40 °C ... +80 °C (-40 °F...+176 °F) ■ For calibration to regulatory standards: -25 °C ... +55 °C (-30 °F...+140 °F) <p>With $T_u < -20$ °C and $T_u > +60$ °C the operability of the LC-display is reduced. A weather protection cover should be used for outdoor operation if the instrument is exposed to direct sunlight.</p>
Storage temperature	-40 °C ... +80 °C (-40 °F...+176 °F)
Climate class	DIN EN 60068-2-38 (test Z/AD)
Degree of protection	<ul style="list-style-type: none"> ■ Housing: IP 68, NEMA 6P (open housing and removed liquid crystal display: IP20, NEMA 1) ■ Antenna: IP 68 (NEMA 6P)

Vibration resistance DIN EN 60068-2-64 / IEC 68-2-64: 20...2000 Hz, 1 (m/s²)²/Hz

Cleaning of the antenna The antenna can get contaminated, depending on the application. The emission and reception of microwaves can thus eventually be hindered. The degree of contamination leading to an error depends on the medium and the reflectivity, mainly determined by the dielectric constant ϵ_r . If the medium tends to cause contamination and deposits, cleaning on a regular basis is recommended. Care has to be taken not to damage the antenna in the process of a mechanical or hose-down cleaning. The material compatibility has to be considered if cleaning agents are used! The maximum permitted temperature at the flange should not be exceeded

Electromagnetic compatibility (EMC)

- Interference Emission to EN 61326, Electrical Equipment Class B.
- Interference Immunity to EN 61326, Annex A (Industrial) and NAMUR Recommendation NE 21 (EMC)
- Use a screened cable for the connection to the sensor.

10.1.7 Operating conditions: Process

Process temperature range -40 °C...+200 °C

Process pressure limits 0...40 bar (Option 64 bar)

Wetted parts **FMR531**

Type of antenna / Seal	Wetted parts
Rod gas-tight , antistatic	1.4404 / SS 316 L / PTFE
Stab gas-tight ¹⁾	1.4404 / SS 316 L / PTFE (TFM 1600)

1) Rod antenna with FDA listed materials, white PTFE (TFM 1600), 3A approved in combination with 2" and 3" Tri-clamp process connection.

Dielectric constant

- In a stilling well: $\epsilon_r \geq 1.4$
- In free space: $\epsilon_r \geq 1.9$

10.1.8 Mechanical construction

Design, dimensions see Page 14

Weight Approx 6 kg + weight of flange

Material see Page 9

Process connection see Page 9
All process connections dispose of a gas-tight glass feed-through to prevent any gas leakage to the inside of the housing.

10.1.9 Certificates and approvals

CE approval	The measuring system meets the legal requirements of the EC-guidelines. Endress+Hauser confirms the instrument passing the required tests by attaching the CE-mark.
RF approvals	R&TTE 1999/5/EG, FCC CRF 47, part 15
Custody type approval	All aspects of OIML R85 are fulfilled.
Overspill protection	WHG, see ZE243F/00/de.
External standards and guidelines	<p>To conception and development for Micropilot S have been followed the external standards and guidelines::</p> <p>EN 60529 Protection class of housing (IP-code)</p> <p>EN 61010 Safety regulations for electrical devices for measurement, control, regulation, and laboratory use.</p> <p>EN 61326 Emissions (equipment class B), compatibility (appendix A – industrial area)</p> <p>NAMUR Standards committee for measurement and control in the chemical industry</p> <p>API (American Petroleum Institute) Particularly "Manual of Petroleum Measurement Standards".</p> <p>OIML R85 (Organisation Internationale de Métrologie Légale)</p> <p>EN 60529 Protection class of housing (IP-code)</p>
Ex approval	<p>XA081F-A</p> <p>Safety Instructions for Micropilot S FMR530, FMR531, FMR532, FMR533 (T12 / EEx ia IIC T6...T1)</p> <p>PTB 00 ATEX 2067 X, Equipment marking: (II 1/2 G)</p>
Marine certificate	GL (Germanischer Lloyd)

10.1.10 Supplementary Documentation

Supplementary Documentation	<ul style="list-style-type: none"> ■ System Information Micropilot (SI019F/00/en) ■ Technical Information (TI344F/00/en) ■ Operating Instructions "Description of Instrument functions" (BA217F/00/en) ■ Certificate "German WHG" (ZE243F/00/de)
-----------------------------	--

11 Appendix

11.1 Operating menu HART (Display modul), FieldCare

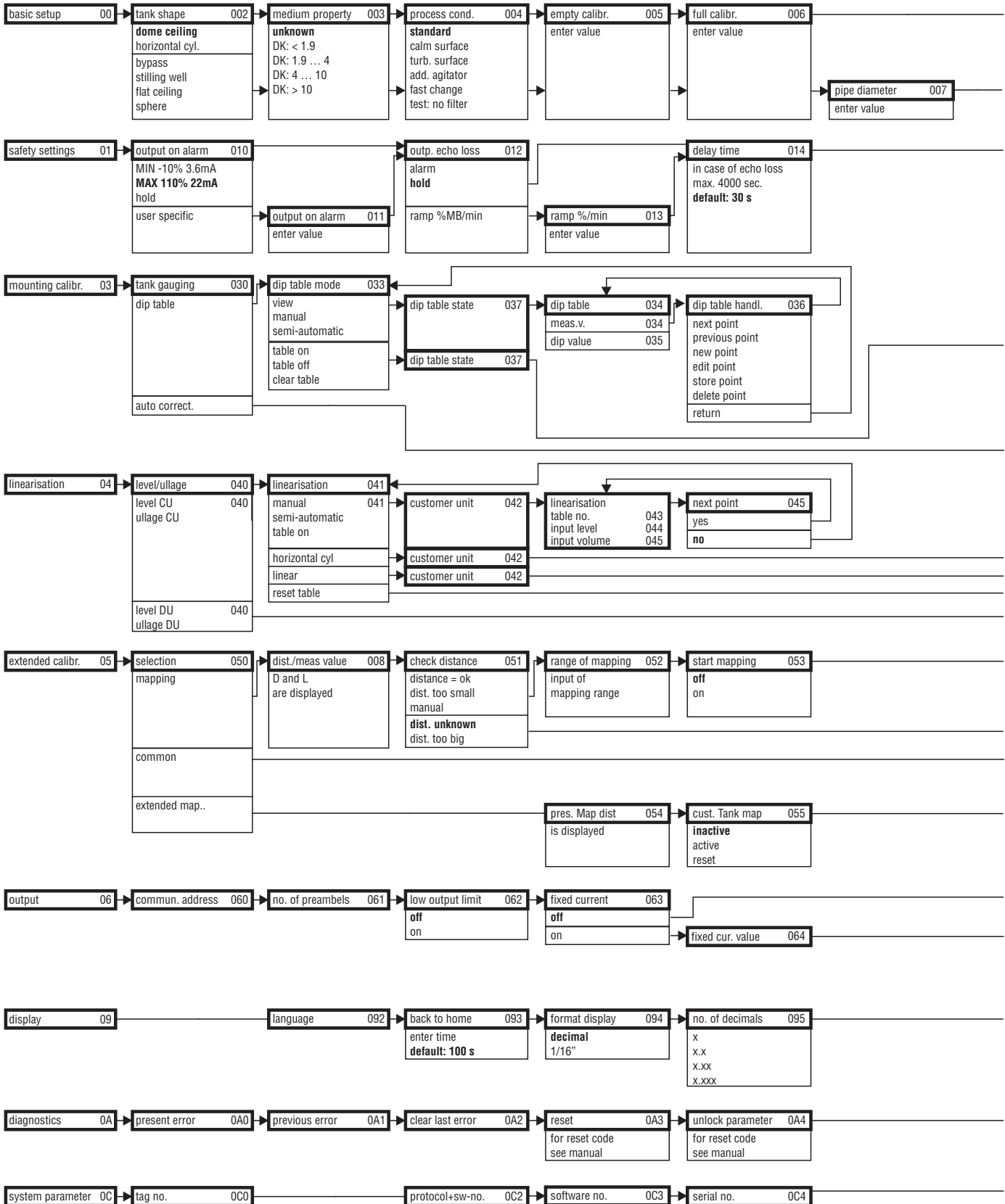

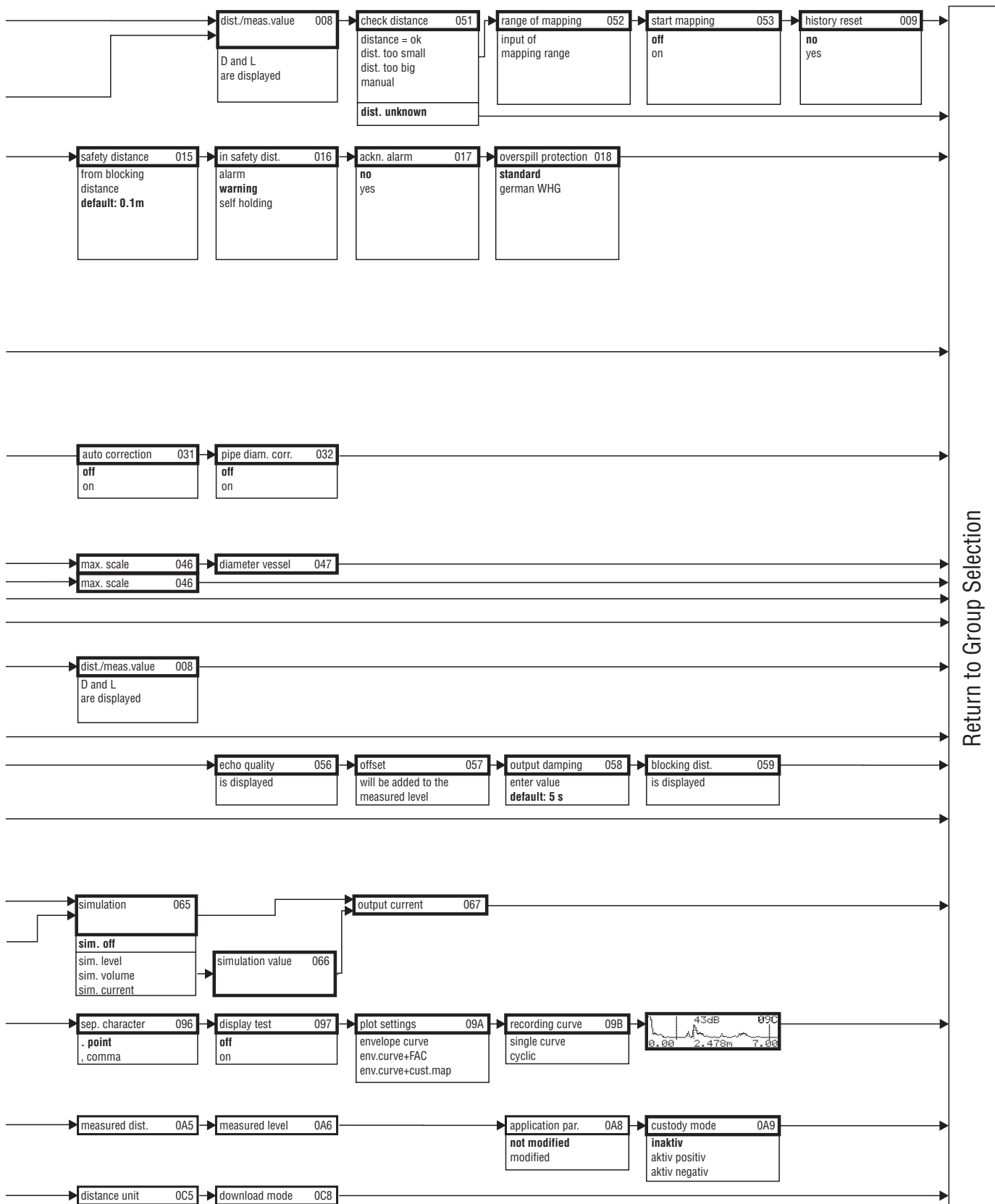

Return to Group Selection

11.2 Description of functions



Note!

A detailed description of the function groups, functions and parameters is given in the documentation BA217F/00/en "Description of Instrument Functions" on the enclosed CD-ROM.

11.3 Function and system design

11.3.1 Function (Measuring principle)

The Micropilot is a "downward-looking" measuring system, operating based on the time-of-flight method. It measures the distance from the reference point (process connection) to the product surface. Radar impulses are emitted by an antenna, reflected off the product surface and received again by the radar system.

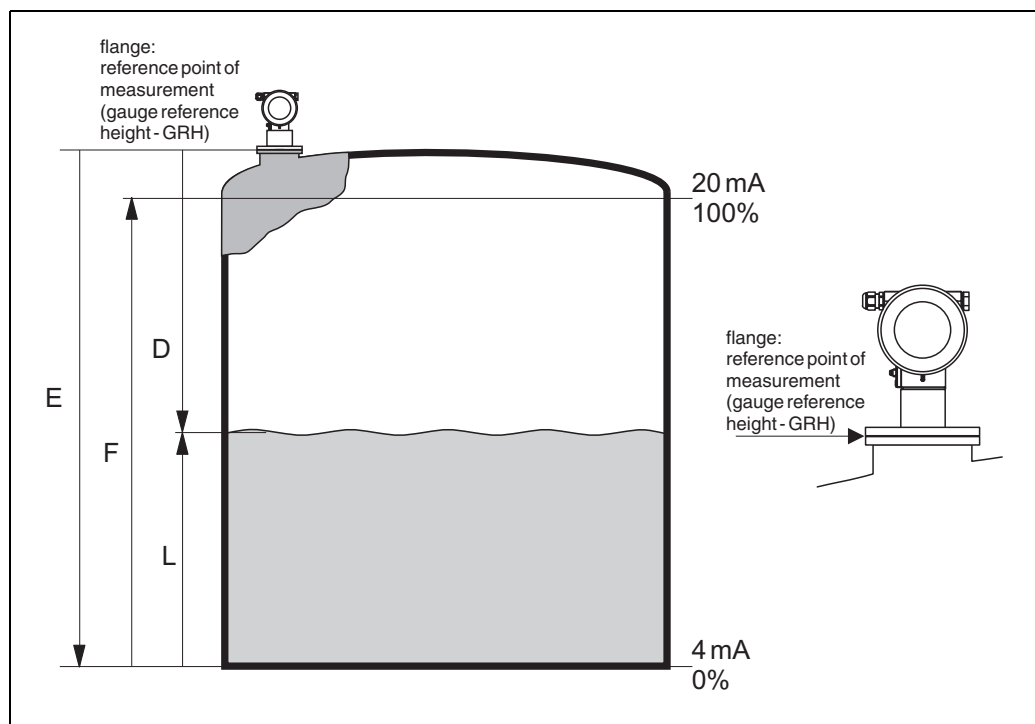

Input

The reflected radar impulses are received by the antenna and transmitted into the electronics. A microprocessor evaluates the signal and identifies the level echo caused by the reflection of the radar impulse at the product surface. The unambiguous signal identification is accomplished by the PulseMaster® software, based on many years of experience with time-of-flight technology. The mm-accuracy of the Micropilot S could be achieved with the patented algorithms of the PhaseMaster® software.

The distance D to the product surface is proportional to the time of flight t of the impulse:

$$D = c \cdot t/2,$$

with c being the speed of light.

Based on the known empty distance E , the level L is calculated:

$$L = E - D$$

Refer to the above figure for the reference point for "E".

The Micropilot is equipped with functions to suppress interference echoes. The user can activate these functions. They ensure that interference echoes (i.e. from edges and weld seams) are not interpreted as level echo.

Output

The Micropilot is commissioned by entering an empty distance E (=zero), a full distance F (=span) and an application parameter. The application parameter automatically adapts the instrument to the process conditions. The data points "E" and "F" correspond with 4mA and 20mA for instruments with current output. They correspond with 0 % and 100 % for digital outputs and the display module.

A linearization with max. 32 points, based on a table entered either manually or semi-automatically, can be activated locally or remotely. This function provides a measurement in engineering units and a linear output signal for spheres, horizontal cylindrical tanks and vessels with conical outlet.

11.3.2 Equipment architecture

Stand-alone

The Micropilot S can be used for measurement in a stilling well as well as in free space. The different instrument versions are applied as follows:

- The Micropilot S FMR532 with planar antenna is the preferred device in stilling wells ≥ 150 mm.
- In stilling wells with a diameter < 150 mm, the Micropilot S FMR532 can be applied in connection with a suitable reducing adapter. For more information please contact your Endress+Hauser representative.
- The Micropilot S FMR533 with parabolic antenna is preferred for free-space measurements. The Micropilot S FMR530 with horn antenna can be used as an alternative for small nozzle. It is essential to keep the minimum distance from the tank wall.
- The Micropilot S FMR531 with rod antenna (PTFE) should be used for measurements of highly aggressive media (e.g. sulphur).
- The instruments are equipped with a passive 4...20 mA output with HART protocol.
- Reliable transmission of a measurement with mm accuracy is only ensured by the HART protocol

4...20 mA output with HART protocol

The complete measuring system consists of:

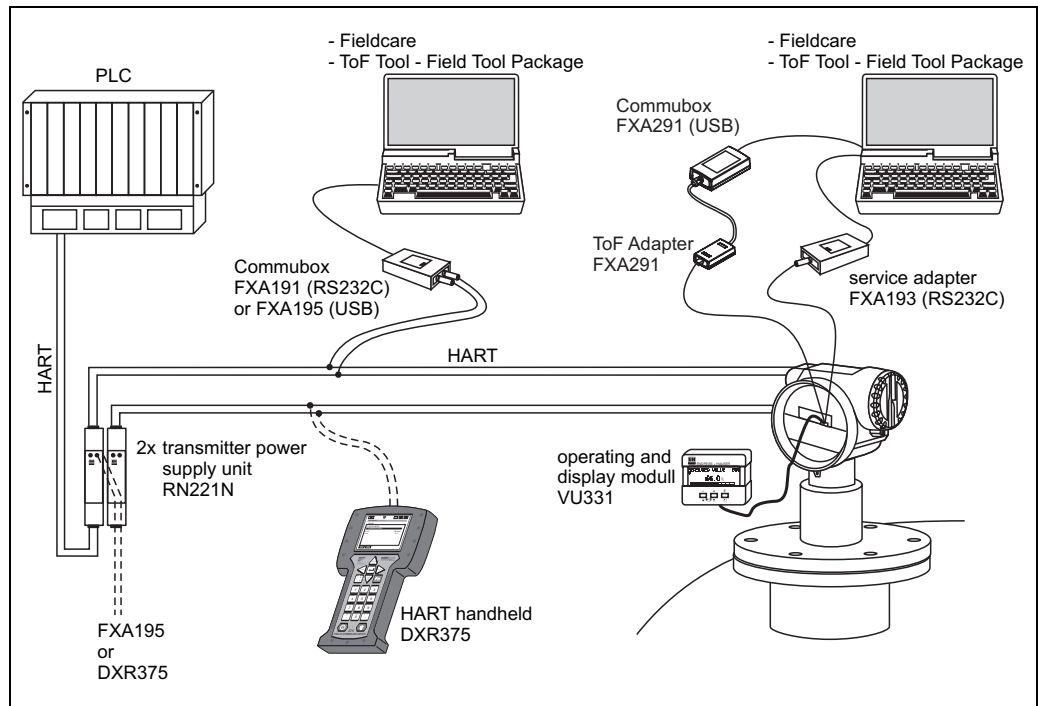

L00-FMR53xxx-14-00-06-en-002

On-site operation:

- with display and operating module VU331,
- with a Personal Computer, FXA193 (RS232C) or FXA291 and ToF Adapter FXA291 (USB) and the operating software "FieldCare".

Remote operation

- with HART handheld DXR375,
- with a Personal Computer, Commubox FXA195 and the operating software "FieldCare".
- With a Personal Computer, TSM (Tank Side Monitor) and the operating software FuelsManager.

Integration into the Asset Management System

The HART interface allows the integration into the AMS® (Asset Management System) from Fisher-Rosemount.

11.3.3 Custody transfer mode

Micropilot S is a weight and measure approved level transmitter. Either the innage or the ullage can be selected as the custody transfer variable.

The selected variable is the basis for the subsequent calculation of the current amount of product in a tank, along with other measured variables such as (average) temperature and pressure.

This opens up numerous application options in custody transfer:

- Quantity calculation of mineral oils
- Quantity calculation of alcohols

11.3.4 Weight and measure approval, Standards Authorities approval, Compulsory reapproval

The *type approvals for custody transfer* issued by the PTB and NMI, a copy of which is enclosed with every device, prove the fundamental suitability of the various types for custody transfer.

In addition to this, the *accuracy* of every single device is documented using a calibration certificate, which is issued in the factory after the device has been tested on a reference test rig.

On request, a separate *Initial verification* of the devices can be carried out with a National Standards Authorities inspector present, who issues a *preliminary test certificate* for every device. In the initial verification, the device is tested to ensure that it complies with the *limit of error in legal metrology*, which lies at $\pm 2\text{mm}$ for radar measuring devices in Germany.

Essentially, this proves that the devices are *weight and measure approved*. The devices must not, however, be used in custody transfer mode straight away.

The measuring device is not approved until after the *approval after installation* by the Standards Authorities. For this, the device's level measurement is compared with the tank gauging by a National Standards Authorities inspector using manual dips (also "Initial verification"). As a rule, a quiescent tank gauging is dipped by hand three times in a row and then compared with the value displayed by the level radar. Depending on national regulations, the transfer error limit, calculated as the arithmetic mean of the absolute deviations of all three measurements, must not exceed double the limit of error in legal metrology (compare, for example, the German "Eichordnung" or the American "API 3.1B", in which the necessary procedures are also defined).

Depending on national regulations, this test is repeated with various tank gaugings. Using linearisation tables to compensate any non-linearities that occur in measurement is permitted. For this, the Micropilot S level radar offers a special dip table, compare → Chap. 6.5.

After the measurement has been approved by an inspector, he seals the level radar at the stamp position and thereby also secures the programming status of the device.

Those operating an approved level transmitter are obligated to obtain *reapproval* in accordance with the applicable national regulations from the Standards Authorities.

11.3.5 Particularities in "approved" operation

The Micropilot S level radar is set to custody transfer mode after commissioning using a custody locking switch (see Page 32) The position of the custody locking switch is secured and sealed using the sealing pin.

During custody transfer measurement, all custody transfer-relevant functions for operation are automatically locked, so that the device software can not be used, either via local operation or via digital communication settings. This locked status is displayed by the key symbol ($\frac{L}{\text{L}}$).

Micropilot S radar devices continuously monitor the compliance with accuracy requirements for custody transfer measurements according to OIML R85. If, for example, the accuracy cannot be maintained due to quick surface movements, this is reported via a separate alarm in the local display (displays "#"- symbols) and via digital communication.

11.3.6 Definition of terms

For definitions and procedures please refer to the following documents:

- Manual of Petroleum Measurement Standards, Chapter 3 - Tank Gauging, Section 1.B - Standard Practice for Level Measurement of Liquid Hydrocarbons in Stationary Tanks by Automatic Tank Gauging, American Petroleum Institute, second edition, 2001
- OIML R 85, Organisation Internationale de Métrologie Légale, International Recommendation R 85, edition 1998 (E).

11.3.7 Integrated in tank gauging system

The Endress+Hauser Tank Side Monitor NRF590 provides integrated communications for sites with multiple tanks, each with one or more sensors on the tank, such as radar, spot or average temperature, capacitive probe for water detection and/or pressure sensors. Multiple protocols out of the Tank Side Monitor guarantee connectivity to nearly any of the existing industry standard tank gauging protocols. Optional connectivity of analog 4...20 mA sensors, digital I/O and analog output simplify full tank sensor integration. Use of the proven concept of the intrinsically safe HART bus (HART multidrop) for all on-tank sensors yields extremely low wiring costs, while at the same time providing maximum safety, reliability and data availability.

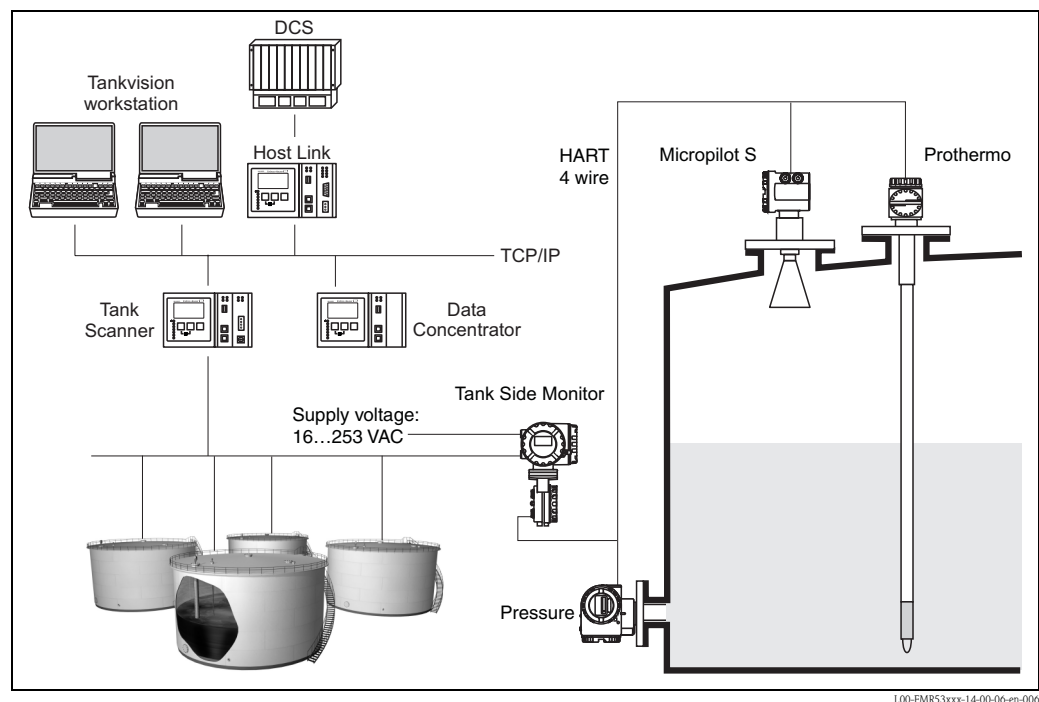

11.3.8 Patents

This product may be protected by at least one of the following patents.
Further patents are pending.

- US 5,387,918 \cong EP 0 535 196
- US 5,689,265 \cong EP 0 626 063
- US 5,659,321
- US 5,614,911 \cong EP 0 670 048
- US 5,594,449 \cong EP 0 676 037
- US 6,047,598
- US 5,880,698
- US 5,926,152
- US 5,969,666
- US 5,948,979
- US 6,054,946
- US 6,087,978
- US 6,014,100

Index

A

Accessories.....	68
Alarm.....	33, 38
Allignment.....	65
Application errors.....	73

B

Basic setup.....	41, 43, 61
Beam angle.....	16
Bypass.....	47

C

Cable entry.....	26
CE mark.....	11
Commissioning.....	40
Commubox.....	28, 68
Connection.....	28
Current consumption.....	26
Custody locking switch.....	34

D

declaration of conformity.....	11
Declaration of contamination.....	81
Degree of protection.....	29
Designated use.....	6
Dielectric constant.....	44
Dielektrizitätszahl.....	18
Dimensions.....	14
Dip table.....	54
Display.....	32
Disposal.....	81
Distance.....	41, 48
DXR375.....	28

E

Echo quality.....	75–76
Empty calibration.....	41, 46, 62–64
Engineering hints.....	15
Envelope curve.....	59
Equipotential bonding.....	29
Error messages.....	38
Ex approval.....	86
Exterior cleaning.....	67

F

FieldCare.....	61, 88
Full calibration.....	41, 47, 62–64
Function (Measuring principle).....	90
Function groups.....	31
Functions.....	31
FXA191.....	28
FXA193.....	28

G

Grüne LED.....	33
----------------	----

H

Hardware lock.....	35
Hardware unlock.....	36
HART.....	28, 39
Housing T12.....	25

I

Installation in tank (free space).....	20
Interference echo.....	75
Interference echo suppression.....	49, 64
Interference echoes.....	48

K

Key assignment.....	34
---------------------	----

L

Level.....	41
------------	----

M

Maintenance.....	67
Mapping.....	48–49
Measuring conditions.....	17
Media group.....	18
Mediengruppe.....	18
Medium properties.....	44, 62
Mounting.....	12

N

Nameplate.....	8
----------------	---

O

Operating menu.....	88
Operating menus.....	30–31
Operation.....	30, 35
Operational safety.....	6
Optimisation.....	75
Ordering structure.....	9
Orientation.....	75

P

Performace characteristics.....	83
Pipe diameter.....	47, 63
Power consumption.....	26
Process conditions.....	45, 62

R

Repair.....	67
Repairs to Ex- approved devices.....	67
Replacement.....	67
Reset.....	37
Return.....	81
Rf approval.....	86
RN221N.....	28
Rote LED.....	33

S

Safety conventions and symbols.....	7
-------------------------------------	---

Safety distance	41
Service Interface FXA291	68–69
Software history	81
Stutzen	23
Supply voltage	26
System error messages	71
T	
Tag	62
Tank installations	15
Tank shape	43, 62
Technical data	82
Trouble-shooting	70
Trouble-shooting instructions	70
Turn housing	12, 21
U	
Unlock parameter	35–36
V	
VU331	43, 59
W	
Warning	38
Warnung	33
Wetterschutzhaube	15, 68
Wiring	24

Declaration of Hazardous Material and De-Contamination *Erklärung zur Kontamination und Reinigung*

RA No.

Please reference the Return Authorization Number (RA#), obtained from Endress+Hauser, on all paperwork and mark the RA# clearly on the outside of the box. If this procedure is not followed, it may result in the refusal of the package at our facility.

Bitte geben Sie die von E+H mitgeteilte Rücklieferungsnummer (RA#) auf allen Lieferpapieren an und vermerken Sie diese auch außen auf der Verpackung. Nichtbeachtung dieser Anweisung führt zur Ablehnung ihrer Lieferung.

Because of legal regulations and for the safety of our employees and operating equipment, we need the "Declaration of Hazardous Material and De-Contamination", with your signature, before your order can be handled. Please make absolutely sure to attach it to the outside of the packaging.

Aufgrund der gesetzlichen Vorschriften und zum Schutz unserer Mitarbeiter und Betriebseinrichtungen, benötigen wir die unterschriebene "Erklärung zur Kontamination und Reinigung", bevor Ihr Auftrag bearbeitet werden kann. Bringen Sie diese unbedingt außen an der Verpackung an.

Type of instrument / sensor

Geräte-/Sensortyp _____

Serial number

Seriennummer _____

Used as SIL device in a Safety Instrumented System / Einsatz als SIL Gerät in Schutzeinrichtungen

Process data / Prozessdaten

Temperature / Temperatur _____ [°F] _____ [°C] Pressure / Druck _____ [psi] _____ [Pa]
Conductivity / Leitfähigkeit _____ [µS/cm] Viscosity / Viskosität _____ [cp] _____ [mm²/s]

Medium and warnings

Warnhinweise zum Medium



	Medium / concentration <i>Medium / Konzentration</i>	Identification CAS No.	flammable <i>entzündlich</i>	toxic <i>giftig</i>	corrosive <i>ätzend</i>	harmful/ irritant <i>gesundheitsschädlich/ reizend</i>	other * <i>sonstiges*</i>	harmless <i>unbedenklich</i>
Process medium <i>Medium im Prozess</i>								
Medium for process cleaning <i>Medium zur Prozessreinigung</i>								
Returned part cleaned with <i>Medium zur Endreinigung</i>								

* explosive; oxidising; dangerous for the environment; biological risk; radioactive

* *explosiv; brandfördernd; umweltgefährlich; biogefährlich; radioaktiv*

Please tick should one of the above be applicable, include safety data sheet and, if necessary, special handling instructions.

Zutreffendes ankreuzen; trifft einer der Warnhinweise zu, Sicherheitsdatenblatt und ggf. spezielle Handhabungsvorschriften beilegen.

Description of failure / Fehlerbeschreibung _____

Company data / Angaben zum Absender

Company / Firma _____	Phone number of contact person / Telefon-Nr. Ansprechpartner: _____
Address / Adresse _____	Fax / E-Mail _____
_____	Your order No. / Ihre Auftragsnr. _____

"We hereby certify that this declaration is filled out truthfully and completely to the best of our knowledge. We further certify that the returned parts have been carefully cleaned. To the best of our knowledge they are free of any residues in dangerous quantities."

"Wir bestätigen, die vorliegende Erklärung nach unserem besten Wissen wahrheitsgetreu und vollständig ausgefüllt zu haben. Wir bestätigen weiter, dass die zurückgesandten Teile sorgfältig gereinigt wurden und nach unserem besten Wissen frei von Rückständen in gefährlicher Menge sind."

(place, date / Ort, Datum)

Name, dept./Abt. (please print / bitte Druckschrift)

Signature / Unterschrift

www.endress.com/worldwide

Endress+Hauser 
People for Process Automation

