

electronics

GETTING MORE BANDWIDTH

From dipole antennas, p 40
(Photo below)

FIVE NEW DIODE CIRCUITS

For fast micro-wave switching, p 37

HOW TO SELECT SHAFT ENCODERS

In analog-digital conversion, p 48



R D SKINNER
1020 COVINGTON RD
LOS ALTOS CALIF
L

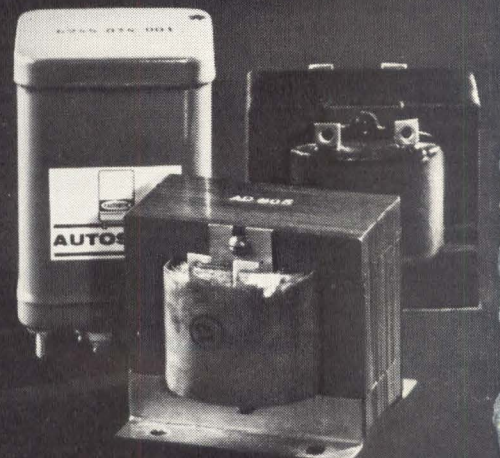
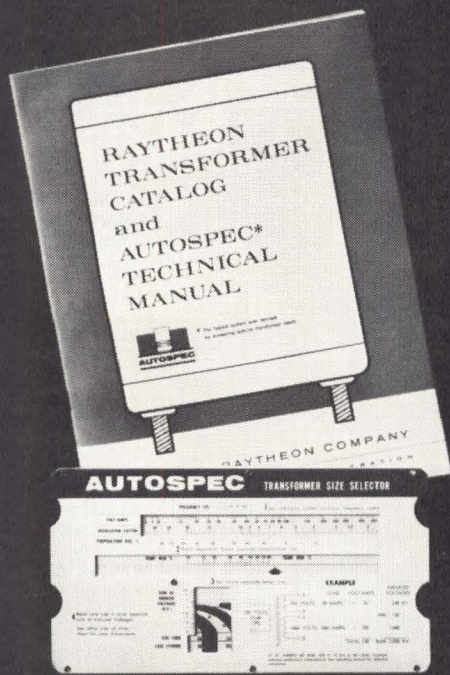

Now, Raytheon gives quote by phone with Autospec

TRANSFORMER USERS:

1. You use unique AUTOSPEC slide rule selector as an aid in specifying your transformer parameters. Slide rule calculations include volt-amps, regulation factors, temperature rise and size information. Technical manual helps, too.

2. You phone Raytheon collect—Waltham, Mass., Area Code 617, TW 9-8400, Ext. 3400. Discuss your needs or questions. Raytheon quotes price plus exact particulars on size, style and electrical characteristics over the phone.

3. You receive your order of transformers that exactly meet your electrical requirements within 3 weeks.

Over 6,500 design engineers now have AUTOSPEC slide rule and catalog/manual. Write for yours. Then call us collect for a quote. Raytheon Company, Magnetics Operation, Waltham 54, Mass.

RAYTHEON

CIRCLE 900 READERS SERVICE CARD

electronics

A McGraw-Hill Publication 75 Cents



W. W. MacDONALD, Editor

J. M. CARROLL, Managing Editor
 SENIOR EDITORS: Samuel Weber, George W. Sideris. SENIOR ASSOCIATE EDITOR: Michael F. Wolff. ASSOCIATE EDITORS: Michael F. Tomaino, Sylvester P. Carter, William P. O'Brien, John F. Mason, Sy Vogel, Leslie Solomon, George J. Flynn, Laurence D. Shergalis. ASSISTANT EDITORS: Nilo Lindgren, Stanley Froud, Stephen B. Gray, Roy J. Bruun, George V. Novatny, Leon H. Dulberger. REGIONAL EDITORS: Harold C. Hood (Pacific Coast, Los Angeles), Thomas Maguire (New England, Boston), Cletus M. Wiley (Midwest, Chicago). ART DIRECTOR: Harry Phillips; Howard R. Berry. PRODUCTION EDITOR: John C. Wright, Jr. EDITORIAL ASSISTANTS: Gloria J. Meurer, Bernice Duffy, Lorraine Rossi, Virginia T. Bastian, Lynn Emery, Bette H. Snyder, Rosemary Abbruzzese, Ann Mella, Lorraine Werner. FOREIGN NEWS BUREAU: Director, John Wilhelm, Alyne Elias. LONDON—John Shinn, Derek Barlow, Nicholas Landon. Bonn—Peter Forbath, Silke McQueen. Paris—Robert Farrell, Arthur Erikson. Milan—Marc A. Messina. Mexico City—Bruce Bendow. Rio de Janeiro—Leslie Warren. Moscow—Stewart Ramsey. Tokyo—Richard Halloran, Charles Cohen, John Yamaguchi.

JAMES GIRDWOOD, Publisher

BROADBAND DIPOLE ANTENNA by Avien is one of 16 dipoles used with disk-rod directors in a tactical troposcatter communications array for the integrated AN/MRC-80 system. *The element is matched to a coaxial feed line over the range 350 to 600 Mc with a maximum vswr of 1.5. For formulas, charts and design procedure, see p 40* COVER

DIRECT DEMODULATION Next Step in Laser Communications. Stanford researchers reveal progress in phototubes and diodes. *Microwave signals modulate light beam* 18

CABLE REPEATERS Take Oceans in Stride. Two-way repeaters enable single submarine cable to handle 128 two-way telephone conversations. *Dual amplifiers send messages both ways* 24

GLASS-FIBER LASERS. Stimulated emission is observed in glass fiber bundles. Each fiber operates like a waveguide. *Researchers also report work in semiconductor and organic lasers* 25

EXOTIC POWER SOURCES. Developers see 10,000-hour lives for thermionic converters. *The big problem is materials* 26

COMPUTER MAKES MAPS from Stereo Photos. Technique matches tiny areas in pairs of photos. *ACM conference will also hear report on new function generator* 28

FIVE NEW DIODE CIRCUITS for Nanosecond Microwave Switching. Two coaxial switches use three-diode ladder networks; slab-line switch uses series back-to-back diodes one-half wavelength apart; each arm of five-arm switch uses two back-to-back diode switches in series; waveguide switch has shunt diodes one-quarter wavelength apart. *Switching voltage is 8-volt pulse; 10 to 500 mw have been switched at nanosecond speeds.* By P. Ravenhill and H. Smith, Westinghouse Electric 37

GETTING MAXIMUM BANDWIDTH With Dipole Antennas. Analytical approach uses zero-pole plot of reflection coefficient on complex frequency plane for composite dipole-balun circuit. *Technique matches antenna system radiators to coaxial transmission system.* By H. Shnitkin and S. Levy, Avien 40

WHAT IS THE OPTIMUM MODE for Magnetostrictive Delay Lines? Computer memories using magnetostrictive delay lines offer high speed at low cost. The lines may be operated in either the nonreturn-to-zero (nrz) or return-to-zero (rz) mode. *The nrz mode provides for maximum storage at highest clock rate, but the rz mode affords considerable circuit simplification.* By A. Rothbart and A. J. Brown, Cutler-Hammer 43

NOVEL SLOTTED LINE Uses Slow-Wave Techniques. Microwave techniques for measuring vswr and impedance seem attractive to engineers working around 25 Mc but conventional slotted lines would be far too long. *This serpentine line slows down radio waves much like a slalom course in downhill skiing.* By L. L. Oh and C. D. Lunden, Boeing 46

Published weekly, with Electronics Buyers' Guide and Reference issue as part of the subscription, by McGraw-Hill Publishing Company, Inc. Founder: James H. McGraw (1860-1948).

Title ® registered U.S. Patent Office; © copyright 1962 by McGraw-Hill Publishing Co., Inc. All rights reserved, including the right to reproduce the contents of this publication, in whole or in part.

Executive, editorial, circulation and advertising offices McGraw-Hill Building, 330 West 42nd Street, New York 36, N. Y. Telephone Longacre 4-3000. Teletype TWX N.Y. 1-1636. Cable McGrawhill, N. Y. PRINTED IN ALBANY, N. Y.; second class postage paid at Albany, N. Y.

OFFICERS OF THE PUBLICATIONS DIVISION: Nelson L. Bond, President; Shelton Fisher, Wallace F. Traendly, Senior Vice Presidents; John R. Callahan, Vice President and Editorial Director; Joseph H. Allen, Vice President and Director of Advertising Sales; A. R. Venezian, Vice President and Circulation Coordinator; Daniel F. Crowley, Vice President and Controller.

OFFICERS OF THE CORPORATION: Donald C. McGraw, President; Hugh J. Kelly, Harry L. Waddell, Executive Vice Presidents; L. Keith Goodrich, Executive Vice President and Treasurer; John J. Cooke, Vice President and Secretary.

Subscriptions are solicited only from those actively engaged in the field of the publication. Position and company connection must be indicated on orders. Subscription rates: United States and Possessions, \$6.00 one year, \$9.00 two years, \$12.00 three years. Canada, \$10.00 one year. All other countries \$20.00 one year. Single Copies, United States and Possessions and Canada 75¢. Single copies all other countries \$1.50.

THE PUBLISHER, UPON WRITTEN REQUEST FROM ANY SUBSCRIBER TO OUR NEW YORK OFFICE, AGREES TO REFUND THAT PART OF THE SUBSCRIPTION PRICE APPLYING TO COPIES NOT YET MAILED.

Subscribers: Please address change of address notices, subscription orders or complaints to Fulfillment Manager, Electronics, at above address. Change of address notices should provide old as well as new address, including postal zone number if any. If possible, attach address label from recent issue. Allow one month for change to become effective.

Postmaster: Please send Form 3579 to Fulfillment Manager, Electronics, 330 West 42nd Street, New York 36, New York.



Audited Paid Circulation

CONTENTS continued

SELECTING SHAFT-POSITION ENCODERS. Measurement of shaft position and velocity is one of the keys to good guidance and tracking system performance. Encoder types include: brush-and-commutator circuits, photosensing encoders relying on either light transmission or reflection, magnetic pickups, capacitors and potentiometers. *Each has its particular advantages and disadvantages.*
By F. W. Kear, Lytle Corp. 48

NEW COMPLEMENTARY TRANSISTORS Make Series Schmitt Circuits Practical. In series Schmitt circuits both transistors are either on or off, saving power in low-duty-cycle operation. The circuits require high source resistance, can compare current amplitudes and use R-L input tuning. *Only recently have suitable complementary transistors become available at a price low enough to make series Schmitt circuits attractive.*
By J. K. Skilling, General Radio 52

LONG STAIRCASE GENERATOR. Linear voltage sweeps are used to tune swept-frequency ionospheric sounders. But in backscatter work a step waveform must be used. *This generator provides a 100-volt amplitude staircase output with rundowns of up to 10 minutes duration.*
By K. Perry, University of Queensland 54

DEPARTMENTS

Crosstalk. <i>Antennas for Space Communications. Klystron Anniversary</i>	3
Comment. <i>Information Storage and Retrieval. Competition from Japan</i>	4
Electronics Newsletter. <i>USSR Satellite Tv</i>	7
Washington Outlook. <i>Sprint: New Antimissile</i>	10
Meetings Ahead. <i>National Winter Convention on Military Electronics</i>	30
Research and Development. <i>Modulation Techniques Cut Radar Cost</i>	56
Components and Materials. <i>New Cables Withstand More Heat</i>	60
Production Techniques. <i>Line of Balance Shows Production Problems</i>	66
New Products Design and Application. <i>Digital Test Set Uses Magnets for Signals</i>	72
Literature of the Week	83
People and Plants. <i>Hazeltine Opens New Laboratory</i>	84
Index to Advertisers	91

CROSSTALK

SILVER ANNIVERSARY. This month marks the 25th anniversary of the klystron. On the evening of Aug. 19, 1937 the model "A" klystron oscillated in the Stanford University physics laboratory for the first time. On Nov. 5, the model "B" (shown in the photo) was successfully modulated.

Idea that led to the klystron was born in the mind of a Pan American Airlines pilot flying in Mexico during the mid-1930's. Captain Sigurd Varian, flying the then hazardous Brownsville—Canal Zone route, recognized the need for blind-flying aids to guide aircraft through darkness and fog, and, also, the need for some way to detect enemy bombers attacking at night or behind cloud cover.

Sigurd posed the problem to his brother Russell, who was then studying for his doctorate in physics at Stanford University. Together they set up shop in a converted laboratory-barn at the family home, and in the spring of 1937 returned to Stanford. There they were appointed as unpaid research associates, given \$100 for materials and allowed free use of the physics laboratories.

Together with W. W. Hansen, they tried and discarded dozens of ideas throughout the summer until, in late July, Russell Varian hit upon his velocity modulation scheme. Using two rhumbatrons (which Hansen had invented) in a back-to-back arrangement, Sigurd Varian built a crude device to test Russell's idea. On August 19, the first oscillations were observed.

The work was accomplished just in time to make possible many types of World War II radar, helping the British turn back the Luftwaffe and aiding in the destruction of the German submarine fleet. During the war, the Varians and other microwave researchers pushed klystron development at Sperry Gyroscope Co. Afterwards they returned to California where, with \$22,000, they founded Varian Associates. All three of the inventors are now dead.

The handbuilt klystron shown in the photo was a laboratory oddity that produced only a few watts of microwave energy. Today, klystrons have been built that produce megawatts of power, and others have been pushed to frequencies higher than 100 Gc.

Several recent **ELECTRONICS** articles show how far the klystron has come. Since our special report on tubes in April 29, 1960 (p 54), these articles include millimeter-wave applications (p 56, Feb. 23 and p 37, May 25, 1962), multiple

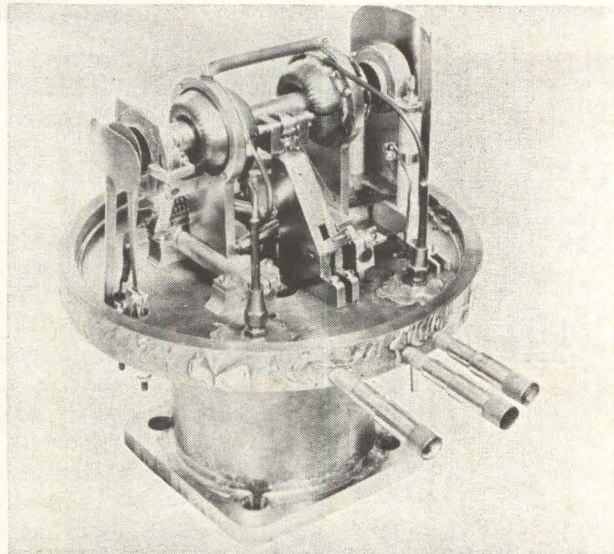

beam klystrons (p 72, March 30, 1962) and a high-power microwave source (p 46, June 15, 1962). Historians, however, might prefer an article published on p 9, April, 1939.

Coming In Our September 7 Issue

MODERN ANTENNAS. Scientific and economic pressures are driving the field of antenna technology toward new forms and capabilities. The requirements imposed by the expanding exploration and observation of space are opening up new directions in antenna design.

Research trends in antennas for space communications are described in a 10-page article next week by Carlyle J. Sletten, of Air Force Cambridge Research Laboratories. His highly interesting article discusses the design principles and relative merits of different large-aperture antennas including spherical reflectors, paraboloidal reflectors, parabolic cylinder antennas, flat antenna arrays and interferometers. Particular attention is given to the new multiplate antenna designs.

Various methods of electronic scanning of antennas and arrays are compared, and a look is given at advanced designs in nonlinear antennas.

Sletten suggests new techniques whereby the giant radio telescopes of the future can have much higher aperture efficiency and information gathering capability through multibeam generation and antenna pattern optimization. Importance of focal region research to improve space antennas is emphasized.

INSIDE THIS MODERATELY PRICED ATTENUATOR IS AN EXTREMELY STABLE FILM RESISTOR

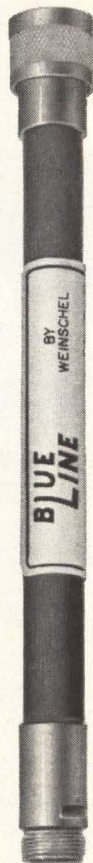

It gives excellent shock and vibration resistance. It assures stability under temperature and humidity cycling. It can withstand appreciable peak pulse power and reasonable overloads without changes in characteristics. It can do all of these things and yet the price is moderate!

This is one of a new series of general utility coaxial components by Weinschel Engineering. The new series is known as BLUELINE. All BLUELINE components are rugged, stable and moderately priced. They are suitable for many applications not requiring Weinschel Precision Components.

Illustrated is the BLUELINE Model HF-N attenuator. Attenuation Range: 3 to 20 db. Frequency Range: 2 to 10 KMC. Average Power: 1 to 5 Watts. Peak Power: 1 to 10 KW. We invite you to write for complete specifications and prices.

For your more exacting applications we recommend Weinschel Precision Attenuators.

**BLUE
LINE** By

WEINSCHTEL

ENGINEERING

Kensington, Maryland

Tel: 949-0141 (area code 301)

TWX: KENS 446

Santa Monica, California

631 Wilshire Blvd., TWX: SMON 7185

COMMENT

Information Storage and Retrieval

I should like to commend you on the excellent job you performed in your survey on Information Storage and Retrieval (p 39, June 29). I also wish to thank you for deeming the CRIS unit, for which I hold the patents, of sufficient relative importance to give it such a prominent place in your survey (p 55).

Your survey dealt with information storage and retrieval in its broadest terms and gave the whole matter a review with all its aspects so that the whole field assumed its proper dimensions. This is truly difficult to do, but you achieved it admirably.

EMIK A. AVAKIAN

The Teleregister Corporation
Stamford, Connecticut.

Competition From Japan

We were most heartened to read the article, Competition from Japan, in the July 6 issue (*Crosstalk*, p. 3). The objectivity shown in this article was most appreciated.

You have reported the facts and drawn from the facts a reasoned and reasonable conclusion. The position taken by *ELECTRONICS* gives us a welcome respite from the scare-type of writing often used to portray the electronics trade between the United States and Japan.

Too often it can be easily forgotten that trade means an exchange.

Thank you for remembering.

MISAO MATSUDA

Japan Machinery Exporters'
Association
Tokyo, Japan

The *Crosstalk* says, in part, that the fruitful Japanese market for U. S. products would be hurt if we imposed trade barriers, and that the Japanese electronics industry, so vital to that country, is a prime source of capital to buy needed imports, of employment and of military strength, so that trade restrictions by our government would materially weaken a strong ally in the Far East.

Competition From Abroad

I would like to add a comment to your very fine article printed in the *Crosstalk* column of your July 6 issue (p 3) entitled, Competition from Japan.

We believe that every U. S. electronics manufacturer should be concerned about the importing of lower-priced components and consumer goods, regardless of whether he is in the business of manufacturing components or the finished product.

True, the U. S. component manufacturer certainly feels much earlier the impact of loss of business due to low-priced foreign components. However, the U. S. manufacturer of the consumer product who makes purchases of components in a low-wage foreign country, helps build up that industry in that country, furthers their capacity, reduces their cost, and in turn, the manufacturer of the consumer product in that country is able to quote even lower prices on a product that will compete with the U. S. producer.

Furthermore, the U. S. manufacturer of consumer products expects the domestic manufacturer of components to work with his engineering staff in developing components especially suited to his needs. We have on many occasions learned that after we had completed the development of a new component, and finished one or two production quantity orders, that samples of our product were then sent to a "low-wage nation" so that they might be copied and purchased there for much less money. How can a U. S. manufacturer of a consumer product expect to draw on the talent and know-how of the domestic component manufacturers, when he knows that eventually a carbon copy will be purchased from foreign shores?

There is no question but that the art of our components industry will suffer, and indirectly adversely affect the U. S. manufacturers of electronic consumer goods.

W. L. LARSON
President

Switchcraft, Inc.
Chicago, Illinois

MR. RELAY *by Allied Control*

1. **GRACIOUS TO MULTIPOLE!
YOU MEAN I'M A
FATHER AGAIN!**



2. **YOU'VE LATCHED ONTO QUITE A
BABY. HE'S SMALLER AND
LIGHTER AND... BOY!...
CAN HE TAKE SHOCK.**



3. **THAT'S FINE
BUT WILL HE FIT
IN ANY "CRIB"?**



4. **HE'S JUST MADE FOR CHASSIS
AFTER CHASSIS. FACT, I THINK
YOU OUGHT TO CALL HIM
"INTERCHANGEABLE!"**



Yes, sir, Mr. Relay has another "heir" . . . and he's quite a baby. The MP polarized magnetic latching relay is just a mite . . . only 1.124" high—a 1/4" shorter than similar relays—thus saving 18% in volume. And this "featherweight" scales in at 2.2 ounces, trimming 7 pounds per bank of 100 relays. When you look at the MP closely, you'll see its all-welded internal construction and precision one-piece die cast armature assembly. Note, too, the captive slot actuator which securely holds the movable contact arms. It's only one of the secrets of the MP's outstanding vibration, shock, and bounce performance. Want application data? Write for Catalog Sheet MP.

©1962 BY ALLIED CONTROL COMPANY, INC.

OPERATING CONDITIONS	
Contact Rating: (at nominal coil voltage)	2 amperes resistive at 29 volts d-c
Contact Arrangement:	Two, four and six pole double throw
Shock:	100g operational
Vibration:	5 to 55 cps at 0.195 inch double-amplitude 55 to 2000 cps at a constant 30g
Latch in Time: (at +25°C)	10.0 milliseconds maximum at nominal coil voltage
Reset Time: (at +25°C)	10.0 milliseconds maximum at nominal coil voltage
Terminals:	Plug-in (with index pin) or hook-type solder terminals



AL-225-MP

ALLIED CONTROL COMPANY, INC.

2 EAST END AVENUE, NEW YORK 21, N. Y.



A 300 KC Solid State Counter for \$750



rugged
reliability



Measure frequency and ratio directly; measure speed, rpm, pressure, temperature, acceleration or any phenomena that can be converted with transducers to ac or pulses.

The same design, circuitry and construction features of all new transistorized  counters are incorporated in this low-priced, general-purpose counter. Time base is derived from the power line, providing 0.1% accuracy—fully adequate for many frequency measurements. The counters have a maximum counting rate of 300 KC. 0.1 v sensitivity permits low-level measurements.

Model 5211A has gate times of 0.1 and 1 second. Model 5211B has an additional gate time of 10 seconds. Otherwise, the instruments are identical. A storage feature, which can be disabled by a rear-panel switch, provides a continuous display, each reading held on the 4-digit neon columnar readout until the count itself changes. The counters provide a 1-2-2-4 BCD code output for systems use or recording devices. Manual gate allows the 5211 counters to be controlled by the front panel, or be operated remotely by contact closure or suitable pulses.

Solid state design and construction provide low power consumption, low heat dissipation, operation over a wide temperature range. The counters are housed in the new  modular cabinet for bench and rack mount. Plug-in circuit modules and ready accessibility simplify maintenance. Both models weigh but 10 lbs. and can easily be carried in one hand. Conservative design features, such as the use of decade dividers in the gate generating circuits, provide operational stability and eliminate calibration problems.

Specifications

Maximum counting rate: 300 KC

Display: 4 digits, neon column

Input sensitivity: 0.1 v rms sine wave

Temperature range: -20 to 50°C

Time base: 50 or 60 cps power line

Manual gate: Controlled by front panel function switch, by external contact closure, or by 3 volt peak positive pulses at least 10 μ sec wide at half amplitude point.



Frequency measurement: 2 cps to 300 KC; accuracy ± 1 count, \pm time base accuracy

Ratio measurement: Reads: (f_1/f_2)

Range: f_1 : 2 cps to 300 KC (0.1 v rms)
 f_2 : 100 cps to 300 KC (1 v rms into 1000 ohms)

Accuracy: ± 1 count of f_1 , \pm trigger error of f_2

Dimensions: 16 $\frac{3}{4}$ " wide x 3 $\frac{1}{2}$ " high x 11 $\frac{1}{2}$ " deep, 10 lbs.

Price:  5211A, \$750.00;  5211B, \$825.

Data subject to change without notice. Prices f.o.b. factory.

HEWLETT-PACKARD COMPANY

1501 Page Mill Road, Palo Alto, California
Area Code 415, DA 6-7000

Sales and service representatives in all principal areas; Europe, Hewlett-Packard S.A., 54-54bis Route des Acacias, Geneva; Canada, Hewlett-Packard (Canada) Ltd., 8270 Mayrand Street, Montreal.

7903

ELECTRONICS NEWSLETTER

USSR May Have First Global Satellite Tv

THE RUSSIANS hinted recently that they may have the first global television satellite system, using three satellites in high-altitude synchronous orbits. NASA is working on a similar system in the U. S., called Syncom, under development by Hughes. A voice-only experimental model is to be launched next year, with models large enough to relay tv to follow later (p 30, Aug. 17).

An article in the *Gazeta Pomorska* quoted A. Kakunin, USSR vice minister of communications, as saying that a tv satellite will be put into a 24-hour orbit at an altitude of 38,000 kilometers and that three such satellites will give an "everlasting" tv relay system. He said work on tv satellites was begun in 1959.

Also quoted was a Prof. K. Sergeyev, who said the launch date is "in the very near future." A "cosmovation center" would alternately receive and transmit programs on a four-hour cycle, it was reported.

More Japanese Radio Kits Going to U.S., Hong Kong

TOKYO—Japan Electronic Parts Industry Association says it is making business deals for the export of large quantities of two-transistor and six-transistor radio parts and components to the U.S. and Hong Kong.

According to a JEPIA spokesman, arrangements are being made to send 50,000 two-transistor and six-transistor units each month—worth \$150,000—to a Los Angeles firm called Bell Products, under a long-term contract. The spokesman said similar deals will be signed soon with firms in Chicago and New York.

In addition, the association reported it recently signed a contract to send a minimum of 35,000 six-transistor units worth \$112,000 to a Hong Kong firm. (An earlier report, p 7, Aug. 17, said the deal involved 50,000 units worth \$250,000.)

JEPIA said the Hong Kong branch of the association has

reached similar agreements with 22 firms in Hong Kong.

How Close Were Vostoks? 10 Km Right after Launch

TOKYO—Soviet and American reports that Vostoks 3 and 4 came close to a rendezvous, but did not actually achieve one, were backed up last week by a tracking report from Yoshiaka Nakata, chief, Ionospheric Research Room, Radio Research Laboratory, Postal Ministry.

A study of the doppler effect on radio transmissions from the two Vostoks showed that they were closest—"as close as less than 10 kilometers"—immediately after Vostok 4 was launched. They were more than six minutes apart by the time they landed, Nakata said.

Nakata and his colleagues had monitored seven Soviet orbital flights prior to Vostok 3 and 4. Nakata said he caught the characteristic tracking signal about 10 or 15 minutes before Vostok 3 was

launched and his men stayed with the Russians throughout the flight. Monitoring equipment included 20-Mc telemetry sets and two sets of antennas, Yagis and conventional doublet.

Inertial Navigators Going Into 10 More Polaris Subs

THIRTY-NINE more Ship's Inertial Navigation Systems (Sins) will be built by North American Aviation's Autonetics division under a \$41-million Navy contract. The systems will be used in 10 new *Lafayette* class Polaris submarines. Autonetics said that the contract means that 24 of the total 29 Polaris submarines built or authorized will be equipped with Sins made by Autonetics.

The 39 new systems will be improved versions of Sins used on 9 *George Washington* class subs and the first nine *Lafayette* class subs. Improvements include a gas-spin bearing gyro, new velocity meter, a marine Verdan computer with larger capacity and a redesigned binnacle unit.

Report Development of a Practical Laser Modulator

LOS ANGELES—RCA announced at WESCON that its Semiconductor and Materials division has developed a practical Kerr-effect laser-

H-Blast Radiation Blacks Out 3 Satellites

ARTIFICIAL, high-intensity radiation belt created by the high-altitude nuclear explosion July 9 damaged solar cells on three satellites and has caused them to stop transmitting, according to an AEC report cited in an announcement by the State University of Iowa.

The announcement's main topic was what SUI physicists knew about the radiation belt from data received from the Injun I satellite, which passes through the belt.

The blast created a radiation intensity of 1 (1 count per second, the same as at the lower edge of the natural Van Allen belts) at an altitude of 200 miles. At 600 miles, where the intensity had been 1, it jumped to 100. At 800 miles, where intensity was 100 to 500, it increased to 10,000.

Radiation in the belt is decreasing, but will be measurable for many months, SIU expects. Two weeks after the blast intensity of the artificial belt was still higher than the natural belt

beam modulator, based on single crystals of semiconducting cuprous bromide or cuprous chloride.

The modulator, a serpentine microwave cavity, uses a 10-Ge carrier signal to vary the refractive index of the crystal and to modulate a beam going through the crystal. Initial application will be in coherent light radar systems.

RCA said properties of the crystal overcome obstacles to practical modulator development—they are mechanically rugged and resist destruction by the modulating signal, Q can be controlled by doping, and voltage and power required for optical rotation are reduced by a factor of 50.

ITT Sends First Telex Call over AT&T Telstar

NEW YORK—Last Week, Telstar relayed its first transatlantic Telex call, between the American Cable and Radio Corp. (AC&R) facilities in New York and the British Post Office facilities in London, reports ITT. Two of Telstar's six communication channels were used to send one message from New York to two persons in England simultaneously.

Officials of AC&R, a subsidiary of ITT, said the quality of the transmission was as good as that of conventional Telex calls sent via submarine cable. ITT will conduct several tests during the next few weeks, including testing of automatic correction equipment, transmission of facsimile information and high-speed data transmission.

Mariner II on Its Way To Make Probe of Venus

MARINER II was successfully launched on a 109-day, 180-million-mile flight to Venus from Cape Canaveral early Monday morning. Planned to make fly-by studies of Venus in an attempt to discover the nature of the planet's atmosphere and its surface, the spacecraft follows by five weeks the failure to successfully launch Mariner I (p 26, July 27).

According to latest calculations, a 50-second rotation of the Atlas-Agena booster during launch caused a 250,000-mile digression from the

planned course. But correction is believed well within the capability of the space probe's radio-controlled rocket-steering motor. Mid-course control signals will be sent Saturday from Goldstone. Mariner II is planned to miss Venus by 10,000 miles.

EIA Proposes All-Channel Television Set Standards

RECOMMENDATIONS for minimum technical standards for all-channel tv receivers were submitted to the FCC last week by an EIA task force headed by H. O. Wood, of Philco. The recommendations are based on views of receiver and tuner manufacturers representing 97 percent of U. S. production and sales.

It was recommended that receivers be able to receive any uhf channel with a noise figure not to exceed 18 db and that for any given receiver, average limits of sensitivity of the uhf channels be not more than 8 db below average sensitivity of the vhf channels.

Microwave Components Sales Rate \$100 Million

EIA estimates that factory sales of microwave components during the first quarter of 1962 totaled \$27.6 million, including \$25.3 million for nonferrite components, \$1.4 million for ferrite components and \$0.9 million for semiconductor and solid-state components.

Sales figures were extrapolated from information given EIA by 73 firms, including captive manufacturers of such high-volume products as waveguides.

Satellite Tracking Net's Antennas To Be Automated

DATA ACQUISITION antenna systems that will automatically orient themselves to transmitting spacecraft are planned by NASA as a major improvement to its worldwide instrumentation network, Minitrack. NASA will negotiate with Dalmovector Co. and Amelco, Inc., for R&D and production of 10 systems estimated to cost \$1.25 million.

In Brief . . .

LIONEL CORP. has sold Hathaway Instruments, Denver, to a group of investors. Other companies in the Hathaway group of Lionel subsidiaries are not affected.

K. K. MCCONNELL, of Westrex, will head a new EIA panel working on standards for facsimile equipment using switched telephone facilities.

GE AND TOSHIBA have formed a joint venture company in Japan to produce and repair ground radar and accessories, including AN/FPS-6 and 8, for the Self-Defense Agency.

SINGER MFG. CO. says it is completing arrangements to acquire Panoramic Electronics for 103,914 shares of Singer common stock.

TRANSISTOR sales were 558,118 units and \$1,422,618 better in June than May, EIA reports. June sales were 21.8 million units and \$26.4 million.

BRITISH International Computers and Tabulators is setting up a subsidiary in Poona, India, with \$2.1 million capitalization.

JAPANESE government has approved formation of Komatsu-Hoffman Electronics Corp., joint venture firm that will make zener diodes, rectifiers and solar cells, primarily for the Asian market.

VICTORY ELECTRONICS reports an initial \$560,000 order for 2,600 microminiature infrared power supplies to be used in military night weapons sights. The units step up voltage from a 1.5-v cell to 16 Kv. The company will develop a 24-Kv source under an Army R&D contract.

MELPAR is to develop two speech bandwidth compression systems under a \$291,447 Army contract.

LIBRASCOPE will produce two aircraft digital computers for the 665A reconnaissance/strike program. The AN/ASN-24(V) sets are to be flight-tested in 1963. Contract is for \$215,000.

NOW
AVAILABLE
WITH WELDABLE
LEADS

**RUGGED END-CAP
CONSTRUCTION FOR
LONG TERM STABILITY**

**EXCEPTIONAL RESISTANCE
TO MOISTURE
AND MECHANICAL
DAMAGE**

**SURPASS MIL-R-10509
PERFORMANCE
REQUIREMENTS**

AVAILABLE IN
REEL PACKING
FOR AUTOMATED
PWB INSERTION

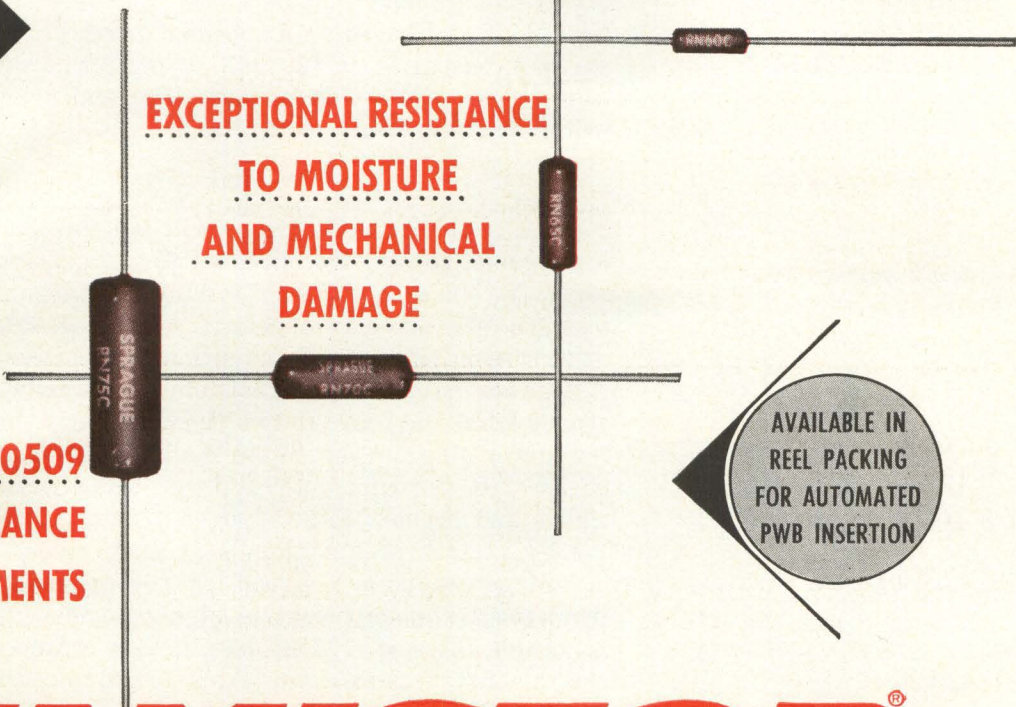

FILMISTOR[®] METAL FILM RESISTORS

**OFFER 5 DISTINCT
TEMPERATURE
COEFFICIENTS TO
MEET ALL CIRCUIT
REQUIREMENTS**

Providing close accuracy, reliability and stability with low controlled temperature coefficients, these molded case metal-film resistors outperform precision wirewound and carbon film resistors. Prime characteristics include minimum inherent noise level, negligible voltage coefficient of resistance and excellent long-time stability under rated load as well as under severe conditions of humidity.

Close tracking of resistance values of 2 or more resistors over a wide temperature range is another key performance characteristic of molded-case Filmistor Metal Film Resistors. This is especially important where they are used to make highly accurate ratio dividers.

Filmistor Metal Film Resistors, in 1/8, 1/4, 1/2 and 1 watt ratings, surpass stringent performance requirements of MIL-R-10509D, Characteristics C and E. Write for Engineering Bulletin No. 7025 to: Technical Literature Section, Sprague Electric Co., 35 Marshall Street, North Adams, Mass.

*For application engineering assistance write:
Resistor Division, Sprague Electric Co., Nashua, New Hampshire.*
SPRAGUE COMPONENTS



'Sprague' and '®' are registered trademarks of the Sprague Electric Co.

- | | | |
|---------------------|------------------------|-------------------------------|
| RESISTORS | INTERFERENCE FILTERS | HIGH TEMPERATURE MAGNET WIRE |
| CAPACITORS | PULSE TRANSFORMERS | CERAMIC-BASE PRINTED NETWORKS |
| MAGNETIC COMPONENTS | PIEZOELECTRIC CERAMICS | PACKAGED COMPONENT ASSEMBLIES |
| TRANSISTORS | PULSE-FORMING NETWORKS | FUNCTIONAL DIGITAL CIRCUITS |

WASHINGTON OUTLOOK

SPRINT: NEW ANTIMISSILE

ARMY IS EXPECTED to award study contracts within the next few months for a new antimissile system called Sprint. Officials refuse to say much about it, but Sprint is believed to be more compact than Nike Zeus and based on a speedier ground-to-air missile. The Army reportedly has at least \$20 million for Sprint in its present budget and wants seven times that amount for fiscal year 1964. Redstone Arsenal will manage Sprint.

NASA RELAXES ON PATENT RIGHTS FOR CONTRACTORS

NASA CONTRACTORS will get minimal rights to nonexclusive, irrevocable, royalty-free licenses for inventions developed under NASA contracts, under a waiver of NASA rights approved last week. Contractors will still have to negotiate with NASA for other rights, ranging up to rare outright patent retention or exclusive license.

Another patent policy revision NASA may announce this fall is to reduce from five years to two or three years the time given a contractor for developing an invention under NASA waived rights or patent licenses. If the contractor did not act, NASA would give the unused rights and licenses to another contractor.

Less certain of adoption is "class waiver" of NASA patent rights before contracts are signed or before work begins under contracts involving technology that is highly developed or in which NASA has no major interest. NASA has already granted some class waivers in special circumstances, for example in the Telstar contract—in which AT&T paid NASA, not conversely.

VOSTOKS BEEF UP AIR FORCE SPACE PLEAS

AIR FORCE has mounted a massive drive for expansion of the military space program. Air Force officials are citing the Vostok 3 and 4 flights as evidence of a much more serious U.S. lag in the space race than has been officially conceded. There are even claims that the two Soviet satellites rendezvoused and docked in orbit. The claim is apparently based on radar returns which reportedly showed them as a single blip. The Soviets announced the craft approached within three miles, disclaimed any attempt to rendezvous or dock. Officials outside the Air Force pooh-poo the rendezvous and docking claims.

Says Defense Secretary McNamara: "I have no information to lead me to believe that the Vostoks rendezvoused and docked." McNamara concedes the importance of the latest Vostok flights, but says they will "have no affect" on next year's military space budget. However, an increase over this year's \$1.5 billion rate was already being considered.

HOUSE GROUP CHALLENGES ARMS BUYING

LEGAL AUTHORITY of the Defense Supply Agency to buy electronic parts for all military services has been challenged by a House Armed Services Subcommittee headed by Rep. Porter Hardy (D.-Va.). Hardy opposes the centralization of military authority.

His subcommittee expressed skepticism over McNamara's claim that DSA's consolidated buying will result in savings and purchasing efficiencies, and implied that DSA is buying items not necessarily common to more than one agency.

The subcommittee said the law vests procurement contracting authority solely in the military services. Hardy did not propose abolition of DSA (DSA has too many congressional proponents for that), but he urged continuing congressional scrutiny of DSA's operations.

**SEPTEMBER 1962
THIRD ANNUAL ROAD SHOW**



SCHEDULE

BOSTON, MASS.

September 10th
Charter House
Route 128
Waltham, Massachusetts
Hours: 12 noon-7:30 p.m.

SYRACUSE, N. Y.

September 11th
Sheraton Inn
Carrier Circle
Hours: 12 noon-7:30 p.m.

JERICHO, L. I., N. Y.

September 13th
The Meadowbrook Motel
Jericho Turnpike
Hours: 12 noon-7:30 p.m.

CEDAR GROVE, N. J.

September 17th
The Towers
Route 23
Hours: 12 noon-7:30 p.m.

CAMDEN, N. J.

September 19th
Cherry Hill Inn
Route State Highway No. 38
Hours: 12 noon-7:30 p.m.

PHILADELPHIA, PA.

September 20th
Marriott Motor Hotel
City Line Avenue
& Monument Road
Hours: 12 noon-7:30 p.m.

WATCHUNG, N. J.

September 24th
Wally's Tavern
154 Bonnie Burn Road
Hours: 12 noon-7:30 p.m.

RED BANK, N. J.

September 26th
Molly Pitcher Hotel
88 Riverside Avenue
Hours: 12 noon-7:30 p.m.

WASHINGTON, D. C.

September 27th
Marriott Motor Hotel
Twin Bridges
Hours: 12 noon-7:30 p.m.

Electronic
Instrument
Manufacturers'
Exhibit

**Practical Operating Displays
of Latest Developments in Electronic Instruments
by 8 Leading Manufacturers**

The 1962 EIME Road Show will feature practical operating displays of products manufactured by eight leading electronic instrument companies. Typical applications will be demonstrated. Engineering personnel from participating companies will be in attendance at all times to answer your technical and application questions in a completely casual atmosphere. You and your associates are cordially invited to attend. Please check the schedule and note the day the EIME Road Show will be in your area.

**FREE PARKING • BUFFET
NO TICKETS REQUIRED**



AMPEX CORP.



FXR



GENERAL RADIO COMPANY



LAMBDA ELECTRONICS CORP.



NON-LINEAR SYSTEMS, INC.



PANORAMIC ELECTRONICS, INC.



SENSITIVE RESEARCH
INSTRUMENT CORPORATION



TRIO LABORATORIES, INC.



New

MODEL LE

Lindeck Microvolt Source for use as:

• A comparator in the calibration of volt ratio boxes, saturated standard cells and similar instrumentation.

• A direct measuring instrument in the microvolt range.

Ranges: 0-1/2/5/10/20/50/100/200/500 μ V; 1/2/5/200 mv; 2 v.

Accuracy: \pm .5% of full scale

Readout: SRIC Model C. 100 division, 6.3" hand-drawn scale. Accuracy .25%. Diamond pivoted!

Application is described in NBS Paper RP1419, "Testing and Performance of Volt Ratio Boxes". Copies available upon request.

10 NEW INSTRUMENTS

Model PCM "Pocket-Pot." A new multirange, high sensitivity, miniature potentiometer, with self-contained galvanometer and battery operated standardization circuit. In-line readout. Continuous resolution on slidewire with 1 mv. divisions. Infinite resistance at null. Total measuring range 0-5.100 v. Plug in unit available to increase measuring range to 500 v. and 1 amp. (Model PC-S). Accuracy \pm .05% of reading; \pm .5 mv. on x1 range; \pm .1 mv. on x.1 and x.01 ranges.

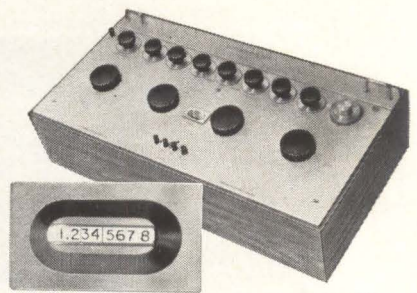

SINGLE WINDOW READOUT

COMMANDER TYPE 9120

New

A 4 dial, 7 figure precision potentiometer with single window readout and a resolution of 1 part in 20 million. Total measuring range of 2,099,999.9 volts in steps of .1 μ v. is achieved without the necessity of switching ranges. **Accuracy \pm (.0015% of reading \pm .1 μ v.)**

Facilities are incorporated to enable the user to completely "Self Check" the potentiometer within its guaranteed accuracy. All positions on the measuring dials are calibrated steps (no slide-wire). Thermal emf's are less than .1 μ v.

SENSITIVE RESEARCH

ELECTRICAL MEASURING INSTRUMENTS SINCE 1927

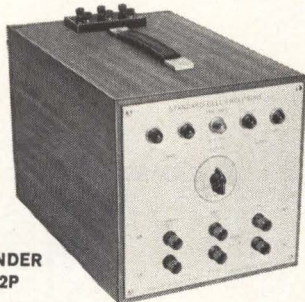

COMMANDER TYPE 9152P

New

A portable constant temperature air bath designed to eliminate the hazards involved in transporting saturated standard cells. It is an ideal transfer standard when direct intercomparison of saturated standard cells is desired between a calibration laboratory and NBS or between variously located calibration facilities of the same organization. Enclosure accommodates three saturated cadmium cells constructed with a porous partition to greatly improve portability. Cells can be certified to \pm .0001%.

Weight (30 lbs.) and box size (18" L x 10" W x 10" H) are convenient for hand carrying. Provision is made for operation from a portable battery pack, a 110 volt AC line or a car cigarette lighter outlet. Enclosure is maintained at a nominal 32°C and is guaranteed not to vary more than \pm .01°C even after continuous exposure to ambient temperatures down to 0°F (-17.4°C) in still air.



MODEL PC-R

"Plug-in" Wheatstone Bridge for use with PocketPot to make DC resistance measurements from .1 Ω to 9,999 megohms. Accuracy is \pm 1% from .1 Ω to 10 Ω ; \pm .2% above 10 Ω to 1 megohm; \pm 2% above 1 megohm to 9,999 megohms.

New

COMMANDER Type 9770: Constant current source for standardizing a DC potentiometer or supplying a stable current to any circuit in the range of 10 ma. to 100 ma. Current stability is \pm (1 ppm + stability of reference cell).

New

COMMANDER Type 9180: A 3 dial, 5 figure version of the Dauphinee Potentiometer. Accuracy \pm .002% of reading. Range: -10 μ v. to +2.10100 v. in steps of 10 μ v. on X1. Additional ranges of X.1, X.01 and X.001 with resolution to .01 μ v. Thermal emf's less than .1 μ v. "Self Checking".

New

COMMANDER Type 9174: A dual range, 2 dial, 4 figure microvolt potentiometer. Thermal emf's less than .02 μ v. Accuracy \pm .01% of reading. Range: -10 μ v. to + 1010 μ v.

New

Model ESX: AC/DC, 0-150 v., electrostatic voltmeter with DC scale expansion enabling practical readings down to 2 v. Input resistances from $1 \times 10^{14} \Omega$.

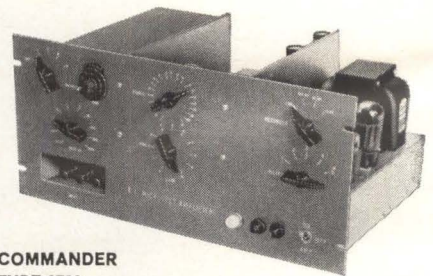

COMMANDER TYPE 9790

New

A DC amplifier for the measurement of low level voltages in the fractional microvolt range. Features are:

1. .03 μ v. lowest range.
2. Immediate recovery from overloads of 1,000,000%.
3. .003 μ v. stability over a 24 hour period.
4. Facility for compensation of stray thermal emf's.
5. Easy accessibility for maintenance purposes.

Output is 1 ma. into 1500 Ω , or 1 mv., 10 mv. or 100 mv. F.S. Input resistance of 50 Ω to 1000 Ω depending on input transformer selected. Continuously variable gain control. Calibration signals to the input (accuracy \pm 5%) are .03/.1/3/1/3/10/30/100/300 μ v. Response time is 2 to 5 seconds to 90% F.S.



SENSITIVE RESEARCH INSTRUMENT CORPORATION

New Rochelle, N. Y.



COMMANDER instruments are manufactured for Sensitive Research by Guildline Instruments, Ltd., Smiths Falls, Canada.

See Panoramic "in action" at the EIME exhibits

PANORAMIC SUMMARY OF SPECIFICATIONS



SPECTRUM ANALYZERS

5 cps to 44 kmc

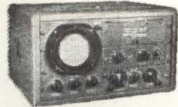

LP-1a
Sim. to AN/URM-133

BROADBAND SPECTRUM ANALYZERS
5 cps to 25 mc. Easy-to-operate direct reading analyzers display plot of signal amplitude vs. frequency on 5" CRT or optional strip chart. Features include: "quick look" wideband scans plus highly selective narrow scans. Center frequency, sweep width, and selectivity (resolution) are adjustable. Calibrated linear and 40-db log scales selectable.

All these broadband spectrum analyzers are available with accessories and in systems which materially improve specifications and application versatility.
*This specification improved or adjustable with optional accessories.

PORTABLE SONIC ANALYZER
MODEL LP-4 4 cps-20 kc.

Frequency Range	Model No.	Sweep Width	Resolution (I-F Bandwidth)	Sensitivity Range (Full Scale Linear)	Sweep Rate	Harmonic Products (Dynamic Range)
20 cps* to 22.5 kc.	LP-1a (5" CRT) Sim. to AN/URM-133	40 cps-20 kc log scan. Linear* pre-set 200, 1000, 5000 cps	Automatic optimum. Best resolution 30 cps*	500 μ v to 500 v	*1 cps	-60 db
200 cps to 300 kc	SB-7bZ (5" CRT) Sim. to KS 15872	0-200 kc	100 cps-2 kc	250 μ v to 100 v	*6.7 cps.	-50 db
100 cps to 600 kc	SB-15a (5" CRT)	1 kc-200 kc	100 cps-4 kc + automatic optimum	200 μ v to 100 v	*1-60 cps	-60 db
1 kc to 15 mc	SPA-3 (5" CRT)	0-3 mc	200 cps-30 kc	20 μ v to 2 v	1-60 cps	-46 db
1 kc to 25 mc	SPA-3/25 (5" CRT)	0-3 mc	200 cps-30 kc	20 μ v to 2 v	1-60 cps	-46 db

Proportional bandwidth vibration and noise analyzer with automatic scans and manual tuning. Compact, transistorized unit. Frequency bands are 40 cps-20 kc and 4 cps-2 kc (manually tuned

only). Adjustable constant percentage selectivity plus all-pass for over-all monitoring. Calibrated 3" CRT readout plus level meter. Strip chart optional. Sensitivity 1 m v full scale.

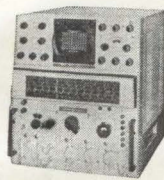

SPA-4a

MICROWAVE SPECTRUM ANALYZERS 10 mc to 44 kmc. Feature unsurpassed usable sensitivity and freedom from spurious effects for pulsed AM, FM and CW signals. Direct reading frequency dial $\pm 1\%$. They have adjustable dispersion, I-F bandwidth and sweep rate; 1-50 cps, free running or synchronized; 3 calibrated amplitude scales, linear, 40 db log, and power; calibrated frequency markers. Model SPA-4a and SPA-10 cover their respective frequency ranges with 1 composite tuning head, including wave guide and coax mixers. SPA-1 covers band to 4 kmc with 3 plug-in heads.

Frequency Range	Model No.	Sweep Width (Dispersion)	I-F Bandwidth Continuously Adjustable	Guaranteed Min. CW Sensitivity (Min. Discernible Signal)	Other Features
10 mc to 44,000 mc 1 Tuning Head	SPA-4a (5" CRT)	2 swept oscillators 0 to 70 mc 0 to 5 mc	1 kc to 80 kc	10 mc -100 dbm 100 mc -100 dbm 1 kmc -105 dbm 10 kmc -95 dbm 40 kmc -75 dbm	All mixers built-in • Dynamic range to -60 db. • Low residual FM permits high resolution narrow band analyses • Synchroscope Output • Marker Modulation
10 mc to 43,000 mc 1 Tuning Head	SPA-10 (5" CRT)	200 kc to 80 mc	1 kc to 80 kc	10 mc -95 dbm 100 mc -95 dbm 1 kmc -85 dbm 10 kmc -80 dbm 40 kmc -50 dbm nom.	Low cost • Wave guide and coax. mixers built-in • Dispersion marker with ext. modulation • I-F attenuators
10 mc to 4000 mc 3 plug in tuning heads	SPA-1 (5" CRT)	100 kc to 10 mc	9 kc to 80 kc	RF-1 10-50 mc -95 dbm RF-2 50-250 mc -100 dbm* RF-3 220-4000 mc; Sensitivity range -100 to -76 dbm* *Subtract 25 dbm without PRA-1	Extremely low cost • Exceptionally stable • Available in 4 styles • Highly sensitive I-F preamp, Model PRA-1 optional.

COMMUNICATIONS SYSTEMS ANALYZERS

SSB, AM, FM



SSB-3b
Sim. to AN/URM-134

PANADAPTORS. For use with communication receivers with I-F = Panadaptor center frequency. Panadaptor response shaped to match receiver. Specify receiver model no. and I-F.

PANALYZERS scan through an adjustable sweep width about their center frequencies. An external VFO* is used for conversion of signals in Panalyzer input mixer. Mixer range up to 1000 mc. *Model RF-7a Panoramic VFO, 2-40 mc.

For Receivers With Intermediate Frequency of		SUMMARY OF SERIES SPECIFICATIONS						CRT Size
Model Series	Model Series	Sweep Width	Resolution	Sensitivity (at receiver I-F)	Sweep Rate	Amplitude Scales	CRT Size	
450 kc-30 mc	SA-8b (4 types)	0-100 kc to 0-10 mc	50 cps to 80 kc	150-2000 mv full scale	1-60 cps	Linear, 40 db log Power	5" (camera mount style optional)	
450 kc-30 mc	SA-3 (10 types)	0-50 kc to 0-6 mc	2 kc to 50 kc	10 μ v - 10 mv 1/4" deflection	30 cps	linear (nominal)	3 inch	

Model Series (Input Center Frequency)	Sweep Width	Resolution	Signal Sensitivity (VFO 0.1 volt rms)	Sweep Rate	Amplitude Scales
(+) SB-12b, 500 kc (or 455 kc) Sim. to AN/URM-135	0 to 100 kc + 5 preset modes	10 cps-3 kc (see also SSB-3b)	2 mv full scale log (VFO 0.3 v rms)	0.1-30 cps	linear 40 db log
SB-8b 3 types (500 kc-30 mc)	0 to 200 kc to 0 to 10 mc	50 cps-80 kc	10-100 mv full scale log	1-60 cps	linear 40 db log power
SB-3 5 types (500 kc-30 mc) (+)SB-12b also part	0 to 50 kc to 0 to 6 mc of SSB-3b, (below)	2 kc-40 kc	1-10 mv, 1/4" deflection	30 cps	linear (nominal)

SINGLE SIDEBAND SPECTRUM ANALYZER. Advantages are: 60 db dynamic range (65 db optional), simple pre-set operation and self-checking facilities. Excellent skirt selectivity for narrow-band analyses. Options: Range Extender to 10 cps, REC-1; High Z probe, PRB-2; 2 Tone RF Gen, Model TIG-5, 3 to 30 mc.

SSB-3b Frequency Range	SSB-3b Includes Panalyzer Model SB-12b(s)	Model RF-7a Tuning Head	2 tone AF Gen. Model TG-2	Resolution (I-F Bandwidth)	Sensitivity
2 mc to 40 mc 10 cps to 40 mc with Model REC-1 (Optional)	See SSB-12b specs. above	2-40 mc Fast search + precise vernier tuning 1% accuracy	100 cps-10 kc ($\pm 2\%$) 0-4 volts rms metered outputs 0-100 db attenuator 1db steps	(Same as SB-12b) Minimum -60 db bandwidth = 50 cps	2 mv full scale log, Uniform sensitivity ± 3 db, 10 cps-40 mc. 0-50 db input attenuator adjustable in 1 db steps

FREQUENCY RESPONSE PLOTTERS

20 cps to 15 mc



G-3a

COMPANION SWEEP GENERATORS FOR BROADBAND SPECTRUM ANALYZERS: Response to fundamental frequency only; discriminate against noise and hum; virtually unlimited dynamic range; single line plots. Accessories available for comparison testing, bi-directional scanning, and manual tuning.

Narrow-band frequency response plotter MODEL SGR-3 100kc-15mc
Sweep Generator Models SG-1 & SG-1R
20 cps-200 kc

Frequency Range	Sweeper Model No.	Used With Analyzer Model	Output Voltage (& Impedance)	Output Attenuator	Overall Flatness
20 cps to 22,500 cps	G-2a	LP-1a	50 mv-5v (100/600, 3K Ω)	0-100 db	± 1 db
200 cps to 300 kc	G-3a	SB-7bZ	250 μ v to 2.5 v (600 Ω)	0-80 db	± 0.5 db (-1300 kc)
100 cps to 600 kc	G-15a	SB-15a	250 μ v to 2.5 v (600 Ω)	0-80 db	± 1 db (0.2-600 kc)
1 kc to 15 mc	G-6	SPA-3 SPA-3/25	200 μ v to 0.2 v (72 Ω)	0-60 db	± 2 db (1 kc-13.5 mc)

Precise tracing of crystal filters and other narrow-band networks on calibrated 5" CRT. Strip chart optional. 0-100 kc calibrated sweep width. Scan

time adjustable from 0.1 to 80 sec. plus manual tuning. Jitter less than 10 cps. Dynamic range at least 80 db.
markers. Log amplifier provides 40 db calibrated scope display. (SG-1R used for tape recorder response testing.)

TELEMETRY TEST INSTRUMENTS

(for IRIG FM/FM Systems)



TMI-1b
Telemetry Indicator

Model No.	Name	Features	Uses
TMI-1b (TMI-1b/120)	Telemetry Indicator	Analyzes 350 cps-85 kc. (TMI-1b/120, to 120 kc). • Both log & lin scans • Optimized resolution • Internal markers. (TMI-1b/120 not used with TMC-1a or CHS-1.)	Subcarrier spectrum analysis • pre-emphasis • distortion measurements • spillover • noise
TMC-1a	3 Point Calibration and Sub-carrier Deviation Indicator	Xtal controlled $\pm 0.02\%$; $\pm 7.5\%$, 0, -7.5% ; also A to E • Special deviations available • Provides markers for uni-channel scans for TMI-1b analyzer	Discriminator calibration $\pm 0.02\%$ With TMI-1b, monitors individual channels or VCO deviation linearity
TMC-411E	Simultaneous 3 & 11 Pt. Calibrator	Accuracy $\pm 0.002\%$ • All $\pm 7\frac{1}{2}\%$ channels + A to E • 18 channel outputs simultaneously or individually • auto./manual sequencing • special provisions available	Complete discriminator checkout in seconds! Multiple frequency reference source for data reduction and system calibration. With TMI-1b for VCO checks.
TMC-505	Simultaneous 5 point calibrator.	Accuracy $\pm 0.002\%$ • All $\pm 7\frac{1}{2}\%$ channels + A to E • 18 channel outputs simultaneously or individually • auto./manual sequencing • special provisions available • all electronic, 7" high • distortion -40db	

Specifications subject to change without notice.

PANORAMIC ELECTRONICS, INC.

Formerly Panoramic Radio Products, Inc.

530 So. Fulton Avenue, Mount Vernon, N. Y. • Phone: (Area Code 914) OWENS 9-4600 • TWX: MT-2-NY-5229
Cables: Panoramic, Mount Vernon, N. Y. State

Write for detailed specifications and catalog.



- **Microwave Training Kit for schools and industry**
- **Versatile Amphenol®/ipc® triaxial connectors**
- **Quick-Crimp™ Subminax® Series 27 connectors**

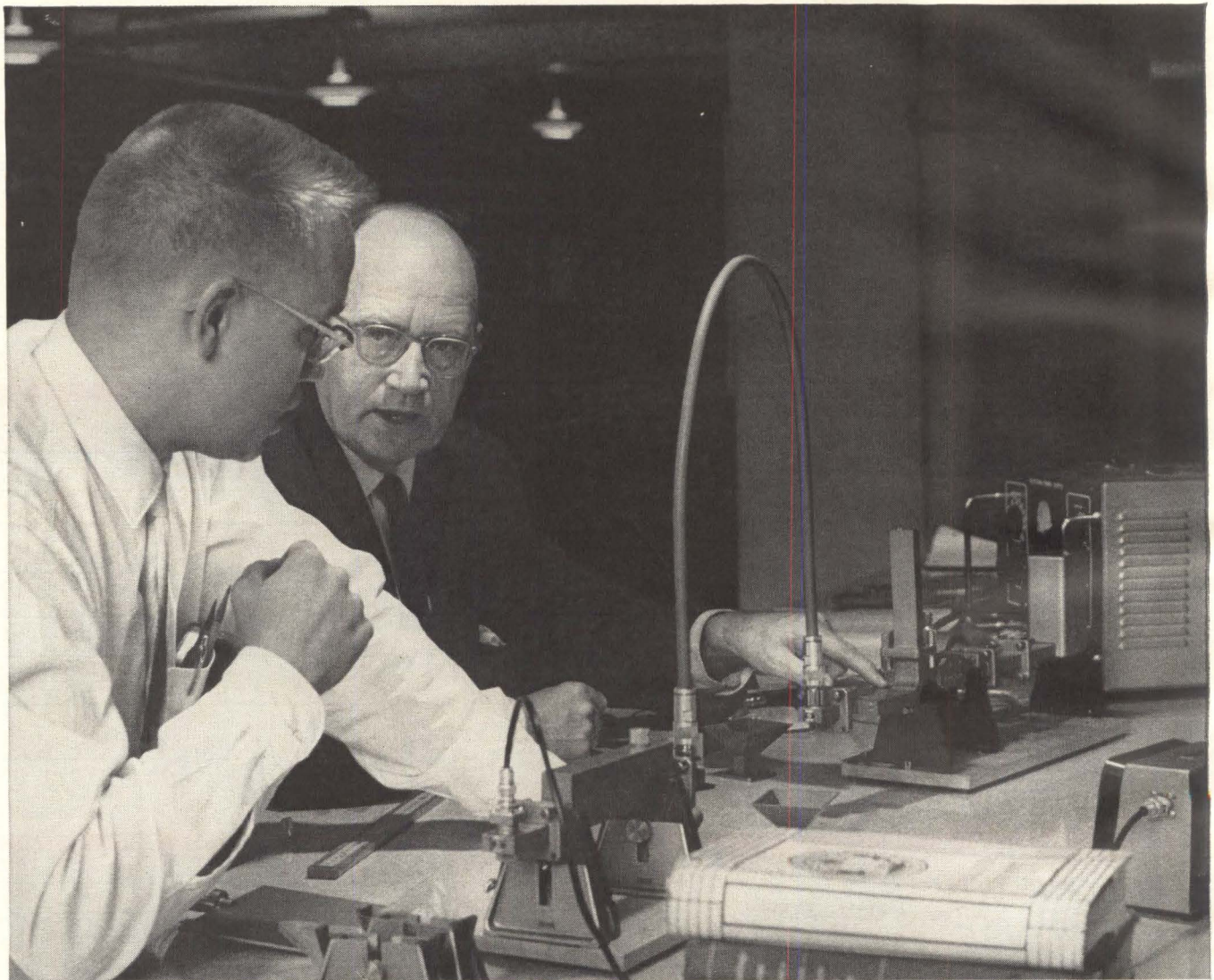

Shown above is H. S. Baird, Assistant Professor of Engineering, Northeastern University, in the lab demonstrating microwave theory to a student with the FXR Microwave Training Kit. Northeastern has two FXR training kits, which are used in microwave coursework. The versatile and complete FXR microwave training program is an increasingly popular product for teaching the fundamentals of microwave theory in both schools and industry. The training kit has been sold not only in the U.S., but in Canada, England, India and other countries.

Microwave Training Kit for schools and industry

FXR offers a packaged microwave training program for schools and industry. This complete training kit enables students to visualize microwave

theory and learn microwave measurement techniques. It's simple and compact. Gives students practical knowledge and experience for work in the microwave field.

The Microwave Training Kit consists of a complete receiver, transmitter, and accessory group in a compact carrying case. It includes text material, instructor's demonstration notes, and laboratory exercises.

Students, by changing accessories, learn basics of propagation, shielding,



The FXR Microwave Training Kit is shown above, minus carrying case and text material. This FXR package is a complete program for teaching microwave theory and methods.

polarization, reflection, focusing and bending of microwaves.

Kit contains following items:

Klystron Power Supply	Klystron Tube Mount	
Padding Attenuator		
Direct Reading Frequency Meter (8.2-12.4 Kmc/s)		
Slotted Section and Probe Assembly		
Waveguide Horn (2)		
Wavelength Measuring Assembly		
Flap Attenuator	Crystal Detector	
Waveguide-to-Coaxial Cable Adaptors		
Cable (BNC-to-BNC)	Indicating Meter	
Protractor Board		
Angle Deviation Indicator Arrow		
Plywood Plate	Masonite Plate	
Waveguide Nut-Screw Assembly		
Brass Plate	Metal Comb	Glass Lens
Directional Coupler	Termination	
Training Manual (Not Shown)		
Plastic Bend	Coaxial Cable	
Transit Case (Not Shown)		
Waveguide Stands (S-studded)		

The complete kit costs \$1685.00. For further information Circle Reader Service Card 253 ■

Versatile Amphenol®/ipc® triaxial connectors

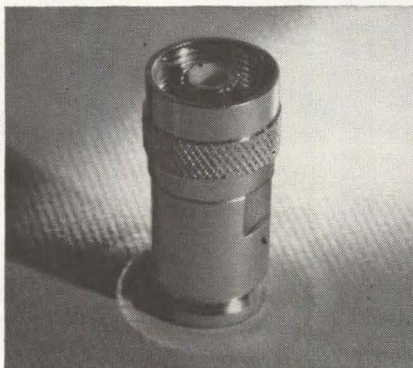

FXR designed these Amphenol/ipc triaxial connectors for applications where maximum rf shielding and minimum noise radiation are required. They are available in plugs, jacks, bulkhead adapters and receptacles. Use them with FXR's standard Amphenol triaxial cables 21-

204, 21-527, 21-529, 21-583. Screw-on coupling, weather-proof design and Teflon* insulation make them ideal for tough environmental conditions. Circle Reader Service Card 254 ■

*Registered trademark of E. I. DuPont.

Quick-Crimp™ Subminax® Series 27 connectors

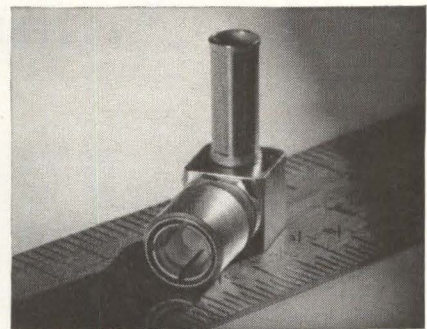

Here's an Amphenol/ipc coaxial connector which really makes assembly simple yet gives you complete interchangeability with the other connector groups in Series 27 (the original radial crimp group and the field serviceable groups). In addition to ease of assembly, the new design gives greatly improved cable retention and strain relief. Circle Reader Service Card 255 ■

FXR, 33 East Franklin Street, Danbury, Connecticut, is the RF Products and Microwave Division of Amphenol-Borg Electronics Corporation.

FXR™

Now from LAMBDA new LE SERIES Transistorized Regulated

DESIGNED
TO PERFORM
TO MILITARY
ENVIRONMENT
SPECIFICATIONS

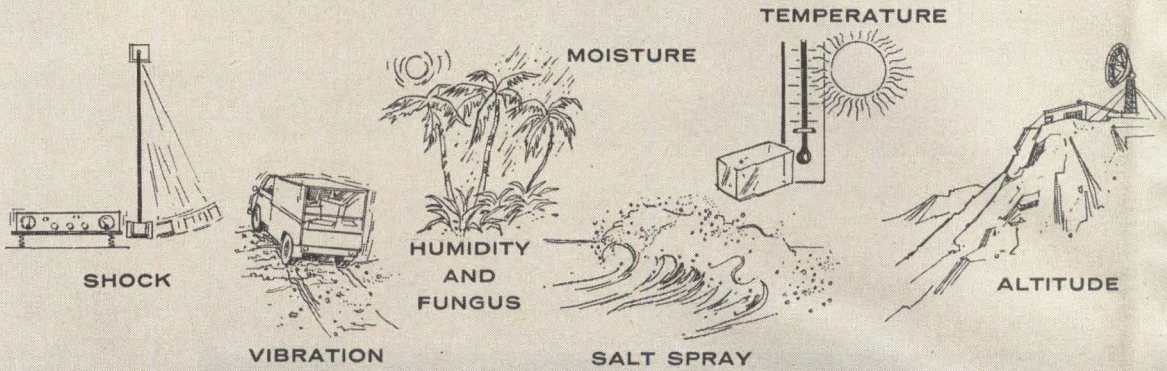

Environment-engineered...
...at mass-production prices

LE 101-FM
LE 105-FM
LE 109-FM

LE 102-FM

LE 103-FM

LE 104-FM

PATENTS
PENDING

for:

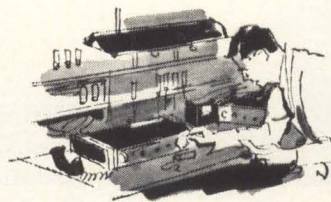

LABORATORY

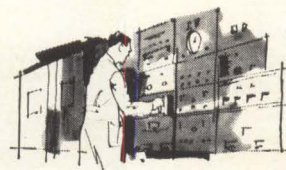

INDUSTRIAL

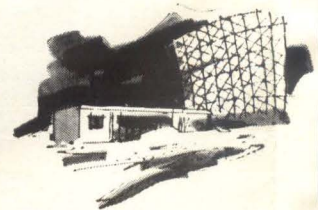

MILITARY
APPLICATIONS



LAMBDA ELECTRONICS CORP.

515 BROAD HOLLOW ROAD • HUNTINGTON, L. I., NEW YORK • 516 MYRTLE 4-4200

Western Regional Office: 230 North Lake Avenue, Pasadena, California • Phone: Code 213, MUrray 1-2544

New England Regional Office: 275 Boston Post Road, Marlboro, Massachusetts • Phone: Code 617, HUrtle 5-7122

Middle Atlantic District Office: 515 Broad Hollow Road, Huntington, L. I., New York • Phone: Code 516, MYrtle 4-4200

Southeastern Region: W. A. Brown & Associates, Inc., Engineering Representatives

Orlando, Fla. • Fort Lauderdale, Fla. • Huntsville, Ala. • Alexandria, Va. • Winston-Salem, N. C.

Power Supplies

CONVECTION COOLED

No blowers or filters; maintenance free.

CONSTANT VOLTAGE CONSTANT CURRENT

by automatic switchover.

**6 MODELS
AVAILABLE**

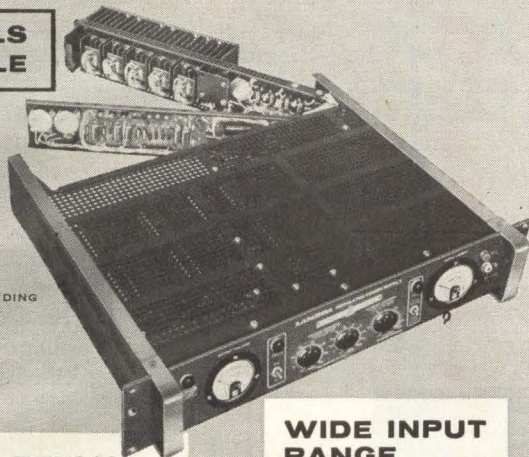

PATENTS PENDING

COMPLETELY PROTECTED

against—short circuit and electrical overload; input line voltage transients; excessive ambient temperatures. No voltage spikes due to "turn-on, turn-off" or power failure.

WIDE INPUT RANGE

Wide input voltage and frequency range—105-135 VAC, 45-66 CPS and 320-480 CPS in two bands selected by switch.

REMOTELY PROGRAMMABLE AND CONTINUOUSLY VARIABLE

Voltage continuously variable over entire range. Programmable over voltage and current range.

OTHER FEATURES

- Adjustable automatic current limiting.
- 0°C to +50°C ambient.
- Grey ripple finish.
- Ruggedized voltmeters and ammeters per MIL-M-10304B on metered models.



5-YEAR GUARANTEE

covers all Lambda Power Supplies including LE Series models

Every Lambda power supply sold since 1953 has been backed by Lambda's 5-year guarantee, which covers workmanship and materials (except for tubes and fuses).

**See New LAMBDA
LE Series on Display
at the EIME Road Show**

**For Schedule
Please turn to Page 11**

LE SERIES

CONDENSED TENTATIVE DATA

DC OUTPUT (VOLTAGE REGULATED FOR LINE AND LOAD)⁽¹⁾

Model	Voltage Range	Current Range	Price ⁽²⁾
LE101	0-36 VDC	0- 5 Amp	\$420
LE102	0-36 VDC	0-10 Amp	525
LE103	0-36 VDC	0-15 Amp	595
LE104	0-36 VDC	0-25 Amp	775
LE105	0-18 VDC	0- 8 Amp	425
LE109	0- 9 VDC	0-10 Amp	430

(1) Current rating applies over entire voltage range.

(2) Prices are for nonmetered models. For models with ruggedized MIL meters add suffix "M" to model number and add \$40 to the non-metered price. For metered models and front panel control add suffix "FM" and add \$50 to the nonmetered price.

REGULATED VOLTAGE:

Regulation (line) Less than .05 per cent or 8 millivolts (whichever is greater). For input variations from 105-135 VAC.

Regulation (load) Less than .05 per cent or 8 millivolts (whichever is greater). For load variations from 0 to full load.

Transient Response
(line) Output voltage is constant within regulation specifications for any 15 volt line voltage change within 105-135 VAC.

(load) Output voltage is constant within 25 MV for load change from 0 to full load or full load to 0 within 50 microseconds of application.

Remote Programming 50 ohms/volt constant over entire voltage range.

Ripple and Noise Less than 0.5 millivolt rms either positive or negative terminal grounded.

Temperature Coefficient Less than 0.015%/°C.

DC OUTPUT (CURRENT REGULATED FOR LINE AND LOAD)⁽³⁾

Current range 10% to 100% rated load for entire voltage range. Full specifications upon request.

AC INPUT 105-135 VAC; 45-66 CPS and 320-480 CPS in two bands selected by switch.

OPERATING AMBIENT TEMPERATURE AND DUTY CYCLE

Continuous duty at full load 0°C to +50°C (122°F) ambient.

OVERLOAD PROTECTION:

Thermal Thermostat, reset by power switch, thermal overload indicator light front panel.

Electrical:

External Overload

Protection Adjustable, automatic electronic current limiting circuit limits the output current to the preset value upon external overloads, including direct short, thereby providing protection for load as well as power supply. Current limiting settable from 10% to 110% of load.

METERS: Ruggedized voltmeter and ammeter to Mil-M-10304B specifications on metered models.

CONTROLS:

DC Output Controls Coarse and fine voltage adjust and current adjust on front panel for models with suffix "FM", all other models same controls are mounted in rear.

PHYSICAL DATA:

Mounting Standard 19" rack mounting.

Size LE101, LE105, LE109 3½" H x 19" W x 16" D
LE102, 5¼" H x 19" W x 16" D
LE103, 7" H x 19" W x 16½" D
LE104, 10½" H x 19" W x 16½" D

WRITE FOR COMPLETE CATALOG

CIRCLE 17 ON READER SERVICE CARD

Next Step in Laser Communications: Direct

*Stanford researchers
reveal progress in
phototubes and diodes*

SAN FRANCISCO—Experiments in the demodulation of microwave-modulated light, including two successful broadband light detection

and demodulation devices and an experimental f-m discriminator microwave phototube, were discussed this month at a government-sponsored research review at Stanford University's Electronics Lab.

Prof. A. E. Siegman, of the electron devices research group, reviewed successful tests of fast semiconductor photodiodes and trav-

eling-wave phototubes and demonstrated the f-m discriminator phototube as a significant step toward direct demodulation of laser-carried microwave signals.

The detectors were compared by Siegman with early crystal radio receivers. He said, however, that they can be refined into super-heterodyners. In the past year, Stanford has employed the photodiodes and the traveling-wave phototubes as mixers in optical heterodyning experiments.

The traveling-wave phototubes were developed by Stanford with Sylvania. Laser oscillations are studied by shining the beam onto the photocathode and observing photobeats between simultaneous axial-mode oscillations of the lasers. Frequencies at which such beats have been observed and studied range from uhf (700 Mc) to high X-band (13 Gc).

Madeline Shows Her Stuff

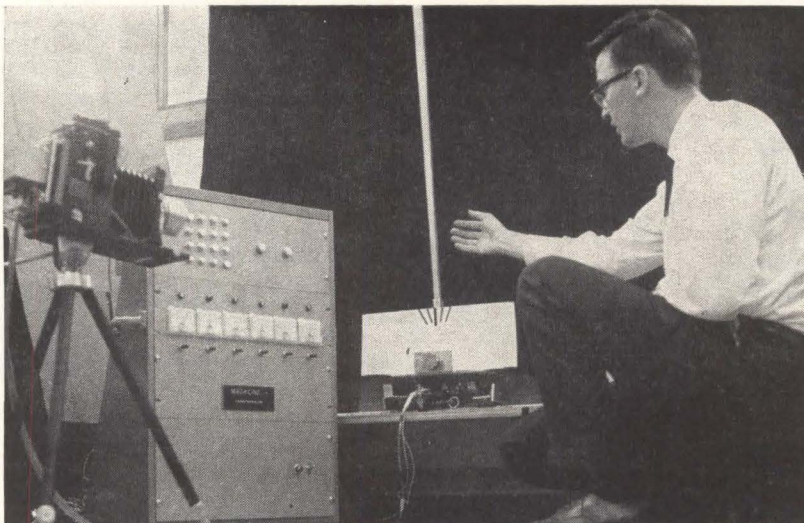

MADELINE I, the adaptive computer (see p 20, June 8 issue), demonstrated some of her abilities at the Stanford University conference. In the top photo, 50 photocells in a camera watch as Prof. M. E. Hoff, Jr., balances a broom handle on a toy train engine. After Madeline learned the balancing actions by memorizing the photocell signals, it took over. In the lower photo, the computer aided by an IBM 1620 types words dictated by a student. It analyzes the spectra of spoken words and formulates word patterns, recognizing them and printing them out

PHOTODIODES—The fast semiconductor photodiodes are strongly back-biased and, with their thin depletion regions, can serve as photodetectors for modulated light or for optical heterodyning at modulation frequencies well into the microwave region.

The *pin* diode structure with a thin, epitaxially grown *i* region is useful for this purpose since the *i* region thickness can be carefully controlled and the reverse current kept low at large reverse bias.

Stanford is using a silicon photodiode of the epitaxial *pin* type (fabricated for them by Prof. J. F. Gibbons, of the Solid-State Electronics Laboratory) to observe photobeats between simultaneous axial-mode oscillations in ruby lasers. Experiments were similar to the microwave phototube experiment.

F-M DISCRIMINATOR—In the f-m discriminator microwave phototube experiment, a cavity-type KDP modulator was used to amplitude-modulate light at 2.8 Gc, and the amplitude-modulation was then detected and recovered by a traveling-wave microwave phototube

Demodulation of Signals

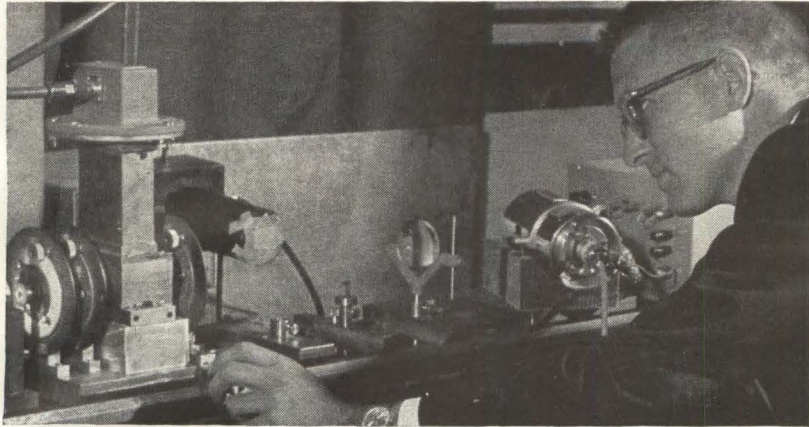

LABORATORY SETUP for demodulating microwave signals transmitted over light beam is demonstrated by A. E. Siegman. The demodulator is a microwave phototube in the cylinder at right

(Sylvania SY-4302, S-1 photosurface). Successful experiments were carried out using both coherent light from a ruby laser and the incoherent light from a mercury-arc lamp.

The KDP modulator requires approximately 100 watts to give 100 percent amplitude-modulation. The sensitivity of the detector, however, was such that Stanford could readily detect the modulation with modulator inputs in the range from 10 milliwatts to one watt. The bandwidth of the resulting micro-

wave-optical communications channel is limited entirely by the bandwidth of the modulator cavity (about 5 Mc) since the useful bandwidth of the microwave phototube is 3 Gc (from 1.5 Gc to 4.5 Gc).

Siegman said that, while other labs have reported the detection of microwave light modulation by various indirect and low-frequency methods, Stanford believes the above experiments are the first direct detection in which the microwave signal on the light beam is available directly from the detector over a broad microwave bandwidth.

Monochromatic ruby lasers, producing a single sharp line by reducing the several frequencies inherent in oscillation occurring simultaneously in many axial modes, were described by Prof. A. L. Schawlow.

He said this can be achieved with ruby that has very strong, narrow fluorescent lines at 77 K, enabling the laser to be operated with one end unsilvered. By using a sapphire-clad rod immersed in liquid nitrogen, a single line was obtained and its width determined with a tilted-plate interferometer. Width was found to be less than 0.0025 mm at the threshold.

The Stanford review was a four-day conference given in two two-day sessions, one for 250 invited scientists and one for 150 representatives of government contractors.

PREVIOUS REPORTS

The work reported at the recent Stanford conference is part of a continuing research program at the university.

Photomixing experiments were reported on p 20, of our Sept. 15, 1961 issue. Direct modulation and demodulation of light at microwave frequencies were revealed at NAECON this spring. The report, on p 19, June 1, 1962, included a schematic of the experimental setup.

A detailed, five-page feature article on Sylvania's microwave phototube, its application in detectors and mixers, and a review of the relative merits of phototubes and semiconductor photodetectors for detection and demodulation of light was published on p 37 of our July 20, 1962, issue

"Nothing is impossible to diligence and skill"

Samuel Johnson

These are the trademarks of some of our customers—each an important contributor to a dramatically growing industry. We at Potter pledge our diligence and skills to this growth through a constantly expanding program of research and development.



Autonetics

chose

POTTER

tape transports...

for the Recomp II MT computer system, Recomp offers a magnetic tape memory unit with a capacity of over 600,000 words—and four of these units can be coupled to permit a total memory capacity of over 2,500,000 words.

Key to this highly reliable memory system is the Potter Model 910 digital magnetic tape transport which is teamed with the Model 921A Read-Write amplifier system to provide flexibility for virtually any digital tape application.

To learn more about Potter digital magnetic tape transports... write today.

Manufacturers of:

- Digital Magnetic Tape Systems
- Perforated Tape Readers
- High Speed Printers
- Data Storage Systems



POTTER INSTRUMENT CO., INC.
Sunnyside Boulevard • Plainview, New York

MASTER

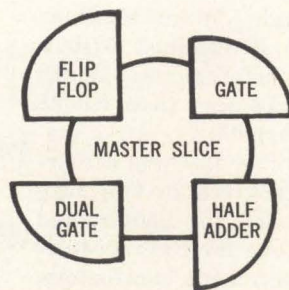
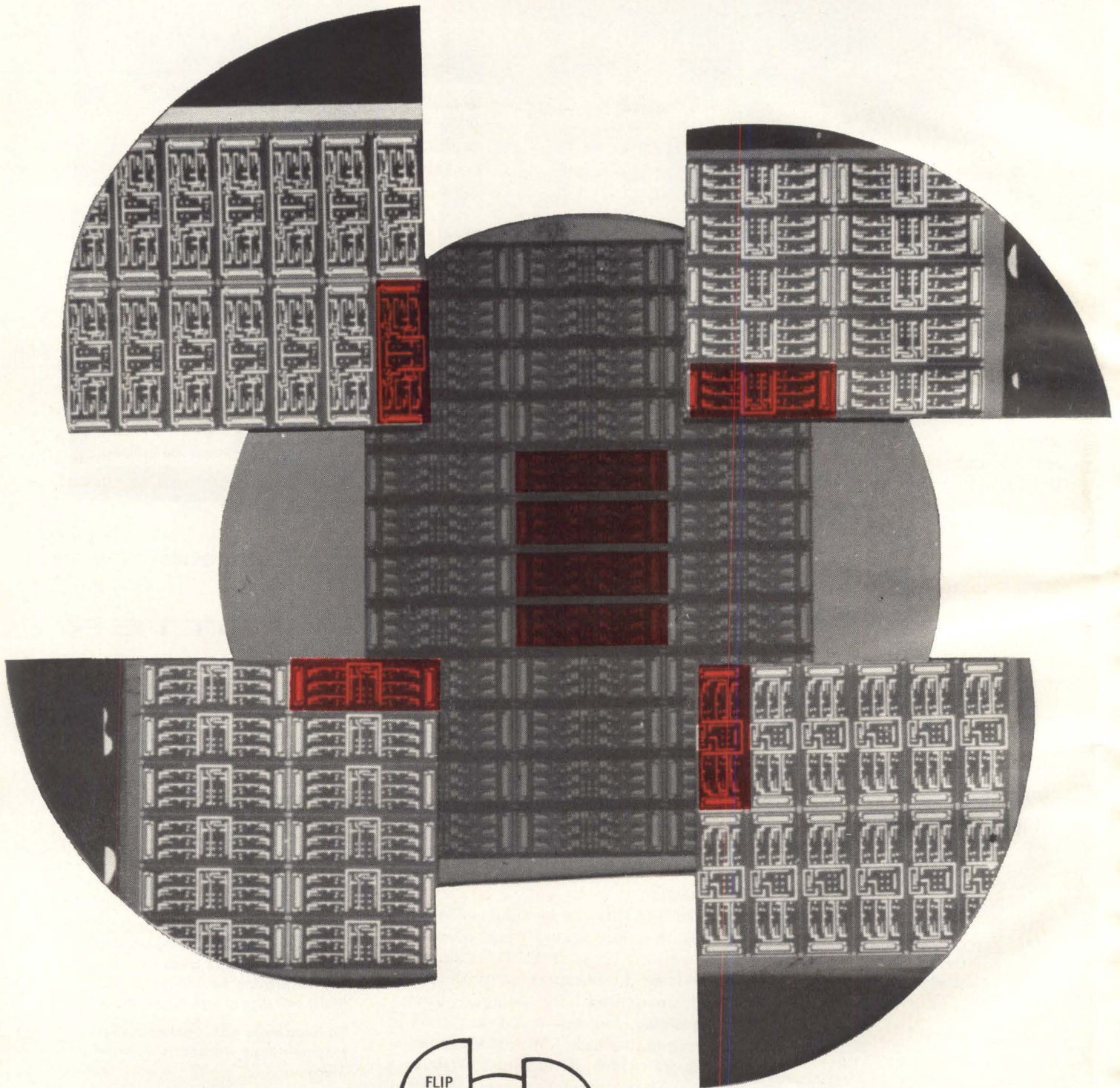

(ACTUAL SIZE)

SOLID CIRCUIT semiconductor networks are manufactured from pure silicon "master slice" wafers (center illustration) which contain more than 30 separate circuit bars. Customized interconnection patterns (four corner wafer fragments) are then photo-etched in aluminum on "master slice" wafers, producing completely integrated semiconductor networks ready for packaging.

SLICE

...the first
economical
answer to
custom
circuits

Texas Instruments now offers you hundreds of variations in **SOLID CIRCUIT*** semiconductor networks. Today you can get the exceptional reliability and miniaturization benefits of **SOLID CIRCUIT** semiconductor networks in many customized designs — at only slightly more cost than standard, catalog circuits. The flexible “master slice” design concept developed by Texas Instruments makes this achievement possible.

HERE'S HOW: First, standard “master slice” integrated circuit bars — complete except for interconnections — are taken from established, high-volume production lines. Second, a special interconnection pattern mask for your circuit is prepared. Third, your special interconnection pattern is photo-etched in aluminum on the “master slice” circuit bar.

YOUR BENEFITS: You get a complete semiconductor network, integrating resistors, capacitors, diodes and transistors into a single, high-purity silicon wafer — to *your* specifications. Evaluation samples can be available within several weeks from final design approval. Because preparation of the special interconnection pattern is the only custom step in the manufacturing process, you get most of the economy and delivery benefits of using standard TI production units.

Of course, “master slice” variations may not satisfy all your circuit requirements. Totally custom semiconductor networks — starting with the pure silicon — can be designed by Texas Instruments to meet an even greater variety of applications.

**Trademark of Texas Instruments Incorporated*

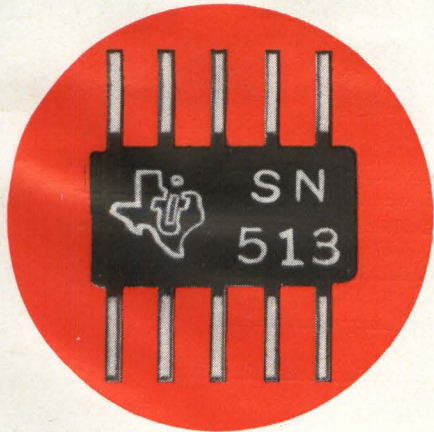

Completed **SOLID CIRCUIT** semiconductor network, enlarged 5½ times.

For more detailed information on how “master slice” design offers you the first economical answer to custom circuits, call your local TI Sales Engineer or write to Department 370 today for this brochure.

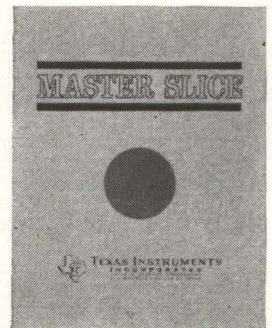

SEMICONDUCTOR / COMPONENTS
DIVISION



**TEXAS INSTRUMENTS
INCORPORATED**
13500 N. CENTRAL EXPRESSWAY
P. O. BOX 5012 • DALLAS 22, TEXAS

19370

television

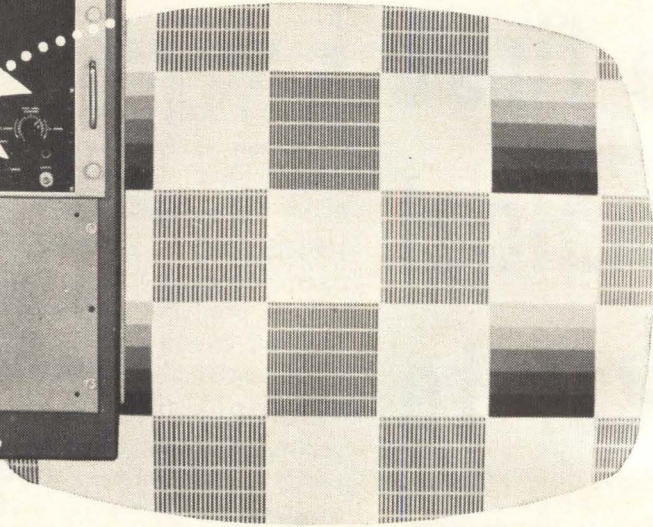
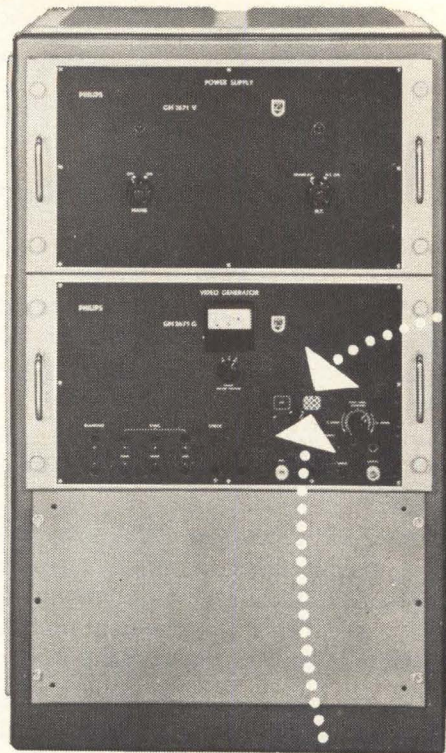

The pattern generator GM 2671 gives a composite video pattern, while the VHF generators GM 2681 and GM 2682 supply picture and sound carriers.

Combination of the pattern generator with one of the VHF generators makes it possible to produce a modulated video signal.

The generators can be used in the development, manufacture and service of all kinds of TV equipment, and may also be employed to provide the test pattern in TV studios and (link) transmitters, to supply the carriers for industrial TV equipment, and as pulse generators for TV systems and similar applications.

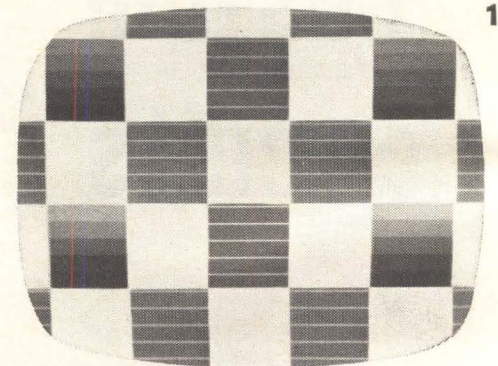

Typical faults in a TV receiver shown up on the screen utilizing pattern generator GM 2671 and VHF generator GM 2681.

- 1** loss of definition, 4 Mc/s lines invisible
- 2** bad frequency characteristic
- 3** hum in the horizontal time base

PHILIPS *electronic measuring*

Sold and serviced by Philips Organizations all over the world
Further information will gladly be supplied by

N.Y. Philips' Gloeilampenfabrieken, EMA-Department, Eindhoven, the Netherlands
For Canada: Philips Electronic Equipment Ltd., 116 Vanderhoof Ave., Toronto 17, Ont.

generators

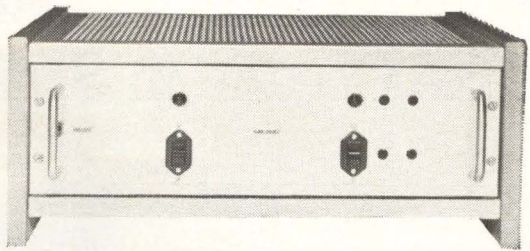

Standard Pattern Generator, type GM 2671

This standard pattern generator provides a composite video pattern giving fast checking of picture-geometry, linearity, ringing, overshoot, frequency characteristics, gamma etc.

T.V. systems

C.C.I.R., 625 lines (50 c/s); F.C.C., 525 lines (60 c/s) and French, 819 lines (50 c/s).

Master oscillator

Synchronisation by crystal oscillator, mains comparison, or external source.

Waveforms

The pulse timing, duration and rise times comply with the system specifications. The picture/sync. ratio is adjustable around the standardized value.

Output

Voltage of the composite video signal: 1 V_{pp} into 75 Ω

Polarity: positive or negative.

Auxiliary signals: total blanking, total sync., line sync. and frame sync. Voltage of these signals: 3 V_{pp} into 75 Ω

External picture modulation

Required voltage: 1 V_{pp} into 75 Ω. Polarity: positive.

Housing

The generator can be supplied in a metal cabinet, or for mounting in a 19" rack.

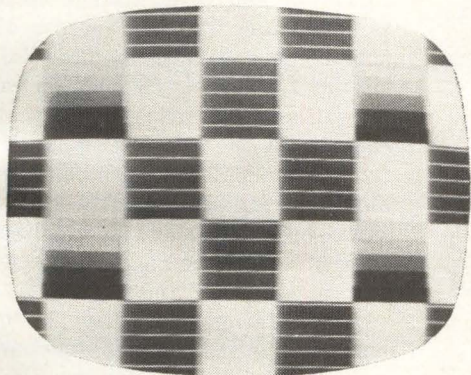

2

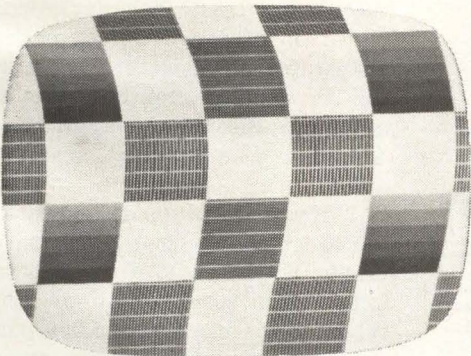

3

VHF generator, type GM 2682

A crystal-controlled VHF generator, supplying picture and sound carriers in one of the channels in the TV-bands I and III. The picture carrier can be modulated by a video signal, e.g. from the pattern generator GM 2671 or an industrial TV chain.

T.V. systems C.C.I.R., 625 lines (50 c/s). Negative video modulation, FM sound.

Picture carrier Frequency: one of the channels in bands I and III, crystal controlled. Voltage: 1.5 V (video-modulated).

Modulation: the required voltage is at least 0.3 V_{pp} into 0.5 MΩ

Sound carrier Frequency: picture carrier + 5.5 Mc/s

Voltage: 1/3 of the picture carrier

Modulation: externally 30 - 20,000 c/s (1.5 V_{rms} into 600 Ω).



VHF generator, type GM 2681

This VHF generator supplies the picture and sound carriers separately or simultaneously, modulated or unmodulated in bands I and III.

It can be used by itself, or together with pattern generator GM 2671. The output voltages, modulation depth and sweep can be adjusted to standard specifications with the aid of a built-in voltmeter.

T.V. systems C.C.I.R., 625 lines (50 c/s); F.C.C., 525 lines (60 c/s); O.I.R., 625 lines (50 c/s) and special versions for Australia, Italy, New Zealand and Japan. Negative video modulation, FM sound.

Picture and sound carriers Frequency: 12 channels in the TV-bands I and III, crystal controlled, accurate within 0.02%

Picture carrier voltage: 100 mV max. into 75 Ω

Sound carrier voltage: 30 mV max. into 75 Ω

Attenuation: max. 80 dB in steps of 4 and 20 dB.

Modulation Required voltage for video modulation: 1 V_{pp} into 75 Ω (positive). Sound modulation: internally or externally.

instruments: quality tools for industry and research



Two-Way Cable Repeaters Take Oceans in Stride

*Enable single cable
to handle 128 two-way
telephone conversations*

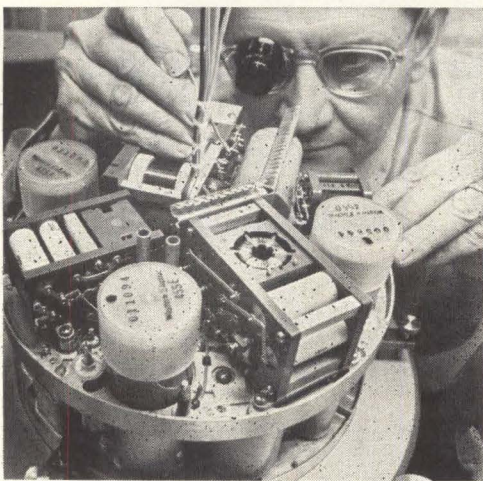
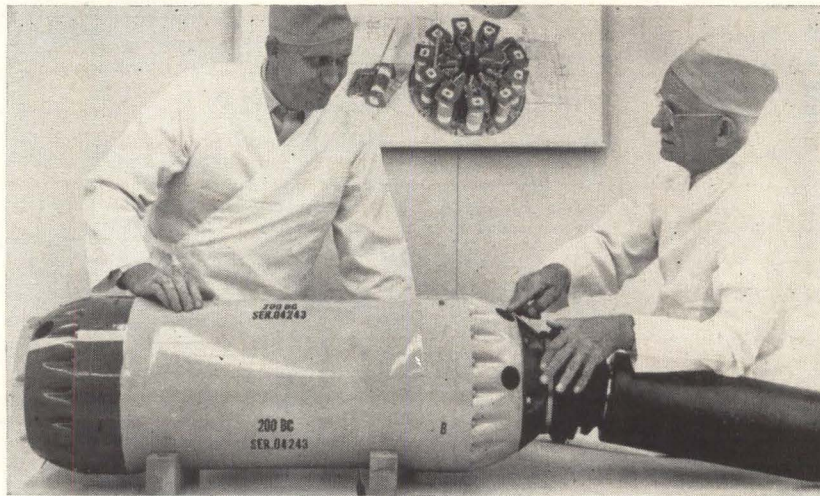

REPEATER is built to operate for 20 years under 2½ miles of sea water (photo above)

POINT - TO - POINT wiring is accomplished with gold-plated copper straps, connections are made by soldering

TWO-WAY REPEATERS and armorless coaxial cable are the prime elements in the new long distance, underwater telephone system designed by Bell Telephone Labs and scheduled for use early next year to link Florida and Jamaica.

The first telephone cables in the 1950's used one way repeaters, so two cables were needed for 48 two-way conversations.

The new system requires only one cable but handles 128 two-way conversations. Repeaters, designed and built to last 20 years, are spliced into the cable every 20 miles, and 3,600 miles of ocean can be spanned in one unbroken run. To equalize losses and amplification, one equalizer unit is spliced in for 10 repeaters.

Dual amplifiers are used in the repeaters and plate voltage is obtained from the drop across the tube heaters, as diagrammed. Voice signals from the west ride on carriers from 652 to 1,052 Kc and those from the east are on carriers from 116 to 512 Kc. Both bands are amplified indiscriminantly 100,000 times by both A and B amplifiers in parallel and the high band is sent east and the low band west.

Amplification integrity is enhanced by the surge tube unit across tube heater strings. If a tube heater opens, this device completes the circuit again by putting an equivalent resistance back into the circuit. The amplifier tubes are a special Bell Labs design (type 455, not commercially available) and are an improved version of a type used in earlier repeaters.

Repeaters are manufactured at Clark, N. J. by Western Electric under clean room conditions. Each repeater has more than 5,000 parts and requires 15 months to go through all manufacturing and testing operations. Most of the resistors, capacitors and inductors are made by hand, in the plant.

The rigid manufacturing and testing operations runs the cost of repeaters up to \$60,000 to \$70,000, but replacing a repeater once installed in a long distance sea link might cost as much as \$250,000.

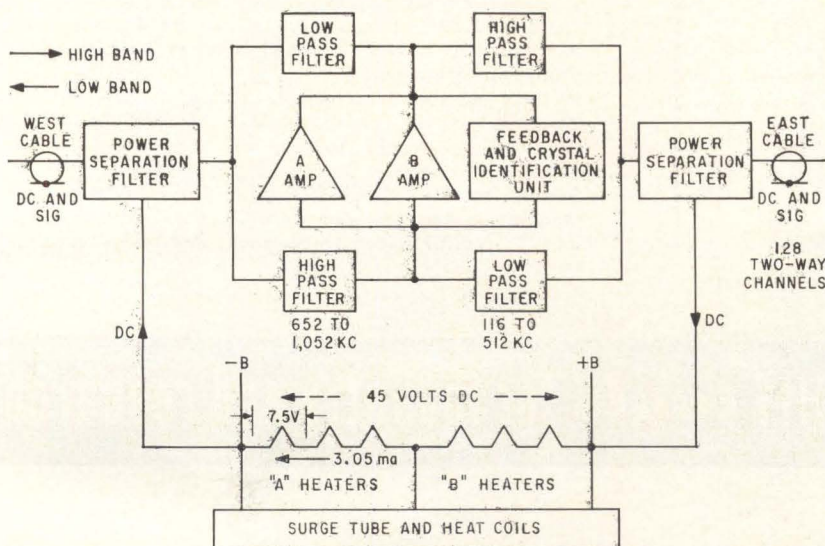

DUAL AMPLIFIERS operate in parallel in two-way undersea repeater. Crystal unit in feedback circuit identifies repeater if it fails

Laser Action Is Observed in Glass Fibers and Rods

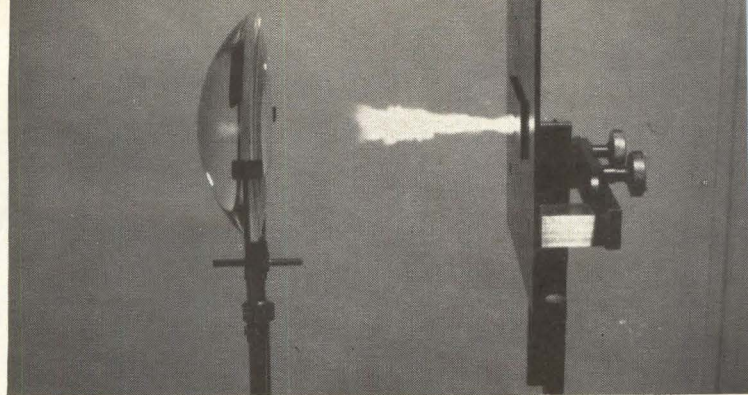

CARBON STEEL gives off metal vapor plume when hit by focused beam of American Optical Co.'s Nd glass laser

Researchers also report work in semiconductor and organic lasers

BOSTON—Stimulated emission in optic fibers was reported by two researchers at the Boston Laser Conference, held this month at Northeastern University.

Laser action has been observed in helix-shaped bundles of about 2,000 neodymium-activated glass fibers of 20-micron diameter and separated by 40 microns, it was disclosed by Hoyt A. Bostick, of MIT Lincoln Laboratory.

The bundle of fibers is surrounded by a small reflector, and a flash tube used for pumping at an energy level of 40 joules or higher. Measurement of the output showed that the fibers were not coupled but were oscillating independently.

It is expected that smaller fibers, with closer spacing between them, will permit coupling.

Bostick characterized the fiber bundles as operating similar to a very large waveguide which can support many modes, having a diameter 20 times that of the radiation inside. He said the technique might be most applicable to amplifying waves, rather than as a source of coherent emission competing with a Fabry-Perot cavity.

R. F. Woodcock, of American Optical Co., reported laser action in long, clad fibers containing trivalent neodymium as the active ion.

Woodcock said the maximum output measured on neodymium glasses to date is 113 joules for an electrical input of 9,000 watt-seconds. The configuration was a clad rod 18 inches long with a quarter-inch core. Thus, output was about 8 joules per cc. The glass was a 6 wt. percent Nd_2O_3 in a barium

crown base. Beam spread was about 6 degrees.

DIODE LASER—At Air Force Cambridge Research Laboratories, attempts are underway to develop a semiconductor diode laser which would operate through impurity levels.

Richard G. Seed, of Northeastern University, who is conducting the experimental team effort, reported that indium-doped silicon appears attractive (ELECTRONICS, p 7, Aug. 10). Laser action in the proposed device would be based on radiative recombination of injected carriers in the base region.

To date, the recombination observed has appeared to be acoustic rather than optical, Seed said. The loss mechanism poses the most serious problem with diode lasers, especially absorption of the injected free carriers.

ORGANIC EMITTERS—Frederick Lowenstein, of AF Cambridge Research Laboratories, who conceded that his results were inconclusive, reported laser-type emission from a liquid solution of indole suspended in a rigid glass matrix of EPA—ethyl ether, isopentane and ethanol—at 77 K.

Scope traces with spikes in the blue part of the spectrum—at 410 millimicrons—have not been reproducible, Lowenstein said, nor have interference experiments been performed. One of the principal problems is the broad spectral-line characteristic of organic molecules. Some laboratories are working with chelates, organic compounds in which a metal ion is linked with a heterocyclic organic molecule, the hope being that the metal ions, which have a very narrow spectral line, will emit.

Attempts to achieve stimulated

emission in organic molecules is attracting substantial research efforts, principally because resulting devices would permit coherent light of virtually any frequency.

European Satellites Will Be Launched in Australia

MELBOURNE—Experts from countries in the European Launcher Development Organization (ELDO) will visit the Woomera Rocket Range next month to inspect facilities. ELDO plans a rocket program at Woomera, Prime Minister Robert Menzies said.

Britain, France and Germany are to build a three-stage rocket, Italy the satellites and the Dutch and Belgium the instrumentation.

Australia won't contribute to ELDO facilities at Woomera and has cut her ELDO funds for the next five years by \$1.6 million, to \$19.6 million. However, Australia is now financing her own weapons projects, formerly paid for by ELDO.

Measuring Instrument Shipments Go up in '62

ELECTRICAL measuring instrument shipments by U. S. manufacturers in the first quarter of 1962 totaled \$35 million worth of equipment, compared with \$32.5 million during the same period in 1961, reports the Business and Defense Services Administration. Included were over 12,000 portable instruments worth \$1.7 million; 3,000 direct deflecting instruments worth \$1 million; 12,000 self-balancing instruments worth \$7.5 million; and 20,000 oscillographic, galvanometric and oscilloscopic type instruments worth \$11.6 million.

EXOTIC POWER SOURCES

The Big R&D Problem Is Better Materials

Developers see 10,000-hour lives for thermionic converters in space use

SAN FRANCISCO—Engineering progress in all of the exotic power sources was reported at the Pacific Energy Conversion Conference this month, but speakers saw years more work—with better materials the chief problem—before the promises of direct conversion paid off. Some 600 scientists and engi-

neers attended the meeting.

Among the significant reports:

- Life tests of thermionic converters, described by Harold F. Webster, General Electric Research Laboratory. Three converters—with cylindrical emitters of tantalum, molybdenum and niobium, inside stainless steel collectors—had been operating for periods of 4,339, 3,254 and 3,668 hours, respectively, when he gave his report.

- Studies of liquid semiconductors, reported by C. M. Kelley, University of Denver. These molten materials may hold promise for high-temperature thermoelectric converters. The most efficient alloy he found was 75 percent cuprous telluride and 25 percent cuprous sulfide.

- Results of experimental work indicating that gallium arsenide solar cells are some 10 times more resistant to radiation damage than silicon cells, and thus may offer an appreciably longer life span, described by Paul Rappaport, RCA Laboratories.

THERMIONICS—The tests reported by Webster are believed the first to show the long-life capability of thermionic converters. The GE tubes were designed primarily for reliability, but operated at efficiencies of 9 to 10 percent. Scientists at the session agreed that 10,000-hour thermionic converters for space use now seem feasible.

G. N. Hatsopoulos, of MIT and Thermo Electron Engineering Corp., says thermionic converters are potentially superior for space applications than other energy converters. High operating temperatures provide highest power output per unit area, volume or weight and also minimize radiator weight, a prime consideration in space.

Hatsopoulos expects it will take at least two years to put a solar thermionic converter into space. Putting a nuclear thermionic con-

verter into space will take several years, it was conceded, from the time that the AEC may decide to invest in the project. AEC has designated Snap 70 as a nuclear thermionic unit, but has supported little work in this field.

Top efficiency obtained so far in experiments is 17 percent, but scientists hope to reach 20 percent soon and predict 30 to 50 percent.

Robert Pidd, General Dynamics Corp., figured weight of 4 to 5 lb/Kw on a projected space unit composed of $\frac{1}{4}$ -cubic-inch, 100-watt thermionic converter modules GD is developing.

PROBLEMS—Many problems remain to be solved, however.

Pidd noted that the GD modules perform well as units, but variations in modules and reactor operating conditions could present problems during series operation; output is limited by the weakest module. Power produced can oscillate 100 percent.

Materials present the overriding problems.

"Everybody's backed up against the wall on materials," declared Walter Reichelt, University of California at Los Alamos, who reported on in-pile cesium plasma diode experiments. Although the experiment showed power densities of 17 watts/cm², the diodes failed after 250 to 300 hours, and the experimenters learned little about what happens to components in a reactor.

H. M. Ogle, Applied Systems Corp., who also reported on in-pile tests of plasma diodes, added the problem of fission products. "Many of these gases—these 'tramp gases'—diffuse through the metals," he said. "We can't control them and we don't know what they do."

SOLAR CELLS—Gallium arsenide cells, Rappaport stated, will operate at 300 C and perhaps 400 C. This, and resistance to radiation,

Silicon Circuit Slices

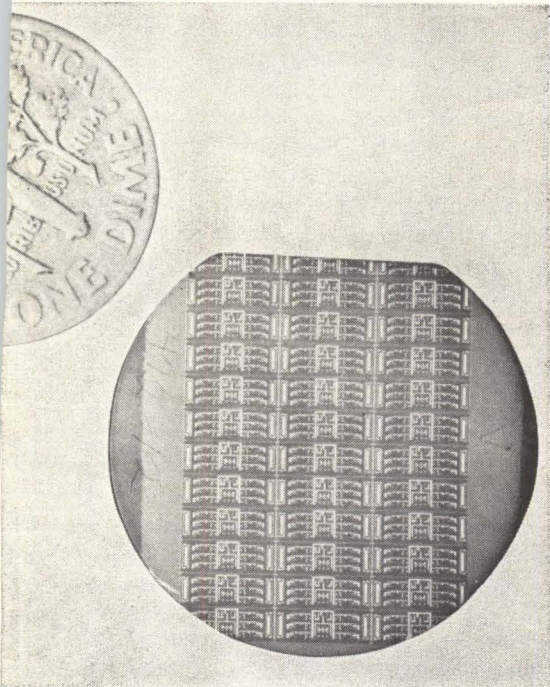

SEMICONDUCTOR networks are made by Texas Instruments from wafers like this. Wafers contain numerous circuit bars, integrating resistors, capacitors, diodes and transistors in single chips. Connecting diffused areas by photo etching aluminum permits hundreds of circuit configurations to be readily produced. The concept was shown at WESCON

make the cells highly promising. Rappaport sees life spans from two to ten years.

The cost problem is being attacked through development of a polycrystalline film. Growing a film by vapor deposition on a lightweight flexible substrate using epitaxial techniques is promising, he said. Efficiencies of 8 to 11 percent have been obtained.

Future growth of the photovoltaic power industry depends on development of polycrystalline techniques and improvement of storage capability, according to W. R. Cherry, director of NASA's direct energy conversion project. Cherry predicted that economic photovoltaic systems for use on the ground are three to five years away.

He reported that at least 16 NASA spacecraft programs in the next four years will use solar cells and that NASA's annual needs will rise from 154,500 cells this year to 977,500 in 1965.

Big Magnetohydrodynamic Generator Ordered by NASA

SAN FRANCISCO—It was announced at the Pacific Energy Conversion Conference that a magnetohydrodynamics generator to produce 20 megawatts of burst power is being built for DOD's Advanced Research Projects Agency by the Avco-Everett Research Laboratory.

Arthur Kantrowitz, AE vice president, said the unit's energy source will be a specially built chemical rocket engine. The unit will be used as a re-entry simulator and for other experiments.

Kantrowitz said that the MHD rocket generator, an Avco-Everett concept, would produce burst power at a cost below that of equivalent power produced conventionally. It will be reusable "for a considerable time," he said.

The rocket generator concept could be used to produce much higher bursts of power, Kantrowitz said. A unit the size of the Atlas rocket could produce 900 megawatts, he estimated.

Kantrowitz predicts an MHD power generator will not be economic for conventional uses here by 1970, but he says that one might be economic in Japan by that time.



present a new solid-state 20 MC counter

model A. 1149

maximum counting rate **> 20 MC**

with external aperiodic divider (optional) **> 60 MC**

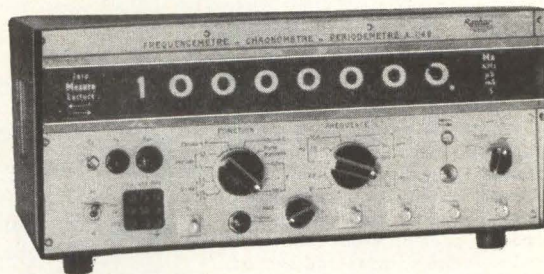

- Count capacity : 99, 999, 999.
- Bright in line readout : 8 digits
- Unit and point indication (displayed)
- High inputs sensitivity : 50 mV to 100 Vrms
- Temperature range : 0 to 50° C (- 10 to + 60° C on test)
- Crystal stability : a) ± 1 part in 10^{-7} (longterm) b) ± 1 part in 10^{-8}

- Gate time : 0.1—1 and 10 seconds or any other value with external preset time base (optional)
- Time interval measurements 0.1 μ s to > 100 days
- Pulse duration measurements (polarity + or -)
- Period measurements
- Ratio measurements
- Shock and vibration tested

manufactured by **Rochar**
electronique

Distributed in U.S.A. and Canada by :
WESTON - Newark (N.J.)
for complete information on our line of products and address of our agency in your country please apply to
**ROCHAR-ELECTRONIQUE, 51, rue Racine
MONTROUGE (Seine) FRANCE.**

SPRAGUE PIEZO- ELECTRIC CERAMIC ELEMENTS



**ELEMENTS
FOR ALL
APPLICATIONS
AS WELL AS
COMPLETE**

**TRANSDUCER ASSEMBLIES
FOR MOST APPLICATIONS,
SUCH AS UNDERWATER
SOUND AND
VARIOUS ORDNANCE AND
MISSILE DEVICES.**



Sprague-developed mass production and quality-control techniques assure lowest possible cost consistent with utmost quality and reliability. Here too, complete fabrication facilities permit prompt production in a full, wide range of sizes and shapes.

Look to Sprague for today's most advanced ceramic elements—where continuing intensive research promises new material with many properties extended beyond present limits.



**YOUR INQUIRIES
ARE INVITED**

**WRITE FOR
LITERATURE**

SPRAGUE ELECTRIC COMPANY
35 Marshall Street, North Adams, Mass.

SPRAGUE®
THE MARK OF RELIABILITY

Computer Makes Maps from Stereo Photos

ACM conference will also hear report on new function generator

STEREO PHOTOS are compiled into orthophotomaps by digital data processing techniques developed at IBM. The method will be described by C. W. Williams at the Association of Computing Machinery's national conference in Syracuse, N. Y., next week.

Small areas in each photo—about 100,000 to 200,000 areas a square inch—are assigned a numerical value according to their shades of gray. A 9 × 9-inch photo scanned at a resolution of 50 lines per mm with a scale of 128 gray shades contains about a billion bits of information.

The computer program correlates data from two photos of a stereo pair, rectifying tilt and scale changes and producing a tape for the rectified picture. Elevation and orthographic projection for each point is computed for each tape, then a final output tape produces the map.

FUNCTION GENERATOR—R. A. Cowan, of Bell Telephone Laboratories, will report on a function generator that can provide reference curves or auxiliary data for digital simulations. It can also be combined with a digital-to-analog converter to generate accurate analog nonlinear functions when more conventional analog devices are unsatisfactory.

The device permits simple preparation of path specifications and generates command information to maintain a constant velocity along the path of the function. A third-order polynomial, fitted to each path segment, is generated using three digital integrators acting on the polynomial's three derivatives. Digital differential analyzer techniques are used for integration.

PERT—In one of the conference's many software papers, A. A. McGee and M. D. Markarian, of IBM, will tell how to modify the Pert technique to show manpower requirements needed for tasks that must

be performed concurrently. The technique enables an organization to make the best use of its technical manpower before hiring more.

Automatic error recovery in the Nike-Zeus guidance computer will be discussed by G. M. Griffith and G. A. Champline, of Remington Rand Univac. The computer recovers completely from transient errors and can ignore some types of catastrophic errors with a minimum of shock to the system.

Portable Communication System Weighs 2 Pounds

PORTABLE RADIO receiver and transmitter, designed for use by law enforcement officials, has been introduced by Motorola. The 36-ounce f-m radiophone operates on both vhf high band (136 Mc to 174 Mc) and vhf low band (25 Mc to 54 Mc) frequencies. Motorola says receiver sensitivity is 0.35 mv and r-f output power is over 1.4 w. Receiver squelch sensitivity is between 0.18 mv and 0.25 mv depending on band, selectivity is 80 db at the adjacent channel, spurious response rejection is more than 70 db, and spurious emission and harmonic attenuation is 45 db below output power in the high band and 50 db in the low band.

Radar PPI Display

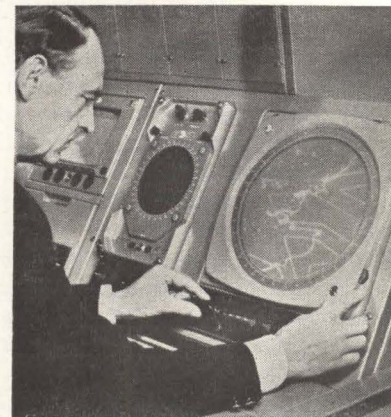

DISPLAY combining radar, map and identifying data on ppi tube will be introduced by Marconi at British Airshow next month. It is transistor version of vacuum tube model shown last year

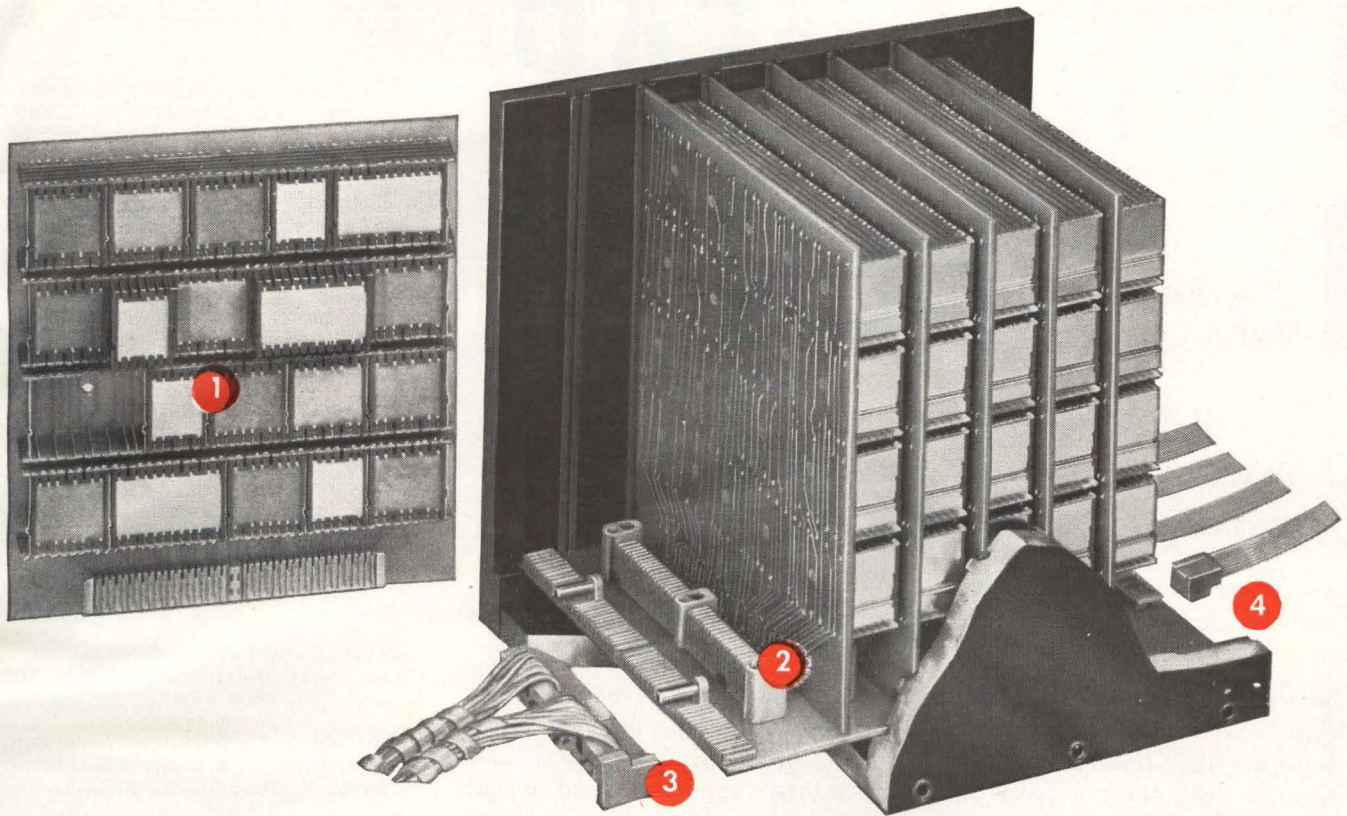

THE AMP-MECA* SYSTEMS APPROACH TO INTERCONNECTIONS

AMP-MECA assemblies, first with three-dimensional interconnections for pluggable sub-module circuits, gets down to specifics when it comes to interconnections for all your electronic systems requirements. Your systems no longer need to be interconnected using connectors which are not uniform in design and reliability.

From individual sub-module circuit (1), to plug-in module boards (2) to base plane wired inputs (3), or using the increasingly popular TAPE CABLE†(4), the AMP-MECA Systems Approach to interconnections provides, throughout, performance of maximum reliability because contacts of all the systems connectors are uniform in design, and incorporate a redundant 4 point contact.

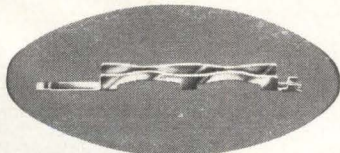

In addition, the AMP-MECA Systems Approach starts with the layout of circuit interconnections. Through the use of AMP-MECA graph layout charts, time to layout each plug-in board can easily be reduced from the normal three to five weeks to less than one week.

Send today for complete information on how the AMP-MECA Systems Approach can apply to your interconnection problems.

*Trademark of AMP INCORPORATED

†Trademark of Tape Cable Electronics Co., Inc.

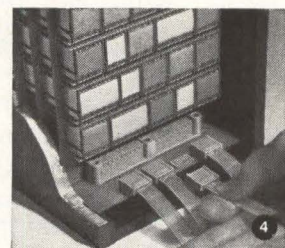
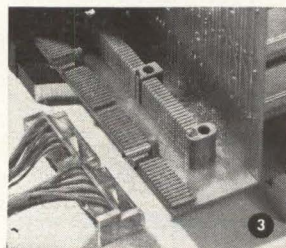
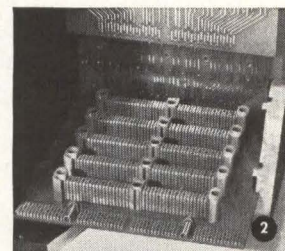
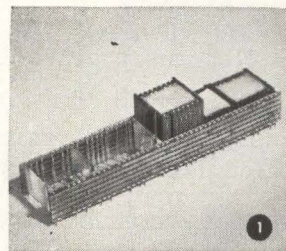

AMP
INCORPORATED
Harrisburg, Pennsylvania

AMP products and engineering assistance are available through subsidiary companies in: Australia • Canada • England • France • Holland • Italy • Japan • Mexico • West Germany

HOW CHEAP IS "CHEAP"?

"Why should we buy from you when we can get the 'same thing' from other suppliers at a lower price?"

In selecting a supplier of lacing tape (or any component), price and compliance with specifications are not the only criteria. But too often, manufacturers ignore the other factors involved and consequently lose money.

For example, in a \$15,000 piece of equipment there may be only 15 cents worth of Gudebrod lacing tape. It costs \$75 to work this tape. It may be possible to buy the same amount of tape from other suppliers for 2 or 3 cents less . . . it "will meet the specs" according to these suppliers. But one of our customers recently pointed out why he still specifies only Gudebrod lacing tape in such cases.

"We tried buying some cheaper tape that 'met the specs.' Within a few months our production was off by 50% . . . boy, did the production people really scream about that tape. And our labor costs doubled . . . our costing people really flipped!

"Another thing, why should we risk the possible loss of thousands of dollars when the original material cost difference is only a few cents. Once you put cheaper tape on and something goes wrong after the equipment is finished . . . you've had it. No, thank you! We learned our lesson! We buy Gudebrod lacing tape!"

Whether your firm uses one spool of lacing tape or thousands, there are four advantages in specifying Gudebrod for all your lacing requirements:

1. *Gudebrod lacing tape guarantees increased production!*
2. *Gudebrod lacing tape guarantees reduced labor costs!*
3. *Gudebrod lacing tape guarantees minimal maintenance after installation!*
4. *Gudebrod guarantees quality!* On every spool is a lot number and seal which guarantees that all Gudebrod lacing tape is produced under strict quality control. Our standards are more exacting than those required for compliance with Mil-T.

Our Technical Products Data Book explains in detail the complete line of Gudebrod lacing tapes for both civilian and military use. For your copy write to Mr. F. W. Krupp, Vice President, Electronics Division

GUDEBROD BROS. SILK CO., INC.

Electronics Division
225 West 34th Street
New York 1, New York

Executive Offices
12 South 12th Street
Philadelphia 7, Pa.

MEETINGS AHEAD

INFORMATION ON THEORY INTERNATIONAL SYMPOSIUM, PGIT and Benelux Section of IRE; Free Univ. of Brussels, Belgium, Sept. 3-7.

MICROWAVE TUBES INTERNATIONAL CONFERENCE, URSI; Technological U. of Delft, Netherlands, Sept. 3-7.

ADVANCED TECHNOLOGY MANAGEMENT CONFERENCE, IRE-PGEM, AIEE, et al; Opera House on World's Fair Grounds, Seattle, Wash., Sept. 3-7.

DATA PROCESSING EXHIBIT, Assoc. for Computing Machinery; Onondaga County War Memorial, Syracuse N. Y., Sept. 4-7.

AUTOMATIC CHECKOUT TECHNIQUES SEMINAR, AF Aeronautical Systems Div. and Batelle Memorial Institute; at Batelle, Columbus, Ohio, Sept. 5-7.

ENGINEERING MANAGEMENT, IRE-PGEM, AIEE et al; Hotel Roosevelt, New Orleans, La., Sept. 13-14.

ENGINEERING WRITING AND SPEECH SYMPOSIUM, IRE-PGEWS; Mayflower Hotel, Wash., D. C., Sept. 13-14.

ELECTROCHEMICAL SOCIETY MEETING; Statler-Hilton Hotel, Boston, Mass., Sept. 16-20.

RECTIFIERS IN INDUSTRY MEETING, AIEE; Desher-Hilton Hotel, Columbus, Ohio, Sept. 18-19.

ORDNANCE ENVIRONMENTAL SYMPOSIUM (unclassified), Research & Development Div. of the Army Chief of Ordnance, Southwest Research Institute; El Tropicano Hotel, San Antonio, Texas, Sept. 18-20.

INDUSTRIAL ELECTRONICS ANNUAL SYMPOSIUM, IRE-PGIE, ISA; Sheraton-Chicago Hotel, Chicago, Ill., Sept. 19-20.

TUBE TECHNIQUES NATIONAL CONFERENCE, Advisory Group on Electron Devices in the Office of the Director of Defense Research and Engineering; Western Union Auditorium, N.Y.C., Sept. 19-21.

BROADCAST ANNUAL SYMPOSIUM, IRE-PGB; Willard Hotel, Washington, D. C., Sept. 20-29.

ADVANCE REPORT

MILITARY ELECTRONICS NATIONAL WINTER CONVENTION, IRE-PGMIL, Ambassador Hotel, Los Angeles, Jan. 30-Feb. 1, 1963. Oct. 15 is the deadline for submitting a 100-word unclassified abstract, a 500-word summary and a short author biography to: Fred P. Adler, Manager, Space Systems Division, Hughes Aircraft Co., Culver City, Calif. Both unclassified and classified papers are invited. Authors are responsible for obtaining all necessary clearances. Fields of interest include the following systems: ballistic missiles; space; tactical warfare; antisubmarine warfare; missile defense; airborne (fire control, reconnaissance, etc.); command and control.

Power ratings to
225 WATTS

1 to 999,999
ohms

1 ohm increments

NOW **2**
POWER
RESISTOR
DECADES
BY

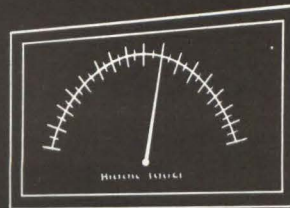
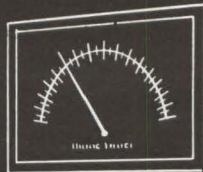

Unique with Clarostat—a Power Resistor Decade utilizing famous Clarostat Greenohm Power Resistors. Handles real loads—switch it in and out of circuits—stands overloads. Direct reading dials indicate exact ohmage at all times. Self-cleaning switches hold load till next decade is switched in. Available in rack-mounted or bench models. A “must” in every lab, every shop, and many production line tests. Write for complete details, or ask your Clarostat distributor . . .

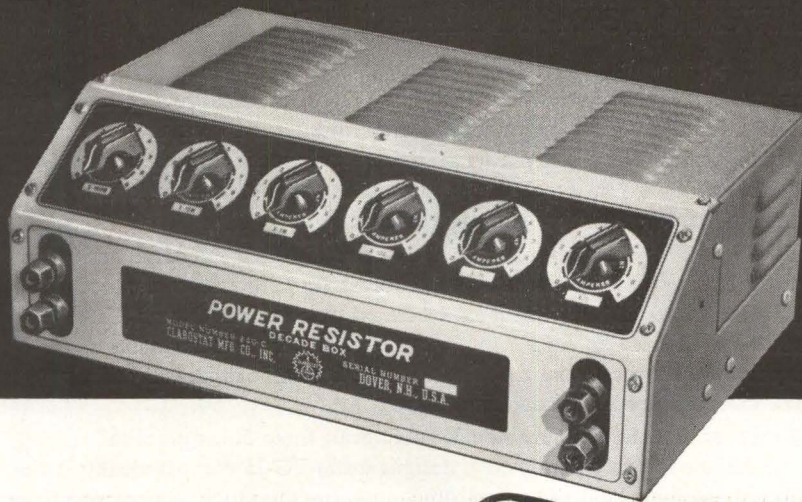

POWER RESISTOR DIVISION



CLAROSTAT

CLAROSTAT MFG. CO., INC. DOVER, NEW HAMPSHIRE

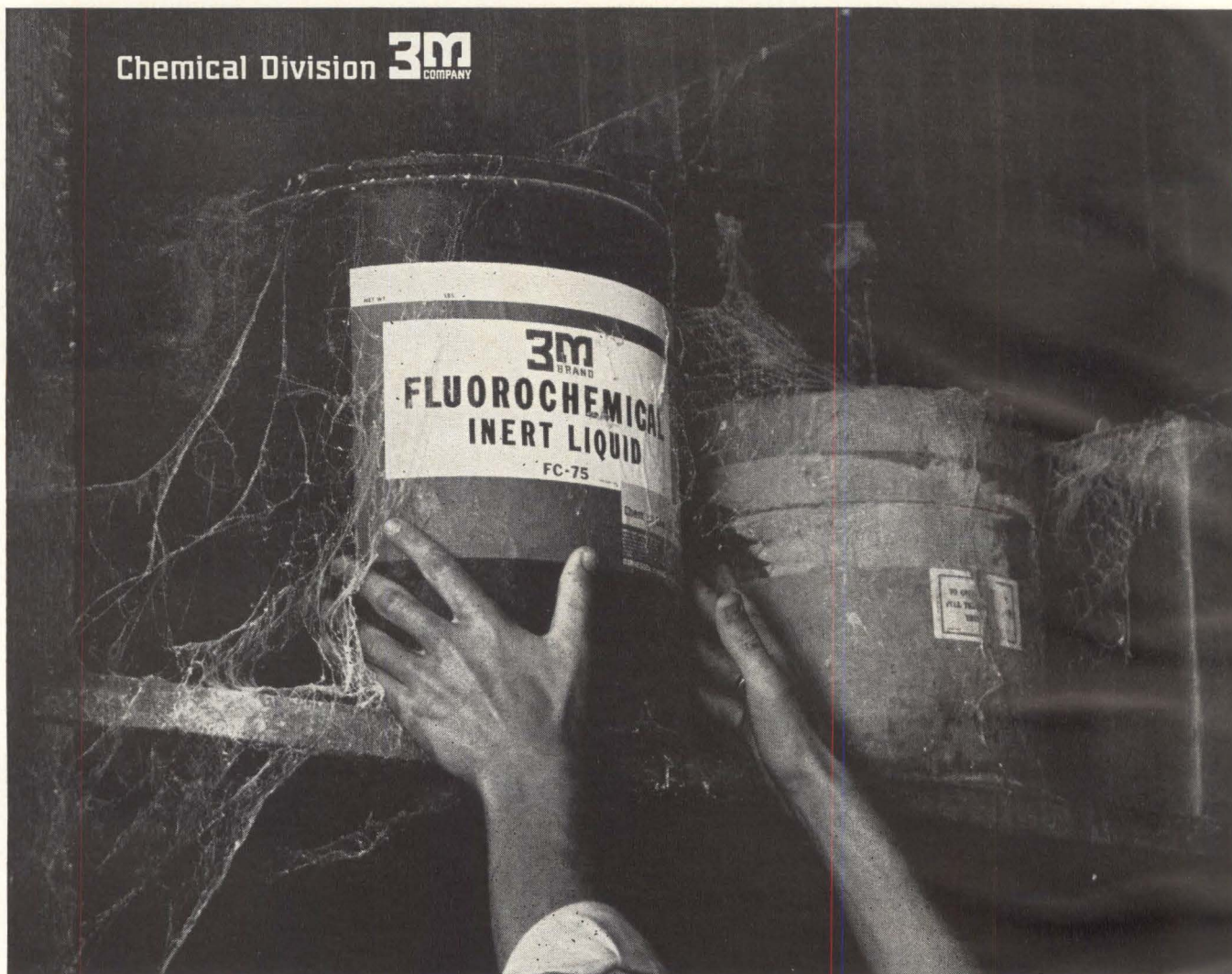

Once in a blue moon you might have to replenish FC-75

Yes, we *have* known cases where 3M Brand Fluorochemical Inert Fluid FC-75 needed replenishing or service after installation; but they are extremely rare. Fact of the matter is, there is no practical age limit to the life of FC-75! In a well-designed closed system this fluid offers complete freedom from coolant maintenance.

FC-75 and its companion fluid, FC-43, retain their physical and electrical properties indefinitely under normal conditions. In contact with other materials they suffer no electrical or chemical change. Unlimited use in heat or cold in no way affects their coolant qualities. They remove 30 to 40 times more heat than less volatile organic liquids, when used under boiling conditions.

As a heat transfer medium in electronic gear, these fluids practically eliminate hot-spot problems. New designs using FC-75 can drastically reduce the volume "cube" of electronic units. In fact, much equipment is specifically designed around the heat-removing talents of these dielectric coolants. Write for further information and for specific application details.

PROPERTIES PROFILE ON 3M BRAND INERT LIQUIDS FC-43 AND FC-75

ELECTRICAL PROPERTIES

	FC-43	FC-75
Electric Strength	35KV	35KV
Dielectric Constant (1 to 40 KC @ 75°F)	1.86	1.86
Dissipation Factor (75°F) (1000 cycles)	<0.0005	<0.0005

TYPICAL PHYSICAL PROPERTIES

	FC-43	FC-75
Pour Point	<-40°F	<-80°F
Boiling Point	340°F	212°F
Density	1.88	1.77
Surface Tension (77°F) (dynes/cm)	16	15
Viscosity Centi- stokes (77°F)	2.74	0.65
Thermal Stability	600°F	700°F
Chemical Stability	Inert	Inert
Radiation Resistance	25% change@ 1 x 10 ⁸ rads	25% change@ 1 x 10 ⁸ rads

For more information on FC-43 and FC-75, write today, stating area of interest to: 3M Chemical Division, Dept. KAX-82, St. Paul 19, Minn.

MINNESOTA MINING & MANUFACTURING CO. **3M**

IN COMMEMORATION

This year commemorates the 25th anniversary of the development of the klystron tube by the late Russell and Sigurd Varian. The invention of the klystron by Dr. Russell Varian made possible the exploration of whole new fields of scientific knowledge, including modern radar and microwave technology. These stem from the creative initiative of the modest, gentle man who has rightfully taken his place among the great scientists of all time.



PALO ALTO CALIFORNIA

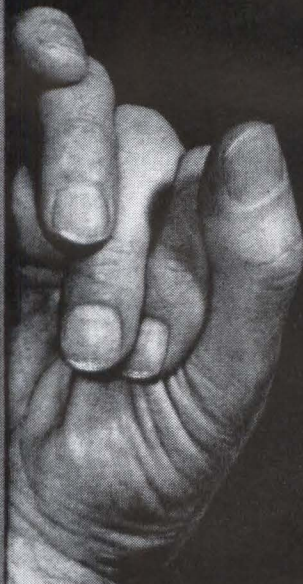

Photograph by Ansel Adams

DR. RUSSELL VARIAN
1898 - 1959

Varian Subsidiaries: BOMAC LABORATORIES, INC. • S-F-D LABORATORIES, INC. • SEMICON ASSOCIATES, INC. • VARIAN ASSOCIATES OF CANADA, LTD. • SEMICON OF CALIFORNIA, INC. • VARIAN A. G. (SWITZERLAND)

CIRCLE 33 ON READER SERVICE CARD

CIRCLE 34 ON READER SERVICE CARD →

Be fussy

Two things determine whether or not a particular printed circuit connector is "right" for your application:

1. How the printed circuit board mates with the connector, and
2. How the connector connects to the rest of the system.

Take mating, for example. Besides having the correct number of contacts, a printed circuit connector must hold the board securely whether the board happens to fall at the high or low end of thickness tolerances.

IT TAKES THREE

These considerations convinced Amphenol engineers that no single contact design could satisfy the requirements of a wide range of applications. So they designed three contacts that will.

One, used in Prin-Cir* connectors, looks a lot like a tuning fork with lips. The circle lip design makes contact overstressing or "setting" impossible—even after repeated insertions. The contact's long spring base also enables it to accommodate boards that range in thickness from .055" to .073", while doing an excellent "wiping" job.

EASY DOES IT

But not every application requires the Prin-Cir "bite." For this reason, Amphenol engineers designed connectors with ribbon contacts that mate with a gradual wedge-like force. In

blind mating applications, gradual mating makes the feeling of *correct* mating unmistakable. (Just the thing when your equipment may eventually be maintained by less-skilled and less-concerned personnel.) Ribbon contact wedge action also makes it possible for connectors using these contacts to accept the same wide range (.055" to .073") of board thicknesses as do Prin-Cir connectors.

Finally, advances in micro-miniaturization (like Amphenol-Borg's Intercon® pre-fabricated circuitry) meant that tinier-than-ever-before connectors were needed. Amphenol's answer was the Micro-Min® receptacle and printed circuit board adapter. Micro-Min contacts are actually tiny springs of beryllium copper wire, formed in a precisely designed arc to assure firm circuit board retention. This unique design makes it possible to space contacts on .050" centers and crowd 19 connections into a little more than an inch of space.

TERMINATIONS COUNT, TOO

"How to connect connectors to the rest of the system" also merits a good deal of consideration. In some cases, hand soldered terminations will do just fine. In others, higher volume requirements call for high production rate methods like dip soldering and wire-wrapping. Some engineers prefer taper pin terminations.

Our printed circuit connectors are available with contact tails designed for each of these termination methods. In addition, adapters are available for use in connecting printed circuit boards at right angles to each other or in modular arrangements. We make printed circuit connectors with hermetically sealed contacts — still others with coaxial contacts.

Take your choice.

Any Amphenol Sales Engineer or authorized Amphenol Industrial Distributor will be happy to discuss printed circuit connectors (ours) with you. Or, if you prefer, write directly to Dick Hall, Vice President, Marketing, Amphenol Connector Division, 1830 S. 54th Avenue, Chicago 50, Illinois.

*T.M. Amphenol-Borg Electronics Corp.

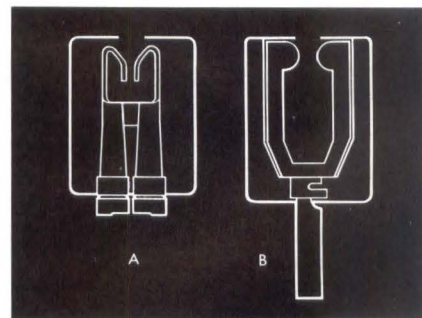

Wedging action of Amphenol ribbon-type (A) and long spring base of Amphenol Prin-Cir connectors (B) assure firm printed circuit board retention, whether board happens to fall at low (.055") or high (.073") end of thickness tolerance.



Connector Division / Amphenol-Borg Electronics Corporation

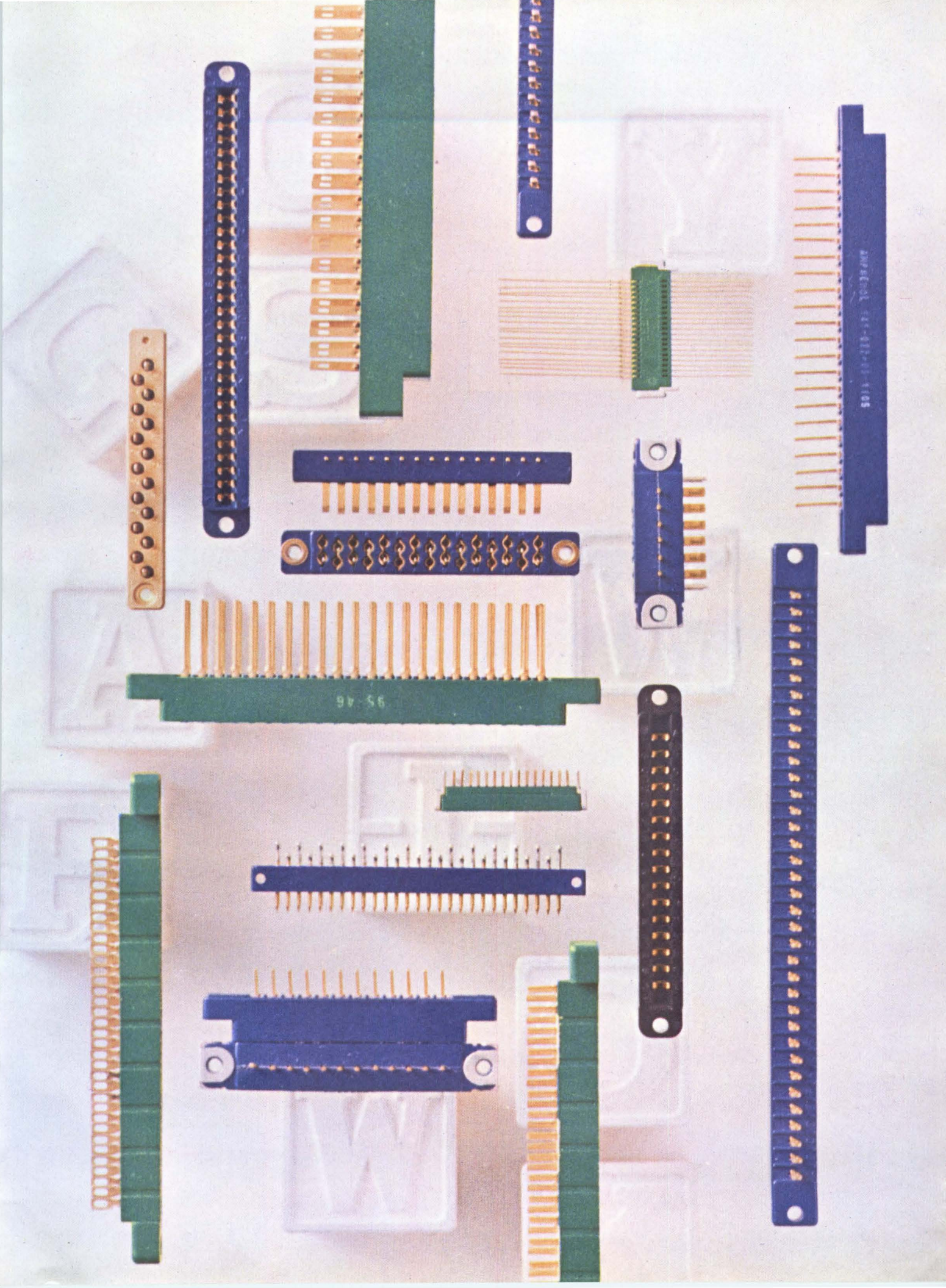

in full bloom...Synkote® MULTI-CONDUCTOR CABLES



We got a "million of 'em" . . . made to your design or ours! The booming Synkote® line of multi-conductor cables is being used for outer space, under sea, and dry land purposes. Heavy, powerful watertight cables. Light, strong aerial cables. Cables for telemetry, instrumentation, data tabulating and computing equipment. All are thoroughly tested, quality controlled, performance proven. Myriad multi-conductor cables are only part of Plastoid's growing multiplicity of cables. Write or call for detailed information today. Our application engineers are at your service.

PLASTOID

 CORPORATION

42-61 24TH STREET / LONG ISLAND CITY 1, N. Y. / ST 6-6200

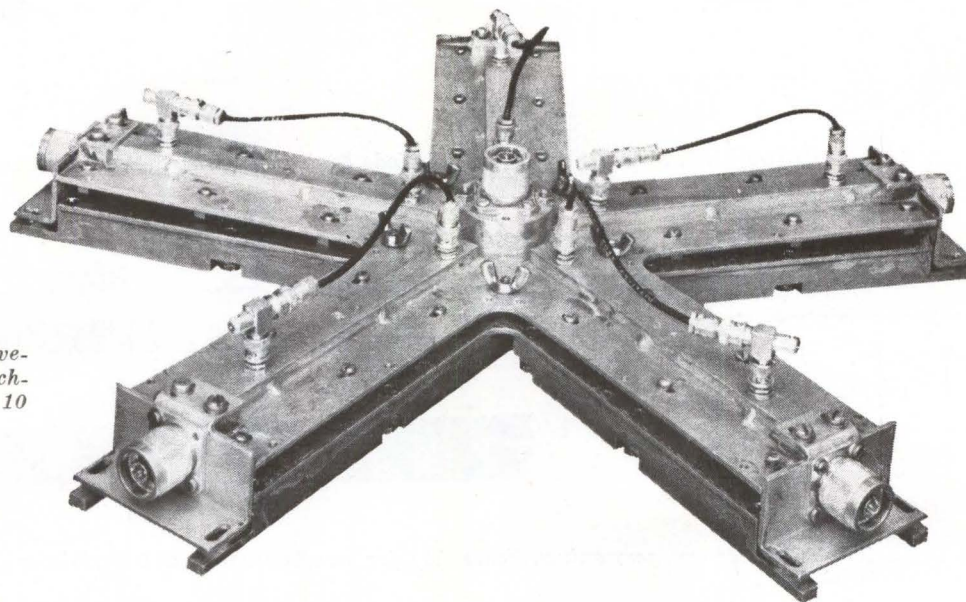

DIODE SWITCH in a five-way configuration has switching times of the order of 10 nanoseconds

Five New Diode Circuits for Nanosecond Microwave Switching

Switches developed for uhf and microwave applications use changing bias to achieve passing and stop conditions

By P. RAVENHILL
H. SMITH

Weapons Control Department,
Westinghouse Electric Corporation,
Baltimore, Md.

UHF AND NEW MICROWAVE devices capable of switching at nanosecond speeds make use of crystal diodes. These switches require low driving power, and are extremely compact. The crystal is a resonant circuit network consisting of nonlinear elements, Fig. 1A. By varying the bias from reverse to forward current, these nonlinear elements can be changed. A reverse current produces a high impedance and a large amount of power is reflected. A forward current decreases the resistance, produces a low impedance and a small amount of power is absorbed. This difference of impedance provides the switching action.

In Fig. 1A, L represents the cat-whisker whose length is unaffected by the bias condition. Fixed resistance R' is dependent on the contact area and conductivity of the diode.

R is the nonlinear barrier resistance of the crystal and point contact whose value is determined by the bias conditions: C is the barrier capacitance whose value is determined by the bias. When reverse bias is applied to the diode, L and R' are small compared to R and C and their values may be neglected.

SWITCHES 1 AND 2—These two switches are similar in that each is a coaxial line structure and each employs the same circuit configuration, Fig. 1B. One operates at 30-120 Mc, the other at 200-400 Mc.

Inductance L_1 isolates the switch from the switching voltage source so that no loss of r-f energy occurs. When forward bias is applied by L_1 , diodes D_1 and D_2 are biased such that forward conduction takes place, while diode D_3 is biased to cutoff. Little incident power is ab-

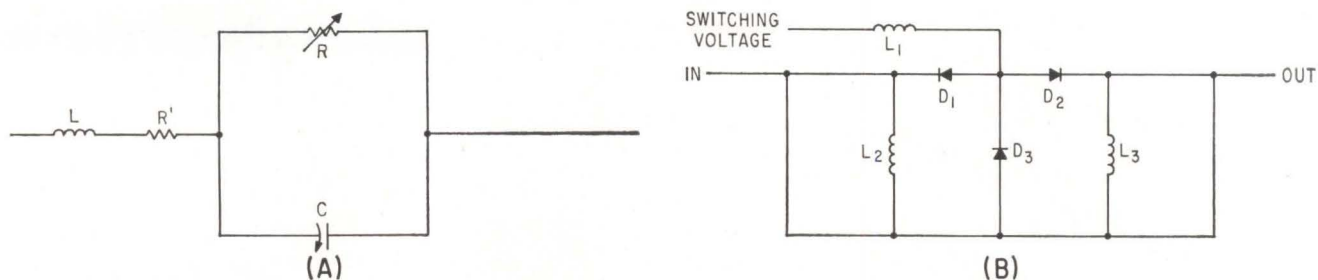

NONLINEAR IMPEDANCES R and C of the crystal diode equivalent circuit (A) and coaxial line switch using silicon diodes (B)—Fig. 1

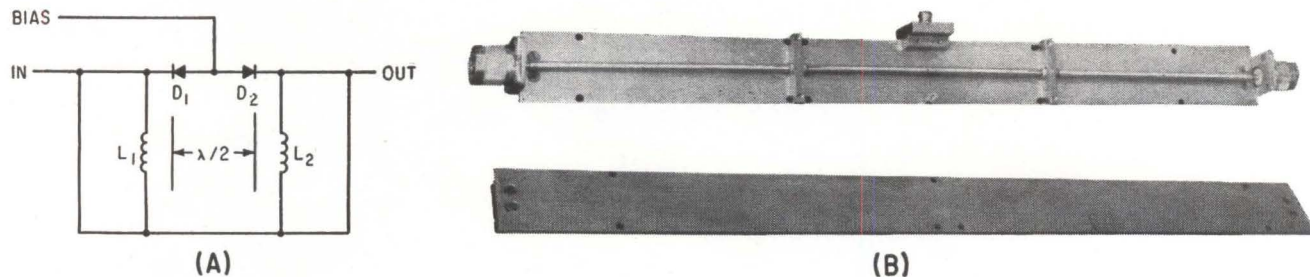

SLAB LINE SWITCH uses two germanium diodes (A) for on-off operation at 1 Gc. Diodes are mounted one-half wavelength apart (B)—Fig. 2

sorbed by the diodes and the majority of power passes down the line. When a voltage of opposite polarity is applied by L_1 , diodes D_1 and D_2 will be biased off and D_3 will be biased on, thus presenting to the input signal a ladder network of high attenuation.

Chokes L_2 and L_3 are connected across the input and output to provide a d-c path for the diodes. These chokes are built into the modified N-type connectors. Using Fairchild FD100 series diodes, switching times in the order of 10 nanoseconds have been achieved with these switches.

Isolation of the 30 to 120-Mc switch is about 80 db. Insertion loss is 3 db. Isolation of the 200 to 400-Mc switch drops from 60 to 50 db as frequency increases. Insertion loss remains constant at 3 db.

SWITCH 3—This 1-Gc switch consists of a 50-ohm slab line structure with two diodes, spaced $\lambda/2$ apart in series with the center conductor, Fig. 2.

Operation is similar to that of

switches 1 and 2. When a forward bias is applied, diodes D_1 and D_2 are biased such that forward conduction takes place. Little power is absorbed by the diodes and the majority of the power passes down the line.

Inductances L_1 and L_2 , which are $\lambda/4$ long, serve as the d-c return paths for the diodes. These inductances are built into the modified N-type connectors. Using 1N263 diodes, switching times in the order of 10 nanoseconds were achieved with isolation values of 35 db and insertion loss of 3.5 db. This switch operated as a single-pole device.

SWITCH 4—This switch consists of five arms joined to a common 50-ohm line. Each arm consists of four diodes inserted in series in the center conductor of the slab line. The operation of the switch is as outlined for switch 3. Figure 3A shows that each arm is a multiple of switch 3.

Using 1N263 diodes, switching times from 3.24 to 3.32 Gc in the order of 10 nanoseconds were achieved. Isolation is 60 db and in-

sertion loss is 8 db over the frequency range.

SWITCH 5—This 5.9 to 6.4 Gc switch consists of two diodes, spaced $\lambda/4$ apart, mounted in a length of RG50/U waveguide, Fig. 4A. Considering one diode only, the operation of the switch is such that when a forward bias is applied, R approaches R' . It attains a value of approximately 10 ohms, and now shunts C , Fig. 4B.

At 6 Gc, this circuit has a $Q = X_L/R = 120/20 = 6$, transforming this to waveguide simple equivalent circuit, $R = QX_L = 6 \times 120 = 720$ ohms. This is a parallel R - L circuit as shown in Fig. 4C.

The diode in shunt with the waveguide results in a low standing wave ratio with incident power being absorbed, and most of the power passing down the waveguide. When back bias is applied to the diode, R becomes large and is shunted by C , Fig. 7D. C now resonates with L and the diode in shunt across the waveguide presents a high standing wave ratio. Most of the incident power will be reflected, while a

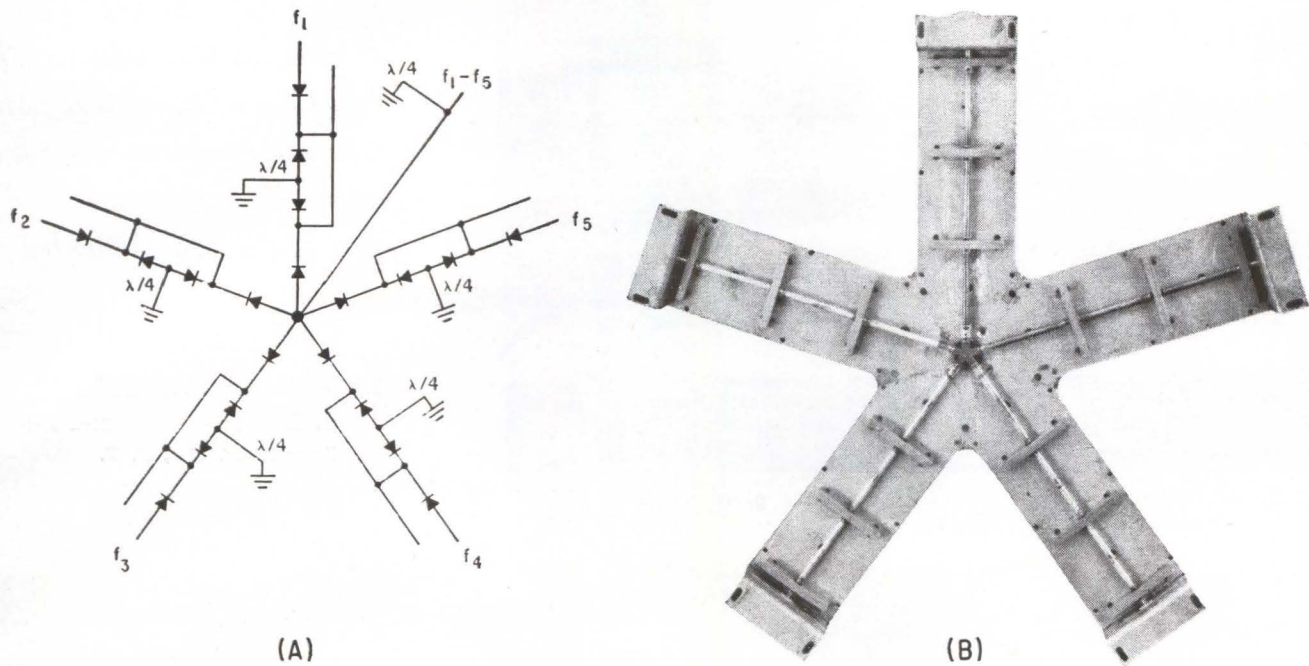

FIVE WAY switch at S-band is a slab line structure using germanium diodes (A). Center conductors (B) contain four diodes in series—Fig. 3

small amount of power will be absorbed by the diode and the load terminating the waveguide. Insertion loss is 4 db over the frequency range and isolation varies from 40 to 45 db.

APPLICATIONS — The switching voltage is normally an 8-volt pulse which produces a forward current in each diode in the signal conducting path of 10-20 ma. This current is sufficient to insure that the series resistance presented by each series diode is low enough to minimize insertion loss without raising diode dissipation to an intolerable level. The reverse voltage applied to the

switch in the nonconducting mode should be sufficient to produce 4-8 volts across each of the cut-off diodes in the signal path.

The sum of the bias voltage and the peak signal applied should not be of such an amplitude that the voltage across any reverse-biased diodes exceeds the reverse breakdown value for the diodes. Peak signal current through the diodes when the switch is in the conducting mode should not exceed the switching current supplied by the switching waveform. Power handled by the switches is dependent on the type of diode used, but powers of the order of 10-500 mw

have been successfully switched.

Mechanically the switches present no more than the usual problem encountered in the construction of high frequency devices, namely, that the effect of discontinuities, that is, the diodes, are kept to a minimum so that the vswr in the conducting mode is kept as low as possible. For certain diode types, this means that matching sleeves of dielectric or metal, depending on the nature of the discontinuity, must be used with each diode.

These switches are restricted in both power-handling capacity and bandwidth. This restricts the range of possible application to powers of 2-5 watts and less and to bandwidths less than 5 percent of center frequency. In these respects the switches are inferior to ferrite devices or mechanical coaxial and waveguide switches. But where a high switching speed is required, the switches described are indispensable. Switching speeds of several microseconds are possible with ferrite devices, but with crystal switches, switching times of several nanoseconds have been obtained.

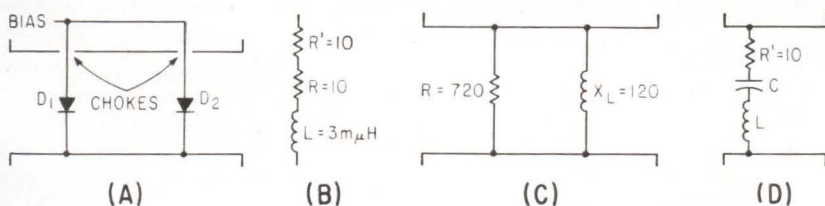

WAVEGUIDE SWITCH contains two germanium diodes one-quarter wavelength apart (A). Equivalent circuit of one diode with forward bias (B) and the waveguide equivalent circuit at 6 Gc. Waveguide equivalent circuit with reverse bias (D)—Fig. 4

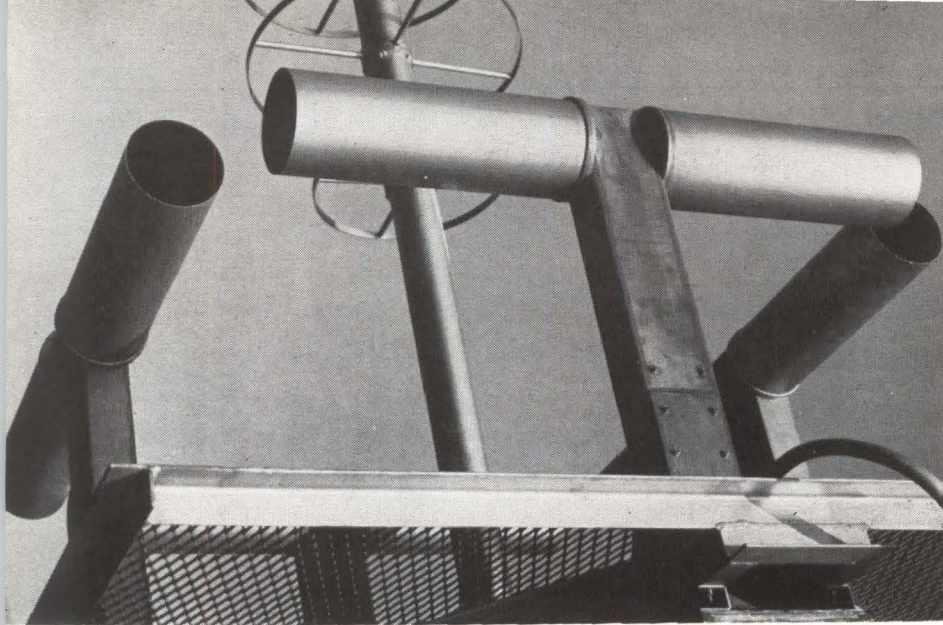

THIS DIPOLE, designed by the procedure given in text, yielded impedance data shown in Fig. 2C

Using a zero-pole analysis for a composite dipole-balun circuit, it becomes possible to achieve the widest bandwidth for a given maximum vswr. Equations and design procedure are presented

By HAROLD SHNITKIN

S. LEVY Antenna Div., Avien,
Long Island City, N. Y.

Getting Maximum Bandwidth With Dipole Antennas

DIPOLE RADIATORS used in broadband antenna systems must often match a coaxial transmission system over more than an octave in frequency. Low standing waves are essential for high transmission efficiency as well as phase and amplitude accuracy in dipole excitation.

Since dipoles are balanced circuit elements (two radiating arms have equal impedance to ground) while coaxial cables are unbalanced (one conductor always grounded), a balanced-to-unbalanced transformer called a balun is usually incorporated within the dipole structure. This balun is always antiresonant at the center frequency and exhibits shunt susceptances elsewhere.

Dipoles are resonant only at a number of specific frequencies while exhibiting series reactances elsewhere; consequently, wideband applications require a technique for counteracting the dipole reactances off resonance. The usual approach is to match the dipole at the center frequency and to count on the balun susceptance, which appears in parallel with the dipole arms (see Fig. 1A), to cancel the equivalent shunt susceptance of the dipole near the band edges.¹

This article discusses the susceptance cancellation phenomenon, from which an optimum bandwidth design, exhibiting maximum vswr values at both center frequency and band edges, can be derived. Included also are the theoretically obtainable bandwidths for given maximum vswr values, design equations for determining balun impedance, balun length, gap ca-

acitance and generator impedance. The analytical approach makes use of a zero-pole plot of the reflection coefficient on a complex frequency plane for the composite dipole-balun circuit, referenced to the dipole center. This procedure is similar to the customary zero-pole plots of impedances.

CIRCUIT ANALYSIS—An equivalent lumped element circuit of the combined dipole and balun structure, referenced to the dipole center, is shown in Fig. 1B. Resistor R represents the dipole radiation resistance, L_D and C_D the off-resonance dipole reactance, C the gap capacitance, L_B the balun inductance consisting of a shorted stub usually less than 0.2 wavelength long and resonating with the gap capacitance; Z_0 is the required effective generator impedance at the dipole center. The latter takes impedance transformations between dipole center and generator into account. To simplify the subsequent expressions for admittance and reflection coefficient, the following definitions are made:

$$Q = \omega_0 L_D / R \quad K = L_D / RC = Q / \omega_0 C$$

Where ω_0 is the resonant or center frequency and Q the dipole quality factor, which is readily obtainable from the physical dipole dimensions. A complex frequency variable S must now be defined as the frequency deviation from resonance or the difference between the true complex frequency and the resonant frequency ω_0 . Input admittance and its reflection co-

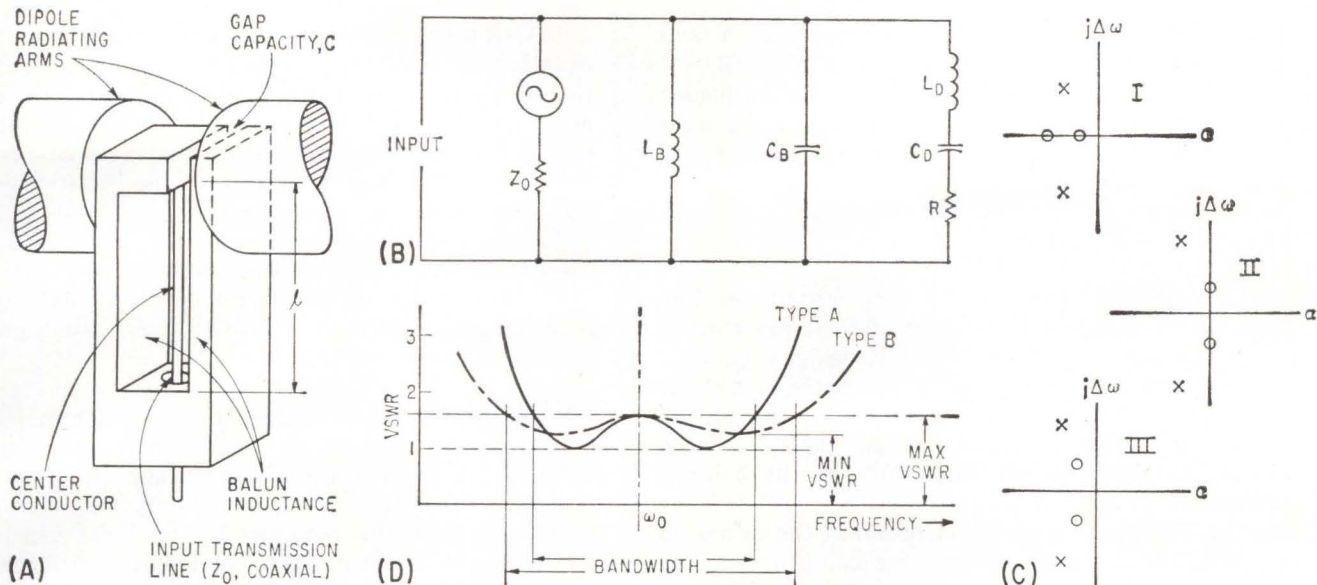

TYPICAL DIPOLE STRUCTURE with balun (A) has the equivalent circuit of (B); three types of zero-pole plots of gamma are given in (C) and plots of predicted vswr against frequency for broadband designs in (D)—Fig. 1

efficient can then be written as follows:

$$Y_{in} = \frac{(2Q/\omega_0 K)S^2 + S/K + \omega_0/2QR}{S + \omega_0/2Q}$$

$$\Gamma = \frac{S^2 + (\omega_0/2Q - K\omega_0/2QZ_0)S + (K/R)(\omega_0/2Q)^2(1 - R/Z_0)}{S^2 + (\omega_0/2Q + K\omega_0/2QZ_0)S + (K/R)(\omega_0/2Q)^2(1 + R/Z_0)}$$

The expression for gamma can lead to three zero-pole configurations (Fig. 1C). The value of gamma can be found graphically by selecting an operating frequency on the imaginary axis and drawing vectors from every zero and every pole to this point. Gamma is then computed as the product of the vectors drawn from all zeros, divided by the product of the vectors drawn from all poles.² This procedure shows that diagram I of Fig. 1C constitutes a narrowband design since the zeros are both closest to the center fre-

quency. Thus the reflection coefficient increases monotonically as the frequency deviates from resonance. A more broadband design would be that of diagrams II and III, which result in doubly tuned characteristics of $|\Gamma|$ as well as of vswr (Fig. 1D). The zero-pole plot II yields zero values of gamma at two off-resonant frequencies, resulting in unity minimum values of vswr. This configuration will be called Type A design and its vswr characteristic is shown in Fig. 1D. This design (Type A) demands that the middle term in the numerator vanish and therefore, $K = Z_0$. The zero-pole plot III makes it possible to achieve the widest bandwidth for a given maximum vswr. The corresponding vswr characteristic, shown as Type B design in Fig. 1D, is also doubly tuned but does not have any unity minimum vswr values.

To avoid the zero-pole configuration I, the term $1 - R/Z_0$ must be positive. Furthermore, at the center frequency $S = 0$ and gamma reduces therefore to $(Z_0/R - 1)/(Z_0/R + 1)$ so that the maximum vswr value at the center frequency can be defined by $vswr = Z_0/R$.

These changes result in the modified expressions for gamma given in the table.

DIPOLE - ANTENNA DESIGN EQUATIONS

	Type A Design	Type B Design
K	Z ₀	(Z ₀)(vswr)
f _{max} /f _{min}	$\frac{Q + \sqrt{(vswr-1)/2}}{Q - \sqrt{(vswr-1)/2}}$ (See Fig. 2A)	$\frac{2Q + \sqrt{(vswr)^2 - 1}}{2Q - \sqrt{(vswr)^2 - 1}}$ (See Fig. 2A)
C	Q/(ω ₀ Z ₀)	Q/(ω ₀ Z ₀ • vswr)
l	$(V_p/\omega_0) \arctan(Z_0/Z_{0B}Q)$ (V _p = phase velocity)	$(V_p/\omega_0) \arctan(Z_0 vswr/Z_{0B}Q)$ (V _p = phase velocity)
vswr _{min}	1.0	$\frac{(vswr-1)^{3/2}(3vswr+1)^{1/2} + (vswr+1)^{3/2}(3vswr-1)^{1/2}}{(vswr-1)^{3/2}(3vswr+1)^{1/2} - (vswr+1)^{3/2}(3vswr-1)^{1/2}}$ (See Fig. 2B)
Gamma	$\frac{S^2 + (\omega_0/2Q)^2(vswr-1)}{S^2 + (\omega_0/2Q)^2(vswr+1)}$	$\frac{S^2 + (\omega_0/2Q)(1-vswr)S + (\omega_0/2Q)^2(vswr)(vswr-1)}{S^2 + (\omega_0/2Q)(1+vswr)S + (\omega_0/2Q)^2(vswr)(vswr+1)}$

BANDWIDTH—To establish the bandwidth over which a maximum given vswr can be maintained, the reflection coefficient magnitude equivalent to this vswr value is equated to the general equation of reflection coefficient magnitude and solved for the frequency variable S, now signifying the half-bandwidth ΔS. The ratio of maximum frequency to minimum frequency is as follows:

$$f_{max}/f_{min} = \frac{j\omega_0 + \Delta S}{j\omega_0 - \Delta S}$$

For Type A design ($K = Z_0$) this procedure leads to the frequency ratio expression shown in the table and plotted in Fig. 2A. To establish bandwidths for Type B design, the expression for ΔS must be max-

imized by differentiating it with respect to K and equating to zero. The resulting value of $K = (Z_o) \times (\text{vswr})$ is then used to evaluate ΔS and the frequency ratio (table and Fig. 2A). The corresponding minimum vswr for a specified maximum vswr is found by differentiating the magnitude of gamma, equating to zero and substituting; the results are shown in the table and Fig. 2B.

BALUN DESIGN—Since the gap capacitance has been previously defined in terms of K , it can now be evaluated for both Type A and B designs (table). Balun dimensions are derived by resonating the balun inductance with the gap capacitance at the center frequency so that $1/\omega_o C = Z_{ob} \tan(\omega_o l/v_p)$, where Z_{ob} is the characteristic impedance of the balance transmission line, v_p its phase velocity and l its length. With the proper substitution of the values of C for Types A and B designs, the balun length can be expressed as in the table.

DESIGN PROCEDURE—(1) Bandwidth and maximum vswr specs must be used together with the curves of Fig. 2A, to determine whether Type A or B design is more suitable and to arrive at the required value of Q .

(2) The dipole Q must be determined either by independent measurement of the particular arm configuration (impedance plot) or by computation¹, where for a half-wave resonant dipole: $Q = 94/R[\ln(\lambda/D) - 1]$. The quantity D stands for the equivalent diameter of the dipole arm cross section. If the cross section is square, D becomes $1.18 \times$ the side of the square; if the dipole arms are flat sheets, the value of D becomes $\frac{1}{2}$ the width of the strip. (For other configurations, see Ref. 3). Quantity R is the resonant radiation resistance which is 72 ohms for a half wave dipole radiating into free space and 83 ohms when placed a quarter wavelength in front of a reflecting plane.

The minimum value of Q attainable lies between 2 and 2.2 (dipole reactances change their behavior at very large arm diameters). Should a design call for a Q below these minima, either the bandwidth must be reduced or the maximum vswr raised.

(3) Dipole length must be chosen for resonance at the center frequency by conventional techniques.⁴ Thus half-wave dipole length = $0.48 \lambda_o / (2D/\lambda_o + 1)$.

(4) Gap capacity is determined according to the equations in the table. The surface area and separation of the capacitor plates may be calculated for the desired dielectric constant.

(5) Z_{ob} must be calculated as the balanced (even mode) characteristic impedance of the three-wire or slab line comprising the balun.

(6) Balun dimensions can now be determined in accordance with the table equations.

(7) Impedance transformer from Z_o to characteristic impedance of coaxial feed line can be designed by conventional techniques.

EXAMPLE—A dipole design is desired for the frequency band of 350 Mc to 600 Mc with a maximum vswr of 1.5. Checking with the graph for Type A design, a Q of 1.9 is needed to satisfy the vswr requirement over the required 1.7 to 1 frequencies. This value of Q is considered too low so that Type B design must be evaluated. Here the required Q value is 2.1. A length-to-diameter ratio of 7.1 is selected to yield a $Q = 2.1$, since $R = 83$ ohms, and the dipole is located in front of a ground plane. Figure 2A yields a maximum vswr of 1.45. Dipole length is now computed at 475 Mc as 10.62 in. and the dipole arm diameter as 1.5 in. A gap capacitance of 4 pF is needed, and a balun length of 3.15 in. with balun characteristic impedance of 85 ohms is used to resonate this capacitance at 475 Mc. The required generator characteristic impedance is $(R) \times (\text{vswr})$ or 120 ohms. The type of balun employed (Fig. 1A) incorporates a 4:1 impedance transformation independent of frequency, because each dipole arm is excited by only half the current of the input coaxial lines.⁵ Thus a 37-ohm $\frac{1}{4}$ -wavelength transformer is incorporated so that the 50 ohm generator impedance appears as 30 ohms to the dipole. The 4:1 balun impedance transformation raised this value to 120 ohms, as required by the design equation $Z_o = (R) \times (\text{vswr})$. A model of the dipole thus designed, shown in the photo, yielded the impedance data shown in Fig. 2C.

REFERENCES

- (1) E. C. Jordan, "Electromagnetic Waves and Radiating Systems", Prentiss-Hall, para. 14.04 and para. 13.01.
- (2) Van Valkenberg, "Network Analysis", Prentiss-Hall.
- (3) H. Jasik, "Antenna Engineering Handbook", McGraw-Hill, p. 3.
- (4) J. D. Krauss, "Antennas", McGraw-Hill.
- (5) S. Silver, "Microwave Antenna Theory and Design", McGraw-Hill, sec. 8-4.

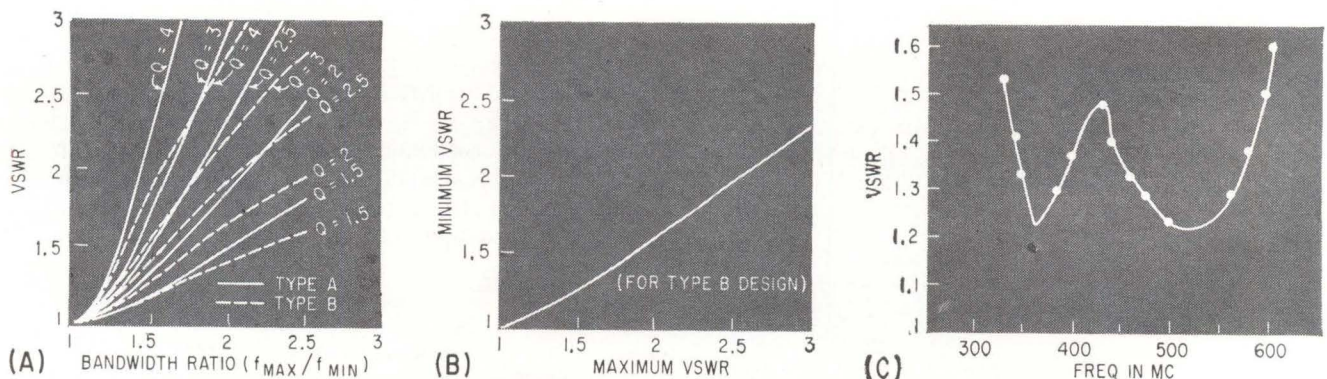

FOR A AND B—TYPE designs, this is the vswr plotted against bandwidth ratio (A); for type B, the minimum vswr's that correspond to specified maximum vswr's (B); and measured vswr of dipole example (C)—Fig. 2

What Is the Optimum Mode for Magnetostrictive Delay Lines?

To obtain the maximum benefit from magnetostrictive delay lines in computer applications, differences between several possible return-to-zero and non-return-to-zero modes of operation must be understood and exploited properly

By ARTHUR ROTHBART
Consulting Engineer, New York, N. Y.

ALAN J. BROWN
AIL Div., Cutler-Hammer Inc., Deer Park, N. Y.

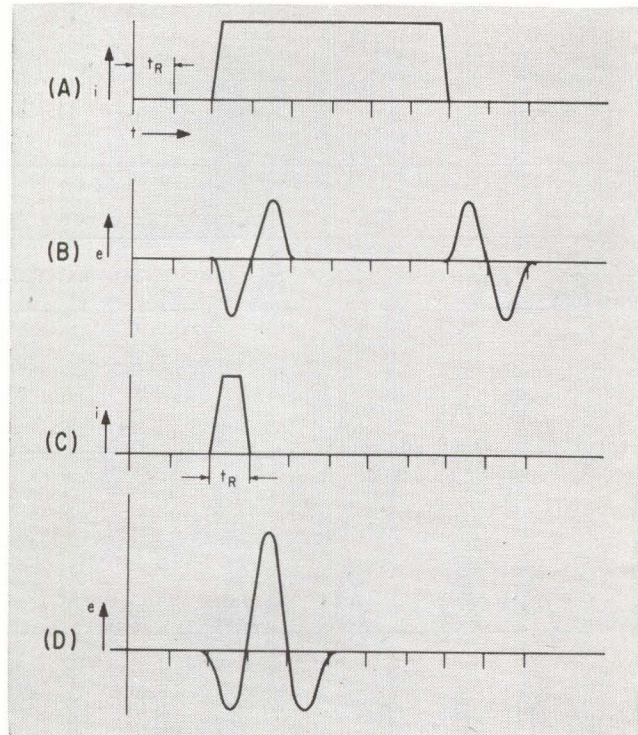

WIDE CURRENT PULSE (A) applied to input produces waveform (B) at output. Narrow input current pulse (C) produces output triplet (D)—Fig. 1

MEMORY SYSTEMS for small digital computers may be magnetic drums, magnetic cores, or magnetostrictive delay lines. Drum memories are relatively low cost but operate at low speeds. Core memories operate at higher speeds at substantially higher costs. On the other hand, memories using magnetostrictive delay lines offer both high speed and low cost. Additional advantages are simplicity of the associated transistor circuits, temperature stability, expandability, and high reliability with minimum maintenance.

When a step function of current is applied to the input coil of a properly constructed and operated magnetostrictive delay line under the linear conditions of small signal operation, a voltage doublet¹ is generated across the output coil. The peaks of the doublet will be symmetrical in shape and have equal amplitudes. Positive and negative current steps will

produce identical doublets except for reversed polarity. Either polarity of doublet may be obtained with either polarity of input current by reversing the output coil connections. In this discussion, assume that a positive input current step generates an output doublet whose first peak is negative.

Time spacing, t_R , between the doublet peaks determines the delay-line resolution. This is the minimum spacing between adjacent amplitude changes in the input current which the delay line can distinguish. For example, if t_R is $0.5 \mu\text{s}$, the line can store bits of information which are $0.5 \mu\text{s}$ apart. This permits a maximum information rate of 2 Mc in a non-return-to-zero (nrz) mode. In a return-to-zero (rz) application, the maximum information rate or pulse repetition frequency (prf) becomes 1 Mc for the same value of t_R .

In selecting a magnetostrictive delay line, if maxi-

imum storage capacity at the highest clock rate is desired, nrz operation should be specified. In many applications the maximum storage obtainable in nrz operation may not be needed. Then the rz mode at one-half the digit rate with a consequent simplification and lower cost of associated circuits may be chosen.

RZ OPERATION—When a wide current pulse, Fig. 1A, is applied to the input coil of a delay line, the output voltage waveform, Fig. 1B, consists of a pair of doublets of reversed phase separated in time by the width of the input pulse. As the input pulse is

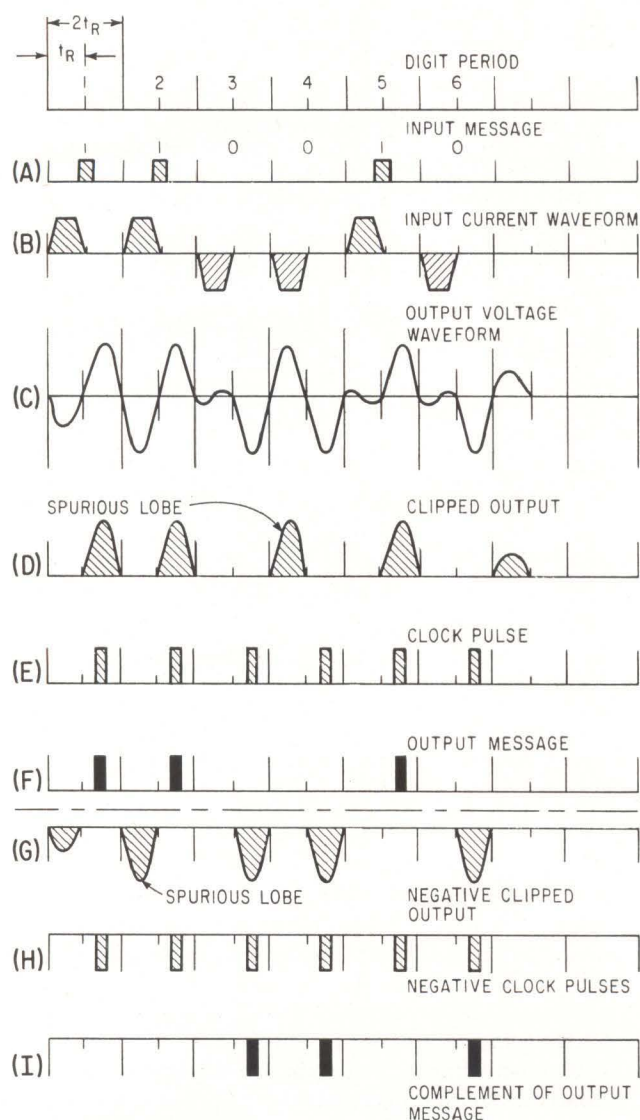

BIPOLAR RZ mode is characterized by the presence of a negative pulse when a digital zero is transmitted—Fig. 2

TWO-LEVEL GATE method for nrz operation applies output waveform to a flip-flop for detection—Fig. 3

narrowed to a width equal to t_R , Fig. 1C, the doublets will overlap to form the triplet in Fig. 1D. The center section of the triplet, which is reversed in phase with the end sections, has twice their amplitude. This center section is clipped, shaped, and strobed in rz applications.

In conventional rz operation, a digital 1 is generated by applying to the input coil a current pulse whose width is equal to t_R . A digital 0 is indicated by the absence of a pulse. The minimum digit spacing for maximum resolution is $2t_R$. For example, if t_R is $0.5 \mu s$, the digital period is $1 \mu s$ and the corresponding prf is 1 Mc. The digital message, is transmitted along the delay line by the input current waveform. The positive portion of the amplified output waveform is clipped. This waveform is strobed by the clock pulses to recover the output message.

The clipped output may be squared and widened to the full digital period of $2t_R$ before strobing. If this is done, the total change in delay of the line due to variations in temperature and other factors can be slightly less than $2t_R$. In practice, the change in delay is limited to a smaller value to obtain a sufficient safety factor.

Bi-polar rz operation, Fig. 2 which is similar to the conventional method, has the added feature that a digital 0 is transmitted as a current pulse of the opposite polarity to that of a digital 1. The digital message, 110010, Fig. 2A, is transmitted along the delay line by the input current waveform, Fig. 2B. The positive portion of the amplified output waveform, Fig. 2C is clipped to obtain Fig. 5D. This waveform is strobed by the clock pulses in Fig. 2E to recover the output message in Fig. 2F.

The negative portion of the output waveform may be clipped to obtain Fig. 2G which can be strobed by the clock pulses, Fig. 2H to recover the digital

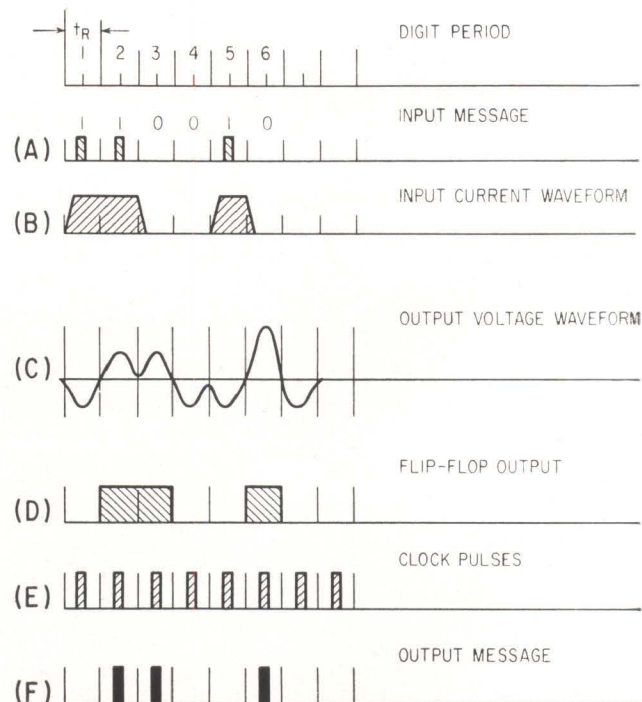

zeroes, Fig. 2I, which form the complement of the output message. This feature adds redundancy to the operation.

The most important advantage of bi-polar operation is the reduction in bandwidth of the output amplifier. In conventional rz operation, in order to avoid low-frequency distortion in random digital patterns, the output amplifier must have an excellent low-frequency response. In bi-polar operation, the amplifier bandwidth may be restricted from a lower limit of one-half of the prf to the prf. The narrowed bandwidth reduces low-frequency noise, and permits more effective automatic gain control of the amplifier.

One disadvantage of bi-polar operation is the limitation of delay variation in the line to one-half that of conventional operation to avoid spurious lobes. Therefore, the temperature coefficient of delay of a given line must be halved to insure an equivalent safety factor.

NRZ OPERATION—In an nrz mode, the digital period is equal to t_r as compared to $2t_r$ for rz operation. Therefore, the storage capacity of a delay line may be doubled in an nrz application.

In one nrz method, which has been used in a high-speed serial general purpose computer², a two-level amplitude gate is transmitted along the delay line. One level represents digital ONES; the other level represents digital 0, Fig. 3. The digital message, 110010, Fig. 3A, is transmitted along the delay line by the input current waveform in Fig. 3B. Output waveform, Fig. 3C is amplified and squared, before it is applied to a flip-flop which changes state whenever the applied signal changes polarity. The output of the flip-flop, Fig. 3D is strobed by the clock pulses in Fig. 3E to recover the output message in Fig. 3F.

This nrz method, although economical, suffers from delay-line noise that can cause uncertainty in the zero axis crossing and shift the point at which the flip-flop changes state.

Delay-line noise may be avoided by another nrz detection technique³, which compares a delayed (time delay of t_r) and inverted output waveform with the original output. This technique will now be described in conjunction with an input current waveform which changes level each time a digital 1 is to be transmitted, Fig. 4. The digital message, 110010 in Fig. 4A, is transmitted along the delay line by the input current waveform in Fig. 4B. The original output signal and the processed output signal are shown in Figs. 4C and 4D, respectively. The positive portions of each waveform are removed by clipping, Figs. 4E and 4F, and are AND gated against each other to produce Fig. 4G.

Negative portions of the output signals are clipped, Figs. 4H and 4I, and are AND gated against each other to obtain Fig. 4J. This waveform is inverted and combined with Fig. 4G to provide Fig. 4K which is strobed by the clock pulses, Fig. 4L, to recover the output message, Fig. 4M.

Either type of nrz transmission technique, the two-level gate in the first method or the digital ONES

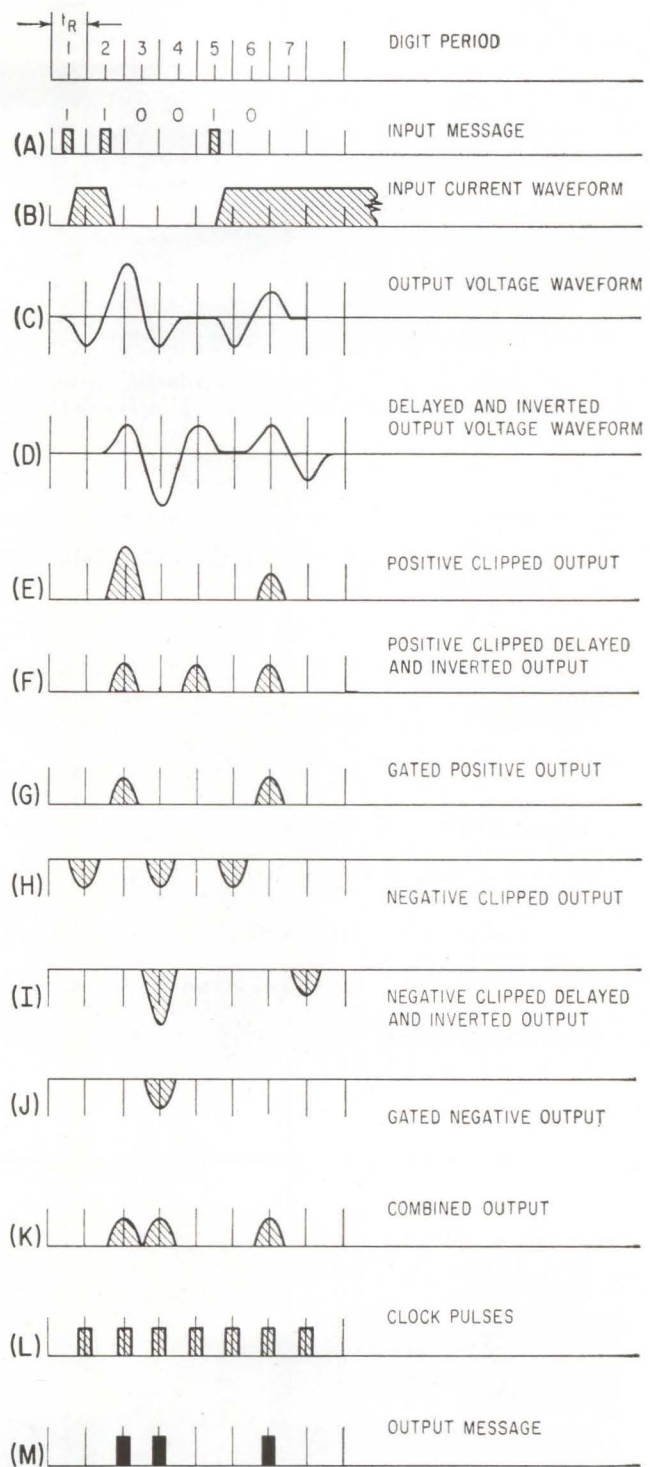

COMPARISON of a delayed and inverted output waveform with the original output avoids delay line noise in another nrz detection method—Fig. 4

in the second method, may be used with either flip flop or comparison detection.

REFERENCES

1. A. Rothbart and A. J. Brown, How to Specify Magnetostrictive Delay Lines, *ELECTRONICS*, p 54, May 18, 1962.
2. R. M. Beck, PB 250—A High-Speed Serial General Purpose Computer Using Magnetostrictive Delay Storage, *Proc EJCC*, New York, N. Y., p 283, Dec., 1960.
3. A. Rothbart, A Non-Return to Zero (NRZ) Mode of Operation for a Magnetostrictive Delay Line, *Proc IRE (Correspondence)*, 48, p 1,486, Aug., 1960.

Novel Slotted

By LUIS L. OH and C. D. LUNDEN
The Boeing Co., Transport Div., Renton, Wash.

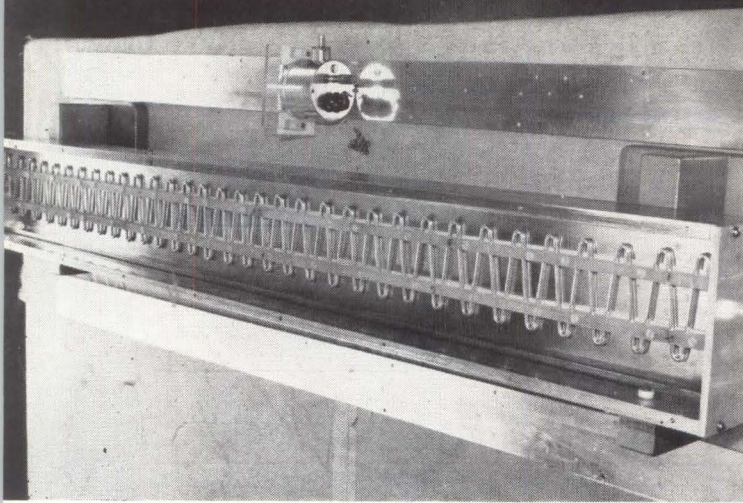

SLOTTED LINE No. 1 has a wave retardation factor of 5, a range from 25 to 200 Mc, and is 62½ inches long

FOR VSWR AND IMPEDANCE measurements at uhf and in the microwave region, a conventional slotted line operating down to 25 Mc would be from 10 to 15 feet long.

But a slotted line designed using a serpentine slow-wave technique will measure vswr and impedance down to 25 Mc and is only 3 to 5 feet long.

The vhf slow-wave slotted line consists of conductor formed in a serpentine shape and placed over a conducting ground plane. A fundamental wave travels along the serpentine line with the velocity of light and another much slower wave travels along the axis of the line. If the line is terminated with a load other than its characteristic impedance, a standing wave will exist along the line, but the wavelength is much shorter than in free space.

The ratio of free-space wavelength, λ_0 , and the axial serpentine line wavelength, λ_s , is termed the wave-retardation factor and is approximately $\lambda_0/\lambda_s = \sqrt{\epsilon} \csc \psi = \sqrt{\epsilon} 2L/P$ (see Fig. 1A).

The characteristic impedance of the serpentine line above a conducting plane can be calculated as the impedance of a straight wire over

ELECTRICAL CHARACTERISTICS AND DIMENSIONS OF THE SLOTTED LINES

Slotted Line	No. 1	No. 2*	No. 3
Frequency Range in Mc	25 to 200	(a) 25 to 200 (b) 200 to 500	25 to 250
Characteristic Impedance in ohms	50 ± 1	(a) 50 ± 1 (b) ± 0.5	50 ± 0.5
Wave-Retardation Factor	5	(a) 8.3 (b) 1.25	8.75
Residual VSWR (Max.)	1.05	1.05	1.05
Short Circuit VSWR (Min.)	100:1	100:1	60:1
Connectors	UG 270/U	UG 58/U	UG 58/U
Detector Element	1N21	1N21	1N21
Tuner	Lump L-C circuit	Semidistributed L-C circuits	Semidistributed L-C circuits
Dimensions in inches	3 × 6¾ × 62½	3¾ × 6 × 36	3½ × 6 × 36
Weight in pounds	40	30	23

* (a) serpentine line side, (b) straight line side

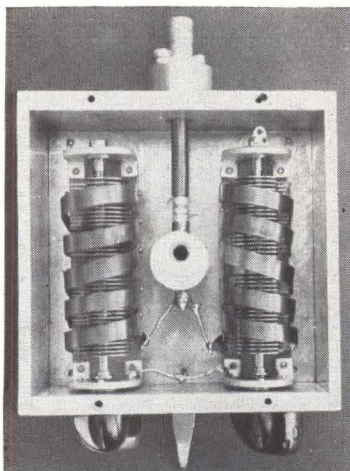

GANGED CAPACITORS inside coils make up the probe

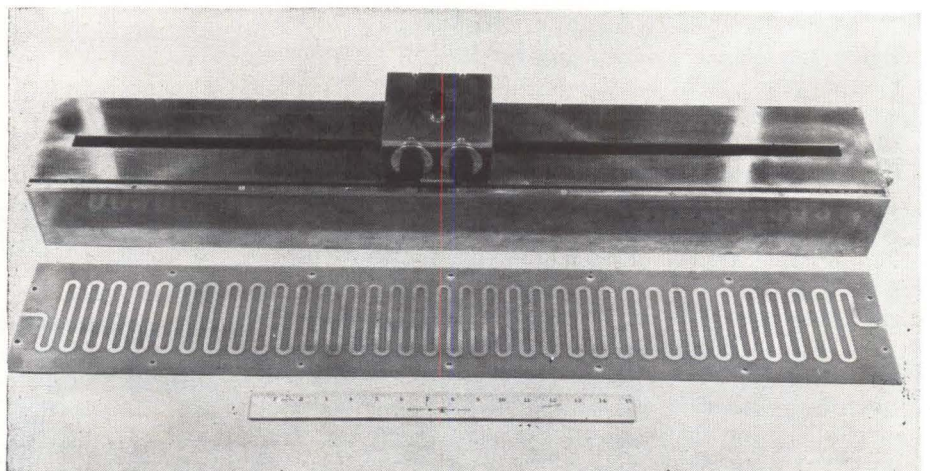

SLOTTED LINE No. 3, with traveling probe, is only three feet long but can be used from 25 to 250 Mc

Line Uses Slow-Wave Technique

an infinite ground plane. If the spacing between the serpentine line and the plane is small compared to the spacing between adjacent legs of the line, the error due to increased distributed capacitance is negligible, and the characteristic impedance is $Z_0 = (60/\sqrt{\epsilon}) \cosh^{-1}(2h/d)$, where ϵ = composite dielectric constant of the materials surrounding the wire, h = distance between the center of the wire and the ground plane, and d = diameter of the wire.

Data on three experimental models of the slow-wave slotted line are given in the table. Lines No. 1 and 2 were formed with $\frac{3}{16}$ -inch aluminum rod and No. 3 with $\frac{3}{16}$ -inch wide by 0.002-inch thick printed circuit.

The serpentine line of line No. 1 is insulated from the ground plane by two thin strips of Teflon tape and is secured by two Rexolite bars.

The structure in line No. 2 (Fig. 1) is similar to line No. 1 except that the retardation factor was increased to about 8, thus reducing the length of the line from 5 feet to 3 feet. A thin Teflon sheet insulates the serpentine line from the conducting ground plane, and a sheet of $\frac{1}{4}$ -inch Plexiglas maintains a uniform distance between the serpentine line and the ground plane. Slotted line No. 2 is recommended

for use from 25 to 200 Mc. Beyond this frequency the loss becomes excessive and the residual voltage standing wave becomes too high for accurate measurements. To extend the frequency to 500 Mc, another line structure is placed on the other side of the ground plane. The second line consists of a $\frac{3}{16}$ -inch straight aluminum rod placed over the common conducting ground plane. The straight line is insulated from the ground plane with thin Teflon tape and held in place with a $\frac{1}{4}$ -inch-thick Teflon sheet. Because of the proximity of the dielectric to the line, the velocity of the wave is slowed by a factor of 0.8, or a wave retardation factor of 1.25. Two coaxial terminals are provided for each line structure. To go from one line structure to the other, the probe tuner is removed and the slotted line is turned over to the desired side.

TUNABLE PROBE—The tunable (25 to 1,000 Mc) probe operates on the same principle as a double stub tuner, but two semi-distributed L-C circuits are used in place of the stubs. Two sets of identical semi-distributed L-C circuits are connected in parallel and are housed in an aluminum casing (see photograph). Each set of L-C circuits consists of an inductance coil wound

around six ganged variable air capacitors. Since the capacitors are inside the coil, a change in capacitance also changes the inductance of the coil, thus increasing the tuning range of the circuit.

Critical tolerances in the slow-wave slotted line are the uniformity of the serpentine line and its spacing from the ground plane. Non-uniformity of the line causes errors in wavelength measurement while variation in ground spacing causes impedance variations. Characteristic impedances¹ are shown in Fig. 2.

The gradual upward slope of the impedance plots is caused partly by losses in the lines. Since the sampling oscilloscope always sees the sum of the incident and reflected voltages, the upward slope of the reflected voltages is also caused by the rising incident voltage at the input of the slotted line. Measurements with a coaxial sliding short at the load end of the slotted lines show that the slow-wave standing wave minimum moves with that of the sliding short at the rate of the wave-retardation factor.

REFERENCE

- (1) H. Halverson, Testing Microwave Transmission Line Using the Sampling Oscilloscope, *ELECTRONICS*, 34, p 86, June 30, 1961.

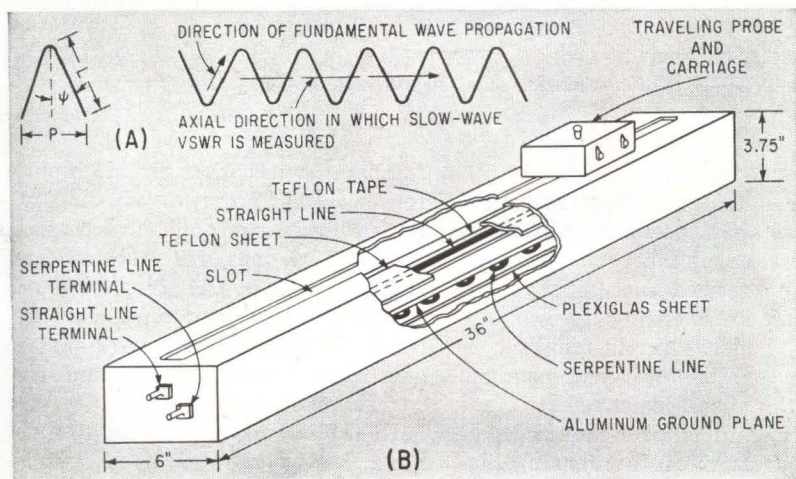

WAVE PROPAGATION in slow-wave structure (A), and cutaway view of slotted line No. 2, which covers 25 to 500 Mc in two ranges—Fig. 1

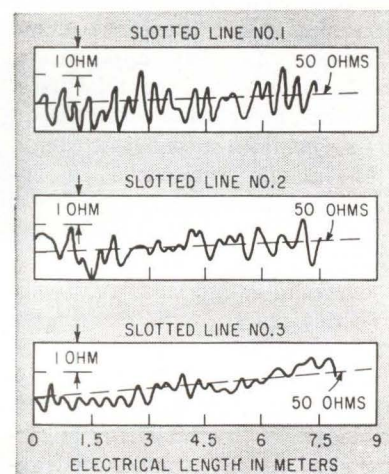

MEASURED characteristic impedance for three lines—Fig. 2

PERFORMANCE of guidance and tracking systems is dependent on shaft-position measurements made by encoders like these typical units shown in their cases

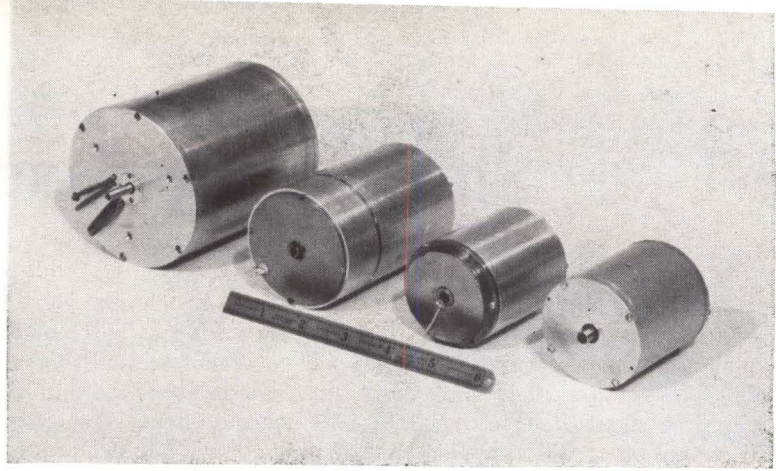

How to Select SHAFT-POSITION ENCODERS

Guidance and tracking system performance is no better than measurements of shaft position and velocity. Shaft-position information can be obtained in digital or analog form using a variety of techniques. Selection for a particular application requires consideration of their relative merits

By FRED W. KEAR
Lytle Corp., Albuquerque,
New Mexico

MEASUREMENT of small changes in shaft position is the factor that limits performance of many integrating and tracking systems. Devices for measuring shaft position and speed may be used in equipment that determines the relative bearing of targets or the courses of aircraft and missiles. Accuracy and resolution are therefore prime requirements for these applications as well as for some industrial uses. Other characteristics desired in shaft position-measuring techniques include resistance to environmental influences.

ENCODER TYPES — Shaft-position encoders range from relatively simple devices through more complex arrangements with improved operating characteristics to sophisticated designs under development. Knowledge of methods for measuring shaft position and speed enables performance characteristics to be selected in accordance with

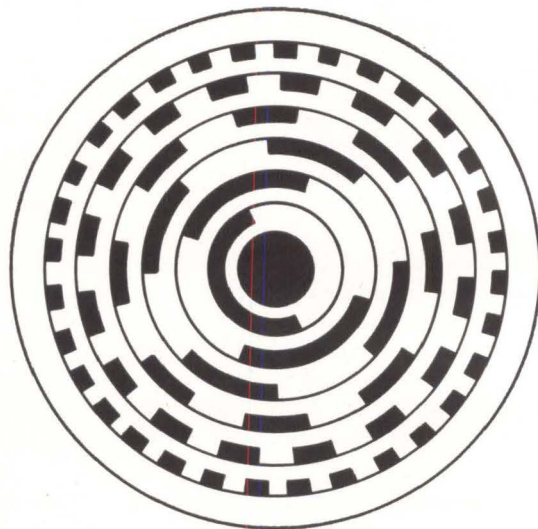

OUTER TRACK of disk encodes least significant bit—Fig. 1

the intended uses.

Several factors affect measurements of shaft position and speed, limiting the number of methods that can be used successfully. In designing an encoding system, the first consideration is finding a method for sensing small changes in angular displacement that is not susceptible to environmental influences. Output of the sensing element must be read electronically or electromechanically, and it must be

compared with other circuit inputs for encoding, recording or display. Both digital and analog encoders are used to measure and indicate changes in angular displacement. Sometimes the two methods are combined to advantage, with analog and digital outputs compared for correction.

Reliability in an encoding system must be weighed against system cost. Often many coding circuits can be eliminated by maintaining

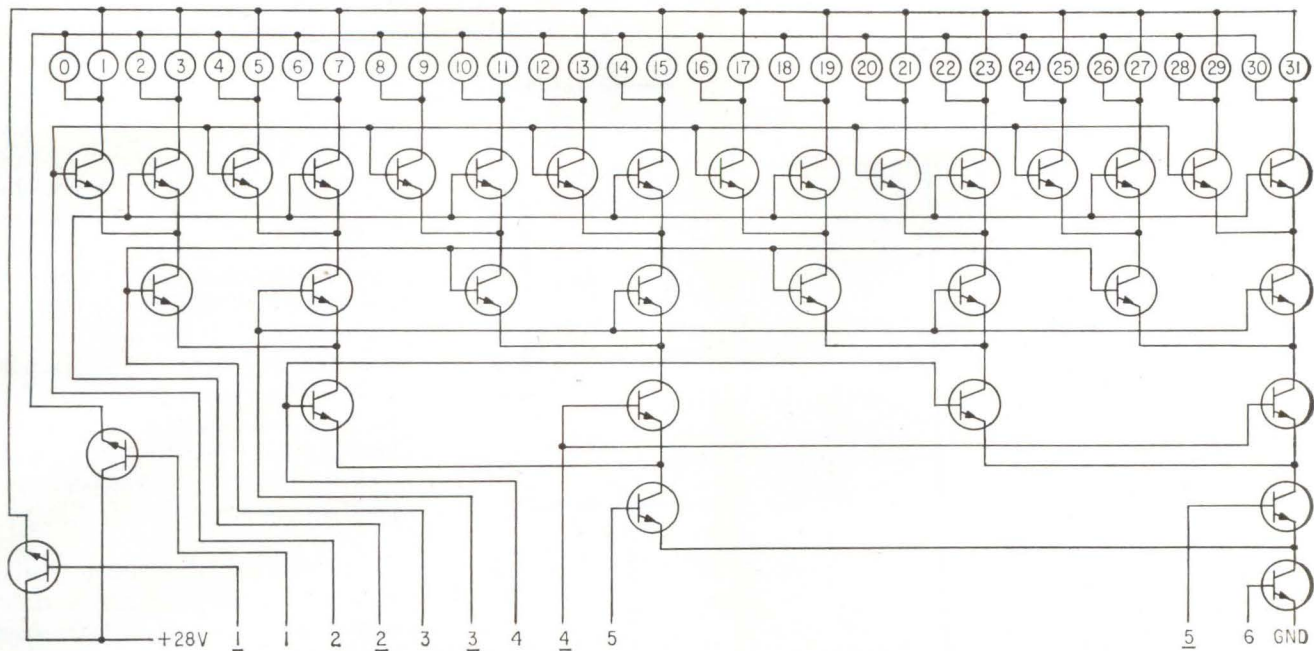

CONDITION OF brush-to-commutator circuit of encoder disk is read as binary input to logic circuit, which can drive display or provide output to be recorded with time base—Fig. 2

close tolerances on mechanical components and by using more elaborate mechanical designs. However, this approach tends to be more costly than systems using electronic compensation, and it requires more production time. The reject rate for uncompensated encoder systems, which require greater inherent accuracy, often precludes their acceptance. A variety of alternate methods are available for measuring, displaying and recording shaft position information having relative merits suitable for a variety of applications.

Angular displacements as small as a few degrees of arc can be measured conveniently by printed-encoder disks. They are usually made from copper laminate using printed-wiring facilities. Patterns like that in Fig. 1 are etched in the laminate, and the circuit is pressed flush with the base material to minimize wear on brushes. Other methods used for producing such disks include photoetching of metal foils and molding the base material over the etched pattern and the use of pattern inlays.

Brushes used to extract data from the encoder disks should be made of soft material and have little contact bounce. Brushes should not cause excessive wear of disk segments, and similarly the

segments should not cause excessive brush wear. Spurious pulses can be produced in readout circuits by small fragments of brush material. A solution to this problem is offered by soft metallic brushes that have been correctly designed for brush pressure and contact angle. When encoder segments are plated with wear-resistant metal like rhodium, less care is needed in selecting brush material.

The disk in Fig. 1 is used in a binary encoding system. The segments in the outer of the six encoding tracks encodes the least significant bit. This track determines resolution of the disk and the maximum time for encoding and display of each digital shaft position code. Since the least significant bit track on this disk contains 32 segments, resolution is 360 degrees divided by 32 or 11.25 degrees per segment. Greater resolution is possible, but the attainable resolution in etching commutator disks determines the practical limit. The number of segments per track proceeding from the least significant digit to the most significant digit is in the 32-16-8-4-2-1 binary order.

The circuit in Fig. 2 can be used to readout encoded shaft positions. The condition of the brush-to-commutator circuit of the encoder is

read as a binary input to the logic circuit. Output can be used to drive a decimal display unit; it can be recorded simultaneously with a coded time base; or it can be supplied as a signal to other circuits. Binary encoded signals are one of many types of outputs that can be obtained from encoder disks.

TORQUE LOADING—One disadvantage of the encoding disk is that it places frictional torque on the shaft being monitored. These torque loads often preclude use of this type of shaft position encoder. Also, noise content of the output signal is high. Although adequate filtering can usually solve the noise problem, it adds to the physical size of the system. Noise is particularly significant when such an encoder is used in an environment where it encounters shock and vibration. Use of the encoder disk is thus limited by environmental conditions and by the resolution that can be attained using etched segments. However, disks are inexpensive compared to other encoding methods and the readout method is more reliable.

The frictional torques of encoder disks can be conveniently avoided by using optical sensing. A light beam or reflected light beam is interrupted to produce pulses. Reso-

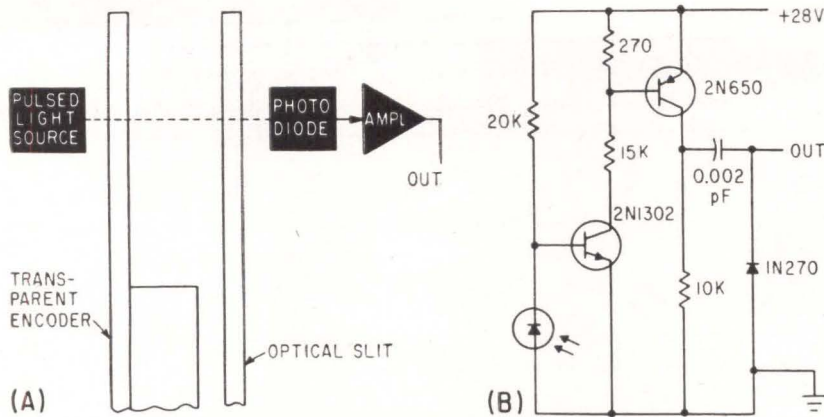

TYPICAL PHOTODIODE shaft-position encoder (A) can be used with amplifier (B) to produce pulses for logic circuit—Fig. 3

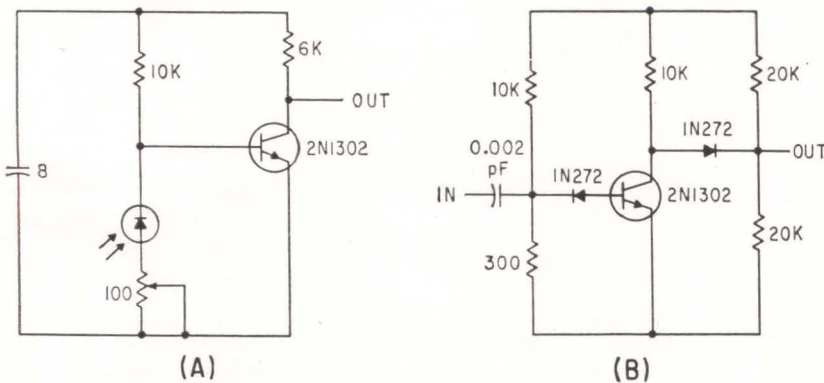

PHOTODIODE switching circuit (A). Simple arrangement (B) removes noise from diode signal—Fig. 4

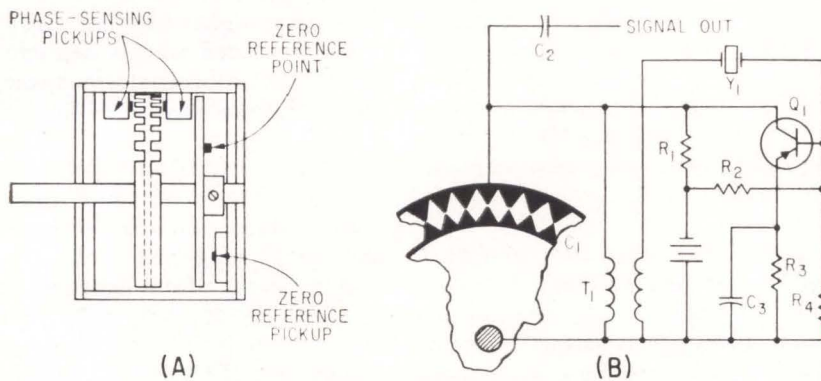

HIGH RESOLUTION can be obtained using phase-relationship encoding systems (A) and (B) with a sensing readout circuit (C)—Fig. 5

lution is limited by the size of photodiodes or other light detectors used. However, it is feasible to attain the accuracy indicated for the encoder disk in Fig. 1 with such a system.

The base material of the encoder disk is transparent. Segmented areas are made opaque to interrupt light to the photodiode on the opposite side of the disk. Opaqued segments can also be used to interrupt reflected light. If the encoder disk readout arrangement requires leading and lagging pickoff for logic circuit operation, the tracks must be wider to accommodate two photodiodes per track.

PERFORMANCE — Photosensing encoder-disk outputs are a stable source of information both from the standpoint of environment and noise. Properly mounted photodiodes provide a rugged encoder system, overcoming the limitations of brush-encoder disks in relation to environment. In particular, the capability of withstanding shock in each of its planes does not vary widely. Slightly more space is required for the disk and take-off assembly than for brush take-off systems, but it is sufficiently small to meet subminiature device needs.

The typical photodiode encoder in Fig. 3A with the amplifier in Fig. 3B produces pulses of the correct amplitude and rise time to drive the logic circuit in Fig. 2.

In systems that mechanically integrate variables by rotary motion, inertia is often high enough to require storage of most of the available torque before rotating speed can be measured. Testing and calibrating this class of device often requires precise measurement of rotating speed or of elapsed time from initial motion until some predetermined terminating point has been reached. Rotation must be measured without applying torque to the rotating element, which rules out brush-commutator pick-off devices as well as inductive devices. A further restriction is placed on the use of phase-shift devices by their limited accuracy and the desirability of avoiding additional weight to the system under test, which would alter its inertia.

A practical solution to this problem is the use of photocells excited by light reflected from the rotating

element. Semiconductor photodiodes have proved adequate when response time and available light intensity at the diode junction are optimized in the system. Photodiode recovery times are comparatively slow, which must be compensated by the method used for shading the reflecting area of the rotating element. Unfortunately, this compensation requires some sacrifice in resolution, but the loss does not usually seriously impair accuracy of the test. A ratio of about 2:1 should be maintained between shaded and reflecting portions of the switching area.

Length of the shading zone is governed by the diode and the speed at which switching areas pass the diode. Ample time must be provided for diode recovery, which is normally about 20 milliseconds. The typical photoswitching circuit in Fig. 4A also provides amplification for readout.

Prior to the test, the rotating element is positioned so that the photodiode is as near to the reflecting surface as possible without actually being activated. At this position, initial motion of the element can be sensed. If timing tests can then be correlated to a time base, accuracy need not be sacrificed for system resolution.

Reflectivity must be uniform to avoid false shading. Most metallic surfaces afford ample reflectivity unless heavily oxidized. Shaded areas must have a matte-type surface, and light-absorptive materials in general do not provide such a surface. If a liquid material is applied to the cylinder and allowed to dry, it normally must be buffed to dull its surface before it can provide proper shading for operating a photodiode circuit. If shading paper strips or similar materials are used, the change in inertia caused by their weight must be taken into account.

A highly dispersed light source is more satisfactory than direct light. Without high intensity and adequate dispersion, it is difficult to orient the diode correctly with the light source because of the convex reflecting surface. Dispersion should be limited to the general area, however, and intensity should not be unnecessarily high, which would result in excessive radiated heat.

A number of more complex electromechanical systems are commercially available that offer much higher resolution than disk encoders. A variety of methods are used to detect and extract shaft-position information. Some of the more elaborate systems achieve accuracies up to 4 seconds of arc.

Typical of the more complex encoding arrangements is the phase-relationship system in Fig. 5A. It uses a constant-frequency source provided by a signal generator and a rotor driven by a synchronous motor. The source enables phase

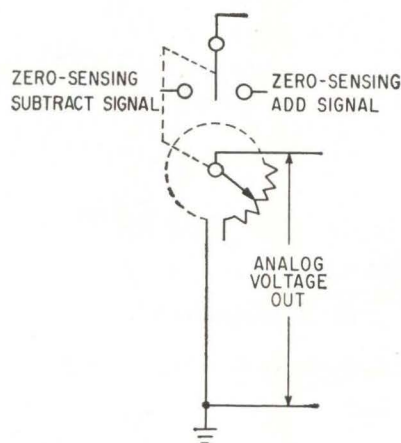

POTENTIOMETER encoder with analog output—Fig. 6

comparison with a second signal of the same frequency (or a different frequency) but varying in phase. The second signal is produced by a rotor mounted on the shaft being monitored and a magnetic pickup stator.

Another method for producing signals in the generators is shown in Fig. 5B. The teeth on the rotor and stator form capacitor C' . As shaft rotation changes the relative positions of the teeth, capacitance varies. All stator and all rotor teeth together form the two capacitor plates, and the large capacitor plate area results in sufficient output amplitude to drive transistor or vacuum-tube circuits. In typical systems, as many as 1,000 teeth each have been used in the stator and rotor.

Maintaining close machining tolerances is important in systems of this type. Displacements exceeding 0.0001 inch introduce enough

error to seriously affect system performance. Placement of the stator teeth in both of these generators must correspond exactly, as must the spacing of the rotor teeth. Shaft alignment and shaft runout must be closely controlled, and materials must be chosen for environmental stability and optimum machining characteristics.

The block diagram in Fig. 5C shows the sensing readout circuit for the phase-relationship encoders in Fig. 5A and B. The signal from the reference generator is a base for detecting any shift in phase of the signal from the generator measuring shaft rotation. Changes in phase result in an output that is compared with an encoded time base, providing accurate records of shaft position as a function of time.

POTENTIOMETERS—Many shaft position measurements do not require the accuracy attainable with digital systems, and a simple shaft position-measuring encoder such as a potentiometer can be used. Several shaft rotations can be measured by multiturn potentiometers and with potentiometers having external planetary gearing arrangements. The circuit in Fig. 6 can measure multiple shaft rotations with a single-turn potentiometer. It produces an output pulse each time the wiper passes through zero in one direction and a subtracting pulse each time the wiper passes through zero in the opposite direction.

Photosensing techniques can provide a voltage analog of shaft position. A circular slit of variable width is cut in the encoder housing or in an encoder disk. A lamp is placed on one side of the slit and a photodiode on the other. Rotation varies the amount of light that can pass through the slit and therefore the amount of current through the diode, providing a measure of relative shaft position.

The importance of shaft-position encoders in the fields of guidance and tracking is increasing with corresponding increases in accuracy requirements. Many much more sophisticated approaches to encoder design are being investigated at this time. Success with these techniques could change methods of measurement and provide a more reliable instrumentation capability.

CONVENTIONAL or parallel Schmitt circuit (A), with input voltage and input current characteristic of (B), requires a drive with low source resistance. One of the transistors (C) is always saturated so there is continuous power drain—Fig. 1

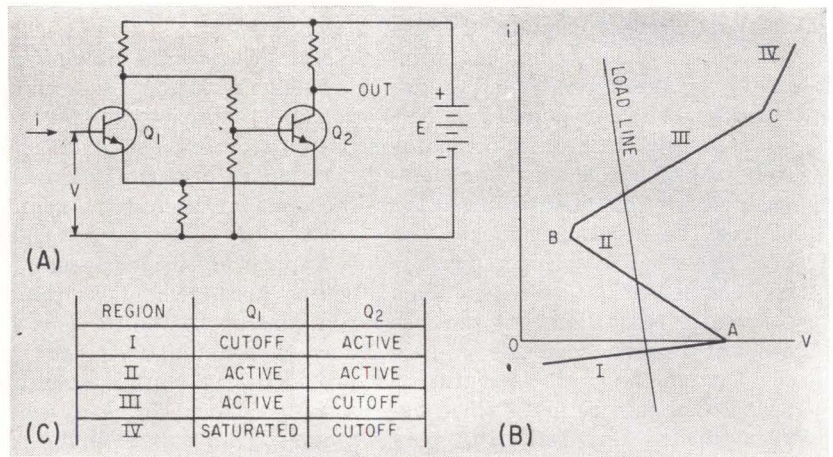

New Complementary Transistors Make

Complementary transistors in the series Schmitt circuit are either both on or both off. This characteristic can be used to conserve power in applications with low on-to-off ratios. An added advantage is that fewer components are needed

By JAMES K. SKILLING, General Radio Co., West Concord, Mass.

THE SCHMITT CIRCUIT can serve as a trigger generator, amplitude comparator, set-reset flip-flop, one-shot multivibrator, or oscillator, depending on bias and source impedance. The parallel or conventional transistorized version shown in Fig. 1A closely resembles the original vacuum-tube circuit¹. The series version shown in Fig. 2A uses complementary transistor types, which until recently have been difficult to obtain with similar performance and price.

COMPARISON — A convenient method of analysis and comparison uses the curve of input voltage as a function of input current².

Both circuits are capable of switching operation only when the load line—with slope appropriate for the input source resistance—intersects the curve at more than one point. The input curve for the parallel version (Fig. 1B) is single-

valued in current and therefore requires a low source resistance; the series circuit is single-valued in voltage and therefore requires a high source resistance. By similar reasoning, the parallel version can compare voltage amplitudes and the series version current amplitudes. Also, for monostable or astable oscillations, the input tuning can be RC for the parallel circuit and RL for the series.

Another difference is the power required from the source. In the parallel Schmitt circuit one transistor is always on and power drain is continuous. In the series circuit the transistors conduct at the same time or not at all. This characteristic can be used to save power in circuits with low on-to-off ratios.

THE SERIES SCHMITT—The input curve for the circuit shown in Fig. 2 is for a voltage source. For negative and small positive volt-

ages, Q_2 is cut off; thus Q_1 is also cut off, as indicated by region I. (Cut off here means insufficient base-emitter voltage or current for a transistor to display normal current gain.)

When the input voltage is large enough (beyond point A) to forward-bias Q_2 , collector current flows and a portion is amplified by Q_1 and fed back to the input terminals, region II. Note that in Region II an increase in input voltage (along the X axis) causes a negative input current, so this region is one of negative resistance. As the input voltage is increased, a point is reached where the transistors saturate simultaneously (point B). For larger input voltages the input resistance is small and positive, region III.

Resistance of region I is essentially the cutoff input resistance of Q_2 in parallel with the collector resistance of Q_1 , and is usually about 100 kilohms or larger. The voltage at point A is the knee voltage of the transistor—about 0.3 volt for germanium and 0.6 volt for silicon transistors. In region II the collector current of Q_2 is approximately V/R_{E2} ; the collector load resistance consists of R_{E1} times the common emitter current gain of Q_1 , in parallel with R_{C2} . The former term is usually large enough to be neglected, so that the voltage across R_{C2} is approximately $V R_{C2}/R_{E2}$. At point B the transistors are just

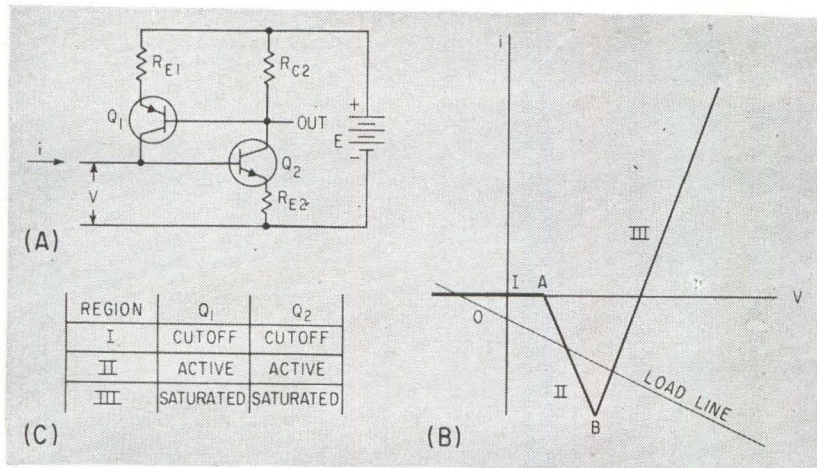

BOTH TRANSISTORS are either saturated or cut off in series Schmitt circuit and fewer components are required than in conventional circuit. To ensure the cutoff of Q_1 , it may be desirable to return R_{C2} to a slightly more positive voltage than E —Fig. 2

Series Schmitt Circuits Practical

saturating, so the voltage across the input terminals, plus the voltage across R_{C2} equals supply voltage E . The resulting expressions for the input voltage and current at point B are

$$V_B = E \frac{R_{E2}}{R_{E2} + R_{C2}}$$

$$i_B = -\frac{E - V_B}{R_{E1}} = -E \frac{R_{C2}}{R_{E1}(R_{E2} + R_{C2})}$$

For input voltages larger than at point B , the resistance at the input terminals is approximately equal to R_{E2} , R_{C2} , and R_{E1} in parallel.

The simple analysis presented is intended as a guide to basic circuit operation although the expressions are accurate enough for many applications.

The input curves of Fig. 1 and 2 are static curves, valid only at low frequencies. High-frequency performance is improved and switching time decreased by adding peaking capacitors across the collector-to-base coupling resistor of Fig. 1 and across the emitter resistors of Fig. 2.

DESIGN EXAMPLE—It is sometimes misstated that the series circuit is easy to turn on but hard to turn off. But the current from an infinite resistance source necessary to cycle the circuit from on to off is the current difference between points A and B . If this current is to be 1 ma, then point B can be taken at -1 ma, since point A can be sensibly taken as the origin. If

the circuit is to switch for source resistances greater than 5 kilohms, the voltage at point B is 5 volts. The source current necessary to cycle the circuit then varies from 1 ma for infinite resistance sources to zero for 5 kilohms. For sources less than 5 kilohms, the circuit will not switch but will act as a non-linear amplifier.

When the circuit is on the verge of saturation, the current through R_{E1} and Q_1 is 1 ma, and the voltage at the base of Q_2 is 5 volts. Since both transistors are almost saturated, all transistor terminals may be considered to be at the same voltage. Current through R_{C2} , Q_2 , and R_{E2} may be chosen at 5 ma, which

is reasonable since it gives a circuit current gain of five—small compared with the transistor's current gain. If the supply voltage is 20 volts, as shown in Fig. 3, then $R_{E1} = 15 \text{ v}/1 \text{ ma} = 15 \text{ kilohms}$, $R_{C2} = 15 \text{ v}/5 \text{ ma} = 3 \text{ kilohms}$, and $R_{E2} = 5 \text{ v}/5 \text{ ma} = 1 \text{ kilohm}$.

The resistance of region III will then be 15, 3, and 1 kilohms all in parallel, or 715 ohms. The waveforms of Fig. 3 are for a 2-ma, 10 kilohm, 1-Kc, sinusoidal source.

REFERENCES

- (1) O. H. Schmitt, A Thermionic Trigger, *Journal of Scientific Instruments*, 15, p 24, Jan., 1938.
- (2) H. J. Zimmerman, S. J. Mason, "Electronic Circuit Theory," p 437, John Wiley & Sons, Inc.

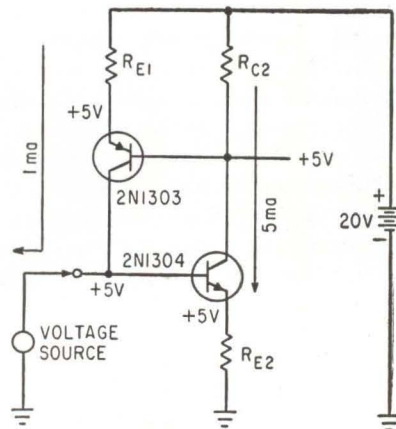

TYPICAL SERIES Schmitt circuit above and waveforms right: top, input curve; center, input current, 1 ma per cm with center zero; bottom, output voltage, 5 volts per cm with bottom zero—Fig. 3

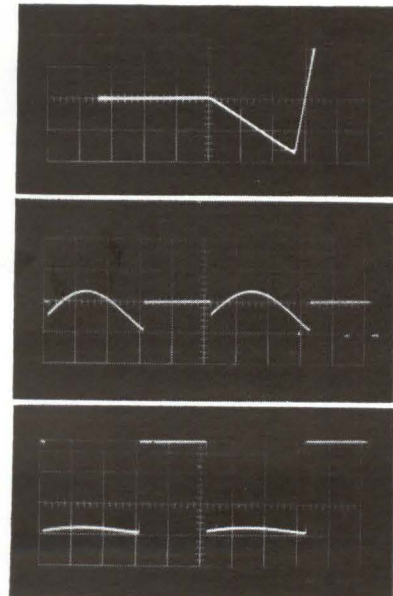

Long Staircase Generator

By K. PERRY

Physics Department,
University of Queensland,
Australia

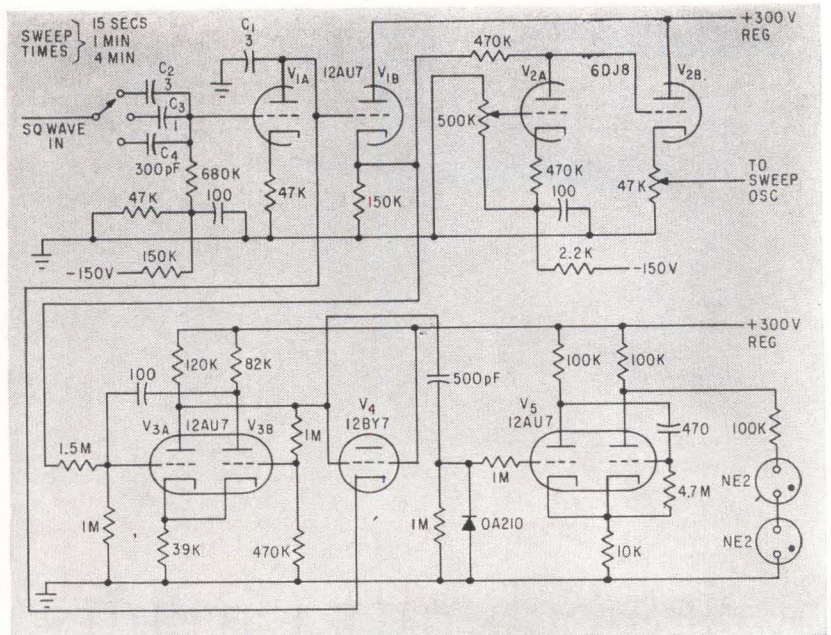

SCHMITT TRIGGER V_3 detects end of rundown and initiates capacitor recharging. Output level from V_1 is shifted to vary about ground potential

Staircase output has 100-volt amplitude; circuit controls local oscillator frequency in swept-frequency ionosonde

MODERN SWEEP-FREQUENCY IONOSONDES usually use a voltage-tuned sweeping local oscillator with voltage-sweep derived from a slow sawtooth generator. However, when the ionosonde is used to investigate back scattering, pulse repetition rates are decreased, pulse lengths are increased, and receiver bandwidths is reduced. Thus, a linearly changing sweep is no longer satisfactory, because receiver tuning moves too far in frequency between successive pulses to receive the returning echo.

One solution is to apply a staircase waveform instead of a sweep to the local oscillator, and time

it to step just before the transmitter fires. Most staircase generators will not generate the necessary long stepped run downs, with duration up to 5 min. However, this generator was designed for long stepped sweeps and can supply run-downs of up to 10-minutes duration and 100 volt amplitude.

OPERATION—Referring to the circuit diagram, V_{1A} is the actual staircase generating tube. Capacitor C_1 in the plate of V_{1A} is charged to 300 v, and cathode follower V_1 is turned off. If a square wave is applied to input capacitor C_2 , the differentiated positive edge will discharge C_1 by an increment proportional to the capacitance of C_2 . Thus, the stepping increment can be altered by changing the value of the input capacitor, while step duration is determined by the input square wave prf. Cathode resistor of V_{1A} is large, providing negative feedback to linearize the rundown. If C_1 is not allowed to discharge to a low voltage, linearity is good: as the oscillogram shows, circuit rundown of 100 v is permitted.

At the end of rundown, C_1 is re-

charged to 300 v by cathode follower V_1 . Cathode follower V_{1B} feeds a Schmitt trigger V_3 , which fires when C_1 reaches the predetermined level. The positive pulse from the plate of V_{3A} turns on cathode follower V_4 , which charges the run-down capacitor. The charging pulse length is determined by the Schmitt trigger time constants.

PERFORMANCE—run down capacitor C_1 must be of high quality if leakage is not to degrade the linearity. There will of course be some leakage in the circuits around the capacitor, but in an actual example this was offset by the leakage across cathode follower V_4 , which tended to recharge the capacitor. If greater linearity is required; external leakage resistors could be used.

Tube V_{2A} is a d-c level shifter¹ while the potentiometer in V_{2B} cathode controls amplitude.

The one-shot circuit V_5 also fires at the end of the rundown and indicates the end of sweep.

REFERENCE

(1) E. W. Van Winkle, Circuit Removes D-C From Amplifier Signal Output, *ELECTRONICS*, P 151, Aug. 12, 1960.

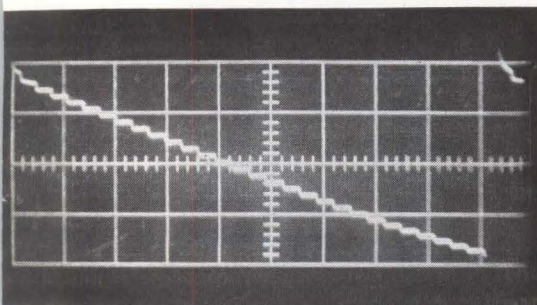

RUNDOWN has duration about 4 minutes with 100-volt amplitude

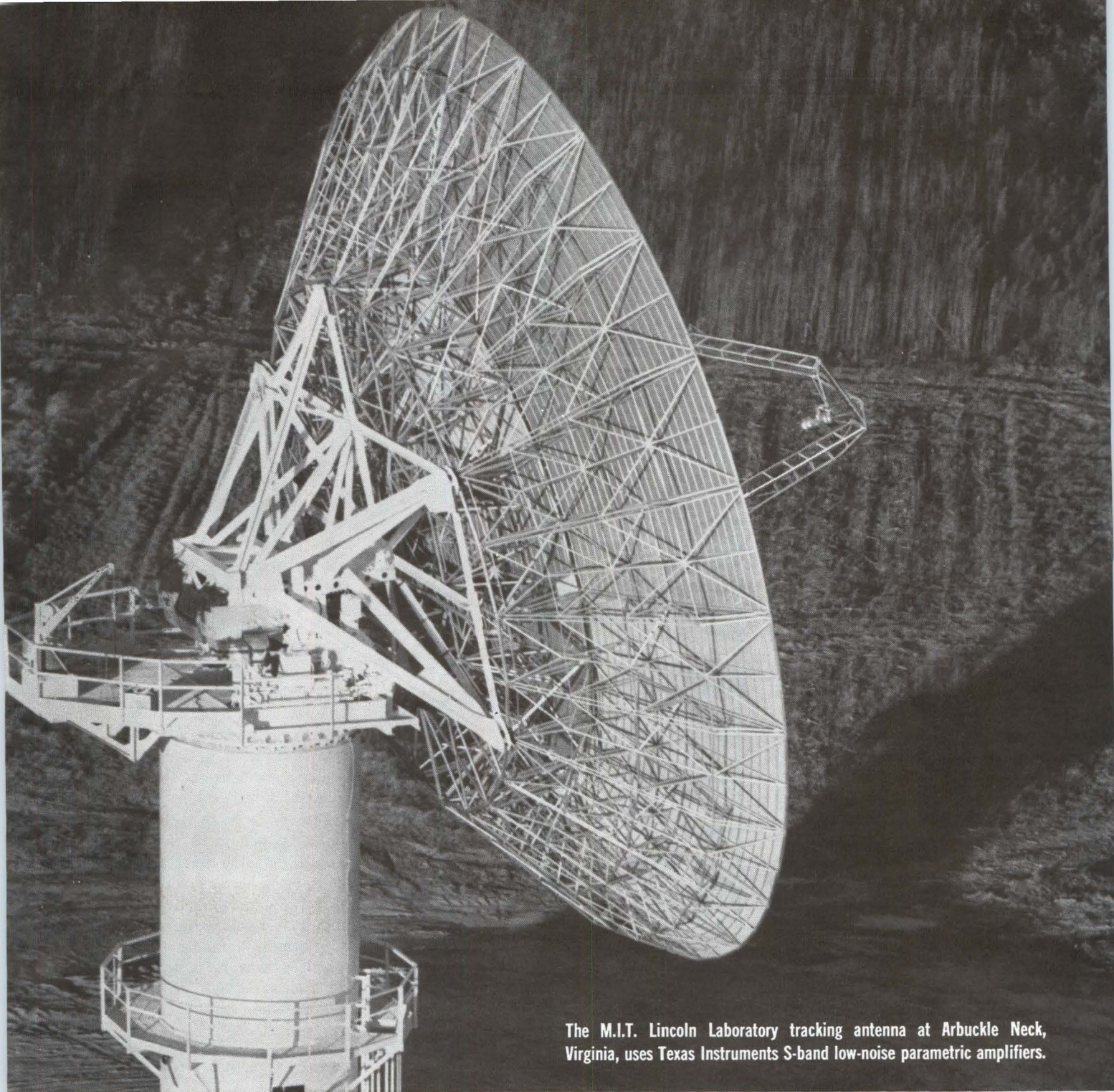

The M.I.T. Lincoln Laboratory tracking antenna at Arbuckle Neck, Virginia, uses Texas Instruments S-band low-noise parametric amplifiers.

Hearing better with TI paramps!

Many microwave communication and radar systems now incorporate parametric amplifiers and low-noise receiver assemblies from Texas Instruments. From L band through K_u band, standard and custom equipments operate efficiently and dependably in monopulse radar, polarization diversity tracking, troposcatter communication, and other airborne and ground applications. ■ Texas Instruments staff of experienced applications specialists will help you analyze your systems requirement. Call today. ■

APPARATUS DIVISION
PLANTS IN DALLAS
AND HOUSTON, TEXAS



TEXAS INSTRUMENTS
INCORPORATED
6000 LEMMON AVENUE
P. O. BOX 6015 • DALLAS 22, TEXAS

CIRCLE 55 ON READER SERVICE CARD

Modulation Techniques Cut Radar Cost

Experimental system uses video crystal and chopper for wideband c-w detection

By **ROGER FLEMING**

Sylvania Electronic Systems
Sylvania Electric Products, Inc.
Buffalo, N. Y.

RADAR environment surveillance appears feasible using low-cost broadband c-w receivers. This conclusion is the result of an investigation of c-w detection techniques that would enable a receiver to cover a frequency range of several octaves simultaneously. A method was found of using simple modulators and crystal video detectors to make c-w broadband receivers having sensitivities of better than -50 dbm.

Published data about low-cost receivers suitable for this application was lacking. Also, the use of traveling-wave tubes and swept-frequency techniques in conjunction with superhetrodyning is possible but expensive. However, the investigation indicated the possibilities of using a crystal video detector, which provides an output voltage proportional to c-w input power.

Use of a wideband d-c amplifier following the crystal detector did not provide the circuit reliability or low cost required in this applica-

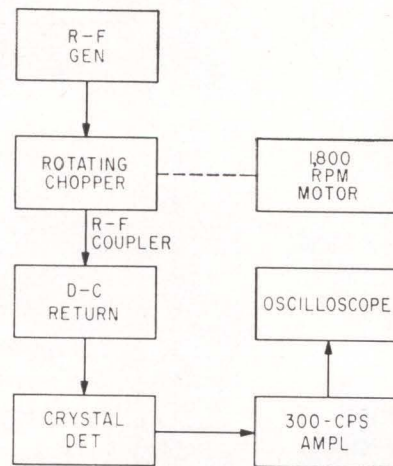

ROTATING chopper preceding crystal detector results in low-frequency output signal proportional to r-f input power—Fig. 1

tion. Also, the use of well known methods for chopping the d-c output voltage of the crystal detector was unsatisfactory. However, modulating the c-w input r-f signal before the detector provides a direct method of obtaining an easily processed low-frequency signal. Modulating the microwave signal before detection results in a video signal proportional to received power and having a fundamental frequency corresponding to the modulation rate.

R-F MODULATION—One method for modulating the r-f signal is the

use of microwave crystal diode switches. One to four diodes are used, depending on the amount of isolation required and the type circuit used. The switches are generally mounted in a section of waveguide. Since the waveguide usually limits bandwidth to an octave or less, parallel crystal switches can be used for separate frequency ranges to cover several octaves.

The results obtainable by chopping the r-f signal can be seen by applying square-wave modulation to a microwave generator. Detecting generator output with a IN630 crystal detector and amplifying it with a wideband (10-Mc) amplifier enables a signal of -44 db to be readily detected. Crystal tangential sensitivity (power required to increase output noise fluctuation an amount equal to average noise level) corresponds to about 4 db over minimum discernible signal.

The c-w signal can also be chopped by operating on the waveguide, as is done by the rotating disk chopper in Fig. 1. The disk, which contains ten equally spaced slots, revolves at 1,800 rpm. Output of an X-band generator tuned to about 1 Gc was coupled to a section of waveguide feeding the chopper, which passes r-f energy when the slots are aligned with the waveguide. Thus generator output is chopped at 300 cps.

EXPERIMENTAL AMPLIFIER—

The crystal detector mounted on the opposite side of the disk produces a 300-cps sine wave that is proportional in amplitude to input power level. The narrow-band a-c amplifier in Fig. 2 was built to investigate minimum detectable signal compared with amplifier bandwidth. The narrow bandwidth is obtained by a twin-tee feedback loop tuned to the modulating frequency (between 60 and 400 cps). Although no attempt was made to find low-noise transistors, some precautions were taken to operate each stage at a quiescent point.

A-c amplifier output of 5 milli-

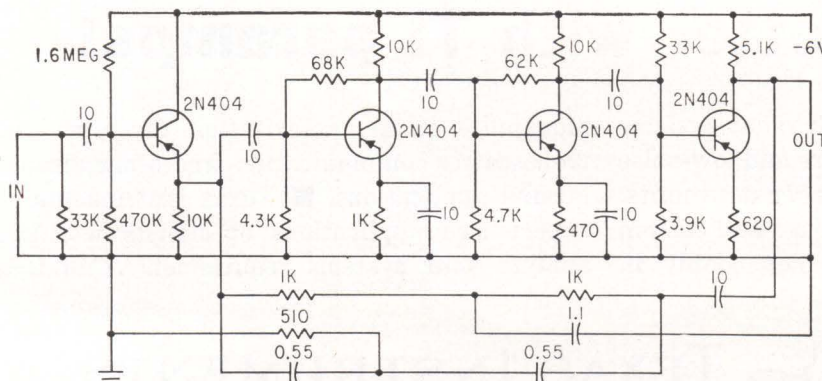

NARROW bandwidth of experimental amplifier is obtained using feedback loop tuned to chopping frequency—Fig. 2

Simplex Electronic Cables...

Float at Sea

Eliminate Hosing Problems

Link Rockets to Ground Control

Many inner space projects require cable that will not sink to the ocean floor. To meet such requirements, Simplex has designed and produced special cables with built-in flotation. If desired, cables can be designed with plastic tubes to be used as gas, pneumatic or hydraulic lines.



For the growing number of installations where hosing of water through a cable could cause serious trouble, Simplex offers a "non-hosing" cable construction. Cables with this construction contain a special filler compound which eliminates wicking action even if the cable jacket is damaged.



Umbilical cables manufactured by Simplex are used to connect rockets to their sites before firing. Essential characteristics of these cables include flexibility, exceptional reliability, resistance to mechanical damage and chemical attack by exotic fuels.

There's a Simplex electronic cable to meet virtually every existing application involving the transmission of power, control and communications. And Simplex has unique capabilities for solving any problems you may encounter in these areas. For further information, write Department 365, Simplex Wire & Cable Co., Cambridge, Mass.



Simplex

WIRE & CABLE CO.

EXECUTIVE OFFICES: Cambridge, Mass.

Plants at Cambridge, Mass., Portsmouth, N.H.,

Westbury, L.I., Monrovia, Calif.

CIRCLE 57 ON READER SERVICE CARD



NOW READY:

ANALOG-TO-DIGITAL CONVERTER

NAVCOR MODEL 2201

LOW PRICE: **\$2935**
 ACCURACY: **.05%** ABSOLUTE
 DELIVERY: **30** DAYS

Format: Binary, 10 bits plus sign.
 Conversion Rate: 10,000 complete conversions per second (9.1 microseconds per bit plus 9.1 microseconds.)
 Input Range: ± 10.23 volts; lower or higher ranges available.
 Input Impedance: 5,000 ohms; high impedance amplifier optional.

Other models start from \$2,775. Both Binary and Binary-Coded-Decimal formats are available. Options include Sample and Hold, Multiplexing, and Over-Range Indication. For more information, write to NAVIGATION COMPUTER CORPORATION, Valley Forge Industrial Park, Norristown, Pennsylvania.



volts resulted from an input of -45 dbm. Thus this arrangement provides a minimum discernible signal level of -55 dbm. Insertion loss from the 0.25-inch gap in the waveguide was only 2 db, and slight misalignment of waveguide sections had negligible effect on maximum sensitivity level. With more attention to amplifier layout, ground loops and motor-noise pickup, a minimum discernible signal level of -60 dbm could have been achieved.

LINE POWER SIGNAL—A wide-band microwave variable low pad was also investigated for modulating the r-f signal in place of the rotating chopper. Amplifier center frequency was changed to 400 cps so that line power applied to the pad solenoid could modulate signal. Insertion loss for the pad was 10 db, and sensitivity was -40 dbm with a 1-millivolt amplifier output. With another stage of gain added to the amplifier output, 1 millivolt

was obtained with an input of -47 dbm.

DIFFERENTIATION DESIRABLE—Sensitivity of this circuit to pulsed signals varies, depending on amplitude, pulse width and repetition rate, as well as amplifier bandwidth. Because the environment of radar surveillance receivers includes pulsed as well as c-w signals, a differentiation of at least 30 db is desirable, which can be obtained with the circuit under investigation.

Even better modulating techniques might be possible using devices such as ferrite magnetic modulators, wideband crystal switches or gas switches. Comparable performance might be obtained using such methods as impedance modulators acting on the waveguide section or coaxial cables, antenna gain modulation by element changes or other types of field devices, while still meeting military requirements for specific systems.

Improved Display Panel Described

HAMILTON, CANADA — Solid-state, electroluminescent display panel designed to receive computer-digested data and to display it in geometric pattern was described at a recent symposium here. The symposium, probably the first held for R&D by industry in Canada, was sponsored by Canadian Westinghouse Company Ltd.

INFORMATION STORED — The EL display panel, described by K. Mabson and R. Challis, can display maps with target and auxiliary information (such as velocity, location, and identification). Messages consisting of any of 64 difference characters can be written near or above targets. The pattern of the display is memorized and retained for an indefinite time.

Two salient features of the panel are the storage facilities and the selection of the standard characters by a diode matrix. The storage is provided by a three-layer EL panel. The rear layer is used for temporary storage of new information. The intermediate layer is used to

retain previous information and to add new information. The front layer, optically connected to the intermediate layer, is used to display the information. Each layer contains about 16,000 cells, 10×10 inch layer which can be individually excited.

A diode matrix produces up to 64 different binary codes which can be written in the display panel. A 6-bit word is required for the selection of the character and a 14-bit word for its location on the display panel. Thus, up to 64 cells can be excited by a 20-bit word.

SELECTIVE ERASE—A wall display can be built using individual panels. Selective erase of small areas can be easily done.

A second type of display module, consisting of two lines of 12 characters each, uses the same principle for storage and character selection. Photoconductive and electroluminescent elements simplify the result in a compact and lightweight panel.

Writing speed of both modules is about 100 msec per character.

NEWS FROM BELL LABORATORIES

A simple, highly sensitive microwave amplifier

Bell Laboratories engineers have developed an extremely sensitive parametric amplifier which approaches the maser in sensitivity. Both will be used in experiments with Telstar, the Bell System's experimental communications satellite.

Heart of the parametric amplifier is a newly developed semiconductor diode with very low intrinsic noise. Previously, the sensitivity of such amplifiers at microwave frequencies was severely limited by the unwanted noise generated in their diodes. The new diode, no bigger than the eye-end of a needle, solved this problem.

Our engineers also devised new circuitry to stabilize precisely the output of the klystron (microwave generator) supplying power for the amplifier. To reduce further the intrinsic noise of the amplifier, they immersed the diode and its circuits in liquid nitrogen, utilizing a new cooling arrangement which economically maintains a low temperature for many days without attention.

The new amplifier fills a need in the communications field for a simple microwave amplifier of high sensitivity in applications for which the higher sensitivity of the maser does not justify its additional complication.

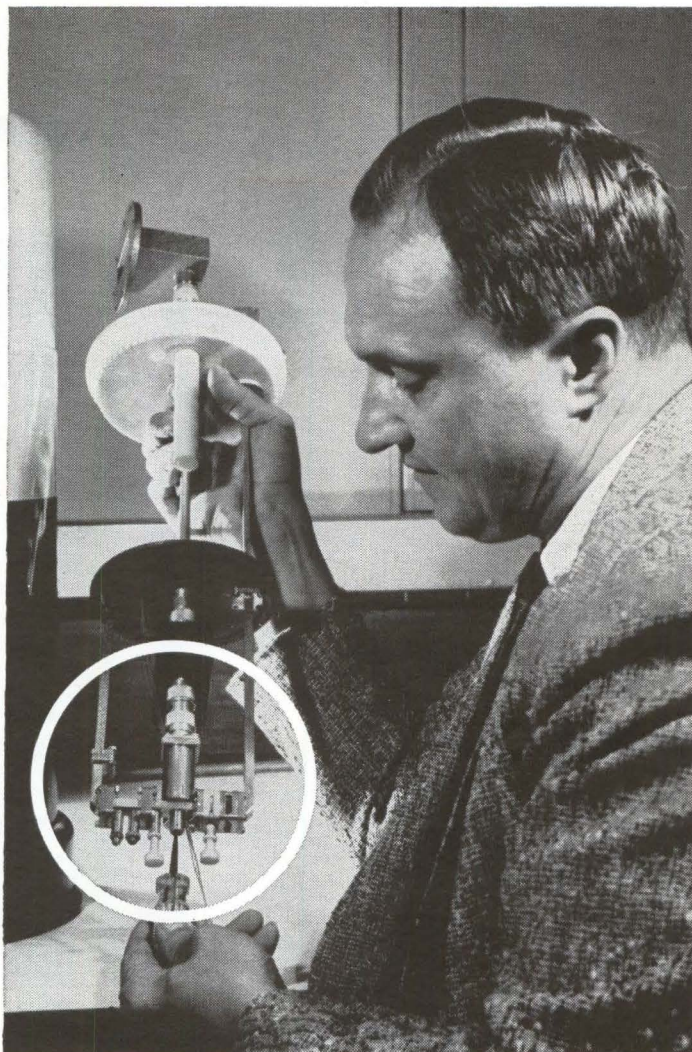

Bell Laboratories' Michael Chrunev adjusts waveguide assembly (in circle) housing the diode. After adjustment the entire parametric amplifier will be immersed in liquid nitrogen in dewar at left. The new amplifier operates at 4170 megacycles (center of band) and provides an almost flat gain of 38 db over a 50-megacycle band with a noise figure of approximately 0.6 db.

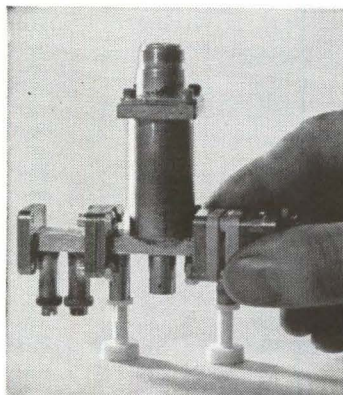

Close-up of the waveguide assembly, in which Bell Telephone Laboratories' newly developed diode is located.

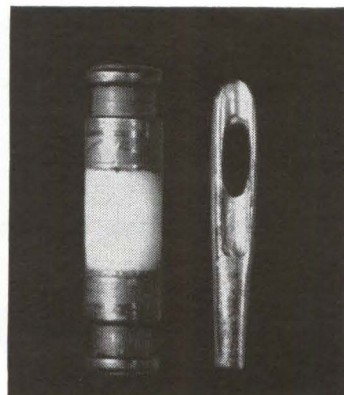

Heart of amplifier—a hermetically sealed gallium arsenide diode—is compared with eye of average-sized sewing needle.



BELL TELEPHONE LABORATORIES

World center of communications research and development

New Cables Withstand More Heat

Understanding radiation, heat and signal needs, helps eliminate problems

By M. C. CHENEY

Vice President and Chief Engineer
Lewis Engineering Company
Naugatuck, Connecticut

WIRE INSULATION requirements for long term operation from 600 to 1,000 deg F have led to the availability of special hookup wire and control cables now used as signal carriers for miniaturized systems, power cables, and high-temperature wires that are also radiation resistant. A number of useful by-products have emerged as a result of developing these insulations, and many new applications suggest themselves that offer a new degree of independence from many hostile environments.

MINIATURIZED SYSTEMS—The first type of wire is designed for electronic systems where the compact design of the equipment itself creates temperature problems for conventional wiring hookups. Stranded nickel-coated copper conductors are protected by laminated insulation of impregnated high-purity asbestos and a composite system of supported and unsupported high-dielectric materials. This wire has been designed with considerations of small diameter, light weight, high flexibility, and abrasion resistance. Problem here was to improve current carrying capacity. Amperes per unit of weight is increased approximately 30 percent compared to conventional insulating materials.

Heat resistance of this type of wire also withstands sudden overloads—asbestos acting as thermal barrier and heat sink. This wire is designed for 600 deg F maximum ambient, with 650 deg F maximum conductor temperatures. The wire is suitable for 600 volt, 400 cycle service for a minimum life of 500

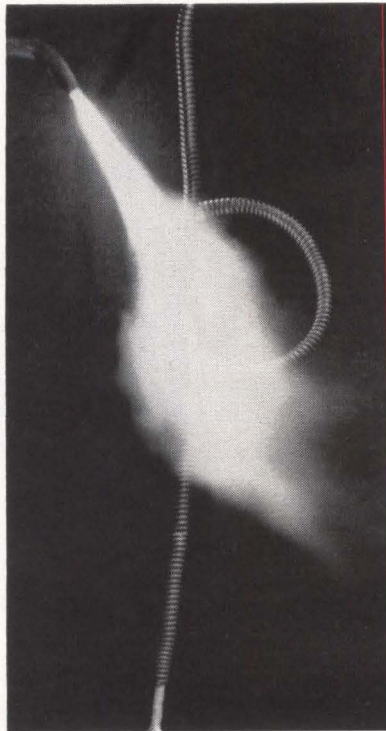

CABLE MAINTAINS full insulation and conductivity while incandescence along insulation, meets high Roentgen levels. Present applications are classified

hours at atmospheric pressures equivalent to an altitude of 80,000 feet. Applications may extend to wiring now using extruded insulation, and the new wire justifies the additional costs where reliability is a key factor. In industrial use, a service life of 10,000 hours or more may be expected in ambients from -65 deg F to 500 deg F. Wire meets military specifications set forth by BuWeps for missile reliability.

POWER CABLE—Wiring designed for conductor temperatures of 850 deg C can withstand a 2,000 flame for 15 minutes with a high degree of insulation resistance, conductor to ground, during this exposure.

Special laminated insulation consists of high purity asbestos, with elastomeric materials providing a dielectric and solvent barrier. This

is primarily a power cable rather than a signal carrier, is moisture resistant, and surge-current resistant for pulsed circuits.

Applications for this type of wiring are now centered in airborne emergency systems, or any use where high current-carrying capacities, high abrasion resistance, sudden overloads, and adverse temperature environments are a factor. Before this cable finds industry-wide acceptance, other components will have to be developed that can also survive in the same high temperature environment.

The high temperature electrical motors now under development at the Westinghouse Aircraft Equipment Department will greatly broaden the applications of improved wire. Several firms are working in this area, including Burndy with high-temperature conductors, General Electric with generators and J & H with motors. Other elements of the electrical system must follow.

A number of manufacturers have found that the use of improved power cable extends the periods between rewiring of highly loaded equipment, or high temperature locations like blast furnaces and soaking pits, from weeks to many months.

RADIATION RESISTANT — A hookup, power and control wire family is designed for 850 deg maximum ambient temperature with 1,000 deg maximum conductor temperature. Stranded nickel-coated copper conductors use special laminated insulation of multiple layers of inorganic tapes. These are topped with binder of high-temperature asbestos and a sheath of continuous convoluted flexible Monel or stainless steel. This wire has been designed for radiation as well as heat.

Construction is primarily designed for control and instrumentation wiring. Its applications include high temperature transducers, vibration detectors, and

Crystallizing ideas into products

Raytheon selects
NORTON "HOT RODS" for long
trouble-free service life

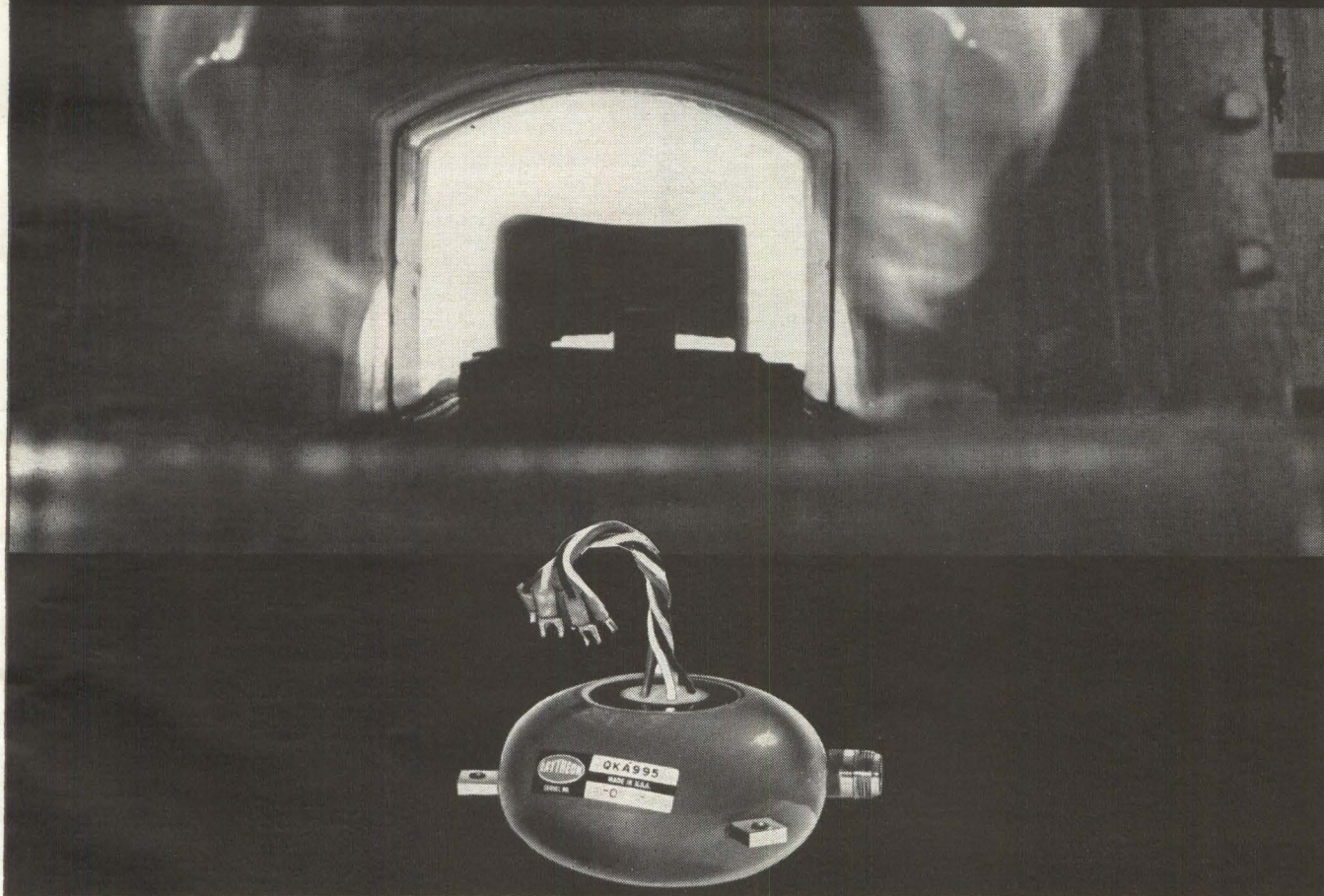

Mr. Elliott Anderson, Heating Engineer of the Raytheon Company plant in Waltham, Mass., endorses the performance of Norton CRYSTOLON* heating elements — "Hot Rods" — in the production of Raytheon Backward Wave Oscillators in a conveyor-type furnace — both of which are shown above.

To assure ruggedness and reliability in space and missile use, the high alumina bodies for these Oscillators are accurately brazed and soldered in these furnaces.

Furnace temperatures are quickly raised from a non-operative 790°C. to an operative 1140°C. and maintained at ± 4 or 5°C for this operation. Mr. Anderson reports that "Hot Rods" are used because of their long, dependable service life.

"Hot Rod" applications include the firing of ceramics for electronics and other industries...hardening of metals...sintering, calcining, refining...melting of glass and metals.

For details of "Hot Rod" advantages

in your own kiln or furnace operations, write to NORTON COMPANY, Refractories Division, 687 New Bond St., Worcester 6, Massachusetts.

*Trade Mark Reg. U.S. Pat. Off. and Foreign Countries.



REFRATORIES

*Making better products . . .
to make your products better*

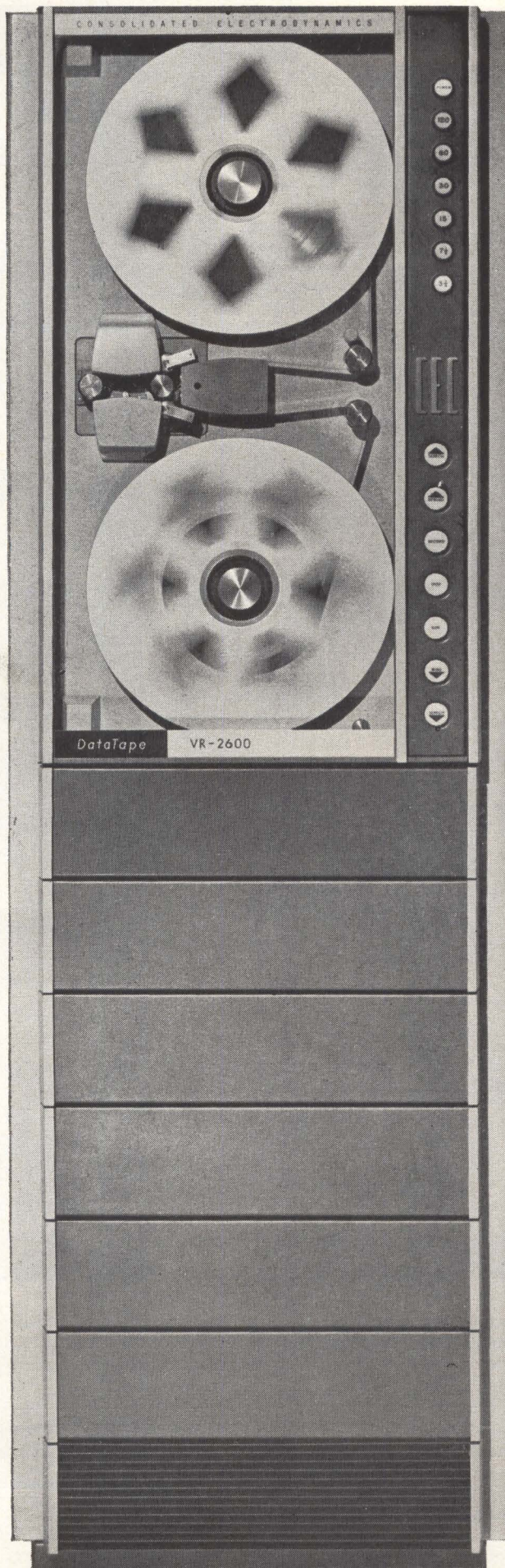

similar instruments. It has proved itself in an operational range from -100 deg to 850 deg and resists moisture, shock, and exhibits good dielectric strength.

The wire can be used not only on the outside of the primary shield of nuclear reactors, but also inside reactor cores at extremely high Roentgen levels. Present applications are classified, but this wiring is highly suitable for nuclear rockets and ramjets, auxiliary nuclear power supplies for space applications, shipboard propulsion systems, and stationary power plants.

HOLDS INSULATION — Organic dielectric strength keeps exposure to temperatures that produce incandescence along the insulation—with exposure periods ranging to 3 hours. Stainless steel sheath materials permit operation in temperatures up to $1,500$ deg for short periods of time, with a minimum service life of 500 hours in an 850 deg ambient and atmospheric pressure equivalent to 80,000 feet altitude. Service life of 5,000 hours or more is claimed for nonflexing service in the temperature range from -65 to 850 deg F.

Lewis Engineering has been designing and developing high-temperature wires and cables for many years. Wire types developed to date and described above were conceived for specific applications, many still under military wraps. The new Grumman turbine-powered Denison-Hydrofoil boat uses Lewis high-temperature wiring throughout, in view of environmental conditions in its engine bay, which house a jet turbine.

Pure Copper Improves Coil Forming Properties

REFLECTOR DISHES for Hawk and Sparrow missiles use oxygen-pure (99.96 percent) copper bases. Raytheon shapes polarized reflectors into pie-plate forms that have no cracks or tears, and have uniform properties in all directions. Rejections are eliminated by use of American Metal Climax's OFHC copper. Month's supply of dishes are formed in one day by mass-production techniques, complex configura-

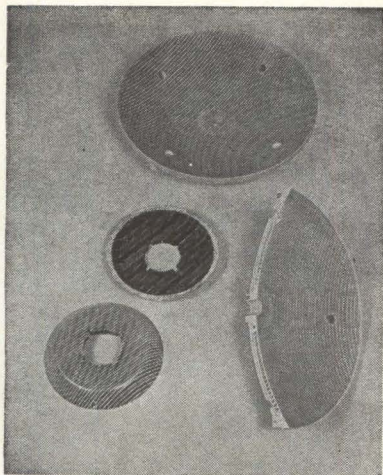

tions are obtained in one operation.

Absence of oxygen in the copper eliminates impurities formed in grain boundaries. This increases ductility of material and decreases cracking during formation. Reflector dishes, see photo above, are used in missile Doppler systems.

New Approach To Crt Faceplates

NEW YORK—During a discussion of fiber optic cathode-ray tube faceplates at a convention of the Society of Photographic Instrumentation Engineers, Walter P. Siegmund of American Optical Company indicated that the company has a scheme for producing cathode-ray-tube faceplates suitable for use in very bright areas, such as cockpits of high-flying aircraft, giving a bright, high-contrast image unaffected by stray light. The technique consists in making the plates of double-clad optical fibers (see *ELECTRONICS*, June 1, p 37) that reject almost all stray light, eliminating the need for darkened rooms and tube shields.

At the same meeting, Aeroflex Laboratories showed an improved vertical gyro with high static accuracy and low free drift, in a package lighter than six pounds. The new gyro uses two capacitor-type pickoffs of unusual design to sense roll and pitch, and to drive the erection torquers to maintain gyro verticality. Free drift is 15 minutes of arc per minute of time, static accuracy one minute of arc. A self-contained oscillator-detector is mounted atop the hermetically sealed unit.

**D-C to
500,000 CPS
or
"bits"**

The VR-2600 Magnetic Tape Recorder / Reproducer is a completely integrated multi-channel wide-band data recording and reproducing system embodying unique concepts of accuracy, reliability, and simplicity. Equally suited to telemetry or laboratory applications and installations, the system provides d-c to 40 kc FM, 300 cps to 500 kc direct, IRIG, PDM and 1000 bit/inch parallel PCM record/reproduce capabilities. The VR-2600 employs all solid-state electronics and full push-button controls (6 speeds ranging from 17/8 to 120 ips in two ranges). A complete 7 or 14-channel record and playback system is housed in a single or dual cabinet (at customer option), with plug-in record and playback amplifiers available to handle Direct, FM, PDM, and PCM (Digital) Techniques. Exceptionally low-skew characteristics of the transport allow parallel PCM recording of 1000 bits per inch and provide lowest interchannel time displacement. Complete data? Call your nearby CEC sales and service office or write for Bulletin CEC 2600-X6.

CEC

Data Recorders Division

CONSOLIDATED ELECTRODYNAMICS
PASADENA, CALIFORNIA • A SUBSIDIARY OF BELL & HOWELL

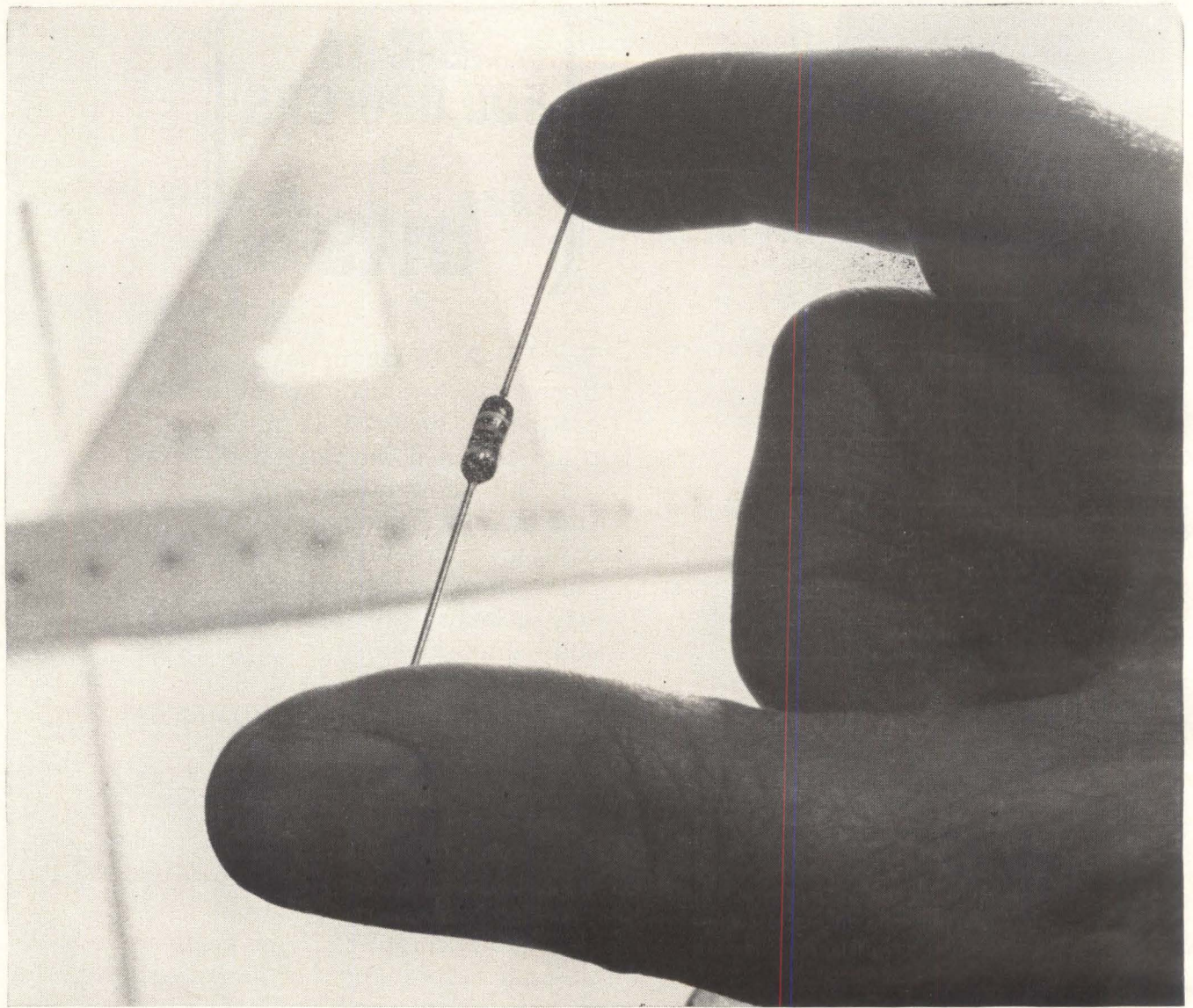

Why more good circuits start with Corning C resistors

First, you get performance within precision parameters from general purpose C-style resistors.

Second, C resistors let you plan a circuit within *known* limits of total resistance change from nominal—as little as 5%. Our new Corning Design Tolerances, based on extended load-life tests, give you that assurance.

Third, you get this predictably high performance at low

cost. C resistors are priced competitively with composition types.

C resistors give you these design advantages uniformly because we control the composition of their materials, and the way those materials bond together, in a continuous process.

C resistors that meet MIL-R-22684 are available from your Corning distributor in four sizes and values.

Get data sheets, test reports, and a brochure, "The Story Behind the Corning C Resistor," by writing Corning Glass Works, 3901 Electronics Drive, Raleigh, N. C.

Type	Wattage	Resistance (ohms)		Nominal Dimensions	Design Tolerance Full power, 70°C.
		min.	max.		
C07, Mil Style RL07	¼	51	150K	.250" x .090"	5% plus purchase tolerance
C20, Mil Style RL20	½	51	150K	.375" x .138"	
C32, Mil Style RL32	1	51	470K	.562" x .190"	
C42S, Mil Style RL42	2	10	1.3 meg	.688" x .318"	

CORNING

Electronic Components

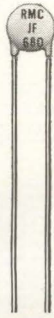

Reliability
Stability
Performance

RMC TYPE **JF DISCAPS**

- Characteristic frequency stability—superior to similar types.
- Working voltage rated at 1000 V. D. C.
- Capacity change of only $\pm 7.5\%$ between $+10^{\circ}\text{C}$ and $+85^{\circ}\text{C}$.
- Manufactured in capacities between 150 MMF and 10,000 MMF.
- Available with tolerances $\pm 10\%$, $\pm 20\%$, $+80-20\%$
- Available with standard or plug-in leads.

Type JF DISCAPS are one item in an extensive line of ceramic capacitors. Write today on your letterhead for RMC engineering counsel on design problems concerning capacitor application.

DISCAP
CERAMIC
CAPACITORS

RMC

RADIO MATERIALS COMPANY

A DIVISION OF P. R. MALLORY & CO., INC.
GENERAL OFFICE: 4242 W. Bryn Mawr Ave., Chicago 46, Ill.
Two RMC Plants Devoted Exclusively to Ceramic Capacitors
FACTORIES AT CHICAGO, ILL. AND ATTICA, IND.

LINE OF BALANCE is the critical level for each step in the production process so shipping dates can be met. Problems are spotted if bars fail to reach or exceed the line of balance

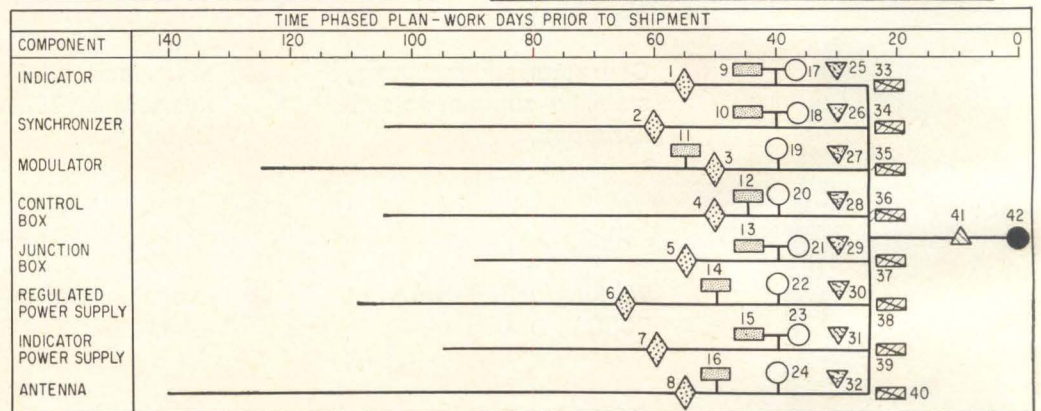
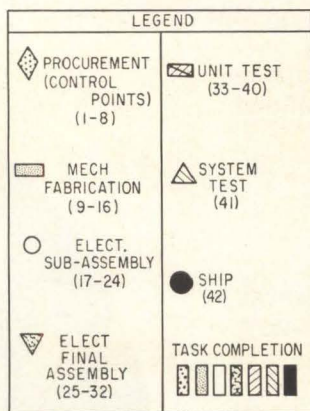
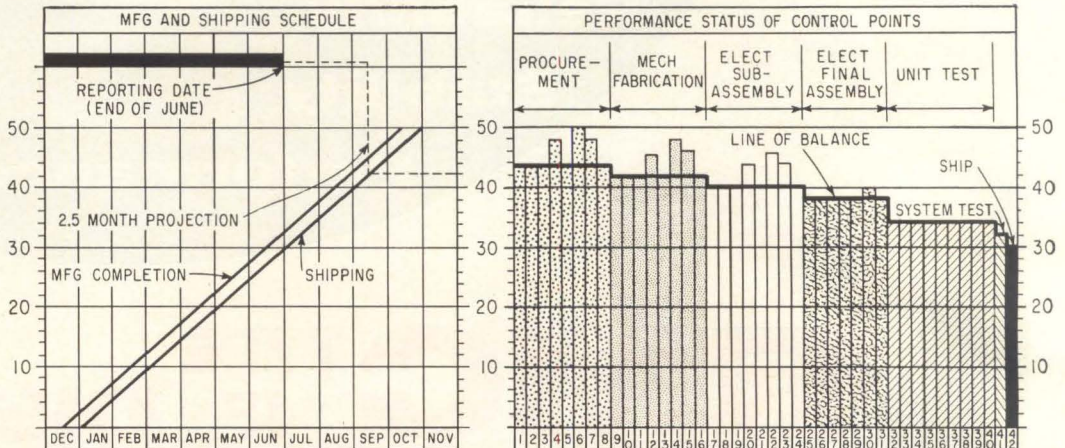

Line of Balance Shows Production Problems

Will shipping dates be met? Chart gives answer and shows production status

By A. J. CATALANO

General Dynamics/Electronics, San Diego, Calif.

PRODUCTION TROUBLES that might hold up important programs can be spotted quickly by a management tool called Line of Balance.

Adapted from the U.S. Navy system, Line of Balance is now in use on airborne radar production programs at this plant. The system is not a control method, as is the Pert system, but complements the Pert system by providing production management with a general picture of how a specific program

is progressing in relation to its schedule.

Production operations appear in capsule form on a single chart. The chart is updated weekly and copies are distributed to interested executives. From this single chart, management can determine what phases of a program are behind schedule and what effect these delays are having on delivery.

SCHEDULE—First step in developing the chart is establishing the manufacturing and shipping schedule, as shown in the upper left hand corner of the sketch. Dots on the graph indicate when each unit (one complete radar system) must be completed and when it must be shipped. (The dots are connected by lines to give a better graphic view.) Dates for shipment are determined by contract with the cus-

tomers and the dots must be accurately plotted since the final Line of Balance is taken from the line indicating shipment dates.

In the lower left hand corner of the chart are symbols for each major production step, one symbol for procurement, one for mechanical fabrication, electrical subassembly, and so forth.

TIME PHASED PLAN—The symbols are used in the Time Phased Plan diagram which is developed in the lower right hand corner. Eight components or subsystems of the radar units are charted in the example shown.

The time plan for each component shows the lead time required for each production step. The chart shows indicator procurement (designated by the diamond) must be completed 55 work days before the

Closer tolerances in your
**PRECISION
EQUIPMENT**

**FOR ONLY
A FEW
CENTS
MORE**

with Wilrite Metalloy

1%

**CARBON FILM
RESISTORS**

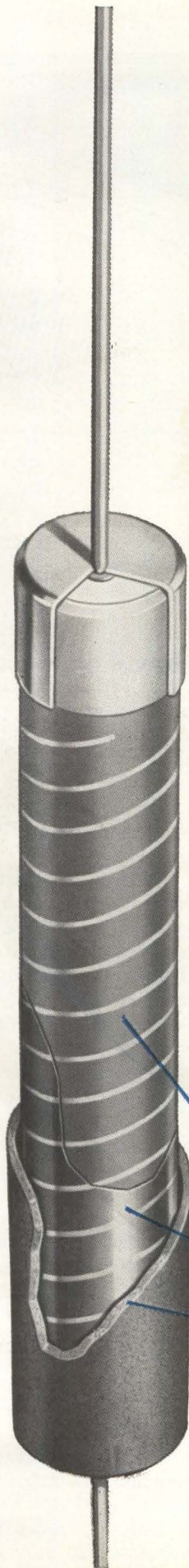

Greater precision and greater stability can be built into test equipment and other precision devices with the use of Wilrite's 1/2 watt, 1% film resistors, series CMC. These units are only slightly higher in price than 5% carbon composition resistors, but provide greatly improved performance.

These resistors are fabricated by Wilrite's patented "Metalloy" process that deposits a hard crystalline carbon alloy film on a ceramic substrate. The film cannot scratch or rub off. This is coated with an exclusive silicone formula and cured. A resin impregnated kraft sleeve provides excellent mechanical and additional electrical protection.

The Series CMC resistors are rated at 70°C, full load, and derate to zero at 150°C. They can also be supplied to closer tolerances on special order.

MOISTURE RESISTANCE

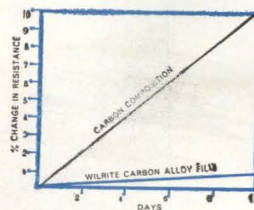

AGING STABILITY

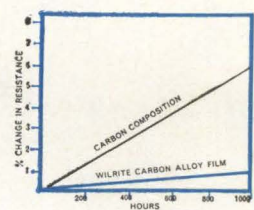

COST VS. TOLERANCE

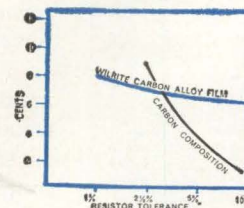

WILRITE—Film Resistors built to MIL-R-10509D

Type CMG
Hermetically Sealed—meets MIL characteristic B (150°C)

Type CMI
Silicone Resin Molded—meets MIL characteristic D (165°C)

Type CMH
Ceramic encased—meets MIL characteristic G (165°C)

CRYSTALLINE CARBON FILM

BAKED SILICONE

KRAFT SLEEVE

W-6216

WILRITE PRODUCTS, INC.
A SUBSIDIARY OF GLOBE-UNION INC.
3835 West 150th Street • Cleveland 11, Ohio
in association with
Centralab, the Electronics Division of Globe-Union, Inc.

From Aircraft Instruments to Recorders and Indicators...

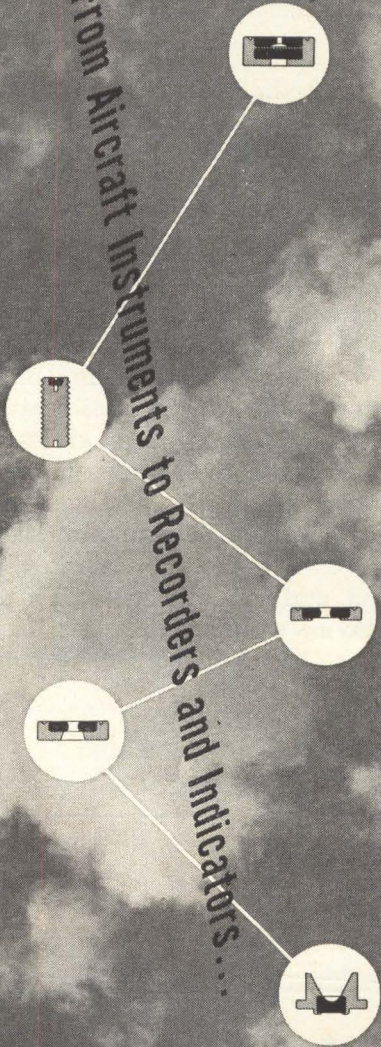

Bird PRECISION
JEWEL BEARINGS
are at the heart
of accurate
performance

For peak performance in less space, select from a wide range of standard Bird Sapphire and Glass Jewel Bearings, or Complete Jewel Assemblies and Cushion Jewel Assemblies. Or, if you have a special requirement, let our engineers aid you in arriving at the proper solution. Write for your free copy of the Bird catalog, which has complete details on properties and uses of jewel bearings for aircraft, electrical and timing instruments, recorders and indicators.

Richard H. Bird & CO., INC.

1 Spruce St., Waltham, Mass.

servicing industry with fine jewels since 1913

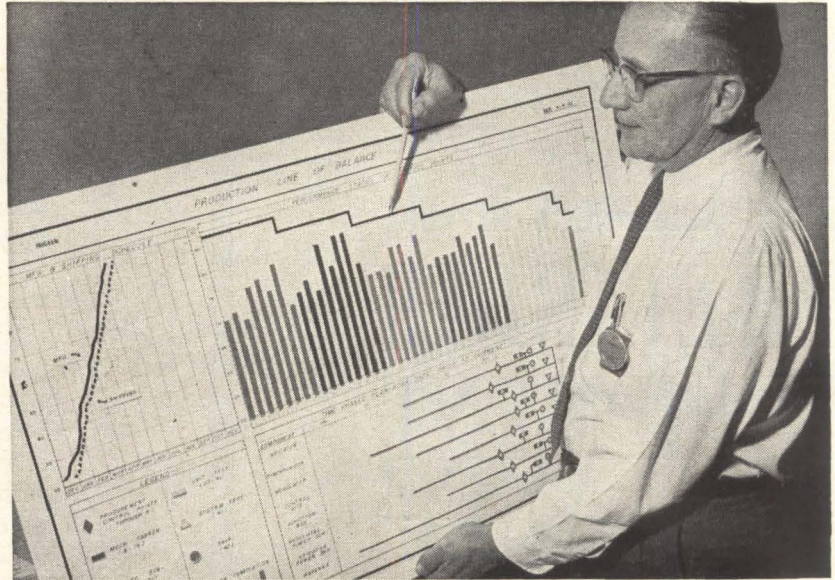

PRODUCTION MANAGEMENT tool shows problems quickly, does not require a great deal of work to keep up to date

complete radar unit can be shipped; mechanical fabrication and electrical subassembly must be completed 40 work days before shipment, etc.

The symbols on the time phase plan thus are control points that must be met if a radar unit is to be shipped on schedule.

LINE OF BALANCE—Next the control points are translated into a line of balance. To do this, each major production step is considered separately. Procurement support for all components may be considered as an example. Each procurement control point is given a value equal to its lead time. Thus, procurement for indicators must be completed 55 work days before shipment of a unit, so 55 becomes the value of that particular control point. Then control point values are averaged for all procurement.

In the example, procurement must be completed an average of 2½ calendar months before shipment. This information is next related to the manufacturing and shipping schedule. If the report is being made as of July 1, the 2½ months projects to Sept. 15. The number of units that must be shipped on Sept. 15 is determined from the diagonal shipping line, in this case 43 units.

Thus by July 1, procurement must be completed to support 43

units, since procurement must be complete 2½ months in advance. This then becomes the level of the line of balance for procurement, and a line is drawn at the 43-unit level on the graph titled Performance Status of Control Points.

Procurement submits reports on each component once each week. One report might show that procurement has been completed for indicators to support production through the 43rd unit. This is posted to the performance status chart as a bar drawn up to the 43-unit level.

When the bar meets or exceeds the line of balance, procurement is on schedule for that component. If the bar does not meet the line, a problem exists that threatens the schedule.

Identical procedure is followed for each task for each component. The result is a chart which summarizes the entire production operation. As production proceeds, the line of balance moves upward until it reaches the limit set by the manufacturing schedule.

The line of balance chart requires little preparation time. Input from production departments is usually available in data prepared for other reports, so the only additional time required is in interpreting the data and transferring it to the chart.

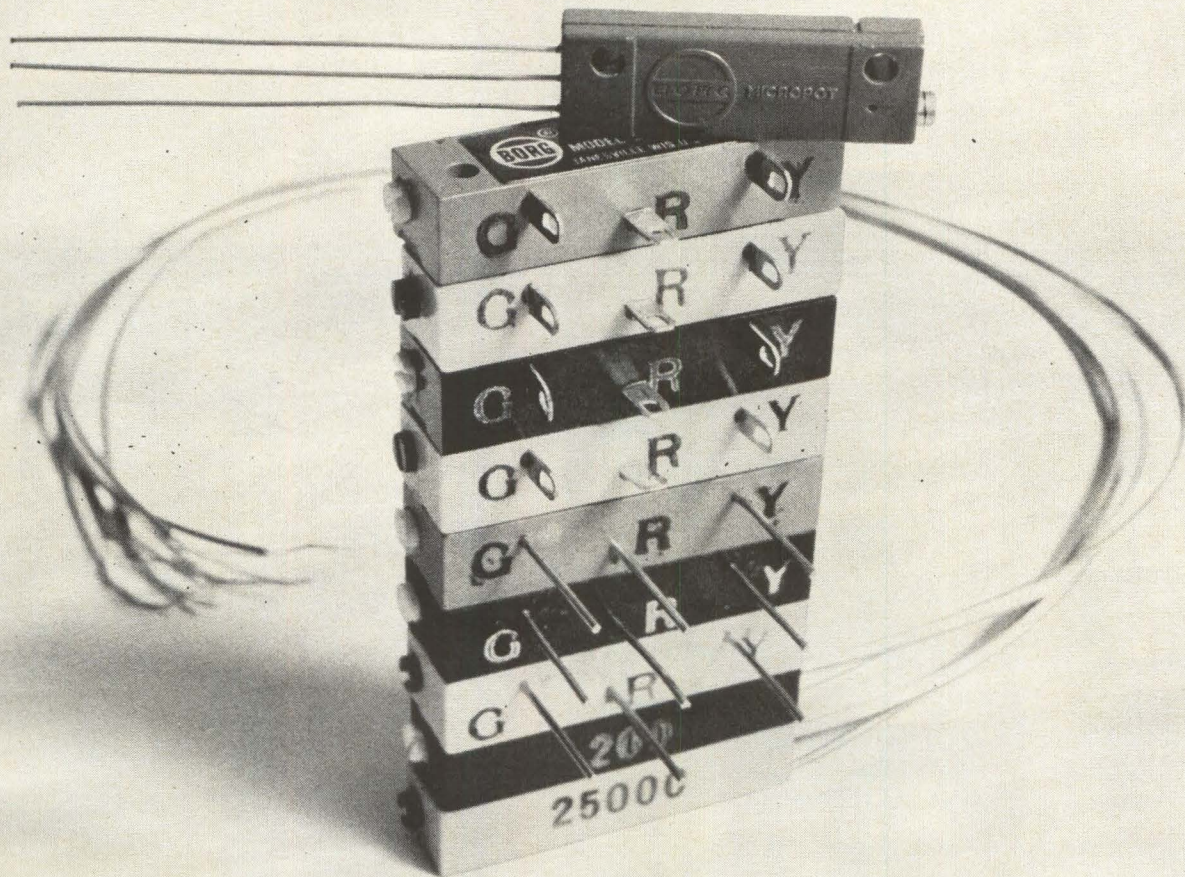

The complete Borg Trimmer line starts at the top

Everything must start someplace. The complete Borg line of Trimming Micropot® potentiometers can be said to start with its latest addition, the subminiature (1" x 3/16" x 5/16") 2700 series. This new Micropot is not only tiny, but a high-temperature, humidity-proof model as well.

However, if a quarter of an inch isn't important to your application, there are six other Borg Trimmer series from which to choose:

- 2800—High temperature, humidity proof, wirewound.
- 990—High temperature, wirewound.
- 992—General purpose, wirewound.
- 993—General purpose, carbon.
- 994—General purpose, humidity proof, wirewound.
- 995—General purpose, humidity proof, carbon.

Here are some of the advantages of-

- fered by Borg Trimmers: 1. Single-piece, welded terminations. 2. Low-mass contacts. 3. 100% noise test. 4. 100% contact resistance check. 5. 100% ratcheting test. 6. Resistances from ten ohms to one meg.

Selecting the right Borg Trimmer can be a lot easier if you'll call your nearby Borg technical representative or Amphenol-Borg Industrial Distributor. Or, if you prefer, write directly to R. K. Johnson, Sales Manager:



BORG EQUIPMENT DIVISION

Amphenol-Borg Electronics Corporation,
Janesville, Wisconsin.

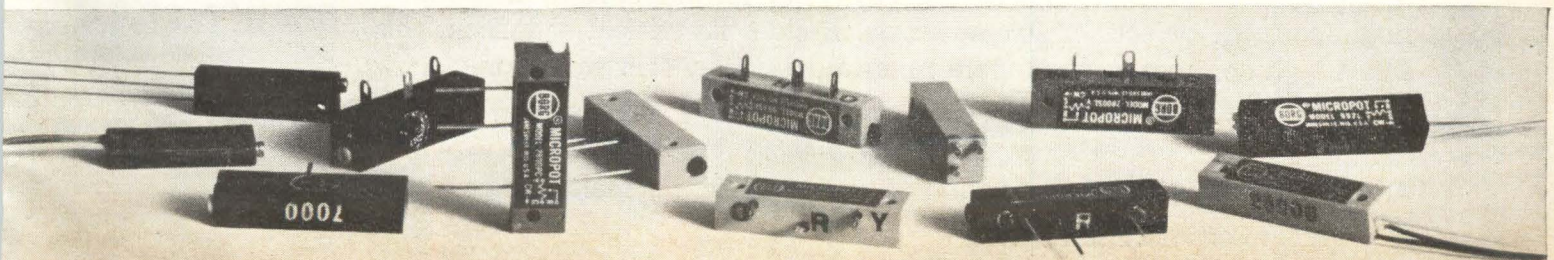

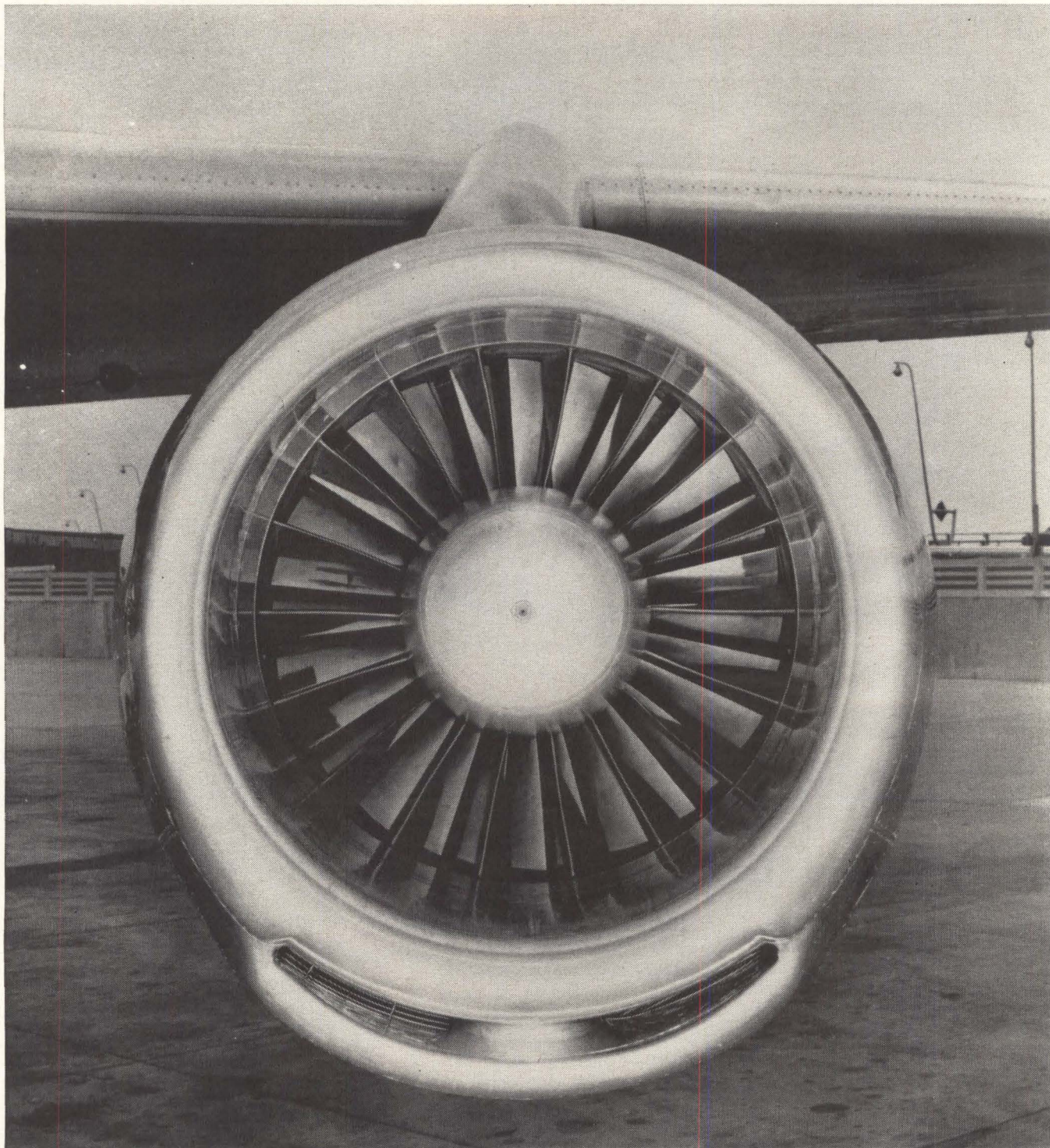

Say, "Ahhhh!"

Be "Ansko-sure" . . . Aircraft radiography demands Ansko Superay H-D® — the first, ultra-fine-grain American X-ray film for pinpointing the smallest manufacturing defects or stress fatigue. Besides its critical definition, this film's high contrast records more minute details—which would only show up marginally on conventional films.

For radiography—it's Ansko best by definition

Ansko—America's first manufacturer of photographic materials . . . since 1842

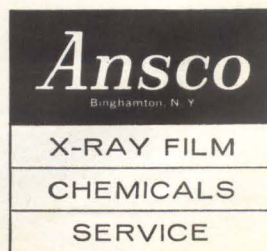

SORENSEN CUSTOM-DESIGNED HIGH-VOLTAGE SUPPLY POWERS CRITICAL NUCLEAR EQUIPMENT

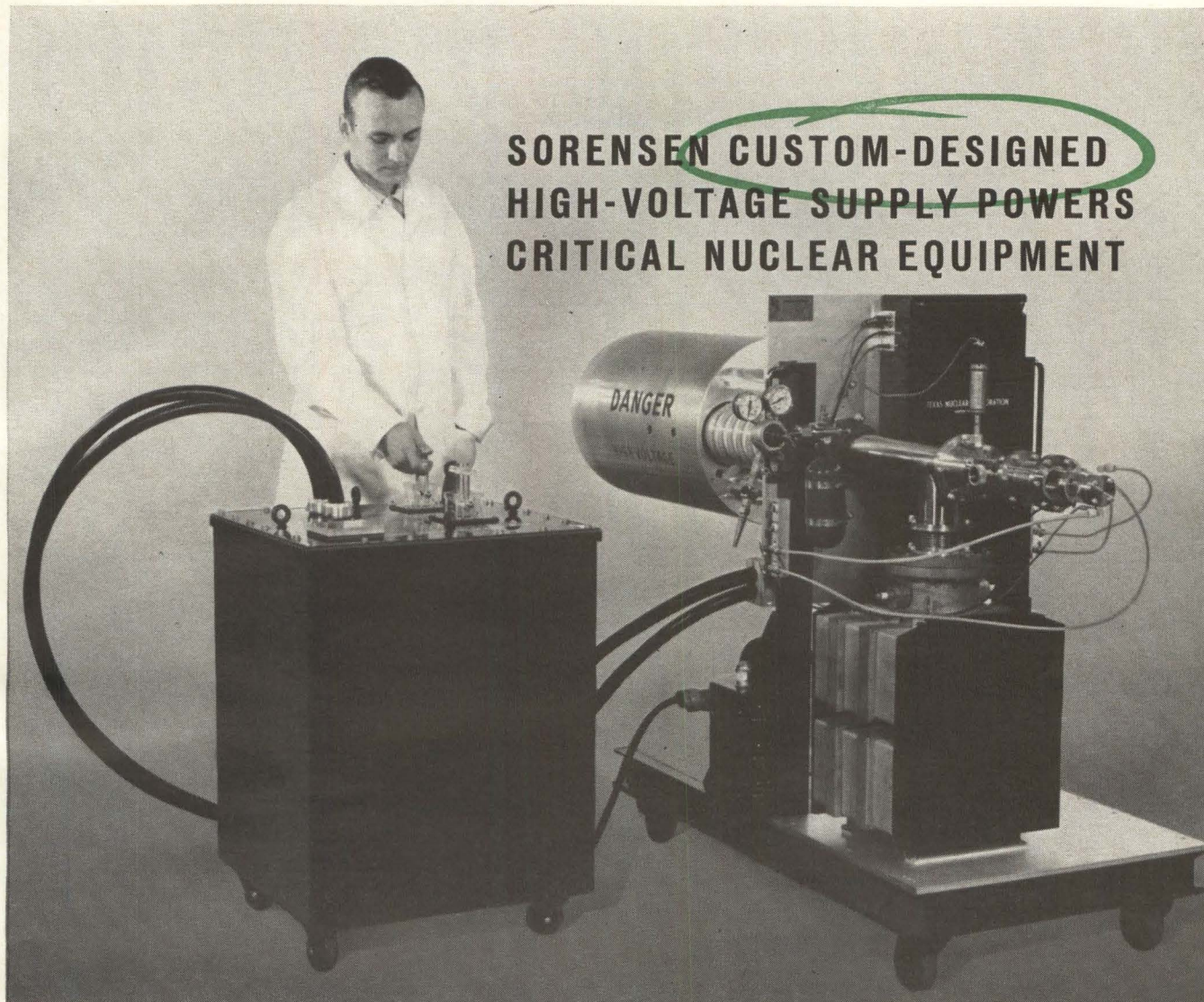

PROBLEM: How to get a high-spec, high-voltage power supply combining complete safety features and small size . . . at the right price . . . to power a compact, inexpensive neutron generator.

SOLUTION: *Texas Nuclear Corporation specified a Sorensen custom-designed unit supplying continuously variable voltage of 0 to 150,000 VDC at 5 MA.

Separate controller and tank units are from 25% to 50% smaller than anything offered by other power supply manufacturers. Complete personnel and equipment safety characteristics have been met in full. And the entire unit is competitively priced.

SORENSEN CUSTOM FEATURES: Solid state design . . . easily reversible polarity . . . externally accessible spark gap adjustment . . . internal isolation transformer with 1KVA rating . . . 125 VAC . . . custom-engineered controller unit.

SORENSEN STANDARD FEATURES: Automatic output voltage shorting mechanism . . . gaseous discharge devices for meter and relay protection . . . provision for external interlock . . . series resistance in output circuit . . . spark gap to ground from meters and transformer primaries . . . zero start interlock . . . overcurrent relay . . . overvoltage relay.

POWER SUPPLY PROBLEMS: Perhaps Sorensen engineering can help. For

more information on how Sorensen can help solve your power supply problems, write for our new brochure on custom design capabilities. Or, circle reader service number **71**.

*A division of Nuclear Chicago Corporation

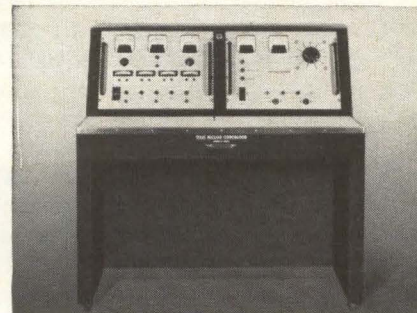

Texas Nuclear's 9500 neutron generator is used for activation analysis, student nuclear training, process control, research. High-voltage control panel (right) was custom designed to match generator panel.



A UNIT OF RAYTHEON COMPANY

RICHARDS AVENUE • SOUTH NORWALK • CONNECTICUT

DESIGN AND APPLICATION

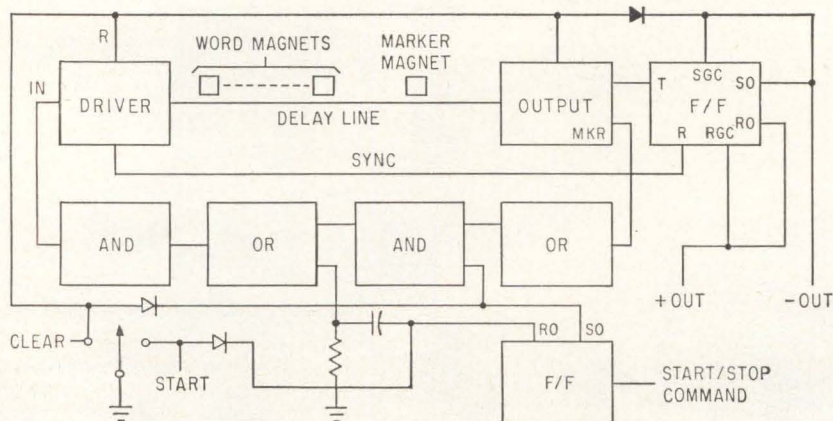

Digital Test Set Uses Magnets for Signals

Magnets placed on delay line create unlimited digital variations

INTRODUCED by Consolidated Avionics Corp., 800 Shames Drive, Westbury, N. Y., the Vari-Bit model 8003 can function as a continuously variable delay line between 10 and 1,000 μ s with prr of 250 Kc, 248 pulse function generator, variable frequency pulse generator between 1 and 100 Kc, can divide frequencies of 500 Kc by factors from 2 to 500, can multiply frequencies between 500 cps and 125 Kc by factors between 2 and 248 (upper limit 250 Kc), variable capacity serial memory with built-in reclocking and erasure and has provisions for other special functions that can be added by logic cards. The device uses the Torsmag principle where the fields of permanent magnets spaced along a torsional delay line generates pulses in the line as a wave traveling the length of the

line passes through the magnetic fields. Pulse timing is determined by spacing the permanent magnets along the line. Up to 248 magnets may be placed on the line with spacing determining the required pulse pattern every time the line is triggered. For periodic repeating, a

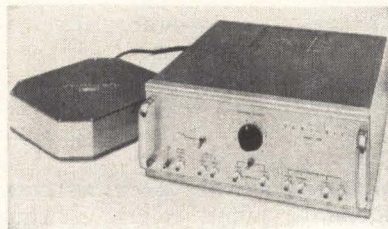

marker magnet is used. The sketch shows typical application in a function generator with internal rate control. The marker magnet is placed on the delay line so that distance of marker with respect to launch represents pattern periodicity.

CIRCLE 301, READER SERVICE CARD

Stabilized Semiconductor For Low-Level Chopping

RECENTLY announced by National Semiconductor Corp., Danbury, Conn., the Inch integrated chopper

is a new semiconductor component which replaces two extremely well-matched transistors. Differences between various units are offset voltage, dynamic saturation resistance and breakdown voltage. The unit is

specifically designed for low-level commutating, demodulating and chopper applications. As shown in the sketch, total number of thermocouples in signal path are reduced to four, drive current does not generate a voltage gradient along path of signal current, and only one base-collector junction is used. The device can chop in the Mc region and with base-emitter junction capacitance of 5 pf, considerably less turn-off spiking occurs. Typical transfer resistance is 5 to 10 milli-

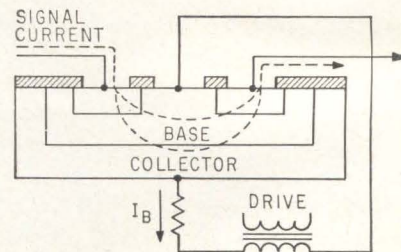

ohms, therefore unit is less sensitive to variations in base drive. The unit fits into a TO-18 case with the collector in electrical contact with the case. (302)

Improving Accelerometer Resolution by 12:1

MANUFACTURED by Donner Scientific Div., 888 Galindo St., Concord, California, the model 4105 range extender acts as a variable window and voltage expander of accelerometer outputs improving resolution through data transmission link by a factor of 12 to 1. Accelerometer accuracy deration is only 0.4 percent of full scale. The instrument accepts the complete accelerometer output and biases off the majority of this output with a stable reference source. The difference is amplified. Total output is determined by adding magnitude of bias voltage to magnitude of amplified difference voltage. The input range

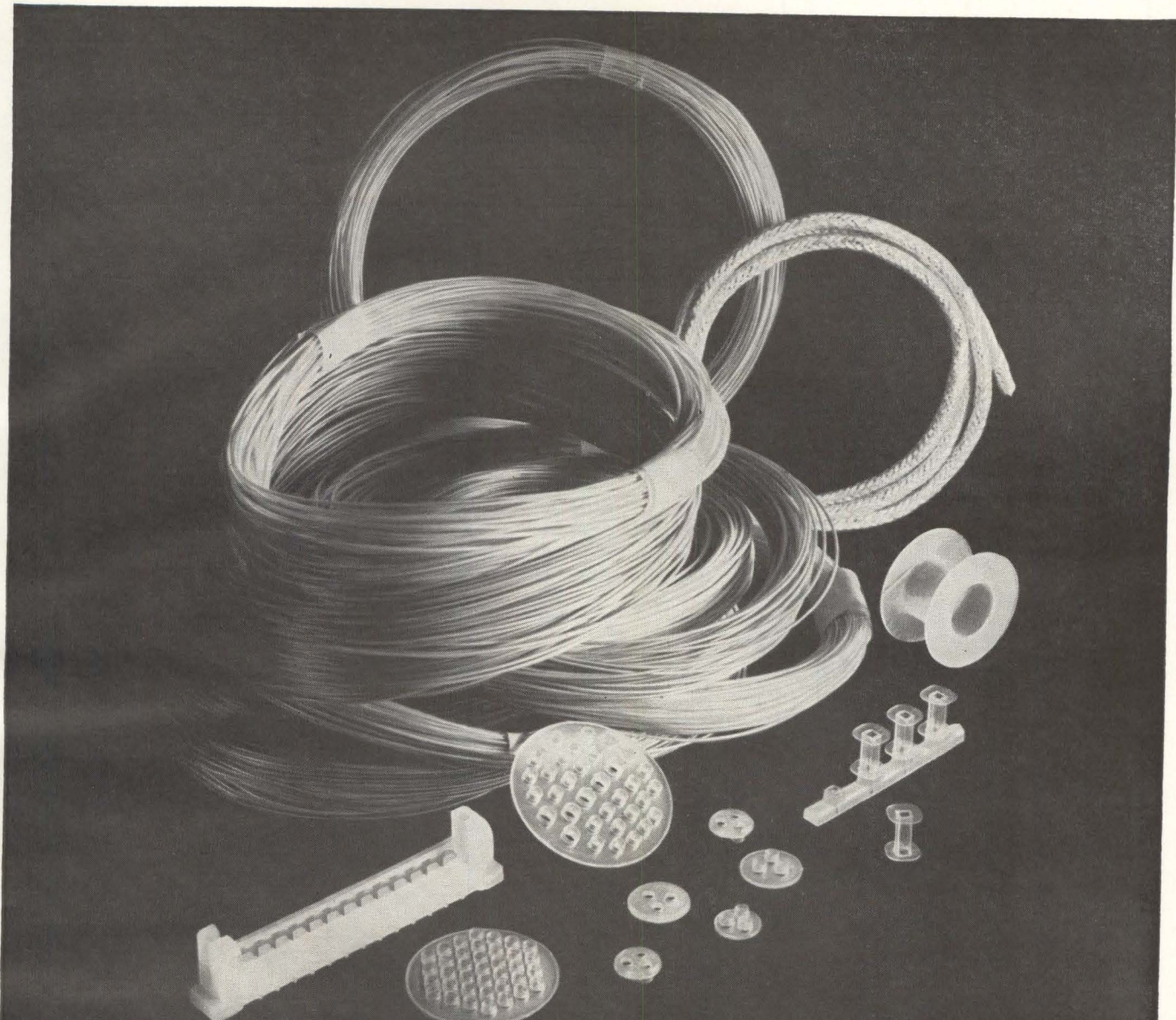

KYNAR[®] vinylidene fluoride resin... the new high performance insulating material

Kynar, the new fluorocarbon resin from Pennsalt Chemicals, offers an outstanding combination of properties for electronic applications. Coupled with high dielectric strength and resistivity, Kynar offers extreme mechanical strength and toughness, stability to temperatures ranging from -80 to $+300^{\circ}\text{F}$, and resistance to severe environmental stresses caused by weather, radiation and corrosive chemicals. Kynar is readily extruded to form primary wire insulation, abrasion-resistant jackets, and thin wall tubing. And Kynar-insulated hook-up wire withstands the mechanical stresses imposed by high speed automatic wrap and assembly without deterioration.

Typical properties of 10-mil Kynar insulation extruded over AWG 24 solid soft copper conductor:

Dielectric strength, volts.....	10,000
Insulation Resistance, meg-ohm/M.....	$> 1,000$
Cold bend, $\frac{1}{2}$ " dia., 1 lb. weight at -70°F , volts..	8,000
Abrasion Resistance, Janco Tester grade 400 alumina, inches of tape.....	50
Cut through, anvil at 90° , 350 gm. hours at 270°F	> 500

Soldering test, flare back..... None
Flammability..... self extinguishing

Write for our new brochure and the names of nearby fabricators who supply Kynar. Plastics Dept., PENNSALT CHEMICALS CORPORATION, 3 Penn Center, Phila. 2, Pa.



IN THE EXPANDING FIELD OF

PHOTOGRAPHY

THE UNIQUELY CONTROLLED CHARACTERISTICS OF

CLAIREX[®] PHOTOCONDUCTIVE CELLS

... ARE THE BASES FOR A GROWING NUMBER OF PRECISION APPLICATIONS

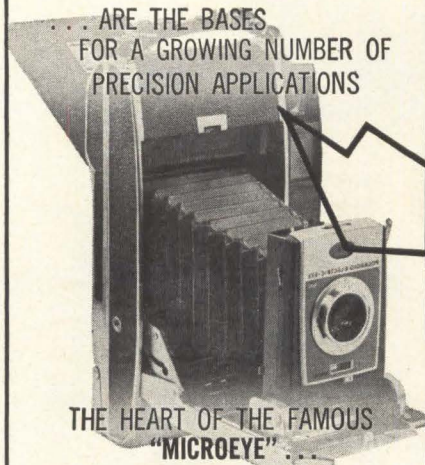

THE HEART OF THE FAMOUS "MICROEYE" ...

in the Model 900 Polaroid[®] Land Camera is a Clairex cell of special design, with a sensitivity capable of controlling the precise adjustment of the exposure mechanism over a light range from less than 1/10 of one foot-candle to several hundred foot candles.

Clairex Corporation, through:

- CAREFULLY CONTROLLED CHARACTERISTICS
- CUSTOM DESIGN AND
- ULTRA SENSITIVITY

has pioneered the use of photoconductive cells in the photographic industry. A growing number of high quality still and movie cameras, exposure meters, enlargers and projectors are now using Clairex cells.

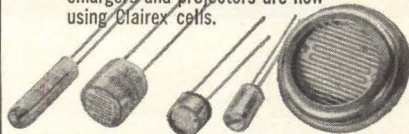

Approximately 1/2 actual size

The broadest standard line — 5 Series in both glass and metal packages plus unique abilities to custom engineer ... because "Photoconductors are our only business."

CLAIREX CORPORATION

8 West 30 Street, New York 1, N. Y.
The Light Touch in Automation and Control

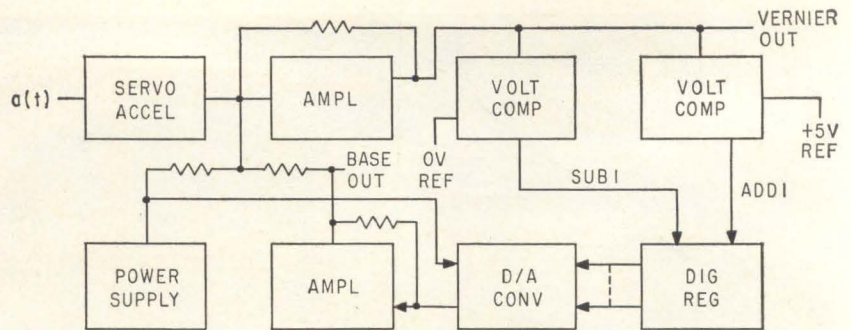

must be symmetrical about 0 g. Two outputs are available: the base channel with 0—5 v equally divided into 24 incremental steps so that 0 v equals — full g, 2.5 v equals 0 g, and 5 v equals + full g range; the vernier channel has amplified voltage variations scaled from 0—5 v such that 2.5 v equals 0 g, and 5 v and 0 v are equivalent in g magnitude of one base channel step. Re-

sponse is zero to full scale in less than 0.01 second. As shown in the sketch, the system consists of a linear servo accelerometer, a precision reference source, two chopper-stabilized operational amplifiers, two voltage-comparison gates, a digital step register and an analog-to-digital converter.

CIRCLE 303, READER SERVICE CARD

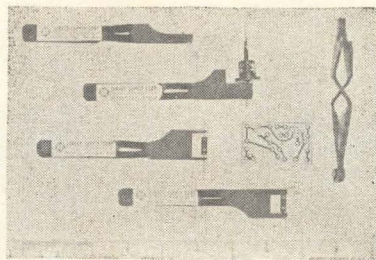

Assembly Heat Sink Avoids Thermal Shock

SURVEY SUPPLY CORP., 8092 Engineer Rd., San Diego 11, Calif. Designed to improve the reliability of electronic circuitry by avoiding the possibility of thermal shock of components during assembly soldering into boards or modules, Transisav also reduces production cost by lessening component loss and increasing individual productivity. Manufactured in 27 standard configurations for various axial lead components, height control, board spacing module assemblies, and anti-wicking applications. (304)

short-circuit current with a low rms current output. The unit delivers 6 v peak-to-peak, rise time of 100 μsecs and pulse duration of 100 ms. Feedback makes temperature and line stability very high. The amplifier is self regulating in that constant load output from scr's is maintained rather than con-

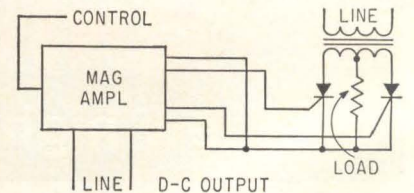
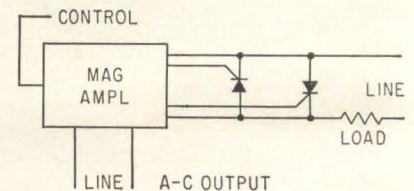

stant firing angle with varying line voltages in a transistor circuit. Sketch shows operation with either a-c or d-c outputs from the scr's. (305)

Current-Controlled Magnetic Amplifier Triggers SCR's

ANNOUNCED by MACE Corp., 900 N. E. 13th St., Ft. Lauderdale, Fla., the P-series of scr firing magnetic amplifiers are current controlled but can be modified for impedance control. Design is based on the scr as a current-triggered device and thus is capable of delivering 200 ma

Vacuum Controllers

HASTINGS-RAYDIST INC., Hampton, Va. Series of vacuum controllers featuring miniaturized, self-contained circuitry and taut-band pivotless meters, are available in three ranges: 0-20 mm Hg, 0-100

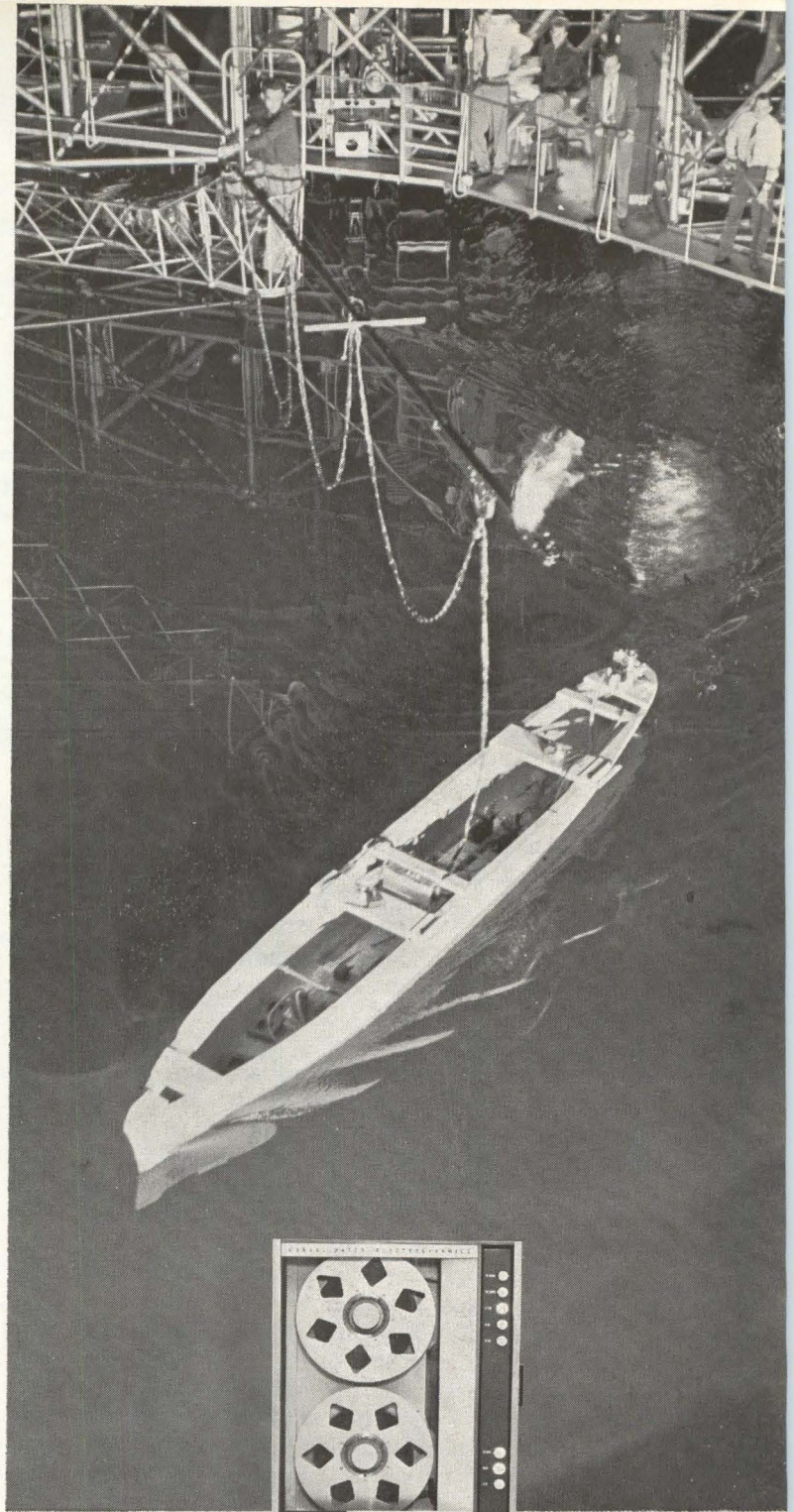
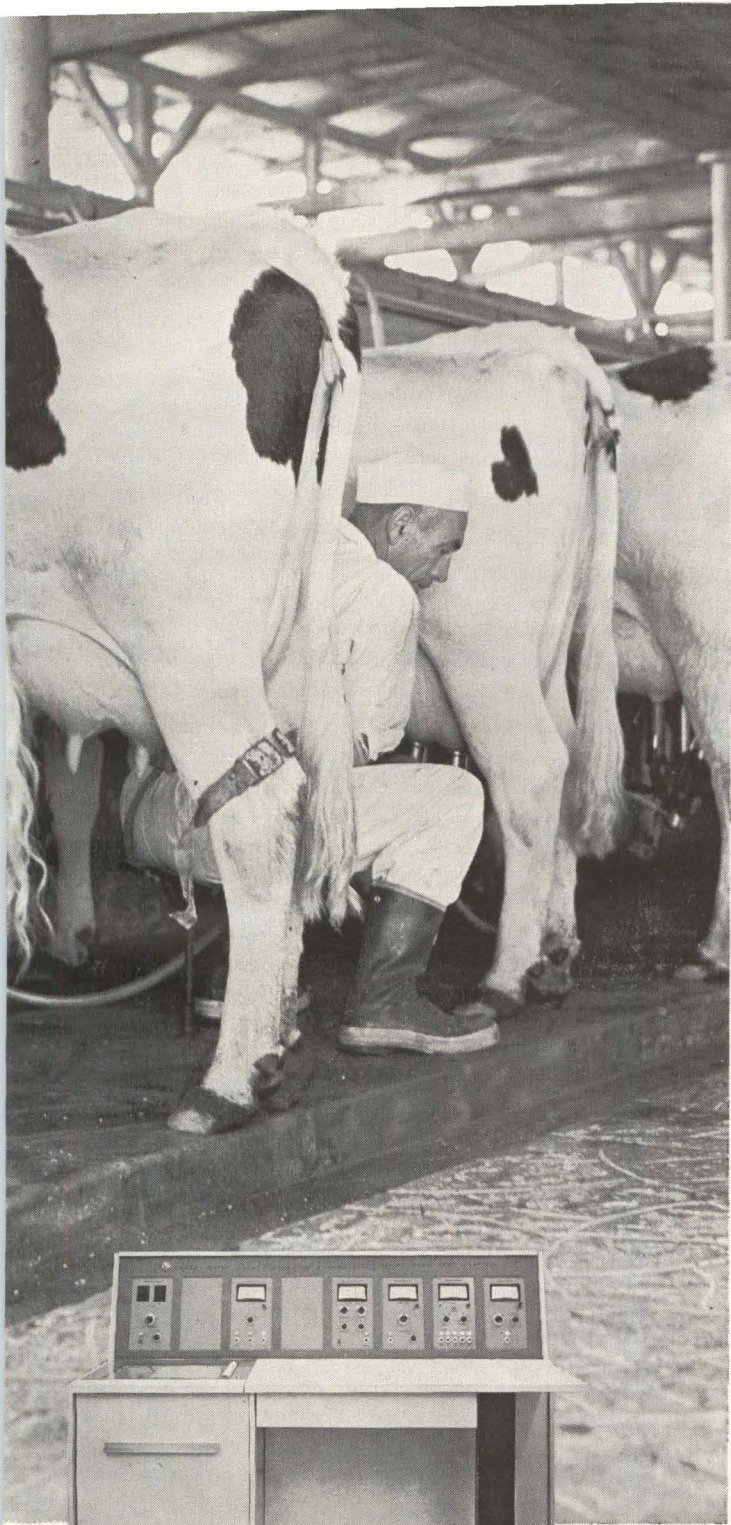

INSTRUMENTATION FROM CEC

keeps milk pure in Melbourne... builds better ships in Maryland

A Mass Spectrometer on an Australian dairy farm seeks out milk impurities... A Recorder/Reproducer and Vibration Transducers take part in model tests of a new ship design... AND both instruments are from CEC—producers of instruments for measuring and recording physical and chemical phenomenon... analytical instruments... process control instrumentation... high vacuum technology. CEC instruments deliver an important end product: FACT... mathematical fact... vast amounts of data obtained quickly, accurately and reliably. If information is a key element in your industry...

whether in research and development or in production... CEC instrumentation may be of service to you. Why not find out? A call to your nearby CEC sales and service office will bring an expert to consult with you—or your request will bring our new 28-page brochure describing CEC's capabilities. Ask for Bulletin CEC 303.

CEC/Bell & Howell

CONSOLIDATED ELECTRODYNAMICS, Pasadena, California • divisions: ANALYTICAL & CONTROL • TRANSDUCER • DATA RECORDERS DEVAR-KINETICS • subsidiary: CONSOLIDATED VACUUM CORPORATION

CIRCLE 75 ON READER SERVICE CARD

CANNON

engineering notes:

DESIGNING SUBMINIATURE RF PLUGS FOR SATELLITE CIRCUITRY

As the Space Program has expanded, there has been an increasing need for more sophisticated RF subminiature electronic circuitry to meet the exacting demands of satellites and spacecraft. This subminiaturized circuitry is used in many new design applications which require more ideally matched RF electrical connectors with very low VSWR and superior performance characteristics. To meet these needs we have developed the Cannon CX Series of subminiature RF Coaxial Plugs. This 50-ohm, matched-impedance series introduces a VSWR of less than 1.08:1 from dc up to 2000 mc, and does not exceed 1.25:1 up to 6000 mc.

Because the total VSWR of a system is a function of several characteristics, with a high degree of probability of the phasing of many discontinuities, the individual electrical connector and its cable junction must be designed to exhibit extremely low reflections.

The high performance of Cannon CX Coaxial Plugs is made possible by incorporating Cannon Micropins[®] and Microsockets[®] as center contacts which are fully captivated. This design

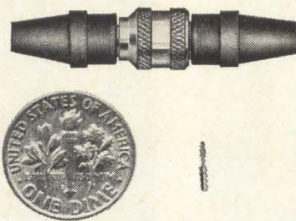

MICROPIN AND CX COAXIAL PLUG (ACTUAL SIZE)

eliminates the "slotted-contact" technique which exists in other configurations, and more closely approximates the ideal RF transmission concepts. Both the center contact and the outer-shielding braid ring are crimped securely to RG-188/U cable by means of the same hand tool, and with negligible physical distortion. Cable retention forces are the same as those required to break the cable shielding braid, which ranges from 23 - 30 pounds. A mated plug and jack weigh approximately .011 pounds. These connectors exceed the environmental and electrical performance requirement of MIL-C-22557 (SHIP) and thus are ideally suited for the exacting demands of satellites and spacecraft.

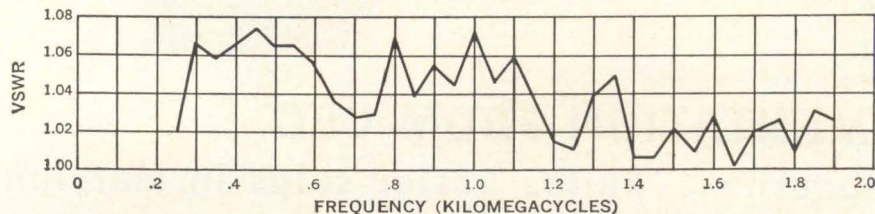

James H. Cannon
Vice President, Engineering

Imaginative Engineering For The Space Era.



CANNON ELECTRIC COMPANY, 3208 Humboldt St., Los Angeles 31, Calif.

microns Hg and 0-1,000 microns Hg, and operate from 90-140 v a-c power.

CIRCLE 306, READER SERVICE CARD

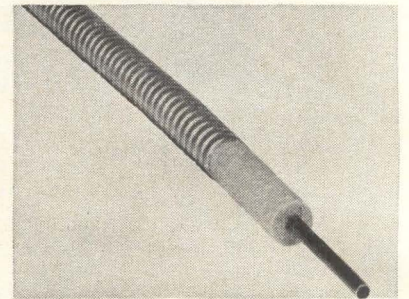

Coaxial Cable Features Foam Dielectric

ANDREW CORP., P.O. Box 807, Chicago 42, Ill., offers a flexible, low loss, foam dielectric coaxial cable. The low density foam insulation, together with high conductivity of both copper conductors, result in minimum attenuation. Foam Helix is available in 50 ohm, $\frac{1}{2}$ in. and $\frac{7}{8}$ in. sizes in splice free continuous lengths. Selection of end fittings available. (307)

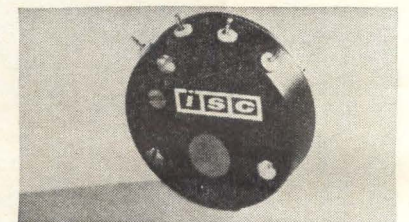

Magnetic Transducers $1\frac{1}{2}$ IN. BY $1\frac{1}{2}$ IN.

INSTRUMENT SYSTEMS CORP., 129-07 18th Ave., College Point 56, L. I., N. Y., offers a magnetic transducer which generates a voltage proportional to the magnetic field applied, for automation applications. Model MT-10 consists of a Hallistor (Hall generator), heat sink, magnetic flux concentrator, and zeroing network in a self-contained enclosure. Principal application is contactless signaling in industrial control and data systems. (308)

All Purpose Diode

AMERICAN MICRO DEVICES, INC., 10838 N. 19th Ave., Phoenix 20, Ariz. An all purpose diode, designed to satisfy the need for a single component which will serve both as a rectifier and a switch,

Imaginative Engineering For The Space Era.



RF CANNON COAXIAL PLUGS FOR SPACE AGE APPLICATIONS

SUBMINIATURE TO SUPERSIZE...CANNON CAN SOLVE YOUR COAXIAL CONNECTOR PROBLEMS.

Cannon RF Coaxial Plugs—both subminiature and standard—meet the exacting demands of space age environments. Our newest line of subminiature RF plugs, the "Crimp-Imp"*, incorporates crimp assembly techniques for both the cable center conductor and the cable braid. These impedance-matched connectors have a VSWR not greater than 1.08:1 up to 2.0 KMC, a new level of achievement in subminiature RF connectors...also employ Cannon Micropin® and Micro-socket® contacts. For use with large RF cable, our lightweight

ALLT Series provides specially designed environmental plugs for continuous operation at 1000 watts CW over the range of 0.03-5.0 KMC from sea level to 70,000 feet altitude. An assembly of two ALLT plugs on 50 inches of cable exhibit a VSWR not greater than 1.2:1 over this same range. The Crimp-Imp and the ALLT are but two typical examples of Cannon's capabilities to design and produce RF connectors meeting the most demanding requirements of size and electrical characteristics. For information write to:

CRIMP-IMP VSWR CURVE

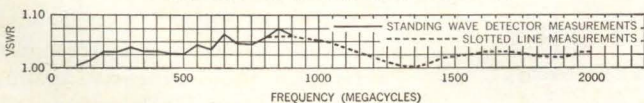

* TRADEMARK

CANNON ELECTRIC COMPANY, 3208 Humboldt Street, Los Angeles 31, Calif.



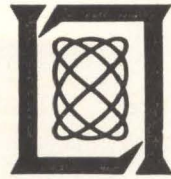

The Lincoln Laboratory program for ballistic missile range measurements and penetration research includes:

EXPERIMENTAL RESEARCH

Measurements and analysis of ICBM flight phenomena for discrimination and for decoy design purposes, including optical, aerodynamic and RF effects.

SYSTEM ANALYSIS

Studies to apply research findings to advance the technology of ICBM and AICBM systems.

INSTRUMENTATION ENGINEERING

Designing radar, optical and telemetry equipment with which to measure ICBM flight effects under actual range conditions.

RADAR SYSTEMS RESEARCH

Extending the theory and application of radar techniques to problems of discrimination, countermeasures and performance in a dense-target environment.

HYPERSONIC AERODYNAMICS

Study of the flow-fields around re-entering bodies for various body designs and flight conditions. Excellent computer facilities available.

RADAR PHYSICS

Theoretical and experimental studies in radar back-scattering. Interaction of RF radiation with plasmas.

- *A more complete description of the Laboratory's work will be sent to you upon request.*

All qualified applicants will receive consideration for employment without regard to race, creed, color or national origin.



Research and Development
LINCOLN LABORATORY
Massachusetts Institute of Technology
BOX 27
LEXINGTON 73, MASSACHUSETTS

shows a very high piv rating, a high forward current and a low capacitance combined with moderate switching speed.

CIRCLE 309, READER SERVICE CARD

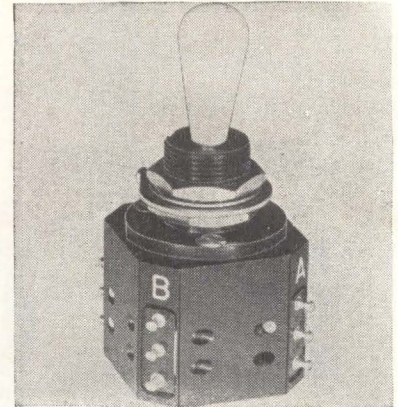

Toggle Switch Saves Panel Space

MICRO GEE PRODUCTS, INC., 6319 W. Slauson Ave., Culver City, Calif. A 5-position toggle switch, designed for space saving of instrument panels, weighs 1.4 oz. Model 2200 was developed to provide reliable switching in condensed circuit applications and as an aid to improve the utilization and operation of complex control panels. It is designed to meet the environmental requirements of MIL-E-5272B. (310)

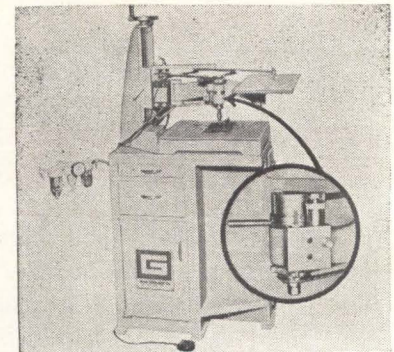

Spindle Feed Control Improves P-C Drill

GREEN INSTRUMENT CO., INC., 295 Vassar St., Cambridge, Mass. Printed circuit drills can now be equipped with a spindle feed control that provides a constant rate of feed to the work. Materials such as metal-clad epoxy glass can now be drilled without expensive tooling or specialized labor. Spindle speeds of up to 26,000 rpm permit use of carbide drills when required. Drill



**Are you a
COMPLETELY INFORMED
electronics engineer?**

Today you may be working in microwaves. But on what project will you be working tomorrow? You *could* have read **electronics** this past year and kept abreast of, say, microwave technology. *There were 96 individual microwave articles between July, 1961 and June, 1962!*

But suppose tomorrow you work in some area of standard electronic components, in semiconductors, in systems? Would you be up-to-date in these technologies? Did you read the more than 3,000 editorial pages that **electronics'** 28-man editorial staff prepared last year?

electronics is edited to keep you current *wherever* you work in the industry, *whatever* your job function(s). If you do not have your own copy of **electronics**, subscribe today via the Reader Service Card in this issue. Only 7½ cents a copy at the 3 year rate.

electronics

**NOW...K_u-BAND
NONDEGENERATE
PARAMETRIC AMPLIFIER-CONVERTER**

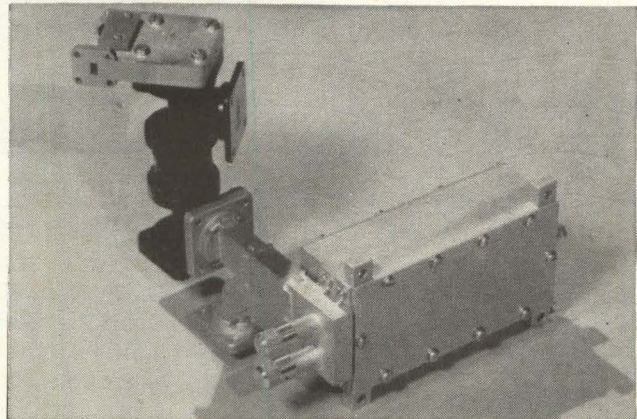

Reliable low-noise radar and communication receiver assemblies at K_u-band frequencies are now available from Texas Instruments! The nondegenerate parametric amplifier, *solid-state* signal source for local oscillator, all transistorized mixer-preamplifier and power supplies — provide extremely high reliability. Integration into *your* system will be effected by TI's staff of experienced applications specialists. Call today.

**MODEL K-22A
PARAMETRIC AMPLIFIER - CONVERTER ASSEMBLY**

Frequency Range	13.0 to 14.0 Gc
Gain	35 db minimum
System noise figure	5 db at 25°C typical
Instantaneous Bandwidth	25 mc at 1-db points 30 mc at 3-db points
Temperature	0°C to +50°C
Gain Stability	± 1 db per one-hour period
Frequency Stability of local oscillator	±0.001% over temperature range
Output	238 mc (40-mc bandwidth)
Varactor Diode	TI Gallium Arsenide

For more details about Texas Instruments parametric amplifiers and associated mixers, pumps, signal sources, harmonic generators, filters, and complete low-noise receivers, contact Marketing Department - 46.



APPARATUS DIVISION
**TEXAS INSTRUMENTS
INCORPORATED**
6000 LEMMON AVENUE
P. O. BOX 6015 DALLAS 22, TEXAS

Acoustical Components of Superior Quality

JAPAN PIEZO supplies 80% of Japan's crystal product requirements.

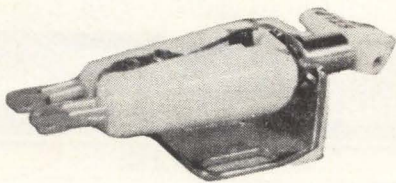
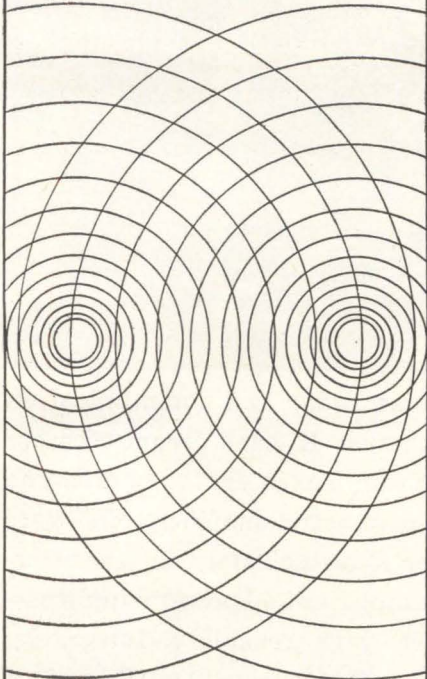

STEREO CARTRIDGE Crystal — "PIEZO" Y-130 X'TAL STEREO CARTRIDGE

At 20°C, response: 50 to 10,000 c/s with a separation of 16.5 db. 0.6 V output at 50 mm/sec. Tracking force: 6 ± 1 gm. Compliance: 1.5×10^{-6} cm/dyne. Termination: $1M\Omega + 150$ pF.

Write for detailed catalog on our complete line of acoustical products including pickups, microphones, record players, phonograph motors and many associated products.



JAPAN PIEZO ELECTRIC CO., LTD.

Kami-renjaku, Mitaka, Tokyo, Japan

speeds and feeds are adjusted independently.

CIRCLE 311, READER SERVICE CARD



Industrial Triode Used as R-F Oscillator

AMPEREX ELECTRONIC CORP., 230 Duffy Ave., Hicksville, N. Y. Type DX232 is designed as an r-f oscillator in equipment for localized dielectric heating applications. It will operate with extreme reliability at frequencies up to 300 Mc. Tube has an external forced-air cooled anode with a 300 w dissipation rating. Its cathode is a thoriated tungsten filament. In typical grounded grid class C operation as an industrial oscillator, the DX232 will provide up to 300 w to the load. (312)

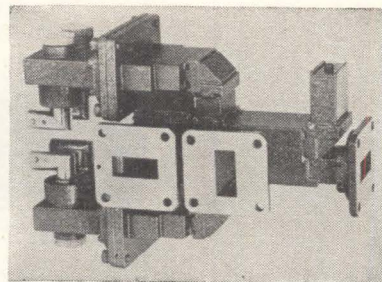

Image Rejection Mixer Needs No Filters

MICROWAVE DEVELOPMENT LABORATORIES, INC., 15 Strathmore Rd., Natick Industrial Centre, Natick, Mass., has available model 90MR-16-1 with an image rejection of 20 db. This mixer by phasing accomplishes image rejection without the use of filters. Operating over the frequency range from 8.5 to 9.6 Gc, the unit has a noise figure of 7.5 db, a 1.3 vswr and an isolation of 20 db. (313)

Synchros

THE BENDIX CORP., Montrose Division, South Montrose, Pa., has available size 10 and size 11 high-temperature radiation-resistant synchros suitable for operation at 800 F. (314)

RELIABILITY

for
the
"birds"



*"Birds," such as the Advanced POLARIS (we build the guidance system); the "birds" for anti-missile defense (we have boost-intercept, mid-course and terminal studies under way); the orbiting "birds" like SYNCOM (our synchronous communications satellite); the soft lunar landing "birds" like SURVEYOR—and there are others.

At Hughes in Southern California, a scientific, organized approach to total reliability makes the Reliability Engineer a key man in every phase of every program—from proposal to production.

A few of our current openings for qualified Reliability Engineers include:

SYSTEM RELIABILITY ANALYSTS

To determine reliability requirements and make reliability forecasts for weapon systems under development.

QUALITY ASSURANCE ENGINEERS

Experienced in quality control management, quality testing, electronic test instrumentation, processing of performance data and development of corrective programs.

COMPONENT RELIABILITY SPECIALISTS

With experience in reliability and failure analysis of components, testing methods, test equipment design and environmental testing.

RELIABILITY ENGINEERS

Familiar with organizing reliability programs, circuit analysis, maintenance analysis, test planning, missile system test and failure analysis, parts standardization and selection, documentation, qualification and Mil Specs.

If you feel that you are qualified by interest, training and experience—and hold a degree from an accredited university and U.S. Citizenship, we would like to talk with you.

Please airmail your resume, in confidence, to:

MR. ROBERT A. MARTIN
Head of Employment

creating a new world with electronics

HUGHES

HUGHES AIRCRAFT COMPANY
AEROSPACE DIVISIONS

11940 W. Jefferson Blvd.

Culver City 57, California

An equal opportunity employer

PRODUCT BRIEFS

TRANSIENT VOLTAGE DETECTOR is all-solid state. Unit has three ranges—100 v, 1 Kv and 10 Kv. Halmar Electronics, Inc., 1550 W. Mound St., Columbus 23, O. (315)

LINEAR PHASE SHIFTER for 10-60 Mc. Delay change may be specified within range of 2-200 μ sec. Andersen Laboratories, Inc., 501 New Park Ave., West Hartford 10, Conn. (316)

SPST WAVEGUIDE SWITCH for X-band use. It features a switching rate of $\frac{1}{2}$ μ sec. Micro State Electronics Corp., 152 Floral Ave., Murray Hill, N.J. (317)

CONVERTER MODULES in two new Bipco types. Prices are \$145 and \$320. Burroughs Corp., P. O. Box 1226, Plainfield, N.J. (318)

RFI MEASURING EQUIPMENT covers 150 Kc to 32 Mc. It has a built-in capability for data and spectrum signature recording. Stoddart Aircraft Radio Co., Inc., 664 Santa Monica Blvd., Hollywood 38, Calif. (319)

MAGNETIC REED SWITCH can handle 5,000 v with breakdown voltages up to 20,000 v. It offers high speed and long operating life. Hamlin Inc., Lake and Grove Streets, Lake Mills, Wisc. (320)

DRY REED RELAYS, encapsulated assemblies. They are designed to plug into printed circuits. Magnecraft Electric Co., 5565 N. Lynch, Chicago 30, Ill. (321)

INDUCTIVE RESISTOR for logic circuits. Nominal inductance of 275 μ h is typical. California Resistors Corp., 1631 Colorado Ave., Santa Monica, Calif. (322)

DIFFERENTIAL OPERATIONAL AMPLIFIER for data handling and control systems. It features low drift and high common mode rejection. Keltron Corp., Box F, West Newton 65, Mass. (323)

TRANSISTORIZED CHOPPER is solidly encapsulated. Model 10 Microchopper can be driven from d-c to 100 Kc. Solid State Electronics Co., 15321 Rayen St., Sepulveda, Calif. (324)

AUTOMATIC TESTERS/CLASSIFIERS for diodes at elevated temperatures. Production rate is around 4,000 per hr. Transistor Automation Corp., 101 Erie St., Cambridge, Mass. (325)

D-C AMPLIFIER with 50 nsec rise time. It uses isolated power modules. Elcor, Inc., 1225 West Broad St., Falls Church, Va. (326)

SILICON STABISTORS cover 1.10 to 2.8 v. Nine standard types are available with an operating temperature range from -65 to +150 C. International Rectifier Corp., 233 Kansas St., El Segundo, Calif. (327)

C-D TV SYSTEM has horizontal resolution in excess of 800 lines. It fea-

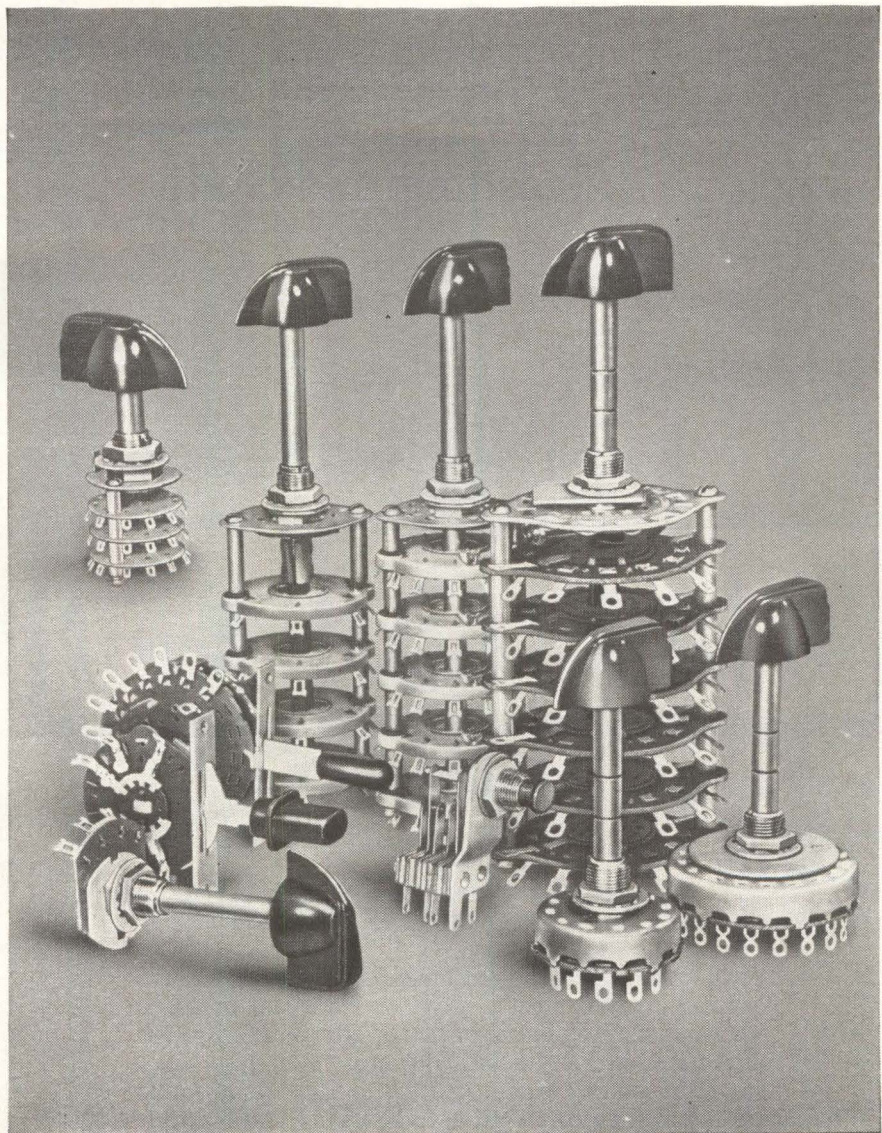

Switches...as you want 'em ...when you need 'em

Need a rotary switch? Or a lever action? Your Mallory distributor can give you off-the-shelf delivery on some 16 different Mallory switch types, in dozens of variations. All the way from the subminiature 12M Mallory-Grigsby to the rugged Mallory 1200-1300 series. There are shorting and non-shorting types... phenolic, ceramic, and even glass-epoxy wafers. All made to the strictest quality standards. Call your Mallory distributor—if you don't have his number, write us.

Distributor Division, P. R. Mallory & Co. Inc.
P. O. Box 1558, Indianapolis 6, Indiana

P. R. MALLORY & CO. INC.
MALLORY

IDEAS, too, grow Tall in Washington ↑ State

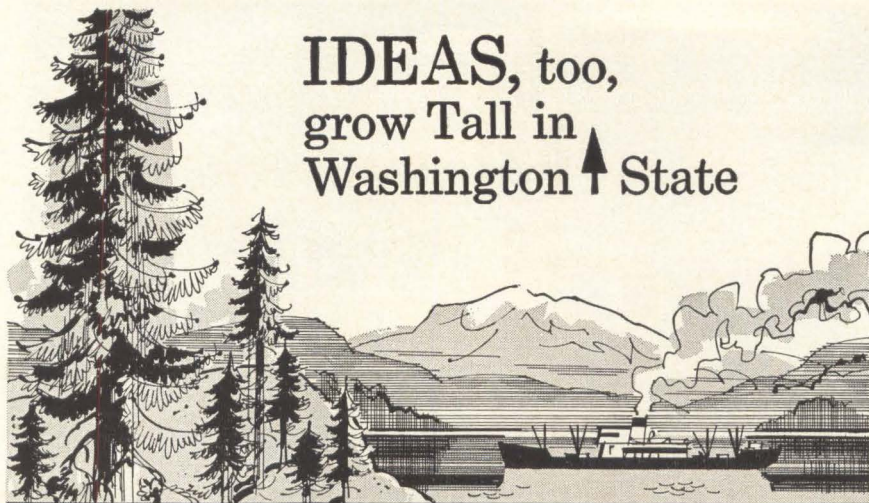

...and IDEAS are the
stock in trade of the
Electronics Industry

Trees, mountains and buildings soar to the skies in Washington, but not alone. For here the minds of creative men find pleasant stimulation. Your scientists, researchers and engineers will enjoy a happy, agreeable atmosphere, with opportunity for cultural, educational and recreational activity. Too, you'll find an undreamed-of wealth of natural resources to help make your business prosper. If you're relocating, or expanding, won't you consider surprising Washington State?

John E. Jones

DIRECTOR, WASHINGTON STATE DEPARTMENT
OF COMMERCE & ECONOMIC DEVELOPMENT

Al. M. R. Paulsen

GOVERNOR
STATE OF WASHINGTON

WRITE FOR "The Surprising State... Washington,"
a 15-Minute Film on Industrial Opportunities here.

STATE OF WASHINGTON



A wonderful place to play in
... a great state to stay in!

FOR INFORMATION ABOUT
THE MANY SITE OPPORTU-
NITIES IN WASHINGTON
STATE, SIMPLY FILL OUT
AND MAIL THIS COUPON.

Washington State Department of Commerce
and Economic Development - Industrial Division
General Administration Building
Olympia, Washington

Please send me information on sites and economic
opportunities in the State of Washington.

Name: _____

Company: _____

Address: _____

City: _____ Zone: _____ State: _____

tures automatic operation. General Precision, Inc., Pleasantville, N.Y. (328)

SUBMINIATURE COAXIAL ISOLATORS feature light weight. Standard designs are available from 750 Mc to 8,000-Mc. Cascade Research, Los Angeles, Calif. (329)

SILICON CONTROLLED RECTIFIERS, 16 amp and 25 amp devices. They are characterized by high surge, low leakage, and fast recovery time. Semicon, Inc., Sweetwater Ave., Bedford, Mass. (330)

POWER SUPPLY is static digital signal controlled. It features high accuracy and high capacity. Pioneer Magnetics Inc., 850 Pico Blvd., Santa Monica, Calif. (331)

L-F WAVEFORM GENERATOR ATTACHMENT enables one to measure phase angle. Guaranteed accuracy is ± 2 deg. Servomex Controls Ltd., Crowborough, Sussex, England. (332)

LIQUID COOLING SYSTEM for airborne electronics. It features wet motor and constant mass blower. Eastern Industries, a division of Laboratory For Electronics, 100 Skiff St., Hamden 14, Conn. (333)

VOLTMETERS, both a-c and d-c to 10 Kc. Accuracies are ± 0.5 percent of center scale value. Quality Electric Co., 3700 South Broadway, Los Angeles 7, Calif. (334)

TRUE RMS VOLTMETERS, to 20 Kc bandwidth. Accuracy is ± 2 percent of full scale. Quality Electric Co., 3700 South Broadway, Los Angeles 7, Calif. (335)

SILICONE ENCAPSULANT for diodes, transistors. Resin withstands ambient temperatures to 300 C for at least 1,000 hr. Dow Corning Corp., Midland, Mich. (336)

REVERSE CURRENT TESTER is transistorized. Leakage currents from 1 na to 100 μ a are read out. Micro Instrument Co., 3851 Sepulveda Blvd., Culver City, Calif. (337)

REGULATED POWER SUPPLY offers constant voltage, constant current. Price is \$119.50. Lasers and Masers Corp. of America, Hudson St., Mineola, N. Y. (338)

MAGNETORESISTIVE ELEMENTS are thin film devices. They have broad circuit control applications. American Aerospace Controls, Inc., 123 Milbar Blvd., Farmingdale, N. Y.

D-C AMPLIFIER is galvanometer-recorder type. The SA-112 is ideal for use on battery power. Texas Research and Electronic Corp., 6612 Denton Drive, Dallas, Texas. (340)

REFERENCE OSCILLATOR uses state circuitry. Frequency range is 10 cps to 0.1 Mc. Burr-Brown Research Corp., Box 6444, Tucson, Ariz. (341)

SOLID-STATE ELECTRO-OPTIC LIGHT MODULATORS in three models. They operate by the Pockels effect. Isomet Corp., 433 Commercial Ave., Palisades Park, N. J. (342)

Literature of the Week

PRINTED CIRCUITS Precision Circuits, Inc., 85 Weyman Ave., New Rochelle, N.Y., has issued a brochure showing innovations in printed-wiring boards and modular circuitry. (343)

COIL WINDING MACHINE Associated American Winding Machinery, Inc., 750 St. Ann's Ave., New York 36, N.Y. Catalog covers a precision coil winding machine with automatic electrical wire-guide traverse. (344)

COPPER CLAD LAMINATES Thiokol Chemical Corp., N. Enterprise Ave., Trenton 4, N.J., offers a case history report on Panelyte copper clad laminates designed chiefly for use in printed circuitry. (345)

AUDIO OSCILLATOR MODULE Henry Francis Parks Laboratory, 7544 23rd Ave. N.E., Seattle 15, Wash., has published a leaflet illustrating and describing model 101 fixed frequency audio oscillator module. (346)

MICROWAVE ENERGY SOURCES Trak Microwave Corp., 5006 N. Coolidge Ave., Tampa 3, Fla. Catalog 62B covers a complete line of microwave energy sources—oscillators, harmonic generators and amplifiers. (347)

AIR SUPPORTED STRUCTURES Birdair Structures, Inc., Buffalo Industrial Park, 1800 Broadway, Buffalo 12, N.Y., offers a brochure showing its capabilities and performance in the field of large air supported radomes and shelters. (348)

TRIMMING POTENTIOMETERS Daystrom, Inc., Archbald, Pa., offers a technical data sheet on the 210 series Squaretrim subminiature trimming potentiometers. (349)

COAXIAL CONNECTORS Greenpar Engineering Ltd., Station Works, Cambridge Road, Harlow, Essex, England. Leaflet C2 is a six-page folder covering a line of BNC coaxial connectors. (350)

ELECTROSTATIC GENERATOR SAMES, USA, Inc., 269 Commercial Ave., Palisades Park, N.J. Data sheet describes a portable electrostatic generator which provides highly stable continuous or stepped d-c output from 0-80 Kv. (351)

MILITARY DIODES National Transistor, 500 Broadway, Lawrence, Mass. Catalog describes a line of military type Gold Bonded germanium diodes. (352)

PLASTIC TUBING Adam Spence Corp., 963 Frelinghuysen Ave., Newark, N.J. Four-page folder deals with Kel-F seamless extra thin wall plastic tubing. (353)

CIRCUIT BREAKERS Airpax Electronics Inc., Cambridge, Md. Brochure describes characteristics and application of electromagnetic circuit breakers. (354)

TI has what you need in pulse programming!

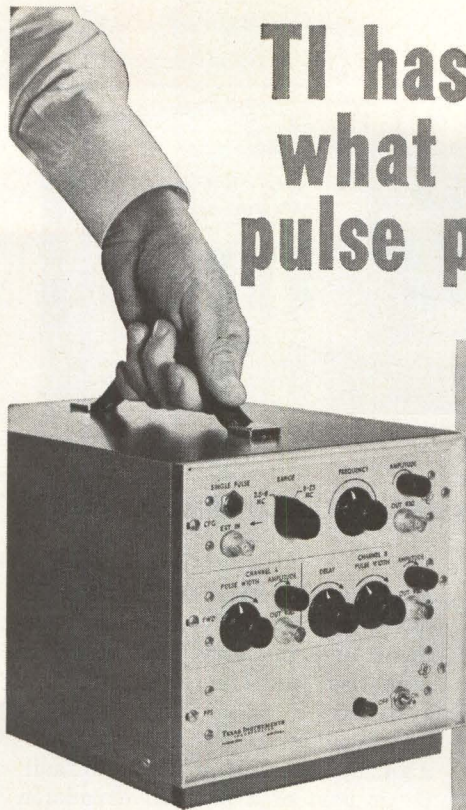

VERSATILITY

Custom combination of modules for any desired performance characteristics.

HIGH REP RATE

Repetition rates of 100 cycles to 100 megacycles.

PORTABILITY

Compact, lightweight, easy to carry.

Texas Instruments Series 6000 Pulse Generators are the smallest instruments available with the advantages of modular construction plus a wide range of operating features which include:

- Variable Width and Delay
- Variable Rise and Fall Times
- Plus and Minus Outputs
- Pulse Mixing
- Programmed and Random Word Generation

TI Pulse Generators combine dependable performance with a high degree of versatility and convenience. Circuitry is all solid state with compact controls. Modular construction provides extreme flexibility in combining features to suit specific applications. Write for complete information.

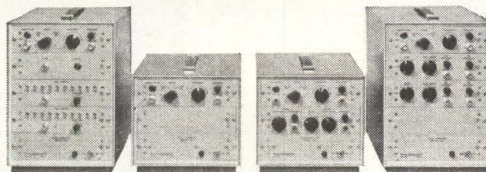

TEXAS INSTRUMENTS

INCORPORATED
3609 BUFFALO SPEEDWAY
P. O. BOX 66027 HOUSTON 6, TEXAS

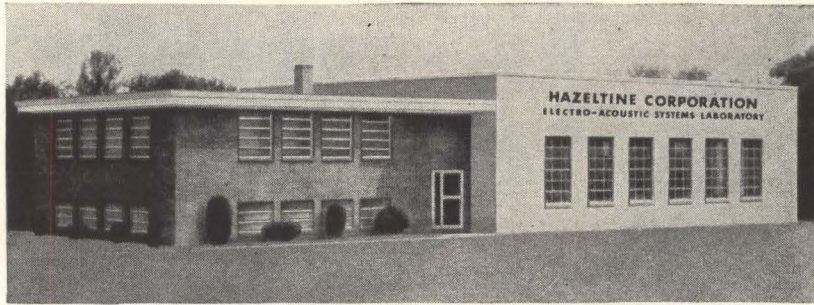

Hazeltine Opens New Laboratory

HAZELTINE CORPORATION recently opened an Electro-Acoustic Systems Laboratory in Avon, Mass. The laboratory will be responsible for broadening Hazeltine's participation in the antisubmarine warfare (ASW) field. The facility will contribute to the growing research and development of new electro-acoustic systems used in detection, localization and destruction of submarines and will bring immediate effort to bear on improved hydrophones and transducers for sonobuoys of advanced design. Since 1948, the company has been one of the largest producers of sonobuoys for submarine detection.

Melvin S. Wilson has been named general manager of the new laboratory, which will operate as part of

Hazeltine Electronics division. He has more than 20 years of government and industry experience in acoustics and undersea warfare systems.

According to a company spokesman, the opening of the new facility is part of a planned expansion of Hazeltine's existing research, development and production activities. With plants and laboratories in 11 communities in Long Island, Indianapolis and Chicago, Hazeltine is one of the nation's leading defense contractors. The company is active in electronic identification, airborne and ground radar, displays, air traffic control, missile electronics, antisubmarine warfare, communications and other electronic fields.

support function for delivered electronics products and for insuring their maximum utilization.



Younger Advances at Martin Company

ROWLAND M. YOUNGER, a veteran engineer at Martin Co., Baltimore, Md., has been named director of the logistics department of Martin's Electronic Systems & Products division. He will be responsible for providing a complete



Selbach Assumes Quantic Post

WILLARD M. SELBACH was recently named director of applications en-

gineering for the Pelmec division of Quantic Industries, Inc., San Carlos, Calif. He was formerly senior electronics engineer with the Librascope division of General Precision, Inc., and previously senior design engineer with Lockheed Missile and Space Co.

National Beryllia Appoints Styhr

KARSTEN H. STYHR has been named head of the Ceramic Research department of National Beryllia Corp., Haskell, N. J., manufacturer of beryllia ceramics and ceramic-to-metal assemblies.

Styhr was previously a project engineer with Sperry Gyroscope Co. on ceramic-to-metal sealing processes for high power electron tubes.

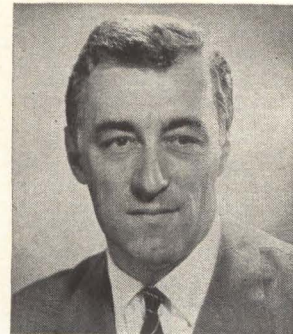

Hughes Appoints Dietrich Jenny

DIETRICH JENNY recently joined Hughes Aircraft Company, Newport Beach, Calif., as manager of the semiconductor division. He comes to Hughes after two years as general manager of Societa Generale Semiconduttori of Milan, Italy.

In his new position, Jenny will have over-all responsibility for all operations of the division, which include the current product lines of transistors, diodes and rectifiers, as well as the division's research and development programs.

Raytheon Promotes Gustave Mayner

GUSTAVE H. MAYNER, JR., has been named to the new post of manufacturing operations manager for Raytheon Co. Semiconductor division. He will make his headquarters in

WHAT IS THE "HH" SERIES?

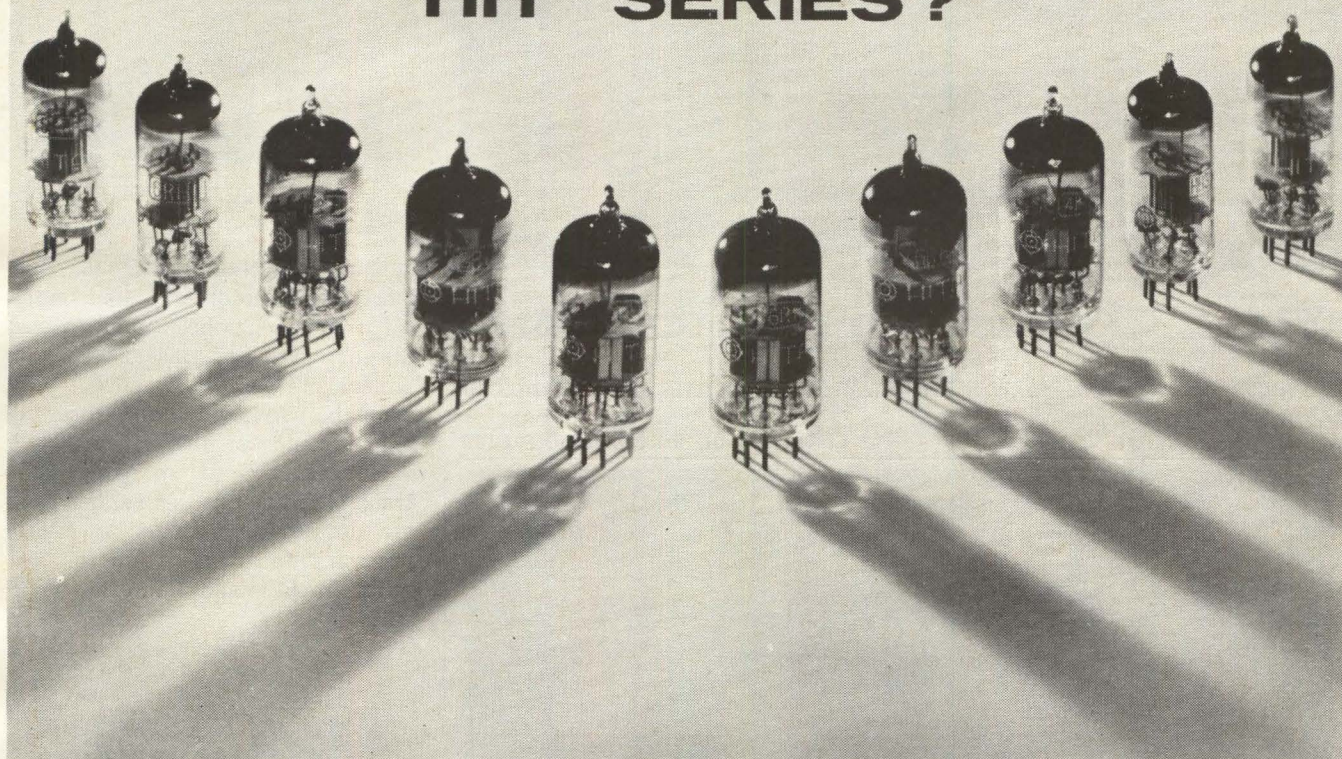

The "HH" series is Hitachi's new superior line of television receiver tubes, the ultimate in far-reaching reception of television waves.

For RF amplifier of VHF television tuners, specify the 4R-HH2 and 6R-HH2 which feature very high transconductance, high sensitivity and low noise. These twin triode tubes replace the 4BQ7A and 6BQ7A without change of circuit.

For frequency convertor and local oscillator of VHF television tuners, specify 5M-HH3 and 6M-HH3 twin triodes which replace the 5J6 and 6J6 without change of circuit.

The "HH" series is another fine quality line from Hitachi, one of the most completely integrated electrical manufacturers in the world.

INTERNATIONAL IMPORTER INC.

2242 South Western Avenue,
Chicago 8, Illinois, U.S.A.

 **Hitachi, Ltd.**
Tokyo Japan

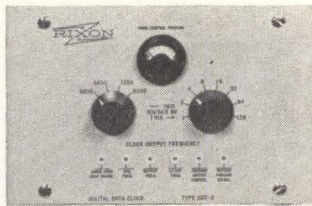

drift < 5 parts in 10^8 / day

Just one of many features of Rixon DD clocking systems

Other features?

- thirty-two standard (75 X 2ⁿ) bit rates, switch selectable
- provisions for special bit rates like 2550 b/s
- rack economy provided by modular construction
- compatible with other Rixon DD data communications equipments
- completely transistorized
- state-of-the-art techniques
- high reliability at low cost
- off-the-shelf availability

For further information, ask for Rixon bulletins EB-80 and PB-1018

RIXON ELECTRONICS, INC.

2121 INDUSTRIAL PARKWAY—MONTGOMERY INDUSTRIAL PARK—SILVER SPRING, MARYLAND
TELEPHONE: 622-2121

TWX: S SPG 213

CIRCLE 201 ON READER SERVICE CARD

**NEW, RECTANGULAR
KELVIN
Wire-Wound
RESISTORS**

*for reliability
in printed circuit
high-density packaging*



RECTANGULAR RESISTORS



... SAVE MORE SPACE!!

Rectangular and flat in configuration, the new Kelvin Series "P" precision wire-wound resistors offer a circuit designer the ideal solution for high density packaging. The new, flat configuration permits "stacking" one on top of another or laying resistors side-by-side for minimum space requirements, especially in printed circuit applications. All units are wound with a single length of wire (no splices permitted) using Kelvin developed "relaxed" winding techniques. This method, by allowing a winding tension of only 1 1/2 to 3 grams, minimizes resistance drift with age and "opens" or "shorts" resulting from over-stressed wire. Units are further stabilized by artificial aging and temperature cycling prior to final inspection. Vacuum encapsulation eliminates voids.

General Specifications

Wattage Ratings: based upon maximum ambient temperature of 125°C, derated 5%/°C above 125°C.

Windings: card type

Temperature Coefficient: ± 20 ppm/°C; (as low as ± 2 ppm/°C — limited temperature range). Resistance wire having low thermal E.M.F. to copper is used exclusively.

Temperature Range: -65° to +125°C.

Standard Tolerances: 1%, 0.5%, 0.1%, .05%, .025%, .02%, .01%.

Connections: welded.

Encapsulating Material: high temp. epoxide resin.

KELVIN TYPE	COMMERCIAL WATTAGE*	MAXIMUM OHMS	MINIMUM OHMS	SIZE	MAXIMUM VOLTS	LEAD SPACING	LEAD DIA.
446-P	.200	2 Meg.	1	1/8" x 1/4" x 1/2"	100	.250	#20
447-P	.125	1 Meg.	1	1/8" x 1/4" x 1/4"	100	.125	#20

Our experienced engineers will answer your high-density packaging application inquiries promptly. Send specifications or requirements to:

Representatives in principal cities



KELVIN ELECTRIC COMPANY

5907 Noble Ave., Van Nuys, Calif., TRiangle 3-3430
New York: Yonkers, 916 McLean Ave., BEverly 7-2500

Lowell, Mass., and will direct transistor, diode, and modular circuit manufacturing activities at plants there, in Lewiston, Me., and in Mountain View, Calif.

Mayner joined Raytheon in 1961 as a senior manufacturing consultant on the corporate staff.



Gnaedinger Accepts AMD Position

ROBERT J. GNAEDINGER, JR., formerly with Motorola's Semiconductor division, has been named director of advanced development for American Micro Devices, Inc., Phoenix, Ariz., manufacturer of silicon computer diodes.

Gnaedinger's group will concentrate on advanced device and process development aimed at AMD's program to produce micro computer diodes and integrated circuits.

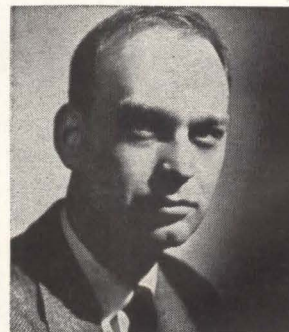

Aerospace Sets Up Communications Group

AEROSPACE CORPORATION, Los Angeles, Calif., is forming new Communication Satellite Systems Program Offices in response to increased emphasis being focused on military communication satellites, Ivan A. Getting, corporate president, has announced.

Wilbur L. Pritchard (picture), formerly of Raytheon Co. and ex-

50-1 QUADRATURE REJECTION with a **PLUG-IN** TRANSISTOR AMPLIFIER

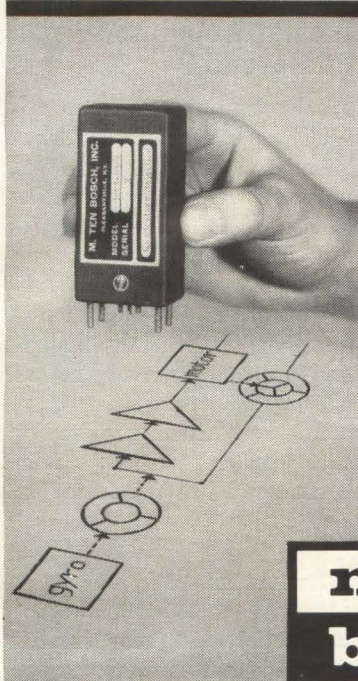

INPUT IMPEDANCE.....500,000 ohms
(A wide range of input values may be made available to suit source impedance requirements.)
LOAD IMPEDANCE.....500 ohms
POWER GAIN.....30 Db.
VOLTAGE GAIN.....Unity
PHASE SHIFT.....Zero
CARRIER FREQUENCY.....380 to 420 c.p.s.
OUTPUT.....450 millivolts
minimum saturated signal at 500 ohm output impedance
INPUT-POWER REQUIREMENTS.....28 V.D.C. at 12 ma.; 115 V. 400 c.p.s., 1 ma.

**m. ten
bosch**

**i
n
c.**

For detailed QUADRATURE REJECTION AMPLIFIER SPECS, MODEL 1805-0500
Write to Dept. TR-30, M. Ten Bosch Inc., Pleasantville, New York

CIRCLE 200 ON READER SERVICE CARD



**Are you a
COMPLETELY
INFORMED
electronics
engineer?**

Today you may be working in microwaves. But on what project will you be working tomorrow? You *could* have read **electronics** this past year and kept abreast of, say, microwave technology. *There were 96 individual microwave articles between July, 1961 and June, 1962!*

But suppose tomorrow you work in some area of standard electronic components, in semiconductors, in systems? Would you be up-to-date in these technologies? Did you read the more than 3,000 editorial pages that **electronics'** 28-man editorial staff prepared last year?

electronics is edited to keep you current *wherever* you work in the industry, *whatever* your job function(s). If you do not have your own copy of **electronics**, subscribe today via the Reader Service Card in this issue. Only 7½ cents a copy at the 3 year rate.

electronics

August 31, 1962



**Time after time
engineers specify
Johnson capacitors!**

Whatever the choice . . . sub-miniature capacitors for printed circuit use—or large, heavy duty types . . . time and time again design and development engineers specify Johnson Air Variables!

More than 11 basic capacitor series are readily available in a wide selection of single section, dual section, butterfly and differential types. Units range in size from the diminutive sub-miniature Type "U" capacitors, requiring less than 0.2 square inch of mounting space, to large, rugged heavy duty "C" and "D" types. Standard stock capacitors in a wide range of plate spacings, capacity per section, breakdown ratings, and finishes will meet many military and commercial applications . . . specials to your specifications are also available in production quantities. Complete information on all Johnson capacitors and other electronic components is available on request—write for our newest components catalog today!



E. F. JOHNSON COMPANY

3320 TENTH AVENUE S.W. • WASECA, MINN.

AIR VARIABLE CAPACITORS

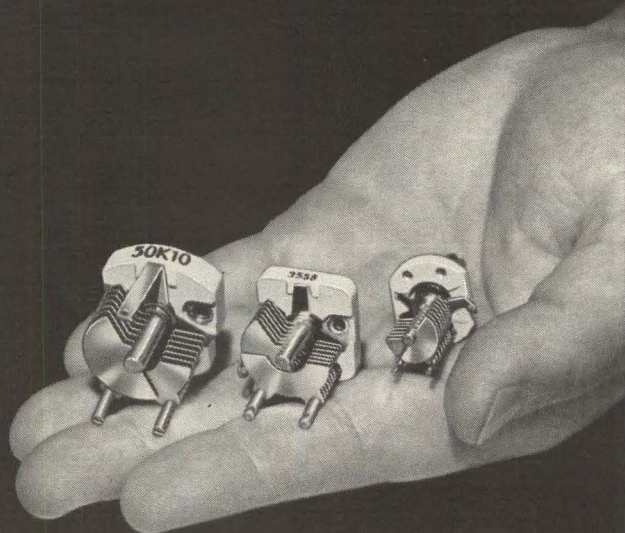

DETAILED COMPONENTS CATALOG AVAILABLE
—Write today on company letterhead!

•CAPACITORS •TUBE SOCKETS •CONNECTORS •PILOT LIGHTS
•INSULATORS •KNOBS AND DIALS •INDUCTORS •HARDWARE

CIRCLE 87 ON READER SERVICE CARD

87

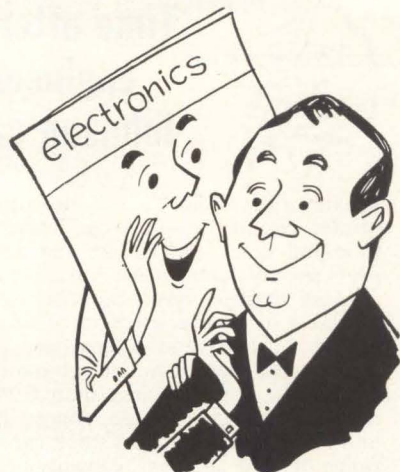

**electronics IS EDITED
TO KEEP YOU FULLY INFORMED**
— a “well-rounded” engineer

What's your *present* job in electronics? Do you work on computers? (**electronics** ran 158 articles on computers between July, 1961 and June, 1962!) Are you in semiconductors? (For the same period, **electronics** had 99 articles, not including transistors, solid-state physics, diodes, crystals, etc.) Are you in military electronics? (**electronics** had 179 articles, not including those on aircraft, missiles, radar, etc.)

In all, **electronics'** 28-man editorial staff provided more than 3,000 editorial pages to keep you abreast of all the technical developments in the industry. No matter where you work today or in which job function(s), **electronics** will keep you fully informed. Subscribe today via the Reader Service Card in this issue. Only 7½ cents a copy at the 3 year rate.

electronics

perienced in both the communications and technical management fields, has been named director for the new offices.

**Chesapeake Appoints
Design Engineer**

HAROLD S. HORIUCHI has been appointed design engineer of Chesapeake Instrument Corporation's Transducer Engineering Laboratory, Shadyside, Md. In this position he will be responsible for the design and construction of high frequency transducers for underwater communication applications including line hydrophones, projectors and ultrasonic devices.

Horiuchi was formerly senior electronics engineer with the Diamond Ordnance Fuze Laboratories.

PEOPLE IN BRIEF

Allen E. Puckett, Hughes Aircraft v-p, appointed vice chairman of the National Defense Science Board. **Walter P. Soboleski**, ex-Huyck Systems Co., joins Gap Instrument Corp. as v-p and director of engineering. **Yale Barkan**, from Marquardt Corp. to Telecomputing Corp. as systems engineering mgr. California Technical Industries elevates **Herbert G. Ayers** to g-m. **John G. Fitzpatrick** leaves Minneapolis-Honeywell to join Autonetics as a v-p. **Henry Mutz**, formerly with Astron Corp., named chief engineer of Film Capacitors, Inc. **James T. Arnold** moves up at Varian Associates to mgr. of the special products group in the Instrument div. **Frank Enge** upped to chief engineer for Ford Instrument Co., div. of Sperry Rand Corp. Five are promoted at Potter Instrument Co. to the position of associate engineer: **Edward Brummerloh**, **Serge Pellaumail**, **Bob Schoeneman**, **Stanley Stankowski**, and **Miles Tintle**. Fairchild Semiconductor advances **Charles E. Sporck** to the new position of operations mgr. Granger Associates adds three engineers to its staff: **Ray M. Johnson**, formerly with Hughes Aircraft Co.; **Jenkin Leong**, ex-Farion Electric; and **Paul D. Hopper**, previously at U. S. Navy's Underwater Sound Lab.

IBM asks basic questions in memory

What is the fastest way to remember?

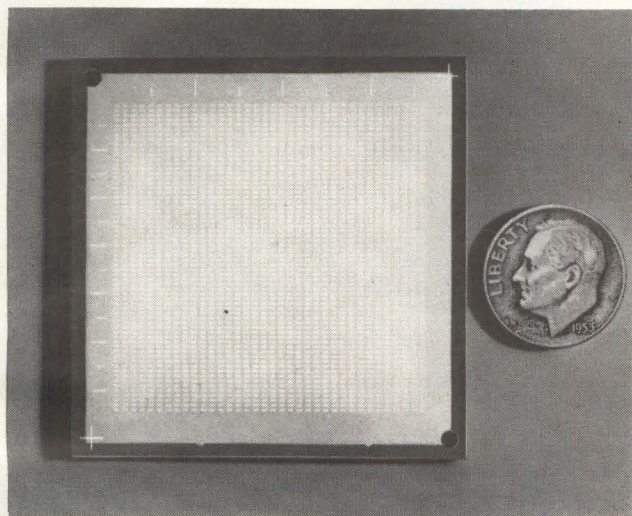

This is one of eight 2"x2" substrates in a new experimental memory containing 576 bits of information per square inch, the densest packaging ever reported for thin magnetic films.

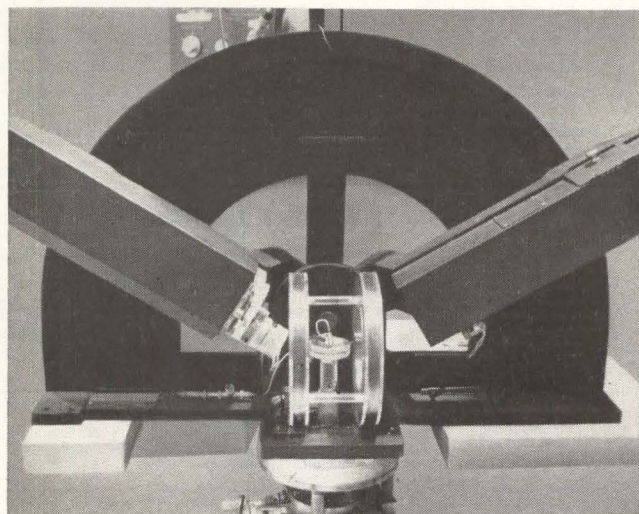

The switching speed of this experimental thin-film device (center) is being measured by timing a polarized light beam which rotates each time direction of magnetization changes.

Computing speed is accelerating constantly. But before computers can process data, they must pass it through main storage. Unless ways are found to transfer more information in less time from main storage to central processing units, the time required to obtain stored data will limit the speed of the computer.

To shorten access time, IBM is developing advanced memories. Recently, IBM scientists fabricated a magnetic thin-film memory which completes a full read-write cycle in 100 nanoseconds. They also have put to use a technique for measuring switching times in the nanosecond range with polarized light. Experiments with this technique revealed that a multi-layer-bit thin-film "sandwich" switched ten times faster than an equivalent single-layer-bit device.

More immediate gains in access time can be attained through new developments in ferrite core technology. By reducing the core size from 50 thousandths of an inch to 30 thousandths of an inch in outside diameter, IBM engineers have created a 1.2 million bit magnetic core memory with a cycle time of only 2 microseconds. A device which contributed greatly to this development, a load-sharing matrix switch, was also instrumental in the creation of a 74,000 bit "scratch pad" ferrite core memory capable of a read-write cycle time of less than 700 nanoseconds. This matrix

switch makes it possible for the switching-power load to be shared by several drivers at once, thus reducing the total power requirements.

The efficiency of computing systems can be increased by improving the design of their memory structures as well as through the development of new components. IBM engineers are developing nondestructive read-out techniques which can reduce the number of machine operations required in thin-film and ferrite core memories. They have formulated addressing systems in which machine-word lengths vary according to the natural lengths of the bits of information being stored. They have devised associative memory techniques which retrieve information on the basis of related data rather than specified addresses. Out of several developments like these, which reduce machine references to memory and simplify programming, may come the memory systems of the future.

If you have been searching for an opportunity to make important contributions in memory development, software, space systems, or any of the other fields in which IBM scientists and engineers are finding answers to basic questions, please contact us. IBM is an Equal Opportunity Employer. Write to: Manager of Professional Employment, IBM Corp., Dept. 554U5, 590 Madison Avenue, New York 22, N. Y.

electronics

WEEKLY QUALIFICATION FORM FOR POSITIONS AVAILABLE

ATTENTION: ENGINEERS, SCIENTISTS, PHYSICISTS

This Qualification Form is designed to help you advance in the electronics industry. It is unique and compact. Designed with the assistance of professional personnel management, it isolates specific experience in electronics and deals only in essential background information.

The advertisers listed here are seeking professional experience. Fill in the Qualification Form below.

STRICTLY CONFIDENTIAL

Your Qualification form will be handled as "Strictly Confidential" by ELECTRONICS. Our processing system is such that your form will be forwarded within 24 hours to the proper executives in the companies you select. You will be contacted at your home by the interested companies.

WHAT TO DO

1. Review the positions in the advertisements.
2. Select those for which you qualify.
3. Notice the key numbers.
4. Circle the corresponding key number below the Qualification Form.
5. Fill out the form completely. Please print clearly.
6. Mail to: D. Hawksby, Classified Advertising Div., ELECTRONICS, Box 12, New York 36, N. Y. (No charge, of course).

COMPANY	SEE PAGE	KEY #
ATLANTIC RESEARCH CORPORATION Jansky & Bailey Div. Alexandria, Va.	75*	1
ATOMIC PERSONNEL, INC. Philadelphia, Pennsylvania	73*	2
AVCO RESEARCH AND ADVANCED DEVELOPMENT Division of Avco Corporation Wilmington, Massachusetts	74*	3
ESQUIRE PERSONNEL SERVICE INC. Chicago, Illinois	74*	4
F & M SCIENTIFIC CORP. Avondale, Penna.	74*	5
INTERNATIONAL BUSINESS MACHINES CORP. New York, New York	89	6
JET PROPULSION LABORATORY Pasadena, California	91	7
McDONNELL St. Louis, Mo.	73*	8
MICROWAVE SERVICES INTERNATIONAL INC. Denville, New Jersey	74*	9
MOLONEY ELECTRIC CO. St. Louis 20, Mo.	91	10
REPUBLIC AVIATION CORPORATION Farmingdale, Long Island, New York	75*	11
REPUBLIC AVIATION CORPORATION Missile Systems Division Mineola, Long Island, NY	73*	12
P 9428	75*	13

* These advertisements appeared in the 8/24/62 issue.

(cut here)

electronics WEEKLY QUALIFICATION FORM FOR POSITIONS AVAILABLE

(cut here)

(Please type or print clearly. Necessary for reproduction.)

Personal Background

NAME

HOME ADDRESS

CITY ZONE STATE

HOME TELEPHONE

Education

PROFESSIONAL DEGREE(S)

MAJOR(S)

UNIVERSITY

DATE(S)

FIELDS OF EXPERIENCE (Please Check)

- | | | |
|--|--|---------------------------------------|
| <input type="checkbox"/> Aerospace | <input type="checkbox"/> Fire Control | <input type="checkbox"/> Radar |
| <input type="checkbox"/> Antennas | <input type="checkbox"/> Human Factors | <input type="checkbox"/> Radio-TV |
| <input type="checkbox"/> ASW | <input type="checkbox"/> Infrared | <input type="checkbox"/> Simulators |
| <input type="checkbox"/> Circuits | <input type="checkbox"/> Instrumentation | <input type="checkbox"/> Solid State |
| <input type="checkbox"/> Communications | <input type="checkbox"/> Medicine | <input type="checkbox"/> Telemetry |
| <input type="checkbox"/> Components | <input type="checkbox"/> Microwave | <input type="checkbox"/> Transformers |
| <input type="checkbox"/> Computers | <input type="checkbox"/> Navigation | <input type="checkbox"/> Other |
| <input type="checkbox"/> ECM | <input type="checkbox"/> Operations Research | <input type="checkbox"/> |
| <input type="checkbox"/> Electron Tubes | <input type="checkbox"/> Optics | <input type="checkbox"/> |
| <input type="checkbox"/> Engineering Writing | <input type="checkbox"/> Packaging | <input type="checkbox"/> |

83162

CATEGORY OF SPECIALIZATION

Please indicate number of months experience on proper lines.

	Technical Experience (Months)	Supervisory Experience (Months)
RESEARCH (pure, fundamental, basic)
RESEARCH (Applied)
SYSTEMS (New Concepts)
DEVELOPMENT (Model)
DESIGN (Product)
MANUFACTURING (Product)
FIELD (Service)
SALES (Proposals & Products)

CIRCLE KEY NUMBERS OF ABOVE COMPANIES' POSITIONS THAT INTEREST YOU

1 2 3 4 5 6 7 8 9 10 11 12 13 14 15 16 17 18 19 20 21 22 23 24 25

JPL needs

SCIENTISTS AND ENGINEERS

for
JPL's Lunar and Planetary Programs

with experience in any of the following areas:

- Celestial Mechanics
- Orbit Determination
- Space Navigation Theory
- Trajectory Studies
- Systems Analysis

Openings are now available in both theoretical and project positions.

Send complete resume to
PERSONNEL DEPT.

JET PROPULSION LABORATORY

Operated by California Institute of Technology for
the National Aeronautics & Space Administration
4814 OAK GROVE DR. • PASADENA, CALIF.

"An equal opportunity employer"

ELECTRONICS ENGINEERS

With experience in components or system design
for high power radar or communications.

Send Complete Resume
Including Salary Requirement

D. F. Winter, Vice President
MOLONEY ELECTRIC COMPANY

5390 Bircher Blvd. St. Louis 20, Mo.

POSITION VACANT

Test Engineer—Nationally known progressive company in transportation equipment field has opportunity in Research and Development in Chicago area for B.S.E.E. with three years minimum experience in the operation, maintenance, and development of electronic and electro-mechanical transducers and instrumentation for test purposes. M.S.E.E. degree may be substituted for experience. Must be capable of supervising experienced electronic technicians in test group. Understanding of dynamics particularly in mechanical systems desirable. Will consider B.S.M.E. with experience described. Above average benefit program including tuition reimbursement. Please send resume in confidence stating salary desired. P-9545, Electronics, Classified Adv. Div. 645 North Michigan Ave., Chicago 11, Ill.

SEARCHLIGHT SECTION

FOR RESEARCH — DEVELOPMENT & EXPERIMENTAL WORK

Over 10,000 different electronic parts: waveguide, radar components and parts, test sets, pulsers, antennas, pulse xmfrs, magnetrons, IF and pulse amplifiers, dynamotors, 400 cycle xmfrs, 584 ant. pedestals, etc.

PRICES AT A FRACTION OF ORIGINAL COST!
COMMUNICATIONS EQUIP. CO.

343 CANAL ST., N. Y. 13, W.O. 6-4045
CHAS. ROSEN (Formerly at 131 Liberty St.)
CIRCLE 950 ON READER SERVICE CARD

OVER 2,000,000

RELAYS IN STOCK!

Send for Catalog \$5

Universal RELAY CORP.

42 WHITE ST., N. Y. 13, N. Y. • WAlker 5-6900

CIRCLE 951 ON READER SERVICE CARD

August 31, 1962

INDEX TO ADVERTISERS



Audited Paid Circulation

• AMP Incorporated	29	• Permag Corp.	92
• Allied Control Company, Inc.	5	Philips Gloeilampenfabrieken, N.V. 22,	23
• Amphenol-Borg Electronics Corp. Connector Division	34, 35	Plastoid Corp.	36
AnSCO	70	• Potter Instrument Co., Inc.	19
Bell Telephone Laboratories	59	• Radio Corporation of America... 4th Cover	
• Bird & Co., Inc., Richard H.	68	Radio Materials Co.	65
• Borg Equipment Division, Amphenol- Borg Electronics Corp.	69	• Raytheon Company	2nd Cover
• Brush Instruments, Div. of Clevite Corp.	3rd Cover	• Rixon Electronics, Inc.	86
• Cannon Electric Co.	76, 77	• Rochar Electronique	27
• Clairex Corp.	74	• Sensitive Research Instrument Corp. ...	12
• Clarostat Mfg. Co., Inc.	31	Simplex Wire & Cable Co.	57
Consolidated Electrodynamics Corp.	62, 63, 75	• Sorensen	71
• Corning Electronic Components	64	Sprague Electric Co.	9, 28
• Electronic Instrument Co., Inc. (EICO) 92		Texas Instruments Incorporated	83
Electronic Instrument Manufacturers' Exhibit	11	Texas Instruments Incorporated Apparatus Division	55, 79
• FXR, A Div. of Amphenol-Borg Elec- tronics Corp.	14, 15	Texas Instruments Incorporated Semiconductor-Components Div.	20, 21
Gudebrod Bros. Silk Co., Inc.	30	Varian Associates	33
• Hewlett-Packard Company.	6	Washington State Dept. of Commerce & Economic Development	82
• Hitachi, Ltd.	85	• Weinschel Engineering	4
Hughes Aircraft Co. Aerospace Divisions	80	Wilrite Products Inc.	67
• Japan Piezo Electric Co., Ltd.	80		
Johnson Company, E.F.	87	CLASSIFIED ADVERTISING	
Kelvin Electric Company	86	F. J. Eberle, Business Mgr.	
• Lambda Electronics Corp.	16, 17	EMPLOYMENT OPPORTUNITIES ..	89, 91
Lincoln Laboratory	78	EQUIPMENT (Used or Surplus New) For Sale	91
M. Ten Bosch Inc.	87	INDEX TO CLASSIFIED ADVERTISERS	
Mallory and Co., Inc., P.R.	81	• Communications Equipment Co.	91
• Minnesota Mining & Mfg. Co. Chemical Div.	32	International Business Machines Corp. 89	
• Navigation Computer Corp. (NAVCOR) 58		Jet Propulsion Laboratory	91
Norton Company	61	Moloney Electric Co.	91
• Panoramic Electronics Inc.	13	• Universal Relay Corp.	91
Pennsalt Chemicals Corp.	73	• See advertisement in the July 25, 1962 issue of Electronics Buyers' Guide for complete line of products or services.	

This index and our Reader Service Numbers are published as a service. Every precaution is taken to make them accurate, but electronics assumes no responsibilities for errors or omissions.



PERMAG

24-HOUR DELIVERY from our stock of magnets in all sizes, all shapes, all grades. Magnets also precision engineered and promptly fabricated to your needs.

MAGNETS

PERMAG CORP.

88-06 VAN WYCK EXPRESSWAY, JAMAICA 18, N. Y.
OLympia 7-1818 • TWX: NY 4-4798

PERMAG PACIFIC CORP.

6178 W. JEFFERSON BLVD., LOS ANGELES 16, CALIF.
VERmont 7-4479 • TWX: CVR-CY 8043

CIRCLE 202 ON READER SERVICE CARD



**PUTS THE BEST IN
CREATIVE ELECTRONICS
INTO YOUR HANDS**

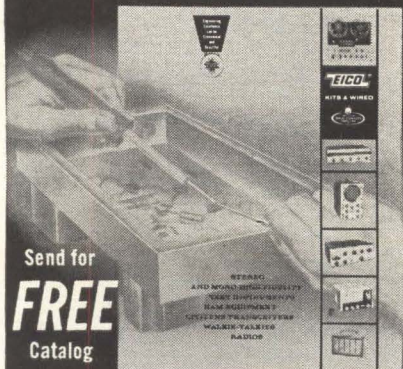

Send for
FREE
Catalog

28 pages of professional electronic equipment in kit and wired form—for Lab . . . Line . . . Home

EICO, 3300 N. Blvd., L.I.C. 1, N. Y. E-8C
 Send free 32-page catalog & dealer's name.
 Send new 36-page Guidebook to HI-FI for which I enclose 25¢ for postage & handling.

Name _____
 Address _____
 City _____ Zone _____ State _____

EICO 3300 N. Blvd., L.I.C. 1, N. Y.
 Export Dept., Roburn Agencies
 431 Greenwich St., N. Y. 13, N. Y.

electronics



Audit Bureau
of Circulations

Associated Business
Publications

Audited Paid Circulation

JAMES T. HAUPTLI

Advertising Sales Manager

R. S. QUINT:
Assistant Publisher Buyers'
Guide and Business Manager
FRED STEWART:
Promotion Manager
B. ANELLO:
Market Services Manager

RICHARD J. TOMLINSON:
Production Manager
GEORGE E. POMEROY:
Classified Manager
HUGH J. QUINN:
Circulation Manager

ADVERTISING REPRESENTATIVES

ATLANTA (9):
Michael H. Miller, Robert C. Johnson
1375 Peachtree St. N.E., Trinity 5-0523
(area code 404)

BOSTON (16):
William S. Hodgkinson, Donald R. Furth
McGraw-Hill Building, Copley Square,
Congress 2-1160 (area code 617)

CHICAGO (11):
Harvey W. Wernecke, Robert M. Denmead
645 North Michigan Avenue, Mohawk 4-5800
(area code 312)

CLEVELAND (13):
Paul T. Fegley
55 Public Square, Superior 1-7000
(area code 216)

DALLAS (1):
Frank Le Beau
The Vaughn Bldg., 1712 Commerce St.
Riverside 7-9721 (area code 214)

DENVER (2):
J. W. Patten
Tower Bldg., 1700 Broadway,
Alpine 5-2981 (area code 303)

HOUSTON (25):
Joseph C. Page, Jr.
Prudential Bldg., Halcombe Blvd.,
Riverside 8-1280 (area code 713)

LOS ANGELES (17):
Peter S. Carberry, Ashley P. Hartman
1125 W. 6th St., Huntley 2-5450
(area code 213)

NEW YORK (36):
Donald H. Miller, Henry M. Shaw,
George F. Werner
500 Fifth Avenue, LO-4-3000
(area code 212)

PHILADELPHIA (3):
Warren H. Gardner, William J. Boyle
6 Penn Center Plaza, LOcust 8-4330
(area code 215)

SAN FRANCISCO (11):
R. C. Alcorn
255 California Street, Douglas 2-4600
(area code 415)

LONDON W1:
Edwin S. Murphy Jr.
34 Dover St.

FRANKFURT/Main:
Matthée Herfurth
85 Westendstrasse

GENEVA:
Michael R. Zeynel
2 Place du Port

"Headquarters for Business Information"

McGraw-Hill Technical and Business Publications

American Machinist/Metal-
working Manufacturing
Aviation Week and Space
Technology
Business Week
Chemical Engineering
Chemical Week
Coal Age
Construction Methods and
Equipment
Construction Daily
Control Engineering
Electrical Construction
and Maintenance
Electrical Merchandising Week
Electrical Newsletter
Electrical West

Electrical Wholesaling
Electrical World
Electronics
Engineering Digest
Engineering and Mining Journal
E & MJ Metal and Mineral
Markets
Engineering News-Record
Factory
Fleet Owner
Industrial Distribution
National Petroleum News
Nucleonics
Nucleonics Week
Platt's Oilgram News
Platt's Oilgram Price Service
Power

Product Engineering
Purchasing Week
Science Week
Textile World

Overseas only:
Automobile International
(English, Spanish)
Ingenieria Internacional
Construcción (Spanish)
International Management
(English, Spanish
Portuguese editions)
Metalworking Production
(Great Britain)

Available by subscription only — to qualified persons actively engaged in the field of the publication. For subscription rates and information describing the editorial coverage of any of the above publications, write to: Subscription Manager, Circulation Department, McGraw-Hill Publishing Company, 330 West 42nd Street, New York 36, N. Y.

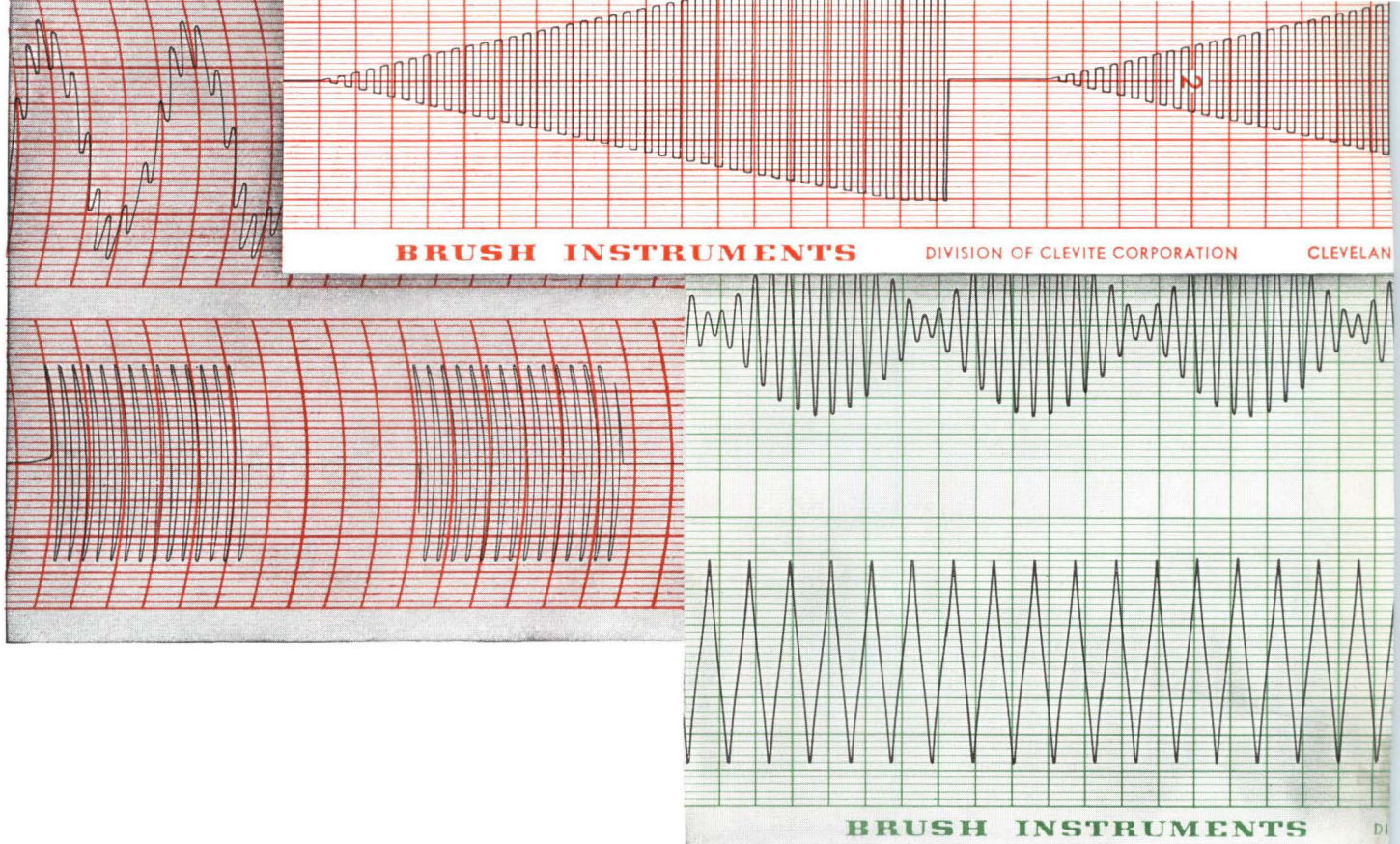

it pays
to use
Engineered
chart paper

Engineered details make the difference in chart paper. And only Brush chart paper is engineered as an integral part of the rigid specifications for today's Recording Systems. Imitation papers cannot match the special processing of paper surface to minimize pen friction; the unusual dimensional stability and tensile strength; the perfect alignment attained by winding and then rewinding the rolls; the carefully controlled printing conditions. Eliminate chance—specify *Brush* and you'll know your records will be accurate, permanent, easily read and reproduced. Stocks available from branches and sales representatives throughout the U. S. and Canada. Write for samples of actual tracings on Brush Chart Paper. Ask for "Brush Engineered Recording Supplies".

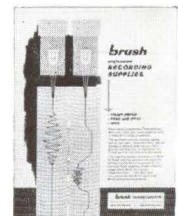

brush INSTRUMENTS
DIVISION OF CLEVITE 37TH AND PERKINS, CLEVELAND 14, OHIO

CIRCLE 901 READERS SERVICE CARD

Achieve ultra-high switching speeds at currents up to 100 ma

WITH NEW RCA SILICON PLANAR EPITAXIAL 2N2475

Now, RCA combines the latest silicon technology, including planar epitaxial structure and subminiature junctions, in the ultra-high-speed 2N2475. Check these outstanding features:



- Ultra-High Frequency... Gain-Bandwidth Product—800 Mc typical
- High Beta At High Currents... Min h_{FE} of 20 at $I_C = 50$ ma
- Low Saturation Voltage... $V_{CE\text{ Sat}}$ — 0.4 volt max.
- Low Output Capacitance... C_{ob} — 3 pf. max.
- Low Charge Storage Time... t_s — 6 nsec. max.
- Short Turn-On Time... t_{on} — 20 nsec. max. at $I_C = 20$ ma
- Short Turn-Off Time... t_{off} — 15 nsec. max. at $I_C = 20$ ma

The exceptional stability and ruggedness of the planar epitaxial structure, and its combination of outstanding performance features make the 2N2475 an excellent choice for switching applications. This transistor is available for immediate delivery in production quantities.

Call your RCA Representative today for further information on the 2N2475, and ask him about RCA's broad line of Silicon Planar Epitaxial Transistors, now including the RCA 2N709. For additional technical data, write RCA Semiconductor & Materials Division, Commercial Engineering, Section CN8-4, Somerville, N. J.

ELECTRICAL CHARACTERISTICS AT 25°C			
	MIN.	MAX.	UNITS
h_{FE} ($I_C = 1.0$ ma, $V_{CE} = 0.3$)	20	—	—
h_{FE} ($I_C = 20$ ma, $V_{CE} = 0.4$)	30	150	—
h_{FE} ($I_C = 50$ ma, $V_{CE} = 0.5$)	20	—	—
I_{CBO} ($V_{CB} = 5V$, $I_E = 0$)	—	0.05	μ a
V_{CEO} (S_{vs}) ($I_C = 10$ ma, $I_B = 0$ Pulsed)	6	—	volts
C_{ob} ($V_{CB} = 5V$, $I_E = 0$)	—	3.0	pf
t_s ($I_C = I_{B1} = I_{B2} = 5$ ma)	—	6	nsec
t_{on} ($I_C = 20$ ma, $I_{B1} = I_{B2} = 1$ ma)	—	20	nsec
t_{off} ($I_C = 20$ ma, $I_{B1} = I_{B2} = 1$ ma)	—	15	nsec
h_{fe} ($I_C = 20$ ma, $V_{CE} = 2V$, $f = 100$ Mc)	6	—	—

AVAILABLE THROUGH YOUR RCA DISTRIBUTOR



THE MOST TRUSTED NAME IN ELECTRONICS

RCA SEMICONDUCTOR & MATERIALS DIVISION FIELD OFFICES... EAST: Newark, N. J., 744 Broad St., HU 5-3900 • (Camden-Philadelphia Area) Eriton, N. J., 605 Marlton Pike, HA 8-4802 • Syracuse, N. Y., 731 James St., Rm. 402, GR 4-5591 • Baltimore, Md., EN 9-1850 • NORTHEAST: Needham Heights 94, Mass., 64 "A" St., HI 4-7200 • SOUTHEAST: Orlando, Fla., 1520 Edgewater Dr., Suite #1, GA 4-4768 • EAST CENTRAL: Detroit 2, Mich., 714 New Center Bldg., TR 5-5600 • CENTRAL: Chicago, Ill., Suite 1154, Merchandise Mart Plaza, WH 4-2900 • Indianapolis 5, Ind., 2132 East 52nd St., CL 1-1405 • Minneapolis 16, Minn., 5805 Excelsior Blvd., WE 9-0676 • Denver 11, Colorado, Continental Terrace Bldg., Suite 301, 2785 N. Speer Blvd., 477-1688 • WEST: Los Angeles 22, Calif., 6801 E. Washington Blvd., RA 3-8361 • (San Francisco Area) Burlingame, Calif., 1838 El Camino Real, OX 7-1620 • Seattle 4, Wash., 2250 First Ave. S., MA 2-8816 • SOUTHWEST: Dallas 7, Texas, 7905 Carpenter Freeway, ME 1-9720 • GOV'T: Dayton, Ohio, 224 N. Wilkinson St., BA 6-2366 • Washington, D. C., 1725 "K" St., N.W., FE 7-8500 • RCA INTERNATIONAL DIVISION, 30 Rockefeller Plaza, New York 20, N. Y. Cable Address: RADIOINTER, N. Y.

CIRCLE 902 READERS SERVICE CARD