

AT&T Internet Wi-Fi® Gateway

self-
installation
guide



Get started

Approximate installation time: 40-45 minutes

Before you begin:



1. Check your service activation date.

Do not attempt to install your service until **2pm or later** on the date provided to you by AT&T. This date is also located on your packing slip.



2. Do you have a monitored home security system or health alarm?

If either of these apply to you, you will need an AT&T technician to install your service. Call 800.288.2020 to schedule an appointment. Additional charges will apply for professional installation services from an AT&T service technician.

In the box:

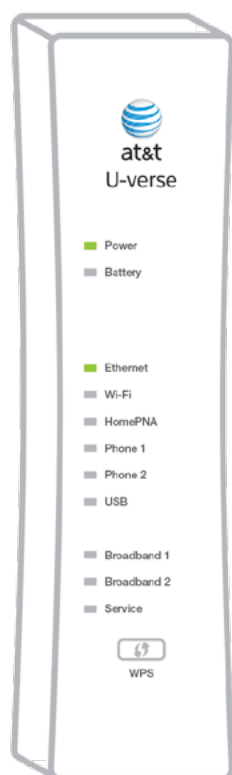

Yellow Ethernet cable

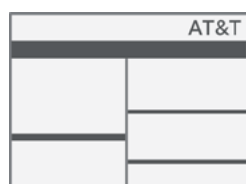

Packing slip

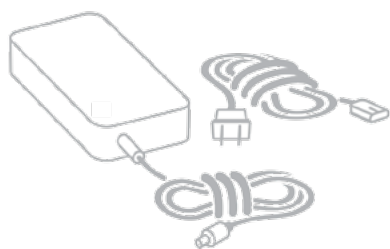

Power cord
2 parts

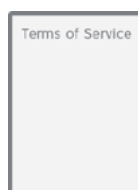

Terms of Service

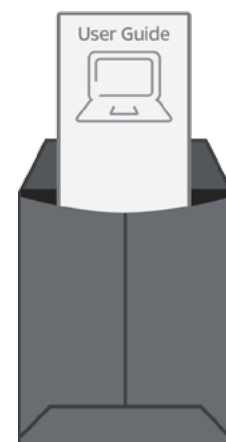

Internet User Guide

Also needed:



Your 4-digit passcode. You received a separate email/letter confirming the 4-digit passcode you designated when placing your order.

Wi-Fi Gateway
Images are not to scale.

(FTTP-GPON CSI SP)
12/16



1. Connect ONT

Approximate time: 5 minutes

- Locate your ONT in the home (common locations are near a wall jack, in the basement, in a phone closet or in the garage).
 - Remove lower cover by pinching in sides and lifting out or sliding lower cover down. The green fiber connector should now be exposed. Check to see if the green connector is plugged into the green PON port.
 - Connect cables as follows:
 - If the green fiber connector is not plugged into the green PON port of the ONT, plug the white cord with the green connector into the green PON port of the ONT.
- CAUTION:** Do not look into the end of the fiber connector as this can cause eye damage.
- Connect a yellow Ethernet cable to the yellow ONT port.
 - Now connect the black power cord to the ONT and press in the ON/OFF button on the ONT.
 - To the right of the ONT power cord is an on/off switch—push the gray button in.
- Replace lower cover.

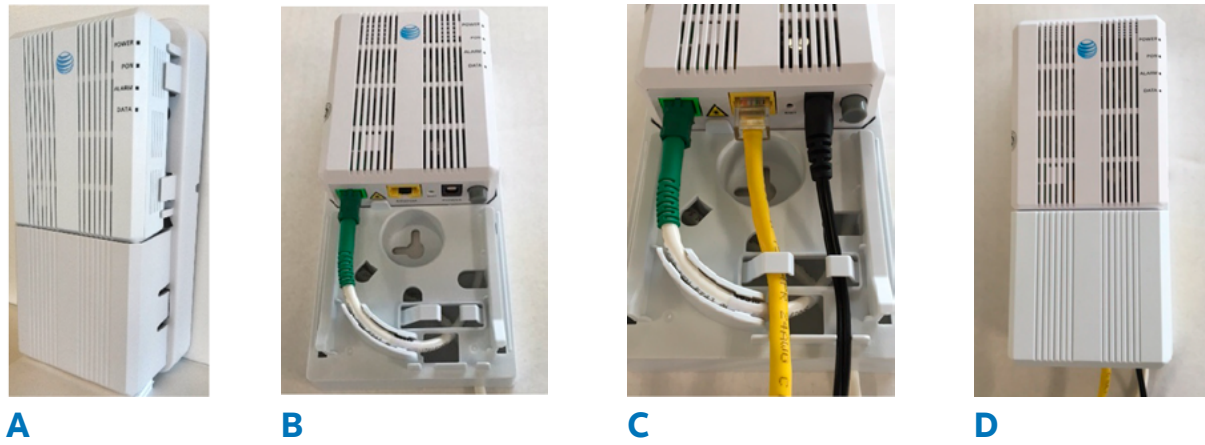

Indicator	LED Behavior	LED Description
POWER	Off	Power is Off
	Solid Green	Power is On
	Red	Startup failed
PON	Off	No Service
	Solid Green	Service is on
	Flashing Green	Service is activating

NOTE: Proceed to **2. Set up** if the ONT's POWER and PON lights are solid green. If both lights do not turn solid green, refer to the Indicator behavior chart to the right and **Need more help?** on the back page of this guide.

2. Set up

Approximate time: 10 minutes

Note: If you have traditional dial tone phone service, install single-port filters in wall jacks that have devices such as phones, fax machines, satellite receivers, or modems.

- Connect the green data cable from the Wi-Fi Gateway's DSL Broadband port to your wall jack.
- Connect the yellow Ethernet cable from the ONT port to the Wi-Fi Gateway's red ONT Broadband port.
- Connect the other yellow Ethernet cable from the Wi-Fi Gateway's Ethernet port to your computer.
- Plug the power cord into the Wi-Fi Gateway and into an electrical outlet.

Below is a completed setup. Your connections and Wi-Fi Gateway model may vary but the port color coding will be consistent.

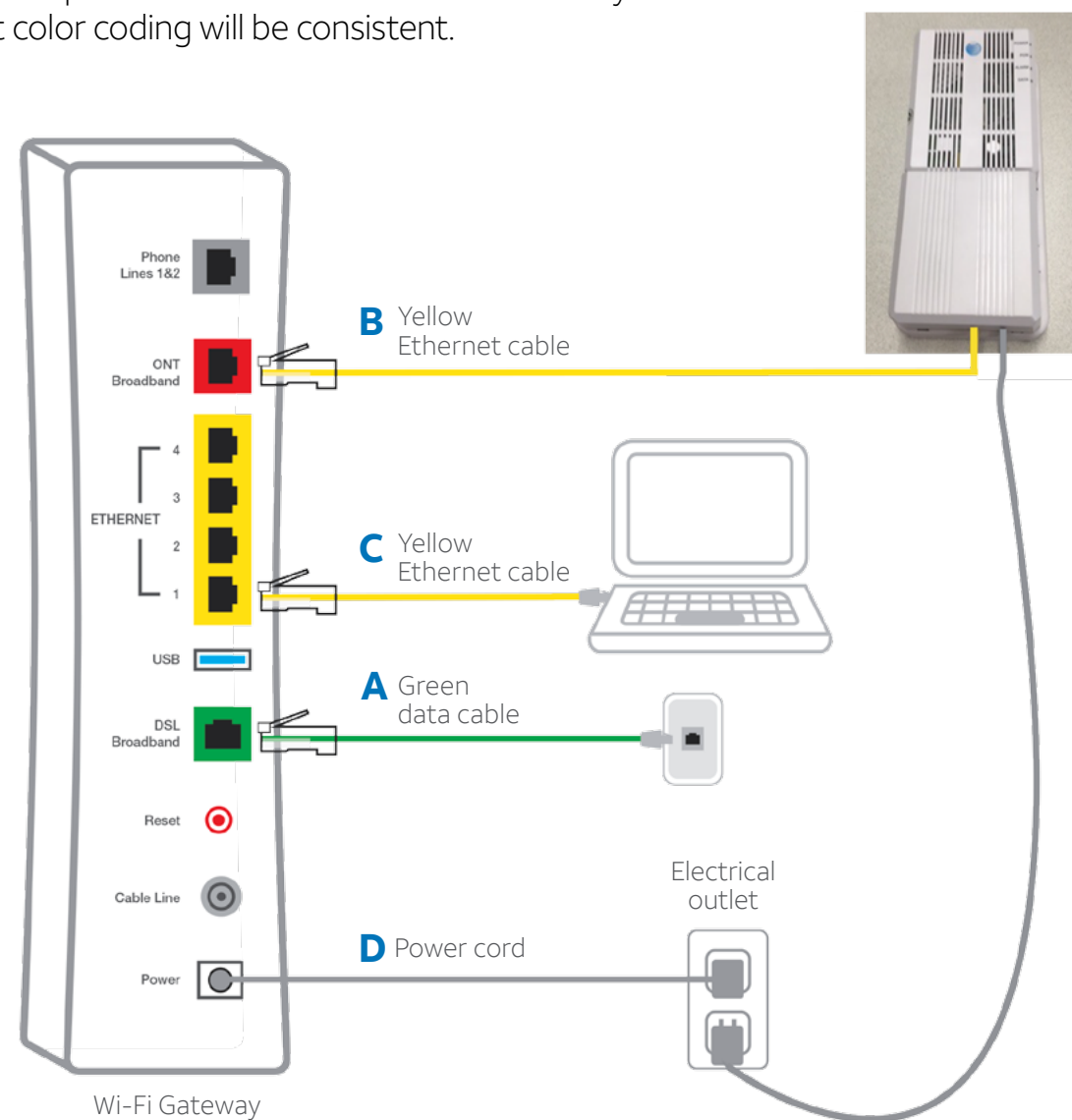

Images are not to scale.

3. Power up

Approximate time: 10-15 minutes

- Your Wi-Fi Gateway is now powering up. Wait 10-15 minutes for the Broadband and Service indicator lights to turn solid green.

CAUTION: During this time, do not unplug the green data cable, as this can permanently damage the Wi-Fi Gateway and significantly delay your Service Activation.

- If the Broadband and Service lights do not turn solid green or continue to blink after 15 minutes, see **Having Trouble?** on the back of this guide.

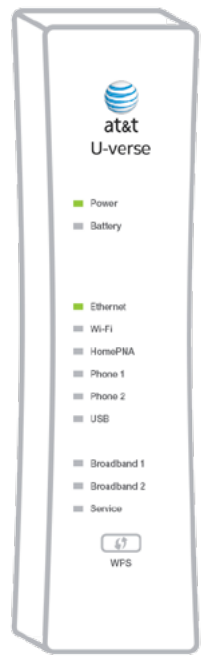

Lights may vary with setup or Wi-Fi Gateway model.

4. Registration & Activation

Approximate time: 5 minutes

Customers who have already completed the online registration

- Activation of your high-speed Internet and voice services will be completed automatically.
- The service activation may take a few minutes to complete.
- Be sure to open a browser, go to a Web site, and check that you can access it.

CAUTION: Be sure to test that you can make and receive calls from the phone connected to the Wi-Fi Gateway to ensure it is working.

Customers who have NOT completed the online registration

- Open your Internet browser (Internet Explorer, Safari, etc.).
- The online registration process will start automatically. If it doesn't, enter **att.net/Uverse** into your address bar.
- Follow the online instructions to complete your registration and activate your Internet service.
 - Enter your Account Number and Passcode. Your Account Number is available on your order confirmation email or letter. Your Passcode is the four-digit number you selected when you placed your order.

– OR –

- Enter your Access ID and Passcode available in the emails you received after you placed your order.
- Upon successful registration, you will see the following:

Congratulations. Your AT&T services are now activated and ready to use!

CAUTION: Be sure to test that you can make and receive calls from the phone connected to the Wi-Fi Gateway to ensure it is working.

5. Go Wi-Fi

Approximate time: 10 minutes

Write down the Wi-Fi Network Name (SSID) and Wi-Fi Password (Wireless Network Key) to configure additional Wi-Fi devices. This information is on the side of your Wi-Fi Gateway. The Wi-Fi Network Name consists of "ATT" plus the last seven characters of the Wi-Fi Gateway's serial number. Be sure to record this information in the form below.

Now configure your Wi-Fi Network:

- Go to your computer's "Wireless Network Settings" and refresh the network list.
- Select your Wi-Fi Network Name (SSID) from the list. You may need to scroll through the list to find your Wi-Fi Network Name.
- Enter the 12-character Wi-Fi Password (Wireless Network Key) in the Password field to connect to your network.

Congratulations! You should now be connected to the Internet via Wi-Fi.

Wi-Fi Network Name: ATTXXXXXXX
 Wi-Fi Password: XXXXXXXXXXXXX
 For help, att.com/support

Wi-Fi Network Name (SSID)

12-character Wi-Fi Password

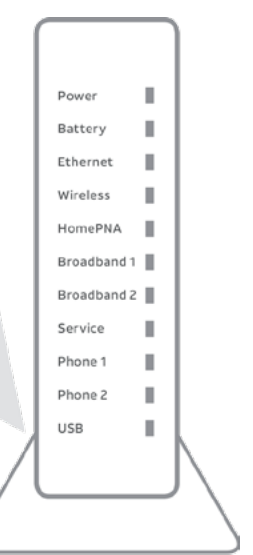

Having trouble?



What is your service activation date?

Do not attempt to install your service until **2pm or later** on your service activation date. You can find this date on your packing slip.

Still having problems? Many issues can be resolved with these simple steps:



Did you activate your service?

You must complete activation for your Internet service to work correctly. See Step **3** inside.



Check your connections.

Check that all cables and cords are connected properly and securely.



Power down, power up.

Unplug the power cord from the back of the Wi-Fi Gateway. Leave the Wi-Fi Gateway unplugged for 15 seconds and plug it back in. You may need to wait up to two minutes for blinking indicator lights to turn solid green.

Additional information

Test your Internet connection speed

Our speed test takes less than a minute to perform two key measurements (Download and Upload) to help you determine if you should take steps to improve the performance of your online experience.

Visit att.com/speedtest.

Manage your account:

Available 24/7, download the myATT app at att.com/myattapp from your mobile device.

Repair center:

Phone: 800.246.8464

IPv6

AT&T supports IPv6 across our network, equipment and devices. Visit att.com/ipv6 for more information.

Accessibility support:

- Alternate format guides:
 - Braille or large print: call **800.288.2020** and request guide number ATT162220926-3
 - Accessible tagged PDF: visit att.com/userguides
- Telephone equipment for visual and/or hearing impaired:
 - Phone: 877.902.6350
 - TTY: 800.772.2889
- Repair Center:
 - Phone: 800.246.8464
 - TTY: 800.397.3172
- Device Compatibility Feature: Compatible with any TTY/TDD devices with standard phone line

¿Hablas español?

Por favor visita att.com/uverseguias para ver la información en español. También puedes ver la siguiente guía: **ATT162220926-3** (FTTP-GPON CSI SP) para más detalles.

Smart Home Manager

(For AT&T Internet customers only)

Learn how the Smart Home Manager can help you manage your Wi-Fi Network information, connect devices to your network, and more.

The Smart Home Manager (SHM) Dashboard gives you easy access to all the network information you need.

- View your Wi-Fi Network and connected devices
- Easily reboot your Wi-Fi Gateway
- Change your Wi-Fi Network Name or Password

Access the Smart Home Manager

Log in with your AT&T ID and Password that manages your AT&T Internet Account to have your network connections at your fingertips.

Need more control over your home network?

Go to <https://myhomenetwork.att.com> to see how *you can easily manage all the devices in your home.*

SHM Dashboard

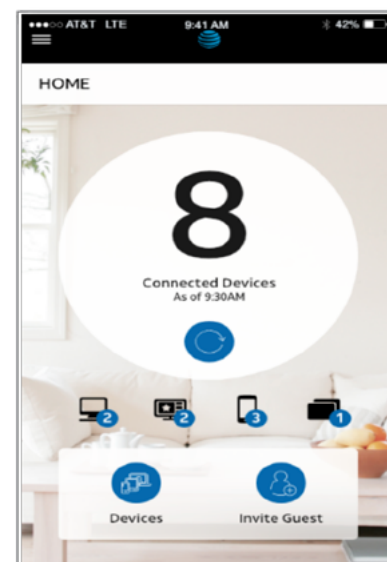

Need more help?

Visit att.com/support

Call us at **800.288.2020** and ask for “technical support.”

