

**OutBack**  
**POWER™**

an EnerSys® company



**Mojave™ Grid-Hybrid  
Inverter/Charger  
OGHI8048A**



**Operator's Manual**





an EnerSys® company

## About OutBack Power

OutBack Power™ is a leader in advanced energy storage and conversion technology. OutBack Power products include true sine wave inverter/chargers, batteries, maximum power point tracking charge controllers, and system communication components, as well as circuit breakers, accessories, and assembled systems.

## Applicability

These instructions apply to OutBack Power inverter/charger model OGH18048A only.

## Contact Information

Address: 3767 Alpha Way  
Bellingham, WA 98226 USA

Telephone: +1.360.435.6030

Website: [www.outbackpower.com](http://www.outbackpower.com)

## Warranty

The warranty for this product can be downloaded from [www.outbackpower.com/downloads/warranty\\_and\\_safety/warranty\\_mojave](http://www.outbackpower.com/downloads/warranty_and_safety/warranty_mojave). A printed copy is available by sending a self-addressed envelope to the above address.

## Notice of Copyright

*Mojave Grid-Hybrid Inverter/Charger Operator's Manual* © 2021 by OutBack Power. All Rights Reserved.

## Trademarks

Trademarks and logos are the property of Alpha Technologies Services, Inc., EnerSys, and its affiliates unless otherwise noted. Subject to revisions without notice. The IEEE and CSA trademarks are not the property of Alpha Technologies Services, Inc. or EnerSys.

## Date and Revision

December 2021, Revision A

## Part Number

900-00275-01-001 Rev A



# Table of Contents

<b>General Safety .....</b>	<b>7</b>
Audience .....	7
Symbols Used .....	7
Symbols Used on the Mojave Inverter .....	8
<b>Introduction .....</b>	<b>9</b>
Welcome to OutBack Power .....	9
Inverter Functions .....	10
Components and Accessories .....	11
Battery Bank .....	11
<b>User Interface .....</b>	<b>13</b>
Accessing the User Interface (UI) .....	13
Tabs and Views .....	14
STATUS View .....	15
Inverter Tab .....	18
Battery Tab .....	19
Grid Tab .....	21
Generator Tab .....	22
Network Tab .....	24
ACTIONS View .....	25
SETTINGS View .....	26
EVENTS View .....	27
OPTICS RE .....	28
<b>Operation .....</b>	<b>31</b>
Connections .....	31
CT .....	31
LED Indicator .....	32
Description of Inverter Operations .....	33
SETTINGS View .....	33
Admin Tab .....	34
Change Password .....	35
Historical Data .....	35
Firmware Update .....	35
Network Tab .....	36
Inverter Tab .....	37
AC Coupling .....	39
Time of Use (ToU) .....	40
Rapid Shutdown (RSD) .....	42
Grid Tab .....	43
Grid Protection Settings .....	43
Battery Tab .....	49
Battery Usage .....	51
Battery Charging .....	53
State of Charge (SoC) .....	53
Charge Cycle .....	54
Lithium-Chemistry Batteries (BMS and Two-Stage Charging) .....	64

# Table of Contents

Generator Tab.....	70
Generator Input.....	72
Generator Control.....	74
Automatic Generator Start .....	75
<b>Troubleshooting.....</b>	<b>79</b>
FAQ .....	79
Basic Troubleshooting .....	80
<b>Service Instructions .....</b>	<b>85</b>
Replacement Kits.....	85
Preparatory Steps.....	86
Replacement of Control Board .....	88
Replacement of AC Board.....	91
Replacement of Fan Module .....	95
Replacement of Power Module .....	96
Replacement of Carrier Board.....	98
Preventative Maintenance .....	100
<b>Specifications.....</b>	<b>101</b>
Electrical Specifications .....	101
Mechanical Specifications.....	102
Environmental Specifications.....	102
Wireless Specifications .....	103
Regulatory Specifications .....	103
Listings .....	103
Certifications .....	103
Directives .....	103
Grid Protection Settings (All Profiles).....	104
<b>Index.....</b>	<b>111</b>

## List of Tables

Table 1	Included in Box.....	11
Table 2	Start and Stop Reasons .....	78
Table 3	Frequently Asked Questions .....	79
Table 4	Troubleshooting .....	81
Table 5	Electrical Specifications for Mojave Inverter .....	101
Table 6	Mechanical Specifications for Mojave Inverter.....	102
Table 7	Environmental Specifications for Mojave Inverter .....	102
Table 8	Wireless Specifications for Mojave Inverter .....	103
Table 9	Grid Protection Settings (IEEE 1547 and CA Rule 21) .....	104
Table 10	Grid Protection Settings (HECO and ISO-NE).....	107

# List of Figures

Figure 1	Mojave Inverter/Charger.....	9
Figure 2	User Interface.....	13
Figure 3	User Interface (Tabs and Views).....	14
Figure 4	User Interface (Status Graphics).....	15
Figure 5	User Interface (Inverter tab, STATUS view).....	18
Figure 6	User Interface (Battery tab, STATUS view).....	19
Figure 7	User Interface (Grid tab, STATUS view).....	21
Figure 8	User Interface (Generator tab, STATUS view).....	22
Figure 9	User Interface (Action Menu).....	25
Figure 10	User Interface (SETTINGS View, Inverter Tab).....	26
Figure 11	User Interface (Event History Screen).....	27
Figure 12	Network Port.....	28
Figure 13	OPTICS RE Account.....	29
Figure 14	Icon Images.....	31
Figure 15	Current Transducers.....	31
Figure 16	LED Indicator.....	32
Figure 17	SETTINGS View (Default).....	33
Figure 18	Admin Tab (SETTINGS View).....	34
Figure 17	Serial Number.....	34
Figure 18	After Login.....	35
Figure 21	Network Tab (SETTINGS View).....	36
Figure 22	AC Coupling.....	39
Figure 21	Time of Use.....	40
Figure 24	ToU with AC Coupling.....	41
Figure 25	AUX terminals.....	42
Figure 26	Charge Status.....	54
Figure 27	Charging Stages.....	55
Figure 28	Absorption Stage.....	56
Figure 29	Repeated Charging (1 <sup>st</sup> and 2 <sup>nd</sup> Cycles).....	60
Figure 30	Repeated Charging (3 <sup>rd</sup> , 4 <sup>th</sup> , and 5 <sup>th</sup> Cycles).....	61
Figure 31	Equalization.....	62
Figure 32	Communications Ports.....	65
Figure 33	Charging Stages.....	66
Figure 34	Absorption Stage.....	67
Figure 35	Repeated Charging (1 <sup>st</sup> , 2 <sup>nd</sup> , and 3 <sup>rd</sup> Cycles).....	69
Figure 36	AUX terminals.....	74

## Table of Contents





Figure 37	Measurement Points .....	80
Figure 38	Removal of Covers.....	87
Figure 39	Control Board External Attachments .....	88
Figure 40	Control Board Connectors.....	89
Figure 41	Dismounting Control Board .....	90
Figure 42	AC Terminals .....	91
Figure 43	Transformer Terminals .....	92
Figure 44	AC Board Connectors .....	93
Figure 45	Dismounting AC Board.....	94
Figure 46	Fan Module .....	95
Figure 47	Control Board Connectors.....	96
Figure 48	Power Module Cover.....	96
Figure 49	Bus Bars and Power Modules .....	97
Figure 50	Common-Mode Choke .....	98
Figure 49	Carrier Board.....	99

# General Safety

## Audience

This book provides instructions for the physical installation and wiring of this product. These instructions are for use by qualified personnel who meet all local and governmental code requirements for licensing and training for the installation of electrical power systems with AC and DC voltage up to 600 volts. This product is only serviceable by qualified personnel.

## Symbols Used

	<b>WARNING: Hazard to Human Life</b> This type of notation indicates that the hazard could be harmful to human life.
	<b>CAUTION: Hazard to Equipment</b> This type of notation indicates that the hazard may cause damage to the equipment.
	<b>IMPORTANT:</b> This type of notation indicates that the information provided is important to the installation, operation and/or maintenance of the equipment. Failure to follow the recommendations in such a notation could result in voiding the equipment warranty.
	<b>NOTE:</b> This type of notation indicates useful information. This symbol is not always used.

### MORE INFORMATION

This symbol means that more information is available in other literature. If a number is present, it refers to the corresponding QR code near the beginning of the section. A numbered symbol is also a clickable hyperlink.

## Important Safety Instructions

# Symbols Used on the Mojave Inverter

The symbols shown below mean the following:



**WARNING: To reduce risk of injury, read all instructions**

The instructions indicated here include this manual, as well as the *Mojave Inverter/Charger Quick Start Guide*, and any other pertinent literature.

## General Safety



**WARNING: Limitations on Use**

This equipment is NOT intended for use with life support equipment or other medical equipment or devices.



**WARNING: Reduced Protection**

If this product is used in a manner not specified by Mojave product literature, the product's internal safety protection may be impaired.



**CAUTION: Equipment Damage**

Only use components or accessories recommended or sold by OutBack Power or its authorized agents.





# Introduction

## Welcome to OutBack Power

Thank you for purchasing the Mojave™ Grid-Hybrid Inverter/Charger. This product offers a power conversion system between batteries and AC power. This inverter can provide backup power during loss of utility grid, unlike grid-direct (GD) inverters that only convert solar (PV) power to send to the grid. The inverter contains an onboard wireless (wi-fi) network. It can also be connected to other local networks, wirelessly or by using a physical Ethernet connection.

The Mojave inverter is designed to be “AC Coupled”; that is, the inverter is meant to be installed in existing grid-direct systems to add energy storage and backup capability without interfering with grid interaction.

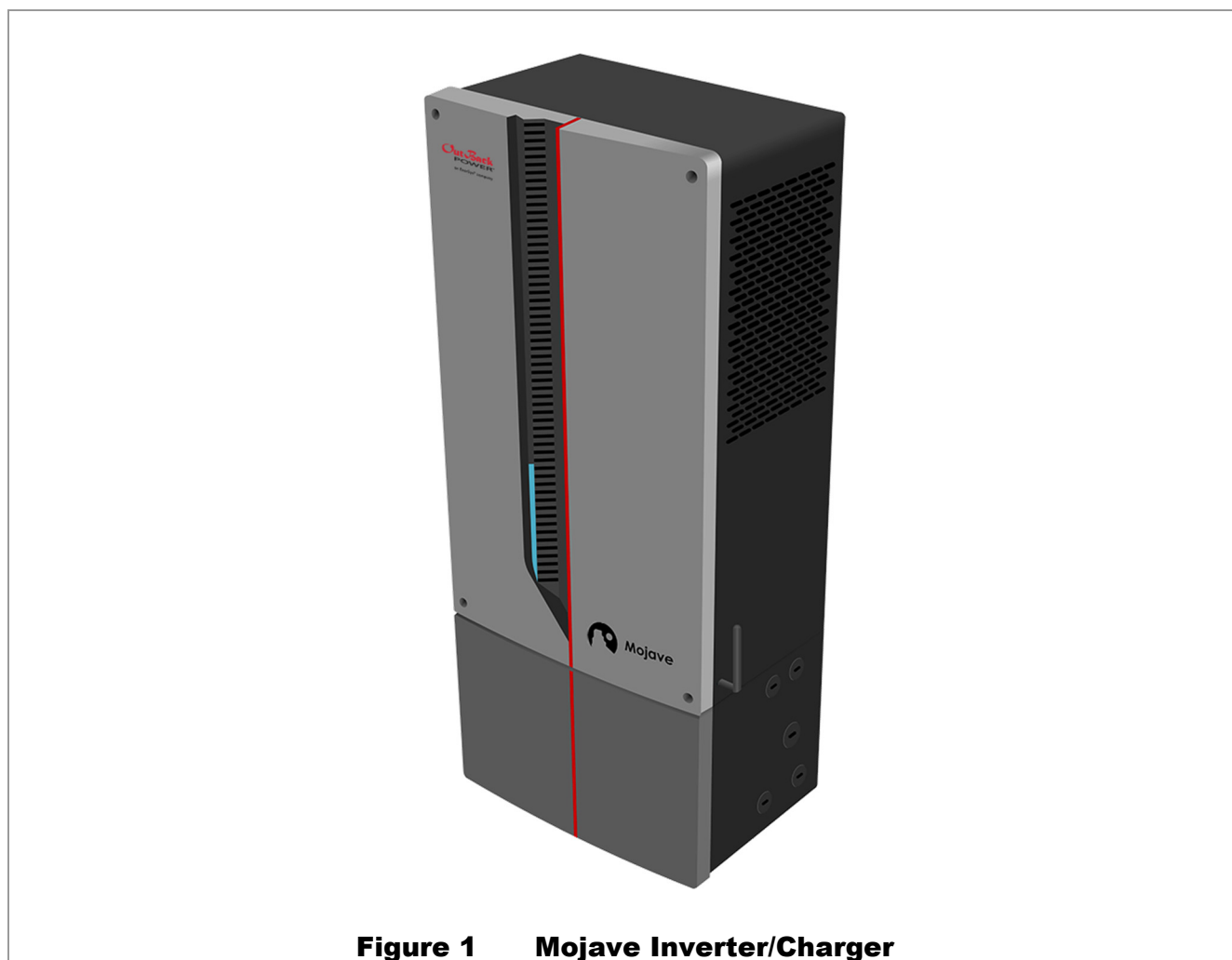

**Figure 1** Mojave Inverter/Charger

# Inverter Functions

- o Battery-to-AC inverting which delivers power to run backup loads and other functions
  - Split-phase output
  - Model OGH18048A can continuously produce up to 8 kVA (33 Aac)
- o AC-coupled interaction
  - Mojave inverter accepts power on **GRID** connection and transfers it to protected **LOAD** connection
  - GD inverter is present on **LOAD** and maintains **GRID** connection through the Mojave inverter
  - **LOAD** connection accepts exported power from GD inverter and exports it back to **GRID**
    - ✓ Any loads on the Mojave inverter output will also be supported by the GD inverter production.
    - ✓ During grid loss, the Mojave inverter's protected load output will keep the GD inverter energized; exported power from the GD inverter will be used to run loads
- o AC-to-battery charging
  - Requires split-phase input and a neutral conductor
  - During AC coupling, surplus GD inverter power can be used to charge batteries
- o Dual AC inputs allow direct wiring to multiple sources
  - Utility grid
  - AC generator
- o Rapid transfer between AC source and inverter output with minimal delay time
- o Automatic generator start (AGS) function in the event of low batteries or other conditions
- o Listed by UL to UL 1741 (2nd Edition with supplement SA) and CSA 22.2 #107.1-16
- o Meets SunSpec IEEE 2030.5-2018 CSIP
  - Provides secure communications protocols with utility companies
  - Certified for California Rule 21 Phase 2 and Phase 3, Functions 1 and 8



### **CAUTION: Hazard to Equipment**

- ❖ This product is for use in backup power and AC-coupled applications. Use with independent solar charge controllers is not supported at this time.
- ❖ This product is designed and tested for stationary applications only. It is not listed or warranted for mobile use.
- ❖ This product is designed for use with the external current transducers included in the box. (See next page.) Other current transducer products must not be used.



## Components and Accessories



### IMPORTANT:

The Mojave OGH18048A inverter includes integrated communications and does not require accessories such as a system display. It is not compatible with previous system display products, including MATE-class or MATE3-class system displays. It is not compatible with HUB products or FM-class charge controllers.

**Table 1 Included in Box**

Inverter Literature	Mounting Bracket
Hardware Kit	Wi-Fi Antenna
Current Transducers	Ground-Bonding Conductor

## Battery Bank



### IMPORTANT:

Battery charger settings need to be correct for a given battery type. Always follow battery manufacturer recommendations. Making incorrect settings, or leaving them at factory default settings, may cause the batteries to be undercharged or overcharged.



### CAUTION: Hazard to Equipment

Batteries can emit vapors which are flammable and which are corrosive over long periods of time. Installing the inverter in the battery compartment may cause corrosion which is not covered by the product warranty. (Sealed batteries may be an exception.)



### NOTE:

If the Mojave ESS battery is in use, refer to the *Mojave Energy Storage System Operator's Manual* in place of the present manual. This manual, also called the *ESS Manual*, contains necessary battery and inverter instructions. The *ESS Manual* also includes inverter presets for the Mojave ESS battery.

When planning a battery bank, consider the following:

- **Cables:** See the *Quick Start Guide* for cable sizes, torque values, and other requirements.  The maximum length will determine placement of the battery bank, but should not exceed 10 feet (3 meters). Local codes or regulations may apply and may take priority over OutBack Power recommendations.
- **Battery Type:**
  - These inverters are designed to work with a battery bank of nominal 48 Vdc. The default settings for three-stage battery charging assume a deep-cycle stationary lead-acid battery, such as OutBack Power's EnergyCell™ PLR or NorthStar Blue+ series batteries. The charger settings for many of these batteries are pre-loaded. (See page 49.) The inverter's settings can be adjusted for other battery types.
  - OutBack Power does not support installation of lithium-ion batteries that have not been tested and published as installable with OutBack Power equipment.
    - ✓ OutBack Power supports the installation and use of the Mojave battery, which was engineered for use with this inverter.

## Introduction

- ✓ OutBack Power supports batteries that have been certified and published for use with this product. (See the **Lithium-Chemistry** section on page 64.)
- ✓ Supported batteries are assumed to be new (not repurposed, purchased used, etc), covered under manufacturer's warranty for the intended application, and fully compliant to all local and national regulatory requirements.
- Consult the documentation for the specific batteries used in the system to ensure that the settings are appropriate. All types of batteries must be regularly maintained according to the instructions of the battery manufacturer. 

**Enclosure:** Specialized enclosures with active or passive venting may be required for certain batteries. Consult the battery manufacturer's literature as well as applicable building and electrical codes.



# User Interface

## Accessing the User Interface (UI)

The Mojave inverter’s web-based user interface allows monitoring and programming of all items. It can be accessed using a web browser once a local area network connection is established. The following information assumes local access. For remote access using the OPTICS RE site, see page 28.

Check the tablet, smartphone, or other device that will be used for access. A new wi-fi connection will appear after power-up. It appears as “Mojave-xxxx” and incorporates part of the inverter’s serial number. Connect to the device. When prompted for a wi-fi password, the password consists of the last eight digits of the inverter’s serial number. (See page 34 for serial number location.) In a new browser window, enter the inverter’s IP address, which is 192.168.2.2. This will open the UI.

**System Status**

DATE: 2021-05-13 13:34:29 PDT

1.4 kW  
240.0 V  
60.0 Hz

1.6 kW  
64%  
48.4 V

0.0 kW  
243.4 V  
60.0 Hz

1.1 V  
0.0 Hz

**Tab Data**

Status:	ON
Power:	1402 W
Frequency:	60.010 Hz
Voltage L1:	119.4 V
Voltage L2:	120.6 V
Current L1:	11.7 A
Current L2:	0.0 A
Info:	none

© 2021 OutBack Power Technologies, Inc. All Rights Reserved. Trademarks and logos are the property of Alpha Technologies Services, Inc., EnerSys and its affiliates unless otherwise noted. Subject to revisions without prior notice. E. & O.E.

**Example of computer UI**

**Example of smartphone UI**

**Figure 2 User Interface**



### NOTE:

Upon initial UI access, an overlay will appear. The viewer can use it to “walk” through available screens and options. Buttons will appear for the **Previous** or **Next** screen.

## Tabs and Views

The interface features five tabs showing inverter functions. The tabs are **Inverter**, **Battery**, **Grid**, **Generator**, and **Network**. When a tab is selected, a solid box will appear around it.

The tabs are accessed with either of two views: **STATUS** and **SETTINGS**. Two additional views, **EVENTS**, and **ACTIONS**, allow access to more details not accessed by the tabs. When a view is selected, the title will turn gray.

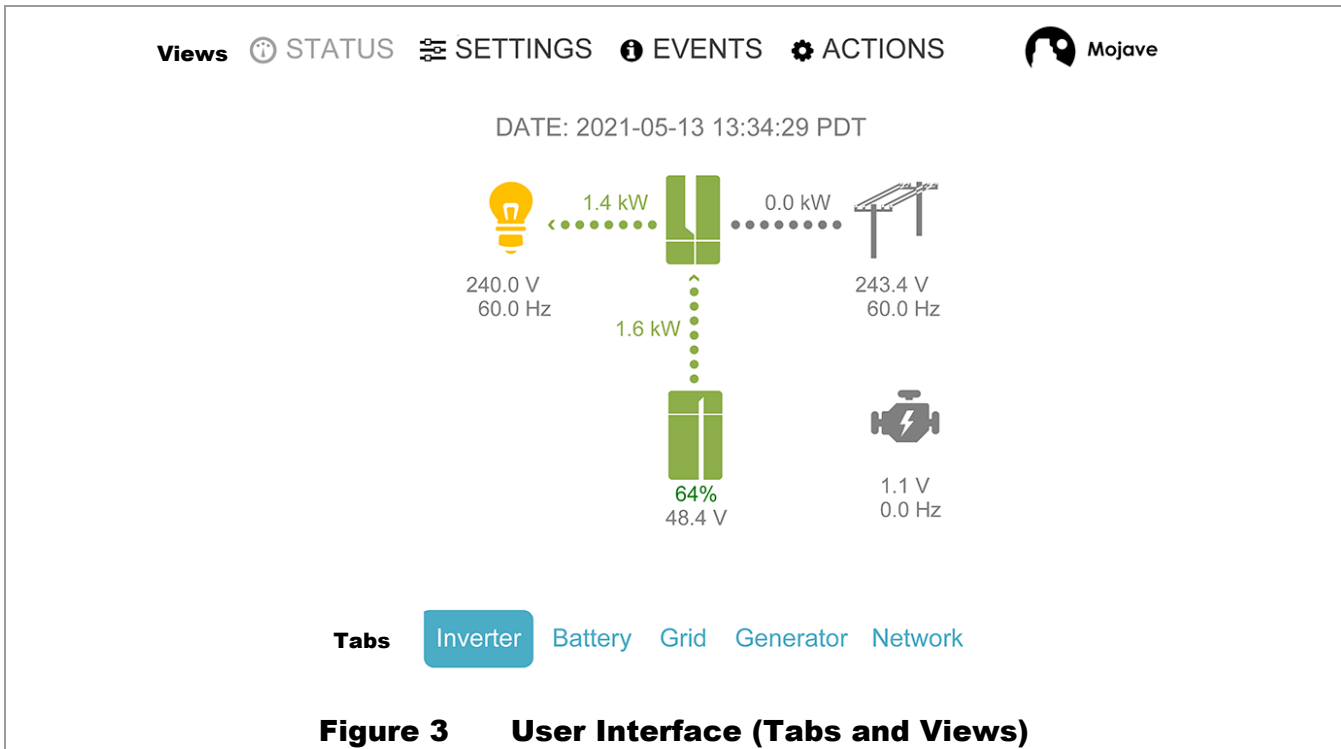

The **STATUS** view allows system monitoring. This is the default view; it will appear initially after connection. Selecting an individual tab brings up a table with data. See page 15 for more information on this view and each tab.

The **SETTINGS** view allows functions to be changed. Selecting an individual tab brings up a table with set points. This view also depicts a sixth tab, **Admin**, which permits login for higher-level access. See page 26 for a brief description of **SETTINGS**. See page 33 in the **Operations** chapter, for a full description of inverter functions as related to these settings.

The **ACTIONS** view features basic controls such as turning the inverter and some of its functions on and off. See page 25.

The **EVENTS** view features a history of significant inverter events. See page 27.

Most views feature a **Help** button which re-opens the UI overlay from page 13. This provides a walk-through of the screen as a reminder.

# STATUS View

The **STATUS** view provides a simplified graphic of the supported elements in this system, the power flow to each, and other data.

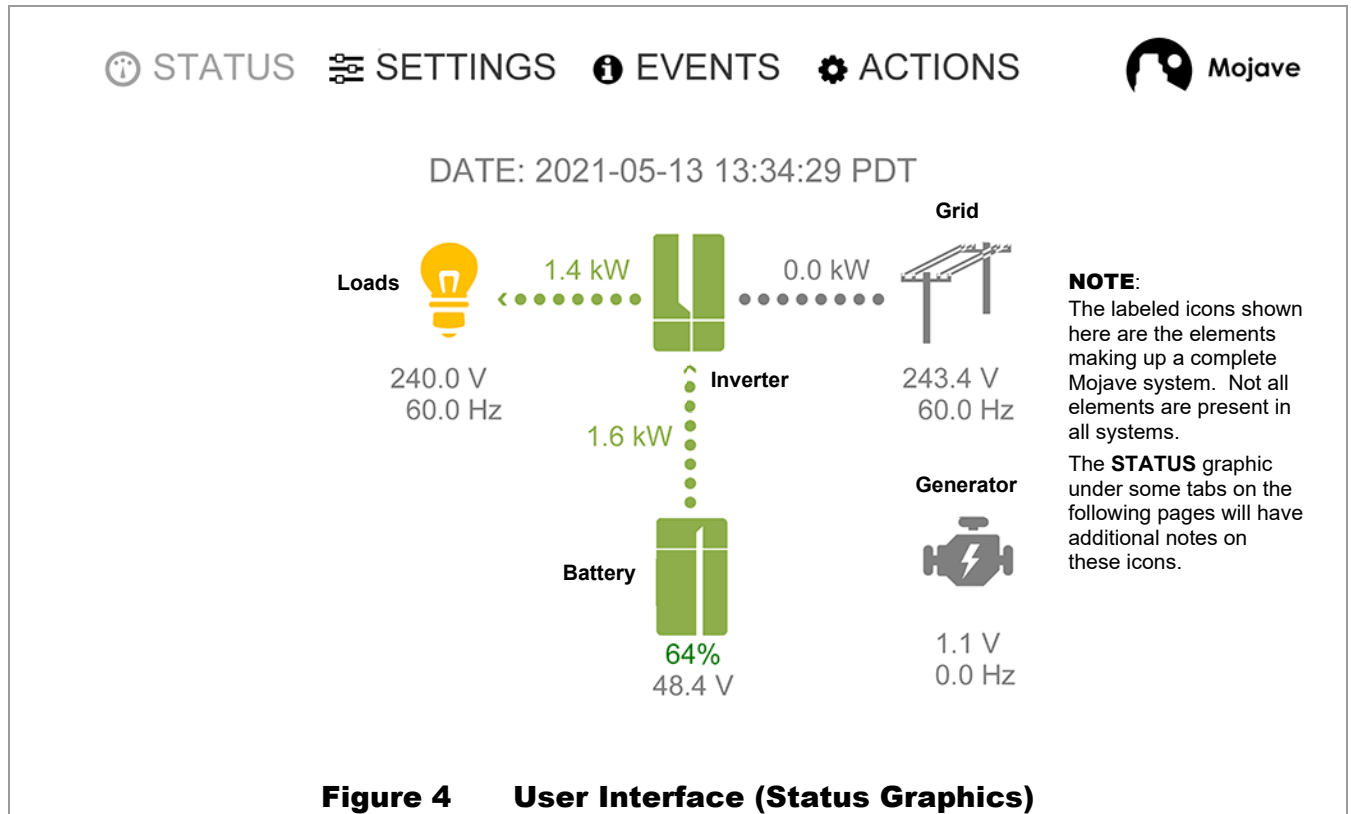

**Figure 4 User Interface (Status Graphics)**

- o **SYSTEM TIME:** This displays the time of day (24-hour format), date, and time zone. It is normally synchronized automatically (to connected device or internet).
  - This item can be reset by entering any login under the **Admin** tab (see page 34). A small **SET** icon will appear to the right of this item. When pressed, a pop-up will appear, confirming update to the local time and date. Press the **OK** button to proceed. A complete reset of all power sources may be needed if the time zone has changed.
- o Dotted lines: The flow of power between devices is shown by dotted lines between icons. Each line will “ripple” in the direction of power flow. This is also shown by a chevron-style arrow at the destination icon.
  - A green dotted line indicates power not purchased from grid or generator.
  - During AC-coupled operation (see page 39), the line to the load icon will be green and point to the right. If power is being exported to the grid, the grid icon line will also be green and point to the right.
  - A red dotted line indicates power purchased from grid or generator.
  - A red-green dotted line (leading to the loads) indicates a combination of power taken from both battery and grid.
  - A dotted line pointing away from the battery icon indicates that the battery is discharging. A dotted line pointing toward the battery indicates that it is charging. The color will depend on the source.

# User Interface

## o Icons:

- **Grid:** The utility grid source on the **GRID** terminals. This icon displays grid voltage and frequency. See page 20 for more information, including all **Status** items below.

Icon colors:

- ✓ Green = grid **Status** is **Connected**. Inverter is using grid power. The grid relay is closed. (See page 46.)
- ✓ Yellow = connection has been limited, by one of two means.

When **Inverter** is set to **Off** in the **Action Menu** while **Grid Input** was set to **Use**, **Status** is **Connected**. The inverter will close the grid relay to transfer power to loads. However, it will not connect this power with the battery charger or any internal function.

If **Grid Input** was set to **Drop** in the **Action Menu**, **Status** is **Dropped**. No power will be transferred. The inverter will run loads with battery power, if it is able.

- ✓ Red = problem with grid source. See the **Info** item on page 21.
  - ✓ Gray = grid **Status** (and grid power) is **Not Available**. The grid relay is open. The icon will be gray with a **Status** of **Disconnected** if the grid relay is automatically opened for another reason while grid power is still present.
- **Inverter:** The Mojave inverter itself. See page 18 for more information, including all **Status** items.

Icon colors:

- ✓ Green = inverting, charging, or other normal operation. The inverter **Status** is simply **ON**.
- ✓ Yellow = inverter is operating, but is in a **Warning** state. See the **EVENTS** view on page 27.
- ✓ Red = inverter has shut down with a status of **Error**. This will usually be shown by the main LED indicator turning red. See the **Info** item on page 18, the **EVENTS** view on page 27, and **Troubleshooting** on page 79 for more information on symptoms and errors.

See page 32 for more information on the main LED indicator.

- ✓ Gray = inverter is inactive. It has been set to the status of **OFF**.
- **Loads:** The protected items on the **LOAD** terminals. This icon displays load voltage and frequency. See page 18.

Icon colors:

- ✓ Green = inverter is performing **AC Coupling**. See page 39.
- ✓ Yellow = inverter is powering loads, either by battery, grid, or generator.
- ✓ Red = inverter has shut down with a status of **Off**. The inverter has detected an error at the **LOAD** terminals. See the **Info** item on page 18 and the **EVENTS** view on page 27.
- ✓ Gray = no loads are being powered.



- **Battery:** The primary DC storage device. This icon displays both state of charge (SoC)% and battery voltage.

**NOTE:**

The inverter uses a unique icon if the Mojave battery is in use and a generic battery icon for any other model of battery. See page 18.

Icon colors:

- ✓ Green = any active battery condition (inverting, charging, etc.) during normal operation. It may not be green if any of the low-battery criteria have been met.
- ✓ Yellow = low-battery criteria were met (LBCO, HBCO, or minimum SoC). A low-battery error may occur. See page 52.
- ✓ Red = battery-related error. This is most likely a low-battery condition, a high battery temperature, or a BMS issue. See the **Info** item on page 19, the **EVENTS** view on page 27, and **Troubleshooting** on page 79 for more information on the problem.
- ✓ Gray = no current flow in any direction.

- **Generator:** The AC source on the inverter's **GEN** terminals. This icon displays generator voltage and frequency. See page 22.

Icon colors:

- ✓ Green = generator **Status** is **Connected**. Inverter is using generator power. The generator relay is closed. (See page 73.)
- ✓ Yellow = generator is running, but inverter is not accepting power. The generator relay is open. Status may be **Warming Up** or **Cooling Down**.  
If **Gen Input** was set to **Drop** in the **Action Menu**, **Status** is **Dropped**.
- ✓ Red = problem with generator source. See the **Info** item on page 22, the **EVENTS** view on page 27, and **Troubleshooting** on page 79 for more information on the problem.
- ✓ Gray = generator **Status** (and generator power) is **Not Available**. The generator relay is open. This should appear when the generator is not running. The icon will be gray with a **Status** of **Disconnected** if the generator relay is automatically opened for another reason while power is still present.

## Inverter Tab

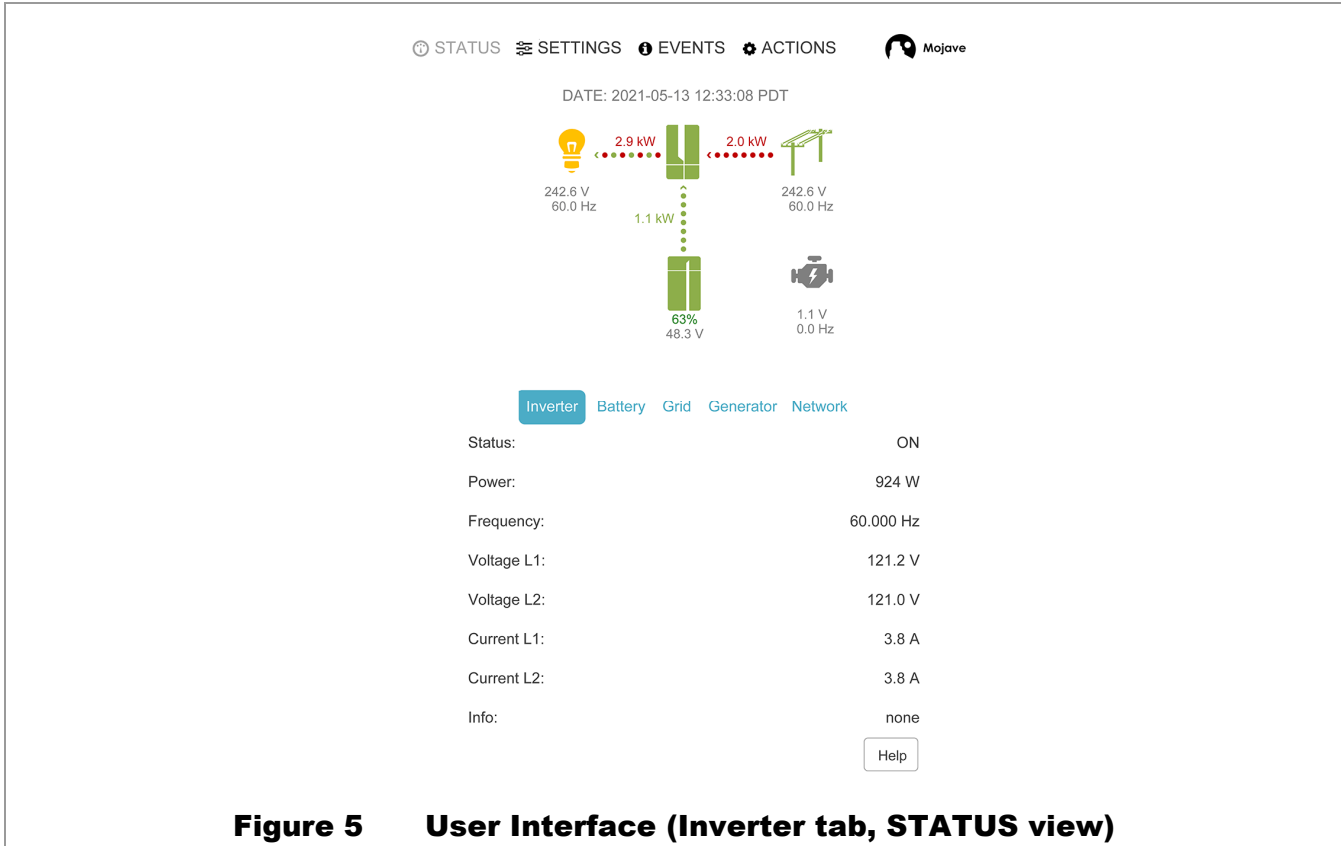

**Figure 5 User Interface (Inverter tab, STATUS view)**

This tab shows basic inverter output information. The first item is inverter **Status**:

- **ON**: Inverter set to **On** in **ACTIONS**. See page 25.
  - **OFF**: Inverter set to **Off** in **ACTIONS**.
  - **Error**: Shutdown due to a critical issue. See the **EVENTS** view on page 27 and **Troubleshooting** on page 79 for more information on symptoms and errors.
- **Power** — The power in watts (W) being exported using the inverting function.
  - **Frequency** — The frequency in hertz (Hz) delivered by the internal frequency control.
  - **Voltage L1** — The voltage in AC volts (Vac) measured at the inverter’s L1 **LOAD** terminal.
  - **Voltage L2** — The voltage in AC volts (Vac) measured at the inverter’s L2 **LOAD** terminal.
  - **Current L1** — The current in AC amperes (Aac) measured as imported or exported at the inverter’s L1 **LOAD** terminal.
  - **Current L2** — The current in AC amperes (Aac) measured as imported or exported at the inverter’s L2 **LOAD** terminal.

**Info** — This item lists a series of messages providing additional information to what is shown in **Status**. A common message is **Performing Energy Management** (when the **Time of Use** function is operating). It is equally common for this item to read **None**. When **Error** is present as a **Status**, the specific name of the error will appear here.

See the **EVENTS** view on page 27 and **Troubleshooting** on page 79 for more information on symptoms and errors.

# Battery Tab

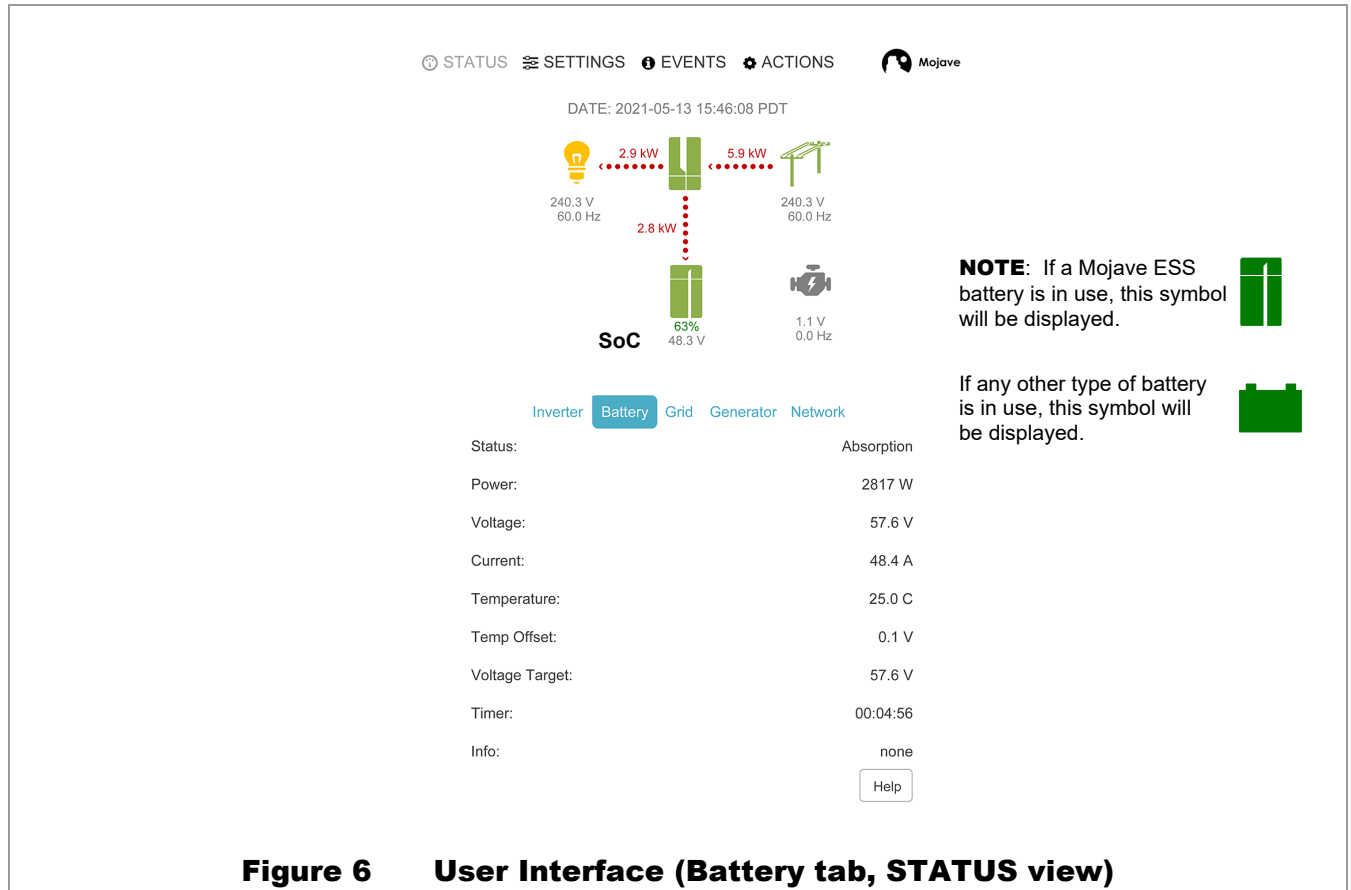

This tab shows battery information. The first item is battery charger **Status**:

- **Idle:** The inverter is neither charging nor discharging. It is still capable of either function and has not been turned off. See page 58.
- **Bulk:** The Bulk stage has been triggered. See page 56.
- **Absorption:** The Absorption stage has been triggered. See page 57.
- **Float:** The Float stage has been triggered. See page 58.
- **EQ:** The Equalization cycle has been triggered. See page 62.
- **Error.** Shutdown due to a battery-related error.
- **BMS:** The charger is under the control of a battery management system. See page 64.
- **Off:** Unable to use the batteries due to an error elsewhere in the system. **Error** will be visible as a status under another tab. The appropriate icon will also be red. The battery icon will be gray instead of red.



**NOTES:**

- ❖ A status message only shows the charger's goal, not its present activity. If the battery reaches the Refloat set point, the Mojave inverter will technically enter the Float stage of charging. This item will show Float status even if a charging source is not yet available.
- ❖ State of charge (SoC) is not included in the data items listed below. Instead, it is shown in Figure 6.

## User Interface

Additional items under the **Battery** tab:

- o **Power** — The net power in watts (W) being imported from, or delivered to (in charging), the battery.
- o **Voltage** — The voltage in DC volts (Vdc) measured at the inverter's internal battery terminals.
- o **Current** — The net current in DC amperes (Adc) measured as imported or exported from the batteries.
- o **Temperature** — The battery temperature in degrees Celsius as measured by the remote temperature sensor (RTS) or the BMS.
- o **Temp Offset** — Temperature-compensated voltage added to the configured voltage target.
- o **Voltage Target** — The configured value for the present charging stage. See page 54.
- o **Timer** — The timer that runs when the **Status** is **Float**, **Absorption**, or **EQ**.

**Info** — This item lists a series of messages providing additional information to what is shown in **Status**. A common message is **Discharging to support TOU schedule** (when the **Time of Use** function is operating). It is equally common for this item to read **None**. When **Error** is present as a **Status**, the specific name of the error (such as **At Minimum SOC setting**) will appear here.

See the **EVENTS** view on page 27 and **Troubleshooting** on page 79 for more information on symptoms and errors.

# Grid Tab

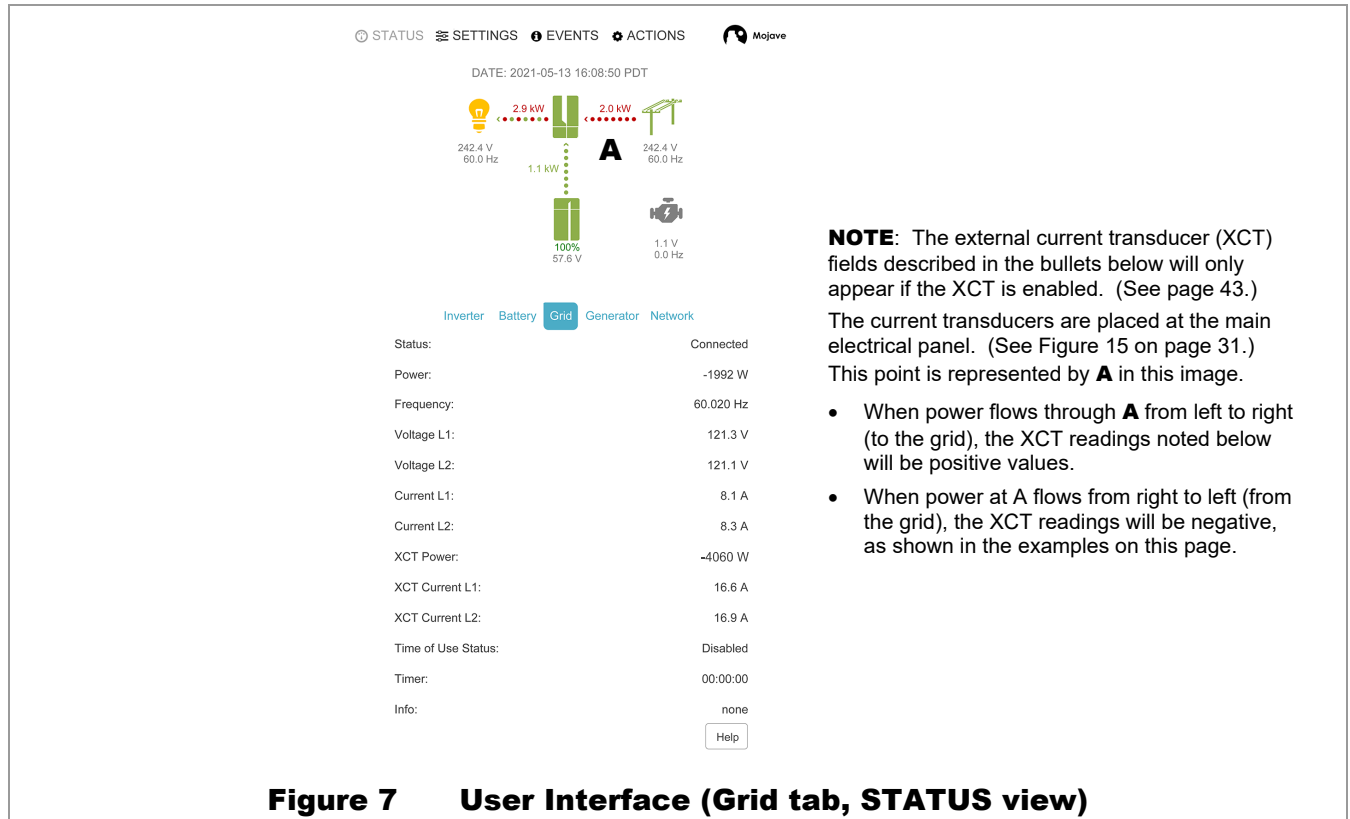

**NOTE:** The external current transducer (XCT) fields described in the bullets below will only appear if the XCT is enabled. (See page 43.) The current transducers are placed at the main electrical panel. (See Figure 15 on page 31.) This point is represented by **A** in this image.

- When power flows through **A** from left to right (to the grid), the XCT readings noted below will be positive values.
- When power at **A** flows from right to left (from the grid), the XCT readings will be negative, as shown in the examples on this page.

**Figure 7 User Interface (Grid tab, STATUS view)**

This tab shows information on the inverter’s connection to the utility grid. The first item is grid **Status**:

- **Connected** — grid power is accepted for use. The grid relay is closed. (See page 46.)
  - **Disconnected** — voltage is present at the **GRID** terminals, but the power is unacceptable or was manually disconnected. The grid relay is open.
  - **Dropped** — grid power was manually disconnected in the **Actions Menu**. The grid relay is open.
  - **Error** — the inverter has detected a critical problem at the **GRID** terminals. The grid relay is open.
  - **Not Available** — no voltage (or minimal voltage) is detected at the **GRID** terminals.
- o **Power** — The net power in watts (W) being imported from, or exported to, the L1 and L2 **GRID** terminals.
  - o **Frequency** — The frequency in hertz (Hz) measured at the inverter’s L1 and L2 **GRID** terminals.
  - o **Voltage L1** and **Voltage L2** — The voltage in AC volts (Vac) measured at the L1 and L2 **GRID** terminals.
  - o **Current L1** and **Current L2** — The current in AC amperes (Aac) measured at the **GRID** terminals.
  - o **XCT Power** — The net exported power in watts (W) measured at the external current transducers. This will read zero if the transducers are disabled. See pages 31 and 43.
  - o **XCT Current L1** and **XCT Current L2** — The current in AC amperes (Aac) measured at the L1 and L2 current transducers. This will read zero if the transducers are disabled. See pages 31 and 43.
  - o **Time of Use Status** — **Disabled, Off-Peak (Grid), On-Peak (Battery)**. See page 40.
  - o **Timer** — The timer that runs when the **Status** is **Connecting**.
  - o **Info** — This item lists a series of messages providing additional information to what is shown in **Status**. A common message is **Grid dropped**. It is equally common for this item to read **None**. When **Error** is present as a **Status**, the specific name of the error will appear here.

See the **EVENTS** view on page 27 and **Troubleshooting** on page 79 for more information on symptoms and errors.

## Generator Tab

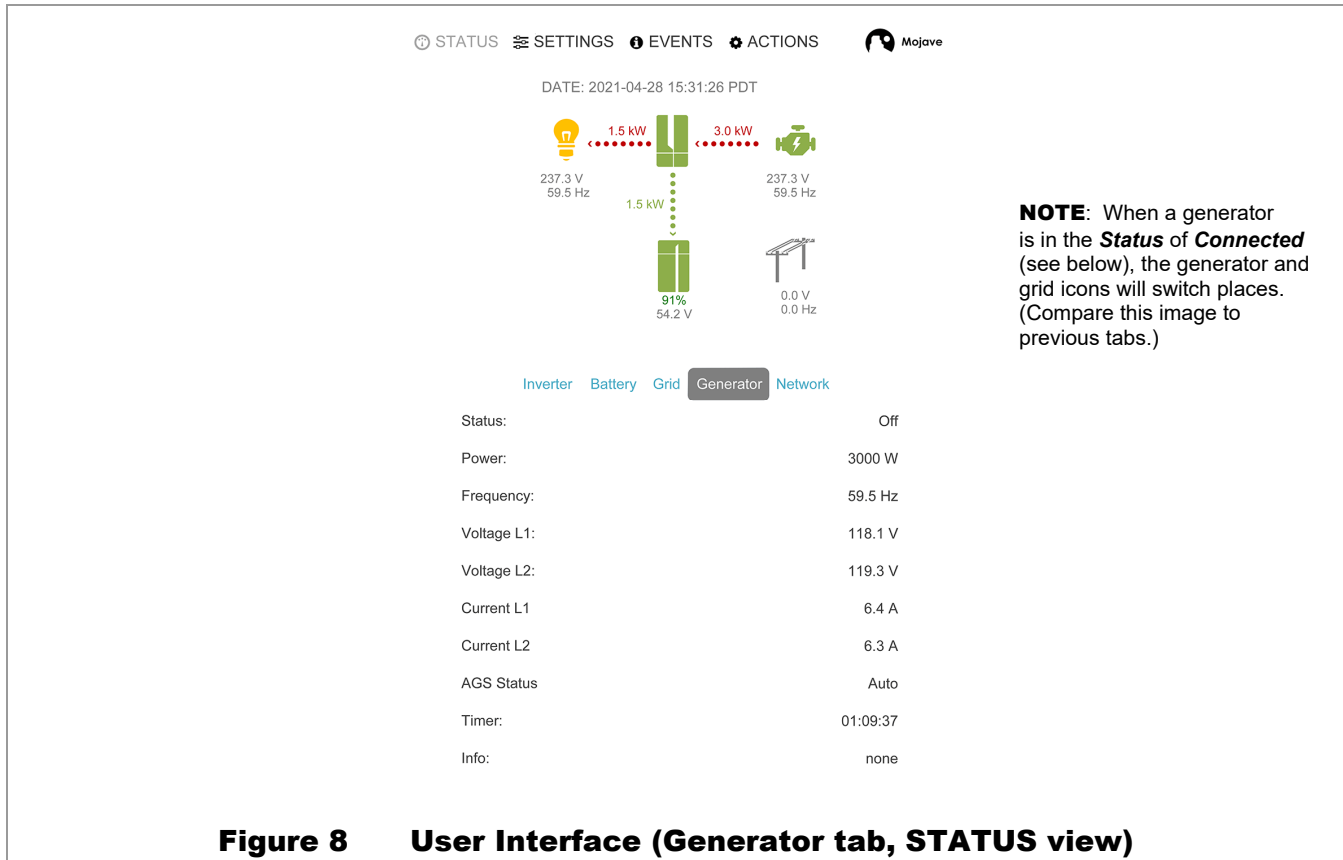

This tab shows information on the inverter's connection to an AC generator. This includes the status of automatic generator starting (AGS), if used. The first item is generator **Status**:

- **Warming Up** — generator is running without connecting to the inverter. The generator relay is open. The **Timer** is counting down the warmup time before connection.
- **Connected** — generator power is accepted for use. The generator relay is closed. The **Timer** is counting the generator's running time.
- **Disconnected** — voltage is present at the **GEN** terminals, but the power is unacceptable or was manually disconnected. The generator relay is open.
- **Cooling Down** — generator is running without connecting to the inverter. The generator relay is open. The **Timer** is counting down the cooldown time before stopping the generator.
- **Dropped** — generator power was manually disconnected in the **Actions Menu**. The generator relay is open.
- **Error** — the inverter has detected a critical problem at the **GEN** terminals. The generator relay is open.
- **Not Available** — no voltage (or minimal voltage) is detected at the **GEN** terminals. The generator relay is open.

Additional items under the **Generator** tab:

- o **Power** — The power in watts (W) being imported from the generator.
- o **Frequency** — The frequency in hertz (Hz) measured at the inverter's L1 and L2 **GEN** terminals.
- o **Voltage L1** and **Voltage L2** — The voltage in AC volts (Vac) measured at the inverter's L1 and L2 **GEN** terminals.
- o **Current L1** and **Current L2** — The current in AC amperes (Aac) measured at the inverter's L1 and L2 **GEN** terminals.
- o **AGS Status**
  - **Enabled** — The AGS function has been activated in the **Actions Menu** and also in **AGS** under the **Generator** tab. (See pages 25, 70, and 75.) It is waiting for proper conditions to start the generator.
  - **Disabled** — The AGS function has been deactivated in the **Actions Menu**, in the **Generator** tab, or both. The generator may be started manually, but it will not start automatically.
- o **Timer** — The timer that runs when the **Status** is **Warming Up**, **Connected**, or **Cooling Down**.
- o **Info** — This item lists a series of messages providing additional information to system operation. AGS conditions will appear here. A common message is **Gen going through warmup period**. If the generator is not in use, this item will read **None**. When **Error** is present as a **Status**, the specific name of the error (such as **At Minimum SOC setting**) will appear here.

See the **EVENTS** view on page 27 and **Troubleshooting** on page 79 for more information on symptoms and errors.

## Network Tab

This tab shows the information for connection to a personal computer or network. As these settings can be customized (see page 36), not all items may match what is shown here.

- o **Wireless** — The connection state when using a wireless (“wi-fi”) network connection.
  - **Disabled** — The configuration has manually disabled the connection.
  - **Disconnected** — The wireless interface is enabled but is not able to connect.
  - **Connected** — The interface is enabled and connected.
  - **Limited** — The interface has a connection to the local network, but cannot reach external resources, such as internet.
- o **SSID** — Service Set IDentifier; the designated name of the user’s wireless network.
- o **IP Address** — Internet Protocol address; the unique identifier assigned to the Mojave inverter.
- o **Netmask** — The subnet “mask” assigned to the Mojave inverter.
- o **Gateway** — The IP address of the device used to transfer requests between internet and local network. This often refers to the system’s router.
- o **Wired** — The connection state when using a wired (cable) network connection.
  - **Disabled** — The configuration has manually disabled the connection.
  - **Disconnected** — The wireless interface is enabled but is not able to connect.
  - **Connected** — The interface is enabled and connected.
  - **Limited** — The interface has a connection to the local network, but cannot reach external resources, such as internet.
- o **IP Address** — Internet Protocol address; the unique identifier assigned to the Mojave inverter.
- o **Netmask** — The subnet “mask” assigned to the Mojave inverter.
- o **Gateway** — The IP address of the device used to transfer requests between internet and local network. This often refers to the system’s router.
- o **DNS1** and **DNS2** — Domain Name Server; the IP addresses for the first and second servers used to resolve domain names into IP addresses.
- o **MAC Address** — The unique address of the Mojave inverter hardware; used to register with OPTICS RE. See page 28.
- o **OpticsRE** — The status of connection to the OPTICS RE website. See page 28.
  - **Disconnected** — The inverter is not communicating with the OPTICS RE website
  - **Connected** — The inverter is communicating with the OPTICS RE website.



## ACTIONS View

This view displays the **Action Menu**, with various off/on and other commands for basic functions. It does not replace the **STATUS**, **SETTINGS**, or **EVENTS** views, but appears alongside them.



### NOTE:

Clicking on this item a second time, or on the **Action Menu** heading, does not remove it from the screen. To remove it, press the **x** symbol (see **A** in Figure 9).

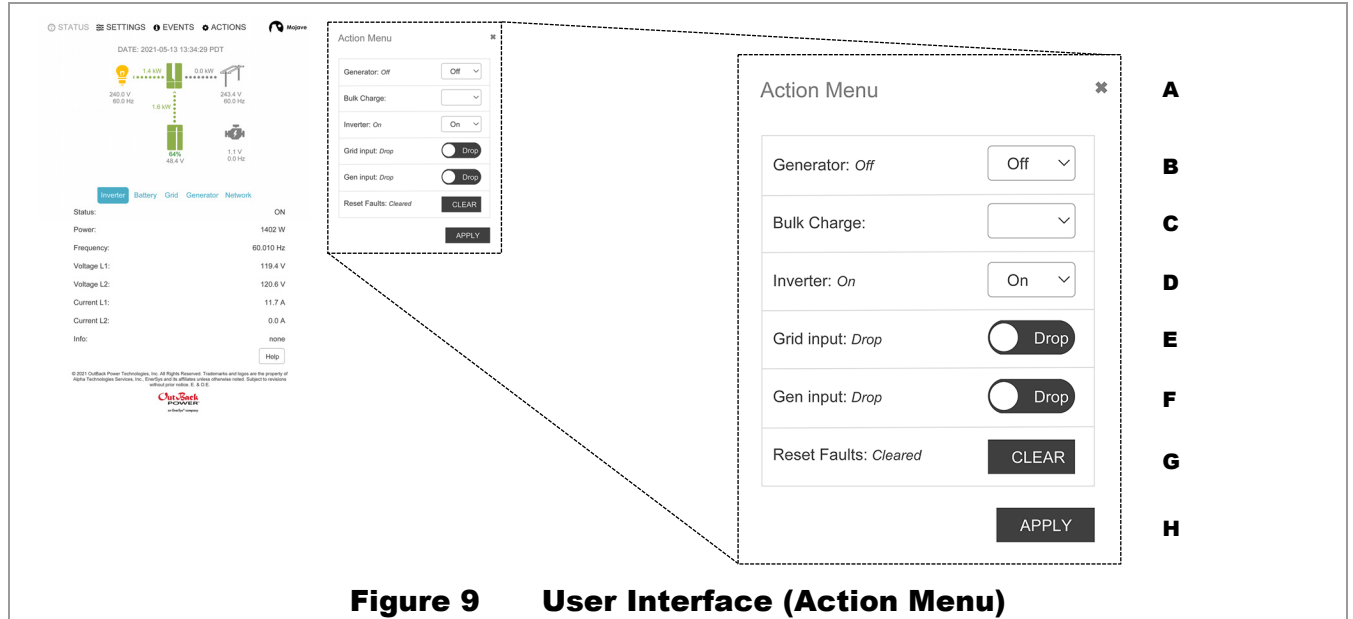

**Figure 9 User Interface (Action Menu)**

- B. Generator** — This drop-down menu has the options **On**, **Off** (start or stop the generator immediately), and **Auto** (enable AGS for automatic generator control; see page 74).
- C. Bulk Charge** — This drop-down menu has the options **Bulk Start** (begin charging) or **Stop**. See either page 56 or page 66, depending on the battery type. This item may not be required for battery chemistries other than lead-acid. See page 64.
- D. Inverter** — This drop-down menu has the options **On** (begin inverting; see page 38) or **Off**.
- E. Grid Input** — This onscreen toggle has the options **Use** (connect) or **Drop** (disconnect). This is a manual command to connect or disconnect from the utility grid. **Use** connects to the grid if all other conditions are met. (See page 45.)
- F. Gen Input** — This onscreen toggle has the options **Use** (connect) or **Drop** (disconnect). This is a manual command to connect or disconnect from the generator. **Use** connects to the generator if all other conditions are met. (See page 72.) It does not influence AGS or any other generator interaction.



### NOTES:

- ❖ If **Grid** or **Gen Input** are set to **Use** with **Inverter Off**, the unit will transfer power to loads (see pages 46 and 73). It will not charge batteries or otherwise interact with the power.
- ❖ The inverter cannot accept generator power if grid power is already being accepted. (See page 47.) It can accept the generator if the grid is present but **Grid Input** is set to **Drop**.

**G. Reset Faults** — The **CLEAR** button resets any active errors. When errors appear, they are displayed in the **Status** field under each of the **STATUS** tabs. See pages 18 through 22.

**H. Apply** — This button finalizes changes to the **Action Menu**. Changes will not take effect otherwise.

## SETTINGS View

This view allows functions to be changed. Selecting any of the tabs that were already discussed (**Inverter**, **Battery**, **Grid**, **Generator**, **Network**) brings up a table with set points related to that topic. This view also depicts a sixth tab, **Admin**, which permits login for higher-level access.

Selecting any tab in this view causes a gray box to appear around it.

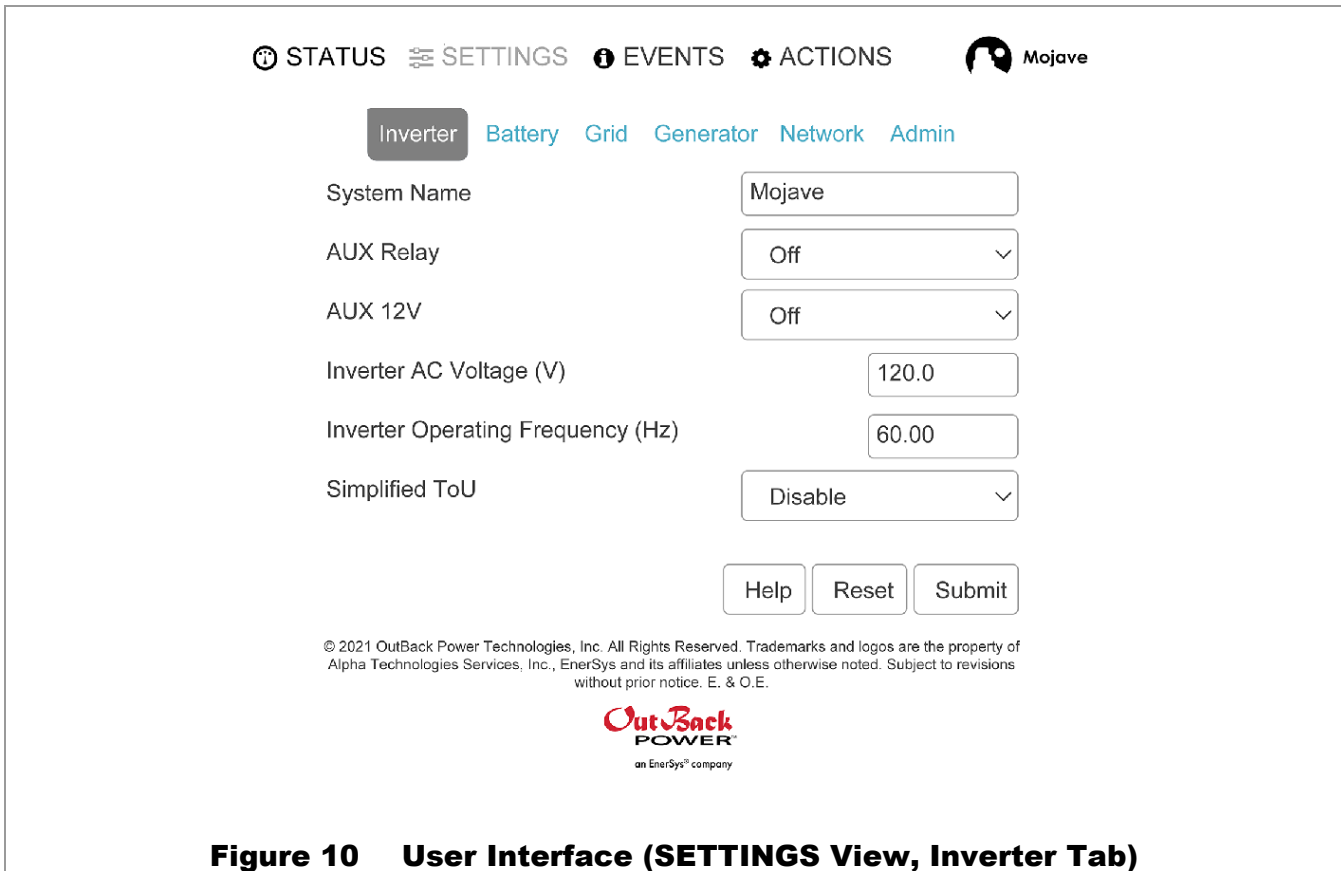

**Figure 10 User Interface (SETTINGS View, Inverter Tab)**

Each tab is addressed in the **Operation** chapter. This section of the book describes all inverter functions and explains the use of each setting. (The tabs may appear in a different order in **Operation** than they do here.)

- o **Inverter** — Allows settings for all inverter functions, including Time of Use (ToU). See page 37.
- o **Grid** — Allows settings for grid-related functions while connected. See page 43. Most items can only be adjusted by users with **Installer** access, after entering a password under the **Admin** tab. See page 34.
- o **Generator** — Allows settings for all generator functions, including automatic generator start (AGS). See page 70.
- o **Battery** — Allows settings for all battery functions, including various charging profiles for differing battery chemistries. See page 49.
- o **Network** — Allows settings for connection to a personal computer or network. See page 36.
- o **Admin** — Allows the selection of three access levels for the **Grid** tab. See page 34.

# EVENTS View

This screen shows a history of all notable changes in Mojave inverter state or status. Event messages are dynamically generated and depend on the particulars of the occurrence. Types of events include the following.

- o Fault history
- o Changes in operating state
- o Input source availability changes
- o Charge state changes

Events are arranged under several categories. The user can select the number of items displayed.

- o Type of event
  - Info — information on a status change or other event.
  - Warning — a non-critical issue that does not require the unit to shut down.
  - Fault – a critical wiring-related issue that requires the unit to shut down.
  - Error – a critical issue that requires the unit to shut down.

See **Troubleshooting** on page 79 to investigate problems.

- o Description of event
- o Date and time of occurrence

The **Show \_\_\_ entries** item **A** can be set to display 10, 25, 50, or 100 items. These items can be sorted by **Type**, **Description**, or **Time** using the small arrow icons **B** to the right of each column. They can be organized in either ascending or descending order.

Clicking on a Description message will bring up additional details on the event.

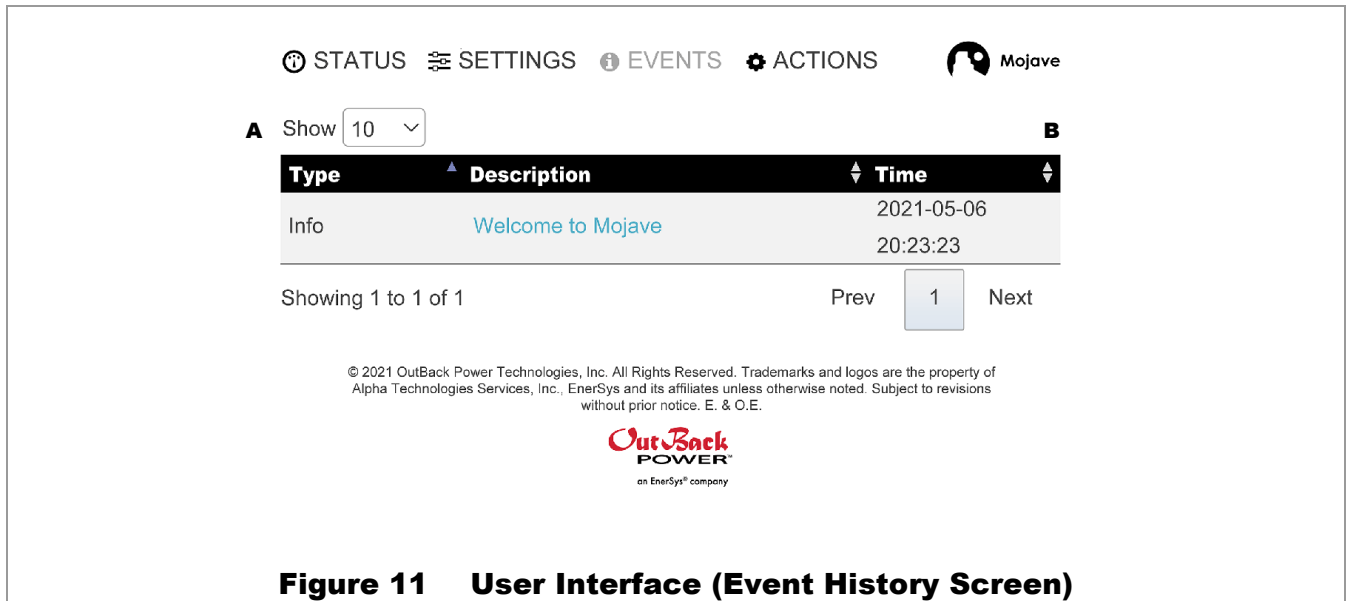

**Figure 11 User Interface (Event History Screen)**



## OPTICS RE

OPTICS RE is the web-based remote monitoring and control application for OutBack Power devices, including the Mojave inverter.

OPTICS RE displays data in three tier levels. The levels are as follows.

- o **Profile:** The entity or person that is the owner of the system.
  - **Site:** A physical location in which the Mojave inverters are installed. Since **Site** information is shared within a **Profile**, most **Profiles** only have one **Site**.
  - ✓ **System:** The installed OutBack Power equipment. Each inverter is treated as a different **System**.

A video tutorial for aggregating multiple **Systems** with OPTICS RE is part of the WattSchool  series of tutorials. OPTICS RE allows **Systems** to be entered as part of the same **Site**, or different **Sites** with other **Profiles**. Note that this product does not support stacking of multiple inverters on the same **System** at this time.

### To set up OPTICS RE:

1. Connect a CAT5 cable to the **NETWORK** port in the Mojave inverter. (See Figure 12 and the *Mojave Inverter/Charger Quick Start Guide* for more information.) 
2. Plug the cable into a router to put the inverter online.

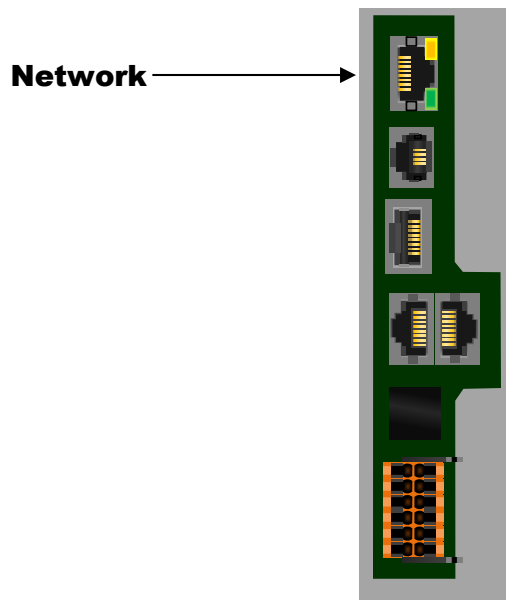

**Figure 12 Network Port**

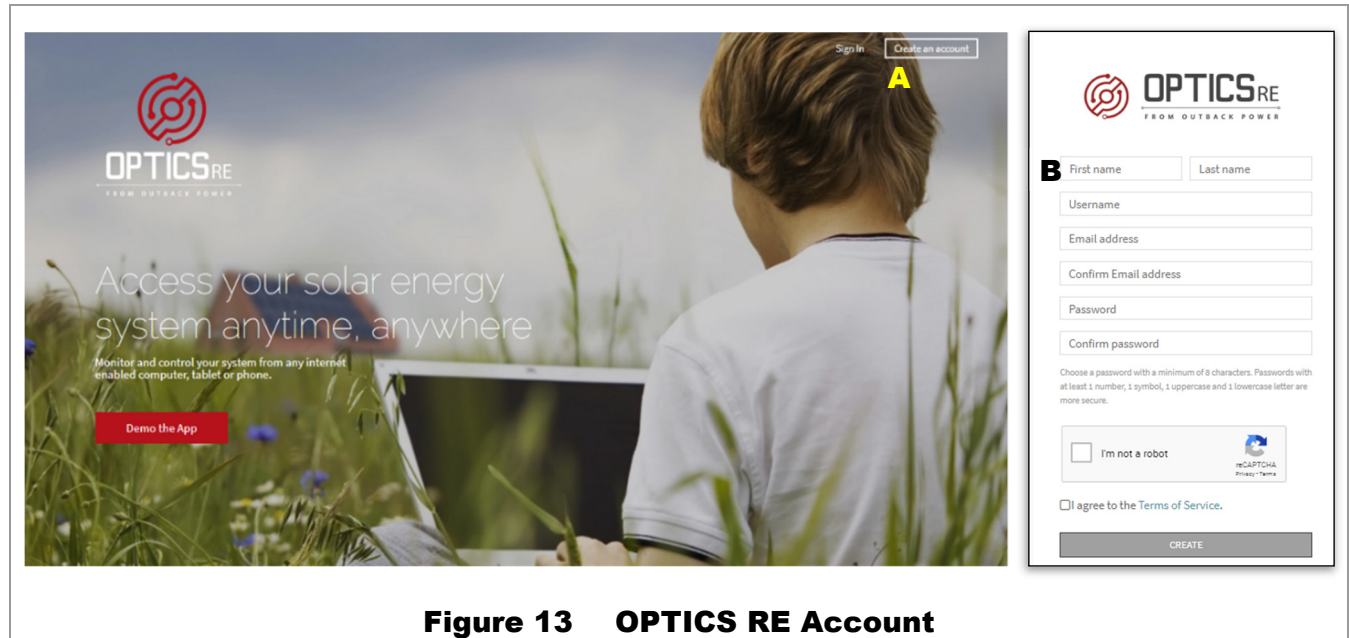

**Figure 13 OPTICS RE Account**

3. Create an account to be able to log in. From [www.opticsre.com](http://www.opticsre.com), click **Create an Account**. See **A** in Figure 13.
4. Fill in the appropriate account information fields. (See **B** in Figure 13.)
  - a. Check the *I'm not a robot* box.
  - b. After reading the terms of service, check the *I agree to the terms of service* box.
  - c. Click the **Create** button at the bottom of the screen.
5. OPTICS RE will send an email to the listed address for verification. Click on the confirmation within the email. Once confirmed, the account will be set up and ready for login.

#### To add a Mojave inverter to a Site:

1. Sign in to OPTICS RE. Note that the following steps require a valid MAC address from page 24.
2. Click on **Add a Profile**.
3. Set the **System Type** as **Mojave**.
4. Enter the MAC address for a Mojave inverter to be added to the **Site**. This unit must be online so that OPTICS RE can recognize it.
5. Select the existing **Profile** to add the selected inverter.
6. Select the existing **Site** to add the selected inverter.
7. Enter a unique **System** name to designate the inverter.
8. Verify device registration.

Once these steps are implemented, OPTICS RE can monitor each **System** on a **Site**. It can deliver aggregated **Site** data (by clicking on a **Profile**) or communicate with individual **System** units for settings, warnings, and errors.



#### **IMPORTANT:**

- ❖ Ensure that the *OpticsRE* status of each inverter shows as **Connected**. See the **Network** tab on page 24.
- ❖ Make certain to record the MAC address for each inverter.





# Operation

## Connections

The Mojave inverter has two sets of AC source connections, which are labeled **GRID** and **GEN**. Two different AC sources can be connected during inverter installation.  1

In addition, it has connections for batteries, which are used both to supply power for operation, and to receive charging. Finally, it has AC **LOAD** terminals. These are used to operate the critical protected loads. They are also used for AC coupling operation. See page 39.



### NOTES:

- ❖ The battery charger uses the same programming and settable limits regardless of which source is used. It does not have independent charger settings on each input.
- ❖ For wiring instructions and more information on terminal hardware, see the *Mojave Inverter/Charger Quick Start Guide*.
- ❖ For more information on inverting, charging, and other functions, see the descriptions of the **Inverter** tab on page 37, the **Grid** tab on page 43, the **Battery** tab on page 49, and the **Generator** tab on page 70.

Each distinct function or operation is accompanied by a symbol representing the inverter and that operation, as shown in Figure 14.

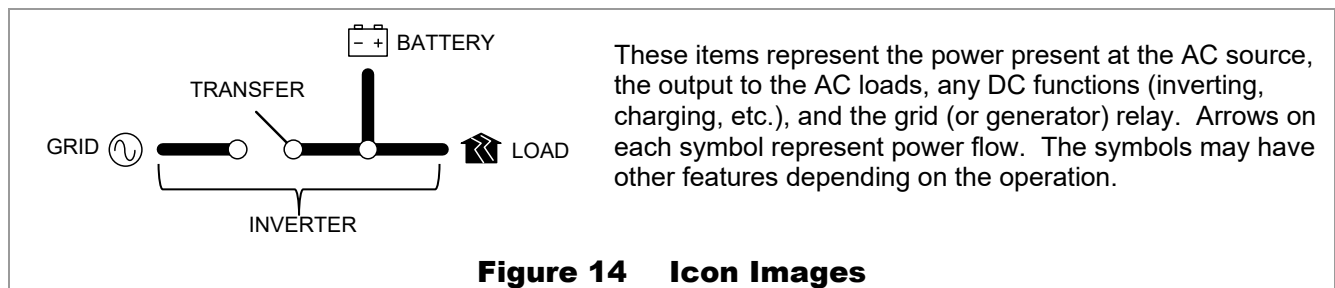

## CT

Normally the Mojave inverter senses AC power at the **GRID** terminals. This point is shown as **B** in Figure 15. Once installed, the current transducers (CTs) will move this sensing point to another location, usually the main grid input **A**. See page 43 to enable the CT.

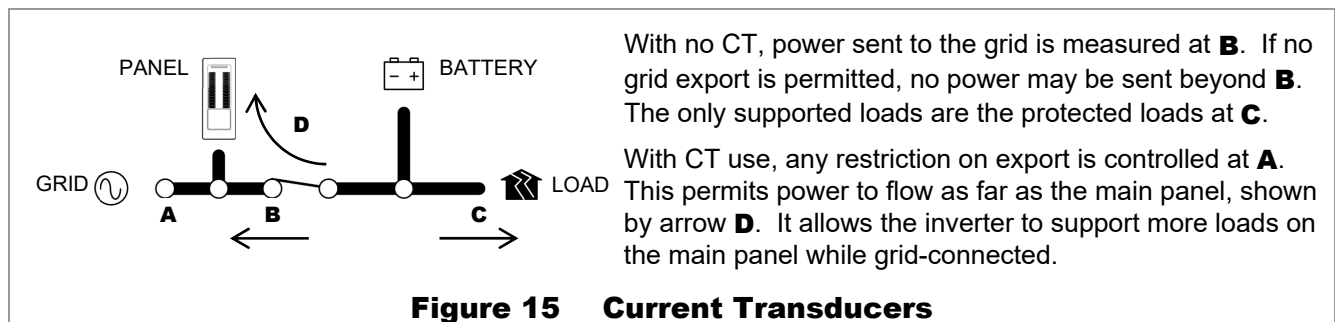

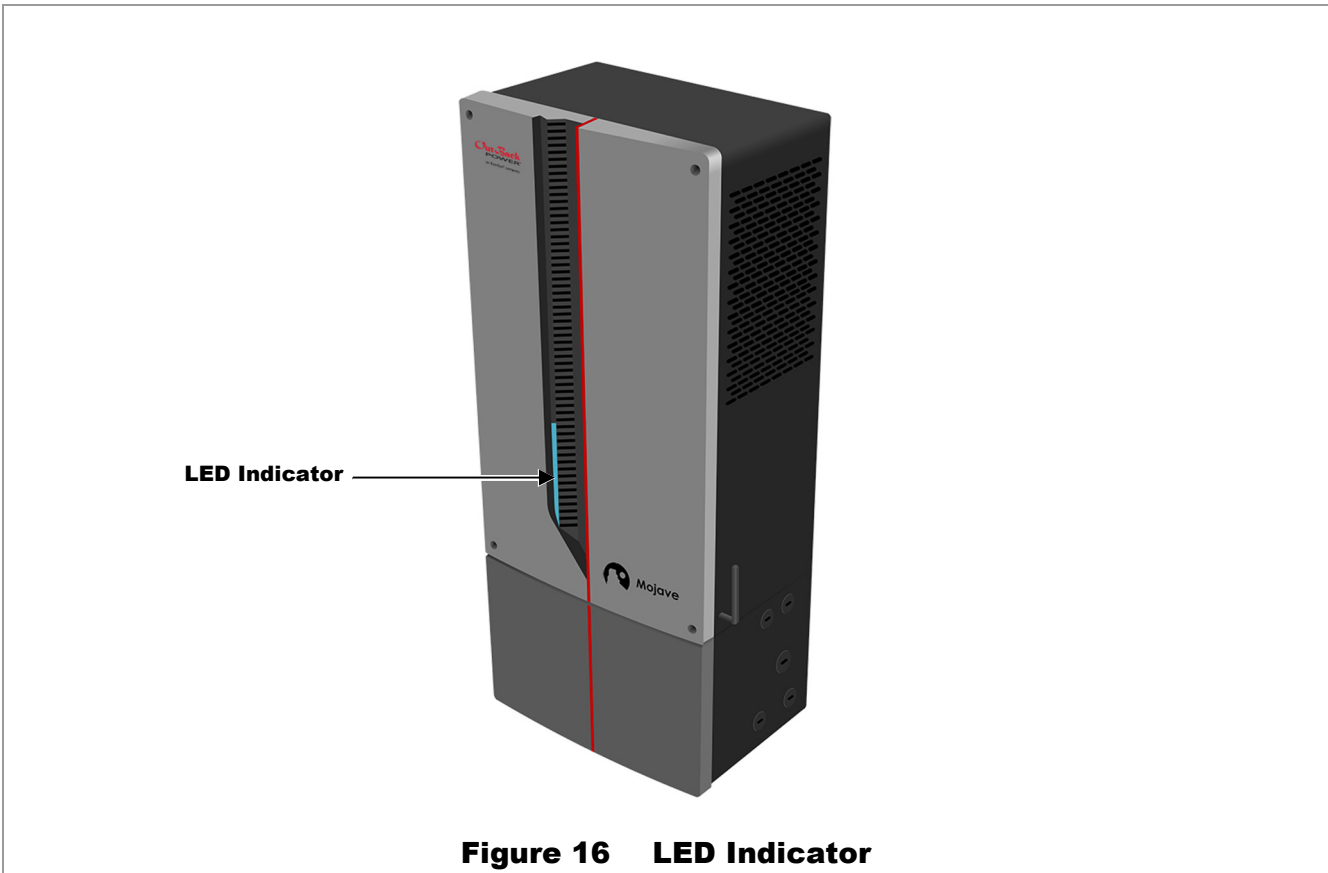

# LED Indicator



**Figure 16 LED Indicator**

The Mojave inverter has a single LED indicator to show states of operation. Additional states may be added in the future, using firmware updates, to reflect new features.

If the inverter indicates a state not shown here, please refer to the firmware release notes.  Alternately, consult an updated revision of this manual from [www.outbackpower.com](http://www.outbackpower.com). 

- o **Blue**
  - Flashing — Powering up. The indicator will also flash blue during a firmware update.
  - Solid — Ready for operation. The Mojave inverter is off.
- o **Green**
  - Solid — The Mojave inverter is operating. Any number of functions may be active. See page 15.
- o **Yellow**
  - Flashing — An error threshold was exceeded. An error shutdown may be about to happen.
  - Solid — Inverter has been turned off, but is transferring power from grid to loads.
- o **Red**
  - Solid — Error shutdown. See the **EVENTS** view on page 27 for error messages. See **Troubleshooting** on page 79 to investigate.
- o **Alternating Red and Green**
  - Flashing — AC source problem (grid or generator). The inverter has disconnected from the source. See **Troubleshooting** on page 79 to investigate problems.



# Description of Inverter Operations

Most of the operations and functions can be programmed from the user interface **SETTINGS** view. This allows customization or fine tuning of inverter performance. Some of the inverter’s operations occur automatically. Others are conditional or must be enabled manually before they will operate.

This section is organized using the six tabs available under the **SETTINGS** view: **Inverter**, **Grid**, **Generator**, **Battery**, **Network**, and **Admin**. These may not be in the same order as shown here.

Each section shows the settable items available under each tab. Following the list of items is a description of the related inverter functions.

Some of the items in this section are functions which can be manually selected, enabled, or customized. Other items are general topics or applications for the inverter. Any of these items may need to be adjusted so that the inverter is best matched to a particular application. The operator should review these items to see which are applicable.

## SETTINGS View

The six selections under the **SETTINGS** view (tabs) are described beginning below. Each tab has different options. This view does not include the inverter’s operating graphics. Instead, each of the following **Tab** topics shows the settable items available under each tab. Following the list of items is a description of the related inverter functions.

- o After making any changes under a tab, press **Submit** to send the changes to the system.
- o Select **Reset** to return that tab’s values to factory default settings. Press **Submit** to finalize the **Reset**.
- o Press **Help** to restart the “walk-through” overlay for that tab. (See page 13).

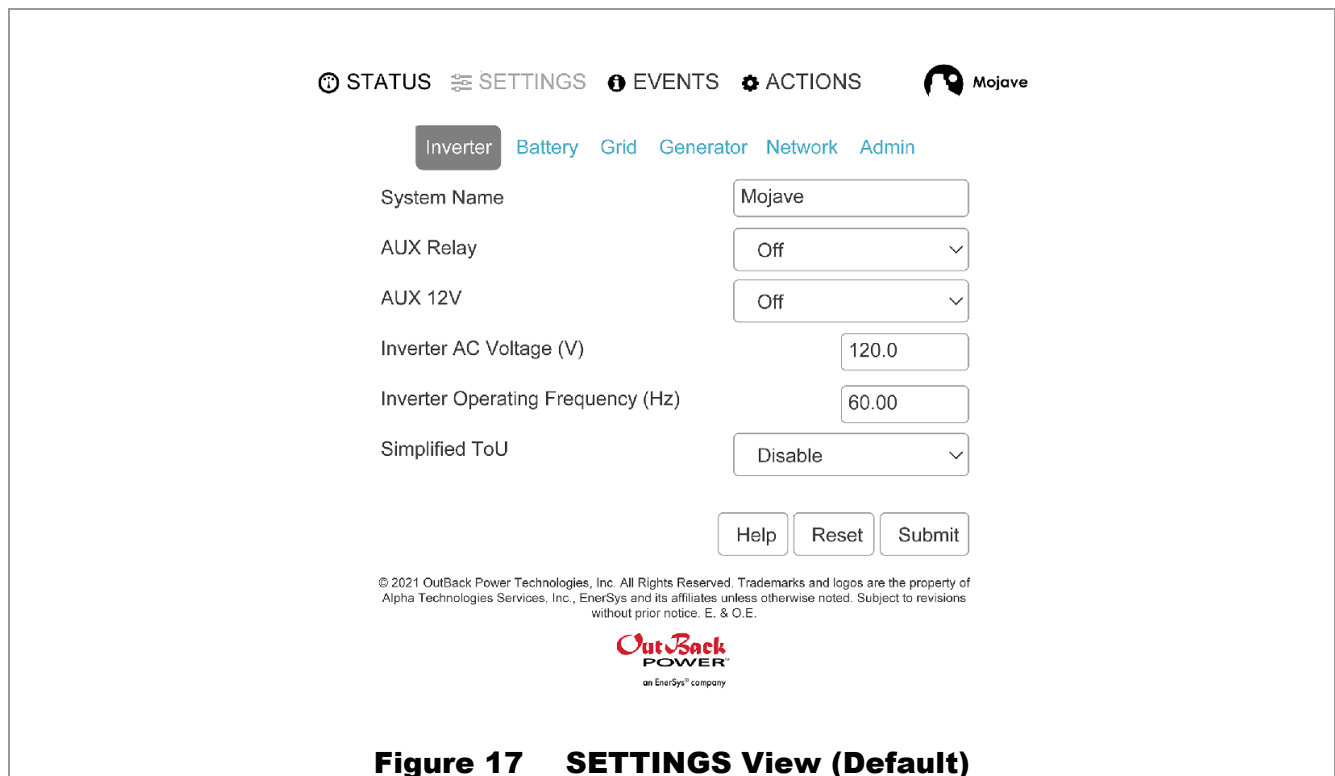

**Figure 17 SETTINGS View (Default)**

## Admin Tab

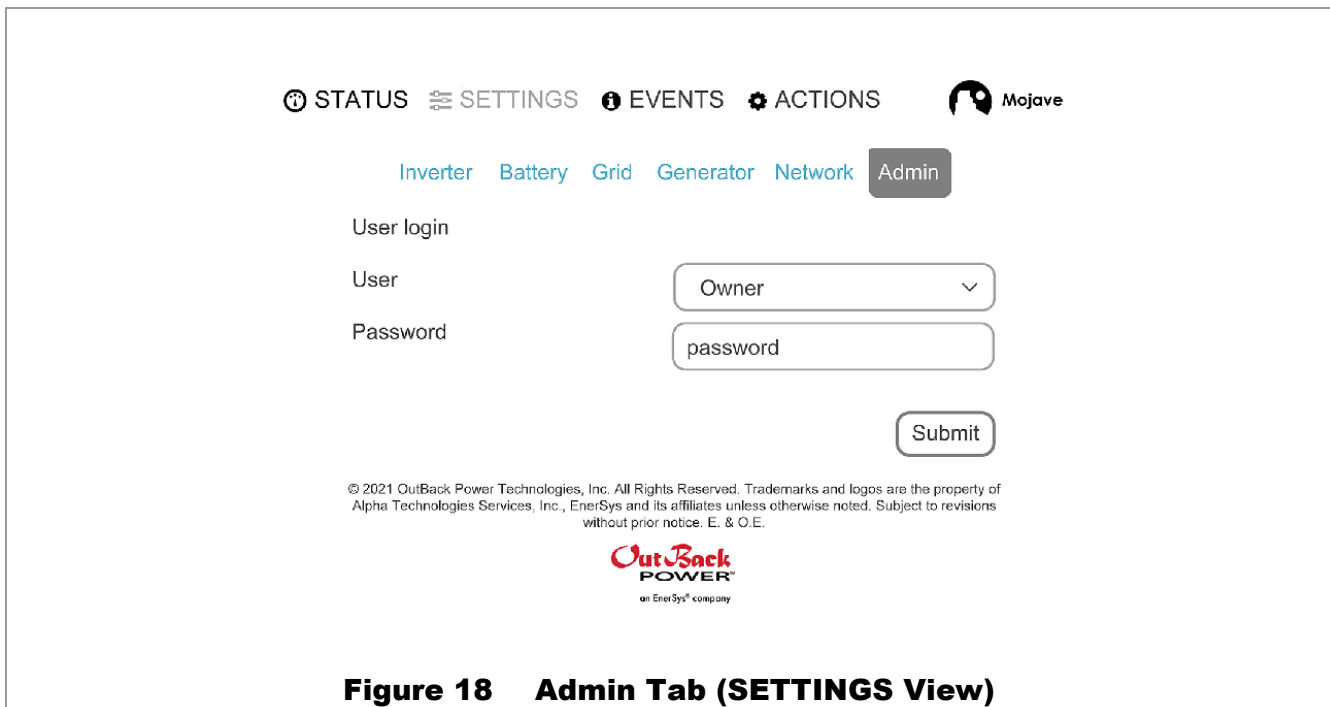

**Figure 18 Admin Tab (SETTINGS View)**

The page displayed by this tab allows login for greater access to settings. To log in, select the **User** level, enter the **Password**, and press **Submit**. (See Figure 18.)

**UserName** — Range: **Owner, Installer, Admin**.  
Default: **Owner**.

This item selects the access level for settings. These passwords are also used for initial UI login as described on page 13.

- o The **Owner** settings allow changes to items under the **Network, Inverter, Battery, or Generator** tabs.
- o The **Installer** settings can change the grid-protection settings under the **Grid** tab.
- o The **Admin** selection is reserved for future use.

**Password** — The default password is the same in all three cases. It consists of the last eight digits of the inverter's serial number. For example, in a unit with the serial number OGH12107E0100236, the default password would be E0100236. The serial number can be found on a label directly beneath the wi-fi antenna as shown in Figure 19.

After installation, it is recommended that all passwords be changed for security.

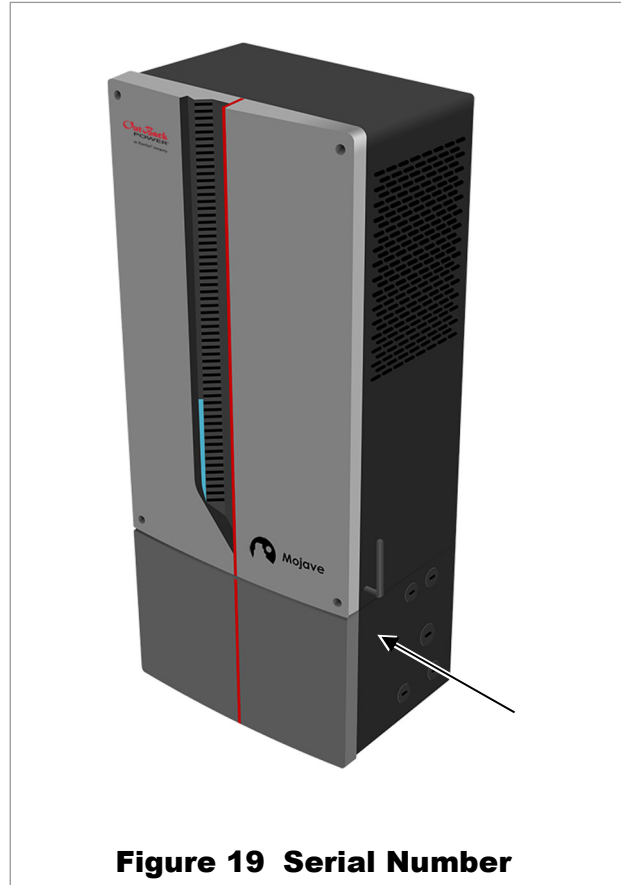

After the initial login, the screen will change as shown in Figure 20. Three new options are offered.

## Change Password

This item will change the password for the current access level.

Enter the new password under **New**, then re-enter the new password under **Confirm**. Press **Submit**.

## Reset

When an invalid password is entered, a **Reset** button is displayed. If the password is lost or forgotten, press the **Reset** button to reset the password. Additional instructions will appear.

## Historical Data

This item allows download of a .csv file to review system data.

Enter the date range under **From** and **To** (two-digit month, two-digit day, four-digit year). Press **Download**.

## Firmware Update

This item shows the last version of firmware to be installed. It also shows the newest downloaded version. To update to the newest version, press **Install**.

If an upgrade file is located elsewhere on the computer or device, press **Choose File** to locate and download it.

To log out, press **Logout**.

STATUS SETTINGS EVENTS ACTIONS Mojave

Inverter Battery Grid Generator Network Admin

Logout

Change Password:

New

Confirm

Submit

Historical Data (csv)

From:

To:

Download

Firmware Update:

Installed Version: 1.0.0

Available Version: 1.0.1

Use "Install" button to install the downloaded update, or select an update file from your desktop or mobile device.

Choose File No file chosen

NOTE: The inverter will drop protected loads while updating the firmware. Please verify it is OK to do so before proceeding.

Install

[Open Source License Information](#)

© 2021 OutBack Power Technologies, Inc. All Rights Reserved. Trademarks and logos are the property of Alpha Technologies Services, Inc., EnerSys and its affiliates unless otherwise noted. Subject to revisions without prior notice: E. & O.E.

**OutBack POWER**  
an EnerSys® company

**Figure 20 After Login**

## Network Tab

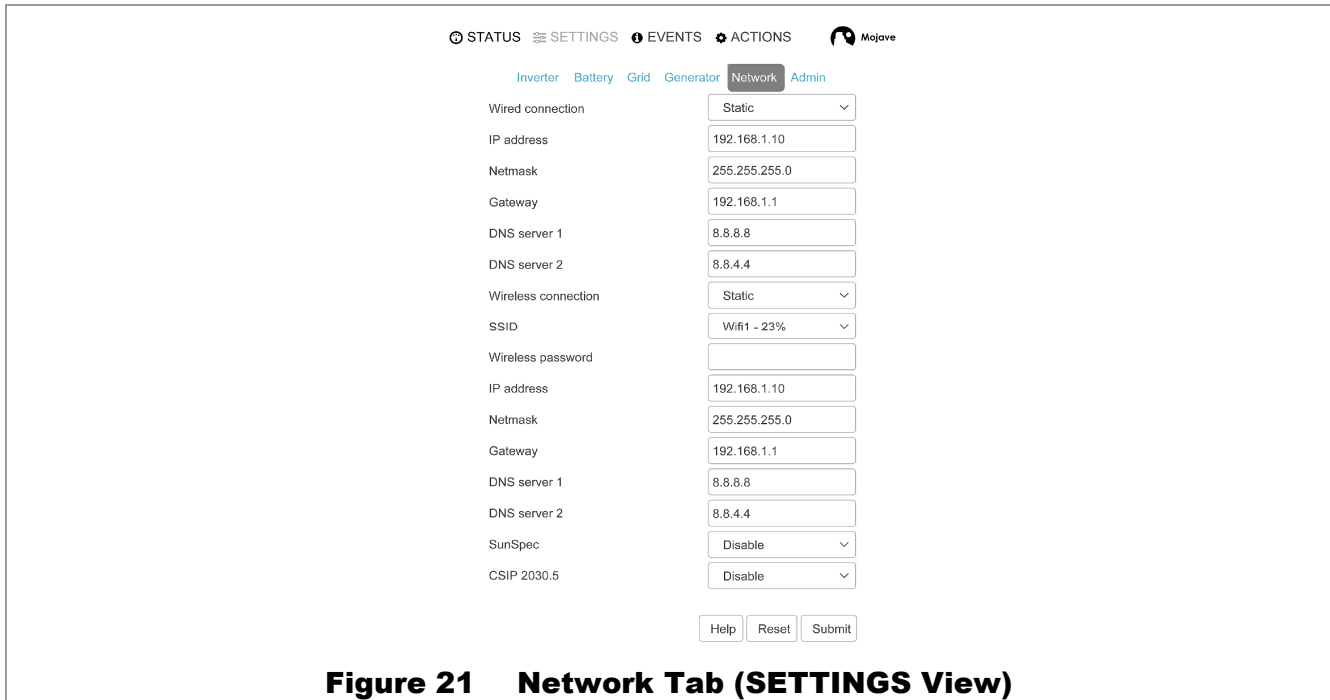

**Figure 21 Network Tab (SETTINGS View)**

The items under this tab allow connection to a personal computer or network (wired or wireless). If DHCP is used with a network device such as router, modem, or switch, then many of these values will be assigned from the network device. If the local area network does not use DHCP, **Static** should be selected. The values in each field must then be set manually.

When DHCP is selected, the configuration elements are provided by the router and cannot be configured here. These items will not appear onscreen. They can be viewed on page 24.

- o **Wired\_Connection** — Range: **Disabled, DHCP, or Static**. Default: **Static**
- o **IP address** —Default: 192.168.1.10 (DHCP will auto-populate this item.)
- o **Netmask** — Default: 255.255.255.0 (DHCP will auto-populate this item.)
- o **Gateway** — Default: 192.168.1.1 (DHCP will auto-populate this item.)
- o **DNS server 1 and 2** — The first and second domain name servers (DHCP will auto-populate these items.) If a static network is used, these items are available from the service provider.
- o **Wireless\_Connection** — Range: **Disabled, DHCP, or Static**. Default: **DHCP**
- o **SSID** — The names and signal strength (in percentage) of any available wireless networks.
- o **Wireless\_Password** — The password for the selected wireless network.
- o **IP address** — Default: 192.168.1.11 (DHCP will auto-populate this item.)
- o **Netmask** — Default: 255.255.255.0 (DHCP will auto-populate this item.)
- o **Gateway** — Default: 192.168.1.1 (DHCP will auto-populate this item.)
- o **DNS server 1 and 2** — The first and second domain name servers (DHCP will auto-populate these items.) If a static network is used, these items are available from the service provider.
- o **SunSpec** — Range: **Disabled or Enabled**. Default: **Disabled**
- o **SunSpec port**

These items activate a remote control interface that is accessed using third-party software. See [www.sunspec.org](http://www.sunspec.org) for more information.

- o **CSIP 2030.5** — Displays a series of elements to be configured by the utility company when required.

## Inverter Tab

The items under this tab affect many of the Mojave inverter's basic functions. Interactions with utility grid, generator, and battery charging are set under other tabs.

The items presented here are described on the designated pages. They may not appear in the same order as shown below.

**NOTE:** Although **SYSTEM TIME** on page 15 uses a 24-hour clock format, settable times of day in this menu are formatted using a 12-hour clock.

- o **System Name** — This item is user-settable and provides an easy identifier to the system. A unique name can be assigned with up to 60 characters.
- o **AUX Relay** — Range: **Off, On, AGS, or Rapid Shutdown**. Default: **Off**  
These are dry contacts that can serve as a switch for the AGS function. It can also serve to set off an indicator or alarm for the rapid shutdown function. See pages 42 and 74.
- o **AUX 12V** — Range: **Off, On, AGS, or Rapid Shutdown**. Default: **Off**  
This is a 12-volt output that can drive a relay to activate the AGS function. It can also serve to set off an indicator or alarm for the rapid shutdown function. See pages 42 and 74.
- o **Inverter AC Voltage (V)** — Range: **0 to 148**. Default: **120**  
In off-grid usage, the inverter's output voltage can be adjusted for unique applications or devices. This does not affect the voltage transferred from an AC source. See pages 38, 46, and 73.
- o **Inverter Operating Frequency (Hz)** — Range: **55 to 66**. Default: **60**  
In off-grid usage, the inverter's operating frequency can be adjusted for unique applications or devices. This does not affect the frequency transferred from an AC source. See pages 38, 46, and 73.
- o **Simplified ToU** — Range: **Disabled or Enabled**. Default: **Disabled**  
This enables Time of Use operation. When the cost of grid energy exceeds the cost of battery energy, the inverter displaces grid use with battery energy. See page 40.  
When **Simplified ToU** is set to **Enabled**, the items below will appear. These items will not appear on the screen, nor will they function, if it is set to **Disabled**.
- o **Peak rate period** — Range: **Disabled, Weekdays, Weekends, or Daily**. Default: **Weekdays**
- o **Start time** — Range: **12:00 AM to 11:59 PM**. Default: **04:00 PM**
- o **Stop time** — Range: **12:00 AM to 11:59 PM**. Default: **09:00 PM**
- o **Peak rate period** — Range: **Disabled, Weekdays, Weekends, or Daily**. Default: **Disabled**
- o **Start time** — Range: **12:00 AM to 11:59 PM**. Default: **12:00 AM**
- o **Stop time** — Range: **12:00 AM to 11:59 PM**. Default: **12:00 AM**
- o **Peak rate period** — Range: **Disabled, Weekdays, Weekends, or Daily**. Default: **Disabled**
- o **Start time** — Range: **12:00 AM to 11:59 PM**. Default: **12:00 AM**
- o **Stop time** — Range: **12:00 AM to 11:59 PM**. Default: **12:00 AM**
- o **Peak rate period** — Range: **Disabled, Weekdays, Weekends, or Daily**. Default: **Disabled**
- o **Start time** — Range: **12:00 AM to 11:59 PM**. Default: **12:00 AM**
- o **Stop time** — Range: **12:00 AM to 11:59 PM**. Default: **12:00 AM**

## Inverting

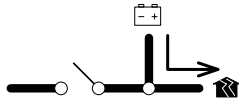

This is the Mojave inverter's primary function. The inverter converts DC voltage from batteries into AC voltage that is usable by AC loads. It will continue to do this as long as the batteries have sufficient energy.

The inverter's design uses a transformer and high-frequency H-Bridge FET modules to achieve the required high-wattage output. It can deliver the rated wattage continuously at 25°C. The maximum output is derated at temperatures exceeding 40°C. See page 102 for worst-case derated output.

Calculate the total load wattage so that it does not exceed the inverter's capacity. When excessive load is applied, the inverter's output current will be limited and the voltage waveform may be distorted. If enough overload occurs, its output voltage will drop low enough that it will shut down with an undervoltage error (displayed under the **EVENTS** view and the **Inverter** tab under the **STATUS** view).



### IMPORTANT:

- ❖ The Mojave inverter cannot support severe output load imbalance. It can maintain a load difference of no more than 4.2 kVA continuously between the L1 or L2 output (a neutral current exceeding 35 Aac). For example, it cannot maintain the inverter's full output of 8 kVA on L1, even if the load on L2 is 0.  
Neutral currents exceeding 35 Aac will be current-limited (similar to an excessive load) and may result in undervoltage.
- ❖ The Mojave inverter requires batteries within normal voltage range (approximately 46 to 60 Vdc) for normal operation. No other DC sources are supported for this product.



### CAUTION: Equipment Damage

Do not substitute other DC sources in place of the batteries. High or irregular voltages may damage the inverter.

## AC Voltage

The Mojave inverter's nominal voltage is 120/240 Vac (split-phase), consisting of 120 Vac on L1 and L2. The **Inverter AC Voltage (V)** set point can adjust the output voltage for off-grid operation in applications that require a more specific nominal voltage.

The **Inverter AC Voltage (V)** adjustment is applied to both single-phase output voltages on the **LOAD L1** and **L2** terminals (with respect to neutral). For example, if **Inverter AC Voltage (V)** is set to a value of **125**, both the L1 and L2 outputs will read 125 Vac. The total output voltage will become 250 Vac.

## AC Frequency

The Mojave inverter's nominal frequency is 60 Hz. The **Inverter Operating Frequency (Hz)** set point can adjust the output frequency for off-grid operation in applications that require a more specific nominal frequency.



### NOTES:

- ❖ The Mojave inverter only supports split-phase systems where the center-tap neutral is a grounded conductor. It cannot support 230 Vac (single-phase) loads or power systems. It cannot support three-phase loads or power systems, or any system where L1 and L2 are unbalanced by more than 5% in voltage.
- ❖ The Mojave inverter cannot support 50 Hz loads or power systems.

## AC Coupling

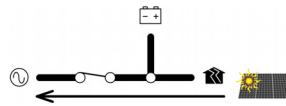

### NOTE:

This function is performed automatically when the conditions are met as described below. It has no adjustable settings.

Many inverter products are “grid-direct” (GD), converting PV power to AC power and sending it directly to the utility grid without the use of batteries. These products have no backup capability.

In systems with an existing GD inverter, the Mojave inverter can be added to “couple” the battery backup ability to the grid-tied AC system.

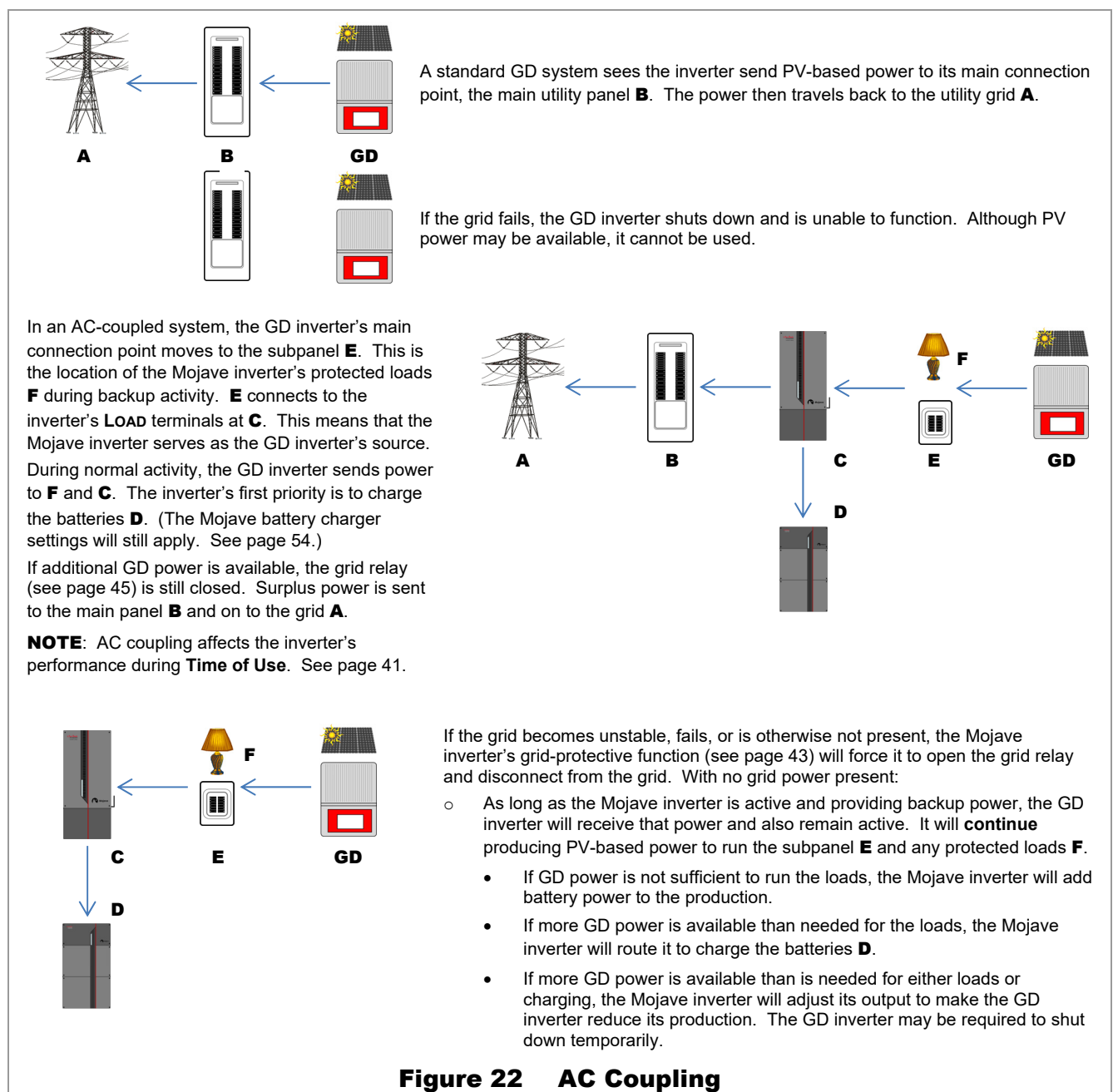

**Figure 22 AC Coupling**

## Time of Use (ToU)

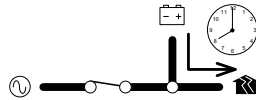

The Mojave inverter can choose to run the protected loads using either grid or battery power based on day and time. This permits the system to take advantage of varying utility rates. ToU in this inverter is referred to as “simplified”. It is less complex than similar functions in other products, which may require the entry of specific utility rates and the like. It does, however, require the user to know when the most and least advantageous billing rates are in effect.

The settable time blocks are to designate periods when the inverter ceases importing grid power and switches to battery use. This is most effective if used when utility rates are highest. The term “time of use” refers to use of battery power, not grid power.

This function should be set to activate during the time(s) of day when peak utility rates are in effect.

The ToU function is activated by setting **Simplified ToU** to **Enable**. Four ToU blocks are available. Each has the following settable items.

- o **Peak rate period**
- o **Start time**
- o **Stop time**

**Peak rate period** has four options.

- **Disable** prevents ToU from using this time block.
- **Weekdays** utilizes ToU during this time block, Monday through Friday only.
- The first **Weekdays** block is preset to operate between 4 PM and 9 PM, as this is the most common peak rate period.
- **Weekends** utilizes ToU during this time block, Saturday and Sunday only.
- **Daily** utilizes ToU during this time block every day.

**Start time** and **Stop time** begin and end the time period for use of battery power.

The screenshot shows a configuration interface for the Time of Use (ToU) function. It features four distinct time blocks. Each block has a dropdown menu for the 'Peak rate period' (options: Enable, Weekdays, Disable) and two time selection fields for 'Start time' and 'Stop time'. The first block is pre-configured with 'Weekdays' and a peak period of 04:00 PM to 09:00 PM. The other three blocks are set to 'Disable' with a peak period of 12:00 AM. At the bottom of the interface are 'Help', 'Reset', and 'Submit' buttons.

**Figure 23 Time of Use**



### IMPORTANT:

- ❖ If the batteries reach either the **Min SoC (%)** set point or the **LBCO** set point before reaching **Stop time**, the inverter will revert to using grid power. This avoids over-discharge of the batteries.
- ❖ The above items, as well as the size of the battery bank and the protected loads, should be arranged for the most effective operation of the system. Undersized batteries, oversized loads, or inappropriate settings could cause the system to revert to grid power long before expected.



### NOTES:

- ❖ This function is not a timed connection or disconnection from the grid. The grid relay does not open. See **Grid Relay** on page 45.
- ❖ This function may be used in conjunction with AC Coupling. See pages 39 and 41.

The choice to use the ToU function should depend on utility rates and individual factors, including the cost effectiveness of recharging the battery during off-peak periods.

- It may only be feasible to use battery power at a fixed time every day (the **DAILY** option).
- For greater flexibility, separate times may be set up for **WEEKDAY** and **WEEKEND** use.
- Note that other settings such as **Import limit** will be in effect regardless of peak times. See page 43.





AC coupling (see page 39) may be used with ToU. In the example shown in Figure 24, the Mojave inverter is used in conjunction with a GD inverter (with a PV array) on the protected loads panel.

The utility company's peak rate occurs between 5 PM and 8 PM. The user sets **Simplified ToU** to **Enable**. The first **Peak rate period** block remains on **Weekdays**, but the **Start time** is changed to **05:00 PM**. The **Stop time** is changed to **08:00 PM**. The system proceeds to operate.

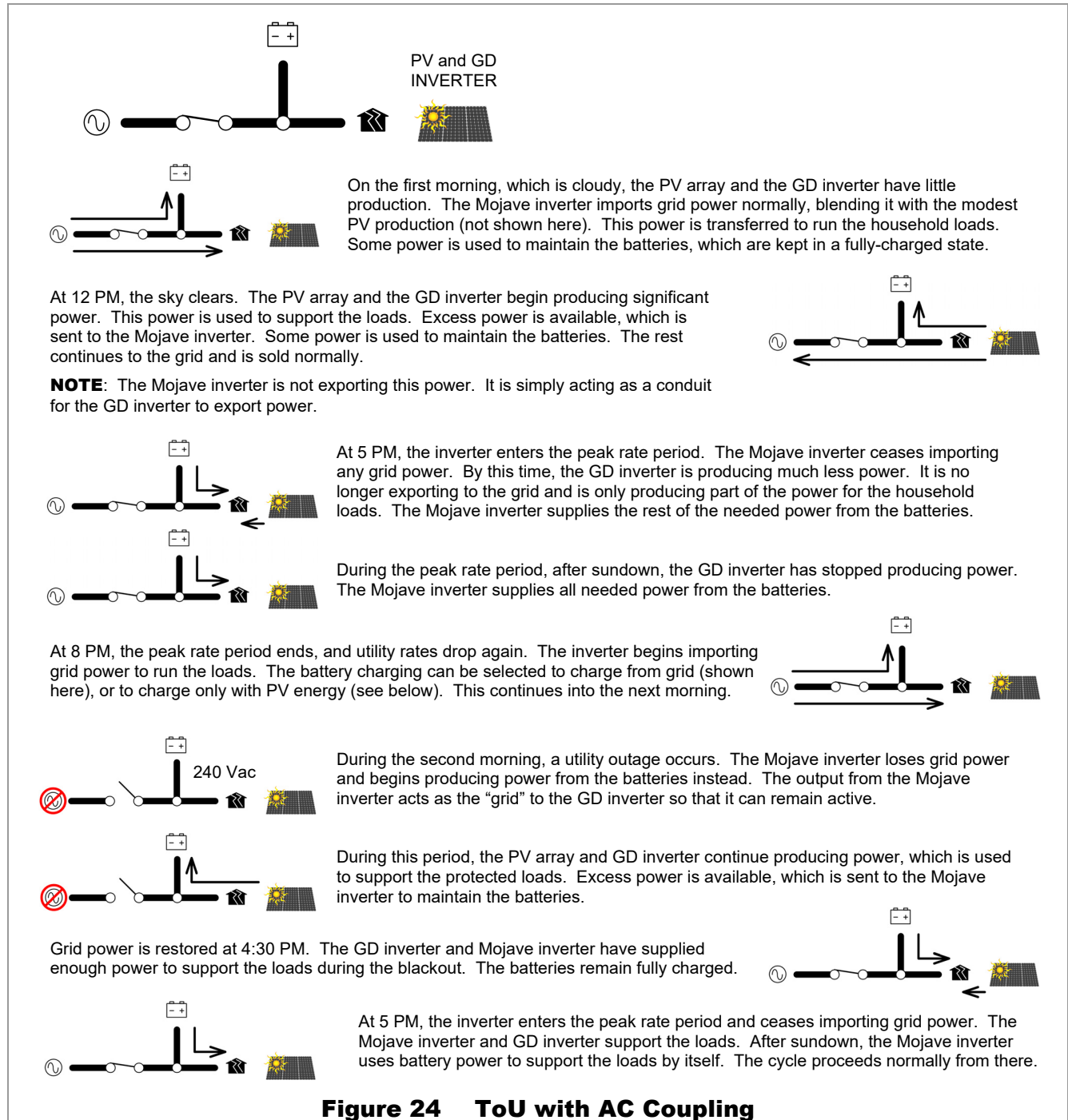
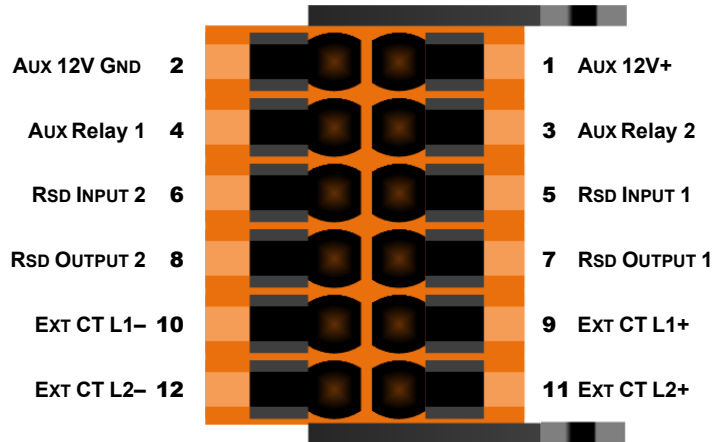

**Figure 24 ToU with AC Coupling**

For illustrations of the respective flow of power between grid, each inverter, and batteries, see the explanation of AC coupling on page 39. For specific examples of utility rates as well as a highly detailed description of AC coupling, see the applications note *AC Coupling with Time of Use (ToU) using the Mojave Inverter*. 6

## Rapid Shutdown (RSD)

In an emergency, a responder may need to quickly place the system in a de-energized state. The auxiliary (**AUX**) terminal block has terminals designed to receive signals from OutBack Power's RSI (Rapid Shutdown Initiator) or a similar rapid shutdown device.



**Figure 25 AUX terminals**

Terminals **5** and **6** are used for the rapid shutdown function. These terminals can receive rapid shutdown (RSD) commands to quickly shut down the Mojave inverter. The terminals detect electrical continuity, which is present while the RSD contacts remain closed. If a rapid shutdown event occurs (an RSD switch is opened), these contacts will open. The circuit will detect the loss of continuity and the inverter will shut down. The inverting function will not operate. The inverter will not accept power from AC sources, and consequently cannot transfer power or charge batteries.

Any initiator device with normally-closed contacts can work with this function. If more than one device is used, all contacts must be wired in series so that any device will shut down the inverter.

If a rapid-shutdown device is not installed, this function should be disabled. This is performed by directly shorting terminals **5** and **6** with a small wire. A jumper is installed at the factory for this purpose.



### IMPORTANT:

- ❖ A jumper is factory-installed on terminals **5** and **6**. It may need to be removed if another device is installed.
- ❖ The inverter will not function unless the jumper, the RSI, or a similar normally-closed device is installed. Initial power-up will result in a Rapid Shutdown signal.

The **AUX 12V** connections (terminals **1** and **2**) or **AUX Relay** connections (terminals **3** and **4**) can activate an alarm in response to a rapid shutdown. The **AUX 12V** or **AUX Relay** menu item should be set to **Rapid Shutdown**.

It is most common for the rapid shutdown function to be implemented separately in the GD inverter. If the GD inverter has terminals for an external connection (“daisy-chaining”), they can be connected to terminals **5** and **6** to cause rapid shutdown in the Mojave inverter. If another external device requires rapid shutdown, the RSD output on terminals **7** and **8** can be used.

Note that in AC coupling applications (see page 39), a GD inverter may require the RSD function.

## Grid Tab

The items under this tab affect the Mojave inverter’s interactions with the utility grid.

The items presented here are described on the designated pages. They may not appear in the same order as shown below.

- o **Grid Profile** — Range: **IEEE 1547-2003, IEEE 1547-2018, CA Rule 21, CA Rule 21 2022, HECO 14H, ISO NE, PREPA**. Default: **IEEE 1547-2003**  
Also known as a grid interconnection profile, this is the code or utility company regulation which specifies a series of preloaded settings.
- o **External CT** — Range: **Disabled** or **Enabled**. Default: **Enabled**
- o The default reading of utility grid current would take place at the **GRID** terminals. Once installed, the current transducer (CT) adds an external location for current sensing. See page 31 (earlier) for a simplified description of placement and operation. See the *Quick Start Guide* for wiring instructions.  
When this is set to **Enabled**, the items below will change to **Export limit at external CT** and **Import limit at external CT** to reflect the new monitoring locations.
- o **Export limit (W)** — Reserved for future use.
- o **Import limit (W)** — Range: **48000** to **0**. Default: **48000**
- o **Charge from grid limit (W)** — Range: **13200** to **0**. Default: **7860**

## Grid Protection Settings

The items below this point are a series of protective settings required by various regulations or utility companies for interconnection.

Not all items are available with all **Grid Profiles**. The settings shown are for the **IEEE 1547-2003** profile. Certified ranges are only shown when they differ from the maximum range.



### IMPORTANT:

- ❖ For the configurations of other If the preconfigured **Grid Profile** items do not apply, each setting can be customized.
- ❖ Changing these settings requires **Installer** login as shown under the **Admin** tab on page 34. These settings should not be changed unless explicitly instructed by the utility company or the appropriate authorities.
- ❖ For the configuration of **Grid Profile** items other than the settings of IEEE 1547-2003, see Table 9 and Table 10 beginning on page 104.

- |  |   |                       |
|--|---|-----------------------|
| o <b>LV1 voltage (pu)</b> — Range: <b>0</b> to <b>0.98</b>   | Certified Range: <b>0.5</b> to <b>0.95</b>  | Default: <b>0.880</b> |
| o <b>LV1 time (s)</b> — Range: <b>0.08</b> to <b>50</b>      | Certified Range: <b>0.1</b> to <b>50</b>    | Default: <b>2.00</b>  |
| o <b>LV2 voltage (pu)</b> — Range: <b>0</b> to <b>0.98</b>   | Certified Range: <b>0.25</b> to <b>0.70</b> | Default: <b>0.500</b> |
| o <b>LV2 time (s)</b> — Range: <b>0.08</b> to <b>50</b>      | Certified Range: <b>0.1</b> to <b>50</b>    | Default: <b>0.16</b>  |
| o <b>HV1 voltage (pu)</b> — Range: <b>1.02</b> to <b>1.2</b> | Certified Range: <b>1.05</b> to <b>1.2</b>  | Default: <b>1.100</b> |
| o <b>HV1 time (s)</b> — Range: <b>0.08</b> to <b>13</b>      | Certified Range: <b>0.1</b> to <b>13</b>    | Default: <b>1.00</b>  |
| o <b>HV2 voltage (pu)</b> — Range: <b>1.02</b> to <b>1.2</b> | Certified Range: <b>1.05</b> to <b>1.2</b>  | Default: <b>1.200</b> |
| o <b>HV2 time (s)</b> — Range: <b>0.08</b> to <b>13</b>      | Certified Range: <b>0.1</b> to <b>13</b>    | Default: <b>0.16</b>  |
| o <b>LF1 Hz (Hz)</b> — Range: <b>50</b> to <b>59.98</b>      | Certified Range: <b>50</b> to <b>59.9</b>   | Default: <b>59.3</b>  |
| o <b>LF1 time (s)</b> — Range: <b>0.16</b> to <b>1000</b>    | Certified Range: <b>0.16</b> to <b>1000</b> | Default: <b>0.16</b>  |
| o <b>LF2 Hz (Hz)</b> — Range: <b>50</b> to <b>59.98</b>      | Certified Range: <b>50</b> to <b>59.9</b>   | Default: <b>57.00</b> |
| o <b>LF2 time (s)</b> — Range: <b>0.16</b> to <b>1000</b>    | Certified Range: <b>0.16</b> to <b>1000</b> | Default: <b>0.16</b>  |

## Operation

o <b>HF1 Hz (Hz)</b> — Range: <b>60.02</b> to <b>66</b>	Certified Range: <b>60.1</b> to <b>66</b>	Default: <b>60.50</b>
o <b>HF1 time (s)</b> — Range: <b>0.16</b> to <b>1000</b>	Certified Range: <b>0.16</b> to <b>1000</b>	Default: <b>0.16</b>
o <b>Enter service</b> — Range: <b>Disabled</b> or <b>Enabled</b>		Default: <b>Enabled</b>
o <b>Enter service HV (pu)</b> — Range: <b>0.88</b> to <b>1.1</b>		Default: <b>1.050</b>
o <b>Enter service LV (pu)</b> — Range: <b>0.88</b> to <b>1.1</b>		Default: <b>0.917</b>
o <b>Enter service HF (Hz)</b> — Range: <b>55</b> to <b>66</b>		Default: <b>60.10</b>
o <b>Enter service LF (Hz)</b> — Range: <b>55</b> to <b>66</b>		Default: <b>59.50</b>
o <b>Enter service delay (s)</b> — Range: <b>0</b> to <b>1600</b>		Default: <b>300</b>
o <b>Random delay (s)</b> — Range: <b>0</b> to <b>1000</b>		Default: <b>0</b>
o <b>Enter service ramp time (s)</b> — Range: <b>0</b> to <b>1000</b>		Default: <b>300</b>
o <b>PF export</b> — Range: <b>Disabled</b> or <b>Enabled</b>		Default: <b>Disabled</b>
o <b>PF import</b> — Range: <b>Disabled</b> or <b>Enabled</b>		Default: <b>Disabled</b>
o <b>Export limit</b> — Range: <b>Disabled</b> or <b>Enabled</b>		Default: <b>Disabled</b>
o <b>Export limit (pu)</b> — Range: <b>0</b> to <b>1</b>		Default: <b>1.000</b>
o <b>Constant Vars</b> — Range: <b>Disabled</b> or <b>Enabled</b>		Default: <b>Disabled</b>
o <b>Constant Vars setpoint (pu)</b> — Range: <b>-1</b> to <b>1</b>		Default: <b>0.000</b>
o <b>Export ramp (pu/s)</b> — Range: <b>0.01</b> to <b>1</b>		Default: <b>1.000</b>
o <b>PF export setpoint (pu)</b> — Range: <b>0.4</b> to <b>1</b>		Default: <b>1.000</b>
o <b>PF import setpoint (pu)</b> — Range: <b>0.4</b> to <b>1</b>		Default: <b>1.000</b>

## Grid Input

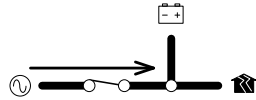

When the Mojave inverter's **GRID** terminals are connected to a grid-quality AC source and the **Grid Input** command is set to **Use**, the inverter will synchronize itself with the grid source and connect to it. Its grid relay will engage, linking the **GRID** terminals directly with the **LOAD**. (See page 46.) It can also use the grid to charge batteries. (See below; also, see **Battery Charging** on page 53.)

## Charging from the Grid

This product will not import grid power to charge batteries under all conditions. It will not charge from the grid if any of the following conditions are true:

- o **Grid Input** is set to **Drop** in the **ACTIONS** view.
- o **Inverter** is set to **Off** in the **ACTIONS** view. If **Grid Input** is set to **Use**, the inverter will transfer power to loads, but it will not charge batteries while the inverting function is off.
- o **Charge from grid limit (W)** is set to **0** under the **Grid** tab (**SETTINGS** view)
- o **Max Charge Current (A)** is set to **0** under the **Battery** tab (**SETTINGS** view)
- o **Simplified ToU** is enabled and the inverter enters any of the **Peak Rate Period** time settings under the **Inverter** tab (**SETTINGS** view)

The inverter will restrict charging from the grid if any of the following conditions are true:

- o **Charge from grid limit (W)** is set to a low number
- o **Max charge current (A)** is set to a low number
- o AC-coupled power, supplied by a GD inverter, is supplying most or all of the charging needs

## Grid Protection Parameters

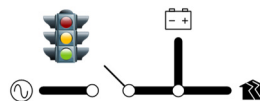

- o The inverter must wait for the configured grid-interactive delay period (usually 5 minutes) before it can connect to grid power.
- o To be accepted, the utility grid must meet certain parameters, notably voltage and frequency. Agreements for utility interconnection may require other specified settings. See below.
  - When these conditions are met, the inverter will close its grid relay and accept the grid.
  - If the conditions are not met, the inverter will not accept the grid.
  - When a grid instability, outage, or shutoff occurs during normal operation, the inverter will open the relay. This isolates itself and the protected loads from the grid so that it may serve the loads from the battery.
- o The loads powered by the inverter must not exceed the size of the inverter's grid relay.

## Grid Profile and Protection Settings

When a **Grid Profile** is selected, it preloads a series of grid protection settings that have been designated according to each regulation or company. See page 43.

# Operation

## Grid Relay

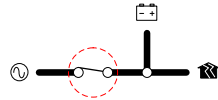

The Mojave inverter uses mechanical relays to connect the inverter, AC sources, and loads. The **GRID** and **GEN** terminals have separate, independent relays. These are not interchangeable. Each input has a separate set of acceptance criteria (also known as “enter service” criteria). (See the **Generator** tab on page 70.)

Until the grid relay energizes, the **GRID** terminals are electrically isolated from **LOAD**. When the relay closes, the **GRID** and **LOAD** terminals are electrically common. (The **GEN** terminals remain isolated.) When the relay changes states, the physical transfer delay is as fast as 20 milliseconds.

The inverter’s input is limited to 55 Aac per phase or line. The continuous loads should never exceed this amount. When connected to an AC source, the inverter cannot limit the load current. The **GRID** or **LOAD** circuit breakers may trip.

	<p><b>CAUTION: Equipment Damage</b></p> <p>Current draw in excess of the recommended amount can damage the inverter’s components. This damage is not covered by warranty. Use protective devices of appropriate size.</p>
	<p><b>IMPORTANT:</b></p> <ul style="list-style-type: none"> <li>❖ Do not apply generator power to the <b>GRID</b> terminals.</li> <li>❖ Do not apply grid power to the <b>GEN</b> terminals.</li> </ul>
	<p><b>NOTES:</b></p> <ul style="list-style-type: none"> <li>❖ The relay does not open during any stage of <b>Time of Use</b>. (See page 40.)</li> <li>❖ The neutral connections are not switched. Neutral conductors use a common bus bar.</li> <li>❖ The independent inputs are intended to simplify the connection to multiple AC sources; however, the inverter can only use one input at a time. If both inputs are powered, the default setting is for the inverter to accept the <b>GRID</b> input.</li> <li>❖ If the grid voltage or frequency vary too widely, the inverter will disconnect itself. However, any variations within the inverter’s acceptance range will be transferred to the loads. The inverter does not “clean up” or condition the power from the source.</li> </ul>

## Power Limits

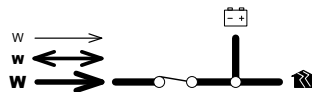

The inverter’s settings control the amount of power (kilowatts) that the inverter uses from the grid. These settings are meant to protect an AC source of limited size, as well as other possible limits to the system. If necessary, adjust these settings to match the input size.

- o **Import limit (W)** attempts to restrict the total amount of power used from the grid. This setting affects **Charge from grid limit (W)**. It does not affect **Export limit (W)**.
- o **Export limit (W)** is reserved for future use.
- o **Charge from grid limit (W)**, as indicated by its name, restricts the amount of power used to charge batteries from the grid. This number is limited by the **Import limit (W)** setting. This item is not the same as **Max Charge Current (A)** on page 53.

See the next page for more information.



## NOTES:

- ❖ The charger cannot exceed the **Import limit (W)** setting, even if **Charge from grid limit** is set higher than **Import limit (W)**.
  - ✓ The inverter gives priority to any loads. The inverter cannot restrict the amount of power sent to the loads.
  - ✓ If the combination of loads and charging exceeds **Import limit (W)**, the inverter will reduce the charge rate to avoid overloading the source. This could cause the inverter to charge at a rate considerably less than the **Grid charge limit** setting.
  - ✓ If the loads **equal Import limit (W)**, the charge rate will be reduced to zero.
  - ✓ If the loads **exceed Import limit (W)**, see below.
- ❖ The **Charge from grid limit (W)** setting does not restrict charging performed while AC coupling. See page 39.

## Demand Mitigation (Peak Reduction)

If the loads exceed **Import limit (W)**, the inverter will support the loads by adding battery power to the power used from the grid. It will discharge the batteries at a level up to the **Max Discharge Current (A)** setting on page 53.

This operation can continue until the batteries reach the **Minimum SoC** setting on page 52.



## IMPORTANT:

With sustained loads and no other DC source, the batteries may discharge to the **Low Battery Cut-Out** point. The inverter will shut down with an error message. (See pages 19 and 52.) To prevent the loss of power, load use should be planned accordingly.







## Battery Tab

The items under this tab affect the Mojave inverter's interactions with the battery bank, particularly battery charging.

Many items will vary with the battery type. There are no default settings that apply to all batteries. Each **Battery Model** selection pre-loads the other items with default settings that have been optimized for that particular battery type. The default settings shown below are those used for the **Custom Lead Acid** selection.



### NOTE:

If the Mojave ESS battery is in use, refer to the *Mojave Energy Storage System Operator's Manual* in place of the present manual. This manual, also called the *ESS Manual*, contains necessary battery and inverter instructions. The *ESS Manual* also includes inverter presets for the Mojave ESS battery.



The items presented here are described on the designated pages. They may not appear in the same order as shown below.

- o **Battery Model** — All supported battery models, with preloaded specifications. See page 51. As noted, the settings here are for the **Custom Lead Acid** selection.
- o **Amp hours per string (Ah)** — Range: **0** to **2000**. Default: **200**.  
The size (amp-hours) of each “string”, or set of batteries in series. See page 51.
- o **Number of strings** — **1** to **100**. Default: **1**.  
The number of battery strings in parallel with each other. See page 51.
- o **Max SOC (%)** — Range: **60** to **100**. Default: **100**.  
The uppermost SOC for the charger to work. See page 52.
- o **Min SOC (%)** — Range: **10** to **60**. Default: **50**.  
The lowest operating point for the inverter. See page 52.
- o **Max charge current (A)** — Range: **0** to **175**. Default: **170**.  
The maximum total charging current that is permitted to charge the battery bank by any means. See page 53.
- o **Max discharge current (A)** — Range: **0** to **200**. Default: **170**.  
The maximum total DC current that is permitted to discharge the battery bank by any means. See page 53.
- o **Rebulk voltage (V)** — Range: **40** to **64**. Default: **48.00**.  
The trigger voltage to re-start a charging cycle. See pages 59 and page 68.
- o **Absorb charge mode** — Range: **Disabled** or **Timed**. Default: **Timed**.  
The command that permits the second stage of charging to operate. See pages 57 and 67.
- o **Absorb voltage (V)** — Range: **40** to **64**. Default: **56.5**.  
The target voltage for the first two stages of charging. See pages 57 and 67.
- o **Absorb time (m)** — Range: **0** to **1439**. Default: **120**.  
The duration for the second stage of charging. See pages 57 and 67.
- o **Absorb end amps (A)** — Range: **0.2** to **170**. Default: **4.0**.

## Operation

The exit (taper) current level for the second stage of charging. See pages 57 and 67.

- o **Refloat voltage (V)**— Range: **42** to **64**. Default: **50.00**

The trigger voltage to re-start a maintenance charge. See page 58.

- o **Float charge mode** — Range: **Disabled, Timed, Continuous**. Default: **Timed**

The command that permits the third stage of charging to operate. See page 58.

- o **Float voltage (V)** — Range: **40** to **64**. Default: **54.5**

The target voltage for the third (maintenance) stage of charging. See page 58.

- o **Float time (m)** — Range: **0** to **1439**. Default: **120**

The duration for the third stage of charging. See page 58.

- o **Equalize voltage (V)** — Range: **40** to **64**. Default: **56.5**

The target voltage for an equalization cycle. See page 62.

- o **Equalize time (m)** — Range: **0** to **1439**. Default: **0**

The duration for an equalization cycle. See page 62.

- o **HBCO (V)** — Range: **40** to **64**. Default: **60.00**

The voltage setting for high battery cut-out. See page 52.

- o **HBCI (V)** — Range: **40** to **64**. Default: **58.00**

The recovery point for HBCO. See page 52.

- o **HBCO delay (s)** — Range: **0** to **1**. Default: **1.0**

The delay for HBCO to take effect. See page 52.

- o **LBCO (V)** — Range: **40** to **64**. Default: **44.00**

The voltage setting for low battery cut-out. See page 52.

- o **LBCI (V)** — Range: **40** to **64**. Default: **44.50**

The recovery point for LBCO. See page 52.

- o **LBCO delay (s)** — Range: **0** to **10**. Default: **10**

The delay for LBCO to take effect. See page 52.

- o **Temperature compensation (mV/C)** — Range: **0** to **10**. Default: **5.0**

The amount (“slope”) that the battery charging is adjusted for temperature changes. This adjustment is made in millivolts per degree Celsius per battery cell. See page 63.

- o **Charge efficiency** — Range: **50** to **100**. Default: **95**

The efficiency factor which modifies the final battery state of charge. See page 63.

## Battery Usage

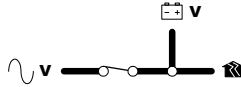

The Mojave inverter requires batteries to operate. Other sources may not maintain DC voltages that are consistent enough for the inverter to operate reliably.



### CAUTION: Equipment Damage

Do not substitute other DC sources in place of the batteries. High or irregular voltages may damage the inverter.

## Battery Selection

The Mojave inverter can auto-populate the specifications of select OutBack Power/EnerSys and third-party battery models. If one of these models is in use, it can be selected under **Battery Model**. This item shows a list of supported batteries. Select the most applicable type.

- Selecting **Custom Lead Acid** or **Custom Lithium** allows the settings to be adjusted manually.
- The remaining selections will load the charger with settings that were recommended by each battery manufacturer.

## Bank Size

- **Amp hours per string (Ah)**: Battery capacity is measured in ampere-hours or amp-hours (Ah), the ability to deliver current over time. Batteries may be wired in series or parallel. Batteries in series are known as a “string”. Strings (or single batteries) placed in parallel make up a bank.
  - Capacities in series are not additive. This means that **Amp hours per string (Ah)** is also the capacity of a single battery.
  - Series voltages are additive. The battery bank voltage is determined by the length of a string of batteries (the number of batteries placed in series).
- **Number of strings**: The battery bank capacity is determined by the number of strings placed in parallel.
  - Parallel capacities are additive.
  - Voltages in parallel are not additive. Parallel strings have the same voltage as a single string.



### IMPORTANT:

- ❖ The Mojave inverter uses the **Amp hours per string (Ah)** setting for many calculations. This number must be set correctly.
- ❖ Always enter the battery's capacity at the 20-hour rate (as specified by the battery manufacturer).
- ❖ Battery capacity will diminish over time from the rated quantity. The inverter will perform automatic corrections to its measurements.

## Low and High Battery Limits

- o **Max SoC (%)**: After reaching maximum SoC (state of charge), the charger turns off. Setting it to less than 100% could result in the battery becoming undercharged. See page 53 for more discussion of SoC.
- o **Min SoC (%)**: This selection is the lowest operating point for all functions that discharge the batteries. When the batteries reach **Min SoC (%)**, the inverter will begin a new charge cycle.
  - The system graphic under the **STATUS** view will show the system's measured SoC. (See page 19.)
  - If no charging source is available, the inverter will remain inactive until a source becomes available.
  - Below this point is the reserve battery supply for inverter basic functionality when no AC source is present. This battery reserve is required to boot the inverter's internal functions.
- o **LBCO (V)**: The LBCO (Low **B**attery **C**ut-**O**ut) function prevents the inverter from draining the batteries completely.
  - When the DC voltage drops below **LBCO (V)** for the duration of **LBCO delay (s)**, the inverter will stop functioning. The **Battery** tab will display a low battery message under **Info**, as will the **EVENTS** view. See pages 19 and 27.
  - This function is intended to protect both the batteries and the inverter's output. (Continuing to invert on a low DC voltage may produce a distorted waveform.) The voltage and time are both adjustable.
  - Once loads are no longer supported at **Min SOC (%)** (see page 52), LBCO creates a reserve or "buffer" against the inverter's own battery drain. It should be set below the **Min SOC (%)** point to avoid overlap. In the **Custom Lead Acid** battery selection used in this book, the setting is 44 Vdc. However, this item should be carefully set according to the battery manufacturer's instructions.
- o **LBCI (V)**: LBCI (Low **B**attery **C**ut-**I**n) is the recovery point from LBCO.
  - When the DC voltage rises above **LBCI (V)** for 10 seconds, the condition will clear and the inverter will resume functioning. The voltage is adjustable. The time delay is not adjustable.
  - Connecting an AC source for the inverter to charge the batteries will also clear this condition.
- o **HBCO (V)**: HBCO (High **B**attery **C**ut-**O**ut) prevents operation at excessively high voltage.
  - When the DC voltage rises above **HBCO (V)** for the duration of **HBCO time delay**, the inverter will stop functioning. The **Battery** tab will display a high battery message under **Info**, as will the **EVENTS** view. See pages 19 and 27.
  - This function is intended to protect the inverter's output and loads. Continuing to invert on a high DC voltage may produce a distorted waveform. The voltage and time are both adjustable.
  - Note that the HBCO function does not alleviate the high battery state. The cause is an external condition which could damage the inverter.
- o **HBCI (V)**: LBCI (High **B**attery **C**ut-**I**n) is the recovery point from HBCO.
  - When the DC voltage drops below **HBCI (V)** for 10 seconds, the fault will clear and the inverter will resume functioning. The voltage is adjustable. The time delay is not adjustable.

## Battery Charging

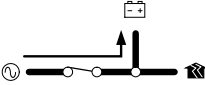

### IMPORTANT:

Battery charger settings need to be correct for a given battery type. Always follow battery manufacturer recommendations. Making incorrect settings, or leaving them at factory default settings, may cause the batteries to be undercharged or overcharged.

## State of Charge (SoC)

Battery capacity is measured in ampere-hours or amp-hours (Ah), a measurement of current over time. SoC is a percentage of the battery's total capacity, which is provided by the battery manufacturer and entered in **Amp hours per string (Ah)**. The inverter senses the current flow either into or out of the batteries over time and calculates the Ah gain or loss. The resulting SoC is displayed on page 19.

## Criteria

State of charge is not strictly a matter of counting amp-hours. The charger must reach the requisite criteria (voltage, current, time) before the batteries can be fully charged. For this reason, the charger settings on page 49 must be programmed accurately. Similarly, **Amp hours per string (Ah)** and **Number of strings** must be correct for the inverter to make accurate measurements.

## Charge Current

Batteries or battery banks usually have a recommended limit on the maximum current used for charging or discharging. Often this is calculated as a percentage or fraction of the battery capacity, represented by "C". For example, C/5 would be a DC amperage figure that is 1/5 of the total amp-hours of the bank.

- o **Max charge current (A):** The maximum total DC input current that the battery can accept.
- o **Max discharge current (A):** The maximum total DC output that the battery can support. This item only applies when connected to an AC source. It restricts the amount of current drawn from the battery for supporting or demand mitigation when blended with an AC source. It may be used to protect a battery of limited size, or simply to pace the rate of discharge.



### CAUTION: Equipment Damage

**Max charge current (A)** must be set so that the peak charge current does not exceed the maximum current recommended by the battery manufacturer.

## Charge Efficiency

The batteries cannot accept 100% of the charging energy due to internal losses. The charging algorithm discounts a percentage of the charge and does not apply it to the SoC. The amount can be set as the **Charge efficiency** on page 50. The default setting is 95% but should be set as accurately as possible for the batteries. Charging efficiency decreases with battery age.

## Charge Cycle

Battery charging requirements will vary with battery chemistry. The Mojave inverter uses one of several different charge cycles. Selecting a **Battery Model** on page 51 will set up a charge cycle that has been pre-programmed for that battery. Most cycles operate in a combination of progression of constant-current and constant-voltage steps. The charger brings the batteries to a series of “target” voltages.

- o Charging for lead-chemistry batteries is described beginning on page 55.
- o Charging for lithium-chemistry batteries is described beginning on page 64.

Most charger settings are adjustable for different priorities. For example, the Float voltage could be set higher than the Absorption voltage, or a step could be completely skipped.

The status of the charger is shown on the User Interface as shown in Figure 26. Note that a status message only shows the charger’s goal, not its present activity. If the battery reaches the **Refloat** set point, this item will show **Float** status even though a charging source is not yet available.

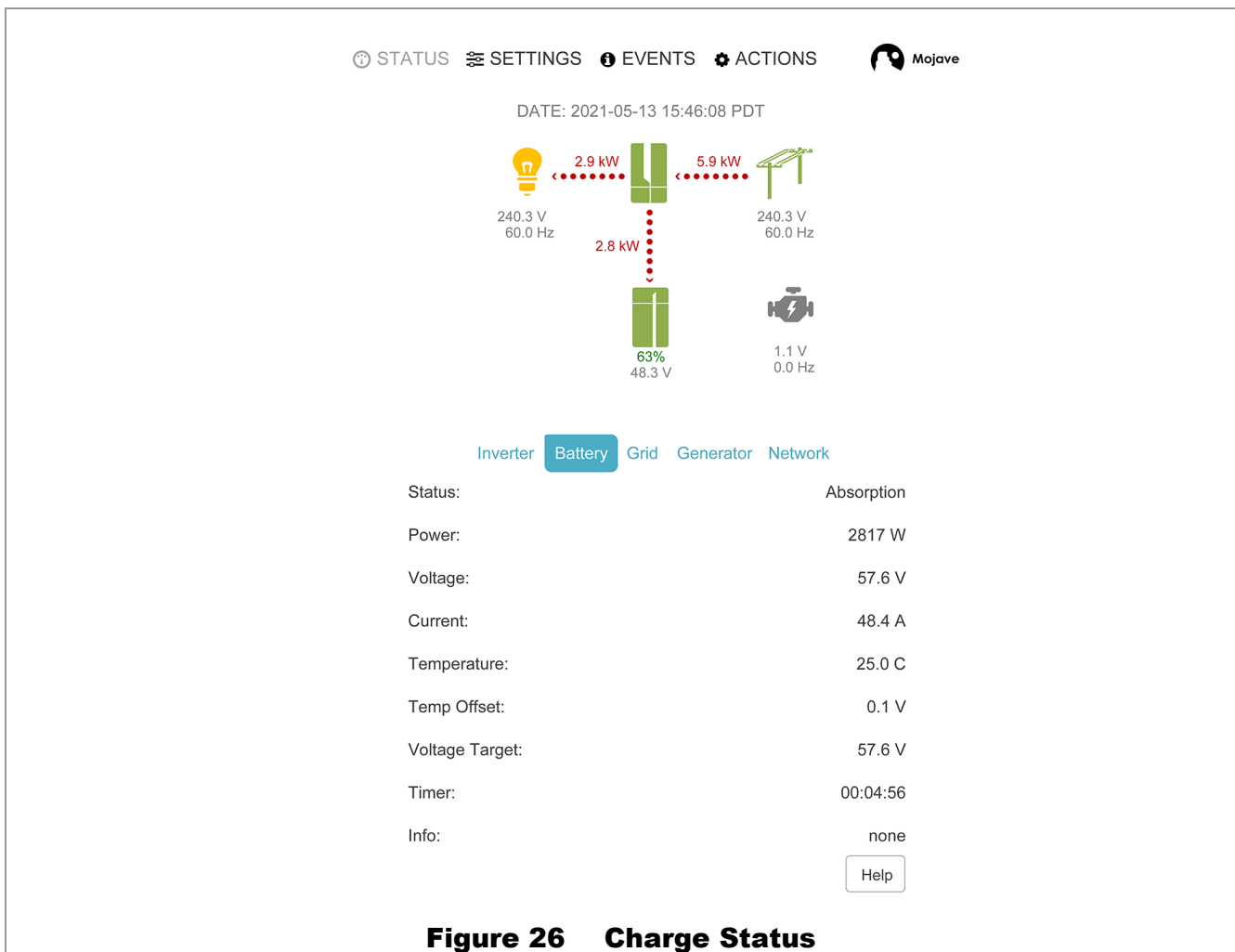

**Figure 26 Charge Status**

## Lead-Chemistry Batteries (Three-Stage Charging)

When selecting a **Battery Model** for a lead-acid, AGM, or similar battery, this cycle is generally used. The three stages of this charge cycle are Bulk, Absorption, and Float. These stages are introduced in Figure 27 and described beginning below.

The following items describe the operation and intended use for each individual charging step as shown in the graphs. Note that some charging cycles may not follow this exact sequence. These include cycles which were previously interrupted, and also customized charging. Each step describes how to defeat or customize the step if specialized charging is required.

See page 58 for a description of multiple three-stage cycles when the charger is restarted after the cycle is complete. This page also describes multiple cycles when the charger is restarted after being interrupted.

For battery types using three-stage charging, all selections under the **Battery** tab on page 49 can be edited or customized.

### Manual Start

In the **Action Menu**, pressing **Bulk Start** will initiate a charge cycle, beginning with the Bulk stage. See page **Error! Bookmark not defined.**

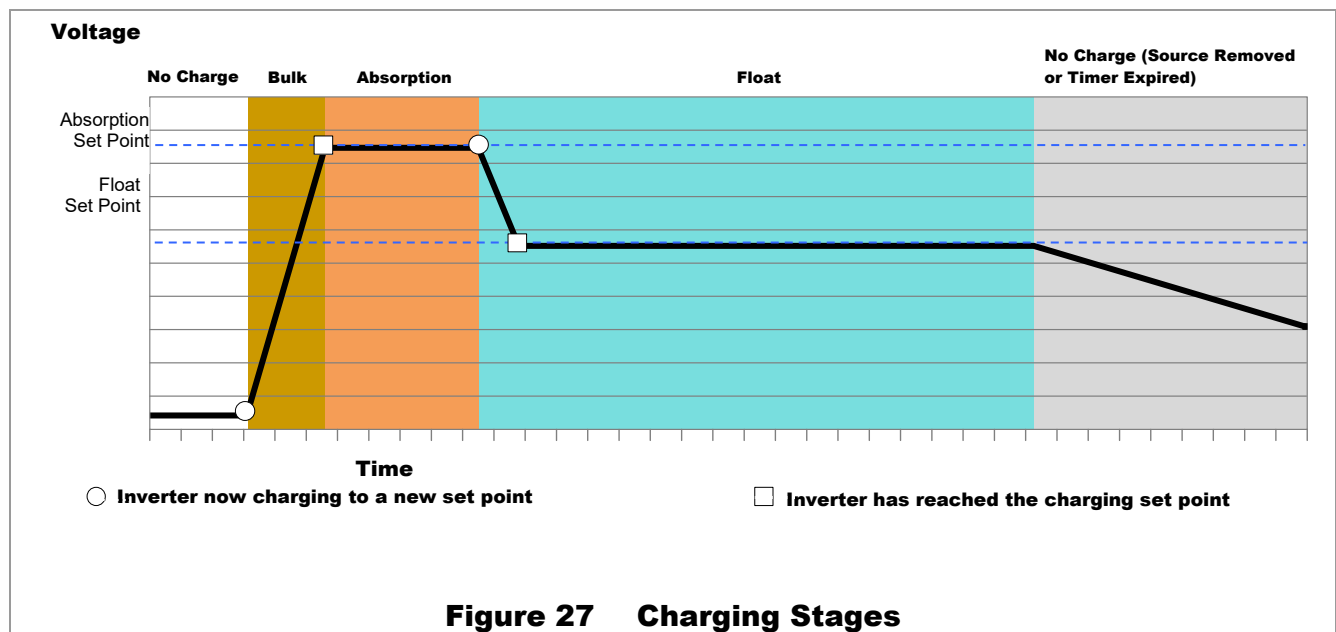

### No Charging

If the inverter is not charging, several conditions may apply:

- o The unit is not connected to a qualified AC source. If a generator is present, it may not be running.
- o The unit is connected to an AC source but the charger has been stopped. See page 25.

### Displayed:

- o **Status message:** *Idle*

**Entering Bulk:** Upon pressing **Bulk Start** (see above), or upon initial battery power-up and initial connection of grid power. Any subsequent connection to the grid will only enter the Bulk stage if the Rebulk point is reached. (See page 59.) Otherwise the charger will return to its previous stage.

# Operation

## Bulk Stage

This is the first stage in the cycle. It is a constant-current stage which drives the battery voltage up. Bulk typically leaves the batteries at 75% to 90% of their capacity, depending on the battery type, the charger setting, and other conditions.

### Displayed:

- o **Status message:** *Bulk*
- o **Voltage Used:** *Absorb voltage (V)* setting.

**Exiting to Absorption stage:** Upon reaching the *Absorb voltage (V)* setting.

The DC current will operate at a high level, often at the charger's maximum current setting. The actual charging kilowatts are shown in Figure 28.

### To skip this step:

- o Setting *Absorb voltage (V)* equal to *Float voltage (V)* causes the charger to proceed through the normal three-stage cycle, but at a single voltage.
- o Setting *Absorb time (m)* to zero causes the charger to skip both the Bulk and Absorption stages and proceed directly to the Float stage.
- o Setting *Absorb charge mode* to *Disable* also causes the charger to skip both stages and proceed directly to the Float stage.

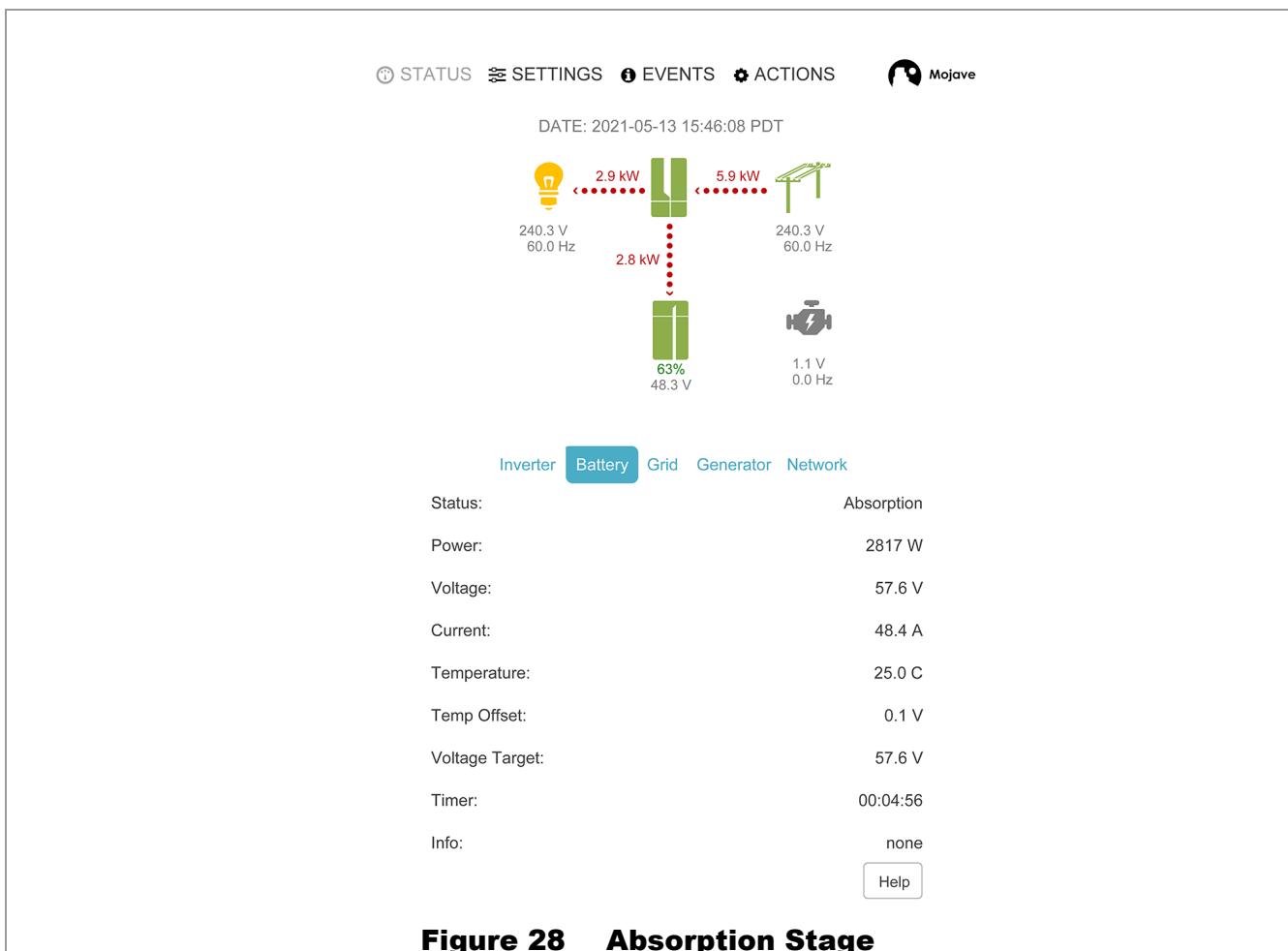

**Figure 28 Absorption Stage**



## **Absorption Stage**

This is a timed constant-voltage stage. It uses only enough current to maintain the Absorb voltage (usually requiring a tapering current). It "tops off" the batteries at effectively 100% SoC.

### **Displayed:**

- o **Status message:** *Absorption*
- o **Voltage Used:** *Absorb voltage (V)* setting. For the three-stage cycle to proceed normally, this setting should be kept higher than the *Float voltage (V)* and *Rebulk voltage (V)* settings.

**Exiting to Float stage:** Upon reaching the *Absorb time (m)* or *Absorb end amps (A)* setting.

**Time limit:** *Absorb time (m)* setting. The timer counts down from the inception of Absorption stage until it reaches zero. The time remaining can be viewed in Figure 28.

The charger may not always run through the timer's full duration.

- o The timer may expire early if the starting time was left over from a previous cycle.
- o The charger will leave Absorption if the charging current tapers down to the *Absorb end amps (A)* setting. This prevents holding the battery at a high voltage for unnecessary amounts of time. The timer will retain any remaining time and use it on the next cycle.

The Absorption timer does not reset to its maximum amount, or to zero, when AC power is disconnected or reconnected. It only goes to zero if the timer runs out during Absorption stage. In other cases it retains any remaining time for use on the next cycle.

*Absorb time (m)* is reset to its maximum amount whenever the battery voltage decreases to the *Rebulk voltage (V)*. The reset occurs immediately, regardless of the time spent below this point.

### **To skip this step:**

- o Setting *Absorb time (m)* to a short duration causes the charger to spend minimal time in Absorption once the Bulk stage is complete.
- o Setting *Absorb time (m)* to zero will cause the charger to proceed directly to Float stage. This may not be desired if the intent is to skip Absorption but retain the Bulk stage.
- o Setting *Absorb Charge Mode* to *Disable* also causes the charger to skip both stages and proceed directly to the Float stage.

# Operation

## Float Stage

This is a timed constant-voltage stage. It is sometimes known as maintenance charging. Float stage balances the batteries' tendency to self-discharge (as well as balancing the draw of any other DC loads). It maintains the batteries at 100% of capacity.

### Displayed:

- o **Status message:** *Float*
- o **Voltage Used:** *Float voltage (V)* setting. For the three-stage cycle to proceed normally, this setting should be kept higher than the **Refloat voltage (V)** setting.

**Exiting to Idle:** Upon reaching the **Float time (m)** setting.

**Time limit:** **Float time (m)** setting. The timer begins running as soon as the charger exits Absorption for any reason. The charger will go Idle once the timer has expired. The Float timer is reset to its maximum amount whenever the batteries decrease to the **Refloat voltage (V)** setting.

### To skip this step:

- o Decreasing the **Float time (m)** setting to zero causes the inverter to enter the Idle condition as soon as the absorption stage is complete.
- o Setting **Float voltage (V)** equal to the **Absorb voltage (V)** level causes the charger to proceed through the normal three-stage cycle, but at a single voltage.
- o Selecting a **Battery Series** that utilizes two-stage charging will limit the cycle to performing only the Bulk and Absorption stages before exiting to Idle. See page 65.
- o Setting **Float charge mode** to **Disable** causes the inverter to enter Idle as soon as the absorption stage is complete.



### NOTE:

Setting **Float charge mode** to **Continuous** causes the charger remain in Float continuously so that the Float timer no longer applies. The charger will still conduct a three-stage charge if the criteria are met, after which it will return to continuous Float.

## Idle

This is not a charging stage, but a period between stages. Following the expiration of the Float timer, the unit enters (or re-enters) the Idle condition. The unit remains connected to the utility grid, but the charger is inactive. The battery voltage will naturally decrease when not maintained by another means such as a renewable source.

### Displayed:

- o **Status message:** *Idle*
- o **Voltage Used:** **Refloat voltage (V)** setting.

**Entering Refloat:** Upon reaching the **Refloat voltage (V)** setting.

**To skip this step:** Setting **Float charge mode** to **Continuous** makes the charger remain in Float continuously so that it does not enter Idle.

## Refloat

The charger re-enters Float stage with constant-current charging to maintain the batteries.

### Displayed:

- o **Status message:** *Float*.
- o **Voltage Used:** *Float voltage (V)* setting. This step may also be used to return to an interrupted Float stage.

**Entering Float:** Upon reaching the *Float voltage (V)* setting, the charger will behave as on page 58. The unit will continue cycling between Float and Idle for as long as the grid is present.

## Manual Stop

In the *Action Menu*, pressing **Stop** will end a charge cycle. The charger will return to *Idle*.

## New Charging Cycle

If the utility grid is lost or disconnected, the unit will return to inverting mode if enabled. The battery voltage will begin to decrease due to loads or natural loss unless charging is available from the GD inverter. When the grid is restored, the inverter will return to the charging cycle.

## Rebulk

If the battery voltage decreases due to discharge, the charger will restart the cycle as soon as the grid is available, beginning at Bulk stage. See page 56.

If the batteries do not decrease to the **Rebulk** point, the charger will not enter the Bulk stage when the grid is reconnected. It will return to its previous stage.

### Displayed:

- o **Status message:** *Bulk*
- o **Voltage Used:** *Rebulk voltage (V)* setting.

**Entering Bulk:** Upon reconnection of grid power.

**Exiting to Absorption stage:** Upon reaching the *Absorb voltage (V)* setting.

## Absorption Timer

**Time limit:** *Absorb time (m)* setting. This is reset to its maximum amount whenever the battery voltage decreases to the *Rebulk voltage (V)* setting. The reset occurs immediately, regardless of the duration spent below this voltage.

If the battery voltage does not decrease to the Rebulk point, the *Absorb time (m)* setting will not reset. It will retain any remaining time from the previous cycle. The Absorption stage will only last for the duration of the remaining time.

The remaining charging steps proceed as described on the previous pages.

# Operation

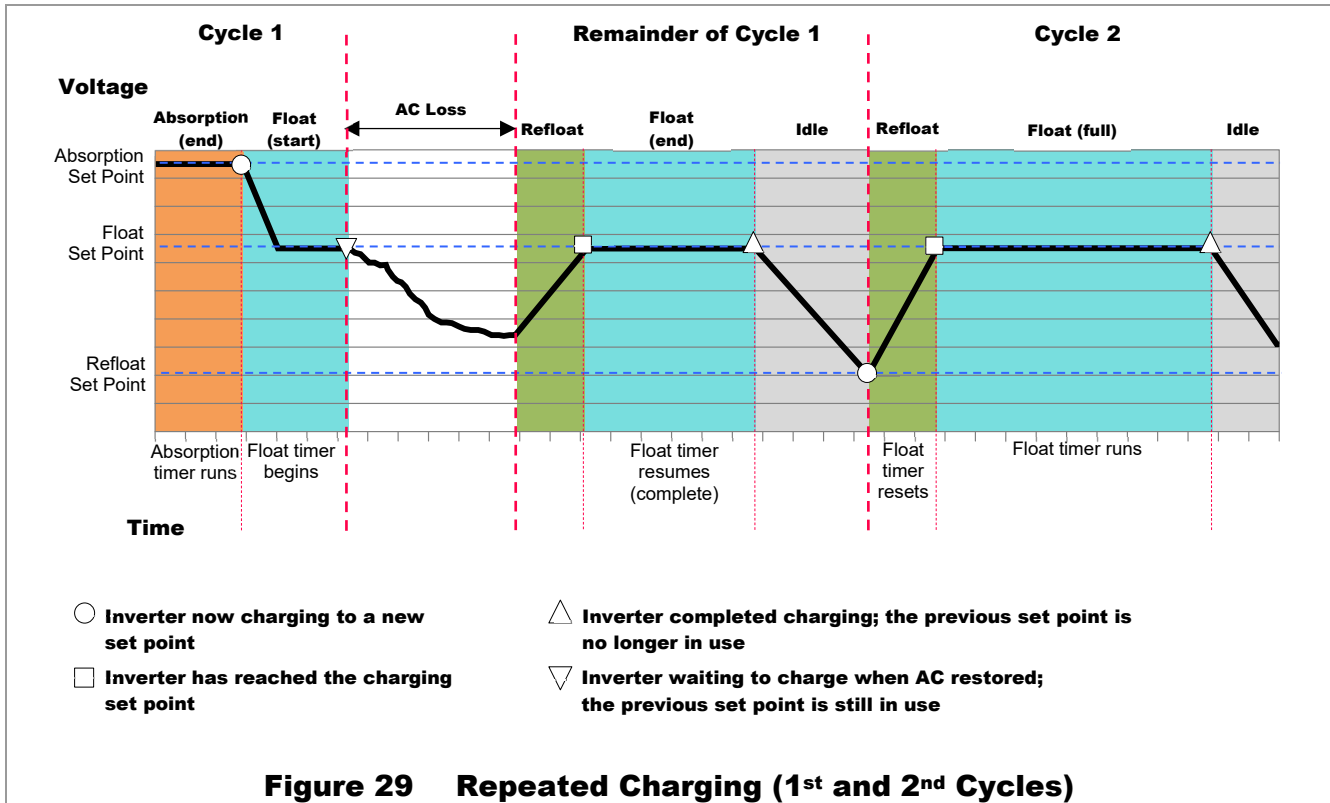

## Example of Multiple Cycles

- o In Figure 29 (Cycle 1), the charger completes Absorption. When the Absorption timer expires, the charger enters Float stage. The battery voltage decreases to the **Float** setting and is maintained there. The Float timer begins to run.
- o The charger is interrupted by the loss of AC input (utility grid power). With loads being supported, the battery voltage decreases. In this example it does not reach the level of the **Refloat** setting.
- o Cycle 1 resumes when the AC input is restored. During the power loss, the battery voltage did not decrease to the **Refloat** setting, so **Float Time** retains the remainder of the previous cycle. The charger returns to Refloat and proceeds through the rest of Float stage. Cycle 1 completes the Float stage when its timer expires. It then goes to the Idle condition.
- o While Idle following Cycle 1, the battery voltage decreases to the **Refloat** setting.
- o Cycle 2 begins when the **Refloat** setting is reached. The Float timer is reset to its maximum. The charger resumes operation in Refloat and raises the battery voltage to the **Float** setting.
- o The charger proceeds uninterrupted through the Float stage. The timer expires and the charger goes Idle, ending Cycle 2.

The alternation between the Float, Idle, and Refloat steps will continue indefinitely as long as no other conditions change.

This graph is continued in Figure 30. During the Idle period, the AC input is lost again. The battery voltage decreases until it reaches the **Rebulk** set point. This causes the charger to prepare a new three-stage charge (Cycle 3) from the beginning, but it cannot do so until the AC input is restored.

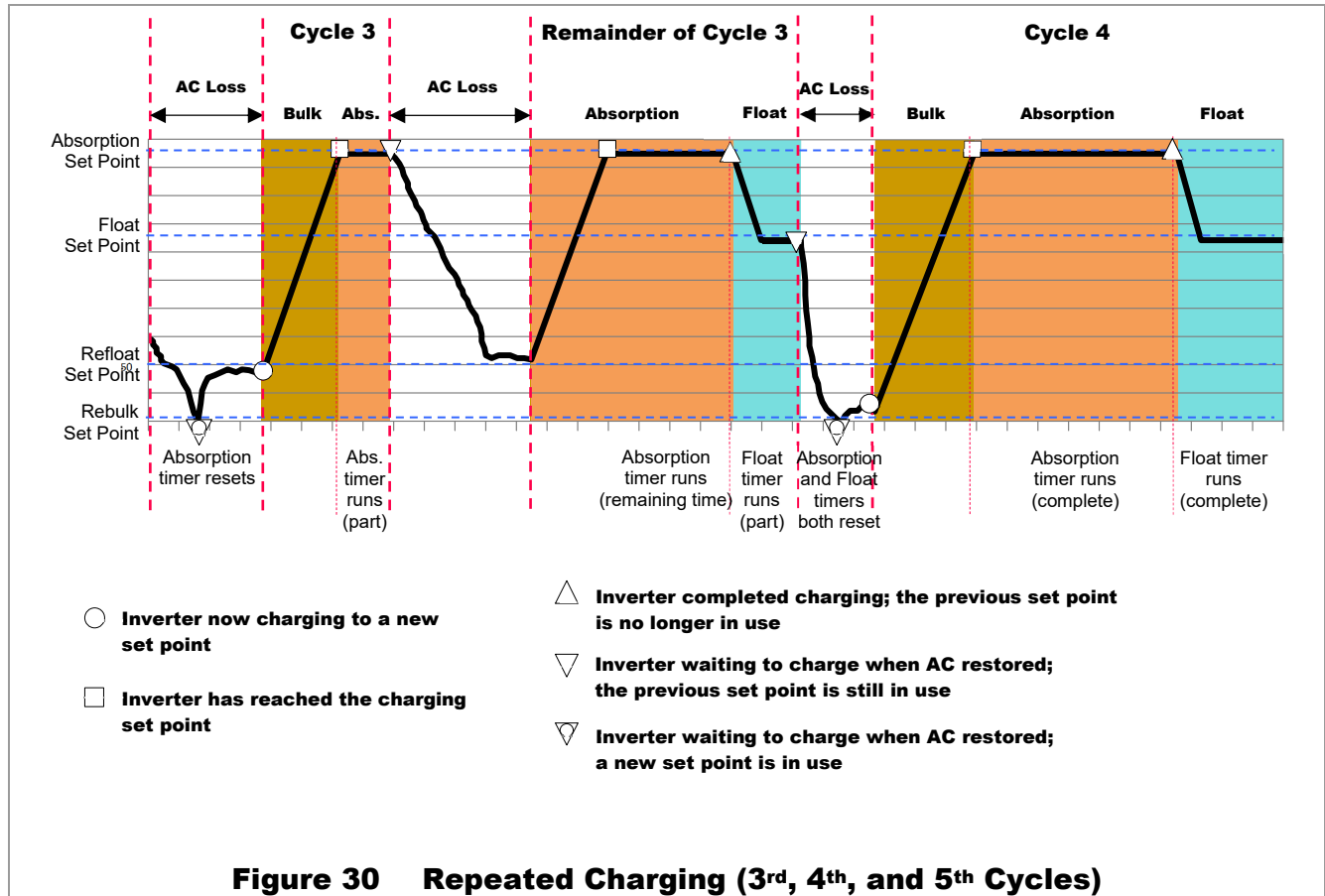

Prior to the beginning of Cycle 3, the AC input failed and all charging stopped. With loads being supported, the battery voltage decreased below the level of the **Rebulk** set point. (Whenever this occurs, the Absorption timer will reset to its maximum amount.) Note that in Figure 30, the voltage also decreased below the **Refloat** set point, resetting the Float timer to its maximum amount.

- o In Figure 30, Cycle 3 begins when charging is restored again. The charger begins a new cycle by entering Bulk stage. When it enters Absorption, the timer runs until it is interrupted by another loss of AC power.  
During this power failure, the battery voltage decreases due to loads, but does not decrease below **Rebulk**. The Absorption timer retains the remaining time from Cycle 3.
- o Cycle 3 resumes when charging is restored again. The charger re-enters Absorption stage and raises the battery voltage to the **Absorption** setting.  
This stage does not last for the full duration of the **Absorb Time** setting. The timer uses up the remaining time from the beginning of Cycle 3. Absorption ends when the timer expires. The charger enters Float. The timer runs until it is interrupted by another loss of AC power.  
During this power failure, heavy battery use causes the voltage to decrease below **Rebulk**. The Absorption timer resets to its maximum amount. Note that the voltage also decreased below the **Refloat** set point, causing the Float timer to reset as well.
- o Cycle 4 begins when charging is restored again. It is triggered by the new Rebulk command. The charger begins a new cycle by entering Bulk stage, proceeding through Absorption, and ending in Float.  
Although Float stage was not completed in Cycle 3, the timer does not resume with the previous time because it was reset after the last power failure. Instead, the Float timer runs through its full duration. After that, it will continue alternating between the Idle, Refloat, and Float steps indefinitely as depicted in Figure 29 and Cycle 2.

## Equalization

⊙ STATUS ⚙ SETTINGS ⓘ EVENTS ⚙ ACTIONS 👤 Mojave

Inverter **Battery** Grid Generator Network Admin

Battery Model: Custom Lead Acid

Amp hours per string (Ah): 200

Number of strings: 1

Max SoC (%): 100

Min SoC (%): 50

Max charge current (A): 170.0

Max discharge current (A): 170.0

Rebulk voltage (V): 48.00

Absorb charge mode: Timed

Absorb voltage (V): 56.50

Absorb time (m): 120

Absorb end amps (A): 4.0

Refloat voltage (V): 50.00

Float charge mode: Timed

Float voltage (V): 54.50

Float time (m): 120

**A** Equalize voltage (V): 56.50

Equalize time (m): 0

HBCO (V): 60.00

HBCI (V): 58.00

HBCO delay (s): 1.0

LBCO (V): 44.00

LBCI (V): 44.50

LBCO delay (s): 10.0

Temperature compensation (mV/C): 5.0

Charge efficiency (%): 95

Help Reset Submit

Action Menu \*

Generator: Off Off

**B** Bulk Charge: EQ Start

Inverter: On On

Grid input: Drop Drop

Gen input: Drop Drop

Reset Faults: Cleared CLEAR

APPLY

**Figure 31 Equalization**

Equalization is a controlled overcharge that is part of regular battery maintenance. Equalization brings the batteries to a much higher voltage than usual and maintains this high voltage for a period of time. This has the result of removing inert lead sulfate compounds from the battery plates. It also reduces stratification by circulating the electrolyte.

Equalization follows the same pattern as standard three-stage charging, as shown in Figure 27 on page 55. However, instead of the Absorption voltage and time set points, it is controlled by the **Equalize voltage (V)** and **Equalize time (m)** settings. (See **A** in Figure 31. Also see page 50).

This process is started in the **ACTIONS** view by manually setting **Bulk Charge** to **EQ Start**. (See **B** in Figure 31.) The inverter cannot be programmed for automatic battery equalization. This is a safety measure.



- o Equalization is normally performed only on flooded lead-acid batteries. The schedule for equalization varies with battery use and type. If performed correctly, this process can extend battery life by a considerable amount.
- o This function is not available for battery types that use two-stage charging or a BMS.



### CAUTION: Battery Damage

- ❖ Do not equalize any lithium-technology battery.
- ❖ Do not equalize any nickel-technology battery.
- ❖ Do not equalize any sealed battery types unless approved by the manufacturer. Some batteries may suffer severe damage from equalization.
- ❖ Contact the battery manufacturer for recommendations on equalization voltage, duration, schedule, and/or advisability. Other battery manufacturers may recommend a different definition of equalization than that shown above. Always follow manufacturer recommendations for equalization.

## Temperature Compensation

Battery performance will change when the temperature varies above or below room temperature (77°F or 25°C). Temperature compensation is a process that adjusts battery charging to correct for these changes. The Mojave inverter, when equipped with the Remote Temperature Sensor (RTS), will compensate for changes in temperature. To achieve a representative temperature, the RTS is attached to a single battery near the center of the bank. The inverter has a designated port for RTS installation. 

This function is not available for battery types that use a BMS.

### If temperature compensation is not used:

When a battery is cooler than room temperature, its internal resistance goes up and the voltage changes more quickly. This can result in the battery being undercharged.

Conversely, when a battery is warmer than room temperature, its internal resistance goes down and the voltage changes more slowly. This can result in overcharging, which may shorten the life of the battery.

### Slope

When charging, an inverter system with an RTS will adjust the charging voltage inversely with changes in temperature. It will **increase** the charge voltage by a certain number of mV for every decrease of 1 degree Celsius per battery cell. Similarly, it will **decrease** the voltage by the same amount for every increase of 1°C per cell. This is referred to as compensation “slope”. A common slope is 5 mV/°C/cell. The slope can be set with **Temperature Compensation (mv/C)** menu item.

This setting affects the Absorption, Float, and Equalization set points. The Rebulk and Refloat set points are not temperature compensated. In a 48 Vdc system (24 cells, 2 volts each), this means 0.12 volts per degree Celsius above or below 25°C.



### NOTE:

Temperature compensation only applies to the battery charging function. Other set points in the inverter, such as the **AUX** functions, are not compensated for temperature.





## Lithium-Chemistry Batteries (BMS and Two-Stage Charging)



### CAUTION: Battery Damage

- ❖ OutBack Power does not approve custom applications, including installation of lithium-ion batteries that have not been published as installable with OutBack Power equipment. Supported batteries are assumed to be new (not repurposed, purchased used, etc), covered under the manufacturer's warranty for the intended application, and fully compliant to all local and national regulatory requirements.
- ❖ Please note that Outback Power does not claim responsibility for any damage done by or to batteries that are deployed using the information found at the link below.

The OutBack Power website  has a list of batteries that have been reviewed and tested by OutBack Power personnel and whose manufacturers have provided specific guidance on equipment settings and limitations. Use of batteries not on this list — including unlisted battery models from the same manufacturers — is at the risk of the installer and host site and may result in the product warranty being void. This remains the case regardless of any technical advice or assistance that may be provided by OutBack Power, its personnel, or representatives.

Most of the batteries on the list also have application notes available at the website.  Please refer to the application notes and any manufacturer recommendations for recommended settings. Note that inclusion on this list does not constitute an endorsement of these battery products and that not all combinations carry the safety listings required by some permitting authorities.

PLEASE NOTE THAT OUTBACK POWER DOES NOT CLAIM RESPONSIBILITY FOR ANY DAMAGE DONE BY OR TO BATTERIES THAT ARE DEPLOYED USING THE INFORMATION FOUND AT THE LINK ABOVE.

### Battery Management System (BMS)

A battery equipped with a BMS will typically manage its own charging dynamically, rather than relying on staged charging. The BMS tracks the battery's condition and automatically assesses the best charging parameters based on current conditions. These parameters can be communicated to the inverter/charger using a CANBUS connection, or managed directly within the BMS. The inverter/charger can adjust the charging voltage and current to maintain the best performance of the battery, while still respecting any user-set limits.

There is no "typical" BMS charging cycle due to the adaptive nature for each unique situation. Many 48 Vdc lithium-ion battery systems include an open-loop BMS that does not require a communications link with the inverter/charger. These batteries typically manage their own charging from a fixed voltage source. Consult the battery manufacturer's instructions for the proper settings.

The BMS plays a critical role in the safe operation of a battery pack. While monitoring the battery's condition, a BMS can communicate alerts or faults to the inverter/charger. In some cases, the BMS may disconnect the battery pack entirely if a potentially unsafe situation is detected. Because the coordinated response of the BMS and inverter/charger to such situations is critical to the proper and safe operation of the system, an unsupported closed-loop BMS should never be used with the Mojave inverter.

The Mojave inverter has a CANBUS communications port allowing it to connect to the BMS of batteries supported by OutBack Power. This port is depicted in Figure 32 on the next page. See the *Mojave Inverter/Charger Quick Start Guide* for more information. 





**CAUTION: Battery Damage**

Only use lithium-ion batteries specifically supported by OutBack Power. See the list of supported batteries at the link on the previous page.  
Even batteries equipped with CANBUS connections may not be supported by the Mojave inverter/charger. If the battery settings do not automatically configure upon connection, stop and verify compatibility and installation instructions.

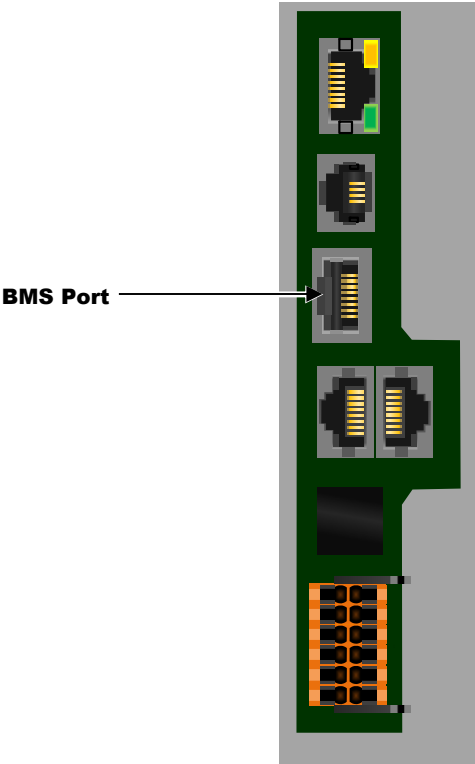

**Figure 32 Communications Ports**

# Operation

## Two-Stage Charging

When selecting a **Battery Model** that does not require continuous maintenance, this cycle is generally used. The two stages of this charge cycle are Bulk and Absorption. These stages are introduced in Figure 33 and described beginning below.

The following items describe the operation and intended use for each individual charging step as shown in the graphs. Note that some charging cycles may not follow this exact sequence. These include cycles which were previously interrupted, and also customized charging.

Figure 33 depicts the pattern of multiple completed charge cycles. See page 69 for a description of multiple two-stage cycles when the charger is restarted after being interrupted.

For battery types using two-stage charging, not all selections under the **Battery** tab on page 49 are available. The Float stage is unavailable, as are Equalization and temperature compensation.

## Manual Start

In the **Action Menu**, pressing **Bulk Start** will initiate a charge cycle, beginning with the Bulk stage of charging. See page 67.

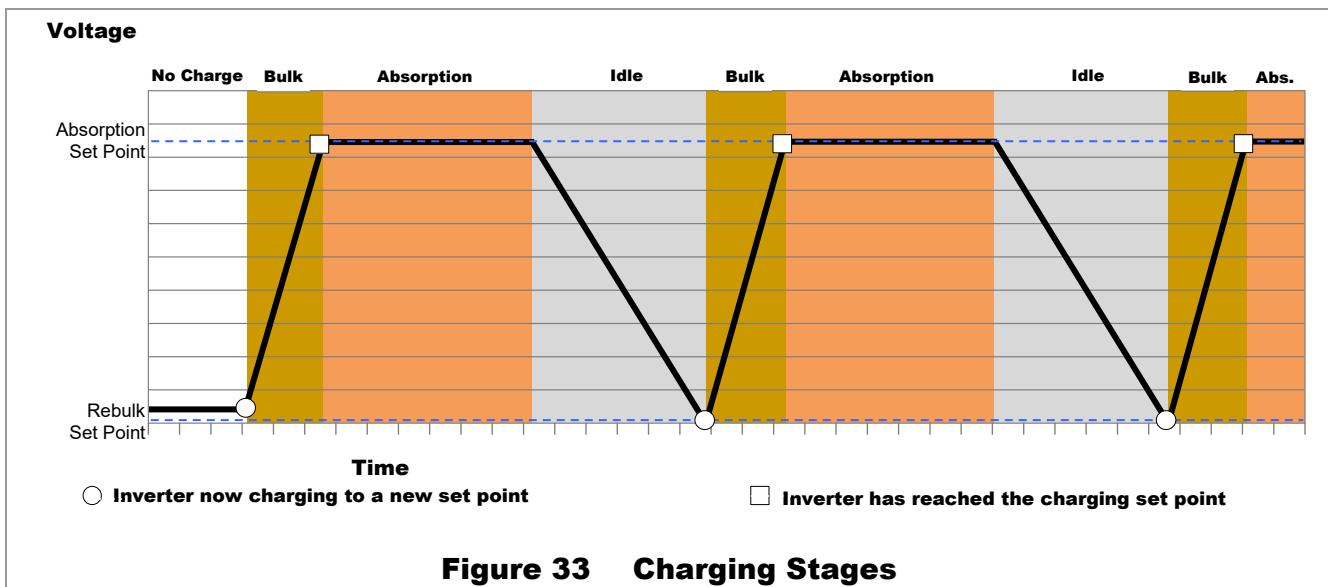

## No Charging

If the inverter is not charging, several conditions may apply:

- The unit is not connected to a qualified AC source. If a generator is present, it may not be running.
- The unit is connected to an AC source but the charger has been stopped. See page 25.

**Displayed:**

- **Status message:** *Idle*

**Entering Bulk:** Upon initial battery power-up and initial connection of grid power. Any subsequent connection to the grid will only enter the Bulk stage if the Rebulk point is reached. (See page 68.) Otherwise the charger will return to its previous stage.

## Bulk Stage

This is the first stage in the cycle. It is a constant-current stage which drives the battery voltage up. Bulk typically leaves the batteries at 75% to 90% of their capacity, depending on the battery type, the exact charger setting, and other conditions.

### Displayed:

- o **Status message:** Bulk
- o **Voltage Used:** *Absorb voltage (V)* setting.

**Exiting to Absorption stage:** Upon reaching the *Absorb voltage (V)* setting.

The DC current will operate at a high level, often as high as the charger's maximum. The actual charging kilowatts are shown in Figure 34.

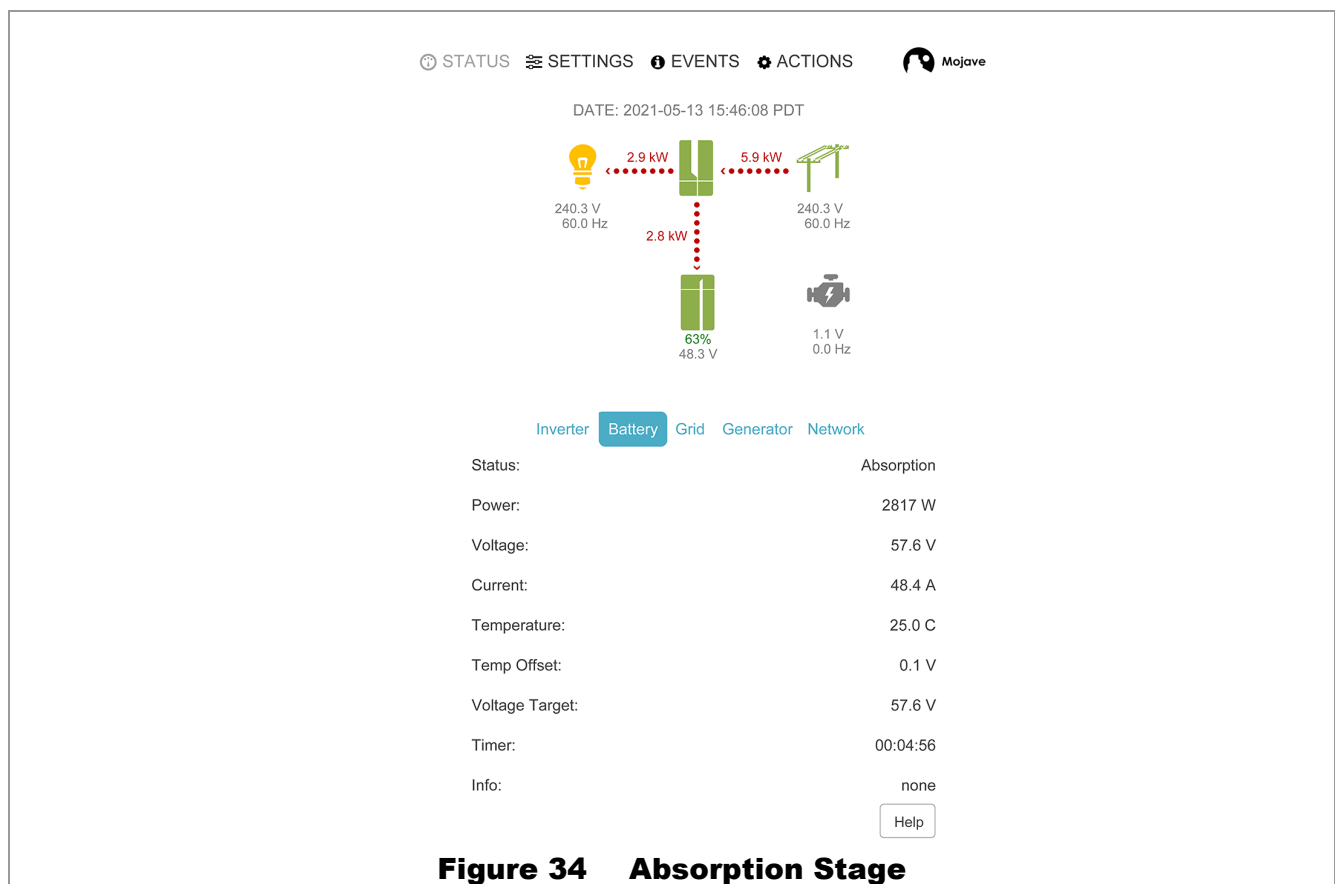

**Figure 34 Absorption Stage**

## Absorption Stage

This is a timed constant-voltage stage. It uses only enough current to maintain the Absorb voltage (usually requiring a tapering current). It "tops off" the batteries at effectively 100% SoC.

### Displayed:

- o **Status message:** Absorb
- o **Voltage Used:** *Absorb voltage (V)* setting. For the three-stage cycle to proceed normally, this setting should be kept higher than the *Rebulk voltage (V)* setting.

**Exiting to Idle:** Upon reaching the *Absorb time (m)* or *Absorb end amps (A)* setting.

## Operation

**Time limit:** *Absorb time (m)* setting. The timer counts down from the inception of Absorption stage until it reaches zero. The time remaining can be viewed in Figure 34.

The charger may not always run through the timer's full duration.

- o The timer may expire early if the starting time was left over from a previous cycle.
- o The charger will leave Absorption if the charging current tapers down to the **Absorb end amps** setting. This prevents holding the battery at a high voltage for unnecessary amounts of time. The timer will retain any remaining time and use it on the next cycle.

The Absorption timer does not reset to its maximum amount, or to zero, when AC power is disconnected or reconnected. It only goes to zero if the timer runs out during Absorption stage. In other cases it retains any remaining time for use on the next cycle.

**Absorb time (m)** is reset to its maximum amount whenever the battery voltage decreases to the **Rebulk voltage (V)**. The reset occurs immediately, regardless of the time spent below this point.

If **Absorb time (m)** is set to zero, the charger will immediately skip to Idle.

### Idle

This is not a charging stage, but a period between stages. Following the expiration of the Absorption timer, the unit enters (or re-enters) the Idle condition. The unit remains connected to the utility grid, but the charger is inactive. The battery voltage will naturally decrease when not maintained by another means such as a renewable source.

#### **Displayed:**

- o **Status message:** Idle
- o **Voltage Used:** *Rebulk voltage (V)* setting.

**Entering Bulk:** Upon reaching the **Rebulk voltage (V)** setting.

### **Manual Stop**

In the **Action Menu**, pressing **Stop** will end a charge cycle. The charger will return to **Idle**.

### **New Charging Cycle**

If the utility grid is lost or disconnected, the unit will return to inverting mode if enabled. The battery voltage will begin to decrease due to loads or natural loss unless charging is available from the GD inverter. When the grid is restored, the inverter will return to the charging cycle.

### Rebulk

If the battery voltage decreases due to discharge, the charger will restart the cycle as soon as the grid is available, beginning at Bulk stage. See page 66.

If the batteries do not decrease to the Rebulk point, the charger will not enter the Bulk stage when the grid is reconnected. It will return to its previous stage.

#### **Displayed:**

- o **Status message:** Bulk
- o **Voltage Used:** *Rebulk voltage (V)* setting.

**Entering Bulk:** Upon reconnection of grid power.

## Absorption Timer

**Time limit:** *Absorb time (m)* setting. This is reset to its maximum amount whenever the battery voltage decreases to the *Rebulk voltage (V)* setting. The reset occurs immediately, regardless of the duration spent below this voltage.

If the battery voltage does not decrease to the Rebulk point, the *Absorb time (m)* setting will not reset. It will retain any remaining time from the previous cycle. The Absorption stage will only last for the duration of the remaining time.

The remaining charging steps proceed as described on the previous pages.

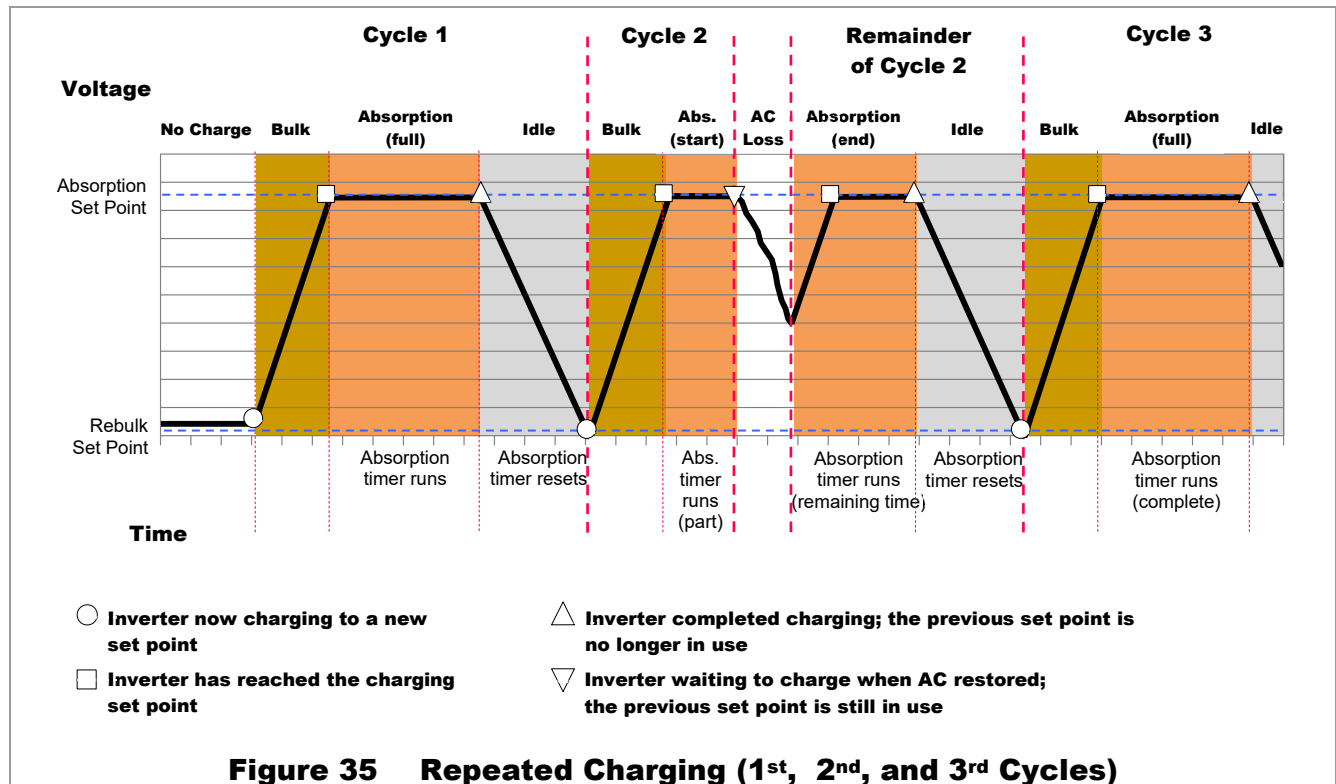

## Example of Multiple Cycles

- o In Figure 35 (Cycle 1), the charger begins a new cycle by entering Bulk stage and proceeding through Absorption. When the Absorption timer expires, the charger goes to the Idle condition. The battery voltage decreases naturally for an indefinite period.
- o When the battery voltage decreases to the level of the *Rebulk* setting, the charger begins a new cycle, Cycle 2. It re-enters Bulk stage. The Absorption timer resets to maximum.
- o During Cycle 2, the charger is interrupted by the loss of AC input. With loads being supported, the battery voltage decreases. In this example it does not reach the level of the *Rebulk* setting.
- o Cycle 2 resumes when the AC input is restored. The charger returns the batteries to the *Absorption* setting. During the power loss, the battery voltage did not decrease to the *Rebulk* setting, so *Absorption Time (m)* retains the remainder of the previous cycle. When the remaining Absorption time expires, the charger goes to the Idle condition. The battery voltage decreases naturally for an indefinite period.
- o When the battery voltage decreases to the level of the *Rebulk* setting, the charger begins a new cycle, Cycle 3. The Absorption timer resets to maximum. The charger re-enters Bulk stage and proceeds through Absorption. When the Absorption timer expires, the charger goes to the Idle condition. After that, it will continue alternating between the Rebulk, Absorption, and Idle steps indefinitely.

# Generator Tab

The items under this tab affect the Mojave inverter's interactions with an AC generator, particularly automatic starting.

The items presented here are described on the designated pages. They may not appear in the same order as shown below.

**NOTE:** Although **SYSTEM TIME** on page 15 uses a 24-hour clock format, settable times of day in this menu are formatted using a 12-hour clock.

- **Generator output rating (kVA)** — Range: **0** to **100**. Default: **5.0**.  
The generator's size in kilovolt-amperes (kVA), usually treated the same as kilowatts (kW). See page 72.
- **High voltage limit (V)** — Range: **84** to **140**. Default: **130**.  
The highest AC voltage the inverter can accept from a generator before disconnection. See page 72.
- **Low voltage limit (V)** — Range: **85** to **140**. Default: **105**.  
The lowest AC voltage the inverter can accept from a generator before disconnection. See page 72.
- **High frequency limit (Hz)** — Range: **55** to **65**. Default: **63**.  
The highest frequency the inverter can accept from a generator before disconnection. See page 72.
- **Low frequency limit (Hz)** — Range: **55** to **65**. Default: **57**.  
The lowest frequency the inverter can accept from a generator before disconnection. See page 72.
- **Warmup time (s)** — Range: **0** to **1800**. Default: **60**.  
The time in seconds the generator is allowed to run with no load (before charging begins). This time should follow the generator manufacturer's recommendations. This setting applies only when using AGS. See pages 72 and 74.
- **Cooldown time (s)** — Range: **0** to **1800**. Default: **300**.  
The time in seconds the generator is allowed to run with no load (after charging has finished). This time should follow the generator manufacturer's recommendations. This setting applies only when using AGS. See pages 72 and 74.
- **AGS** — Range: **Disabled** or **Enabled**. Default: **Disabled**.  
This item controls the Automatic Generator Start (AGS) function. See page 74.
- **Start on low battery** — Range: **Disabled** or **Enabled**. Default: **Disabled**.  
This item allows AGS to start the generator upon reaching a either a low state of battery charge, or progressively lower battery voltages. See page 76.
  - **Start SoC (%)** — Range: **0** to **80**. Default: **50**.  
The low state of charge that causes AGS to start the generator. See page 75.
  - **Stop SoC (%)** — Range: **0** to **100**. Default: **80**.  
The high state of charge that causes AGS to stop the generator. See page 75.
  - **24 hour start voltage (V)** — Range: **40** to **64**. Default: **48.8**.  
The low battery (DC) voltage that will cause AGS to start the generator after 24 hours. See page 75.
  - **2 hour start voltage (V)** — Range: **40** to **64**. Default: **47.2**.  
The low battery (DC) voltage that will cause AGS to start the generator after 2 hours. See page 75.
  - **2 minute start voltage (V)** — Range: **40** to **64**. Default: **44.0**.  
The low battery (DC) voltage that will cause AGS to start the generator after 2 minutes. See page 75.

- o **Start on high load (V)** — Range: **Disabled** or **Enabled**. Default: **Disabled**.  
This item allows AGS to start the generator due to a high inverter load. See page 77.
  - **Start kW (kW)** — Range: **0** to **8**. Default: **5.0**.  
The load size above which AGS will start the generator. See page 77.
  - **Stop kW (kW)** — Range: **0** to **8**. Default: **2.0**.  
The load size below which AGS will stop the generator. See page 77.
  - **High load start delay (m)** — Range: **0** to **90**. Default: **1**.  
The delay in minutes before AGS starts the generator due to high load. See page 77.
- o **Quiet time** — Range: **Disabled** or **Enabled**. Default: **Disabled**.  
This item restricts AGS from starting the generator automatically during certain hours. See page 77.
  - **Quiet time start** — Range: **12:00 AM** to **11:59 PM**. Default: **10:00 PM**.  
The beginning of the scheduled period that restricts automatic start. See page 77.
  - **Quiet time stop** — Range: **12:00 AM** to **11:59 PM**. Default: **05:00 AM**.  
The end of the scheduled period that restricts automatic start. See page 77.
- o **Exercise** — Range: **Disabled** or **Enabled**. Default: **Disabled**.  
This item starts the generator periodically regardless of other conditions. See page 77.
  - **Exercise day** — Range: **Sunday** to **Saturday**. Default: **Sunday**.  
The scheduled day for automatic generator exercise. See page 77.
  - **Exercise start** — Range: **12:00 AM** to **11:59 PM**. Default: **04:00 PM**.  
The scheduled time for automatic generator exercise. See page 77.
  - **Exercise duration** — Range: **5 minutes**, **15 minutes**, or **30 minutes**. Default: **15 minutes**.  
The scheduled length of the exercise period. See page 77.

## Generator Usage

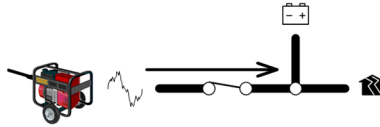

The Mojave inverter can connect to a generator to charge batteries and run loads when the utility grid is not available. The generator must be 120/240 Vac (three-wire or “split-phase”) and 60 Hz. It cannot accept single-phase (two wire 120 Vac, 230 Vac, or 240 Vac) or three-phase input.

The generator can be started with a manual command or programmed to run automatically with the automatic generator start (AGS) function. The generator can start or stop according to battery state, load size, or several other external conditions.

## Generator Limits

The generator’s size should be specified with the setting **Generator output rating**. This will help prevent the inverter from overloading the generator.

The generator must be stable within certain voltage and frequency limits. These limits are adjustable with the following settings:

- o **High voltage limit**
- o **Low voltage limit**
- o **High frequency limit**
- o **Low frequency limit**

	<p><b>CAUTION: Equipment Damage</b></p> <p>Use of a three-phase generator with this equipment may damage either the inverter or the generator. This damage to the inverter is not covered by the product warranty.</p>
	<p><b>NOTES:</b></p> <ul style="list-style-type: none"><li>❖ The Mojave inverter will not work with a DC generator. The input from an AC generator must be connected to the <b>GEN</b> terminals and must not be connected to other locations.</li><li>❖ The inverter has a separate <b>GRID</b> connection (see page 46). These independent connections are used for wiring to multiple AC sources. However, the inverter can only use one AC source at a time. If both connections are powered, the inverter automatically accepts <b>GRID</b>. It cannot accept <b>GEN</b> as long as <b>GRID</b> is active.</li><li>❖ If inverter programming has forced a disconnection from the grid (even if grid power is still present), the inverter can accept generator power instead.</li></ul>

## Generator Input

When the inverter **GEN** terminals are connected to a stable AC generator, the **GRID** terminals are not in use, and **Generator** in the **ACTIONS** view is set to **Use**, the inverter will synchronize itself with the generator and connect to it. When automatically started, the **Warmup time (s)** setting allows the generator to temporarily run unloaded while its output stabilizes. Once this time expires, the generator relay will engage, linking the **GEN** terminals directly with the **LOAD**.

See page 73 for more information on the function of the generator relay.

- o When these conditions are met, the inverter will close its relay and accept the generator. If the conditions are not met, the inverter will not close the relay or accept the generator.
- o If the generator is shut down (or if the parameters are no longer met), the inverter will open the relay. This isolates the protected loads from the generator and allows the inverter to serve the loads instead.
- o Upon connection, the generator power will be used to run any loads and charge batteries.
- o During automatic shutdown, the inverter will open its relay for the **Cool down time**. It then turns off the generator. This avoids the condition of shutting off the generator while loaded.



- o If the loads exceed **Generator output rating (kVA)**, the inverter will support the loads by adding battery power to the power used from the generator. It will discharge the batteries at a level up to the **Max Discharge Current (A)** setting on page 53.
- o This operation can continue until the batteries reach the **Minimum SoC** setting on page 52.



### IMPORTANT:

With sustained loads and no other DC source, the batteries may discharge to the **Low Battery Cut-Out** point. The inverter will shut down with an error message. (See pages 19 and 52.) To prevent the loss of power, load use should be planned accordingly.

## Generator Relay

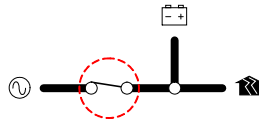

The Mojave inverter uses mechanical relays to alternate between the states of inverting and of accepting an AC source. The **GRID** and **GEN** terminals have separate, independent relays. These terminals are not interchangeable. Each input has a separate set of acceptance criteria.

Until the generator relay energizes, the **GEN** terminals are electrically isolated from **LOAD**. When the relay closes, the **GEN** and **LOAD** terminals are electrically common. (The **GRID** terminals remain isolated.) When the relay changes states, the physical transfer delay is as fast as 20 milliseconds.

The inverter's input is limited to 55 Aac per phase or line. The continuous loads should never exceed this. When connected to an AC source, the inverter cannot limit the load current. The **GEN** or **LOAD** circuit breakers may trip.



### CAUTION: Equipment Damage

Current draw in excess of the recommended amount can damage the inverter's components. This damage is not covered by warranty. Use protective devices of appropriate size.



### IMPORTANT:

- ❖ Do not apply generator power to the **GRID** terminals.
- ❖ Do not apply grid power to the **GEN** terminals.



### NOTES:

- ❖ The neutral connections are not switched. Neutral conductors use a common bus bar.
- ❖ The independent inputs are intended to simplify the connection to multiple AC sources; however, the inverter can only use one input at a time. If both inputs are powered, the default setting is for the inverter to accept the **GRID** input.
- ❖ If the generator's voltage or frequency vary too widely, the inverter will disconnect itself. However, any variations within the inverter's acceptance range will be transferred to the loads. The inverter does not "clean up" or condition the power from the source.

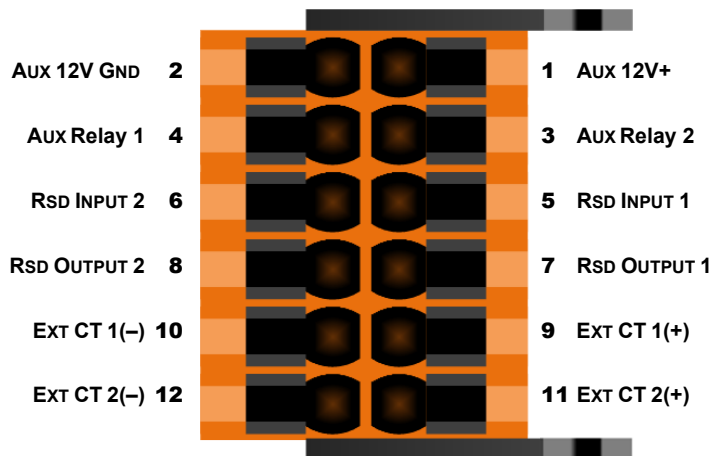

**Figure 36 AUX terminals**

## Generator Control

The **Generator** item in the **Action Menu** (see page 25) will manually start or stop a generator when set to **On** or **Off**. When set to **Auto**, it will start and stop the generator automatically once the requirements for **AGS** are met (under the **Generator** tab). A "start command" in the Mojave inverter refers to either situation. (See the next page for more explanation of automatic control.)

The **AUX** connections send generator commands. It is more common for the start circuit on a two-wire-start generator to use dry contacts. However, either a 12-volt output or "dry" relay contacts can be used, as shown in the *Quick Start Guide*. 

If using a generator with a three-wire-start circuit, a three-wire to two-wire conversion kit may be needed in conjunction with the **AUX**. Atkinson Electronics ([www.atkinsonelectronics.com](http://www.atkinsonelectronics.com)) is one company that makes these kits. The Atkinson GSM-Mini is intended to work with OutBack Power products.



### CAUTION: Equipment Damage

These functions, particularly AGS, can damage the generator or the batteries if either are not properly maintained. Be sure to follow all maintenance requirements for all the components in the system to prevent unnecessary and expensive damage.



### NOTES:

- ❖ When Start is pressed, the generator will continue to run until commanded to Stop. It will not stop automatically unless AGS is in use.
- ❖ The Cool down time setting only applies when AGS is in use. It is not used during a manual stop.

## To Enable the Generator for Operation:

1. Connect the generator's AC wiring to the inverter's **GEN L1** and **L2** input terminals.
2. Connect the generator's control wiring to either the **AUX RELAY** or the **AUX 12V** terminals.
  - Connect any additional hardware needed for starting the generator.
  - Consult the generator literature or manufacturer as needed to determine the generator's starting requirements.
  - See the *Quick Start Guide* for more information on any of these wiring connections.
3. Using the UI:
  - Under the Generator Tab, set AGS to Enabled.
  - In the Action Menu, set Generator to Auto.
  - Enter any generator settings, such as power or voltage limits.
  - Enable either the **RELAY AUX** or the **12V AUX** terminals, depending on the wiring.
  - Test-start the generator.

## Manual Generator Start

The generator may be manually started using the **Generator** item in the **Action Menu**, or from the generator's own controls. AGS does not need to be enabled for a manual start. The **Quiet Time**, **Exercise**, warm-up, and cool-down functions will not operate when the generator has been manually started. The generator will continue to run until it is manually stopped.

## Automatic Generator Start

AGS allows the inverter to start and stop the generator automatically. The advanced functions allow generator control based on battery state or load size. It can be exercised during inactive periods, or prevented from starting late at night or during other "quiet times."

AGS starts the generator when any of its Start conditions are met and stops the generator when any of its Stop conditions are met. A **Quiet Time** schedule overrides most Start conditions to keep the generator from running at inappropriate hours.

AGS requires two functions to be enabled before it can operate.

- o The **Generator** item in the **Action Menu** is set to **Auto**. (See page 25.)
- o **AGS** is set to **Enabled** under the **Generator** tab. (See page 70.)

If both of these items are not set correctly, none of the functions below will start the generator. However, it can still be manually started as described below.

When the **AUX** connection sends a start command and the **GEN** terminals receive voltage from the running generator, the **Status** (under the **Generator** tab) changes to **Warming Up**. During this countdown, the generator is allowed to run with no load. When the **Warm up time** setting expires, the inverter will close its generator relay and display **Connected**.

- o If the start command was due to an exercise period, it will not close the relay. **Info** will display **Gen start triggered due to exercise schedule** instead. The **Status** will display **Disconnected**.
- o If the **GRID** terminals are in use, it will not close the relay and will display **Disconnected**.

## Operation

- o If the power becomes unacceptable at any point (including while warming up), the inverter will open the generator relay and display a status of **Error**. (**Info** will indicate the specific problem.) It will not shut off the generator in the expectation that the power will return to normal.
- o If no power is received after three minutes of attempting the start sequence, the inverter will cease any starting attempts. **Status** will display **Error**. (**Info** will indicate **Generator failed to start**.) This error must be cleared before the inverter can attempt to start the generator again (see page 25). The **EVENTS** view will also display details. (See page 27.)

When the run period is over (whether due to automatic criteria or a manual command), the inverter opens its relay and displays **COOLING DOWN**. During this countdown, the generator is allowed to run with no load.

When the **Cool down time** setting expires, the **AUX** connection sends a stop command.

### SOC Start

When the battery discharges to the **Start SoC (%)** set point, the generator will start and the inverter will use generator power to charge the batteries. When the battery is charged to the **Stop SoC (%)** set point, the generator will stop. These settings will only operate when the **Start on low battery** item is enabled.

- o The system graphic under the **STATUS** view will show the system's measured SoC. (See page 19.)

### Voltage Start

When the batteries discharge to any of several selected low-voltage points for a designated period of time, the generator will start and the batteries will be given a "basic" charge. The designated time periods are 24 hours, 2 hours, and 2 minutes. When the inverter completes the bulk stage of charging (see pages **Error! Bookmark not defined.** and 66), the generator will stop. The generator will also stop if it reaches the **Max SOC (%)** set point (see page 52) before reaching the end of the bulk stage.

- o If the battery voltage decreases below any of these set points, the designated timer starts counting down.
- o If the voltage increases above the set point, the timer resets to maximum.
- o The timers also reset to maximum when AGS stops the generator or upon an AGS fault.
- o When any timer reaches zero (0), a start command is sent to the generator.
- o These timers cannot be viewed.

The three time designations are meant to show increasing levels of urgency (due to increased battery discharge). The voltages should be set accordingly.

- o **24 hour start voltage** is intended to start the generator after a mild battery discharge.
- o **2 hour start voltage** is intended to start the generator after a major battery discharge.
- o **2 minute start voltage** is intended to start the generator after a critical battery discharge.
  - This is considered an emergency start and should be set accordingly. It is the only AGS setting that will override **Quiet Time**.

These settings will only operate when the **Start on low battery** item is enabled.

## Load Start

The inverter will start the generator when running a high load. It will stop the generator when the load decreases.

- o When the **LOAD** terminals register an amount greater than **Start kW** for the **High load start delay** time, the generator will start.  
Following this operation:
- o When the **LOAD** terminals register an amount less than **Stop kW** for the **High load start delay** time, the generator will stop.



### NOTES:

- ❖ This function is meant to protect against rapid and unnecessary battery discharge. It does not protect against overload if the load is simply too large. Large, instantaneous loads can still overload the Mojave inverter if the generator does not start in time. The loads should be sized appropriately.
- ❖ When this function runs the generator, the inverter will charge the batteries. However, it is not programmed to perform a complete charge cycle. The charge might not be complete if the inverter reaches the **Stop kW** point and shuts down.

These settings will only operate when the **Start on high load** item is enabled.

## Quiet Time

During evening hours or other times when generator noise is not desired, the generator can be prevented from starting automatically.

- o The 24-hour and 2-hour start settings will not start the generator during these times.
  - Similarly, the **Start SoC**, **Start on high load**, and **Exercise** functions will not start the generator.
- o The generator can be started normally with the **Generator** item under the **ACTIONS** view.
- o The generator can be started normally using its own controls
- o **Quiet time start** will begin a single, daily quiet time. This period will end upon reaching **Quiet time stop**.
  - Alternate quiet times for weekends or other occasions are not available.



### NOTE:

The 2-minute start setting will start the generator regardless of quiet time. This is considered an emergency start due to low battery voltage. It overrides quiet time to perform required battery charging.

These settings will only operate when the **Quiet time** item is enabled.

## Exercise Start

The generator can be started on a regular basis to ensure that it does not sit unmaintained too long.

- o When the inverter reaches the **Exercise start time** on the designated **Exercise day**, the generator will start. It will continue running for the **Exercise duration**.
- o The generator will not close the relay during an exercise period. It will not charge batteries or deliver generator power to the loads.

## Start/Stop Table

This table summarizes the various start and stop conditions that apply to both AGS and manual control.

**Table 2 Start and Stop Reasons**

START REASONS	Full Charge Cycle	Stop Reasons						Run During Quiet Time?
		Stop SOC%	Below Stop kW	Quiet Time	Exercise Time Expires	Generator set to Off	Generator Controls	
<i>2 minute start voltage</i>	Yes	Stop				Stop	Stop	Yes
<i>2 hour start voltage</i>	Yes	Stop		Stop		Stop	Stop	No
<i>24 hour start voltage</i>	Yes	Stop		Stop		Stop	Stop	No
<i>Start SoC (%)</i>		Stop		Stop		Stop	Stop	No
<i>Start kW</i>			Stop	Stop		Stop	Stop	No
Exercise				Stop	Stop	Stop	Stop	No
<i>Generator set to On</i>	Yes					Stop	Stop	Yes
Generator controls	Yes					Stop	Stop	Yes



# Troubleshooting

## FAQ

**Table 3** Frequently Asked Questions

Question	Answer
What is the default password?	The default password for all access levels ( <b>Owner</b> , <b>Installer</b> , <b>Admin</b> ) consists of the last eight digits of the unit's serial number. See page 34.
What is the inverter's IP address?	The IP address is 192.168.2.2.
I forgot my password. How do I reset it?	<b>Owner:</b> Enter the incorrect password and use the <b>Reset</b> button. See page 35. <b>Installer:</b> Consult OutBack Power. <b>Admin:</b> Consult OutBack Power.
Why is there a difference between my own handheld meter readings and the readings on the UI?	Differences in both reading tolerances and calibration may result in different figures. In addition, efficiency losses are not always taken into account.
Can I turn off AC coupling?	No. See page 39.
Does this inverter have a mode for exporting power from other DC sources ("DC coupling")?	No. See page 10.
Can I use lithium-ion battery models other than those discussed in this book?	No. See page 64.
Can I use current transducer products other than those discussed in this book?	No. See page 11.
Can I interface the Mojave inverter with previous products by OutBack Power?	No. See page 11.
Can I use ACC power during ToU to charge the battery?	Yes. See page 41.



## Basic Troubleshooting

If the main LED indicator turns red or an error is shown by another means, check the **Status** view. If any errors are present, one icon will turn red to indicate the general location of the error. Only one icon can be red at a time.

**To continue troubleshooting:**

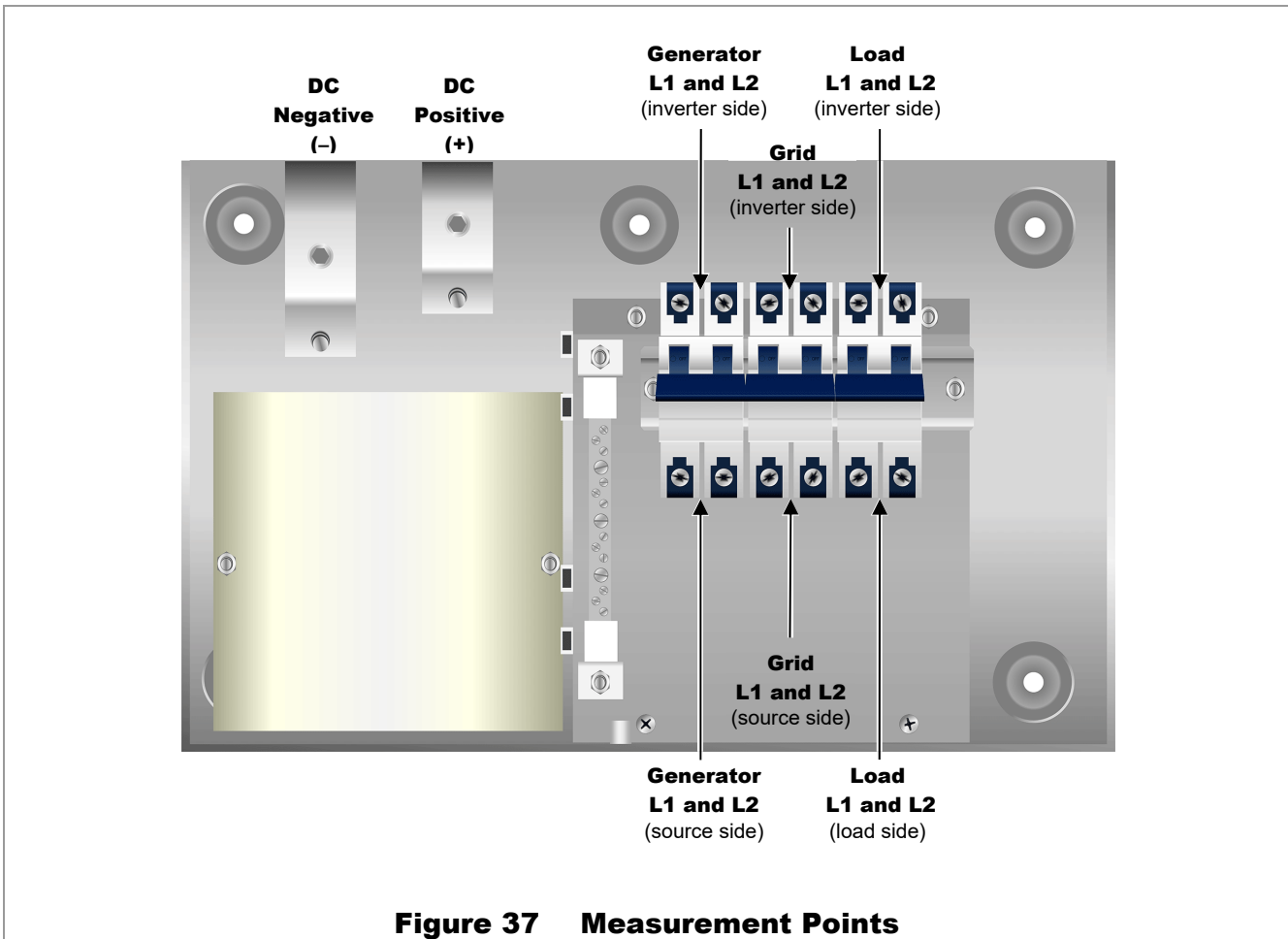

**Figure 37 Measurement Points**

On the following pages, Table 4 is organized in order of common symptoms, with a series of possible causes. It shows which LED indicator or icon colors should accompany a known problem. Each shows possible troubleshooting remedies, including checks with a handheld meter at the points shown in Figure 37. 



# Troubleshooting

**Table 4 Troubleshooting**

Symptom	Possible Cause	LED Indicator or Icon	Possible Remedy
No AC output (will not invert)	No DC voltage	N/A	Use a DC voltmeter to check the voltage directly on the DC terminals. If not present, the problem is external. If present, the inverter could be damaged.
	Battery voltage <40 Vdc	<ul style="list-style-type: none"> <li>Red LED</li> <li>Red battery icon</li> </ul>	Use a DC voltmeter to check the voltage directly on the DC terminals. Check the voltage at the batteries. Charge the batteries if necessary.
	Circuit breaker open (in wiring compartment)	<ul style="list-style-type: none"> <li>Green inverter icon</li> </ul>	Check position of load circuit breaker. (See Figure 37.) Use an AC voltmeter to check the voltage on both sides of the circuit breaker.
	Inverter set to <b>Off</b>	<ul style="list-style-type: none"> <li>Gray inverter icon</li> </ul>	In the <b>ACTIONS</b> view, set the <i>Inverter</i> item to <b>On</b> .
Inverter set to <b>On</b> and will not go to the "ON" state	Rapid shutdown connection not installed	<ul style="list-style-type: none"> <li>Red LED</li> <li>Red inverter icon</li> </ul>	Ensure that a jumper or rapid shutdown device is installed across pins <b>5</b> and <b>6</b> of the <b>AUX</b> terminal block.
	Error condition	<ul style="list-style-type: none"> <li>Red LED</li> <li>Various icons red</li> </ul>	Check the <b>EVENTS</b> view for any errors.
Will not connect to the AC source	Circuit breaker open (in wiring compartment)	<ul style="list-style-type: none"> <li>Gray source icon (grid or generator)</li> </ul>	Check position of circuit breaker. (See Figure 37.)
	No AC input	<ul style="list-style-type: none"> <li>Gray source icon (grid or generator)</li> </ul>	Using a handheld meter, check the AC voltage at the inverter's grid or generator terminals. (See Figure 37.) If not present, the problem is external. If present, the inverter could be damaged.
	AC source does not meet requirements	<ul style="list-style-type: none"> <li>Red/green LED</li> <li>Red source icon (grid or generator)</li> </ul>	Check the <b>EVENTS</b> view for the reason for disconnection. Check the source voltage and frequency using the <b>Grid</b> or <b>Generator</b> tabs under the <b>STATUS</b> view. Confirm these readings with a handheld meter if necessary.
	Inverter is connected to two lines of three-phase source	<ul style="list-style-type: none"> <li>Red/green LED</li> <li>Red source icon (grid or generator)</li> <li>Red inverter icon</li> </ul>	Inverter cannot connect to three-phase power. Make certain that 120/240 Vac power is available.
	Inverter was manually set to disconnect from AC	<ul style="list-style-type: none"> <li>Gray source icon (grid or generator)</li> </ul>	In the <b>ACTIONS</b> view, set the appropriate toggle ( <b>Grid</b> or <b>Gen</b> ) to <b>Use</b> . (If this setting was intentional, then no action is required.)

# Troubleshooting

**Table 4 Troubleshooting**

Symptom	Possible Cause	LED Indicator or Icon	Possible Remedy
Will not charge	No AC input	<ul style="list-style-type: none"> <li>Gray source icon (grid or generator)</li> </ul>	See “Will not connect to the AC source” listings.
	Inverter set to <b>Off</b>	<ul style="list-style-type: none"> <li>Gray inverter icon</li> </ul>	In the <b>ACTIONS</b> view, if <b>Grid</b> or <b>Gen</b> is set to <b>Use</b> but <b>Inverter</b> is set to <b>Off</b> , inverter will not charge.
	Charger set to zero	<ul style="list-style-type: none"> <li>Green battery icon</li> </ul>	In the <b>SETTINGS</b> view, check <b>Max charge current (A)</b> under the <b>Battery</b> tab. (If this setting was intentional, then no action is required.) <b>NOTE:</b> The ability to charge from the utility grid may have been restricted due to utility requirements.
	Grid input set to zero	<ul style="list-style-type: none"> <li>Green grid icon</li> </ul>	In the <b>SETTINGS</b> view, check the following under the <b>Grid</b> tab: ❖ <b>Import limit (W)</b> ❖ <b>Charge from grid limit (W)</b> (If either setting was intentional, then no action is required.) <b>NOTE:</b> The ability to import from the utility grid may have been restricted due to utility requirements.
Low charge rate	Charge complete or nearly complete	<ul style="list-style-type: none"> <li>Green battery icon</li> </ul>	Check the DC voltage and charging stage using the UI. Confirm with a handheld DC voltmeter.
	System display DC meter reads significantly higher than actual battery voltage	<ul style="list-style-type: none"> <li>N/A</li> </ul>	Using a handheld DC voltmeter, check the voltage on the inverter’s DC terminals. If different from the UI reading, the inverter could be damaged. Otherwise, check the DC voltage on the batteries. If different from the reading on the inverter, this could be a DC connection problem.
	High output loads	<ul style="list-style-type: none"> <li>N/A</li> </ul>	If total loads and charge exceed the AC input setting, charge rate decreases to give priority to the loads. Turn off some of the output loads and test the charge rate again.
	High inverter temperature	<ul style="list-style-type: none"> <li>N/A</li> </ul>	The inverter will reduce the current rate for charging and other activities if the internal temperature exceeds a certain level. Check temperature and allow the inverter to cool if necessary. External cooling may also be applied.
Multiple HBCI events	Battery bank too small in AC coupling application	<ul style="list-style-type: none"> <li>N/A</li> </ul>	The inverter will charge the batteries with excess AC-coupled power. The batteries must be sized accordingly. Increase the bank size if necessary.

**Table 4 Troubleshooting**

Symptom	Possible Cause	LED Indicator or Icon	Possible Remedy
Will not export AC-coupled power to the utility grid (See page 39)	Grid power does not meet requirements; inverter will usually disconnect	<ul style="list-style-type: none"> <li>Red/green LED</li> <li>Red grid icon</li> </ul>	Verify grid voltage and frequency. Determine if they are within the inverter's approved limits. If not, the inverter is operating correctly. Contact the utility company if necessary.
	The inverter has other criteria which must be met, such as the qualifying time	<ul style="list-style-type: none"> <li>Gray grid icon</li> </ul>	Wait until qualifying timer expires.
	All available AC-coupled power is used by batteries	<ul style="list-style-type: none"> <li>N/A</li> </ul>	If the batteries need a full charge, this may consume all power. Wait until charge is complete.
	All available AC-coupled power is used by loads	<ul style="list-style-type: none"> <li>N/A</li> </ul>	Reduce loads. (If loads are desired size, no action is required.)
	GD inverter problem	<ul style="list-style-type: none"> <li>N/A</li> </ul>	Confirm that the grid-direct inverter is operating correctly.
Unusual voltage on hot or neutral output line	System neutral and ground may not be bonded	<ul style="list-style-type: none"> <li>N/A</li> </ul>	Using a handheld AC voltmeter, test the <b>N</b> , <b>L1</b> and <b>L2 LOAD</b> terminals. (See page 80.) These measurements should give full voltage. Test neutral and ground connections. This measurement should read zero volts. Any other result means neutral and ground are not bonded correctly. If this is the case, the hot line often reads 60 to 75 Vdc and the neutral reads 45 to 60 Vdc with respect to ground. (If bonding is not required or is prohibited by national or local codes, then no action may be required.)
Unusual and different voltages on AC hot input lines	Input neutral is not connected correctly ❖ Inverter may also not connect to AC source ❖ Loads may behave unusually	<ul style="list-style-type: none"> <li>N/A</li> </ul>	Test <b>L1</b> input and neutral connections with AC voltmeter. Test <b>L2</b> input and neutral connections with AC voltmeter. (This can be on <b>GRID</b> or <b>GEN</b> input, depending on where the symptoms appear.) Test <b>L1</b> to <b>L2</b> input. From hot to neutral should be approximately 120 Vac unless the output has been adjusted. <b>L1</b> to <b>L2</b> should be approximately 240 Vac. If the two outputs are different voltages but still add up to 240 Vac, the neutral is not connected to the inverter.

# Troubleshooting

**Table 4 Troubleshooting**

Symptom	Possible Cause	LED Indicator or Icon	Possible Remedy
Loads drop out or crash during transfer	Loads sensitive to inverter's transfer time	<ul style="list-style-type: none"> <li>N/A</li> </ul>	The inverter features a small but noticeable response time during transfer. Certain loads (such as highly sensitive computers) may not respond well. An uninterruptible power supply may be needed.
	Loads too large	<ul style="list-style-type: none"> <li>Red LED</li> <li>Red inverter icon</li> </ul>	The unit can transfer more power than it can invert. If loads are oversized, the unit will falter or crash when switching to batteries. Reduce the size of the loads.
	Undersized battery cables	<ul style="list-style-type: none"> <li>Red LED</li> </ul>	Battery cables smaller than recommended will cause a significant voltage drop when switching to batteries, acting like either an overload or a low-battery condition. Size all cables correctly.
Generator fails to start; AGS conditions were met	<b>Generator</b> not set to <b>Auto</b> in <b>Action Menu</b>	<ul style="list-style-type: none"> <li>N/A</li> </ul>	Both items must be set before AGS can function. In the <b>STATUS</b> view, <b>AGS Status</b> will not read <b>Enabled</b> if both items are not set.
	<b>AGS</b> not set to <b>Enable</b> under <b>Generator</b> tab		
Generator, external fan, etc. fails to start when signal is provided by <b>AUX</b> output	<b>AUX</b> output is not connected	<ul style="list-style-type: none"> <li>Yellow LED</li> <li>Yellow generator icon</li> </ul>	<p>Test the generator or device to confirm functionality. Test the appropriate <b>AUX</b> terminals with a DVM. (If the <b>RELAY AUX</b> terminals are in use, test for continuity. If the <b>12V AUX</b> terminals are in use, test for 12 Vdc.)</p> <ul style="list-style-type: none"> <li>❖ If the proper results are present when the <b>Action Menu</b> indicates the function is <b>On</b> (and the device still does not work), then there is an external connection problem.</li> <li>❖ If the proper results are not present with the function <b>On</b>, the <b>AUX</b> circuit may be damaged.</li> </ul>
	Wrong <b>AUX</b> terminals were programmed	<ul style="list-style-type: none"> <li>Yellow LED</li> <li>Yellow generator icon</li> </ul>	Confirm that the <b>AUX</b> item that was programmed matches the terminals that are in use.
	Wrong <b>AUX</b> terminals are in use	<ul style="list-style-type: none"> <li>Yellow LED</li> <li>Yellow generator icon</li> </ul>	If generator or external device requires 12 Vdc, confirm the <b>12V AUX</b> terminals have been connected. The <b>RELAY AUX</b> terminals do not provide voltage.



# Service Instructions



## **CAUTION: Equipment Damage**

- ❖ These instructions are for use by qualified personnel who meet all local and governmental code requirements for licensing and training for the installation of electrical power systems with AC and DC voltage up to 600 volts.
- ❖ This product is only serviceable by qualified personnel. Performing these operations without first consulting OutBack Power may void the product's warranty.

## Replacement Kits

This chapter details how to perform service on the Mojave Series Inverter/Charger. The following instructions will cover the following replacement kits:

- o **SPARE-501** (Mojave Control Board)
- o **SPARE-502** (Mojave 60 Hz AC Board)
- o **SPARE-504** (Mojave Carrier Board)
- o **SPARE-506** (Mojave Power Module)
- o **SPARE-508** (Mojave Fan Module)

The instructions for the following kits are not included as separate procedures. The instructions for these kits are either part of existing procedures (as noted on the following pages), or are part of the standard installation instructions as detailed in the *Mojave Inverter/Charger Quick Start Guide*.

- o **SPARE-509** (Mojave CANBUS Terminator and Auxiliary Terminal)
- o **SPARE-510** (Mojave Antenna Kit)
- o **SPARE-511** (Mojave Mounting Bracket)
- o **SPARE-512** (Mojave Cover)
- o **SPARE-514** (Mojave BOS [Wiring Compartment] Door)
- o **SPARE-515** (Mojave BOS [Wiring Compartment] Door Hardware Kit)

The following parts are also available.

- o OBR-16-DIN (Relay)
- o RTS (Remote Temperature Sensor)
- o OBCT-200 (Current Transducer)
- o DIN-60D-AC (AC Circuit Breaker)
  - This item is usable when adding a **GEN** input, as well as a replacement for the **GRID** or **LOAD** circuit breakers.

# Preparatory Steps

Follow the procedures which are applicable to the system. If any elements are not present, ignore those procedures.

## Tools Needed

- o Digital multimeter (DMM)
- o 5 mm hex (Allen) wrench
- o #1 Phillips screwdriver
- o #2 Phillips screwdriver
- o Torque driver

## Disconnection

Power down and disconnect all power sources from the inverter prior to performing any service. Turn off all circuit breakers connected to the inverter.

- o **LOAD** circuit breaker
- o **GRID** circuit breaker
- o **GEN** circuit breaker
- o DC circuit breakers
- o Generator start circuit

## Voltage Check

Once these connections are turned off, verify with a voltmeter that NO voltage is present at the DC+ to DC- terminals. Refer to Figure 37 on page 80.



### **WARNING: Shock Hazard and Equipment Damage**

It may take time for internal capacitance to fully discharge. Ensure full discharge for at least one minute (less than 1 Vdc) prior to continuing. The inverter's capacitors may retain a sizable charge, which can cause electrical shock or severe equipment damage during normal handling. This damage is not covered under the unit's warranty.

## Removal of Covers

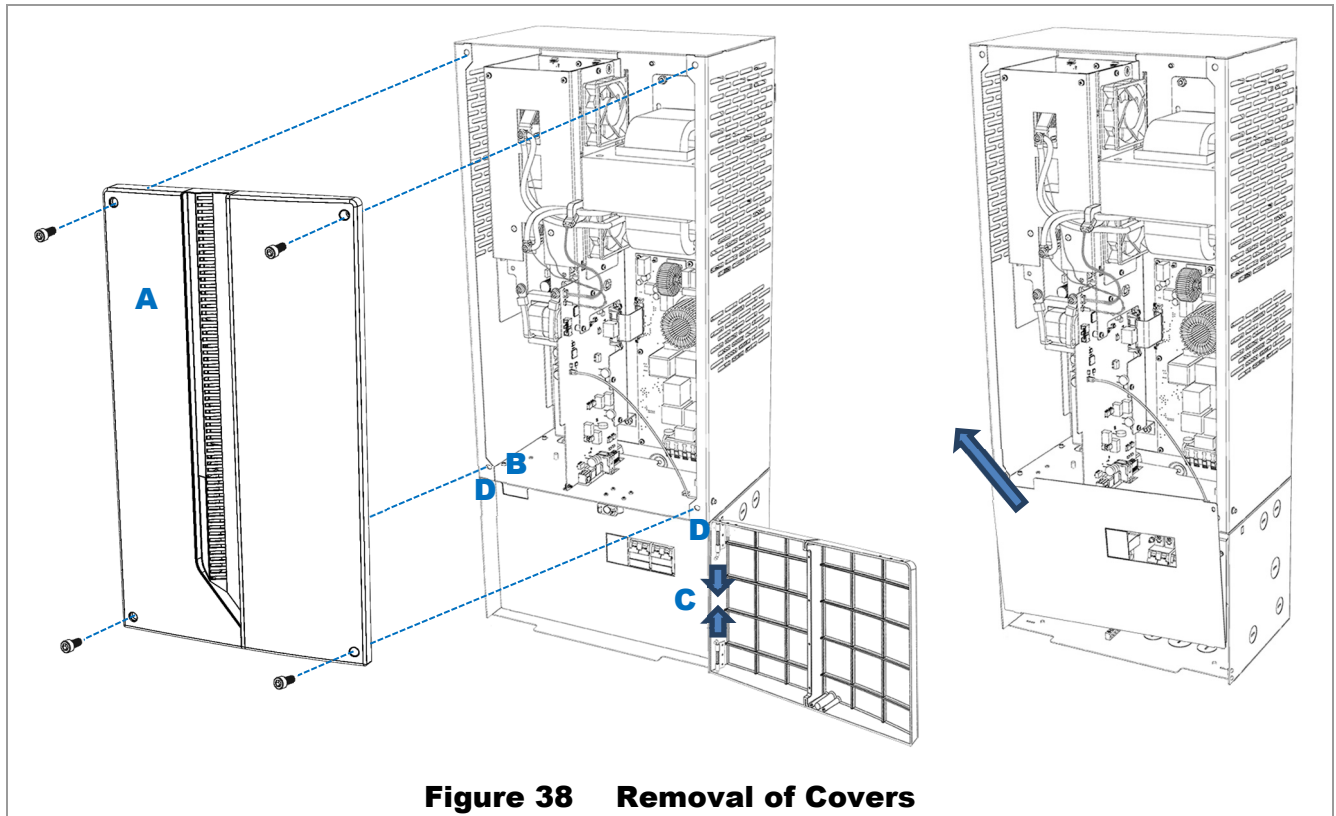

**Figure 38 Removal of Covers**

### To remove the covers:

1. Using a 5 mm hex (Allen) wrench, remove 4 screws from the cover. Remove the cover. See **A** in Figure 38.
2. Open the wiring compartment door by pressing the latch at **B**. The door swings to the right. Remove the door by pulling inward on the pins **C** at the corners of the door.
3. Inside is a “dead front” which prevents accidental contact with anything other than the circuit breakers. To remove the dead front, remove the two screws **D** from the corners of the dead front. The dead front will rotate forward from the top, but is slotted in place at the bottom. Remove the dead front by pulling upward and out. See **E**.

**Removal is complete. Proceed to the replacement instructions.**

## Replacement of Control Board

### To replace the control board (SPARE-501):

1. Remove the **AUX** terminal block from its socket. See **A** in Figure 39. Use the black levers **B** on the sides of the block to help remove it.
2. Using a #1 Phillips screwdriver, remove the securing screw for the control board. See **C** in Figure 39.

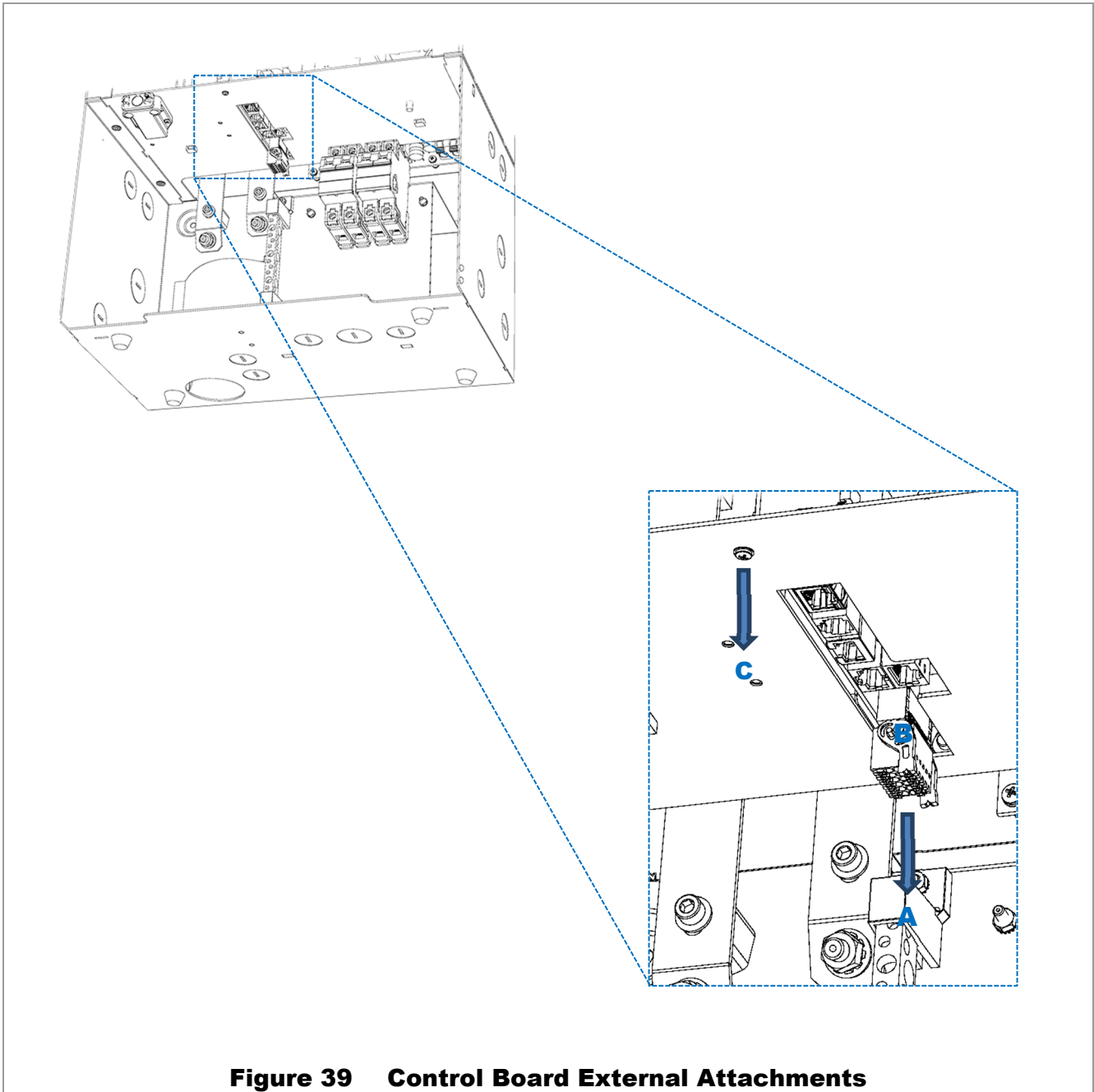
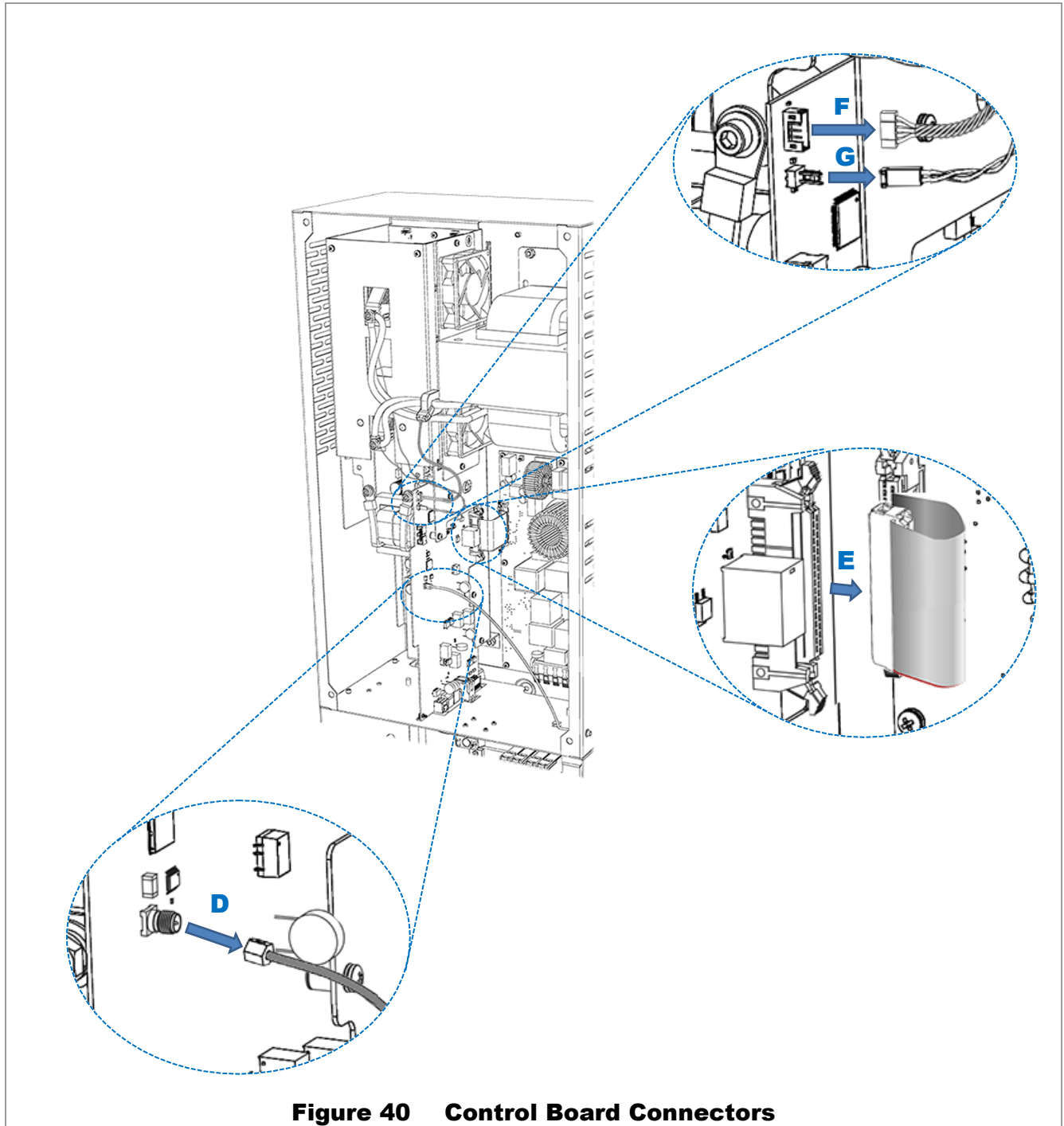

**Figure 39 Control Board External Attachments**



3. On the control board, remove the following connectors (see Figure 40):

- RP-SMA connector (**D**) for the antenna wire.
- Ribbon cable (**E**) for the AC board.
- 5-pin connector (**F**) for the current transducer.
- 2-pin connector (**G**) for the power modules.



4. Using a #2 Phillips screwdriver, remove 4 screws **H** from the control board. See Figure 41.

## Service

- Carefully remove the control board, pulling toward the front of the inverter, as shown in Figure 41.

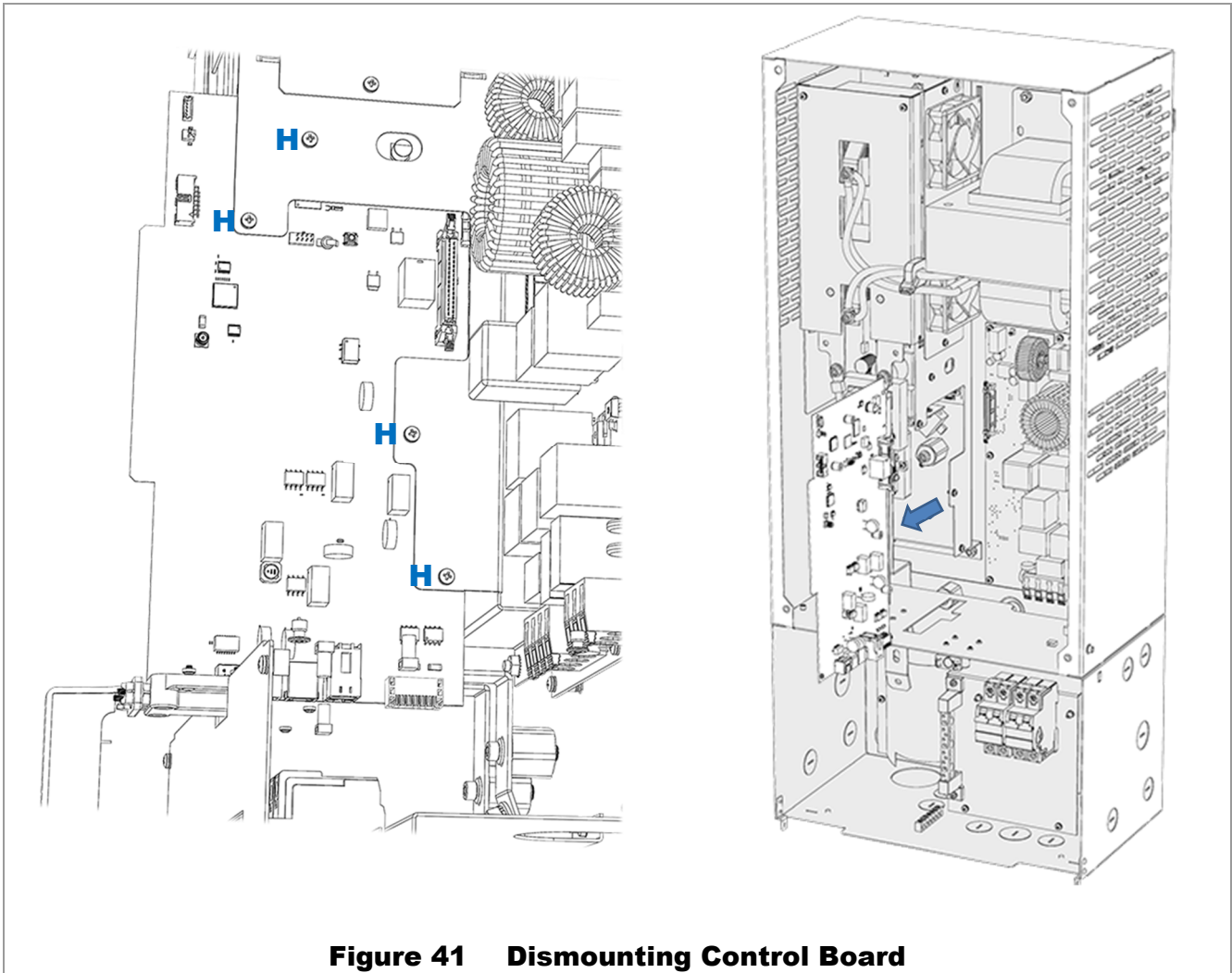

**Figure 41 Dismounting Control Board**

- Replace the control board. Perform all previous steps in reverse order.
  - Insert the control board.
  - Replace the screws **H**. Do not tighten.
  - Replace the connectors **G** and **F**. See Figure 40 if necessary.
  - Replace the ribbon cable **E** and the RP-SMA cable **D**. See Figure 40 if necessary.
  - Replace the securing screw **C**. See Figure 39 if necessary.
  - Tighten all screws **H**.
  - Replace the **AUX** terminal block **A**. See Figure 39 if necessary.

**Replacement is complete.**

## Replacement of AC Board

### To replace the AC board (SPARE-502):

1. Before beginning, remove the RP-SMA cable for the antenna wire. See **A** in Figure 42. Note that this is not a required step for board replacement, but will make access to the board easier.
2. Unclip all wires from AC terminals at the bottom of the board, including the neutral wire. See **B**.



#### IMPORTANT:

- ❖ Mark or note the wire positions so that they can be reinstalled correctly. The wire positions on the terminals do not correspond to their positions on the circuit breakers.
- ❖ This example does not depict generator wiring. If a generator is connected (**B1** and **B2**), these wires must be disconnected as well.

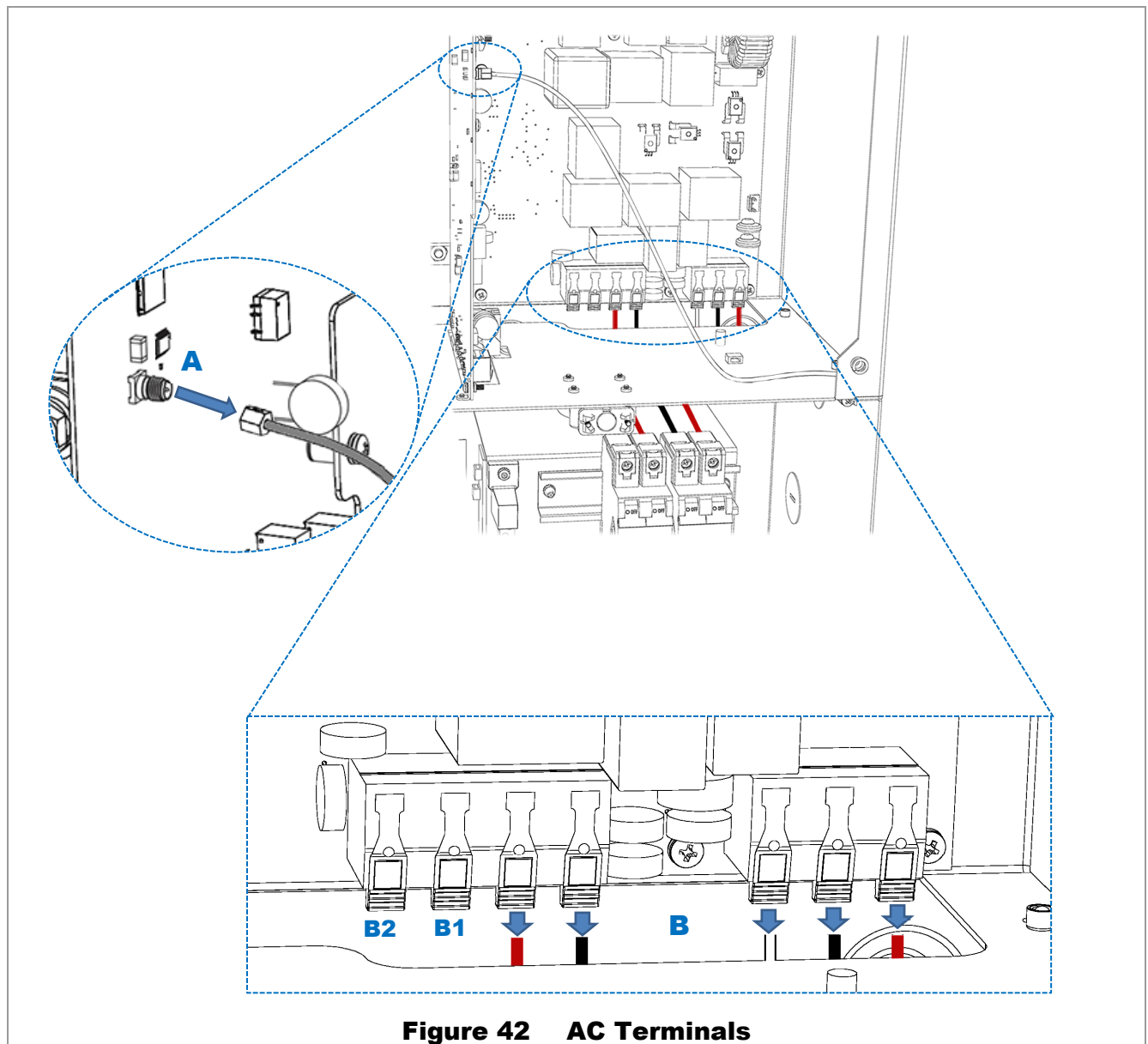

Figure 42 AC Terminals

# Service

Unclip all wires from the transformer terminals. See **C** in Figure 43.



## IMPORTANT:

- ❖ Mark or note the wire positions so that they can be reinstalled correctly. The four wires are marked with numbers 5 through 8. They are installed in the positions shown in Figure 43. The terminals, however, are not marked.

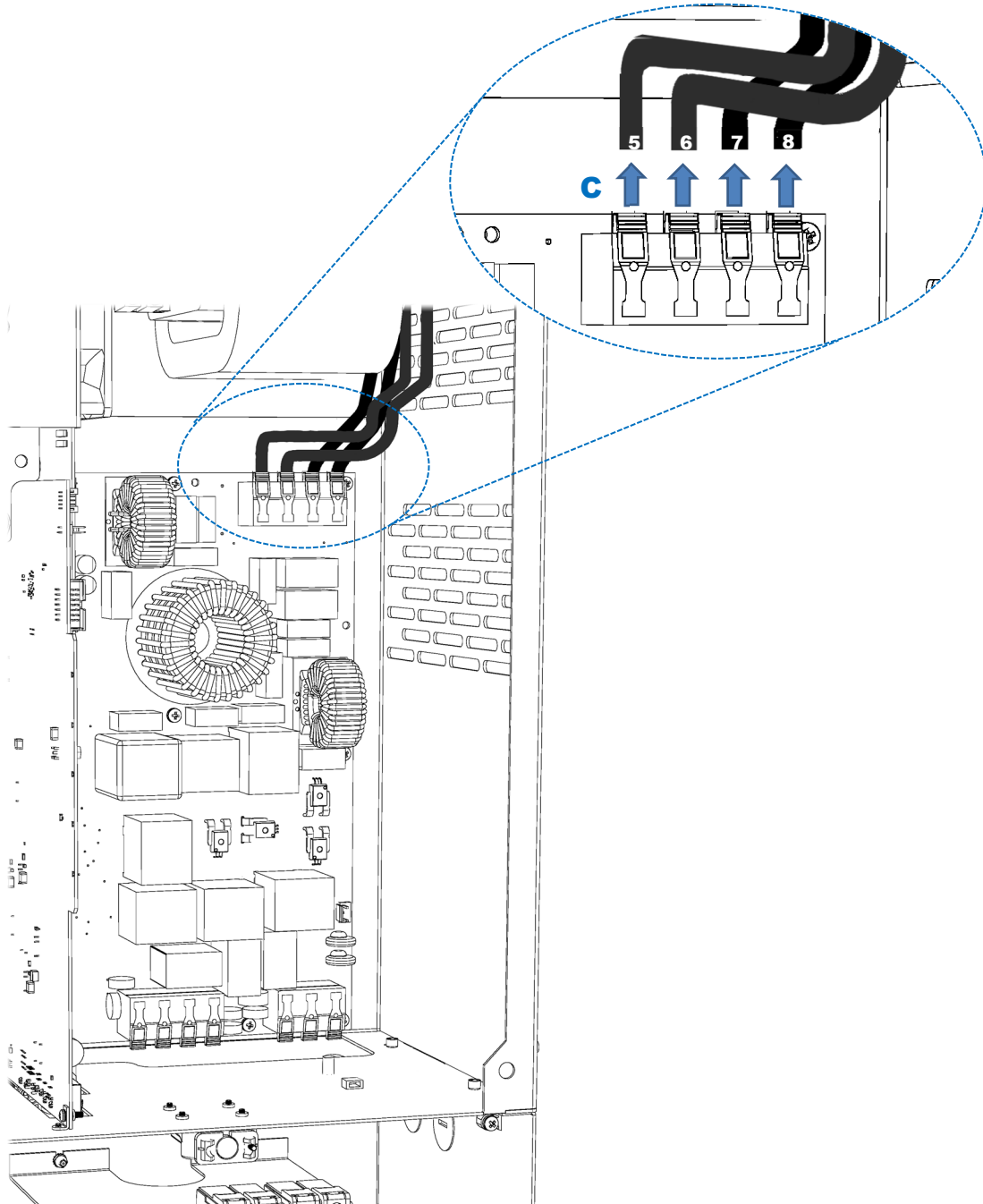

**Figure 43 Transformer Terminals**

3. On the AC board, remove the following connectors (see Figure 44):
  - Ribbon cable (**D**) for the control board.
  - 2-pin connector (**E**) for the transformer.

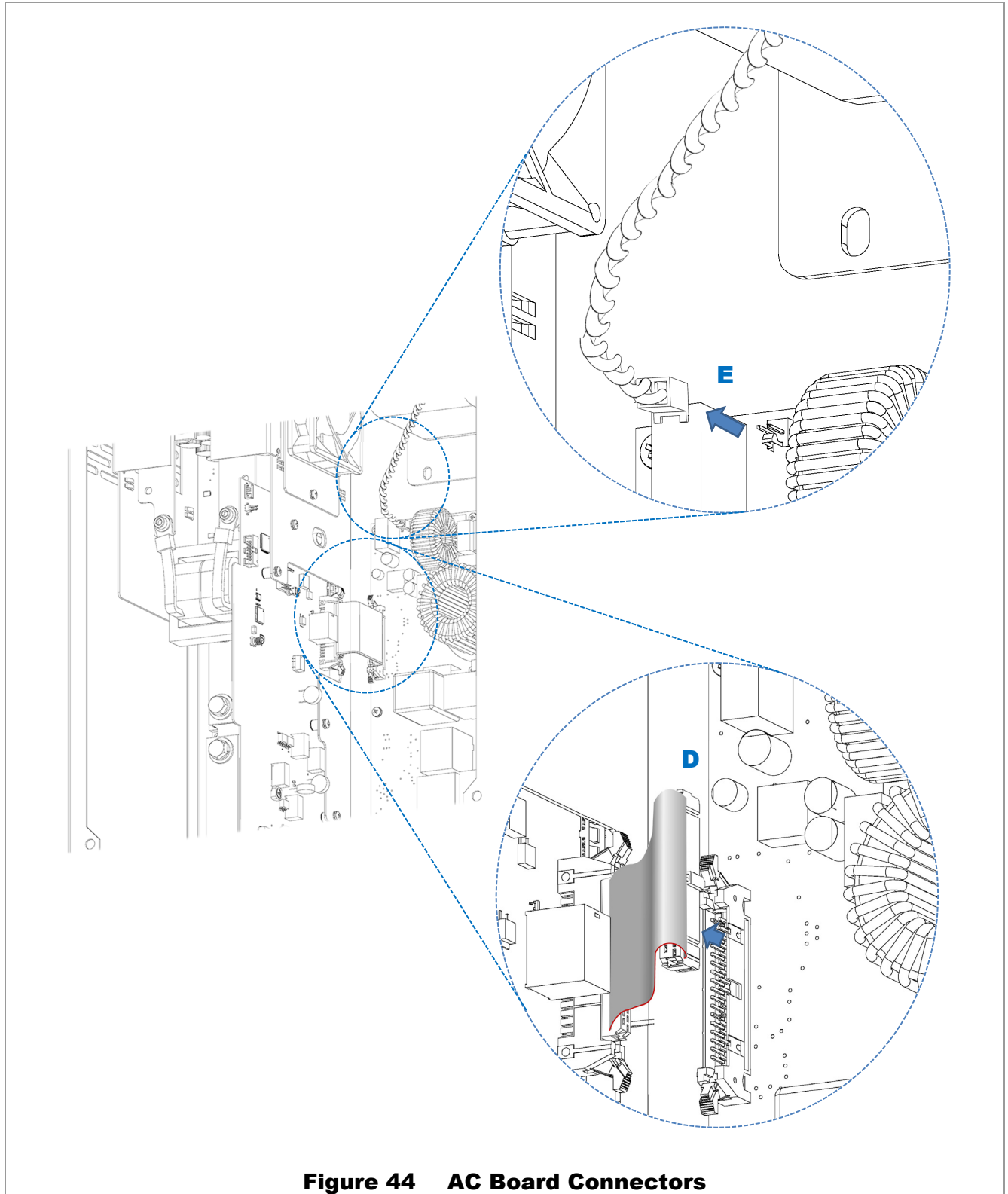

**Figure 44 AC Board Connectors**

## Service

- Using a #2 Phillips screwdriver, remove 9 machine screws **F** that secure the AC board in place. See Figure 45.
- Carefully remove the AC board. Avoid gripping the board by the large chokes (coils). If necessary, the plastic relay housings such as **G** can be used to hold the board.

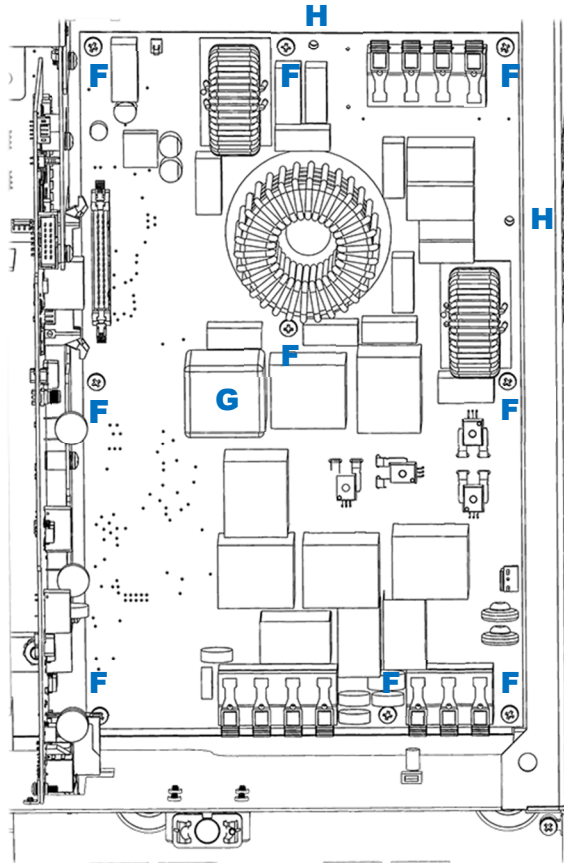

**Figure 45 Dismounting AC Board**

- Replace the AC board. Perform all previous steps in reverse order.
  - Carefully insert the AC board. Ensure that the board fits over the two alignment pins **H**. Components on the board can be damaged through mishandling at this stage.
  - Replace the screws **F**.
  - Replace the connectors **E** and **D**. See Figure 44 if necessary.
  - Replace the transformer wires **C**. Make certain to observe the correct wire positions. See Figure 43 if necessary. Make certain that the wires are fully inserted and that no stray strands are exposed. After latching, tug on the wires to ensure that they are secure.
  - Replace the AC wires **B** and the RP-SMA cable **A**. See Figure 42 if necessary. After latching, tug on the wires to ensure that they are secure.

**Replacement is complete.**

## Replacement of Fan Module

### To replace the fan module (SPARE-508):

1. Remove the two fan plugs at the top of the carrier board. See **A** in the Figure 46 inset. If necessary, loosen the power module cage cover at **B** to allow access to the plugs.
2. Using a #2 Phillips screwdriver, remove the two screws securing the fan module. See **C** in Figure 46.
3. Slide the fan module out of its slot in the direction indicated by **D** in Figure 46. Note that the module will have to slide under the transformer cables **E**, which have not been removed.

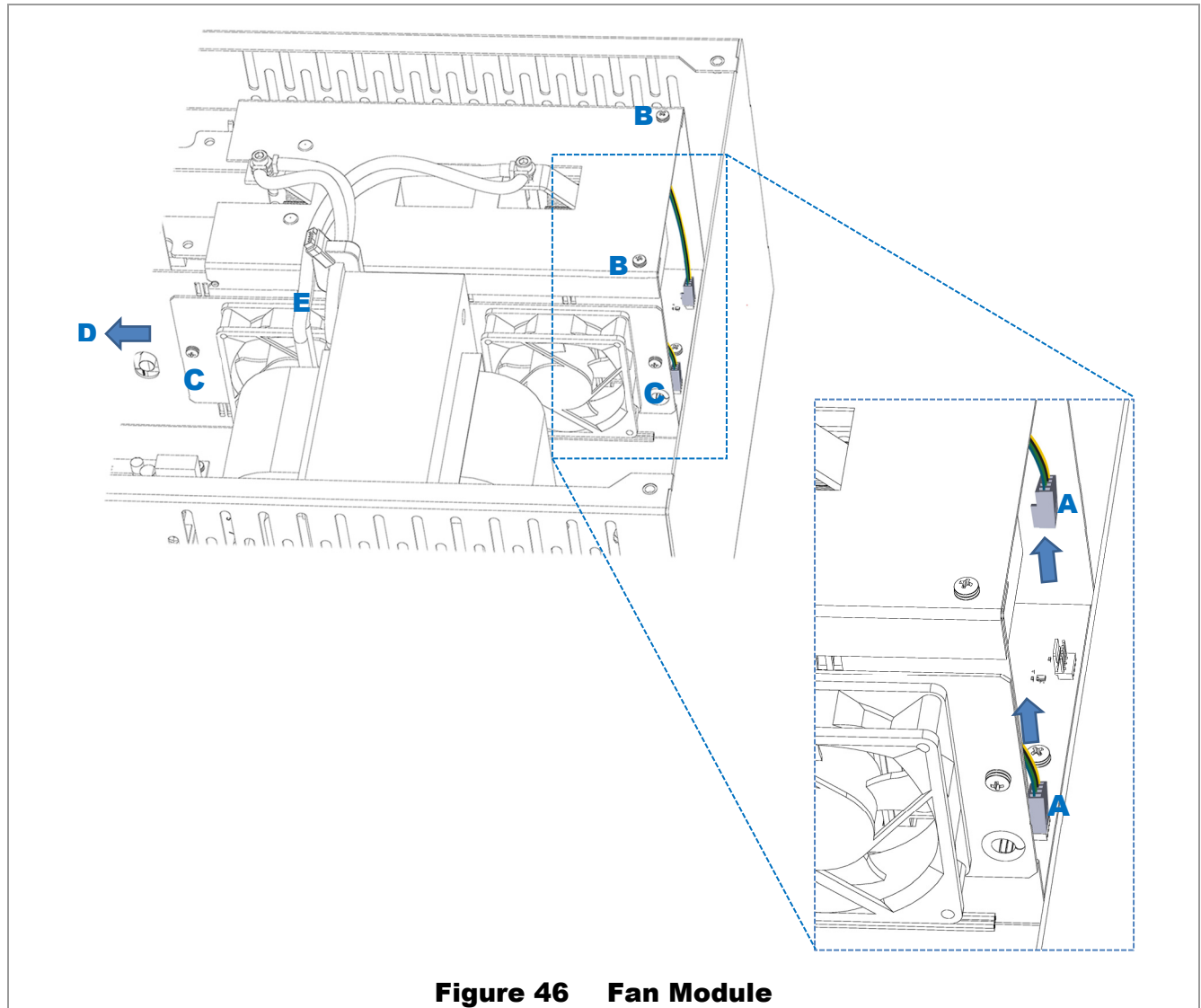

**Figure 46 Fan Module**

4. Replace the fan module. Perform all previous steps in reverse order. See Figure 46.
  - Insert the fan module by passing it under the transformer cables **E**.
  - Replace the screws **C**.
  - Replace the connectors **A**. (Replace the screws **B** if loosened.)

**Replacement is complete.**

## Replacement of Power Module

To replace either of the two power modules (SPARE-506):

1. Remove the 5-conductor current transducer plug from the control board. See **A** in Figure 47.
2. Remove the 2-pin voltage sense connector. See **B** in Figure 47.

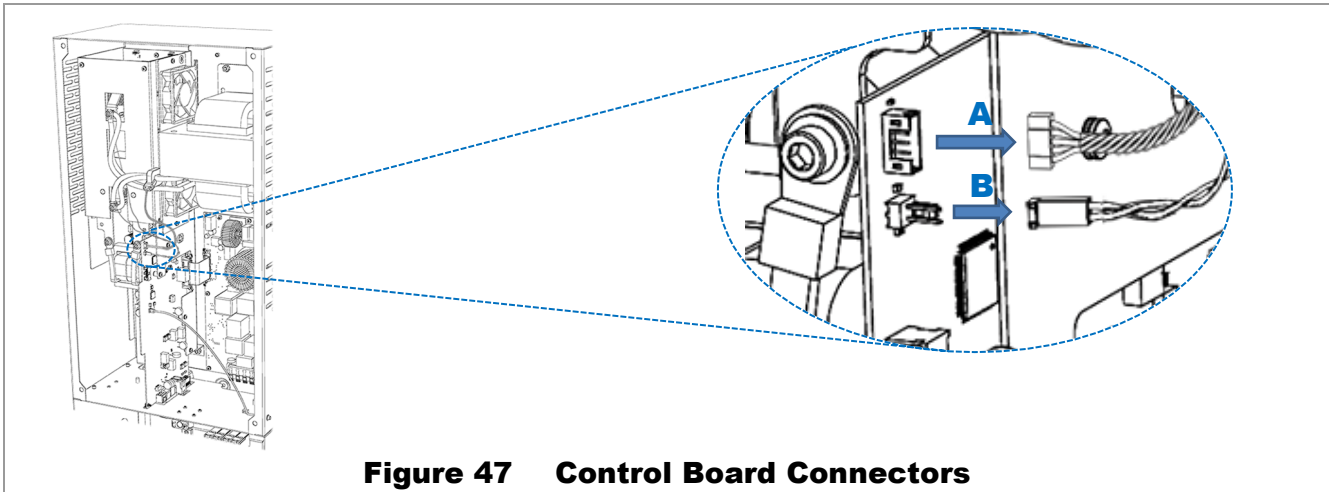

**Figure 47 Control Board Connectors**

3. Using a 5 mm hex (Allen) wrench, remove bolts and washers for transformer cables. See **C** in Figure 48.
4. Remove transformer wires by bending them away from work area. See **D** in Figure 48. The voltage sense wires will be completely disconnected at this stage; set them aside.
5. Remove the cover for the power module cage. See Figure 48 for all items.
  - Using a #2 Phillips screwdriver, remove the two screws **E** securing the cover at the top.
  - Tilt the cover up from the top as in **F**. Disengage the keyhole fasteners from the bottom of the cover as in **G**. Once disengaged, remove the cover.

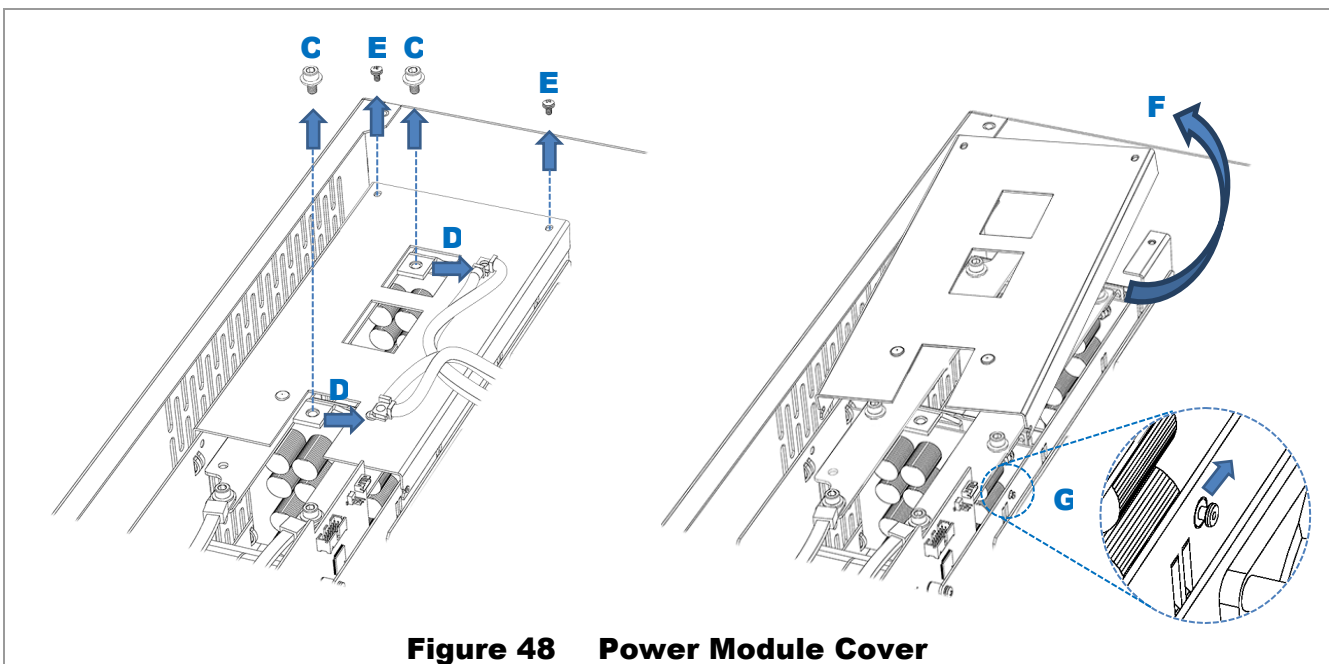

**Figure 48 Power Module Cover**



6. Using a 5 mm hex (Allen) wrench, remove bolts for bus bars. See all items **H** in Figure 49. Remove the two bus bars **I**.
7. Remove the power module to be replaced. Pull upward to unsocket the module. See **J** in Figure 49.

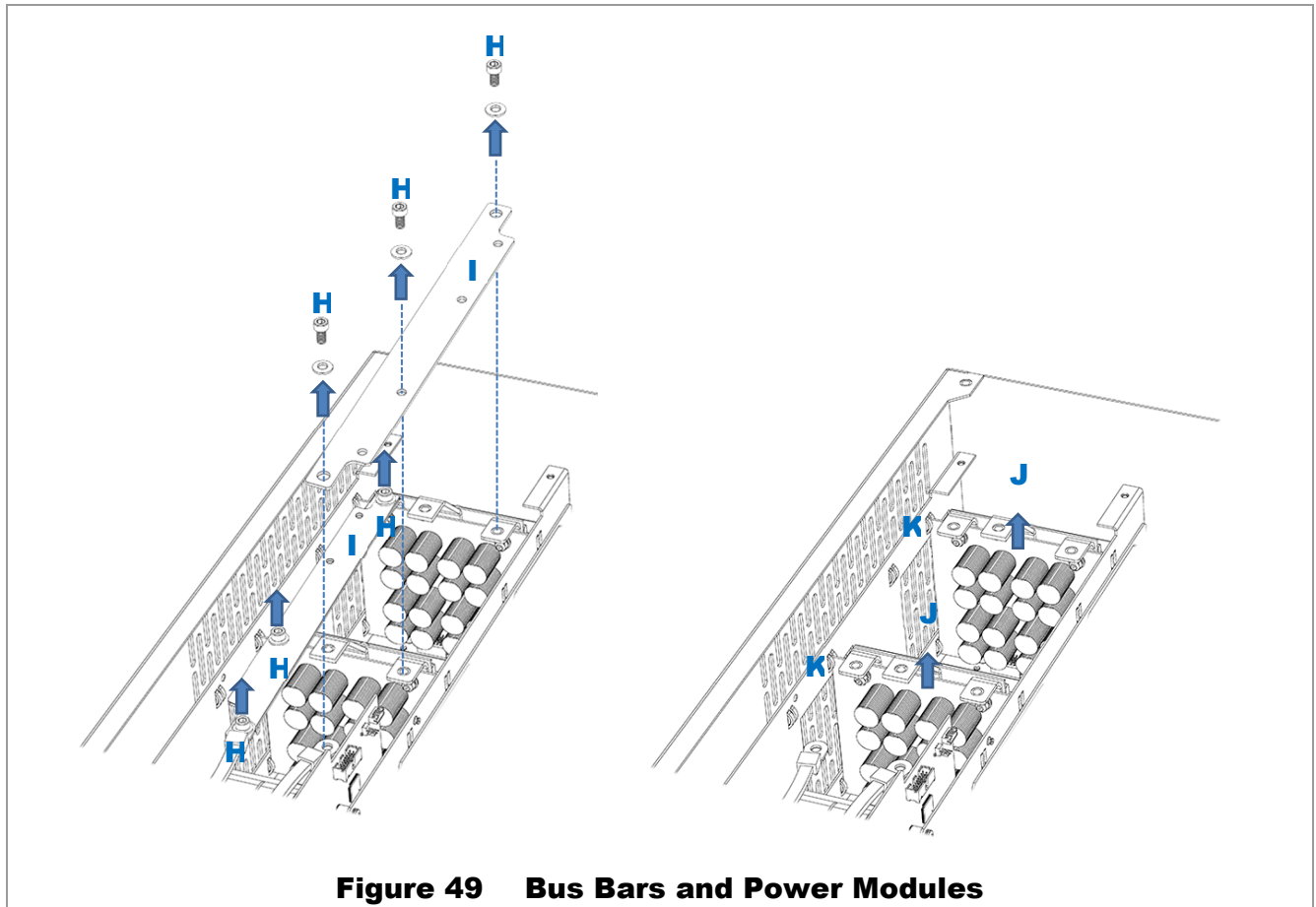

8. Replace the power module or modules. Perform all previous steps in reverse order.
  - Insert the power module into its slot. Ensure that the new board is slotted into the card guides **K**. (See Figure 49.) Ensure it is seated firmly.
  - Replace bus bars **I**. Replace bolts **H**. Tighten to a torque value of 60 in-lb (6.8 Nm). See Figure 49.
  - Replace the cage cover by attaching the keyhole fastener **G** and lowering the cover into place **F**. Replace the cover screws **E**. See Figure 48 if necessary.
  - Replace the transformer cables and hardware **C**. See Figure 48 if necessary. Ensure that the hardware is stacked in the following order.
    - ✓ Voltage sense wire (top)
    - ✓ Washer
    - ✓ Transformer cable
    - ✓ Transformer cable (bottom)
  - Replace voltage sense connector **B** and current transducer connector **A**. See Figure 47 if necessary.

**Replacement is complete.**

# Replacement of Carrier Board

### To replace the carrier board (SPARE-504):

1. Follow all steps to remove the control board. See the procedure **Replacement of Control Board** on page 88.
2. Remove the common-mode choke **A**. See Figure 50 for all items.
  - Using a 5 mm hex (Allen) wrench, remove the bolts **B** on the bus bars.
  - Using a 5 mm hex (Allen) wrench, remove the bolts **C** on the bottom of the choke. Support the choke while the bolts are being removed, then remove the choke.
3. Remove the 4-pin connector (not depicted in Figure 50) that plugs into the carrier board at **D**.

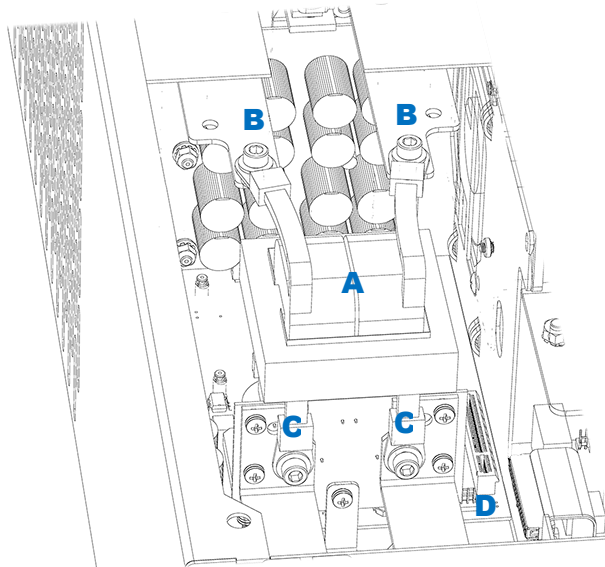
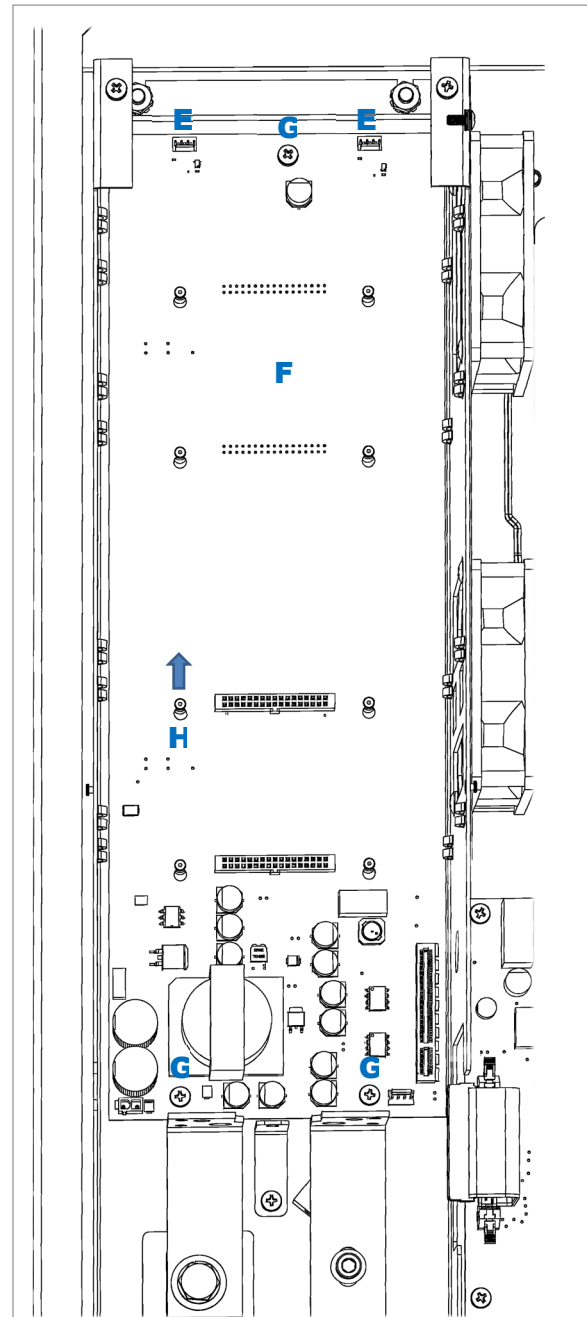

**Figure 50 Common-Mode Choke**

4. Follow all steps to remove the power modules. See the procedure **Replacement of Power Module** on page 96. Both modules must be removed.

5. Remove the two fan plugs at the top of the carrier board **F**. See **E** in Figure 51. If necessary, see **A** in the Figure 46 inset.
  6. Using a #2 Phillips screwdriver, remove the screws **G** at the top and bottom of the carrier board. See Figure 51.
  7. Push the board upward slightly to disengage the keyhole fasteners. One of these fasteners is indicated at **H**. All fasteners must be disengaged.
  8. Remove the carrier board **F**. It may be necessary to tilt the board to avoid obstacles.
9. Replace the carrier board. Perform all previous steps in reverse order. When reinstalling washers, bolts, and similar hardware, use the replacement hardware included in the kit.
    - Replace the carrier board **I**. See Figure 51 for all items.
      - ✓ Pull downward to engage the keyhole fasteners **H**.
      - ✓ Replace the screws **G**.
    - Replace the fan plugs **E**.
    - Replace the common-mode choke **A**. See Figure 50 for all items.
      - ✓ Replace the lower bolts **C** while supporting the choke by hand.
      - ✓ Do not replace the bus bar bolts **B** yet.
    - Replace the power modules. See page 96 if necessary.
      - ✓ Replace the bus bars and all bolts.
    - Replace the connector at **D**.
    - Replace the control board. See page 88 if necessary.

**Replacement is complete.**





**Figure 51 Carrier Board**



## Preventative Maintenance

The Mojave inverter requires almost no regular maintenance. However, OutBack Power recommends the following items on a periodic basis:

- o Vacuum or otherwise clean all vents on a regular basis.
- o Check all electrical connections periodically for tightness using the torque values listed in the *Mojave Inverter/Charger Quick Start Guide*.  Turn off all circuit breakers before making these checks.
- o Check the batteries according to the recommendations and schedule provided by the battery manufacturer. Perform equalization as appropriate. 



# Specifications

## Electrical Specifications

**Table 5 Electrical Specifications for Mojave Inverter**

Specification		Value
Continuous output power at 40°C	Grid-tied	7680 VA
	Off-grid	8000 VA
Continuous AC output current	Grid-tied	32 Aac
	Off-grid	34 Aac
AC output voltage		120/240 Vac
AC output frequency		60 Hz
AC output type		Split-phase
AC waveform		True Sinewave
Peak efficiency		93.5%
CEC weighted efficiency		Pending
Total harmonic distortion (maximum)	Voltage	0.75%
	Current	1.5%
Power factor		-1 to 1
AC Overload Capability (100 ms surge)		10 kVA
AC Overload Capability (5 second)		10 kVA
AC Overload Capability (30 minute)		8 kVA
AC Maximum Output Fault Current and Duration		365 Aac for 75 $\mu$ S
AC Maximum Backfeed Current and Duration	UL 1741	420 A <sub>peak</sub> for 17.7 ms
	CSA	Zero
Power Consumption (idle) – Invert mode, no load		100 W
Power Consumption – Off		10 W
Grid Input Current (maximum continuous)		55 Aac
Grid-Interactive Voltage Range (continuous)		211.2 to 264 Vac
Grid-Interactive Frequency Range		50 to 66 Hz
Generator Input Current (maximum continuous)		55 Aac
DC Input Voltage (nominal)		48 Vdc
DC Input Voltage Range		42 to 60 Vdc
DC Maximum Input Voltage		68 Vdc
DC Input Max. Current (continuous full power)		200 Adc
DC Input Maximum Current (short-circuit)		352.5 Adc for 13.9 ms
Battery Charger Maximum AC Input		32 Aac at 240 Vac

# Specifications

**Table 5 Electrical Specifications for Mojave Inverter**

Specification	Value	
Battery Charger Maximum DC Output	170 Adc	
DC Output Voltage Range (charging)	40 to 64 Vdc	
Auxiliary Output	0.8 Adc at 12 Vdc	
Auxiliary Relay	4 A at 250 Vac or 30 Vdc	
CT wire length	Included with product	8' (2.5 m)
	Maximum allowed length	32.8' (10 m)

## Mechanical Specifications

**Table 6 Mechanical Specifications for Mojave Inverter**

Specification	Value
Inverter Dimensions (H × W × D)	37.75 × 15.87 × 11.22" (95.9 × 40.3 × 28.5 cm)
Shipping Dimensions (H × W × L)	16.0 × 21.25 × 44.5" (40.6 × 53.9 × 113.0 cm)
Inverter Weight	133.0 lb (60.3 kg)
Accessory Ports	RJ11 (batt temp) and CANBUS (BMS)
Non-volatile Memory	Yes
Neutral-Ground Bond Switching	No
Chassis Type	Vented

## Environmental Specifications

**Table 7 Environmental Specifications for Mojave Inverter**

Specification	Value
Rated Temperature Range (meets component specifications; however, please note that the inverter output is derated between 40° and 50°C)	-4°F to 122°F (-20°C to 50°C)
Derated Output (worst-case)	6600 VA
Operational Temperature Range (functions, but not rated for operation; does not necessarily meet all specifications)	-40°F to 140°F (-40°C to 60°C)
Storage Temperature Range	-40°F to 140°F (-40°C to 60°C)
IP (Ingress Protection) Rating of Enclosure	IP2X
Environmental Category	Indoor unconditioned
Wet Locations Classification	Wet locations: No
Relative Humidity Rating	93%
Pollution Degree Classification	PD 2
Maximum Altitude Rating	6561' (2000 m)
Overvoltage Category (AC Input)	3

Overvoltage Category (DC Input)	1
---------------------------------	---

# Wireless Specifications

**Table 8 Wireless Specifications for Mojave Inverter**

Specification	Value
2.4 GHz	2,4 GHz
Wireless Standard	WiFi 4 (802.11n; also supports 802.11b/g)
Speed	Up to 150 Mbps

# Regulatory Specifications

## Listings

This product carries a listing report by UL and is listed to the following standards:

- o UL® 1741 2nd Edition with SA
- o CSA C22.2, No. 107.1-16 Ed:4

## Certifications

This product has been certified by UL to meet the following standards:

- o IEEE 1547-2003 — Standard for Interconnecting Distributed Resources with Electric Power Systems
- o IEEE 1547.1-2005 — Standard for Conformance Test Procedures for Equipment Interconnecting Distributed Resources with Electric Power Systems

## Directives

This product meets the following directive:

- o RoHS: Directive 2011/65/EU — “The restriction of the use of certain substances in electrical and electronic equipment”

## Grid Protection Settings (All Profiles)

Tables Table 9 and Table 10 contain the default settings for all grid profiles (see page 43). The ranges of adjustment are also included for reference.



### NOTE:

IEEE 1547-2018 default settings are used in grid profiles where the utility has set no requirement. In most cases this has no impact to the operating performance of the unit. However, some value must be loaded into the settings registers, so the IEEE default values are used. This will most commonly be seen for the **Watt/VAr** function. At present, no utilities are known to require this function and the utilities have no need to specify **Watt/VAr** settings.

**Table 9 Grid Protection Settings (IEEE 1547 and CA Rule 21)**

Parameter	Range of Adjustment		Certified Range		IEEE 1547-2003	IEEE 1547-2018 Cat III/B	CA Rule 21
	Min	Max	Min	Max			
<b>Volt/VAr<sup>1</sup></b>	<i>Disabled</i>	<i>Enabled</i>	n/a	n/a	n/a	<i>Disabled</i>	<i>Enabled</i>
<b>Volt/VAr Vref (pu)</b>	<i>0.950</i>	<i>1.050</i>	n/a	n/a	n/a	<b>1</b>	<b>1</b>
<b>Volt/VAr Vref Auto</b>	<i>Disabled</i>	<i>Enabled</i>	n/a	n/a	n/a	<i>Disabled</i>	<i>Disabled</i>
<b>Volt/VAr auto vref response time (s)</b>	<i>300</i>	<i>5000</i>	n/a	n/a	n/a	<b>300</b>	<b>300</b>
<b>Volt/VAr response time (s)</b>	<i>0.0</i>	<i>90.0</i>	n/a	n/a	n/a	<b>5.0</b>	<b>5.0</b>
<b>Volt/VAr 1 voltage (pu)</b>	<i>0.770</i>	<i>1.050</i>	<b>0.770</b>	<b>1.030</b>	n/a	<b>0.920</b>	<b>0.920</b>
<b>Volt/VAr 1 reactive power (pu)</b>	<i>0.000</i>	<i>0.700</i>	<b>0.000</b>	<b>0.530</b>	n/a	<b>0.440</b>	<b>0.300</b>
<b>Volt/VAr 2 voltage (pu)</b>	<i>0.920</i>	<i>1.050</i>	<b>0.920</b>	<b>1.050</b>	n/a	<b>0.980</b>	<b>0.967</b>
<b>Volt/VAr 2 reactive power (pu)</b>	<i>-0.700</i>	<i>0.700</i>	<b>-0.530</b>	<b>0.530</b>	n/a	<b>0.000</b>	<b>0.000</b>
<b>Volt/VAr 3 voltage (pu)</b>	<i>0.950</i>	<i>1.080</i>	<b>0.950</b>	<b>1.080</b>	n/a	<b>1.020</b>	<b>1.033</b>
<b>Volt/VAr 3 reactive power (pu)</b>	<i>-0.700</i>	<i>0.700</i>	<b>-0.530</b>	<b>0.530</b>	n/a	<b>0.000</b>	<b>0.000</b>
<b>Volt/VAr 4 voltage (pu)</b>	<i>0.950</i>	<i>1.230</i>	<b>0.970</b>	<b>1.180</b>	n/a	<b>1.080</b>	<b>1.070</b>
<b>Volt/VAr 4 reactive power (pu)</b>	<i>-0.700</i>	<i>0.000</i>	<b>-0.530</b>	<b>0.000</b>	n/a	<b>-0.440</b>	<b>-0.300</b>
<b>Volt/Watt</b>	<i>Disabled</i>	<i>Enabled</i>	n/a	n/a	n/a	<i>Disabled</i>	<i>Enabled</i>
<b>Volt/Watt response time (s)</b>	<i>0.0</i>	<i>90.0</i>	n/a	n/a	n/a	<b>10.0</b>	<b>10.0</b>
<b>Volt/Watt 1 voltage (pu)</b>	<i>1.000</i>	<i>1.090</i>	<b>1.000</b>	<b>1.090</b>	n/a	<b>1.060</b>	<b>1.060</b>
<b>Volt/Watt 1 power (pu)</b>	<i>1.000</i>	<i>1.000</i>	<b>1.000</b>	<b>1.000</b>	n/a	<b>1.000</b>	<b>1.000</b>
<b>Volt/Watt 2 voltage (pu)</b>	<i>1.010</i>	<i>1.100</i>	<b>1.010</b>	<b>1.100</b>	n/a	<b>1.100</b>	<b>1.100</b>
<b>Volt/Watt 2 power (pu)</b>	<i>-1.000</i>	<i>1.000</i>	<b>0.000</b>	<b>0.000</b>	n/a	<b>0.000</b>	<b>0.000</b>
<b>LV1 voltage (pu)</b>	<i>0.000</i>	<i>0.980</i>	<b>0.500</b>	<b>0.950</b>	<b>0.880</b>	<b>0.880</b>	<b>0.880</b>
<b>LV1 time (s)</b>	<i>0.08</i>	<i>50.00</i>	<b>0.100</b>	<b>50.00</b>	<b>2.00</b>	<b>21.00</b>	<b>21.00</b>
<b>LV2 voltage (pu)</b>	<i>0.000</i>	<i>0.980</i>	<b>0.250</b>	<b>0.700</b>	<b>0.500</b>	<b>0.500</b>	<b>0.700</b>
<b>LV2 time (s)</b>	<i>0.08</i>	<i>50.00</i>	<b>0.10</b>	<b>50.00</b>	<b>0.16</b>	<b>2.00</b>	<b>11.00</b>
<b>LV3 voltage (pu)</b>	<i>0.000</i>	<i>0.980</i>	<b>0.250</b>	<b>0.700</b>	n/a	n/a	<b>0.500</b>

<sup>1</sup> Only one of the four VAr functions (**Volt/VAr**, **Watt/VAr**, **Constant PF**, **Constant VAr**) can be enabled at one time.



# Specifications

**Table 9 Grid Protection Settings (IEEE 1547 and CA Rule 21)**

Parameter	Range of Adjustment		Certified Range		IEEE 1547-2003	IEEE 1547-2018 Cat III/B	CA Rule 21
	Min	Max	Min	Max			
LV3 time (s)	0.08	50.00	0.10	50.00	n/a	n/a	1.50
LV momentary voltage (pu)	0.000	0.980	n/a	n/a	n/a	0.500	0.500
LV momentary time (s)	0.08	50.00	n/a	n/a	n/a	0.08	0.16
HV1 voltage (pu)	1.020	1.200	1.050	1.200	1.100	1.100	1.100
HV1 time (s)	0.08	13.00	0.10	13.00	1.00	13.00	13.00
HV2 voltage (pu)	1.020	1.200	1.050	1.200	1.200	1.200	1.200
HV2 time (s)	0.08	13.00	0.10	13.00	0.16	0.16	0.16
HV momentary voltage (pu)	1.020	1.200	n/a	n/a	n/a	1.100	1.100
HV momentary time (s)	0.08	13.00	n/a	n/a	n/a	0.08	0.16
LF1 Hz (Hz)	50.00	59.98	50.00	59.9	59.30	58.50	58.50
LF1 time (s)	0.16	1000.00	0.16	1000.00	0.16	300.00	300.00
LF2 Hz (Hz)	50.00	59.98	50.00	59.9	57.00	56.50	57.00
LF2 time (s)	0.16	1000.00	0.16	1000.00	0.16	0.16	0.16
HF1 Hz (Hz)	60.02	66.00	60.1	66.00	60.50	61.20	60.50
HF1 time (s)	0.16	1000.00	0.16	1000.00	0.16	300	300.00
HF2 Hz (Hz)	60.02	66.00	60.1	66.00	n/a	62.00	62.00
HF2 time (s)	0.16	1000.00	0.16	1000.00	n/a	0.16	0.16
Freq Droop	Disabled	Enabled	n/a	n/a	n/a	Enabled	Enabled
Freq Droop OF deadband (Hz)	0.000	1.000	0.000	1.000	n/a	0.036	0.036
Freq Droop UF deadband (Hz)	0.000	1.000	0.017	1	n/a	0.036	0.036
Freq Droop OF ratio	0.020	0.070	0.02	0.07	n/a	0.050	0.033
Freq Droop UF ratio	0.020	0.070	0.02	0.07	n/a	0.050	0.033
Freq Droop response time (s)	0.20	10.00	5	5	n/a	5.00	5.00
Freq Droop PMin (%)	-100.0	100.0	n/a	n/a	n/a	0.0	0.0
Watt/VAr <sup>2</sup>	Disabled	Enabled	n/a	n/a	n/a	Disabled	Disabled
Watt/VAr 1 power (pu)	-1.000	0.000	n/a	n/a	n/a	-1.000	-1.000
Watt/VAr 1 reactive power (pu)	-0.500	0.500	n/a	n/a	n/a	0.440	0.440
Watt/VAr 2 power (pu)	-1.000	0.000	n/a	n/a	n/a	-0.500	-0.500
Watt/VAr 2 reactive power (pu)	-0.500	0.500	n/a	n/a	n/a	0.000	0.000
Watt/VAr 3 power (pu)	-1.000	0.000	n/a	n/a	n/a	-0.200	-0.200
Watt/VAr 3 reactive power (pu)	-0.500	0.500	n/a	n/a	n/a	0.000	0.000
Watt/VAr 4 power (pu)	0.000	1.000	n/a	n/a	n/a	0.200	0.200
Watt/VAr 4 reactive power (pu)	-0.500	0.500	n/a	n/a	n/a	0.000	0.000
Watt/VAr 5 power (pu)	0.000	1.000	n/a	n/a	n/a	0.500	0.500
Watt/VAr 5 reactive power (pu)	-0.500	0.500	n/a	n/a	n/a	0.000	0.000
Watt/VAr 6 power (pu)	0.000	1.000	n/a	n/a	n/a	1.000	1.000

<sup>2</sup> Only one of the four VAr functions (Volt/VAr, Watt/VAr, Constant PF, Constant VAr) can be enabled at one time.

# Specifications

**Table 9 Grid Protection Settings (IEEE 1547 and CA Rule 21)**

Parameter	Range of Adjustment		Certified Range		IEEE 1547-2003	IEEE 1547-2018 Cat III/B	CA Rule 21
	Min	Max	Min	Max			
<i>Watt/Var 6 reactive power (pu)</i>	-0.500	0.500	n/a	n/a	n/a	-0.440	-0.440
<i>Enter service</i>	<i>Disabled</i>	<i>Enabled</i>	n/a	n/a	<i>Enabled</i>	<i>Enabled</i>	<i>Enabled</i>
<i>Enter service HV (pu)</i>	0.880	1.100	n/a	n/a	1.058	1.050	1.058
<i>Enter service LV (pu)</i>	0.880	1.100	n/a	n/a	0.917	0.917	0.883
<i>Enter service HF (Hz)</i>	55.00	66.00	n/a	n/a	60.50	60.10	60.50
<i>Enter service LF (Hz)</i>	55.00	66.00	n/a	n/a	59.30	59.50	58.50
<i>Enter service delay (s)</i>	0	1600	n/a	n/a	300	300	15
<i>Random delay (s)</i>	0	1000	n/a	n/a	0	0	0
<i>Enter service ramp time (s)</i>	1	1000	1	1000	1	300	50
<i>PF export</i> <sup>3</sup>	<i>Disabled</i>	<i>Enabled</i> <sup>4</sup>	n/a	n/a	<i>Enabled</i>	<i>Enabled</i>	<i>Disabled</i>
<i>PF import</i> <sup>3</sup>	<i>Disabled</i>	<i>Enabled</i> <sup>4</sup>	n/a	n/a	<i>Enabled</i>	<i>Enabled</i>	<i>Disabled</i>
<i>Export limit</i>	<i>Disabled</i>	<i>Enabled</i>	n/a	n/a	<i>Disabled</i>	<i>Disabled</i>	<i>Disabled</i>
<i>Export limit (pu)</i>	0.000	1.000	n/a	n/a	1.000	1.000	1.000
<i>Constant Vars</i> <sup>3</sup>	<i>Disabled</i>	<i>Enabled</i>	n/a	n/a	<i>n/a</i>	<i>Disabled</i>	<i>Disabled</i>
<i>Constant Vars setpoint (pu)</i>	-1.000	1.000	n/a	n/a	<i>n/a</i>	0	0.000
<i>Export ramp (pu/s)</i>	0.010	1.000	0.010	1.000	1.000	1.000	1.000
<i>PF export setpoint</i> <sup>5</sup>	0.400	1.000	0.400	1.000	1.000	1.000	0.950
<i>PF import setpoint</i> <sup>5</sup>	0.400	1.000	0.400	1.000	1.000	1.000	0.950
<i>PF export excitation</i> <sup>6</sup>	<i>Absorbing</i>	<i>Injecting</i>	<i>Absorbing</i>	<i>Injecting</i>	<i>Absorbing</i>	<i>Absorbing</i>	<i>Absorbing</i>
<i>PF import excitation</i> <sup>6</sup>	<i>Absorbing</i>	<i>Injecting</i>	<i>Absorbing</i>	<i>Injecting</i>	<i>Injecting</i>	<i>Injecting</i>	<i>Injecting</i>

<sup>3</sup> Only one of the four VAR functions (*Volt/Var*, *Watt/Var*, *Constant PF*, *Constant Var*) can be enabled at one time.

<sup>4</sup> *PF export* and *PF import* must both be either enabled or disabled. It is not valid to have one enabled while the other is disabled. This is the *Constant PF* function from IEEE 1547-2018 and the previous notes.

<sup>5</sup> By default, *PF export* is set to under-excited while *PF import* is set to over-excited. Modification of those defaults is only possible through SunSpec or 2030.5 communications.

<sup>6</sup> Power Factor during export should always be absorbing, and during import it should be injecting. This will be made clear in a pending update to IEEE P1547.9. The simple reason is that during active power export voltage will tend to rise and absorbing VARs will help pull voltage back down. Conversely, during active power import, voltage will tend to drop and injecting VARs will help to pull voltage back up. This minimizes the impact on voltage from changes in active power import and export.

# Specifications

**Table 10 Grid Protection Settings (HECO and ISO-NE)**

Parameter	Range of Adjustment		Certified Range		HECO 14H-2018	ISO NE-2018	ISO NE-2021
	Min	Max	Min	Max			
Volt/VAr <sup>7</sup>	<i>Disabled</i>	<i>Enabled</i>	n/a	n/a	<i>Enabled</i>	<i>Disabled</i>	<i>Disabled</i>
Volt/VAr Vref (pu)	0.950	1.050	n/a	n/a	1	1	1
Volt/Var Vref Auto	<i>Disabled</i>	<i>Enabled</i>	n/a	n/a	<i>Disabled</i>	<i>Disabled</i>	<i>Disabled</i>
Volt/VAr auto vref response time (s)	300	5000	n/a	n/a	300	300	300
Volt/VAr response time (s)	0.0	90.0	n/a	n/a	10.0	5.0	5.0
Volt/VAr 1 voltage (pu)	0.770	1.050	0.770	1.030	0.940	0.920	0.920
Volt/VAr 1 reactive power (pu)	0.000	0.700	0.000	0.530	0.440	0.440	0.440
Volt/VAr 2 voltage (pu)	0.920	1.050	0.920	1.050	0.970	0.980	0.980
Volt/VAr 2 reactive power (pu)	-0.700	0.700	-0.530	0.530	0.000	0.000	0.000
Volt/VAr 3 voltage (pu)	0.950	1.080	0.950	1.080	1.030	1.020	1.020
Volt/VAr 3 reactive power (pu)	-0.700	0.700	-0.530	0.530	0.000	0.000	0.000
Volt/VAr 4 voltage (pu)	0.950	1.230	0.970	1.180	1.060	1.080	1.080
Volt/VAr 4 reactive power (pu)	-0.700	0.000	-0.530	0.000	-0.440	-0.440	-0.440
Volt/Watt	<i>Disabled</i>	<i>Enabled</i>	n/a	n/a	<i>Disabled</i>	<i>Disabled</i>	<i>Disabled</i>
Volt/Watt response time (s)	0.0	90.0	n/a	n/a	10.0	10.0	10.0
Volt/Watt 1 voltage (pu)	1.000	1.090	1.000	1.090	1.060	1.060	1.060
Volt/Watt 1 power (pu)	1.000	1.000	1.000	1.000	1.000	1.000	1.000
Volt/Watt 2 voltage (pu)	1.010	1.100	1.010	1.100	1.100	1.100	1.100
Volt/Watt 2 power (pu)	-1.000	1.000	0.000	0.000	-1.000	0.000	0.000
LV1 voltage (pu)	0.000	0.980	0.500	0.950	0.880	0.880	0.880
LV1 time (s)	0.08	50.00	0.100	50.00	21.00	2.00	3.00
LV2 voltage (pu)	0.000	0.980	0.250	0.700	0.700	0.500	0.500
LV2 time (s)	0.08	50.00	0.10	50.00	11.00	1.10	1.10
LV3 voltage (pu)	0.000	0.980	0.250	0.700	0.500	n/a	n/a
LV3 time (s)	0.08	50.00	0.10	50.00	2.00	n/a	n/a
LV momentary voltage (pu)	0.000	0.980	n/a	n/a	0.500	0.500	0.500
LV momentary time (s)	0.08	50.00	n/a	n/a	0.16	0.08	0.08
HV1 voltage (pu)	1.020	1.200	1.050	1.200	1.100	1.100	1.100
HV1 time (s)	0.08	13.00	0.10	13.00	1.00	2.00	2.00
HV2 voltage (pu)	1.020	1.200	1.050	1.200	1.200	1.200	1.200
HV2 time (s)	0.08	13.00	0.10	13.00	0.16	0.16	0.16
HV momentary voltage (pu)	1.020	1.200	n/a	n/a	n/a	n/a	1.100
HV momentary time (s)	0.08	13.00	n/a	n/a	n/a	n/a	0.08
LF1 Hz (Hz)	50.00	59.98	50.00	59.9	57.00	58.50	58.50
LF1 time (s)	0.16	1000.00	0.16	1000.00	21.00	300.00	300
LF2 Hz (Hz)	50.00	59.98	50.00	59.9	56.00	56.50	56.50
LF2 time (s)	0.16	1000.00	0.16	1000.00	0.16	0.16	0.16

<sup>7</sup> Only one of the four VAr functions (**Volt/VAr**, **Watt/VAr**, **Constant PF**, **Constant VAr**) can be enabled at one time.  
900-00275-01-001 Rev A

# Specifications

**Table 10 Grid Protection Settings (HECO and ISO-NE)**

Parameter	Range of Adjustment		Certified Range		HECO 14H-2018	ISO NE-2018	ISO NE-2021
	Min	Max	Min	Max			
HF1 Hz (Hz)	60.02	66.00	60.1	66.00	63.00	61.20	61.20
HF1 time (s)	0.16	1000.00	0.16	1000.00	21.00	300	300
HF2 Hz (Hz)	60.02	66.00	60.1	66.00	65	62	62
HF2 time (s)	0.16	1000.00	0.16	1000.00	0.16	0.16	0.16
Freq Droop	Disabled	Enabled	n/a	n/a	Enabled	Disabled	Enabled
Freq Droop OF deadband (Hz)	0.000	1.000	0.000	1.000	0.036	0.036	0.036
Freq Droop UF deadband (Hz)	0.000	1.000	0.017	1	1.000 <sup>8</sup>	0.036	0.036
Freq Droop OF ratio	0.020	0.070	0.02	0.07	0.040	0.050	0.050
Freq Droop UF ratio	0.020	0.070	0.02	0.07	0.040	0.050	0.050
Freq Droop response time (s)	0.20	10.00	5	5	0.50	5.00	5.00
Freq Droop PMin (%)	-100.0	100.0	n/a	n/a	0.0	0.0	0.0
Watt/VAr <sup>9</sup>	Disabled	Enabled	n/a	n/a	Disabled	Disabled	Disabled
Watt/VAr 1 power (pu)	-1.000	0.000	n/a	n/a	-1.000	-1.000	-1.000
Watt/VAr 1 reactive power (pu)	-0.500	0.500	n/a	n/a	0.440	0.440	0.440
Watt/VAr 2 power (pu)	-1.000	0.000	n/a	n/a	-0.500	-0.500	-0.500
Watt/VAr 2 reactive power (pu)	-0.500	0.500	n/a	n/a	0.000	0.000	0.000
Watt/VAr 3 power (pu)	-1.000	0.000	n/a	n/a	-0.200	-0.200	-0.200
Watt/VAr 3 reactive power (pu)	-0.500	0.500	n/a	n/a	0.000	0.000	0.000
Watt/VAr 4 power (pu)	0.000	1.000	n/a	n/a	0.200	0.200	0.200
Watt/VAr 4 reactive power (pu)	-0.500	0.500	n/a	n/a	0.000	0.000	0.000
Watt/VAr 5 power (pu)	0.000	1.000	n/a	n/a	0.500	0.500	0.500
Watt/VAr 5 reactive power (pu)	-0.500	0.500	n/a	n/a	0.000	0.000	0.000
Watt/VAr 6 power (pu)	0.000	1.000	n/a	n/a	1.000	1.000	1.000
Watt/VAr 6 reactive power (pu)	-0.500	0.500	n/a	n/a	-0.440	-0.440	-0.440
Enter service	Disabled	Enabled	n/a	n/a	Enabled	Enabled	Enabled
Enter service HV (pu)	0.880	1.100	n/a	n/a	1.100	1.100	1.050
Enter service LV (pu)	0.880	1.100	n/a	n/a	0.880	0.880	0.917
Enter service HF (Hz)	55.00	66.00	n/a	n/a	60.10	61.20	60.10
Enter service LF (Hz)	55.00	66.00	n/a	n/a	59.90	58.50	59.50
Enter service delay (s)	0	1600	n/a	n/a	300	300	300
Random delay (s)	0	1000	n/a	n/a	0	0	0
Enter service ramp time (s)	1	1000	1	1000	303 <sup>10</sup>	50	300

<sup>8</sup> Setting dBuf to 1.000 Hz is the limit of the range of adjustment in this inverter model. Setting the value to this limit partially disables frequency-droop under-frequency response. HECO 14H does not require under frequency response, see Figure 4 of HECO 14H, where frequency response is flat below 60 Hz.

<sup>9</sup> Only one of the four VAr functions (**Volt/VAr**, **Watt/VAr**, **Constant PF**, **Constant VAr**) can be enabled at one time.

<sup>10</sup> The published requirement in HECO 14H is 0.33 % / s. A value of 1/0.0033 = 303 seconds.

**Table 10 Grid Protection Settings (HECO and ISO-NE)**

Parameter	Range of Adjustment		Certified Range		HECO 14H-2018	ISO NE-2018	ISO NE-2021
	Min	Max	Min	Max			
<i>PF export</i> <sup>11</sup>	<i>Disabled</i>	<i>Enabled</i> <sup>12</sup>	n/a	n/a	<i>Disabled</i>	<i>Enabled</i>	<i>Enabled</i>
<i>PF import</i> <sup>11</sup>	<i>Disabled</i>	<i>Enabled</i> <sup>12</sup>	n/a	n/a	<i>Disabled</i>	<i>Enabled</i>	<i>Enabled</i>
<i>Export limit</i>	<i>Disabled</i>	<i>Enabled</i>	n/a	n/a	<i>Disabled</i>	<i>Disabled</i>	<i>Disabled</i>
<i>Export limit (pu)</i>	<i>0.000</i>	<i>1.000</i>	n/a	n/a	<i>1.000</i>	<i>1.000</i>	<i>1.000</i>
<i>Constant Vars</i> <sup>11</sup>	<i>Disabled</i>	<i>Enabled</i>	n/a	n/a	<i>Disabled</i>	<i>Disabled</i>	<i>Disabled</i>
<i>Constant Vars setpoint (pu)</i>	<i>-1.000</i>	<i>1.000</i>	n/a	n/a	<i>0.000</i>	<i>0.000</i>	<i>0.000</i>
<i>Export ramp (pu/s)</i>	<i>0.010</i>	<i>1.000</i>	<i>0.010</i>	<i>1.000</i>	<i>1.000</i>	<i>1.000</i>	<i>1.000</i>
<i>PF export setpoint</i> <sup>13</sup>	<i>0.400</i>	<i>1.000</i>	<i>0.400</i>	<i>1.000</i>	<i>0.950</i>	<i>0.950</i>	<i>1.000</i>
<i>PF import setpoint</i> <sup>13</sup>	<i>0.400</i>	<i>1.000</i>	<i>0.400</i>	<i>1.000</i>	<i>0.950</i>	<i>0.950</i>	<i>1.000</i>
<i>PF export excitation</i> <sup>14</sup>	<i>Absorbing</i>	<i>Injecting</i>	<i>Absorbing</i>	<i>Injecting</i>	<i>Absorbing</i>	<i>Absorbing</i>	<i>Absorbing</i>
<i>PF import excitation</i> <sup>14</sup>	<i>Absorbing</i>	<i>Injecting</i>	<i>Absorbing</i>	<i>Injecting</i>	<i>Injecting</i>	<i>Injecting</i>	<i>Injecting</i>

<sup>11</sup> Only one of the four VAr functions (*VoltVAr*, *WattVAr*, *Constant PF*, *Constant VAr*) can be enabled at one time.

<sup>12</sup> *PF export* and *PF import* must both be either enabled or disabled. It is not valid to have one enabled while the other is disabled. This is the *Constant PF* function from IEEE 1547-2018 and the previous notes.

<sup>13</sup> By default, *PF export* is set to under-excited while *PF import* is set to over-excited. Modification of those defaults is only possible through SunSpec or 2030.5 communications.

<sup>14</sup> Power Factor during export should always be absorbing, and during import it should be injecting. This will be made clear in a pending update to IEEE P1547.9. The simple reason is that during active power export voltage will tend to rise and absorbing VArS will help pull voltage back down. Conversely, during active power import, voltage will tend to drop and injecting VArS will help to pull voltage back up. This minimizes the impact on voltage from changes in active power import and export.





# Index

## A

Absorption Stage.....	57, 67, 69
AC Coupling.....	9, 10, 39, 41
AC Test Points.....	80
Access Levels.....	34
Accessories.....	11
ACTIONS View.....	14, 25
Automatic Generator Start (AGS).....	22, 25, 70, 74, 75
AUX.....	37, 42

## B

Battery	
Low and High Voltages.....	52
State of Charge (SOC).....	53
Battery Bank.....	11
Size.....	51
Battery Charging	
BMS.....	64
Current.....	53
Efficiency.....	53
Graphs.....	54, 55, 60, 61, 69
Steps.....	54
Three-Stage.....	55
Two-Stage.....	66
Battery Tab	
SETTINGS View.....	49
STATUS View.....	19
Battery Types.....	51
Lead-Acid.....	55
Lithium-Chemistry.....	64
BMS.....	19
Book Symbol.....	7
Bulk Stage.....	56, 67

## C

Caution Symbol.....	7, 8
Charging	
Absorption.....	57, 67, 69
Bulk.....	56, 67

Current.....	53
Efficiency.....	53
Equalization.....	62
Float.....	58
Idle.....	55, 58, 59, 66, 68
New Bulk.....	60, 69
Rebulk.....	59, 61, 68
Refloat.....	58, 60
Steps.....	59, 68
Components.....	11, 85
CSA.....	10, 103
Current Transducer (CT).....	11, 31, 43

## D

Data Download.....	35
Design.....	38
Discharge Current.....	53

## E

Equalization.....	62
EVENTS View.....	14, 27

## F

FAQ.....	79
Firmware Update.....	35
Float Stage.....	58
Functions.....	10

## G

Generator	
Starting.....	84
Generator Input and Voltage.....	72
Generator Start and Control.....	74
Automatic.....	75
Exercise.....	77
Load.....	77
Manual.....	75
Quiet Time.....	77
SOC.....	76
Table.....	78
Voltage.....	76

# Index

Generator Tab	
SETTINGS View.....	70
STATUS View .....	22
Generator Type.....	72
Grid Acceptance .....	45
Grid Protection.....	43, 45, 104, 107
Grid Tab	
SETTINGS View.....	43
STATUS View .....	21

## I

Idle .....	55, 58, 59, 66, 68
IEEE 1547.....	103
IEEE 2030.....	10
Important Symbol.....	7, 8
Inverter	
Design .....	38
Maintenance.....	100
Service.....	85
Inverter Tab	
SETTINGS View.....	37
STATUS View .....	18
Inverting .....	38

## L

LED Indicator .....	32
Listings.....	10

## M

Maintenance Checks .....	100
--------------------------	-----

## N

Network Tab	
SETTINGS View.....	36
STATUS View .....	24
Note Symbol .....	7, 8

## O

On/Off .....	25
OPTICS RE .....	13, 24, 28

## P

Password .....	13, 34, 35
Peak Reduction .....	47

## R

Rapid Shutdown .....	42
Rebulk.....	59, 61, 68

Refloat.....	60
Regulatory.....	103
Relay	
Generator.....	73
Grid .....	46
Remote Temperature Sensor (RTS).....	63
Replacement of	
AC Board .....	91
Carrier Board .....	98
Control Board.....	88
Fan Module .....	95
Power Module .....	96
RoHS.....	103

## S

SETTINGS View .....	14, 26, 33
Battery.....	49
Generator.....	70
Grid .....	43
Inverter.....	37
Network.....	36
SoC .....	19
Spare Parts .....	85
Specifications	
Electrical .....	101
Environmental .....	102
Mechanical.....	102
Regulatory.....	103
Wireless .....	103
State of Charge (SOC).....	53
STATUS View .....	14, 15
Battery.....	19
Generator.....	22
Grid .....	21
Icons .....	16
Inverter.....	18
Network.....	24
System Time.....	15
SunSpec.....	10
Symbols Used .....	7, 8
System Time .....	15

## T

Temperature.....	102
Temperature Compensation .....	63
Test Points .....	80
Time of Day.....	15
Time of Use.....	20, 37, 40, 41
Timers	
Equalize .....	62
Float.....	58
Troubleshooting .....	79, 80
FAQ.....	79



## **U**

UL1741 ..... 10, 103  
User Interface (UI) ..... 13, 14

## **V**

View  
ACTIONS ..... 14, 25  
EVENTS ..... 14, 27

SETTINGS ..... 14, 26, 33  
STATUS ..... 14, 15

## **W**

Warning Symbol ..... 7, 8

## **X**

XCT ..... 11, 21, 31, 43

**This page intentionally left blank.**

**This page intentionally left blank.**



an EnerSys® company

**Masters of the Off-Grid.™ First Choice for the New Grid.**

3767 Alpha Way  
Bellingham, WA 98226 USA