



CS-3G

Digital Transceiver Kits
incorporating the COM111 modem



Guarantee

This equipment is guaranteed against defects in materials and workmanship. We will repair or replace products which prove to be defective during the guarantee period as detailed on your invoice, provided they are returned to us prepaid. The guarantee will not apply to:

- Equipment which has been modified or altered in any way without the written permission of Campbell Scientific
- Batteries
- Any product which has been subjected to misuse, neglect, acts of God or damage in transit.

Campbell Scientific will return guaranteed equipment by surface carrier prepaid. Campbell Scientific will not reimburse the claimant for costs incurred in removing and/or reinstalling equipment. This guarantee and the Company's obligation thereunder is in lieu of all other guarantees, expressed or implied, including those of suitability and fitness for a particular purpose. Campbell Scientific is not liable for consequential damage.

Please inform us before returning equipment and obtain a Repair Reference Number whether the repair is under guarantee or not. Please state the faults as clearly as possible, and if the product is out of the guarantee period it should be accompanied by a purchase order. Quotations for repairs can be given on request. It is the policy of Campbell Scientific to protect the health of its employees and provide a safe working environment, in support of this policy a "Declaration of Hazardous Material and Decontamination" form will be issued for completion.

When returning equipment, the Repair Reference Number must be clearly marked on the outside of the package. Complete the "Declaration of Hazardous Material and Decontamination" form and ensure a completed copy is returned with your goods. Please note your Repair may not be processed if you do not include a copy of this form and Campbell Scientific Ltd reserves the right to return goods at the customers' expense.

Note that goods sent air freight are subject to Customs clearance fees which Campbell Scientific will charge to customers. In many cases, these charges are greater than the cost of the repair.



Campbell Scientific Ltd,
80 Hathern Road,
Shepshed, Loughborough, LE12 9GX, UK
Tel: +44 (0) 1509 601141
Fax: +44 (0) 1509 601091
Email: support@campbellsci.co.uk
www.campbellsci.co.uk

PLEASE READ FIRST

About this manual

Some useful conversion factors:

Area: 1 in² (square inch) = 645 mm²

Length: 1 in. (inch) = 25.4 mm
1 ft (foot) = 304.8 mm
1 yard = 0.914 m
1 mile = 1.609 km

Mass: 1 oz. (ounce) = 28.35 g
1 lb (pound weight) = 0.454 kg

Pressure: 1 psi (lb/in²) = 68.95 mb

Volume: 1 UK pint = 568.3 ml
1 UK gallon = 4.546 litres
1 US gallon = 3.785 litres

Recycling information



At the end of this product's life it should not be put in commercial or domestic refuse but sent for recycling. Any batteries contained within the product or used during the products life should be removed from the product and also be sent to an appropriate recycling facility.

Campbell Scientific Ltd can advise on the recycling of the equipment and in some cases arrange collection and the correct disposal of it, although charges may apply for some items or territories.

For further advice or support, please contact Campbell Scientific Ltd, or your local agent.



Campbell Scientific Ltd, Campbell Park, 80 Hathern Road, Shepshed, Loughborough, LE12 9GX, UK
Tel: +44 (0) 1509 601141 Fax: +44 (0) 1509 601091
Email: support@campbellsci.co.uk
www.campbellsci.co.uk

Safety

DANGER — MANY HAZARDS ARE ASSOCIATED WITH INSTALLING, USING, MAINTAINING, AND WORKING ON OR AROUND **TRIPODS, TOWERS, AND ANY ATTACHMENTS TO TRIPODS AND TOWERS SUCH AS SENSORS, CROSSARMS, ENCLOSURES, ANTENNAS, ETC.** FAILURE TO PROPERLY AND COMPLETELY ASSEMBLE, INSTALL, OPERATE, USE, AND MAINTAIN TRIPODS, TOWERS, AND ATTACHMENTS, AND FAILURE TO HEED WARNINGS, INCREASES THE RISK OF DEATH, ACCIDENT, SERIOUS INJURY, PROPERTY DAMAGE, AND PRODUCT FAILURE. TAKE ALL REASONABLE PRECAUTIONS TO AVOID THESE HAZARDS. CHECK WITH YOUR ORGANIZATION'S SAFETY COORDINATOR (OR POLICY) FOR PROCEDURES AND REQUIRED PROTECTIVE EQUIPMENT PRIOR TO PERFORMING ANY WORK.

Use tripods, towers, and attachments to tripods and towers only for purposes for which they are designed. Do not exceed design limits. Be familiar and comply with all instructions provided in product manuals. Manuals are available at www.campbellsci.eu or by telephoning +44(0) 1509 828 888 (UK). You are responsible for conformance with governing codes and regulations, including safety regulations, and the integrity and location of structures or land to which towers, tripods, and any attachments are attached. Installation sites should be evaluated and approved by a qualified engineer. If questions or concerns arise regarding installation, use, or maintenance of tripods, towers, attachments, or electrical connections, consult with a licensed and qualified engineer or electrician.

General

- Prior to performing site or installation work, obtain required approvals and permits. Comply with all governing structure-height regulations, such as those of the FAA in the USA.
- Use only qualified personnel for installation, use, and maintenance of tripods and towers, and any attachments to tripods and towers. The use of licensed and qualified contractors is highly recommended.
- Read all applicable instructions carefully and understand procedures thoroughly before beginning work.
- Wear a **hardhat** and **eye protection**, and take **other appropriate safety precautions** while working on or around tripods and towers.
- **Do not climb** tripods or towers at any time, and prohibit climbing by other persons. Take reasonable precautions to secure tripod and tower sites from trespassers.
- Use only manufacturer recommended parts, materials, and tools.

Utility and Electrical

- **You can be killed** or sustain serious bodily injury if the tripod, tower, or attachments you are installing, constructing, using, or maintaining, or a tool, stake, or anchor, come in **contact with overhead or underground utility lines**.
- Maintain a distance of at least one-and-one-half times structure height, or 20 feet, or the distance required by applicable law, **whichever is greater**, between overhead utility lines and the structure (tripod, tower, attachments, or tools).
- Prior to performing site or installation work, inform all utility companies and have all underground utilities marked.
- Comply with all electrical codes. Electrical equipment and related grounding devices should be installed by a licensed and qualified electrician.

Elevated Work and Weather

- Exercise extreme caution when performing elevated work.
- Use appropriate equipment and safety practices.
- During installation and maintenance, keep tower and tripod sites clear of un-trained or non-essential personnel. Take precautions to prevent elevated tools and objects from dropping.
- Do not perform any work in inclement weather, including wind, rain, snow, lightning, etc.

Maintenance

- Periodically (at least yearly) check for wear and damage, including corrosion, stress cracks, frayed cables, loose cable clamps, cable tightness, etc. and take necessary corrective actions.
- Periodically (at least yearly) check electrical ground connections.

WHILE EVERY ATTEMPT IS MADE TO EMBODY THE HIGHEST DEGREE OF SAFETY IN ALL CAMPBELL SCIENTIFIC PRODUCTS, THE CUSTOMER ASSUMES ALL RISK FROM ANY INJURY RESULTING FROM IMPROPER INSTALLATION, USE, OR MAINTENANCE OF TRIPODS, TOWERS, OR ATTACHMENTS TO TRIPODS AND TOWERS SUCH AS SENSORS, CROSSARMS, ENCLOSURES, ANTENNAS, ETC.

Contents

PDF viewers note: These page numbers refer to the printed version of this document. Use the Adobe Acrobat® bookmarks tab for links to specific sections.

1. Introduction	1
2. Quick Start Guide	2
2.1 Setting up a system with a fixed IP address	2
2.2 Setting up a system with a dynamic IP address using the Konect routing service or similar	6
3. Specifications and general considerations	7
3.1 Specifications.....	7
3.2 Power use.....	7
3.3 Network coverage	8
4. Using GPRS and 3G IP communications	8
4.1 Using GPRS and 3G IP communications introduction	8
4.2 Network contracts and costs for IP communications	10
4.3 Modes of operation for IP communication	11
4.3.1 Using systems with fixed IP addresses.....	11
4.3.2 Using systems with dynamic IP addresses	11
4.4 Minimising power use.....	12
4.5 Sending configuration commands to the modem	13
5. Using the COM111 for GSM dial-up	14
5.1 GSM dial-up principles.....	14
5.2 GSM dial-up contracts and costs	14
5.3 GSM dial-up power use	15
5.4 Calling the logger in GSM dial-up mode when it is set-up for IP comms	15
6. Installation of the COM111 modem	16
6.1 Configuring and fitting the SIM.....	16
6.2 Connection to a Datalogger.....	16
6.2.1 Connection to a CS I/O Port	17
6.2.2 Connection to an RS232 Port.....	17
6.3 Connecting power	18
6.4 Selecting and connecting an antenna.....	18
6.4.1 Antenna supplied by Campbell Scientific	20
7. Configuring the COM111 modem	21
7.1 Using the Mobile Data Assistant Program for system configuration	22
7.2 Mobile Data Assistant Program terminology	23
7.3 Mobile Data Assistant advanced options	25
7.4 Changing the modem and logger settings without Mobile Data Assistant.....	26

8. Using Loggernet for GPRS communications	27
8.1 Setting up to call a logger with a fixed IP address or when using the Konec Routing Service	27
8.2 Setting up call-back in Loggernet	28
8.2.1 Setting up call-back in Loggernet Version 3.....	28
8.2.2 Setting up call-back in Loggernet Version 4.....	29
8.2.3 Keeping the connection open when calling-back.....	31
8.2.4 Firewall issues.....	32
9. Using Loggernet for GSM dial-up.....	33
9.1 Configuring a desk-top modem as a base station	33
9.2 Configuring the COM111 modem as a base station using Loggernet	33
9.2.1 Extending the default time-outs	33
10. Preventing COM111 connection problems	34
11. Fault finding	35
11.1 General.....	35
11.2 The modem cannot be configured using the Mobile Data Assistant package	36
11.3 GPRS/3G fault finding – when using the logger TCP/IP stack	36
11.3.1 First stage fault finding	36
11.4 IP advanced fault finding	39
11.5 GPRS fault finding – when using the modem TCP/IP stack	40
11.6 A base station fails to get a response from the logger with a modem in GSM dial-up mode	41

Table

1. COM111 Modem Power Supply Connections via a PSW12 switch	18
---	----

Figures

1. Connecting the COM111 modem to a Datalogger using an SC-WMI	17
2. Low-gain, wideband antenna supplied by Campbell Scientific.....	20

Appendices

A. Controlling the power use of the COM111 modem and methods of resetting the modem	A-1
B. Useful configuration commands for the COM111	B-1
C. Configuring the COM111 using the datalogger talk-thru mode.....	C-1

D. Using the COM111 in transparent GSM dial-up mode.....	D-1
E. Using the COM111 with the PIN security feature enabled.....	E-1

CS-3G Digital Transceiver Kits (including the COM111 modem)

This manual provides the details of how to use the CS-3G digital transceiver kits with Campbell Scientific dataloggers. This version of the manual covers kits that use the COM111 modem as the communication device.



1. Introduction

The CS-3G kits use the COM111 modem that is designed to allow transfer of data across digital cellular phone networks. The COM111 modem is a digital radio transceiver that works on GSM (known as “2G” or GPRS) and European U-TMS/HSPA+ (“3G”) networks.

The CS-3G kits include all the cables and antenna to allow easy use with most Campbell Scientific dataloggers. This manual covers the CS-3G RS232 and CS-3G SDC kits which are primarily sold for IP communications.

A CS-3G kit are primarily designed for data transfer where data is transferred using Internet protocols (IP, including TCP/IP and UDP), often over the public internet. This protocol is supported either using the built-in IP capability of some Campbell Scientific dataloggers or using a software feature built into the modem that allows more basic loggers to communicate using an IP connection, albeit with less functionality.

The modems can also be reconfigured to be used for “dial-up” or CSD (circuit switched data) connections which are supported on some 2G networks.

Before use the modems must be configured using a configuration tool called the Mobile Data Assistant which is available for download free of charge from <http://www.campbellsci.co.uk/downloads> with the use of a programming cable this tool allows the modem to easily be reconfigured for different functions or communication speeds.

2. Quick Start Guide

The COM111 modem is primarily used for IP communications, for use in dial-up (GSM/CSD) mode see Section 5.

This quick start section is split into two sections showing two common modes of operation. You will need the modem with its SIM card, a power supply, aerial and the programming cable (supplied in the CS-3G kits). You may also need a serial to USB convertor.

2.1 Setting up a system with a fixed IP address

This section covers systems which have a network service with a fixed IP address.

Make sure you have a data enabled SIM with the security PIN disabled and enabled for data use. To insert the SIM card eject the card tray from the end of the modem by pushing in the button with a small screwdriver or pen. Put the SIM card in the small card tray taking care the angled corner of the card matches the moulding in the tray. The gold plated contacts of the card should be uppermost and remain so when the card tray is pushed back into the modem.

1. Now the modem and logger should be setup using the Mobile Data Assistant package. To do this you require a modem programming cable (a grey 9 to 15 way serial cable), plus a USB-Serial convertor if needed, a cable to allow communication with the data logger and a power supply to power the modem and logger. (Please note setup via the USB connector built into the modem is not supported.)
2. Install the Mobile Data Assistant package and start it running. You will be presented with a screen like that shown below.

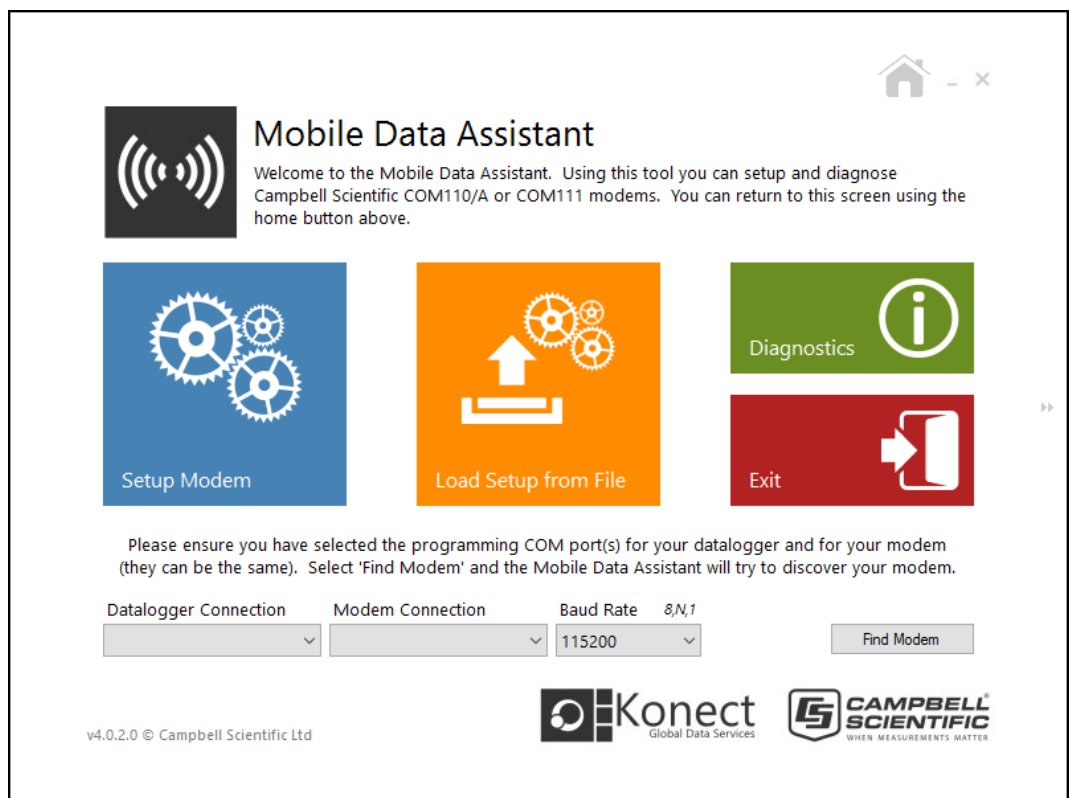

3. Connect the modem to the PC using the programming cable (use a serial to USB convertor if necessary). Connect the modem to a nominal 12V DC supply (the data logger supply can be used if available).
4. When using the MDA for the first time select the com ports on your PC to which you intend connecting the data logger and modem you are going to setup (they can be the same if the devices are swapped at the appropriate steps in the process). Also set the baud rate, which would normally be 115200, except for the CR200X and older loggers which communicate at 9600 baud. If you are connecting to a data logger via it's built in USB port the logger will need to be powered on and connected to the PC for it to appear in the COM port list.
5. Now select the "Setup modem" option, then select the data logger you are going to use, then the modem type (select COM111). You will then be prompted if you want to make a GSM (dial-up) or GPRS/2G/3G (data) connection, select the latter. Then you will be asked for the type of IP connection. For the CR300, CR6, CR800, CR1000 and CR3000 select "Logger IP Stack"(this indicates you will use the TCP/IP functionality built into the logger operating system, often known as a "software stack").
6. Now select the method of connection control – select "Logger Listening", for the CR200X and older loggers select "Modem Listening" option.
7. At this point you will be asked for detail of the connection you are going to use with this screen:

Setup - Settings

Please provide the information below in order to configure your modem. All highlighted fields are required before you can proceed by selecting 'Next'...

Datalogger Port: CS I/O SDC7 the port to which you will attach the modem

APN: mobile.o2.uk e.g. mobile.o2.co.uk

User ID:

Password:

Listening Port: 6785 e.g. 6785

Modem Mode: Auto (Default)

Back Next

v3.1.11.0 © Campbell Scientific Ltd

Konect Global Data Services

CAMPBELL SCIENTIFIC WHEN MEASUREMENTS MATTER

This screen varies with logger type. A data logger port option will be shown if different connections are possible so you can select the port on the logger the COM111 will be connected to using the drop down option list. Select RS232 for a direct connection to the RS232 serial port on the logger or one of the CS I/O SDC options to match the configuration of an SC105 if used, normally set to SDC7. Other options

are shown for some loggers, e.g. control ports and the CR6 RS232/CPI port but these need cables not supplied in the CS-3G kits.

For all logger types you then need to fill in the APN name provided by your SIM card provider, a user ID and password associated with the APN (although these are sometimes blank) and the port the logger will listen on for its normal Pakbus communications traffic, the default being 6785.

There is also a setting labelled “Modem mode” that allows you to select whether to fix the mode to operate in GPRS (2G) or 3G modes which can be useful if there is an intermittent or poor 3G service or if you want to switch to GSM dial-up mode routinely as that mode of operation is only supported in 2G mode. Normally this setting can be left in Auto mode where the modem will connect to whichever service is available, with preference for 3G services.

If shown leave the idle time and reset time settings at the defaults of 10 and 60 for now.

When you click on Next you will be shown a screen asking you to connect the COM111 and install the SIM card so the modem can be configured.



8. Now click on Apply Setup. The program will then send the required settings to the modem to configure it. At the end of this process, which takes a minute or so, the program should report it has setup the modem correctly. Then click on “Done”.

For some of the options previously selected you will now be prompted if you wish to setup the data logger to suit. This process will load the APN username and password into the logger and configure its communication ports. If not already done, select the port the data logger is connected to on your PC. Click continue and after short delay it

should report it has been successful. If so click done and exit the program.

Note that with version 4.0 on of the MDA program you are given the option to save both the modem and logger setup to a file, which is useful if setting up multiple loggers with the same setting. You can load the setup when the program is first started.

9. Now connect the modem to the data logger either with the supplied cable if using the RS232 connection, or via one of the interfaces if connecting to the CS I/O port.
10. Install the aerial supplied as high as possible on your mounting structure and away from any vertical metal poles. Route the cable into the enclosure and connect it to the aerial socket on the COM111 modem labelled "GSM" – this may involve use of a coaxial adaptor (supplied if needed).
11. Connect the power supply to the COM111 modem, by connecting the red/black power lead either directly to the outlet of the power supply, if powering the device continuously, or to a suitable power switch – see Section 5.3 below. It is best to connect the power as close as possible to the battery rather than to terminals on the data logger if possible.
12. Turn on the power to the data logger and COM111 modem. The status LED on the end of the modem, near the SIM socket should come on continuously initially. After a period of about 15 seconds the LED will start to flash briefly every 2-3 seconds. When the LED starts to flash it indicates that the modem has registered on the phone network successfully. Note the frequency of flashing will vary depending on the power state of the modem and whether data is being transferred.

Start-up your PC and run PC400, Loggernet or your chosen communications program. Set up an IPPort connection to the data logger, following the instructions for your software package to do this. Enter the IP address relevant to the SIM card and the port number to match the one you entered in step 5 above. If the IP address is a public address you should then be able to make a test connection to the logger using the connect tool in the program being used. If the IP address is fixed, but private, you may have to open a VPN connection to the private network, following details from your SIM provider, before attempting to make the connection to the data logger.

If the connection does not work you can reconnect the modem to the PC and use the diagnostics tool in the Mobile Data Assistant to check the network connection and signal strength. Please also refer to the fault finding section in this manual.

CAUTION

The COM111 includes features to prevent it locking up and going offline. However, there are still some rare events, e.g. voltage surges or network reconfiguration from which it may not automatically recover. For the highest reliability it is therefore advisable to include code within your data logger program to reset the modem at regular intervals. Please refer to Section 9 of this manual for more details of how to do this.

NOTE It is advisable to make sure you are running the latest operating system in the data logger before deploying a system to ensure you have all the latest IP related features in the data logger and to ensure best reliability.

2.2 Setting up a system with a dynamic IP address using the Konect routing service or similar

This section covers systems which have a service which has a dynamic IP address where the logger is to be contacted via a router service on the internet.

The setup procedure is the same as steps 1-5 above. At step 6 select the option for a Konect/Dynamic connection rather than the Listen option. This screen will appear.

The screenshot shows a 'Setup - Settings' window with a blue gear icon. The title is 'Setup - Settings' and the subtitle says 'Please provide the information below in order to configure your modem. All highlighted fields are required before you can proceed by selecting 'Next'...'. The form fields are: Datalogger Port (dropdown: CS I/O SDC7), APN (text: mobile.o2.uk), User ID (text: mobile), Password (text: web), Konect Port (text: 32105), Konect Address (text: pathwayrtr.konectgds.com), and Modem Mode (dropdown: Auto (Default)). There are 'Back' and 'Next' buttons at the bottom right. Logos for Konect and Campbell Scientific are at the bottom.

Follow the instructions in step 7 above to fill in the fields described there. For the Konect router option you also need to fill in the fields labelled Konect Address and Konect Port with the details provided to you when you sign up for the Konect routing service. The Konect address will be a URL such as “gatewayrtr.konectgds.com”

Then click on Next and you will be shown a screen asking you to connect the COM111 and install the SIM card so it can be configured.

Now follow steps 8-11 from the section above.

When setting up the PC software to call out to the logger, select an IPPort as the root connection device and enter the Konect router URL in the Internet IP field, followed by the Konect port details you were provided when you signed up for the service. (For the above example this would be

pathwayrtr.konectgds.com:32105) You should then be able to connect to the logger as normal.

Please note that each logger connecting to the same port of the Konect router must have a unique Pakbus address which, if not the default of 1, must be set using the Device Configuration program. Please also take note of the warnings cautions and notes at the end of the section above.

3. Specifications and general considerations

3.1 Specifications

The COM111 specifications are:

Input Power Supply voltage and current:

- 5-32V DC (capable of supplying up to 400 mA continuously and 2A spikes)

System Power Consumption:

- Typical: (modem only) 5 mA in 'standby' mode (GSM)
- <400 mA on-line, transmitting (typically 100-200 mA)
- ~ 20-30 mA when online in GPRS/3G mode.

Frequencies supported:

- Quad band GSM/GPRS/EDGE 850/900/1800/1900 MHz
- 900/2100 HSDPA (3G) for Europe and Asia

Modem serial port speed:

- 9600 baud for older dataloggers and the CR200X.
- 115 kbaud for GPRS/3G use with newer loggers.

Physical: (module only)

- Operating Temperature: -30°C to +65°C
- Humidity: Up to 90%, non-condensing

The specifications for the interface devices included in the kit, e.g. the SC105, are given in their respective manuals.

3.2 Power use

As can be seen from above the additional power use of using a COM111 connected to a datalogging system may not be insignificant and can vary from nothing, when powered off, to several hundred mA when the modem is fully powered and sending data at high speed to a distant base station. Even when not communicating, if the modem is left powered on, its power use can

vary from 5 up to 20 mA. The logger and interfaces to the modem also consume additional current when the modem is active.

Because the power use can be relatively high compared to the quiescent power use of most Campbell dataloggers careful consideration must be made of the likely power use versus the available power on site when running a remote system.

Please see the relevant sections below under the IP and GSM dial-up sections to see ways of minimising the power use.

3.3 Network coverage

One of the main advantages of using a cell phone network is being able to set up a communications link to a data logger virtually anywhere without installing land or telephone lines. However, this only applies if a suitable network covers your installation site.

Within the Europe the coverage of many networks is good in most areas. However, coverage in remote areas can still be quite poor and sometimes only 2G coverage is available. Unless coverage is known to be good at the proposed site, we strongly recommended that you test the coverage using a standard handset (on the same network as the COM111 modem is to be used) to measure the exact signal strength. Make sure the phone is reporting good signal strength with the correct type of data connection available, noting some networks will switch to another network for voice only when there is no signal on the providers network. The COM111 does not work on 4G networks.

NOTE

Even areas shown as having good coverage on network maps can have ‘holes’ due to local interference or other technical reasons, so site testing is recommended.

In areas of normal signal strength the COM111 modem can be used with a small, low gain, wideband antenna (as supplied in the CS-3G package). However, if the signal strength is marginal it may be possible to improve reception using a raised and/or a higher gain antenna. Poor quality reception will normally lead to breaks in communication or result in the PC software having to make multiple requests to ensure uncorrupted data is collected. This will not usually lead to data loss or corruption, but may result in longer calls and thus higher call charges.

The network provider will be able to offer advice on coverage problems. Campbell Scientific can also offer further advice on suitable antennae to suit the application.

4. Using GPRS and 3G IP communications

This section discusses the principles of using the COM111 for GPRS and 3G data transfer in more detail.

4.1 Using GPRS and 3G IP communications introduction

In recent years GPRS (General Packet Radio Service) on 2G networks (GSM/Edge) and 3G (UTMS) services have become a standard for “always-

on” data connections, e.g. with smart phones. This technology offers many potential advances in remote telemetry. These include:

- Fast connection time compared to landline modem – as fast as a few seconds
- Lower cost of data transfer
- Always on connection – if your system has the power to keep a modem powered all the time then it is possible to set-up a system that is “always-on” which can be connected from anywhere on the net at any time
- Higher speed data transfer from the data logger back to the PC
- Easy access from anywhere in the world
- Alternative ways of accessing data in the data logger due to it being connected to an IP network.

Those alternative ways include:

- Direct Loggernet IP Pakbus communications
- Supports a telnet connection (like the serial terminal mode), including talk-through modes to serial sensors connected to the data logger.
- Supports Modbus and DNP3 over IP
- Supports serving webpages – which are user defined
- Supports requesting data with http commands
- Supports acting as an ftp (file) server.

Plus, under program control:

- Can send email messages (emailsend)
- Can send files by ftp (ftpcient)
- Can synchronise the data logger clock to Internet time (networktimeprotocol).
- Can send data to other loggers via IP (Send/Get variables, files and data)
- Can do a normal callback to a Loggernet server (send variables)
- Can do a one way transmission to Loggernet or another logger (Senddata)
- Can open virtual serial ports to other dataloggers or sensors via the IP network.

NOTE

Only standard Pakbus communication with Loggernet is possible if using the TCP/IP function built into the modem. The other advanced communications options require a data logger capable of running its own TCP/IP “stack”. Those loggers currently include the CR6, CR300, CR800 series, CR1000 and CR3000 dataloggers.

GPRS and 3G technology offer faster data transfer rates than the GSM dial-up mode. GSM dial-up is generally limited to an over-the-air speed of 9600 baud. GPRS and 3G systems can offer much higher speeds and with good signal a 3G connection with the faster dataloggers the over-air speed can be limited by the 115200 baud rate that is the maximum baud rates currently supported for modem connections by the dataloggers.

Please note though that the throughput of data over the network is more often limited by the latency of the network which for 2G and 3G networks can be anything from 0.5-2 seconds. This can slow down the opening of sockets and more significantly the overall data transfer rate, especially where the protocol relies on acknowledgement of each packet of data sent, e.g. as is currently done with the data logger Pakbus protocol. This can mean that when collecting data from the data logger with Loggernet the rate may only be 2-3 times faster on a 3G rather than 2G connection. Transfer of files by ftp or http can be considerably faster as those protocols do not rely on sequential acknowledgment of each packet sent so they should be considered for optimal speed.

4.2 Network contracts and costs for IP communications

The modem needs to be used with an airtime contract that allows GPRS/3G data communications. Most support GPRS(2G) or 3G modes, although some contracts do not support fall back to the GPRS (2G) mode for data, if there is no coverage on the native network.

When buying a contract the standard offering in Europe is for a connection where you are allocated a dynamic, private IP address. This can be used with Campbell dataloggers and is often the cheapest way to get a system up and running. However, when operating in this way you can only have a limited numbers of PCs or loggers connected to one logger and you lose some of the ftp server, http and other functions as the logger cannot accept unsolicited calls from the public internet because it is on a private network behind a firewall.

For full flexibility specialist suppliers provide a service to give individual devices a fixed IP address, which can either be private (accessed via a VPN connection) or a public address on the internet. Such contracts are suitable for larger scale data logger networks and provide additional on-line tools to let you monitor the state of your GPRS connections, traffic use etc. Campbell Scientific Ltd can supply such airtime contracts as part of a subscription to its Konect data service, see: <http://www.konectgds.com/>

It is important to ensure you are aware of the likely costs of data transfer. Many “M2M” fixed IP contracts are sold with very limited amounts of inclusive data which can be adequate but are easy to over-run. Prices for use beyond the inclusive allowance can be high and can range from £0.005 to £10.00 per Megabyte of data transferred. As it can require in excess of 50 Kbytes of data per day to just check and keep a data connection open, let alone transfer any data, it is important to find the right tariff for your needs. Where an always on connection is required, a flat-rate tariff will likely be more economic or you should at least negotiate a volume discount tariff with your provider. Currently the best value SIMs, which include much larger data allowances, e.g. 1-10 GB per month generally have dynamics addresses. These can be used with the Konect Routing Service, which allows loggers with dynamic addresses, i.e. these standard low cost data SIMs, to be connected to via a router running on the public internet “in the cloud”, see: <https://www.campbellsci.eu/konect-pakbus-router>

Whichever contract you have you need to know the APN server name of your provider, plus your username and password to gain access to the data services.

4.3 Modes of operation for IP communication

4.3.1 Using systems with fixed IP addresses

If you have a fixed IP service it may be either with routing to a public internet address or to a private fixed IP address that you connect to via a VPN tunnel.

If it is via a VPN tunnel please seek the advice from the SIM provider on how to setup and use the VPN tunnel. The tunnel will need to be open and kept open automatically if you wish to use Loggernet to call the logger automatically.

With a fixed IP address, once connected to the network the logger will be able to accept incoming connections for the services you have enabled, e.g. Pakbus, ftp, http. If you connect to the logger for normal data logger communications (via the Pakbus/TCP service port) the data logger will automatically start to send beacon messages once per minute to the device that called. This will hold the connection open (which is useful as some GPRS providers will cut-off inactive connections) and also ensures the connection is working, however this does incur data traffic charges. (See the help within Loggernet for connecting via an IP port – the port number must match that set for the Pakbus/TCP Service port set in the logger.)

With a fixed IP address, Loggernet should be able to call out to the logger on demand so it is possible to setup scheduled data collection. To minimise data charges you can prevent the extra traffic outside the scheduled calls by unchecking the box on the Pakbus port that forces it to stay open.

With a fixed IP it should also be possible for multiple PCs to call the same logger either for data collection or connecting to the logger's web or ftp server functions. If you choose to do this though be careful to ensure the logger has an adequate power supply to support multiple and lengthy connections and also check that you are certain the traffic costs will not get out of hand. If calling the data logger from multiple PCs that use the Pakbus protocol please make sure that Pakbus port of each copy of the calling software has a unique Pakbus address.

NOTE

If using the TCP/IP function built into the modem only one simultaneous connection is possible at any time.

4.3.2 Using systems with dynamic IP addresses

On many networks the data logger is assigned a different IP address each time it connects, this is known as a dynamic IP address.

For some networks, even though the data logger has a dynamic IP address, it is a public IP address which means you can connect to it from the public internet. The problem then is tracking which address the data logger has at one time. It is sometimes possible to use a dynamic name service to do this (please contact Campbell Scientific for more details).

More commonly if you are on a network where dynamic IPs are used you will not be able to connect directly to the logger as it is on a private network

behind a router/firewall. Instead you have to get the data logger or modem to open a connection back to either a data routing service, such as Campbell Scientific's Konect routing service, or a Loggernet PC which itself must have a public IP address (see firewall issues below) and have Loggernet hold the connection open.

- 1) When using the Datalogger TCP/IP stack you can configure the logger to automatically establish a socket connection to a remote system, e.g. your Loggernet server. It will do this as soon as it is powered up and a PPP connection is established. It will try to open the socket once per second, until successful. This is done when selecting the "Callback" or "Konect Router" options in the Mobile Data Assistant program. Alternatively you can set this by using Campbell Scientific's device configuration program to setup the logger and entering the IP address and socket in the Net Services tab, as a Pakbus/TCP Server setting. This method is easy to setup and does not rely on code in the data logger program.

If you are using the Modem IP/Stack the Mobile Data Assistant package enables a similar function in the modem, which tries to keep open a permanent connection to the socket to the Konect router or Loggernet.

- 2) Alternatively you can call the TCPOpen/TCPClose command in your program at regular intervals (the speed determines how quickly the logger will re-establish a broken link). In the TCPOpen command you need to give the public address of the Loggernet server and the port you are going to connect on. This method is only normally used where the logger needs to make more than four connections to different servers, which is rare. If setting up a modem using the Mobile Data Assistant Package select the Listen option at the Connection Control stage and then add code to your program to control outgoing connections.

When using the Modem IP/Stack the modem can be set to only call-back when it receives data from the attached logger to transmit to Loggernet. Normally you would trigger the connection by using the standard call-back commands in the logger program, which would trigger data exchange with Loggernet on a direct connection, e.g. using SendGetVariables. To enable this mode you need to use the Advanced terminal mode of the Mobile Data Assistant program and, after setting up the modem for call-back, issue the command `AT+AUOPT=1,10` to the modem to tell it to shutdown its PPP connection after 10 minutes of inactivity.

For either method the port (socket) number must match the call-back port number either provided when you sign up to the Konect routing service or if setting the logger to call-back to Loggernet, that entered in the setup screen of Loggernet (see below) plus you should also enable call-back for the data logger on the data logger hardware tab.

The method of managing Loggers which call-back over IP varies with the Loggernet version. Loggernet 4.1 or later is recommended. A description of how to setup Loggernet for call-back is given in Section 8.2 below.

4.4 Minimising power use

When there is an open PPP/IP connection the average additional power consumption of the COM111 and data logger, will typically be 30-40 mA. During communications activity both the data logger and modem power use

will increase significantly – the transmitter using an extra 100-400 mA depending on where the installation is and the speed of communication.

To achieve even lower power states when using the Loggers IP stack, you can close the PPP connection at times when you can afford to lose connectivity. This is done by calling the PPPClose command in your program to close the link at chosen times and PPPOpen to reopen the link. Closing the PPP connection will put the modem into a lower power state (10-15 mA). and also allow the logger to go into its lowest power modem too (< 1 mA for low activity programs). Once in this state the modem can still accept incoming GSM dial-up calls providing the modem is set to run in 2G mode either permanently or during this period (see below).

The absolutely lowest power use is achieved by cutting power to the modem by switching the 12V supply to the modem. When doing this it is important to deregister the modem from the network before turning off the power. This is usually done by sending the PPPClose command and sending a command AT+CFUN=0 to the modem and waiting at least 2 seconds before turning off the power. Failure to do this may result in subsequent connections to the network being refused for prolonged periods or the modem even being barred from the network if this is done frequently. When powering up the modem again and then using PPPOpen to restart the IP connection, it is advisable to add delays (of 20s or so) in the program for the modem to register on the network and the PPP session to start before starting to send out any data. Please see Appendix A for an example of the CRBasic code required.

NOTE

By implication the logger defaults to the PPPOpen state as soon as a port is activated for PPP. This is not dependent on a program running. To stop a PPP connection being made when a program is recompiled, include a PPPClose instruction after the BEGIN instruction. Do this with consideration because if you load a program that incorrectly calls PPPClose you could block further communications.

If using the Modem IP stack, there are less options for shutting down the IP link. It is not normally practical to reconfigure the modem by sending it commands from the logger, especially with older loggers. The data logger will sometimes go into a lower power state if there are periods of no communications but the modem will remain powered. Normally the only option beyond this is to switch the power to the modem. If this is done, avoid doing this too frequently as it is not possible to cleanly log off from the network, which can lead to delays in registering the modem when power is restored.

In either mode of operation you can optimise power use by writing code to only turn the modem on for limited periods and use the “call-back” function to Loggernet (see above) where the logger calls back and using the Sendvariables command which in turn triggers Loggernet to do a normal data collection from the logger. The power can be controlled to enable the modem only during the call-back

4.5 Sending configuration commands to the modem

It is often advisable to reset the modem at regular intervals or send other configuration commands to the modem, for instance to enable very low power states between calls. When using the loggers IP Stack, this can be done within the data logger program by opening the serial port to which the

modem is connected, using the SerialOpen command in the program, which will close the PPP session and then sending out commands using the serialout command. To restart the PPP connection the program must close the serial port using serialclose otherwise the PPP connection will be permanently blocked. The general principles are shown in Appendix A where “AT” commands are sent to the modem as part of the reset process. Similar code can be used to send other “AT” commands to reconfigure the modem.

When using the Modem IP stack configuration commands are not normally sent from the data logger.

5. Using the COM111 for GSM dial-up

This section discusses the principles of using the COM111 for GSM dial-up data transfer in more detail. Please note that any COM111 modem needs to be configured using the Mobile Data Assistant package to work in GSM dial-up mode unless specifically sold in a “GSM” package.

5.1 GSM dial-up principles

GSM networks are based on international standards and are widespread throughout the world – see the web site www.gsm.org. Theoretically a GSM phone can be used anywhere in the world if it is within range of a GSM network of the same frequency. For voice communications this theory almost works in practice, except that many airtime providers (the company you pay for use of the phone) limit the geographical range of most phones, and some do not have agreements with distant providers.

For data transmission, most networks support the SMS (Short Message System). This is not very practical for collecting large volumes of data, but can be useful for sending alarm messages – see Technical Note 33 for more details of using SMS with older loggers. Contact Campbell Scientific for details of sending or receiving text messages with CRBasic dataloggers. (Please note that the COM111 modem defaults to Text format SMS messages and as the message centre is normally preset in the SIM it is not necessary to pre-configure the modem as described in the technical note.)

Larger networks support connections where an open data connection is formed through the network. If this is supported, you may choose to connect to a GSM data-phone either via a landline modem (landline to GSM) or by using a second GSM phone in your office (GSM to GSM). This works in a similar way as dialling up a data logger with a landline telephone modem.

5.2 GSM dial-up contracts and costs

Before considering the use of the COM111 modem in your application, check with your local GSM network company that they support ‘non-transparent’ mode of data transmission, at 9600 baud. Check also that they provide suitable routes to allow you to communicate with it, such as access via land-line modems – this is called asynchronous connectivity.

For some networks, e.g. O₂ in the U.K, you may need to specify the mode of data transfer. If this is required, request it to work in ‘non-transparent mode’ at 9600 baud. This is the default setting for most networks. Your airtime provider will normally supply you with an extra phone number for the SIM specifically for data use.

Generally as you will be calling the data logger from a landline the airtime contract needed for the COM111 which is used with the data logger does not have to include inclusive minutes or data. If you intend to send outgoing SMS messages you may pay for an inclusive bundle of messages.

The major cost in using this service is the cost of outgoing calls from the base station modem to the remote system. These are normally charged on the time of the call not data transfer and the bill due on the contract of the calling modem. It is advisable to seek out a contract that includes a lot of minutes of connection time to mobile networks.

NOTE The COM111 will not work in CSD mode on some networks. Please contact Campbell Scientific for further information.

5.3 GSM dial-up power use

If the COM111 is programmed for GSM dial-up it is set in a specific mode of operation to allow it to reduce its power drain to <10 mA between calls whilst still registered on the network and able to accept incoming calls. The modem will enter a higher power state and answer when a call comes in. It will revert back to the low power state some 30 seconds after the end of the call.

If a continuous power drain of 5-10 mA is not acceptable the modem power can be controlled using a power switch or the SW12V output on the logger wiring panel with code in the program to enable the modem.

NOTE The modem must be set into 2G only “modem mode” to allow the dial-up connection to work. This mode can either be fixed using the Mobile Assistant program or can be switched by sending configuration commands from the data logger, please contact Campbell Scientific for more details.

5.4 Calling the logger in GSM dial-up mode when it is set-up for IP comms

In some circumstances it may be advantageous to be able to call a data logger using the GSM dial-up mode even though the normal mode of operation is the GPRS/3G method. This may be necessary in the event of failure of the IP network or network connections that prevent dial-back to the Loggernet server. It is possible to call the logger in the standard way providing you know the GSM data phone number and also providing the logger has periods of operation when the PPP connection is not enabled, i.e. PPPClose has been called.

NOTE The modem must be set into 2G only mode to allow the dial-up connection to work. This mode can either be fixed using the Mobile Data Assistant program or can be switched by sending configuration commands from the data logger, please contact Campbell Scientific for more details.

6. Installation of the COM111 modem

6.1 Configuring and fitting the SIM

Before the COM111 modem can be configured, used or tested, it must be fitted with a 'SIM' card (Subscriber Identification Modem) that enables it for use on a specific cellular telephone network in a particular frequency band.

If possible, ensure that the SIM is configured so that it does not require a Personal Identification Number (PIN) security code to be entered after the modem is powered up. The PIN can most easily be disabled by inserting it into a separate, hand-held standard GSM phone and following the instructions contained in the phone manual. If a separate phone is not available, please contact Campbell Scientific for details of how to disable the PIN code for use with the COM111. If this is not possible, or if your airtime provider only allows operation with a PIN enabled, please refer to Appendix E.

NOTE

Some SIM suppliers send the SIM with the PIN enabled and set to a default PIN number. Check the documentation that came with your SIM

The SIM card is installed in the COM111 modem in the slot at the aerial end of the case. Before installing the SIM make sure power is disconnected from the modem. The SIM is installed in a small tray that has to be ejected by pushing in the small green button which is to the right of the slot holding the tray. Use a pen or similar to push the button inwards. Insert the SIM with card with the gold contact side of the card facing upwards in the tray. Ensure the cut-out of one corner of the card is orientated to match the recess in the tray so the SIM sits flat in the tray. Push the tray back into the slot until fully in then, with the aerial connected, power on the modem and check if the LED starts flashing within a minute or so to indicate successful registration on the network.

6.2 Connection to a Datalogger

The COM111 modem can either be connected directly to the RS232 port of the data logger, if it has one, using the RS232 cable provided as part of the CS-3G RS232 kit or to the CS I/O port of dataloggers that have this port, using an SC-105 as provided in the CS-3G SDC kit.

If a CS-GSM package was purchased the logger interface will be the SC-WMI interface. The SC932A can also be used for older loggers that only have CS I/O ports but do not support SDC communications.

NOTE

The SC-WMI or SC932A are not recommended for use where other devices are sharing the CS I/O port. The maximum baud rate the SC-WMI supports is 38400 baud.

NOTE

It is advisable to make sure you are running the latest operating system in the data logger before deploying a GPRS system to ensure you have all the latest IP related features in the data logger and to ensure best reliability.

6.2.1 Connection to a CS I/O Port

The SC105 which is supplied as part of the CS-3G SDC kit, is connected to the data logger using an SC12 cable and then to the COM111 using a 0.5 m grey cable (which also doubles up as the programming cable). Please take note of the marking on the case of the SC105 indicating which end connects to the data logger to ensure it is installed the correct way around. The SC932A (see below) would be connected in the same way.

The SC105 may need to be configured before use to make sure it is in modem mode and the baud rate of its serial port matches the speed set for the COM111. Please refer to the SC105 manual for further details. If bought as part of the CS-3G kit the modem will be configured at 115 kbaud ready to use.

The simpler Campbell Scientific SC-WMI interface provides a simple, very low power interface for connecting the COM111 modem to the CS I/O port on Campbell Scientific dataloggers. The quiescent current consumption of the SC-WMI is typically less than 100 μ amps and it uses less than 3 mA when communications are in progress. The more general use SC932A interface performs the same function albeit requiring extra power and cables for connection. There is no user configuration of these devices. They are simply connected between the data logger CS I/O port and the COM111 modem as shown below in Figure 1. Both would be set to use the CS I/O ME port on the logger when using the Mobile Data Assistant package.

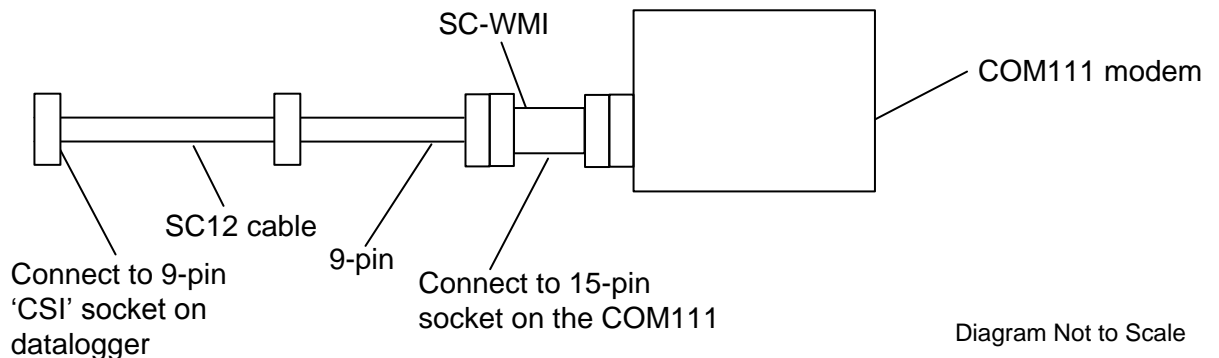

Figure 1. Connecting the COM111 modem to a Datalogger using an SC-WMI

6.2.2 Connection to an RS232 Port

The cable required for the direct connection to a data logger serial port is supplied as part of the CS-3G RS232 kit. The 9-pin connector plugs in the data logger RS232 port and the 15-way connector directly into the COM111 modem.

The CR6 needs an additional CPI port to D-connector, RS232 cable (part 009635) which in turn connects to the RS232 cable included in the kit.

6.3 Connecting power

The COM111 modem requires a power supply capable of supplying 5-32V DC, at an average current of up to 400 mA, with short peak currents of 2.5A (at 5.5 V supply). COM111 is fitted with a 2A slow acting, fuse in an inline fuse holder in its power cable, to minimise damage in the event of a failure.

The normal colour scheme for wiring is RED for positive and BLACK for negative. If the COM111 modem is to be powered from the same supply as the data logger, ensure that the power connections for the COM111 modem are made as close as possible to the battery outputs. This will prevent the COM111 modem causing voltage drops and noise on the supply to the data logger.

The quiescent power consumption of the COM111 modem is typically around 5 -15 mA, once the unit automatically shuts down at the end of a call.

For very low power installations turning the power off may be essential though. To do this it is possible to control the power supply to the COM111 modem by using a solid state relay, such as the PSW12 power switch or, if free, to use the power switch built into the wiring panel of some dataloggers. See Appendix A for example programs where the data logger controls power to the COM111. Table 1 shows the wiring from the PSW12 power switch to the data logger. The failsafe wire, if connected to 5V, ensure the modem remains powered if the logger program stops running and the control port the yellow power control wire is connected to is not driven.

Table 1. COM111 Modem Power Supply Connections via a PSW12 switch	
COM111 modem Cable Colour	Connection
Red (positive supply)	+ 12V
Black (negative supply)	G
Yellow (power control)	Control Port (or +12V for testing)
White (Failsafe function)	5V (normally)
N.B. These colours and connections only apply to the cable supplied by Campbell Scientific Ltd.	

NOTE

In the case of CR10X dataloggers, only the power switch in wiring panels fitted with *green terminal blocks* is suitable.

6.4 Selecting and connecting an antenna

When selecting an antenna, please note the following points:

- Make sure the antenna used covers the frequency you intend to use the COM111 modem on, i.e. does the antenna cover 900, 1800 MHz (common 2G frequencies, 900 or 2100 MHz (common 3G frequencies) or some combination of them. Check the with your service provider which frequencies will be in use at the installation site. Also check the gain of the antenna at that frequency as many so-called high gain wideband antenna are optimised for one band.
- Low cost, 1/4- or 1/2-wave antennae are adequate for most applications where signal coverage is good. It is important to realise that most low

cost antennae designed for vehicle mounting require a flat, metal sheet to form a ground plane at the base of the antenna to achieve the specified gain figure and to ensure proper impedance matching. As an approximate rule the ground plane should have a radius equal to or greater than the height of the radiator.

- Slightly higher priced co-linear, or dipole antennae do not require such a ground plane and can be more easily pole or cross-arm mounted.
- In areas of poor signal coverage a directional, high-gain ‘Yagi’ antenna can be considered, but this requires knowledge of where the cell base stations are situated in order to enable proper alignment and often the frequency the base station uses needs to be known to match the antenna correctly.
- Raising the antenna is often the most effective way of getting better signal reception. However, if long cables are required to achieve this, use low-loss extension cables that do not have the significant signal loss of low cost cables. Long cables are a particular problem when operating at 1800MHz or above.
- Like most cellular-based systems, the COM111 modem varies its transmitter power to ensure good communications with the remote cell station. Using a cheaper, low-gain, antenna may result in a significant increase in power consumption in areas of poor signal coverage.
- If the antenna is placed near the top of a mast or has long antenna cables it may be vulnerable to lightning damage. If lightning is common at the installation site, additional lightning protection may be required to protect the COM111 modem – please contact Campbell Scientific for further advice.

CAUTION

Using an antenna that is installed incorrectly, or with faulty wiring, can lead to premature failure of the transmitter output of the COM111.

Install the antenna so that the radiator is positioned away from other vertical metal structures. It should also be at a distance from any sensors so that it does not either physically or electrically interfere with the sensor readings.

Connect the aerial cable to the connector labelled “GSM”. The other connector labelled “GPS” is not used.

If the COM111 modem can be connected to a PC (see below) it is possible to check the received signal strength using the diagnostics option in the Mobile Data Assistant package or using the **AT+CSQ** command in a terminal program (see Appendix C for further details). This can be used to find the optimum antenna position. You should aim to get the highest signal strength (as close to 31) as possible. For reasonable communications you need a minimum level of approximately 10 when operating in non-transparent mode for GSM dial-up or 12-14 for data use. Be sure that the modem is configured to talk only to the network operator you intend to use when doing this (see the **AT+COPS** command).

CAUTION

Many antenna have bodies that are connected to the coaxial cable screen. It is therefore essential to ensure the correct polarity is maintained through the cabling system to avoid the possibility of shorting the transmitter output of the COM111 modem to the power supply ground via the lightning protection cables and mounting structure.

6.4.1 Antenna supplied by Campbell Scientific

Campbell Scientific can supply various antennas, if required; including a standard, compact wideband antenna (see Figure 2, below). This is supplied as part of the standard CS-3G package.

In areas of high signal strength, this antenna will be suitable for almost all applications. The antenna, as supplied 'off the shelf', is fitted with a connector which will either directly fit the COM111 modem transceiver aerial socket or plug into an adaptor that will be supplied. When the antenna is supplied as part of a weather station or other complete installation, Campbell Scientific may replace the original connector with a compatible connector before the system is tested.

In a field installation it is recommended that the cable length between the antenna and the transceiver is kept as short as possible to reduce the signal loss in the cable, although, as mentioned above, it is often more advantageous to mount the antenna higher. In some applications the cable will need to be shortened, and so a new connector can be installed onto the cable at this time by cutting off the surplus cable, together with the original connector, and fitting a new connector. Ensure that all connections are well made, and the connector is secured using a crimping tool or pliers. The connector which connects to the modem is only suitable for use in dry environments and so must be protected from direct exposure to water and precipitation.



Figure 2. The standard, wideband antenna supplied by Campbell Scientific

The antenna is supplied with a pole mounting adaptor, a 'V' bolt, allowing it to be fitted to 30-54 mm diameter vertical tubing. If you need to mount antenna onto a smaller diameter pole, insert some hard packing material between the pole and bracket. Alternatively, without the adaptor, it can be screwed to a suitable flat vertical surface. The design of the antenna means that *no ground plane is required*, thus allowing more flexibility in mounting. Avoid mounting the antenna close to other vertical metal structures or on flat metal surfaces.

Higher gain co-linear or YAGI style antennas are available from Campbell Scientific to special order. These can help with reception in remote areas or where reception is poor due to obstacles, but can take some experimentation to find the best orientation to get the optimum reception.

7. Configuring the COM111 modem

Before use the COM111 modem requires configuration. When supplied as part of a CS-3G package or bought separately the COM111 needs to be configured using the Mobile Data Assistant software package that will run on Windows PC platforms.

To use this package you need a special cable to allow connection of the 15 way connector on the modem and the serial port of a PC (or a serial-USB cable connector to the PC). One of these cables are supplied as part of the CS-3G kits. These are also available from Campbell Scientific Ltd and are called a Wavecom /COM111 programming cable. Please note that although the COM111 has a USB connection this cannot be used to configure the modem for connection to a data logger via its serial port.

If you do not have the Mobile Data Assistant package you can use a terminal emulation program to communicate with the modem and manually send it some basic setup and diagnostic commands, some of which are detailed in Appendix B.

When using the CR6, CR300, CR800, CR1000 or CR3000 dataloggers it is also possible to 'talk-through' from one serial port to the modem connected on another port. When the modem is offline you can manually send configuration commands to the modem via this route – see the data logger manual for a description of terminal mode, and refer to Appendix C of this manual. It is not possible to run the Mobile Data Assistant package via this type of connection.

If the COM111 modem has been purchased with a cable for plugging into a data logger RS232 port, a null modem cable or adaptor will be required allow correct connection to a PC serial port. Any terminal software used with this combination should be set to "No hardware handshaking". This type of connection can be used to do some minor reconfiguration of the modem but cannot be used with the Mobile Assistant program because the reset procedure does not work via this cable combination.

Prior to attempting to setup a modem for GPRS communication you need to decide whether you will use the TCP/IP stack built into the data logger (possible and generally advised with the CR800, CR1000 and CR3000) or use the TCP/IP stack built into the modem itself. You also need to know whether the SIM card you are using has a fixed IP address or a dynamic address requiring the logger to call-back to a Loggernet server.

7.1 Using the Mobile Data Assistant Program for system configuration

The Mobile Data Assistant program is available as a free download from www.campbellsci.co.uk/downloads. Running the downloaded EXE file will start the installation process. This program will run on Windows Vista, Windows 7, 8 and 10 and equivalent server versions.

NOTE This program is provided free of charge but is only licensed for use with COM110A and COM111 modems purchased from Campbell Scientific or an authorised reseller.

After installation the start up screen looks like this:

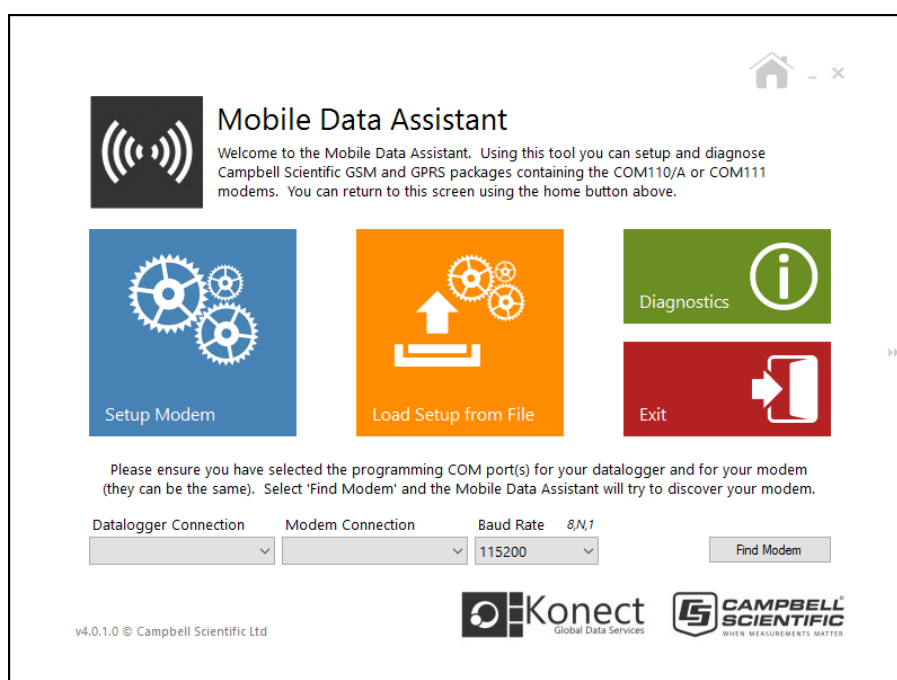

Operation of the package is fairly intuitive so this manual is limited to a description of the general steps of operation and an explanation of the terminology used.

As can be seen above the main options, apart from Exiting the program, are either to Setup equipment or run some Diagnostics on the modem. You also have the option to load a previously save set-up configuration from a file, which is useful for configuring several modems in the same way.

The Setup option is normally used first and will configure the modem for its selected use and, where the data logger needs to be, will configure a data logger too, if it is available. If the logger is not available it can be setup later using either this program or using the Campbell Scientific Device Configuration program.

The Diagnostics option shows you the modem can connect to the local network, giving a measure of signal strength too. If the modems own TCP/IP stack is being used you can also see if it has acquired an IP address.

7.2 Mobile Data Assistant Program terminology

The list below gives a brief description of the options available in each screen.

Setup Modem: use this option to start the process of configuring the modem.

Load Setup from file: this option is used if you have previously configured a modem and saved the settings to file. You can use this to setup several modems in the same way.

Diagnostics: use this option to check the signal strength and other aspects of the network connection start the process of configuring the modem.

Exit: leave the program.

Setup Modem Type: select the model of modem you are using, the COM111 being the latest model.

Setup Connection, GSM will setup the modem for GSM (CSD) dial-up access.

Setup Connection, GPRS/2G/3G: will setup the modem for IP based data transfer.

Setup – Logger Selection: allows you to select the data logger type the modem will be connected to. Pick your data logger from those shown. Contact Campbell Scientific if your logger type is not shown.

Setup – Baud rate: controls the baud rate the modem serial port is set at – this is only shown for some logger/modem combinations

Setup – IP Control: allows you to select whether you will be using the logger's own IP stack or the one built into the modem – this is only shown if the data logger can run its own IP stack, as if not the modem's own stack is used.

Setup – IP Control – Logger IP Stack: sets the logger to run its own IP Stack (this option is only shown for loggers that support this). This allows full TCP/IP access by the logger, allowing email, ftp etc.

Setup – IP Control – Modem IP Stack: sets the modem to run its own IP Stack (applicable to all loggers). This only allows basic communications with the logger as if connected via a serial cable.

Setup – Connection Control: allows you to define the mode of the IP connection (see Section 4.3 for a detailed description)

Setup – Connection Control – Listening (incoming): where the modem has a fixed IP and the logger or modem listens for incoming IP connections.

Setup – Connection Control – Callback (outgoing): where the data logger calls back to a Loggernet Server automatically to establish the connection. This is often used when the data logger is behind a firewall.

Setup – Connection Control – Konect Router/Dynamic: where the data logger has a dynamic address and calls-back automatically to the Konect Router service. This allows one or more copies on the internet to connect to that logger via the routing service (contact Campbell Scientific Ltd for more details).

Setup – Settings - Datalogger port: allows you to select the serial port on the data logger to which the modem will be connected. For the CS-3G this will normally either be the RS232 port or a CS I/O SDC port, when using the SC105.

Setup Settings (for IP connection) – APN: the access point name provided by your SIM provider. This points the system to a server through which it accesses the GPRS/3G service.

Setup Settings (for IP connection) – User ID: the user name provided by your SIM provider to allow access to their service. Sometimes this is blank or a common name for all users.

Setup Settings (for IP connection) – Password: the password provided by your SIM provider to allow access to their service. Sometimes this is blank or a common for all users.

Setup Settings (for IP connection) – Listening port: when set to listen for an incoming connection, this is the port which the logger or modem will listen on for incoming connections (the logger has a default of 6785).

Setup Settings (for IP connection) – Call-back port: this is shown when the logger is calling back to a server. This is the port on the server to which the logger should try and connect to.

Setup Settings (for IP connection) – Call-back address: this is shown when the logger is calling back to a server. Enter the public IP address or domain name of the loggernet server (or the router its traffic is being routed through).

Setup Settings (for IP connection) – Konect port: this is shown when the logger is calling back to the Konect routing service. This is port will be given to you when you sign up for the service.

Setup Settings (for IP connection) – Konect address: this is shown when the logger is calling back to the Konect routing service. This is address or URL given to you when you sign up for the service.

Setup Settings (for IP connection, Modem IP Stack) – Idle Time: if a connection has been opened to the modem and there is no traffic for this period the modem will close the socket connection as it may be erroneous or faulty.

Setup Settings (for IP connection, Modem IP Stack) – Reset interval: shown where the modem is set to listen for connections. If no connection is made within this time the modem will reset the connection to remake the GPRS link, in case that link is faulty. If the connections to the modem are less frequent than the default time of 60 mins then increase this time – at the possible cost of the extra time it will take to recover a bad connection.

Setup Settings (for IP connection, Modem IP Stack) – Max Time Online: limits the maximum time the call-back socket is opened for. This is useful for resetting ‘broken’ connections that can be held open forever otherwise. This can be disabled by setting it to “0” which may be done if the modem is reset by regular power cycling.

Setup Settings (for IP connection, Mode) – This settings allows you to force the modem to force connections to the network to only be made in 2G (GSM/GPRS) or 3G modes. Normally this is left in automatic mode where the modem will try and negotiate the fastest connection possible.

Setup – Modem Connections – After entering your settings this gives you the options of saving the previously selected and entered settings to a file for repeat use later on, applying the settings to the modem or skipping the modem configuration which will jump straight to the data logger configuration (if needed). You also have options of confirming the serial port the modem is connected to the PC and also going back to the previous step. When applying the settings the progress of sending the settings is shown. If successful you have the option of repeating the process which can be useful when you have multiple modems to configure in the same way.

Setup – Datalogger Connection – This screen is then shown if there are settings that need to be loaded into the data logger. You have the options of Skipping this step or continuing with the setup. Again you have an option of confirming which serial port the data logger is connected to on the PC. After successful configuration of the data logger. When this process completes you are also given the option of repeating the process of returning to the start screen, using the “Done” button.

At the home screen you can Exit the program using the Exit button.

7.3 Mobile Data Assistant advanced options

Generally use of the Mobile Data Assistant is straightforward and only requires you to step through the options and wait for the system to be setup. If this process is not completed correctly and does not complete after a second attempt there is a facility to be able view the commands sent to the modem and also to record the process to aid in support. This is accessed by clicking in the very right of the screen which becomes highlighted in orange as shown below when you move your mouse over this part of the screen:



Once you click on that bar a serial communication activity windows appears as shown below. By clicking on the icons below this window you can save the contents of the window to a file or the clipboard so the information can be captured for sending in with a support request.

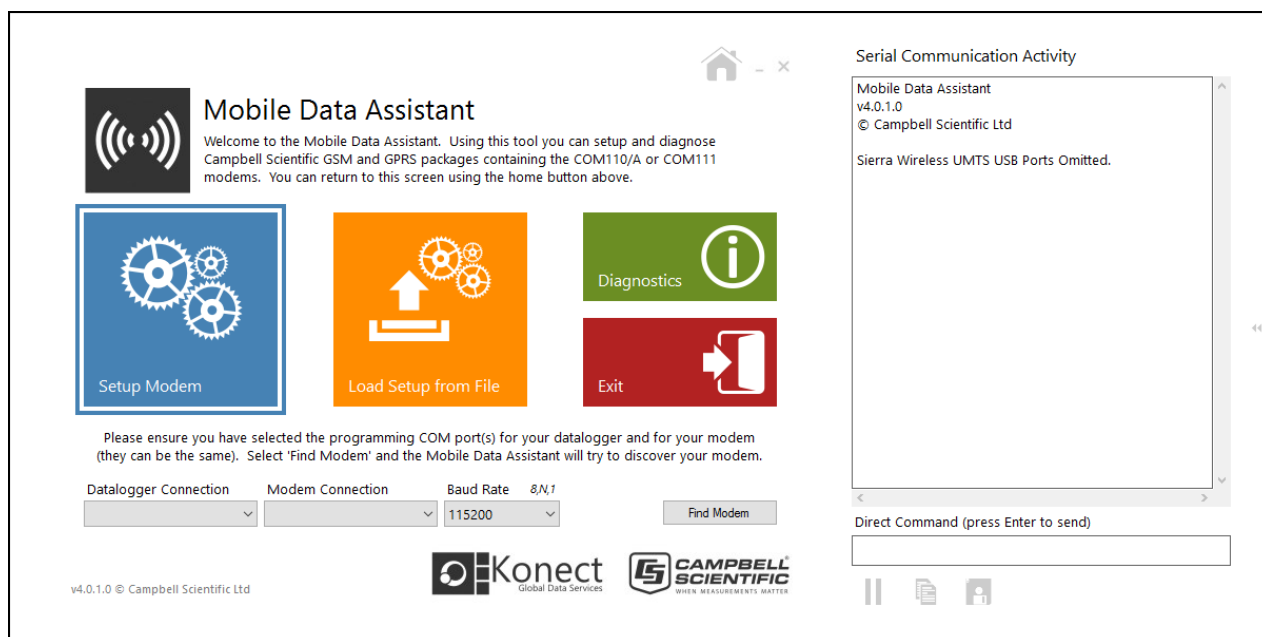

When this window is opened on the home screen an additional entry window appears below the activity window that lets you send commands directly to the modem. This can be used to send diagnostic commands to the modem and also to send non-standard configuration commands. Prior to using this make sure the COM port and baud rate are selected correctly to match the connection and setup of the modem.

7.4 Changing the modem and logger settings without Mobile Data Assistant

The COM111 can be configured, as most such modems, using a terminal emulator program by sending a series of “AT” commands to it. Please contact Campbell Scientific for details of those commands if required.

The setup of the data logger can also be done using the Campbell Scientific Device Configuration program. This can be used to manually enter the PPP settings, change the communications port or its baud rate and also to control the automatic call-back option. This tool may still need to be used if you are running the logger’s TCP/IP stack and you wish to change the IP services it supports as a server, e.g. http, ftp etc. These are accessed via Network Services tab.

There are some other settings supported in the Modem which are not changeable via the Mobile Data Assistant program. The modem supports the dynamic DNS service for instance which can be used on some networks with SIM cards that have dynamic IP addresses but which are public.

8. Using Loggernet for GPRS communications

8.1 Setting up to call a logger with a fixed IP address or when using the Konect Routing Service

Where there are no restrictions on outgoing connections from Loggernet to the remote IP address, the connection can be setup as a standard IPPort connection as documented in the help system. An example is shown below. The only change from entering the IP address and port in the normal way is the an “Extra response” delay of a few seconds may be required when using a slow connection.

For the Konect routing service enter the URL followed by “:” and the port number you are given to access the service.

NOTE

Do not extend the extra response beyond 5 secs as it is not beneficial.

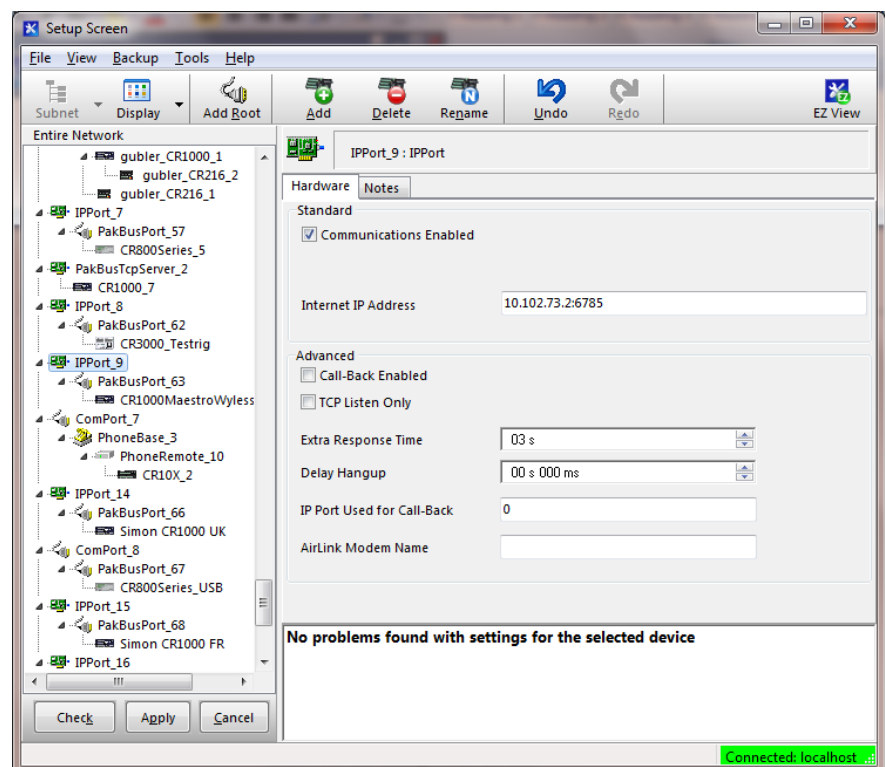

Where the number of outgoing IP ports is limited, perhaps due to a firewall restriction, Pakbus loggers with discreet Pakbus addresses can be connected via a PakbusTCPServer, as shown below (Loggernet 4 onwards). The IP address of the remote logger is entered in the Routing screen as an Outgoing connection.

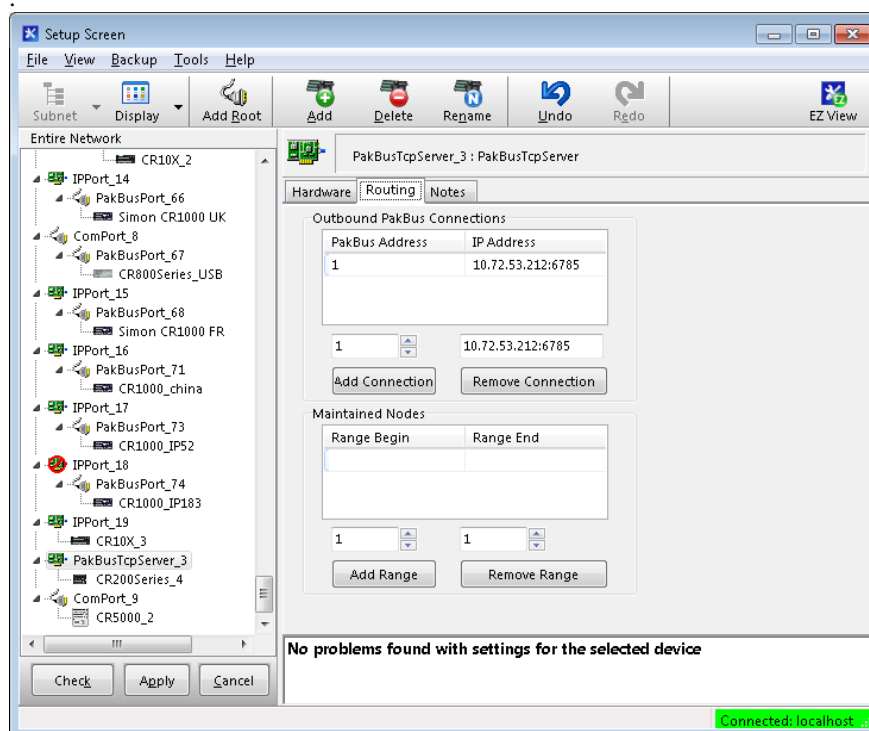

8.2 Setting up call-back in Loggernet

Where the logger is programmed to call-back to a Loggernet server, perhaps because it has a dynamic IP address, Loggernet needs to be configured to expect a call-back on a chosen port. The same settings apply whether using the loggers own TCP/IP stack or the modem stack.

8.2.1 Setting up call-back in Loggernet Version 3

Version 3.x versions of Loggernet require an IPPort be entered for each logger and a separate call-back socket be allocated to each IPPort. For each socket you will need to open a hole in your firewall(s) and possibly put an entry in your router tables, if using one.

In versions of Loggernet 3.4 there is an extra setting in the set-up screen called "TCP Listen only". This should be set when using dynamic, private IP addresses to prevent Loggernet trying to call-back out to the logger in some circumstances, e.g. loss of a connection. This setting ensures Loggernet returns to a state of waiting for another call-back as soon as possible. The setup screen for Loggernet 3.4 is shown below.

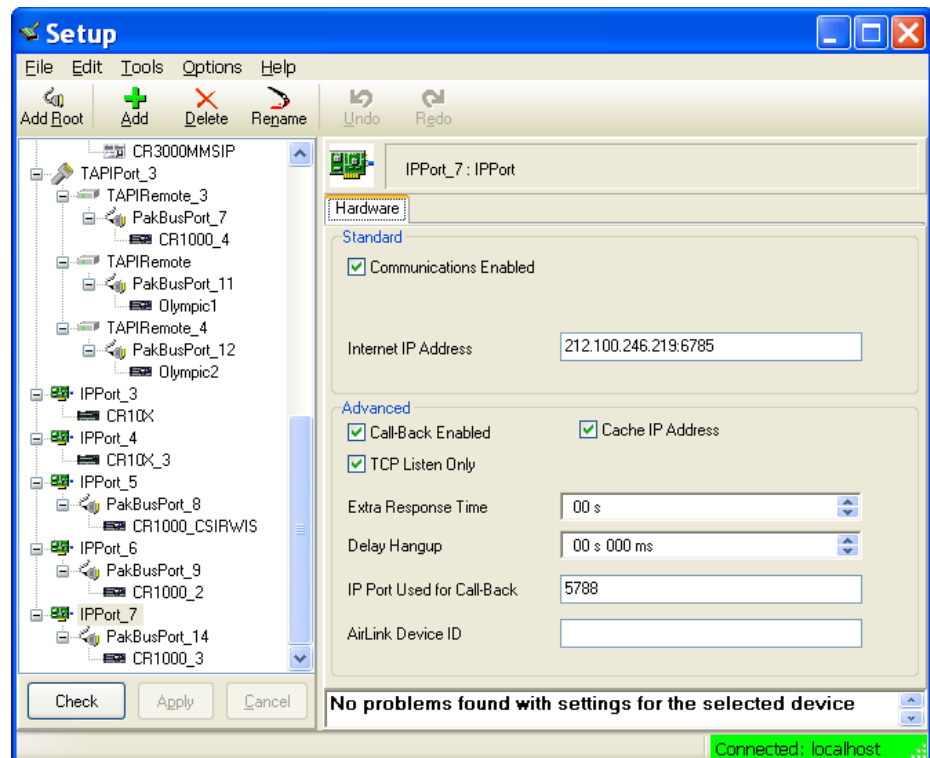

When filling in that setup screen, the settings for the Internet address and the IPPort on the IPPort hardware screen are largely irrelevant in this case as Loggernet cannot make new outgoing calls as most loggers with dynamic IPs (assigned to the data logger) do not allow incoming connections. You should still add a valid IP address and match the port number to the Pakbus port number in the data logger to prevent Loggernet flagging errors. When a successful connection is made from a remote logger you will see that Loggernet updates the IP address of the remote logger, as viewed in the Setup screen. Unless your provider allows this, do not expect to be able to make connections out to this address though as it is normally the address of an intermediate router that is the barrier between the private and public networks. If you have several systems with service from the same airtime provider you will often find the same IP address shown for several of different loggers

8.2.2 Setting up call-back in Loggernet Version 4

In Loggernet 4 there is a new root device called a PakbusTCPServer that has a single call-back port. Multiple dataloggers are attached to this port and are identified, when they call-back, by their Pakbus address rather than the port they call-back on. This simplifies the configuration of the dataloggers and only requires one port to be configured in firewalls/routers.

The call-back port is entered in the hardware tab as shown below.

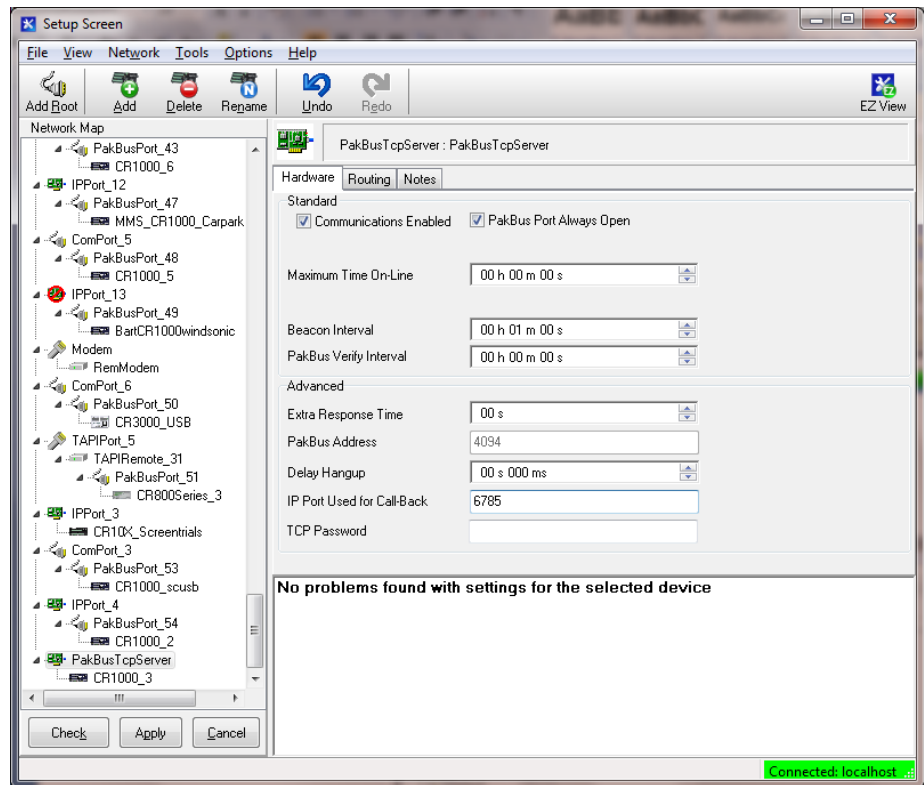

The details of the way calls are routed via this port are entered in the routing tab as shown below and fully documented in the Loggernet help system. If you are able to call out to a device that has a fixed IP address enter it in the Outbound Pakbus connection table, matching the logger Pakbus address to its fixed IP address, with the logger's Pakbus service port appended to the end.

If the logger can only call-back and you wish Loggernet to try to hold on and maintain the connection, enter the logger or range of loggers with a specific Pakbus address into the Maintained node table.

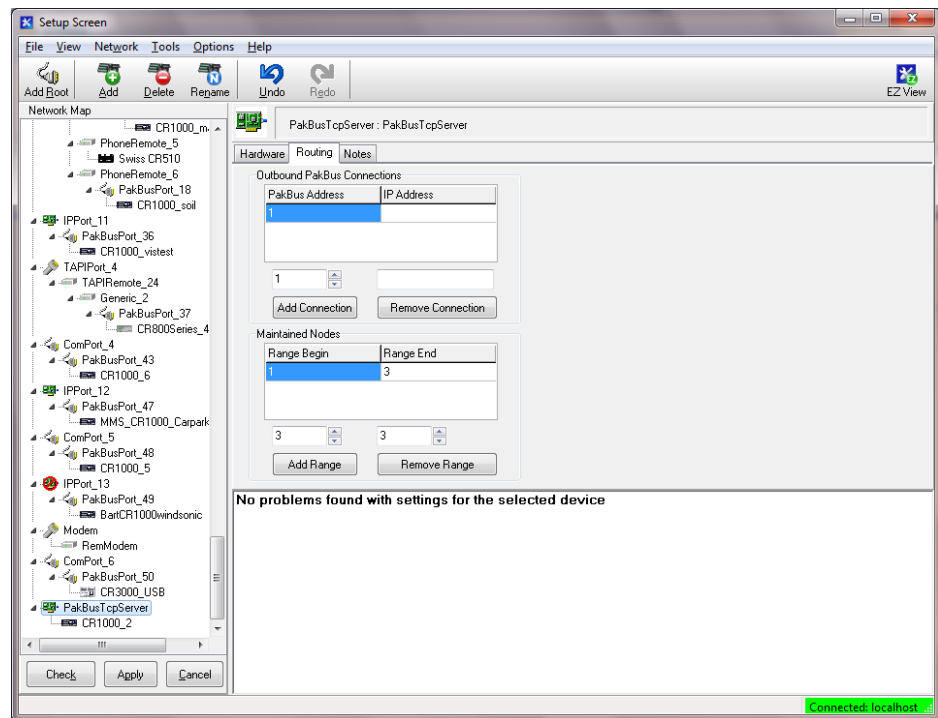

You then need to attach a data logger entry to the PakbusTCPserver for each data logger in your GPRS network, making sure each logger has a unique Pakbus address which matches the logger Pakbus address set in the logger using the Device Configuration program. Other settings, such as data collection parameters, clock correction are set as normal in the data logger tabs.

8.2.3 Keeping the connection open when calling-back

Once a connection between the logger and the Loggernet PC is established, if the connection is set to be maintained (Loggernet 4) or always open, Pakbus messaging will keep the port open and allow Loggernet to make outgoing calls to the logger, e.g. scheduled data collections. Note, for the connection to stay open you must set the Pakbus port to be always open (but do not set this setting if the logger is making less frequent call-back connections controlled by code in the logger or modem to conserve power).

Whether operating in call-back or fixed IP mode if no valid TCP/IP packets are received by the data logger within a few minutes, either it or the modem will test the PPP link locally using a special PPP link test that most providers support. If that fails or 30 minutes pass with no real data being transferred it will attempt to hang up the PPP connection and reconnect. This process allows detection and recovery from a broken GPRS connection (which is not uncommon on some networks). When using the Modem IP stack the idle time (no valid data) and maximum time online are settings you can configure.

In many cases a broken connection may be detected earlier than 30 mins because for instance Windows detects the loss of the TCP/IP connection within a few minutes. Please be aware though that these delay can be lengthy when checking for and debugging lost connections. If you have a poor connection it is possible to speed up the detection of loss routing back to Loggernet by adding code to the logger program, e.g. using the PingIP command. Please contact Campbell Scientific Ltd for further details.

If you are not using Loggernet for Pakbus communications, e.g. you are collecting data by FTP, you either need to setup some FTP activity at an interval less than 30 minutes or set up another process, e.g. low frequency pinging, to prevent the data logger resetting the connection.

It should be noted that when you download a program to the data logger via a TCP/IP connection, and the logger is using its own TCP/IP stack, it will reset the connection as part of the process of compiling the program. This will cause it to drop the PPP connection for some tens of seconds. This process should not be evident from a user standpoint as Loggernet should wait long enough for this to take place so should not report an error in most instances.

8.2.4 Firewall issues

When using any of the above call-back methods you need to have the Loggernet PC either be directly attached to the internet with its own public IP, or be behind a router that forwards incoming calls to specific ports onto the Loggernet PC. With some airtime providers you might also be able to setup a private network connection (or VPN) to the Loggernet PC to avoid it being on the public network.

In addition to allow incoming connections to that PC you will need to open up “holes” in any firewall software running on the PC and/or external routers to allow incoming connections to the call-back sockets and outgoing responses from those sockets.

If using a PC running Windows XP with SP2/SP3, Vista, Windows 7 or Windows 8 (or equivalent server versions) as the Loggernet server you will as a minimum need to check the Firewall settings, via the advanced setting, and add Exception rules for the incoming port numbers you wish to allow dataloggers to call-back in on.

You can test the firewall settings by using that PC from outside your local network to make a connection to Loggernet using the Telnet program (this is an optional part of recent Windows installations that you may need to enable first). If enabled use Start, Run, cmd <enter> and then type

```
telnet n.n.n.n port <enter>
```

Where n.n.n.n is the public IP address of the LN server and port is the callback port defined in your IPPort or PakbusTCPSTServer. When you run this a black telnet window should appear on the screen and say connected in the top bar. You should also see messages in Loggernet’s logfile indicating something has connected to LN on a particular socket (which it is listening on). It will eventually timeout (as you cannot emulate logger speak). If the telnet box flashes on the screen or generates an error message in the top bar it is likely one or more of the firewall, router or Loggernet are setup incorrectly.

NOTE

If you are unable to install your Loggernet server outside a firewall or getting routing enabled through the firewall it is possible to use an NL200 device (installed outside the firewall) to route traffic to a Loggernet server. Please contact Campbell Scientific for more details.

9. Using Loggernet for GSM dial-up

These instructions apply to Loggernet. They also apply to software products based on Loggernet, that support telephone modem or TAPI connections, e.g. PC400.

9.1 Configuring a desk-top modem as a base station

You can use most desktop landline and even cell phone modems to connect to a remote COM111 modem. The modem should be setup as if calling a remote landline modem. The baud rate for connection should be set to 9600 minimum.

The modem can be configured to connect either via the TAPI or Phone modem settings (TAPI being the preferred option if you have installed the modem into your Windows environment.)

NOTE

While Campbell Scientific Ltd may be able to give some advice as to the best settings to use for common modems, the connection of the landline modem to a cellular network is specific to the cellular network being used. Problems establishing the connections are often not related to the fact that a COM111 modem or data logger are connected at the remote end of the connection, but are caused by compatibility issues of the PC modem with the network. Please also contact your cellular network support team for advice on any problems that you might encounter.

9.2 Configuring the COM111 modem as a base station using Loggernet

Neither Campbell Scientific nor the manufacturer provide specific drivers for the COM111 modem. Instead they recommend that you follow the normal Windows procedure for installing a TAPI modem and select the modem type "Standard 9600 bps" or "Standard 19200 bps". Check that Windows finds the modem and attaches it to the correct COM port. For this to work you must make sure the baud rate of the modem has been setup previously to match the modem type selected. Thereafter you can use the modem to call-out using the TAPI interface.

You can also use the Phone modem option in Loggernet, using the default modem type, with the baud rate set to 9600 baud. This option is preferred if additional modem settings are required (see below) or if the COM111 modem is often unplugged from the PC, as the TAPI interface expects to find the modem connected at all times.

NOTE

Before use it is also necessary to reconfigure the modem back to its factory default settings using a terminal emulator and issuing the AT&F, AT+IFC=2,2, then the AT&W commands.

9.2.1 Extending the default time-outs

When using either a landline base modem or a COM111 modem as the base, it is sometimes necessary to increase the time both the PC and the base modem will wait before timing out an attempted connection to a remote

modem. Many modems have a default timeout of 30 seconds which may not be long enough for connection over busy or distant networks. Adding "S7=45" to the end of the modem initialisation string sets the timeout at 45 seconds and Loggernet will increase its own timeouts to suit. Normally you are allowed to increase this setting up to 60 (seconds) if a call is seen to take such a long time to connect. Setting too long a delay may, however, slow down the retry sequence in the event of a failed connection.

To add this setting, use the Phone modem option in Loggernet where you can edit the modem initialisation string in the setup screen. You cannot amend this setting for a TAPI interface in a way that Loggernet can also detect.

Campbell Scientific communications software includes other time-outs which are used to check for hung communications links. These are set to be quite short for land-based modems, as the response to any command sent from the PC should be almost instantaneous. A link to a remote COM111 modem normally passes through several nodes of a digital data network, all of which can add delays. Usually these delays are less than one second and so have no effect on the communications process. However, on a long distance call or busy network, the built in time-out delay for the PC software may need to be extended.

In Loggernet or PC400W, a station-specific delay can be added by increasing the time in the 'Extra response time' box shown on the data logger hardware set-up screen. This delay is entered in seconds. Loggernet has a default, built-in, delay of ~2 seconds, which is adequate for use with the COM111 modem in most cases. On busy networks, or with poor communication links, a value of 3 or even 4 may be required, to allow the error correction process to function.

Where a COM111 modem is used as the base station modem, it is advisable to increase these delays even more by perhaps another 1-2 seconds, if communications are proving to be unreliable.

NOTE Entering too large a delay can slow down the entire communications process, and so an optimal value should be determined by trial and error.

10. Preventing COM111 connection problems

The COM111 monitors its connection state to the network. The modem will reset itself if it gets deregistered and will often re-establish its connection to the network. Generally, this will provide a reliable connection long term. However, there is a very small chance that the COM111 modem could crash as a result of electrical spikes on the power supply or local electrical storms. If the COM111 modem is powered continuously, such a crash will often prevent it answering an incoming call again until it has been reset.

To help overcome these problems, the data logger can be programmed to either reset the COM111 modem by sending it commands (see Appendix A) or to shut down the COM111 modem at regular intervals using a power switch as described in Appendix A. This will save power, but also ensures that the COM111 modem is reset into a known state and make it re-register itself on the network. To be sure that the COM111 modem resets properly, it must be turned off for at least 10 seconds. How often the COM111 modem is turned off will depend on the normal calling schedule, considerations of power consumption and of how long you could afford to lose communication with the COM111 modem if it did go offline.

When turning the power off to the modem it is advisable to avoid cutting the power when the modem is online. The program examples in Appendix B check if the modem is online before turning off the power. You should also avoid scheduling calls to the logger when it is due to power off. If possible the AT+CFUN=0 command should also be sent to the modem before cutting the power to let the modem cleanly deregister from the network and shutdown its radio modem (also shown in the example in Appendix B). If the modem is not cleanly shutdown there may be a delay of some minutes before the network will allow access to the modem again (and in data mode, prevent modem from establishing a PPP connection).

NOTE COM111 based CS-3G modems automatically monitor their connection to the network and will reset the connection if the modem believes it has not properly registered on the network for at least 5 minutes.

11. Fault finding

11.1 General

Before placing the COM111 modem out in the field it is important to check that it is properly registered the network. To do this, connect it to a power supply and turn on any power switch, if used, by connecting the power control line to 5V or 12V. After power has been applied, the small LED in the case should come on continuously initially. Within 30 seconds the LED should switch to start to flash briefly every 2 seconds or so indicating that the unit has registered itself successfully with a GSM network. As a second check, if the SIM contract allows dialled calls to be made (this is not always allowed on GPRS/3G only contracts) connect it to a PC and, using a terminal emulation program, instruct it to dial a valid telephone number, e.g. **ATD01509601091 <ENTER>**. If the COM111 modem does not cause the remote phone to ring but instead immediately responds with a result of NO CARRIER it is likely that:

- It has not been registered properly on a GSM network

or

NOTE If the COM111 modem has definitely been registered on the GSM network, check that the registration is for 'non-transparent use'. Also check it is enabled for GSM Data (CSD) at 9600 baud – not just GPRS data. For GSM data connections you need to be able to connect from analogue landlines – the SIM provider will normally give you a second phone number to dial it on.

- It is not fitted with a SIM, the SIM draw is not in place or the SIM is not enabled (check with your provider)

or

- The SIM is programmed to require a PIN to be entered every time it is turned on. **This is often the case with newly supplied SIMs.** We strongly recommend that this feature is disabled; this is best done using a phone (please refer to your SIM provider for more information).

NOTE

Please refer to Appendix A if you can only access a network where use of a PIN is a legal obligation with the airtime provider.

- The power supply is inadequate, e.g. it cannot supply the high surge currents during transmission (see Section 5.3).

Once communication is established with a data logger via the COM111, it is essential to monitor how error-free the communications link is, Loggernet generates log files which indicate the number of attempts required to retrieve good data ('retries'). While the chances of getting bad data stored to disk are very small (because of the error checking protocols used) the speed at which data is collected can fall markedly if the link is very noisy. This will lead to much higher phone charges. If many retries are recorded it is worth checking the signal strength, studying the antenna position and the likely causes of interference.

If you still encounter problems it is also worth checking the firmware version of the COM111 modem. Campbell Scientific has validated use with units with firmware revision: "R7.53" (checked using instruction **ATI3**). While later software revisions will probably be backwards compatible, older software may not work so well. Please contact your supplier for an upgrade if necessary.

11.2 The modem cannot be configured using the Mobile Data Assistant package

If the modem does not appear to be correctly responding to commands when running the Mobile Data Assistant package, aside from checking the cables and power supply, please make sure that the modem has a valid SIM card installed in it and if not power cycle the modem again after putting the card in. Without a card installed the modem will sometimes only echo commands and not action them and it will fail some of the configuration steps where the software makes changes to settings which are stored in the SIM card, not the modem itself.

11.3 GPRS/3G fault finding – when using the logger TCP/IP stack

11.3.1 First stage fault finding

The diagnostics screen of the Mobile Data Assistant package allows you to check the basic connection of the modem to the network and also to get a measure of the signal strength the modem is seeing, which is a useful tool for antenna positioning. The IP address of the modem will normally be shown as no IP as this relates an IP assigned to the modem when running its own TCP/IP stack.

There is no external feedback provided by the data logger of the state of the PPP connection, e.g. an LED indicator (although this could be done if required by including code in your logger program and an LED to a control port). There are some other methods of checking if a connection has at least been established. The simplest of these is to connect a PC to the other spare serial port on the data logger (USB, CS I/O or RS232 depending on which interface is used for the modem, and presuming you have a compatible cable/interface). Run the Device Configuration program screen, connect to the data logger and Deployment, PPP tab to check the PPP status which is

updated every few seconds. Scroll down to view the IPInfo values. If the ppp IP field is 0.0.0.0 there is no active connection. If valid IP addresses are shown as in the example below all is OK.

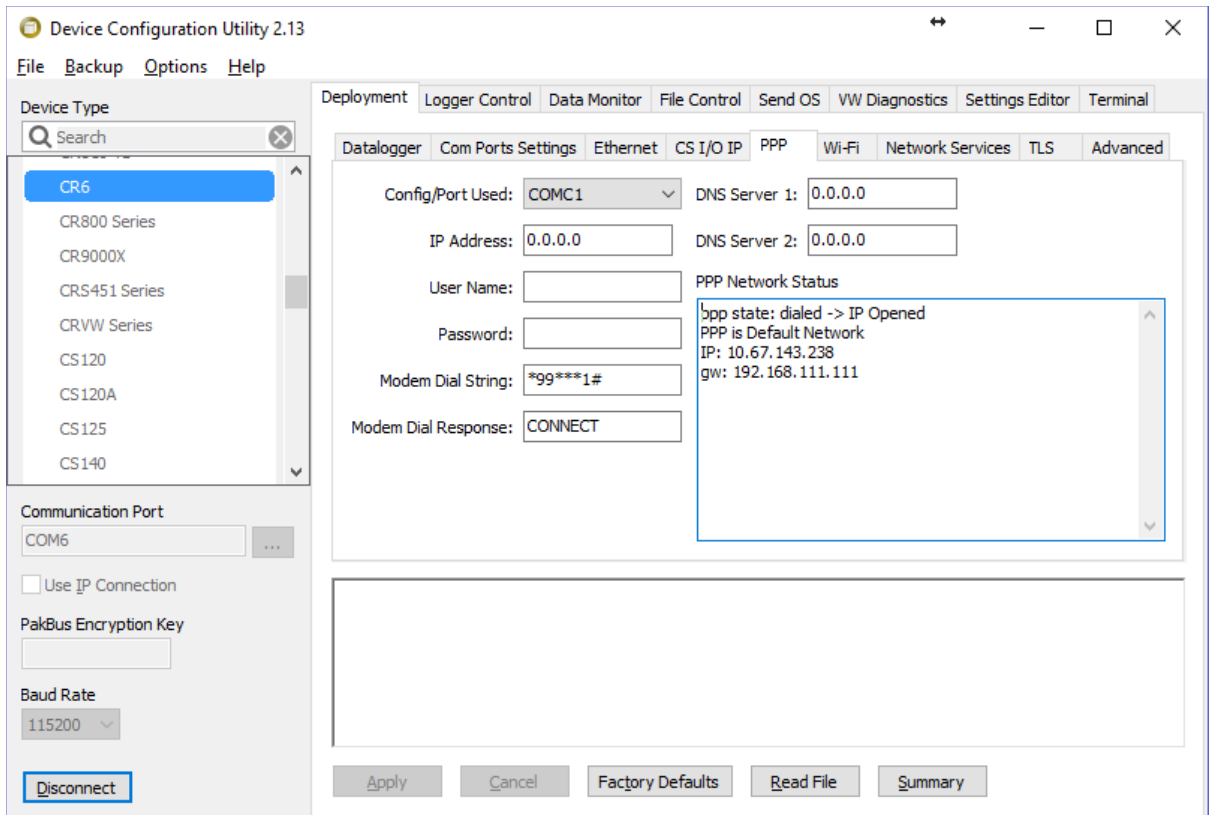

If the IP address shown in the status box above stays at 0.0.0.0, here are some basic checkpoints to follow:

- Check the cabling to the logger, power supply and aerial. Check the modem is powered and on network (there is normally an LED which flashes slowly to indicate this). If the LED is on permanently then check the SIM card is inserted correctly and the retaining switch is clicked across. If it still does not work try the SIM in a mobile handset and follow the fault finding above, including checking the signal strength and network registration.
- Check the modem was configured correctly.
- Check you have set the correct APN, username and password.
- Double check with your airtime provider that the SIM is GPRS enabled.
- Check the data logger operating system is up to date.

If the data logger has firmware version 22 onwards additional information is provided in the IPInfo field of the status table that can be used to track progress of PPP connection. The information is shown at the end of the address messages after the "ppp gw:..." information. This field can be monitored with the Device Configuration program, or in the Table monitor of the Connect client of Loggernet. Either of those programs only update every second, at best, which may not be fast enough as some of the information messages displayed are transitory. To get a faster update of the message you need to use the numeric monitor screen and show the IPInfo

field alone. You can decrease the update interval below 1 second. You can also increase the field width to see the whole message.

Messages that can appear include:

Message	Cause/Fault
ppp initialized	PPP was enabled and initialised OK
ppp program opening	PPPOpen in the program
ppp program closing	PPPClose in the program
ppp closing	Now trying to hang up the connection
ppp closed failed	Could not hang up the modem. Check the modem/settings
ppp close success	The PPP session was closed successfully
ppp dialling	The data logger is trying to dial
ppp dial connecting	The dial string was accepted. Waiting for a connection.
ppp dial failed	Invalid dial string or service not available
ppp dialled	The PPP server has been dialled OK – a connect message was received.
ppp opening	Starting negotiations with the PPP server
ppp authenticating	Sending the username password information
ppp authentication failed	Username/Password invalid for APN being used
ppp authenticated	Username/Password accept and OK
ppp up: ip xxx.xxx.xxx.xxx peer xxx.xxx.xxx.xxx	

At the end of a call “ppp up:” should end up showing the same values as ppp ip: and ppp gw:

Where "peer" should be the gateway.

For a successful connection the messages should follow a sequence such as initialized, dialling, dial connecting, dialled, opening, authenticating, authenticated and up. If the sequence stops along the way and reports a failed message this gives an indication of the cause of the failure as shown in the table above.

NOTE

If there is no dial string, or if the dial string is PPP, then dialling is skipped and ppp “opening” should start up immediately.

If the PPP link works (i.e. you get a non-zero IP address in the screen above) but you do not get a connection to Loggernet, check these points for calling out to fixed IP addresses:

- That you are using the right IP and port setting in Loggernet to match those assigned to you for the SIM.
- Make sure any local firewalls allow you to make outgoing connections on the ports being used. (Some institutions limit you to standard ports) .
- Make sure the service provider lets you use non-standard ports over their IP service (a very few incorporate strict firewalls between the modem and public internet).
- Double check the Net Services settings for the Logger using Device Configuration program.

If you are using a SIM with a dynamic address check these:

- Check the IP address of Loggernet or the Konect Router used is correct – it needs to be a public address (possibly redirected to the LN server by a router if the PC is on an internal private network).
- That the router and PC firewall has holes opened for the logger to call into. This requires low level configuration of the firewall which might be Windows own firewall or third party firewall software running on the machine.
- That the server port in Devconfig matches the port specified in Loggernet.
- Check you have an up to date version of Loggernet.

You can also look in Loggernet's Status/log tool to make sure Loggernet is listening on the socket for call-backs. When a call-back is made you should see activity in the log showing a connection is being made.

11.4 IP advanced fault finding

The data logger has an advanced tracing capability that can be used to debug IP connection problems at a very low level. The easiest way to capture this information is to connect a PC to the data logger via another serial port on the data logger, other than the one to which the GPRS modem is connected as described below. The full trace information can then be captured into a file for long periods.

If this is not possible it is possible to capture some key trace messages either into a data table or file in the data logger memory. The former is done using the IPTrace command in your program (see the CRBasic help), however only a limited amount of information can be captured that way. To capture the trace to a file on the logger use the File Manager (accessed via the Advanced settings in the Device configuration utility) and set the ID to 3212. Enter a valid filename and the maximum file size in the "count" parameter taking into account the free memory available in the data logger. The problem with either of these techniques is that you still have to be able to connect to the data logger to recover the trace data unless data can be stored to a card or SC115.

If a second serial connection can be made to the logger, e.g. via a spare RS232 or USB port follow this procedure:

Connect to the logger with the Device configurator program (Devconfig). Select the terminal tab, then press the enter key several times until the logger terminal prompt is return, e.g. CR1000>. At this point type “W” and press enter to enter the “sniffing” mode. Select the option by number from the menu for the “IPTrace”. Then enter a valid trace code to see the level of information needed, entering “2” will give the basic information needed to diagnose a fault with the initial PPP negotiation.

Click on Start export and enter a filename (end it in .txt). Connect for some minutes or long enough to capture enough data to cover the problematic event. When done click on end export.

You can exit the IPTrace sniffer mode by pressing ESC.

This process will capture the IPtrace log in the file specified. You can open the file in a text editor and review the information there. The information in that file can be interpreted by many familiar with PPP connections and sometimes errors are obvious, e.g. mistyped dial strings. For expert diagnosis the file can be emailed to your support contact at Campbell Scientific who should be able to work out what is the problem and the solution for it.

11.5 GPRS fault finding – when using the modem TCP/IP stack

The following steps are some basic steps to check why a connection does not work.

- Following guidance above to check the modem is connected to the network and has reasonable signal strength. You can do this by using the Mobile Data Assistant program and run the Diagnostics option. This will show the signal strength, network connection and whether an IP address has been allocated to the modem. If the address has not been allocated please try setting up the modem again making sure the APN, username and password are entered correctly.
- If an IP address has been allocated you can check a system setup for call-back operation by running Loggernet and use the Logtool to check the modem is opening the incoming socket as expected. If not, check Loggernet, any firewall software and any routers are configured correctly to allow the incoming connections on the expected socket. This can be verified using a PC on the public internet to Telnet into the IP and socket you are going trying to use. You should see this causes a connection attempt to be registered by Loggernet which you can see by watching the Logtool screens.
- Fault finding a non-working modem with a fixed IP address is slightly easier as the modem will still be in command mode whilst waiting for a connection. You can also use a second PC and the Telnet program to connect to the socket you have configured to validate if the connection is open or not. If the modem has a fixed IP address and is on the public internet OR your PC is connected to the same private IP network as the modem you can also use the standard Ping command to check routing to the modem.
- The modem also supports two advanced methods of remote debugging and reconfiguration. This can be done either via sending

SMS messages or, if the modem is online and with a fixed IP address, by opening a telnet session with the modem and issuing AT commands to the modem by that interface. Please contact Campbell Scientific for more details of these advanced options if needed.

11.6 A base station fails to get a response from the logger with a modem in GSM dial-up mode

Check the following points:

- Is the COM111 modem configured to ignore hardware handshaking? – It will be if setup with the Mobile Data Assistant.
- Was the COM111 modem configured with the “Modem Mode” setting set to 2G. This is the only mode that will allow GSM dial-up mode as this mode is not supported for 3G connections.
- Have you ensured that your base station modem setup includes commands to switch off flow control from the base station?
- Are you powering the COM111 modem on and off periodically?
- If so, the data logger program which is controlling the power of the COM111 modem is either wrong, or is not running (perhaps due to a low battery voltage).
- The number you are dialling - is the voice number for the SIM rather than the data number - if you get a "dead line" when the COM111 modem is on or an "answerphone" service when it is turned off this is almost certainly the problem.
- If you manually dial the number with a phone and hear a buzzing noise rather than modem negotiation tones (beep and whistles) the SIM is configured to accept incoming digital (UDI) calls only - contact the SIM supplier.

Appendix A. Controlling the power use of the COM111 Modem and methods of resetting the modem

This Appendix describes how the datalogger can be used to control the power supply to a COM111 modem to minimise power consumption, which also causes a hard reset of the logger. An example is also shown of how to perform a soft reset of the logger.

A.1 Controlling the power used by a COM111 modem

The power consumption of the COM111 system is much lower than many other cellular modems, being typically 5 mA while waiting for calls in GSM mode, 20-25 mA in GPRS/3G mode online and <200 mA when on-line. As an option a power switch (PSW12) or one of the power switches in the wiring panels of the logger can be used to turn off the power supplied to the COM111 and thereby minimise power use. Clearly, the COM111 will not answer any incoming calls when in this state.

The first thing to do when designing the power supply for your COM111 system is to work out the likely time the modem will be powered on and the length of times it will be online and transmitting data. Using the figures about you can estimate the likely daily power use and match that to the battery capacity and solar panel if used. Take care to check the worst case solar input in the depth of winter.

If the power use is higher that the solar panel can provide you can consider only switching on the COM111 for, say, one hour per day, during which time a base station can be synchronised to collect data. The lowest overall power consumption can be obtained by making the datalogger turn the power on only when it makes outgoing calls. However, this would prevent you calling the datalogger at will from a base station to check its status or to load a new program.

Once the total time per day that the datalogger will be turned on in its different power states is determined, a daily power consumption can be estimated and the power supply designed accordingly. For most typical remote applications a PS150 and a medium-sized solar panel will suffice. Please refer to Technical Note 12 (Calculating Power Consumption and Solar Panel Size) for further details.

To allow the COM111 to receive calls, program the datalogger to set the relevant control port high which controls the power switch which will turn the COM111 on. The COM111 will not answer an incoming call when the power control line is low. Control is normally done using the datalogger code to do turn the power on or off at specific times, e.g. `IF Timeinterval(a,b,c)` followed by a command to turn the power on or off at the specified time. It is also common only to turn the power back on if the battery is above a certain level. Loggers with later operating systems also support the `Timeisbetween` instruction which is slightly simpler to code.

The period that the COM111 is switched on needs to be long enough to allow an incoming call to be started, data collection made and the call completed.

The power can also be switched off/on when using the modem for GPRS/3G communications but extra steps should be added to the program to shut down the PPP connection before power-off (use `PPPClose`) and to re-enable it (`PPPOpen`), on power-up.

For extreme low power consumption applications where the modem has to be left powered on it is possible to disable the status LED which will save a further 1-2 mA power use on average. Please contact Campbell Scientific for further details on how to do this.

The code below implicitly performs a “**hard-reset**” of the logger as it is forced to power up from cold. You can use this code just for a hard reset, rather than saving power, by changing the off/on time to be a few seconds. Additional code can also be added to only call this code by checking if connection is lost to the internet by using the IPPing command, for instance. Contact Campbell Scientific for more details.

A.1.1 A CRBasic Program Example of Power Control/hard reset

This example can be used on the CR6, CR300, CR800 series, CR1000 and CR3000 dataloggers with only minor amendments. It uses the standard CRBasic serialopen, serialout and serialclose commands to send out configuration commands to the modem. The example shows using a slow sequence to turn on and then turn off the modem after 5 minutes. When it comes to turn off the modem it sets a flag. If communications are still active the modem is not turned off unless a full 15 minutes have expired since it was turned on. Please note that the logger may indicate that a Com port is active all the time when used with a PPP connection.

This example also shows how to log off the network before power is turned off (using AT+CFUN=0) and how to disable a PPP connection if the logger is setup to make a PPP connection automatically for IP communications.

```
'CR1000 Series Datalogger
'Example program showing how to turn on/off a GSM modem
'This example only turns on the modem for 5 minutes, but extends the time on for up
'to 15 minutes if the com port is active when it is time to shutdown.
'Also includes the correct sequence to shutdown the modem cleanly before turning
'off the power.
'The modem control is done in a slow sequence to avoid interference
'with measurements

'Declare Public Variables
'Example:
Public PTemp, batt_volt

'Main Program
BeginProg
  'Normal measurements in the main scan here
  Scan (1,Sec,3,0)
    PanelTemp (PTemp,250)
    Battery (batt_volt)
    '.....etc
  NextScan

  '-----
  'Modem control slow sequence - can be cut and pasted as self-contained

  'Set this constant to match the port the modem is connected to
  Const Modemport=COMRS232
  Const Modembaud = 115200 'Change to match modem baud rate

  Public timetogooff As Boolean

  SlowSequence
  'Run once a minute so can have one minute resolution of timing
  Scan (1,Min,3,0)
    'Every hour, in this example, turn on the modem
    If TimeIntoInterval (0,60,Min) Then
      'Turn on the SW12V port if using it
      'SW12 (1 )
      'OR
```



```

    'Set port 1 to 1 (ON) (use writeio as in slowsequence)
    WriteIO (&B00000001,1)
    Delay(1,20,sec) 'Allow 20s seconds for the modem to power on and re-register
    'If using a PPP connection, restart the PPP session
    PPPOpen 'No checks of success in this example
EndIf

    '5 minutes later turn the modem off if it is not online
    'First set a variable to indicate the 5 min time has passed
    If TimeIntoInterval (5,60,Min) Then timetogooff=true
    'If time to go off also check we are offline OR that 15 mins has not passed
    'i.e. shutdown at 15 mins anyway
If(timetogooff AND (NOT ComPortIsActive (Modemport)))OR TimeIntoInterval(15,60,min) Then
    'If using an IP connection shutdown the PPP session
    PPPClose
    'Open the serial port to allow commands to be sent
    SerialOpen (Modemport,Modembaud,0,0,100)
    'Send the command to log off the network and shutdown cleanly,
    'wait up to 3 sec.
    'First send the +++ sequence to get the modem in command mode - in case
    'online
    SerialOut (Modemport,"+++", "OK"+CHR(13),1,150)
    SerialOut (Modemport,"AT+CFUN=0"+CHR(13), "OK"+CHR(13),1,300)
    'Delay to allow deregistration
    Delay (1,5,sec)
    'Turn the SW12 off if using it
    SW12 (0)
    'OR
    'Set port 1 to 0 (LOW) (use WriteIO As in SlowSequence)
    WriteIO (&B00000001,0)
    'Closing the serial port saves power too.
    SerialClose(Modemport)
    timetogooff=false
EndIf
'-----

NextScan

EndProg

```

A.2 Performing a soft reset

To perform a “soft” reset the modem the command AT+CFUN=1<CR> is sent to the modem without controlling the power to the modem. This attempts to disconnect the modem from the network, fully resets the module to a power up state and then reconnects it to the network. This entire process can take up to 30 seconds, although the module will accept non-network related commands within a few seconds of receiving the reset command.

Performing a “soft” reset only cause a short break in communications and is almost as effective as a full power cycle reset.

A.2.1 A CRBasic Program Example of a soft reset

This example can be used on the CR6, CR300, CR800 series, CR1000 and CR3000 dataloggers. It uses the standard CRBasic serialopen, serialout and serialclose commands to send out configuration commands to the modem. The example shows using a slow sequence to reset the modem every 12 hours, using the command AT+CFUN=1.

```

'CR1000 Series Datalogger
'Example program showing how to regularly reset the GSM/GPRS modem
'The modem control is done in a slow sequence to avoid interference with measurements

'Declare Public Variables
'Example:
Public PTemp, batt_volt

```

```
'Main Program
BeginProg
'Normal measurements in the main scan here
Scan (1,Sec,0,0)
  PanelTemp (PTemp,250)
  Battery (Batt_volt)
  '.....etc
NextScan

'-----
'Modem control slow sequence - can be cut and pasted as self-contained

'Set this constant to match the port the modem is connected to
Const Modemport=COMRS232
Const Modembaud = 115200 'Change to match modem baud rate

SlowSequence
'Run once a minute so can have one minute resolution of timing
Scan (1,Min,3,0)
'Every 12 hours, in this example and only if we are not communicating
If TimeIntoInterval (0,12,hr) Then
  'Note that opening the serial port will automatically close any PPP session
  SerialOpen (Modemport,Modembaud,0,0,100)
  'First send the +++ sequence to get the modem in command mode
  SerialOut (Modemport,"+++", "OK"+CHR(13),1,150)
  'Send the command to reset the modem the connection wait up to 5 sec
  SerialOut (Modemport,"AT+CFUN=1"+CHR(13), "OK"+CHR(13),1,500)
  Delay(1,20,sec) 'Wait another 20 sec just to make sure the reset is complete and
  the modem has time to reconnect
  SerialClose(Modemport) 'which will allow PPP to restart if enabled
EndIf

NextScan
'-----

EndProg
```

Appendix B. Useful Configuration Commands for the COM111

This section gives details of some of the useful test commands that can be used during setup of the COM111. Further details can be found in the COM111 technical manuals available on request from Campbell Scientific Ltd.

General details referring to the telecommunications industry can be found at the European Telecommunications Standards Institute (ETSI) web site at www.etsi.org.

B.1 Signal Quality Checks

AT+CSQ	Signal Quality
Test command AT+CSQ=?	Response +CSQ: (list of supported <rssis>), (list of supported <ber>) OK <i>Parameter</i> See execute command
Execute command AT+CSQ	Response TA returns received signal strength indication <rssis> and channel bit error rate <ber> from the ME. +CSQ: <rssis>, <ber> OK <i>Parameter</i> <rssis> : 0: -113 dBm or less 1: -111 dBm 2 to 30: -109 to -53 dBm 31: -51 dBm or greater 99: not known or not detectable <ber> : 0...7: as RXQUAL values in the table GSM 05.08 99: not known or not detectable

B.2 Network Registration Checks

AT+COPS	Operator selection												
Test command AT+COPS=?	Response The modem returns a list of quadruplets, each representing an operator present in the network. Any of the formats may be unavailable and should then be an empty field. The list of operators will be in the following order: home network, networks referenced in SIM, and other networks. +COPS: [list of supported (<stat>,long alphanumeric <oper>,short alphanumeric <oper>,numeric <oper>[,<Act>])s] OK <i>Parameter: See set command</i>												
Read command AT+COPS?	Response The modem returns the current mode and the currently selected operator. If no operator is selected, <format> and <oper> are omitted. +COPS : <mode>[, <format>[, <oper>[,<Act>]]] OK <i>Parameter: See set command</i>												
Set command AT+COPS=<mode>[,<format>[,<oper>[,<Act>]]]	Response The modem forces an attempt to select and register the network operator. If the selected operator is not available, no other operator will be selected (except <mode>=4). The selected operator name format will apply to further read command (+COPS?) also. OK <i>Parameter</i> <table data-bbox="571 1093 1045 1211"> <tr> <td><stat></td> <td>0</td> <td>unknown</td> </tr> <tr> <td></td> <td>1</td> <td>operator available</td> </tr> <tr> <td></td> <td>2</td> <td>operator current</td> </tr> <tr> <td></td> <td>3</td> <td>operator forbidden</td> </tr> </table> <mode> 0: automatic (default value) 1: manual 2: deregistration ; ME will be unregistered until <mode>=0 or 1 is selected. 3: set only <format> (for read command AT+COPS?) 4: manual / automatic (<oper> shall be present), if manual selection fails, automatic mode is entered. 127: Force to automatic at next power cycle. <format> : format of <oper> field <format> 0: long alphanumeric format <oper> 1: short alphanumeric format <oper> 2: numeric <oper> (default value) <stat>: status of <oper> <stat> 0: unknown 1: available 2: current 3: forbidden <oper> : operator identifier (MCC/MNC in numeric format only for operator selection) <Act> : Access Technology – 0: GSM (2), 2: UTMS (3G)	<stat>	0	unknown		1	operator available		2	operator current		3	operator forbidden
<stat>	0	unknown											
	1	operator available											
	2	operator current											
	3	operator forbidden											

AT+CREG	Network registration
Test command AT+CREG=?	Response +CREG: list of supported <n>s OK <i>Parameter</i> See set command
Read command AT+CREG?	Response +CREG : <mode>, <stat> [,<lac>,<ci>[,<Act>]] for AT+CREG? Command only
Set command AT+CREG=<n>	Response TA controls the presentation of an unsolicited result code +CREG:<stat> when <n>=1 and there is a change in the ME network registration status or code +CREG: <stat>[,<lac>,<ci>] when <n>=2 and there is a change of network cell. OK <i>Parameter</i> <mode> 0: Disable network registration unsolicited result code (default) 1: Enable network registration code result code +CREG : <stat> 2: Enable network registration and location information unsolicited result code +CREG: <stat>,<lac>,<ci> if there is a change of network cell. <stat> 0: not registered, ME is not currently searching for a new operator. 1: registered, home network. 2: not registered, ME currently searching for a new operator to register to. 3: registration denied. 4: unknown. 5: registered, roaming. <lac> : string type; two byte location area code in hexadecimal format (e.g. "00C3" equals 195 in decimal). <ci> : string type; two byte cell ID in hexadecimal format. <Act> : Access Technology – 0: GSM (2), 2: UTMS (3G)

B.3 PIN Configuration

AT+CPIN	Enter PIN																					
Test command AT+CPIN=?	Response OK																					
Read command AT+CPIN?	<p>Response</p> <p>TA returns an alphanumeric string indicating whether some password is required or not.</p> <p>+CPIN: <code> OK</p> <p>If error is related to ME functionality:</p> <p>+CME ERROR: <err></p> <p><i>Parameter</i></p> <table> <tr> <td><code></td> <td>READY</td> <td>no further entry needed</td> </tr> <tr> <td></td> <td>SIM PIN</td> <td>ME is waiting for SIM PIN</td> </tr> <tr> <td></td> <td>SIM PUK</td> <td>ME is waiting for SIM PUK</td> </tr> <tr> <td></td> <td>PH_SIM PIN</td> <td>ME is waiting for phone to SIM card (antitheft)</td> </tr> <tr> <td></td> <td>PH_SIM PUK</td> <td>ME is waiting for SIM PUK (antitheft)</td> </tr> <tr> <td></td> <td>SIM PIN2</td> <td>PIN2, e.g. for editing the FDN book, possible only if preceding command was acknowledged with +CME ERROR:17</td> </tr> <tr> <td></td> <td>SIM PUK2</td> <td>possible only if preceding command was acknowledged with error +CME ERROR:18</td> </tr> </table>	<code>	READY	no further entry needed		SIM PIN	ME is waiting for SIM PIN		SIM PUK	ME is waiting for SIM PUK		PH_SIM PIN	ME is waiting for phone to SIM card (antitheft)		PH_SIM PUK	ME is waiting for SIM PUK (antitheft)		SIM PIN2	PIN2, e.g. for editing the FDN book, possible only if preceding command was acknowledged with +CME ERROR:17		SIM PUK2	possible only if preceding command was acknowledged with error +CME ERROR:18
<code>	READY	no further entry needed																				
	SIM PIN	ME is waiting for SIM PIN																				
	SIM PUK	ME is waiting for SIM PUK																				
	PH_SIM PIN	ME is waiting for phone to SIM card (antitheft)																				
	PH_SIM PUK	ME is waiting for SIM PUK (antitheft)																				
	SIM PIN2	PIN2, e.g. for editing the FDN book, possible only if preceding command was acknowledged with +CME ERROR:17																				
	SIM PUK2	possible only if preceding command was acknowledged with error +CME ERROR:18																				
Set command AT+CPIN=<pin> [, <newpin>]	<p>Response</p> <p>TA stores a password which is necessary before it can be operated (SIM PIN, SIM PUK, PH-SIM PIN, etc.). If the PIN is entered twice, the TA will automatically repeat the PIN. If no PIN request is pending, no action is taken and an error message, +CME ERROR is returned to TE.</p> <p>If the PIN required is SIM PUK or SIM PUK2, the second PIN is required. This second PIN, <newpin>, is used to replace the old PIN in the SIM.</p> <p>OK</p> <p>If error is related to ME functionality:</p> <p>+CME ERROR: <err></p> <p><i>Parameter</i></p> <table> <tr> <td><pin></td> <td>password (string type) does not need any quotes. e.g. AT+CPIN=9515</td> </tr> <tr> <td><new pin></td> <td>if the PIN required is SIM PUK or SIM PUK2: new password</td> </tr> </table>	<pin>	password (string type) does not need any quotes. e.g. AT+CPIN=9515	<new pin>	if the PIN required is SIM PUK or SIM PUK2: new password																	
<pin>	password (string type) does not need any quotes. e.g. AT+CPIN=9515																					
<new pin>	if the PIN required is SIM PUK or SIM PUK2: new password																					

B.4 Changing the operating frequency between EU/Rest of world and US wavebands

The standard COM111 only supports the 900 and 2100 MHz UTMS/3G frequencies that are common in Europe and Asia. It does not support the alternative frequencies 850/1900 MHz that are common in the Americas or frequencies specific to Australia. Contact Campbell Scientific for alternative versions of these modems if a large scale deployment in those countries are likely.

Unlike earlier modems sold by Campbell Scientific Ltd, the COM111 is a full quad band modem for GSM/2G connections. It also supports EDGE communications if the local network supports it. By default the modem will switch automatically over the frequencies of 850/900/1800/1900 MHz bands which covers use on 2G networks around the world, so no reconfiguration is normally needed.

If it is necessary to fix the 2G band use a terminal emulation program, such as the Device Configuration Program to enter the **AT+WMBS=<band>, 0** command.

The table below gives the commands for various band(s) selection:

AT+WMBS Band Selection

AT+WMBS=0,0	Select mono band mode 850 MHz
AT+WMBS=1,0	Select mono band mode extended 900 MHz
AT+WMBS=2,0	Select mono band mode 1800 MHz
AT+WMBS=3,0	Select mono band mode 1900 MHz
AT+WMBS=4,0	Select dual band mode 850/1900 MHz
AT+WMBS=5,0	Select dual band mode extended 900 MHz/1800 MHz
AT+WMBS=6,0	Select dual band mode extended 900 MHz/1900 MHz
AT+WMBS=7,0	Select quad-band mode 850/900E (extended)/1800/1900 MHz*

*The default setting in Europe.

After issuing the command the COM111 module will have to be reset, by power cycling the module to change to the new specified band(s). The setting is stored in non-volatile memory automatically.

To check the Band(s) Selection

To check the band selection for the COM111, use a communication software such as HyperTerminal, then enter **AT+WMBS?** command.

The table below gives the main responses returned:

AT+WMBS Responses

+WMBS: 0, x Mono band mode 850 MHz is selected
+WMBS: 1, x Mono band mode extended 900 MHz is selected
+WMBS: 2, x Mono band mode 1800 MHz is selected
+WMBS: 3, x Mono band mode 1900 MHz is selected
+WMBS: 4, x Dual band mode 850/1900 MHz are selected

+WMBS: 5, x	Dual band mode extended 900 MHz/1800 MHz are selected
+WMBS: 6, x	Dual band mode extended 900 MHz/1900 MHz are selected
+WMBS: 7, x	Quad-band mode 850/900E (extended)/1800/1900 MHz

Appendix C. Configuring the COM111 using the datalogger talk-thru mode

It is possible to reconfigure the modem connected to a logger without the programming cable by talking through the datalogger from one communications interface to another. This works with the CR6, CR300 Series, CR800 series, CR1000 or CR3000 dataloggers.

This process can be generally used when you do not have a modem programming cable but you do have a cable or interface to talk to the datalogger via one interface and the modem is plugged into another. The possible configurations include a PC connected to the RS232 port and the modem via an SC-WMI or the PC connected to the CS I/O port (via an SC32B or SC-USB) and the modem connected to the RS232 or USB port. (This procedure can work when the modem is connected via an SC105, but that is not normally necessary as the cable for connecting an SC105 and modem can also be used directly as a modem programming cable.)

To allow you to talk to the modem via the datalogger follow this procedure (amending the connection details to suit your configuration).

1. Connect the modem to the logger via the relevant interface and communications port, e.g. the SC-WMI and CS I/O port.
2. Power up the modem and logger.
3. Connect the logger to the PC, e.g. via the RS232 or USB port if supported, and start communicating with it using the Device Configuration program (use the latest version from www.campbellsci.com/downloads). Select the correct PC COM port you intend to use and the baud rate and press connect.
4. First to turn off any PPP function in the logger, using the PPP tab. Set the PPP port to inactive.
5. Then under the Comport settings check the serial port to which the modem is connected is set to a baud rate which matches the setup of the modem (it is not necessary to do this to receive calls normally but is best to do if trying to make outgoing calls or to configure the modem). CS normally set the baud rate to 9600 for GSM use and for 115200 for GPRS/3G use. Make sure to click the Apply button after making a change and then reconnect to the logger.
6. Then click on the Terminal tab.
7. Press enter a few times and you should get a prompt like "CR1000>" (a similar model specific prompt is given for other loggers).
8. Then press P and enter (you need to do this within 3 seconds of receiving the prompt as there is a fast timeout). If you miss this repeat step (7).
9. Then, in response to the list of com port addresses, enter 2 for ComME (for the SC-WMI or SC932A) or the relevant entry to suit the com port to which the modem is connected.
10. If prompted enter a timeout of say 300 (seconds), press enter after each entry.

11. The logger should then report “opening 2” (in the case of ComME), which means you now have a “talk through” path to the modem, i.e. it should respond as if connected directly to the PC.
12. If the modem is being used for GPRS/3G use and particularly if the modem is set to use its own TCP/IP stack it will be necessary to get it back into command mode, by sending “+++” then waiting for a response, normally OK.
13. Then to check it is responding normally send “ATZ” and press enter, the modem at a minimum should respond “0” or “OK”, unless it has been configured at the wrong baud rate or all responses have been turned off.
14. If there is no response at all, please consider the baud rate may not be set as expected, so press ESC a few times to quit the talk through session, back out and return to step (5) above to change the baud rate of the logger serial port, then try again.
15. Once a valid response is received, enter the configuration command you need to change as normal, remembering to save the setting to non-volatile memory if required (AT&W).
16. When completed press “ESC” three times to quit the talk-through mode.
17. If you are using the modem in GPRS/3G mode remember to go back to the PPP setting tab and re-enable PPP on the port to which the modem is connected.

Appendix D. Using the COM111 in Transparent GSM Dial-up mode

It is possible to use the COM111 in transparent mode, when the default non-transparent (RLP) mode is not supported by the cellular phone network or is incompatible with the COM111.

D.1 Introduction

The COM111 software includes an advanced error correction protocol known as RLP, which is specially designed for RF links. This protocol is now used in one form or another by most GSM data units but the COM111 implementation of RLP may not be compatible with all GSM networks and some networks do not support this mode at all.

NOTE

If you find that the COM111 does not work on the network and suspect that it may be due to the RLP protocol, you must check carefully with your own network provider to see if the COM111 implementation of the protocol is known to work correctly on their network. Also check the modem has been configured to connect in 2G Modem Mode Only.

The transparent mode relies on Loggernet/PC400W to correct any communication errors. On poor quality lines the PC software will often drop the call and redial when it sees a certain level of errors. (The non-transparent mode is less prone to doing this.) For successful and fast communication a signal strength (as reported by AT+CSQ – see Appendix C) of 18 or above is recommended for transparent mode. The non-transparent mode will operate at signal levels down to as low as 10.

D.2 Disabling the RLP Protocol

If you wish to use the COM111 in transparent mode, do the following:

1. Get your SIM card in the COM111 enabled for transparent mode. In some cases you may have to call your airtime provider to do this, (e.g. UK O2 where you will be allocated a new number for this mode) while others (such as UK Vodafone) need no configuration on the network and will switch automatically depending on the COM111 configuration.
2. Configure the modem for GSM dial-up using the Mobile Data Assistant package, but afterwards using the Advanced mode to enter a revised setting using the command AT+CBST=7,0,0 (where the last digit, 0, switches the unit to transparent mode).
3. Save the settings using the AT&W command as normal.

Appendix E. Using the COM111 with the PIN Security Feature Enabled

It is possible to use the COM111 with Campbell Scientific dataloggers with the COM111's PIN (Personal Identification Number) feature enabled. However, this has the following disadvantages:

- If the COM111 loses power momentarily, it will not answer further calls until the datalogger sends the PIN again as part of the normal program sequence. If the datalogger is programmed to send the PIN only once (leaving the COM111 permanently switched on), a datalogger reset would be needed to re-enable the system. If a regular turn on / turn off sequence is used (as described under 'Controlling the Power Consumption of the COM111' in Appendix A), the system will be disabled until the next sequence occurs.*
- If the COM111 fails to unlock the PIN code, for whatever reason, three times in a row, the SIM card will be permanently locked. This will require you to contact your airtime service provider to provide an 'unlock' code for the SIM.*

Therefore if at all possible disable the PIN function otherwise follow these instructions.

E1. Introduction

To operate with the COM111's PIN feature enabled, the datalogger must transmit the command to send the PIN to the COM111 after turning on the power. For CRBasic dataloggers this is simply done by using serial commands to send the PIN code after the modem is turned on, see the example below.

Users of older dataloggers, e.g. the CR10X, 21X, CR10 or CR7, should contact Campbell Scientific to obtain a copy of a manual written for early versions of this manual which gives examples for Edlog programmed loggers.

E2. CRBasic Program Example

This example can be used on the CR800 series, CR1000 and CR3000 dataloggers. It uses the standard CRBasic serialopen, serialout and serialclose commands to send out configuration commands to the modem. The example shows using a slow sequence to sending the command to unlock the PIN immediately after turning on the modem.

```
'CR1000 Series Datalogger
'Example program showing how to turn on/off a GSM modem and disable the PIN code
'Also includes the correct sequence to shutdown the modem cleanly before turning
'off the power.
'The modem control is done in a slow sequence to avoid interference with measurements

'Declare Public Variables
'Example:
Public PTemp, batt_volt
```

```
'Main Program
BeginProg
'Normal measurements in the main scan here
  Scan (1,Sec,0,0)
    PanelTemp (PTemp,250)
    Battery (Batt_volt)
    '.....etc

  NextScan

'-----
'Modem control slow sequence - can be cut and paste as self-contained
'Set this constant to match the port the modem is connected to
Const Modemport=COMME
Const Modembaud = 9600 'Change to match modem baud rate

SlowSequence
'Run once a minute so can have one min resolution of timing
Scan (1,Min,3,0)
'Every hour, in this example, turn on the modem
If TimeIntoInterval (0,60,Min) Then
  'Set port 1 to 1 (ON) (use writeio as in slowsequence)
  WriteIO (&B00000001,1)
  Delay(1,2,sec) 'Allow 2 seconds for the modem to power on
  SerialOpen (Modemport,modembaud,0,0,100)
  'Send the command to unlock the pin code (PIN=601141 in this case)
  'Allow one retry
  SerialOut (Modemport,"AT+CPIN=601141"+CHR(13),"OK"+CHR(13),1,100)
  SerialClose(Modemport)
EndIf

'10 minutes later turn the modem off
If TimeIntoInterval (10,60,Min) Then
  SerialOpen (Modemport,modembaud,0,0,100)
  'Send the command to log off the network and shutdown cleanly
  SerialOut (Modemport,"AT+CFUN=0"+CHR(13),"OK"+CHR(13),1,300)
  SerialClose(Modemport)
  'Set port 1 to 0 (LOW) (use writeio as in slowsequence)
  Delay(1,2,sec) 'Allow 2 seconds for the modem to shutdown
  WriteIO (&B00000001,0)

EndIf

NextScan

EndProg
```

Global Sales & Support Network

A worldwide network of companies to help meet your needs



- Campbell Scientific group companies
- Sales representatives

Australia

Location: Garbutt, QLD Australia
Phone: 61.7.4401.7700
Email: info@campbellsci.com.au
Website: www.campbellsci.com.au

Brazil

Location: São Paulo, SP Brazil
Phone: 11.3732.3399
Email: vendas@campbellsci.com.br
Website: www.campbellsci.com.br

Canada

Location: Edmonton, AB Canada
Phone: 780.454.2505
Email: dataloggers@campbellsci.ca
Website: www.campbellsci.ca

China

Location: Beijing, P. R. China
Phone: 86.10.6561.0080
Email: info@campbellsci.com.cn
Website: www.campbellsci.com

Costa Rica

Location: San Pedro, Costa Rica
Phone: 506.2280.1564
Email: info@campbellsci.cc
Website: www.campbellsci.cc

France

Location: Vincennes, France
Phone: 0033.0.1.56.45.15.20
Email: info@campbellsci.fr
Website: www.campbellsci.fr

Germany

Location: Bremen, Germany
Phone: 49.0.421.460974.0
Email: info@campbellsci.de
Website: www.campbellsci.de

South Africa

Location: Stellenbosch, South Africa
Phone: 27.21.8809960
Email: sales@campbellsci.co.za
Website: www.campbellsci.co.za

Southeast Asia

Location: Bangkok, Thailand
Phone: 66.2.719.3399
Email: thitipongc@campbellsci.asia
Website: www.campbellsci.asia

Spain

Location: Barcelona, Spain
Phone: 34.93.2323938
Email: info@campbellsci.es
Website: www.campbellsci.es

UK

Location: Shepshed, Loughborough, UK
Phone: 44.0.1509.601141
Email: sales@campbellsci.co.uk
Website: www.campbellsci.co.uk

USA

Location: Logan, UT USA
Phone: 435.227.9120
Email: info@campbellsci.com
Website: www.campbellsci.com

Other Locations: Sales and support are provided in many other locations through an extensive network of international reps. For the full list, please visit www.campbellsci.com/contact#dir.