

Honeywell

GasBook



Honeywell Gas Detection

1

Introduction

The Gas Book is intended to offer **a simple guide to anyone considering the use of fixed and portable gas detection equipment.**

The aim has been to provide a complete and comprehensive introduction to the subject— from detailing the principles of detection that different devices employ to providing information on certifications and application suitability.

A diverse variety of applications and processes increasingly involve the use and manufacture of highly dangerous substances, particularly flammable, toxic and Oxygen gases. Inevitably, occasional escapes of gas occur, which create a potential hazard to the industrial plants, their employees and people living nearby. Worldwide incidents, involving asphyxiation, explosions and loss of life, are a constant reminder of this problem.

In most industries, one of the key parts of any safety plan for reducing risks to personnel and plant is the use of early warning devices such as gas detectors. These can help to provide more time in which to take remedial or protective action. They can also be used as part of a total, integrated monitoring and safety system which may include various other safety aspects including fire detection and emergency process shutdown. Gas detection can be divided into two overriding categories; fixed gas detection and portable gas detection. As the name might suggest, fixed gas detection represents a static type of detection system for flammable, toxic and Oxygen gas hazards and is designed to monitor processes, and protect plant and assets as well as personnel on-site.

Portable gas detection is designed specifically to protect personnel from the threat of flammable, toxic or Oxygen gas hazards and is typically a small device worn by an operator to monitor the breathing zone. Many sites incorporate a mix of both fixed and portable gas detection as part of their safety philosophy, but the suitability of which type to use will depend on several factors, including how often the area is accessed by personnel. ■

Contents

Section	Subject	Page	Section	Subject	Page
1	Introduction	2	18	ATEX	80-81
2	Honeywell Gas Detection brands	4-5		IEC Standards	82-83
3	What is gas?	6		Equipment markings	84-85
4	Gas hazards	7	19	Area classification	86-87
5	Flammable gas hazards	8	20	Apparatus design	88-89
	Flammable limit	9	21	Apparatus classification	90-91
	Flammable gas properties	10-11	22	Ingress protection of enclosures	92-93
	Flammable gases data	12-19	23	Safety integrity levels (SIL)	94-95
6	Toxic gas hazards	20	24	Gas detection systems	96-97
	Workplace exposure limits	21		Location of sensors	98-99
	Toxic exposure limits	22-25		Typical sensor mounting options	100
	Toxic gases data	26-29		Typical system configurations	100-101
7	Asphyxiant (Oxygen deficiency) hazard	30	25	Installation	102
8	Oxygen enrichment	31	26	Gas detection maintenance and ongoing care	106-109
9	Typical areas that require gas detection	32-35	27	Glossary	110-113
10	Principles of detection	36			
	Combustible gas sensor	36			
	Catalytic sensor	36			
	Speed of response	37			
	Sensor output	37			
	Calibration	38			
	Infrared gas detector	39			
	Open path flammable infrared gas detector	40			
	Electrochemical cell sensors	41			
	Photo Ionised Detection (PID)	42			
	Chemcassette® sensor	42			
	Comparison of gas detection techniques	43			
11	Selecting gas detection	44-45			
12	Maximising time and efficiency	46-47			
13	Communications protocols	48-49			
14	Fixed gas detection from Honeywell	50-51			
15	Portable gas detectors	52			
	Why are portable gas detectors so important?	54			
	Breathing zone	55			
	Typical gases requiring portable detection	55			
	Portable gas detector types	56			
	Operational modes of a gas detector	56			
	Features and functionality	57			
	Accessories	58			
	Alarms and status indication	59			
	Typical applications for portable gas detectors	60			
	Confined spaces	60-61			
	Marine	62			
	Water treatment industry	63			
	Military	64-65			
	Hazardous Material (HAZMAT) emergency response	66			
	Oil and gas (on and offshore)	67			
	PID Information	68			
	Measuring Solvent, Fuel and VOC Vapour in the workplace environment	68-71			
	Maintaining portable gas detection	72			
	Reducing the cost of device testing	73			
	How to perform a manual bump test	73			
	Portable gas detectors from Honeywell	74-75			
16	North American hazardous area standards and approvals	76			
	North American Ex marking and area classification	77			
17	European hazardous area standards and approvals	78-79			

2

Honeywell Gas Detection brands

Honeywell Analytics Experts in Gas Detection

At Honeywell Analytics our key focus is our customers. We believe that the evolution of gas detection should be driven by the people using our equipment, rather than engineers deciding the needs of industry. With this in mind, we listen to what our customers want, refine our solutions to meet changing demands and we grow as our customers grow to ensure we are able to provide an added value service that meets individual requirements.

Working with Industry... since the birth of gas detection

With 50 years experience in the industry, we have been influential in gas detection since the very beginning. Many of our historic products set new benchmarks for gas detection in terms of performance, ease of use and innovation. Today, our product lines have evolved to meet the requirements of diverse industries and applications, delivering comprehensive solutions designed to drive down the cost of gas detection, whilst providing enhanced safety.

Our Technical Support Centre and Product Application and Training Specialists, field engineers and in-house engineering support represent some of the very best the industry has to offer, providing over 1,100 years cumulative expertise, allowing us to deliver local business support on a corporate scale. ■





GAS FACT

The word gas was coined in 1650–60 by J. B. van Helmont (1577–1644), a Flemish chemist. It comes from the Greek word for chaos.

BW Technologies

by Honeywell

BW Technologies by Honeywell is a World leader in the gas detection industry with a strong commitment to providing customers with high performance, dependable portable products that are backed up by exceptional customer service and ongoing support.

We design, manufacture and market innovative portable gas detection solutions for a wide variety of applications and industries, with options to suit all budgets and hazard monitoring requirements.

Our comprehensive range includes options from single gas units that require no ongoing maintenance, to feature-rich multi-gas devices that deliver additional value-added functionality.

As a leading expert in the field of portable gas detection, we provide customised on-site/field based training to meet specific customer needs and application support to assist customers with the selection and integration of solutions that are entirely fit for purpose.

When it comes to device care, we also offer cost-effective benchmark support and maintenance through our comprehensive approved partner network.

Delivering value added solutions at affordable prices for 25 years

BW Technologies by Honeywell was originally established in 1987 in Calgary, Canada. Over the last 25 years, we have been bringing innovative gas detection solutions to market that add value, enhance safety and help to reduce the ongoing cost of portable gas detection.

With offices all over the World, and a diverse and talented team of industry experts on hand to provide support to customers, we offer a large corporate infrastructure supported by locally focused teams that have a unique understanding of industry and applications as well as regional needs. ■

3

What is Gas?

The name gas comes from the word chaos. Gas is a swarm of molecules moving randomly and chaotically, constantly colliding with each other and anything else around them. Gases fill any available volume and due to the very high speed at which they move will mix rapidly into any atmosphere in which they are released.

Different gases are all around us in everyday life. The air we breathe is made up of several different gases including Oxygen and Nitrogen.

Vehicle engines combust fuel and Oxygen and produce exhaust gases that include Nitrogen Oxides, Carbon Monoxide and Carbon Dioxide.

Air Composition

The table gives the sea-level composition of air (in percent by volume at the temperature of 15°C and the pressure of 101325 Pa).

Name	Symbol	Percent by Volume
Nitrogen	N ₂	78.084%
Oxygen	O ₂	20.9476%
Argon	Ar	0.934%
Carbon Dioxide	CO ₂	0.0314%
Neon	Ne	0.001818%
Methane	CH ₄	0.0002%
Helium	He	0.000524%
Krypton	Kr	0.000114%
Hydrogen	H ₂	0.00005%
Xenon	Xe	0.0000087%

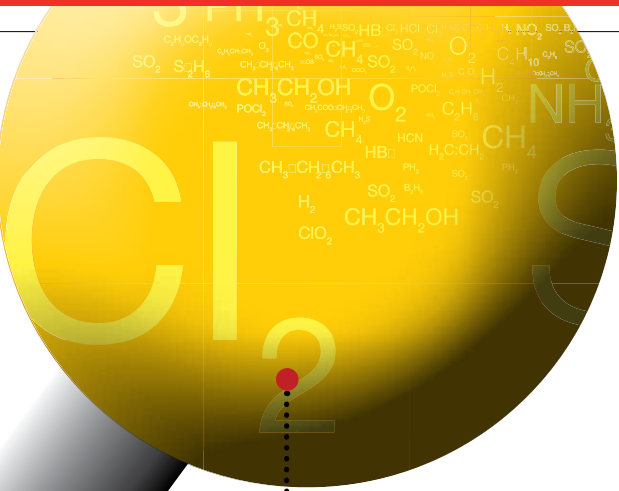

Gases can be lighter, heavier or about the same density as air. Gases can have an odour or be odourless. Gases can have colour or be colourless. If you can't see it, smell it or touch it, it doesn't mean that it is not there.



Natural Gas (Methane) is used in many homes for heating and cooking.

4

Gas Hazards

There are three main types of gas hazard:

Flammable

RISK OF FIRE AND/OR EXPLOSION

e.g.
Methane,
Butane, Propane



Toxic

RISK OF POISONING

e.g.
Carbon Monoxide,
Hydrogen, Chlorine



Asphyxiant

RISK OF SUFFOCATION

e.g.
Oxygen deficiency. Oxygen can be consumed or displaced by another gas



5

Flammable Gas Hazards

Combustion is a fairly simple chemical reaction in which Oxygen is combined rapidly with another substance resulting in the release of energy. This energy appears mainly as heat – sometimes in the form of flames.

The igniting substance is normally, but not always, a Hydrocarbon compound and can be solid, liquid, vapour or gas. However, only gases and vapours are considered in this publication.

(N.B. The terms 'flammable', 'explosive', and 'combustible' are, for the purpose of this publication, interchangeable).

The Fire Triangle

The process of combustion can be represented by the well known fire triangle.

Three factors are always needed to cause combustion:

- 1 A SOURCE OF IGNITION
- 2 OXYGEN
- 3 FUEL IN THE FORM OF A GAS OR VAPOUR

In any fire protection system, therefore, the aim is to always remove at least one of these three potentially hazardous items.

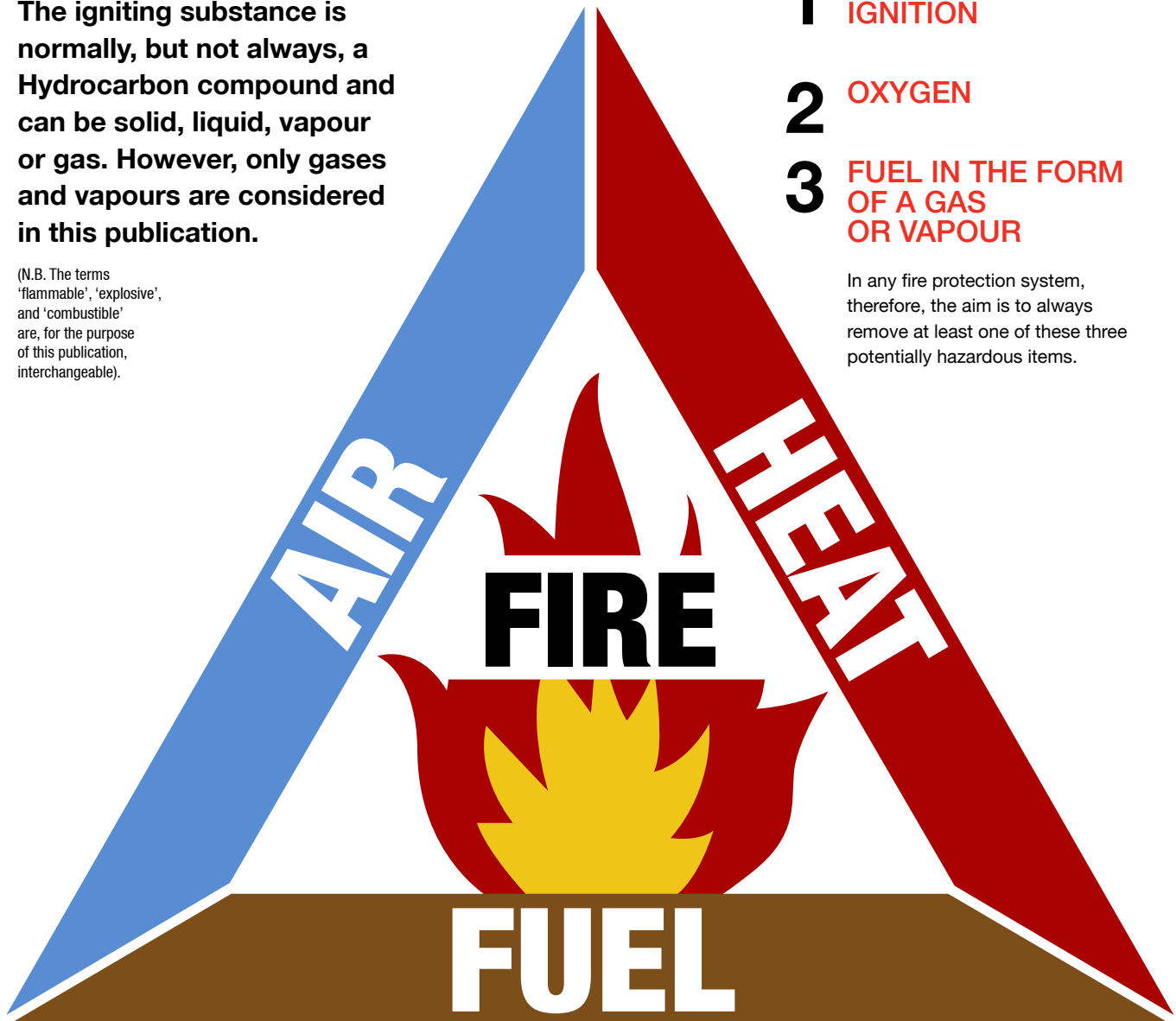

Flammable Limit

There is only a limited band of gas/air concentration which will produce a combustible mixture. This band is specific for each gas and vapour and is bounded by an upper level, known as the Upper Explosive Limit (or the UEL) and a lower level, called the Lower Explosive Limit (LEL).

GAS FACT

High levels of O₂ increase the flammability of materials and gases – at levels such as 24%, items such as clothing can spontaneously combust!

Limits of Flammability

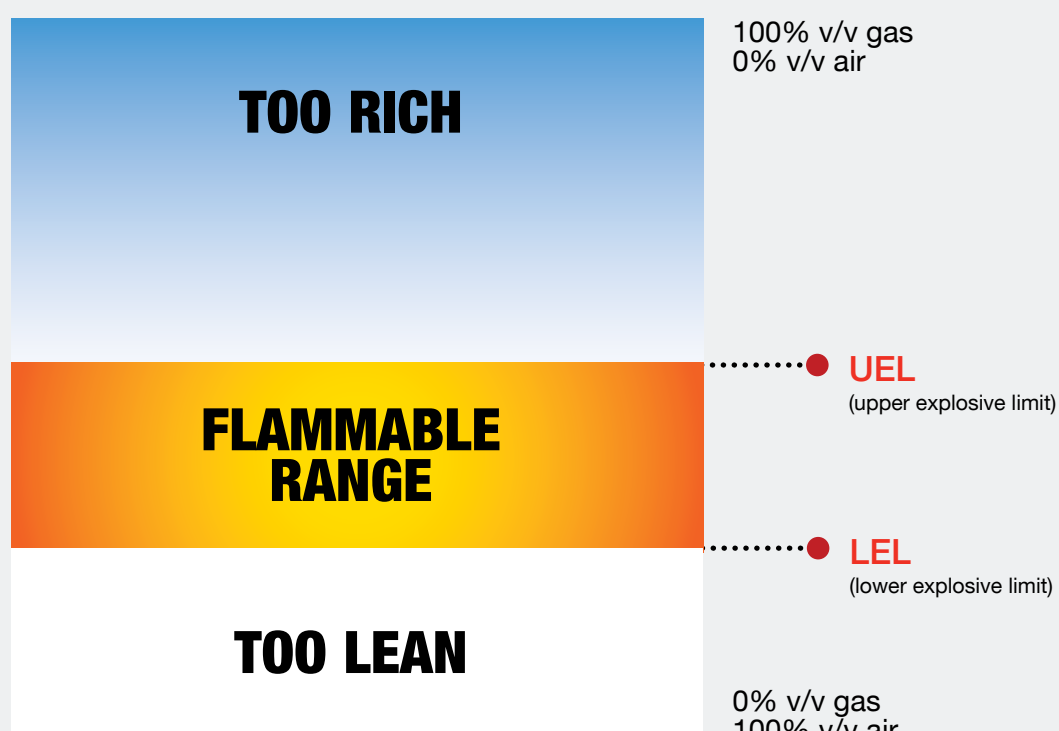

At levels below the LEL, there is insufficient gas to produce an explosion i.e. the mixture is too 'lean', whilst above the UEL, the mixture has insufficient Oxygen i.e. the mixture is too 'rich'. The flammable range therefore falls between the limits of the LEL and UEL for each individual gas or mixture of gases. Outside these limits, the mixture is not capable of combustion. The *Flammable Gases Data* on page 12 indicates the limiting values for some of the better-known combustible gases and compounds. The data is given for gases and vapours at normal conditions of pressure and temperature.

An increase in pressure, temperature or Oxygen content will generally broaden the flammability range.

In the average industrial plant, there would normally be no gases leaking into the surrounding area or, at worst, only a low background level of gas present. Therefore the detecting and early warning system will only be required to detect levels from 0% of gas up to the lower explosive limit. By the time this concentration is reached, shut-down procedures or site clearance should have been put into operation. In fact this will typically take place at a concentration

of less than 50% of the LEL value, so that an adequate safety margin is provided.

However, it should always be remembered that in enclosed or unventilated areas, a concentration in excess of the UEL can sometimes occur. At times of inspection, special care needs to be taken when operating hatches or doors, since the ingress of air from outside can dilute the gases to a hazardous, combustible mixture. ■

(N.B LEL/LFL and UEL/UFL are, for the purpose of this publication, interchangeable).

Flammable Gas Properties

Ignition Temperature

Flammable gases also have a temperature where ignition will take place, even without an external ignition source such as a spark or flame. This temperature is called the Ignition Temperature. Apparatus for use in a hazardous area must not have a surface temperature that exceeds the Ignition Temperature. Apparatus is therefore marked with a maximum surface temperature or T rating.

FLASH POINT (F.P. °C)

The flash point of a flammable liquid is the lowest temperature at which the surface of the liquid emits sufficient vapour to be ignited by a small flame. Do not confuse this with Ignition Temperature as the two can be very different:

Gas / Vapour	Flash Point °C	Ignition Temp. °C
Methane	<-188	595
Kerosene	38	210
Bitumen	270	310

To convert a Celsius temperature into Fahrenheit: $T_f = ((9/5) * T_c) + 32$ E.g. to convert -20 Celsius into Fahrenheit, first multiply the Celsius temperature reading by nine-fifths to get -36. Then add 32 to get -4°F.

VAPOUR DENSITY

Helps determine sensor placement

The density of a gas/vapour is compared with air

When air = 1.0:

Vapour density < 1.0 will rise

Vapour density > 1.0 will fall

Gas/Vapour	Vapour Density
Methane	0.55
Carbon Monoxide	0.97
Hydrogen Sulphide	1.45
Petrol Vapour	3.0 approx



GAS FACT

It's not just gas that holds a potential threat - dust can also be explosive! Examples of explosive dusts include polystyrene, cornstarch and iron.



Flammable Gases Data

Common Name	CAS Number	Formula	Molecular Weight	Boiling Point °C	Relative Vapourisation Density
Acetaldehyde	75-07-0	CH ₃ CHO	44.05	20	1.52
Acetic acid	64-19-7	CH ₃ COOH	60.05	118	2.07
Acetic anhydride	108-24-7	(CH ₃ CO) ₂ O	102.09	140	3.52
Acetone	67-64-1	(CH ₃) ₂ CO	58.08	56	2.00
Acetonitrile	75-05-8	CH ₃ CN	41.05	82	1.42
Acetyl chloride	75-36-5	CH ₃ COCl	78.5	51	2.70
Acetylene	74-86-2	CH=CH	26	-84	0.90
Acetyl fluoride	557-99-3	CH ₃ COF	62.04	20	2.14
Acrylaldehyde	107-02-8	CH ₂ =CHCHO	56.06	53	1.93
Acrylic acid	79-10-7	CH ₂ =CHCOOH	72.06	139	2.48
Acrylonitrile	107-13-1	CH ₂ =CHCN	53.1	77	1.83
Acryloyl chloride	814-68-6	CH ₂ CHCOCl	90.51	72	3.12
Allyl acetate	591-87-7	CH ₂ =CHCH ₂ OOCCH ₃	100.12	103	3.45
Allyl alcohol	107-18-6	CH ₂ =CHCH ₂ CH ₂ OH	58.08	96	2.00
Allyl chloride	107-05-1	CH ₂ =CHCH ₂ Cl	76.52	45	2.64
Ammonia	7664-41-7	NH ₃	17	-33	0.59
Aniline	62-53-3	C ₆ H ₅ NH ₂	93.1	184	3.22
Benzaldehyde	100-52-7	C ₆ H ₅ CHO	106.12	179	3.66
Benzene	71-43-2	C ₆ H ₆	78.1	80	2.70
1-Bromobutane	109-65-9	CH ₃ (CH ₂) ₂ CH ₂ Br	137.02	102	4.72
Bromoethane	74-96-4	CH ₃ CH ₂ Br	108.97	38	3.75
1,3 Butadiene	106-99-0	CH ₂ =CHCH=CH ₂	54.09	-4.5	1.87
Butane	106-97-8	C ₄ H ₁₀	58.1	-1	2.05
Isobutane	75-28-5	(CH ₃) ₂ CHCH ₃	58.12	-12	2.00
Butan-1-ol	71-36-3	CH ₃ (CH ₂) ₂ CH ₂ OH	74.12	116	2.55
Butanone	78-93-3	CH ₃ CH ₂ COCH ₃	72.1	80	2.48
But-1-ene	106-98-9	CH ₂ =CHCH ₂ CH ₃	56.11	-6.3	1.95
But-2-ene (isomer not stated)	107-01-7	CH ₃ CH=CHCH ₃	56.11	1	1.94
Butyl acetate	123-86-4	CH ₃ COOCH ₂ (CH ₂) ₂ CH ₃	116.2	127	4.01
n-Butyl acrylate	141-32-2	CH ₂ =CHCOOC ₄ H ₉	128.17	145	4.41
Butylamine	109-73-9	CH ₃ (CH ₂) ₃ NH ₂	73.14	78	2.52
Isobutylamine	78-81-9	(CH ₃) ₂ CHCH ₂ NH ₂	73.14	64	2.52
Isobutylisobutyrate	97-85-8	(CH ₃) ₂ CHCOOCH ₂ CH(CH ₃) ₂	144.21	145	4.93
Butylmethacrylate	97-88-1	CH ₂ =C(CH ₃)COO(CH ₂) ₃ CH ₃	142.2	160	4.90
Tert-butyl methyl ether	1634-04-4	CH ₃ OC(CH ₃) ₂	88.15	55	3.03
n-Butylpropionate	590-01-2	C ₂ H ₅ COOC ₄ H ₉	130.18	145	4.48
Butyraldehyde	123-72-8	CH ₃ CH ₂ CH ₂ CHO	72.1	75	2.48
Isobutyraldehyde	78-84-2	(CH ₃) ₂ CHCHO	72.11	63	2.48
Carbon disulphide	75-15-0	CS ₂	76.1	46	2.64
Carbon monoxide	630-08-0	CO	28	-191	0.97
Carbonyl sulphide	463-58-1	COS	60.08	-50	2.07
Chlorobenzene	108-90-7	C ₆ H ₅ Cl	112.6	132	3.88
1-Chlorobutane	109-69-3	CH ₃ (CH ₂) ₂ CH ₂ Cl	92.57	78	3.20
2-Chlorobutane	78-86-4	CH ₃ CHClCH ₂ CH ₃	92.57	68	3.19
1-Chloro-2,3-epoxypropane	106-89-8	OCH ₂ CHCH ₂ Cl	92.52	115	3.30
Chloroethane	75-00-3	CH ₃ CH ₂ Cl	64.5	12	2.22
2-Chloroethanol	107-07-3	CH ₂ ClCH ₂ OH	80.51	129	2.78
Chloroethylene	75-01-4	CH ₂ =CHCl	62.3	-15	2.15
Chloromethane	74-87-3	CH ₃ Cl	50.5	-24	1.78
1-Chloro-2-methylpropane	513-36-0	(CH ₃) ₂ CHCH ₂ Cl	92.57	68	3.19
3-Chloro-2-methylprop-1-ene	563-47-3	CH ₂ =C(CH ₃)CH ₂ Cl	90.55	71	3.12
5-Chloropentan-2-one	5891-21-4	CH ₃ CO(CH ₂) ₃ Cl	120.58	71	4.16
1-Chloropropane	540-54-5	CH ₃ CH ₂ CH ₂ Cl	78.54	37	2.70
2-Chloropropane	75-29-6	(CH ₃) ₂ CHCl	78.54	47	2.70
Chlorotrifluoroethyl-ene	79-38-9	CF ₂ =CFCl	116.47	-28.4	4.01
Chlorotoluene	100-44-7	C ₆ H ₅ CH ₂ Cl	126.58		4.36

References: BS EN 60079-20-1 (supersedes 61779) Electrical apparatus for the detection and measurement of flammable gases-Part 1: General requirements and test methods. NIST Chemistry Web Book June 2005 release. Aldrich Handbook of Fine Chemicals and Laboratory Equipment 2003-2004.

Data may change by country and date, always refer to local up-to-date regulations.

Please note: Where "gas" is stated under Flash Point (F.P. °C), the compound is always in a gaseous state and therefore does not have a FP.

Flammable Limits

F.P. °C	LFL % v/v	UFL % v/v	LFL mg/L	UFL mg/L	I.T. °C
-38	4.00	60.00	74	1,108	204
40	4.00	17.00	100	428	464
49	2.00	10.30	85	428	334
<-20	2.50	13.00	80	316	535
2	3.00	16.00	51	275	523
-4	5.00	19.00	157	620	390
gas	2.30	100.00	24	1,092	305
<-17	5.60	19.90	142	505	434
-18	2.80	31.80	65	728	217
56	2.90		85		406
-5	2.80	28.00	64	620	480
-8	2.68	18.00	220	662	463
13	1.70	10.10	69	420	348
21	2.50	18.00	61	438	378
-32	2.90	11.20	92	357	390
gas	15.00	33.60	107	240	630
75	1.20	11.00	47	425	630
64	1.40		62		192
-11	1.20	8.60	39	280	560
13	2.50	6.60	143	380	265
<-20	6.70	11.30	306	517	511
gas	1.40	16.30	31	365	430
gas	1.40	9.30	33	225	372
gas	1.30	9.80	31	236	460
29	1.40	12.00	52	372	359
-9	1.50	13.40	45	402	404
gas	1.40	10.00	38	235	440
gas	1.60	10.00	40	228	325
22	1.20	8.50	58	408	370
38	1.20	9.90	63	425	268
-12	1.70	9.80	49	286	312
-20	1.47	10.80	44	330	374
34	0.80		47		424
53	1.00	6.80	58	395	289
-27	1.50	8.40	54	310	385
40	1.00	7.70	53	409	389
-16	1.80	12.50	54	378	191
-22	1.60	11.00	47	320	176
-30	0.60	60.00	19	1,900	95
gas	10.90	74.00	126	870	805
gas	6.50	28.50	100	700	209
28	1.30	11.00	60	520	637
-12	1.80	10.00	69	386	250
<-18	2.00	8.80	77	339	368
28	2.30	34.40	86	1,325	385
gas	3.60	15.40	95	413	510
55	4.90	16.00	160	540	425
gas	3.60	33.00	94	610	415
gas	7.60	19.00	160	410	625
<-14	2.00	8.80	75	340	416
-16	2.10		77		478
61	2.00		98		440
-32	2.40	11.10	78	365	520
<-20	2.80	10.70	92	350	590
gas	4.60	84.30	220	3,117	607
60	1.10		55		585

Flammable Gases Data (continued)

Common Name	CAS Number	Formula	Molecular Weight	Boiling Point °C	Relative Vapourisation Density
Cresols (mixed isomers)	1319-77-3	CH ₃ C ₅ H ₄ OH	108.14	191	3.73
Crotonaldehyde	123-73-9	CH ₃ CH=CHCHO	70.09	102	2.41
Cumene	98-82-8	C ₆ H ₅ CH(CH ₃) ₂	120.19	152	4.13
Cyclobutane	287-23-0	CH ₂ (CH ₂) ₂ CH ₂	56.1	13	1.93
Cycloheptane	291-64-5	CH ₂ (CH ₂) ₅ CH ₂	98.19	118.5	3.39
Cyclohexane	110-82-7	CH ₂ (CH ₂) ₄ CH ₂	84.2	81	2.90
Cyclohexanol	108-93-0	CH ₂ (CH ₂) ₄ CHOH	100.16	161	3.45
Cyclohexanone	108-94-1	CH ₂ (CH ₂) ₄ CO	98.1	156	3.38
Cyclohexene	110-83-8	CH ₂ (CH ₂) ₃ CH=CH	82.14	83	2.83
Cyclohexylamine	108-91-8	CH ₂ (CH ₂) ₄ CHNH ₂	99.17	134	3.42
Cyclopentane	287-92-3	CH ₂ (CH ₂) ₃ CH ₂	70.13	50	2.40
Cyclopentene	142-29-0	CH=CHCH ₂ CH ₂ CH	68.12	44	2.30
Cyclopropane	75-19-4	CH ₂ CH ₂ CH ₂	42.1	-33	1.45
Cyclopropyl methyl ketone	765-43-5	CH ₃ COCHCH ₂ CH ₂	84.12	114	2.90
p-Cymene	99-87-6	CH ₃ CH ₆ H ₄ CH(CH ₃) ₂	134.22	176	4.62
Decahydro-naphthalene trans	493-02-7	CH ₂ (CH ₂) ₃ CHCH(CH ₂) ₃ CH ₂	138.25	185	4.76
Decane (mixed isomers)	124-18-5	C ₁₀ H ₂₂	142.28	173	4.90
Dibutyl ether	142-96-1	(CH ₃ (CH ₂) ₃) ₂ O	130.2	141	4.48
Dichlorobenzenes (isomer not stated)	106-46-7	C ₆ H ₄ Cl ₂	147	179	5.07
Dichlorodiethyl-silane	1719-53-5	(C ₂ H ₅) ₂ SiCl ₂	157.11	128	
1,1-Dichloroethane	75-34-3	CH ₃ CHCl ₂	99	57	3.42
1,2-Dichloroethane	107-06-2	CH ₂ ClCH ₂ Cl	99	84	3.42
Dichloroethylene	540-59-0	ClCH=CHCl	96.94	37	3.55
1,2-Dichloro-propane	78-87-5	CH ₃ CHClCH ₂ Cl	113	96	3.90
Dicyclopentadiene	77-73-6	C ₁₀ H ₁₂	132.2	170	4.55
Diethylamine	109-89-7	(C ₂ H ₅) ₂ NH	73.14	55	2.53
Diethylcarbonate	105-58-8	(CH ₃ CH ₂ O) ₂ CO	118.13	126	4.07
Diethyl ether	60-29-7	(CH ₃ CH ₂) ₂ O	74.1	34	2.55
1,1-Difluoro-ethylene	75-38-7	CH ₂ =CF ₂	64.03	-83	2.21
Diisobutylamine	110-96-3	((CH ₃) ₂ CHCH ₂) ₂ NH	129.24	137	4.45
Diisobutyl carbinol	108-82-7	((CH ₃) ₂ CHCH ₂) ₂ CHOH	144.25	178	4.97
Diisopentyl ether	544-01-4	(CH ₃) ₂ CH(CH ₂) ₂ O(CH ₂) ₂ CH(CH ₃) ₂	158.28	170	5.45
Diisopropylamine	108-18-9	((CH ₃) ₂ CH) ₂ NH	101.19	84	3.48
Diisopropyl ether	108-20-3	((CH ₃) ₂ CH) ₂ O	102.17	69	3.52
Dimethylamine	124-40-3	(CH ₃) ₂ NH	45.08	7	1.55
Dimethoxymethane	109-87-5	CH ₂ (OCH ₃) ₂	76.09	41	2.60
3-(Dimethylamino)propionitrile	1738-25-6	(CH ₃) ₂ NHCH ₂ CH ₂ CN	98.15	171	3.38
Dimethyl ether	115-10-6	(CH ₃) ₂ O	46.1	-25	1.59
N,N-Dimethylformamide	68-12-2	HCON(CH ₃) ₂	73.1	152	2.51
3,4-Dimethyl hexane	583-48-2	CH ₃ CH ₂ CH(CH ₃)CH(CH ₃)CH ₂ CH ₃	114.23	119	3.87
N,N-Dimethyl hydrazine	57-14-7	(CH ₃) ₂ NNH ₂	60.1	62	2.07
1,4-Dioxane	123-91-1	OCH ₂ CH ₂ OCH ₂ CH ₂	88.1	101	3.03
1,3-Dioxolane	646-06-0	OCH ₂ CH ₂ OCH ₂	74.08	74	2.55
Dipropylamine	142-84-7	(CH ₃ CH ₂ CH ₂) ₂ NH	101.19	105	3.48
Ethane	74-84-0	CH ₃ CH ₃	30.1	-87	1.04
Ethanethiol	75-08-1	CH ₃ CH ₂ SH	62.1	35	2.11
Ethanol	64-17-5	CH ₃ CH ₂ OH	46.1	78	1.59
2-Ethoxyethanol	110-80-5	CH ₃ CH ₂ OCH ₂ CH ₂ OH	90.12	135	3.10
2-Ethoxyethyl acetate	111-15-9	CH ₃ COOCH ₂ CH ₂ OCH ₂ CH ₃	132.16	156	4.72
Ethyl acetate	141-78-6	CH ₃ COOCH ₂ CH ₃	88.1	77	3.04
Ethyl acetoacetate	141-97-9	CH ₃ COCH ₂ COOCH ₂ CH ₃	130.14	181	4.50
Ethyl acrylate	140-88-5	CH ₂ =CHCOOCH ₂ CH ₃	100.1	100	3.45
Ethylamine	75-04-7	C ₂ H ₅ NH ₂	45.08	16.6	1.50
Ethylbenzene	100-41-4	CH ₂ CH ₃ C ₆ H ₅	106.2	135	3.66
Ethyl butyrate	105-54-4	CH ₃ CH ₂ CH ₂ COOC ₂ H ₅	116.16	120	4.00
Ethylcyclobutane	4806-61-5	CH ₃ CH ₂ CHCH ₂ CH ₂ CH ₂	84.16		2.90
Ethylcyclohexane	1678-91-7	CH ₃ CH ₂ CH(CH ₂) ₄ CH ₂	112.2	131	3.87
Ethylcyclopentane	1640-89-7	CH ₃ CH ₂ CH(CH ₂) ₃ CH ₂	98.2	103	3.40
Ethylene	74-85-1	CH ₂ =CH ₂	28.1	-104	0.97

Flammable Limits

F.P. °C	LFL % v/v	UFL % v/v	LFL mg/L	UFL mg/L	I.T. °C
81	1.10		50		555
13	2.10	16.00	82	470	280
31	0.80	6.50	40	328	424
gas	1.80		42		
<10	1.10	6.70	44	275	
-18	1.00	8.00	35	290	259
61	1.20	11.10	50	460	300
43	1.30	8.40	53	386	419
-17	1.10	8.30	37		244
32	1.10	9.40	47	372	293
-37	1.40		41		320
<-22	1.48		41		309
gas	2.40	10.40	42	183	498
15	1.70		58		452
47	0.70	5.60	39	366	436
54	0.70	4.90	40	284	288
46	0.70	5.60	41	332	201
25	0.90	8.50	48	460	198
86	2.20	9.20	134	564	648
24	3.40		223		
-10	5.60	16.00	230	660	440
13	6.20	16.00	255	654	438
-10	9.70	12.80	391	516	440
15	3.40	14.50	160	682	557
36	0.80		43		455
-23	1.70	10.00	50	306	312
24	1.40	11.70	69	570	450
-45	1.70	36.00	60	1,118	160
gas	3.90	25.10	102	665	380
26	0.80	3.60	42	190	256
75	0.70	6.10	42	370	290
44	1.27		104		185
-20	1.20	8.50	49	358	285
-28	1.00	21.00	45	900	405
gas	2.80	14.40	53	272	400
-21	2.20	19.90	71	630	247
50	1.57		62		317
gas	2.70	32.00	51	610	240
58	1.80	16.00	55	500	440
2	0.80	6.50	38	310	305
-18	2.40	20	60	490	240
11	1.40	22.50	51	813	379
-5	2.30	30.50	70	935	245
4	1.20	9.10	50	376	280
gas	2.50	15.50	31	194	515
<-20	2.80	18.00	73	466	295
12	3.10	19.00	59	359	363
40	1.70	15.70	68	593	235
47	1.20	12.70	65	642	380
-4	2.00	2.80	73	470	460
65	1.00	9.50	54	519	350
9	1.40	14.00	59	588	350
<-20	3.50	14.00	49	260	425
23	0.80	7.80	44	340	431
21	1.40		66		435
<-16	1.20	7.70	42	272	212
<24	0.80	6.60	42	310	238
<5	1.05	6.80	42	280	262
	2.30	36.00	26	423	425

Honeywell

IGNITION OF HAZARDOUS
 CONNECT CIRCUITS
 POWER. KEEP COVER TIGHT
 CIRCUITS ARE ENERGIZED

Power

Fault



XNX



Universal Transmitter

Honeywell

Flammable Gases Data (continued)

Common Name	CAS Number	Formula	Molecular Weight	Boiling Point °C	Relative Vapourisation Density
Ethylenediamine	107-15-3	NH ₂ CH ₂ CH ₂ NH ₂	60.1	118	2.07
Ethylene oxide	75-21-8	CH ₂ CH ₂ O	44	11	1.52
Ethyl formate	109-94-4	HCOOCH ₂ CH ₃	74.08	52	2.65
Ethyl isobutyrate	97-62-1	(CH ₃) ₂ CHCOOC ₂ H ₅	116.16	112	4.00
Ethyl methacrylate	97-63-2	CH ₂ =CCH ₃ COOCH ₂ CH ₃	114.14	118	3.90
Ethyl methyl ether	540-67-0	CH ₃ OCH ₂ CH ₃	60.1	8	2.10
Ethyl nitrite	109-95-5	CH ₃ CH ₂ ONO	75.07		2.60
Formaldehyde	50-00-0	HCHO	30	-19	1.03
Formic acid	64-18-6	HCOOH	46.03	101	1.60
2-Furaldehyde	98-01-1	OCH=CHCH=CHCHO	96.08	162	3.30
Furan	110-00-9	CH=CHCH=CHO	68.07	32	2.30
Furfuryl alcohol	98-00-0	OC(CH ₂ OH)CHCHCH	98.1	170	3.38
1,2,3-Trimethyl-benzene	526-73-8	CHCHCHC(CH ₃)C(CH ₃)C(CH ₃)	120.19	175	4.15
Heptane (mixed isomers)	142-82-5	C ₇ H ₁₆	100.2	98	3.46
Hexane (mixed isomers)	110-54-3	CH ₃ (CH ₂) ₄ CH ₃	86.2	69	2.97
1-Hexanol	111-27-3	C ₆ H ₁₃ OH	102.17	156	3.50
Hexan-2-one	591-78-6	CH ₃ CO(CH ₂) ₃ CH ₃	100.16	127	3.46
Hydrogen	1333-74-0	H ₂	2	-253	0.07
Hydrogen cyanide	74-90-8	HCN	27	26	0.90
Hydrogen sulphide	7783-06-4	H ₂ S	34.1	-60	1.19
4-Hydroxy-4-methyl-penta-2-one	123-42-2	CH ₃ COCH ₂ C(CH ₃) ₂ OH	116.16	166	4.00
Kerosene	8008-20-6			150	
1,3,5-Trimethylbenzene	108-67-8	CHC(CH ₃)CHC(CH ₃)CHC(CH ₃)	120.19	163	4.15
Methacryloyl chloride	920-46-7	CH ₂ CCH ₃ COCl	104.53	95	3.60
Methane (firedamp)	74-82-8	CH ₄	16	-161	0.55
Methanol	67-56-1	CH ₃ OH	32	65	1.11
Methanethiol	74-93-1	CH ₃ SH	48.11	6	1.60
2-Methoxyethanol	109-86-4	CH ₃ OCH ₂ CH ₂ OH	76.1	124	2.63
Methyl acetate	79-20-9	CH ₃ COOCH ₃	74.1	57	2.56
Methyl acetoacetate	105-45-3	CH ₃ COOCH ₂ COCH ₃	116.12	169	4.00
Methyl acrylate	96-33-3	CH ₂ =CHCOOCH ₃	86.1	80	3.00
Methylamine	74-89-5	CH ₃ NH ₂	31.1	-6	1.00
2-Methylbutane	78-78-4	(CH ₃) ₂ CHCH ₂ CH ₃	72.15	30	2.50
2-Methylbutan-2-ol	75-85-4	CH ₃ CH ₂ C(OH)(CH ₃) ₂	88.15	102	3.03
3-Methylbutan-1-ol	123-51-3	(CH ₃) ₂ CH(CH ₂) ₂ OH	88.15	130	3.03
2-Methylbut-2-ene	513-35-9	(CH ₃) ₂ C=CHCH ₃	70.13	35	2.40
Methyl chloro-formate	79-22-1	CH ₃ OOCCl	94.5	70	3.30
Methylcyclohexane	108-87-2	CH ₃ CH(CH ₂) ₄ CH ₂	98.2	101	3.38
Methylcyclo-pentadienes (isomer not stated)	26519-91-5	C ₆ H ₆	80.13		2.76
Methylcyclopentane	96-37-7	CH ₃ CH(CH ₂) ₃ CH ₂	84.16	72	2.90
Methylenecyclo-butane	1120-56-5	C(=CH ₂)CH ₂ CH ₂ CH ₂	68.12		2.35
2-Methyl-1-buten-3-yne	78-80-8	HC=CC(CH ₃)CH ₂	66.1	32	2.28
Methyl formate	107-31-3	HCOOCH ₃	60.05	32	2.07
2-Methylfuran	534-22-5	OC(CH ₃)CHCHCH	82.1	63	2.83
Methylisocyanate	624-83-9	CH ₃ NCO	57.05	37	1.98
Methyl methacrylate	80-62-6	CH ₃ =CCH ₃ COOCH ₃	100.12	100	3.45
4-Methylpentan-2-ol	108-11-2	(CH ₃) ₂ CHCH ₂ CHOHCH ₃	102.17	132	3.50
4-Methylpentan-2-one	108-10-1	(CH ₃) ₂ CHCH ₂ COCH ₃	100.16	117	3.45
2-Methylpent-2-enal	623-36-9	CH ₃ CH ₂ CHC(CH ₃)COH	98.14	137	3.78
4-Methylpent-3-en-2-one	141-79-7	(CH ₃) ₂ (CCHCOCH) ₃	98.14	129	3.78
2-Methyl-1-propanol	78-83-1	(CH ₃) ₂ CHCH ₂ OH	74.12	108	2.55
2-Methylprop-1-ene	115-11-7	(CH ₃) ₂ C=CH ₂	56.11	-6.9	1.93
2-Methylpyridine	109-06-8	NCH(CH ₃)CHCHCHCH	93.13	128	3.21
3-Methylpyridine	108-99-6	NCHCH(CH ₃)CHCHCH	93.13	144	3.21
4-Methylpyridine	108-89-4	NCHCHCH(CH ₃)CHCH	93.13	145	3.21
α-Methyl styrene	98-83-9	C ₆ H ₅ C(CH ₃)=CH ₂	118.18	165	4.08
Methyl tert-pentyl ether	994-05-8	(CH ₃) ₂ C(OCH ₃)CH ₂ CH ₃	102.17	85	3.50
2-Methylthiophene	554-14-3	SC(CH ₃)CHCHCH	98.17	113	3.40
Morpholine	110-91-8	OCH ₂ CH ₂ NHCH ₂ CH ₂	87.12	129	3.00

Flammable Limits

F.P. °C	LFL % v/v	UFL % v/v	LFL mg/L	UFL mg/L	I.T. °C
34	2.50	18.00	64	396	403
<-18	2.60	100.00	47	1,848	435
-20	2.70	16.50	87	497	440
10	1.60		75		438
20	1.50		70		
gas	2.00	10.10	50	255	190
-35	3.00	50.00	94	1,555	95
60	7.00	73.00	88	920	424
42	18.00	57.00	190	1,049	520
60	2.10	19.30	85	768	316
<-20	2.30	14.30	66	408	390
61	1.80	16.30	70	670	370
51	0.80	7.00			470
-4	0.85	6.70	35	281	215
-21	1.00	8.90	35	319	233
63	1.10		47		293
23	1.20	9.40	50	392	533
gas	4.00	77.00	3.4	63	560
<-20	5.40	46.00	60	520	538
gas	4.00	45.50	57	650	270
58	1.80	6.90	88	336	680
38	0.70	5.00			210
44	0.80	7.30	40	365	499
17	2.50		106		510
<-188	4.40	17.00	29	113	537
11	6.00	36.00	73	665	386
4.10	4.10	21.00	80	420	
39	1.80	20.60	76	650	285
-10	3.10	16.00	95	475	502
62	1.30	14.20	62	685	280
-3	1.95	16.30	71	581	415
gas	4.20	20.70	55	270	430
-56	1.30	8.30	38	242	420
16	1.40	10.20	50	374	392
42	1.30	10.50	47	385	339
-53	1.30	6.60	37	189	290
10	7.50	26	293	1,020	475
-4	1.00	6.70	41	275	258
<-18	1.30	7.60	43	249	432
<-10	1.00	8.40	35	296	258
<0	1.25	8.60	35	239	352
-54	1.40		38		272
-20	5.00	23.00	125	580	450
<-16	1.40	9.70	47	325	318
-7	5.30	26.00	123	605	517
10	1.70	12.50	71	520	430
37	1.14	5.50	47	235	334
16	1.20	8.00	50	336	475
30	1.46		58		206
24	1.60	7.20	64	289	306
28	1.40	11.00	43	340	408
gas	1.60	10	37	235	483
27	1.20		45		533
43	1.40	8.10	53	308	537
43	1.10	7.80	42	296	534
40	0.80	11.00	44	330	445
<-14	1.50		62		345
-1	1.30	6.50	52	261	433
31	1.40	15.20	65	550	230



Flammable Gases Data (continued)

Common Name	CAS Number	Formula	Molecular Weight	Boiling Point °C	Relative Vapourisation Density
Naphtha				35	2.50
Naphthalene	91-20-3	C ₁₀ H ₈	128.17	218	4.42
Nitrobenzene	98-95-3	CH ₃ CH ₂ NO ₂	123.1	211	4.25
Nitroethane	79-24-3	C ₂ H ₅ NO ₂	75.07	114	2.58
Nitromethane	75-52-5	CH ₃ NO ₂	61.04	102.2	2.11
1-Nitropropane	108-03-2	CH ₃ CH ₂ CH ₂ NO ₂	89.09	131	3.10
Nonane	111-84-2	CH ₃ (CH ₂) ₇ CH ₃	128.3	151	4.43
Octane	111-65-9	CH ₃ (CH ₂) ₃ CH ₃	114.2	126	3.93
1-Octanol	111-87-5	CH ₃ (CH ₂) ₆ CH ₂ OH	130.23	196	4.50
Penta-1,3-diene	504-60-9	CH ₂ =CH-CH=CH-CH ₃	68.12	42	2.34
Pentanes (mixed isomers)	109-66-0	C ₅ H ₁₂	72.2	36	2.48
Pentane-2,4-dione	123-54-6	CH ₃ COCH ₂ COCH ₃	100.1	140	3.50
Pentan-1-ol	71-41-0	CH ₃ (CH ₂) ₃ CH ₂ OH	88.15	136	3.03
Pentan-3-one	96-22-0	(CH ₃ CH ₂) ₂ CO	86.13	101.5	3.00
Pentyl acetate	628-63-7	CH ₃ COO-(CH ₂) ₄ -CH ₃	130.18	147	4.48
Petroleum					2.80
Phenol	108-95-2	C ₆ H ₅ OH	94.11	182	3.24
Propane	74-98-6	CH ₃ CH ₂ CH ₃	44.1	-42	1.56
Propan-1-ol	71-23-8	CH ₃ CH ₂ CH ₂ OH	60.1	97	2.07
Propan-2-ol	67-63-0	(CH ₃) ₂ CHOH	60.1	83	2.07
Propene	115-07-1	CH ₂ =CHCH ₃	42.1	-48	
Propionic acid	79-09-4	CH ₃ CH ₂ COOH	74.08	141	2.55
Propionic aldehyde	123-38-6	C ₂ H ₅ CHO	58.08	46	2.00
Propyl acetate	109-60-4	CH ₃ COOCH ₂ CH ₂ CH ₃	102.13	102	3.60
Isopropyl acetate	108-21-4	CH ₃ COOCH(CH ₃) ₂	102.13	85	3.51
Propylamine	107-10-8	CH ₃ (CH ₂) ₂ NH ₂	59.11	48	2.04
Isopropylamine	75-31-0	(CH ₃) ₂ CHNH ₂	59.11	33	2.03
Isopropyl Chloroacetate	105-48-6	ClCH ₂ COOCH(CH ₃) ₂	136.58	149	4.71
2-Isopropyl-5-methylhex-2-enal	35158-25-9	(CH ₃) ₂ CH-C(CHO)CHCH ₂ CH(CH ₃) ₂	154.25	189	5.31
Isopropyl nitrate	1712-64-7	(CH ₃) ₂ CHONO ₂	105.09	101	
Propyne	74-99-7	CH ₃ C≡CH	40.06	-23.2	1.38
Prop-2-yn-1-ol	107-19-7	HC≡CCH ₂ OH	56.06	114	1.89
Pyridine	110-86-1	C ₅ H ₅ N	79.1	115	2.73
Styrene	100-42-5	C ₆ H ₅ CH=CH ₂	104.2	145	3.60
Tetrafluoroethylene	116-14-3	CF ₂ =CF ₂	100.02		3.40
2,2,3,3-Tetrafluoropropyl acrylate	7383-71-3	CH ₂ =CHCOOCH ₂ CF ₂ CF ₂ H	186.1	132	6.41
2,2,3,3-Tetrafluoropropyl methacrylate	45102-52-1	CH ₂ =C(CH ₃)COOCH ₂ CF ₂ CF ₂ H	200.13	124	6.90
Tetrahydrofuran	109-99-9	CH ₂ (CH ₂) ₂ CH ₂ O	72.1	64	2.49
Tetrahydrofurfuryl alcohol	97-99-4	OCH ₂ CH ₂ CH ₂ CHCH ₂ OH	102.13	178	3.52
Tetrahydrothiophene	110-01-0	CH ₂ (CH ₂) ₂ CH ₂ S	88.17	119	3.04
N,N,N',N'-Tetramethyldiaminomethane	51-80-9	(CH ₃) ₂ NCH ₂ N(CH ₃) ₂	102.18	85	3.50
Thiophene	110-02-1	CH=CHCH=CHS	84.14	84	2.90
Toluene	108-88-3	C ₆ H ₅ CH ₃	92.1	111	3.20
Triethylamine	121-44-8	(CH ₃ CH ₂) ₃ N	101.2	89	3.50
1,1,1-Trifluoroethane	420-46-2	CF ₃ CH ₃	84.04		2.90
2,2,2-Trifluoroethanol	75-89-8	CF ₃ CH ₂ OH	100.04	77	3.45
Trifluoroethylene	359-11-5	CF ₂ =CFH	82.02		2.83
3,3,3-Trifluoro-prop-1-ene	677-21-4	CF ₃ CH=CH ₂	96.05	-16	3.31
Trimethylamine	75-50-3	(CH ₃) ₃ N	59.1	3	2.04
2,2,4-Trimethylpentane	540-84-1	(CH ₃) ₂ CHCH ₂ C(CH ₃) ₃	114.23	98	3.90
2,4,6-Trimethyl-1,3,5-trioxane	123-63-7	OCH(CH ₃)OCH(CH ₃)OCH(CH ₃)	132.16	123	4.56
1,3,5-Trioxane	110-88-3	OCH ₂ OCH ₂ OCH ₂	90.1	115	3.11
Turpentine		C ₁₀ H ₁₆		149	
Isovaleraldehyde	590-86-3	(CH ₃) ₂ CHCH ₂ CHO	86.13	90	2.97
Vinyl acetate	108-05-4	CH ₃ COOCH=CH ₂	86.09	72	3.00
Vinylcyclohexenes (isomer not stated)	100-40-3	CH ₂ CHC ₆ H ₉	108.18	126	3.72
Vinylidene chloride	75-35-4	CH ₂ =CCl ₂	96.94	30	3.40
2-Vinylpyridine	100-69-6	NC(CH ₂ =CH)CHCHCHCH	105.14	79	3.62
4-Vinylpyridine	100-43-6	NCHCHC(CH ₂ =CH)CHCH	105.14	62	3.62
Xylenes	1330-20-7	C ₆ H ₄ (CH ₃) ₂	106.2	144	3.66

Flammable Limits

F.P. °C	LFL % v/v	UFL % v/v	LFL mg/L	UFL mg/L	I.T. °C
<-18	0.90	6.00			290
77	0.60	5.90	29	317	528
88	1.40	40.00	72	2,067	480
27	3.40		107		410
36	7.30	63.00	187	1,613	415
36	2.20		82		420
30	0.70	5.60	37	301	205
13	0.80	6.50	38	311	206
81	0.90	7.00	49	385	270
<-31	1.20	9.40	35	261	361
-40	1.40	7.80	42	261	258
34	1.70		71		340
38	1.06	10.50	36	385	298
12	1.60		58		445
25	1.00	7.10	55	387	360
<-20	1.20	8.00			560
75	1.30	9.50	50	370	595
gas	1.70	10.90	31	200	470
22	2.10	17.50	52	353	405
12	2.00	12.70	50	320	425
gas	2.00	11.10	35	194	455
52	2.10	12.00	64	370	435
<-26	2.00		47		188
10	1.70	8.00	70	343	430
4	1.70	8.10	75	340	467
-37	2.00	10.40	49	258	318
<-24	2.30	8.60	55	208	340
42	1.60		89		426
41	3.05		192		188
11	2.00	100.00	75	3,738	175
gas	1.70	16.8	28	280	340
33	2.40		55		346
17	1.70	12.40	56	398	550
30	1.00	8.00	42	350	490
gas	10.00	59.00	420	2,245	255
45	2.40		182		357
46	1.90		155		389
-20	1.50	12.40	46	370	224
70	1.50	9.70	64	416	280
13	1.00	12.30	42	450	200
<-13	1.61		67		180
-9	1.50	12.50	50	420	395
4	1.10	7.80	39	300	535
-7	1.20	8.00	51	339	
	6.80	17.60	234	605	714
30	8.40	28.80	350	1,195	463
	27.00	502	904	319	
	4.70		184		490
gas	2.00	12.00	50	297	190
-12	0.70	6.00	34	284	411
27	1.30		72		235
45	3.20	29.00	121	1,096	410
35	0.80				254
-12	1.30	13.00	60		207
-8	2.60	13.40	93	478	425
15	0.80		35		257
-18	6.50	16.00	260	645	440
35	1.20		51		482
43	1.10		47		501
30	1.00	7.60	44	335	464



6

Toxic Gas Hazards

1 MILLION
BALLS

Some gases are poisonous and can be dangerous to life at very low concentrations. Some toxic gases have strong smells like the distinctive 'rotten eggs' smell of Hydrogen Sulphide (H₂S). The measurements most often used for the concentration of toxic gases are parts per million (ppm) and parts per billion (ppb). For example 1ppm would be equivalent to a room filled with a total of 1 million balls and 1 of those balls being red. The red ball would represent 1ppm.

More people die from toxic gas exposure than from explosions caused by the ignition of flammable gas. (It should be noted that there is a large group of gases which are both combustible and toxic, so that even detectors of toxic gases sometimes have to carry hazardous area approval). The main reason for

treating flammable and toxic gases separately is that the hazards and regulations involved and the types of sensor required are different.

With toxic substances, apart from the obvious environmental problems, the main concern is the effect on workers of exposure to even very low concentrations, which could be inhaled, ingested, or absorbed through the skin. Since adverse effects can often result from additive, long-term exposure, it is important not only to measure the concentration of gas, but also the total time of exposure. There are even some known cases of synergism, where substances

can interact and produce a far worse effect when combined than the separate effect of each on its own.

Concern about concentrations of toxic substances in the workplace focus on both organic and inorganic compounds, including the effects they could have on the health and safety of employees, the possible contamination of a manufactured end-product (or equipment used in its manufacture) and also the subsequent disruption of normal working activities. ■

Workplace Exposure Limits

The term 'workplace exposure limits' or 'occupational hazard monitoring' is generally used to cover the area of industrial health monitoring associated with the exposure of employees to hazardous conditions of gases, dust, noise etc. In other words, the aim is to ensure that levels in the workplace are below the statutory limits.

This subject covers both area surveys (profiling of potential exposures) and personal monitoring, where instruments are worn by a worker and sampling is carried out as near to the breathing zone as possible. This ensures that the measured level of contamination is truly representative of that inhaled by the worker.

It should be emphasised that both personal monitoring and monitoring of the workplace should be considered as important parts of an overall, integrated safety plan. They are only intended to provide the necessary information about conditions as they exist in the atmosphere. This then allows the necessary action to be taken to comply with the relevant industrial regulations and safety requirements.

Whatever method is decided upon, it is important to take into account the nature of the toxicity of any of the gases involved. For instance, any instrument which measures only a time-weighted average, or an instrument which draws a sample for subsequent laboratory analysis, would not protect a worker against a short exposure to a lethal dose of a highly toxic substance. On the other hand, it may be quite normal to briefly exceed the average, Long-Term Exposure Limit (LTEL) levels in some areas of a plant, and it need not be indicated as an alarm situation. Therefore, the optimum instrument system should be capable of monitoring both short and long-term exposure levels as well as instantaneous alarm levels. ■



1 RED BALL

100%V/V = 1,000,000ppm
1%V/V = 10,000ppm

EXAMPLE

100%LEL Ammonia = 15%V/V
50%LEL Ammonia = 7.5%V/V
50%LEL Ammonia = 75,000ppm

Toxic Exposure Limits

European Occupational Exposure Limits

**GAS
FACT**

Hydrogen is the lightest, most abundant and explosive gas on Earth.

Occupational Exposure Limit values (OELs) are set by competent national authorities or other relevant national institutions as limits for concentrations of hazardous compounds in workplace air. OELs for hazardous substances represent an important tool for risk assessment and management and valuable information for occupational safety and health activities concerning hazardous substances.

Occupational Exposure Limits can apply both to marketed products and to waste and by-products from production processes. The limits protect workers against health effects, but do not address safety issues such as explosive risk. As limits frequently change and can vary by country, you should consult your relevant national authorities to ensure that you have the latest information.

Occupational Exposure Limits in the UK function under the Control of Substances Hazardous to Health Regulations (COSHH). The COSHH regulations require the employer to ensure that the employee's exposure to substances hazardous to health is either prevented or if not practically possible, adequately controlled.

As of 6 April 2005, the regulations introduced a new, simpler Occupational Exposure Limit system. The existing requirements to follow good practice were brought together by the introduction of eight principles in the Control of Substances Hazardous to Health (Amendment) Regulations 2004.

Maximum Exposure Limits (MELs) and Occupational Exposure Standards (OESs) were replaced with a single type of limit - the Workplace Exposure Limit (WEL). All the MELs, and most of the OESs, are being transferred into the new system as WELs and will retain their previous numerical values. The OESs for approximately 100 substances were deleted as the substances are now banned, scarcely used or there is evidence to suggest adverse health effects close to the old limit value. The list of exposure limits is known as EH40 and is available from the UK Health and Safety Executive. All legally enforceable WELs in the UK are air limit values. The maximum admissible or accepted

concentration varies from substance to substance according to its toxicity. The exposure times are averaged for eight hours (8-hour Time-Weighted Average TWA) and 15 minutes (Short-Term Exposure Limit STEL). For some substances, a brief exposure is considered so critical that they are set only a STEL, which should not be exceeded even

for a shorter time. The potency to penetrate through skin is annotated in the WEL list by remark "Skin". Carcinogenicity, reproduction toxicity, irritation and sensitisation potential are considered when preparing a proposal for an OEL according to the present scientific knowledge. ■



Effects of exposure to Carbon Monoxide

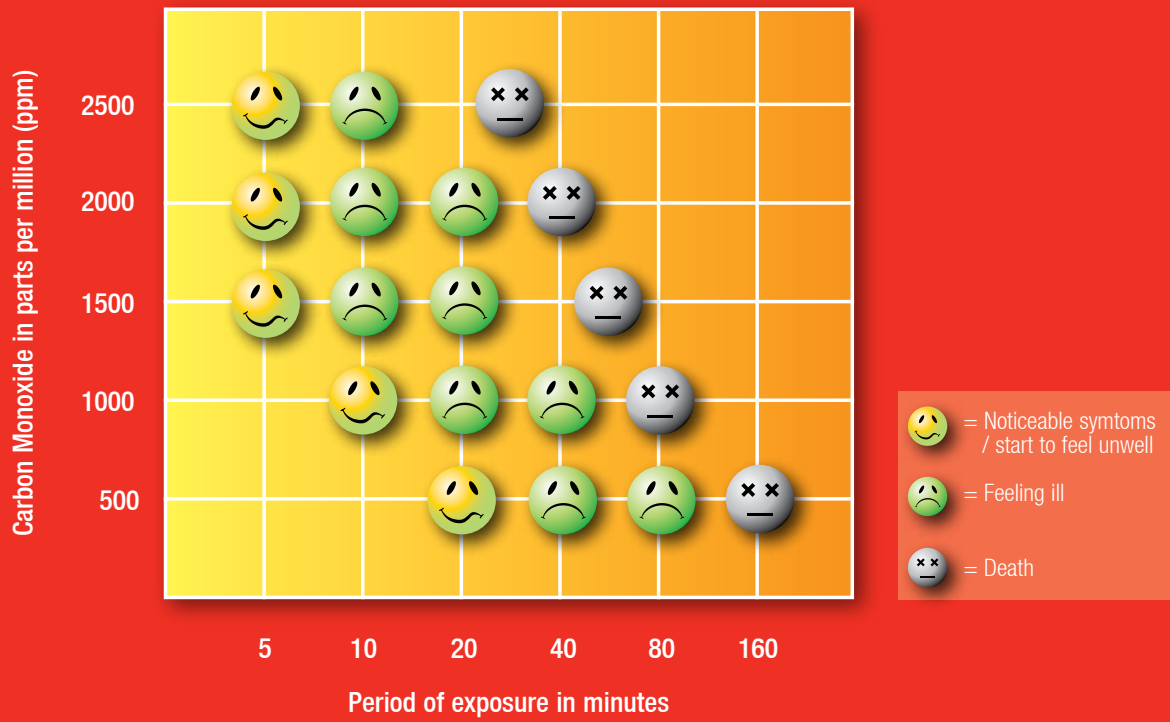

US Occupational Exposure Limits

The Occupational Safety systems in the United States vary from state to state. Here, information is given on 3 major providers of the Occupational Exposure Limits in the USA - ACGIH, OSHA, and NIOSH.

The American Conference of Governmental Industrial Hygienists (ACGIH) publishes Maximum Allowable Concentrations (MAC), which were later renamed to "Threshold Limit Values" (TLVs).

Threshold Limit Values are defined as an exposure limit "to which it is believed nearly all workers can be exposed day after day for a working lifetime without ill effect". The ACGIH is a professional organisation of occupational hygienists from universities or governmental institutions. Occupational hygienists from private industry can join as associate members. Once a year, the different committees propose new threshold limits or best working practice guides. The list of TLVs includes more than 700 chemical substances and physical agents, as well as dozens of Biological Exposure Indices for selected chemicals.

The ACGIH defines different TLV-Types as:

Threshold Limit Value – Time-Weighted Average (TLV-TWA): the Time-Weighted Average concentration for a conventional 8-hour workday and a 40-hour workweek, to which it is believed that nearly all workers may be repeatedly exposed, day after day, without adverse effect.

Threshold Limit Value – Short-Term Exposure Limit (TLV-STEL): the concentration to which it is believed that workers can be exposed continuously for a short period of time without suffering from irritation, chronic or irreversible tissue damage, or narcosis. STEL is defined as a 15-minute TWA exposure, which should not be exceeded at any time during a workday.

Threshold Limit Value – Ceiling (TLV-C): the concentration that should not be exceeded during any part of the working exposure.

There is a general excursion limit recommendation that applies to those TLV-TWAs that do not have STELs. Excursions in worker exposure levels may



Occupational Exposure Limits Comparison Table

ACGIM	OSHA	NIOSH	EH40	Meaning
Threshold Limit Values (TLVs)	Permissible Exposure Limits (PELs)	Recommended Exposure Levels (RELs)	Workplace Exposure Limits (WELs)	Limit definition
TLV-TWA	TWA	TWA	TWA	Long-term Exposure Limit (8hr-TWA reference period)
TLV-STEL	STEL	STEL	STEL	Short-Term Exposure Limit (15-minute exposure period)
TLV-C	Ceiling	Ceiling	-	The concentration that should not be exceeded during any part of the working exposure
Excursion Limit	Excursion Limit	-	-	Limit if no STEL stated
-	BEIs	BEIs	-	Biological Exposure Indices



exceed 3 times the TLV-TWA for no more than a total of 30 minutes during a workday and under no circumstances should they exceed 5 times the TLV-TWA, provided that the TLV-TWA is not exceeded.

ACGIH-TLVs do not have a legal force in the USA, they are only recommendations. OSHA defines regulatory limits. However, ACGIH-TLVs and the criteria documents are a very common base for setting TLVs in the USA and in many other countries. ACGIH exposure limits are in many cases more protective than OSHA's. Many US companies use the current ACGIH levels or other internal and more protective limits.

The Occupational Safety and Health Administration (OSHA) of the US Department of Labor publishes Permissible Exposure Limits (PEL). PELs are regulatory limits on the amount or concentration of a substance

in the air and they are enforceable. The initial set of limits from 1971 was based on the ACGIH TLVs. OSHA currently has around 500 PELs for various forms of approximately 300 chemical substances, many of which are widely used in industrial settings. Existing PELs are contained in a document called "29 CFR 1910.1000", the air contaminants standard. OSHA uses in a similar way as the ACGIH the following types of OELs: TWAs, Action Levels, Ceiling Limits, STELs, Excursion Limits and in some cases Biological Exposure Indices (BEIs).

The National Institute for Occupational Safety and Health (NIOSH) has the statutory responsibility for recommending exposure levels that are protective to workers. NIOSH has identified Recommended Exposure Levels (RELs) for around 700 hazardous substances. These limits have no legal force. NIOSH recommends their

limits via criteria documents to OSHA and other OEL setting institutions. Types of RELs are TWA, STEL, Ceiling and BEIs. The recommendations and the criteria are published in several different document types, such as Current Intelligent Bulletins (CIB), Alerts, Special Hazard Reviews, Occupational Hazard Assessments and Technical Guidelines. ■

Toxic Gases Data

The toxic gases listed below can be detected using equipment supplied by Honeywell Gas Detection. Gas data is supplied where known. As product development is ongoing, contact Honeywell Analytics if the gas you require is not listed. Data may change by country and date, always refer to local up-to-date regulations.

Common Name	CAS Number	Formula
Ammonia	7664-41-7	NH ₃
Arsine	7784-42-1	AsH ₃
Boron Trichloride	10294-34-5	BCl ₃
Boron Trifluoride	7637-07-2	BF ₃
Bromine	7726-95-6	Br ₂
Carbon Monoxide	630-08-0	CO
Chlorine	7782-50-5	Cl ₂
Chlorine Dioxide	10049-04-4	ClO ₂
1,4 Cyclohexane diisocyanate		CHDI
Diborane	19287-45-7	B ₂ H ₆
Dichlorosilane (DCS)	4109-96-0	H ₂ Cl ₂ Si
Dimethyl Amine (DMA)	124-40-3	C ₂ H ₇ N
Dimethyl Hydrazine (UDMH)	57-14-7	C ₂ H ₈ N ₂
Disilane	1590-87-0	Si ₂ H ₆
Ethylene Oxide	75-21-8	C ₂ H ₄ O
Fluorine	7782-41-4	F ₂
Germane	7782-65-2	GeH ₄
Hexamethylene Diisocyanate (HDI)	822-06-0	C ₆ H ₁₂ N ₂ O ₂
Hydrazine	302-01-2	N ₂ H ₄
Hydrogen	1333-74-0	H ₂
Hydrogen Bromide	10035-10-6	HBr
Hydrogen Chloride	7647-01-0	HCl
Hydrogen Cyanide	74-90-8	HCN
Hydrogen Fluoride	7664-39-3	HF
Hydrogen Iodide	10034-85-2	HI
Hydrogen Peroxide	7722-84-1	H ₂ O ₂
Hydrogen Selenide	7783-07-5	H ₂ Se
Hydrogen Sulphide	7783-06-4	H ₂ S
Hydrogenated Methylene Bisphenyl Isocyanate (HMDI)		
Isocyanatoethyl Methacrylate (IEM)		C ₇ H ₉ NO ₃
Isophorone Diisocyanate (IPDI)		C ₁₂ H ₁₈ N ₂ O ₂
Methyl Fluoride (R41)	593-53-3	CH ₃ F
Methylene Bisphenyl Isocyanate (MDI)	101-68-8	C ₁₅ H ₁₀ N ₂ O ₂
Methylene Bisphenyl Isocyanate -2 (MDI-2)	101-68-8	C ₁₅ H ₁₀ N ₂ O ₂
Methylenedianiline (MDA)	101-77-9	C ₁₃ H ₁₄ N ₂
Monomethyl Hydrazine (MMH)	60-34-4	CH ₆ N ₂
Naphthalene Diisocyanate (NDI)	3173-72-6	C ₁₂ H ₆ N ₂ O ₂
Nitric Acid	7697-37-2	HNO ₃

EH40 Workplace Exposure Limit (WEL)				OSHA Permissible Exposure Limits (PEL)	
Long-Term Exposure Limit (8-hour TWA reference period)		Short-Term Exposure Limit (15-minute reference period)		Long-term Exposure Limit (8-hour TWA reference period)	
ppm	mg/m ³	ppm	mg/m ³	ppm	mg/m ³
25	18	35	25	50	35
0.05	0.16			0.05	0.2
				1 (ceiling)	3 (ceiling)
0.1	0.66	0.2	1.3	0.1	0.7
30	35	200	232	50	55
		0.5	1.5	1 (ceiling)	3 (ceiling)
0.1	0.28	0.3	0.84	0.1	0.3
				0.1	0.1
2	3.8	6	11	10	18
5	9.2			1.5	
1	1.6	1	1.6	0.1	0.2
0.2	0.64	0.6	1.9		
0.02	0.03	0.1	0.13	1	1.3
		3	10	3	10
1	2	5	8	5 (ceiling)	7 (ceiling)
		10	11	10	11
1.8	1.5	3	2.5		2
1	1.4	2	2.8	1	1.4
				0.05	0.2
5	7	10	14	2	10
0.01	0.08				
		1	2.6	2	5

■ Toxic Gases Data (continued)

Common Name	CAS Number	Formula
Nitric Oxide	10102-43-9	NO
Nitrogen Dioxide	10102-44-0	NO ₂
Nitrogen Trifluoride	7783-54-2	NF ₃
n-Butyl Amine (N-BA)	109-73-9	C ₄ H ₁₁ N
Ozone	10028-15-6	O ₃
Phosgene	75-44-5	COCl ₂
Phosphine	7803-51-2	PH ₃
Propylene Oxide	75-56-9	C ₃ H ₆ O
p-Phenylene Diamine (PPD)	106-50-3	C ₆ H ₈ N ₂
p-Phenylene Diisocyanate (PPDI)	104-49-4	C ₈ H ₄ N ₂ O ₂
Silane	7803-62-5	SiH ₄
Stibine	7803-52-3	SbH ₃
Sulphur Dioxide	7446-09-5	SO ₂
Sulphuric Acid	7664-93-9	H ₂ SO ₄
Tertiary Butyl Arsine (TBA)		
Tertiary Butyl Phosphine (TBP)	2501-94-2	C ₄ H ₁₁ P
Tetraethyl Orthosilicate (TEOS)	78-10-4	C ₈ H ₂₀ O ₄ Si
Tetrakis (Dimethylamino) Titanium (TDMAT)	3275-24-9	C ₈ H ₂₄ N ₄ Ti
Tetramethyl Xylene Diisocyanate (TMXDI)		C ₁₄ H ₁₆ N ₂ O ₂
Toluene Diamine (TDA)	95-80-7	C ₇ H ₁₀ N ₂
Toluene Diisocyanate (TDI)	584-84-9	C ₉ H ₆ N ₂ O ₂
Triethyl Amine (TEA)	121-44-8	C ₆ H ₁₅ N
Trimethylhexamethylene Diisocyanate (TMDI)		C ₁₁ H ₁₈ N ₂ O ₂
Unsymmetrical Dimethylhydrazine (UDMH)	57-14-7	C ₂ H ₈ N ₂

EH40 Workplace Exposure Limit (WEL)				OSHA Permissible Exposure Limits (PEL)	
Long-Term Exposure Limit (8-hour TWA reference period)		Short-Term Exposure Limit (15-minute reference period)		Long-term Exposure Limit (8-hour TWA reference period)	
ppm	mg/m ³	ppm	mg/m ³	ppm	mg/m ³
				25	30
				5 (ceiling)	9 (ceiling)
				10	29
				5 (ceiling)	15 (ceiling)
		0.2	0.4	0.1	0.2
0.02	0.08	0.06	0.25	0.1	0.4
0.1	0.14	0.2	0.28	0.3	0.4
5	12			100	240
	0.1				0.1
0.5	0.67	1	1.3		
				0.1	0.5
				5	13
					1
50	191	150	574		
		0.02 (ceiling)	0.14 (ceiling)		
2	8	4	17	2.5	100

7

Asphyxiant Hazard (Oxygen Deficiency)

OXYGEN DEPLETION CAN BE CAUSED BY:

- Displacement
- Combustion
- Oxidation
- Chemical reaction
- Bacterial action

We all need to breathe the Oxygen (O_2) in air to live. Air is made up of several different gases including Oxygen. Normal ambient air contains an Oxygen concentration of 20.9% v/v. When the Oxygen level falls below 19.5% v/v, the air is considered Oxygen-deficient. Oxygen concentrations below 16% v/v are considered unsafe for humans.

100%
v/v O_2

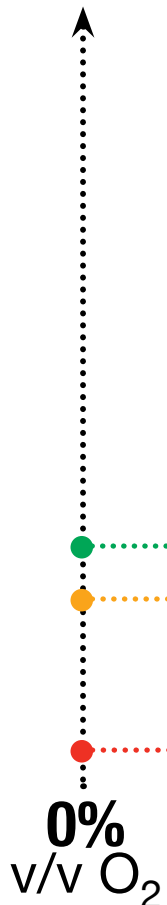

20.9%
v/v normal

16%
v/v depletion

6%
v/v fatal



8

Oxygen Enrichment

GAS FACT

The atomic weight of Radon is 222 atomic mass units making it the heaviest known gas. It is 220 times heavier than the lightest gas, Hydrogen.

It is often forgotten that Oxygen enrichment can also cause a risk. At increased O₂ levels the flammability of materials and gases increases. At levels of 24% items such as clothing can spontaneously combust.

Oxyacetylene welding equipment combines Oxygen and Acetylene gas to produce an extremely high temperature. Other areas where hazards may arise from Oxygen enriched atmospheres include manufacturing areas for storing rocket propulsion systems, products used for bleaching in the pulp and paper industry and clean water treatment facilities.

Sensors have to be specially certified for use in O₂ enriched atmospheres.

9

Typical Areas that Require Gas Detection

There are many different applications for fixed and portable gas detection. Industrial processes increasingly involve the use and manufacture of highly dangerous substances, particularly toxic and combustible gases. Inevitably, occasional escapes of gas occur, which create a potential hazard to the plant, its employees and people living nearby. Worldwide incidents involving asphyxiation, explosions and loss of life, are a constant reminder of this problem.



Oil and gas (drilling and production)

The oil and gas industry covers a large number of upstream activities from the on and offshore exploration and production of oil and gas to its transportation and storage. The Hydrocarbon gases involved are a serious explosive risk and toxic gases such as Hydrogen Sulphide are often present.

Typical Applications:

- Exploration drilling rigs
- Production platforms
- Onshore oil and gas terminals
- Facility turnarounds/shutdowns
- LPG storage areas
- Offshore and onshore drilling and service rigs
- Offshore production platforms
- Personal Protective Equipment (PPE)

Typical Gases:

Flammable: Various Hydrocarbon gases including Methane

Toxic: Hydrogen Sulphide, Carbon Monoxide

Oxygen: Depletion



Refineries and petrochemical facilities

Refineries take crude oil mixes and convert them into various blends of Hydrocarbons for use in a wide variety of subsequent products.

Typical Applications:

- Flanges and pump seals for Hydrocarbon detection
- Catalytic cracking process monitoring
- Bulk storage areas
- Water drains, run-off gullies and trenches
- Confined space entry
- Loading areas
- Ventilation systems
- Perimeter/fence-line monitoring
- Planned maintenance and shutdown/plant modification

Typical Gases:

Flammable: Various Hydrocarbon gases including Ethylene, Kerosene, Propane and Methane

Toxic: Hydrogen Sulphide and Sulphur Dioxide

Oxygen: Depletion



Chemical plants

Chemical plants manufacture a myriad of products and feedstocks. The nature and diversity of chemicals used and produced on site provide considerable danger to assets and personnel. These plants often use a wide range of both flammable and toxic gases in their manufacturing processes.

Typical Applications:

- Raw material storage
- Process areas
- Laboratories
- Pump rows
- Compressor stations
- Loading/unloading areas

Typical Gases:

Flammable: Various Hydrocarbons including Petroleum and resins

Toxic: Various including Hydrogen Sulphide, Hydrogen Fluoride and Ammonia



Power generation (traditional and renewable)

Traditionally fossil fuels like coal, oil and Natural Gas have been used to generate electricity. Today renewable energy is becoming a key aspect of power generation with wind power and biogas becoming more prevalent forms of power generation.

Typical Applications:

- Around boiler pipework and burners
- In and around turbine packages
- Working near landfill gas pipework
- Surface emissions monitoring in landfills
- Blade production and welding of steel parts (wind energy manufacture)
- Confined spaces (in the tower and nacelle)
- Working near landfill leachate pools and perimeter boreholes

Typical Gases:

Flammable: Natural Gas, Hydrogen

Toxic: Carbon Monoxide, Sulphur Oxide, Nitrogen Oxide, Hydrogen Sulphide, VOCs

Oxygen: Depletion

We have produced various technical documents regarding applications for gas detection. If you would like to access this information, please visit www.honeywellanalytics.com for fixed gas detection applications and www.gasmonitors.com for portable gas detection applications.



Water treatment

Water treatment is a large industry comprising of many processes and aspects from the production and distribution of clean water to the collection, treatment and disposal of waste such as sewage.

Typical Applications:

- Purification plant monitoring
- Sewage digesters
- Plant sumps
- Plant intakes and penstocks
- Plant power generation monitoring
- Hydrogen Sulphide scrubbers

Typical Gases:

Flammable: Various Hydrocarbons including Methane

Toxic: Hydrogen Sulphide, Carbon Dioxide, Chlorine, Sulphur Dioxide and Ozone

Oxygen: Depletion



Marine

Marine gas hazards are numerous. Liquid gas, fuel, chemicals and other fossil fuels harbour a risk of explosion. There is a danger of suffocation from Oxygen displacement when using Nitrogen or other gases for inerting. Toxic gases like Hydrogen Sulphide also pose considerable risks.

Typical Applications:

- Clearance measurements of tanks and cargo bays
- Ship hold inspections
- Vessel entry/below deck entry
- Confined spaces, e.g. electric motor room, hold spaces and inter-barrier spaces
- Inerting and purging
- Leak detection
- Airlocks
- Burner platform vent hoods
- Engine room gas supply pipelines

Typical Gases:

Flammable: Various Hydrocarbons including Liquid Natural Gas and Methane

Toxic: Hydrogen Sulphide and Carbon Monoxide

Oxygen: Depletion



Military and national security

The World's militaries require gas detection monitoring and due to their mobility, portable gas detection forms a key part of protection against dangerous gases.

Typical Applications:

- Fuel storage tanks (including inspection)
- Transportation (particularly of fuel)
- Vehicle refuelling
- Aircraft tank inspections
- Submarine septic tanks and Hydrogen build-up
- Naval vessels engine room monitoring and septic tanks
- Equipment and vehicle maintenance

Typical Gases:

Flammable: Various blends of Aviation Kerosene, Diesel and Gasoline

Toxic: Carbon Monoxide, Carbon Dioxide, Hydrogen Sulphide and Volatile Organic Compounds (VOCs)

Oxygen: Depletion



Pulp and paper production

This vast industry includes both mechanical and chemical pulping methods that turn wood into a variety of paper based products. Toxic gas threats are present from bleaching agents, whilst fuels used to drive mechanical pulping create flammable gas risks.

Typical Applications:

- Digesters (in chemical pulping)
- Chlorine during bleaching
- Fuel monitoring in mechanical pulping

Typical Gases:

Flammable: Methane

Toxic: Chlorine, Chlorine Dioxide and Ozone

Oxygen: Depletion

Typical Areas that Require Gas Detection (continued)



Printing

Depending on the materials being printed, processes within the printing industry use various solvents, inks and dangerous chemicals, which are often dried in very hot ovens, creating the need for robust gas detection to ensure process safety.

Typical Applications:

- Bulk storage of inks and varnishes
- Dryers and ovens
- Exhaust monitoring

Typical Gases:

Flammable: Various Hydrocarbons including solvents and Methane



Tunnels and car parks

Exhaust fumes can build-up in car parks and tunnels, creating toxic gas hazards. Gas detection is used to monitor the build up of gases like Carbon Monoxide and Methane and also control the ventilation systems.

Typical Applications:

- Car tunnels
- Underground and enclosed car parks
- Ventilation control
- Access tunnels

Typical Gases:

Flammable: Methane, Liquid Petroleum Gas and Petrol vapour

Toxic: Carbon Monoxide and Nitrogen Dioxide



Semiconductor

Manufacturing semiconductor materials involves the use of toxic and flammable gas. Phosphine, Arsenic, Boron Trichloride and Gallium are commonly used as doping agents. Hydrogen is used both as a reactant and a reducing atmosphere carrier gas. Etching and cleaning gases include Ammonia and other perfluoro compounds.

Typical Applications:

- Wafer reactor
- Wafer dryers
- Gas cabinets
- Chemical Vapour Deposition

Typical Gases:

Flammable: Hydrogen, Propane, Silane and Methane

Toxic: Hydrogen Chloride, Arsine, Boron Trichloride, Phosphine, Carbon Monoxide, Hydrogen Fluoride, Ozone, Dichlorosilane, Tetraethyl Orthosilicate, Hexafluorobutadiene 1,3, Octafluorocyclopentene, Germane, Ammonia and Nitrogen Dioxide

Oxygen: Depletion

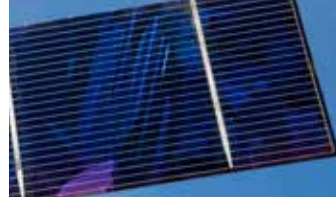

Photovoltaics

With more focus on renewable energy, the photovoltaic (PV) industry is experiencing considerable growth. PV applications use semiconductors that exhibit the photovoltaic effect in order to convert solar radiation into direct current electricity, and therefore use a semiconductor manufacturing process.

Typical Applications:

- Wafer reactor
- Wafer dryers
- Gas cabinets
- Chemical Vapour Deposition

Typical Gases:

Flammable: Hydrogen, Propane, Silane and Methane

Toxic: Hydrogen Chloride, Arsine, Boron Trichloride, Phosphine, Carbon Monoxide, Hydrogen Fluoride, Ozone, Dichlorosilane, Tetraethyl Orthosilicate, Hexafluorobutadiene 1,3, Octafluorocyclopentene, Germane, Ammonia and Nitrogen Dioxide

Oxygen: Depletion



Confined spaces

These locations provide one of the key application uses for portable gas detectors, owing to their ability for dangerous gases to build up (see *Confined spaces* on page 60 for detailed information).

Typical Applications:

- Shafts
- Trenches
- Sewers and manholes
- Pits
- Boilers
- Tunnels
- Tanks
- Vessels (including marine vessel tanks)
- Pipelines
- Containers

Typical Gases:

Flammable: Methane

Toxic: Carbon Monoxide and Hydrogen Sulphide

Oxygen: Depletion



Building and construction

Various dangerous chemicals are used during construction work and due to the mobility of operatives in these applications, portable gas detection forms an integral part of on-site Personal Protective Equipment (PPE)

Typical Applications:

- Trenching and shoring

Typical Gases:

Flammable: Methane

Toxic: Carbon Monoxide and Hydrogen Sulphide

Oxygen: Depletion

■ Typical Areas that Require Gas Detection (continued)



Ammonia Refrigeration

Many industries use refrigeration as part of their processes – from food and beverage manufacture, gas liquefaction and chemical manufacture to cryogenics and Liquid Natural Gas shipping. It is essential to ensure that Ammonia does not build-up, causing potentially explosive atmospheres.

Typical Applications:

- Ammonia storage areas
- Plant room valves, joints and seals
- Chiller and refrigerator monitoring
- Air conditioning systems

Typical Gases:

Flammable: Ammonia

Toxic: Ammonia



Laboratory and medical

Laboratories and medical facilities like hospitals may use many different flammable and toxic substances. Very large installations may also feature their own on-site utility supplies and back-up power stations.

Typical Applications:

- Laboratories
- Cryogenics and refrigeration
- Boiler rooms

Typical Gases:

Flammable: Methane and Hydrogen

Toxic: Carbon Monoxide, Chlorine, Ammonia and Ethylene Oxide

Oxygen: Depletion/enrichment



Steel Mills

Due to the large number of furnaces and processes that subject metals to extreme heat, Carbon Monoxide detection is essential throughout the plant.

Typical Applications:

- Furnace monitoring
- Oven monitoring

Typical Gases:

Toxic: Carbon Monoxide



Landfill monitoring and Biogas generation

Landfills are designed to promote and accelerate the decomposition of organic material and may also contain sorting and storage areas for inorganic material. Landfill gas (known as Biogas), is often collected at these sites so care should be taken when personnel are working close to potential sources.

Typical Applications:

- When working near leachate pools
- When working near perimeter boreholes
- When working near landfill gas pipework
- When monitoring surface emissions
- When working near weighbridges
- When handling waste

Typical Gases:

Flammable: Methane

Toxic: Carbon Dioxide, Hydrogen Sulphide, Benzene and Toluene

Oxygen: Depletion



Agriculture and live stock

When it comes to keeping livestock, Methane and Ammonia can build-up to dangerous levels in cattle sheds. Agricultural stores where fertilisers and pesticide stocks are held can also pose additional explosive dangers.

Typical Applications:

- Cattle shed monitoring
- Agricultural fertiliser and chemical stores



Mining

There is an abundance of mineral and fossil fuel reserves being mined globally, leaving personnel at risk from dangerous gas build-ups in the enclosed spaces of mine shafts. This makes portable gas detection an essential component of mining safety.

Typical Applications:

- Excavation
- Continuous monitoring whilst working in shafts

Typical Gases:

Flammable: Methane

Toxic: Carbon Monoxide

Oxygen: Depletion



Commercial buildings and public facilities

Commercial and public facilities like swimming pools, shopping centres and schools use integrated safety systems, which can include gas detection. Large visitor numbers can increase the risk of Carbon Dioxide build-up and heating systems may also need to be monitored for flammable gas leaks.

Typical Applications:

- Mechanical rooms
- Swimming pools
- Schools
- Heating pipework monitoring
- Indoor air quality monitoring

Typical Gases:

Flammable: Methane

Toxic: Carbon Dioxide, Carbon Monoxide, Chlorine

Oxygen: Depletion



Turnarounds, plant shutdowns and planned equipment modifications

No matter what the industry and application, planned shutdowns and maintenance schedules create additional risks on site because they represent deviations from standard processes. Gas detection in the form of portable monitoring solutions should always be used to limit these risks when modifying aspects or processes of the plant.

10

Principles of Detection

Combustible Gas Sensors

Many people have probably seen a flame safety lamp at some time and know something about its use as an early form of 'firedamp' (the gases found in coal mines. Also known as "minedamp") gas detector in underground coal mines and sewers. Although originally intended as a source of light, the device could also be used to estimate the level of combustible gases - to an accuracy of about 25-50%, depending on the user's experience, training, age, colour perception etc.

Modern combustible gas detectors have to be much more accurate, reliable and repeatable than this and although various attempts were made to overcome the safety lamp's subjectiveness of measurement (by using a flame temperature sensor for instance), it has now been almost entirely superseded by more modern, electronic devices.

Nevertheless, today's most commonly used device, the catalytic detector, is in some respects a modern development of the early flame safety lamp, since it also relies for its operation on the combustion of a gas and its conversion to Carbon Dioxide and water. ■



Catalytic sensor

Nearly all modern, low-cost, combustible gas detection sensors are of the electro-catalytic type. They consist of a very small sensing element sometimes called a 'bead', a 'Pellistor', or a 'Siegestor' - the last two being registered trade names for commercial devices. They are made of an electrically heated Platinum wire coil, covered first with a ceramic base such as Alumina and then with a final outer coating of Palladium or Rhodium catalyst dispersed in a substrate of Thoria.

This type of sensor operates on the principle that when a combustible gas/air mixture passes over the hot catalyst surface, combustion occurs and the heat evolved increases the temperature of the 'bead'. This in turn alters the resistance of the Platinum coil and can be measured by using the coil as a temperature thermometer in a standard electrical bridge circuit. The resistance change is then directly related to the gas concentration in the surrounding atmosphere and can be displayed on a meter or some similar indicating device. ■

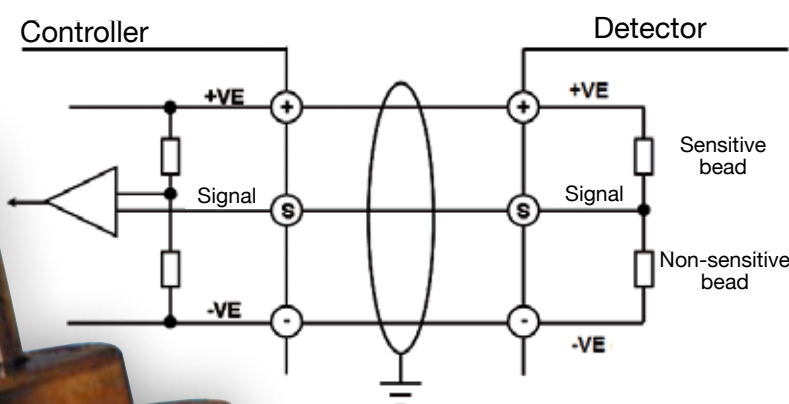

3 Wire mV Bridge Circuit

Speed of response

To achieve the necessary requirements of design safety, the catalytic type of sensor has to be mounted in a strong metal housing behind a flame arrester. This allows the gas/air mixture to diffuse into the housing and on to the hot sensor element, but will prevent the propagation of any flame to the outside atmosphere. The flame arrester slightly reduces the speed of response of the sensor but, in most cases the electrical output will give a reading in a matter of seconds after gas has been detected. However, because the response curve is considerably flattened as it approaches the final reading, the response time is often specified in terms of the time to reach 90 percent of its final reading and is therefore known as the T90 value. T90 values for catalytic sensors are typically between 20 and 30 seconds.

(N.B. In the USA and some other countries, this value is often quoted as the lower T60 reading and care should therefore be taken when comparing the performance of different sensors). ■

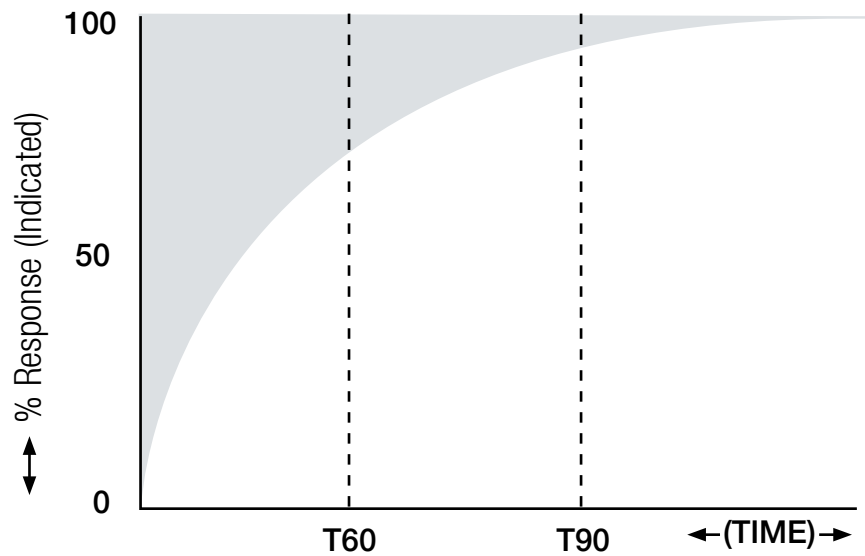

Sensor output

To ensure temperature stability under varying ambient conditions, the best catalytic sensors use thermally matched beads. They are located in opposing arms of a Wheatstone bridge electrical circuit, where the 'sensitive' sensor (usually known as the 's' sensor) will react to any combustible gases present, whilst a balancing, 'inactive' or 'non-sensitive' (n-s) sensor will not. Inactive operation is achieved by either coating the bead with a film of glass or de-activating the catalyst so that it will act only as a compensator for any external temperature or humidity changes.

A further improvement in stable operation can be achieved by the use of poison-resistant sensors. These have better resistance to degradation by substances such as silicones, Sulphur and lead compounds which can rapidly de-activate (or 'poison') other types of catalytic sensor. ■



■ Principles of Detection (continued)

Typical types of gas sensor/transmitter

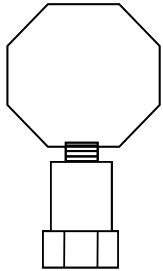

Sensor screwed to Junction Box – two-man calibration

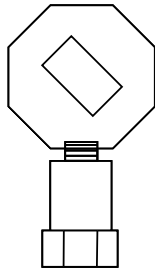

Sensor screwed to Transmitter with intrusive one-man calibration

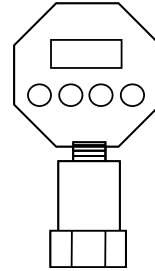

Sensor screwed to Transmitter with non-intrusive one-man calibration

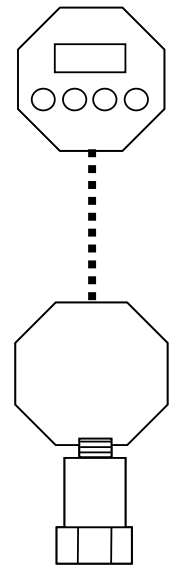

Transmitter with remote sensor – one-man non-intrusive calibration

Calibration

The most common failure in catalytic sensors is performance degradation caused by exposure to certain poisons. It is therefore essential that any gas monitoring system should not only be calibrated at the time of installation, but also checked regularly and re-calibrated as necessary. Checks must be made using an accurately calibrated standard gas mixture so that the zero and 'span' levels can be set correctly on the controller.

Codes of practice such as EN 60079-29-2 outline the legal requirement for calibrating flammable gas detectors (%LEL) and also guidance on the calibration of toxic gas detectors (please note: toxic gas detectors will have a legal requirement for calibration in the future). Typically, checks should initially be made at weekly intervals but the periods can be extended as operational experience is gained. Where two alarm levels are required, these are normally set at 20-25%LEL for the lower level and 50-55%LEL for the upper level.

Older (and lower cost) systems require two people to check and calibrate, one to expose the sensor to a flow of gas and the other to check the reading shown on the scale of its control unit. Adjustments are then made at the controller to the zero and span potentiometers until the reading exactly matches that of the gas mixture concentration.

Remember that where adjustments have to be made within a flameproof enclosure, the power must first be disconnected and a permit obtained to open the enclosure. Today, there are a number of 'one-man' calibration systems available which allow the calibration procedures to be carried out at the sensor itself. This considerably reduces the time and cost of maintenance, particularly where the sensors are in difficult to get to locations, such as an offshore oil or gas platform. Alternatively, there are now some sensors available which are

designed to Intrinsically Safe (IS) standards, and with these it is possible to calibrate the sensors at a convenient place away from the site (in a maintenance depot for instance). Because these sensors are IS, they can be freely exchanged with the sensors needing replacement on site, with no need to shut down the system first.

Maintenance can therefore be carried out on a 'hot' system and is much faster and cheaper than early, conventional systems. ■



■ Principles of Detection (continued)



I Infrared Gas Detector

Many combustible gases have absorption bands in the infrared region of the electromagnetic spectrum of light and the principle of Infrared (IR) absorption has been used as a laboratory analytical tool for many years. Since the 1980s, however, electronic and optical advances have made it possible to design equipment of sufficiently low power and smaller size to make this technique available for industrial gas detection products as well.

These sensors have a number of important advantages over the catalytic type. They include a very fast speed of response (typically less than 10 seconds), low maintenance and greatly simplified checking, using the self-checking facility of modern micro-processor controlled equipment. They can also be designed to be unaffected by any known 'poisons', they are fail-to-safety (no fault that develops within the device can result in a safety critical situation) and they will operate successfully in inert atmospheres and under a wide range of ambient temperatures, pressure and humidity conditions.

The technique operates on the principle of dual wavelength IR absorption, whereby light passes through the sample mixture at two wavelengths, one of which is set at the absorption peak of the gas to be

detected, whilst the other is not. The two light sources are pulsed alternatively and guided along a common optical path to emerge via a flameproof 'window' and then through the sample gas. The beams are subsequently reflected back again by a retro-reflector, returning once more through the sample and into the unit. Here a detector compares the signal strengths of sample and reference beams and, by subtraction, can give a measure of the gas concentration.

This type of detector cannot detect diatomic gas molecules and is therefore unsuitable for the detection of Hydrogen. ■



GAS FACT

Autoignition temperature of a flammable gas is the temperature at which an ignition will take place, even without an external spark or flame.

Principles of Detection (continued)

Open Path Flammable Infrared Gas Detector

Traditionally, the conventional method of detecting gas leaks was by point detection, using a number of individual sensors to cover an area or perimeter. More recently, however, instruments have become available which make use of infrared and laser technology in the form of a broad beam (or open path) which can cover a distance of several hundred metres. Early open path designs were typically used to complement point detection, however the latest generation instruments are now often being used as the primary method of detection. Typical applications where they have had considerable success include FPSOs, loading/unloading terminals, pipelines, perimeter monitoring, offshore platforms and LNG (Liquid Natural Gas) storage areas.

Early designs use dual wavelength beams, the first coinciding with the absorption band peak of the target gas and a second reference beam which lies nearby in an unabsorbed area.

The instrument continually compares the two signals that are transmitted through the atmosphere, using either the back-scattered radiation from a retroreflector or more commonly in newer designs by means of a separate transmitter and receiver. Any changes in the ratio of the two signals is measured as gas. However, this design is susceptible to interference from fog as different types of fog can positively or negatively affect the ratio of the signals and thereby falsely indicate an upscale gas reading/alarm or downscale gas reading/fault. The latest generation design uses a double band pass filter that has two reference wavelengths (one either side of the sample) that fully compensates for interference from all types of fog and rain. Other problems associated with older designs have been overcome by the use of coaxial optical design to eliminate false alarms caused by partial obscuration of the beam.



The use of Xenon flash lamps and solid state detectors makes the instruments totally immune to interference from sunlight or other sources of radiation such as flare stacks, arc welding or lightning.

Open path detectors actually measure the total number of gas molecules (i.e. the quantity of gas) within the beam. This value is different to the usual concentration of gas given at a single point and is therefore expressed in terms of LEL meters. ■

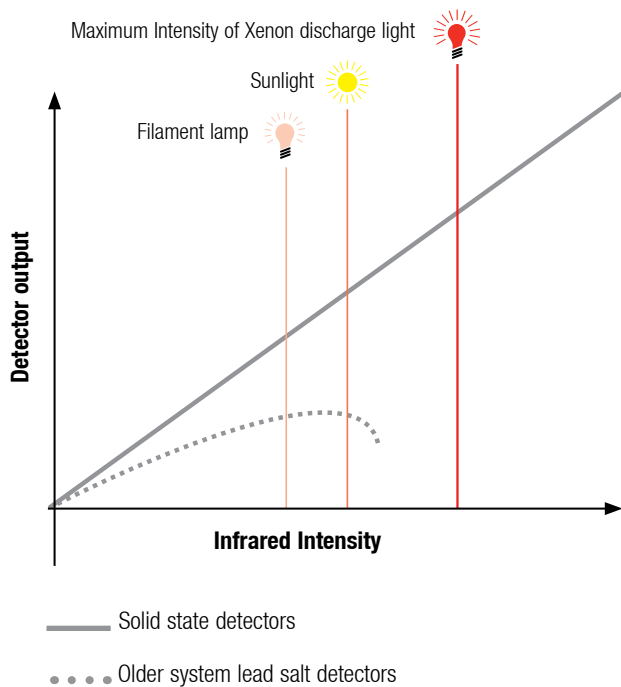

Single reference design – fog interference

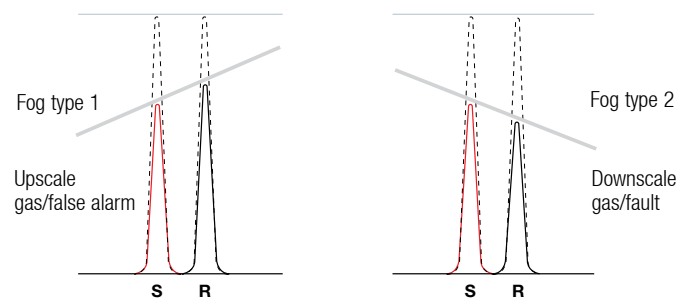

Double reference design – fully compensates

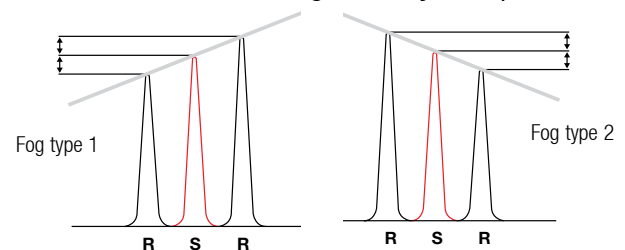

Principles of Detection (continued)

Electrochemical Cell Sensors

Gas specific electrochemical sensors can be used to detect the majority of common toxic gases, including CO, H₂S, Cl₂, SO₂ etc. in a wide variety of safety applications.

Electrochemical sensors are compact, require very little power, exhibit excellent linearity and repeatability and generally have a long life span, typically one to three years. Response times, denoted as T90, i.e. time to reach 90% of the final response, are typically 30-60 seconds and minimum detection limits range from 0.02 to 50ppm depending upon target gas type.

Commercial designs of electrochemical cells are numerous but share many of the common features described below:

Three active gas diffusion electrodes are immersed in a common electrolyte, frequently a concentrated aqueous acid or salt solution, for efficient conduction of ions between the working and counter electrodes.

Depending on the specific cell the target gas is either oxidised or reduced at the surface of the working electrode. This reaction alters the potential of the working electrode relative to the reference electrode. The primary function of the associated electronic driver circuit connected to the cell is to minimise this potential difference by passing current between the working and counter electrodes, the measured current being proportional to the target gas concentration. Gas enters the cell through an external diffusion barrier that is porous to gas but impermeable to liquid. Many designs incorporate a capillary diffusion barrier to limit the amount of gas contacting the working electrode and thereby maintaining "amperometric" cell operation.

A minimum concentration of Oxygen is required for correct operation of all electrochemical cells, making them unsuitable for certain process monitoring applications. Although the electrolyte contains a certain amount of dissolved Oxygen, enabling short-term detection (minutes) of the target gas in an Oxygen-free environment, it is strongly advised that all calibration

Patented Surecell™ Two Reservoir Design

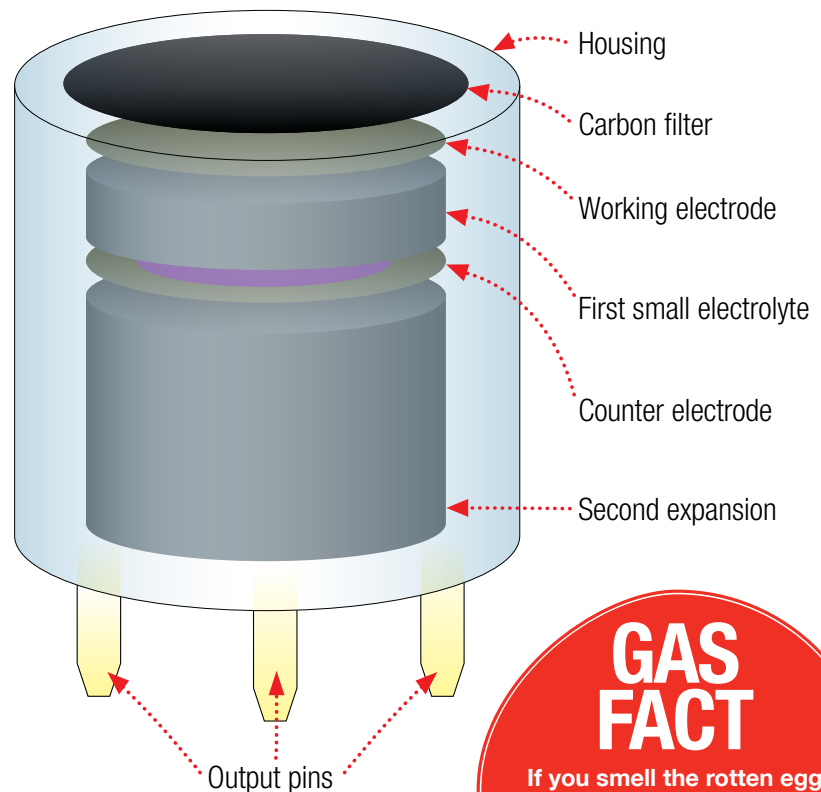

gas streams incorporate air as the major component or diluent.

Specificity to the target gas is achieved either by optimisation of the electrochemistry, i.e. choice of catalyst and electrolyte, or by incorporating filters within the cell which physically absorb or chemically react with certain interferent gas molecules in order to increase target gas specificity. It is important that the appropriate product manual be consulted to understand the effects of potential interferent gases on the cell response.

The necessary inclusion of aqueous electrolytes within electrochemical cells results in a product that is sensitive to environmental conditions of both temperature and humidity. To address this, the patented

Surecell™ design incorporates two electrolyte reservoirs that allows for the 'take-up' and 'loss' of electrolyte that occurs in high temperature/high humidity and low temperature/low humidity environments.

Electrochemical cell sensor life is typically warranted for 2 years, but the actual lifetime frequently exceeds the quoted values. The exceptions to this are Oxygen, Ammonia and Hydrogen Cyanide sensors where components of the cell are necessarily consumed as part of the sensing reaction mechanism. ■

GAS FACT

If you smell the rotten egg aroma of Hydrogen Sulphide from the decomposition of organic matter, you are only smelling 1ppm. Just 1,000 ppm of H₂S is enough to kill you.

Principles of Detection (continued)

Photo Ionised Detection (PID)

This type of detection principle is often employed in portable gas detection solutions and is designed to deliver highly sensitive monitoring of Volatile Organic Compounds (VOCs) or other gases that need to be detected in very small quantities, such as Chlorinated Hydrocarbons.

A PID sensor can detect down to parts per billion (ppb), and this is necessary when dealing with VOCs which can be highly toxic in very small quantities.

The principle uses high-energy photons, which are usually in the Ultraviolet (UV) range to break gas molecules into positively charged ions. When the gas molecules encounter the UV light, the UV light is absorbed, resulting in the ionisation of the molecules. This occurs because the UV light excites the molecules, resulting in the temporary loss of their electrons and the subsequent formation of positively charged ions. This process causes the gas to become electrically charged and the current resulting from the positively charged ions acts as the gas detector's signal

output. This means that the higher the electrical current, the greater the concentration of the gas in the environment because when there is more gas, more positively charged ions are produced.

PID gas detectors are popular due to their efficiency, low-level detection capabilities and cost-effectiveness (when compared to other detection principles). Please see *Portable gas detection* on page 52 for more detailed information about PID detection suitability. ■

Chemcassette®

Chemcassette® is based on the use of an absorbent strip of filter paper acting as a dry reaction substrate. This performs both as a gas collecting and gas analysing media and it can be used in a continuously operating mode. The system is based on classic colorimetry techniques and is capable of extremely low detection limits for a specific gas. It can be used very successfully for

a wide variety of highly toxic substances, including Di-isocyanates, Phosgene, Chlorine, Fluorine and a number of the hydride gases employed in the manufacture of semiconductors.

Stain intensity is measured with an electro-optical system which reflects light from the surface of the substrate to a photo cell located at an angle to the light source.

Then, as a stain develops, this reflected light is attenuated and the reduction of intensity is sensed by the photo detector in the form of an analogue signal. This signal is, in turn, converted to a digital format and then presented as a gas concentration, using an internally-generated calibration curve and an appropriate software library. Chemcassette® formulations provide a unique detection medium that is not only fast, sensitive and specific, but it is also the only available system which leaves physical evidence, i.e. the stain on the cassette tape that a gas leak or release has occurred.

Detection specificity and sensitivity are achieved through the use of specially formulated chemical reagents, which react only with the sample gas or gases. As sample gas molecules are drawn through the Chemcassette® with a vacuum pump, they react with the dry chemical reagents and form a coloured stain specific to that gas only. The intensity of this stain is proportionate to the concentration of the reactant gas, i.e. the higher the gas concentration, the darker the stain. By carefully regulating both the sampling interval and the flow rate at which the sample is presented to the Chemcassette®, detection levels as low as parts-per-billion, i.e. 10^{-9} can be readily achieved. ■

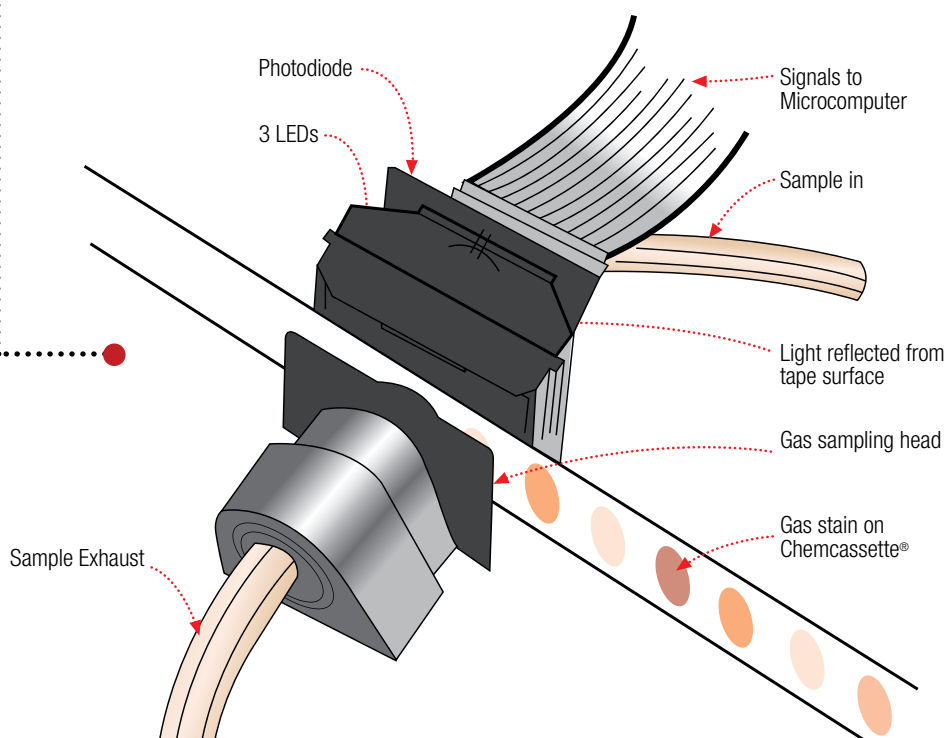

Principles of Detection (continued)

Comparison of Gas Detection Techniques

Detection Principle	Catalytic	ECC	Point IR	Open Path	PID	Semiconductor	Paper Tape
Works in inert atmosphere	No (requires presence of Oxygen)	No (requires presence of Oxygen)	Yes	Yes	Yes	No (requires presence of Oxygen)	No (requires presence of Oxygen)
Resistant to poison	Susceptible to poisons like Lead and Sulphur containing compounds, silicones vapours and phosphates	Yes	Yes	Yes	Yes	Susceptible to poisons like Halide compounds, Silicone vapours, caustic and acid liquids and concentrated vapours	Yes
Detects Hydrogen	Yes	Yes	No	No	No	No	No
Performance in 100% humidity	Yes	Yes	Yes	Yes	No	Yes	No
Performance in typical pressure conditions	Yes	Yes	Yes	Yes	Yes	Yes	Yes
Performs in all temperatures	Yes	No (some models can be unstable in low and high temperatures)	Yes	Yes	Yes	No (some models can be compromised below -40°C and above 90°C)	No (some models can be compromised below 10°C and above 40°C)
Immune to dust/dirt	Yes, with adequate weather and dust protection	Yes, with adequate weather and dust protection	Yes, with adequate weather and dust protection	Yes, with adequate weather and dust protection	Yes, with adequate weather and dust protection	Yes, with adequate weather and dust protection	Yes, with adequate filter and dust protection
Immune to sunlight	Yes	Yes	Yes	Yes	Yes	Yes	No (decays tape)
Performance in O ₂ enriched atmosphere	Yes	No (can alter readings and response)	Yes	Yes	Yes	No (can alter readings and response)	No (detection of mineral acids is compromised in Oxygen enriched atmospheres)
Immune to human interference	No	No	No	No, e.g. poor alignment	No	No	No
Speed of response	<20 secs	<30 secs (typical)	<6.5 secs	<3-5 secs	<5 secs	<60 secs	<10-30 secs
Maintenance requirement	High	High	Low	Low	High	High	High

Selecting Gas Detection

There are many gas detection products on the market that might appear to be the same, but a closer inspection of specification, functionality and features reveals major differences in what products can do and the potential value they can offer. Similarly, individual applications are also unique in their respective designs, needs and processes undertaken.

Know your site risks

Before beginning to consider gas detection equipment, a risk assessment needs to be conducted. Any company employing staff has the obligation to conduct risk assessments to identify potential hazards and these can include potential gas, vapour or Oxygen deficiency risks. If gas hazards are identified, gas detection is applicable as a risk reduction method.

Identifying the prime objective

Depending on the processes being undertaken and the gases being detected, remote or off-site alarm notification plus event datalogging/reporting may also be required for Health and Safety management records. Another factor impacting on the need for enhanced reporting functions might be regulatory compliance or a condition of insurance.

Knowing the prime objective and motivation for having gas detection is the first step in selecting the best solution.

Ask the right questions

Having identified the primary objective, the suitable equipment is selected by asking a number of key questions. These fall into three broad categories:

- The gases to be detected and where they may come from
- The location and environmental conditions where detection is to take place
- The ease of use for operators and routine servicing personnel

The answers to these questions will have a direct impact upon the proposed solution and the associated costs to supply and maintain equipment.

The gases to be detected and where they may come from

The gases to be detected should be identified by the risk assessment, however experienced gas detection equipment manufacturers and their approved distributors are often able to help in this process, based on their experience of similar applications. However, it is important to remember that it is the end-user's responsibility to identify all potential hazards.

The gas detection vendor uses published data to identify whether a gas is flammable, toxic or an asphyxiant and the relative levels at which it could cause a hazard. An ideally suited gas detection solution aims to detect and alarm prior to dangerous levels being reached. The same published data gives information as to whether the gas or vapour is lighter or heavier than air, as this will affect the selection of sensor positioning at the points of detection.

It is also essential to identify the potential source of a gas release as this helps determine the number and location of detectors required for a fixed gas detection system.

In instances where the source of gas release is not known, portable gas detection equipment, worn by site personnel may offer a better solution.

Some typical gas sources include:

- Natural occurrence, e.g. Methane and Hydrogen Sulphide from the decomposition of waste
- Leakage for a supply pipe or storage tank, e.g. piped Natural Gas supplies
- Emissions from a combustion process, e.g. Carbon Monoxide from an exhaust or a boiler flue
- Emissions from a production process, e.g. solvents in the printing and coating industry
- Emissions from a manufacturing plant, e.g. Ammonia from a refrigeration plant or Nitrogen from a Nitrogen supply plant





Consider the environmental conditions

The performance, accuracy and reliability of any gas detection equipment will be affected by the environmental conditions it is subjected to. Temperature, humidity and pressure levels at the location all have a direct bearing on the type of equipment that should be selected. Additional factors such as potential variations resulting from a production process itself, diurnal/nocturnal fluctuations and seasonal changes may also affect the type of device which is suitable. It is important to consider whether the equipment will be used inside or externally as this can greatly affect the design of the device. For example, an external location that is exposed to elements such as wind, rain and salt spray, will require equipment which is resistant to the corrosive effects of that environment. Although indoor locations typically require less robust housing, consideration should be made for internal areas which are hosed down on a frequent basis. In locations where water/moisture, dust and dirt are prevalent it's important to get a device that is protected by water/dirt ingress. Please see *Ingress protection of enclosures* on page 92 for more detailed information.

Aside from natural environmental conditions such as weather, there may be other materials in the environment that can have a potential affect on the type of equipment that is

chosen. For example, there may be other elements such as Hydrogen Sulphide, which have corrosive properties or other airborne compounds which could have an adverse affect upon the reliable operation of some sensing technologies, e.g. Silicones poisoning catalytic bead sensing technologies.

Another important consideration is a device's suitability for use in certain hazardous locations. Hazard areas are classified according to their perceived likelihood of gases being present. It's important that a device cannot ignite a gas cloud. With this in mind equipment that is Intrinsically Safe (Ex ia/Ex ib) or Explosion-Proof (Ex d) has been created to provide enhanced safety. Please see *Area classification* on page 86 for more detailed information.

A competent gas detection equipment supplier will have a range of different sensing technologies available that can be applied to a given application. In addition, the environmental conditions start to determine the best mechanical configuration of the final solution.

Product functionality

The next area of consideration relates to additional product functionality. Aspects like wiring configuration are important, especially when retro-fitting into an existing application. If the apparatus is being

integrated into a separate safety system, certain communication protocols may also be required such as HART®, Lonworks or Modbus®. Please see *Communication protocols* on page 48 for more detailed information.

Consideration will also need to be given regarding the requirement for local displays on transmitter units and local configuration of the unit and gas displays may also be a useful addition.

A holistic approach needs to be adopted when looking at the functionality of a device. There are a large number of variations with products and as you would expect, there is often a cost implication with increased functionality. Again, this is where working with a gas detection specialist can help by identifying the additional spec that could be valuable. Things like local displays, local user interfaces, software compatibility, the number of relays and outputs required, remote sensor mounting capabilities, on-board diagnostics, cartridge hot swapping and event logging abilities provide additional benefits to the user and make one product more applicable than another.

The ease of use for operators and routine servicing personnel

Routine maintenance is another important consideration. Some gases and vapours can be detected with a number of different sensing technologies, e.g. Hydrocarbon gases with catalytic beads or Non-dispersive Infrared NDIR. Catalytic beads do not provide fail-to-safety operation and therefore can require a high frequency of routine maintenance, however NDIR based solutions tend to have a higher initial purchase price, but may require less routine maintenance. In-house resource to undertake such routine maintenance needs to be identified and in the absence of such a resource, budgeting for third party maintenance is an important factor in selecting the right equipment.

Detection equipment downtime during routine sensor replacement can lead to the loss of production. If this is a concern, some solutions can provide a fast, simple and safe method of sensor exchange without needing to down-power the system or the plant.

A good gas detection equipment supplier should be able to offer a range of service packages to help maintain equipment. Please see *Gas detection maintenance and ongoing care* on page 106 for detailed information on looking after equipment. ■

Maximising time and efficiency

“Smart” functionality may mean different things to different people and encompasses much more than just a device’s features and in-built intelligence. The smartest solutions are those that provide efficiency and cost-effectiveness over the whole product life.

Developments with firmware are often seen as being “smarter” than traditional analogue systems because they may be able to self-diagnose, improve accuracy, and possibly decrease the amount of time spent calibrating or maintaining the device. Today more than ever, businesses are concerned with reducing costs and maximising efficiency and the choice of a smart solution can result in considerable savings over whole product life.

This does not necessarily mean that a device can only save you money if it features in-built intelligence. Products can only be properly evaluated within the context of their subsequent use and where they will be

situated; this means that the application itself, environmental factors and additional elements the device could come into contact with, all impact upon whether one device is really a “smart” choice after all. In some cases, non-intelligent devices may be a better choice for an application. This is highlighted by the divide in the global petrochemical industry with different regions adopting different technologies.

Functionality doesn’t necessarily have to be intelligent to make a big impact. The Sensepoint XCD range from Honeywell Analytics features a tri-colour display that clearly indicates the unit’s status at a glance – even from a distance; green for

normal operation, yellow to indicate a fault status and red to indicate an alarm status. Although there are many models on the market that offer tri-colour LCD indicators, the Sensepoint XCD range provides a full colour-illuminated screen that is easily seen from a distance. An example of the cash saving this functionality could actually translate into can be illustrated by the following example: Consider a plant set-up, where a series of devices are monitoring for gas hazards and are feeding back information to a Programmable Logic Controller (PLC). If a hazard occurs, the maintenance engineer must enter the area, and find the sensor that has gone into warning/fault. If the plant is large with many points of detection,



this could take some time. In the case of Sensepoint XCD, the device in warning/fault will be clearly visible by its bright illuminated screen, meaning that the engineer can get straight to the unit and the simplicity of the colour coding means that the device's status is instantly accessible with a simple glance.

Aspects like Sensepoint XCD's tri-colour display screen are not necessarily "smart" in their own right, but as the example highlights, the resulting impact they can have in saving time and subsequent costs may well make them a "smarter" choice over a comparable solution. In addition, the device's display also negates the need for additional expense associated with integrating local status lights, providing a cost saving.

Save time... save money

The most cost-effective systems are those that permit quick and easy use of the device and minimal training. Even a small reduction in the time required on each device – just a few minutes – can quickly translate into big cash savings, as the following hypothetical example highlights: Consider a site that has 100 catalytic bead driven devices; if each unit takes 10 mins to check and re-calibrate using one solution compared with 6 mins per device using another, a saving of 37% on labour costs is achieved just by saving 4 minutes per device.

Products like the Sensepoint XCD range and the XNX Universal Transmitter from Honeywell Analytics provide complete monitoring solutions for flammable, toxic and Oxygen gas hazards and they also feature the same interface and calibration methods. This means that operators do not need to be trained to use each variant separately. This is particularly valuable as plants can evolve and processes can change, meaning additional gas detection solutions may be required. Using devices like these mean that training can be minimised and when you consider the training fees, expenses to get personnel to the location where training is situated and also any cost implications resulting from additional personnel cover whilst training of one group is taking place, this can provide notable savings.

Any minimisation of production loss can save money. Consider a site that uses a device like Sensepoint XCD Remote Flammable Detector (RFD) to monitor for Methane gas in a potentially explosive environment. The device's ability to provide useful warnings that indicate the need for maintenance can help to reduce nuisance alarms.

Smart sensor and calibration philosophies

Ease of sensor swapping and calibration can also deliver savings. This can be highlighted by the auto recognition "Plug and Play" sensor capabilities of devices like Apex from Honeywell Analytics, which use smart pre-calibrated sensors. These sensors can be taken out into the field and changed over in just one minute.

This means that the change out of 100 Apex sensors would take just under two hours to complete compared with a standard sensor technology where each device could take up to 20-30 minutes to change out and re-calibrate (equating to 3 ½ days labour by comparison).

Speculate to accumulate

The saying "you get what you pay for" often rings true, meaning that more intelligent devices and those that deliver enhanced functionality tend to have a higher purchase price. But often this money can be recouped many times over as can be highlighted by the savings that automatic datalogging can have on a site's labour cost. A gas and fire controller that can carry out regular automatic datalogging may cost \$500 more (for argument's sake) than a controller that cannot offer this functionality. A site that wishes to datalog every hour will need an engineer to undertake this work manually, if an automatic facility is not available. If each datalog check takes 15 mins to complete, this means that in a 16 hour day (many plants operate two eight hour shifts per day), 4 hours will be required to make the relevant checks. By the time the device has been used for a year, the purchaser will have saved around 208 hours in labour.

The same can be said of aspects like intelligent communications platforms such as HART®, Modbus® and LonWorks that facilitate enhanced two-way communication between the device and the control system. This type of functionality has many potential benefits like assisting with planned maintenance activities, allowing operators to schedule maintenance and improve time efficiency as well as ensure maximum equipment uptime. For sites using a 4-20mA infrastructure, HART® can deliver enhanced communications without the need for additional cabling, and considering that cabling is the single biggest cost for any site, this is highly valuable. Please see *Communications protocols* on page 48 for more detailed information.

Field time can also be reduced because devices that have been inhibited so field work can be carried out on them, do not need to be manually put back online by a second employee working in a control room; they can be set to automatically go online. This functionality also limits the occurrence of nuisance false alarms that can adversely impact on a plant's production.

The value of common design

Today's devices are being built with not only functionality in mind but also a smarter approach to product design; aspects such as common device and spare parts design enable businesses to carry less spares. As an industry average, 2-5% of the total order is required as additional spares stock. Spares stock can also be reduced through the use of common design devices like XNX Universal Transmitter. Typically using XNX Universal Transmitters, the value of the overall system cost attributable to spares stock can be reduced to one-third of that of a conventional system utilising separate transmitter types. This is achieved through the removal of the need to carry different types of spares for the various transmitter types that may be installed.

Another value aspect of devices that use common design and intuitive user interfaces is that they reduce the chance of incorrect set-up or calibration, which can lead to nuisance alarms. Just one nuisance alarm that causes a required process shutdown of 60-90 minutes at a site producing 1,000 barrels of oil per hour, can equate to 1,500 barrels of lost oil production.

A Case by Case approach

Local factors and individual plant set-up will have a large impact on whether one device is more suitable than another in terms of providing a cash saving. It's important to work with a supplier who can provide multiple technologies and specification variance, as this will enable them to give impartial guidance on choosing the right solution that is truly fit-for-purpose, based on your individual variables. ■

Communications Protocols

Communication is essential in all areas of life – and gas detection is no exception. In fact, the application of communication capabilities to smart field devices and process monitoring technologies is able to bring valuable dimensions to site safety.

Safety control systems are usually organised with a hierarchical system of three core levels of hardware and software.

The highest level is represented by the Human Machine Interface (HMI), which is often a PC based solution. This allows an operator to interact and monitor the system, using protected passwords allowing for acknowledgement and/or modification as needed. The second level down is the Programmable Logic Controllers (PLCs). These allow signals from analogue, digital and bus to interface with the HMI. The tertiary level consists of the devices such as Infrared (IR) gas detectors, toxic sensors, pressure and temperature sensors and flow measurement field devices.

The type of communication protocol employed by the system to interface between the PLCs and field devices will determine the type of data that can be obtained from a device and the frequency with which that data can be transmitted or received. Many PLCs tend to use a 4-20mA input.

Communications protocol types

The concept of gas detection with communications capabilities is not a new one; in fact, gas detectors have been using protocols like Foundation Fieldbus™, Modbus®, Profibus® and Highway Addressable Remote Transducer (HART®) since the 1980s.

Since the inception of communication protocols, many variants have emerged, with Modbus® being the first to be developed in 1979. Foundation Fieldbus™ was a protocol released in the 1980s and was strongly adopted in the USA. Profibus® soon emerged as an alternative to Foundation Fieldbus™ and became popular in Europe.

HART® COMMUNICATION PROTOCOL



Today Foundation Fieldbus™ co-exists with Modbus®, Profibus® and Industrial Ethernet (an ethernet concept that offers enhanced data checking and stability).

The plethora of options available is brought about by the varying needs of industry when it comes to communication. Some protocols offer peer-to-peer communication (such as Foundation Fieldbus™), meaning that the PLC is always receiving streamed data as well as being able to request information from the device. Others (such as HART®) work on a master-slave principle where data is not being streamed continuously and the PLC (acting as master) requests the information from the slave device, which in turn sends data back to the PLC.

HART® actually operates with two master functions; a Primary Master (such as a PLC or Distributed Control System (DCS)) and a Secondary Master (such as a HART®-enabled hand-held device); this provides the user with additional value. For example, an operator can go out into the field with a HART®-enabled handheld interrogator or can use a PLC/DCS situated in a control room or another area.

Modbus® RTU has been very popular for the last 20 years. This is due to the speed with which it can transmit data and the fact it features an error check mechanism to ensure the reliability of data being sent and received, and continues to be popular due to Modbus® TCP/IP over Ethernet.

Honeywell Analytics released its own digital system in 1985 called Gas Data Acquisition and Control System (GDACS), using a proprietary protocol. It was created to offer flexibility and an enhanced level of interaction to its users, and its value has stood the test of time. In fact, today Honeywell Analytics still supports customers using this protocol.

Communications protocol value

Communications protocols offer considerable value, helping to improve safety, simplifying maintenance and reducing ongoing costs:

- They can allow the user to access information from the smart field device (such as gas readings, signal level, raw sensor readings and temperature)
- They can allow a user to change calibration and device configuration
- They can help to facilitate proactive, scheduled maintenance over reactive maintenance
- They can reduce ongoing costs because proactive maintenance is less costly than reactive
- They can reduce field engineering costs, because device communication allows you to “know before you go”, meaning that an engineer can be prepared for work needing to be undertaken in the field.



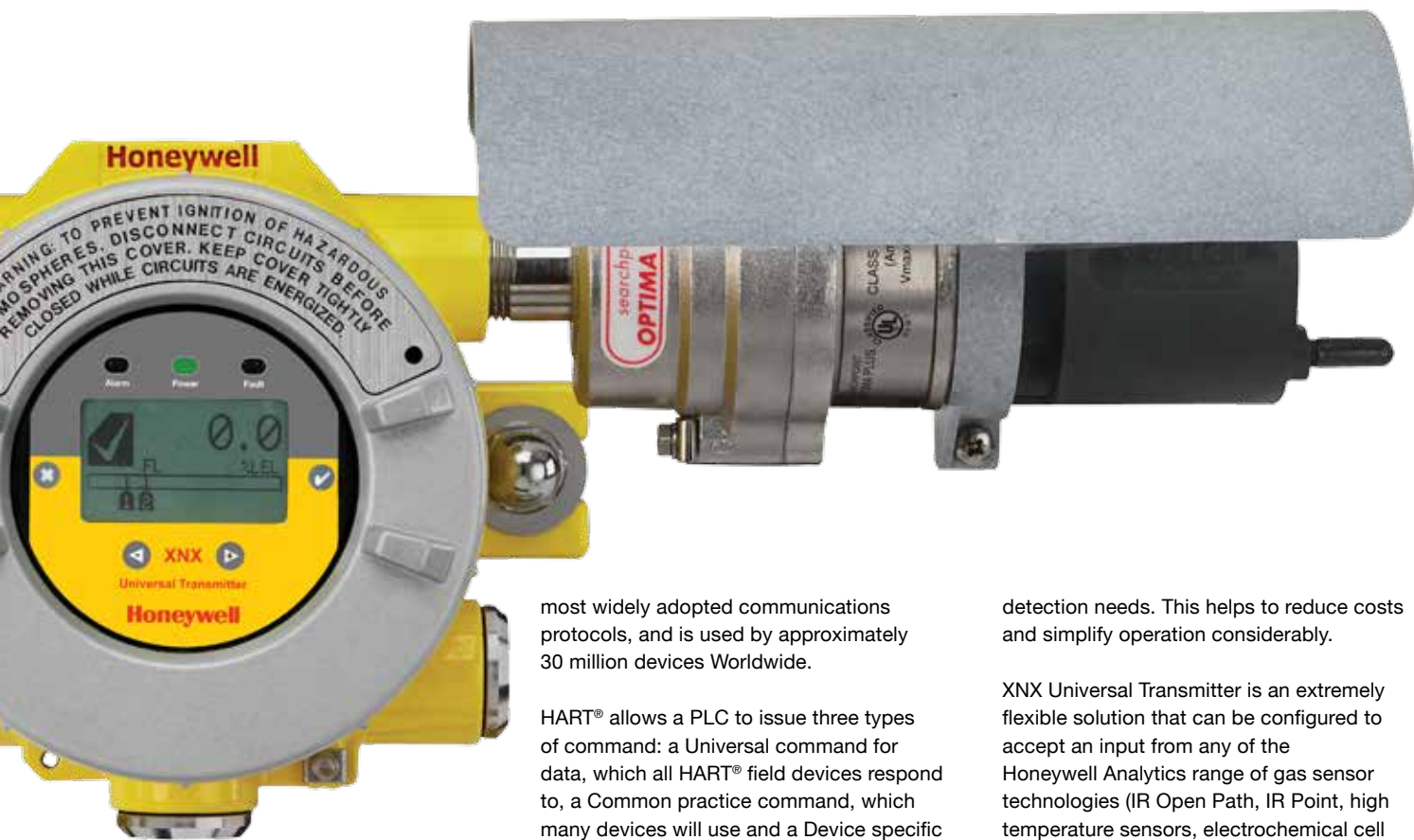

Trends and the popularity of HART®

Communications protocols all work in slightly different ways and for this reason, they offer varying benefits and disadvantages over each other. Peer-to-peer communication protocols such as Foundation Fieldbus™ require more power because of the extra data being constantly streamed from the device to the PLC, but conversely they offer the additional benefit of allowing constant communication from the field device to the PLC, which is essential for many regulated processes.

HART® is becoming an ever-more popular communication protocol owing to the fact that it communicates over a legacy 4-20mA analogue wiring topology; the digital HART® signal is superimposed over the existing 4-20mA signal and permits bidirectional communication, which allows the operator the flexibility to make device modifications using the HART® signal. Infrastructural costs like wiring are one of the most expensive aspects of a plant, so this ability makes HART® highly attractive to many sites. In fact, its growing popularity highlights the large global install base of 4-20mA wiring. Today it is one of the

most widely adopted communications protocols, and is used by approximately 30 million devices Worldwide.

HART® allows a PLC to issue three types of command: a Universal command for data, which all HART® field devices respond to, a Common practice command, which many devices will use and a Device specific command, which is unique to a particular device. A Device Description (DD) file is produced by a manufacturer of a HART®-enabled field device, and it allows the user to interact directly with a device such as Searchpoint Optima Plus from Honeywell Analytics. This allows the user to poll the device for information and any procedures specific to that device anywhere in the loop, using a HART®-enabled hand-held that includes the DD file from Honeywell Analytics.

The true value of HART® becomes apparent in the context of a specific product such as Searchpoint Optima Plus. In essence, there are two core areas that a site can benefit from HART®; commissioning/set-up and ongoing maintenance/operational efficiencies.

HART® and universal device use: a winning combination

The advent of “one size fits all” devices like the XNX Universal Transmitter from Honeywell Analytics are very much in-line with market needs; in fact the perfect solution for most end-users is a universal device that can interface with most existing gas sensing technologies on site, providing one simple, long-lasting solution to ever-changing gas

detection needs. This helps to reduce costs and simplify operation considerably.

XNX Universal Transmitter is an extremely flexible solution that can be configured to accept an input from any of the Honeywell Analytics range of gas sensor technologies (IR Open Path, IR Point, high temperature sensors, electrochemical cell and mV), providing one single interface solution to all flammable, toxic and gas monitoring on site. The device also offers a wide variety of output signals including HART®, Foundation Fieldbus™, Modbus®, 4-20mA and relays, delivering the flexibility to meet the demands of a wide variety of industries and applications including onshore and offshore oil and gas, power stations and chemical and petrochemical plants.

When this value is combined with the benefits facilitated by HART®, the ongoing cost of gas detection can be reduced further. HART®-enabled, universal-use field devices like the XNX Universal Transmitter are likely to grow in popularity, thanks to their functionality and cost saving potential. ■

GAS FACT

There are 17 gases in total, which can be found in the natural atmosphere on Earth. Only Oxygen and Nitrogen are found in large concentrations; 20.9476% and 78.084% respectively.

14

Fixed gas detection from Honeywell

Honeywell Analytics produces a comprehensive range of flammable, toxic and Oxygen gas detectors, with options designed to meet the needs of all industries and applications; from low-cost compliance through to high-end solutions that minimise maintenance and maximise equipment uptime.

Honeywell Analytics Experts in Gas Detection

Fixed Gas Detection (Flammable and Toxic)

XNX Universal Transmitter



A universal transmitter compatible with all Honeywell Analytics gas sensor technologies

Series 3000 MkII and MkIII



2-wire loop powered toxic and Oxygen gas detectors for use in potentially explosive atmospheres

Sensepoint XCD RFD



A flammable gas transmitter for use with remotely mounted flammable gas sensors

Sensepoint XCD RTD



A gas transmitter for use with directly or remotely mounted toxic and Oxygen gas sensors

Sensepoint XCD



Flammable, toxic and Oxygen transmitter and sensor with tri-colour display for viewing status from a distance

Searchline Excel



World renowned open path IR detector with 200m dynamic monitoring range

Apex



High performance flammable and toxic detector with a choice of communications platforms

Searchpoint Optima Plus



Market leading point IR detector with 100 gases available. Optional HART® over 4-20mA output

Signalpoint Range



Low cost range of flammable, toxic and Oxygen gas detectors

Signalpoint Pro



Low cost range of flammable, toxic and Oxygen gas detectors with integral gas concentration display

Sensepoint Range



Low cost ATEX certified flammable, toxic and Oxygen gas detectors

Sensepoint High Temperature Sensor



Ideal for combustible gases in high temperature areas

Fixed Gas Detection (Toxic)

Vertex M



Cost effective, 8-24 point toxic gas monitoring with physical evidence of a leak

Vertex™



Flexible device providing continuous monitoring of up to 72 points

Midas®



Sensitive detection using smart sensor cartridges and Power over Ethernet (PoE)

Chemcassette®



Calibration-free toxic gas detection with physical evidence of a leak

Satellite XT



Small and compact toxic gas detection with a wide range of sensors

Sat-Ex



Comprehensive monitoring of corrosive, combustible and toxic gases in potentially explosive atmospheres

SPM Single Point Monitor



A fast response device detecting in the ppb range with physical evidence of a leak

ACM 150 FT-IR



Versatile and sensitive detection of up to W40 points with many gases available

CM4



Low cost continuous monitoring of up to four detection points with minimal maintenance requirements

Controllers

System 57



Precision controller accepting inputs from toxic, flammable, Oxygen, flame, smoke and heat detectors



Touchpoint 1

Flammable, toxic and Oxygen controller for use with the Sensepoint range of gas detectors



Touchpoint 4

Flammable, toxic and Oxygen controller for use with the Sensepoint range offering 4 points of detection



Unipoint

DIN rail mounted controller offering flexibility at low cost

Portable Gas Detectors

Flammable and toxic gas detection instruments are generally available in two different formats: portable, i.e. 'spot reading' detectors and 'fixed', permanently sited monitors. Which of these types is most appropriate for a particular application will depend on several factors, including how often the area is accessed by personnel, site conditions, whether the hazard is permanent or transitory, how often testing is needed, and last but not least, the availability of finances.

Portable instruments probably account for nearly half of the total of all modern, electronic gas detectors in use today.

In most countries, legislation also requires their use by anyone working in confined spaces such as sewers and underground telephone and electricity ducts. Generally, portable gas detectors are compact, robust, waterproof and lightweight and can be easily carried or attached to clothing.

Portable gas detectors are available as single or multi-gas units. Single gas units contain one sensor for the detection of a specific gas, whilst multi-gas units usually contain up to six different gas sensors (typically Oxygen, flammable, Carbon Monoxide and Hydrogen Sulphide).

Products range from simple alarm only disposable units to advanced fully configurable and serviceable instruments with features such as datalogging, internal pump sampling, auto calibration routines and connectivity to other units.

Recent portable gas detector design advances include:

- The use of more robust and lightweight materials for construction
- The use of high power microprocessors, enabling enhanced datalogging and self-checking etc
- The employment of modular designs that allow simplified routine servicing and maintenance
- Battery advancements providing extended operating time between charges and a smaller battery pack. ■

GAS FACT

Hydrogen Sulphide bubbling up from the sea may have caused a global extinction of flora and fauna nearly 250 million years ago.





Portable Gas Detectors (continued)

Why are portable gas detectors so important?

Portable gas detectors are classed as a type of Personal Protective Equipment (PPE), designed to keep personnel safe from gas hazards and allow mobile testing of locations before they are entered.

These small devices are essential in many areas where gas hazards could occur, because they are the only means of monitoring an operator's breathing zone continuously, whilst stationary and moving.

Although fixed gas detection does provide personnel protection in its own right, it cannot move with the operator, and this creates the possibility that the operator could enter an area beyond the detection perimeter of the fixed detector.

Many sites employ a mix of both fixed and portable gas detection, but sometimes portable gas detection is used on its own.

This choice may be made for the following reasons:

- The area may not be entered by personnel very often, making the addition of fixed gas detection cost-prohibitive
- The area may be small or hard to reach, making the placement of fixed gas detection impractical
- The application requiring detection may not be stationary itself. For example, when a Liquid Natural Gas tanker is offloading its cargo at the dock, the dock will be stationary, whilst the tanker itself will be moving due to the motion of the sea

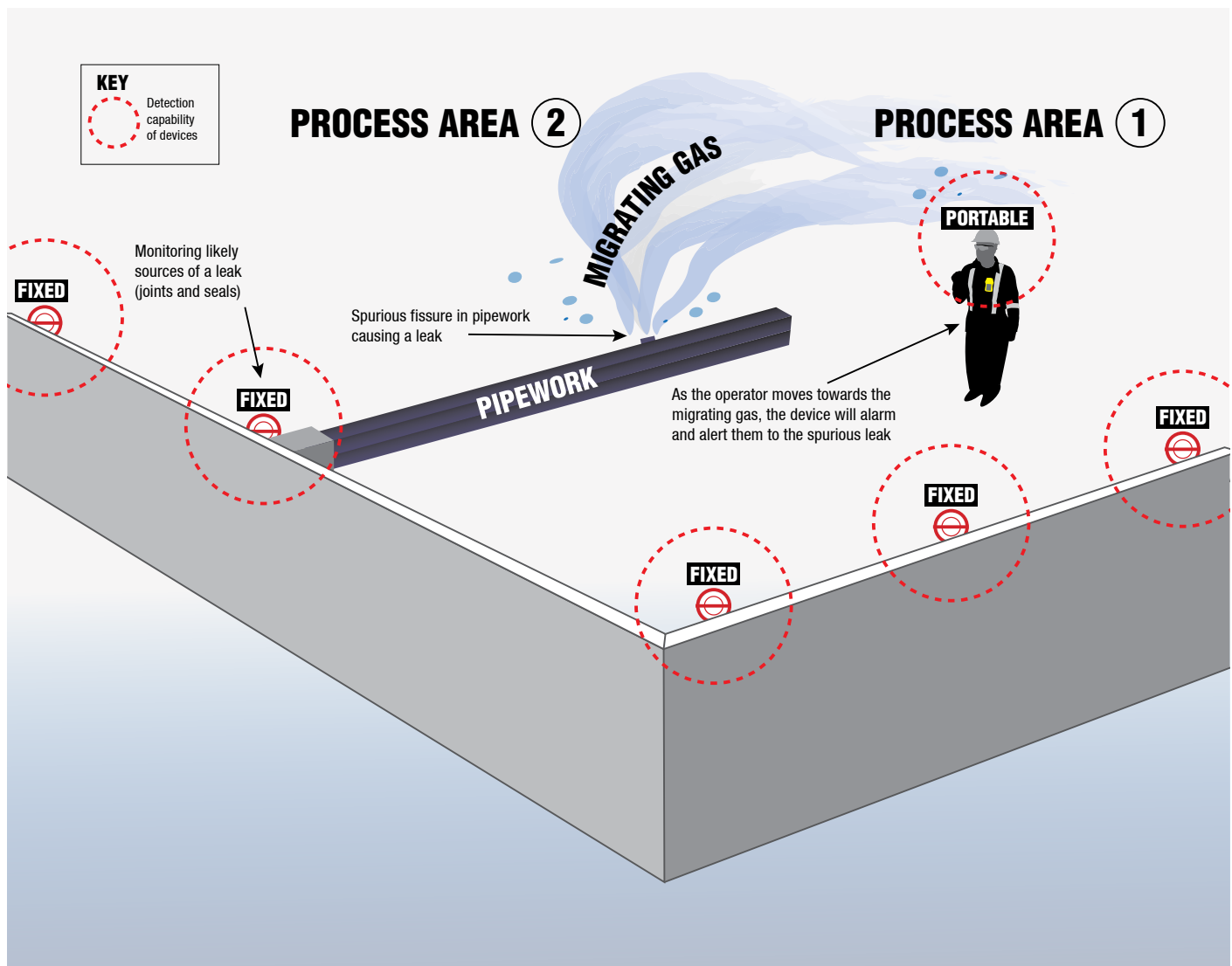

Portable Gas Detectors (continued)

Breathing zone

The breathing zone is defined as the 25 cm/10 inch radius of an operator's mouth and nose. A portable device can be fixed in various locations within the breathing zone including being fastened to jackets or to breast pockets (but never inside a pocket), or held in place by a harness/hat clip. It's essential that the device is secure at all times.

Typical gases requiring portable detection

There are diverse applications and environments that require portable gas detection monitoring and numerous toxic and flammable gases may be encountered.

The most commonly detected gases include:

- Carbon Monoxide
- Carbon Dioxide
- Hydrogen Sulphide
- Oxygen depletion
- Flammable gases such as Methane, Liquid Petroleum Gas and Liquid Natural Gas
- Ammonia
- Sulphur Dioxide
- Chlorine
- Chlorine Dioxide
- Nitrous Oxide
- Nitrous Dioxide
- Phosphine
- Hydrogen Cyanide
- Ozone
- Various Volatile Organic Compounds (VOCs) including Acetone, Benzene, Toluene and Xylene

Due to the variety of applications and different processes undertaken, many additional gases may also be detected by portable devices. Please see *Typical applications for portable gas detectors* on page 60 for information on which gases are likely to be found in specific applications.

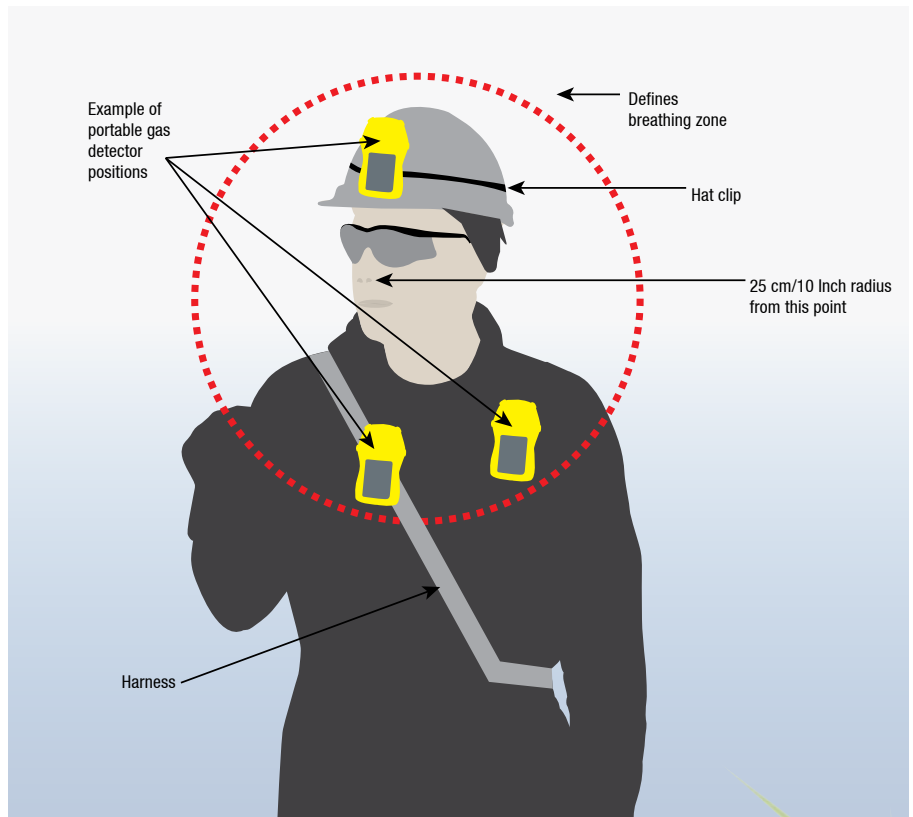

Enhancing safety with portable gas detectors

Changing legislation and regulatory compliance, combined with evolving insurance pre-requisites are making the use of portable gas detectors more prevalent in many industries.

There is a big drive within many sites to “enhance safety” and the integration of a portable gas detection fleet on site is one way of assisting with this.

In addition to legislated requirements (where compliance is mandatory), many sites also choose to implement site-specific rules; for example bump testing a portable gas detector before it is used by any operative. Please see *Maintaining portable gas detection* on page 72 for more information on device testing.



■ Portable Gas Detectors (continued)

Portable gas detector types

There are two primary types of portable gas detector:

- **Single gas** – devices that are designed to detect one gas
- **Multi-gas** – devices that can detect multiple gases. Variants usually range from 4 gases up to 6 gases and tend to employ various detection principles in one unit

When it comes to ongoing device operation and maintenance, portable detectors fall into two further groups:

- **Serviceable** – this means that the device is a long-term solution, requiring ongoing maintenance, which the operator can choose to carry out in-house or via a third party service provider
- **Disposable** – this means that the device is a short-term solution (2 or 3 year) and does not require any maintenance during its operational life. This type of device is often continuously operational from first activation until its expiry. ■

Operational modes of a portable gas detector

Portable detectors can draw air in (known as sampling) or they can allow air to diffuse into the sensor, depending on the application needs:

- **Diffusion:** This is the mode that the portable device will be in the majority of the time it is being used for personnel breathing zone monitoring. As an operator enters an area where a concentration of gas is located, the gas will need to reach the sensor and diffuse into it for the detector to “see” the gas
- **Sampling:** An integrated motorised pump or sample kit, which includes a hand aspirator, can allow a device to draw air towards the sensor. The ability to sample the air - either manually or using a motorised pump - is safety-critical when an area may contain hazards, because it allows an operator to check the air for gases before entering and breathing the air in.

The following picture shows two examples of BW Technologies by Honeywell’s portable solutions – a single gas disposable device and also a multi-gas detector. Products are shown at actual size. ■

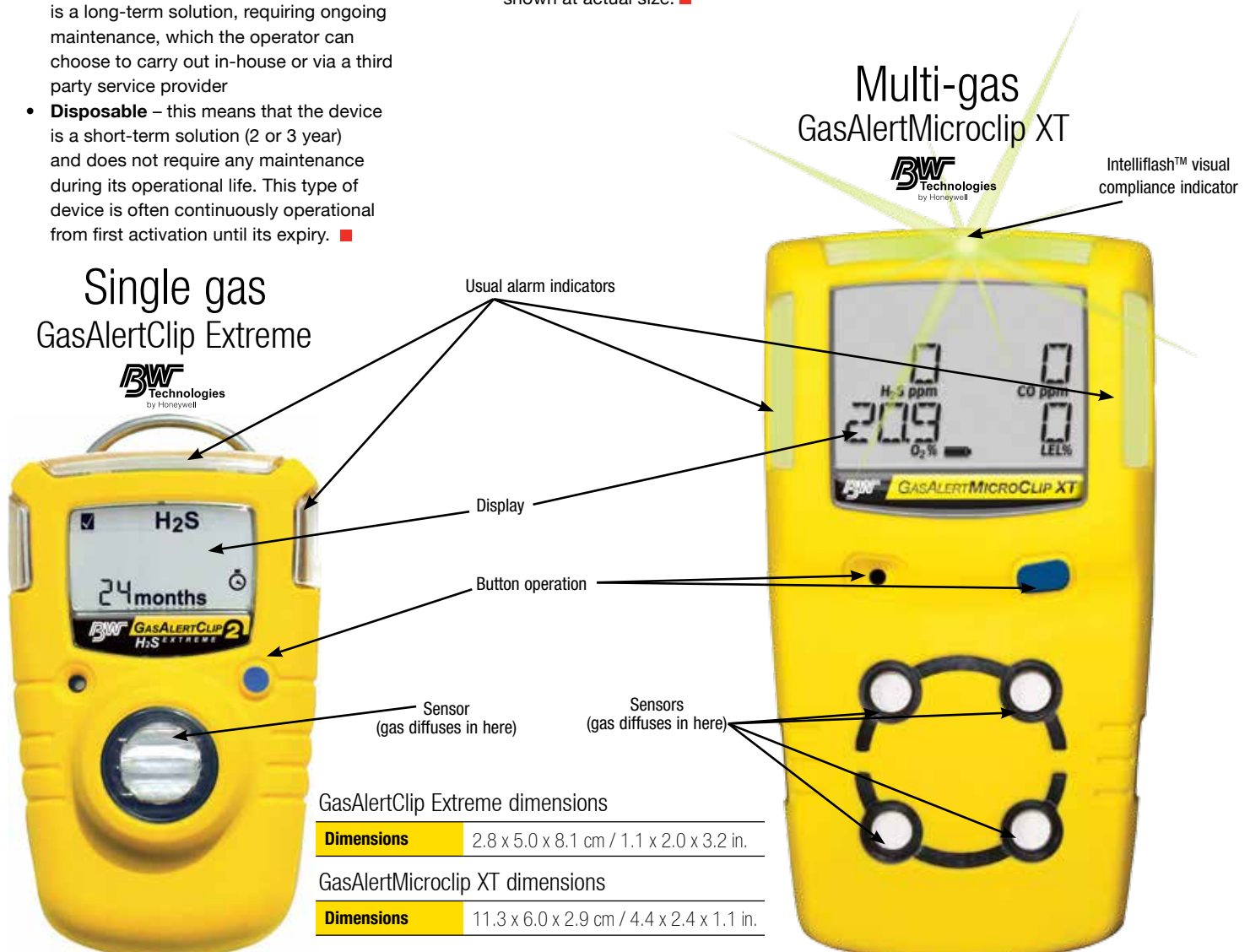

■ Portable Gas Detectors (continued)

Features and functionality

Due to the diversity of applications and the hazards that are contained within them, the specification for portable gas detectors varies considerably.

The key functionality/specification aspects a portable device delivers and its associated value is detailed in the table below:



Aspect	Description	Value
Display	The addition of a display allows the operator to see the monitoring results of the detector. Many devices feature a real-time display and this means that the device visually shows gas values to the operator as well as other operational icons.	Safety can be enhanced because an operator can see a rising gas value before the alarm is sounded. A display can also provide peace of mind to an operator, through the display of "correct operation" icons and aspects like the gases being detected and how many days until the next calibration. When it comes to disposable devices, a display can also advise of how many operational months are left.
Device protection (also known as Ingress Protection)	The Ingress Protection (IP) rating (<i>please see page 92 for more information</i>) and impact resistance of a device indicates its suitability in challenging environments where water, dust, dirt and other materials may be located.	A device that is impact resistant and capable of being submerged in water will provide a flexible monitoring solution that can adapt to many application needs on site. In fact, water treatment and offshore applications require this protection. It also helps to ensure the longevity of a device.
Button operation	Some devices (including those provided by Honeywell), use large, single button operation designed to provide simplified interaction. Other devices may feature multiple buttons.	Large, single button operation allows an operator to work with the device more easily and also means that he/she does not need to remove gloves to activate the buttons. This can save considerable time over product life.
Integrated datalogging	An integrated datalogging capability means that any event (such as an alarm), is automatically stored in the device and can be downloaded later and used for reporting purposes by a portable fleet manager. The amount of data that can be logged will vary from device to device.	Integrated automatic datalogging helps to simplify and assist time-effective event reporting. It is also important to remember that many insurers stipulate detailed reporting.
Battery performance	Battery type, run time and also charge time can vary considerably from device to device.	A high performance, quick charge battery can provide the flexibility to cover long shifts or multiple shifts without needing to be re-charged. A shorter charge cycle can also reduce the number of portables required on site and the power consumption required over product life to charge devices.
Sensor integration types	Some devices allow individual sensors to be added or removed, whilst others use an integrated sensor cartridge.	Both aspects have their merits: the former allows flexibility in terms of being able to update one sensor if needed, but keeping other sensors intact. Conversely, an integrated sensor cartridge provides a quick and simple means of replacement, thus reducing the time and cost of maintenance over product life.
Motorised sampling pump	A motorised pump allows a device to draw air from a potentially hazardous area without having to enter it. Some devices feature integrated motorised pumps, whilst others don't.	Applications like confined spaces need to be tested before they can be entered. Testing using a device that can switch between diffusion and sample mode can save time over using a manual sample kit, which needs to be fitted to the device. The flow of air is also regulated with a motorised pump.
Alarms	Most devices feature visual, audible and vibrational alarms to alert operators to hazards.	It's essential that a device can get attention – even in high noise locations – so the use of multiple alarm types helps to ensure that an alarm event is never missed. Honeywell's portable gas detectors feature ultra-bright, wide angled alarms that can be seen easily, supported by loud audible and vibrational alarms that are guaranteed to demand attention in any application.
Visual compliance indicators	Some devices, like those from BW Technologies by Honeywell, feature special visual indication LEDs that are automatically de-activated when the device is overdue for calibration or bump testing.	This aspect can improve site safety and assist considerably with fleet management activities because it makes non-compliant devices easier to spot, prompting operators to ensure their device is maintained in accordance with site standards.

Portable Gas Detectors (continued)

Accessories

Portable gas detectors come with a wide range of accessories, which fall into the following categories:

Accessories designed to secure portable devices:

It's essential a portable gas detector is always securely fastened within the breathing zone. Many jobs demand the use of both hands, and there are various options available that allow a unit to be securely fastened comfortably.

- Lanyards/neck straps in various lengths, which allow the operator to wear a portable securely around his/her neck
- Hard hat clip allowing the device to be secured to the side of a hard hat
- Harnesses securing the device to the chest or other area of the body



Accessories designed to protect devices

Although many units are designed to be "concussion proof" an accidental drop can cause damage which could either compromise the unit's ability to detect gas and alert to a danger or could limit the operational life of the unit and make ongoing maintenance difficult. Additional protection can be used when working in challenging locations.

- Concussion proof boot
- Carrying holster
- Vehicle attachment



Accessories designed to protect devices against water, dust and dirt ingress

Many applications requiring gas detection may be dirty, full of airborne particulates, dusts and water. If the unit is not properly protected, these elements can get into the device's sensor and prevent it being able to detect gas properly, which can be very dangerous. Additional protection can be provided by filters designed to prevent debris and water from getting into the unit and compromising its detection capabilities.

- Sensor protection filters (including hydrophobic and particulate)
- Water floatation aids



Accessories designed to facilitate air sampling

If a gas hazard could potentially be present in an area that an operator is planning on entering, the air should be sampled first, using a kit or pump that allows the air to be drawn. Entering an area without carrying out this test could result in death; especially when highly toxic gases could be present. Just one breath of 1000ppm of Hydrogen Sulphide is enough to kill.

- Manual hand aspirator
- Probe and flow tubing
- Test cap (allowing only sampled air to be drawn into the sensor)
- Pump module (a device that fits over the unit's sensors and allows air to be drawn)
- Honeywell produces integrated sampling kits and confined space entry kits for its full range of portable gas detection products



Accessories for power and charging

Sites can have varying shift lengths so it's important to choose the right power solutions that can meet requirements. Sometimes a number of operators may share a device, so there might not always be time to fully charge between shifts. Car charging kits and cradles provide easy charging on the move for operators who travel.

- Various battery options including Alkaline or Lithium batteries
- Rechargeable battery packs
- Vehicle charger adapters
- Cradles and accompanying chargers



Accessories for datalogging

When datalogging directly to a PC or laptop is required, USB-based readers provide a quick and simple means of downloading data. Multi-media cards also allow additional data to be stored and held on compatible devices.

- USB memory card readers
- Multimedia cards ■



■ Portable Gas Detectors (continued)



I Alarms and status indication

Alarm types

A portable gas detector can be configured to alarm in various conditions, so that it can alert operators to certain hazard states.

The purpose of an alarm is to indicate an impending danger before it becomes safety-critical or dangerous to health. Please see page 21 for detailed information on *Workplace Exposure Limits (WELs)*.

- **Short-term exposure limit (STEL)**
(15 min duration)
- **Long-term exposure limit (LTEL)**
(8hr duration)
- **Low level alarm:** This defines the low alarm set point
- **High level alarm:** This defines the high alarm set point

Most portable gas detectors feature three alarm types – audible, visual and vibrational – designed to alert the operator to an alarm event, even in high noise areas, or when the portable gas detector is attached somewhere that the visual alarms cannot be seen (such as fixed to a hard hat).

As previously mentioned, a portable unit can be used in two key ways; to monitor the breathing zone of an operator (diffusion mode) or to pre-check an area before an operator enters a location that could contain hazardous gases.

Portables are particularly important when operators are working in areas where toxic gases are present that they can be exposed to for limited amounts of time and in limited concentrations. STEL and LTEL alarm types provide this protection and alert the operator when maximum exposure levels are reached.

Value-added visual status indication

The range from BW Technologies by Honeywell also provides an additional value-added visual indicator that can enhance site safety considerably. IntelliFlash™, provides a clearly visible green LED indicator to show device compliance to site-standards. When a device is not maintained correctly, the IntelliFlash™ indicator will switch off, highlighting device non-compliance to the operator and also the fleet manager. ■



■ Portable Gas Detectors (continued)

Typical applications for portable gas detectors

Confined spaces

Confined spaces can be found in a myriad of industries and applications and are one of the most prevalent applications for portable gas detection. A confined space is defined as being:

1. A space that has a limited or a restricted means of entry/exit
2. A space that is large enough for an operator to enter and perform certain tasks
3. A space that is not designed for constant worker occupancy
4. A space where ventilation may be poor, allowing gases to build up

There are two types of confined space:

- A normal confined space (no permit required)
- A permit-required confined space

In addition to the criteria defining a standard confined space, a permit-required confined space will also have one or more of the following attributes:

- Is known to contain (or has contained) a hazardous atmosphere
- Is known to contain a recognised safety hazard
- Is known to contain material with the potential for engulfment
- The design of the space itself has the potential to trap or asphyxiate the operator entering the space

Confined space types

Confined spaces can be found in a wide diversity of industries and applications. Common types include:

- Shafts
- Trenches
- Sewers and manholes
- Pits
- Boilers
- Tunnels
- Tanks
- Vessels (including marine vessel tanks)
- Pipelines
- Containers



■ Portable Gas Detectors (continued)

Gas hazards in confined spaces

Depending on the application, numerous gases can be found in confined spaces. The atmosphere may contain a mix of flammable, toxic and Oxygen depletion gas hazard risks. The typical gases that may be encountered include but are not limited to:

- Oxygen
- Carbon Monoxide
- Hydrogen Sulphide
- Methane
- Ammonia
- Chlorine
- Nitrogen Dioxide
- Sulphur Dioxide
- Hydrogen Cyanide

Due to the dangerous nature of confined spaces, a two-step portable monitoring procedure needs to be employed. The area must first be tested and then continuous monitoring of the space must take place for the duration that the operator is working inside it.

Confined space stratified testing (Step 1)

Before entering the confined space, a portable gas detector combined with confined space entry accessories such as manual aspirator kits (if an integrated automatic sampling pump is not available), and a sample hose with probe should be used. This will allow the operator to be located outside of the confined space but be able to draw air from inside it so it can be tested by the portable gas detector.

It's essential to sample the air at various levels from floor to ceiling - heavier-than-air gases will collect in low lying areas whilst lighter-than-air gases will collect at the highest levels.

- Pay special attention to uneven floors or ceilings that could allow high concentrations of gas to form
- Always sample at a distance from the opening; air can intrude into the confined space resulting in false readings and inaccurate Oxygen level data
- Once this full test has been conducted and no hazards have been found, a worker can enter the confined space



GasAlertQuattro



GasAlertMax XT II



GasAlertMicro 5



GasAlertMicroClip XT



Impact Pro



PHD6™

Subsequent continuous monitoring (Step 2)

Even if no dangers are identified whilst performing the stratified testing, it is essential to monitor the confined space continuously to ensure the atmosphere remains safe. Always remember that the atmosphere can change quickly in a confined space.

- Use a 4-gas simultaneous portable gas monitoring solution - 5 or 6 gas devices can be used for additional hazard coverage including Photo Ionised Detection (PID) sensors for the detection of low-level Volatile Organic Compounds (VOCs). This makes solutions like GasAlertMicro 5 from BW Technologies by Honeywell and PHD6™ from Honeywell flexible solutions for all confined space types
- Choose a device with a robust crocodile clip/harness so hands are free to undertake the necessary work. Make sure the portable gas detector is always situated within the breathing zone (no more than 25 cm/10 inches from the mouth/nose)

- "Daisy chain" portable units together, allowing one worker to be inside the confined space, whilst a second is monitoring the entrant's data from a safe location on a second unit. This technique is particularly useful in the most potentially dangerous confined spaces

Monitoring confined space applications

4-gas portable devices like Impact Pro from Honeywell Analytics and GasAlertQuattro and GasAlertMicroClip XT from BW Technologies by Honeywell can meet the needs of most confined spaces, but additional protection (including VOC monitoring) can be delivered by a 5-gas device such as GasAlertMicro 5 from BW Technologies by Honeywell or a 6-gas device like PHD6™ from Honeywell.

■ Portable Gas Detectors (continued)



GasAlertQuattro



Impact Pro



Marine

Marine gas hazards are numerous. Liquid gas, fuel, chemicals and other fossil fuels harbor a risk of explosion and there is a danger of suffocation from Oxygen displacement when using Nitrogen or other gases for inerting.

It is also important to be aware of dangers presented by toxic gases such as Carbon Monoxide from exhaust fumes, or Hydrogen Sulphide from the decomposition of organic compounds found in the briny water inside ballast tanks.

Due to the mobility of ships, portable gas detection is used predominantly as it affords flexibility and mobility.

Marine applications requiring portable gas detection

Portable multi-gas monitoring solutions are an essential part of marine-based PPE, providing operator protection in a variety of applications and environments:

- Protection whilst carrying out clearance measurements of tanks and cargo bays
- Pre-entry check and subsequent monitoring for confined spaces
- Inerting and purging
- Leak detection

- Confined space entry including:
 - Cargo compressor room
 - Electric motor room
 - Cargo-control room (unless classified as gas-safe)
 - Enclosed spaces such as hold spaces and inter-barrier spaces (with the exception of hold spaces containing Type 'C' cargo tanks)
- Airlocks
- Burner platform vent hoods and engine room gas supply pipelines
- Hot work jobs

Gas hazards in marine applications

- Flammables (various flammable fuels are shipped via tanker including Liquid Petroleum Gas and Liquid Natural Gas)
- Carbon Monoxide
- Hydrogen Sulphide
- Oxygen depletion (from inerting via Nitrogen)

Marine regulations:

The marine industry is highly regulated due to the potential hazards that can be found, and legislation includes guidance on specific certifications that are required so portable devices can be used within marine applications:

- Within European Union (EU) Member States portable gas detectors need to be certified to the Marine Equipment Directive (MED)
- In some ports and countries across the World it is recommended that portable gas detectors are certified to the American Bureau of Shipping (ABS)

Monitoring marine applications

This makes devices like GasAlertQuattro from BW Technologies by Honeywell and Impact Pro from Honeywell Analytics, which both feature MED and ABS approval, ideal for marine application monitoring.

■ Portable Gas Detectors (continued)

Water treatment

Water treatment is a large industry comprising many processes and aspects from the production and distribution of clean water to the collection, treatment and disposal of waste such as sewage.

Aside from the domestic provision and treatment of clean water, industries such as chemical manufacture, steel and food processing may often have their own water treatment plants.

Water treatment applications requiring portable gas detection

- **Purification plant monitoring**
 - Various chemicals including Chlorine, Sulphur Dioxide and Ammonia are used to remove impurities from water. It's essential to use robust, multi-gas portable detectors during the purification process and also when entering or working in dosing rooms where chemicals like Ammonia may be used to "sweeten" the water. Carbon Dioxide may also be present, because it is used for PH correction to lower water acidity.
- **Power plant monitoring**
 - Water plants tend to feature their own power generation for the purposes of electricity generation and pumping. This creates the need for fuels like diesel and gas, creating the risk of flammable gas hazards from the fuel itself and also the exhaust fumes (where Carbon Dioxide is a by-product of combustion). A portable solution with %LEL flammable gas monitoring is essential in this application.
- **Waste water plant intake and penstocks**
 - As waste water enters the treatment plant, penstocks (a form of gate) halt/allow the flow of water into the plant. Flammable risks may be encountered because waste water may contain Hydrocarbons from spillages etc, so portable gas detection is often used to perform regular checks of water coming into the plant.

- **Sewerage digester plant**
 - The process of decomposition is accelerated in digesters, allowing filtered sludge to be converted into a safe form for disposal. Depending on the origin of the waste, digesters will promote either aerobic (in the presence of Oxygen) or anaerobic (without the presence of Oxygen) decomposition. Both Methane and Carbon Dioxide are by-products of these decomposition processes, creating the need for portable gas detection when working near digesters.

Gas hazards in water treatment applications

- Chlorine
- Sulphur Dioxide
- Carbon Dioxide
- Ammonia Flammable gases (Liquid Natural Gas and Liquid Petroleum Gas)
- Nitrogen Dioxide
- Oxygen

Water treatment regulations:

There are a variety of standards (international and national) governing the monitoring of toxic, flammable and corrosive substances used in the water industry. For detailed information on the compliance requirements for EU and Non-EU countries, please visit: http://ec.europa.eu/environment/water/water-framework/index_en.html and http://osha.europa.eu/en/good_practice/topics/dangerous_substances/oell/nomembers.stm/members.stm.

Monitoring water treatment applications

GasAlertQuattro, GasAlertMicroClip XT and GasAlertMicro 5 from BW Technologies by Honeywell and Impact Pro from Honeywell Analytics ideally meet the monitoring requirements of water treatment applications.



GasAlertQuattro



GasAlertMicro 5



GasAlertMicroClip XT



Impact Pro



■ Portable Gas Detectors (continued)



Military

Most militaries – regardless of the country they are located in – need to use gasoline, gas oil or Kerosene to power their terrain vehicles, ships, submarines, aircraft and helicopters. Military fuel services contain numerous applications that require portable gas detection.

Militaries use dedicated fuel supply departments to manage and dispatch fuel to all army operatives and in reality, the World's militaries are one of the biggest volume users of these fuels.

Military applications requiring portable gas detection

- Storage tanks
 - Storage tank cleaning
 - Storage tank inspections (in particular ballasts where Hydrogen Sulphide and Carbon Monoxide may build up)

- Pumping
- Storage tank filling
- Transportation
- Distribution
- All works linked fuel management
- Confined space entry and inspection
- Aircraft tank inspection
- Submarine (please see below for more detailed information)
- Ship monitoring (please see bottom right for more detailed information)
- Maintenance of engines and pumps

In addition to the applications detailed above, particular care and attention should be given to the following marine-based military applications:

- **Submarine monitoring:** In a submarine the air is controlled by a dedicated analyser to ensure that the atmosphere is consistent and dangerous levels of Carbon Monoxide and Carbon Dioxide are not allowed to build up.

Hydrogen Sulphide is a real risk due to the fact that the batteries that power submarines may produce Hydrogen. Submarines may also feature flammable gases and other gases like Volatile Organic Compounds (VOCs), so it's important to monitor for these too. The septic tank onboard a submarine will also pose a risk for Hydrogen Sulphide.

Special considerations whilst undertaking submarine gas monitoring include the avoidance of using Carbon Monoxide sensors because there can be cross-sensitivity issues between Carbon Monoxide and Hydrogen Sulphide.

- **Ship Monitoring:** Hydrogen Sulphide is a risk near septic tanks and also where there are confined spaces so it's essential to use a multi-gas portable when working in the vicinity of these locations.

Carbon Monoxide poses a risk in engine rooms, kitchens and can also be found in

■ Portable Gas Detectors (continued)



GasAlertMicro 5



PHD6™



Bespoke carry case

confined spaces. Ballasts can pose a danger of Oxygen depletion, as can confined spaces. It's important to remember that Iron may be oxidised by Oxygen in ambient air, creating Iron Oxide (also known as rust). This means that Oxygen detection may also be required because the creation of rust can deplete Oxygen levels in the air creating deficiency risks. Both VOCs and flammable gas risks are likely in engine rooms, fuel storage locations and also where fuel is being used, replenished or re-located.

Gas hazards in military applications

- Flammable gases (various blends of Aviation Kerosene, Diesel and Gasoline)
- Carbon Monoxide
- Carbon Dioxide
- Hydrogen Sulphide
- Volatile Organic Compounds
- Oxygen

Monitoring military fuels

Robust multi-gas solutions that offer sensitive detection combined with useability are ideal for military fuel applications.

Historically, many military applications would specify 2, 3 or 4-gas portables (for the detection of flammables, Oxygen depletion, Hydrogen Sulphide and Carbon Monoxide), to monitor for fuel supply-related gas risks. In reality, a 5 or a 6-gas device is actually preferable, as it delivers total coverage against all gas hazards that can be found in fuel supply applications.

Devices like GasAlertMicro 5 PID, from BW Technologies by Honeywell, provides a more comprehensive and effective monitoring solution for military fuel supply, with the ability to detect all toxic and exotic gas risks that may be encountered. A military-specific version of GasAlertMicro 5 PID is available (including an automatic device test station and various additional accessories).

■ Portable Gas Detectors (continued)

Hazardous Material (HAZMAT) emergency response

Accidents and releases involving Hazardous Materials (HAZMAT) can occur in a variety of locations including industry, on the roads or at sea during the transportation of materials.

Depending on the nature of the release itself, various emergency response teams may be involved in the isolation and clean-up of hazardous materials, including fire brigades.

Many chemicals and compounds are classified as HAZMAT, due to their associated risk and potential detrimental effect to organic life and the environment. This makes quick, enhanced-safety HAZMAT response and clean-up essential to minimise the impact of dangerous solids, liquids and gases and portable gas detection forms a key part of the Personal Protective Equipment (PPE) used

by HAZMAT responders. Response teams can include various authorities, agencies and groups including:

- Fire departments
- Police
- Spill response teams
- Air transport services

HAZMAT applications requiring portable gas detection

It's important to remember that incidents involving HAZMAT can occur anywhere, but the following examples are likely applications.

- Chemical spillages on highways
- Chemical spillages at sea
- Accidental releases at industrial plants
- Chemical releases into water ways
- Releases affecting commercial buildings or facilities
- Pipeline infrastructure issues resulting in spills

Gas hazards in HAZMAT applications

- Flammable gases including Liquid Natural Gas, Liquid Petroleum Gas, Crude and Methane
- Carbon Monoxide
- Carbon Dioxide
- Hydrogen Sulphide
- Sulphur Dioxide
- Chlorine
- Nitric Oxide
- Nitrogen Dioxide
- Ammonia
- Phosphine
- Hydrogen Cyanide
- Various Volatile Organic Compounds
- Oxygen

Monitoring HAZMAT response applications

Emergency response teams may hold a stock of various devices that can be used during specific incidents, owing to the large diversity of HAZMAT classified materials. 4, 5 or 6-gas portable detectors are ideal for emergency response because of their flexibility. Devices like GasAlertQuattro (4-gas portable), GasAlertMicroClip XT (4-gas portable) and GasAlertMicro 5 PID (5-gas portable) from BW Technologies by Honeywell, Impact Pro (4-gas portable) from Honeywell Analytics and PHD6™ (6-gas) from Honeywell are all ideal solutions for HAZMAT response purposes.



GasAlertQuattro



GasAlertMicro 5

■ Portable Gas Detectors (continued)



Oil and gas (offshore and onshore)

Safety-enhanced portable gas detection forms an integral part of mandatory Personal Protective Equipment (PPE) required for these challenging environments, owing to the abundance of potentially explosive atmospheres that can build up during crude extraction, transportation and subsequent refinement.

Floating Production Storage and Offloading (FPSO) and refineries are classified as "Top Tier" hazard installations and part of the risk reduction requirement includes the use of portable gas detectors.

Offshore applications are often hard to reach and accidents may require air rescue and air emergency response, creating the need for enhanced safety. Numerous flammable and toxic gas hazards exist, including Oxygen depletion risks from inerting with Nitrogen. These locations may also be subject to severe adverse weather and sea spray, creating the need for the most robust solutions with enhanced Ingress Protection (IP).

Oil and gas applications requiring portable gas detection

A wide variety of applications require portable gas detection, but best practice guidance is that operators should always use a portable device to monitor for Hydrogen Sulphide.

- Confined space testing and entry
- Inerting of storage tanks
- Crude extraction from the sea bed
- When working near storage tank farms
- Loading and offloading flammable liquid/materials for transportation
- Working near refinery processes such as Hydrocarbon cracking
- During permit to work testing and when working in permit controlled areas

Gas hazards in oil and gas applications

- Flammable gases including Liquid Natural Gas, Liquid Petroleum Gas, Crude and Methane
- Carbon Monoxide
- Hydrogen Sulphide
- Carbon Dioxide
- Sulphur Dioxide
- Ammonia
- Nitrogen Dioxide
- Oxygen

Monitoring oil and gas applications

4-gas portable detectors with IP 66/67 like Impact Pro from Honeywell Analytics, GasAlertQuattro and GasAlertMicroClip XT from BW Technologies by Honeywell and MultiPro™ from Honeywell provide the ideal monitoring solutions for these applications. ■

The aforementioned examples represent some of the key applications for portable gas detection but if you are interested to learn about additional applications, please visit: www.gasmonitors.com for application notes relating to portable products and www.honeywellanalytics.com for application notes relating to fixed products.

■ Portable Gas Detectors (continued)

PID Information

Measuring Solvent, fuel and VOC vapours in the workplace environment

Solvent, fuel and many other Volatile Organic Compound (VOCs) vapours are pervasively common in many workplace environments. Most have surprisingly low occupational exposure limits. For most VOCs, long before you reach a concentration sufficient to register on a combustible gas indicator, you will have easily exceeded the toxic exposure limits for the contaminant.

A wide range of techniques and equipment are available for measuring the concentrations of these contaminants in air. However, PID equipped instruments are generally the best choice for measurement of VOCs at exposure limit concentrations. Whatever type of instrument is used to measure these hazards, it is essential that the equipment is used properly and the results are correctly interpreted.

(VOCs) are organic compounds characterised by their tendency to evaporate easily at room temperature. Familiar substances containing VOCs include solvents, paint thinner and nail polish remover, as well as the vapours associated with fuels such as gasoline, diesel, heating oil, kerosene and jet fuel. The category also includes many specific toxic substances such as Benzene, Butadiene, Hexane, Toluene, Xylene, and many others. Increased awareness of the toxicity of these common contaminants has led to lowered exposure limits and increased requirements for direct measurement of these substances at their exposure limit concentrations. Photoionisation detector equipped instruments are increasingly being used as the detection technique of choice in these applications.

VOCs present multiple potential threats in the workplace environment. Many VOC

vapours are heavier than air, and can act to displace the atmosphere in an enclosed environment or confined space. Oxygen deficiency is a leading cause of injury and death in confined space accidents. The accident reports contain many examples of fatal accidents caused by Oxygen deficiencies due to displacement by VOC vapours.

Most VOC vapours are flammable at surprisingly low concentrations. For instance, the Lower Explosive Limit (LEL) concentrations for Toluene and Hexane are only 1.1% (11,000 PPM). By comparison,

it takes 5% volume Methane (50,000 PPM) to achieve an ignitable concentration in air. Because most VOCs produce flammable vapours, in the past, the tendency has been to measure them by means of combustible gas measuring instruments. Combustible gas reading instruments usually provide readings in percent LEL increments, where 100% LEL indicates a fully ignitable concentration of gas. Combustible gas instrument alarms are usually set to go off if the concentration exceeds 5% or 10% LEL. Unfortunately, most VOC vapours are also toxic, with Occupational Exposure Limit (OEL) values much lower than the 5% or 10% LEL hazardous condition threshold for combustible gas. The toxic exposure limits are exceeded long before the LEL alarm concentration is reached.

(OELs) are designed to protect workers against the health effects of exposure to hazardous substances. The OEL is the maximum concentration of an airborne contaminant to which an unprotected worker may be exposed during the course of workplace activities. In the United Kingdom, OELs are listed in the EH40 Maximum Exposure Limits and Occupational Exposure Standards. EH40 currently lists exposure limits for about 500 substances. These OELs are enforceable. Unprotected workers may not be exposed to a concentration of any listed substance that exceeds the limit. It's up to the employer to determine that these exposure limits are not exceeded. In many cases, a direct reading gas detector is the primary means used to ensure that the OEL has not been exceeded. OELs are generally defined in two ways, by means of a Long Term Exposure Limit (LTEL) calculated as an 8-hour Time Weighted Average (TWA) and/or a Short Term Exposure Limit (STEL) that represents the maximum allowable concentration over a shorter period of time - usually a 10 or 15 minute period. Exposure limits for gases and vapours are usually expressed in parts per million (PPM) or mg/m³ increments. The TWA concept



■ Portable Gas Detectors (continued)



is based on a simple average of worker exposure during an 8-hour day. The TWA concept permits excursions above the TWA limit only as long as they do not exceed the STEL or ceiling and are compensated by equivalent excursions below the limit. For VOC vapours without a STEL, depending on the jurisdiction, the generally suggested approach is to limit excursions above the TWA to a maximum of two to five times the 8-hour TWA OEL, averaged over a 10 to 15 minute period. Most direct reading instruments include at least three separate alarms for each type of toxic gas measured. Typically, a toxic gas instrument will include an 8-hour TWA alarm, a STEL alarm and an instantaneous Ceiling alarm, (sometimes called the “Peak” alarm), that is activated immediately whenever this concentration is exceeded. Most gas detector manufacturers set their initial instantaneous “Peak” alarm to the 8-hour TWA limit. This is a very conservative approach. Although it is legally permissible to spend an entire 8-hour day at this concentration, most direct reading VOC instruments are set to go into alarm the moment the instantaneous concentration exceeds the TWA limit. Instrument users, of course, are free to modify factory alarm settings to meet the demands of their specific monitoring programs. Airborne toxic substances typically are classified on the basis of their ability to produce physiological

effects on exposed workers. Toxic substances tend to produce symptoms in two time frames: acute and chronic. Hydrogen Sulphide (H_2S) is a good example of an acutely toxic substance that is immediately lethal at relatively low concentrations. Exposure to 1,000 PPM produces rapid paralysis of the respiratory system, cardiac arrest, and death within minutes. Carbon Monoxide (CO) also can act rapidly at high concentrations (1,000 PPM) although not as rapidly as Hydrogen Sulphide.

While some VOCs are acutely toxic at low concentrations, most are chronically toxic, with symptoms that may not become fully manifested for years. Exposure can be via skin or eye contact with liquid or aerosol droplets, or via inhalation of VOC vapours. Inhalation can cause respiratory tract irritation (acute or chronic) as well as effects on the nervous system such as dizziness, headaches and other long-term neurological symptoms. Long-term neurological symptoms can include diminished cognition, memory, reaction time, and hand-eye and foot-eye coordination, as well as balance and gait disturbances. Exposure can also lead to mood disorders, with depression, irritability, and fatigue being common symptoms. Peripheral neurotoxicity effects include tremors, and diminished fine and gross

motor movements. VOCs have also been implicated in kidney damage and immunological problems, including increased cancer rates. Benzene, a notoriously toxic VOC found in gasoline, diesel, jet fuel and other chemical products, has been linked to chemically induced leukemia, aplastic anaemia and multiple myeloma (a cancer of the lymphatic system). There is good reason that the OEL's for VOC vapours are as low as they are. Unfortunately, because of the chronic or long-term nature of the physiological effects of exposure, the tendency in the past has been to overlook their potential presence in the workplace environment at OEL concentrations.

Real-time measurement techniques for VOC vapours

Commonly used techniques used to measure VOC vapours include colorimetric detector tubes, passive (diffusion) badge dosimeters, sorbent tube sampling systems, combustible gas monitors that use catalytic “Hot Bead” combustible gas sensors to detect vapours in percent LEL or PPM ranges, photoionisation detectors (PIDs), flame ionisation detectors (FIDs) and infrared spectra-photometers.

■ Portable Gas Detectors (continued)

All of these techniques are useful, or even mandatory in specific monitoring applications. However, the balance of this article will deal with the most widely used types of portable instruments used for VOC measurement in industrial safety applications: compact multi-sensor instruments equipped with Oxygen, LEL combustible, electrochemical toxic and miniaturised photoionisation detectors (PIDs). Portable gas detectors can be equipped with a number of different types of sensors. The type of sensor used is a function of the specific substance or class of contaminant being measured. Many toxic contaminants can be measured by means of substance-specific electrochemical sensors. Direct reading sensors are available

for Hydrogen Sulphide, Carbon Monoxide, Chlorine, Sulphide Dioxide, Ammonia, Phosphine, Hydrogen, Hydrogen Cyanide, Nitrogen Dioxide, Nitric Oxide, Chlorine Dioxide, Ethylene Dioxide, Ozone and others.

Although some of these sensors are cross-sensitive to other substances, there is very little ambiguity when it comes to interpreting readings. When you are interested in Hydrogen Sulphide, you use a Hydrogen Sulphide sensor. When you are interested in Phosphine, you use a Phosphine sensor. In many cases, however, a substance-specific sensor may not be available.

VOCs are quite detectable, but usually only by means of broad-range sensors. Broad-range sensors provide an overall reading for a general class or group of chemically related contaminants. They cannot distinguish between the different contaminants they are able to detect. They provide a single aggregate reading for all of the detectable substances present at any moment.

The most widely used technique for the measurement of combustible gases and VOCs continues to be the use of a hot-bead pellistor type combustible gas sensor. Pellistor sensors detect gas by oxidising the gas on an active bead located within the sensor. Oxidisation of the gas causes heating of the active bead. The heating is proportional to the amount of gas present in the atmosphere being monitored, and is used as the basis for the instrument reading. Most combustible gas reading instruments display readings in % LEL increments, with a full range of 0 - 100% LEL. Typically these sensors are used to provide a hazardous condition threshold alarm set to 5% or 10% of the LEL concentration of the gases or vapours being measured. Readings are usually displayed in increments of + 1% LEL.

Hot-bead pellistor combustible gas sensors are unable to differentiate between different combustible gases. Hot-bead pellistor sensors that display readings in + 1% LEL increments are excellent for gases and vapours that are primarily or only of interest from the standpoint of their flammability. Many combustible gases, such as Methane, do not have a permissible exposure limit. For these gases using a sensor that expresses readings in percent LEL, increments is an excellent approach. But many other combustible vapours fall into a different category. Although VOC vapours may be measurable by means of a hot-bead sensor, they may also have an OEL that requires taking action at a much lower concentration.

Hexane provides a good example. Most internationally recognised standards, such as the Federal Republic of Germany Maximum Concentration Value (MAK), the American Conference of Governmental Hygienists (ACGIH®) Threshold Limit Value (TLV®) and the United States National Institute of Occupational Safety and Health (NIOSH) Recommended Exposure Limit (REL) reference an 8-hour TWA for Hexane of 50 PPM. In the United Kingdom, the OEL for



■ Portable Gas Detectors (continued)

Hexane is even more conservative.

In the EU, the Long Term Exposure Limit (LTEL) for Hexane is a maximum of only 20 PPM calculated as an 8-hour TWA.

The LEL concentration for Hexane is 1.1%. Below 1.1% volume Hexane the concentration of Hexane vapour to air is too low to form an ignitable mixture. Assuming the combustible sensor alarm is set at 10% LEL, with a properly calibrated combustible gas reading instrument, it would take a concentration of 10% of 1.1% = 0.11% volume Hexane to trigger an alarm. Since 1% volume = 10,000 parts-per-million (PPM), every 1% LEL increment for Hexane is equivalent to 110 PPM. It would therefore take a concentration of 1,100 PPM Hexane to trigger an alarm set to the standard 10% LEL hazardous condition threshold. Even if instruments are set to alarm at 5% LEL, it would require a concentration of 550 PPM to trigger the alarm.

Using a combustible gas monitor to measure VOCs presents a number of other potential problems. To begin with, most combustible sensors have poor sensitivity to the large molecules found in fuels, solvents and other VOCs, with flashpoint temperatures higher than 38°C (100°F). But even when the span sensitivity of a properly calibrated instrument has been increased sufficiently to make up for inherently lower sensitivity, an instrument that provides readings incremented in 1.0% LEL steps cannot resolve changes in concentration smaller than ± 1.0% of the LEL concentration of the substance being measured. Because percent LEL detectors are poor indicators for the presence of many VOCs, lack of a reading is not necessarily proof of the absence of hazard.

Reliance on hot-bead type LEL sensors for measurement of VOC vapours means in many cases that the OEL, REL or TLV® is exceeded long before the concentration of vapour is sufficient to trigger the combustible hazardous condition threshold alarm. When toxic VOCs are potentially present it is necessary to use additional or different detection techniques that are better suited for direct measurement of VOCs at PPM toxic exposure limit concentrations. Photoionisation detectors are becoming increasingly popular for this application.

It should be noted that other combustible gases and vapours may be present at the same time as toxic VOCs.

Although catalytic-bead sensors may have limitations with concern to the measurement of toxic VOCs at exposure limit concentrations, they are by far the most widely used and dependable method for measuring Methane and other combustible gases and vapours with smaller, lighter molecules.

Increasing concern with the toxicity of VOCs has led to a number of newly revised exposure limits, including the TLVs® for diesel vapour, kerosene and gasoline. Because the safety procedures for many international corporations are tied to the most conservative published standard, these new TLVs® have been receiving a lot of attention around the World. The TLV® for diesel vapour adopted in 2002 has proven to be particularly problematic, and has led to the revision of numerous oil industry, maritime, and military health and safety monitoring programmes. The ACGIH TLV® specifies an 8-hour TWA for total diesel Hydrocarbons (vapour and aerosol) of 100 mg/m³. This is equivalent to approximately 15 parts-per-million diesel vapour. For diesel vapour, 1% LEL is equivalent to 60 PPM. Even if the instrument is properly calibrated for the detection of diesel - which is not possible for many designs - a reading of only 1% LEL would exceed the TLV® for diesel by 600 percent!

It goes beyond the scope of this article to argue how long it might be permissible to remain at 5% or 10% LEL without actually exceeding the 8-hour TWA or STEL. What is most striking about the list is how few VOCs have 8-hour TWA exposure limits higher than 5% LEL. None of the VOCs on the list have exposure limits higher than 10% LEL.

Using Photoionisation detectors to measure VOCs

Photoionisation detectors use high-energy ultraviolet light from a lamp housed within the detector as a source of energy used to remove an electron from neutrally charged VOC molecules, producing a flow of electrical current proportional to the concentration of contaminant. The amount of energy needed to remove an electron from the target molecule is called the Ionisation Potential (IP) for that substance. The larger the molecule, or the more double or triple bonds the

molecule contains, the lower the IP. Thus, in general, the larger the molecule, the easier it is to detect! This is exactly the opposite of the performance characteristics of the catalytic hot-bead type combustible sensor.

Photoionisation detectors are easily able to provide readings at or below the OEL or TLV® for all of the VOCs listed in Table 1, including diesel. The best approach to VOC measurement is often a multi-sensor instrument equipped with both LEL and PID sensors.

Multi-sensor detectors with PIDs

Catalytic hot-bead combustible sensors and photoionisation detectors represent complementary, not competing detection techniques. Catalytic hot-bead sensors are excellent for the measurement of Methane, Propane, and other common combustible gases that are not detectable by means of a PID. On the other hand, PIDs can detect large VOC and Hydrocarbon molecules that are effectively undetectable by hot-bead sensors, even when they are operable in PPM measurement ranges.

The best approach to VOC measurement in many cases is to use a multi-sensor instrument capable of measuring all the atmospheric hazards that may be potentially present. Having a single instrument equipped with multiple sensors means no condition is accidentally overlooked. ■

■ Portable Gas Detectors (continued)

Maintaining portable gas detectors

Both field serviceable and disposable portable gas detectors will require ongoing maintenance and care throughout their operational lives, although requirements are greatly reduced for disposable units. In general, there are three core activities that will need to be undertaken:

- **Functional device testing:** This quick test (also known as bump testing) is carried out to ensure that a portable gas detector responds correctly, i.e. goes into alarm in the presence of a known gas concentration. It is the only way of knowing a portable detector is working correctly and for this reason, best-practice recommendation is to carry out a daily bump test (please see *How to perform a bump test* on page 73 for detailed information).
 - Bump testing is applicable to both field serviceable devices and disposable portable gas detectors
- **Calibration:** A calibration is usually carried out twice yearly (although it may be undertaken more or less frequently in specific applications). This procedure is designed to ensure that a portable gas detector's readings are truly representative of actual gas concentrations in the atmosphere. This is particularly important when dangerous gases like Hydrogen Sulphide may be present, because just 1,000 PPM of this gas is enough to kill in a single breath, therefore incorrect readings could cause severe injury or even death.
 - This activity is applicable to field serviceable devices only
- **Sensor replacement:** Sensors have a defined expiry and must be replaced after this period runs out. The average life of sensors is approximately 2-3 years but it is worth remembering that sensors may need to be replaced more frequently when "known poisons" are present, e.g. Silicone poisoning catalytic bead flammable detection sensors. Depending on the type of device, sensors may be replaced individually or as part of an integrated cartridge (as used by devices like the Impact range from Honeywell Analytics).
 - This activity is applicable to field serviceable devices only
- **Datalogging:** Although it is not considered maintenance, datalogging is often legislatively driven or imposed by insurance companies and involves the logging and documenting of portable gas detector readings; especially when alarm events occur.
 - This activity is applicable to both field serviceable devices and disposable portable gas detectors



■ Portable Gas Detectors (continued)

Reducing the cost of device testing

When it comes to device bump testing and datalogging, automatic test and datalogging stations like those produced by Honeywell can greatly reduce the cost and time associated with ongoing device care. In fact, total labour and cost savings can be reduced by as much as 40-60% (dependent on the application and site-standards). A test and datalogging solution from Honeywell can add the following value:

- Minimise training by providing an intuitive, single-button operation solution
- Reduce bump testing time by up to 80% (when compared with a manual method)
- Controls all gas concentrations, preventing too much gas being used, thus potentially reducing test gas costs
- Datalogging with a single button press (no need for PCs)
- No need for additional accessories such as gas bottles, tubing, regulators etc



MicroDock II



Enforcer



IQ6 Docking Station



How to perform a manual bump test

If a test station is not desired, operators can carry out bump testing manually in the following way, using a portable unit and test kit accessories:

- Attach one end of the hose to the regulator of the gas cylinder and the other end to the bump test and calibration cap
- Then attach the bump test and calibration cap to the device
- Apply a short 3 second blast of gas to the device
- The unit should go into alarm. If the device fails to alarm, it will need to be calibrated
- Close the regulator and remove the calibration cap from the device. The unit will continue to alarm until the gas clears from the sensors
- The hose can then be disconnected from the calibration cap and stored in a safe, contaminant-free location

Many devices today, including those built by Honeywell, are optimised to deliver not only user-friendly operation but fail-safe reminders that ensure important maintenance needs are undertaken when required. For example,

BW Technologies by Honeywell's range of portable gas detectors remind of aspects like a "need to bump test or calibrate", followed by "forced bump testing" or "forced calibration", which prevents the device from being used until the necessary activity has been performed. These aspects can be factory-set in order to meet specific site standards, i.e. no more than 180 days between calibrations. Such aspects can be further enhanced by BW Technologies by Honeywell's IntelliFlash™ technology (please see *Value-added visual status indication* on page 59 for detailed information on IntelliFlash™ technology).

What drives device maintenance?

It's important to remember that portable devices are considered safety-critical and this means that they are designed and maintained in accordance with specific legislated directives and standards. With safety-critical products and processes, risk potential is mitigated wherever possible. There are legislated requirements to check devices (bump test) and calibrate them, depending on the application. This requirement explains the long period of operation that

a disposable product can have (with no need for calibration) over a field device. In reality, both are designed to the same high standards, and the calibration of the field device is not attributed to any difference in its constituent parts, but driven by compliance and mitigating the risk that the device may drift and not be representative of true readings. With this in mind, many hazardous applications are not legislatively allowed to use disposable units.

It is essential to take a holistic approach when considering portable gas detection and a suitable device will depend upon not only specification and site needs but also legislative requirements. ■



■ Portable Gas Detectors (continued)

Portable gas detection from Honeywell

Honeywell produces a wide variety of portable devices designed to meet the application monitoring needs of diverse industries; from low-cost, disposable compliance units to functionality-rich, high specification devices.



GasAlertClipExtreme



Compact and affordable, GasAlertClipExtreme offers 24/7 monitoring of single gas hazards with zero maintenance requirements. With easy on/off operation, this single gas detector is available in two and three year model variants.



GasAlertExtreme



Compact and affordable, GasAlertExtreme reliably monitors for any single toxic gas hazard. With easy on/off operation, this single gas detector offers extended longevity with a two year field-replaceable battery and sensor.



GasAlertQuattro



Rugged and reliable, the GasAlertQuattro 4-gas detector combines a comprehensive range of features with simple one-button operation. The graphic LCD displays easy to identify icons that indicate operational information, such as bump test and calibration status for simplified on-site auditing.



GasAlertMicroClip XT



The slim and compact GasAlertMicroClip XT provides affordable protection from atmospheric hazards. With simple one-button operation, this device offers ultimate ease of use and significantly reduces time spent training the user.



GasAlertMax XT II



The rugged GasAlertMax XT II monitors up to four gas hazards and combines straightforward one-button field operation with an integrated sampling pump. Tamper-proof, user-adjustable options enable the instrument to be customised to suit application needs.



GasAlertMicro 5 Series



Compact and lightweight, GasAlertMicro 5 Series instruments are available in diffusion or pumped formats. These portable gas detectors simultaneously monitor and display up to five atmospheric hazards. Model variants include the GasAlertMicro 5 PID model for the low-level detection of VOCs and GasAlertMicro 5 IR for Carbon Dioxide monitoring.



ToxiPro®

Honeywell

A compact and rugged single-gas toxic portable detector with one-button simplicity, continuous real-time display and highly visible/audible alarms for high noise locations. ToxiPro® features an integrated black box data recorder and event logger as standard (compatible with the Honeywell IQ Express Single Gas Docking Station).



MultiPro™

Honeywell

4-gas device with real-time simultaneous readings, simple one-button operation and a large easy-to-read LCD display. MultiPro™ features an integrated black box data recorder and event logger as standard. An optional screw-on pump with automatic leak test and low flow alarm is also available. (Compatible with the Honeywell IQ Express Multi-Gas Docking Station).



PHD6™

Honeywell

Simultaneous monitoring of up to 6-gas hazards with 18 sensor choices, including PID for the low-level detection of Carbon Dioxide and Methane. PHD6™ features an integrated black box data recorder and event logger that records all atmospheric hazards experienced during operation. (Compatible with the Honeywell IQ6 Multi-Gas Docking Station).



Impact range

Honeywell Analytics Experts in Gas Detection

High specification, 4-gas simultaneous monitoring solution designed to meet the needs of the most challenging applications. Model variants include Impact Pro, which features an integrated automatic pump, Impact IR and Impact (standard).



Impulse XT

Honeywell Analytics Experts in Gas Detection

Impulse XT is a single-gas portable detection solution with zero maintenance requirements. Delivering 24/7 monitoring with a two year operational life, this device also features an IP67 rating making it ideal for challenging environments.

■ Portable Gas Detectors (continued)

Automatic device testing solutions from Honeywell



MicroDock II

The MicroDock II is an easy, cost-effective way to bump test, calibrate and charge a device as well as manage records. Fully compatible with the complete BW Technologies by Honeywell product range, its accompanying Fleet Manager II software allows the user to download information faster than ever from the MicroDock II. Improved functionality allows the creation of accurate and user-friendly reports, print receipts of calibration, sort and graph data and archive information, helping to dramatically simplify fleet management activities.



Enforcer

Honeywell Analytics
Experts in Gas Detection

Designed for use with the Impact range of portable gas detectors, Enforcer is a small, lightweight test and calibration station that is fully portable. With no batteries or mains power required, Enforcer permits quick testing on the move and helps to reduce the ongoing cost of portable device maintenance.



ToxiPro IQ Express Docking Station

Honeywell

A fully automated bump test, calibration and datalogging station for use with the ToxiPro portable range, allowing four devices to be linked to a single gas supply. Connects to a PC via USB port or Ethernet (optional).



Multi-Pro IQ Express Docking Station

Honeywell

A fully automated bump test, calibration and datalogging station for use with the MultiPro™ range of portable gas detectors. Connects to a PC via USB port or Ethernet (optional).



IQ6 Docking Station

Honeywell

A fully automated bump test, calibration and datalogging station for use with the PHD6™ range of portable gas detectors. Connects to a PC via USB port or Ethernet (optional). ■



North American Hazardous Area Standards and Approvals

The North American system for the certification, installation and inspection of hazardous locations equipment includes the following elements:

- Installation Codes
 - E.g. NEC, CEC
- Standard Developing Organisations (SDOs)
 - E.g. UL, CSA, FM
- Nationally Recognised Testing Laboratories (NRTLs)
 - Third Party Certifiers e.g. ARL, CSA, ETI, FM, ITSNA, MET, UL
- Inspection Authorities
 - E.g. OSHA, IAEI, USCG

The installation codes used in North America are the NEC 500 and NEC 505 and the CEC (Canadian Electric Code) for Canada. In both countries these guides are accepted and used by most authorities as the final standard on installation and use of electrical products. Details include equipment construction, performance and installation requirements, and area classification requirements. With the issuance of the new NEC these are now almost identical.

The Standards Developing Organisations (SDOs) work with industry to develop the appropriate overall equipment requirements. Certain SDOs also serve as members of the technical committees charged with the development and maintenance of the North American installation codes for hazardous locations.

The Nationally Recognised Testing Laboratories (NRTLs) are independent third party certifiers who assess the conformity of equipment with these requirements. The equipment tested and approved by these agencies is then suitable for use under the NEC or CEC installation standards.

In the United States of America the inspection authority responsible is OSHA (Occupational Safety and Health Administration). In Canada the inspection authority is the Standards Council of Canada. To confirm compliance to all national standards both countries require an additional indication on products tested and approved.

As an example CSA approved product to USA standards must add NRTL/C to the CSA symbol. In Canada, UL must add a small c to its label to indicate compliance to all Canadian standards. ■



North American Ex Marking and Area Classification

Once approved, the equipment must be marked to indicate the details of the approval.

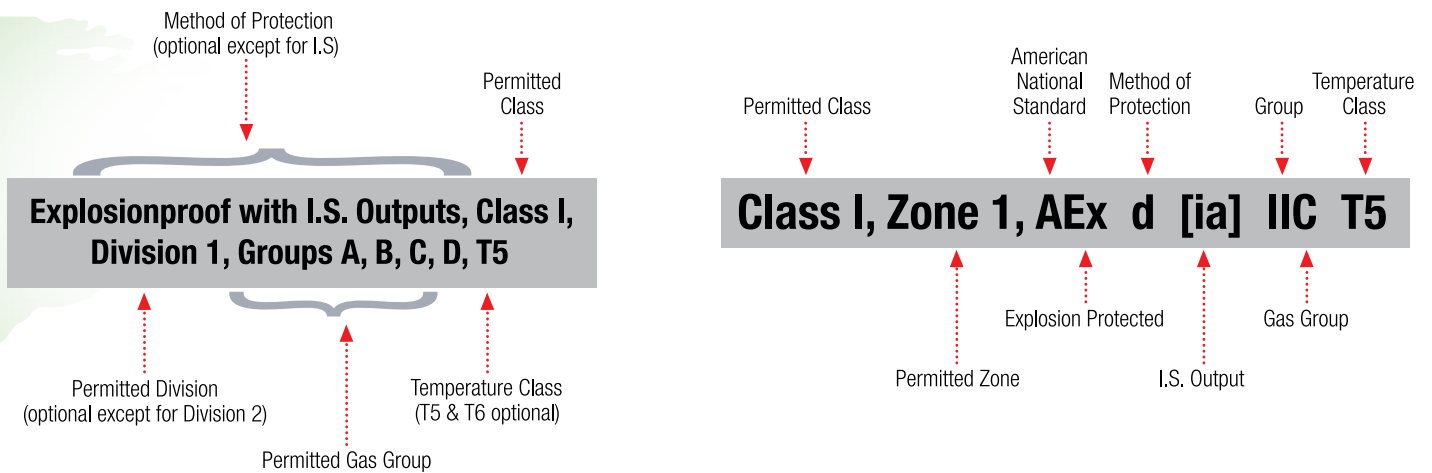

Class I – Explosive Gases

Division 1	Gases normally present in explosive amounts
Division 2	Gases not normally present in explosive amounts

Gas Types by Group

Group A	Acetylene
Group B	Hydrogen
Group C	Ethylene and related products
Group D	Propane and alcohol products

Class II – Explosive Dusts

Division 1	Dust normally present in explosive amounts
Division 2	Dust not normally present in explosive amounts

Dust Types by Group

Group E	Metal dust
Group F	Coal dust
Group G	Grain and non-metallic dust

European Hazardous Area Standards and Approvals

The standards used in most countries outside of North America are IEC/CENELEC and ATEX. The IEC (International Electrotechnical Commission) has set detailed standards for equipment and classification of areas and is the standard that countries outside of both Europe and North America use. CENELEC (European Committee for Electrotechnical Standardisation) is a rationalising group that uses IEC standards as a base and harmonises them with all ATEX standards and the resulting standards legislated by member countries, which are based upon ATEX.

The CENELEC mark is accepted in all European Community (EC) countries.

All countries within the EC also have governing bodies that set additional standards for products and wiring methods. Each member country of the EC has either government or third party laboratories that test and approve products to IEC and/or CENELEC standards. Wiring methods change even under CENELEC, this is primarily as to the use of cable, armoured cable, and type of armoured cable or conduit. Standards can change within a country "and referred as National Differences" depending on the location or who built a facility. Certified apparatus carries the 'Ex' mark. ■

Approved National Test Houses which are cited in the EC Directives may use the EC Distinctive Community Mark:



Note: This is not a Certification Mark

Key

- CENELEC Members
- CENELEC Affiliate
- Water mass

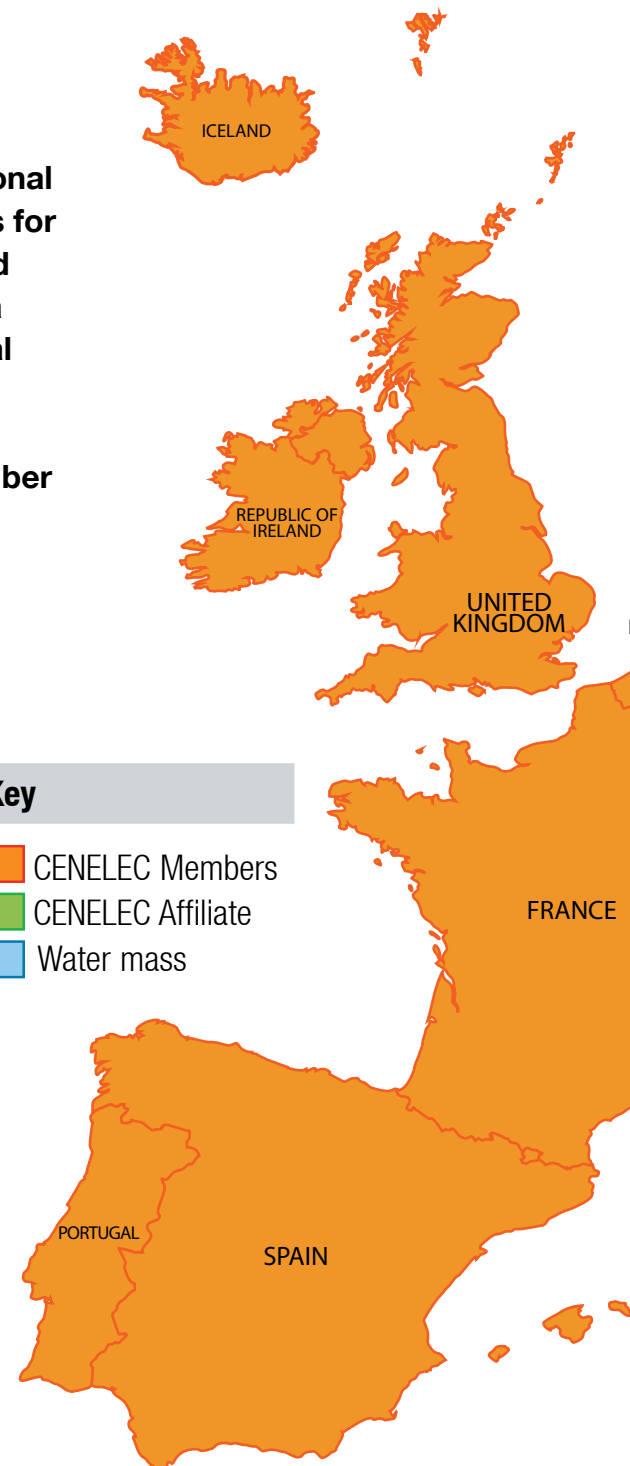



CENELEC MEMBER COUNTRIES:

- | | | |
|----------------|-------------|----------------|
| Austria | Greece | Poland |
| Belgium | Hungary | Portugal |
| Bulgaria | Iceland | Romania |
| Croatia | Ireland | Slovakia |
| Cyprus | Italy | Slovenia |
| Czech Republic | Latvia | Spain |
| Denmark | Lithuania | Sweden |
| Estonia | Luxembourg | Switzerland |
| Finland | Malta | United Kingdom |
| France | Netherlands | |
| Germany | Norway | |

GAS
FACT

ATEX (an abbreviation of ATmospheres EXplosibles) sets the minimum safety standards for both the Employer and Manufacturer regarding explosive atmospheres

ATEX = ATmospheres EXplosibles

There are two European Directives that have been law since July 2003 that detail the manufacturers and users obligations regarding the design and use of apparatus in hazardous atmospheres.



Responsibility	Directive	Article
Manufacturer	94/9/EC ATEX 95	ATEX 100a
End Users/Employers	99/92/EC	ATEX 137

The ATEX directives set the MINIMUM standards for both the employer and manufacturer regarding explosive atmospheres. It is the responsibility of the employer to conduct an assessment of explosive risk and to take necessary measures to eliminate or reduce the risk.

In order to comply with the ATEX directive the equipment must:

- Display a CE mark
- Have the necessary hazardous area certification
- Meet a recognised performance standard, e.g. EN 60079-29-1:2007 for flammable gas detectors (application specific) ■

ATEX DIRECTIVE 94/9/EC ARTICLE 100A

Article 100a describes the manufacturer's responsibilities:

- The requirements of equipment and protective systems intended for use in potentially explosive atmospheres (e.g. Gas Detectors)
- The requirements of safety and controlling devices intended for use outside of potentially explosive atmospheres but required for the safe functioning of equipment and protective systems (e.g. Controllers)
- The Classification of Equipment Groups into Categories
- The Essential Health and Safety Requirements (EHSRs). Relating to the design and construction of the equipment/systems





The classification of hazardous areas is defined in the ATEX directive

Hazardous area	Definition	ATEX
Zone 0	Areas in which explosive atmospheres caused by mixtures of air and gases, vapours, mists or dusts are present continuously or for long periods of time	Category 1
Zone 1	Areas in which explosive atmospheres caused by mixtures of air and gases, vapours, mists or dusts are likely to occur	Category 2
Zone 2	Areas in which explosive atmospheres caused by mixtures of air or gases, vapours, mists or dusts are likely to occur or only occur infrequently or for short periods of time	Category 3

ATEX Category	Permitted Certification Type
Category 1	Ex ia
Category 2	Ex ib, Ex d, Ex e, Ex p, Ex m, Ex o, Ex q
Category 3	Ex ib, Ex d, Ex e, Ex p, Ex m, Ex o, Ex q, Ex n

IEC Standards

IECEx (International Electrotechnical Commission) provides standards that are widely used by countries outside of Europe and North America. IECEx standards relate to area and equipment classification and provide similar guidance to ATEX.

ATEX Zones and IEC Equipment Groupings

ATEX Hazard Zone	IEC Equipment code
Zone 0 (gas and vapours)	1G
Zone 1 (gas and vapours)	2G
Zone 2 (gas and vapours)	3G
Zone 20 (combustible dusts)	1D
Zone 21 (combustible dusts)	2D
Zone 22 (combustible dusts)	3D

IEC Equipment Categories and Method of Protection for Gas and Vapour Hazards

Equipment category	Type of protection	Code	IECEx reference
1G	Intrinsically Safe	ia	EN/IEC 60079-11
1G	Encapsulation	ma	EN/IEC 60079-18
2G	Flameproof enclosure	d	EN/IEC 60079-1
2G	Increased safety	E	EN/IEC 60079-7
2G	Intrinsically Safe	ib	EN/IEC 60079-11
2G	Encapsulation	m / mb	EN/IEC 60079-18
2G	Oil immersion	o	EN/IEC 60079-6
2G	Pressurised enclosures	p / px / py	EN/IEC 60079-2
2G	Powder filling	q	EN/IEC 60079-5
3G	Intrinsically Safe	ic	EN/IEC 60079-11
3G	Encapsulation	mc	EN/IEC 60079-18
3G	Non-sparking	n / nA	EN/IEC 60079-15
3G	Restricted breathing	nR	EN/IEC 60079-15
3G	Energy limitation	nL	EN/IEC 60079-15
3G	Sparking equipment	nC	EN/IEC 60079-15
3G	Pressurised enclosures	pz	EN/IEC 60079-2

IEC Equipment Categories and Method of Protection for Combustible Dust Hazards

Equipment category	Type of protection	Code	IECEx reference
1D	Intrinsically Safe	ia	EN/IEC 60079-11
1D	Encapsulation	ma	EN/IEC 60079-18
1D	Enclosure	ta	EN/IEC 61241-1
2D	Intrinsically Safe	ib	EN/IEC 60079-11
2D	Encapsulation	mb	EN/IEC 60079-18
2D	Enclosure	tb	EN/IEC 61241-1
2D	Pressurised enclosures	pD	EN/IEC 61241-2
3D	Intrinsically Safe	ic	EN/IEC 60079-11
3D	Encapsulation	mc	EN/IEC 60079-18
3D	Enclosure	Tc	EN/IEC 61241-1
3D	Pressurised enclosures	pD	EN/IEC 61241-2



Equipment Markings

ATEX DIRECTIVE 99/92/EC ARTICLE 137

ATEX 99/92/EC Article 137 describes the responsibilities of the employer/end user regarding the use of equipment designed for use in potentially explosive atmospheres. Unlike other directives, which are advisory in nature, ATEX is part of the New Approach Directives issued by the European Union (EU) and is mandatory.

For further information about this directive, please visit: http://ec.europa.eu/enterprise/policies/european-standards/documents/harmonised-standards-legislation/list-references/equipment-explosive-atmosphere/index_en.htm. Member States use this information to draw up their own legislation. For example, in the UK, this legislation is implemented by the Health and Safety Executive (HSE) as the Dangerous Substances and Explosive Atmospheres Regulations 2002 (DSEAR). It sets out to:

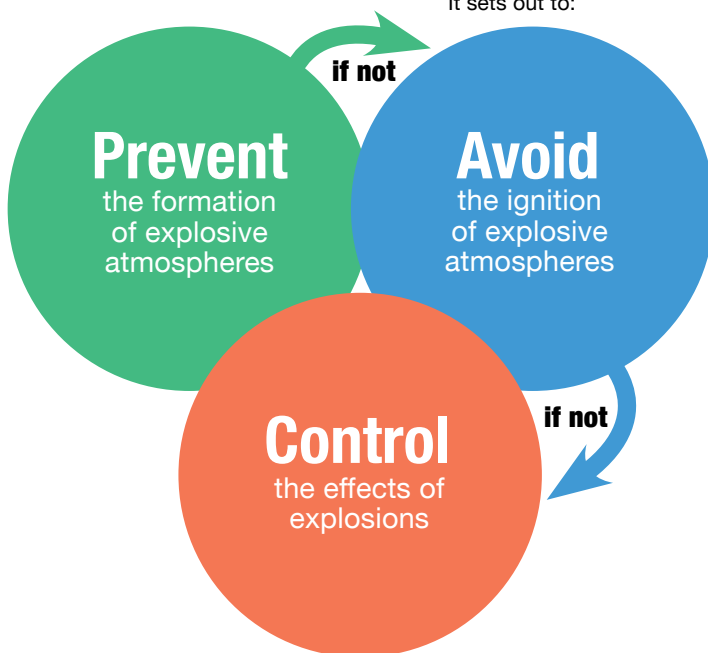

Assessment of Explosion Risks

The employer must conduct a risk assessment including:

- 1 PROBABILITY OF EXPLOSIVE ATMOSPHERE**
Zone Area classification
- 2 PROBABILITY OF IGNITION SOURCE**
Equipment Categories
- 3 NATURE OF FLAMMABLE MATERIALS**
Gas groups, ignition temperature (T rating), gas, vapour, mists and dusts
- 4 SCALE OF EFFECT OF EXPLOSION**
Equipment Protection Level

60079 Series

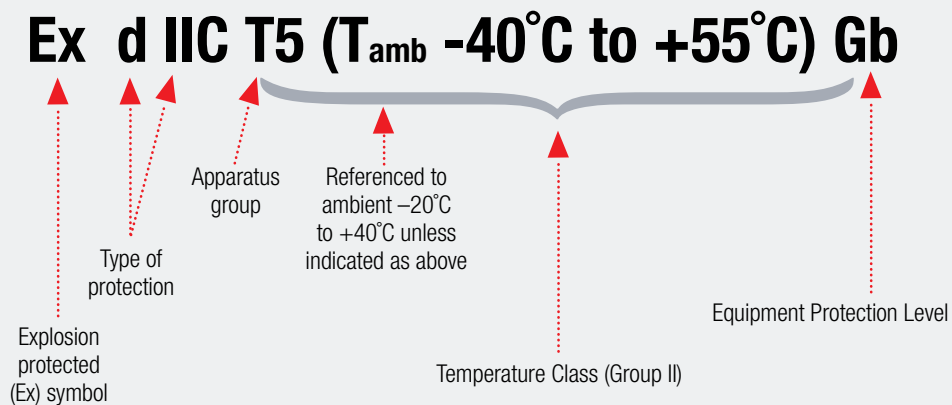

Explosive Atmospheres Warning Sign

The employer must mark points of entry to places where explosive atmospheres may occur with distinctive signs:

In carrying out the assessment of explosion risk the employer shall draw up an Explosion Protection Document that demonstrates:

- explosion risks have been determined and assessed
- measures will be taken to attain the aims of the directive
- those places that have been classified into zones
- those places where the minimum requirements will apply
- that workplace and equipment are designed, operated and maintained with due regard for safety

The employer may combine existing explosion risk assessments, documents or equivalent reports produced under other community acts. This document must be revised with significant changes, extensions or conversions. ■



ATEX Markings

CE 0999

CE Mark
Notified body number



EU Explosive atmosphere symbol

II 2 G

Equipment group
I : Mining
II : Other areas (Ex)

Type of explosive atmosphere

G : Gas, mist, vapour
D : Dust

Equipment category

Gas	Dust	Mining
1 : Zone 0	1 : Zone 20	M1 : Energised
2 : Zone 1	2 : Zone 21	M2 : De-energised
3 : Zone 2	3 : Zone 22	

19

Area Classification



Not all areas of an industrial plant or site are considered to be equally hazardous. For instance, an underground coal mine is considered at all times to be an area of maximum risk, because some Methane gas can always be present. On the other hand, a factory where Methane is occasionally kept on site in storage tanks, would only be considered potentially hazardous in the area surrounding the tanks or any connecting pipework. In this case, it is only necessary to take precautions in those areas where a gas leakage could reasonably be expected to occur.

In order to bring some regulatory control into the industry, therefore, certain areas (or 'zones') have been classified according to their perceived likelihood of hazard. The three zones are classified as:

ZONE 0

In which an explosive gas/air mixture is continuously present, or present for long periods

ZONE 1

In which an explosive gas/air mixture is likely to occur in the normal operation of the plant

ZONE 2

In which an explosive gas/air mixture is not likely to occur in normal operation

	Continuous Hazard	Intermittent Hazard	Possible Hazard
Europe/IEC	Zone 0	Zone 1	Zone 2
North America (NEC 505)	Zone 0	Zone 1	Zone 2
North America (NEC 500)	Division 1		Division 2

In North America the classification most often used (NEC 500) includes only two classes, known as 'divisions'.

Division 1 is equivalent to the two European Zones 0 and 1 combined, whilst Division 2 is approximately equivalent to Zone 2.

Area Classification Example

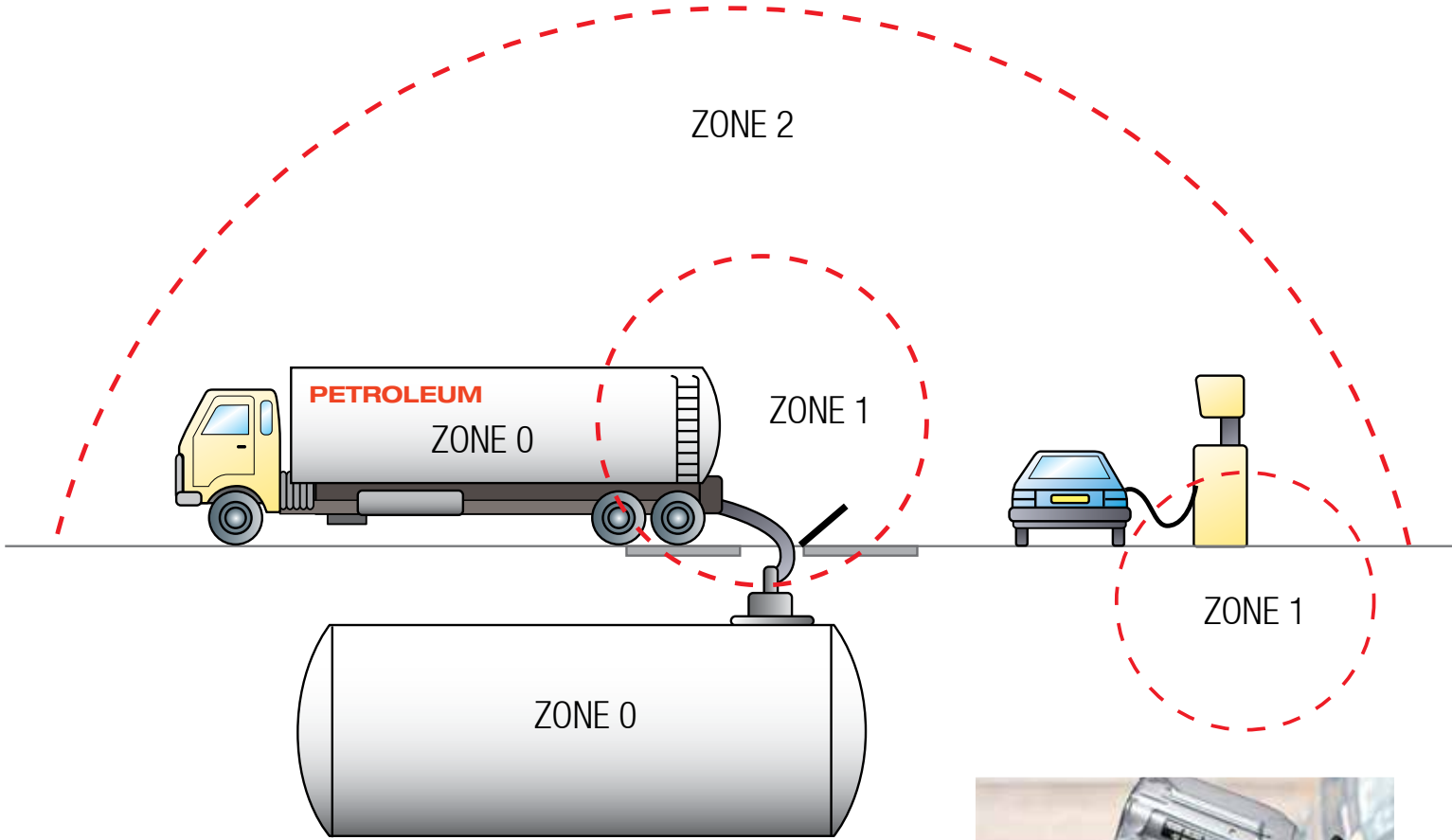

Apparatus Design

To ensure the safe operation of electrical equipment in flammable atmospheres, several design standards have now been introduced. These design standards have to be followed by the manufacturer of apparatus sold for use in a hazardous area and must be certified as meeting the standard appropriate to its use. Equally, the user is responsible for ensuring that only correctly designed equipment is used in the hazardous area.

For gas detection equipment, the two most widely used classes of electrical safety design are 'flameproof' (sometimes known as 'explosion-proof' and with an identification symbol Ex d) and 'intrinsically safe' with the symbol Ex ia or Ex ib.

Flameproof apparatus is designed so that its enclosure is sufficiently rugged to withstand an internal explosion of flammable gas without suffering damage. This could possibly result from the accidental ignition of an explosive fuel/air mixture inside the equipment. The dimensions of any gaps in the flameproof case or box (e.g. a flange joint) must therefore be calculated so that a flame can not propagate through to the outside atmosphere.

Intrinsically safe apparatus is designed so that the maximum internal energy of the apparatus and interconnecting wiring is kept below that which would be required to cause ignition by sparking or heating effects if there was an internal fault or a fault in any connected equipment. There are two types of intrinsic safety protection. The highest is Ex ia which is suitable for use in Zone 0, 1 and 2 areas, and Ex ib which is suitable for use in Zone 1 and 2 areas. Flameproof apparatus can only be used in Zone 1 or 2 areas.

Increased safety (Ex e) is a method of protection in which additional procedures are applied to give extra security to electrical apparatus. It is suitable for equipment in which no parts can produce sparking or arcs

or exceed the limiting temperature in normal service.

A further standard, Encapsulation (Ex m) is a means of achieving safety by the encapsulation of various components or complete circuits. Some products now available, achieve safety certification by virtue of using a combination of safety designs for discrete parts. Eg. Ex e for terminal chambers, Ex i for circuit housings, Ex m for encapsulated electronic components and Ex d for chambers that could contain a hazardous gas. ■

Flameproof

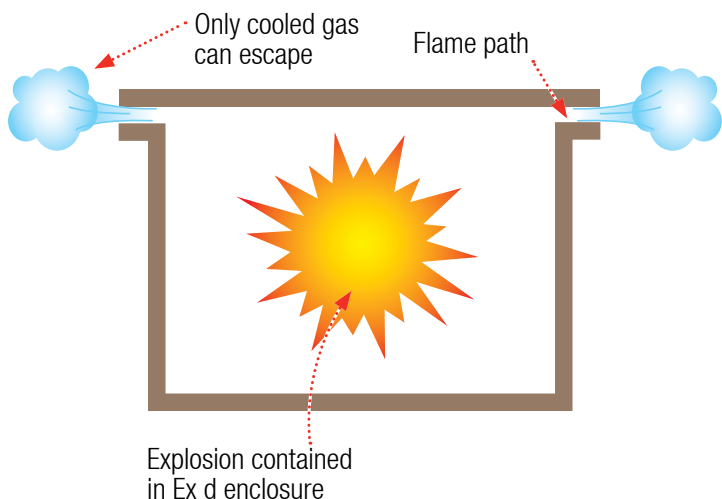

Intrinsically Safe

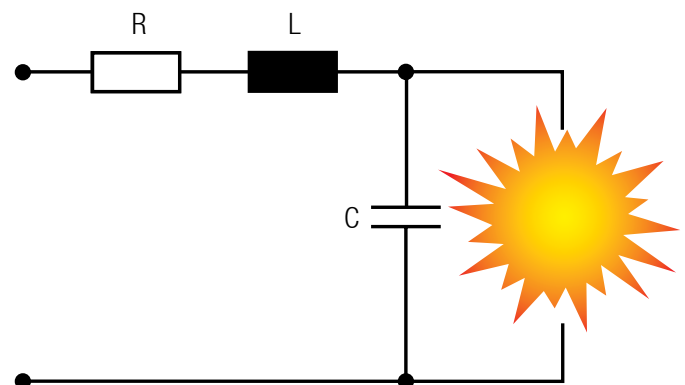

Hazardous Area Design Standards

Division	Zone	Ex	Type of protection
1	0	Ex ia	intrinsically safe
	Any design suitable for zone 0 plus:		
		Ex d	flameproof
		Ex ib	intrinsically safe
	1	Ex p	pressurised/continuous dilution
		Ex e	increased safety
		Ex m	encapsulation
2	Any design suitable for zone 1 plus:		
		Ex n or N	non-sparking (non-incendive)
	2	Ex o	oil
		Ex q	powder/sand filled

Increased Safety

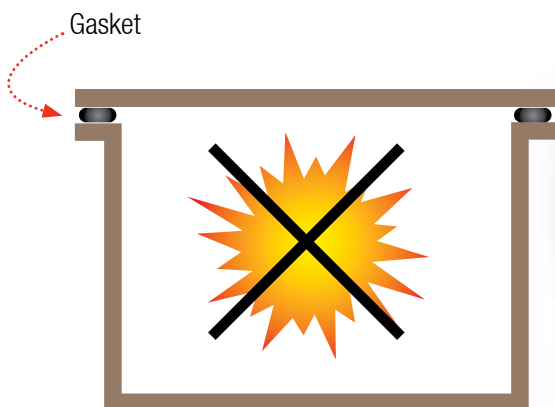

Apparatus Classification

As an aid to the selection of apparatus for safe use in different environmental conditions, two designations, apparatus group and temperature classification, are now widely used to define their limitations.

As defined by standard No EN60079-20-1 of the European Committee for Electrical Standards (i.e. Committee European de Normalisation Electrotechnique or CENELEC), equipment for use in potentially explosive atmospheres is divided into two apparatus groups:

GROUP I

For mines which are susceptible to firedamp (Methane).

GROUP II

For places with a potentially explosive atmosphere, other than Group I mines.

Group II clearly covers a wide range of potentially explosive atmospheres and includes many gases or vapours that constitute widely different degrees of hazard. Therefore, in order to separate more clearly the differing design features required when used in a particular gas or vapour, Group II gases are sub-divided as indicated in the table.

Acetylene is often considered to be so unstable that it is listed separately, although still included in Group II gases. A more comprehensive listing of gases can be found in European Standard EN 60079-20-1.

The Temperature Class rating for safety equipment is also very important in the selection of devices to detect gas or mixture of gases. (In a mixture of gases, it is always advisable to take the 'worst case' of any of the gases in the mixture). Temperature classification relates to the maximum surface temperature which can be allowed for a piece of apparatus. This is to ensure that it does not exceed the ignition temperature of the gases or vapours with which it comes into contact.

The range varies from T1 (450°C) down to T6 (85°C). Certified apparatus is tested in accordance with the specified gases or vapours in which it can be used. Both the apparatus group and the temperature classification are then indicated on the safety certificate and on the apparatus itself.

North America and the IEC are consistent in their temperature or T-Codes. However unlike the IEC, North America includes incremental values as shown opposite. ■



Apparatus Group

Representative Gas	Gas Classification	Ignitability
	Europe and IEC countries	US and Canada
Acetylene	Group IIC	Class I, Group A
Hydrogen	Group IIC	Class I, Group B
Ethylene	Group IIB	Class I, Group C
Propane	Group IIA	Class I, Group D
Methane	Group I	No classification

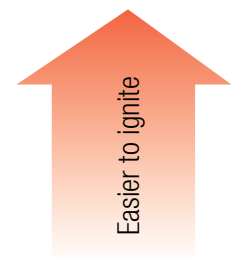

Temperature Class

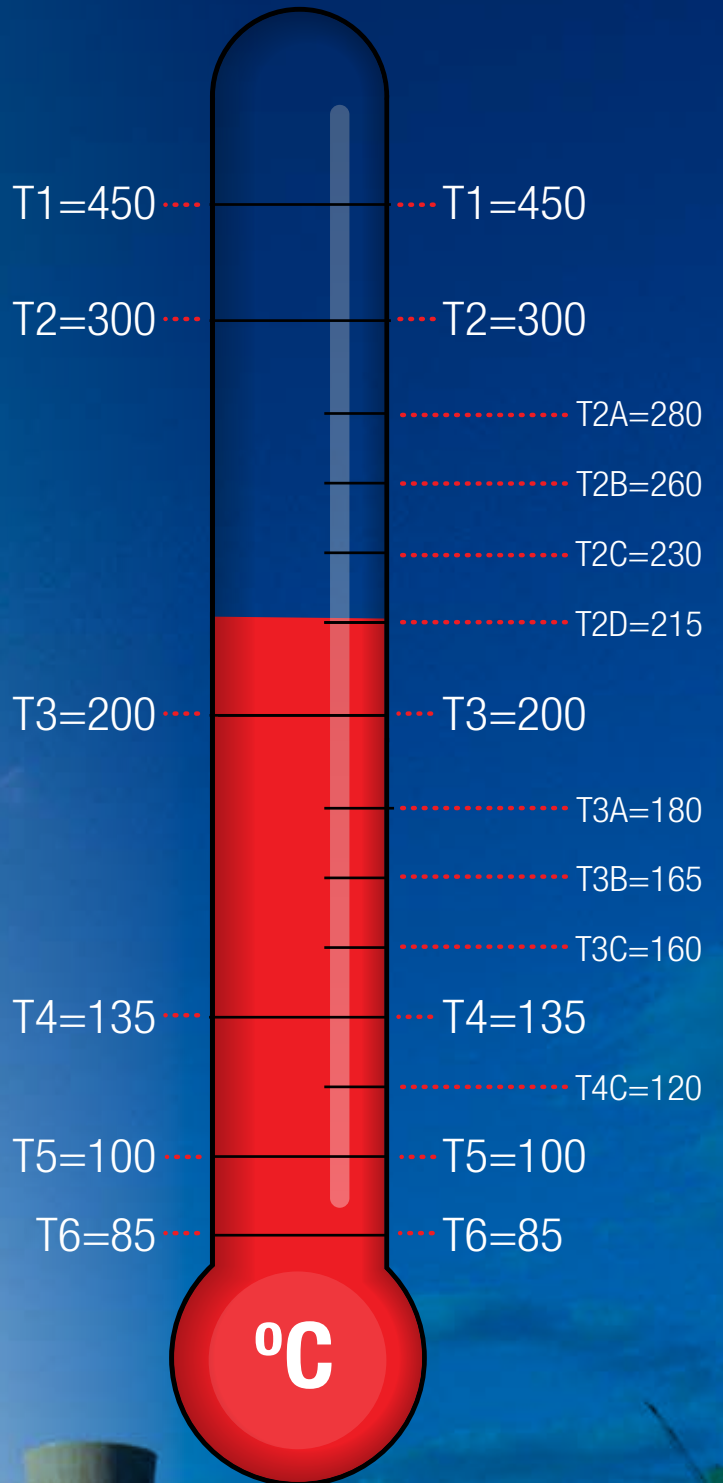

Ingress Protection of Enclosures

Coded classifications are now widely used to indicate the degree of protection given by an enclosure against entry of liquids and solid materials. This classification also covers the protection of persons against contact with any live or moving parts inside the enclosure. It should be remembered that this is supplementary to and not an alternative to the protection classifications for electrical equipment used in hazardous areas.

In Europe the designation used to indicate the Ingress Protection consists of the letters IP followed by two 'Characteristic Numbers' which indicate the degree of protection. The first number indicates the degree of protection for persons against contact with live or moving parts inside, and the second number shows the enclosure's protection against entry of water. For example, an enclosure with a rating of IP65 would give complete protection against touching live or moving parts, no ingress of dust, and would be protected against entry from water spray or jet. This would be suitable for use with gas detection equipment such as controllers, but care should be taken to ensure adequate cooling of the electronics. There is also a third numeral sometimes used in certain countries, relating to impact resistance. The meanings of the numbers are given in the following table. ■



Third Numeral	Meaning
0	No Protection
1	Impact of 0.225 Joule (150g weight dropped from 15cm)
2	Impact of 0.375 Joule (250g weight dropped from 15cm)
3	Impact of 0.5 Joule (250g weight dropped from 20cm)
4	(No meaning)
5	Impact of 2.0 Joule (500g weight dropped from 40cm)
6	(No meaning)
7	Impact of 6.0 Joule (1.5Kg weight dropped from 40cm)
8	(No meaning)
9	Impact of 6.0 Joule (5Kg weight dropped from 40cm)



IP codes (IEC / EN 60529)

First Numeral	IP	Second Numeral
Protection against solid bodies		Protection against liquid
No protection	0 0	No protection
Objects greater than 50mm	1 1	Vertically dripping water
Objects greater than 12mm	2 2	Angled dripping water -75° to 90°
Objects greater than 2.5mm	3 3	Splashed water
Objects greater than 1.0mm	4 4	Sprayed water
Dust protected	5 5	Water jets
Dust tight	6 6	Heavy seas
	7	Effects of immersion (defined in minutes)
	8	Indefinite immersion

Example: IP67 is dust tight and protected against the effects of immersion

NEMA ratings with IP ratings

In North America enclosures are rated using the NEMA system. The table below provides an approximate comparison of NEMA ratings with IP ratings.

NEMA, UL and CSA type rating	Approximate IEC/IP Code	Description
1	IP20	Indoor, from contact with contents
2	IP22	Indoor, limited, falling dirt and water
3	IP55	Outdoor from rain, sleet, windblown dust and ice damage
3R	IP24	Outdoor from rain, sleet and ice damage
4	IP66	Indoor and outdoor, from windblown dust, splashing and hose directed water and ice damage
4X	IP66	Indoor and outdoor, from corrosion, windblown dust, rain, splashing and hose directed water and ice damage
6	IP67	Indoor and outdoor, from hose directed water, water entry during submersion and ice damage
12	IP54	Indoor, from dust, falling dirt and dripping non corrosive liquids
13	IP54	Indoor, from dust, falling dirt and dripping non corrosive liquids

Safety Integrity Levels (SIL)

Certification has essentially been concerned with the safety of a product in its working environment i.e. that it won't create a hazard in its own right. The certification process (particularly in Europe with the introduction of the ATEX standard pertaining to Safety Related Devices) has now moved on to also include the measurement/physical performance of the product. SIL adds a further dimension by being concerned with the safety of the product in terms of being able to carry out its safety function when called to do so (Ref: IEC 61508 manufacturers requirement). This is increasingly being demanded as installation designers and operators are required to design and document their Safety Instrumented Systems (Ref: IEC 61511 user's requirement).

Individual standards applicable to specific types of equipment are being developed from IEC61508. For gas detection equipment the relevant standard is EN50402:2005+A1:2008 Electrical apparatus for the detection and measurement of combustible or toxic gases or vapours or of Oxygen. Requirements on the functional safety of fixed gas detection systems.

its safety function goes undetected. There is a critical distinction between reliability and safety. A product which appears to be reliable may have unrevealed failure modes whereas a piece of equipment which appears to declare a large number of faults may be safer as it is never/rarely in a condition where it is unable to do its function or has failed to announce its inability to do so. ■

Managing safety is about risk reduction.

All processes have a risk factor. The aim is to reduce the risk to 0%. Realistically, this is not possible so an acceptable risk level that is 'As Low As Reasonably Practical' (ALARP) is set. Safe plant design and specification is the major risk reduction factor. Safe operational procedures further reduce the risk as does a comprehensive maintenance regime. The E/E/PES (Electrical/Electronic/Programmable Electronic System) is the last line of defence in the prevention of accidents. SIL is a quantifiable measure of safety capability of the E/E/PES. In typical applications, this relates to the F&G systems-detectors, logic resolvers and safety actuation/annunciation.

It is recognised that all equipment has failure modes. The key aspect is to be able to detect when the failures have occurred and take appropriate action. In some systems, redundancy can be applied to retain a function. In others, self checking can be employed to the same effect. The major design aim is to avoid a situation where a fault which prevents the system carrying out



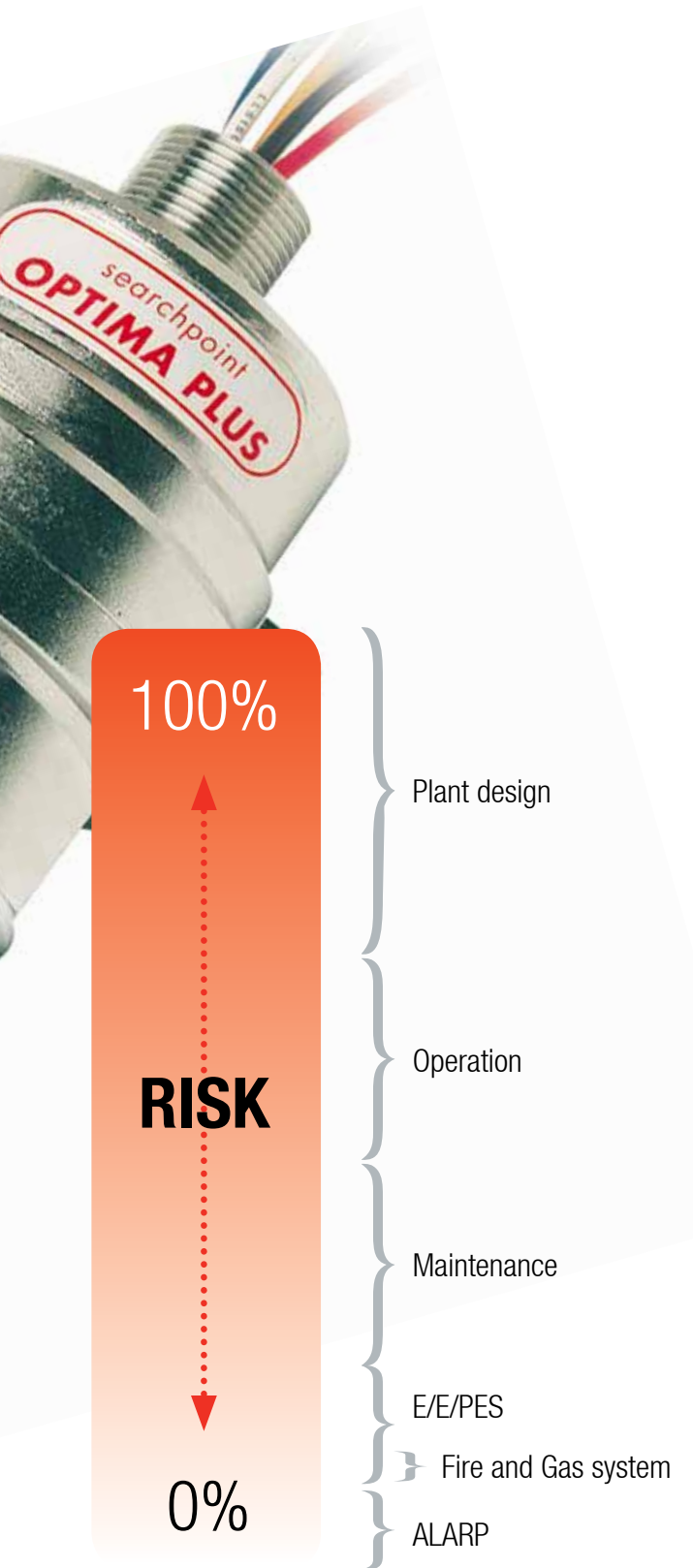

There are 4 levels of SIL and the higher the SIL, the lower its resulting Probability of Failure on Demand (PFD). Many current fire and gas detection products were designed before the introduction of SIL and therefore on individual assessment may only achieve a low or non-SIL rated status. This problem can be overcome by techniques such as decreasing the proof test intervals or combining systems with different technologies (and hence eliminating common mode failures) to increase the effective SIL rating.

For a safety system to achieve a specified SIL, the sum of the PFD must be considered.

SIL	Probability of failure on demand
1	$> 10^{-2}$ to $< 10^{-1}$
2	$> 10^{-3}$ to $< 10^{-2}$
3	$> 10^{-4}$ to $< 10^{-3}$
4	$> 10^{-5}$ to $< 10^{-4}$

Safer equipment

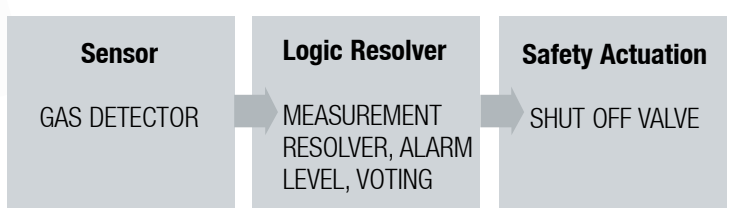

For SIL 2 $PDF (Sensor) + PFD (Resolver) + PFD (Actuator) < 1 \times 10^{-2}$

The selection of SIL required for the installation must be made in conjunction with the level of safety management within the design of the process itself. The E/E/PES should not be considered the primary safety system. Design, operation and maintenance have the most significant combination to the safety of any industrial process.

Gas Detection Systems

The most common method employed to continuously monitor for leakage of hazardous gases is to place a number of sensors at the places where any leaks are most likely to occur. These are often then connected electrically to a multi-channel controller located some distance away in a safe, gas free area with display and alarm facilities, event recording devices etc. This is often referred to as a fixed point system. As its name implies, it is permanently located in the area (e.g. an offshore platform, oil refinery, laboratory cold storage etc).

The complexity of any gas detection system depends on the use to which the data will be put.

Data recording allows the information to be used to identify problem areas and assist in the implementation of safety measures. If the system is to be used for warnings only, then the outputs from the system can be simple and no data storage is necessary. In choosing a system, therefore, it is important to know how the information will be used so that the proper system components can be chosen. In toxic gas monitoring, the use of multi-point systems has rapidly demonstrated their potential for solving a wide variety of workplace exposure problems and is invaluable for both identifying problems and for keeping workers and management aware of pollutant concentrations in the workplace.

In the design of multi-point systems, considerable thought should be given to the various components and to their interconnection. When using catalytic detection sensors, for instance, the electrical cable connections to the sensors would have three cores, each of 1mm squared, carrying not only the output signal, but also power to the electrical bridge circuit, which is located at the sensor to reduce signal voltage drop along the cables.

In the case of toxic (and some flammable) gas monitoring systems, the atmosphere is often sampled at locations remote from the unit and the gases are drawn by pumps to the sensors through a number of synthetic material, narrow-bore tubes. Care in design of such systems will include a selection of



Typical small gas detection system protecting a room

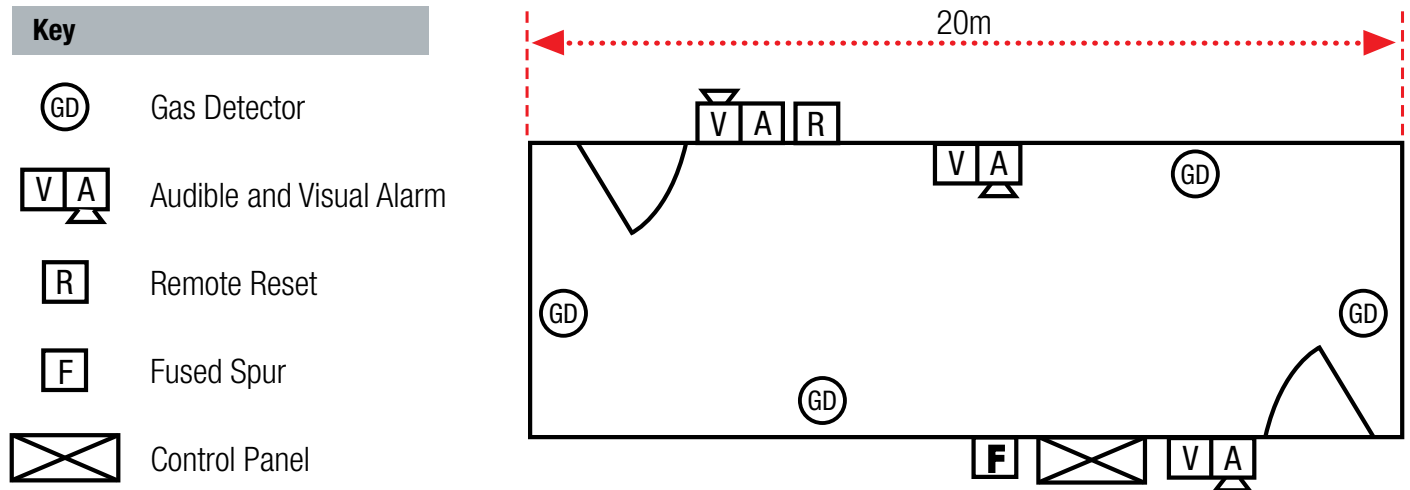

suitable sized pumps and tubes, a sequential sampling unit for sampling each tube in turn and filters to stop particles or water cutting off the flow of gas. The bore size of tubing can be critical, since it needs to be both large enough to allow rapid response times with standard size pumps, but at the same time should not be so large as to allow excessive dilution of the sample by air. Each sampling point must be connected to a separate tube and if a number of points are connected to a single, central sensor, it will be necessary to purge the sensor with clean air between samples.

The controllers used in fixed systems can be centrally located or distributed at various locations in a facility according to the application requirements. They come in a control panel and come in either single channel (i.e. one control card per sensor) or multi-channel configurations, the latter being useful where power, space or cost limitations are important.

The control units include a front panel meter or LCD to indicate the gas concentration at each sensor and will also normally have internal relays to control functions such as alarm, fault and shutdown. The number of alarm levels available varies between controllers but typically up to three levels can be set, depending on statutory requirements or working practices within the industry. Other useful features would include alarm inhibit and reset, over-range indication and analogue 4-20mA outputs. Often digital outputs are also available for interfacing the controller to a DCS/BMS. It is important to

remember that the main purpose of a gas detection system is to detect the build up of a gas concentration before it reaches a hazardous level and to initiate a mitigation process to prevent a hazard occurring. If the gas concentration continues towards a hazardous level then executive shut down and hazard warning alarms are initiated. It is not enough to just log the event or measure the gas levels to which personnel have been exposed.

CABLES AND JUNCTION BOXES

In a typical industrial gas detection system such as that just described, sensors are located at a number of strategic points around the plant and at varying distances from the controller. When installing electrical connections to the controller, it is important to remember that each sensor cable will have a different electrical loop resistance depending upon its length. With constant voltage type detectors, the calibration process will require a person at both the sensor in the field and at the controller. With constant current detectors or those with a local transmitter, calibration of the field device can be carried out separately to that of the controller.

The sensor cables are protected from external damage either by passing them through metal ducting, or by using a suitable mechanically protected cable. Protective glands have to be fitted at each end of the cable and the sensor is mounted on a junction box to help in making simple, low-resistance, 'clean' terminations. It is also very important

to ensure that all the gland sizes and screw threads are compatible with the junction box and the external diameter of the cables being used. The correct sealing washer should be used to ensure a weatherproof seal between the detector and junction box. A further point to remember is that sensor manufacturers normally indicate the maximum loop resistance (not line resistance) of their sensor connections when providing the information to calculate cable core diameters for installation. ■

Location of Sensors

‘How many detectors do I need?’ and ‘where should I locate them?’ are two of the most often asked questions about gas detection systems, and probably two of the most difficult to answer. Unlike other types of safety related detectors, such as smoke detectors, the location and quantity of detectors required in different applications is not clearly defined.

GAS FACT

Xenon is the rarest non-radioactive gas element in the Earth's atmosphere. It represents 90 parts-per-billion of the total atmosphere

Considerable guidance is available from standards such as EN 60079-29-2 and others regarding the selection, installation, use and maintenance of apparatus for the detection and measurement of combustible gases or Oxygen. Similar international codes of practice e.g. National Electrical Code (NEC) or Canadian Electrical Code (CEC) may be used where applicable. In addition, certain regulatory bodies publish specifications giving minimum gas detection requirements for specific applications.

These references are useful, but tend to be either very generic and therefore too general in detail, or application specific and therefore irrelevant in most applications.

The placement of detectors should be determined following the advice of experts having specialist knowledge of gas dispersion, combined with the knowledge of process/equipment engineers and safety personnel. The agreement reached on the location of detectors should also be recorded.

Detectors should be mounted where the gas is most likely to be present. Locations requiring the most protection in an industrial plant would be around gas boilers, compressors, pressurised storage tanks, cylinders or pipelines. Areas where leaks are most likely to occur are valves, gauges, flanges, T-joints, filling or draining connections etc.

There are a number of simple and quite often obvious considerations that help to determine detector location:



Perhaps the most important point of all is not to try and economise by using the minimum number of sensors possible. A few extra sensors could make all the difference if a gas leak occurs!



- To detect gases that are lighter than air (e.g. Methane and Ammonia), detectors should be mounted at high level and preferably use a collecting cone
- To detect heavier than air gases (e.g. Butane and Sulphur Dioxide), detectors should be mounted at a low level
- Consider how escaping gas may behave due to natural or forced air currents. Mount detectors in ventilation ducts if appropriate
- When locating detectors consider the possible damage caused by natural events e.g. rain or flooding. For detectors mounted outdoors it is preferable to use the weather protection assembly
- Use a detector sunshade if locating a detector in a hot climate and in direct sun
- Consider the process conditions. Butane and Propane, for instance are normally heavier than air, but if released from a process line that is at an elevated temperature and/or under pressure, the gas may rise rather than fall
- Detectors should be positioned a little way back from high pressure parts to allow gas clouds to form. Otherwise any leak of gas is likely to pass by in a high speed jet and not be detected
- Consider ease of access for functional testing and servicing
- Detectors should be installed at the designated location with the detector pointing downwards. This ensures that dust or water will not collect on the front of the sensor and stop the gas entering the detector
- When installing open path infrared devices it is important to ensure that there is no permanent obscuration or blocking of the IR beam. Short-term blockage from vehicles, site personnel, birds etc can be accommodated
- Ensure the structures that open path devices are mounted to are sturdy and not susceptible to vibration ■

Typical Sensor Mounting Options

1. Wall mounted
2. Pole mounted
3. Ceiling mounted
4. Duct mounted

Typical System Configurations

5. Remote sensor, local display/gassing
6. Locally driven alarm system
7. Typical sensor/controller system
8. Standalone system
9. Typical sampling/aspirating system

GAS FACT

Jupiter – our solar system's largest gas giant – contains about 90% Hydrogen and 10% Helium. In fact, its composition is actually very similar to a primordial Solar Nebula (the type of Nebular that our solar system developed from).

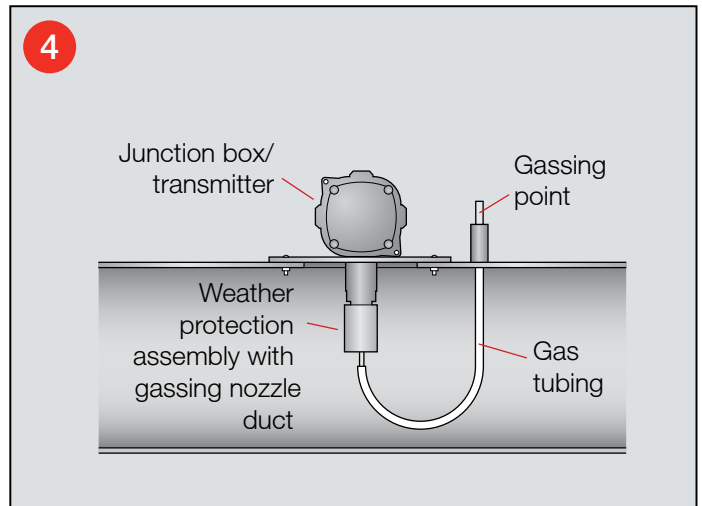
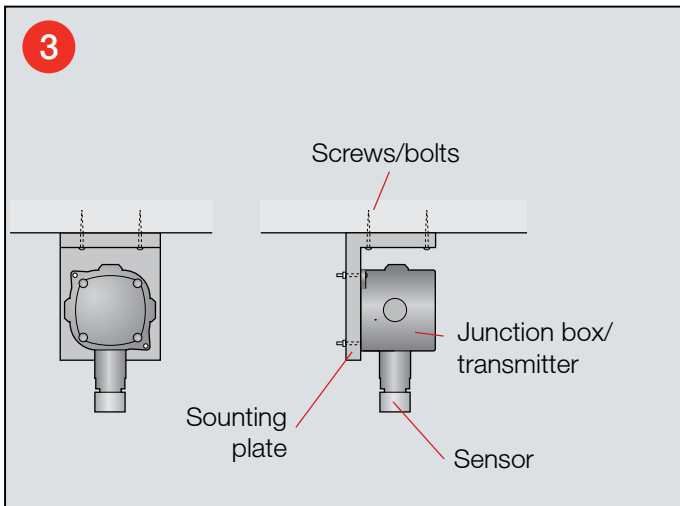
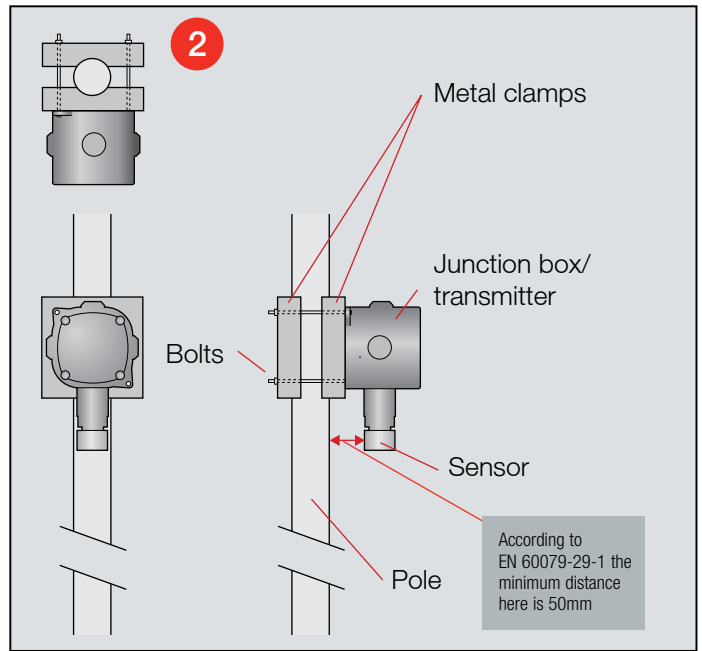
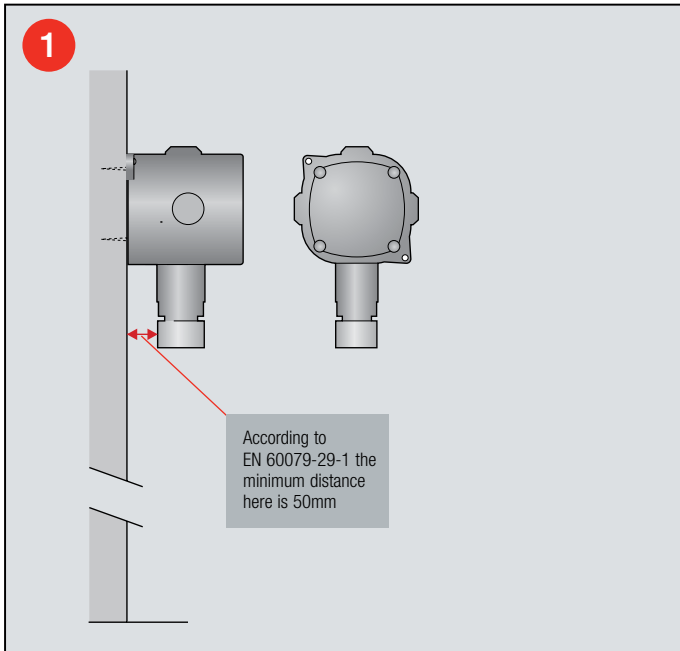

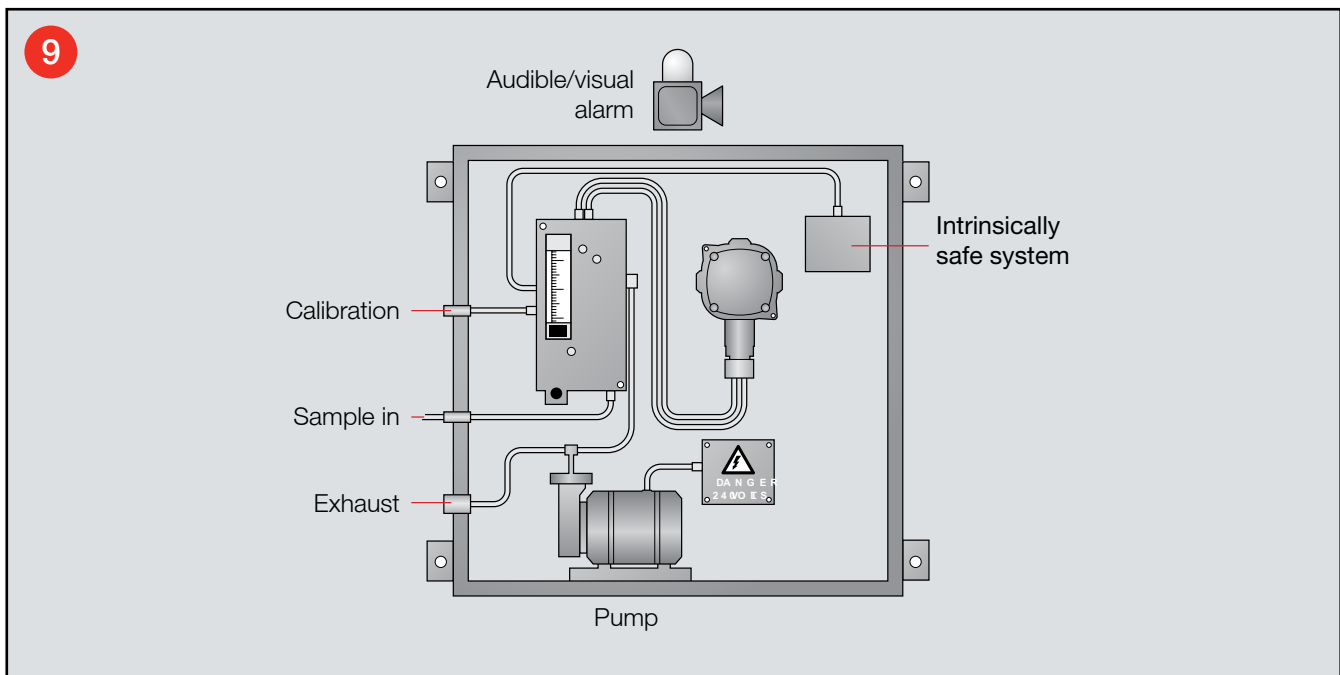
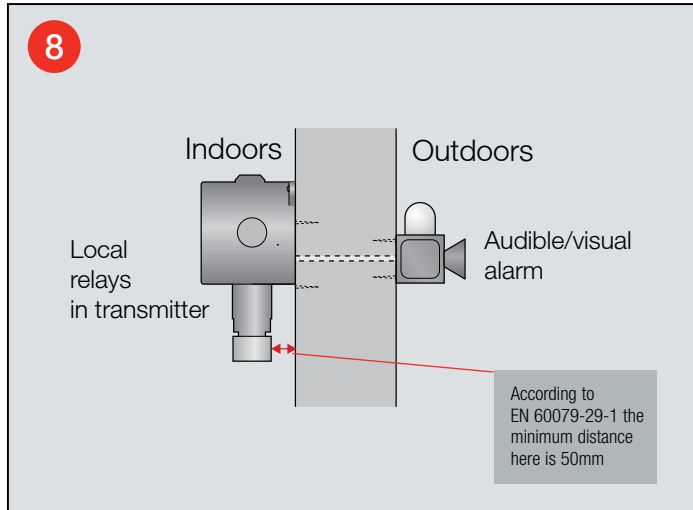
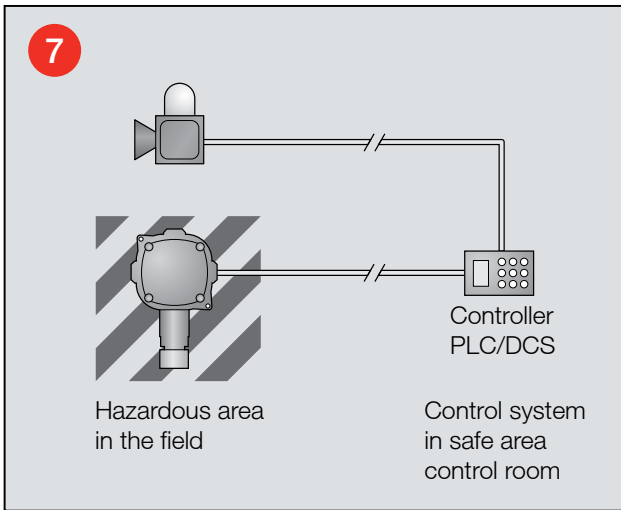
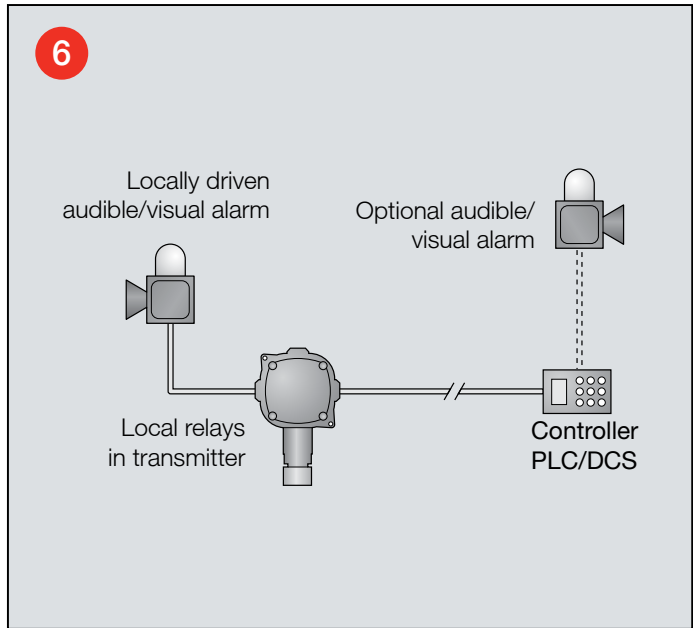
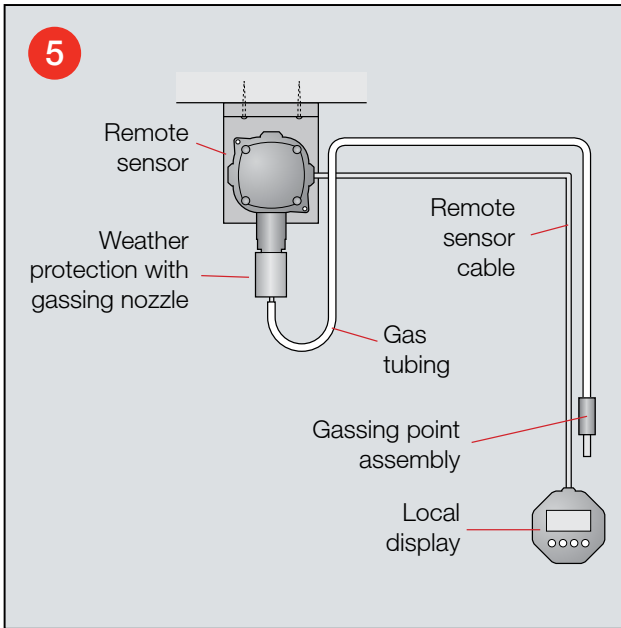

Essentially three installation methods are used Worldwide for electrical equipment in hazardous locations:

1. Cable with indirect entry
2. Cable with direct entry
3. Conduit

Cable Systems

These are mainly used in Europe (although the US and Canadian Electrical Codes list Metal Clad and Mineral Insulated cables for use in Class 1 Div 1 or Zone 1). Ex standards state that cable systems with suitable mechanical protection must be used. The cable is often Steel Wire Armoured (SWA) if used in areas where mechanical damage may occur, or it may be laid in protective conduit which is open at both ends. Certified cable glands are used to safely connect the cable to the enclosure. ■

Cross section of typical SWA cable

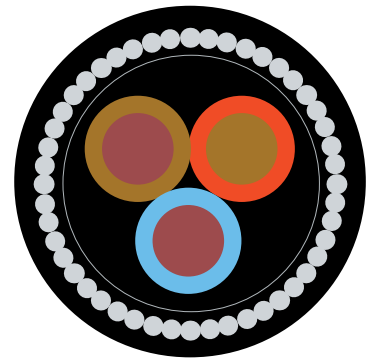

This cable gland is the only type that can meet the IEC 60079-14 requirements. It prevents the migration of gas between the conductors and it features an extruded inner cable bedding.

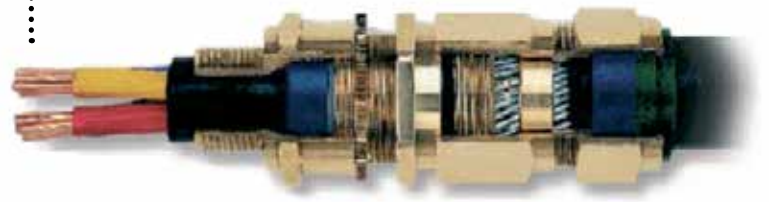

Cutaway of typical cable gland

Indirect Cable Entry

These are mainly used in Europe (although the US and Canadian Electrical Codes list Metal Clad and Mineral Insulated cables for use in Class 1 Div 1 or Zone 1). Explosion-proof standards state that cable systems with suitable mechanical protection must be used. The cable is often Steel Wire Armoured (SWA) if used in areas where mechanical damage may occur, or it may be laid in protective conduit which is open at both ends. Certified cable glands are used to safely connect the cable to the enclosure. ■

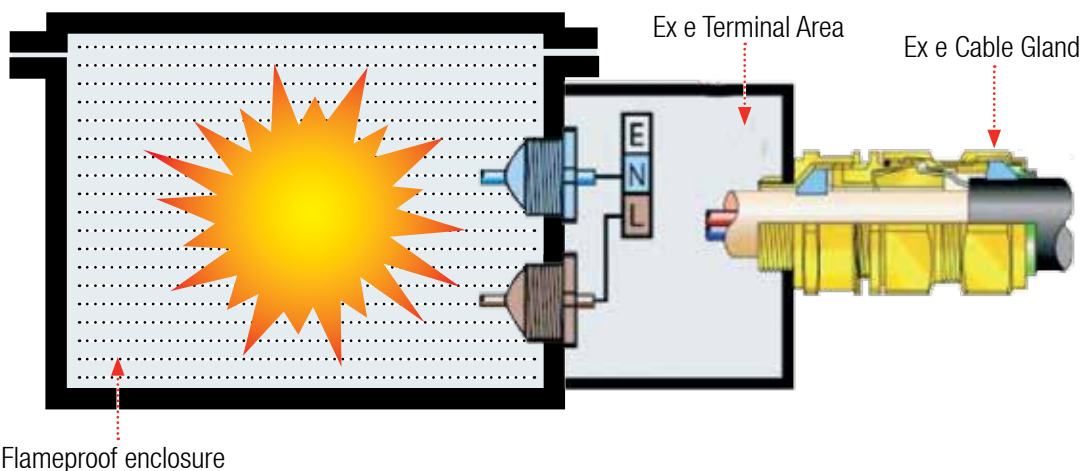

Direct Cable Entry

A2FFC (Indoor/outdoor use, Ex d, Ex ia)

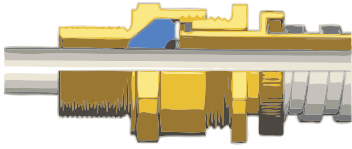

D3CDS (for use with marine, ordinary and hazardous area cables)

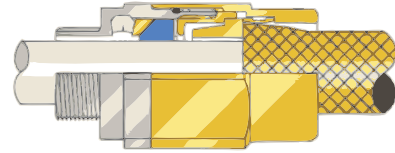

E1FU (Deluge protected, flameproof, Ex d, Ex ia)

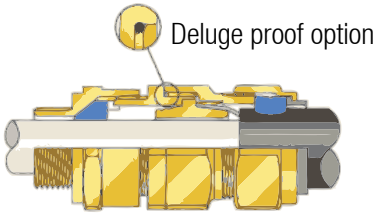

PX2KX (for use with armoured and jacketed cables)

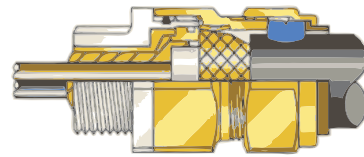

C2K (Armoured cable, Ex)

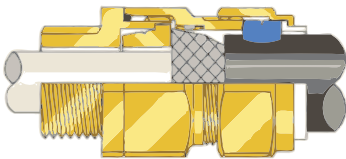

TC (for use in wet/deluge, hazardous locations)

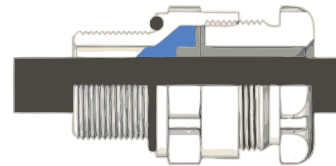

Direct Cable Entry

Direct Cable Entry is made into the flameproof enclosure. Only specially certified glands may be used. The type and structure of the cable must be carefully matched to the correct type of gland. The integrity of the protection is reliant on the correct installation by the installer. ■

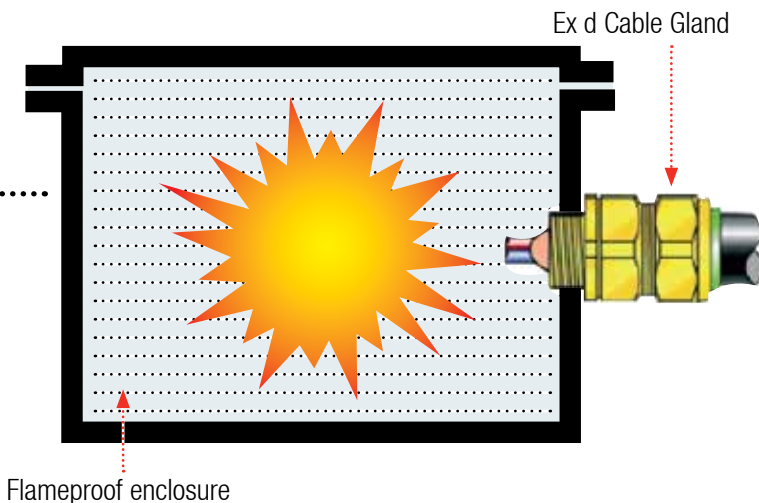

Conduit

Conduit is the main method of installation in hazardous areas throughout the USA. The electrical wires are run as individual wires inside enclosed metal tubes. The tubes are connected to the housings by means of unions and must have a seal within 18 inches (457.2mm) of each entrance point. The entire conduit system is flameproof. ■



Installation Methods

Typical Conduit Installation

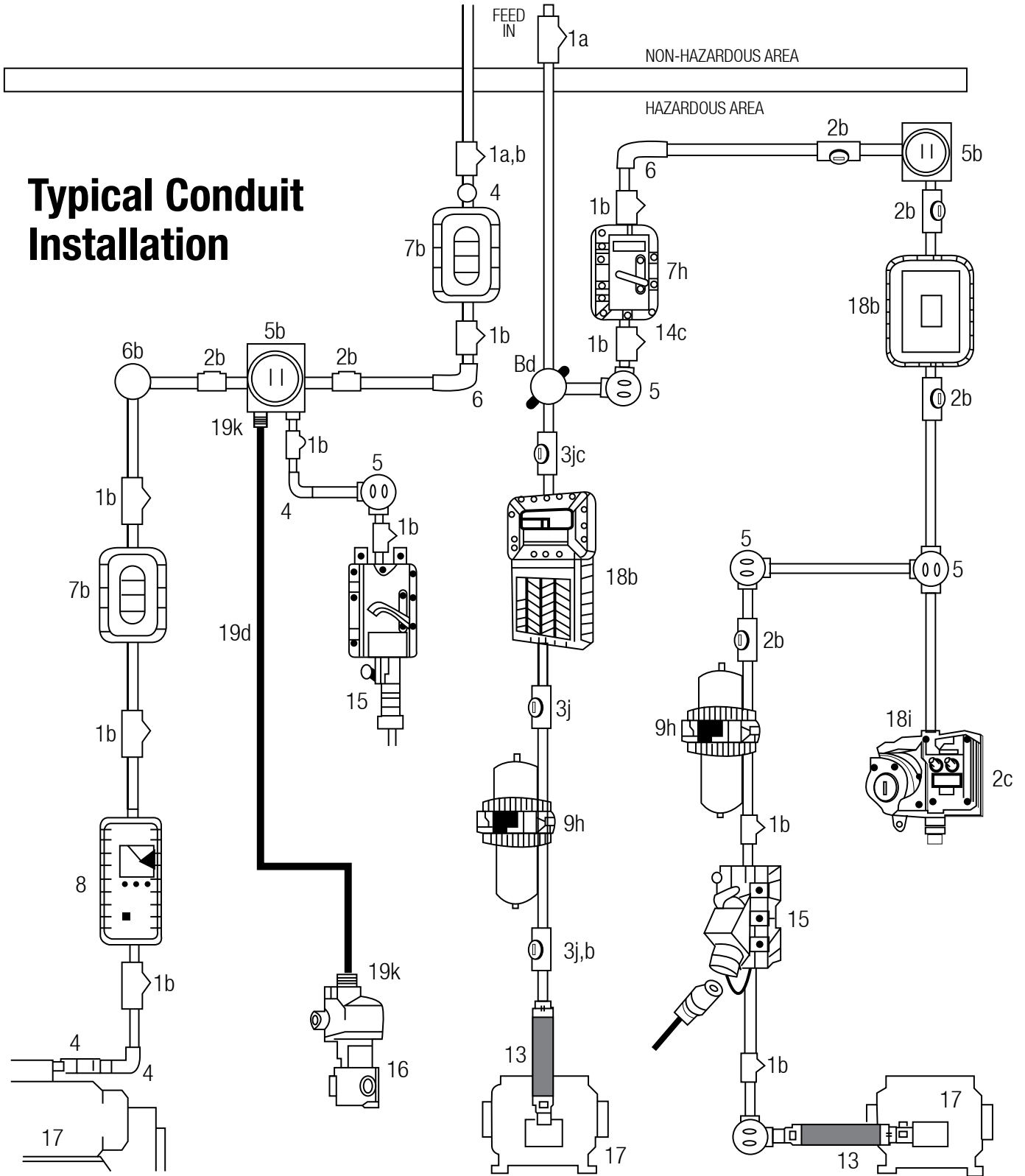

GAS FACT

Fluorine is the most reactive and most electronegative of the elements, making elemental Fluorine a dangerously powerful Oxidant. This leads to direct reactions between Fluorine and most elements, including noble gases Krypton, Xenon, and Radon.



Fittings and Seals for Conduit



Boxes

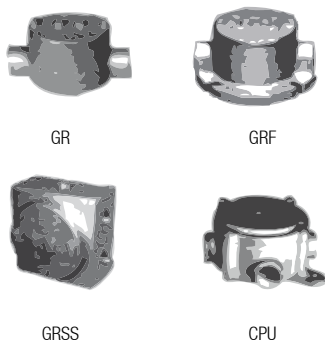

Conduit Seals

The seals prevent any explosions in the tubing from spreading. Drains must be installed at low points where condensation may accumulate.

Horizontal Seal

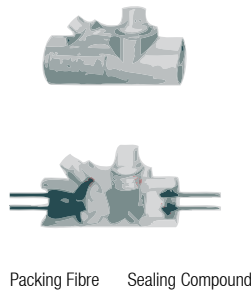

Vertical Seal with Drain

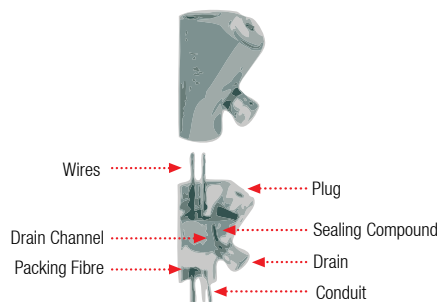

Gas Detection Maintenance and Ongoing Care

A vital part of ensuring that fixed and portable gas detection equipment operates correctly is periodic servicing, maintenance and calibration. Unlike some other types of safety related equipment (e.g. fire detection), gas detection does not have specific legislations or clear guidelines that specify how often it should be serviced. Relevant documents simply state that maintenance should be carried out frequently by competent, trained personnel and in line with the manufacturers recommendations.

Gas detection applications vary considerably and these differences can affect the approach to ongoing device support and also the frequency of servicing required to ensure proper operation and maximise uptime.

It is important that a suitable service period is established for the equipment that takes account of each individual application's unique set of factors. Some sites choose to have their own dedicated in-house support to carry out routine maintenance and ad hoc equipment fixes, whilst others choose to outsource this activity to the equipment manufacturer or third party technical support provider.

As a leading-edge equipment manufacturer and complete solutions provider, Honeywell offers comprehensive technical service and ongoing device support; either directly or through a network of officially approved service partners.

When you work with Honeywell or its approved partner network, you get so much more than just equipment maintenance and field support; our aim is to operate like an extension of your business, providing tailored solutions that maximise uptime of equipment and deliver the flexibility to evolve with your changing business needs.

Selecting the right service provider

When selecting a gas detection solution, it's essential to take a holistic view and consider the impact of ongoing device care at the gas detection selection stage. This means that a gas detector not only needs to be application-suited in terms of its specification and functionality, but its ongoing maintenance requirements.

With a variety of manufacturers in the marketplace claiming to offer the leading-edge solutions and the best provision of support and care, the process of comparing offerings and choosing the most suitable company to work with can be an arduous and lengthy process.

It's important to evaluate any prospective manufacturer or third party service provider against a set of criteria before moving forwards. The following questions will help you gain a valuable insight into whether a supplier is likely to be able to meet your specific individual requirements.

Question: What expertise do you have regarding my specific application?

A service provider needs to have an intrinsic understanding of your business and the unique requirements in not only your application

but also the industry in which you operate and regulations. Application-based variables and legislative requirements (international or national) can impact ongoing maintenance requirements considerably.

Question: Do you offer comprehensive service and support options and the flexibility to meet my exact needs?

Even if you have in-house support to help you maintain your gas detection system, it's important to find out what services can be offered regarding the ongoing care of your system. For example, if a problem occurs, how quickly can the manufacturer respond? What is the provision of field and support resource they can offer, what services will come as part of your package, and what will you need to pay extra for? It's also important to consider the structure of the services offered. Can you create a bespoke package of options designed to meet your specific requirements or are packages more structured and standardised?

Question: What infrastructure do you offer and what customer support will I receive if I choose to work with you?

Knowing the full resource offering of a prospective service provider is essential; you will need to know what resource they have in terms of being able to provide information to



you when you need it. You will also need to know the level of customer support you will have access to in terms of order processing and logistical supply of equipment and services and whether support will be provided in your local language etc.

Question: Will you provide customer service and ongoing device support to me in my local language, taking into consideration my local customs and regulations?

Everyone likes to work in ways that are familiar and language, cultural and legislative differences are particularly important; especially when it comes to highly technical products like gas detectors.

Ongoing support services

The most obvious aspect of ongoing device care is maintenance and equipment fixes (should they be required), but in reality, these aspects only form a small part of all the services that are offered to gas detection users. A good service provider will be able to guide you from the earliest stages of identifying needs and selecting equipment right through to supporting your product for the whole of its operational life.

Selecting and integrating gas detection

A service provider can work with sales engineers, taking an holistic approach to identifying the right equipment solutions and also help with a seamless integration that has a minimal impact to site operations.

Site evaluations: A site evaluation can be particularly beneficial - especially for customers that are unfamiliar with fixed gas detection options available. Expert assistance and site analysis can help to define where gas detection is needed and what types of solutions may meet the requirements of the plant.

Application engineering: Assistance to help define the best solutions within the context of the application and its variables.

System integration: For sites that already have safety systems, guidance can be provided to select the right gas detection elements to integrate into the existing system.

Pre-installation support: After choosing gas detection, consideration needs to be given to receiving and integrating the equipment. Commissioning new equipment can impact upon various aspects of the plant; from its

productivity to the need to modify existing systems. Experts can help to make the process of integration as smooth as possible.

Site Acceptance Testing (SAT): SAT is a full function test conducted on site with all new gas detection equipment to check its performance.

Commissioning: It is always advisable to use competent and product trained Engineers to ensure correct installation and operation. Professional commissioning also preserves the manufacturer's warranty and prevents warranty loss through damage resulting from incorrect set-up.

Ongoing device maintenance

Planned maintenance regimes can greatly benefit sites by limiting the chances of ad hoc issues that can adversely affect productivity, so the right philosophy to ongoing device care can help to maximise uptime and help to prevent potentially costly shutdowns.

Field maintenance: Field assistance is ideal for sites where dedicated maintenance personnel are not available and helps to ensure that equipment is maintained and correctly working. Field teams can carry out planned maintenance activities or ad hoc equipment repairs on site.

Gas Detection Maintenance and Ongoing Care (continued)

Preventative/corrective maintenance: As the saying goes, prevention is always better than cure and the same applies to the care of gas detection equipment. Rather than waiting until an issue occurs (which could adversely affect productivity), a planned maintenance scheme can maximise uptime and greatly limit the potential of ad hoc issues occurring. In fact, market research shows that a preventative maintenance regime can limit the number of equipment related issues by as much as 50% in the first 90 days.

Workshop repairs: When devices need repair work, it's important that they are fixed within the stipulations of their warranty (i.e. work is carried out by the equipment manufacturer or an approved service provider, certified by the manufacturer to carry out such work). When sending an item back for repair, it's essential to work with a service provider who can provide quick turnarounds, to minimise device downtime.

Resident, on-site maintenance: For the most demanding applications, where downtime needs to be minimised wherever possible, a resident on-site expert may be required. Depending on your business approach to

headcount, it may be preferable to have this support provided by a third party. A good service provider will be able to offer on-site support if required.

Mobile Calibration: Carrying out routine calibration of devices doesn't have to have a big impact – in fact, a service provider who offers a mobile calibration service for portables can help to greatly limit plant process interruptions. Devices can be brought down to a calibration vehicle for the work to be carried out on site.

24/7 emergency call out: If the worst should happen and you need immediate support, a good service provider will be able to offer emergency help (whether it is provided technically over the phone, by email or in person).

Repair and maintenance of third party equipment: Many good manufacturers who offer service and ongoing support will not limit their assistance to

just their own products. When selecting a support provider, it's worth considering their ability to repair other gas detection devices you might have on site, so you only need to work with a single supplier.

Additional Extras

Aside from the more traditional services, many suppliers are able to add value in additional ways:

Support documentation: Sites have to keep records of compliance certificates and documentation. A good equipment manufacturer will keep records of this

How to preserve your warranty

As previously mentioned, it's essential to follow the conditions in any product warranty (including installation, commissioning and repair). Failure to adhere to such conditions can invalidate a warranty. One benefit of using technical support from some product manufacturers like Honeywell is the added-value of having a Manufacturer's Work Warranty Compliance Certificate. This provides peace of mind that all work is within warranty condition, preserving your warranty.

Honeywell Gas Detection | The only service provider you'll ever need

We offer a single source solution to technical service and ongoing device support.

At Honeywell Gas Detection, we have a detailed understanding of all gas detection applications and this means that we are able to identify and react to the specific needs of your business. In fact, we have a team of application specialist engineers who can provide the expertise you require to help identify exactly what you need and then find a solution that meets those specifications.

We understand the importance of good onward care, and with this in mind, we offer a rich resource of engineering and workshop support. This means that if you need assistance, we can help you quickly and efficiently, maximising your process uptime. The support we offer is also highly flexible and you can pick and choose options to create a bespoke package that meets your business needs. In fact, we even support third party gas detection equipment.

At Honeywell Gas Detection, we pride ourselves on offering the highest quality of customer support. This enables us to provide excellent lead times and the assistance our customers need; from initial product enquiry right through the whole product life.

Why work with Honeywell?

Honeywell is a pioneering force within the life safety industry, innovating benchmark products that set the standard for workplace safety:

- We produce advanced devices and solutions that help to reduce the ongoing cost of workplace safety
- We provide World class service and support for gas detection
- All our products are designed to meet specific market needs and we work directly with industry and our clients to evolve solutions designed to meet requirements

If you would like further information on Honeywell's technical service and ongoing support options or those offered by Honeywell's approved partner network, please contact us on +41 (0)44 943 4300 or email gasdetection@honeywell.com.

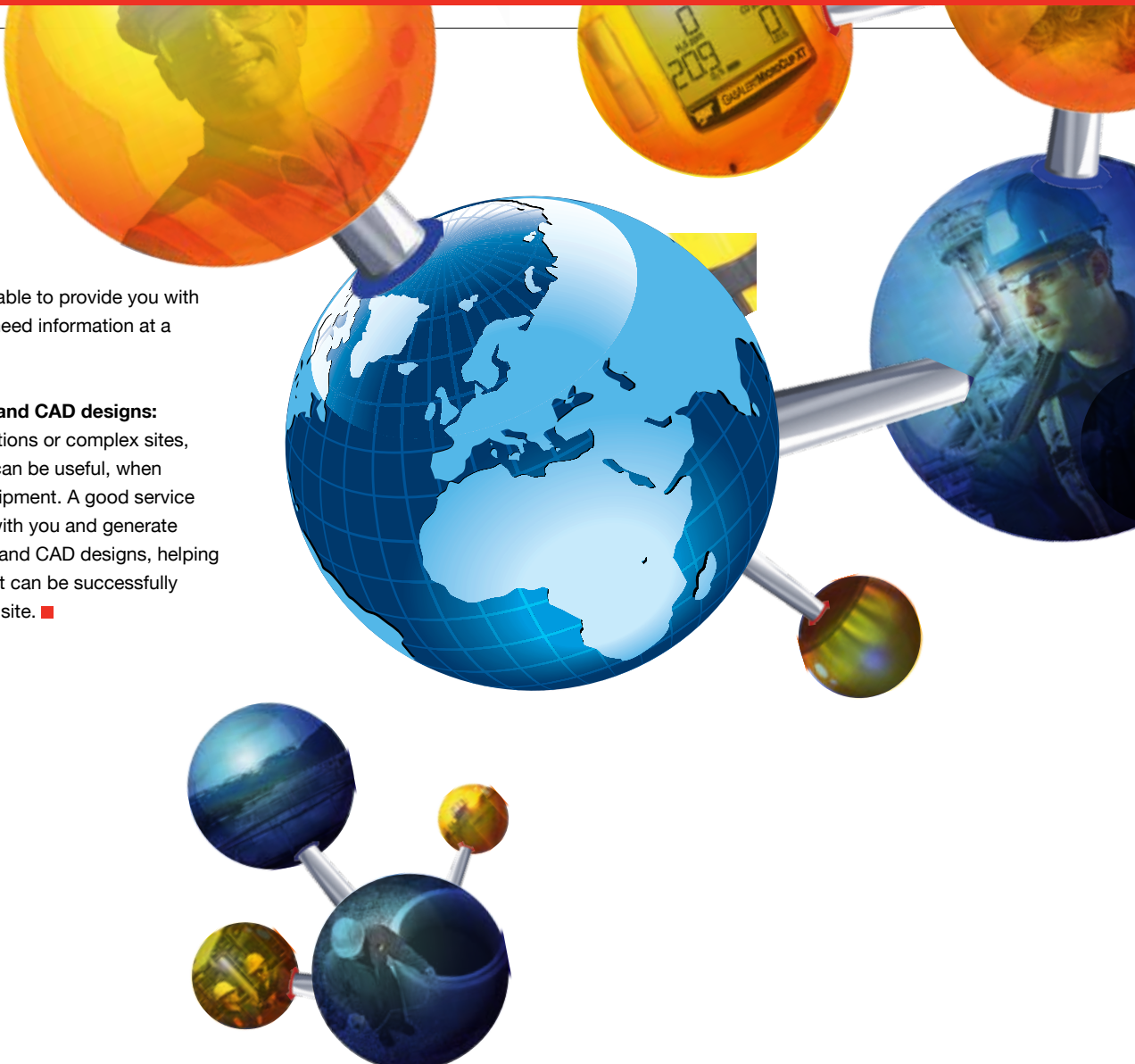

information and be able to provide you with copies should you need information at a later date.

Custom drawings and CAD designs:

For unusual applications or complex sites, bespoke drawings can be useful, when integrating new equipment. A good service provider can work with you and generate customer drawings and CAD designs, helping to ensure equipment can be successfully integrated into your site. ■

Expert end-to-end technical **service** and support

Europe +41 (0)44 943 4300

Americas +1 800 538 0363

Asia +82 (0)2 6909 0300

Glossary

ACGIH	American Conference of Governmental Industrial Hygienists.
AIT	Auto Ignition Temperature.
Analogue/analog output	Standard mA output from a sensor or transmitter. Normally described as 4-20mA. The alternative is a mV bridge output from a catalytic type sensor.
Apparatus group	The classification of flammable gases into groups that are associated with required apparatus design standards.
Asphyxiation	Death resulting from lack of Oxygen.
ATEX	European Explosive Atmospheres Directives (ATmosphere EXplosives).
Baseefa	British Approvals Service for Electrical Equipment in Flammable Atmospheres – UK Safety Certification.
BMS	Building Management System.
Binary mixture of gas	A mixture of two gases only.
Breathing zone	10 In/25cm radius from the nose and mouth.
Bridge circuit	Wheatstone Bridge circuit used in catalytic detector design.
CAS number	Chemical Abstracts Service. CAS registry number used to identify substances without the ambiguity of chemical nomenclature.
Calibration	The process of adjusting the output of the detector to give an accurate reading of gas concentration over its measuring range.
Carcinogenic	Capable of causing Cancer.
Catalytic sensor	For detection of combustible gases. These are made of an electrically heated Platinum wire coil, covered first with a ceramic base such as alumina and then with a final outer coating of Palladium or Rhodium catalyst dispersed in a substrate of Thoria.
CE	Indicates compliance to all relevant European directives.
CEC	Canadian Electrical Code.
Cell	An individual sensor.
GENELEC	Comité Européen de Normalisation Électrotechnique.
Cesi	Centro Elettrotecnico Sperimentale Italiano – Italian Safety Certification.
Channel	One line or point of gas detection.
Chemcassette®	Registered name of a paper tape cartridge used in toxic gas analysers.
Conduit	Metal tubing mainly used in the US for installation of wires in hazardous areas.
COSHH	Control of Substances Hazardous to Health.
CSA	Canadian Standards Association.
dBA	Decibels, relative to the A weighting scale (as affected by the human ear).
DCS	Distributed Control System.
Domestic gas detector	Gas detector designed specifically for use in domestic or residential properties.
Division	North American area classification of a hazardous area (Division 1 or 2) that defines the length of time a hazard is present.
Electrochemical cell sensor	Electrochemical sensors are essentially fuel cells composed of noble metal electrodes in an electrolyte.
EMC	Electromagnetic compatibility.
ESD	Electrostatic discharge.
Ex d	Hazardous Area Design Standard “Flameproof”.

Glossary continued

Ex i	Hazardous Area Design Standard “Intrinsically Safe”.
Ex e	Hazardous Area Design Standard “Encapsulation”.
Ex m	Encapsulated to keep gas out of product. Zones 1 and 2.
Explosimeters	Combustible gas monitor.
Explosion-proof	A name for Ex d apparatus design.
EXAM	Hazardous Area Approvals body based in Germany.
Fail safe	Description of a detector that has no unseen failure modes.
Fieldbus	Digital communication standard.
Firedamp	A mixture of methane and other Hydrocarbon gases that forms in coal mines.
Fixed point system	Gas detection system using individual fixed point gas sensors and / or transmitters.
Flame arrestor	A structure that allows gas to diffuse through it into a detector but prevents propagation of any flame back out.
Flameproof	A name for Ex d apparatus design.
Flammable range	The band in which a gas/air mixture is flammable.
Flash point	This is the lowest temperature at which vapour is given off at a sufficient rate to form an explosive mixture with air.
FM approval	Factory Mutual – USA Safety Certification.
Gas analyser	Normally refers to equipment used to measure extremely small concentrations of gas (low or ppb) or one specific gas in the presence of several others.
Gas detector	Refers to equipment used in applications where there is normally no toxic or explosive gas risk and therefore is used to signal the presence of gas in otherwise safe conditions.
Gas monitor	Equipment used in applications where a gas or gas mixture is constantly present and is therefore used to signal a change in the concentration or mixture of the gas.
GOST	Russian hazardous area approvals body. Widely accepted in Eastern Europe or as a base for own local approvals.
Hazardous areas	Areas where there is the possibility of the presence of an explosive mixture of flammable gas or vapour and air are known as ‘Hazardous’ and other areas as ‘safe’ or ‘non-hazardous’. Any electrical equipment used in hazardous areas must be tested and approved to ensure that, in use even under fault conditions, it can not cause an explosion.
HSE	Health and Safety Executive (UK).
Ignition temperature	The lowest temperature that will cause a mixture to burn or explode.
Ineris	Institut National de l’Environnement Industriel et des Risques.
Infrared detector	Gas detector that uses the principle that infrared light is absorbed by gas molecules at specific frequencies.
International Electrotechnical Committee	International Standards and conformity assessment for government, business and society for all electrical, electronic and related technologies.
Intrinsically safe (IS)	Method of design so that the maximum internal energy of the apparatus and wiring is not sufficient to cause ignition by sparking or heating effects resulting from a fault.
IP	Ingress Protection – a measure of protection against the ingress of dust and water.
LCD	Liquid Crystal Display.
LED	Light Emitting Diode.
LEL	Lower Explosive Limit – the lowest concentration of ‘fuel’ in air which will burn and for most flammable gases and vapours it is less than 5% by volume.

Glossary continued

LEL%	Percentage of the Lower Explosive Limit (for example, 10% LEL of Methane is approx 0.5% by volume).
LEL metres	Scale for measurement for flammable gases by open path infrared detectors.
LFL	Lower Flammable Limit.
LNG	Liquefied Natural Gas.
LPG	Liquefied Petroleum Gas made up of Propane and Butane.
LTEL	Long Term Exposure Limit. The 8 hour LTEL is the time-weighted average concentration for a normal 8 hour day to which most workers may be repeatedly exposed, day after day, without adverse effect.
mA	Milliamp – measurement of current.
MAC	Maximum Allowable Concentrations (replaced by TLVs) - toxic gas levels described by ACGIH.
MAK	Maximale Arbeitsplatz Konzentration.
MEL	Maximum Exposure Limit.
Milligrams per cubic metre	Alternative unit of measurement for toxic gases.
ModBus	ModBus is a serial communication protocol published by Modicon in 1979 for use with its programmable logic controllers (PLCs).
Multi-channel	More than one gas channel.
Multi gas	Portable gas detector with typically up to 4 gas sensors fitted.
mV	Millivolt – measurement of voltage.
Natural gas	Fossil fuel formed almost entirely of Methane.
NEC 500	National Electrical Code (US).
NEC 505	Latest version of NEC.
NEMA	National Electrical Manufacturers Association. US standards developing organisation. NEMA rating of enclosures is similar to the IP rating system.
NIOSH	The National Institute for Occupational Safety and Health.
NRTLs	Nationally Recognised Testing Laboratories (US).
OEL	Occupational Exposure Limit – The 8 hour OEL is the time-weighted average concentration for a normal 8 hour day or 40 hour working week to which most workers may be repeatedly exposed, day after day, without adverse effect.
Open path	Open Path gas detectors are comprised of a transmitter and receiver, separated by a range. The transmitter sends out a beam of Infrared light, detecting gas anywhere along the path between the transmitter and receiver. The path can be anywhere from a few metres to a few hundred metres in length.
OSHA	Occupational Safety and Health Association.
Oxygen deficiency	Concentrations of Oxygen less than 20.9% V/V.
Oz	Ounce (weight).
Peak	The maximum or minimum measurement since switch on.
Perimeter monitoring	Monitoring the outer edge of a plant or storage area as opposed to monitoring specific points.
Pellistor	Registered trade name for a commercial device – a very small sensing element used in catalytic sensors and sometimes also called a 'bead' or a 'siegestor'.
PLC	Programmable Logic Controller.

Glossary continued

PELs	Permissible Exposure Limits (OSHA).
Point detection	Detecting or measuring gas at a fixed point/position.
Poison resistant	Capability of a catalytic sensor to reduce the effect of inhibiting substances or contaminants, such as silicones.
PPB	Parts per billion concentrations in the atmosphere.
PPM	Parts per million concentrations in the atmosphere.
PTB	Physikalisch Technische Bundesanstalt.
RELs	Recommended Exposure Levels (NIOSH).
Response curve	The line that shows detector response to gas at points over time.
Retro reflector	Reflecting panel that returns an infrared signal.
RFI	Radio Frequency Interference.
RH	Relative Humidity.
RS485/232/422	Digital communication protocols.
SAA	Standards Australia Quality Assurance Services Pty Ltd. Australian safety certification.
Safe area	Work area in which there is no danger of contamination with explosive gases.
Semiconductor sensor	Type of sensor that uses semiconductor material in construction.
SIL	Safety Integrity Levels.
Single channel	One point of gas detection.
Sira	Sira Test and Certification Service (UK).
Smart	Used to describe a sensor with a processor that communicates a signal and is able to execute logical functions.
Span	The level at which calibration is made (typically 50% of full scale).
STEL	Short Term Exposure Limit, usually monitored over 15 minute periods.
T90	Time taken for a detector to reach 90% of its final reading.
T60	Time taken for a detector to reach 60% of its final reading.
Temperature classification/class	Relates to the maximum surface temperature apparatus is allowed to have. This is to ensure that a device cannot match or exceed the ignition temperature of the gases or vapours that may be present in the environment.
Thermal conductivity	Method of detecting the level of gas using its properties of thermal conductivity.
TLV	Threshold Limit Value.
TWA	Time-Weighted Average.
UEL	Upper Exposure Limit.
UL	Underwriters Laboratories (USA).
%VOL	Concentration of explosive gas, measured in percentage by volume.
V/V	Another way of representing %VOL.
Vapour density	A measure of the density of gas or vapour relative to air. Gases or vapours with a vapour density less than 1 are lighter than air.
WELs	Work Exposure Limits (EH40).
Zone	Area classification of a hazardous area (Zone 0, 1 or 2) that defines the length of time a hazard is present. Mainly used in Europe.

Find out more

www.honeywellanalytics.com

Contact Honeywell Analytics:

Europe, Middle East, Africa, India

Life Safety Distribution AG
Javastrasse 2
8604 Hegnau
Switzerland
Tel: +41 (0)44 943 4300
Fax: +41 (0)44 943 4398
India Tel: +91 124 4752700
gasdetection@honeywell.com

Americas

Honeywell Analytics Inc.
405 Barclay Blvd.
Lincolnshire, IL 60069
USA
Tel: +1 847 955 8200
Toll free: +1 800 538 0363
Fax: +1 847 955 8210
detectgas@honeywell.com

Asia Pacific

Honeywell Analytics Asia Pacific
#701 Kolon Science Valley (1)
43 Digital-Ro 34-Gil, Guro-Gu
Seoul 152-729
Korea
Tel: +82 (0)2 6909 0300
Fax: +82 (0)2 2025 0328
analytics.ap@honeywell.com

Technical Services

EMEA: HAexpert@honeywell.com
US: ha.us.service@honeywell.com
AP: ha.ap.service@honeywell.com

www.honeywell.com

Please Note:

While every effort has been made to ensure accuracy in this publication, no responsibility can be accepted for errors or omissions. Data may change, as well as legislation, and you are strongly advised to obtain copies of the most recently issued regulations, standards, and guidelines. This publication is not intended to form the basis of a contract.

