

Contents

Motorcycle Safety P. 2

Operation Guide P. 16

Maintenance P. 57

Troubleshooting P. 108

Information P. 127

Specifications P. 151

Index P. 155

Welcome

Congratulations on your purchase of a new Honda motorcycle. Your selection of a Honda makes you part of a worldwide family of satisfied customers who appreciate Honda's reputation for building quality into every product.

To ensure your safety and riding pleasure:

- Read this owner's manual carefully.
- Follow all recommendations and procedures contained in this manual.
- Pay close attention to safety messages contained in this manual and on the motorcycle.

To protect your investment, we urge you to take responsibility for keeping your motorcycle well serviced and maintained. Also, observe the break-in guidelines, and always perform the pre-ride inspection and other periodic checks in this manual.

When service is required, remember that your Honda dealer knows your motorcycle best. If you have the required mechanical "know-how" and tools, you can purchase an official Honda Service Manual to help you perform many maintenance and repair tasks.

➤ P. 145

Read the warranty information thoroughly so that you understand the warranty coverage and that you are aware of your rights and responsibilities. ➤ P. 146

You may also want to visit our website at www.powersports.honda.com.

Canada www.honda.ca

Happy riding!

A Few Words About Safety

Your safety, and the safety of others, is very important. Operating this motorcycle safely is an important responsibility.

To help you make informed decisions about safety, we have provided operating procedures and other information on safety labels and in this manual. This information alerts you to potential hazards that could hurt you or others.

Of course, it is not practical or possible to warn you about all hazards associated with operating or maintaining a motorcycle. You must use your own good judgment.

You will find important safety information in a variety of forms, including:

- Safety labels on the motorcycle
- Safety Messages preceded by a safety alert symbol  and one of three signal words: DANGER, WARNING, or CAUTION.

These signal words mean:

DANGER

You **WILL** be **KILLED** or **SERIOUSLY HURT** if you don't follow instructions.

WARNING

You **CAN** be **KILLED** or **SERIOUSLY HURT** if you don't follow instructions.

CAUTION

You **CAN** be **HURT** if you don't follow instructions.

Other important information is provided under the following titles:

NOTICE Information to help you avoid damage to your motorcycle, other property, or the environment.

Motorcycle Safety

This section contains important information for safe riding of your motorcycle.
Please read this section carefully.

Safety Guidelines	P. 3
Safety Labels	P. 7
Safety Precautions	P. 9
Riding Precautions	P. 10
Accessories & Modifications	P. 14
Loading	P. 15

Safety Guidelines

Follow these guidelines to enhance your safety:

- Perform all routine and regular inspections specified in this manual.
- Stop the engine and keep sparks and flame away before filling the fuel tank.
- Do not run the engine in enclosed or partly enclosed areas. Carbon monoxide in exhaust gases is toxic and can kill you.

Always Wear a Helmet

It's a proven fact: helmets and protective apparel significantly reduce the number and severity of head and other injuries. So always wear an approved motorcycle helmet and protective apparel. 📖 P. 9

Before Riding

Make sure that you are physically fit, mentally focused and free of alcohol and drugs. Check

that you and your passenger are both wearing an approved motorcycle helmet and protective apparel. Instruct your passenger on holding onto the seat strap or your waist, leaning with you in turns, and keeping their feet on the footpegs, even when the motorcycle is stopped.

Take Time to Learn & Practice

Even if you have ridden other motorcycles, practice riding in a safe area to become familiar with how this motorcycle works and handles, and to become accustomed to the motorcycle's size and weight.

We recommend that all riders take a certified course approved by the Motorcycle Safety Foundation (MSF). New riders should start with the basic course, and even experienced riders will find the advanced course beneficial. For information about the MSF training course nearest you, call the national toll-free number: (800) 446-9227.

Safety Guidelines

USA Other riding tips can be found in the You and Your Motorcycle Riding Tips booklet that came with your motorcycle.

Ride Defensively

Always pay attention to other vehicles around you, and do not assume that other drivers see you. Be prepared to stop quickly or perform an evasive maneuver.

Make Yourself Easy to See

Make yourself more visible, especially at night, by wearing bright reflective clothing, positioning yourself so other drivers can see you, signaling before turning or changing lanes, and using your horn when necessary.

Ride within Your Limits

Never ride beyond your personal abilities or faster than conditions warrant. Fatigue and inattention can impair your ability to use good judgment and ride safely.

Don't Drink and Ride

Alcohol and riding don't mix. Even one alcoholic drink can reduce your ability to respond to changing conditions, and your reaction time gets worse with every additional drink. Don't drink and ride, and don't let your friends drink and ride either.

Keep Your Honda in Safe Condition

It's important to keep your motorcycle properly maintained and in safe riding condition. Inspect your motorcycle before every ride and perform all recommended maintenance. Never exceed load limits (➤ P. 15), and do not modify your motorcycle or install accessories that would make your motorcycle unsafe (➤ P. 14).

If You are Involved in a Crash

Personal safety is your first priority. If you or anyone else has been injured, take time to assess the severity of the injuries and whether it is safe to continue riding. Call for emergency assistance if needed. Also follow applicable laws and regulations if another person or vehicle is involved in the crash.

If you decide to continue riding, first turn the ignition switch to the OFF position, and evaluate the condition of your motorcycle. Inspect for fluid leaks, check the tightness of critical nuts and bolts, and check the handlebar, control levers, brakes, and wheels. Ride slowly and cautiously.

Your motorcycle may have suffered damage that is not immediately apparent. Have your motorcycle thoroughly checked at a qualified service facility as soon as possible.

Carbon Monoxide Hazard

Exhaust contains poisonous carbon monoxide, a colorless, odorless gas. Breathing carbon monoxide can cause loss of consciousness and may lead to death.

If you run the engine in confined or even partly enclosed area, the air you breathe could contain a dangerous amount of carbon monoxide.

Never run your motorcycle inside a garage or other enclosure.

WARNING

Running the engine of your motorcycle while in an enclosed or even partially enclosed area can cause a rapid build-up of toxic carbon monoxide gas.

Breathing this colorless, odorless gas can quickly cause unconsciousness and lead to death.

Only run your motorcycle's engine when it is located in a well ventilated area outdoors.

Safety Labels

Safety and information labels on your motorcycle provide important safety information and may warn you of potential

hazards that could cause serious injury. Read these labels carefully and don't remove them. If a label comes off or becomes hard to read, contact your dealer for a replacement.

⚠ WARNING

Improper loading can cause a crash and you may be seriously hurt or killed. See "Load Limits and Guidelines" in your Owner's Manual for complete instructions.

For your protection, always wear your helmet while riding. Read the owner's manual carefully.

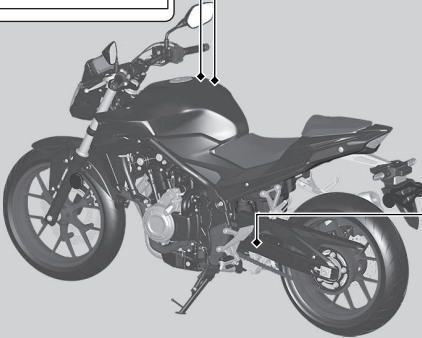

TIRE INFORMATION			
Cold tire pressures	Front	kPa	kgf/cm ² psi
Up to maximum weight capacity	Front	250	2.50 36
	Rear	250	2.50 36
Up to 90kg(200lbs) load	Front	250	2.50 36
	Rear	250	2.50 36
Tire size	Front	120/70ZR17M/C(58W)	
	Rear	160/70R17M/C(69W)	
Minimum recommend tire center tread depth	Front	1.6mm (0.06in.)	
	Rear	2.0mm (0.08in.)	
Maximum weight capacity		165kg(365lbs)	

DRIVE CHAIN	
Keep chain adjusted and lubricated.	
30 mm (1 1/4 in.) Freeply	
	
Read owner's manual.	

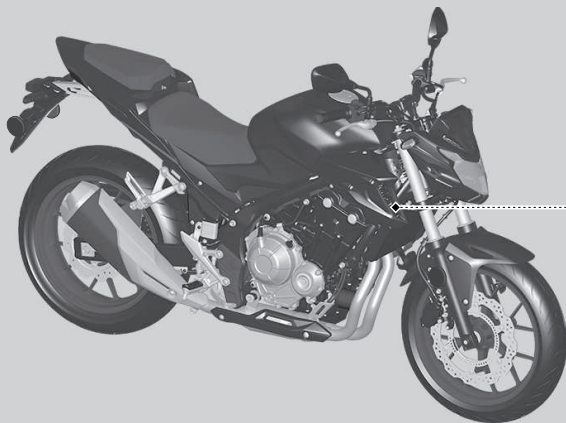

Safety Precautions

- Ride cautiously and keep your hands on the handlebar and feet on the footpegs.
- Keep passenger's hands onto the seat strap or your waist, passenger's feet on the footpegs while riding.
- Always consider the safety of your passenger, as well as other drivers and riders.

Protective Apparel

Make sure that you and any passenger are wearing an approved motorcycle helmet, eye protection, and high-visibility protective clothing. Ride defensively in response to weather and road conditions.

■ Helmet

Should be safety-standard certified, high-visibility, and correct size for your head

- Must fit comfortably but securely, with the chin strap fastened.

- Face shield with unobstructed field of vision or other approved eye protection

USA Look for a DOT (Department of Transportation) certification label on any helmet you buy.

⚠ WARNING

Not wearing a helmet increases the chance of serious injury or death in a crash.

Make sure that you and any passenger always wear an approved helmet and protective apparel.

■ Gloves

Full-finger leather gloves with high abrasion resistance

■ Boots or Riding Shoes

Sturdy boots with non-slip soles and ankle protection

Riding Precautions

Jacket and Pants

Protective, highly visible, long-sleeved jacket and durable long pants for riding (or a protective suit)

Riding Precautions

Break-in Period

During the first 300 miles (500 km) of running, follow these guidelines to ensure your motorcycle's future reliability and performance.

- Avoid full-throttle starts and rapid acceleration.
- Avoid hard braking and rapid down-shifts.
- Ride conservatively.

Brakes

Observe the following guidelines:

- Avoid excessively hard braking and downshifting.
 - ▶ Sudden braking can reduce the motorcycle's stability.
 - ▶ Where possible, reduce speed before turning; otherwise you risk sliding out.

- Exercise caution on low traction surfaces.
 - ▶ The tires slip more easily on such surfaces and braking distances are longer.
- Avoid continuous braking.
 - ▶ Repeated braking, such as when descending long, steep slopes can seriously overheat the brakes, reducing their effectiveness. Use engine braking with intermittent use of the brakes to reduce speed.
- For full braking effectiveness, operate both the front and rear brakes together.

Anti-lock Brake System (ABS)

CB500FA only

This model is equipped with an Anti-lock Brake System (ABS) designed to help prevent the brakes from locking up during hard braking.

- ABS does not reduce braking distance. In certain circumstances, ABS may result in a longer stopping distance.
- ABS does not function at speeds below 6 mph (10 km/h).
- The brake lever and pedal may recoil slightly when applying the brakes. This is normal.
- Always use the recommended front/rear tires and sprockets to ensure correct ABS operation.

Riding Precautions

■ Engine Braking

Engine braking helps slow your motorcycle down when you release the throttle. For further slowing action, downshift to a lower gear. Use engine braking with intermittent use of the brakes to reduce speed when descending long, steep slopes.

■ Wet or Rainy Conditions

Road surfaces are slippery when wet, and wet brakes further reduce braking efficiency. Exercise extra caution when braking in wet conditions.

If the brakes get wet, apply the brakes while riding at low speed to help them dry.

Parking

- Park on a firm, level surface.
- If you must park on a slight incline or loose surface, park so that the motorcycle cannot move or fall over.
- Make sure that high-temperature parts cannot come into contact with flammable materials.
- Do not touch the engine, muffler, brakes and other high-temperature parts until they cool down.
- To reduce the likelihood of theft, always lock the handlebar and remove the key when leaving the motorcycle unattended. Use of an anti-theft device is also recommended.

■ Parking with the Side Stand

1. Stop the engine.
2. Push the side stand down.

3. Slowly lean the motorcycle to the left until its weight rests on the side stand.
4. Turn the handlebar fully to the left.
 - ▶ Turning the handlebar to the right reduces stability and may cause the motorcycle to fall.
5. Turn the ignition switch to the LOCK position and remove the key. 📄 P. 50

Refueling and Fuel Guidelines

Follow these guidelines to protect the engine, fuel system and catalytic converter:

- Use only unleaded gasoline.
- Use recommended octane number. Using lower octane gasoline will result in decreased engine performance.
- Do not use fuels containing a high concentration of alcohol. 📄 P. 144
- Do not use stale or contaminated gasoline or an oil/gasoline mixture.
- Avoid getting dirt or water in the fuel tank.

Accessories & Modifications

We strongly advise that you do not add any accessories that were not specifically designed or approved for your motorcycle by Honda or make modifications to your motorcycle from its original design. Doing so can make it unsafe. Modifying your motorcycle may also void your warranty and make your motorcycle illegal to operate on public roads. Before deciding to install accessories on your motorcycle be certain the modification is safe and legal.

WARNING

Improper accessories or modifications can cause a crash in which you can be seriously hurt or killed.

Follow all instructions in this owner's manual regarding accessories and modifications.

Do not pull a trailer with, or attach a sidecar to, your motorcycle. Your motorcycle was not designed for these attachments, and their use can seriously impair your motorcycle's handling.

Loading

- Carrying extra weight affects your motorcycle's handling, braking and stability. Always ride at a safe speed for the load you are carrying.
- Avoid carrying an excessive load and keep within specified load limits.
Maximum weight capacity ➤ P. 151
- Tie all luggage securely, evenly balanced and close to the center of the motorcycle.
- Do not place objects near the lights or the muffler.

WARNING

Overloading or improper loading can cause a crash and you can be seriously hurt or killed.

Follow all load limits and other loading guidelines in this manual.

Parts Location

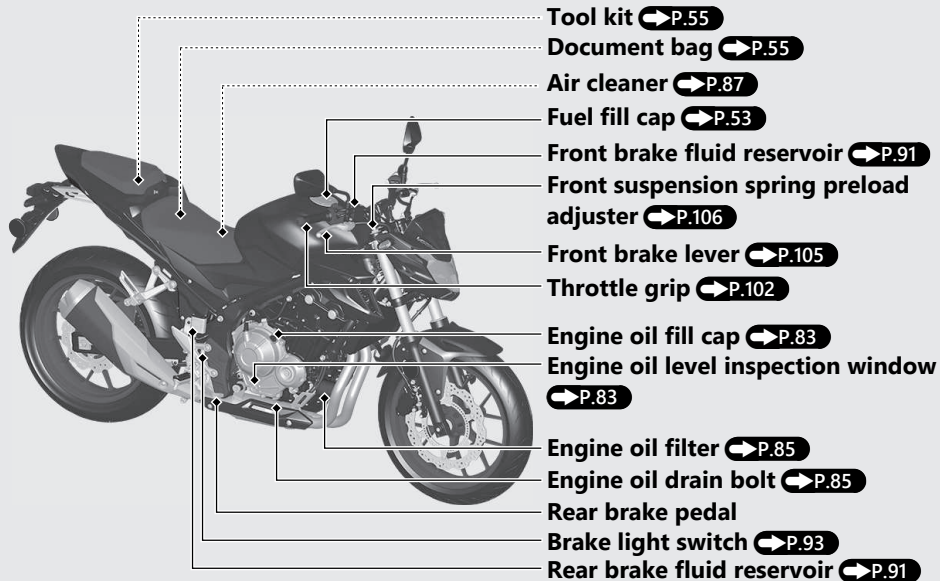

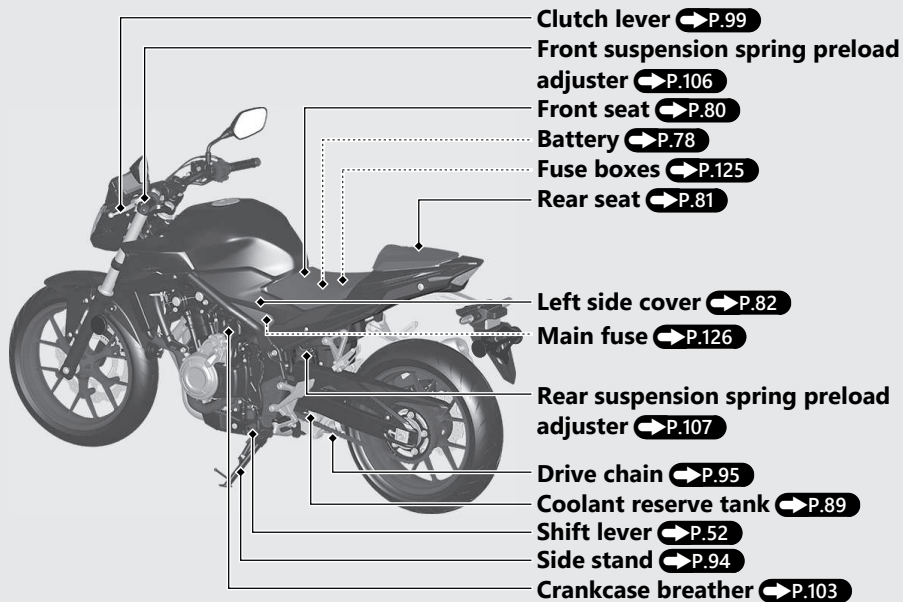

Instruments

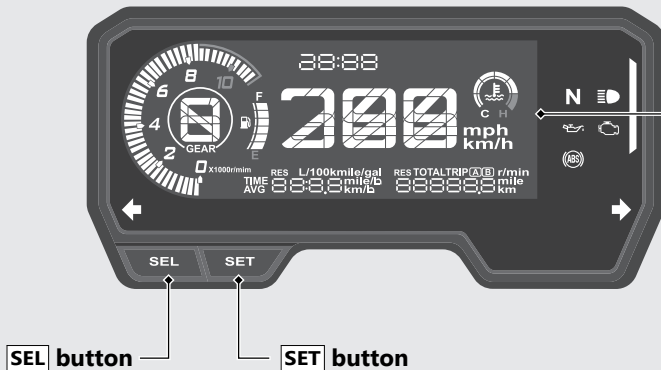

Display Check

When the ignition switch is turned to the ON position, initial animation will show. If any part of these displays does not come on when it should, have your dealer check for problems.

Tachometer red zone
(excessive engine rpm range)

Clock (12-hour or 24-hour display)
To set the clock: P.31

Speedometer



Tachometer

Section B display P.25

Section A display P.21

NOTICE

Do not operate the engine in the tachometer red zone. Excessive engine speed can adversely affect engine life.

Instruments *(Continued)*

Coolant temperature gauge

When the coolant is over specified temperature, the segment H flashes.

If the segment H flashes while riding: →P.110

If the coolant temperature gauge indicator flashes: →P.114



Gear position indicator

The gear position is shown in the gear position indicator.

- ▶ "-" appears when the transmission is not shifted properly.

Fuel gauge

Remaining fuel when only 1st (E) segment starts flashing:
approximately 0.85 US gal (3.2 L)

If the fuel gauge indicator flashes in a repeat pattern or turns off: →P.113



Section A display

You can select the following:

- Current fuel mileage
- Average fuel mileage [AVG]
- Fuel consumption
- Average speed [AVG]
- Elapsed time [TIME]
- Reserve fuel consumption [RES]

Changing the section A display

With the **[SEL]** button, you can switch the section A display between the current fuel mileage, average fuel mileage, fuel consumption, average speed, elapsed time, and reserve fuel consumption.

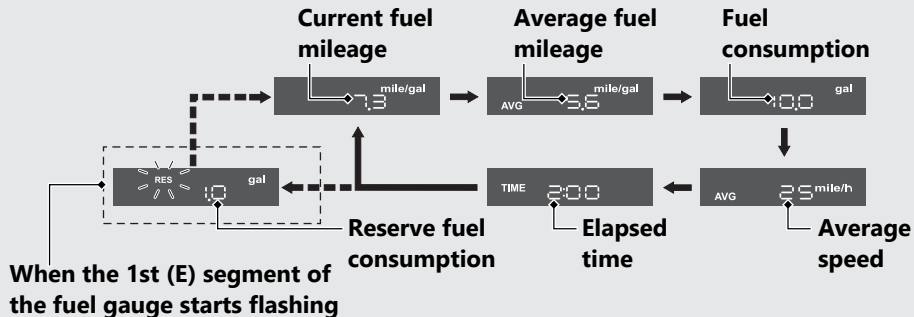

When the 1st (E) segment of the fuel gauge starts flashing, the current fuel mileage, average fuel mileage, fuel consumption, average speed or elapsed time switches to the reserve fuel consumption.

Instruments *(Continued)*

Current fuel mileage

Displays the current instant fuel mileage.

Display range: 0.0 to 300.0 mile/gal (L/100 km or km/L)

- More than 300.0 mile/gal (L/100 km or km/L): "300.0" is displayed.
- When your speed is less than 4 mph (6 km/h): "---.-" is displayed.

When "---.-" is displayed except for the above-mentioned cases, go to your dealer for service.

Average fuel mileage [AVG]

Displays the average fuel mileage since the selected tripmeter was reset.

The average fuel mileage will be calculated based on value displayed on the tripmeter (A or B) selected.

Also, the average fuel mileage for tripmeter A will be displayed when the odometer, tripmeter A, numerical tachometer and reserve tripmeter are selected.

Display range: 0.0 to 300.0 mile/gal (L/100 km or km/L)

- More than 300.0 mile/gal (L/100 km or km/L): "300.0" is displayed.
- When the tripmeter A or B is reset: "---.-" is displayed.

When "---.-" is displayed except for the above-mentioned cases, go to your dealer for service.

To reset the average fuel mileage:

 P.27

■ Fuel consumption

Displays the fuel consumption since the selected tripmeter was reset.

The fuel consumption will be calculated based on value displayed on the tripmeter (A or B) selected.

Also, the fuel consumption for tripmeter A will be displayed when the odometer, tripmeter A, numerical tachometer and reserve tripmeter are selected.

Display range: 0.0 to 300.0 gal (gallon) or 0.0 to 300.0 L (liters)

- More than 300.0 gal (gallon) or 300.0 L (liters): "300.0" is displayed.

When "---.-" is displayed, go to your dealer for service.

To reset the fuel consumption:  **P.27**

■ Average speed [AVG]

Displays the average speed since the selected tripmeter was reset.

The average speed will be calculated based on value displayed on the tripmeter (A or B) selected.

Also, the average speed for tripmeter A will be displayed when the odometer, tripmeter A, numerical tachometer and reserve tripmeter are selected.

Display range: 0 to 185 mile/h (0 to 299 km/h)

- Initial display: "---" is displayed.
- When your motorcycle has traveled less than 0.12 mile (0.2 km) since the engine was started: "---" is displayed.
- When your motorcycle operating time is less than 30 seconds since the engine was started: "---" is displayed.

Instruments *(Continued)*

When “---” is displayed except for the above-mentioned cases, go to your dealer for service.

To reset the average speed: ➡ P.27

Elapsed time [TIME]

Displays the operating time since the selected tripmeter was reset.

The elapsed time will be calculated based on value displayed on the tripmeter (A or B) selected.

Also, the elapsed time for tripmeter A will be displayed when the odometer, tripmeter A, numerical tachometer and reserve tripmeter are selected.

Display range: 0:00 to 99:59 (hours:minutes)

- The elapsed time return to 0:00 when the readout exceeds 99:59.

To reset the elapsed time: ➡ P.27

Reserve fuel consumption [RES]

Displays the fuel consumption since the 1st (E) segment of the fuel gauge starts flashing. When the 1st (E) segment of the fuel gauge starts flashing, the current fuel mileage, average fuel mileage, fuel consumption, average speed or elapsed time switch to the reserve fuel consumption. You should refill the tank as soon as possible.

- Flashes from “0.0” gal or L.
 - ▶ When the amount of consumed fuel is more than 0.26 US gal (1.0 L), the “RES” mark on the display blinks faster.

After refueling more than the reserve amount, the display returns to normal.

Section B display

You can select the following:

- Odometer [TOTAL]
- Tripmeter [TRIP A/B]
- Numerical tachometer
- Reserve tripmeter [RES]

Changing the section B display

With the **SET** button, you can switch the section B display between the odometer, tripmeter A, tripmeter B, numerical tachometer, and reserve tripmeter.

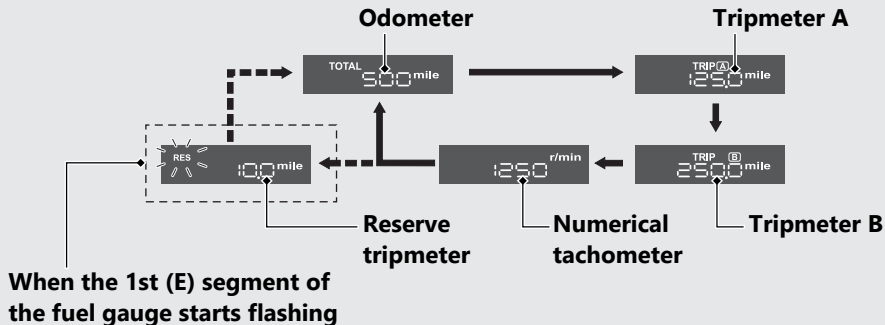

When the 1st (E) segment of the fuel gauge starts flashing, the odometer, tripmeters or numerical tachometer switches to the reserve tripmeter.

Instruments *(Continued)*

Odometer [TOTAL]

Total distance ridden.

When "-----" is displayed, go to your dealer for service.

Tripmeter [TRIP A/B]

Distance ridden since tripmeter was reset.

When "-----.-" is displayed, go to your dealer for service.

To reset the tripmeter:  **P.27**

Numerical tachometer

Displays the engine revolutions per minutes digit.

Display range: 0 to 15,000 r/min

- More than 15,000 r/min: "15,000" is displayed.

Reserve tripmeter [RES]

Distance ridden since the 1st (E) segment of the fuel gauge starts flashing.

When the 1st (E) segment of the fuel gauge starts flashing, the odometer, tripmeters or numerical tachometer switch to the reserve tripmeter. You should refill the tank as soon as possible.

When "----.-" is displayed, go to your dealer for service.

After refueling more than the reserve amount, the display returns to normal.

To reset the tripmeter [TRIP A/B], average fuel mileage [AVG], fuel consumption, average speed [AVG] and elapsed time

To reset the tripmeter A, average fuel mileage A, fuel consumption A, average speed A and elapsed time A (these are based on tripmeter A) together, press and hold the **SET** button while tripmeter A is displayed.

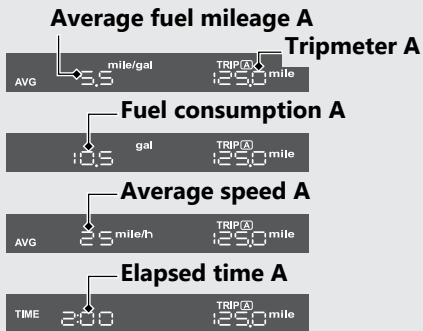

When they are reset, reset display appears at each indication. Then, the display returns to the last selected indication.

Also, the tripmeter A, average fuel mileage, fuel consumption, average speed and elapsed time will be automatically reset by refueling more than the reserve amount and riding your motorcycle for 0.06 mile (0.1 km). You can activate or deactivate the automatic reset mode by refueling. **➡ P.33**

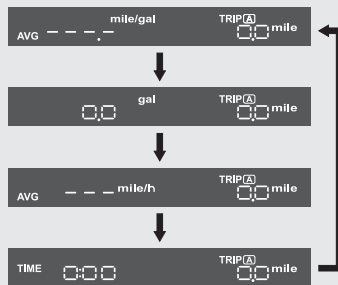

Instruments *(Continued)*

To reset the tripmeter B, average fuel mileage B, average fuel consumption B, average speed B and elapsed time B (these are based on tripmeter B) together, press and hold the **SET** button while tripmeter B is displayed.

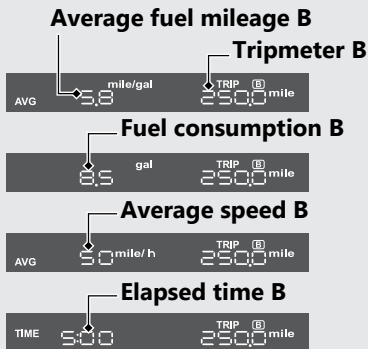

When they are reset, reset display appears at each indication. Then, the display returns to the last selected indication.

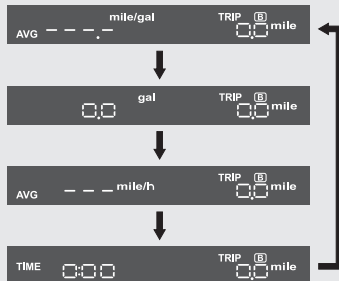

Display Setting Setting Mode A

Following items can be changed sequentially.

➡ P.30

- Time format setting
- Clock setting
- Backlight brightness adjustment
- Activating/deactivating of tripmeter A, average fuel mileage, fuel consumption, average speed and elapsed time automatic reset mode
- Changing the speed and mileage unit
- Changing the fuel mileage meter unit (only when km unit system is selected)

Setting Mode B

Following items can be changed sequentially.

➡ P.35

- Setting of REV indicator
 - RPM setting
 - Interval RPM setting
 - Brightness adjustment
- Changing of tachometer display mode

Instruments *(Continued)*

Setting Mode A

If the buttons are not pressed for about 30 seconds, the control is automatically switched from the setting mode to the ordinary display.

If the buttons are not pressed for about 30 seconds, items in the process of being set will be discarded and only items that were set and finalized will be applied. Only if the ignition switch is turned to the OFF position, items in the process of being set and those that are finalized will be applied.

➡ Press and hold **SEL** and **SET** buttons

⇨ Press the **SET** button

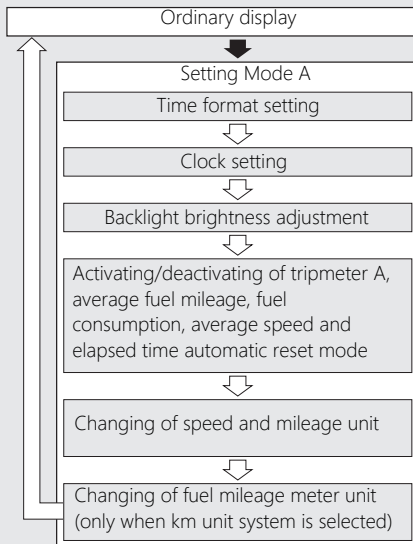

1 Time format setting:

You can switch the time format between 12 hour format or 24 hour format.

- 1 Turn the ignition switch to the ON position.
- 2 Press and hold **SEL** and **SET** buttons until the current time format start flashing.



- 3 Press **SEL** button to select "12hr" or "24hr".



- 4 Press **SET** button. The time format is set, and then the display moves to the clock setting.

2 Clock setting:

- 1 Press **SEL** button until the desired hour is displayed.
 - ▶ Press and hold **SEL** button to advance the hour quickly.



- 2 Press **SET** button. The minute digits start flashing.



Instruments *(Continued)*

- 3 Press **SEL** button until the desired minute is displayed.
- ▶ Press and hold **SEL** button to advance the minute quickly.

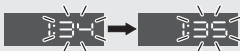

- 4 Press **SET** button. The clock is set, and then the display moves to the backlight brightness adjustment.

3 Backlight brightness adjustment:

You can adjust the brightness to one of five levels.

- 1 Press **SEL** button. The brightness level is switched.
- ▶ You can adjust the brightness level from five levels.



- 2 Press **SET** button. The backlight is set, and then the display moves to the activating/deactivating of tripmeter A, average fuel mileage, fuel consumption, average speed and elapsed time automatic reset mode

4 Activating/deactivating of tripmeter A, average fuel mileage, fuel consumption, average speed and elapsed time automatic reset mode:

You can activate or deactivate the automatic reset mode by refueling after the 1st (E) segment of the fuel gauge starts flashing. Initial setting is activation.

- 1 Press **SEL** button to select "On" (activate) or "OFF" (deactivate) in the automatic reset mode.



- 2 Press **SET** button. The activation/deactivation of automatic reset mode is set, and then the display moves to the changing of speed and mileage unit..

5 Changing of speed and mileage unit:

- 1 Press the **SEL** button to select either "mph" and "mile" or "km/h" and "km" .

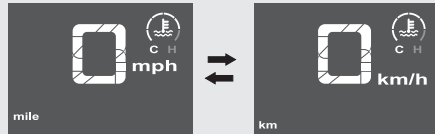

- 2 When the "km/h" for speed and "km" for mileage are selected

Press the **SET** button. The speed and mileage unit is set, and then the display moves to the changing of fuel mileage meter unit.

When the "mph" for speed and "mile" for mileage are selected

Press **SET** button. The speed and mileage unit is set, and then the display moves to the ordinary display.

Instruments *(Continued)*

6 Changing the fuel mileage meter unit:

- 1 Press **SEL** button to select "L/100km" or "km/L".



- 2 Press **SET** button. The fuel mileage meter unit is set, and then the display moves to the ordinary display.

Setting Mode B

If the buttons are not pressed for about 30 seconds, the control is automatically switched from the setting mode to the ordinary display.

If the buttons are not pressed for about 30 seconds, items in the process of being set will be discarded and only items that were set and finalized will be applied. Only if the ignition switch is turned to the OFF position, items in the process of being set and those that are finalized will be applied.

➡ Press and hold the **SEL** button and ignition switch to the ON position until the initial animation ends

➡ Press the **SET** button

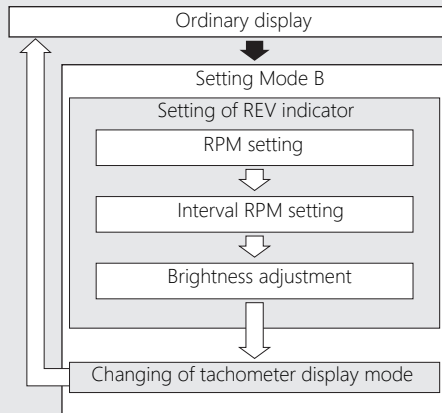

Instruments *(Continued)*

1 Setting of REV indicator:

You can change the setting of the REV indicator.

REV indicator blinks during setting.

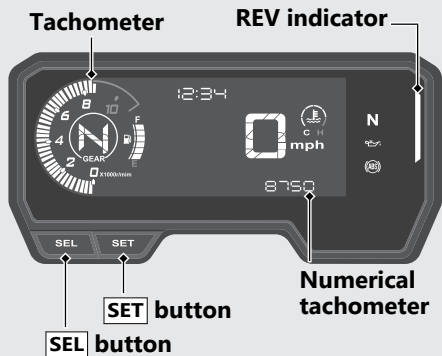

- 1 To change the setting mode B, turn the ignition switch to the ON position while pressing **[SEL]** button until the initial animation ends. The display moves to the setting of "REV indicator blinking fastest RPM". At the same time, the numerical tachometer and the blinking bar segments show the current settings of the "REV indicator blinking fastest RPM".

► Tachometer bar blinks only while setting of REV indicator.

- 2 Each time **SEL** button is pressed, the "REV indicator blinking fastest RPM" setting value will be increased by one segment (250 r/min (rpm)). When the "REV indicator blinking fastest RPM" setting value exceeds 8,750 r/min (rpm), the "REV indicator blinking fastest RPM" setting value automatically returns to 5,000 r/min (rpm).

- ▶ Press and hold **SEL** button to advance the "REV indicator blinking fastest RPM" setting value quickly.

Available Setting Range

5,000 r/min (rpm) to 8,750 r/min (rpm)

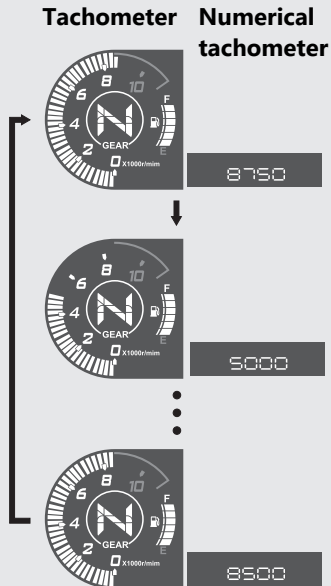

Instruments *(Continued)*

- 3 Press **SET** button. The "REV indicator blinking fastest RPM" is set, and then the display moves to the setting of "REV indicator blinking interval RPM". At the same time, the numerical tachometer shows the current "REV indicator blinking interval RPM" and the blinking bar segment show the current settings of the "REV indicator blinking fastest RPM".

- 4 Each time **SEL** button is pressed, the numbers of the "REV indicator blinking interval RPM" advances as following: 250 r/min (rpm), 500 r/min (rpm), 750 r/min (rpm), 1,000 r/min (rpm) and 0 r/min (rpm).

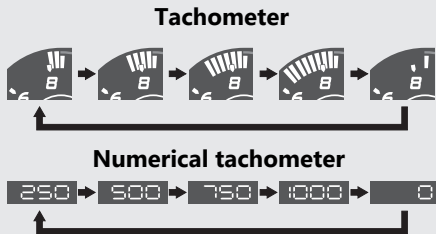

Example: REV indicator blinking fastest
 RPM: 8,750 r/min (rpm)
 REV indicator blinking interval
 RPM: 250 r/min (rpm)

REV indicator	r/min (rpm)
Blinking	8,250 r/min (rpm)
Blinking fast	8,500 r/min (rpm)
Blinking fastest	8,750 r/min (rpm)

If the "REV indicator blinking interval RPM" is 0, the REV indicator blinks when reaching the "REV indicator blinking fastest RPM" setting value.

- Press **SET** button. The "REV indicator blinking interval RPM" is set, and then the display moves to the brightness adjustment of the REV indicator. The REV indicator switches from blinking to lighting.
- Press **SEL** button. The brightness level is switched.
 - You can adjust the brightness level from five levels.



- Press **SET** button. The brightness of the REV indicator is set, and then the display moves to the display setting of the tachometer.

Instruments *(Continued)*

2 Changing of tachometer display mode:

You can change the display mode of the tachometer.

- 1 Press **SEL** button to switch the display mode of tachometer.
- 2 Press **SET** button. The currently selected display mode is set, and then the display moves to the ordinary display.

Conventional display

Shows the engine RPM on the tachometer bar segment.

Peak hold display

Shows the engine RPM on the tachometer bar segment and peak hold segment.

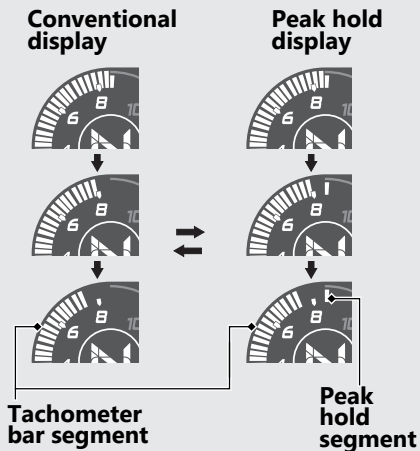

The peak hold segment keeps to show the maximum engine RPM temporarily.

Example: Engine revolutions per minutes
8,750 r/min (rpm)

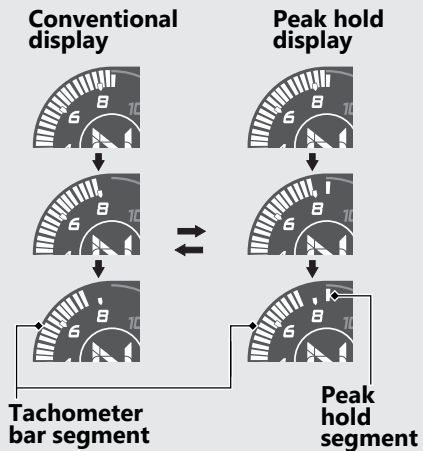

Indicators

If one of these indicators does not come on when it should, have your dealer check for problems.

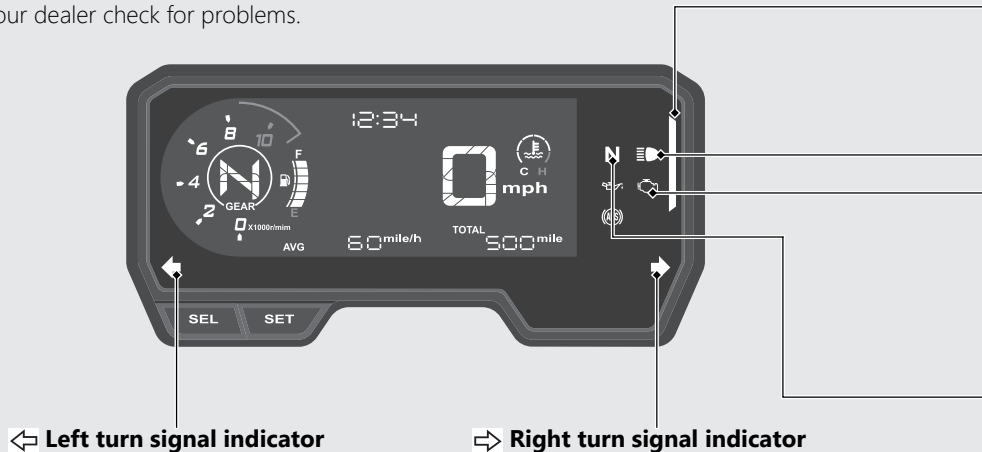

REV indicator  P.36

 **High beam indicator**

 **PGM-FI (Programmed Fuel Injection) malfunction indicator lamp (MIL)**

Comes on briefly when the ignition switch is turned to the ON position with the engine stop switch in the  (Run) position.

If it comes on while engine is running:  P.111

 **Neutral indicator**

Comes on when the transmission is in Neutral.

Indicators *(Continued)*

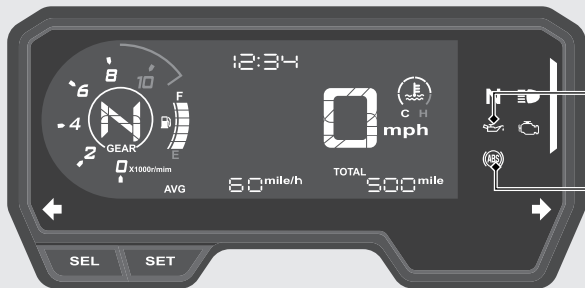

 **Low oil pressure indicator**

- Comes on when the ignition switch is turned to the ON position.
- Goes off when the engine starts.

If it comes on while engine is running: ➔ P.111

 **ABS (Anti-lock Brake System) indicator**

CB500FA only

- Comes on briefly when the ignition switch is turned to the ON position.
- Goes off when your speed reaches approximately 6 mph (10 km/h).

If it comes on while riding: ➔ P.112

Indicators *(Continued)*

REV Indicator

- Comes on briefly when the ignition switch is turned to the ON position.

Initial setting

REV indicator blinking fastest RPM: 8,750 r/min (rpm)

REV indicator blinking interval RPM: 250 r/min (rpm)

REV indicator	r/min (rpm)
Blinking	8,250 r/min (rpm)
Blinking fast	8,500 r/min (rpm)
Blinking fastest	8,750 r/min (rpm)

To set the shift up rev setting: ➡ P.36

To set the shift width setting: ➡ P.38

Switches

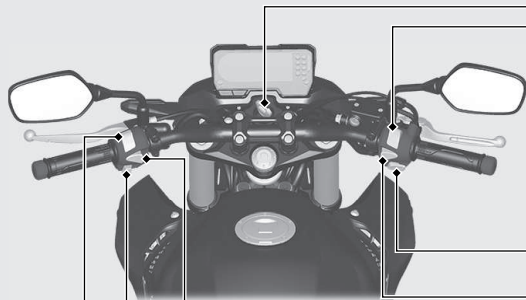



 **Horn button**

 **Turn signal switch**

▶ Pressing the switch turns the turn signal off.

Headlight dimmer switch

-  : High beam
-  : Low beam

Engine stop switch

Should normally remain in the  (Run) position.

▶ In an emergency, switch to the  (Stop) position (the starter motor will not operate) to stop the engine.

 **Start button**

 **Hazard switch**

Switchable when the ignition switch is in the ON position.

Ignition Switch

Switches the electrical system on/off, locks the steering.

- Key can be removed when in the OFF or LOCK position.

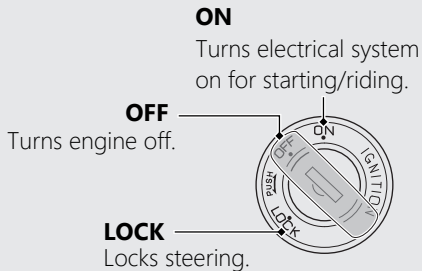

Switches *(Continued)*

Steering Lock

Lock the steering when parking to help prevent theft.

A U-shaped wheel lock or similar device is also recommended.

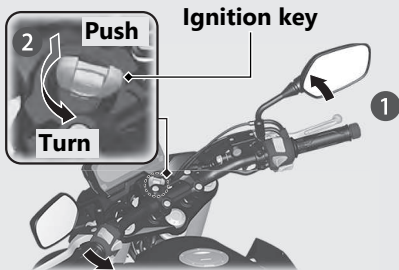

Locking

- 1 Turn the handlebar all the way to the left.
- 2 Push the key down, and turn the ignition switch to the LOCK position.
 - ▶ Jiggle the handlebar if the lock is difficult to engage.
- 3 Remove the key.

Unlocking

Insert the key, push it in, and turn the ignition switch to the OFF position.

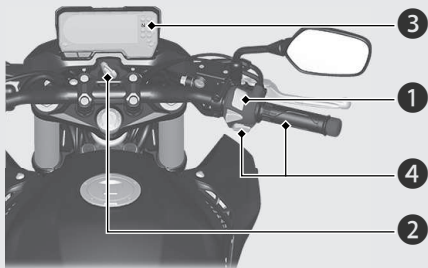

Starting the Engine

Start your engine using the following procedure, regardless of whether the engine is cold or warm.



NOTICE

- If the engine does not start within 5 seconds, turn the ignition switch to the OFF position and wait 10 seconds before trying to start the engine again to recover battery voltage.
- Extended fast idling and reving the engine can damage the engine, and the exhaust system.
- Snapping the throttle or fast idling for more than about 5 minutes may cause exhaust pipe discoloration.
- The engine will not start if the throttle is fully open.

- ① Make sure the engine stop switch is in the  (Run) position.
- ② Turn the ignition switch to the ON position.
- ③ Shift the transmission to Neutral ( indicator comes on). Alternatively, pull in the clutch lever to start your motorcycle with the transmission in gear so long as the side stand is raised.
- ④ Press the start button with the throttle completely closed.

If the engine does not start:

- ① Open the throttle fully and press the start button for 5 seconds.
- ② Repeat the normal starting procedure.
- ③ If the engine starts, open the throttle slightly if idling is unstable.
- ④ If the engine does not start, wait 10 seconds before trying steps ① & ② again.

If Engine Will Not Start ➔ P.109

Shifting Gears

Your motorcycle transmission has 6 forward gears in a one-down, five-up shift pattern.

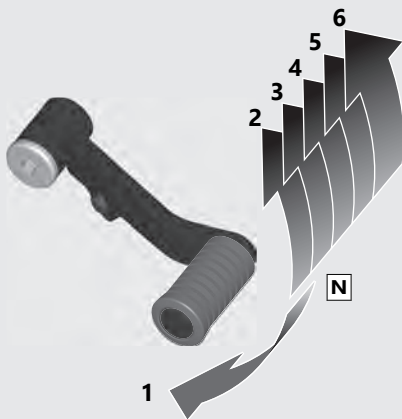

If you put the motorcycle in gear with the side stand down, the engine will shut off.

Recommended Shift Points

Shifting Up

From 1st to 2nd	12 mph (20 km/h)
From 2nd to 3rd	19 mph (30 km/h)
From 3rd to 4th	25 mph (40 km/h)
From 4th to 5th	31 mph (50 km/h)
From 5th to 6th	37 mph (60 km/h)

Shifting Down

From 6th to 5th	28 mph (45 km/h)
From 5th to 4th	22 mph (35 km/h)
From 4th to 3rd	16 mph (25 km/h)

NOTICE

Improper shifting can damage the engine, transmission, and drive train. Also, coasting or towing the motorcycle for long distances with the engine off can damage the transmission.

Refueling

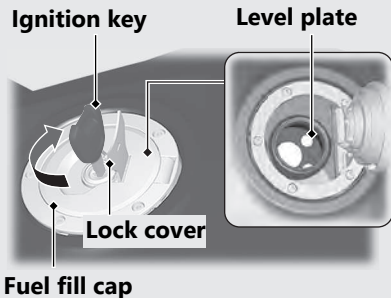

Do not fill with fuel above the level plate.

Fuel type: Unleaded gasoline only

Recommended fuel octane number:

Pump Octane Number (PON) 86 or higher.

Tank capacity: 4.52 US gal (17.1 L)

Refueling and Fuel Guidelines ➔ P.13

Opening the Fuel Fill Cap

Open the lock cover, insert the ignition key, and turn it clockwise to open the cap.

Closing the Fuel Fill Cap

- 1 After refueling, push the fuel fill cap closed until it locks.
- 2 Remove the key and close the lock cover.
 - ▶ The key cannot be removed if the cap is not locked.

⚠ WARNING

Gasoline is highly flammable and explosive. You can be burned or seriously injured when handling fuel.

- Stop the engine, and keep heat, sparks, and flame away.
- Handle fuel only outdoors.
- Wipe up spills immediately.

Storage Equipment

Helmet Holder

The helmet holders are located underside of the rear seat.

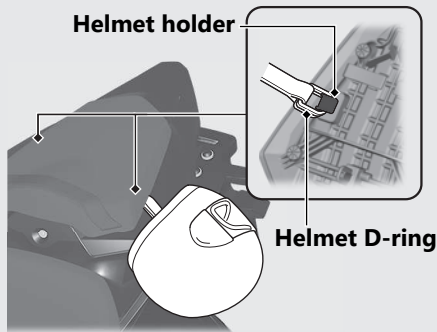

► Use the helmet holder only when parked.

Removing the Rear Seat ➔ P.81

⚠ WARNING

Riding with a helmet attached to the holder can interfere with the rear wheel or suspension and could cause a crash in which you can be seriously hurt or killed.

Use the helmet holder only while parked. Do not ride with a helmet secured by the holder.

Tool Kit

The tool kit is located under the rear seat by the rubber strap.

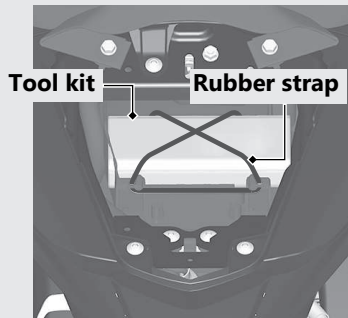

Removing the Rear Seat ➔ P.81

Document Bag

The document bag is located underside of the front seat by the rubber strap.



Removing the Front Seat ➔ P.80

Storage Equipment *(Continued)*

Luggage Tie-Down Hook

The luggage tie-down hooks are located on the underside of the rear seat.

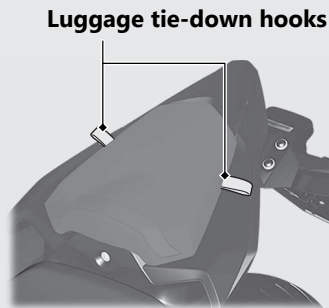
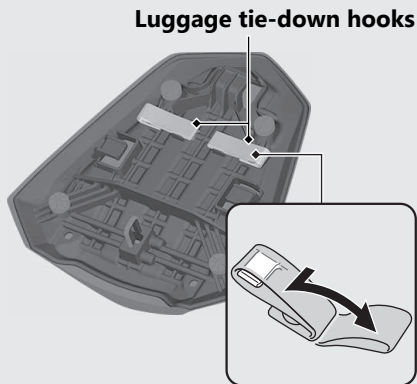

Never use the tie-down hooks to tow or lift the motorcycle.

Removing the Rear Seat ➔ P.81

Maintenance

Please read “Importance of Maintenance” and “Maintenance Fundamentals” carefully before attempting any maintenance. Refer to “Specifications” for service data.

An optional larger tool kit may be available.
Check with your Honda dealer's parts department.

Importance of Maintenance	P. 58	Side Stand	P. 94
Maintenance Schedule	P. 60	Drive Chain	P. 95
Maintenance Record	P. 63	Clutch	P. 99
Maintenance Fundamentals	P. 64	Throttle	P. 102
Removing & Installing Body Components ..	P. 78	Crankcase Breather	P. 103
Battery	P. 78	Other Adjustments	P. 104
Clip	P. 79	Adjusting the Headlight Aim.....	P. 104
Front Seat.....	P. 80	Adjusting the Brake Lever.....	P. 105
Rear Seat	P. 81	Adjusting the Front Suspension	P. 106
Left Side Cover.....	P. 82	Adjusting the Rear Suspension.....	P. 107
Engine Oil	P. 83		
Air Cleaner	P. 87		
Coolant	P. 89		
Brakes	P. 91		

Importance of Maintenance

Importance of Maintenance

Keeping your motorcycle well-maintained is absolutely essential to your safety and to protect your investment, obtain maximum performance, avoid breakdowns, and reduce air pollution. Maintenance is the owner's responsibility. Be sure to inspect your motorcycle before each ride, and perform the periodic checks specified in the Maintenance Schedule. 📄 P. 60

WARNING

Improperly maintaining your motorcycle or failing to correct a problem before you ride can cause a crash in which you can be seriously hurt or killed.

Always follow the inspection and maintenance recommendations and schedules in this owner's manual.

For information about the exhaust emission and noise emission requirements of the U.S. Environmental Protection Agency (EPA), the California Air Resources Board (CARB), and the Environment and Climate Change Canada (ECCC). 📄 P. 139

USA

Maintenance, replacement or repair of the emission control devices and systems may be performed by any motorcycle repair establishment or individual using parts that are "certified" to EPA standards.

Maintenance Safety

Always read the maintenance instructions before you begin each task, and make sure that you have the tools, parts, and skills required. We cannot warn you of every conceivable hazard that can arise in performing maintenance. Only you can decide whether or not you should perform a given task.

Follow these guidelines when performing maintenance.

- Stop the engine and remove the key.
- Place your motorcycle on a firm, level surface using the side stand or a maintenance stand to provide support.
- Allow the engine, muffler, brakes, and other high-temperature parts to cool before servicing as you can get burned.
- Run the engine only when instructed, and do so in a well-ventilated area.

Maintenance Schedule

The maintenance schedule specifies the maintenance requirements necessary to ensure safe, dependable performance, and proper emission control.

Maintenance work should be performed in accordance with Honda's standards and specifications by properly trained and equipped technicians. Your dealer meets all of these requirements. All scheduled maintenance is considered a normal owner operating cost and will be charged to you by your dealer. Keeping an accurate maintenance record will help ensure your motorcycle is properly maintained.

➤ P. 63

Make sure whoever performs the scheduled maintenance completes the maintenance record. Retain all service documents. If you sell your motorcycle, these service documents should be transferred with the motorcycle to the new owner.

Items		Frequency *1								Regular Replace	Refer to page	
		× 1,000 mi	0.6	4	8	12	16	20	24			
		× 1,000 km	1.0	6.4	12.8	19.2	25.6	32.0	38.4			
Emission-Related Items	Fuel Line				I		I		I		-	
	Throttle Operation				I		I		I		102	
	Air Cleaner *2					R			R		87	
	Crankcase Breather *3			C	C	C	C	C	C		103	
	Spark Plug						R				-	
	Valve Clearance						I				-	
	Engine Oil			R		R		R		R	1 Year	83
	Engine Oil Filter			R				R				83
	Engine Idle Speed					I		I		I		-
	Radiator Coolant *5					I		I		I	3 Years	89
	Cooling System					I		I		I		-
	Secondary Air Supply System							I				-
Evaporative Emission Control System *4							I				-	















































Maintenance Level

- : Intermediate. We recommend service by your dealer, unless you have the necessary tools and are mechanically skilled. Procedures are provided in an official Honda Service Manual (➡ P. 145).
- : Technical. In the interest of safety, have your motorcycle serviced by your dealer.

Maintenance Legend

- I** : Inspect (clean, adjust, lubricate, or replace, if necessary)
- L** : Lubricate
- R** : Replace
- C** : Clean

Maintenance Schedule

Items		Frequency *1								Regular Replace	Refer to page	
		× 1,000 mi	0.6	4	8	12	16	20	24			
		× 1,000 km	1.0	6.4	12.8	19.2	25.6	32.0	38.4			
	Drive Chain		Every 600 mi (1,000 km): 									95
Non-Emission-Related Items	Brake Fluid *5									2 Years	91	
	Brake Pads Wear										92	
	Brake System										64	
	Brake Light Switch										93	
	Headlight Aim										104	
	Clutch System										99	
	Side Stand										94	
	Suspension										-	
	Nuts, Bolts, Fasteners										-	
	Wheels/Tires										73	
Steering Head Bearings										-		

Notes:

*1 : At higher odometer readings, repeat at the frequency interval established here.

*2 : Service more frequently when riding in unusually wet or dusty areas.

*3 : Service more frequently when riding in rain or at full throttle.

*4 : 50 STATE (meets California).

*5 : Replacement requires mechanical skill.

Maintenance Record

Distance	Odometer	Date	Performed By:	Notes
600 miles (1,000 km)				
4,000 miles (6,400 km)				
8,000 miles (12,800 km)				
12,000 miles (19,200 km)				
16,000 miles (25,600 km)				
20,000 miles (32,000 km)				
24,000 miles (38,400 km)				
28,000 miles (44,800 km)				
32,000 miles (51,200 km)				
36,000 miles (57,600 km)				
40,000 miles (64,000 km)				
44,000 miles (70,400 km)				
48,000 miles (76,800 km)				
52,000 miles (83,200 km)				
56,000 miles (89,600 km)				
60,000 miles (96,000 km)				
64,000 miles (102,400 km)				
68,000 miles (108,800 km)				

Pre-ride Inspection

To ensure safety, it is your responsibility to perform a pre-ride inspection and make sure that any problem you find is corrected. A pre-ride inspection is a must, not only for safety, but because having a breakdown, or even a flat tire, can be a major inconvenience.

Check the following items before you get on your motorcycle:

- Tire tread wear and air pressures are within limits. ➔ P. 73
- Lights, horn, and turn signals operate normally.
- Check the condition of the drive chain. Adjust slack and lubricate as needed. ➔ P. 71

Check the following items if you are carrying a passenger or cargo:

- Combined weight is within load limits. ➔ P. 151
- Cargo is secured properly.

- Suspension is adjusted to suit load. ➔ P. 106, ➔ P. 107

Check the following items after you get on your motorcycle:

- Throttle action moves smoothly without binding. ➔ P. 102
- Brake lever and pedal operate normally.
- Check the fuel level and refuel when needed. ➔ P. 13, ➔ P. 53
- Engine stop switch functions properly. ➔ P. 48

Check the following items at regular intervals:

- Oil level is between the upper and lower level marks. ➔ P. 83
- Brake fluid level is

Front: above the LWR level mark. ➔ P. 91

Rear: between the UPPER and LOWER level marks. ➔ P. 91

- Engine coolant level is between the UPPER and LOWER level marks. ➔ P. 89
- Side stand functions properly. ➔ P. 94

Periodic Checks

You should also perform other periodic maintenance checks at least once a month regardless of how often you ride, or more often if you ride frequently.

Also, check the odometer reading against the Maintenance Schedule and perform all maintenance that is due. ➤ P. 60

Tires and wheels	Check the air pressure (➤ P. 73), examine tread for wear and damage (➤ P. 73), and check the wheels for damage.
Fluid levels	Check the engine oil level (➤ P. 83), engine coolant level (➤ P. 89), and brake fluid level (➤ P. 91).
Lights	Check that the headlight, position lights, brake light, taillight, turn signals and license plate light are working properly.
Controls	Check the freeplay of the clutch lever (➤ P. 99), and throttle grip (➤ P. 102). Check the front brake lever (➤ P. 105) and rear brake pedal operate properly.
Drive chain	Check the slack (➤ P. 95), adjust the slack (➤ P. 96), and lubricate (➤ P. 72) as needed.
Fuses	Check that you have a full supply of spare fuses.
Nuts & bolts	Check the major nuts and bolts, and tighten as needed.

Replacing Parts

Always use Honda Genuine Parts or their equivalents to ensure reliability and safety. When ordering colored components, specify the model name, color, and code mentioned on the color label.

The color label is attached to the rear fender under the rear seat. ➤ P. 81

Color label

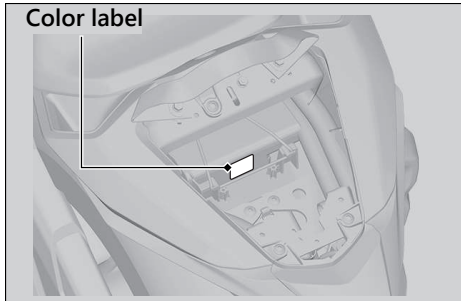

⚠️ WARNING

Installing non-Honda parts may make your motorcycle unsafe and cause a crash in which you can be seriously hurt or killed.

Always use Honda Genuine Parts or equivalents that have been designed and approved for your motorcycle.

Battery

Your motorcycle has a maintenance-free type battery. You do not have to check the battery electrolyte level or add distilled water. Clean the battery terminals if they become dirty or corroded.

Do not remove the battery cap seals. There is no need to remove the cap when charging.

NOTICE

An improperly disposed of battery can be harmful to the environment and human health. Always confirm local regulations for proper battery disposal instruction.

What to do in an emergency

If any of the following occur, immediately see your doctor.

- Electrolyte splashes into your eyes:
 - ▶ Wash your eyes repeatedly with cool water for at least 15 minutes. Using water under pressure can damage your eyes.

- Electrolyte splashes onto your skin:
 - ▶ Remove affected clothing and wash your skin thoroughly using water.
- Electrolyte splashes into your mouth:
 - ▶ Rinse mouth thoroughly with water, and do not swallow.

⚠ WARNING

The battery gives off explosive hydrogen gas during normal operation.

A spark or flame can cause the battery to explode with enough force to kill or seriously hurt you.

Wear protective clothing and a face shield, or have a skilled mechanic do the battery servicing.

WARNING: Battery posts, terminals, and related accessories contain lead and lead compounds.

Wash your hands after handling.

Cleaning the Battery Terminals

1. Remove the battery. ➤ P. 78
2. If the terminals are starting to corrode and are coated with a white substance, wash with warm water and wipe clean.
3. If the terminals are heavily corroded, clean and polish the terminals with a wire brush or sandpaper. Wear safety glasses.

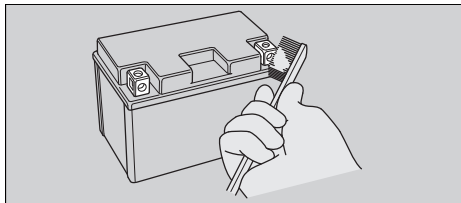

4. After cleaning, reinstall the battery.

The battery has a limited life span. Consult your dealer about when you should replace the battery. Always replace the battery with another maintenance-free battery of the same type.

Charging

If you use electrical accessories that drain the battery or you do not ride frequently, we recommend that you charge the battery every 30 days using a charger designed specifically for your Honda, which can be purchased from your dealer. Read the information that came with your battery charger and follow the instructions on the battery. Avoid using an automobile-type battery charger, as these can overheat a motorcycle battery and cause permanent damage.

Make sure the ignition switch is in the OFF position before charging the battery.

NOTICE

Improper charging can damage the battery. If you can't charge the battery or it appears unable to hold a charge, contact your dealer.

NOTICE

Jump starting using an automobile battery can damage your motorcycle's electrical system and is not recommended. Bump starting is also not recommended.

NOTICE

Installing non-Honda electrical accessories can overload the electrical system, discharging the battery and possibly damaging the system.

Fuses

Fuses protect the electrical circuits on your motorcycle. If something electrical on your motorcycle stops working, check for and replace any blown fuses. ➤ P. 125

Inspecting and Replacing Fuses

Turn the ignition switch to the OFF position to remove and inspect fuses. If a fuse is blown, replace with a fuse of the same rating. For fuse ratings, see "Specifications." ➤ P. 153

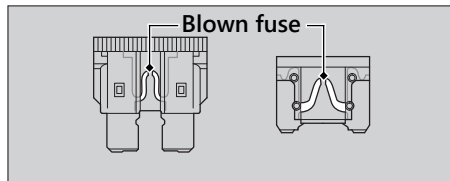
**NOTICE**

Replacing a fuse with one that has a higher rating greatly increases the chance of damage to the electrical system.

Maintenance Fundamentals

If a fuse fails repeatedly, you likely have an electrical fault. Have your motorcycle inspected by your dealer.

Engine Oil

Engine oil consumption varies and oil quality deteriorates according to riding conditions and time elapsed.

Check the engine oil level regularly, and add the recommended engine oil if necessary. Dirty oil or old oil should be changed as soon as possible.

Selecting the Engine Oil

For recommended engine oil, see "Specifications." P. 152

If you use non-Honda engine oil, check the label to make sure that the oil satisfies all of the following standards:

- JASO T 903 standard*¹: MA
- SAE standard*²: 10W-30
- API classification*³: SG or higher

- *1. The JASO T 903 standard is an index for engine oils for 4-stroke motorcycle engines. There are two classes: MA and MB. For example, the following label shows the MA classification.

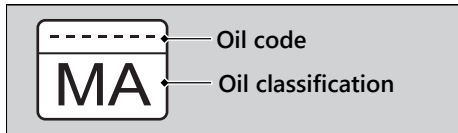

- *2. The SAE standard grades oils by their viscosity.
- *3. The API classification specifies the quality and performance rating of engine oils. Use SG or higher oils, excluding oils marked as "Energy Conserving" or "Resource Conserving" on the circular API service symbol.

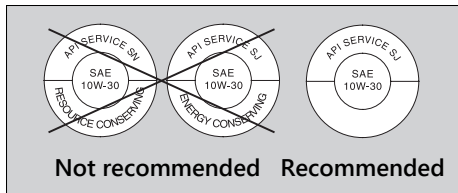

Brake Fluid

Do not add or replace brake fluid, except in an emergency. Use only fresh brake fluid from a sealed container. If you do add fluid, have the brake system serviced by your dealer as soon as possible.

NOTICE

Brake fluid can damage plastic and painted surfaces. Wipe up spills immediately and wash thoroughly.

Recommended brake fluid:

Honda DOT 4 Brake Fluid or equivalent

⚠WARNING

Clean filler cap before removing. Use only DOT 4 fluid from a sealed container.

Drive Chain

The drive chain must be inspected and lubricated regularly. Inspect the chain more frequently if you often

ride on bad roads, ride at high speed, or ride with repeated fast acceleration. ➤ P. 95

If the chain does not move smoothly, makes strange noises, has damaged rollers, has loose pins, has missing O-rings, or kinks, have the chain inspected by your dealer.

Also inspect the drive sprocket and driven sprocket. If either has worn or damaged teeth, have the sprocket replaced by your dealer.

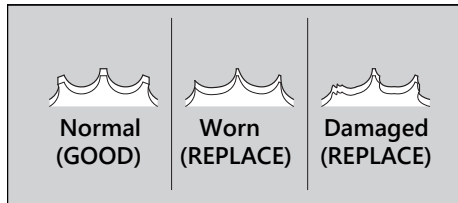

NOTICE

Use of a new chain with worn sprockets will cause rapid chain wear.

| Cleaning and Lubricating

After inspecting the slack, clean the chain and sprockets while rotating the rear wheel. Use a dry cloth with chain cleaner designed specifically for O-ring chains, or neutral detergent. Use a soft brush if the chain is dirty.

After cleaning, wipe dry and lubricate with the recommended lubricant.

Recommended lubricant:

Pro Honda HP Chain Lube or equivalent

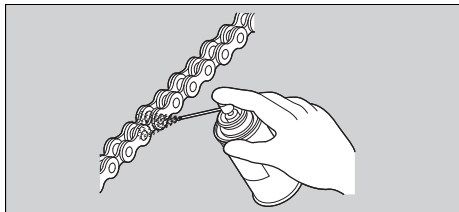

Do not use a steam cleaner, a high pressure cleaner, a wire brush, volatile solvent such as gasoline and benzene, abrasive cleaner, chain

cleaner or lubricant NOT designed specifically for O-ring chains as these can damage the rubber O-ring seals.

Avoid getting lubricant on the brakes or tires.

Avoid applying excess chain lubricant to prevent spray onto your clothes and the motorcycle.

Recommended Coolant

Pro Honda HP Coolant is a pre-mixed solution of antifreeze and distilled water.

Concentration:

50% antifreeze and 50% distilled water

A concentration of antifreeze below 40% will not provide proper corrosion and cold temperature protection.

A concentration of up to 60% will provide better protection in colder climates.

NOTICE

Using coolant not specified for aluminum engines or tap/mineral water can cause corrosion.

Crankcase Breather

Service more frequently when riding in rain, at full throttle, or after the motorcycle is washed or overturned. Service if the deposit level can be seen in the transparent section of the drain tube.

If the drain tube overflows, the air filter may become contaminated with engine oil causing poor engine performance. ➔ P. 103

Tires (Inspecting/Replacing)

Checking the Air Pressure

Visually inspect your tires and use an air pressure gauge to measure the air pressure at least once a month or any time you think the tires look low. Always check air pressure when your tires are cold.

Inspecting for Damage

Inspect the tires for cuts, slits, or cracks that exposes fabric or cords, or nails or other foreign objects embedded in the side of the tire or the tread.

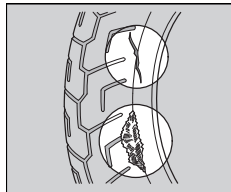

Also inspect for any unusual bumps or bulges in the side walls of the tires.

Inspecting for Abnormal Wear

Inspect the tires for signs of abnormal wear on the contact surface.

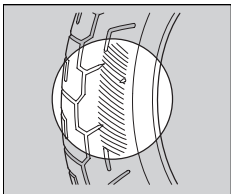

Inspecting Tread Depth

Inspect the tread wear indicators. If they become visible, replace the tires immediately. For safe riding, you should replace the tires when the minimum tread depth is reached.

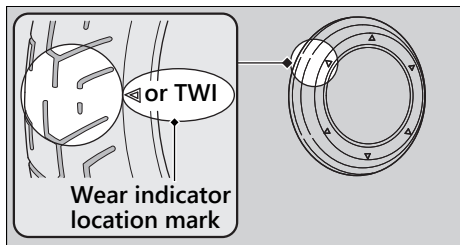

⚠️WARNING

Riding on tires that are excessively worn or improperly inflated can cause a crash in which you can be seriously hurt or killed.

Follow all instructions in this owner's manual regarding tire inflation and maintenance.

Have your tires replaced by your dealer. For recommended tires, air pressure and minimum tread depth, see "Specifications."

➤ P. 152

Follow these guidelines whenever you replace tires.

- Use the recommended tires or equivalents of the same size, construction, speed rating, and load range.
- Have the wheel balanced with Honda Genuine balance weights or equivalent after the tire is installed.
- Do not install a tube inside a tubeless tire on this motorcycle. Excessive heat build-up can cause the tube to burst.
- Use only tubeless tires on this motorcycle. The rims are designed for tubeless tires, and during hard acceleration or braking, a tube-type tire could slip on the rim and cause the tire to rapidly deflate.

WARNING

Installing improper tires on your motorcycle can adversely affect handling and stability, and can cause a crash in which you can be seriously hurt or killed.

Always use the size and type of tires recommended in this owner's manual.

Tire Service Life

The service life of your tires is dependent on many factors, including, but not limited to, riding habits, road conditions, vehicle loading, tire air pressure, maintenance history, speed, and environmental conditions (even when the tires are not in use).

In addition to your regular inspections and maintenance, it is recommended that you have annual inspections performed once the tires reach 5 years old. It is also recommended that all tires be removed from service after 10 years from the date of manufacture, regardless of their condition or state of wear.

The last four digits of the TIN (tire identification number) indicate the date of manufacture.

Tire Identification Number (TIN)

The tire identification number (TIN) is a group of numbers and letters located on the sidewall of the tire.



DOT XXXX XXXX 22 09

DOT: This indicates that the tire meets all requirements of the U.S. Department of Transportation.

① XXXX: Factory code

② XXXX: Tire type code

③ 22 09: Date of manufacture (week & year).
Example: week 22 in year 09.

Tire Labeling Example

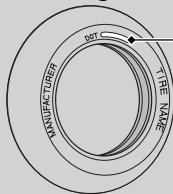

Tire identification number (TIN)

Air Cleaner

This motorcycle is equipped with a viscous type air cleaner element which cannot be cleaned with compressed air or otherwise without degrading its performance.

If the filter becomes dirty, replace it with a new one.

Battery

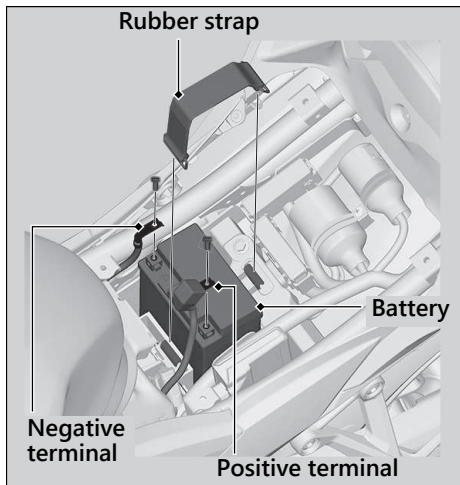

Removal

Make sure the ignition switch is in the OFF position.

1. Remove the front seat. ➤ P. 80
2. Unhook the rubber strap from rear side.
3. Disconnect the negative \ominus terminal from the battery.
4. Disconnect the positive \oplus terminal from the battery.
5. Remove the battery taking care not to drop the terminal nuts.

Installation

Install the parts in the reverse order of removal. Always connect the positive \oplus terminal first. Make sure that bolts and nuts are tight. Make sure the clock information is correct after the battery is reconnected. ➤ P. 31
For proper handling of the battery, see "Maintenance Fundamentals." ➤ P. 67
"Battery Goes Dead." ➤ P. 122

Clip

Removal

1. Press down on the center pin to release the lock.
2. Pull the clip out of the hole.

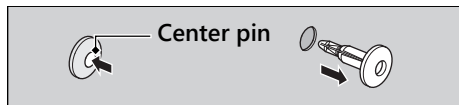

Installation

1. Push the bottom of the center pin.



2. Insert the clip into the hole.
3. Press down on the center pin to lock the clip.

Front Seat

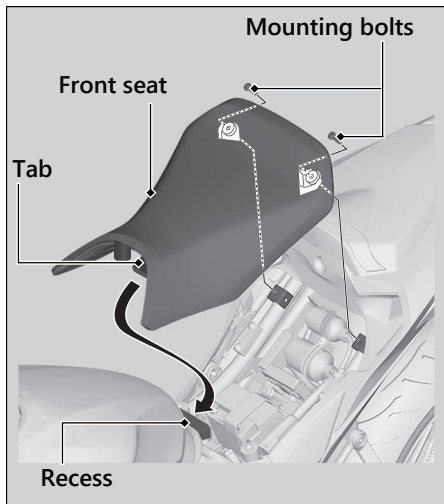

Removal

1. Pull the rear corners of the front seat up, then remove the mounting bolts.
2. Pull the front seat back and up.

Installation

1. Insert the tab into the recess.
2. Install and tighten the mounting bolts securely.
Make sure that the seat is locked securely in position by pulling it up lightly.

Rear Seat

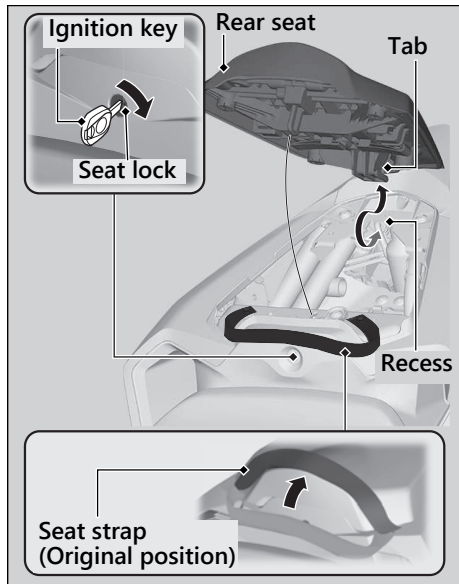

Removal

1. Move the seat strap forward.
2. Insert the ignition key into the seat lock.
3. Turn the ignition key clockwise, then pull the rear seat forward and up.

Installation

1. Insert the tab into the recess.
2. Push down on the front of the rear seat while inserting the ignition key into the seat lock.
Make sure that the seat is locked securely in position by pulling it up lightly.
3. Move the seat strap to its original position.

The seat locks automatically when closed.

Left Side Cover

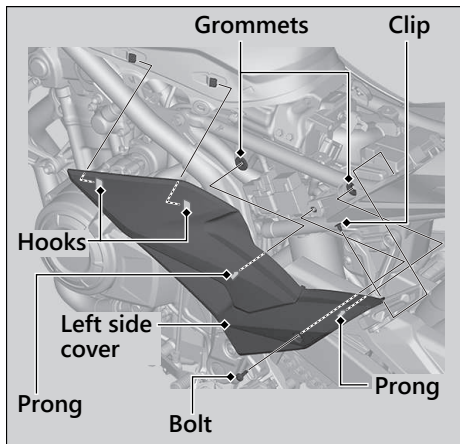

Removal

1. Remove the front seat. ► P. 80
2. Remove the bolt and clip. ► P. 79
3. Remove the prongs from the grommets, then remove the left side cover backward by releasing the hooks.

Installation

Install the parts in the reverse order of removal.

Checking the Engine Oil

1. If the engine is cold, idle the engine for 3 to 5 minutes.
2. Turn the ignition switch to the OFF position and wait for 2 to 3 minutes.
3. Place your motorcycle in an upright position on a firm, level surface.
4. Check that the oil level is between the upper level and lower level marks on the oil level inspection window.

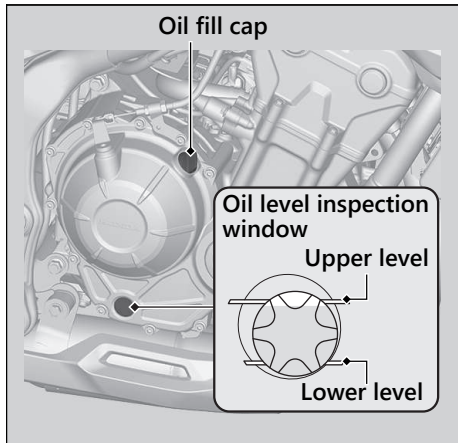

Adding Engine Oil

If the engine oil is below or near the lower level mark, add the recommended engine oil.

► P. 70, ► P. 152

1. Remove the oil fill cap. Add the recommended oil until it reaches the upper level mark.
 - Place your motorcycle in an upright position on a firm, level surface when checking the oil level.
 - Do not overfill above the upper level mark.
 - Make sure no foreign objects enter the oil filler opening.
 - Wipe up any spills immediately.

2. Securely reinstall the oil fill cap.

NOTICE

Overfilling with oil or operating with insufficient oil can cause damage to your engine. Do not mix different brands and grades of oil. They may affect lubrication and clutch operation.

For the recommended oil and oil selection guidelines, see “Maintenance Fundamentals.”

► P. 70

Changing Engine Oil & Filter

Changing the oil and filter requires special tools. We recommend that you have your motorcycle serviced by your dealer.

Use a new Honda Genuine oil filter or equivalent specified for your model.

NOTICE

Using the wrong oil filter can result in serious damage to the engine.

1. If the engine is cold, idle the engine for 3 to 5 minutes.
2. Turn the ignition switch to the OFF position and wait for 2 to 3 minutes.
3. Place your motorcycle on a firm, level surface.
4. Place a drain pan under the drain bolt.

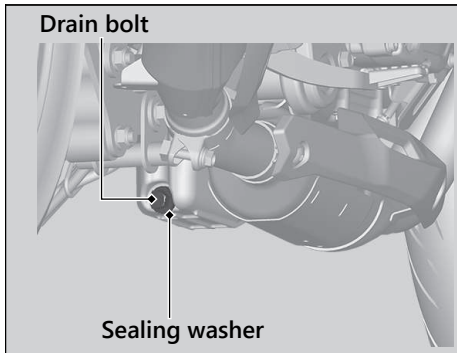

5. Remove the oil fill cap, drain bolt, and sealing washer to drain the oil.
6. Remove the oil filter with a filter wrench and let the remaining oil drain out. Make sure the prior seal is not stuck to the engine.
 - Discard the oil and oil filter at an approved recycling center.

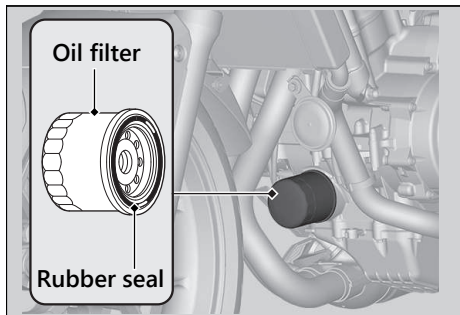

7. Apply a thin coat of engine oil to the rubber seal of a new oil filter.
8. Install the new oil filter and tighten.

Torque: 19 lbf-ft (26 N·m, 2.7 kgf·m)

9. Install a new sealing washer onto the drain bolt. Tighten the drain bolt.

Torque: 22 lbf-ft (30 N·m, 3.1 kgf·m)

10. Fill the crankcase with the recommended oil (► P. 70, ► P. 152) and install the oil fill cap.

Required oil

When changing oil & engine oil filter:

2.9 US qt (2.7 L)

When changing oil only:

2.6 US qt (2.5 L)

11. Check the oil level. ► P. 83
12. Check that there are no oil leaks.

Changing Air Cleaner Element

Use a new Honda Genuine air cleaner element or an equivalent specified for your motorcycle.

NOTICE

Using the wrong air cleaner element may cause premature engine wear or performance problems.

1. Remove the front seat. ➤ P. 80
2. Remove the battery. ➤ P. 78
3. Remove the junction connector by removing the screw A.

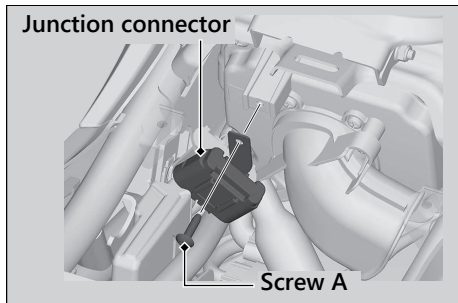

Air Cleaner ► Changing Air Cleaner Element

4. Remove the air cleaner duct and air cleaner case cover/element by removing the screws A.

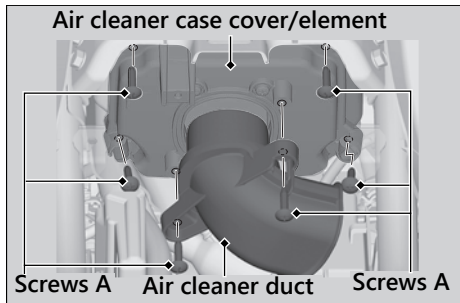

5. Remove the air cleaner element from the air cleaner case cover by removing the screws B.

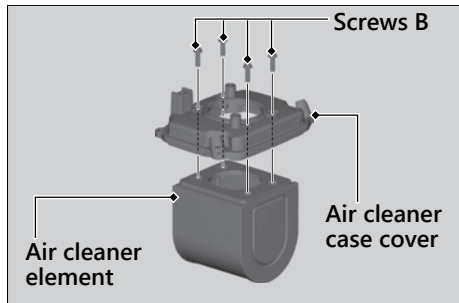

6. Install the new air cleaner element.
► Make sure the air cleaner element is installed securely.
7. Install the parts in the reverse order of removal.
► Tighten the screws A.

Torque: 0.8 lbf·ft (1.1 N·m, 0.1 kgf·m)

Checking the Coolant

Check the coolant level in the reserve tank while the engine is cold.

1. Place your motorcycle on a firm, level surface.
2. Hold your motorcycle in an upright position.
3. Check that the coolant level is between the UPPER level and LOWER level marks on the reserve tank.

If the coolant level is dropping noticeably or the reserve tank is empty, you likely have a serious leak. Have your motorcycle inspected by your dealer.

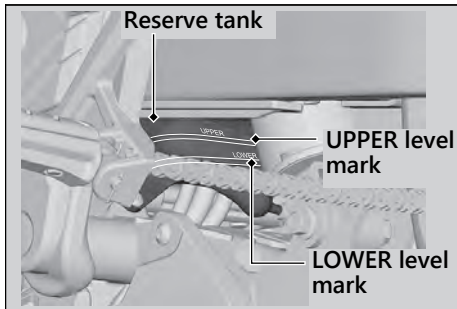

Adding Coolant

If the coolant level is below the LOWER level mark, add the recommended coolant (▶ P. 72) until the level reaches the UPPER level mark.

Add fluid only from the reserve tank cap and do not remove the radiator cap.

Coolant ► Changing Coolant

1. Remove the reserve tank cap and add fluid while monitoring the coolant level.
 - Do not overfill above the UPPER level mark.
 - Make sure no foreign objects enter the reserve tank opening.
2. Securely reinstall the reserve tank cap.

⚠ WARNING

Removing the radiator cap while the engine is hot can cause the coolant to spray out, potentially scalding you.

Always let the engine and radiator cool down before removing the radiator cap.

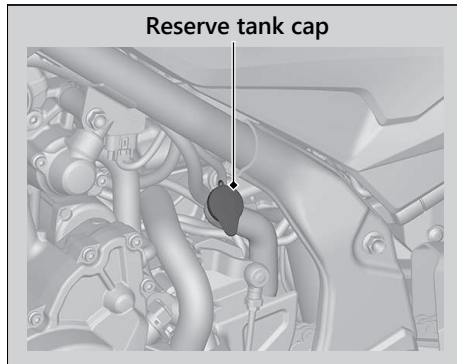

Changing Coolant

Have your dealer change the coolant unless you have the proper tools and are mechanically qualified.

Checking Brake Fluid

1. Place your motorcycle in an upright position on a firm, level surface.
2. **Front** Check that the brake fluid reservoir is horizontal and that the fluid level is above the LWR mark.
Rear Check that the brake fluid reservoir is horizontal and that the fluid level is between the LOWER level and UPPER level marks.

If the brake fluid level in either reservoir is below the LWR mark or LOWER level mark or the brake lever and pedal freeplay becomes excessive, inspect the brake pads for wear. If the brake pads are not worn, you most likely have a leak. Have your motorcycle inspected by your dealer.

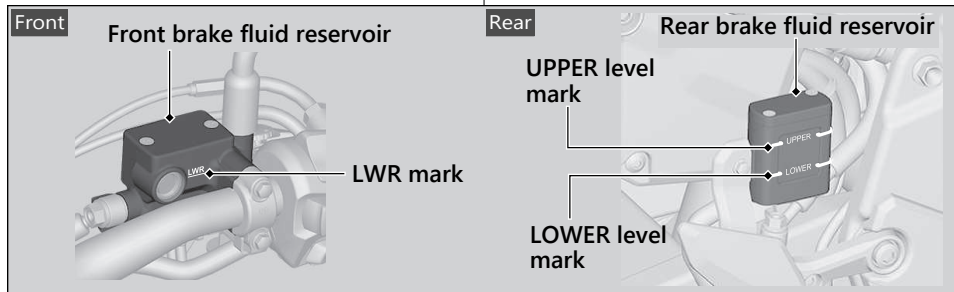

Inspecting the Brake Pads

Check the condition of the brake pad wear indicators.

The pads need to be replaced if a brake pad is worn to the indicator.

1. **Front** Inspect the brake pads from below the brake caliper.
2. **Rear** Inspect the brake pads from the rear right of the motorcycle.

If necessary have the pads replaced by your dealer.

Always replace both left and right brake pads at the same time.

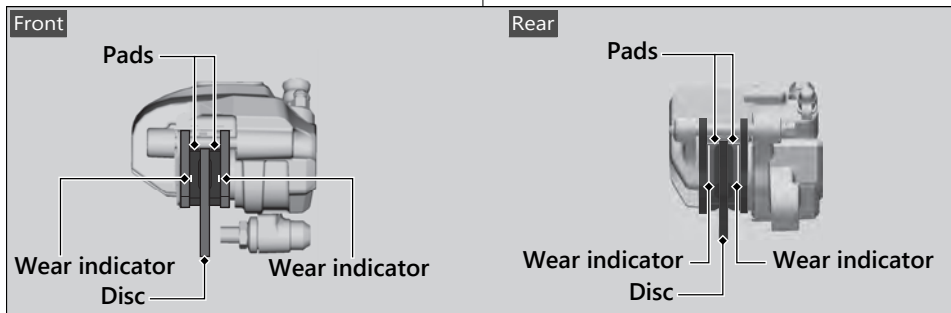

Adjusting the Brake Light Switch

Check the operation of the brake light switch. Hold the brake light switch and turn the adjusting nut in the direction A if the switch operates too late, or turn the nut in the direction B if the switch operates too soon.

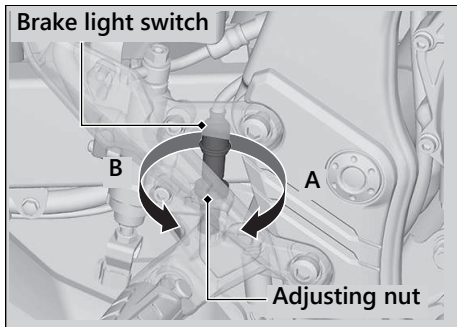

Checking the Side Stand

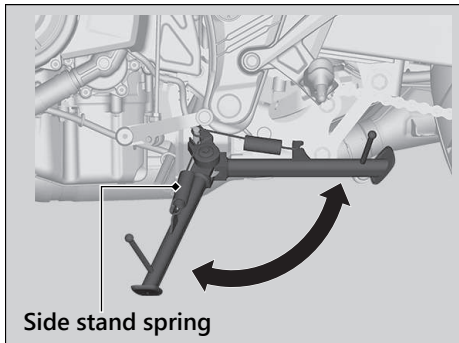

1. Check that the side stand operates smoothly. If the side stand is stiff or squeaky, clean the pivot area and lubricate the pivot bolt with clean grease.
2. Check the spring for damage or loss of tension.

3. Sit on the motorcycle, shift the transmission to Neutral, and raise the side stand.
4. Start the engine, pull the clutch lever in, and shift the transmission into gear.
5. Lower the side stand all the way. The engine should stop as you lower the side stand. If the engine doesn't stop, have your motorcycle inspected by your dealer.

Inspecting the Drive Chain Slack

Check the drive chain slack at several points along the chain. If the slack is not constant at all points, some links may be kinked and binding.

Have the chain inspected by your dealer.

1. Shift the transmission to Neutral. Stop the engine.
2. Place your motorcycle on its side stand on a firm, level surface.
3. Check the slack in the lower half of the drive chain midway between the sprockets.

Drive chain slack:

1 - 1 3/8 in (25 - 35 mm)

- ▶ Do not ride your motorcycle if the slack exceeds 1 15/16 in (50 mm).

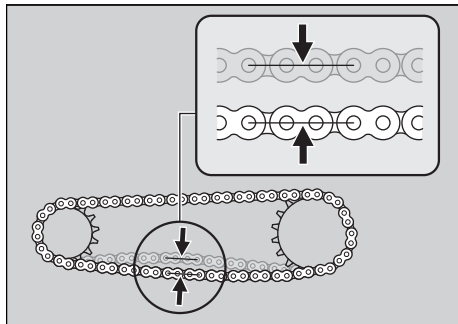

4. Roll the motorcycle forward and check that the chain moves smoothly.
5. Inspect the sprockets. ➤ P. 71
6. Clean and lubricate the drive chain. ➤ P. 72

Adjusting the Drive Chain Slack

Adjusting the chain requires special tools. Have the drive chain slack adjusted by your dealer.

CB500FA only

When adjusting the drive chain slack, be careful not to damage the wheel speed sensor and pulser ring.

1. Shift the transmission to Neutral. Stop the engine.
2. Place your motorcycle on its side stand on a firm, level surface.
3. Loosen the rear axle nut.
4. Loosen the lock nuts on both adjusting bolts.

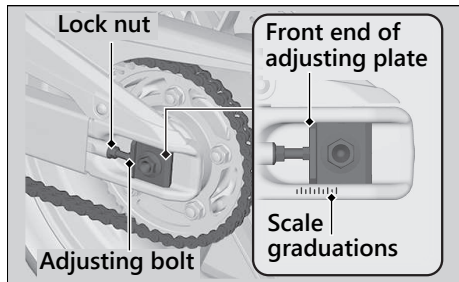
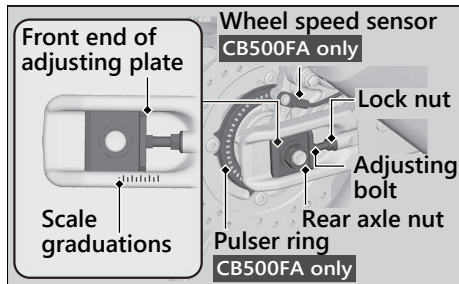

- Turn both adjusting bolts an equal number of turns until the correct drive chain slack is obtained. Turn the adjusting bolts counterclockwise to tighten the chain. Turn the adjusting bolts clockwise and push the rear wheel toward the front to provide more slack. Adjust the slack at a point midway between the drive sprocket and the driven sprocket. Check the drive chain slack. ➤ P. 95
- Check rear axle alignment by making sure the front end of the chain adjusting plate aligns with the scale graduations on both sides of the swingarm. Both marks should correspond. If the axle is misaligned, turn the right or left adjusting bolt until the marks are aligned and recheck chain slack.

- Tighten the rear axle nut.

Torque: 65 lbf·ft (88 N·m, 9.0 kgf·m)

- Hold the adjusting bolts and tighten the lock nuts.

Torque: 20 lbf·ft (27 N·m, 2.8 kgf·m)

- Recheck drive chain slack.

If a torque wrench was not used for installation, see your dealer as soon as possible to verify proper assembly. Improper assembly may lead to loss of braking capacity.

Checking the Drive Chain Wear

Check the chain wear label when adjusting the drive chain. If the front end of the chain adjusting plate enters the red zone on the label after the chain has been adjusted to the proper slack, the chain is excessively worn and must be replaced.

Chain: DID520VF or RK520KLO2

If necessary have the drive chain replaced by your dealer.

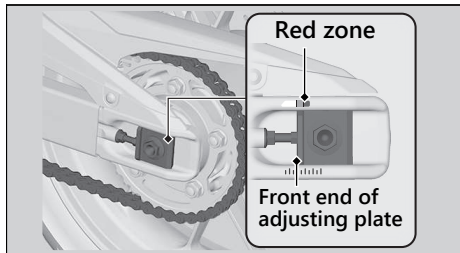

Checking the Clutch

Checking the Clutch Lever Freeplay

Check the clutch lever freeplay.

Freeplay at the clutch lever:

3/8 - 13/16 in (10 - 20 mm)

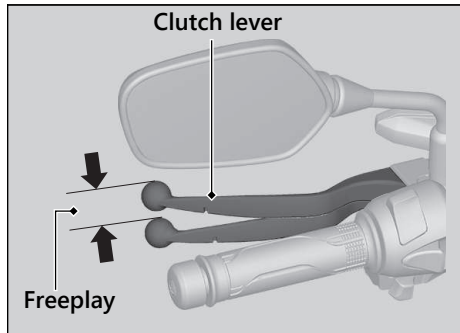

Check the clutch cable for kinks or signs of wear. If necessary have it replaced by your dealer.

Lubricate the clutch cable with a commercially available cable lubricant to prevent premature wear and corrosion.

NOTICE

Improper freeplay adjustment can cause premature clutch wear.

Adjusting the Clutch Lever Freeplay

Upper Adjustment

Attempt adjustment with the upper clutch cable adjuster first.

1. Loosen the upper lock nut.
2. Turn the upper clutch cable adjuster until the freeplay is $\frac{3}{8}$ - $\frac{13}{16}$ in (10 - 20 mm).
3. Tighten the upper lock nut and check the freeplay again.

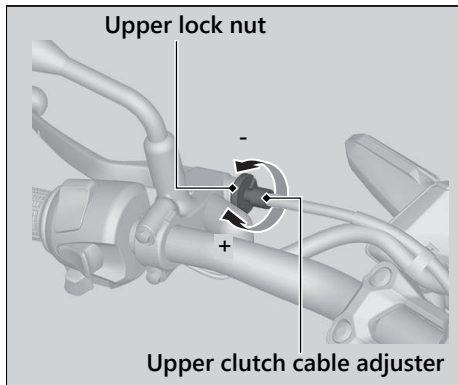

Lower Adjustment

If the upper clutch cable adjuster is threaded out near its limit, or the correct freeplay cannot be obtained, attempt adjustment with the lower clutch cable adjusting nut.

1. Loosen the upper lock nut and turn the upper clutch cable adjuster all the way in (to provide maximum freeplay). Tighten the upper lock nut.
2. Loosen the lower lock nut.
3. Turn the adjusting nut until the clutch lever freeplay is $3/8$ - $13/16$ in (10 - 20 mm).
4. Tighten the lower lock nut and check the clutch lever freeplay.
5. Start the engine, pull the clutch lever in, and shift into gear. Make sure the engine does not stall and the motorcycle does not creep. Gradually release the clutch lever and open the throttle. Your motorcycle should move smoothly and accelerate gradually.

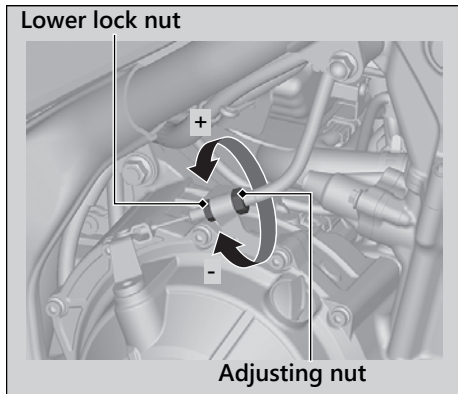

If proper adjustment cannot be obtained or the clutch does not work correctly, see your dealer.

Checking the Throttle

With the engine off, check that the throttle rotates smoothly from fully closed to fully open in all steering positions and throttle freeplay is correct. If the throttle does not move smoothly, close automatically, or if the cable is damaged, have the motorcycle inspected by your dealer.

Freeplay at the throttle grip flange:

1/16 - 1/4 in (2 - 6 mm)

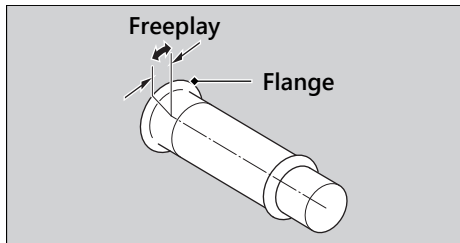

Adjusting the Throttle Freeplay

1. Slide the cable boot.
2. Loosen the lock nut.
3. Turn the adjuster until the freeplay is 1/16 - 1/4 in (2 - 6 mm).
4. Tighten the lock nut and return the cable boot, then inspect the throttle action again.

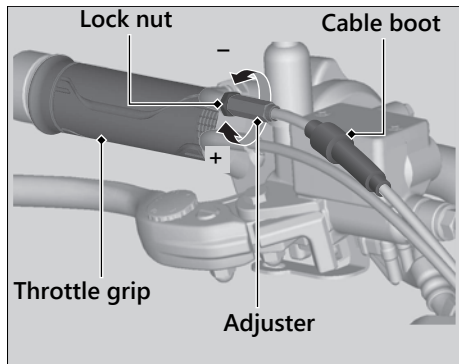

Cleaning the Crankcase Breather

1. Place a suitable container under the crankcase breather tube.
2. Remove the crankcase breather tube plug from the tube.
3. Drain deposits into a suitable container.
4. Install the crankcase breather tube plug.

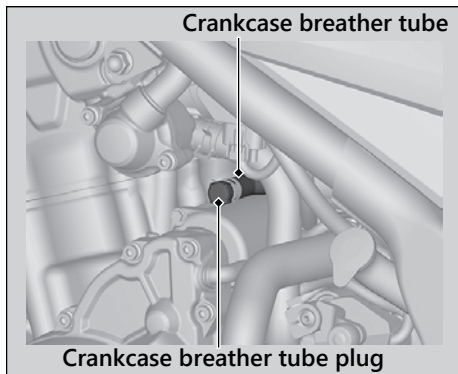

Adjusting the Headlight Aim

You can adjust vertical aim of the headlight for proper alignment. Turn the pinion in or out as necessary using a Phillips screwdriver. Obey local laws and regulations.

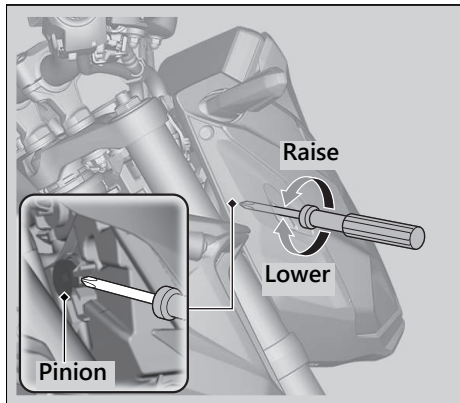

Adjusting the Brake Lever

You can adjust the distance between the tip of the brake lever and handle grip.

Adjustment method

Turn the adjuster until the numbers align with the index mark while pushing the lever forward in the desired position.

After adjustment, check that the lever operates correctly before riding.

NOTICE

Do not turn the adjuster beyond its natural limit.

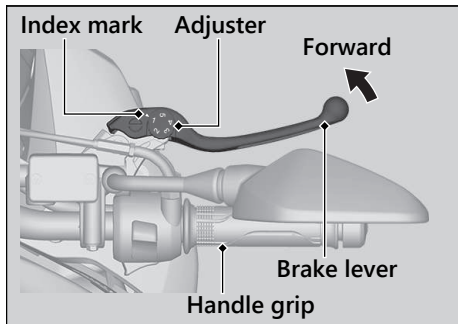

Adjusting the Front Suspension

Spring Preload

You can adjust the spring preload by the adjuster to suit the load or the road surface. Turn clockwise to increase spring preload (hard), or turn counterclockwise to decrease spring preload (soft). The standard position is 3rd groove from the top aligning with the top surface of the fork bolt.

NOTICE

Do not turn the adjuster beyond its limits.
Adjust both left and right forks to the same spring preload.

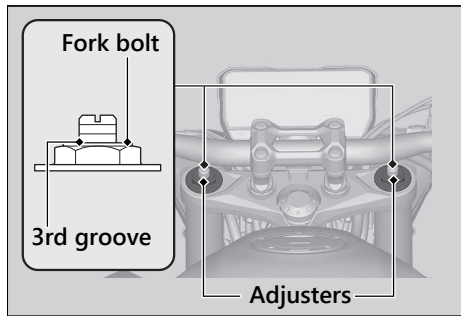

Adjusting the Rear Suspension

Adjusting the suspension requires a pin spanner. We recommend that you have your motorcycle serviced by your dealer.

Spring Preload

You can adjust the spring preload by the adjuster to suit the load or the road surface. Turn the adjuster using a suitable pin spanner and extension bar.

Use the pin spanner and extension bar to turn the adjuster. Position 1 is for a decrease spring preload (soft), or turn the position 3 to 5 increase spring preload (hard). The standard position is 2.

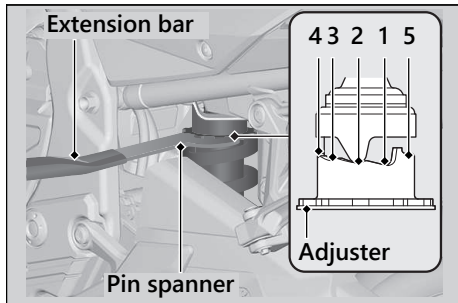

NOTICE

Attempting to adjust directly from 1 to 5 or 5 to 1 may damage the shock absorber.

NOTICE

Do not turn the adjuster beyond its limits.

NOTICE

The rear shock absorber damper unit contains high pressure nitrogen gas. Do not attempt to disassemble, service, or improperly dispose of the damper. See your dealer.

Troubleshooting

Engine Will Not Start	P. 109
Overheating (Segment H flashes in coolant temperature gauge)	P. 110
Warning Indicators On or Flashing	P. 111
Low Oil Pressure Indicator	P. 111
PGM-FI (Programmed Fuel Injection)	
Malfunction Indicator Lamp (MIL).....	P. 111
ABS (Anti-lock Brake System) Indicator	P. 112
Other Warning Indications	P. 113
Fuel Gauge Failure Indication.....	P. 113
Coolant Temperature Gauge Failure	
Indication	P. 114
Tire Puncture	P. 115
Electrical Trouble	P. 122

Battery Goes Dead.....	P. 122
Burned-out Light Bulb	P. 122
Blown Fuse.....	P. 125

Starter Motor Operates But Engine Does Not Start

Check the following items:

- Check the correct engine starting sequence. ➤ P. 51
- Check that there is gasoline in the fuel tank.
- Check if the PGM-FI malfunction indicator lamp (MIL) is on.
 - ▶ If the indicator lamp is on, contact your dealer as soon as possible.

Starter Motor Does Not Operate

Check the following items:

- Check the correct engine starting sequence. ➤ P. 51
- Make sure engine stop switch is in the  (Run) position. ➤ P. 48
- Check for a blown fuse. ➤ P. 125
- Check for a loose battery connection (➤ P. 78) or battery terminal corrosion (➤ P. 67).
- Check the condition of the battery.
 - P. 122

If the problem continues, have your motorcycle inspected by your dealer.

Overheating (Segment H flashes in coolant temperature gauge)

The engine is overheating when the following occurs:

- The segment H flashes in the coolant temperature gauge.
- Acceleration becomes sluggish.
If this occurs, pull safely to the side of the road and perform the following procedure.

Extended fast idling may cause the segment H to flash.

NOTICE

Continuing to ride with an overheated engine can cause serious damage to the engine.

1. Stop the engine using the ignition switch, and then turn the ignition switch to the ON position.

2. Check that the radiator fan is operating, and then turn the ignition switch to the OFF position.
If the fan is not operating:
Suspect a fault. Do not start the engine. Transport your motorcycle to your dealer.
If the fan is operating:
Allow the engine to cool with the ignition switch in the OFF position.
3. After the engine has cooled, inspect the radiator hose and check if there is a leak.
➔ P. 89
If there is a leak:
Do not start the engine. Transport your motorcycle to your dealer.
4. Check the coolant level in the reserve tank. ➔ P. 89
▶ Add coolant as necessary.
5. If 1-4 check normal, you may continue riding, but closely monitor the temperature gauge.

Low Oil Pressure Indicator

If the low oil pressure indicator comes on, pull safely to the side of the road and stop the engine.

NOTICE

Continuing to ride with low oil pressure can cause serious damage to the engine.

1. Check the engine oil level, and add oil as necessary. 📄 P. 83, 📄 P. 84
2. Start the engine.
 - ▶ Only continue riding if the low oil pressure indicator goes off.

Rapid acceleration may momentarily cause the low oil pressure indicator to come on, especially if the oil is at or near the low level. If the low oil pressure indicator stays on when the oil level is at the proper level, stop the engine and contact your dealer.

If the engine oil level goes down rapidly, your motorcycle may have a leak or another serious problem. Have your motorcycle inspected by your dealer.

PGM-FI (Programmed Fuel Injection) Malfunction Indicator Lamp (MIL)

If the indicator comes on while riding, you may have a serious problem with the PGM-FI system. Reduce speed and have your motorcycle inspected by your dealer as soon as possible.

ABS (Anti-lock Brake System) Indicator

CB500FA only

If the indicator operates in one of the following ways, you may have a serious problem with the ABS. Reduce your speed and have your motorcycle inspected by your dealer as soon as possible.

- Indicator comes on or starts flashing while riding.
- Indicator does not come on when the ignition switch is in the ON position.
- Indicator does not go off at speeds above 6 mph (10 km/h).

If the ABS indicator stays on, your brakes will continue to work as a conventional system, but without the anti-locking function.

The ABS indicator may flash if you turn the rear wheel while the rear wheel is lifted off the ground. In this case, turn the ignition switch to the OFF position, and then to the ON position again. The ABS indicator will go off after your speed reaches 19 mph (30 km/h).

Fuel Gauge Failure Indication

If the fuel system has an error, the fuel gauge indicators will be displayed as shown in the illustration.

If these occurs, see your dealer as soon as possible.

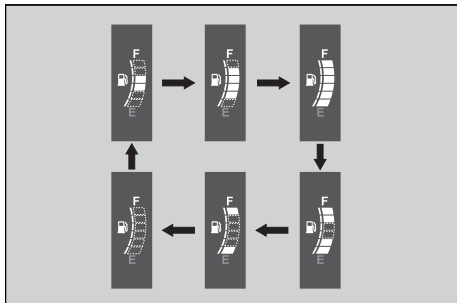
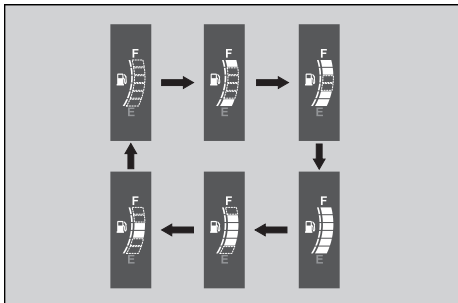

Coolant Temperature Gauge Failure Indication

If the cooling system has an error, all segments will blink as shown in the illustration.

If this occurs, see your dealer as soon as possible.



Tire Puncture

Repairing a puncture or removing a wheel requires special tools and technical expertise. We recommend you have this type of service performed by your dealer.

After an emergency repair, always have the tire inspected/replaced by your dealer.

Emergency Repair Using a Tire Repair Kit

If your tire has a minor puncture, you can make an emergency repair using a tubeless tire repair kit.

Follow the instructions provided with the emergency tire repair kit.

Riding your motorcycle with a temporary tire repair is very risky. Do not exceed 30 mph (50 km/h). Have the tire replaced by your dealer as soon as possible.

WARNING

Riding your motorcycle with a temporary tire repair can be risky. If the temporary repair fails, you can crash and be seriously injured or killed.

If you must ride with a temporary tire repair, ride slowly and carefully and do not exceed 30 mph (50 km/h) until the tire is replaced.

Removing Wheels

Follow these procedures if you need to remove a wheel in order to repair a puncture.

CB500FA only

When removing and installing the wheel, be careful not to damage the wheel speed sensor and pulser ring.

Front Wheel

Removal

1. Place your motorcycle on a firm, level surface.
2. Cover the right side of the front wheel and brake caliper with protective tape or cloth.
3. On the right side, remove the mounting bolts and brake caliper.
 - Support the brake caliper assembly so that it doesn't hang from the brake hose. Do not twist the brake hose.
 - Avoid getting grease, oil, or dirt on the disc or pad surfaces.
 - Do not pull the front brake lever while the brake caliper is removed.

- Take care to prevent the brake caliper from scratching the wheel during removal.

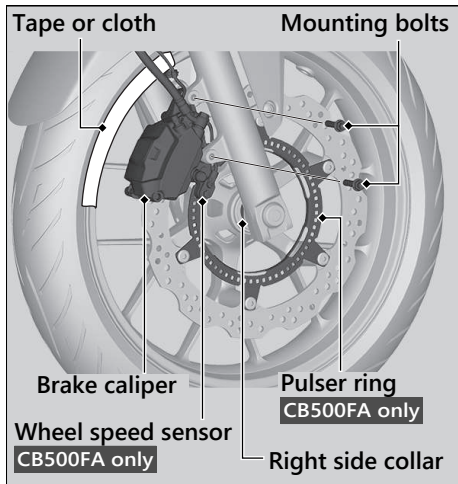

4. Loosen the axle pinch bolt and front axle shaft.
5. Support your motorcycle securely and raise the front wheel off the ground using a maintenance stand or a hoist.
6. Remove the front axle shaft, front wheel and side collars.

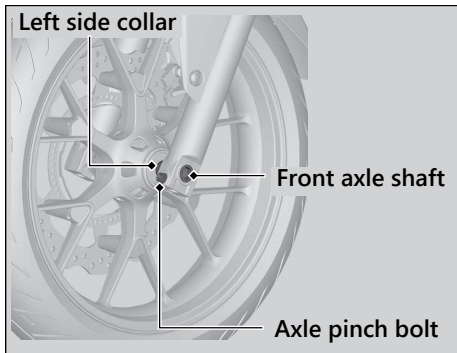

Installation

1. Attach the right and left side collars in their original location on the wheel.
2. On the left side, place the wheel between the fork legs and insert the front axle shaft to the end, through the left fork leg and wheel hub.
3. Tighten the axle shaft.

Torque: 40 lbf·ft (54 N·m, 5.5 kgf·m)

Tire Puncture ► Removing Wheels

4. Install the brake caliper and tighten the mounting bolts.

Torque: 22 lbf-ft (30 N·m, 3.1 kgf·m)

- Take care to prevent the brake caliper from scratching the wheel during installation.
- Use new mounting bolts when installing the brake caliper.

NOTICE

When installing a wheel or caliper into original position, carefully fit the brake disc between the pads to avoid scratching them.

5. Lower the front wheel on the ground.
6. Apply the brake lever several times. Then, pump the fork several times.
7. Tighten the axle pinch bolt.

Torque: 16 lbf-ft (22 N·m, 2.2 kgf·m)

8. Raise the front wheel off the ground again, and check that the wheel rotates freely after you release the brake.
9. Uncover the protective tape or cloth.

If a torque wrench was not used for installation, see your dealer as soon as possible to verify proper assembly. Improper assembly may lead to loss of braking capacity.

■ Rear Wheel

Removal

1. Place your motorcycle on a firm, level surface.
2. Support your motorcycle securely and raise the rear wheel off the ground using a maintenance stand or a hoist.
3. Loosen the rear axle nut, lock nuts and turn the adjusting bolts so the rear wheel can be moved all the way forward for maximum drive chain slack.
4. Remove the drive chain from the driven sprocket by pushing the rear wheel forward.
5. Remove the rear axle nut and washer.
6. Remove the rear axle shaft and adjusting plates.

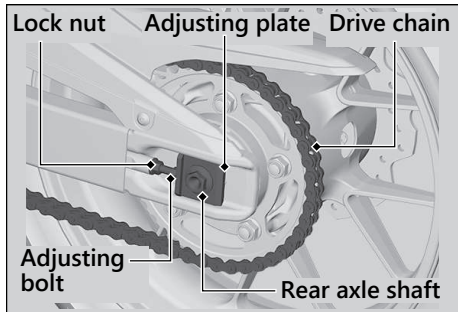
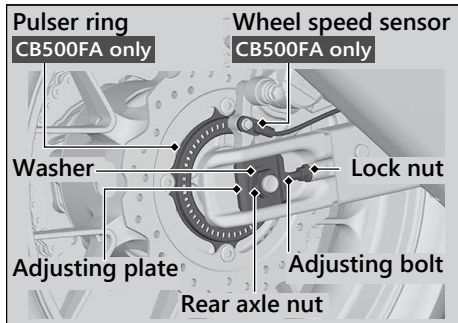

Tire Puncture ► Removing Wheels

7. Remove the brake caliper bracket, rear wheel and side collars.
 - Support the brake caliper assembly so that it doesn't hang from the brake hose. Do not twist the brake hose.
 - Avoid getting grease, oil, or dirt on the disc or pad surfaces.
 - Do not push the brake pedal while the wheel is removed.

Installation

1. To install the rear wheel, reverse the removal procedure.
 - Take care to prevent the brake caliper from scratching the wheel during installation.

NOTICE

When installing a wheel or caliper into original position, carefully fit the brake disc between the pads to avoid scratching them.

2. Make sure that the slot on the brake caliper bracket is positioned in the lug on the swingarm.

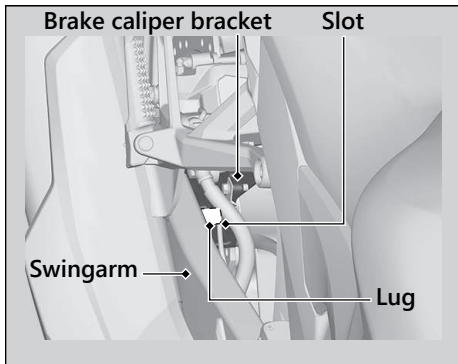

3. Adjust the drive chain slack. ► P. 96
4. Install and tighten the rear axle nut.

Torque: 65 lbf·ft (88 N·m, 9.0 kgf·m)

5. Hold the adjusting bolts and tighten the lock nuts.

Torque: 20 lbf·ft (27 N·m, 2.8 kgf·m)

6. After installing the wheel, apply the brake pedal several times, then check if the wheel rotates freely. Recheck the wheel if the brake drags or if the wheel does not rotate freely.

If a torque wrench was not used for installation, see your dealer as soon as possible to verify proper assembly. Improper assembly may lead to loss of braking capacity.

Battery Goes Dead

Charge the battery using a motorcycle battery charger.

Remove the battery from the motorcycle before charging.

Do not use an automobile-type battery charger, as these can overheat a motorcycle battery and cause permanent damage. If the battery does not recover after recharging, contact your dealer.

NOTICE

Jump starting using an automobile battery can damage your motorcycle's electrical system and is not recommended.

Bump starting is also not recommended.

Burned-out Light Bulb

Follow the procedure below to replace a burned-out light bulb.

Turn the ignition switch to the OFF or LOCK position.

Allow the bulb to cool before replacing it.

Do not use bulbs other than those specified.

Check the replacement bulb for correct operation before riding.

For the light bulb wattage, see "Specifications." ➤ P. 153

Headlight/Position Lights/Front Turn Signals

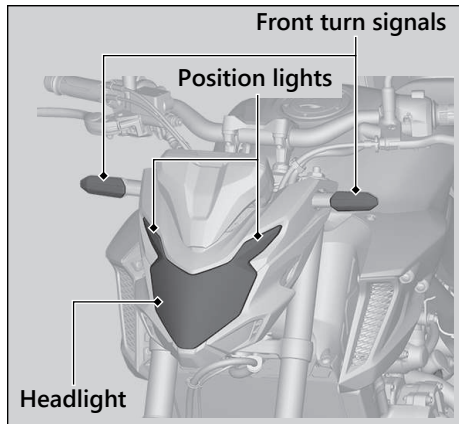

The headlight, position lights and front turn signals use several LEDs. If there is an LED which is not turned on, see your dealer for servicing.

Brake light/Taillight/Rear Turn Signals

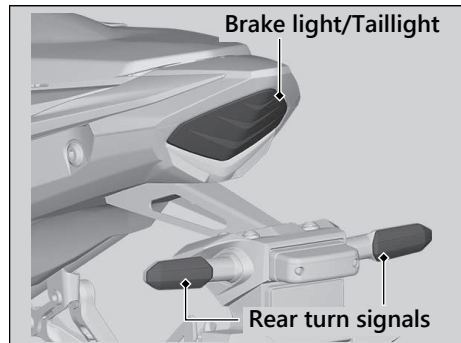

The brake light, taillight and rear turn signals use several LEDs. If there is an LED which is not turned on, see your dealer for servicing.

License Plate Light Bulb

1. Remove the screws, license light cover and license light cover packing.
2. Pull out the bulb without turning.

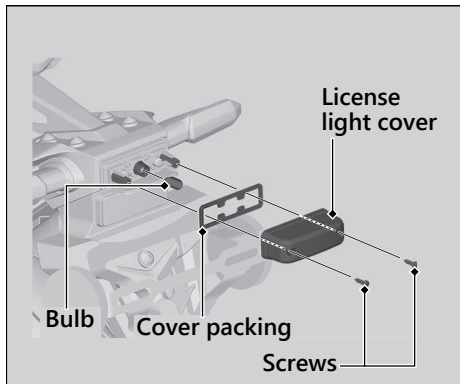

3. Install a new bulb and reinstall the parts in the reverse order of removal.

Blown Fuse

Before handling fuses, see “Inspecting and Replacing Fuses.” P. 69

Fuse Box Fuses

1. Remove the front seat. P. 80
2. Remove the fuse box covers.
3. Pull the fuses out one by one with the fuse puller in the tool kit and check for a blown fuse. Always replace a blown fuse with a spare fuse of the same rating.
4. Reinstall the fuse box covers.
5. Reinstall the front seat.

CB500F

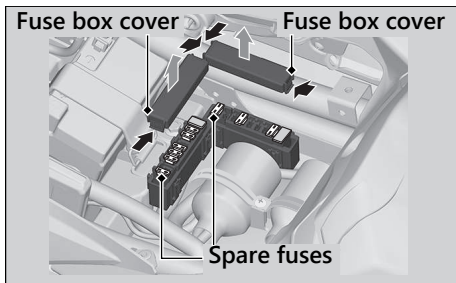

CB500FA

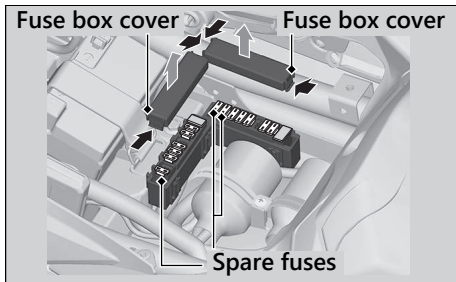

Main Fuse

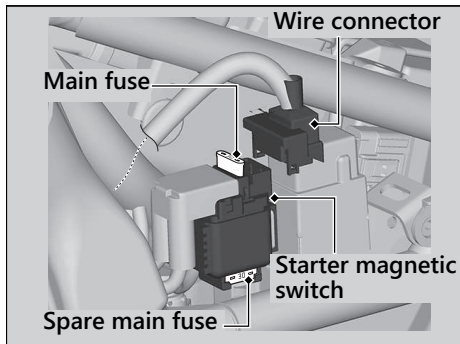

1. Remove the left side cover. ► P. 82
2. Disconnect the wire connector of the starter magnetic switch.
3. Pull the main fuse out and check for a blown fuse. Always replace a blown fuse with a spare fuse of the same rating.
► Spare main fuse is provided in the starter magnetic switch.
4. Reinstall parts in the reverse order of removal.

NOTICE

If a fuse fails repeatedly, you likely have an electrical problem. Have your motorcycle inspected by your dealer.

Information

Keys.....	P. 128
Instruments, Controls, & Other Features...	P. 129
Caring for Your Motorcycle.....	P. 131
Storing Your Motorcycle.....	P. 135
Transporting Your Motorcycle.....	P. 136
You & the Environment.....	P. 137
Vehicle Identification Number.....	P. 138
Emission Control Systems.....	P. 139
Catalytic Converter.....	P. 143
Oxygenated Fuels.....	P. 144
Authorized Manuals.....	P. 145
Warranty Coverage and Service.....	P. 146
Honda Contacts.....	P. 148
USA Reporting Safety Defects.....	P. 150

Keys

Ignition Key

This motorcycle has two ignition keys and a key tag with a key number and a bar code. Store the spare key and the key tag in a safe location. To make a duplicate key, take the spare key and the key tag to your dealer or a locksmith. If you lose all ignition keys and the key tag, the ignition switch assembly will probably have to be removed by your dealer to determine the key number.

A metal key holder may cause damage to the area surrounding the ignition switch.

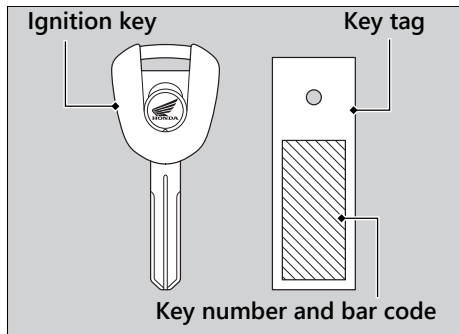

Instruments, Controls, & Other Features

Ignition Switch

Leaving the ignition switch in the ON position with the engine stopped will drain the battery. Do not turn the key while riding.

Engine Stop Switch

Do not use the engine stop switch except in an emergency. Doing so when riding will cause the engine to suddenly turn off, making riding unsafe.

If you stop the engine using the engine stop switch, turn the ignition switch to the OFF position. Failing to do so will drain the battery.

Odometer

The display locks at 999,999 when the read-out exceeds 999,999.

Tripmeter

The tripmeters return to 0.0 when each read-out exceeds 9,999.9.

Document Bag

The owner's manual, registration, and insurance information can be stored in the plastic document bag underside of the front seat.

➤ P. 55

Ignition Cut-off System

A banking (lean angle) sensor automatically stops the engine and fuel pump if the motorcycle falls over. To reset the sensor, you must turn the ignition switch to the OFF position and back to the ON position before the engine can be restarted.

Assist-slipper Clutch System

The assist-slipper clutch system helps to prevent the rear tire from locking up when the deceleration of your motorcycle produces a strong engine braking effect. It also makes the clutch lever operation feel lighter.

Use only MA classification engine oil for your motorcycle. Using engine oil other than MA classification oil could result in damage to the assist-slipper clutch system.

Caring for Your Motorcycle

Frequent cleaning and polishing is important to ensure the life of your Honda. A clean motorcycle makes it easier to spot potential problems.

In particular, seawater and salts used to prevent ice on roads promote the formation of corrosion. Always wash your motorcycle thoroughly after riding on coastal or treated roads.

Washing

Allow the engine, muffler, brakes, and other high-temperature parts to cool before washing.

1. Rinse your motorcycle thoroughly using a low pressure garden hose to remove loose dirt.
2. If necessary, use a sponge or a soft towel with mild cleaner to remove road grime.
 - ▶ Clean the headlight lens, panels, and other plastic components with extra care to avoid scratching them.

Avoid directing water into the air cleaner, muffler, and electrical parts.

3. Thoroughly rinse your motorcycle with plenty of clean water and dry with a soft, clean cloth.
4. After the motorcycle dries, lubricate any moving parts.
 - ▶ Make sure that no lubricant spills onto the brakes or tires. Brake discs, pads, drum or shoes contaminated with oil will suffer greatly reduced braking effectiveness and can lead to a crash.
5. Lubricate the drive chain immediately after washing and drying the motorcycle.
6. Apply a coat of wax to prevent corrosion.
 - ▶ Avoid products that contain harsh detergents or chemical solvents. These can damage the metal, paint, and plastic on your motorcycle. Keep the wax clear of the tires and brakes.
 - ▶ If your motorcycle has any matte painted parts, do not apply a coat of wax to the matte painted surface.

Washing Precautions

Follow these guidelines when washing:

- Do not use high-pressure washers:
 - ▶ High-pressure water cleaners can damage moving parts and electrical parts, rendering them inoperable.
 - ▶ Water in the air intake can be drawn into the throttle body and/or enter the air cleaner.
 - Do not direct water at the muffler:
 - ▶ Water in the muffler can prevent starting and causes rust in the muffler.
 - Dry the brakes:
 - ▶ Water adversely affects braking effectiveness. After washing, apply the brakes intermittently at low speed to help dry them.
 - Do not direct water under the seat:
 - ▶ Water in the under seat compartment can damage your documents and other belongings.
-
- Do not direct water at the air cleaner:
 - ▶ Water in the air cleaner can prevent the engine from starting.
 - Do not direct water near the headlight:
 - ▶ The headlight's inside lens may fog temporarily after washing or while riding in the rain. This does not impact the headlight function. However, if you see a large amount of water or ice accumulated inside the lens(es), have your vehicle inspected by your dealer.
 - Do not use wax or polishing compounds on matte painted surface:
 - ▶ Use a soft cloth or sponge, plenty of water, and a mild detergent to clean matte painted surfaces. Dry with a soft clean cloth.

Aluminum Components

Aluminum will corrode from contact with dirt, mud, or road salt. Clean aluminum parts regularly and follow these guidelines to avoid scratches:

- Do not use stiff brushes, steel wool, or cleaners containing abrasives.
- Avoid riding over or scraping against curbs.

Panels

Follow these guidelines to prevent scratches and blemishes:

- Wash gently using a soft sponge and plenty of water.
- To remove stubborn stains, use diluted detergent and rinse thoroughly with plenty of water.
- Avoid getting gasoline, brake fluid, or detergents on the instruments, panels, or headlight.

Exhaust Pipe and Muffler

The exhaust pipe and muffler are stainless steel but may become stained by mud or dust.

To remove mud or dust, use a wet sponge and a liquid kitchen abrasive, then rinse well with clean water. Dry with chamois or a soft towel.

If necessary, remove heat stains by using a commercially available fine texture compound. Then rinse by the same manner as removing mud or dust.

When the exhaust pipe and muffler are painted, do not use a commercially available abrasive kitchen cleaning compound. Use a neutral detergent to clean the painted surface on the exhaust pipe and muffler. If you are not sure if your exhaust pipe and muffler are painted, contact your dealer.

NOTICE

Even though the exhaust is made of stainless steel, it can become stained. Remove all marks and blemishes as soon as they are noticed.

Storing Your Motorcycle

If you store your motorcycle outdoors, you should consider using a full-body motorcycle cover.

If you won't be riding for an extended period, follow these guidelines:

- Wash your motorcycle and wax all painted surfaces (except matte painted surfaces). Coat chrome pieces with rust-inhibiting oil.
- Lubricate the drive chain. ➤ P. 72
- Place your motorcycle on a maintenance stand and position a block so that both tires are off the ground.
- After rain, remove the body cover and allow the motorcycle to dry.
- Remove the battery (➤ P. 78) to prevent discharge. Fully charge the battery and then place it in a shaded, well-ventilated area.
 - ▶ If you leave the battery in place, disconnect the negative ⊖ terminal to prevent discharge.

After removing your motorcycle from storage, inspect all maintenance items required by the Maintenance Schedule.

USA For more information about storage, refer to the *Honda Winter Storage Guide*, available from your dealer.

Canada For more information about storage, visit our website at www.honda.ca and look up "Storage Tips" under the "Honda Warranty" in the Warranty tab for your Model.

Transporting Your Motorcycle

If your motorcycle needs to be transported, it should be carried on a motorcycle trailer or a flatbed truck or trailer that has a loading ramp or lifting platform, and motorcycle tie-down straps. Never try to tow your motorcycle with a wheel or wheels on the ground.

NOTICE

Towing your motorcycle can cause serious damage to the transmission.

You & the Environment

Owning and riding a motorcycle can be enjoyable, but you must do your part to protect the environment.

Choose Sensible Cleaners

Use a biodegradable detergent when you wash your motorcycle. Avoid aerosol spray cleaners that contain chlorofluorocarbons (CFCs) which damage the atmosphere's protective ozone layer.

Recycle Wastes

Put oil and other toxic wastes in approved containers and take them to a recycling center. Call your local or state office of public works or environmental services to find a recycling center in your area, and to get instructions on how to dispose of non-recyclable wastes. Do not place used engine oil in the trash, or pour it down a drain or on the ground. Used oil, gasoline, coolant, and cleaning solvents contain poisons that can hurt refuse workers and contaminate drinking water, lakes, rivers, and oceans.

Vehicle Identification Number

The VIN and engine serial number uniquely identify your motorcycle and are required in order to register your motorcycle. They may also be required when ordering replacement parts.

You should record these numbers and keep them in a safe place.

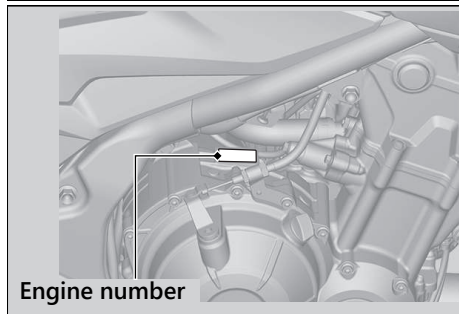
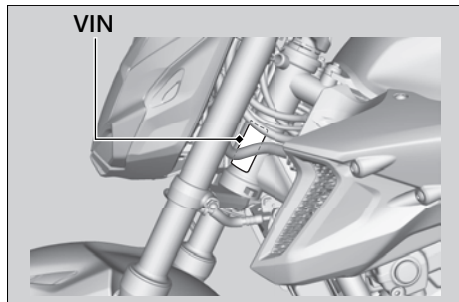
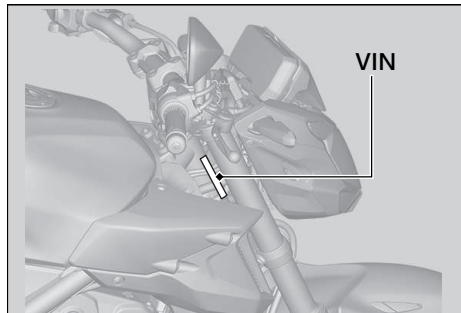

Emission Control Systems

Your motorcycle engine emits combustion byproducts, including carbon monoxide (CO), oxides of nitrogen (NO_x), and hydrocarbons (HC). Gasoline evaporation also emits hydrocarbons. Controlling the production of NO_x, CO, and HC is important for the environment.

Exhaust Emission Requirements

The U.S. Environmental Protection Agency (EPA), the California Air Resources Board (CARB), and Environment and Climate Change Canada (ECCC) require that your motorcycle comply with applicable exhaust, crankcase, and fuel permeation emission standards during its useful life, when operated and maintained according to the instructions provided. CARB also requires that your motorcycle comply with applicable evaporative emission requirements during its useful life, when

operated and maintained according to the instructions provided.

USA Compliance with the terms of the Distributor's Warranties for Honda Motorcycle Emission Control Systems is necessary in order to maintain a valid emissions system warranty.

The Vehicle Emission Control Information label is located on the left side of the swingarm.

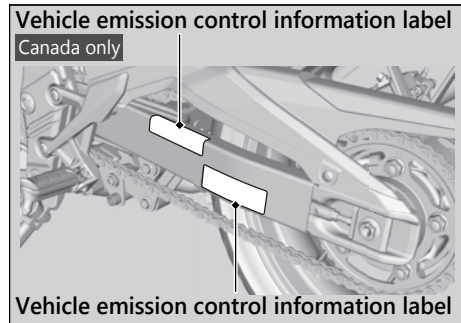

Noise Emission Requirements

The EPA requires that motorcycles built after January 1, 1983 comply with applicable noise emission standards for one year or 3,730 miles (6,000 km) after the time of purchase when operated and maintained according to the instructions provided.

Exhaust Emission Control System

The exhaust emission control system includes the following components that should not need adjustment, although periodic inspection by your dealer is recommended.

PGM-FI System

The PGM-FI (programmed fuel injection) system uses sequential multiport fuel injection, and is comprised of air intake, engine control, fuel control, and exhaust control subsystems. The engine control module (ECM) uses sensors to determine how much air enters the engine, and then controls how much fuel to inject.

Ignition Timing Control System

The ignition timing control system adjusts the ignition timing to reduce the amount of HC, CO, and NO_x produced.

Secondary Air Injection System

The secondary air injection system adds filtered air into the exhaust gas to help improve emission control performance.

Catalytic Converters

The exhaust system contains one or more catalytic converters. Catalytic converters use a catalyst to convert most of the harmful exhaust gas compounds into harmless compounds.

Evaporative Emission Control System

50 STATE (meets California)

An evaporative emissions control system uses a canister filled with charcoal to adsorb fuel vapor from the fuel tank while the engine is off. The vapor is drawn into the engine and burned while riding.

Crankcase Emissions Control System

The engine is equipped with a closed crankcase system to prevent discharging crankcase emissions into the atmosphere. Blow-by gas is returned to the combustion chamber through the crankcase breather hose, air cleaner housing and throttle body.

Fuel Permeation Emission Control

The fuel tank, fuel hoses, and fuel vapor charge hoses use fuel permeation control technologies to prevent fuel vapor emissions. Tampering with these components to reduce or defeat the effectiveness of the fuel permeation technologies is prohibited.

Noise Emission Control System

TAMPERING WITH THE NOISE CONTROL SYSTEM IS PROHIBITED:

U. S. federal law prohibits, and Canadian provincial laws may prohibit, the following acts or the causing thereof: (1) The removal or rendering inoperative by any person, other than for purposes of maintenance, repair or replacement, of any device or element of design incorporated into any new vehicle for the purpose of noise control prior to its sale or delivery to the ultimate purchaser or while it is in use; or (2) the use of the vehicle after such device or element of design has been removed or rendered inoperative by any person.

AMONG THOSE ACTS PRESUMED TO CONSTITUTE TAMPERING ARE THE FOLLOWING ACTS:

- Removal of, or puncturing the muffler, baffles, header pipes or any other component which conducts exhaust gases.

- Removal of, or puncturing of any part of the intake system.
- Lack of proper maintenance.
- Removing or disabling any emissions compliance component, or replacing any compliance component with a noncompliant component.

Problems Affecting Motorcycle Exhaust Emissions

Have your motorcycle inspected and repaired by your dealer if you experience any of the following symptoms:

- Hard starting or stalling after starting
- Rough idling
- Misfiring or backfiring during acceleration
- Poor engine performance and poor fuel economy

Catalytic Converter

This motorcycle is equipped with a three-way catalytic converter. The catalytic converter contains precious metals that serve as catalysts in high temperature chemical reactions that convert hydrocarbons (HC), carbon monoxide (CO), and oxides of nitrogen (NOx) in the exhaust gasses into safe compounds.

A defective catalytic converter contributes to air pollution and can impair your engine's performance. A replacement unit must be an original Honda part or equivalent.

Follow these guidelines to protect your motorcycle's catalytic converter.

- Always use unleaded gasoline. Leaded gasoline will damage the catalytic converter.
- Keep the engine in good running condition. A poorly running engine can cause the catalytic converter to overheat causing damage to the converter or the motorcycle.
- If your engine is misfiring, backfiring, stalling, or otherwise not running properly, stop riding and turn off the engine. Have your motorcycle serviced as soon as possible.

Oxygenated Fuels

Some conventional fuels blended with alcohol or an ether compound are available in some locales to help reduce emissions to meet clean air standards. These gasolines are collectively referred to as oxygenated fuels. If you plan to use oxygenated fuel, check that it is unleaded and meets the minimum octane rating and blend requirement.

The following fuel blends are EPA-approved and have been approved for use in your motorcycle:

- Ethanol (ethyl alcohol) up to 10% by volume.
 - ▶ Gasoline containing ethanol may be marketed under the name Gasohol.
- Methanol (methyl alcohol) up to 5% by volume that contain cosolvents and corrosion inhibitors to protect the fuel system. Never use a blend containing more than 5%.

If you accidentally fill your fuel tank with an oxygenated fuel containing higher percentages, you may experience performance problems. To resolve the problem, have your dealer drain the fuel tank and replace with the correct fuel. Fuel system or performance problems resulting from the use of an oxygenated fuel containing higher percentages are not covered by your warranty.

NOTICE

Improper use of oxygenated fuels can damage metal, rubber, and plastic parts of your fuel system.

Oxygenated fuel can also damage paint.

Damage caused by spilled fuel is not covered by warranty.

If you notice any undesirable operating symptoms or performance problems, try a different brand of gasoline.

Authorized Manuals

USA The Service Manual used by your authorized dealer is available from your Honda dealer or Helm, Inc.

Canada See your dealer to order authorized manuals.

Also available, but not necessary to service your model, is the Honda Common Service Manual, which explains basic service information for various systems on Honda motorcycles, scooters, and ATV.

USA The Winter Storage Guide in conjunction with the Owner's Manual and Service Manual can help you prepare your Honda motorcycle, scooter, ATV, and SxS for winter storage.

These Honda manuals are written for the professional technician. However, if you possess the proper tools, observe the safety standards, and are mechanically capable, you should find them easy to use.

Special Honda tools are necessary for some procedures.

USA

Order On-Line: www.helminc.com

Order Toll Free: 1-888-CYCLE93

(1-888-292-5393)

(NOTE: For Credit Card Orders Only)

Monday - Friday 8:00 AM - 6:00 PM EST

Publication Item No.	Description
61MKP00	2019 CBR500R/RA/CB500F/FA/X/XA Service Manual
61CSM00	Common Service Manual
S9507	USA Winter Storage Guide
31MKPB00	2019 CB500F/FA Owner's Manual

Warranty Coverage and Service

Coverage

Your new Honda is covered by the following warranties:

- Motorcycle Limited Warranty
- Emission Control System Warranty
- **USA** Noise Control Warranty

The responsibilities, restrictions, and exclusions that apply to these warranties are explained in the Warranties Booklet given to you by your Honda dealer at the time of purchase. Always keep your Honda owner's card with your Warranties Booklet.

Canada Please refer to the Warranty Booklet posted on our website at www.honda.ca.

It is important to realize that your warranty applies only to defects in material or workmanship of your Honda. Your warranty

coverage does not apply to the normal wear and deterioration associated with use of the motorcycle.

Your warranty coverage is not voided if you perform your own maintenance. However, failures that occur due directly to improper maintenance are not covered by these warranties.

USA You can extend almost all of your warranty coverage through the Honda Protection Plan. For more information, see your Honda dealer.

Service

Please remember that maintenance recommended in the Maintenance Schedule is not included in your warranty coverage.

If you believe you have a problem with your motorcycle, call the service department of your Honda dealer. Make an appointment for an inspection and diagnosis. You will be asked to authorize that inspection, and your dealer will return the results of the inspection. If a problem exists and is covered under warranty, your dealer will perform the warranty repairs. If you have any questions about your warranty coverage or the nature of the repair, talk to the Service Manager of your Honda dealer.

If a misunderstanding occurs and you aren't satisfied with your dealer's handling of the situation, we suggest you discuss your problem with the appropriate member of the dealership's management team. If you are still not satisfied, contact the owner of the dealership or their designated representative.

Honda Contacts

American Honda Motor Co., Inc.

If you wish to contact Honda directly to comment on your experiences with your motorcycle or with your dealer, please send your comments to the following address:

Motorcycle Division,
American Honda Motor Co., Inc.,
P.O. Box 2200, Torrance,
CA 90509-2200
Mailstop: 100-4C-7B,
Telephone: (866) 784-1870.

Canada

Honda Canada Inc.
Customer Relations Department,
180 Honda Boulevard
Markham, Ontario
L6C 0H9
Telephone: (888) 946-6329
Fax: (877) 939-0909
E-mail: honda_cr@ch.honda.com

Please include the following information in your letter:

- Name, address, and telephone number
- Product model, year, and VIN
- Date of purchase
- Dealer name and address

We will likely ask your Honda dealer to respond, or possibly acknowledge your comments directly.

Your Honda Dealer

The service department of your Honda dealer offers trained personnel to perform regular maintenance and most repairs. It has the latest available service information from Honda and also handles warranty inspections and repairs.

The parts department offers Honda Genuine Parts, Pro Honda products, Honda Genuine Accessories (USA only), and Honda accessories and products (Canada only) that provide the same quality that went into your motorcycle.

USA The sales department offers the Honda Protection Plan to extend almost all of your warranty coverage.

Your Honda dealer can also supply information about, riding events, and information about safety training available in your local area.

USA Reporting Safety Defects

If you believe that your vehicle has a defect which could cause a crash or could cause injury or death, you should immediately inform the National Highway Traffic Safety Administration (NHTSA) in addition to notifying American Honda Motor Co., Inc.

If NHTSA receives similar complaints, it may open an investigation, and if it finds that a safety defect exists in a group of vehicles, it may order a recall and remedy campaign. However, NHTSA cannot become involved in individual problems between you, your dealer, or American Honda Motor Co., Inc.

To contact NHTSA, you may call the Vehicle Safety Hotline toll-free at:

1-888-327-4236

(TTY: 1-800-424-9153); go to

<http://www.safercar.gov>;

or write to:

Administrator, NHTSA,
1200 New Jersey Avenue, SE.,
Washington, DC 20590.

You can also obtain other information about motor vehicle safety from:

<http://www.safercar.gov>.

Specifications

■ Main Components

Overall length	81.9 in (2,080 mm)
Overall width	31.1 in (790 mm)
Overall height	41.7 in (1,060 mm)
Wheelbase	55.5 in (1,410 mm)
Minimum ground clearance	5.7 in (145 mm)
Caster angle	25.5°
Trail	4.0 in (102 mm)
Curb weight	CB500F 412 lb (187 kg)
	CB500FA 417 lb (189 kg)
Maximum weight capacity *1	370 lb (168 kg)
Passenger capacity	Rider and 1 passenger
Minimum turning radius	8.9 ft (2.70 m)
Displacement	28.7 cu-in (471 cm ³)
Bore x stroke	2.64 x 2.63 in (67.0 x 66.8 mm)
Compression ratio	10.7:1
Fuel	Unleaded gasoline
	Recommended: 86 PON or higher
Tank capacity	4.52 US gal (17.1 L)
Battery	YTZ8V
	12 V- 7.0 Ah (10 HR)

Gear ratio	1st	3.285
	2nd	2.105
	3rd	1.600
	4th	1.300
	5th	1.150
	6th	1.043
Reduction ratio (primary / final)	2.029 / 2.733	

*1 : Including rider, passenger, all luggage, and accessories

Specifications

■ Service Data

Tire size	Front	120/70ZR17M/C (58W)
	Rear	160/60ZR17M/C (69W)
Tire type	Radial, tubeless	
Recommended Tire	Front	DUNLOP D222F W MICHELIN ROAD5
	Rear	DUNLOP D222 W MICHELIN ROAD5
Tire air pressure	Front	36 psi (250 kPa, 2.50 kgf/cm ²)
	Rear	42 psi (290 kPa, 2.90 kgf/cm ²)
Minimum tread depth	Front	0.06 in (1.5 mm)
	Rear	0.08 in (2.0 mm)
Spark plug	(standard)	CPR8EA-9 (NGK)
Spark plug gap	0.03 - 0.04 in (0.8 - 0.9 mm)	
Idle speed	(non-adjustable)	1,200 ± 100 rpm
Recommended engine oil	API Service Classification SG or higher except oils labeled as energy conserving or resource conserving on the circular API service label, SAE 10W-30, JASO T 903 standard MA, Pro Honda GN4 4-stroke oil (USA & Canada) or Honda 4-stroke oil, or an equivalent motorcycle oil	

Engine oil capacity	After draining	2.6 US qt (2.5 L)
	After draining & engine oil filter change	2.9 US qt (2.7 L)
	After disassembly	3.4 US qt (3.2 L)
Recommended brake fluid	Honda DOT 4 Brake Fluid	
Cooling system capacity	1.48 US qt (1.40 L)	
Recommended coolant	Pro Honda HP Coolant	
Recommended drive chain lubricant	Pro Honda HP Chain Lube or equivalent	
Drive chain slack	1 - 1 3/8 in (25 - 35 mm)	
Standard drive chain	DID520VF or RK520KLO2	
	No. of links	112
Standard sprocket size	Drive sprocket	15T
	Driven sprocket	41T

■ Bulbs

Headlight	LED
Brake light/Taillight	LED
Front turn signal/Position light	LED
Rear turn signal	LED
Position light	LED
License plate light	12 V-5 W

■ Fuses

Main fuse		30 A
Other fuse	CB500F	15 A, 7.5 A
	CB500FA	30 A, 15 A, 7.5 A

■ Torque Specifications

Oil filter	19 lbf-ft (26 N·m, 2.7 kgf·m)
Engine oil drain bolt	22 lbf-ft (30 N·m, 3.1 kgf·m)
Air cleaner screw A	0.8 lbf-ft (1.1 N·m, 0.1 kgf·m)
Rear wheel axle nut	65 lbf-ft (88 N·m, 9.0 kgf·m)
Drive chain adjusting lock nut	20 lbf-ft (27 N·m, 2.8 kgf·m)
Front wheel axle shaft	40 lbf-ft (54 N·m, 5.5 kgf·m)
Front wheel brake caliper mounting bolt	22 lbf-ft (30 N·m, 3.1 kgf·m)
Front wheel axle pinch bolt	16 lbf-ft (22 N·m, 2.2 kgf·m)

Information Record

VIN	
Engine No.	
Color Label & Code	
Owner's Name	
Address	
City/State	
Phone	
Dealer's Name	
Address	
City/State	
Phone	
Service Manager	

- A**
- ABS (Anti-lock Brake System)..... 11
 - ABS (Anti-lock Brake System) Indicator 45, 112
 - Accessories 14
 - Air Cleaner..... 87
 - Average Speed Meter..... 23
- B**
- Battery..... 67, 78
 - Brake Light Switch..... 93
 - Brakes
 - Fluid..... 71, 91
 - Lever Adjustment..... 105
 - Pad Wear 92
 - Braking 10
 - Bulb
 - Brake light/Tailight/Rear Turn Signals 123
 - Headlight/Position Lights/Front Turn Signals 123
 - License Plate Light..... 124
- C**
- Caring for Your Motorcycle 131
 - Catalytic Converter..... 143
 - Clock..... 19, 31
 - Clutch System 99
 - Coolant..... 72, 89
 - Coolant Temperature Gauge 20
 - Crankcase Breather 103
- D**
- Digital Clock Adjustment..... 31
 - Drive Chain 95
- E**
- Elapsed Time..... 24
 - Electrical Trouble 122
 - Engine
 - Number..... 138
 - Oil..... 70, 83
 - Oil Filter 85
 - Overheats 110
 - Starting 51
 - Stop Switch..... 48, 51, 129
 - Stopping 129
 - Will Not Start 109
 - Environment 137

Equipment

- Owner's Manual 55, 129
- Tool Kit..... 55

F

- Flooded Engine** 51
- Front Seat** 80
- Front Suspension**..... 106

Fuel

- Average Fuel Mileage Meter..... 22
- Consumption Meter 23
- Current Fuel Mileage Meter 22
- Gauge 20
- Recommended 53
- Remaining..... 20
- Reserve Fuel Consumption..... 24
- Tank Capacity 53

- Fuses**..... 69, 125

G

- Gasohol** 144
- Gasoline** 53
- Gear Position Indicator** 20

H

- Hazard Switch**..... 48
- Headlight Aim** 104
- Headlight Dimmer Switch** 48
- Helmet Holder**..... 54
- High Beam Indicator**..... 43
- Honda Contacts** 148
- Horn Button** 48

I**Ignition Cut-off System**

- Banking Sensor..... 130
- Side Stand..... 94

- Ignition Key**..... 128

- Ignition Switch**..... 49, 51, 129

- Indicators**..... 42

- Information Record**..... 154

- Instruments** 18

L

- Labels**..... 7

- Load Limits** 15

- Loading Guidelines**..... 15

- Low Oil Pressure Indicator** 45, 111

Luggage Tie-Down Hook..... 56

M

Maintenance

Fundamentals 64

Importance 58

Safety 59

Schedule..... 60

Maximum Weight Limit 15

Modifications..... 14

N

Neutral Indicator 43

Numerical tachometer 26

O

Odometer..... 26, 129

Oil

Engine..... 70, 83

Overheating 110

Oxygenated Fuels..... 144

P

Parking 12

Parts Location 16

PGM-FI (Programmed Fuel Injection)

Malfunction Indicator Lamp (MIL).... 43, 111

Protective Apparel..... 9

R

Rear Seat..... 81

Rear Suspension 107

Recommended

Coolant..... 72

Fuel..... 53

Oil 70

Refueling..... 53

Removal

Battery..... 78

Clip..... 79

Front Seat..... 80

Left Side Cover 82

Rear Seat..... 81

Repair Kit 115

Reporting Safety Defects..... 150

Reserve Tripmeter 26

REV Indicator..... 36, 43

Riding Precautions 10

S	
Safety Guidelines	3
Safety Labels	7
Safety Precautions	9
SEL button	18
SET button	18
Shifting Gears	52
Side Stand	94
Side Stand Ignition Cut-off System	94
Specifications	151
Speedometer	19
Start Button	48, 51
Starting the Engine	51
Steering Lock	50
Stopping Engine	129
Storage	
Equipment	54
Owner's Manual	55, 129
Tool Kit	55
Storing Your Motorcycle	135
Switches	48
T	
Tachometer	19
Tachometer Display	40
Throttle	102
Tires	
Air Pressure	73
Puncture	115
Replacing	73, 115
Transporting Your Motorcycle	136
Tripmeter	26, 129
Troubleshooting	108
Turn Signal Indicator	42
V	
Vehicle Identification Number	138
W	
Warning Indicators On	111
Warranty Coverage and Service	146
Washing Your Motorcycle	131
Weight Limit	15
Wheels	
Front Removal	116
Rear Removal	119

⚠️ WARNING

Operating, servicing and maintaining a passenger vehicle or off-highway motor vehicle can expose you to chemicals including engine exhaust, carbon monoxide, phthalates, and lead, which are known to the State of California to cause cancer and birth defects or other reproductive harm. To minimize exposure, avoid breathing exhaust, do not idle the engine except as necessary, service your vehicle in a well-ventilated area and wear gloves or wash your hands frequently when servicing your vehicle. For more information go to www.P65Warnings.ca.gov/passenger-vehicle.