

# WALSALL

HAZARDOUS AREA ELECTRICAL EQUIPMENT



## Electrical Equipment For Hazardous and Hostile Environments



Short Form 2009



CABLE JOINTS, CABLE TERMINATIONS, CABLE GLANDS, CABLE CLEATS  
FEEDER PILLARS, FUSE LINKS, ARC FLASH, CABLE ROLLERS, CUT-OUTS

11KV 33KV CABLE JOINTS & CABLE TERMINATIONS  
FURSE EARTHING  
[www.cablejoints.co.uk](http://www.cablejoints.co.uk)  
**Thorne and Derrick UK**

Tel 0044 191 490 1547 Fax 0044 191 477 5371  
Tel 0044 117 977 4647 Fax 0044 117 9775582

Including

**THREAD** 

By Walsall



# WALSALL

HAZARDOUS AREA ELECTRICAL EQUIPMENT

## Electrical Equipment

### Walsall Conduits (now Walsall Ltd)

The company was established in 1892 manufacturing bangles and metalwork for export markets. With the advent of electricity networks in the 1920's, the company began to design and manufacture electrical equipment for both hazardous and non hazardous areas. During this period the company concentrated on equipment for underground applications, in particular coal mining, with the main concept of protection being that of 'flameproof', more recently known as 'Ex d'.

### Petro-chemical and pharmaceutical operations

In the second half of the 20th Century, Walsall designed and manufactured products for use above ground specialising in the fields of switch gear and motor control.

### In The Year 2000

The company was renamed Walsall Ltd and began a new phase of development, widening the product range significantly. From inception to the present day Walsall products have become specified in all parts of the world. The name Walsall is synonymous with high quality electrical equipment and its products can be seen working everywhere where explosive hazards exist.

### A selection of specifiers, end-users and installers

Shell, BP, Chevron, Agip, Maersk Oil & Gas, Elf, NIGC, IOEC, NIOC, Pfizer, Glaxo, Petrobras, Woodside, ADNOC, GASCO, ZADCO, Saudi Aramco, Texaco, Aker-Kvaerner, Costain, Conoco Phillips, ABB, KBR, Bechtel, PFD, Snamprogetti, Cegelec, Technip, Mustang Engineering, Petronas, Marathon Oil & Gas, Transco, BNFL, London Underground, Virgin, Ikea, British Sugar, BAE Systems, Airbus, Lufthansa, British Airways, Air France, Petrofac, Wood Group, Tyco, National Grid, Diageo

### Certification

All products are certified by the British Notified Bodies, Baseefa and SIRA, with the manufacturing facility being ISO9001:2000 approved and ATEX / IECEx notification being held. Current certifications include ATEX, GOST & IECEx with more localised country certification in process.

### Privately Owned

The company is privately owned by the Whorrod family who firmly believe in investing for the future. Multi-million pound investments have been made into the manufacturing facility and new product development. 2009 heralds the launch of many exciting and innovative new products.

Middle East and Far East operations have been added to further enhance the group's ability to customise and service the local marketplace both quickly and efficiently. Complemented by an ever expanding network of experienced affiliated companies, the Walsall product range is available on a worldwide basis.

### Our Aim

The core objective of the company is to offer the very best customer service, the fastest turnaround of standard and bespoke products all at a very competitive price & all across a wide portfolio of products. Quality is key, with all products being designed & built for longevity.

Walsall Conduits was once the world leader in explosion protected electrical equipment and with this unique heritage the company is now heading back to its former glory - a true success story for British manufacturing.



### Contents

- 4 - Terminal Boxes
- 8 - Local Control
- 10 - Control Panels
- 11 - Power Switching
- 12 - Motor Control
- 13 - Distribution Boards
- 14 - Lighting
- 16 - Portable Lighting
- 17 - Emergency Shutdown & Signalling
- 19 - Transformer Outlets
- 20 - Systems
- 21 - Threaded Entry Devices

## For Hazardous & Hostile Environments



Terminal Enclosures with Rain Channel  
FXL Range Features

- Zone 1, 2, 21, 22
- II 2 GD and II 1 GD
- Certification Ex e IIC T6/5/4/3 Gb  
Ex tb IIC T80/95/130/160 °C Db  
Ex ia IIC T6/5/4/3 Ga  
Ex tb IIC T80/95/130/160 °C Db
- Ambient temperature range -50 °C to +120°C
- IP66 to EN60529:1992
- Electropolished 1.5mm (FXL1 - 4) or 2mm (FXL5 - 11) 316L Stainless Steel or powder coated Mild Steel box
- 0 - 4 Electropolished 3mm 316L Stainless Steel or powder coated Mild Steel gland plates
- Sizes ranging from 229mm x 152mm x 130mm to 1177mm x 777mm x 210/300mm
- 4 External mounting feet
- Padlockable hasp as an option
- Return flange rain channel
- Concealed hinges

Small Terminal Enclosures  
SL Range Features

- Zone 1, 2, 21, 22
- II 2 GD and II 1 GD
- Certification Ex e IIC T6/5/4/3 Gb  
Ex tb IIC T80/95/130/160 °C Db  
Ex ia IIC T6/5/4/3 Ga  
Ex tb IIC T80/95/130/160 °C Db
- Ambient temperature range -50 °C to +120°C
- IP66 to EN60529:1992
- Electropolished 1.5mm 316L Stainless Steel or Powder coated (RAL 7032) 3mm 1050A, H14 Aluminium
- Sizes ranging from 110mm x 110mm x 65mm to 190mm x 190mm x 100mm
- 2 External mounting feet

Cost Efficient Terminal Enclosures  
RX Range Features

- Zone 1, 2, 21, 22
- II 2 GD and II 1 GD
- Certification Ex e IIC T3/4/5/6 Gb  
Ex tb IIC T80/95/130/160 °C Db  
Ex ia IIC T3/4/5/6 Ga  
Ex tb IIC T80/95/130/160 °C Db
- Ambient temperature range -50 °C to +120°C
- IP66 to EN60529:1992
- Electropolished 1.2mm 316L Stainless Steel
- Sizes ranging from 100mm x 150mm x 60mm to 600mm x 600mm x 200mm
- 2 or 4 External mounting feet

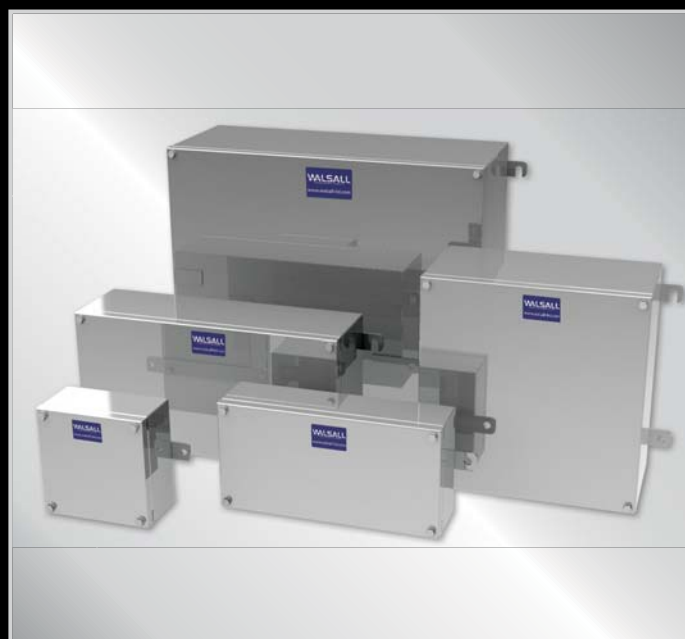
Extra Large Terminal Enclosures  
XLX Range Features

- Zone 1, 2, 21, 22
- II 2 GD
- Certification Ex e IIC T3/4/5/6 Gb  
Ex tb IIC T80/95/130/160 °C Db  
Ex ia IIC T3/4/5/6 Ga  
Ex tb IIC T80/95/130/160 °C Db
- Ambient temperature range -50 °C to +120°C
- IP65 to EN60529:1992
- Electropolished 1.5mm 316L Stainless Steel or powder coated Mild Steel box
- 0 - 4 Electropolished 3mm 316L Stainless Steel or powder coated Mild Steel gland plates
- 4 - 6 External mounting feet
- Padlockable hasp as an option
- Double door range

Bespoke Terminal Enclosures  
FXL Range Features

- Zone 1, 2, 21, 22
- II 2 GD and II 1 GD
- Certification Ex e IIC T6/5/4/3 Gb  
Ex tb IIC T80/95/130/160 °C Db  
Ex ia IIC T6/5/4/3 Ga  
Ex tb IIC T80/95/130/160 °C Db
- Ambient temperature range -50 °C to +120°C
- IP66 to EN60529:1992
- Electropolished 1.5mm (FXL1 - 4) or 2mm (FXL5 - 11) 316L Stainless Steel or powder coated Mild Steel box
- 0 - 4 Electropolished 3mm 316L Stainless Steel or powder coated Mild Steel gland plates
- Any sizes on request
- 4 External mounting feet
- Padlockable hasp as an option
- Return flange rain channel
- Concealed hinges

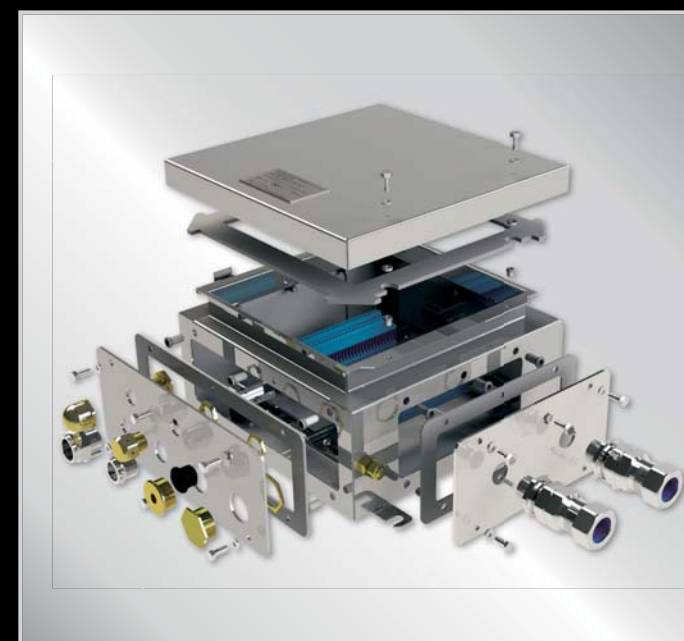
GRP Terminal Enclosures  
GL Range Features

- Zone 1, 2, 21, 22
- II 2 GD and II 1 GD
- Certification Ex e IIC T4/5/6 Gb  
Ex tb IIC T80/95/130 °C Db  
Ex ia IIC T4/5/6 Ga  
Ex tb IIC T80/95/130/ °C Da
- Ambient temperature range -40°C to +60°C
- IP66 to EN60529:1992
- Black moulded finish as standard, other colours are available on request including red, yellow and blue
- Sizes ranging from 75mm x 80mm x 55mm to 405mm x 400mm x 200mm
- Concealed mounting holes



### Heavy Duty GRP Junction Boxes GVU Junction Box Features

- Zone 1, 2, 21, 22
- Ⓜ II 2 GD
- Certification Ex e IIC T6 Gb  
Ex tb IIIC T85°C Db
- Ambient temperature range -40 °C to +50°C
- IP66 to EN60529:1992
- Black moulded finish
- 110mm x 110mm x 65mm
- 2 x external mounting lugs



### Flameproof Terminal Enclosures ASMT Range Features

- Zone 1, 2, 21, 22
- Ⓜ II 2 GD
- Certification Ex d IIB T6 Gb  
Ex tb IIIC T76°C Db
- Ambient temperature range -20 °C to +50°C
- IP66 to EN60529:1992
- Available in Cast Iron, Cast Aluminium or Cast Stainless Steel
- Available in 3 sizes;  
ASM130: 210mm x 185mm x 152mm  
ASM150: 335mm x 310mm x 200mm  
ASM170: 560mm x 560mm x 245mm
- External mounting straps supplied as standard



### Flameproof Junction Boxes E Range Features

- Zone 1, 2, 21, 22
- Ⓜ II 2 GD
- Certification E115: Ex d IIC T4/5/6 Gb  
Ex tb IIIC T130/95/80 °C Db  
E210: EEx d IIB T6  
E220: EEx d IIB T6
- Ambient temperature range  
E115: -40 °C to +50°C  
E210: -20 °C to +40°C  
E220: -20 °C to +40°C
- IP66 to EN60529:1992
- Powder coated cast iron
- Available in 3 sizes;  
E115: 117mm x 117mm x 70mm  
E120: 145mm x 106mm x 65mm  
E115: 104mm diameter x 57.5mm
- 2 External mounting feet



### High Voltage Terminal Enclosure HVB Features

- 6.6kV max operating voltage
- 650 Amps max operating current
- Zone 1, 2, 21, 22
- Ⓜ II 2 GD
- Certification Ex e IIC T6 Gb  
Ex tb IIIC T85°C Db  
Ex e IIC T4 Gb  
Ex tb IIIC T135 °C Db (with anti-condensation heater fitted)
- Ambient temperature range -50 °C to +55°C
- IP66 to EN60529:1992
- Electropolished 2mm 316L Stainless Steel or powder coated Mild Steel box
- 0 - 4 Electropolished 3mm 316L Stainless Steel or powder coated Mild Steel gland plates
- 4 External mounting feet
- Padlockable hasp as standard





### Single Function Local Control in GRP LCP100 Range Features

- Zone 1, 2, 21, 22
- II 2 GD
- Certification Ex edm IIC T6 Gb  
Ex tb IIIC T85 °C Db
- Ambient temperature range -20 °C to +55°C. -40°C when used with a plug and gland rated to -40°C
- IP64 for rotary components  
IP66 for all other functions
- Carbon loaded anti-static glass reinforced polyester
- Enclosure - 110mm x 110mm x 99mm
- 2 x External mounting lugs



### 2 Function Local Control in GRP LCP200 Range Features

- Zone 1, 2, 21, 22
- II 2 GD
- Certification Ex edm IIC T6 Gb  
Ex tb IIIC T85 °C Db
- Ambient temperature range -20 °C to +55°C. -40°C when used with a plug and gland rated to -40°C
- IP64 for rotary components  
IP66 for all other functions
- Carbon loaded anti-static glass reinforced polyester
- Enclosure - 110mm x 220mm x 99mm
- 2 x External mounting lugs



### 3 Function Local Control in GRP LCP300 Range Features

- Zone 1, 2, 21, 22
- II 2 GD
- Certification Ex edm IIC T6 Gb  
Ex tb IIIC T85 °C Db
- Ambient temperature range -20 °C to +55°C. -40°C when used with a plug and gland rated to -40°C
- IP64 for rotary components  
IP66 for all other functions
- Carbon loaded anti-static glass reinforced polyester
- Enclosure - 110mm x 220mm x 99mm
- 2 x External mounting lugs



### Single Function Local Control in Stainless Steel and Aluminium LCS100/LCA100 Range Features

- Zone 1, 2, 21, 22
- II 2 GD
- Certification Ex edm IIC T5 Gb  
Ex tb IIIC T95 °C Db
- Ambient temperature range -20 °C to +50°C. -40°C when used with a plug and gland rated to -40°C
- IP64 for rotary components. IP66 for all other functions
- LCS - Electropolished 1.5mm 316L Stainless Steel
- LCA - Powdered coated 3mm Aluminium
- Enclosure - 116mm x 116mm x 120mm
- 4 x External mounting feet



### 2 Function Local Control in Stainless Steel and Aluminium LCS200/LCA200 Range Features

- Zone 1, 2, 21, 22
- II 2 GD
- Certification Ex edm IIC T5 Gb  
Ex tb IIIC T95 °C Db
- Ambient temperature range -20 °C to +50°C. -40°C when used with a plug and gland rated to -40°C
- IP64 for rotary components. IP66 for all other functions
- LCS - Electropolished 1.5mm 316L Stainless Steel
- LCA - Powdered coated 3mm Aluminium
- Enclosure - 116mm x 171mm x 120mm
- 4 x External mounting feet



### 3 Function Local Control in Stainless Steel and Aluminium LCS300/LCA300 Range Features

- Zone 1, 2, 21, 22
- II 2 GD
- Certification Ex edm IIC T5 Gb  
Ex tb IIIC T95 °C Db
- Ambient temperature range -20 °C to +50°C. -40°C when used with a plug and gland rated to -40°C
- IP64 for rotary components. IP66 for all other functions
- LCS - Electropolished 1.5mm 316L Stainless Steel
- LCA - Powdered coated 3mm Aluminium
- Enclosure - 116mm x 236mm x 120mm
- 4 x External mounting feet



### GRP Control Panels GLCP Range Features

- Zone 1, 2, 21, 22
- II 2 GD
- Certification Ex edm IIC T5/6 Gb  
Ex tb IIIC T80/95°C Db
- Ambient temperature range -50 °C to +50°C
- IP66 to EN60529:1992
- Black moulded GRP enclosures
- Available sizes - GLCP11 - 250mm x 255mm x 120mm  
GLCP12 - 250mm x 400mm x 120mm  
GLCP13 - 405mm x 400mm x 120mm  
GLCP14 - 405mm x 400mm x 165mm
- 4 concealed mounting holes



### Sheet Steel Control Panels FXLCP Range Features

- Zone 1, 2, 21, 22
- II 2 GD
- Certification Ex edm IIC T5/6 Gb  
Ex tb IIIC T130/160 °C Db
- Ambient temperature range -50 °C to +50°C
- IP66 to EN60529:1992
- Electropolished 1.5mm(FXLCP3) or 2mm(FXLCP5, 6 & 9) 316L Stainless Steel or powder coated Mild Steel box
- 0 - 4 Electropolished 3mm 316L Stainless Steel or powder coated Mild Steel gland plates
- Available sizes - FXLCP3 - 306mm x 306mm x 150/200mm  
FXLCP5 - 458mm x 382mm x 150/200mm  
FXLCP6 - 480mm x 480mm x 150/200mm  
FXLCP9 - 762mm x 580mm x 150/200mm
- 4 External mounting feet
- Padlockable hasp as an option
- Return flange rain channel
- Concealed hinges



### Flameproof Control Panels ASMCP Range Features

- Zone 1, 2, 21, 22
- II 2 GD
- Certification Ex d IIB T6 Gb  
Ex tb IIIC T76°C Db
- Ambient temperature range -20 °C to +50°C
- IP66 to EN60529:1992
- Available in cast iron, cast aluminium and cast stainless steel
- Available sizes -  
ASMCP150/CI/AL/SS - 335mm x 310mm x 200mm  
ASMCP170/CI/AL/SS - 560mm x 560mm x 245mm
- 4 external mounting holes



### Changeover Switches RS Range Features

- Zone 1, 2, 21, 22
- II 2 GD
- Certification Ex d IIB T6 Gb  
Ex tb IIIC T85°C Db
- Ambient temperature range -20 °C to +50°C
- IP64 to EN60529:1992
- Black powder coated cast iron
- Supplied with 2 steel mounting straps
- Change over switch in 20, 25, 32 and 63 Amps
- 2 (Labeled 1-2) or 3 (labelled 1 - Off - 2) position switch
- Switch padlockable in the off position



### Switch Disconnectors SD Range Features

- Zone 1, 2, 21, 22
- II 2 GD
- Certification Ex d IIB T6 Gb  
Ex tb IIIC T85°C Db
- Ambient temperature range -20 °C to +50°C
- IP64 to EN60529:1992
- Black powder coated cast iron
- Supplied with 2 steel mounting straps
- 4 & 6 pole switch disconnectors in 20 to 315 Amps
- 2 position switch Labeled 0-1 or On - Off
- Switch padlockable in the off position



### Fused Switch Disconnectors SF Range Features

- Zone 1, 2, 21, 22
- II 2 GD
- Certification Ex d IIB T6 Gb  
Ex tb IIIC T85°C Db
- Ambient temperature range -20 °C to +50°C
- IP64 to EN60529:1992
- Black powder coated cast iron
- Supplied with 2 steel mounting straps
- 4 & 6 pole fused switch disconnectors in 20 to 125 Amps
- 2 position switch Labeled 0-1 or On - Off
- Switch padlockable in the off position





**Direct-On-Line Starters**  
DOL Range Features

- Zone 1, 2, 21, 22
- II 2 GD
- Certification Ex d IIB T6 Gb  
Ex tb IIIC T85°C Db
- Ambient temperature range -20 °C to +50°C
- IP65 to EN60529:1992
- Black powder coated cast iron
- Supplied with 2 steel mounting straps
- Direct online starters from 5.5kW to 30kW
- Adjustable overload relay
- 230 or 425V control circuit



**Star-Delta Starters**  
SDS Range Features

- Zone 1, 2, 21, 22
- II 2 GD
- Certification Ex d IIB T6 Gb  
Ex tb IIIC T85°C Db
- Ambient temperature range -20 °C to +50°C
- IP65 to EN60529:1992
- Black powder coated cast iron
- Supplied with 2 steel mounting straps
- Star Delta Starter/Isolator from 11kW to 30kW
- Adjustable overload relay
- 230 or 425V control circuit



**Distribution Boards**  
DBD150 Range Features

- Zone 1, 2, 21, 22
- II 2 GD
- Certification Ex d IIB T6 Gb  
Ex tb IIIC T76°C Db
- Ambient temperature range -20 °C to +50°C
- IP66 to EN60529:1992
- Available in Cast Iron, Cast Aluminium or Cast Stainless Steel
- External mounting straps supplied as standard
- Up to 2 rows of twenty single pole MCBs rated between 3 & 63 A, up to 500 V.
- 62W maximum dissipation



**Distribution Boards**  
DBD170 Range Features

- Zone 1, 2, 21, 22
- II 2 GD
- Certification Ex d IIB T6 Gb  
Ex tb IIIC T76°C Db
- Ambient temperature range -20 °C to +50°C
- IP66 to EN60529:1992
- Available in Cast Iron, Cast Aluminium or Cast Stainless Steel
- External mounting straps supplied as standard
- Up to 3 rows of twenty single pole MCBs rated between 3 & 63 A, up to 500 V.
- 200W maximum dissipation



**Zone 1 & 2 Fluorescent Fittings**

Ex d Calstar 500/550/600/650 Range Features

- Zone 1, 2, 21, 22
- II 2 GD
- Certification 500/550 - Ex d IIB T\* Gb  
Ex tb IIIC T\*\*\*C Db  
600/650 - Ex d IIC T\* Gb  
Ex tb IIIC T\*\*\*C Db
- Ambient temperature range -20 °C to +60°C
- IP67 to EN60529:1992
- Single lamp 8 Watt version. Also available as an Fire Exit fitting
- Single and double lamp 18, 36, 58 Watt versions
- Polycarbonate over tube as standard. Borosilicate option
- Powder coated cast aluminium housing
- Galvanized / powder coated steel
- 230V AC
- High frequency electronic ballast
- Power factor 0.98
- Maintained or non-maintained operation
- 3 hours operation time in emergency mode
- Ballast lumen factor - 8W - 27%, 18W - 12%, 36W - 10%, 58W - 7%



**Ex e E152 Features**

- Zones 1, 2, 21, 22
- II 2 G, II 2 D
- Certification Ex edq IIC
- Ambient temperature range -20°C to +60°C
- IP66 to EN60529:1992
- Single and double 18, 36 & 58 Watt versions
- GRP body, polycarbonate diffuser & GRP reflector
- Operating voltage 220 - 254 Volts AC or DC
- Power factor 0.98



**Ex n Vipet Features**

- Zones 2, 22
- II 3 GD
- Certification Ex nA II T4/5
- Ambient temperature range -20°C to +40°C
- IP66 to EN60529:1992
- Single and double 18, 36 & 58 Watt versions
- Polycarbonate body & diffuser
- Operating voltage 230 Volts AC
- Emergency versions available

**Bulkhead Fittings**

Calstar 300/350 Range Features

- Zone 1, 2, 21, 22
- II 2 GD
- Certification 300 - Ex de IIC T\* Gb 350 - Ex d IIC T\* Gb  
Ex tb IIIC T\*\*\*C Db Ex tb IIIC T\*\*\*C Db
- Ambient temperature range -20 °C to +60°C
- IP67 to EN60529:1992
- Single 13 Watts compact fluorescent and 60 Watt GLS Versions
- Polycarbonate over tube as standard. Borosilicate option
- Powder coated cast aluminium housing
- Powder coated 1.2mm aluminium reflector

**Single Status/Indicator Lamp**

E501 Features

- Zone 1, 2, 21, 22
- II 2 GD
- Certification Ex d IIB T5/4 Gb  
Ex tb IIIC T100°C/135°C Db
- Ambient temperature range -40 °C to +50°C(T5) or +85°C(T4)
- IP66 to EN60529:1992
- Black powder coated cast iron
- 2 external mounting feet
- 15 Watt incandescent lamp



**Wellglass Fittings**

ORBEX Features

- Zone 1, 2, 21, 22
- II 2 GD
- Certification Ex de IIC T4  
Ex tD A21 IP66 T135°C
- Ambient temperature range -20 °C to +55°C
- IP66 to EN60529:1992
- 230V AC
- 125, 150 and 250 Watt mercury, metal halide and high pressure sodium versions
- Powder coated cast aluminium housing
- Magnetic choke with associated electronic igniter
- Power factor 0.98 with pf correction capacitor
- Optional wire guard



**Floodlight Fittings**

FLN Features

- Zones 2 and 22
- II 3 GD
- Temperature range -40°C to +53°C
- Ex nR II
- IP65 to EN60529:1992
- Magnetic choke with associated electronic igniter
- 230V AC
- 150W, 250W & 400W metal halide and high pressure sodium lamps
- Body and cover - Aluminium 3.0 mm
- Glass - Toughened glass
- Reflector - Smooth polished or hammer Aluminium



**Floodlight Fittings**

Horizon Features

- Zones 1, 2, 21 and 22
- Certification Ex de IIC T\* Gb  
Ex tb IIIC T\*\*\*C Db
- T classes to be confirmed
- Corrosion resistant marine grade Aluminium alloy
- 230V AC
- 250W & 400W tubular sodium and metal halide lamps
- Re-lamping via threaded IIC access hole with separate cover to protect flamepath
- Ex e magnetic ballast with power factor correction and digital ignitor





### LED Handlamp

600 Features

- Zone 0, 1, 2
- Ex II 1 GD
- Ex ia IIC T4 & iaD T180°C
- 8 watt white high intensity LED light source
- Versatile output with optional beam form
- Compact & lightweight
- Up to 25m cable

#### Applications

- Aeronautical inspection and maintenance
- Petrochemical
- Offshore Oil & Gas
- Chemical



### Portable Luminaires

300 Features

- Zone 1, 2
- Ex II 2 GD
- Ex d IIB T5 ExtD T100° A21
- IP66/67
- Polycarbonate over tube
- Moulded suspension hooks secured
- Compact fluorescent lamps
- Compact fluorescent lamps
- The 300F can be festooned by interconnecting suitable cables between light fittings using the 20mm threaded entries. Alternatively each light fitting can be fitted with a suitable cable and flameproof inline plug and coupler to ease deployment.



### Semaphore Unit

The semaphore unit provides a combination of socket output facility and fixed lighting by means of 2 x 2ft 40 watt safetylites mounted on adjustable arms on the rigid or adjustable centre pole fixed to the main enclosure.

All electrical components are housed within the sealed enclosure and all sockets are switched interlocked and circuit breaker protected. The semaphore units are supplied with power from the main distribution units, festoon boxes or other semaphore units via a 3 core PVD insulated screened cable and fused plug.

The service access is achieved by removing the unit from its stand and releasing the hinged base. The main advantage of the semaphore unit is when the aircraft cabin lights are inoperative or lighting is required around the landing gear or engine areas and general lighting is essential.

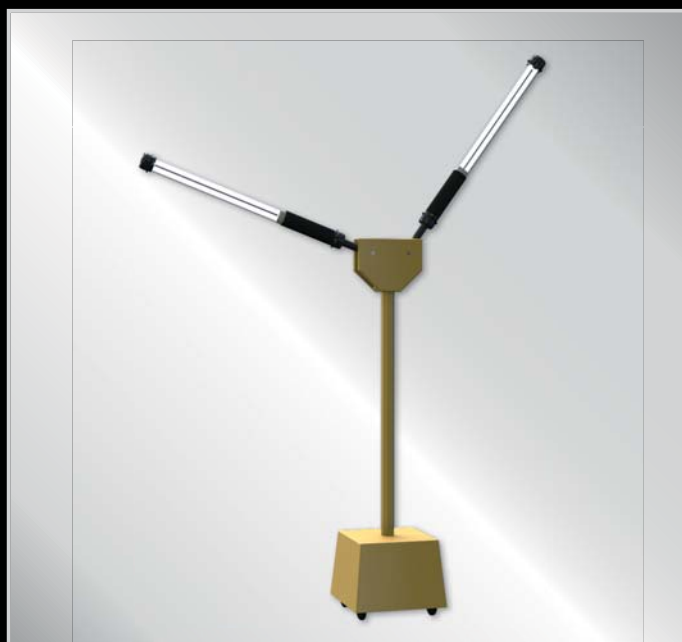

### Flameproof Manual Call Point - Break Glass

E0301 Features

- Zone 1, 2, 21, 22
- Ex II 2 GD
- Certification Ex d IIC T6 Gb  
Ex tb IIIC T80°C Db
- Ambient temperature range -40 °C to +50°C
- IP66 to EN60529:1992
- Red powder coated cast iron
- 2 external mounting feet
- Operating voltage of 415V max



### GRP Manual Call Point - Breakglass

E0302 Features

- Zone 1, 2, 21, 22
- Ex II 2 GD
- Certification Ex ed IIC T6 Gb  
Ex tb IIIC T85°C Db
- Ambient temperature range -40 °C to +55°C
- IP66 to EN60529:1992
- GRP break glass call point
- Moulded red GRP (other colours available)
- 2 external mounting lugs
- Operating voltages - 24V max with resistors fitted, 415 without



### Manual Call Point

E0303/E0304 Features

- Zone 1, 2, 21, 22
- Ex II 2 GD
- Certification Ex ed IIC T6 Gb  
Ex tb IIIC T85°C Db
- Ambient temperature range -40 °C to +55°C
- IP66 to EN60529:1992
- E0303 - GRP key switch call point
- E0304 - GRP push button call point
- Moulded red GRP (other colours available)
- 2 external mounting lugs
- Operating voltages - 24V max with resistors fitted, 415 without



Vantage Beacon  
Features

- Zone 1, 2, 21, 22
- II 2 GD
- Xenon flash tube
- Volt free & telephone initiation
- 24/48V DC or 110/230V AC operation
- 5, 10, 15 & 21J flash powers
- Fixed 1Hz frequency
- GRP Housing
- Ex e terminal chamber



Vantage Sounder  
Features

- Corrosion resistant GRP housing
- Stainless steel fixing strap
- Ex de IIC Gb T\*
- Ex tb IIC Db T\*\* (Temperature classes TBA)
- Up to 115 dB(a) output
- Ex e terminal chamber for easy termination
- IP66
- 24/48VDC, 110/230VAC operation
- Telephone or volt free contact initiation
- Tone selection via polarity of supply allowing for two wire installation on DC versions
- Internal volume control
- User selectable level one and level two warning tones
- Microprocessor controlled
- ATEX & IECEx certification pending



Vantage Loud Speaker  
Features

- Corrosion resistant GRP housing
- Stainless steel fixing strap
- Ex de IIC Gb T\*
- Ex tb IIC Db T\*\* (Temperature classes TBA)
- 3.75/7.5/15/30W RMS output selectable via taps on transformer
- 70 or 100V line operation
- 8 ohm version for direct drive
- Ex e terminal chamber for easy termination
- IP66
- ATEX & IECEx certification pending



DXN Range Features

- Zone 1, 2, 21, 22
- II 2 GD
- Ex de IIC T4/5/6
- Ex tD A21 T70/78/87/90/98/107
- Ambient temperature range -40 °C to +60 °C
- IP 66/67
- 20, 32 and 63 Amp versions.



SP Spider Box  
SPFXL and SPGL Features

- Zone 1, 2, 21, 22
- II 2 GD
- Ex ed IIC T6 T85°C
- IP66/67
- SPFXL - Electro polished 316L Stainless Steel
- SPGL - Enclosure black moulded GRP
- Transformer specification as TF range below



Ex e Transformers  
TF Features

- Zone 1, 2, 21, 22
- II 2 G
- Ex e IIC Gb
- 100 to 550VA
- Voltages available:  
Primary 0-230-400V Secondary 0-24-48V  
Primary 0-230-400V Secondary 2 x 0-110V  
Primary 0-240-415V Secondary 0-24-48V
- Terminals capacity 0.5 - 6mm²

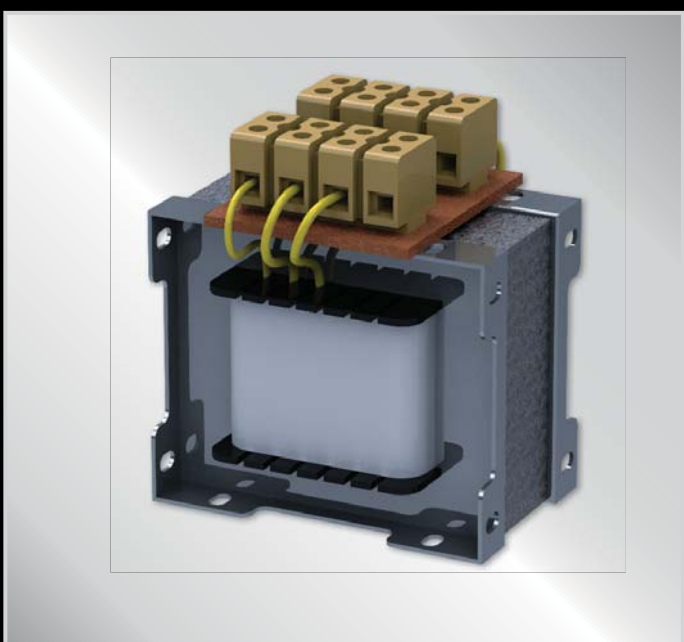



## Customised Systems Features

Walsall Ltd are able to offer Ex protected systems engineered from combinations of the product range. A typical example would be an ASM type Ex d enclosure being used to house industrial equipment such as PLC's, contactors and MCB's close coupled to an FXL type Ex e enclosure via a line bush. The Ex e enclosure is used to house control functions and terminals thus allowing for easier installation.

Component approved line bushes are used to join the enclosures to one another, and if required the whole assembly may be mounted on a steel framework. Since both design and manufacture of the system take place in-house at Walsall, the customer has only one point of contact and can be assured of good communication throughout the process.

In conjunction with the wide range of local control stations, alarm and signalling that Walsall offer, entire automation systems may be placed within the hazardous area if required.



## Stopping Plugs Features

- Zone 1, 2, 21, 22
- Ex II 2 GD
- Ex d, Ex e and Ex e/Ex d dual certified models
- IP66
- -60°C to +160°C (metal plugs)
- -20°C to +70°C (nylon plugs)



## Breather Drains

- Zone 1, 2, 21, 22
- Ex II 2 GD
- Ex e II Ex tD A21
- IP66
- -20°C to +70°C (nitrile O ring)
- -60°C to +160°C (silicone O ring)
- 10mm thread as standard. 20mm thread option



## Adaptors & Reducers

- Zone 1, 2, 21, 22
- Ex II 2 GD
- Dual certified
- Ex d IIC Ex e II Ex tD A21
- IP66
- -60°C to +160°C
- Available in brass, brass nickel plate, stainless steel or mild steel
- ThreadEx adaptors are certified to step up 1 or 2 sizes e.g. M32 to M40 or M20 to M32



Earth Tags

- Brass or Stainless Steel
- Metric M16 to M100
- NPT 1/2" to 4"



Lock Nuts

- Brass or Stainless Steel
- Metric M16 to M100
- NPT 1/2" to 4"

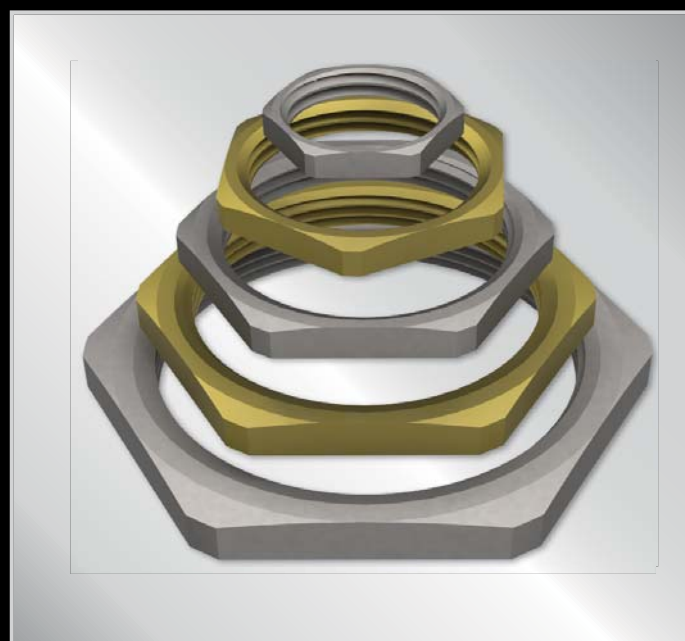

Washers

- White Nylon  
M16 - M100  
NPT 1/2" to 4"
- Red Fibre  
M16 - M100  
NPT 1/2" to 4"
- Serrated  
Stainless Steel or Mild Steel/Zinc Plated  
M16 - M100  
NPT 1/2" to 4"



Notes

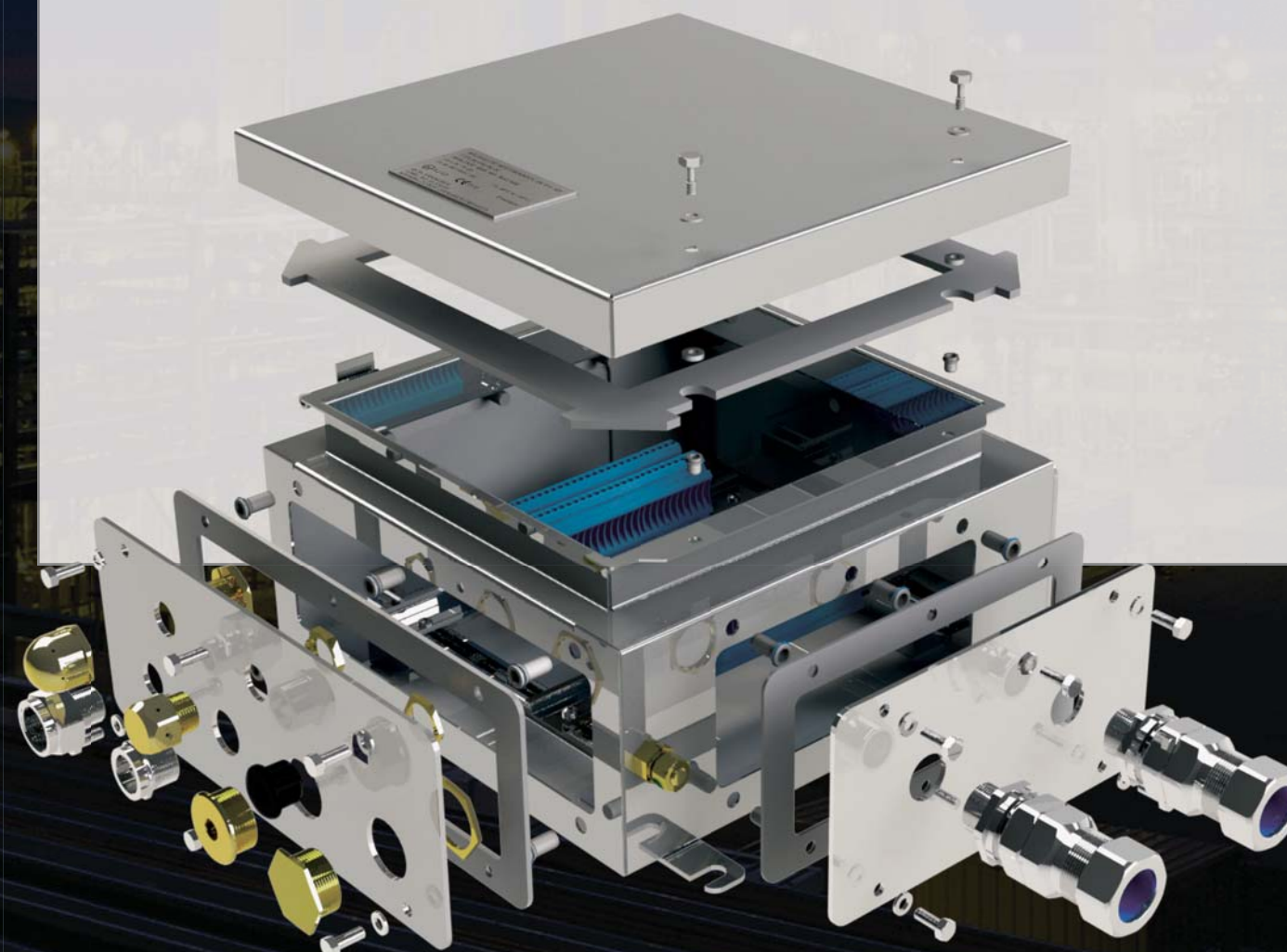



# WALSALL

HAZARDOUS AREA ELECTRICAL EQUIPMENT

The Walsall Group

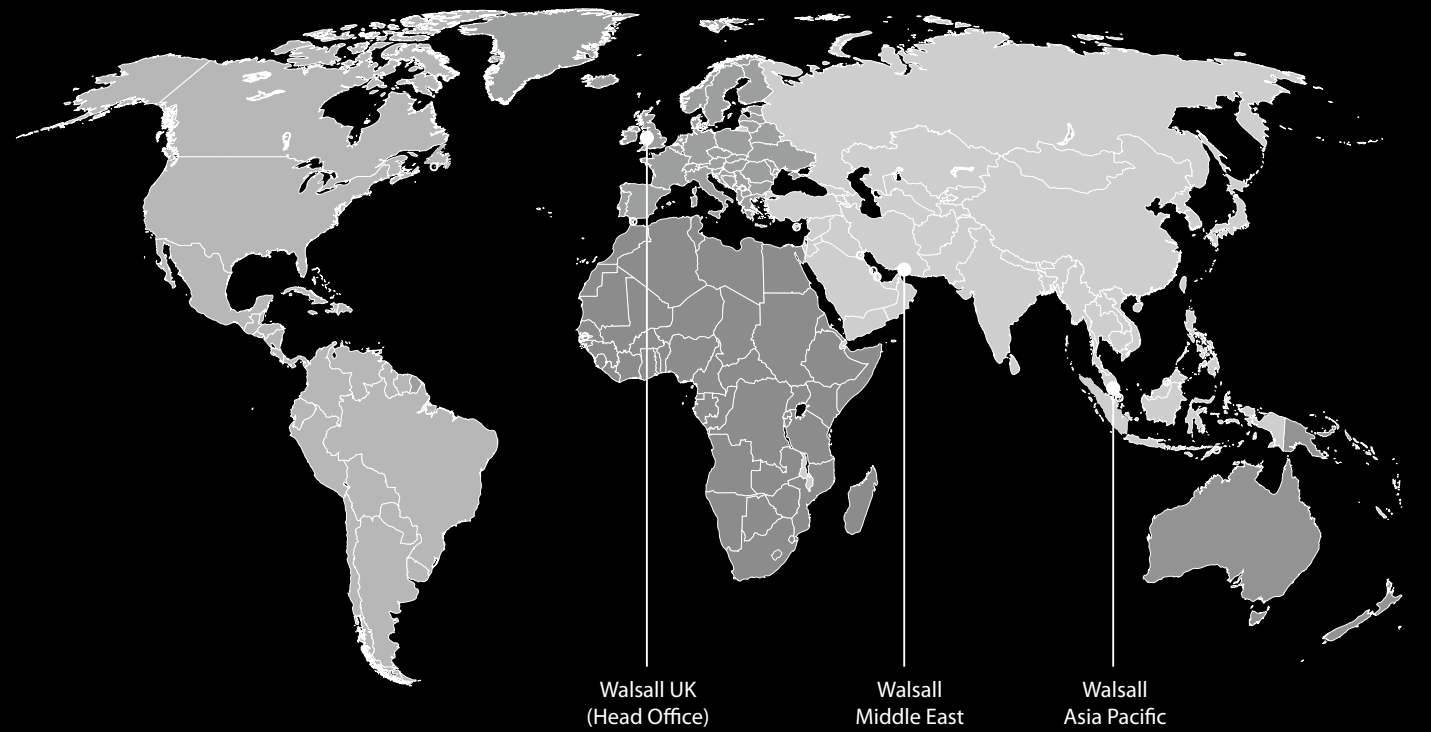

CABLE JOINTS, CABLE TERMINATIONS, CABLE GLANDS, CABLE CLEATS  
FEEDER PILLARS, FUSE LINKS, ARC FLASH, CABLE ROLLERS, CUT-OUTS

11KV 33KV CABLE JOINTS & CABLE TERMINATIONS  
FURSE EARTHING  
[www.cablejoints.co.uk](http://www.cablejoints.co.uk)  
**Thorne and Derrick UK**

Tel 0044 191 490 1547 Fax 0044 191 477 5371  
Tel 0044 117 977 4647 Fax 0044 117 9775582

Your local Walsall partner is:



[www.walsall-ltd.com](http://www.walsall-ltd.com)