

CHECKLINE®

MADE TO MEASURE

Instruction Manual



■ Model ZEF
ZED

Contents

1 Warranty and liability	3
1.1 Notices within the operating instructions.....	3
1.2 Responsibilities of the operating company.....	3
1.3 Responsibilities of the personnel	3
1.4 Informal safety measures.....	4
1.5 Training of the personnel	4
1.6 Intended use	4
1.7 Dangers in handling the device.....	4
1.8 Copyright.....	4
1.9 Declaration of conformity, RoHs II and WEEE registration	4
2 Available Models	5
2.1 Specifications	5
2.2 Connecting the tension meter	6
2.3 Delivery includes	6
2.4 Unpacking	6
3 Operations	7
3.1 Notes before starting measurement.....	7
3.2 Geräte- und Displayelemente	7
3.3 Setup.....	9
3.3.1 Charging the Battery.....	10
3.3.2 Switching the tension meter on	10
3.3.3 Switching the tension meter off	10
3.4 Tension meter settings.....	10
3.4.1 Material setup menu	12
3.4.2 Factory reset.....	12
3.5 Operation procedure	13
3.5.1 Zero adjustment of the measurement position	13
3.5.2 Inserting and removing material to be measured	14
3.5.3 Damping	15
3.5.4 Using the alarm function	15
3.6 Creating a material characteristic.....	16
3.6.1 Setup for calibration.....	16
3.6.2 Calibration procedure	17
3.6.3 Verifying the calibration	19
3.7 Memory functions.....	20
4 Service and maintenance	21
4.1 Rollers.....	21
5 Cleaning	21
6 Verification interval	21
7 Verification of Calibration and Determination of Repair Costs	22
8 Correspondence	23
9 Repairs	23

1 Warranty and liability

In principle, the supply of the device is subject to our “General Conditions of Sale and Delivery.” These have been provided to the operating company on conclusion of the contract, at the latest.

Warranty:

- SCHMIDT tension meters are warranted for 12 months.

Parts subject to wear, electronic components and measuring springs are not covered by the warranty. No warranty or liability will be accepted for bodily injury or property damage resulting from one or several of the following causes:

- Misuse or abuse of the device.
- Improper mounting, commissioning, operation and maintenance of the device (e.g. verification interval).
- Operation of the device if any safeguards are defective or if any safety and protection precautions are not properly installed or not operative.
- Failure to comply with the notices in the Operating Instructions regarding transport, storage, mounting, commissioning, operation, maintenance and setup of the device.
- Any unauthorized structural alteration of the device.
- Insufficient inspection of device components that are subject to wear.
- Opening the device or improper repair work.
- Disasters caused by the effects of foreign objects or by force majeure.

1.1 Notices within the operating instructions

The fundamental prerequisite for the safe handling of this device and its troublefree operation is the knowledge of the basic safety notices and safety instructions.

These Operating Instructions contain the most important notices for the safe operation of the device.

These Operating Instructions, in particular the safety notices, must be observed by any person who works with the device. In addition, the local valid rules and regulations for the prevention of accidents must be complied with.

The representations within the Operating Instructions are not true to scale.

The dimensions given are not binding.

General indications of direction, such as FRONT, REAR, RIGHT, LEFT apply when viewing the front of the device.

1.2 Responsibilities of the operating company

In compliance with the EC Directive 89/655/EEC, the operating company agrees to only permit persons to work with the device who:

- are familiar with the basic regulations on industrial safety and accident prevention and who have been trained in handling the device.
- have read and understood the chapter on safety and the warning notices in these Operating Instructions and have confirmed this with their signatures.
- are examined regularly on their safe and conscientious working method.

1.3 Responsibilities of the personnel

All persons who work with the device agree to perform the following duties before starting work:

- to observe the basic regulations on industrial safety and accident prevention.
- to read the chapter on safety and the warning notices in these Operating Instructions and to confirm with their signatures that they have understood them.

1.4 Informal safety measures

The Operating Instructions must always be kept on hand where the device is operated. Apart from the Operating Instructions, the generally and locally valid regulations on accident prevention and environmental protection must be provided and complied with.

1.5 Training of the personnel

Only trained and instructed personnel is permitted to work with the device. The responsibilities of the personnel must be clearly defined for mounting, commissioning, operation, setup, maintenance, and repair. Trainees may only work with the device under the supervision of experienced personnel.

1.6 Intended use

The device is intended exclusively to be used as a tension meter. Any other use or any use exceeding this intention will be regarded as misuse. Under no circumstances shall HANS SCHMIDT & Co GmbH be held liable for damage resulting from misuse.

The intended use also includes:

- Complying with all notices included in the Operating Instructions and observing all inspection and maintenance works.

1.7 Dangers in handling the device

The device was designed according to the state of the art and the approved safety standards. Nevertheless, its use may cause serious or fatal injury to the user or third persons, and/or an impairment of the device or of other material assets.

The device may only be applied:

- For its intended use in a faultless condition with regard to the safety requirements.
- Malfunctions that could impair safety must be remedied immediately.
- Personal protective equipment must be used according to the EC Directive 89/686/EEC.



The device must not be operated in potential explosive areas and must not come into contact with aggressive substances.

1.8 Copyright

The copyright on these Operating Instructions remains with the company HANS SCHMIDT & Co GmbH.

These Operating Instructions are intended for the operating company and its personnel only. They contain instructions and notices that may only be reproduced on the prior written permission of

HANS SCHMIDT & Co GmbH

and under indication of the complete reference data.

Violations will be prosecuted.

1.9 Declaration of conformity, RoHs II and WEEE registration

In compliance with the EU Directives 2014/30/EU and 2011/65/EU



HANS SCHMIDT & CO GmbH is registered in compliance with the German Electrical and Electronic Equipment Act (ElektroG) under WEEE Reg. No. DE 48092317.

2 Available Models



The individual models of the ZE Series are also available with the following modifications (customized versions):

- Calibration to different materials

Model	Tension Range cN	*Measuring Head Width mm	**SCHMIDT Calibration Material
ZEF-50	0.5 - 50.0	43	PA: 0.12 mm Ø
ZEF-100	0.5 - 100.0	43	PA: 0.12 mm Ø
ZEF-200	1 - 200.0	43	PA: 0.12 mm Ø
ZED-200	1 - 200.0	63	PA: 0.20 mm Ø
ZED-500	1 - 500	63	PA: 0.20 mm Ø

* Width of filament guide

** Suitable for 95% of all applications. PA = Polyamide Monofilament.

If the material to be measured differs significant from the SCHMIDT calibration material in diameter, rigidity, shape, etc., we recommend calibration using customer supplied material. For this purpose a material sample of about 5 m should be supplied.

International unit of tensile force: 1 cN = 1.02 g = 0.01 N

2.1 Specifications

Calibration:	According to SCHMIDT factory procedure
Units of Measure:	cN, g, N, lb, user selectable
Accuracy:	± 1% FS* ± 1 digit (typical ± 0.5% FS*)
Resolution:	0.1 cN
Overrange:	10% FS*, without accuracy guarantee
Overload Protection:	200% FS*
Measuring Principle:	Strain gauge bridge
Meas. Roller Deflection:	0.5 mm, max
Signal Processing:	Digital
Damping:	moving electronic (averaging)
Sampling rate internal:	Approx. 1 KHz
Sampling rate:	250 Hz, 2 Hz: AVG, MIN and MAX
Display Update Rate:	2 times per second
Display:	Colour TFT 128 x 160
Memory:	Average, last value, MAX, MIN
Communication frequency:	250 readings/sec
Temperature Coefficient:	Gain: less than ± 0.01% FS*/°C
Temperature Range:	10 - 45° C
Air Humidity:	85% RH, max.
Auto Power Off:	Automatical after approx. 3 min. of non-use
Power Supply:	LiPo accumulator (25 h continuous use, 3 ½ charging time), USB AC adapter 100 ... 240 V AC with 4 adapters (EU/USA/ UK/AUS-NZ)
Housing Material:	Plastic (POM)
Housing Dimensions:	157 mm x 124 mm x 32 mm (L x W x H)
Weight (net /gross):	Approx. 200 g / 600 g

*FS = Full Scale

2.1 Specifications (Cont.)

ZEF Guide Rollers:

V-grooved	Line Speed max. m/min	Roller Material
Standard	900	Hardcoated Aluminium
Code K	2000	Hardcoated Aluminium
Code T	450	Plastic (POM) black
Code W	450	Nickel plated steel

ZED Guide Rollers:

V-grooved	Line Speed max. m/min	Roller Material
Standard	2000	Hardcoated Aluminium
Code K	3500	Hardcoated Aluminium
Code H	5000	Aluminium plasmabeschichtet
Code T	450	Plastic (POM) black
Code W	450	Nickel plated steel
Code CE2	1000	Aluminium ceramic-coated

2.2 Connecting the tension meter

 The requirements of the CE specification are only complied with if the tension meter is equipped and operated with equipment supplied by HANS SCHMIDT & Co GmbH. Certification to the CE specification does not extend to, and shall be invalid for any other combination. For damage resulting thereby we assume no liability.

2.3 Delivery includes

- 1 Tension meter with accumulator
- 1 USB AC adapter with 4 adapters (EU/US/UK/AUS-NZ)
- 1 Certificate of compliance with the order 2.1 under EN 10204
- 1 Operating Instructions
- 1 Carrying case

2.4 Unpacking

Unpack the tension meter and inspect it for any shipping damage. Notices of defect must be announced immediately, in writing, at the latest within 7 days on receipt of the goods.

3 Operations

3.1 Notes before starting measurement



Have you read and understood the Operating Instructions, in particular Chapter 1 “Basic Safety Notices” ?

You are not permitted to operate the tension meter before doing so.

Before working with the instrument you must put on your personal protective clothing, if necessary. For example, eye protectors, gloves, etc. To avoid damage do not move the center roller by hand.

Tensions that exceed the tension range of the instrument by more than 100 % may cause permanent damage to the measuring spring and must be avoided under any circumstances.



The ID plate with the CE mark and the serial number, the calibration label (optional) as well as the SCHMIDT Quality Seal are provided on the backside of the instrument.

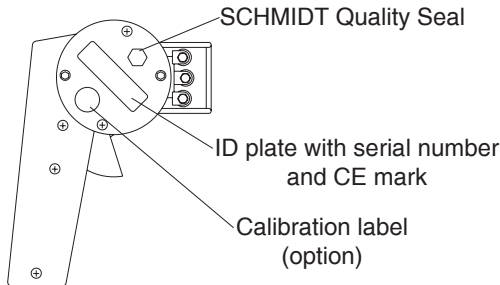

fig. 3.1

3.2 Geräte- und Displayelemente

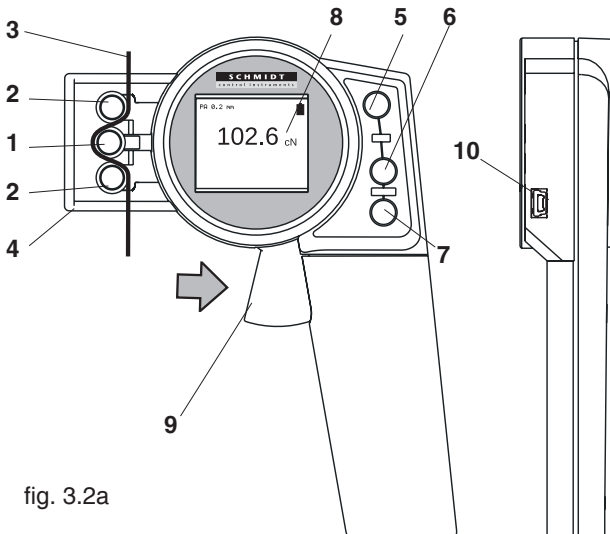

fig. 3.2a

- 1 Measuring roller
- 2 Guide rollers
- 3 Measured Material
- 4 Filament guide
- 5 ON / ZERO key
- 6 DAMP (Damping) key
- 7 Taste MEM
- 8 Display
- 9 Lever
- 10 Power connector

fig. 3.2b

3.2 Operating and display elements

Numeric display

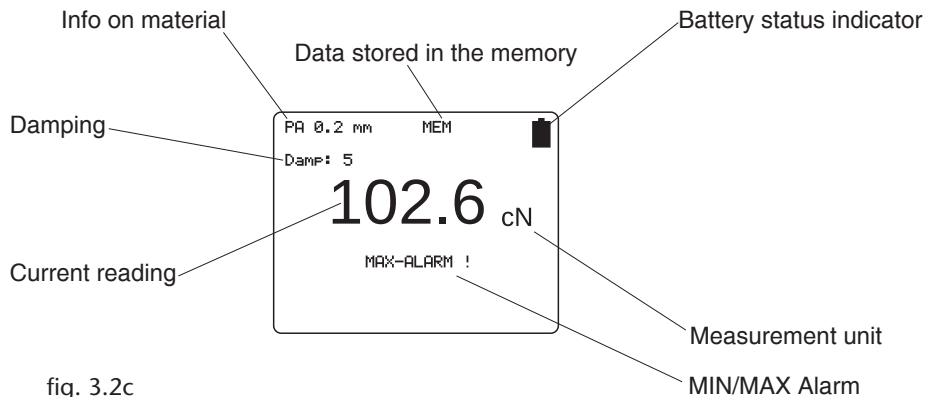

Display with bargraph

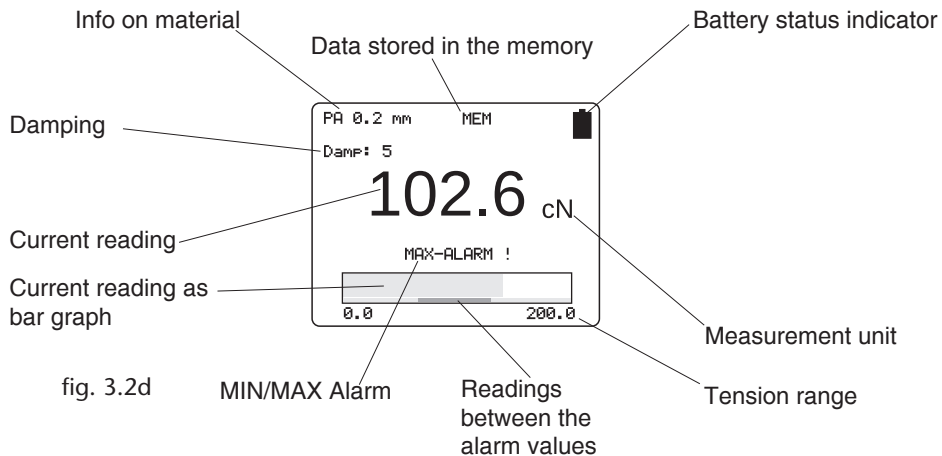

3.2 Operating and display elements

Graphic display

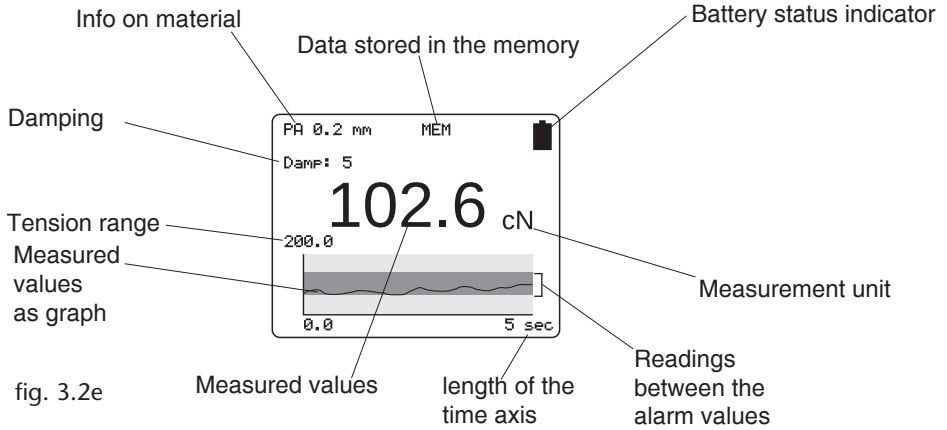

In the display mode, the different displays can be switched through by pressing simultaneously  and .

3.3 Setup

The tension meter is delivered with a built-in rechargeable LiPo battery, which has been charged at the factory. The tension meter can only be switched on if the battery is still working, i.e. if the battery has enough charge. If the instrument does not power up or if the battery level indicator shows a low charge  after power-up (Chapter 3.3.2), the battery needs to be recharged.



To ensure maximum battery life, avoid discharging it completely or charging it frequently for short periods. The battery should not be stored for an extended period of time when empty. After a maximum storage period of one year, the battery has to be recharged.

3.3.1 Charging the Battery



The battery can only be charged at a temperature between +5 °C and +45 °C.

Before you connect the AC adapter, verify that the supply voltage is correct (100 V - 240 V).

HANS SCHMIDT & Co. GmbH provides no warranty or liability for any damage resulting from the use of AC adapters from other manufacturers.

To charge the battery, connect the cable of the AC adapter to the power connector. When the battery is fully charged, the battery level indicator will be shown full . The charging time is approx. 3 ½ hours (using the AC adapter).



Battery overcharging is not possible

3.3.2 Switching the tension meter on

Press and hold the  button (for approx. 1 sec.) until the DISPLAY shows the measuring range, the software and hardware versions, e.g. SW 1.0, and then "0".

During startup, the tension meter performs an automatic zero adjustment. If the tension meter does not display zero, perform a manual zero adjustment procedure (see chapter 3.5.1).

Holding the  button makes the display freeze so that you can read the measuring range, the software and hardware versions.



While switch-on the tension meter, make sure not to move it. Otherwise, the automatic zero adjustment will be faulty.

3.3.3 Switching the tension meter off

Automatic switch-off (if enabled):

- After an idle period of 3 minutes, the tension meter switches off.













Manual switch-off:

- Press and hold the  button for 5 seconds.



The stored data are also automatically deleted after the device is switched off.



3.4 Tension meter settings

- Press the  and  buttons simultaneously to access the main menu.
- The  and  buttons can be used to select the various menu items of the main menu, the submenu and the settings menus.
- Press the  button to open the selected menu; by pressing the  or  button you can close the menu.
- In menus with multi-digit fields (e.g. min Alarm) use the  buttons to move forward between the digits. With the  and  buttons the particular value can be set.
- Press the  button to save the settings and exit the settings menu or press simultaneously the  and the  button to exit the current menu without saving.

3.4 Tension meter settings

Main Menu	Settings Menu	Description
Material		To select a material characteristic for the measurement. In addition, a calibration can be executed for the selected material characteristic, as well as a name and limit values can be defined in the material setup menu. The first material characteristic (factory calibration) can not be recalibrated.
Display Chapter 3.2	[Numeric] [Bargraph] [Graphic]	<ul style="list-style-type: none"> • Measured value displayed as number and alarm monitoring • Measured value displayed as number, bar graph trend display and alarm monitoring • Measured value displayed as graphical trend, measured value/limit values as graph In the display mode, the different displays can be switched through by pressing simultaneously  and 
Time scale	1, 2, 5, 10, 30 and 60 seconds	To choose the displayed time period (only graphic display)
Alarm	[ON] , [OFF]	Activate/deactivate the alarm. The display shows the values of the adjusted material characteristic.
Damping value		chapter 3.5.3 damping
Material setup		chapter 3.4.1 material setup
Tension Unit	[cN] , [g], [lb], [N],	Set the measurement unit.
Backlight	[OFF], [Minimum], [Medium], [Maximum]	For adjusting the brightness of the display.
Background	[white] , [black]	A white or black display background can be adjusted
Scr. Rotation	[AUTO] , [0°], [90°], [180°], [270°]	To set the display rotation to be fixed or to automatically adapt to the current orientation of the device.
Auto Power Off	[OFF] , [ON]	Toggle the „Auto Power off“ function on and off.
Language	English , German, Spanish, French	Select between the four user languages.
Factory reset		Reset to the factory settings.

Factory settings are illustrated bold

3.4.1 Material setup menu

In the material setup menu you can make the settings for the selected material characteristics and perform the calibration. To perform the calibration, the weights for the selected calibration points must be available.

Material Setup	Submenu	Settings Menu	Description
Name of the material characteristic curve	—	[character], [numbers], [special character]	To enter a name for the selected material characteristic.
High alarm limit	—	[000] - [999]	If the set limit value is exceeded, the display reads MAX-ALARM.
Low alarm limit	—	[000] - [999]	If the value falls below the set limit value, the display reads MIN-ALARM.
Calibration Chapter 3.6.2	Start		To perform a calibration, follow the instructions shown on the display.
	Cal. Points	between [5 %] and [90 %] of the tension range	Set three calibration points for which a calibration should be performed.
	Weights	[cN] , [g]	Set the unit of the calibration weights used.

Factory settings are illustrated bold

3.4.2 Factory reset

A factory reset resets the tension meter to its original manufacturer settings. This procedure will delete all settings, including any customer-defined material characteristics (calibrations); the factory calibration, however, will be kept.



Customer calibrations will be deleted.

3.5 Operation procedure

Requirements:

- Switch the tension meter on (chapter 3.3)
- Define the required tension meter settings (chapter 3.4)
- Select the desired material characteristic (chapter 3.4)
- Bring the tension meter into the desired measuring position and carry out a zero adjustment as described in chapter 3.5.1, if required.

3.5.1 Zero adjustment of the measurement position

Each time the measurement position is changed, the tension meter will automatically perform a zero adjustment.



If the tension meter does not display zero in its measuring position, perform a manual zero adjustment procedure.



For this purpose, no material to be measured must have been inserted yet!

Requirements:

- The tension meter has been switched on as described in chapter 3.3.2.

To carry out zero adjustment:

- Bring the tension meter into the desired measuring position and make sure not to move it.
- Press the  button.

The Display momentarily shows  and then switches to .

The tension meter is now adjusted to its new measuring position and ready to take measurements.

3.5.2 Inserting and removing material to be measured

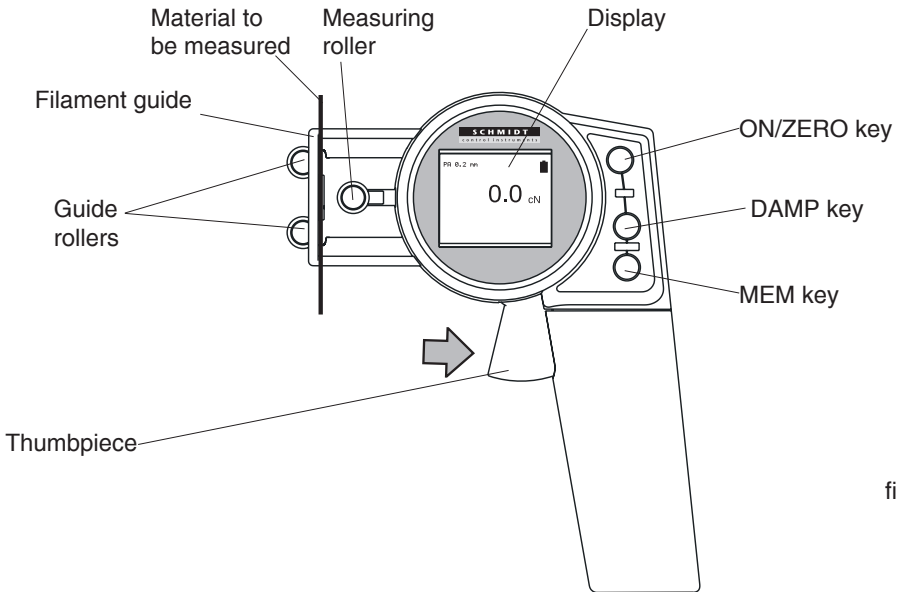

fig. 3.5.2

To insert the process material:

- Push the thumbpiece as far as it will go in the direction of the arrow to extend the guide rollers.
- Capture the process material with the filament guide (see fig. 3.5.2).
- Slowly release pressure on the thumbpiece until the guide rollers return to their original positions.

It is important to assure that the process material runs smoothly between the guide rollers and the measuring roller.



It is essential that the thumbpiece return slowly to its initial position. Any uncontrolled snap-back may affect calibration and may also damage the instrument.

To measure the process material:

The display now shows the measured tension values.

To remove the process material:

- Push the thumbpiece as far as it will go in the direction of the arrow.
- With the guide rollers extended, move the instrument away from the process material.
- Slowly release pressure on the thumbpiece until the outer rollers return to their original positions.

3.5.3 Damping

Feature to be used for tensions that vary strongly

In the Damping menu (chapter 3.4.1), you can specify a damping factor. Back in the display mode, press the  button to activate or deactivate the damping function. This is recommended if the displayed values vary strongly.

The factory setting for the damping factor is 5. The average shown on the display is calculated as follows:

$$\frac{5 \text{ old measured values} + 4 \text{ new measured values}}{9}$$

Damping can be changed in 9 steps from 01 = low damping:

$$\frac{1 \text{ old measured value} + 8 \text{ new measured values}}{9}$$

to 9 = high damping:

$$\frac{8 \text{ old measured values} + 1 \text{ new measured value}}{9}$$

3.5.4 Using the alarm function

Requirements:

In the Material Setup menu, make sure that the MIN and MAX limit values have been set for the material, that will be used for the measurement.

The alarms have to be enabled in the main menu.

3.6 Creating a material characteristic

The tension meter has been calibrated on material 1 according our SCHMIDT procedure for a vertical material path and cannot be deleted or overwritten. The material and diameter is given in chapter 2. Factory calibrations using customer supplied materials follow the same procedure. In this case, however, the calibration on Schmidt material 1 is omitted. fig. 3.6.1 shows a measuring setup for the calibration.

i The SCHMIDT calibration has been preset in the factory and cannot be overwritten. For these material characteristics, you can only change the name and limit values.

3.6.1 Setup for calibration

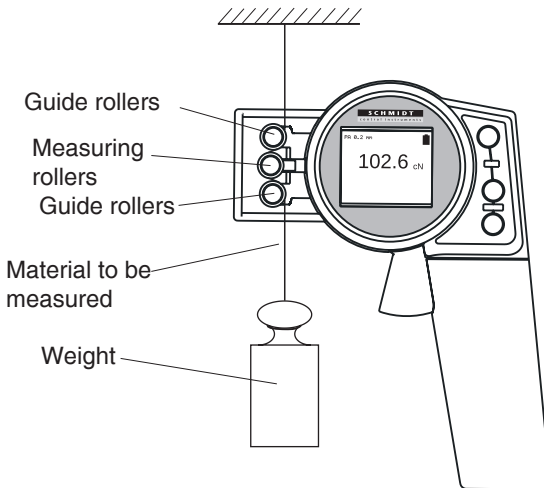

Hang a weight which corresponds to the tension to be measured from the measured material, vertically, as shown here. Pay attention to the correct unit of measure.

fig. 3.6.1

3.6.2 Calibration procedure

Calibrations of the tension meter are performed according to the SCHMIDT factory procedure using weights that correspond to 10 %, 50 %, and 90 % of the measuring range. In 95 % of all industrial applications, the SCHMIDT calibration has been proven to provide the best results. In particular, it is suitable for comparative purposes. If the material to be measured differs significantly from the SCHMIDT calibration material in material type, diameter, rigidity, shape, etc., we recommend to perform a calibration using customer-supplied material. In addition to the factory-preset material, you can save up to 3 additional materials.

Calibration Units and Calibration Points

- The device can be calibrated in centinewton (cN) or gram (g). Although the unit of the calibration weights has to correspond with the unit chosen in the menu „calibration“
- For the calibration of the tension meter, three calibration weights are used. For example, if you select 10 %, 50 %, 90 % for the weights for the calibration must correspond to 10 %, 50 % and 90 % of the measuring range.
In this example, you need the following weights for the ZEF-100:
Calibration in Newton: 10 cN, 50 cN and 90 cN
Calibration in Gram: 10 g, 50 g, and 90 g

i The measured values are displayed in the unit set in the „Settings“ menu, independent from the unit that was used to calibrate the material characteristic. So that they are available when you verify the calibration later or repeat the calibration after a factory reset.

e. g.

Material to be measured	Unit	Calibration points
Yarn	cN	5 %, 50 %, 90 %

To perform the calibration procedure

- Select a material characteristic in the material menu. Existing calibrations can be overwritten (The factory calibration can not be overwritten).
- Change to the material setup menu and define the name and the limits of the material characteristic.
- In the „material-setup“ menu, select Calibration.

i While performing the calibration, the tension meter must be fixed in such a way that the material to be measured runs smoothly between the guide rollers and the measuring roller.
The display gives detailed information on the calibration.

3.6.2 Calibration procedure

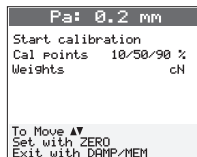

Step 1:

Set the calibration points and weights, e.g. in Newton using the calibration points 10 %, 50 %, and 90 % of full scale

Start: Select the Start menu item.

Alternative calibration points: 5 %, 45 %, 90 % 10 %, 45 %, 90 %
5 %, 50 %, 90 % 5 %, 25 %, 70 %

We recommend to use the 10 %, 50 %, 90 % setting for an initial calibration. If the measured values are not accurate enough when you check the calibration, repeat the calibration using other calibration points.

We recommend that you align the middle of the tension range to be measured with the middle calibration point.

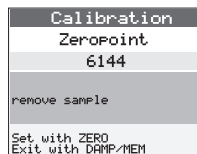

Step 2:

Perform a zero adjustment with the tension meter in its measuring position

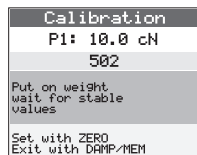

Step 3:

Calibrate calibration point 1

Insert material to be measured

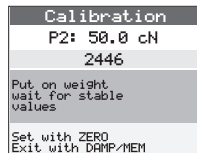

Step 4:

Calibrate calibration point 2

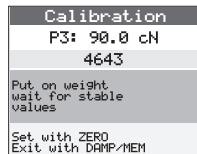

Step 5:

Calibrate calibration point 3



Once you have completed the calibration, make sure to verify it as described in chapter 3.6.3. In case of a large deviation, repeat the calibration or select different calibration points.

3.6.3 Verifying the calibration

When verifying the calibration, make sure to select the same material, calibration position and calibration points as used for creating the associated material characteristic. Otherwise, the precision of the measurements will not be sufficient.

The tension meter has been calibrated on material 1 according our SCHMIDT procedure for a vertical material path and cannot be deleted or overwritten. The diameter and material is given in chapter 2. Calibrations of the tension meter are performed according to the SCHMIDT factory procedure using weights that correspond to 10 %, 50 % and 90 % of the measuring range.

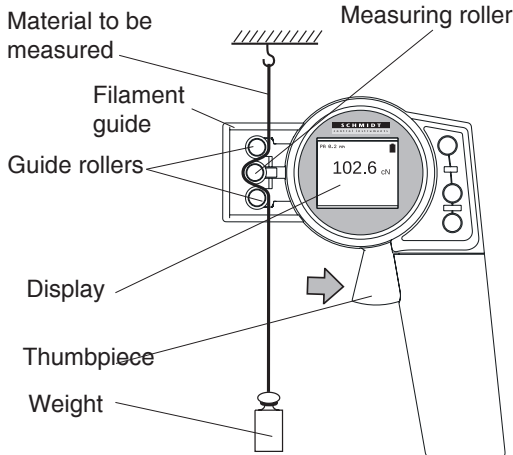

fig. 3.6.3a

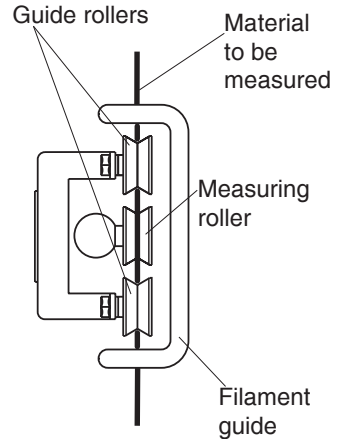

fig. 3.6.3b

- Attach a weight vertically to the process materials that corresponds to the tension to be measured (make sure to select the correct unit). The weight must hang freely. (Always use a fresh portion of the material to be measured.)
- Insert the material as described in chapter 3.5.2.



Do not let the lever snap back as this could affect the calibration and damage the instrument.



- Before verifying the calibration, move the instrument slowly up and down to compensate for any mechanical friction losses and thus ensure repeatability of the measurements.
- The tension value shown on the display should be equal to the mass of the suspended weight.

If the verification of the calibration shows a deviation beyond the allowable tolerance so that reliable operation is no longer possible, the instrument needs to be re-calibrated or returned to the factory for repair.

3.7 Memory functions

You can store and display the statistics of the last 128 measuring values (last measured value, the average, the minimum and maximum measured values as well as the standard deviation). In addition, the measured values are displayed as a graph.

Save data

- When pressing the  button the display will freeze (The display shows MEM, HOLD, Save with Damp, fig 3.7a).
- By pressing the  button the storage takes place (The display shows „MEM“, fig. 3.7b) and the measurement is continued while by pressing the  button the measurement is continued without saving.

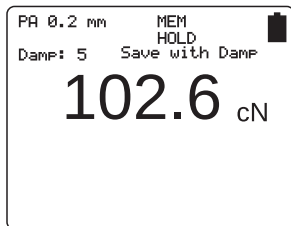

fig. 3.7a

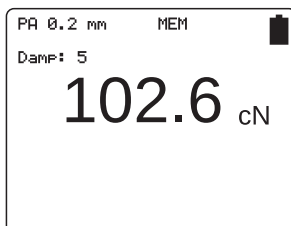





fig. 3.7b

1 When saving measured values again, the existing values are overwritten

Displaying the saved measured values

- Press the  and  buttons simultaneously to display the saved data.



The display will only show statistical values:

- Name of the material to be measured
 - Last reading
 - Average
 - Max.
 - Min.
 - Standard deviation (Std dev)
- By pressing the  button the saved data can be displayed as graph.
 - Press the  button to exit the memory.

Delete the saved measured values

If data is saved in the tension meter, the display shows “MEM”.

Delete data:

- Press the  and  buttons simultaneously.
- Then press the  button. The memory content is now deleted.

1 The stored data are also automatically deleted after the device is switched off.

4 Service and maintenance

The tension meter is easy to maintain.

Depending on operating time and load, the instrument should be checked according to the locally valid regulations and conditions (as described in Chapter 3.6.3). The use of other test methods than the procedure described in Chapter 3.6.3 may cause deviating measuring results.

4.1 Rollers

For example:

Order of spare rollers:

Model: ZEF-100 / ZED-500 (given on rear side of tension meter)

Serial number: 802 - 888888 (given on rear side of tension meter)

Standard rollers:

Model number ZEF: R580005

Delivery: 1 set (3 pcs.) of spare rollers 900 m/min with mounting tool

Standard rollers:

Model number ZED: R581004

Delivery: 1 set (3 pcs.) of spare rollers 2000 m/min with mounting tool
or

Model: ZEF-100-K / ZED-500-K (given on rear side of tension meter)

Serial number: Z 802 - 8888888 (given on rear side of tension meter)

Code K rollers:

Model number ZEF: R580006

Delivery: 1 set (3 pcs.) of spare rollers 2000 m/min with mounting tool

Code K rollers:

Model number ZED: R581003

Delivery: 1 set (3 pcs.) of spare rollers 3500 m/min with mounting tool

5 Cleaning

For cleaning the unit do not use any



AGGRESSIVE SOLVENTS

such as trichloroethylene or similar chemicals.



NO WARRANTY OR LIABILITY

shall be accepted for damage resulting from improper cleaning.

6 Verification interval

The question of finding the right frequency of calibration accuracy verification depends on several different factors:

- Operating time and load of the SCHMIDT tension meter
- Tolerance band defined by the customer
- Changes to the tolerance band compared to previous calibrations

Therefore, the interval between verifications of calibration must be determined by the user's Quality Assurance Department, based on the user's experience.

Assuming normal operating time and load as well as careful handling of the tension meter, we recommend a verification interval of one year.

7 Verification of Calibration and Determination of Repair Costs

Flow chart for verifying the calibration of used tension meters, incoming and outgoing verification with Inspection Certificate 3.1 according to DIN EN 10204

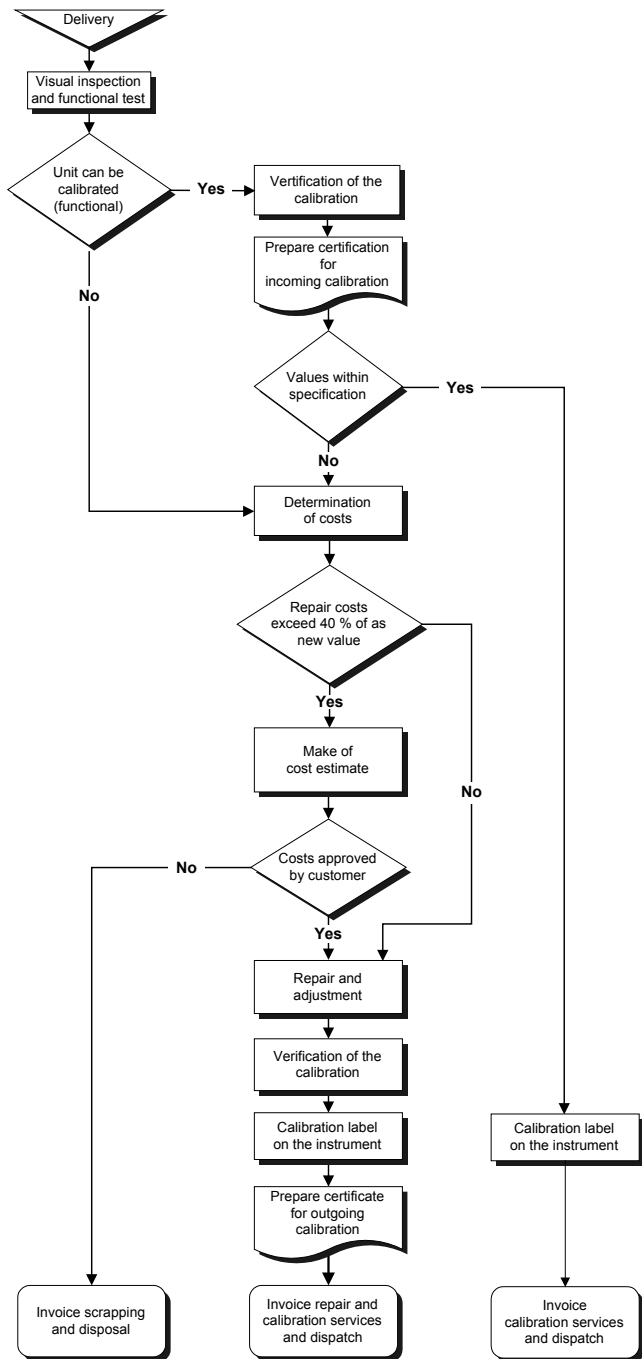

8 Correspondence

If you have any questions regarding the instrument or Operating Instructions or their use, please indicate all the following details which are given on the ID plate:

- 1) Model
- 2) Serial number

9 Repairs

Shipping instructions:

We kindly ask for return free of charge for us, if possible by airmail parcel. All occurring charges, if any (such as freight, customs clearance, duty etc.), will be billed to customer. For return from foreign countries, we ask you to include a proforma invoice with a low value for customs clearance only, e.g. 50 Euro, each and to advise the shipment in advance by fax or eMail.



To avoid unnecessary follow-up questions, and the resulting loss of time or possible misunderstandings, please return the instrument with a detailed fault description to our service department. Please indicate in your order whether you require an Inspection Certificate 3.1 according to DIN EN 10204.

Service address:



Tension Meter



Force Gauge



Torque Meter



Tachometer



Speed- and Lengthmeter



Electronic Lengthmeter



Stroboscope



Screen Printing Tension Meter



Thickness Gauge



Yarn Package Durometer and Shore-A Durometer



Sample Cutter



Balance



Moisture Meter



Leak Tester



Softometer

CHECKLINE®
MADE TO MEASURE

600 Oakland Ave • Cedarhurst, NY 11516 USA
Checkline.com • info@Checkline.com • 516-295-4300