

Operation & Maintenance Manual

LG936L

WHEEL LOADER



WARNING

Operators and maintenance persons should read this manual carefully and understand these instructions before use to avoid serious accident. For the convenience of relevant people using this manual, it should be easily accessible and kept in readable condition.

LG936L WHEEL LOADER

Operation & Maintenance Manual

880×1230 mm 16# 7.25pieces

1th Edition and 2nd Print in 2009. 2

SHANDONG LINGONG CONSTRUCTION MACHINERY CO., LTD

Address: Linyi Economic Development Zone, 276023

Tel: (+86) 0539—8785688

Fax: (+86) 0539-8785698 8785671

Services Tel: 8008607999 4006587999 (+86) 0539-8785800

Services Fax: (+86) 0539-8785671

Website: www.sdlg.cn

Operation & Maintenance Manual

Concise Guide

All reasonable measures have been taken to ensure that this publication is correct and complete, but if any user is in doubt about any detail, clarification may be sought from Shandong Lingong Construction Machinery Co. Ltd. or their accredited representative. The information in this document is subject to change without notice and should not be construed as commitment by Shandong Lingong Construction Machinery Co. Ltd. Shandong Lingong Construction Machinery Co. Ltd accepts no responsibility for any errors that may appear in this document.

®Shandong Lingong Construction Machinery Co. Ltd, P. R. China

All rights reserved. The contents of this publication may not be reproduced in any form, or communicated to a third party without prior written permission of Shandong Lingong construction machinery Co. Ltd.

Shandong Lingong Construction Machinery Co. Ltd

Linyi Economic Development Zone

Linyi, 276023

Shandong Province

P. R. China

Tel: +86 539 8785800

Fax: +86 539 8785698

Email: market@sdlg.cn

Website: <http://www.sdlg.cn>

Feedback

At Shandong Lingong Construction Machinery Co. Ltd, we are continually striving to improve the standards of our manuals and customer feedback is very welcomed. If you would like to comment on any aspect of this manual or our products in general, please send email to:

TechCenter@sdlg.cn

Alternatively, send a fax to +86 539 8785698 or write to

Manual Feedback

Technical Center

Shandong Lingong Construction Machinery Co. Ltd

Linyi Economic Development Zone

Linyi, 276023

Shandong Province

P. R. China

Please quote the title, part number and date of the manual. This will help us to understand your comments, suggestions or problems.

Table of Contents

PREFACE	VIII
SAFETY INFORMATION	X
CHAPTER I SAFETY	1
1 SAFETY LABEL POSITIONS AND THE CONTENTS	1
1.1 Safety Label and Its Position	1
1.2 The Contents of Safety Label (Domestic Type)	2
1.3 The Contents of Safety Label (Export Type)	6
2 SAFETY RULES	11
2.1 Safety Rules	11
2.2 Safety Devices	11
2.3 Protective Items	12
2.4 Unauthorized Modification	12
3 SAFETY OPERATION	13
3.1 Be Familiar with Machine	13
3.2 When Leaving Operator's Seat	13
3.3 Mounting and Dismounting	14
3.4 Fire Prevention	14
3.5 Precautions When Operating at High Temperature	15
3.6 Visibility Requirements	16
3.7 Prevent Crushing or Cutting Body Parts	16
3.8 Notice of Attachment	17
4. STARTING SAFELY	17
4.1 Before Starting Engine	17
5 SAFETY DRIVING	20
5.1 Warning	20
5.2 Safety of self and Others	20
5.3 Full Load Transportation	22
5.4 Drive at Proper Speeds	22
5.5 Ensure Good Visibility	22
5.6 Pay Attention to Blockages	23
5.7 Driving in Dangerous Conditions	23
5.8 Driving Safely on the Ramp	24
5.9 Towing	25
6 SAFETY OPERATION	26
6.1 Keep Good Operation Habits	26
6.2 Pay Attention to Surroundings	28
6.3 Ensure Ventilation in Close Environment	29
6.4 Don't Get Close to Dangerous Environment	29
6.5 Don't Get Close to High Voltage Wire	29
7 SAFETY PARKING	30
7.1 Pay Attention to the Safety of Yourself and Others	30
7.2 Notice for Cold Area	31
8 SAFETY EXAMINATION AND REPAIR	31
8.1 General Knowledge	31
8.2 Working in a Close Area	32
8.3 Maintenance of Frames During Jacking up	32
8.4 Working under the Machine	33
8.5 Working on the Machine	33
8.6 Maintenance While the Engine is Working	34
8.7 Do Not Let Anything Fall into the Inner Part of the Machine	34
8.8 Cleaning	34
8.9 Heavy Materials	35

8.10 Welding Repair.....	35
8.11 Maintenance of Coolant System.....	36
8.12 Examination and Repair of Hydraulic System.....	37
8.13 Preventing Fire.....	37
8.14 Air Storage Tank.....	38
8.15 Electric System.....	39
8.16 Maintenance of Storage Battery.....	39
8.17 Charging of Storage Battery.....	40
8.18 Starting to Use Voltage-Raising Method.....	40
8.19 Maintenance and Storage of Tires.....	41
8.20 Waste Materials.....	42
9 SAFETY TRANSPORTATION.....	42
9.1 Assemble and Disassemble the Machine.....	42
9.2 Transportation on the Ground.....	43
9.3 Lifting.....	43
CHAPTER II INTRODUCTION.....	45
1 GENERAL VIEW OF THE MACHINE & COMPONENTS' NAME.....	45
2 GEOMETRICAL DIMENSIONS.....	46
3 PRODUCT TYPE AND ITS MEANING.....	47
4 NAMEPLATE.....	47
5 USE CONDITIONS.....	48
6 CIRCUMSTANCES REQUIREMENT.....	49
7 FEATURES.....	49
8 TECHNICAL PERFORMANCE & PARAMETER.....	50
8.1 Performance of Whole Machine.....	50
8.2 Principle Dimension and Weight.....	51
8.3 Product Standard and License.....	51
CHAPTER III OPERATION AND APPLICATION.....	52
1 BE FAMILIAR WITH MACHINE.....	52
1.1 Control Systems and Gauges.....	52
1.2 Introduction of Gauges & Controls.....	55
2 RUN-IN PERIOD OF NEW MACHINE.....	70
3 OPERATION AND USE OF LOADER.....	71
3.1 Notices for Usage.....	71
3.2 Starting.....	72
3.3 Running.....	74
3.4 Stopping.....	76
3.5 Operations.....	79
3.6 Oil and Fuel Supply.....	85
3.7 Long-Time Storage.....	92
3.8 General Problems/Possible Cause/Remedies.....	94
CHAPTER IV MAINTENANCE.....	99
1 MAINTENANCE GUIDE.....	99
1.1 Attention to Maintenance and Inspection.....	99
1.2 Hanging Warning Tag.....	99
1.3 Fitting preparation.....	99
1.4 Oil and Fuel preparation.....	99
1.5 Using the Prescriptive Oil and Fuel.....	99
1.6 Keep the Machine Clean.....	99
1.7 Pay Attention to the Refrigerant Water and Oil in High Temperature.....	99
1.8 Check the Oil and Filters.....	100
1.9 Fuel Strainer.....	100

1.10 Oil Changing	100
1.11 Welding Guide.....	100
1.12 Fire Prevention	100
1.13 Sealing Part	100
1.14 Checking the Frame	100
1.15 Attention to Washing Machine	100
1.16 Checking in Raining and Snowing Circumstances	101
1.17 Dusty Circumstances.....	101
1.18 Avoid Using Mixed Oil	101
2. DETAILED RULES OF MAINTENANCE	101
2.1 Detailed Rules of Using Oil, Fuel and Coolant.....	101
2.2 Selection of Fuel, Coolant and Lubricant.....	103
2.3 The Sketch of Lubricating Points.....	106
2.4 Detailed Rules of Electric System Maintenance	106
2.5 Maintenance Tools	106
2.6 Tightening Torque of Screw	107
3. CONTENT OF MAINTENANCE.....	108
3.1 Every 10 Hours (Days) Service.....	108
3.2 Every 50 Hours (Week) Service.....	108
3.3 Every 250 Hours (Month) Service	108
3.4 Every 500 Hours (Season) Service.....	109
3.5 Every 1000 Hours (Half a Year) Service.....	109
3.6 Every 2000 Hours (Year) Service.....	110
3.7 Alteration.....	110
3.8 Replace the Air-Storage Tank after 3 Years of Service.....	110
CHAPTER V THE STRUCTURE AND PRICIPLE OF MAIN COMPONENTS AND SYSTEM	111
1 Transmission System.....	111
2 Hydraulic System.....	111
3 Brake System	113
3.1 Driving Brake System(Single Brake Pedal):.....	114
3.2 Driving Brake System(Single Brake Pedal):.....	115
3.3 Parking Brake System	115
4 Electric System	116

PREFACE

Thank you for purchasing the wheel loader produced by Shandong Lingong.

This manual is a guideline for users to operate and maintain this machine properly. Keep this manual within easy access and have all relevant people read it before use. If this manual is lost, damaged or cannot be read, contact our company or our dealers.

If you sell the machine, be sure to give this manual to the new owners.

Parameters, figures and information included in this manual apply only to basic loaders. For those derivative products, please consult us or refer to the relative manuals.

When selecting working equipment, please follow the user manual of the working equipment to assemble and disassemble, replace and use.

In addition, please read carefully the attached technical user manual for the diesel engine and other functioning parts about operation, use and maintenance.

We are continually striving to improve the quality of our products, to produce more advanced and a safer engineering machine. We reserve the right, at our sole discretion, to change or modify our design, but we do not promise to apply the changes to products that are sold. We also reserve the right to change the data and machine, and the right to maintain it. The design, operation and user information in this document is subject to change without notice. Customer feedback is very welcomed. If you would like to comment on any aspect of this manual or our products in general, please feel free to contact us.

Please give us feed back about the shortcomings immediately upon using our products, so that we can continue to improve our products to satisfy your requirements.

All rights are reserved. The contents of this publication may not be reproduced in any form, or communicated to a third party without prior written permission of Shandong Lingong Construction Machinery Co. Ltd.

 **WARNING**

- The wrong operation, maintenance and repair could result in injury or death.
- An operator should read this manual carefully before operation or maintenance. **Never** attempt to operate, maintain or repair the machine before reading and understanding this manual.
- The operation specifications and precautions given in the manual only apply to intended uses of the machine. If the machine is used for any unintended purpose that is not specifically prohibited, ensure the safety of yourself and others before using.
- Any operation and actions which are in conflict with the description in this manual are prohibited.

SAFETY INFORMATION

Operators should know and obey the safety criteria described in national and local laws. If there is no such national or local criteria, please follow the rules described in this manual.

Most accidents are caused by the failure to follow fundamental safety regulations for the operation and maintenance of machines. To avoid accidents, please read, understand and follow all precautions and warnings in this manual about the machine before performing any operation or maintenance.

Safety precautions are specified in SAFETY of Chapter I, page I.

Safety information described in this manual cannot include safety precautions for every circumstance that might involve a potential hazard in operation and maintenance. Therefore, if procedures or actions which are not recommended in this manual are used, the safety of the operator and machine must be confirmed. Otherwise, consult us or the dealers.

The safety precautions for operation and maintenance in this manual only apply to those conditions specified by the machine. If the uses of the machine are not specified in the manual, users should assume full responsibility for their actions. We will not bear any safety responsibility for the operators or machine.

In any case, you should not engage in prohibited operations as described in this manual.

The following signs are used for identification of safety information in this manual:

 DANGER— This word is used in safety messages and on safety labels where there is a high possibility of serious injury or death if the hazard is not avoided. These safety messages or labels usually describe precautions that must be taken to avoid the hazard. Failure to avoid this hazard may also result in serious damage to the machine.

 WARNING— This word is used in safety messages and on safety labels where there is a potentially dangerous situation. Failure to avoid this hazard may also result in serious injury or death. Failure to avoid this hazard may also result in serious damage to the machine.

 NOTICE— This word is used in safety messages and on safety labels for the hazards that could result in minor or moderate injury if the hazard is not avoided. This word is used for precautions that must be taken in order to avoid actions which could shorten the life of the machine.

CHAPTER I SAFETY

WARNING

Read and follow all safety precautions. Failure to do so may result in serious injury or death.

1 SAFETY LABEL POSITIONS AND THE CONTENTS

1.1 Safety Label and Its Position

The positions of safety labels of this machine are shown in the figure 1-1 and figure 1-2. Please read carefully and follow the contents of all the safety labels. Please maintain the labels; when a label becomes lost, broken or unclear, immediately repair or replace the label. If any component attached with safety labels is replaced, please make sure the new component has the same safety label. When cleaning the safety labels, please use cloth, soap and water. Do not use chemical and gas cleansers.

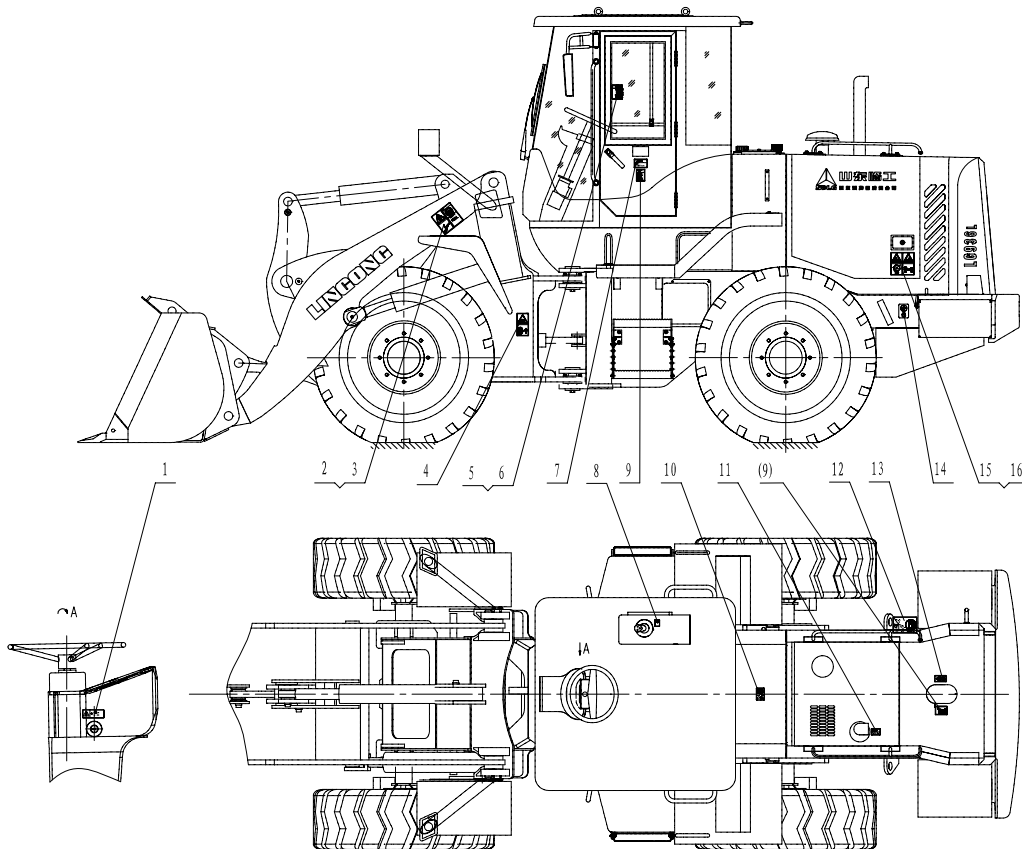
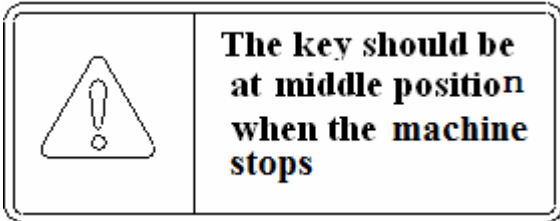

Figure 1-1 Figure of safety label position (Domestic Type)

1.2 The Contents of Safety Label (Domestic Type)

1. Warning for starting

Located above the start button



2. Limit position of lift arm

(Lock the lift arm cylinder before entering dangerous areas.)

Located on both sides of lift arms

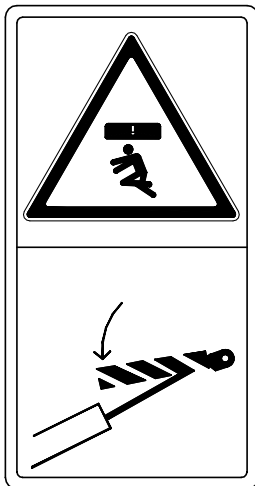

3. Danger of lift arm

Located on both sides of lift arm



4. Danger of injury or death during steering

Located on the steering position of front and rear frames

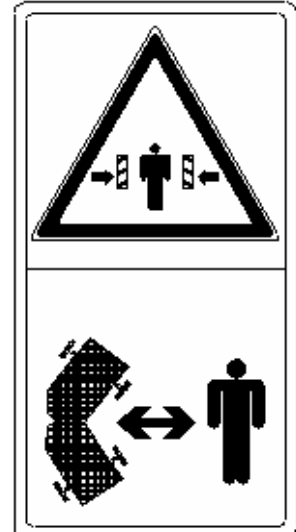

5. Notice for operation

Located on the inner left front glass of the operator cab.

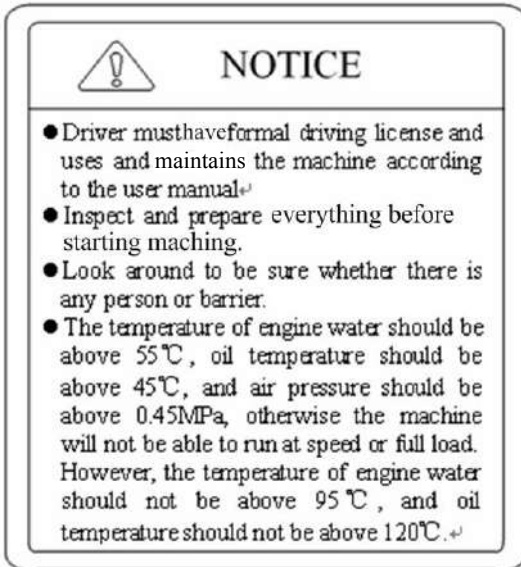

6. Notice for driving

Located on the left side of operator cab door or mouse of radiator of engine hood



7. Notice for the door of operator cab

Located on outside of operator cab left door



8. Notice for parking brake

Located on the operation tank.

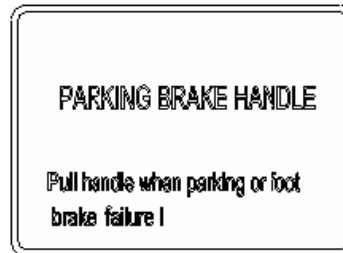

9. Notice for antifreeze fluid (if stuck)

Located on the left side of operator cab door or mouse of radiator of engine hood

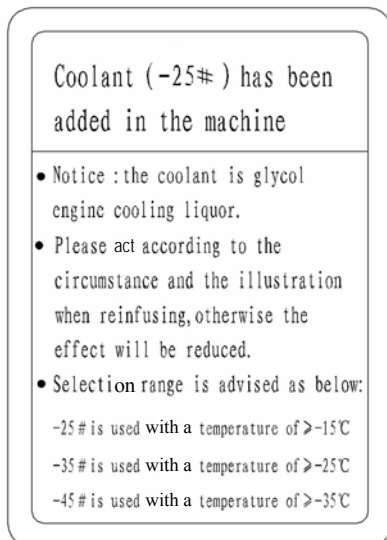

10. Hydraulic oil tank

Located on the hydraulic oil tank

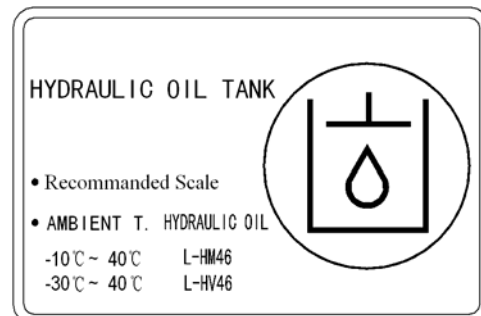

11. Notice for high temperature

Located on vent-pipe of engine hood

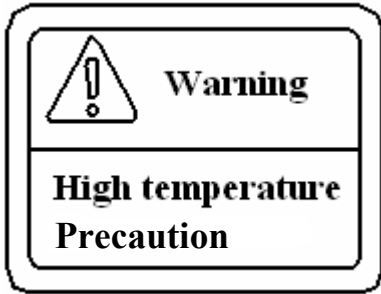

13. Notice of hot water

Pay attention to the steam or hot water ejection.

Located on the cover of engine water tank.



15. Warning of safety distance

Located on both sides of engine.

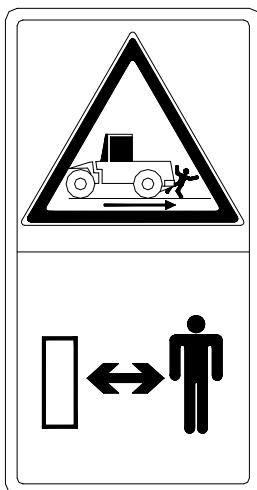

12. Fuel oil tank

Located on the of fuel oil tank.

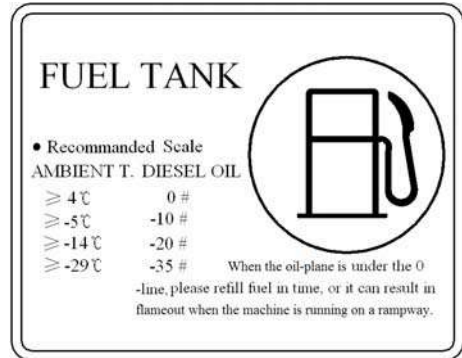

14. Notice for lift

Located on the front of front and rear frames

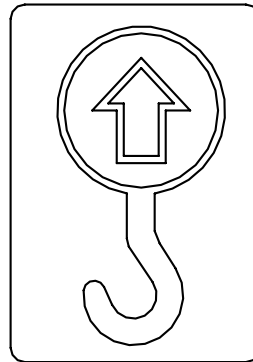

16. Warning to touch the machine

Touch the machine only after all parts stop.
Located on the both sides of engine hood.

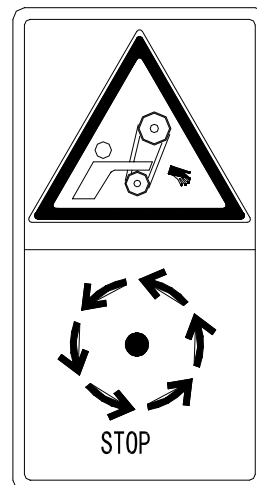

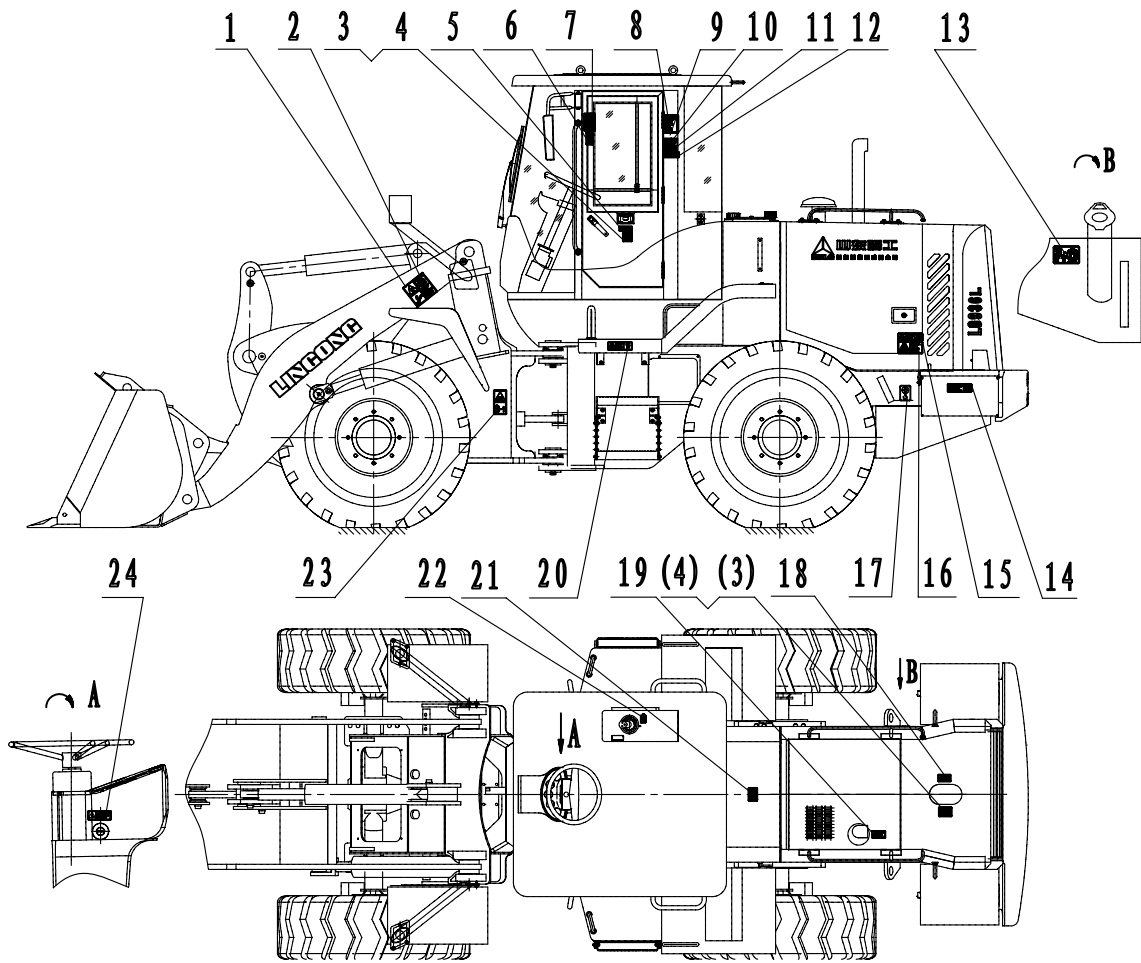
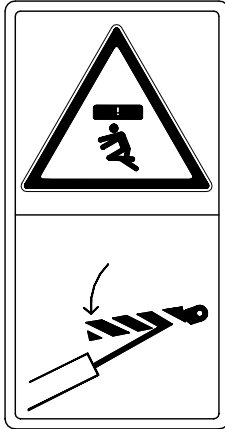

Figure 1-2 Figure of safety label position (Export Type)

1.3 The Contents of Safety Label (Export Type)

1. Limit position of lift arm

Located on both sides of actuating arm.



2. Danger of actuating arm

Located on both sides of actuating arm

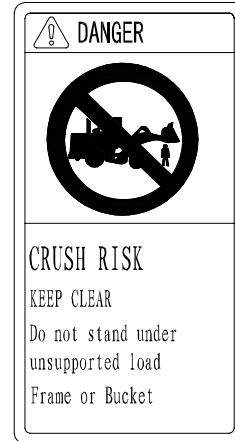

3. Antifreeze fluid (if -45# coolant has been added)

Located on the left operator cab door and mouse of radiator of engine hood

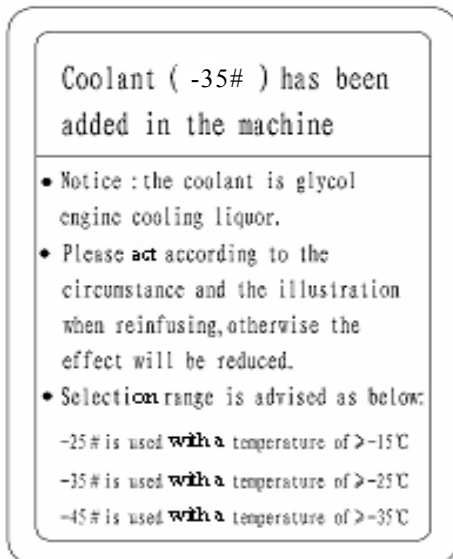

4. Antifreeze fluid (if -45# coolant has been added)

Located on the left operator cab door and mouse of radiator of engine hood

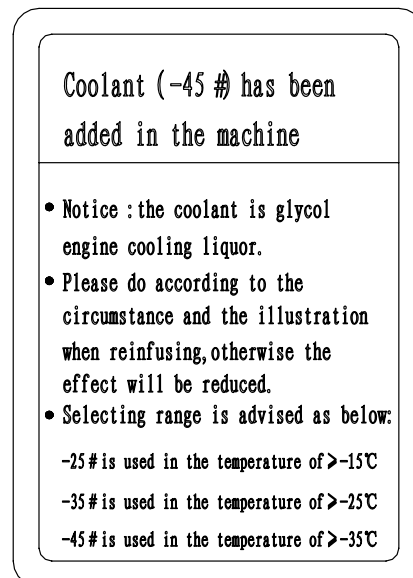

5 Notice for the door of operator cab

Located on right and left operator cab doors

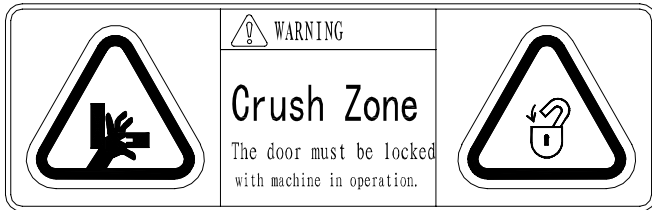

6. Notice of required reading manual

Located on the left front upright column of operator cab.

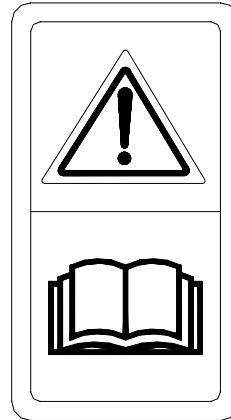

7. Prevent tip-over

Located on the inner right front upright column of the operator cab.



8. Check before starting

Located on the inner left back upright column of the operator cab.

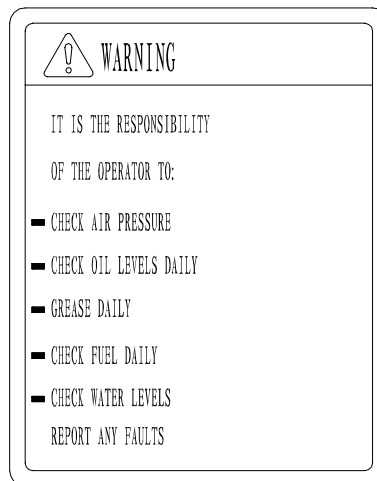

9. No passenger warning

Located on the inner left back upright column of the operator cab.



10. Warning to avoid noise

Located on the inner left back upright column of the operator cab.

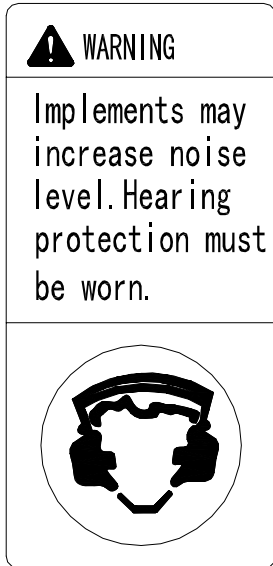

11. Wearing seat belt warning

Located on the inner left back upright column of the operator cab.

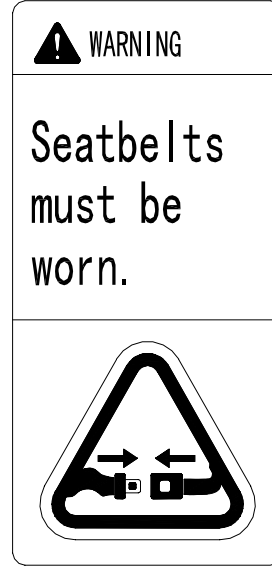

12. Warning of high voltage

Located on the left back upright column in inner operator cab



13. Fuel tank

Located on fuel tank.

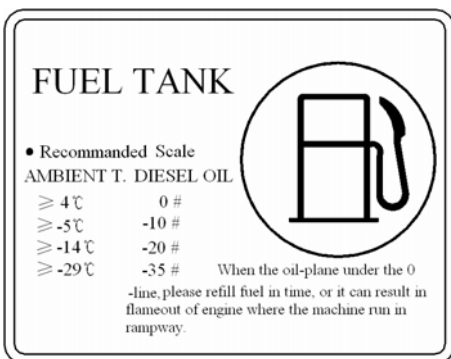

14. No fire warning

Located on battery tank

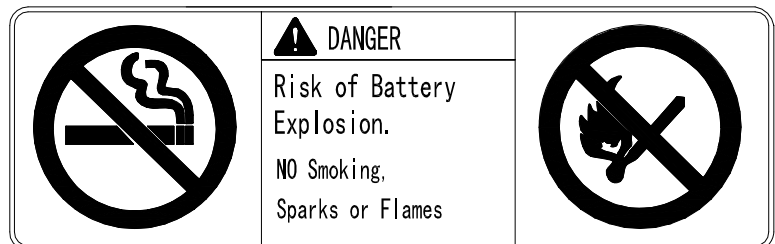

15. Personal safety range

Located on both sides of engine hood.

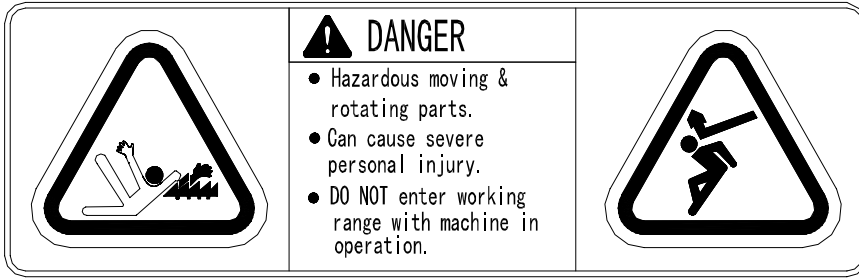

16. Warning of machine reversing

Located on both sides of engine hood.



17. Start for lift

Located on the lifting position of the front and rear frames.

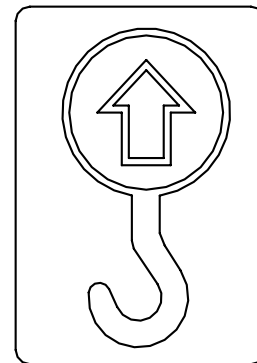

18. Notice of hot water and oil

Pay attention to steam or hot water ejection

Located on filler of water tank of engine hood



19. Warning of high temperature

Located on vent-pipe of engine hood

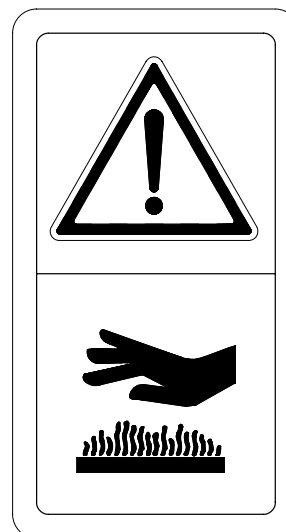

20. Notice for platform frame

Located on right and left platform frames.

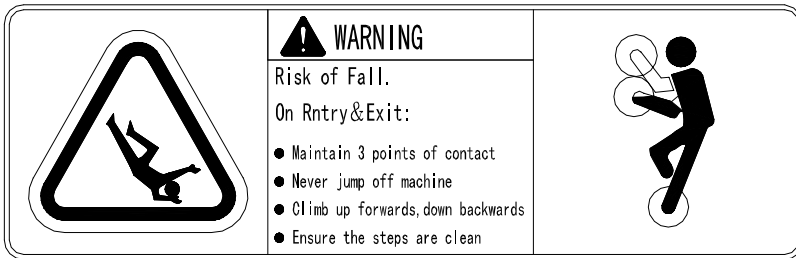

21. Hydraulic oil tank

Located on the hydraulic oil tank

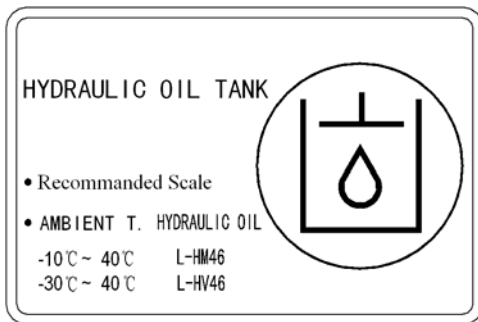

22. Notice for parking brake

Located on the operation tank.



23. Danger of serious injury during steering

Located on the steering position of front and rear frames.

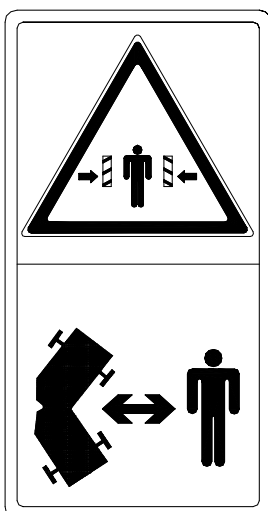

24. Warning for starting

Located above the start bottom

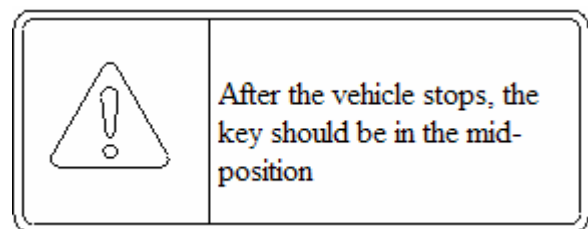

2 SAFETY RULES

2.1 Safety Rules

- Only trained and authorized people can be permitted to operate and maintain the machine.
- Follow all safety rules, precautions and instructions when the machine is in operation or being maintained.
- **Never** operate machine when you are less than fully alert. **Don't** operate machine if you feel sick, or feel sleepy after taking drugs or drinking alcohol when your judgment may be impaired.
- When working with another operator or with a person on worksite traffic duty, be sure that all people understand all hand signals that are to be used.
- Follow all the safety rules.

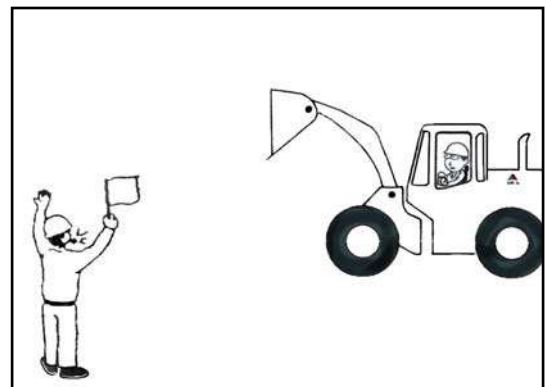
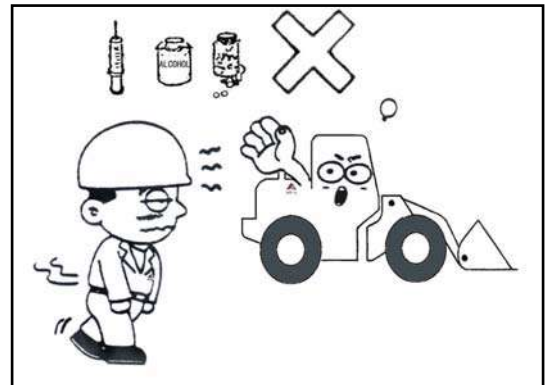
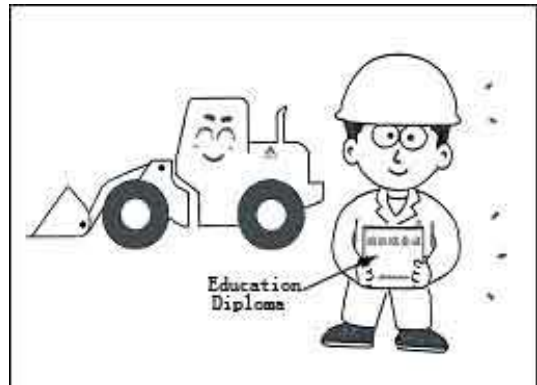

2.2 Safety Devices

- Be sure all guards and covers are in their proper positions, and repair them when damaged.
- Use the safety devices properly, such as parking brake switch and safety belt (if assembled).
- **Never** remove any safety devices. **Always** keep them in good operating condition.
- Improper use of safety devices could result in serious body injury or even death.

2.3 Protective Items

- Wear protective items, such as helmet made of hard materials, safety glasses, shoes, mask reflector protective vest, earplugs, heavy gloves when the machine is in operation or being maintained.

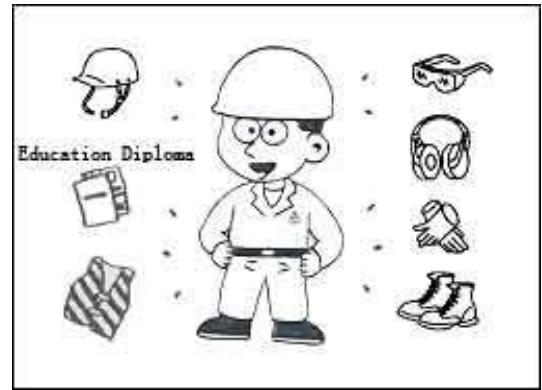

- Make sure to wear a helmet made of hard materials, safety glasses and heavy gloves if there are scattered metal chips or other minute particles in the operation, particularly when cleaning the filter elements of the air cleaner with compressed air, and be sure that there is no one near the machine.
- Never wear loose clothing, jewelry and loose long hair. They can be caught by control levers (or control handles) or moving parts, which may cause serious injury and even death.

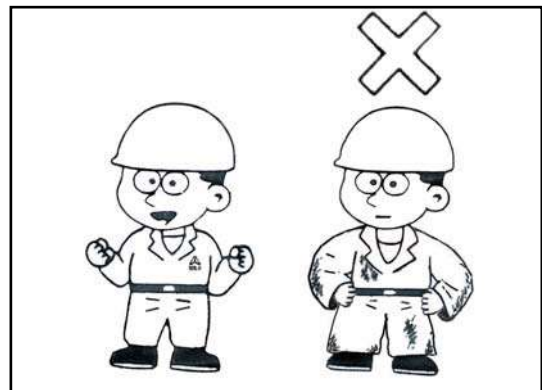

- Avoid wearing oily clothes because they are flammable.
- Compressed air may hurt the body. When using compressed air, be sure to wear a mask, safety cloth and shoes. The pressure of compressed air should be lower than 0.3MPa.
- All the protective items should be routinely examined for proper function before use.

2.4 Unauthorized Modification

- Any modification without the companies authorization may result in serious personal danger.
- Please consult Shandong Lingong Construction Machinery Co. Ltd or the sellers before making modifications.
- The company assume no responsibility for any injury or damage caused by unauthorized modifications.

3 SAFETY OPERATION

3.1 Be Familiar with Machine

- Study the operation manual for the machine. Learn the structure of the machine, operation and maintenance. Be familiar with the positions and functions of the buttons, operation handles, meters and warning devices.
- Know all the rules in operation; understand the gestures of signaling staff.
- If there is any oil near the operating positions that can cause slippage, clean it immediately.
- Check all the safety items, for example, the safety protective devices should be at the safe status. Make sure the tires are not worn and the tire pressure is normal. Routinely check for oil leaks, water leaks, air leaks, deformation, loose fittings and abnormal sounds or accidents may occur. Check the safety devices routinely.

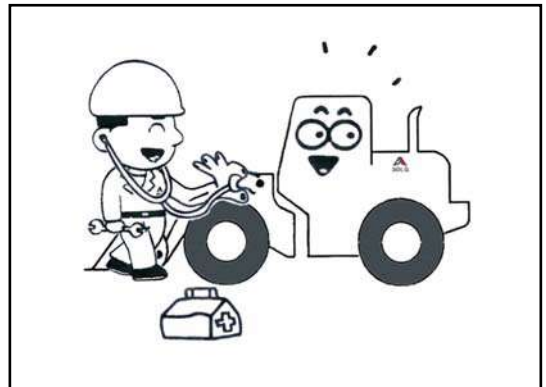
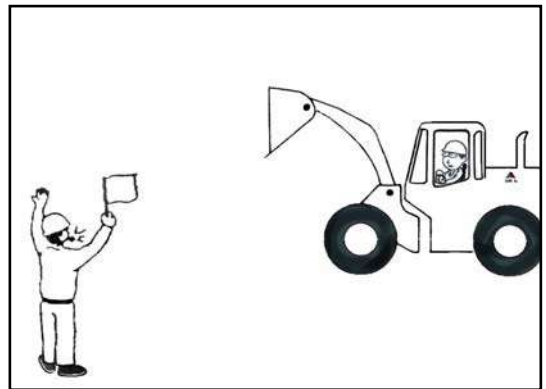
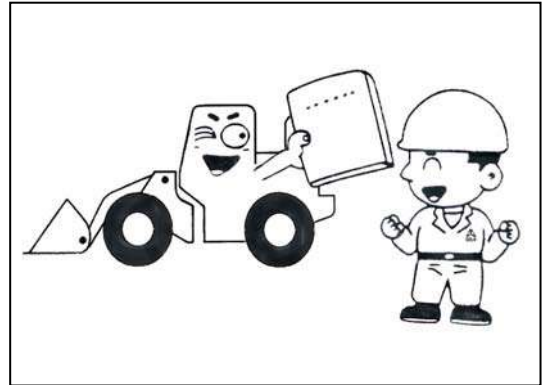

3.2 When Leaving Operator's Seat

- **Always** keep the parking brake switch in the lock position.
- Level the working equipment completely to the ground and put the gear control lever and working equipment control handle in the neutral position, then stop the engine and turn off the starting switch. Set the stop block on the front and rear wheels if necessary.
- Make sure the loader is locked and put the key in a safe place.

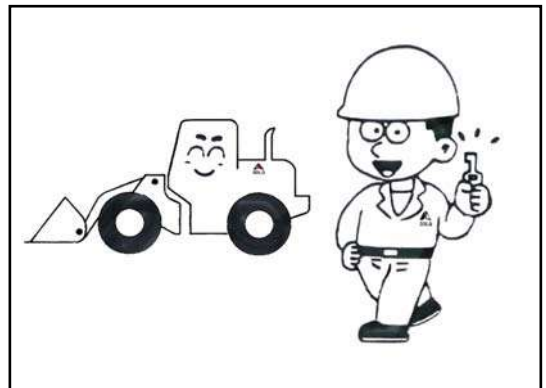

3.3 Mounting and Dismounting

- Check the handrails and pedals, and if there is oil, lubricant or dirt clean them first to prevent slippage. Repair the broken items and fasten the loose nuts.
- **Never** jump on or off the machine. **Never** get on or off a moving machine.

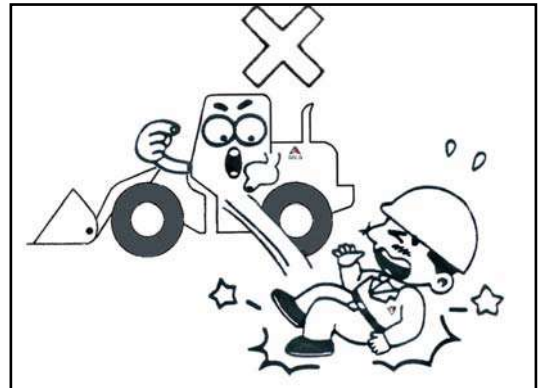

- When getting on or off the machine, face the machine and use the handrails and pedals to ensure that you can support yourself. Keep at least three-point contact (two hands/one foot or two feet/one hand) with the handrails and pedals to ensure body stability.

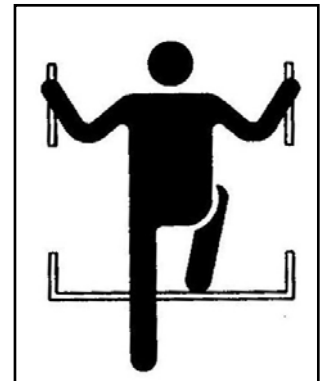

- **Never** hold any control levers when getting on or off the machine.
- **Never** get into the operator cab from the ladder at the back of machine or get off from the wheel at the side of operator cab.
- **Never** hold any tools or other items when climbing up and down the loader; lift the tools needed to the operation flat roof by rope.

3.4 Fire Prevention

The following fluids are flammable and must be kept away from high heat and fire engine: lubricant for loader engine, hydraulic oil for hydraulic system, hydraulic pressure shafting oil and gear oil for transmission system, brake fluid and antifreeze fluid for heat elimination system.

Observe the following:

- Keep fire away from flammable fluids.
- Add refueling and lubricating oil in well-ventilated areas. Stop the engine and no smoking while refueling.
- Tighten all fuel and oil tank caps firmly.
- Put the above flammable liquids in containers with relevant tags and put in a separate, proper place for

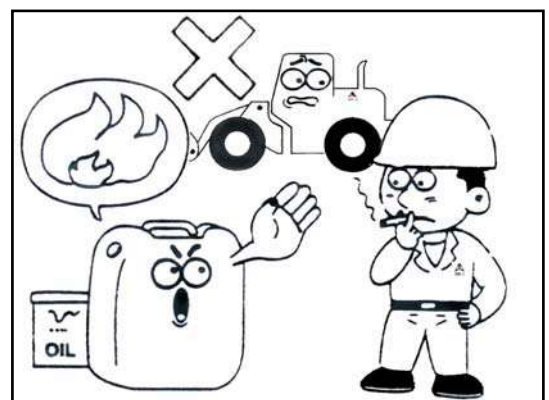

storage. Do not allow unauthorized people to use.

- Electric welding and flame cutting is not allowed for the tubes containing flammable fluid. Clean the tubes with nonflammable fluid before electric welding and flame cutting.
- Clean thoroughly the flammable materials such as sawdust, leaves and paper which collect in the engine and brake clip, and clean the flammable oil, lubricating oil and other substances on the machine.
- While operating, pay attention when the outlet of the muffler is close to flammable materials such as withered grass and old papers.
- When parking the loader, carefully select the environment; especially select the places where there are no flammable materials near the parts with a high temperature such as the muffler.
- Check whether there is the leakage of fuel, lubricating oil, or hydraulic oil. If so, repair or replace the broken items. Clean the repaired items before use.
- If there is explosive air generated near the storage battery, be sure there is no flame or fire nearby. Repair, maintain and use the storage battery as referenced in users manual.
- Do not use flame or fire (match or lighter) to check in a dark place.
- The fire extinguisher should be ready for use at all times and the user must be knowledgeable about its use and function. Check and maintain it as referenced in users manual.
- Never operate machine near flame or fire.
- Do not short circuit.

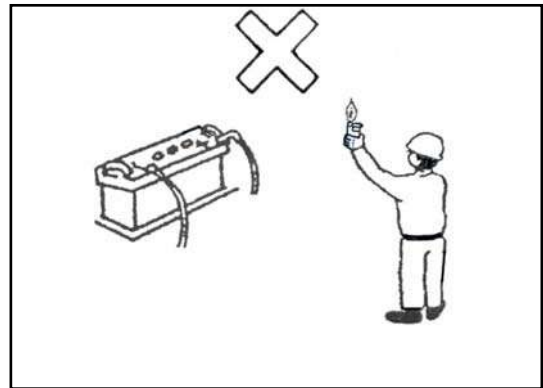

3.5 Precautions When Operating at High Temperature

- Just after turning off the engine, the coolant, engine oil and hydraulic oil are at high temperature and still under high pressure. The attempt to remove the cap, drain the oil or water, or replace filters may lead to serious burns. **Always** wait for the temperature to go down, and follow the specified procedures when performing these operations.
- Stop the engine, wait for the water to become cool, and then loosen the cap slowly to relieve the inner pressure before removing the cap of radiator.



3.6 Visibility Requirements

- Pay attention to the stability of the front and rear of the machine during operation, since work equipment may block vision at the front while the load is concentrated on the back wheels.
- Be sure there is no fog, soot, sand or dust cloud that may block vision.
- Examine the working area and the road condition. Check whether there are holes, blockages, slosh or ice.

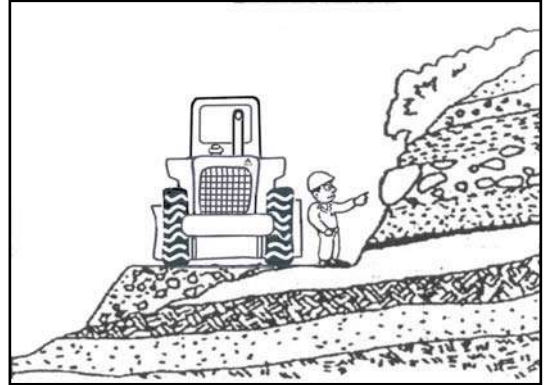

- Understand the objective of the operation; be sure to understand the meaning of the flags, signals, and labels before the operation begins.

3.7 Prevent Crushing or Cutting Body Parts

- Do not put your hand, arm or other parts of your body into movable parts of equipment. If the working equipment is in operation, the clearance will change and this may lead to serious damage or personal injury when standing too close. The engine must be turned off and the working equipment must be locked if people have to work between the moving components.

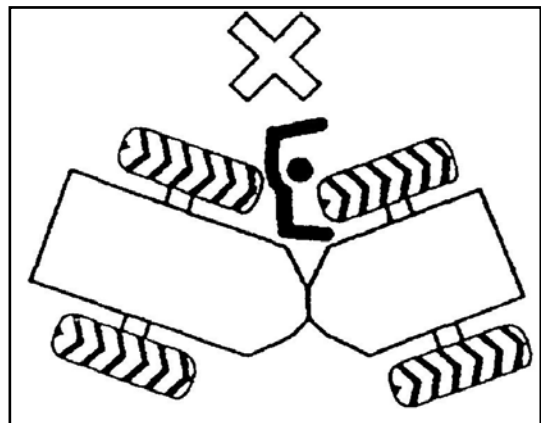

- Make sure the supporter and the accessories are correctly set when some one works under the machine. Do not use the hydraulic tank as support. The accessories may go down and result in an accident when the control system moves or the hydraulic tubes leaks.
- Never do any adjustments when the machine is operating or the engine is working unless there is an outstanding reason, such as an emergency.

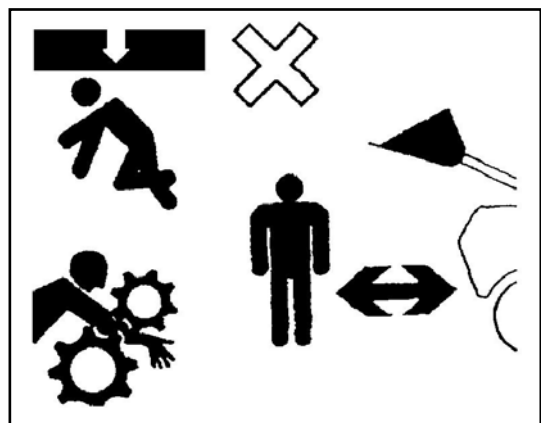

- Stay far away from any rotating and moving parts.
- Make sure there is no sundry on the vane of engine. Vane could shoot off or cut off the sundry, tools inside.

- Do not try to check or maintain a working engine because it is dangerous.

3.8 Notice of Attachment

- Please read the user manual for all of the attachments and the contents in the manual that refers to an attachment when the attachment is being assembled and used.
- Do not use attachments that are not sold by Shandong Lingong Construction Machinery Co. Ltd or the sellers specified by Shandong Lingong Construction Machinery Co. Ltd. Using unauthorized attachments may cause safety problems and go against the normal operation of the machine, which can influence the service life of the machine.
- Shandong Lingong Construction Machinery Co. Ltd assumes no responsibility for any injury, accident, or destruction of the machine induced by using unauthorized attachments.

4. STARTING SAFELY

4.1 Before Starting Engine

4.1.1 Safety Operation at Working Area

- Before starting operations, thoroughly inspect the area for any unusual conditions that could be dangerous.
- Examine the condition of the ground and the quality of the soil in the work area, and determine the proper method of operation. Before starting work, the ground should be planed and pressed firmly. If there is a lot of sand and dust, sprinkle with water first.
- When working on public roads, there should be a trained person managing the traffic. Erect the barricades and use the sign of **DON'T ENTER** to ensure safety of passing traffic and pedestrians.
- In the places where objects are buried such as water pipes, gas pipes, or high-voltage cables, contact the responsible companies to confirm the position of the buried objects and take care not to damage them during operations.
- When working in water, swampland or passing a sand bank, check the ground conditions, speed and depth of the water. Be sure not to exceed the permitted water depth. After working, check and clean the positions where lubricant is needed. Please refer to **CHAPTER II-6 CIRCUMSTANCES REQUIREMENT** for the depth of water for passage.
- Be sure there are good ventilation conditions when working in a close environment.

4.1.2 Check before Starting the Engine

- Check the machine carefully before starting work. Report to the manager if there is any abnormal condition. Operate only after the abnormal conditions are resolved.
- To avoid fire, check whether there are any flammable materials such as wood chips, leaves and paper which have accumulated on the engine.
- Check whether there is leakage of oil, or water, loose nuts, abnormal sounds, broken or lost parts.
- Check the cab floor, rearview mirror, control lever (or control handle), pedal and handrails for oil, grease, snow or dirt, and clean.
- Check the level of coolant, fuel and make sure the level of engine oil in the pan is normal. Please refer to **CHAPTER III – 3.6 Supply of Oils** to check whether the air filter is blocked.
- Adjust the operator's seat to the proper position for operation. Please refer to **CHAPTER III – 1.2.9 Seat Adjustment** to check whether the safety belt and the fixed equipment (if assembled) are broken. **The safety belt must be replaced with a new one every three years.**
- Check the gauges for damage, and make sure the control lever (or control handle) is in the braking position.
- Clean the dirt on the cab window and all the lamps to ensure better visibility.
- Adjust the rear-view mirror and keep the surface clean to ensure the best view from the operator's seat. Replace with a new one if the mirror has been damaged.
- Don't leave any tool or part around the operator's seat. They may fall because of the vibration during moving and working, which could break the control lever (or control handle) or switch, or move the control lever (or control handle) which could start the working equipment and cause an accident.
- Check whether the floodlight and signal light is normal and repair if not.
- Check whether the front and rear frames is unlocked.
- Clean oil from the handrail and the pedal and the silt and sand from the shoes to avoid slippage, which may affect the operations.
- Check whether the tires are worn or broken, the bolts and nuts are loose. Especially pay attention to the loose hub nut and repair or replace for any abnormal situations.

4.1.3 When Starting the Engine

- Before boarding on the machine, check the machine again to see whether there are people or blockages on or under or near the machine. If there are unrelated people in the working area, ask them to leave. Do not begin work until they leave.

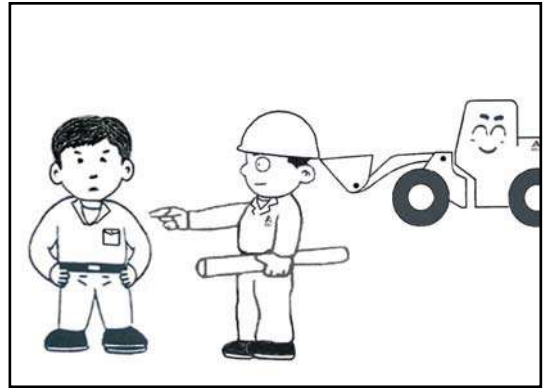

- Don't start the machine if there is the tag of "**NO OPERATION**" on the control handle of the working equipment or shift control handle.



- Sit with the safety belt locked into place.
- Know the meanings for all the warnings on the equipment, meters, and control equipment on the panel.
- Be sure the parking brake switch is at the braking position and all the control equipment are in the neutral position.
- Sound the horn for warning.
- Start the engine. Please refer to **CHAPTER III – 3.2.2 Starting of Engine**.
- Only start the engine in the cab. Do not start the engine by short circuit. It may destroy the machine if it is started from side short circuit. This is very dangerous.

4.1.4 Check after Starting the Engine

Check after the engine is started to make sure there is no potential danger.

- When examining the machine, park the machine in a spacious place, and do not let unauthorized people to get close.
- Check whether the engine runs with an abnormal sound or shaking. If so, there may be some malfunctions; report to the manager immediately. Operate the machine after the malfunctions are eliminated.
- Test the control of the engine speed in the neutral gear.
- Examine the gauges, meters and warning lamp; be sure they are in the normal working range.
- Operate the control mechanism for the gears. Make sure the front, middle and rear gears are in

the correct positions. Make sure all the control levers (or control handles) are easy to use.

- Examine the foot brake valve and oil operation valve according to the user manual to make sure that they are normal. Check whether the left turning and right turning is smooth at low speed.
- Be sure the control lever of the manual brake valve is at rescission of braking state before moving forward.

5 SAFETY DRIVING

5.1 Warning

- The warning light should be turned on to warn the other drivers on the road when the machine is broken down or operating at a low speed.

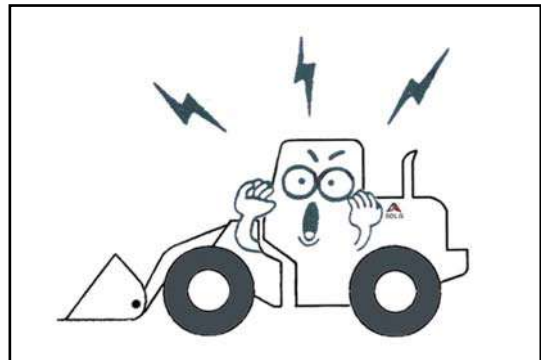

5.2 Safety of self and Others

- Develop good driving habits to ensure everyone's safety.
- Sound the horn to ensure safety before moving.
- Be sure there are no people or blockage on the left and right side.
- Check the brakes on dry and firm, level ground.



- Do not put an arm or foot on the working equipment or extend outside the machine.

- When driving on the level ground, adjust the lower hinge of the arm working equipment to 400~500mm(16~20in) above the ground.

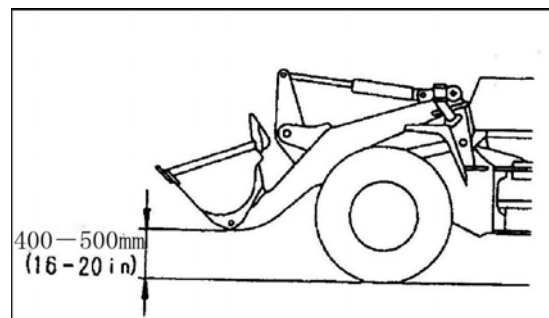

- Always warn people near the machine in all direction by sounding the horn.
- The door of the cab should be locked when driving. Do not open the door while driving.

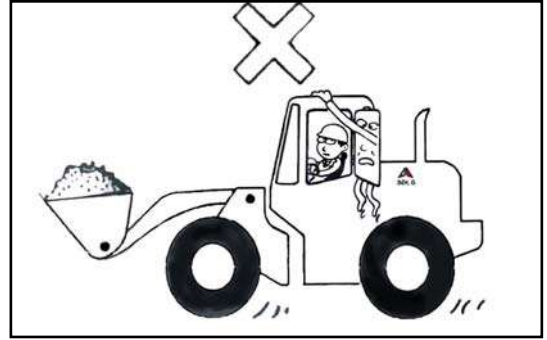

- It is dangerous to pick up other people. No one should sit on the machine body.
- **Never** use the bucket as a people carrier.

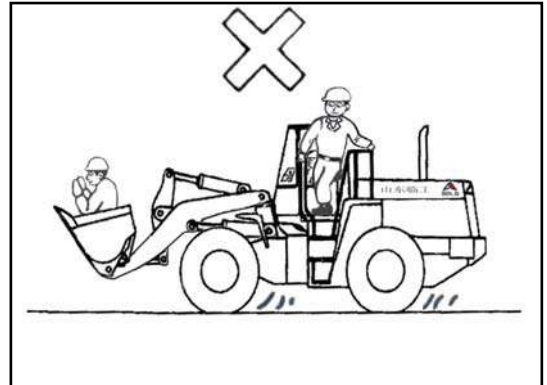

- Follow the traffic rules on the common roads. Pass the crossing road quickly and do not block the road.

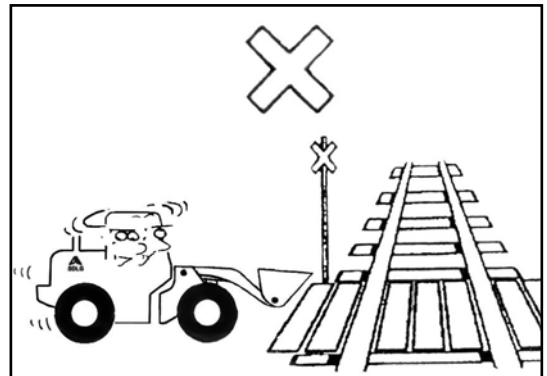

- Drive on the side of the road and let the other vehicles go first. Keep a proper distance from others.
- Brake immediately and stop when the engine flameouts.

 **WARNING**

- Steering unit does not work when engine stops.
- Emergency brake could hurt people!
- It is dangerous to shift from forward to backward gear at high speed.
Never do this!

5.3 Full Load Transportation

- Do not keep a full bucket in the high position when moving. Select the proper speed with a full load during transport. Lower the bucket to contact the tilt block and run with proper height (400~500mm above the ground), so that the center of gravity can be lowered to insure driving smoothly.
- Check the limit lifting weight of the loader. **Never** overload, which may hurt the machine or people. Shandong Lingong Construction Machinery Co. Ltd assumes no responsibility for overload injury or damage to equipment.



- Do not drive, turn or brake suddenly and do not detour.
- **Never** suddenly stop or lower the working equipment, which may throw out the materials from the bucket or cause the loader to turn over.



5.4 Drive at Proper Speeds

- Know the characteristics of the loader, and follow the actual conditions in the working area. Drive at the proper speed. Select path of drive and method of machining to let the others know.
- Keep a low speed so as to maintain control easily at all times.
- **Never** drive fast, turn to brake suddenly on rugged, slippery or oblique ground.
- Slow down when passing over rough or rugged ground with blocks around, which may cause some problems in controlling the steering wheel. Loader may turn over if operated in the wrong way.
- Let the engine run smoothly; **never** drive at high speed.

5.5 Ensure Good Visibility

- Slow the speed and sound the horn if necessary to let others know, and determine the proper direction when the visibility is bad or at a narrow crossing.
- Sand, dust, fog or storm may affect the visibility. Slow down when visibility is poor. When visibility is not good, stop working until the weather cleans.

- The loader is a special vehicle. Drive carefully when taking long parts which may block the visibility. Carefully lift, go forward and backward, and shift gears. **Never** let unauthorized people go into the working area or give specific directions.
- There may be some illusion about the height of the ground and the distance at night, so keep the light on and drive at proper speed.
- Keep the front and rear headlight and working light on when working in dark areas.

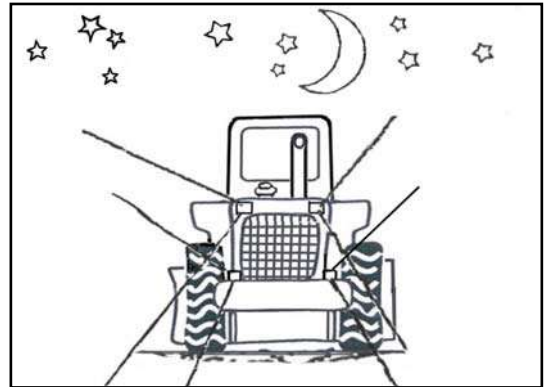

5.6 Pay Attention to Blockages

- If there are blockages (roof of buildings or the door frame), keep the loader away from the blockages when turning or passing.
- Notice the environment. Slow down and check whether there are some blockages when turning or going through a narrow passageway.
- Operate carefully to prevent unstable loads when the ground is uneven and the load is not stable.

5.7 Driving in Dangerous Conditions

- Do not operate when you are unsure about the environment. Investigate the condition of the road, the strength of the bridge, landform of the working area and all geologic features before working.
- Pay attention to the depth that the tires sink and the braking effect on muddy or soft ground.
- When working in water or swampland, prevent the bottom of the axle housing from being soaked. Slow down after passing through water or during rain. Step on the brake pedal gently and alternately to let the skid device dry after working in water or in rain.
- The clay piled on the ground or near the canal is usually soft. **Never** allow a turn over caused by the weight of the loader.

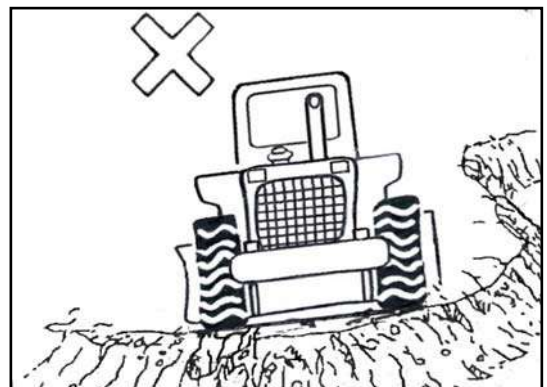
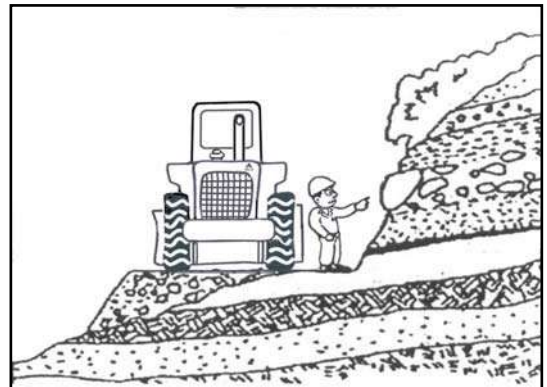

- **Never** drive the machine near hanging things or close to a deep ravine. The machine weight or vibration may cause the ground to collapse, and result in the machine turning over.
- Assemble anti-fall and anti-turn operator cab when working in an area where there is danger of falling stone and machine turnover.
- Continual rainy weather, earthquake and explosions can cause dangerous working conditions. Operate carefully in these cases.
- Drive at a low speed, prevent starting, braking or turning suddenly, and use the tire chain on a snowy road. Brake alternately. Lower the bucket to touch the ground to brake if necessary.
- The load should be decreased to prevent slippage when driving on snowy ground because the adhesive force may change greatly in the piled snow.
- The road shoulder and other road conditions can not be seen under the snow, so take care with the snow shovel.

5.8 Driving Safely on the Ramp

- Turnover or slippage may occur when driving on an abrupt hill, dyke or ramp.
- The bucket should be 200mm ~300mm above the ground when driving on an abrupt hill, dyke or ramp. Lower the bucket and touch the ground to help brake or prevent turn over in emergency conditions.
- Do not turn on the ramp. Do not drive across the ramp or change direction which may turn over the machine.

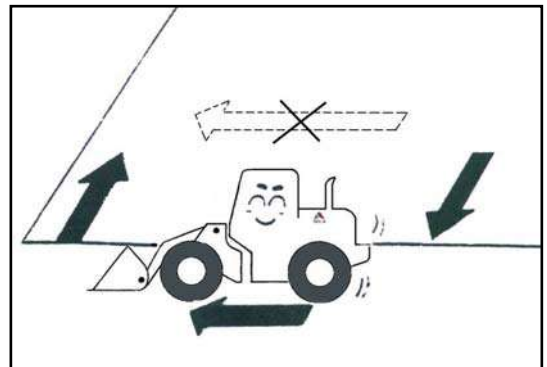

- **Never** turn on the ramp until on the level ground. Slow down and use a small turning angle when working on an abrupt hill, dyke or ramp.
- Go up and down the ramp rather than drive through alleyway or footpath.
- Choose proper gears before going down the slope and never change the speed during going down the slopes.
- Do not suddenly brake on the ramp because the center of gravity is on the front tire or rear tire.
- Use gear I when driving on the ramp with a full load. Go forward when driving up the ramp, go backward when driving down the ramp. Never turn around.
- Brake slowly when driving down the ramp; do not set the gearshift control lever in the position of

the neutral gear.

- Go down the ramp slowly; **never** stop the engine.
- If the engine stops on the ramp (slope is less than 15°), step on the brake padel immediately and lower the bucket to the ground to help brake, use the parking brake, put the gear control lever in the neutral position, and then restart engine.
- When driving with a load, the bucket should face the high direction of the ramp at all times, which means go up forward and go down backward.

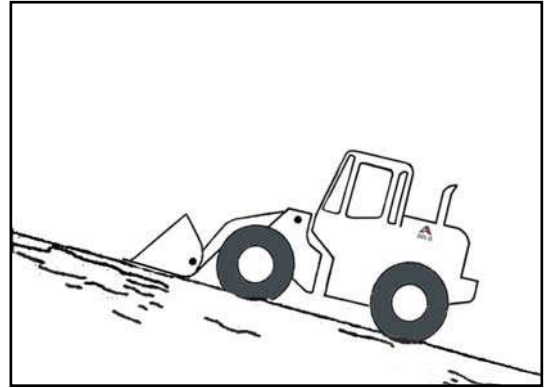

5.9 Towing

WARNING

Injury, even death may occur if the disabled machine is towed incorrectly.

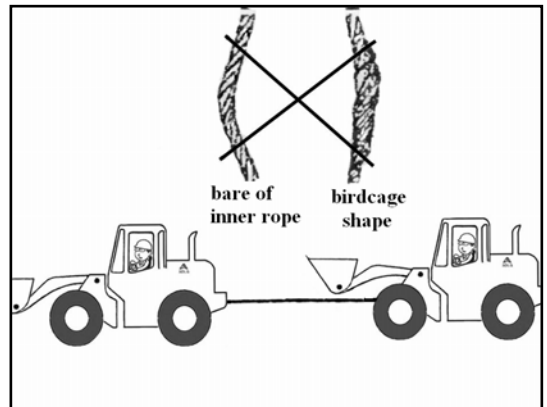

- Follow the direction in **CHAPTER III – 3.5.2 (7) Towing**, a dangerous contion may be caused by using the wrong method.
- Wear gloves to deal with a tightwire.
- Before preparation for the towing confirm the signals with other people.
- Please contact Shandong Lingong Construction Machinery Co. Ltd. or their accredited representative if the engine does not start or the brake system has problems.
- Please tow the machine on level ground; it is dangerous to tow on a ramp.
- If a disabled machine is towed by an other machine, the tightwire should be strong enough to pull the weight of the towed machine. The tightwire with wring or radius reduction can not be used.
- People are not allowed to go between two machines when the machines are connected.
- Do not stand on the towing steel wires or tightwires.



- Keep the hook of the towing machine and the towing parts in a horizontal line.

6 SAFETY OPERATION

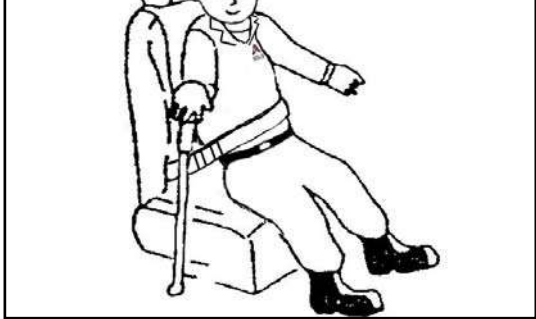
6.1 Keep Good Operation Habits

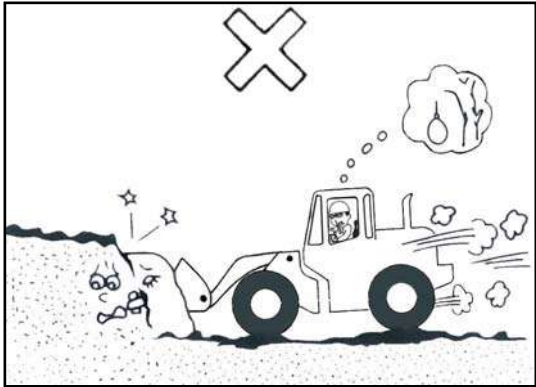
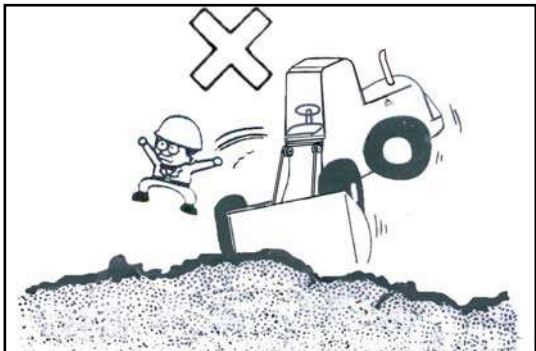
- Always be seated with the safety belt locked during operation. The machine in operation should always be controlled by the operator.
 
- Operate the control lever of the working equipment properly to prevent misoperation.
- Examine and listen to the exceptions carefully, and report immediately. Do not repair while in operation.
- An overload is dangerous. Shandong Lingong Construction Machinery Co. Ltd assumes no responsibility for the injury or damage induced by overload.
 
- It is dangerous to hit any object at a high speed. Damage may be done to the loaders, the goods and the operator.
 
- Keep perpendicular during loading and unloading materials. If working in a side direction, the steering cylinder and differential carriers may be damaged, and the machine may be unbalanced.
- Confirm the ambient conditions and the operation before driving to load and unload materials.
- Check the status of the working area before entering a narrow passageway such as tunnel, overbridge and garage. Take care with the working devices during operation.
- Operate down wind in strong windy weather.
 

- Be careful when the lift arm reaches the upper limit. Loading in the upper limit position may cause destabilization of loader. So the driving speed should be slow and the bucket should tilt forward slowly.
- When unloading to the truck or tipper, make sure the bucket does not hit the truck or tipper. Do not allow anyone to stand under the bucket or to let the bucket go over the cab of the truck.

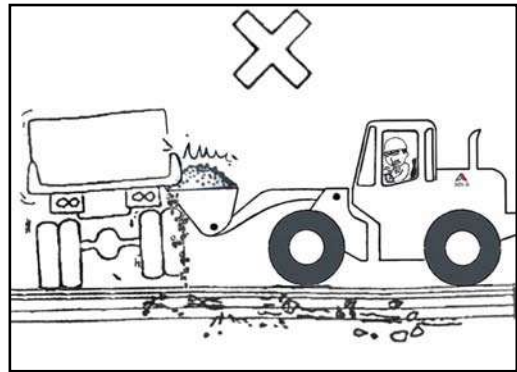

- When driving backwards, ensure visibility of what is behind you.



- Install lighting systems during dark conditions. And stop work when there is smoke, fog, sand, or dust which affects visibility.

- When working at night, please make sure:
 - ◆ Proper lighting system is installed.
 - ◆ Function light works normally.
 - ◆ To carefully estimate the height and distance of objectives.

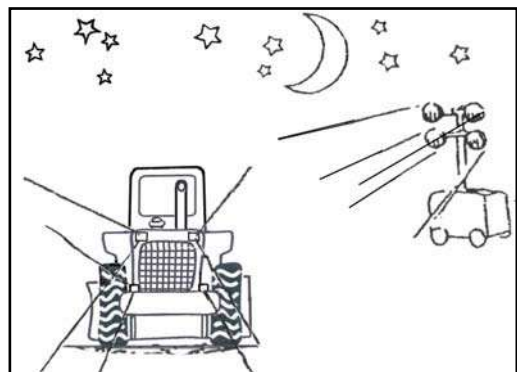

- ◆ Keep alert and stop the engine and examine the environment and the machine frequently.

- Make sure that every bridge is strong enough to let the machine pass.

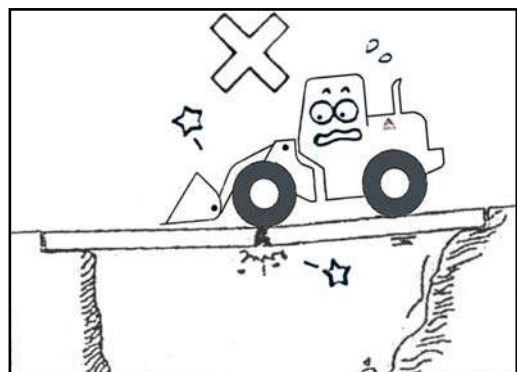

- Don't use the machine for any work other than what the machine is designed for. It may damage the parts or cause an accident when using the head of the working equipment for other functions, such as hook, grasp, draw, push, or tow.

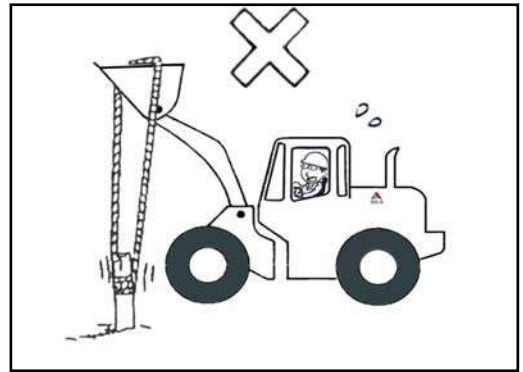

6.2 Pay Attention to Surroundings

- No unauthorized person is allowed to enter the working area because the working equipment will work up and down, turn left and right and move forward and backward all the time. Keep people away from all sides of the working equipment.

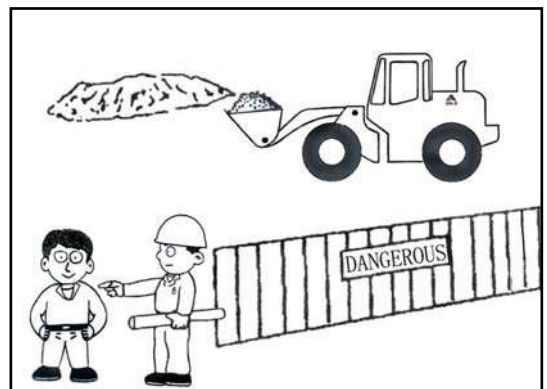

- To ensure safety when working at the side of a road or near a cliff where the land may shift, designate a person to watch and direct at all times.



- Take care with the dumping position when unloading sand or rocks from the high position.

- When pushing material off a cliff or when the highest point is reached, the load may decrease suddenly. Subsequently, the moving speed will increase, so slow down in advance.

- When constructing a dam or unloading soil from a cliff, form one pile first and use the second pile to push the first one.

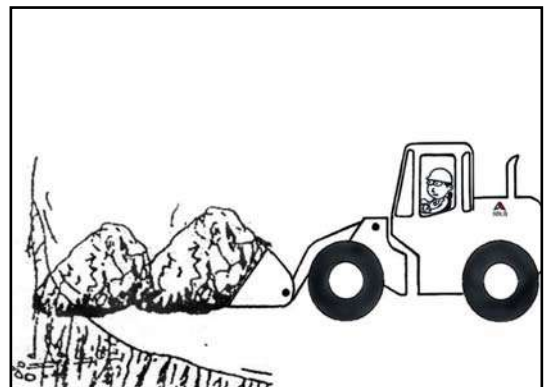

6.3 Ensure Ventilation in Close

Environment

- Open the window to ensure enough air when operating, dealing with fuel, cleaning parts or painting in close or badly ventilated environments to prevent bodily injury. If this can not satisfy the need, please assemble aerator.
- Prepare fire extinguishers for close environments and know where they are stored and how to use when working in this condition.

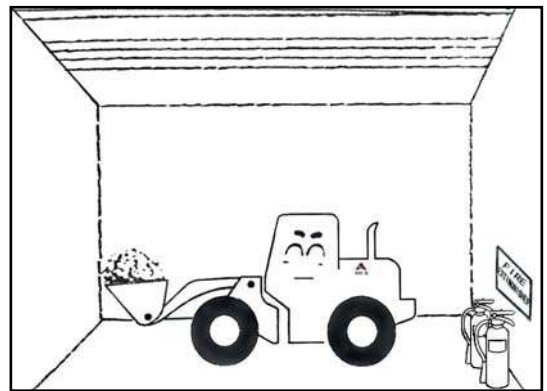
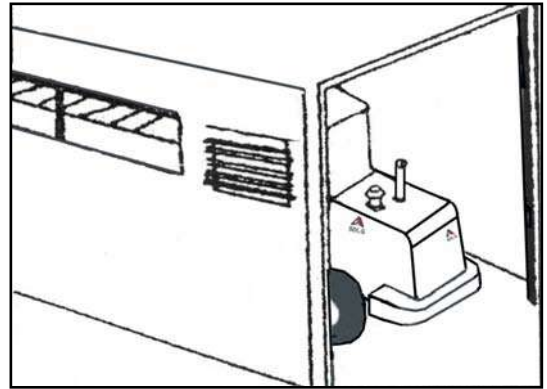

6.4 Don't Get Close to Dangerous

Environment

- If the ejected gas from the silencer hits flammable material, or the vent-pipe is close to the flammable material, fire may occur. Be aware of the flammable materials such as lipin, cotton, papers, dry grass, chemicals and oily or oiled rags.



6.5 Don't Get Close to High Voltage Wire

Do not touch the aerial electric wire. Electroshock may result even when close to a high voltage wire.

The distance between the loader and the electric wire should be:

- At least 2m (6.5ft) at low voltage condition.
- At least 4m (13ft) at 40KV high voltage condition

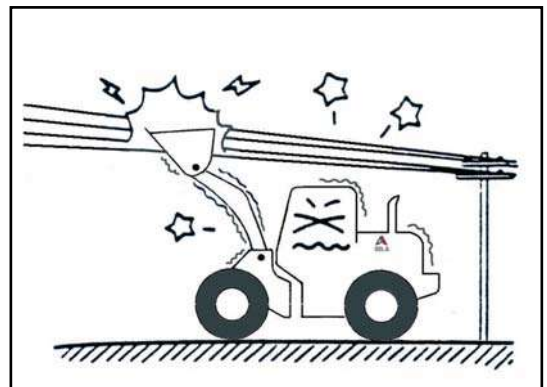

(electric wire is generally supported by fixed insulator).

- At least 6m (20ft) at 40KV high voltage condition (electric wire is generally supported by hanging insulator).

The vertical distance between loader and the overhead electric wire should be:

- At least 2m (6.5ft) at low voltage condition.
- At least 4m (13ft) at high voltage condition.

To prevent an accident, please do as follows:

- First ask the electricity company for the voltage. Check the validity of action according to the relevant rules when the machine may touch the electric cables.
- Wear rubber shoes and rubber gloves. Lay a leather cushion over the operator's shoes. Be sure no part of your body can touch the metal bottom.
- Assign a signal warner, who can give a warning when the machine gets too close to electric cables.
- **Never** leave the operator cab, **never** move and do not touch any part of the machine until the people who are on the ground cut off the electricity once the machine touches the wire.
- When operating near high-voltage cables, make sure other persons are far from the machine.

7 SAFETY PARKING

7.1 Pay Attention to the Safety of Yourself and Others

- Park the machine on level ground. The working equipment should be put on the ground.
- **Never** park on a ramp. If parking on a ramp is necessary, the ramp angle should be less than 20%, and put the wedge under the wheels to prevent moving. Then put the bucket down to the ground.
- If the machine is disabled or must park in a high traffic area, lay bars, signals, flags and warning lamp. Make sure the other cars can see it clearly. Do not block traffic.
- When parking the machine, unload all the material on the machine, lower the bucket to the ground, stop the engine, pull the parking brake switch and put it in the braking position. Lock the engine and put away the keys. Climb down from the machine slowly, according to the “3-points” method. **Never** jump down to the ground.

 WARNING
NEVER get on or off the machine while it is moving.

7.2 Notice for Cold Area

- Clear the water, snow or dust attached to wires, switches, power insert or sensor and the covers of these parts. Otherwise, the water in these parts may be frozen and an unpredictable accident may be caused.
- Before operation, preheat sufficiently. The machine won't start if do not preheat before operating the control handle of the working equipment and an unpredictable accident may be caused.
- Operate the working equipment control handle to let the hydraulic oil cycle in the hydraulic system (Do this by letting the pressure of the system rise up to the system setting, and then release to let the oil flow back to the hydraulic oil tank) to preheat the hydraulic oil, so as to guarantee better reaction and prevent malfunction.
- Do not charge the storage battery with frozen electrolytes, and do not use other power to start the engine. It is dangerous and can cause fire. Please refer to **CHAPTER III 3.5.3 Operation in Cold Weather**.

8 SAFETY EXAMINATION AND REPAIR

8.1 General Knowledge

- Operation and maintenance people should be trained to become the licensed. Do not allow anyone to enter the working area except the maintenance people. If necessary, please assign people to guard.
- The repair of the machine should follow the procedures. Ask the Shandong Lingong Construction Machinery Co. Ltd. for help if you don't know how to do the repair.
- Assure that the people who are responsible for repairs, who decide the working procedures, who determine the person in charge and repair the machine have been trained to, assemble and disassemble the parts step by step.
- Please wear a uniform with a tight wristband and trousers. Always wear safety glasses.

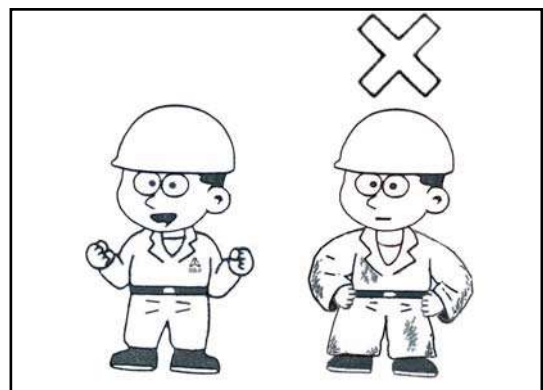
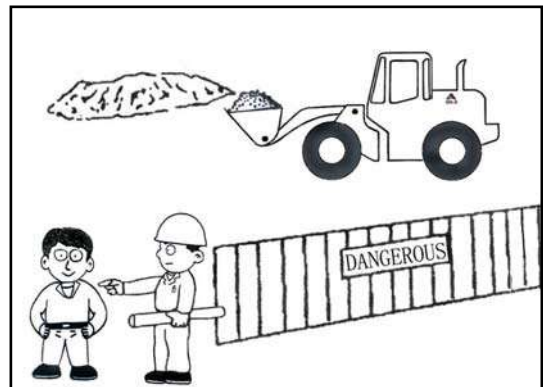

- Please use the repair tools correctly; do not use broken or low quality tools.
- Lower the working equipment completely to the ground, stop the engine, push the parking brake switch, and wedge the tire during repairs to prevent bodily injury.
- Obey the rules of warning labels. Pay attention to the important notices on the label on the machine and obey the rules. Add a new one or clean the label if it is lost or dirty.
- Attach the label of “**No Operation**” or other warning label to the switches or control board during repairs. **Never** let other people operate or start the engine to prevent injury or death.
- Fuel, mobile oil, grease and an oily cloth are dangerous materials which should be kept away from fire or flame. Do not pile oily cloths anywhere because it may self-ignite.
- Never smoke when adding fuel or examining the storage battery.
- Put the accessories in a safe place to prevent lost. Put the handrail around and put the “**No Enter**” warning label to prevent people from entering without permission.
- No people are allowed to get close to the machine or accessories without permission.
- Keep the working area clean and tidy, without flammable materials around to prevent fire or slippage.
- Lock the front and rear frames with a safety bar to prevent rotation before examination and repair.
- Make sure all the levers (or handles) are in the neutral position and use the necessary equipment to support the life-arms cylinder and tilting oil cylinder to prevent the working equipment from falling if you have to examine and repair when the bucket is lifting.

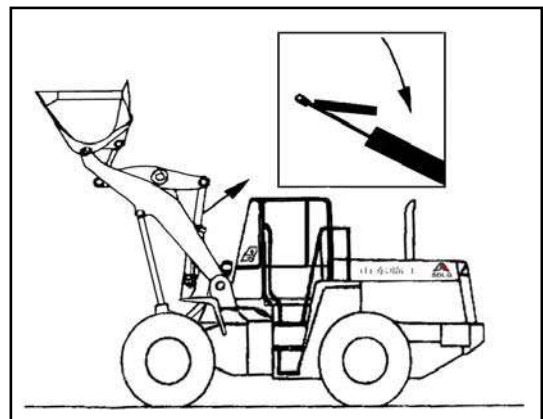
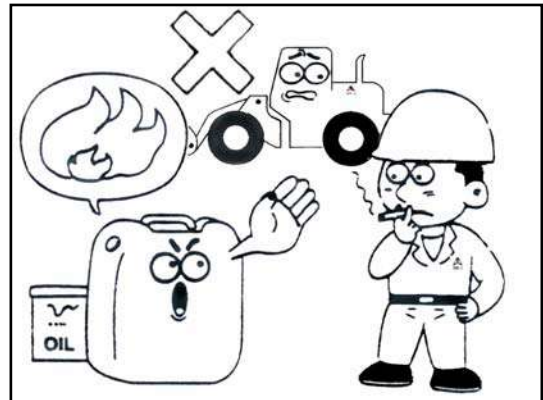

8.2 Working in a Close Area

Exhaust gas from the engine may cause disease or death. If working in a close area, use releaser to release the exhaust gas in the area. If there is no releaser, please open the door.

8.3 Maintenance of Frames During Jacking up

- When jacking up the frame, do not let anyone enter the other side of the frame.
- Before jacking up, lock the front and rear frames with a safety bar and put all the levers (or

handles) in the middle and wedge the tire from the opposite side. Put the cushion blocks under the machine.

8.4 Working under the Machine

- Park the machine on firm ground. Lower the working equipment to the ground before working under the machine.
- Wedge the tire firmly.
- It is dangerous to work under the machine only using the working equipment to support the machine.
- **Never** work under the machine without good support.

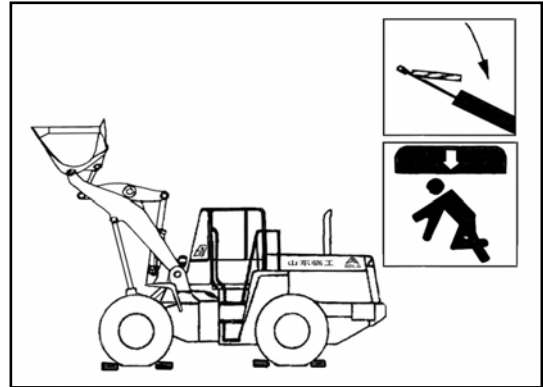

8.5 Working on the Machine

- Make sure the top of the machine has no blockage and is clean when working on the top of the machine. Follow the rules below:

⚠ **NOTICE**

- Do not allow lubricant or grease to leak.
- Do not randomly put the tools around the work place.
- Walk slowly and carefully.

- **Never** jump down from the machine. When climbing up and down the machine, face the machine and keep three points contact (two hands –one foot or two feet one hand) with the handrails and pedals to ensure safety.
- Use protective equipment if necessary.
- **Never** stand on the top of the engine hood because it is slippery and dangerous.
- **Never** stand on the top of tires because they are slippery and dangerous.
- Stand on the mudguard of the front frame and seize the handrail to clean the front glass of the operator cab.

8.6 Maintenance While the Engine is Working

Routine maintenance of the machine should never be done while the engine is working. When it is necessary, please follow the rules below:

- Assign an operator to sit on the seat to ensure all the maintenance people can have contact with him so he can prepare to shut the engine when requested.
- **Never** touch a high temperature part such as tail pipe and silencer to prevent injury.
- Be careful if the repair space is near the rotation part.
- Do not touch any lever (or handle). If necessary to touch it, warn the others to go to a safe place.
- **Never** let any tool or body part touch the fan leaf or fan belt. Otherwise serious hurt may occur.
- Do not make adjustments unless fully trained to do so.

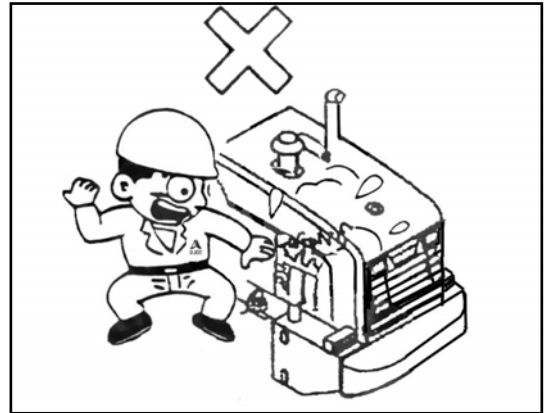

8.7 Do Not Let Anything Fall into the Inner Part of the Machine

- When opening the examination window and the oil filling port of the oil tank, make sure that nothing (such as nuts, bolts, cotton yarn or tools) falls into the inside of the machine. If it happens, the machine may be disabled. Pick out the fallen pieces safely.
- Do not carry any unnecessary tools or parts in your pockets during examination of the machine.

8.8 Cleaning

- Wear the anti-slide shoes to prevent sliding when cleaning the machine. Wear protective clothes when using high pressure water to clean the machine.
- Clean routinely to prevent dirt or mud splashing into the eyes or slippage caused by oil on the machine.
- Do not use a flammable scour when cleaning the machine.
- Shut the engine to clean the inner part of the machine, put all the levers (or handles) in the neutral position, push the parking brake switch and keep it in the braked position.
- Do not let water enter an electric part (such as sensor, wire connector) or operator cab. If so, the

operation may be disabled and the electric circuit may be damaged.

- Wear protect clothes and glasses when using compressed air to clean the filter mesh.

8.9 Heavy Materials

- Wear protect clothes, safety glasses and safety helmet and put a copper bar between the hammer and the part being hit.
- Eyes may be damaged by flying hard particles, such as pin and bearing when hit by a hammer.
- Use tools and heavy materials carefully. Prevent them falling down.

8.10 Welding Repair

Electric welding requires a special technique, proper equipment and place. No person is allowed to weld without a license. Escaped gas and damaged electric wires are potential problems during welding. Obey the following:

- Switch off the electricity in the terminals for storage to prevent explosion.
- For loaders with ZF controlling units, disconnect the wire nipples on the computer control panel, to protect the computer control panel from being burnt out by the impulse current generated in welding. After repairing, do connect the wire nipples on the computer control panel according to requested, or the machine will not work.
- Clean the paint at the welding site to prevent the production of harmful gas.
- Avoid welding on the hydraulic equipment or pipe, or places nearby. Flammable steam and sparks may be generated.
- Cover the rubber, wire or pressure pipe and use anti-fire plate during welding because a spark may cause a sudden crack or shatter the insulating tape.

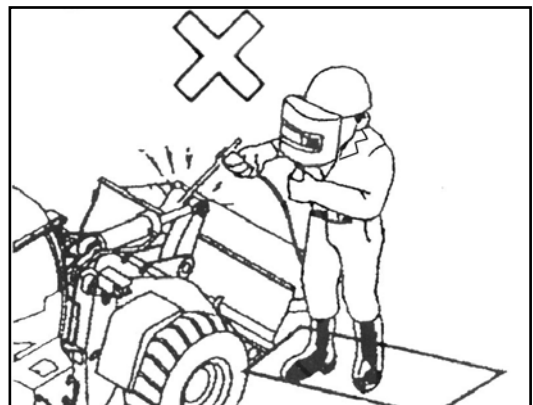

- Be careful when welding near tires, which may cause a thermal explosion.
- Wear protective clothes during welding.
- Keep the welding area ventilated.
- Clean up the flammable materials and check the fire extinguisher.

- **Never** do any modifications which may affect the performance, safety and strength capability of the vehicle and the working equipment.

8.11 Maintenance of Coolant System

- Severe burn may be caused if the cover of the oil tank and the radiator are opened after welding, so pour water or oil on the cover of the oil tank immediately after finishing welding. The temperature and pressure of hydraulic oil, fuel and water in the engine, the oil and water in the radiator may be still very high after just finishing the work. Wait for the temperature falling down and follow the procedures to do the operations above.

- To avoid hot water ejecting from the radiator, stop the engine, let the hot water cool, and open the cover slowly to release the pressure. Never touch the radiator. Check the air temperature in front of the radiator to gauge the temperature.

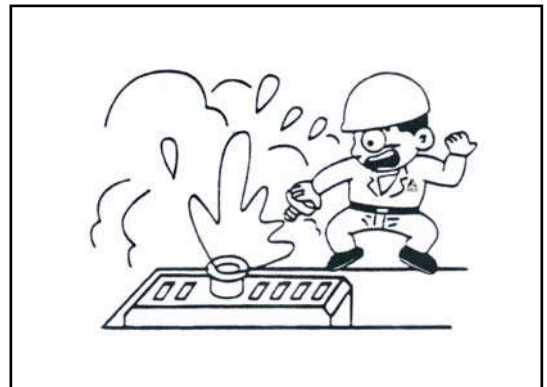

- To avoid hot oil ejecting from the radiator, stop the engine, let the hot water cool, and open the cover slowly to release the pressure. Never touch the radiator. Check the air temperature in front of the radiator to gauge the temperature.

- While the machine is warming-up, do not touch engine, silencer, tail pipe or relay to prevent burn.

- While the machine is warming-up, do not disassemble the water heat sensor of the engine, oil heat sensor of the torque converter or the water pipe of air condition to prevent burn.

- **Never** let the harmful alkaline materials in the coolant system touch your skin or eyes.

- Choose a proper container to hold the liquid when replacing the coolant, mobile oil of the engine, oil of the transmission box and cleaning the parts. Please refer to **8.20 Waste Materials** in this chapter for the methods to deal with the waste liquid.

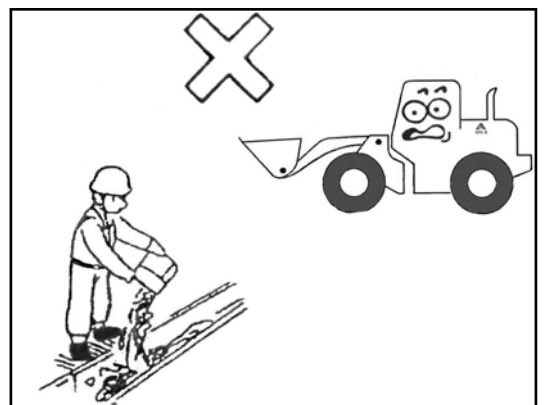

- Keep fire off when disassembling the connection pipe of the air condition compressor.

8.12 Examination and Repair of Hydraulic System

- Lock the oil tank and other hydraulic equipment safely, release the pressure of all hydraulic systems before examining the hydraulic system.
- **Never** bend or beat the high pressure hydraulic pipe. **Never** assemble the hard pipe and soft pipe if they are bent abnormally or broken.
- Routinely repair any loose or broken fuel oil circuits, lubricating oil circuits, the hard and soft pipe of the hydraulic system. Leakage can cause fire, so routine maintenance is critical.
- Examine the pipe system carefully (hard pipe and soft pipe), screw down the connectors according to the proper torque. Do not examine a leak using your hand, rather use a board or paper board. The leaking hydraulic liquid may penetrate your skin and cause death. If the liquid splash onto your skin, the case of a physician trained for this kind of “burn” will be immediately required.

NOTICE

Please replace these parts in the following conditions:

- Connectors are broken or leaking.
- Outside of soft pipe is abrasive or cracked, and the steel wire of the strengthening layer is bare.
- Local of soft pip is upheaval.
- Soft pipe is obviously torqued or staved.
- Steel wire of strengthening layer penetrates the outside layer.
- The end connectors are misplaced.

- Make sure all the pipe clamps, protective board, and anti-heat cover are installed properly to prevent vibration and overheating due to friction with other parts.
- Choose proper container to hold liquid when replacing the hydraulic oil of the hydraulic system and when cleaning the parts. Please refer to **8.20 Waste Materials** in this chapter for the methods to deal with waste liquid.

8.13 Preventing Fire

- Stop the engine before adding fuel. Do not smoke and keep fire away while adding fuel.

- Keep fire away from the storage place of fuel, grease or other flammable materials.
- Clean the flammable substances on the machine such as fuel, grease oily cloth or other flammable materials.
- Keep fire away from the storage battery because explosive gas may be generated. Strictly follow the program in this user manual to maintain the storage battery.
- Make sure there are no flammable materials, such as dry grass and old paper, near the high temperature parts such as the silencer when parking the machine.
- Check whether there is leakage of fuel, mobile oil or hydraulic oil. Replace the broken soft pipes. Clean before operation and after repair.
- Check the wire to see whether it is breakage and voltage leakage; if so, replace it or repair it.
- Use inflammable liquid to clean the parts; do not use gasoline or other flammable materials.
- **Never** weld or flame cut the pipe or tank containing flammable liquid. Clean them using inflammable liquid before welding and flame cutting.
- Check the fire extinguisher before starting repair work. Know the location of fire extinguishers and first-aid bag and know how to use them.
- **Never** use fire (match or lighter) to check dark areas.

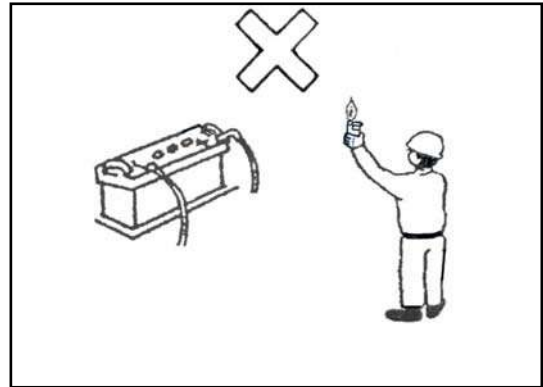

8.14 Air Storage Tank

- Open the drain valve of the air storage tank to drain every day. This is especially important in cold weather. Make sure the drain valve is closed before starting the engine.
- Examine the outside of the air storage tank frequently because of high pressure air. Examine the anti-erosion layer and welding line to ensure safety.

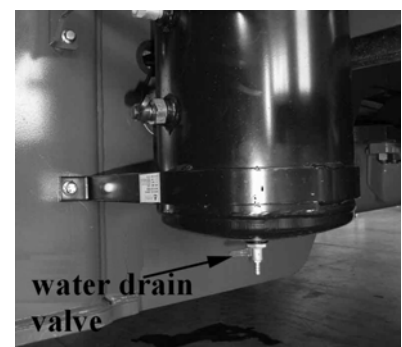

8.15 Electric System

- A professional person with a proper license must maintain the electric system.
- Connect the grounding cable last to prevent an explosion due to electric sparks near the battery when adjusting outside power.
- Remove the start up key before repairing the electric system.

8.16 Maintenance of Storage Battery

Oxygen and hydrogen may be generated during battery charging because the electrolyte of the storage battery contains vitriol. So mis-operation of the storage battery may lead to severe injury or fire.

Please do as follows:

- Keep kids away from the battery. Wear safety glasses and rubber gloves to deal with the battery. If vitriol gets in the eyes or on the clothes or wash with lots of water and go to hospital if hurt severely.
- Keep fire away from the battery during charging because the generation of oxygen and hydrogen may cause an explosion. Prevent circuit from shorting.
- Keep fire away from the crust on the battery because it is flammable.
- Store the battery under dry, clean and well ventilated circumstances with temperatures between 5~25°C. Prevent sun light irradiation. Keep the battery 2m away from a heat source. The battery will be affected by high temperature.
- **Never** reverse and put horizontally. Prevent damage by too much pressure.
- The storage life of a battery is 6 months under room temperature without charging. If over 6 months, please charge before use.
- Pay attention to the labels on equipment before installation to prevent accidents.
- Spread vaseline on the poles to prevent erosion. The wire connections should be firm and credible. **Never** hammer the wire pole which may cause the leak of vitriol.
- Connect the positive pole of the storage battery with the negative pole of the machine first, and then connect the negative pole of the storage battery with the positive pole of the machine.
- Put the battery on the shaft using the upside fixing method or downside fixing method to prevent destruction caused by loosening.

- There is an indicator on the cover of the battery. The green light means it can be used, the black light means it should be charged, and the white light means it should be replaced. Replace with a new battery after the white light indicator.
- Routinely recharge the battery if the battery lacks electric power during use to prevent the capability of battery sulfate going down.
- If the battery is installed, disassemble it and put it in a dry and well ventilated place if it is not used for long time (generally more than 15 days). Recharge the battery every 3~6 months (based on whether the indicator is black or not).

8.17 Charging of Storage Battery

Explosion may occur if the storage batteries are charged in the wrong way. So follow the storage battery instructions in this user manual. Do as follows:

- Charge with constant voltage is recommended:
 - Complementary charge: charge 16 hours at 16.0 Voltage (max current is less than 25A)
 - Normal charge: charge 24 hours at 16.0 Voltage (max current is less than 25A).
- Connect the positive pole of the charging machine with the negative pole of the storage battery, and then connect the negative pole of the charging machine with the positive pole of the storage battery. Never reverse.
- Examine the vent of the battery to prevent blockage, otherwise it may explode.
- Lower the charging voltage or current if the electrolytes are over 45°C to prevent spurt out of electrolytes due to high temperatures.
- **Never** overcharge during use or charging to prevent early invalidation due to water loss, grid increasing and diachylon dropping.

8.18 Starting to Use Voltage-Raising Method

The wrong connection of voltage-raising cable may lead to fire, so please do as follows:

- Two operators are needed to start voltage-raising start (one sits on the operator seat).
- Two machines are not allowed to touch when one is starting.
- Turn off all the starting switches of the normal machine and the broken machine when connecting the voltage-raising cable.
- Connect the positive (+) cable first when the voltage-raising cable is connected. Cut off the

negative or ground (–) cable first when the voltage-raising cable is removed.

- Connect the ground cable to the frame of the broken machine. Connection should be as far as possible away from the storage battery.
- Do not let the voltage-raising cables touch each other or let the clamp touch the machine when the voltage-raising cable is removed.

8.19 Maintenance and Storage of Tires

8.19.1 Maintenance of Tires

- The Explosion of a tire can push the parts, such as tire, rim and driving axle, as far as 500m or more. The explosion and the particles can lead to severe injury, even death, so please keep the pressure of the tire at the normal level. Inflation pressure should not surpass the standing value. The inflation pressure is shown in **CHAPTER II - 8 TECHNICAL PERFORMANCE & PARAMETERS**.
- Driving at high speeds increases the temperature, and therefore, the pressure. **Never** try to reduce the pressure, but reduce the speed to cool the tire. Continuous high speed driving can lead to over heating and tire explosion.
- Stand at the back of the tire, and stand as far as possible away from the tire when adjusting the pressure of the tire.
- Check the tire and rim every day for cracks or bubbles. **Never** operate in a low pressure condition.
- Check that the bolt and nut of the rim are in place. Check whether the torque of the nut satisfies the suggested value of the factory.
- **Never** stand in the front or the rear of the rolling direction of the tire. Check the tire from the side. If disassembling one tire lock the other tires.
- Take care when welding near a tire, which can cause explosion of the tire.
- Only a trained person with a professional license can repair a tire and rim using specific tools and following the proper steps.
- Use the uniform tire with the same standard and same flower pattern for replacement.

8.19.2 Storage of Tires

- It is the basic rule that tires should be stored in a warehouse. No one can enter without permission. Put a fence around and hang a “**No Enter**” sign if the tires are stored outside the warehouse.
- Store the tires in a dry and clean place. Water can oxidize a tire, and dirt and oil can erode a tire. No light, heat insulation or ventilation are needed for storage. Cover the tires with a canvas, plastic or other anti-dust cloth. The wrong storage method can greatly reduce the quality and life of tires.
- Stand the tire on level ground and use a wedge to lock it to prevent it falling down. The quality may be reduced if the tire is laid on its side. The tire should be rotated (90°) once per month at least.
- Please stand aside if a tire starts to fall down. **Never** try to hold a tire since the tires for engineering mechanisms are generally very heavy, and you may be seriously hurt.

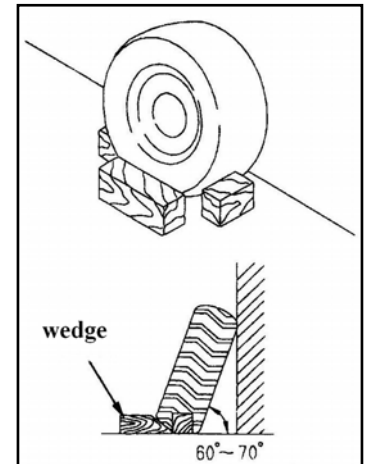

8.20 Waste Materials

Do as follows to prevent pollution:

- **Never** dump waste oil under ground or into the river
- Contain the oil vented from the machine in a container; **never** dump the oil directly onto the ground.
- Obey the relative rules and laws when dealing with harmful materials such as grease, fuel, coolant, solvent, filter and storage battery.

9 SAFETY TRANSPORTATION

9.1 Assemble and Disassemble the Machine

- Keep the engine speed low during loading and unloading the machine.
- Load and unload machine on level ground and remain at a safe distance off the road.
- Secure the tires well during loading and unloading the machine to make sure it will not move. Put a cushion under the gangway.

- Slope boards should be strong enough with sufficient length and width to form a safe slope. The angle with the ground should not be larger than 15°. Keep a safe distance between slope board and board, board and machine.
- Make sure the height of the two sides of the board is uniform to ensure firm orientation.
- Keep the board surface clean, free of lubricant, oil, ice and loose materials. Clean the dirt off the tires.
- **Never** turn around on the slope board. If it is necessary, turn outside the board and then drive back.
- Lock the direction mechanism after assembly, wedge the tires and tie the machine tightly with cords.

9.2 Transportation on the Ground

- Obey the rules about weight, height, width and length prescribed by national and local laws for transporting the machine using a tow truck. Obey the traffic rules.
- Know the weight, height, width and length of machine regulation before deciding the transport routine.
- Know the allowed limit of weight bearing when passing bridges or private buildings. Obey the relative rules when driving on the public roads.
- The machine may be unloaded when using other transportation. Please contact Shandong Lingong Construction Machinery Co. Ltd. or their accredited representative.

9.3 Lifting

Use the hook of the front and rear frame to transport the machine to ship or train.

Select proper lifting equipment according to the weight of the loader, otherwise it is dangerous to surpass the weight limit.

- Notices for lifting:
 - ◆ Make sure the loader is in the transporting state.

The front and rear frame should be in the middle

position. Lock the machine using the lock bar to prevent rotation of the front and rear frame

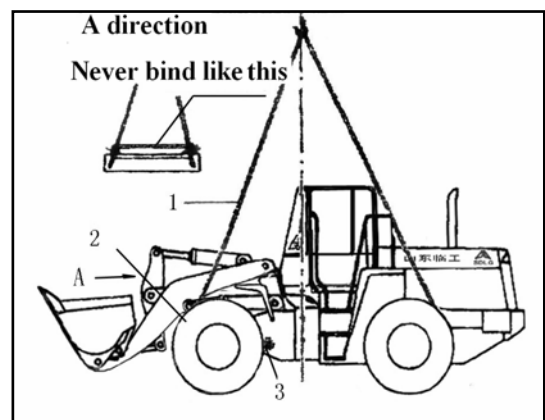

during lifting.

- ◆ All the levers (or handles) should be in the middle position.
- ◆ Stop the engine, lock all the equipment using keys and then remove.
- ◆ No one is allowed to stay in the operator cab.
- ◆ **Never** lift the machine using steel wire connecting the two hooks on the front frame.
- ◆ It is allowed to lift the machine using 4 steel wires of the same length (no shorter than 7m).
- ◆ Keep the machine horizontal during lifting.
- ◆ Prevent damage to hood, operator cab, and hydraulic pipes.
- ◆ No person or car is allowed to pass under the machine during lifting.
- ◆ Draw back the lock bar to turn the machine after lifting.
- Connect the turning equipment using the lock bar after lifting onto the ship (train), wedge the tire and bind the machine tightly to prevent movement during transportation.

CHAPTER II INTRODUCTION

1 GENERAL VIEW OF THE MACHINE & COMPONENTS' NAME

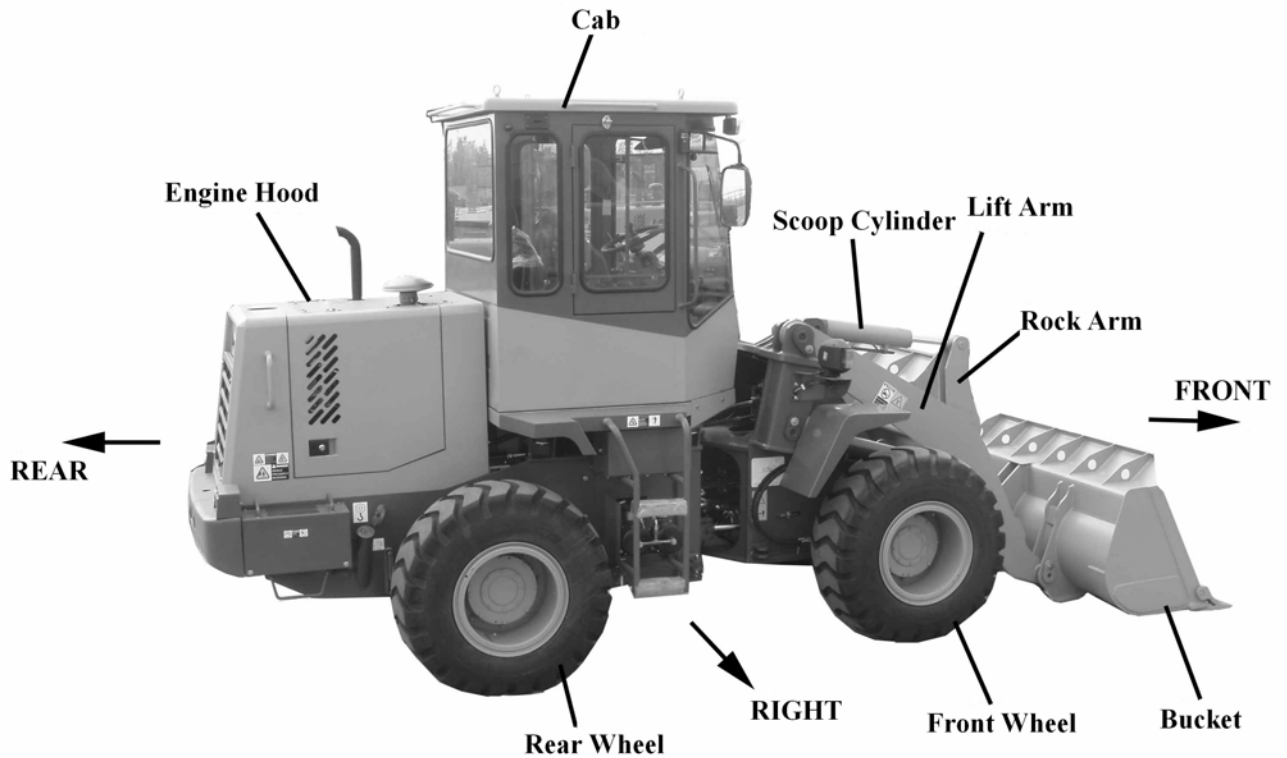

Figure 2-1 General view and components' name of LG936L wheel loader

2 GEOMETRICAL DIMENSIONS

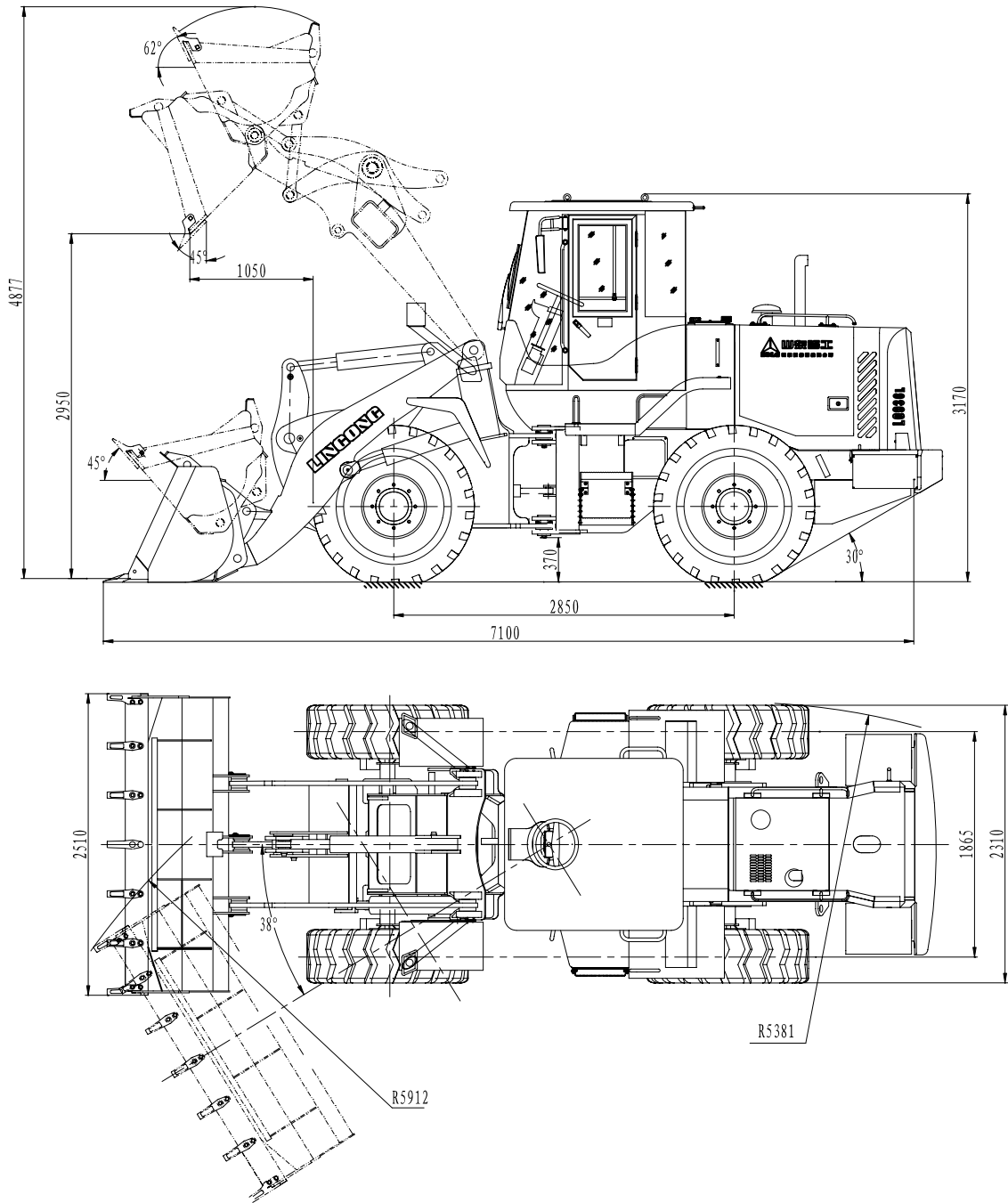
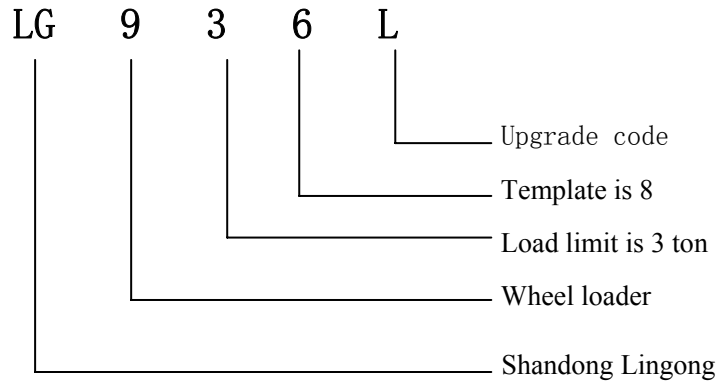

Figure 2-2 Geometrical dimensions of LG936L wheel loader mounted with standard lift arms

3 PRODUCT TYPE AND ITS MEANING



4 NAMEPLATE

The nameplate is fixed on the left rear side of the front frame, describing the model, serial No., production date and manufacturer of the machine. The type of nameplate is shown in Fig. 2-3 and Fig. 2-4. The other configurations of nameplate refer to **CHAPTER II - 8 TECHNICAL PERFORMANCE & PARAMETERS.**

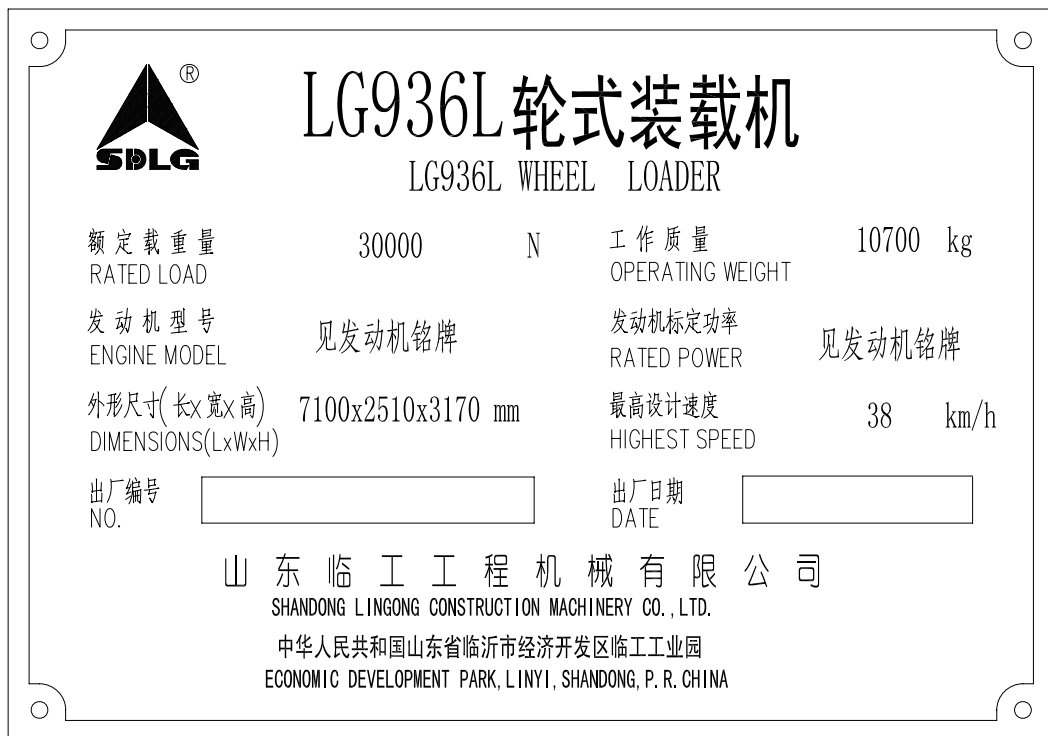

Figure 2-3 Nameplate of LG936L basic configuration loader

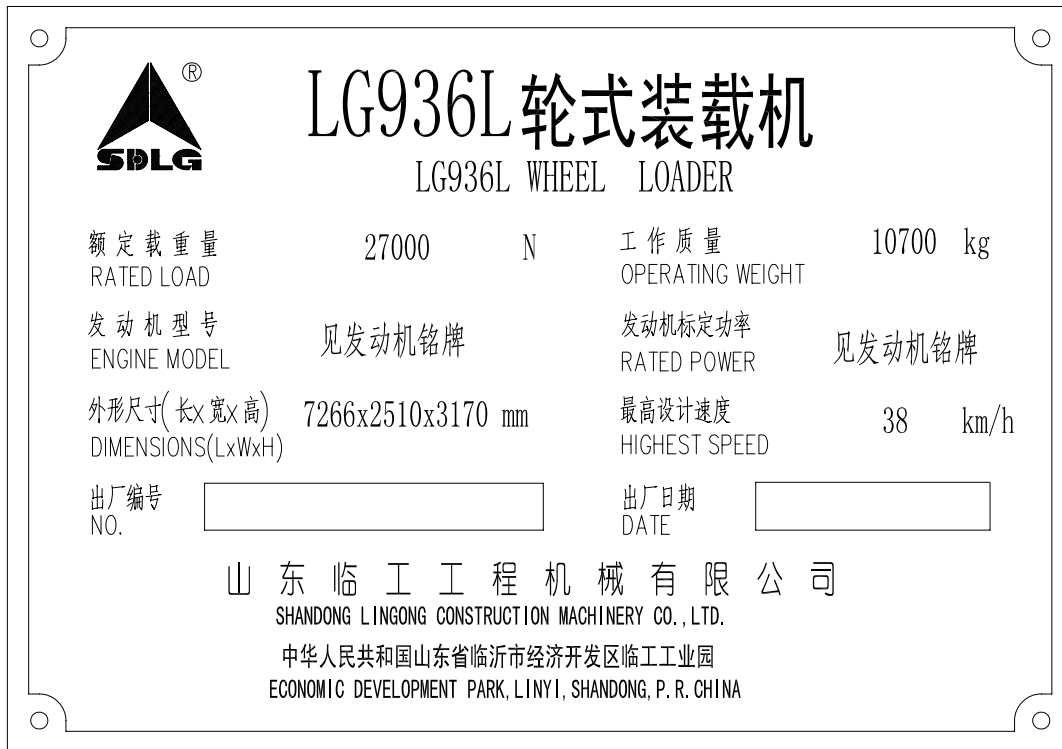

Figure 2-4 Nameplate of LG936L wheel loader mounted with long lift arms

5 USE CONDITIONS

This loader is a multi-purpose large construction machine mainly used for bulk materials. It is widely used in mineral yards, construction, roads, freight yards and ports. It can be used for dragging, to flatten the ground, piling and stacking of bulk soil, sand, sand stone, coal and garbage.

It can chuck wood, fork grass, clean snow and chuck box-liked material with proper work equipment.

Please refer to **CHAPTER III – 3.5 Operations**, for details.



WARNING

The following operations are forbidden for the loader:

1. Over loading.
2. Unbalanced.
3. Digging hard material.
4. Lifting heavy material using a rope hung directly on the bucket.
5. Dig with the bucket above the machine level.

6 CIRCUMSTANCES REQUIREMENT

Requirements for this machine follows:

1. Altitude: $\leq 3000\text{m}$;
2. Temperature: $-15\sim 40^{\circ}\text{C}$;
3. Water depth: $\leq 400\text{mm}$.

The loader is a general construction machine, and can be used under the conditions listed in this manual. Please follow the rules and utilize relative specific purpose equipment. If it is used under other conditions or potentially dangerous circumstances, such as areas with flammable materials, explosives and asbestos dust, the manufacturer assumes no responsibility for the potentially resulting damage and injury.

7 FEATURES

- Luxury streamline appearance and generous figuration.
- The working equipment is optimized, so that the lift weight is larger and the full-efficiency of bucket is high to improve the working efficient.
- Both the wheel base and operating weight are large, so the vertical stability is high.
- Provide 5-ton-grade LG transmission whose reliability is higher.
- Power matches suitably. Select the work pump with large displacement to improve the working efficient.
- Employ dustproof design on the position of pins to prolong the using life
- Employ hydraulic controlling mechanism with patent right to provide portable operation and high reliability.
- Articulated frame structure and big steering angle (38°), the radius of turning is small, son that the whole is mobile and flexible.
- Employ the optimized and improved hydraulic pipe seal structure to improve the seal and reliability of hydraulic system.
- Optimized damping system provides better operating environment; new damping seats with high shock absorbing properties improve the comfort of drivers.
- New style cab with steel structure providing wide view; optimized inner arrangement of cab, larger operating room; whole covered interior trimming, seal and stable, better view; fronting operating floor achieves forward blowing, air conditioners are optional, which can provide

comfortable environment to the customers.

- Install many kinds of optional working equipment such as wood-clipping fork, grass-grabbing fork, increasing bucket, rock bucket, side dumping bucket, level fork, snow plowing and replace quickly attachment.

8 TECHNICAL PERFORMANCE & PARAMETER

8.1 Performance of Whole Machine

	Standard lift arm	Long lift arm
Bucket capacity	1.8 m ³	1.6 m ³
Rated loading capacity	30000N	27000N
Lifting time (full load)	≤5.3 s	≤5.3 s
Lowering time (empty bucket)	≤2.9 s	≤2.9 s
Forward tilting time (empty bucket)	≤1.0 s	≤1.0 s
Travel speed		
Forward:		
1 st	0~13 km/h	0~13 km/h
2 nd	0~38 km/h	0~38 km/h
Reverse:		
1 st	0~17 km/h	0~17 km/h
Max. breakout force	≥96 kN	≥92 kN
Max. traction force (supplied by engine)	≥105 kN	≥105 kN
Max tipping load	≥66 kN	≥66 kN
Max. climbing angle	30°	30°
Min. turning radius(outside of rear wheel)	5381 mm	5381 mm
Level passing radius (outside of bucket)	5912 mm	6073 mm
Max turning angle:	38°	38°
Tire charge pressure:		
Front wheel	0.333~0.353 MPa	0.333~0.353 MPa
Rear wheel	0.275~0.294 MPa	0.275~0.294 MPa

8.2 Principle Dimension and Weight

Length (bucket on ground)	7100 mm	7266 mm
Width (outside of wheels)	2310 mm	2310 mm
Bucket width	2510 mm	2510 mm
Height	3170 mm	3170 mm
Wheel track	1865 mm	1865 mm
Wheel base	2850 mm	2850 mm
Min. ground clearance	370 mm	370 mm
Max. dumping height(-45° dumping angle)	2950 mm	3278 mm
Dumping space (-45° dumping angle)	1050 mm	1020 mm
Dumping angle	≥45°	≥45°
Operating weight	10700kg	1070kg

8.3 Product Standard and License

Product Standard Q/LGJ 001 wheel loader

CHAPTER III OPERATION AND APPLICATION

1 BE FAMILIAR WITH MACHINE

1.1 Control Systems and Gauges

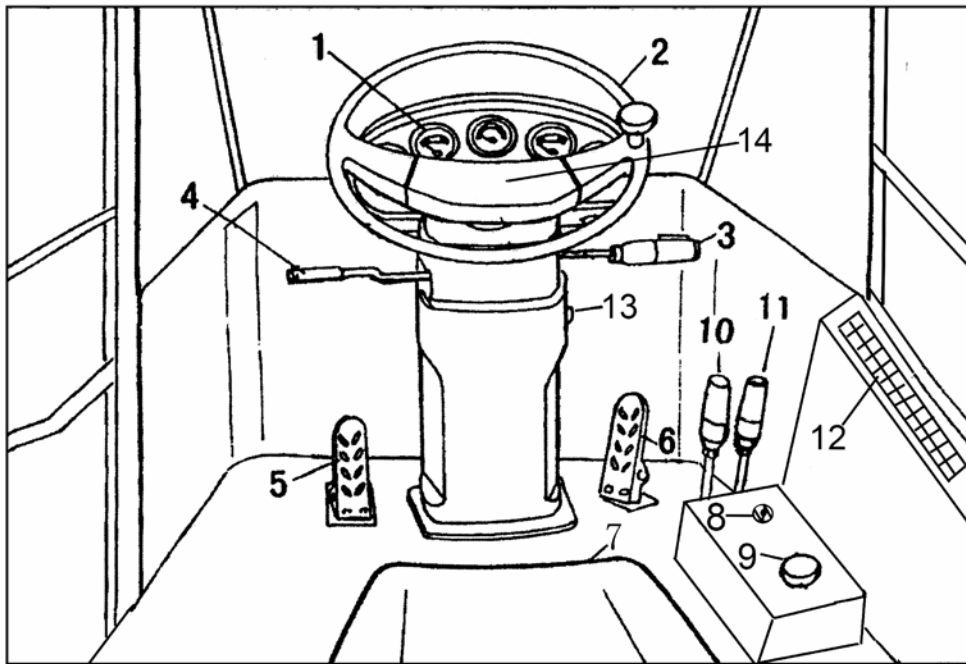
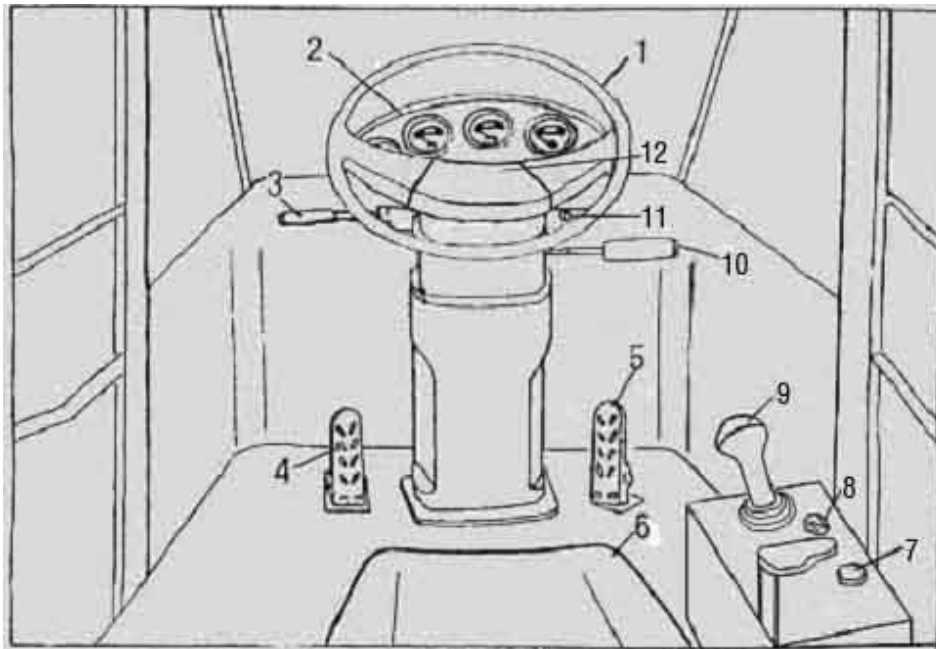

Figure 3-1 General view of control System (Double Control Lever, Manual Flameout)

1. Panel 2. Steering Wheel 3. Turning Switch
4. High and Low Speed Control Lever 5. Brake Pedal 6. Accelerator Pedal 7. Seat
8. Flameout Control Soft Knot 9. Parking Brake Control Switch 10. Bucket Control Lever
11. Lift Arm Control Lever 12. Roker Switch 13. Starting Switch 14. Horn Button



1. Steering Wheel 2. Panel 3. Turning Switch 4. Brake Pedal
 5. Accelerator Pedal 6. Seat 7. Parking Brake Control Switch 8. Flameout Control Soft Knot
 9. Equipment Control Lever 10. High and Low Speed Control Lever 11. Starting Switch
 12. Horn Button

Figure 3-2 General view of control System (Pilot Single Lever, Manual Flameout)

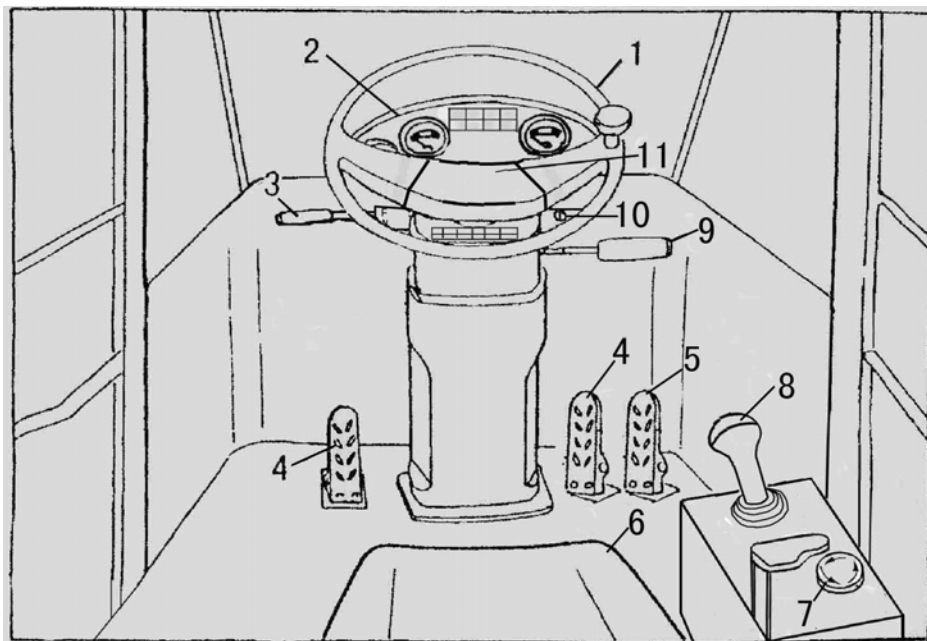

1. Steering Wheel 2. Panel 3. High and Low Speed Control Lever
 4. Brake Pedal (On both sides) 5. Accelerator Pedal 6. Seat 7. Parking Brake Control Lever
 8. Equipment Control Lever 9. Switch Group 10. Starting Switch 11. Horn Button

Figure 3-3 General view of control System (Pilot Single Lever, Three Pedal)

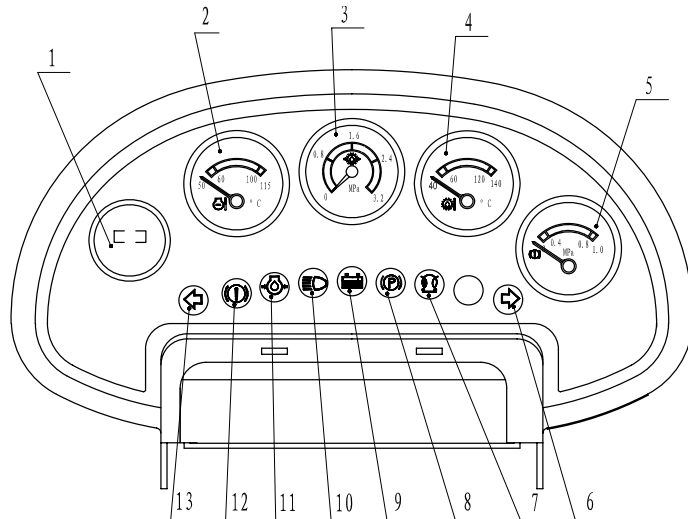

1. Working Chronometer 2. Engine Water Temperature Gauge 3. Gearbox Oil Pressure Gauge
 4. Torque Converter Oil Temperature Gauge 5. Brake Air Pressure Gauge
 6. Right Turn Indicator Lamp 7. Preheating Indicator Lamp 8. Parking Brake Indicator Lamp
 9. Charge Indicator Lamp 10. High Beam Indicator Lamp
 11. Engine Oil Pressure Warning Lamp 12. Low Brake Air Pressure Alarm Lamp
 13. Left Turn Indicator Lamp

Figure 3-4 General view of gauges

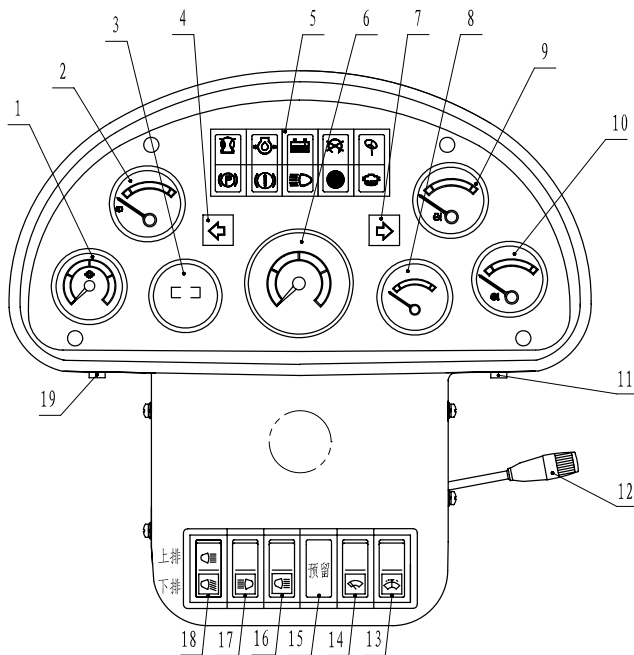

1. Gearbox Oil Pressure Gauge 2. Air Pressure Gauge 3. Working Chronometer
 4. Left Turn Indicator Lamp 5. Indicator Lamp 6. Revolution Indicator
 7. Right Turn Indicator Lamp 8. Fuel Level Gauge 9. Engine Water Temperature Gauge
 10. Torque Converter Oil Temperature Gauge 11. Starting Switch 12. Switch Group
 13. Water Spraying Switch 14. Rain Wiper Switch 15. Cover Board
 16. Rear Lighting Lamp Switch 17. Front Lighting Lamp Switch 18. Rear Headlight Switch
 19. Warning Lamp Switch

Figure 3-5 General view of gauges (with Revolution Indicator and Fuel Level Gauge)

1.2 Introduction of Gauges & Controls

The introduction of gauges & controls needed for operating the machine is below. Be sure to understand their functions and methods for use.

1.2.1 Vehicle Gauges and Lights

- **Engine Water Temperature Gauge**

This gauge indicates the temperature of engine water.

When the temperature index lies in the green ranges (60°C~100°C), the water temperature is normal.

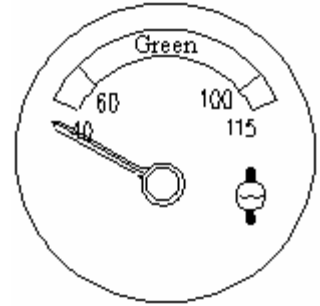

Notice:

If the temperature index moves past green into the red range, be sure to stop the machine for inspection.

Refer to **3.4.2 STEPS TO STOP ENGINE** in this chapter for details of stopping the engine.

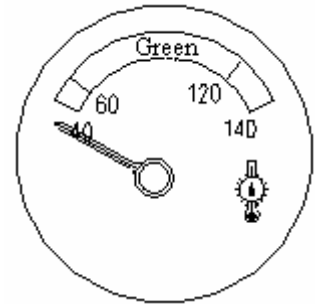

- **Torque Converter Oil Temperature Gauge**

This gauge shows the torque converter oil temperature

When the temperature index lies in the green range (60°C~120°C), the oil temperature is normal. If the temperature index moves past green into the red ranges, be sure to stop the machine for inspection.

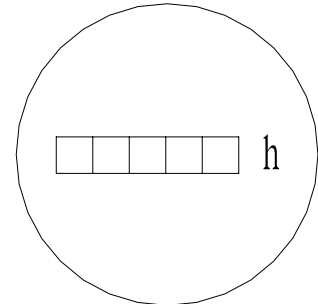

- **Working Chronometer**

This indicator shows the total operation hours of the machine; its value can be used as a reference for inspection and maintenance.

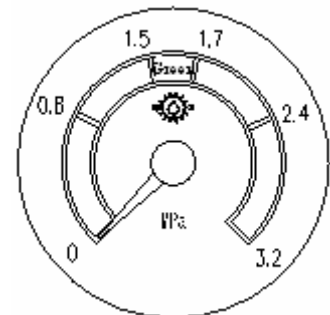

- **Gearbox Oil Pressure Gauge**

This gauge indicates the pressure of the gear-shifting system.

If the pressure index lies in the green range (1.1MPa~1.5MPa), the oil pressure is normal. Be sure to stop the machine for inspection if the index moves outside this range.

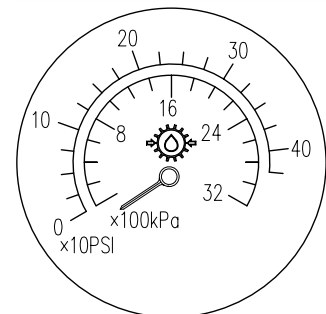

This gauge indicates the pressure of the gear-shifting system.

If the pressure index lies in the green range $(11\sim15) \times 100\text{kPa}$ or $(15.95\sim21.75) \times 10\text{PSI}$, the oil pressure is normal. Be sure to stop the machine for inspection if the index moves outside this range.

- **Brake Air Pressure Gauge**

This gauge indicates the air pressure of the brake system.

If the pressure index lies in the green range (0.4MPa~0.8MPa), the oil pressure is normal. Be sure to stop the machine for inspection if the index moves outside this range.

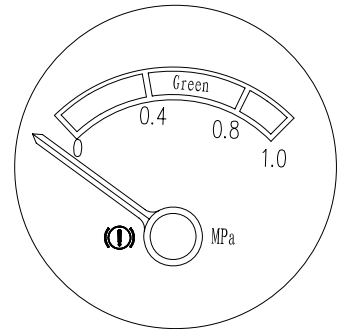

This gauge indicates the air pressure of the brake system.

If the pressure index lies in the green range $(4\sim8) \times 100\text{kPa}$ or $(5.8\sim11.6) \times 10\text{PSI}$, the oil pressure is normal. Be sure to stop the machine for inspection if the index moves outside this range.

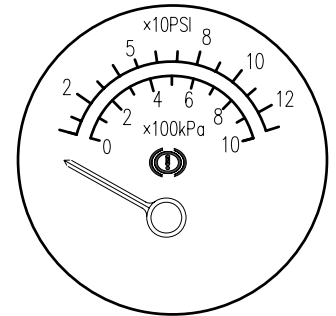

- **Fuel Level Gauge (if assembled)**

This gauge indicates the ratio of remaining fuel level in the fuel tank to the volume of tank.

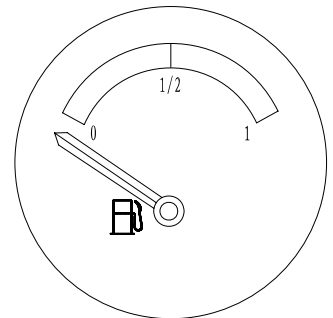

- **Revolution Indicator (if assembled)**

This gauge indicates the rotating speed of engine

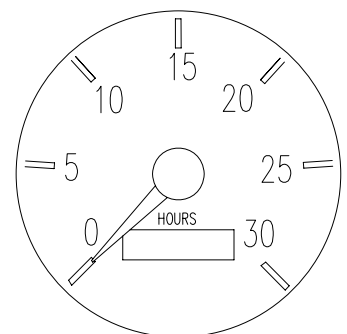

- **Indicator Lamp**

The indicator lamp is located on the gauge panel. Refer to **1.1 General View of Controls and Gauges Figure3-2** in this chapter.

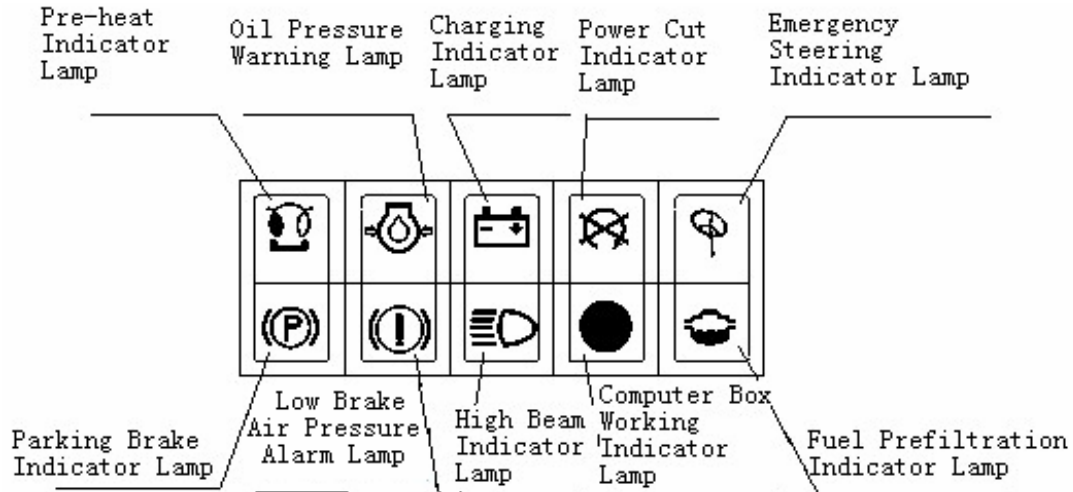

- **Pre-heat Indicator Lamp:** If assemble the pre-heat function, the lamp would be on if in the pre-heating state or the light will be off.
- **Oil Pressure Warning Lamp:** The lamp will come on immediately if the start switch is turned on. It will go off immediately after the engine is started. Otherwise it means the level of lubricant is too low or there is some problem with the lubricant system. Then shut the engine and check it.
- **Charging Indicator Lamp:** The lamp will come on if the start switch is turned on. It will go off immediately after the engine is started. Otherwise it means there is some problem with storage battery. Please examine and repair it.
- **Power Cut Indicator Lamp:** The lamp will come on if the power is cut off, and it will go off if the power is not cut off.
The power will be cut off and the lamp will come on if the left braking pedal is stepped down; the power will not be cut off and the lamp will go off if the right braking pedal is stepped down.
- **Emergency Steering Indicator Lamp:** The emergency steering function is selected to install. When the wheel loader is steered emergently, the lamp will come on if the emergency steering pump works.
- **Parking Brake Indicator Lamp:** The lamp will come on when the parking brake switch is pushed down and the brake air pressure is low. The lamp will go off when the brake air pressure is normal and the parking brake switch springs back.
- **Low Brake Air Pressure Alarm Lamp:** The lamp will come on for a warning if the brake air pressure is below 0.4MPa.
- **High Beam Indicator Lamp:** The lamp will come on if the high beam is used in the front headlight. The lamp will be off if the dipped headlight is used or the front headlight is off.
- **Computer working Indicator Lamp:** If ZF gear box or 4WG180 gear box is assembled, the lamp will come on when the starting switch is on, otherwise examine and repair it.

- **Fuel Prefiltration Indicator Lamp:** The lamp will come on when the fuel preliminary filter is blocked. Please clean it or replace.

1.2.2 Switch

- **Starting Switch**

This switch, on the gauge panel, is used for starting or shutting down the electric system and the engine. Refer to **1.1 General View of Controls and Gauges Figure3-1, Figure3-2, Figure3-3** in this chapter.

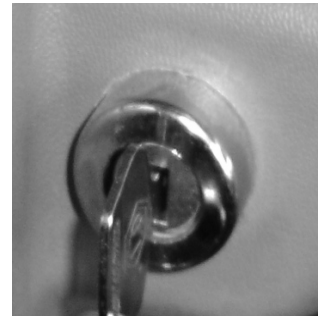

HEAT Position

This position is used for the pre-heating system if the machine has the cold-start function.

OFF Position

Insert or remove the key in this position. Turn the key to this position to cut off the electric power.

ON Position

This position is used to turn on the electric system. Keep the key in this position when the engine is running.

START Position

This is the engine-start position. Keep the key at this position during starting. After the engine has started, immediately pull out the key, or it will return to **ON** position automatically.

- **Radio and CD Player (selectable)**

This switch is at the right side of the ceiling cab, and for the details please refers to **Radio and CD Player Assemble & Operation Manual**. Vehicle without radio, the connection of radio is obligated and further assembly can be carried out by professional workers according to the



- **Turning Switch (selectable)**

Push this switch forward, and the left turning lamp lights. Push this switch backward, and the right turning lamp lights. Refer to **1.1 Control System and the Gauge in the chapter, Figure3-1, Figure3-2**.

- **Switch Group (if assembled)**

Refer to **1.1 Control System and the Gauge Figure 3-3 in this chapter**. The switch controls lighting, high and low beam and steering light.

- ◆ **Lighting**

When the starting switch is in the ON position, the high beam of front headlight is lightened if the switch group turns to OFF and put it up; the head light, tail light and back light is lightened if the switch group turns to the position of ‘’, or ‘’. The high beam of front headlight lights if put it up.



◆ **Control of high and low light**

When the starting switch is in the ON position and switch group turns to the position of ‘’, the low beam of front headlight is lightened; the high beam of front headlight is lightened when put the switch down.

◆ **Control of turning lamp**

The left turning lamp is lightened when the switch is put forward, and the right turning lamp is lightened when the switch is put backward.

Notice:

The turn indicator lamp is lightened when operate the switch. After the operation of turning finished, please put back the switch by your hand.

● **Rocker Switches**

The rocker switch includes rocker switch on gauges and the one on right front side of the cab top. The switches on the gauges refer to **1.1 Control System and the Gauge Figure 3-5** in this chapter. When the start switch is at **ON** position, the spray, rain wiper, rear lighting lamp, front lighting lamp, rear headlight, warning lamp are under control; the rocker switch at right front side of the cab top refers to the figure below, when the start switch is at **ON** position, the unit heater, the spray, front and back headlight lamp, rear lighting lamp, front lighting lamp, back light, warning lamp and rain wiper will be controlled separately by this switch.

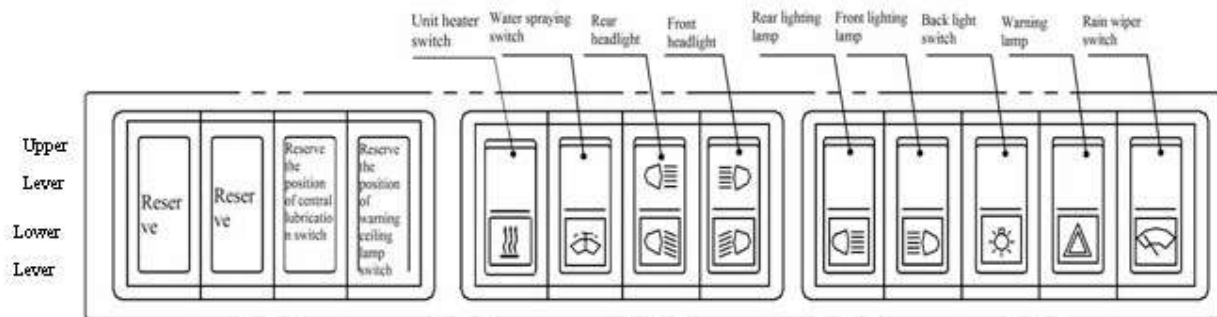

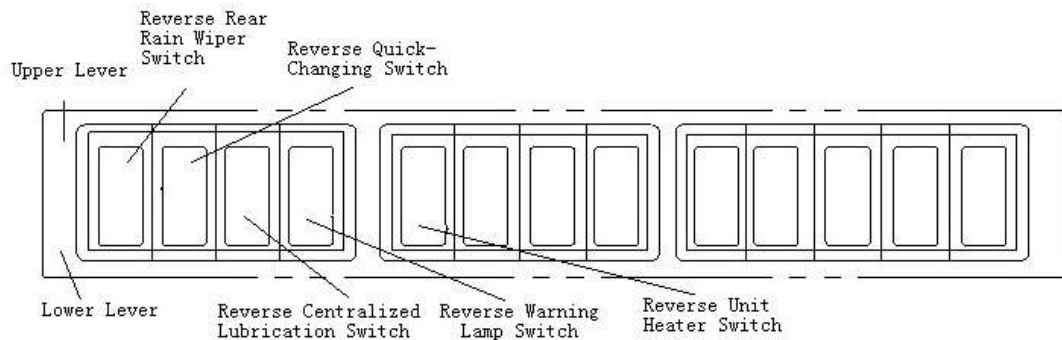

- **Unit Heater Switch (if assembled):**

Press the lower button and unit heater will work; press upper button, and unit heater stops working. When the unit heater or air-condition work, adjust the air outlet in the front or profile of gauge panel. Adjust wind outlet to clean the frost and blow the warm (cool) wind.

- **Water Spraying Switch:**

Press bottom side, the water spraying engine begins working and water is sprayed from the spraying port of rain wiper to clean the glass of the cab; If loose, the switch will return automatically to stop spraying.

- **Rear Headlight Switch:**

Press bottom side, and low beam of the rear headlight will come on;
Press top side, and the high beam of the rear headlight will come on.
If no side is pressed, no lamp will come on.

- **Front Headlight Switch(if assembled):**

Press bottom side, and low beam of the front headlight will come on;
Press top side, and the high beam of the front headlight will come on.
If no side is pressed, no lamp will come on.

- **Front (Rear) Lighting Lamp Switch:**

Press bottom side, and the front (rear) lighting lamp will come on; press top side and the lamp will go off.

- **Back Light Switch(if assembled):**

Press bottom side, the back light lamp and the head and tail lights will come on; press top side, the lamps will go off.

- **Warning Lamp Switch(if assembled):**

When this button is pushed down, all the turning lamps will blink for an emergency circumstance, sending light to warn the other vehicles and passersby. Press the button once again and the button springs back, so all the turning lamps will stop blinking.

- **Warning Button Switch:**

When this button is pushed down, all the turning lamps will blink for an emergency circumstance, sending light to warn the other vehicles and passersby. Press the button once again and the button springs back, so all the turning lamps will stop blinking.

- **Rain wiper Switch:**

Press bottom side, rain wiper will work; press top side, the rain wiper will stop.

- **Water Spraying Switch:**

Press bottom side, spray water to the front glass of the cab; press top side, stop spraying.

- **Top Lamp Switch:**

This switch is behind the ceiling lamp in the operator cab.

Press **ON** position to turn it on.

Press **OFF** position to turn it off.

Turn it **OFF** during driving.

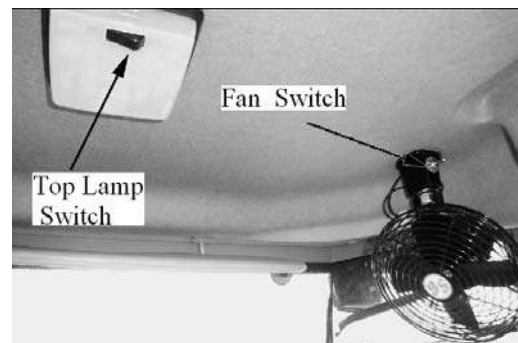

- **Fan Switch:**

Press the bottom side, for low air speed;

Press the top side, for high air speed;

Press the middle of the button, and the fan will stop.

- **Horn Switch:**

Press the button in the middle of the steering wheel, and the horn will sound.

- **Power Switch**

The switch locates in the right battery box. The power of the whole vehicle is shut off when the switch turns to the 'O' position; The power of the whole vehicle is turn on when the switch turns to the 'I' position. Please shut the power switch if park the vehicle for a long time. The position shown in the figure is the state of shut off.



1.2.3 Steering Wheel

The steering wheel is in the operator cab. Refer to **1.1 General View of Controls and Gauges Figure 3-1** in this chapter. The steering wheel and steering unit are connected. Turning the steering wheel clockwise, the machine turns right; turning the steering wheel counter-clockwise, the machine turns left.

The features are listed below:

- The rotation angles of the steering wheel and the machine are not equal. If the steering wheel is

continuously turned; the machine rotation angle will increase until at the needed position.

- The faster the steering wheel turns, the faster the machine turns.
- The steering wheel will not automatically come back after turning, the turning angle of the machine will be kept. After finishing turning the machine, turn the steering wheel in the reverse direction to keep the machine moving in a straight direction.

1.2.4 Control Levers and Pedals

- **Shifting Control Lever**

This lever controls the direction and traveling speed of the machine.

When the lever is at N (0) position, it means neutral gear.

Put the control lever forward to the 1 position can obtain the forward gear I, and the machine goes forward at low speed. When turn it to 2 position, the forward gear II can be obtained, and the machine goes forward at high speed. Putting the lever to R position can obtain the reverse gear and the machine goes backward.



- **Equipment Control Handle and Lever**

(1) Equipment Control Lever

Refer to **1.1 General View of Controls and Gauges Figure 3-1, Figure 3-2** in this chapter.

- ◆ **Bucket Control Lever**

This lever controls the bucket which has three positions.

- ◇ Rear Tilt is used for drawing in the bucket
- ◇ Neutral is used for keeping the bucket in the desired position.
- ◇ Forward Tilt is used for dumping.

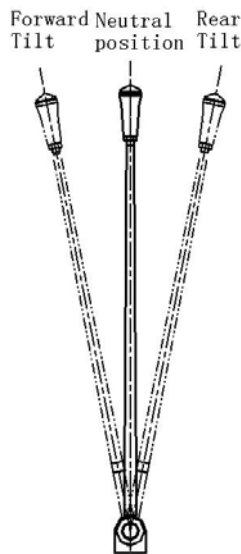

Position of Bucket Control Lever

- ◆ **Lift Arm Control Lever**

This lever controls the lift arm, which has four positions.

- ◇ Lift is used for lifting.
- ◇ Neutral is used for maintaining the

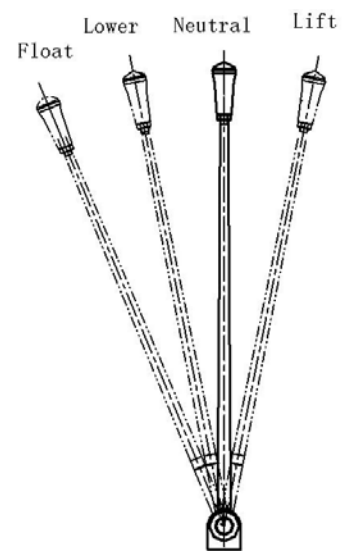

Position of Lift Arm Control Lever

bucket in the desired position.

- ✧ Lower is used for lowering.
- ✧ Float is used for moving freely under applied force.

Notice:

Do not lower the arm at float position.

(2) Equipment Control Handle

Refer to **1.1 General View of**

Controls and Gauges Figure 3-1, Figure 3-2 in this chapter.

This handle controls the bucket and lift arm. There are four gears to control the lift, neutral, lower and float of the lift arm pro-and post, and there are three gears to control the forward tilt, neutral and rear tilt of the bucket from left to right.

Lift Arm:

Lift is used for lifting.

Neutral is used for maintaining the lift arm in the desired position.

Lower is used for lowering.

Float is used for moving freely under applied force.

Notice: Do not lower the arm at float position.

Bucket:

Rear Tilt is used for drawing in the bucket

Neutral is used for keeping the bucket in the desired position.

Forward Tilt is used for dumping.

The working device control handle also has the following functions:

- ✧ **Lifting limit location function:** When place the control handle in the lifting position, the magnetic force from lifting limit location locked magnet coil of pilot valve can lock the control level in the lifting position; When the lift arm lifts to the highest position, the control handle turn to neutral position to realize the lifting limit to prevent the equipment from injury by hydraulic impact.
- ✧ **Set level automatically function:** When dumping in the highest position, move the control

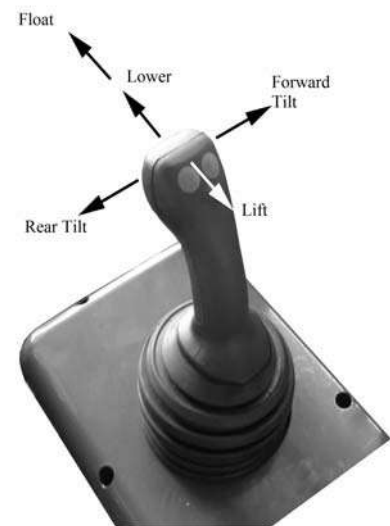

handle left to the rear tilt position and the control handle is locked. During drawing the bucket, the control handle returns to the neutral position and place it in the lowering position when in the set level automatically position. Then the equipment is placed on the ground and the bucket is in the bucketing position in order to realize the set level automatically function and increase the efficient of the whole vehicle.

- ✧ **Lock automatically function:** When leveling the ground, place the control handle in the floating position, and the control handle is locked by the electromagnetic force to realize the lock automatically; Take the control handle from the floating position, it returns to the neutral position automatically to increase the efficient of the whole vehicle.

- **Brake Pedal**

The Brake Pedal controls the brake of the vehicle. Refer to **1.1 General View of Controls and Gauges Figure3-1, Figure3-2, Figure 3-3** in this chapter.

Do not use the left brake pedal to avoid the drive from being cut off on ramp, if double brake pedal are provided.

- **Accelerator Pedal**

This pedal controls the acceleration of the engine. Refer to **1.1 General View of Controls and Gauges Figure3-1, Figure3-2, Figure 3-3** in this chapter.

The engine speed can be freely regulated between idle and full speed.

- **Parking Brake Switch**

This switch is on the right operator box and it is used for the parking brake. Pull this switch to engage the parking brake. Rotate the switch clockwise and the button springs back to release the parking brake.

- **Flameout Control Soft Knot**

This soft knot is on the cover of the heater which on the right side of the seat. Pull this knot, will put out an engine flame.



1.2.5 Cab Door Locking Bar

Outside Cab Locking Bar: Open the left and right door to 180° and the orientation lock on the door will touch the outside lock of the cab and the door will be locked outside the cab. Turn the control bar downward and it will unlock.

Inside Cab Locking Bar: When the lock of the cab is in the locked positions, the door will be locked automatically after closing the door. Insert key outside the cab. Turn 180° clockwise and pull out key. Pull the handle outside the cab and the cab door will open. Turn the lock bar upward and it will open.

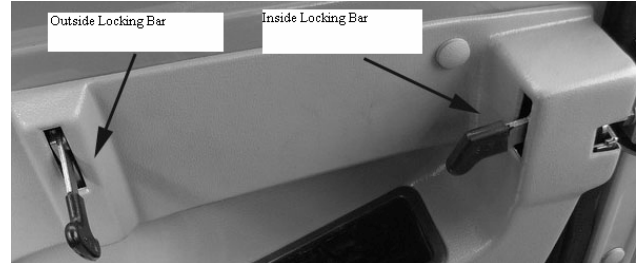

1.2.6 Frame Locking Bar

⚠ WARNING

- Be sure to use the front and rear frame locking bar during maintenance or transporting the machine.
- Be sure to release the frame locking bar during routine travel.

- The frame locking bar is used to lock the front and rear frames during maintenance or transporting vehicles, in order to prevent the frames from moving.

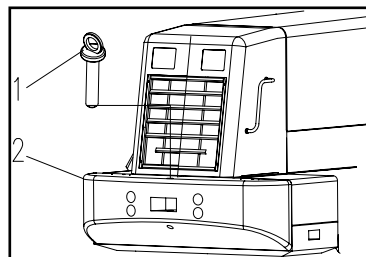
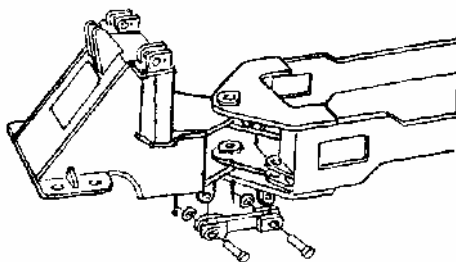

1.2.7 Towing Pin

- During towing, insert the towing pin ① into the counterweight ②.

1.2.8 Fuse

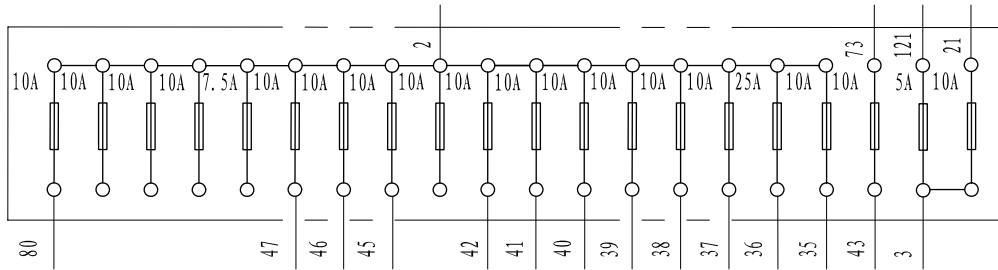

Fuse Box (Domestic Type, Pilot Control)

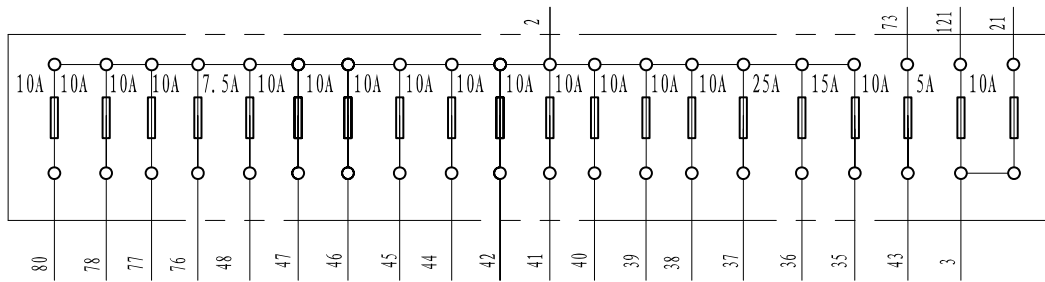

Fuse Box (Mechanical Control)

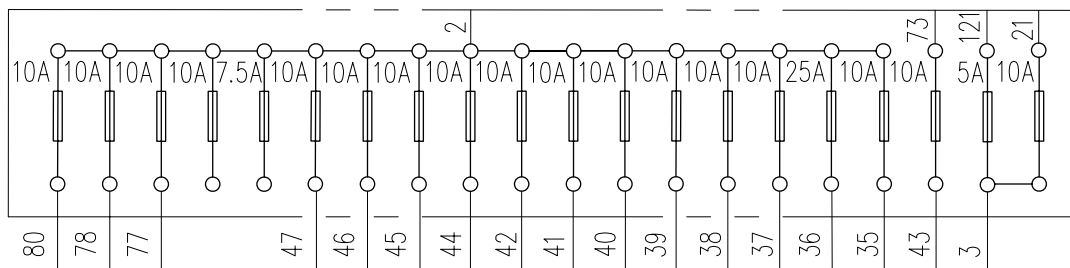

Fuse Box (Export Type, Pilot Control)

⚠ NOTICE

- Always be sure to close the startup switch before replacing the fuse .The fuse is used to protect the wiring and cable from burning out. If the fuse has become corroded by oxidation, or the fuse is loose in the fuse holder, please replace the fuse.
- When replacing the fuse, please replace with a fuse of the same specification.

1.2.9 Air Conditioning

1.2.9.1 I control panel and is operation (if assembled)

● **The Appearance of Panel**

The panel of air conditioning is on the right operator box.

● **Operating methods**

a) Refrigeration

- ✧ Start the engine.
- ✧ Open the air volume and power switch 2 which have three gears (fan low gear, fan middle gear and fan high gear) and four positions (O, L, M and H). The speed of evaporating fan increases from left to right to

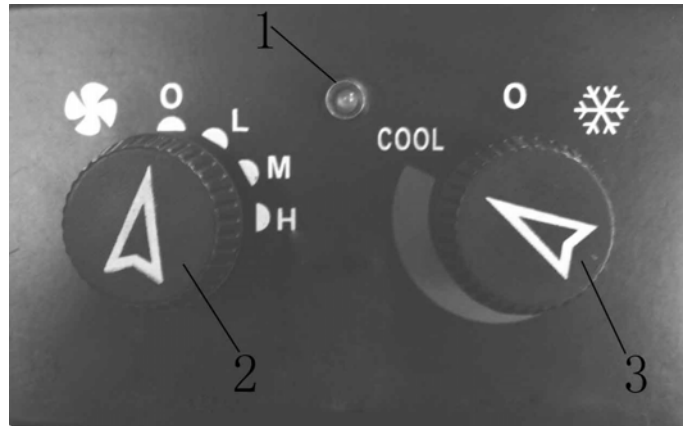

- | |
|---|
| <ul style="list-style-type: none"> 1. Working Indicator Lamp 2. Air Volume and Power Switch 3. The Switch to Control the Temperature |
|---|

adjust the air volume.

- ✧ Open the temperature control switch 3 to the max (the indicator lamp 1 will light), then the compressor starts working for the refrigeration of air conditioning.
- ✧ Turn the air volume and power switch 2 to select different gear to obtain three different volume of air.
- ✧ Turn the temperature control switch anticlockwise slowly to obtain the desired temperature until the indicator lamp 1 turns off and the compressor stops working. Now the setting temperature is the temperature in the cab. When the inside temperature is higher than the setting temperature, the indicator lamp 1 lightens and the compressor will begin to refrigerate; when the inside temperature is lower than the setting temperature, the indicator lamp 1 turns off and the compressor stops working.

b) Heating

- ✧ Before using, turn the temperature control switch to the 'O' position (the state of off).
- ✧ Open the hot water valve and start engine.
- ✧ Open the air volume and power switch 2 to choose the position of gear and adjust to the desired air volume.

1.2.9.2 II control panel and is operation (if assembled)

- **The Appearance of Panel**

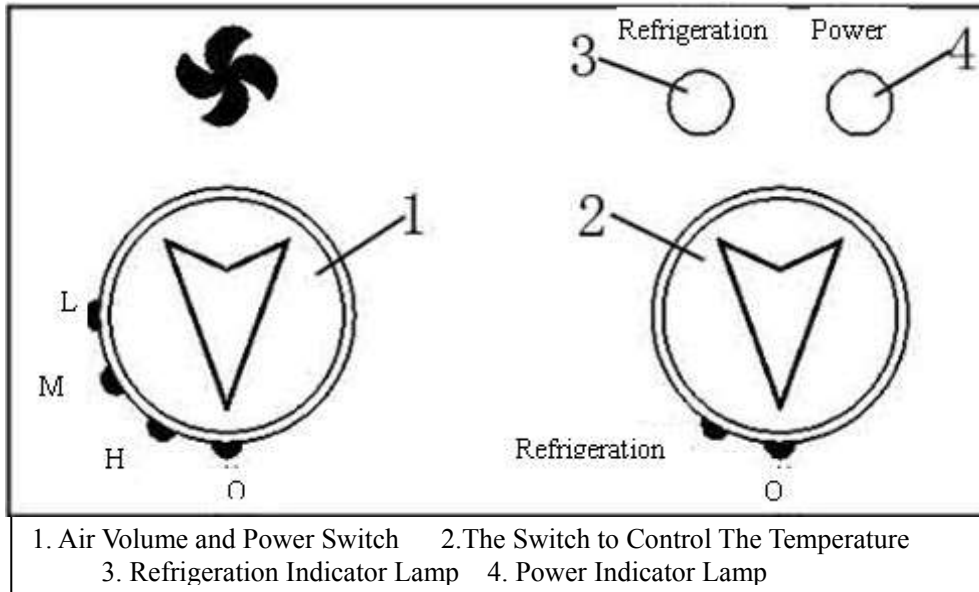

● **Operating methods**

a) Refrigeration

First-time use, turn the air volume and power switch to high gear after the engine started, turn the temperature control switch to refrigeration. Turn the air volume to obtain low, middle and high volume of air.

b) Heating

Turn the temperature control switch to the state of off, open the hot water valve the air volume and power switch, warm air blow constantly. Turn the air volume and power switch to obtain low middle and high volume of air.

c) Power indicator lamp

If the system in a normal energizing the power indicator lamp will come on. If the refrigeration indicator lamp comes on, the compressor starts working for the refrigeration of air conditioning.

Notice:

- ✧ Avoid the temperature control switch 3 is always in the coolest position and the air volume and power switch 2 is in the fan low gear (L position), in order to prevent the evaporator from frosting.
- ✧ Avoid the sun shining directly in summer.
- ✧ Please shut the door and window of cab when using the air conditioning; shut the heat source valve when using for refrigeration; shut the temperature control switch for refrigeration when using for heating in winter.
- ✧ Clean the condenser periodically using compressed air and cold water, but not using hot water

or steam.

- ◇ Run the compressor once a week when the refrigeration isn't used in winter for 1min to maintain the air conditioning in normal state.

1.2.10 Adjustment of Cab's Seat

 <b style="font-size: 1.2em; margin-left: 10px;">WARNING
<ul style="list-style-type: none"> ● When adjusting the cab's seat, park the machine in a safe place and stop the engine. ● Adjust the cab's seat before starting operation or replacing the operator. ● Make sure that you can depress the brake pedal completely when your back is against the seat backrest.

● Weight Adjustment

The weight adjustment handle is in the middle of seat bottom. Turn the handle clockwise to reduce the damping stiffness and turn anticlockwise to increase the damping stiffness. Rotate the damping stiffness adjust handle A by hand according to the operator's weight until feel comfortable.

● Fore-and-Aft Adjustment

This handle is on the left bottom side of the seat. Pull the fore-and-aft handle B and move the seat forward or backward to the desired position; it will lock automatically after pushing it down.

● Backrest Angle Adjustment

Put the backrest angle adjust handle C upward to pull the backrest until the angle is comfortable. The backrest angle is locked when loose the handle.

● Height Adjustment

There are three positions for the height of seat, and the operator can adjust according to the need. During adjusting, set the base under the seat by two hands and draw up forcibly and stably. When the cracking sound is sounded, please loose your hands, then the seat will fix in this position. Adjust the position of seat to the highest position and draw up forcibly, and then press down, the seat will fall to the lowest position.

● Headrest Height Adjustment

Set the headrest of seat by two hands, and then draw up or press down forcibly to adjust the height of

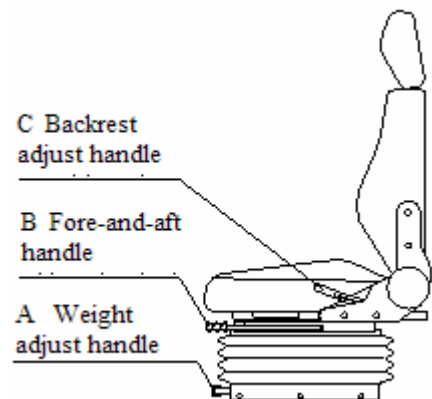

headrest.

1.2.11 Use of Safety Belt

If the safety belt is assembled on the seat, please tie it when operating the machine. Before using safety belt, please check the degree of wear and firm. Replace it if it is necessary.

Adjust the length of safety belt before using to make sure the safety belt can be used for safety guarantee and comfort. Move the position of lock on the safety belt to adjust the length of safety belt. The clasper of the safety belt is at the right side of seat, and put the lock into the opening of clasper to jam the lock. There is a red button on the side of opening of clasper. Press the button and the lock will jump out from the clasper. Before using the safety belt, please check the clasper of safety belt whether lock and loose normally.

1.2.12 Rearview Mirror

Rearview mirrors are on the left and right sides outside the cab and left upper inside the cab. Before starting work, the rearview mirror must angle be adjusted for a good rear.

1.2.13 Key

This loader equips two key for every using condition:

- The key of left and right doors of cab.
- The starting switch key for engine.
- The key of left and right doors of engine hood.
- The key of left and right otter boards of engine hood.
- The key for adding fuel port of fuel box.

2 RUN-IN PERIOD OF NEW MACHINE

A new machine must have a run-in period first to increase the load step by step from free rotating; so that each part of the machine can be have full run-in period for increasing the life of the machine. It needs 60 hours to train the new machine, and operate follows:

- Run the machine in neutral at low-speed to preheat the engine.
- Never accelerate the engine suddenly in the preheating period.
- Never start, accelerate, turn or brake suddenly except in an emergency.
- When the loader is working without a load, the gearshift should be used from low speed to high speed at each level accordingly. Turn left, right or brake steadily in the process of driving.
- In the period of run-in, all speeds including forward and reverse should be adjusted.
- It is better to load bulk materials in the period of run-in. Do not operate the loader too hard or too rudely. The load should be less than 70% of the standard load, and the speed should be better less

than 70% of the maximum speed limit.

- Pay attention to the lubricating condition; routinely add and change the lubricant according to rules.
- Pay attention to the temperatures of the gearbox, torque converter, front and rear frame, rim and brake drum. Once they are overheating, find the reason and repair it.
- Check the fastening conditions of the bolts and nuts.

Do the following maintenance after 10 hours of run-in time on the new loader:

- Check the fastening status of bolts and nuts of all parts, but especially the bolts of diesel engine cylinder cover, vent-pipe bolts, front and rear frame bolts, rim bolts, transmission axle bolts and connection bolts.
- Clean the raw and essential engine oil filter and fuel filter.
- Check the tension status of the belts of fan, electrical machine and air condition compressor
- Check the capacity of the storage battery electrolyte and its reserves, and fasten the connect poles.
- Check the oil level of the gearbox. Please refer to **3.6.3 Adding Oil to Gearbox** in this chapter.
- Check the seal of the hydraulic system and braking system.
- Check the connection and sensitivity of all control levers.
- Check the temperature and the connections of the circuit system, the power supply of electrical machine, gauge, light and lamps and turning signals.
- Open the air storage tank to drain water.

The following maintenance should be done after the run-in period of new machine:

- Clean the filter at the bottom of the gearbox and the oil filter cartridge of the torque converter.
- Check the oil returning filter cartridge of the hydraulic oil tank.
- Change the engine oil. Please refer to **3.6.1 Fuel Supplying of Engine** in this chapter.

3 OPERATION AND USE OF LOADER

3.1 Notices for Usage

1. The diesel must be cleaned and deposited more than 72 hours before it is to be used. The trademark should suit the rules.
2. Transmission oil for the gearbox, torque converter, and the hydraulic oil for hydraulic system must be clean.

3. The loader must be maintained and lubricated periodically.
4. Drive the loader until the brake pressure reaches 0.4MPa after the engine starts.
5. Put some hot water or vapor in front of the engine for preheating it. Preheat the engine until 30~40°C before starting if the environmental temperature is lower than -5°C.
6. There is no need to stop the machine or step on the brake pedal in changing the forward levers during driving. When changing the speed from low to high, release the accelerator a little and operate the Gear Control Lever at the same time, and step on the accelerator; when changing the speed from high to low; release the accelerator first and then change the transmission slowly.
7. After the lift-arm and bucket are moving to the required position, release the control valve lever to the middle position.
8. Change the forward or backward driving direction after stopping the loader.
9. Full load work is allowed until the water temperature of the engine is above 60°C and the mobile temperature of the engine is above 50°C. But the water temperature of the engine should not be over 95°C and the mobile temperature of the engine should not be over 120°C, otherwise stop the loader to cool it.
10. **Never** lift the bucket to the highest position to transport material. The lower hinge of the lift arm should be 400~500mm above the ground to ensure stable driving during the transporting process.
11. A diesel engine is used in the machine. The power of the diesel engine will go down as the altitude, environmental temperature and relative temperature goes up. So please pay attention to the environmental conditions and calculate the real power under the current environmental condition according to the power correcting table in **Diesel Engine Usage and Maintenance User Manual**.

3.2 Starting

3.2.1 Check before Starting

- Check the bottom and surrounding of the machine to see whether there are lost of bolts, dirt, oil, coolant leak, or broken parts. Check the status of accessories and hydraulic parts.
- Check before Starting:

Check the fuel in the fuel tank. Refer to **3.6.2 Adding Fuel to Fuel Tank** in this chapter.
Check the hydraulic oil in hydraulic oil tank. Refer to **3.6.5 Adding Oil to Hydraulic Oil Box** in this chapter.

- 1) Check the engine oil in the engine oil pan. Refer to **3.6.1 Fuel Supplying of Engine** in this chapter.
- 2) Open the water tank cover to check the water level in the water tank.
- 3) Check the brake oil in the oil bowl of the brake booster pump.
- 4) Check the seal ability of the oil pipe, water pipe, air pipe and other parts.
- 5) Check the seal ability of the hydraulic pipes and the surrounding pipes.
- 6) Check the wire connection of the storage battery.
- 7) Check the pressure of the tire to see whether it is normal. Please refer to **CHAPTER II 8.1 Performance**.
- 8) Check the control levers (or handles) to see whether they are sensitive and in the neutral position.
- 9) Adjust the seat position to sit comfortably. Please refer to **1.2.10 Adjustment of Cab's Seat** in this chapter.
- 10) Check the safety belt (if assembled) and other safety equipment for good working order.
- 11) Start the full checking list the engine only after completing.

3.2.2 Engine Starting

- Make sure all the control levers are in the neutral position before starting; make sure the gear control lever is in neutral position, and put the switch in its original position.
- Step on the accelerator slowly when starting to prevent breaking parts.
- Follow the correct starting steps to start the engine.
- Refer to **Diesel Engine Usage and Maintenance User Manual** for other operations of diesel engines.

Steps of starting engine:

- Put the shifting control lever to the **neutral** position
- Turn the start key clockwise to the **ON** position. Connect the power switch and ring the horn.
- Turn the starting key to the **ON** position. Connect the power switch, and press the accelerator slowly. Then turn to the **START** position. After releasing the starting key, it will go back to the **ON** position automatically. The starting time is not more than 5~10 seconds, (the engine starting effort not be more than 15 seconds).
- Try again if the machine does not start the first time. But the alternation time should be more than 1 minute. If the engine does not start after these tries, please check the machine and solve the problem.

3.2.3 After Starting of Engine

- Lowers the speed of the engine, and examine the reason if engine oil pressure gauge is not in the

normal position. After that, start again, otherwise there may be some problem.

- When the engine oil pressure does not reach the designated value, the high running speed of the engine will induce a high temperature and the turbo charger may be broken.
- Use the equipment control levers to let the preheated hydraulic oil circle in hydraulic tank and pipes, so that way the hydraulic parts can warm quickly.
- Keep the engine at an idle speed for several minutes after starting. Increase the speed to 1000~1200r/min gradually, and then enter the partial load running status. Pay attention to the value of the gauge.
- Do not let the engine run at high speed or low speed more than 20 minutes in the idle status.
- If the engine has to run at idle status, the machine should be loaded from time to time or the engine should run at the middle speed.

3.3 Running

3.3.1 Driving

Make sure there is no other person in, on or around the machine or around to prevent accident. And keep the machine under control.

- Raise the lift-arm. Keep the bucket backwards, and keep the motor running.
- Put the gear control lever at forward I or backward I position.
- Press the brake pedal; press the parking brake level to release the brake status.
- Release brake pedal, and step on the accelerator pedal slowly to drive the machine forward or backward.
- It is safe to drive only when the brake pressure is over the specific value of 0.45MPa.

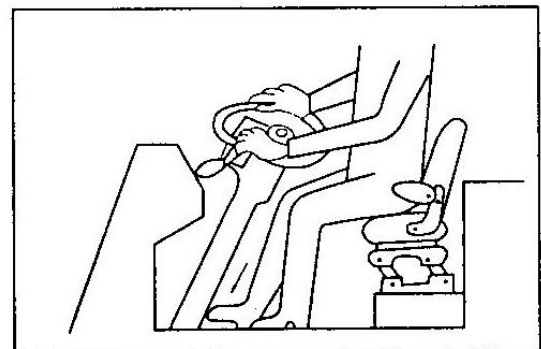
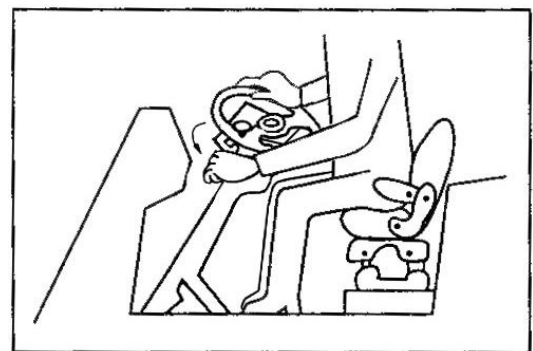
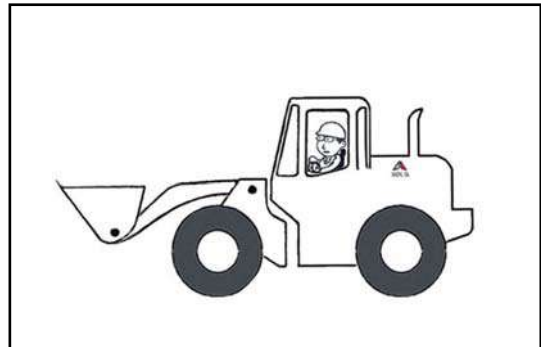

- **Never** lift the bucket to the highest position while transporting material. The lower hinge of the arm working equipment should be 400~500mm above the ground to ensure stable driving in the transporting process.

 **NOTICE**

- **Never** run at high speed if the machine goes on a slope or uneven ground.
- Select the proper transmission gears when go down a slope and **never** change the gears during that time.
- **Never** run over speed while driving on a slope, and use the foot brake pedal to slow the speed (if the double brake pedals are assembled, the left one should not be used).

3.3.2 Gearshift. Changing between Forward and Backward

- Press the accelerator properly when shifting gear to avoid sharp speed increase.
- It is best to change the running direction (from forward to backward or from backward to forward) after stopping the machine to get the best driver comfort and prolonging the life of the engine.
- No need to stop and brake the machine to shift gears while running. Release the accelerator and operate the transmission lever at the same time when changing the speed from low to high and when changing the speed from high to low, release the accelerator first and then change the transmission slowly.

3.3.3 Turning

- Turn the steering wheel to the desired direction. The machine will turn.
- The machine takes the articulated pin at the center. And the front and rear frames turn by rotating its waist.

 **WARNING**

- **Never** turn suddenly or turn on a slope at high speed.
- When driving straight, the machine can not turn if the engine stops

3.3.4 Braking

- **Never** put your foot on the brake pedal unless necessary.
- **Never** press the brake pedal again and again unless necessary.
- **Never** try to stop the engine and put the high-low speed control lever and the fore-and-aft control level in the **neutral** position while driving down sloping ground.

 WARNING
<p>Never use the control lever of the manual brake switch to brake or slow the speed of the machine while running unless in an emergency.</p>

3.4 Stopping

3.4.1 Steps to Stop

- Release the accelerator, and press the brake pedal to stop the machine. Put the gear control lever in the **neutral** position.

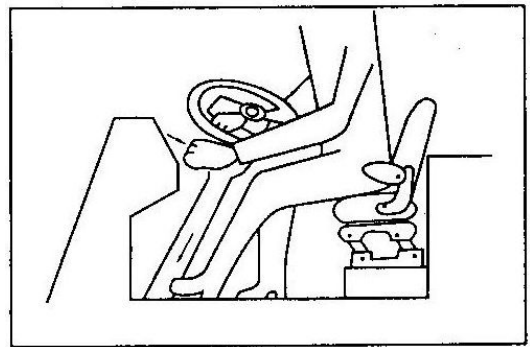

- After safely stopping, push the parking brake switch to lock the machine in place.
- Level the bucket and other equipment to the ground.

- Stop the machine on the level ground where there is no danger of stone falling, coasting or flooding. If it is necessary to stop the machine on a slope, wedge the wheels to prevent movement.

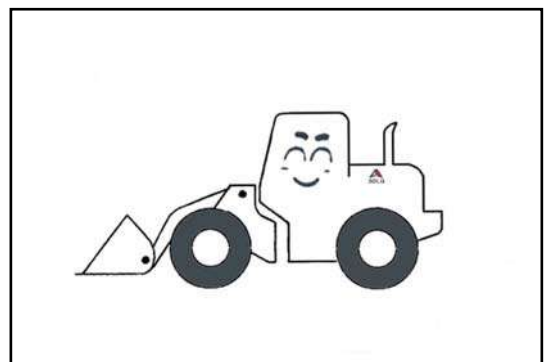

- After stopping, let the cooling water out. The temperature is below 0°C, if antifreeze is not added. Please refer to **3.5.3 Operation in Cold Weather** in this chapter.

3.4.2 Steps to Stop Engine

- Let the engine run freely for 5 minutes to cool all the parts equally.

- Pull the flameout control soft shaft (if assembled).
- Turn the key to **OFF** position. And draw it out and keep in a safe place.



WARNING

Never pull the flameout control soft shaft before the engine is cooled.

3.4.3 Leaving Machine

- Use the ladder and handle to climb down facing the machine. **Never** jump down.
- Check whether there are particle-like materials on the engine. If so, clean them immediately to prevent fire.
- Clean all the flammable materials around the machine to prevent fire.
- Lock the door and window, and draw the key.

3.4.4 Do the Followings after Work Everyday

- Check the fuel reserves.
- Check the oil level of the engine oil pan and its cleanness. If the oil level is too high or diluted, find the reasons and solve them.
- Check the oil pipes, water pipe, gas pipe and other parts for leaking conditions.
- Check the gearbox, torque converter, steering unit, fixing of front and rear frame, and sealing conditions. And check whether there are overheating conditions.
- Check whether the rim bolts, transmission axis bolts and other pins are loose.
- Add antifreeze if the temperature is below 0°C; drain the water out if there is no antifreeze. Refer to **3.5.3 Operation in Cold Weather** in this chapter.
- Check whether the work equipment is in good working order.
- Check whether the wheel pressure and outside surface are normal.
- Add liquid oil to the adding points of work equipment.
- Check the quantity of the brake oil by opening the oil bowl cover of the brake booster pump.
- Drain the water in the air tank from the water outlet valve.
- Clean the outside surface of machine and the inside of the bucket.

3.5 Operations

3.5.1 Prepare to Work

Clean the working area, and fill-up any hollow spaces. Clear away the sharp stones and roadblocks that may break the wheels and operation.

3.5.2 Modes of Work

(1) Loading Operation

- Work together with a truck which can help improve working efficiency especially for long distance transportation.
- When working together, the loader digs the material and the truck transports and unloads the material:

There are generally two loading and unloading ways:

◇ Cross Load:

The loader faces the material, then it moves backward after digging a full load and lets the auto-unload truck move into the position between material and the loader. This method costs the minimum time and can reduce the cycle time most effectively.

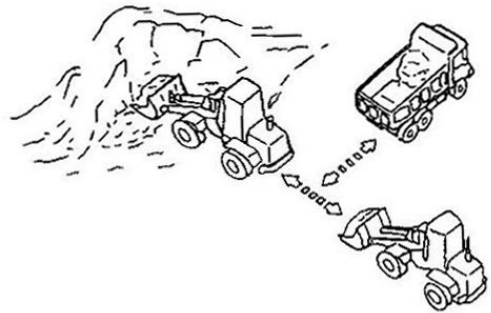

◇ “V” Shape Load:

The auto-unload truck is fixed and forms almost a 60° angle with the backward direction of the loader. After digging, the loader moves backward and turns the designated degree and moves forward to the truck.

The smaller the loader work angle is, the more efficient the work is.

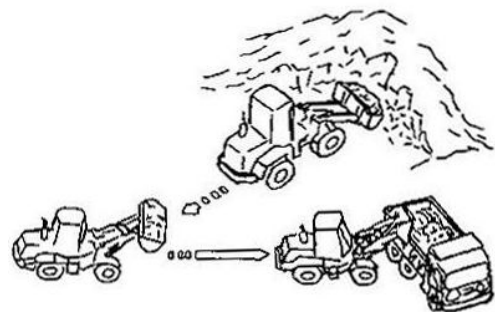

(2) Digging Operation

■ Digging Piled Soil or Blasted Rock

When digging piled soil or blasted rock, the loader should face the material and do as follows:

- If the bucket must be lowered while driving the machine forward, stop the machine when the bucket is about 30cm above from the ground, and then lower it slowly.
- If the bucket hits the ground, the front tires will leave the ground and the tires will slip.
- The operator must slow the speed immediately when the machine reaches the material pile. Simultaneously step on the accelerator pedal, and enter the material pile with the bucket.
- Keep the bucket horizontal when loading the stockpile, but keep the dumping angle down when loading the blasted rock.

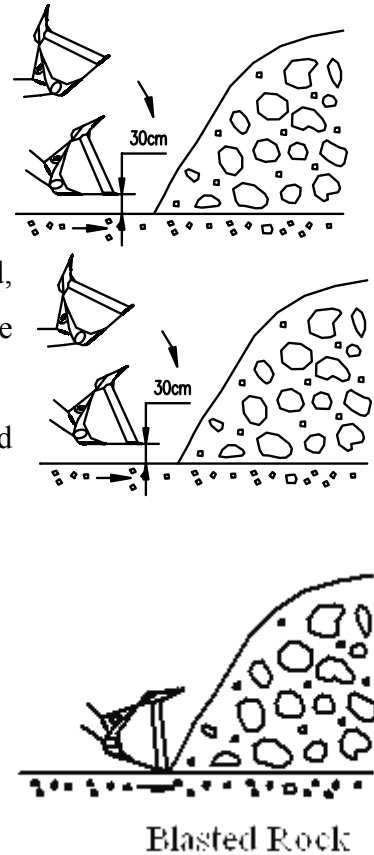

Notice:

Do not let the blasted rock go under the bucket which will make the front tires leave from the ground and slip. Try to hold the load in the center of the bucket; otherwise, if the load is on one side of the bucket, it will be unbalanced.

- Raise the lift arm to prevent the bucket from inserting too deeply while thrusting the bucket into the material. The tires will bring ample traction by raising the lift arm.
- If enough material is loaded into the bucket, operate the working equipment control lever to take back the bucket in order to load it fully.

Remark:

If the shovel edge moves up and down when thrusting material into the bucket or when digging, the front tires will leave the ground and slip.

- If there is too much material loaded into the bucket, the bucket must be dumped and tilted quickly to remove the excessive load so as to prevent the material from dispersing during transportation.

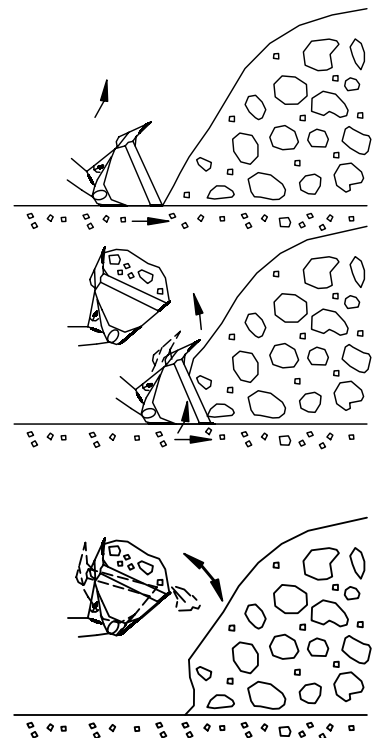

■ **Digging and Shoveling Material on Flat Ground**

Lightly set the bucket edge leaning on the ground (see picture) when digging and shoveling material on flat ground. Be careful not to fasten the load to one side which will cause unbalance. This operation should be carried out carefully in gear I .

- Lightly set the bucket edge facing down.
- When driving the machine forward, operate the working equipment control lever to let the lift arm lower down to the proper position so that it can pick up a thin layer of the surface each time when excavating the soil.
- When driving the machine forward, shift the working equipment control lever backward and forward slightly to reduce the resistance.

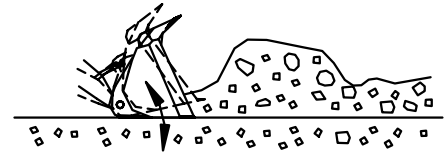
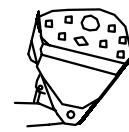
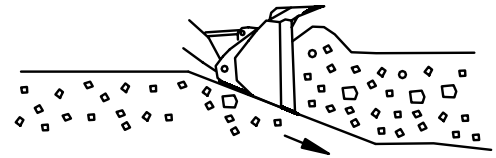
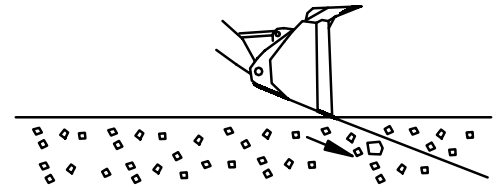

 NOTICE
<p>Keep the two sides of the bucket cutting into the material equally to prevent only a single side working. Face the loader forward and never let an angle exist between the front and rear frame.</p>

(3) Conveying Operation Without Truck

The loader must be used without a truck under the following conditions:

- The ground is too soft and not level, and the truck can not be used.
- When the transportation distance is within 500 meters, it is not economical to use a truck.
- The transportation driving speed is determined by the road condition.
- In order to get good visibility and stability, the bucket should be turned to its upper limit location(bucket lift-arm touch the upper limited block) and keep the lower pin connection point of lift-arm at the transportation position (400~500mm above the ground).

(4) Dumping Operation

- When dumping material on to trucks or into freight yards, raise the lift-arm to the position (forward tilt to the maximum position) where the bucket does not touch the carriage or material pole. And operate working equipment control lever to tilt the bucket forward to dump. Part or all of the material can be dumped by the lever control. Act slowly and gently during dumping to prevent the bucket from striking the ground.
- If the material sticks onto the bucket, move the working equipment control lever cyclically to allow the bucket to tilt forward or backward to shake down the material.
- After dumping, use the bucket to level equipment (if assembled). Rear tilt bucket to level position, and operate the working equipment control handle to allow the lift arm to lower to prepare for next operation.

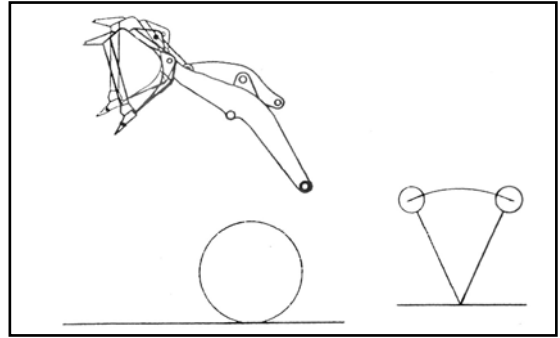

(5) Pushing Operation

Level the bucket to the ground, and push the accelerator to move forward. If there is blockage during moving, raise the lift arm a little and move forward continuously. When operating the lift arm to lift or lower, operate the control lever between lifting and lowering operation. **Never** use the lever at the raising or lowering position to ensure pushing the bucket smoothly.

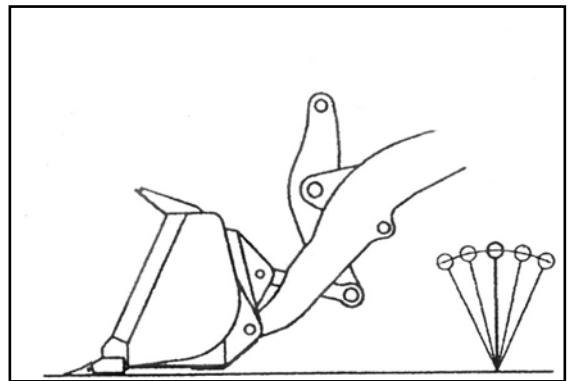

NOTICE

Watch the torque converter oil temperature gauge all the time during a pushing operation. If the temperature is too high, stop the machine to let it cool down and then continue to work.

(6) Striking Operation

Tilt the bucket to let the blade touch the ground.

For hard ground, put the lift arm control lever in the float position; for soft ground, put the lift arm control lever in the neutral position.

Use reverse gear to strike the ground with blade.

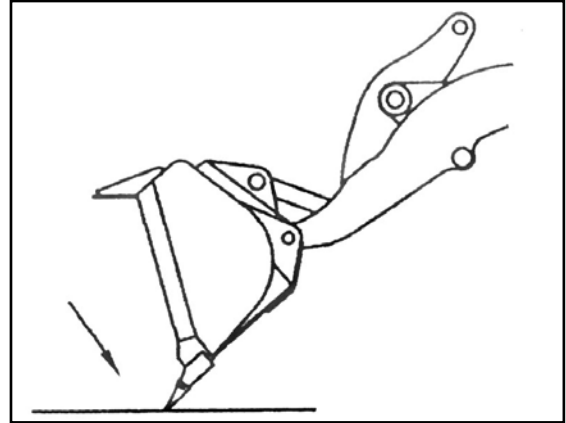

(7) Towing Operation

WARNING

Before towing, the tires must be blocked by the parking brake to prevent the machine from rolling.

During towing, be careful to prevent severe and fatal injury.

- If possible, the engine of the towed machine should keep the engine running to ensure braking and turning is possible.
- If the towed machine engine can not start, disassemble the front and rear transmission axle. If the machine can not turn, disassemble the steering cylinder.
- The connection hole of the rear frame at the inner side of the rear wheel can only be used for lifting and binding, but not for towing.
- If there is no braking system for the towed machine, **never** use soft towing but use fixed towing or use towing bar. Connect the towing bar to the towing pin at the back of the loader.
- If there is no braking system on the towed machine, no one is allowed to stay on it.
- Check whether the towing rope and towing pin are strong enough to suffer the weight of the towed machine. If machine will pass over clay ground or go up a slope, two towing ropes and towing pins should suffer at least 1.5 times the weight of the towed machine.
- Try to decrease the towing angle of the towing rope to ensure that the angle between the towing rope and the towed machine is within 30°. The height of the towing points of the two machines should be close.
- The connection between the towing equipment and the machine should be strong.
- The weight of the towing machine should be heavier than the towed one, and have enough traction power and braking power to be able to pull or brake two vehicles going up and down a slope.
- When towing the machine down a slope, the machine should have sufficient traction power and

braking power. Another towing machine should be used to pull at the back side to prevent the towed machine from losing control or turning over.

- Start to tow and brake gently, at the low speed, and turn on the warning flash lamp.
- The speed for towing the loader should be within 2 km/h. Try to tow the machine to the nearest repairing garage. If the distance is longer than 10 km or the towing speed faster than 10 km/h, the front and rear transmission axle must be disassembled or put the loader on towing truck for transportation.

3.5.3 Operation in Cold Weather

Attention for cold weather

If the temperature is very low, the engine will be difficult to start. And the radiator may be frozen, so please do as follows:

- Use fuel with low viscosity, and add antifreeze into the hydraulic oil and lubricant and coolant. Refer to **CHAPTER IV 2.2.1 Selection Table of Fuel, Coolant and Lubricant** for the details of using oil.
- Attentions for using antifreeze:
 1. Do not use antifreeze containing formaldehyde, ethanol or propanol.
 2. **Never** use any waterproofing agent independently or together with antifreeze.
 3. **Never** use antifreeze with different trademarks together.
 4. Replace antifreeze with the proper ratio according to the requirements. Please refer to **CHAPTER IV 2.1.2 Coolant**.

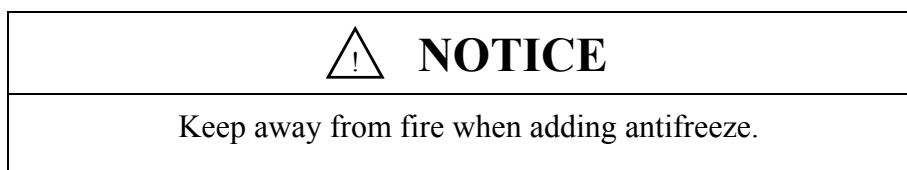

- Attentions for using the storage battery:
 1. If the temperature goes down, the capacity of the storage battery will go down too. If the charging ratio of the storage battery is low, the electrolytes may be frozen. Please ensure the charging ratio is near 100% and try to preserve heat, so that it is easy to start the next day.
 2. If the storage battery is frozen, **never** charge the battery or start the engine. Refer to **CHAPTER I 8.16 Maintenance of Storage Battery** to disassemble the battery and put it into a hothouse or warm water (**NEVER** let water enter the battery). Warm it to 15°C slowly, otherwise an explosion may occur.

3. Please use an anti-alpine storage battery in an anti-alpine area.

- Follow-up after every working day:

In order to prevent the materials from freezing on the machine which may affect it working the next day, please do as follows:

1. Completely clean the silt and water on the machine to prevent silt, water or snow entering the sealed parts which may freeze or break the sealed parts.
2. Park the machine on the dry and hard ground. If that is impossible, park the machine on a wooden board, which can prevent the tires from freezing on the ground.
3. The capacity of storage battery will obviously go down in cold weather. So cover it or move the storage battery to a warm place, and install it the next day.
4. When the temperature is below 0°C and there is no antifreeze in coolant water, please open the water drain valves located at the bottom of the water tank and the engine. Then drain all the coolant water in the evaporators of the cooling system and the air-condition system (if assembled) to prevent cold cracks. If antifreeze is added, please follow the rules on the nameplate of the antifreeze.

After cold weather:

After the weather is warm, the relative parts should use the proper engine oil, fuel and hydraulic oil that are appropriate for the temperature.

3.6 Oil and Fuel Supply

3.6.1 Fuel Supply of Engine

① Fuel Level Checking

 NOTICE
<p>An oil level check must be executed 15 minutes before engaging the engine, or after stopping the engine.</p>

- Park the machine on level ground, and put the transmission lever in the **neutral** (“N”) position. Pull the parking brake switch, and put blocks in front and back of tires.
- Open the side door on the right side of the engine cover.
- Pull the dipstick out, and wipe it clean with a cloth. Insert the dipstick back, and pull it out again to check the oil level (at least twice).

- ◆ Yuchai YC6B125-T10 engine: If the oil level is lower than the "L" line, oil should be added by the oil adding port; It is a suitable oil level if it is between the "L" and the "H" line.

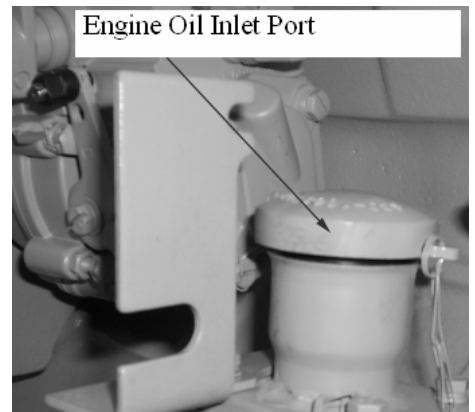
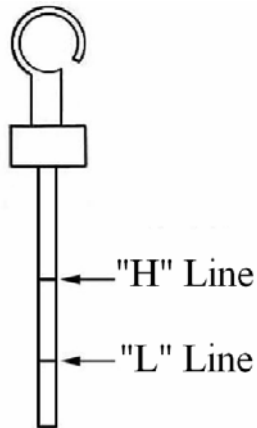
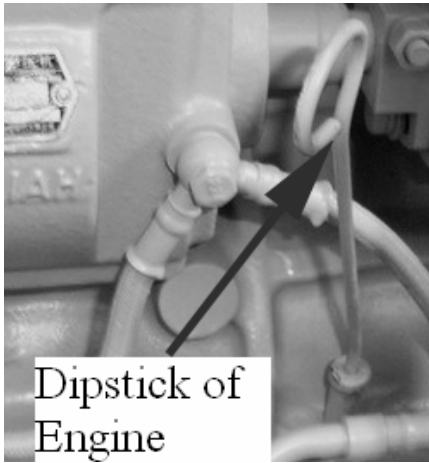

- ◆ Weichai TD226B engine: If the oil level is lower than the "L" line, oil should be added by the oil adding port; It is a suitable oil level if it is between the "L" and the "H" line.

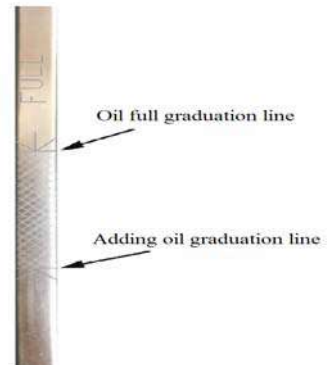
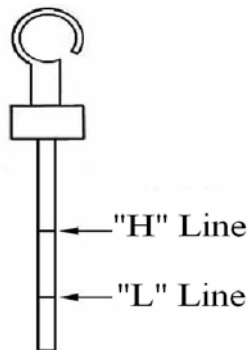

- ◆ Dongfeng Cummins 6BT5.9 engine: If the oil level is lower than the adding oil graduation line, oil should be added by the oil adding port. If it is higher than the oil full graduation line (FULL), check the problem and solve it. It is a suitable oil level if it is between the adding oil graduation line and the oil full graduation line (FULL).

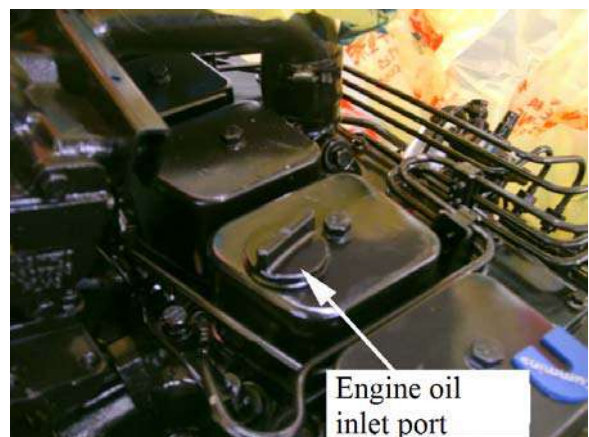

- Lay back the dipstick, close the side door on the cover of engine. For choosing the appropriate oil please refer to **CHAPTER IV 2.2 Oil Selection**.

② Engine Oil Replacement

- Park the machine on level ground, and put the transmission lever in **neutral** position. Pull the parking brake switch and put the blocks in the front and back of the tires. Start the engine and run at idle status until the oil temperature reaches 20°C~40°C, then stop the engine.
- Rotate the oil drain plug and let the oil flow out and hold it in a container.
- After the oil is released completely, rotate the oil drain plug back and open the right side door of engine cover; add prescribed engine oil (about 12L) from oil inlet of engine. Run the engine at idle status, check whether the oil filter and oil releasing plug are leaky.
- After the engine was stopped for 15 minutes, let the engine oil flow back to the oil pan, and check the engine oil level of the engine again.

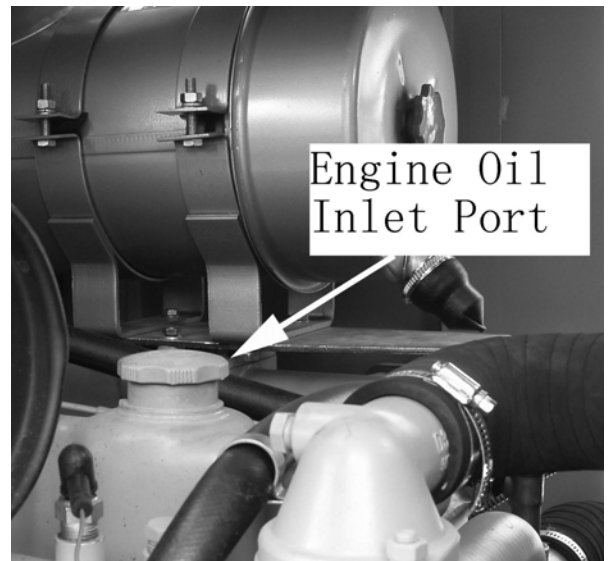

③ Engine oil Filter Replacement

- Clean the area near the engine oil filter. Disassemble it with filter elements spanner.

Assemble

- Add diesel oil full in the filter element and smear engine oil on the rubber seal ring.
- Tighten 3/4~1 cycles after the seal ring connects with the base.
- Start the engine and check whether the seal ring is seal. If not, disassemble the filter element and check the sealing surface.

⚠ **NOTICE**

- After changing the filter elements, the engine must run in the idle status at least 1 minute to ensure the engine is lubricated sufficiently before working.
- Over tight mechanical rotation could damage the screw thread or filter element sealing.

3.6.2 Adding Fuel to Fuel Tank

Fuel Level Check

- Park the machine on level ground, and check the fuel level by dipstick on the outside of fuel tank.
- If the fuel level is under 0, please add fuel from inlet on the fuel tank. For fuel selection please refer to **CHAPTER IV 2.2 Selection of Oil, Fuel and Coolant.**

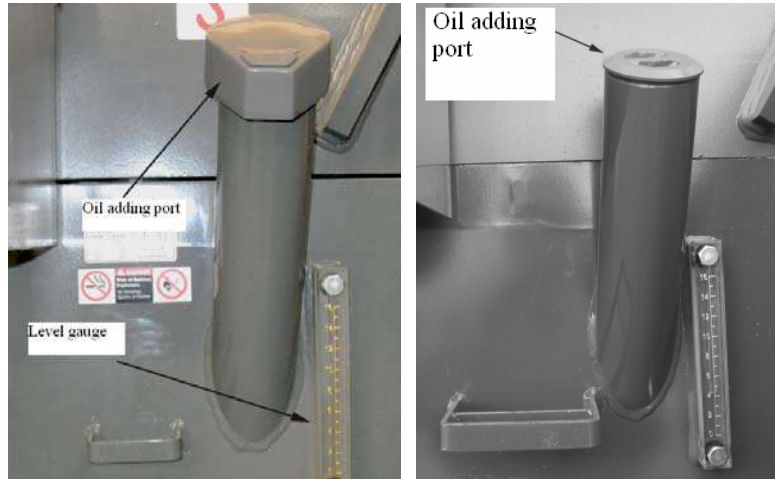

3.6.3 Adding Oil to Gearbox

① Oil Level Check

- Park the machine on level ground and put the transmission lever in the **neutral** (“N”) position. Pull the parking brake switch, and wedge the front tire.
- Start engine and let the engine run in the idle status for minutes. Open the checking plug on the right of the gear box. If some oil flow out without pressure, the oil is of proper volume. If the oil level is lower than the plug, hydraulic transmission oil should be added. The choice of the hydraulic transmission oil can be found in **CHAPTER IV 2.2 Selection of Oil, Fuel and Coolant.**

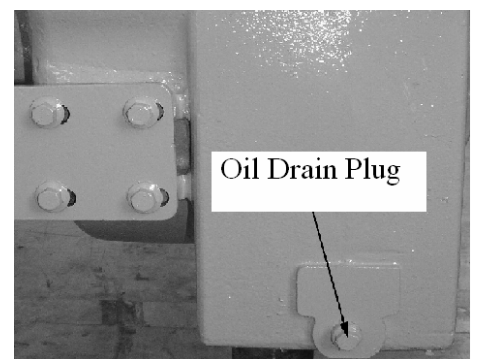

② New Oil Replacement

- Park the machine on level ground and put the transmission lever in the **neutral** (“N”) position. Push the parking brake switch, and wedge the front tire.
- Start engine and let the engine run in the idle status for minutes, then stop the engine. Loosen the oil drain plug on the bottom right of the gearbox to drain the oil, and contain it with container.



⚠ WARNING

If the temperature of the gearbox oil is relatively high please wear protective clothes, and operate carefully to prevent injury.

- Drain all the oil out and clean the oil on the draining plug and the oil on shell of the gearbox. Wrap the plug with new ptfе tape and fit it well.
- Loosen the oil inlet cover on the right side of the gear box which is on the right joint. Inject the new hydraulic transmission oil.
- Start the engine and run in the idle status. Check the oil level again.

⚠ NOTICE

If the old oil is dirty, do not add new oil directly.

- Disassemble the raw oil filter which is in profile, and clean all the parts. If there are any metal powders or fragments please contact the maintenance man.
- Assemble the parts, and add a little new hydraulic transmission oil. Start engine and hold in the idle status for 3~5 minutes. Release the oil in the oil pan and add new oil.

3.6.4 Adding Oil to Axle

① Oil Level Check

- Park the machine on level ground and put the transmission lever in the **neutral** position. Pull the parking brake switch, and wedge the front tire. Loosen the oil inlet plug on the shells of the front and rear axles. It is proper if the oil level is at the bottom side of the oil inlet, otherwise please add axle oil. Please watch for 5 minutes after adding oil. If the oil level keeps stable, please assemble the plug. For selections of axle oil, please refer to **CHAPTER IV 2.2 Selection of Oil, Fuel and Coolant.**

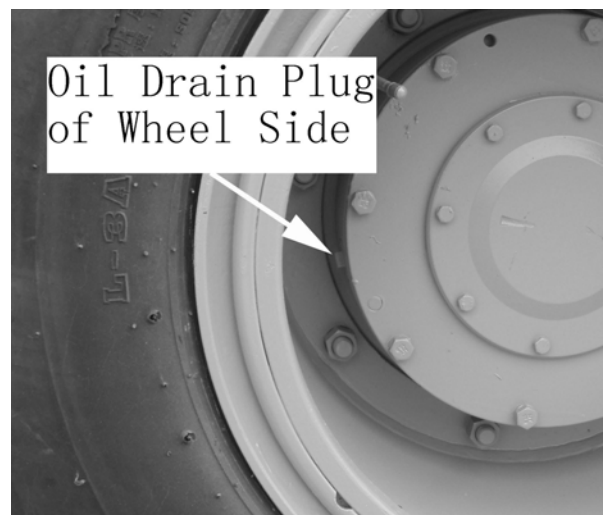

② Oil Replacement

- Park the machine on level ground and run in idle status for about 10 minutes. Trample the accelerator gently to move the machine slowly to let the oil drain plug on the wheel side of the front axle go to the lowest position
- Shut engine. Push transmission lever in the **neutral** (“N”) position. Pull the parking brake lever, and wedge the front and rear wheels.
- Loosen the oil drain plugs on the two wheels on the end sides of the front axle and the oil drain plugs at the center bottom of the axle shell to drain oil to the container.

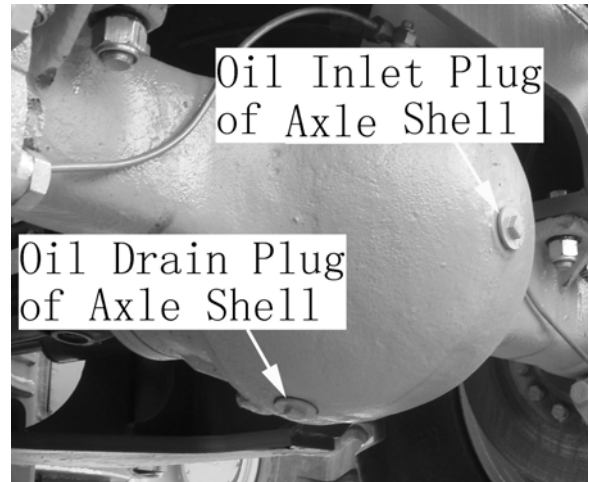

⚠ **WARNING**

The temperature of gear oil may be high, so wear protective clothes, and operate it carefully to prevent injury.

- Drain out all the old oil and screw tight the oil drain plugs at the center bottom of the axle shell.
- Start engine. Rotate the parking brake switch gently until it rebounds. Move the machine slowly with gentle acceleration to let the oil drain plug on the front axle move into the horizontal position, and then shut the engine. Put the transmission lever in the **neutral** position. Pull the parking brake lever.
- Add new gear oil from the oil drain port on the two wheels on the end sides of the front axle and the oil inlet port at the middle of the axle shell. And then check the oil level again.
- Tighten the oil drain plugs on the two wheels on the end sides of the front axle and the oil inlet plug at the middle of the axle shell.
- Replace the rear axle gear oil according to the procedures above.

3.6.5 Adding Oil to Hydraulic Oil Box

① Oil Level Check

- Park the machine on level ground and lower the bucket to the ground. Check whether there is an angle between front and rear frame.
- Check the oil level indicator of the hydraulic oil box on the left side of the machine. The oil level is normal if the level indicator scale is at a range of ± 2 from the middle level. If the oil level indicator is lower than scale -2 of the middle scale, please add hydraulic oil. Refer to

CHAPTER IV 2.2 Selection of Oil, Fuel and Coolant for selection of oil..

② Oil Replacement

WARNING

While replacing oil if other maintenance needs to be done do so following the relevant rules, and pay attention to safety.

NOTICE

Pay attention to the clarity of the oil while replacing it; **never** let other materials enter the hydraulic system directly.

- Clean out the in bucket. Park the machine on level ground and put the transmission lever in the **neutral** position. Pull the braking control lever. Start the engine and keep in the idle status for 10 minutes. Raise and lower the lift arm several times, and tilt the bucket forward and backward several times.
- Raise the lift arm to the highest position; tilt the bucket backwards to the extreme position and shut the engine.
- Push the bucket control lever forward to let the bucket tilt forward freely by its weight. Drain out the oil in the bucket cylinder. After the bucket has tilted to the desired position, push the lift arm control lever forward to let the lift arm fall down by its weight freely. Drain out the oil in the lift arm cylinder.
- Loosen the oil releasing spherical valve on the oil tank bottom to drain the oil to the container. Open the oil inlet cover at the same time to hasten the draining process.

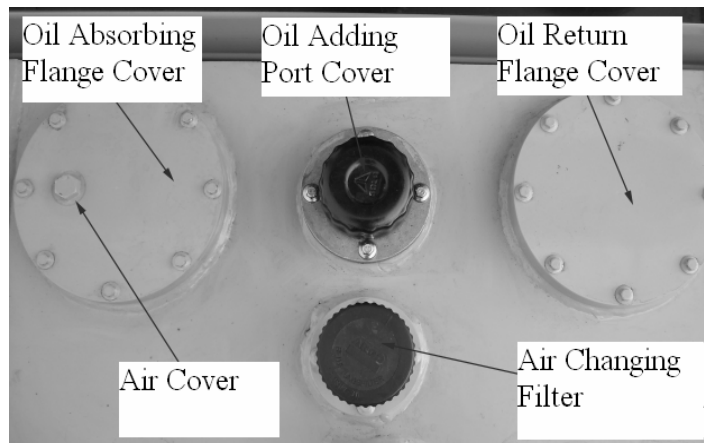
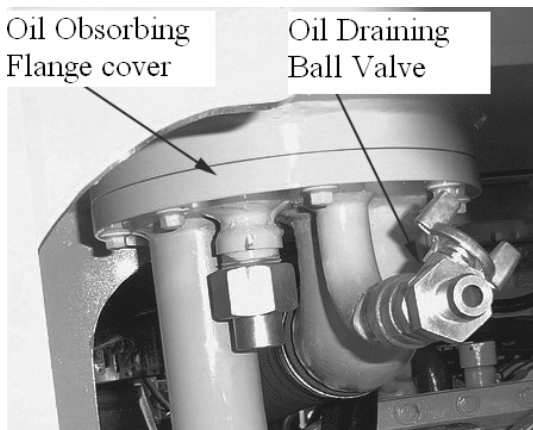

 **WARNING**

The temperature of hydraulic oil may be high, so wear protective clothes, and operate carefully to prevent injury.

- Disassemble the flange cover of the oil box bottom. Clean the oil tank inside, the oil inlet port and the oil recycle elements. If the elements are broken, please replace with a new one.
- Tighten the flange cover and oil releasing spherical valve again.
- Add oil to the oil inlet port at the top of the left bench, until the oil level reaches the middle value of the indicator. Tighten the oil inlet port cover. **Never** add oil directly to the oil tank without oil filter elements.
- Start engine, and raise and lower lift arm. Tilt the bucket forward and backward the bucket to the extreme position 2~3 times to let the hydraulic oil fill the cylinders and pipes sufficiently. And run the engine in the idle status for 5 minutes to release the air in the system.
- Shut the engine. Check the oil level. Add oil when it is not enough.

3.7 Long-Time Storage

3.7.1 Before Storage

When putting the machine in storage for a long time, be sure to do as follows:

- After every part is washed and dried, house the machine in a dry building. **Never** leave it outdoors.
If the machine must be outdoors, park it on well-drained concrete and cover it with canvas.
- Add lubricant grease and change hydraulic oil before storage.
- Apply a thin coat of grease to hydraulic piston rods which appear outside.
- Disassemble the negative electrode of the battery and cover it, or remove it from the machine and store it separately.
- If the ambient temperature is expected to drop below 0°C, drain the coolant (except the one added with antifreeze). Please refer to **3.5.3 Operation in Cold Weather** in this chapter.
- Lower the bucket to the ground and set all control levers (or handles) to the **Neutral** position. Press the parking brake switch and lock the cab door.

3.7.2 During Storage

 **WARNING**

Open doors and windows to ensure ventilation and exhaust to allow of poisonous gas if the antirust is used in the building.

Start the machine once a month so that lubricant can be coated over the surface of the movable parts and other components surfaces. The battery in storage can be charged at the same time.

Wipe off the grease which has coated the hydraulic cylinder rods before work and operation.

3.7.3 After Storage

Do as follows after long-term storage of machine.

- Wipe off the grease coated on the hydraulic cylinder rods.
- Add oil and grease to all the requisite positions.

3.8 General Problems/Possible Cause/Remedies

3.8.1 Electrical System

No.	Problems	Possible Causes	Remedy
1	Lamp is not bright when the engine runs at high speed.	1 Faulty cable (contact problem or open circuit)	1. Check, and repair the loose terminals and disconnections.
2	Lamp flickers when the engine is running.	2 Improper adjustment of fan belt tension	2. Refer to the “Operation and Maintenance Manual” of diesel engine to adjust the tension of fan belt.
3	A meter does not work when engine is running.	1 Faulty alternator 2 Faulty cable 3 Improper adjustment of belt tension	1. Replace 2. Check and repair 3. Refer to “Operation and Maintenance Manual” of diesel engine for adjusting the tension of fan belt.
4	Abnormal noise from alternator.	Faulty alternator	Replace
5	Do not start when starting switch is turned on	1 Faulty cable 2 Insufficient battery charge	1. Check and repair 2. Charge
6	Pinion of starting motor does not mesh or keep meshing without rotation.	Faulty battery charge	Charge
7	Starting motor turns feebly	1 Insufficient battery charge 2 Faulty alternator	1. Charge 2. Replace
8	Starting motor disengages before engine starts	1 Faulty cable 2 Insufficient battery charge	1. Check and repair 2. Charge

3.8.2 Transmission System

No.	Problems	Possible Causes	Remedy
1	Shifting pressure of every gear is low	<ol style="list-style-type: none"> 1 Low oil level in gearbox oil sump 2 Oil leakage in the main oil lines 3 Clogged oil filter of gearbox 4 Faulty converter charging pump 5 Improper adjustment of the pressure-regulator valve in transmission control valve 6 Invalid spring of pressure-regulator valve in transmission control valve 7 Pressure-regulator valve of transmission control valve or accumulator piston is locked 	<ol style="list-style-type: none"> 1 Add oil to the specified level 2 Check the main oil lines 3 Clean or replace the filter 4 Disassemble and check the converter charging pump or replace it 5 Readjust to the specified value 6 Change the spring of pressure regulator valve 7 Disassemble and check to remove the lock
2	Shifting pressure of a certain gear is low	<ol style="list-style-type: none"> 1 Damaged piston seal ring of this gear 2 Damaged gasket in the oil lines of this gear 3 Oil leakage in the oil lines of this gear 	<ol style="list-style-type: none"> 1 Change the seal ring 2 Change the gasket 3 Check and remove the leakage
3	The oil of torque converter overheats	<ol style="list-style-type: none"> 1 Low oil level in gearbox oil tank 2 High oil level in gearbox oil tank 3 Low shifting pressure and clutch slips 4 T/Q radiator is clogged 5 T/Q operates with high load for a continuous long time 6 Radiator is not good 	<ol style="list-style-type: none"> 1 Add oil to the specified level 2 Drain oil to the specified level 3 Refer the problems 1 and 2 4 Clean or replace the radiator 5 Shut down for cooling
4	Machine can not move when engine runs in high speed	<ol style="list-style-type: none"> 1 Cut-off valve spool of transmission control valve can't reset 2 Shift no gear 3 Spring of pressure-regulator valve in transmission valve is broken 4 Same as 1, 2, 3 and 4 of problem 1 	<ol style="list-style-type: none"> 1 Disassemble the cut-off valve, find out the reasons that spool can't reset and remedy 2 Shift gear again or readjust the gearshift control levers and linkages 3 Change the spring of pressure-regulator valve 4 Refer to 1, 2, 3 and 4 of problem 1
5	Insufficient driving force	<ol style="list-style-type: none"> 1 Low shifting pressure 2 High oil temperature of T/Q 3 Damaged T/Q blades 4 Damaged overrunning clutch 5 Insufficient driving force of engine 	<ol style="list-style-type: none"> 1 Refer to problems 1 and 2 2 Refer to problems 3 3 Disassemble and check the torque converter; change blades 4 Disassemble and check free-wheel clutch, change damage parts 5 Check and maintain the engine

3.8.3 Brake System

No.	Problems	Possible Causes	Remedy
1	Insufficient brake force	<ol style="list-style-type: none"> 1 Oil leakage of pliers pump 2 Air in brake hydraulic lines 3 Low brake air pressure 4 Over worn leather cup of booster pump 5 Oil leakage from hub to brake plates 6 Worn brake plates 	<ol style="list-style-type: none"> 1 Change rectangular sealing ring of pump 2 Bleed the air out 3 Check the sealing performance of air compressor, control valve, storage tank and lines. 4 Change the leather cup 5 Check or replace the seal of hub 6 Change brake plates
2	Failure to release the brake normally	<ol style="list-style-type: none"> 1 Wrong position of brake valve spool, locked piston rod, damaged or faulty reset spring 2 Improper operation of booster 3 Pliers piston can't reset 	<ol style="list-style-type: none"> 1 Refer to problem 2 2 Check the booster pump 3 Check or replace the rectangular seal ring
3	Pressure in air storage tank drops quickly after shutting down (pressure drop is over 0.1 MPa in 30 min)	<ol style="list-style-type: none"> 1 Inlet valve of foot brake valve is clogged by dirt as damaged 2 Loose pipe fitting or broken pipes 3 Poor sealing performance of check valve in combination valve of oil-water separator 	<ol style="list-style-type: none"> 1 Brake continuously several times to blow the dirt off or change valve 2 Tighten the pipe fitting or change brake pipes 3 Find out the reasons for sealing failure and change parts if necessary
4	Slow rise of pressure reading in the brake gauge	<ol style="list-style-type: none"> 1 Loose pipe fitting 2 Abnormal work of air compressor 3 Inlet valve or diaphragm of brake valve is not sealed 4 The bleed hole of pressure controlled valve is clogged or the diaphragm of check valve leaks air 	<ol style="list-style-type: none"> 1 Tighten the fitting 2 Check air compressor 3 Check and clean the inner parts of brake valve, find out the unsealed parts then repair 4 Clean air bleed hole, find out the unsealed reasons of retaining valve and diaphragm then repair.

3.8.4 Hydraulic System of Work Equipment

No.	Problems	Possible Causes	Remedy
1	1 Insufficient rising force of life-arms	<ol style="list-style-type: none"> 1 Over worn or damaged cylinders 2 Over worn multi passage valve, excessive clearance between valve spool and valve block 3 Oil leakage of oil lines 4 Severe internal leakage of working pump 5 Idle suction of working pump 6 Low set pressure value of safety valves 7 Clogged suction tube and filter 	<ol style="list-style-type: none"> 1 Change the oil seals of cylinder 2 Change the distribution valve 3 Find out the leaking points and repair 4 Change the oil pump 5 Check oil lines and remedy 6 Regulate the system pressure to set value 7 Clean the filter, strainer, and change oil
2	Insufficient force of the bucket, the bucket tend to lower down or float up	<ol style="list-style-type: none"> 1 Damaged seal ring of steering cylinder piston 2 Over worn of multi passage valve, excessive clearance between valve spool and valve block 3 Low set pressure value of safety valves 4 Overload valve and oil complementary valve is blocked by dirt 	<ol style="list-style-type: none"> 1 Change the oil seals 2 Change multi passage valve 3 Change the system pressure to its prescriptive value 4 Disassemble and clean
3	Hydraulic oil mixing into gearbox	Aged or broken oil seals of working pump or steering pump lead to the hydraulic oil leaking into the gearbox	Change oil seals or change oil pump
4	Foam in hydraulic oil tank and harsh noise	<ol style="list-style-type: none"> 1 Suction oil line is damaged and air is sucked into oil lines 2 Low oil level and large amount of air is sucked into oil lines 	<ol style="list-style-type: none"> 1 Check the oil lines, remedy the leaking parts. Replace if necessary. 2 Add hydraulic oil to specified level

3.8.5 Steering System

No.	Problems	Possible Causes	Remedy
1	Heavy steering	<ol style="list-style-type: none"> 1 Insufficient oil supply for working pump and steering pump 2 Air in steering system 3 Faulty steel-ball in check valve body of steering unit causes heavy steering and little pressure during either slow or quick turning of steering wheel 4 Faulty of piloted valve 5 Too low pressure of safety valve 	<ol style="list-style-type: none"> 1 Check oil pump 2 Discharge air from system and check the suction lines 3 Check the valve. Clean if it is blocked by dirt 4 Replace piloted valve 5 Readjust the pressure to specified value
2	Increased steering turns	<ol style="list-style-type: none"> 1 Insufficient oil level in hydraulic reservoir 2 Leakage in oil lines, damaged oil seals 3 Internal leakage of steering cylinder 4 Worn steering unit 5 High viscosity of oil or wrong brand of oil 	<ol style="list-style-type: none"> 1 Fill oil to specified level 2 Change seals of oil circuits 3 Change seals of hydraulic tanks 4 Replace steering unit 5 Change by the specified oil
3	Inflexible or failure of steering system	<ol style="list-style-type: none"> 1 Damaged spring plate of steering unit 2 Cracked, broken or deformed centre pin and drive shaft 3 Faulty dual overload valve 4 Scuffed rotor and stator, scuffed valve spool, valve body and sleeve 5 Faulty in steering pump or piloted valve 	<ol style="list-style-type: none"> 1 Change the damaged spring plate 2 Change the center pin or drive shaft 3 Check and repair the bi-directional overload valve 4 Disassemble, check, clean and assemble strictly or change parts 5 Change the damaged parts
4	Steering wheel can not reset	<ol style="list-style-type: none"> 1 No concentric steering column and valve spool 2 Steering shaft axially locks the valve plug 3 Large axial resistance of steering column 4 Broken spring plate <p>Phenomena: medium pressure drop increases or the relief of steering unit fails when steering wheel stops (wheel loader deflects from straight traveling line)</p>	Remove the problems according to the respective reasons.

3.8.6 Engine

Refer to **Operation and Maintenance Manual** of diesel engine for troubleshooting.

CHAPTER IV MAINTENANCE

1 MAINTENANCE GUIDE

Read following information carefully before carrying out maintenance and inspection.

1.1 Attention to Maintenance and Inspection

- Perform the maintenance on hard and level ground.
- Lower the work equipment near the ground and level the bucket.
- Set all control levers (or handles) to the **Neutral** position.
- Press the parking brake switch.
- Put blocks in the front and back of wheels.
- Lock the front and rear frames with frame locking bars.

1.2 Hanging Warning Tag

- Attach the warning tag near the starting switch before maintenance to prevent someone starting the engine during maintenance.

1.3 Fitting preparation

- Use only parts specified by the manufacturer of the loaders wheel.

1.4 Oil and Fuel preparation

- Use oil and fuel specified in this manual according to ambient temperature.

1.5 Using the Prescriptive Oil and Fuel

- Keep containers of oil and fuel clean and use clean oil and fuel.

1.6 Keep the Machine Clean

- **Always** keep the machine clean. Keep grease fittings, pipe joints and oil level gauges clean and prevent foreign materials entering.

1.7 Pay Attention to the Refrigerant Water and Oil in High Temperature

- It is very dangerous to drain hot oil and refrigerant water or remove the filters immediately after the engine stops. Make sure the engine is cool. The temperature of the oil drained is appropriately

about 20°C to 40°C. If it is lower than this temperature, be sure to warm it up to this temperature before draining it.

1.8 Check the Oil and Filters

- After the oil is changed or filters are replaced, check the oil and filters. If large amounts of metallic particles or impurities are found, consult the maintenance people.

1.9 Fuel Strainer

- Do not remove the fuel strainer while fueling.

1.10 Oil Changing

- Change oil in relationship dust-free places to keep impurities out of the oil.

1.11 Welding Guide

- Turn off the starting switch of the engine and remove the battery cables.
- Keep the distance between the grounding cable line and welding area more than 1m.
- Avoid welding near the seal rings and bearings.
- **Never** weld any pipe or tube while has fuel as or oil in them.

1.12 Fire Prevention

- Clean the parts with inflammable cleaner or light oil. Keep spark or cigarette light away from them.

1.13 Sealing Part

- When replacing O-ring or gaskets, clean the clamp faces first, and make sure the O-ring and gaskets are in the correct assembly position.

1.14 Checking the Frame

- After a long time of operation in rocky conditions, check for damage of the undercarriage and loose or damaged between bolts and nuts.

1.15 Attention to Washing Machine

- Wash machine after complete cooling of the engine.
- Do not allow water to spray on any electric components.

1.16 Checking in Raining and Snowing Circumstances

- Clean the machine immediately after working in rain and snow. Lubricate and coat anti-rust oil to other parts.

1.17 Dusty Circumstances

Do the following when the machine works in dusty circumstances:

- Inspect and clean air filter frequently to avoid blocking.
- Clean the radiator frequently to avoid blocking.
- Clean and replace fuel filter frequently.
- Clean the electric components, especially the starting motor and alternator, to avoid accumulation of dust affecting dispelling heat.

Refer to **Operation and Maintenance Manual** of diesel engine for replacing and maintaining air filter.

1.18 Avoid Using Mixed Oil

- **Never** use oil mixed from different brands. If only a different kind of oil from the one previously used, drain the oil from the machine, and fill with the new brand oil.

2. DETAILED RULES OF MAINTENANCE

2.1 Detailed Rules of Using Oil, Fuel and Coolant

 WARNING
<ul style="list-style-type: none"> ● Because of bad operating conditions and dusty ambient circumstances, oil easily deteriorates. Change oil as soon as the oil deteriorates or is mixed with many impurities. ● Add the specified volume of oil. Either too much or too little oil may cause problems. ● Clean and replace the relative filters when changing oil.

2.1.1 Fuel

- The fuel pump is a precision instrument. If the fuel mixes with water or dirt, the fuel pump will not work normally.

- **Never** let impurities enter when changing and adding fuel.
- Strictly choose the fuel brand according to this manual.
- The fuel may be frozen at low temperatures (particularly temperatures lower than -15°C). So it is necessary to change the kind of fuel according to the ambient temperature.
- **Always** fill the fuel tank full after operating to prevent the water, which is condensed by the moisture in the air, from entering the fuel tank.
- If the engine fails to suck fuel or the filters have been just replaced, drain out the air in the circuit.

2.1.2 Coolant

- Use clean and soft water, rain or tap water as coolant. Well water and spring water can be used as coolant after soft processing and precipitation to avoid causing scale which can influence the performance of dispelling the heat.
- If the engine overheats, add coolant until the engine cools down completely.
- Add coolant to specified level. If the level is too low, it will cause the overheating of the engine system and the corrosion of the cooling system.
- Add antifreeze to coolant if ambient temperature is lower than 0°C. Drain the coolant out after working (please refer to **CHAPTER III 3.5.3 Operation in Cold Weather** and refill oil before next working if there is no antifreeze in the coolant.
- Antifreeze is flammable. Keep fire away when adding the antifreeze.
- **Never** use 100% antifreeze as coolant. Refer to the following table to select the mixing proportion.

Name	Proportion%					Freezing point≤°C
	Glycol	Alcohol	Glycerin	Water	Proportion	
Glycol Antifreeze	60			40	Proportion in volume	-55
	55			45		-40
	50			50		-32
	40			60		-22
Alcohol Glycerin Antifreeze		30	10	60	Proportion in weight	-18
		40	15	45		-26
		42	15	43		-32

2.1.3 Lubricant

- Lubricant is used to reduce noise and prevent wear on the joint surfaces.
- Joints not included in the manual (connectors, jointing sleeves) are treated during overhaul. So they do not need be lubricated. When some parts become inflexible because of long-term operation, it is necessary to add lubricant.

- Remember to wipe off the overflow lubricant when adding it.

2.1.4 The Storage of Oil and Fuel

- Prevent water, dirt or other impurities from mixing with the oil.
- Follow the rule, first in first out, to maintain oil quality during long-term storage (Use the oil with the longest shell life).

2.1.5 Filters

- Filters are extremely important safety components. They can prevent impurities in the fuel from entering important equipment and causing problems. Replace all filters periodically. For the maintenance cycle, refer to **3. CONTENT OF MAINTENANCE, in this chapter**. Replace filters at shorter intervals when the machine works in a severely bad environment.
- **Never** try to clean paper filter elements and use them again. **Always** replace them with a new one.
- When replacing the oil filters, check whether there are some metallic particles adhering to the old filter. If some metal particles are found, consult the maintenance people.
- **Never** open the packs of new filters until they are used.
- **Always** use authorized filter parts.

2.2 Selection of Fuel, Coolant and Lubricant

2.2.1 Selection Table of Fuel, Coolant and Lubricant

Please choose Shandong Lingong's preferred special oils and choose specified oils from the following table.

Kinds of Fluids	Recommended Types And Standards	Capacity	Using places
Engine oil	Ambient temperature \geq -15° CD 15W-40 Diesel Oil GB11122	17L	Yuchai Engine
	Ambient temperature $<$ -15° CD 5W-30 Diesel Oil GB11122	13.3L	Weichai Engine
	CALTEX & GINDERLEGR engine oil 15W-40	12L	Cummins Engine
Transmit oil	6# transmit oil Q/SH303 064	45L	Torque converter and gearbox
	8# transmit oil Q/SH303 064	45L	
Gear oil	Heavy duty gear oil for automobile (GL-5) 85W-90 GB13895	2×13L	Main reducer and final drive
Hydraulic oil	Ambient temperature \geq -5° L-HM46 hydraulic oil GB11118.1 Ambient temperature \geq -10°L-HM32 hydraulic oil GB11118.1 Ambient temperature \geq -30°L-HV46 hydraulic oil GB11118.1	128L	Hydraulic oil tank (Domestic Type)
	CALTEX superfine wind ring of temperature anti-grinding hydraulic oil or MOBIL DTE25	128L	Hydraulic oil tank (Export Type)

Fuel	Lowest temperature $\geq 4^{\circ}\text{C}$ 0#light diesel Oil GB252 Lowest temperature $\geq -5^{\circ}\text{C}$ -10#light diesel Oil GB252 Lowest temperature $\geq -14^{\circ}\text{C}$ -20#light diesel Oil GB252 Lowest temperature $\geq -29^{\circ}\text{C}$ -35#light diesel Oil GB252	140L	Fuel tank
Brake fluid	Motor-vehicle brake fluid HZY3 (D0T3) GB12981	4L	Brake oil cup
Grease	2# or 3# lithium based grease GB7324	2.8kg	Pins in every joint points of the work equipment
Antifreeze	Engine coolant of glycol type SH0521		Radiator

2.2.2 Reference Table of Foreign and Domestic Oils

● Engine oil

Oil Brands	Similar Oil Brands (classified by SAE standard)			
	MOBIL	SHELL	CALTEX	ESSO
Diesel Machine Oil Exceeded CD and CD 15W-40 GB11122	HEIBAWANG1300 (SAE15W-40) (-15 $^{\circ}\text{C}$ ~50 $^{\circ}\text{C}$)	RotellaSX 40; Rotella TX 40, 20w/40; Rotella DX 40	Caltex Delo Gold Multigrade 15W-40	Essolube XT-3; Essolube XT-2
Diesel Machine Oil Exceeded CD and CD 5W-30 GB11122	HEIBAWANG1300 (SAE10W-30) (-20 $^{\circ}\text{C}$ ~40 $^{\circ}\text{C}$) Delvac super 1 (over -40 $^{\circ}\text{C}$)	Rotella SX30, 10w/30; Rotella TX30; Rotella DX30		Essolube XT-5

● Hydraulic oil

Chinese Brands	Similar Oil Brands				
	CALTEX	SHELL	MOBIL	CASTROL	ESSO
Hydraulic oil L-HM46 (-5 $^{\circ}\text{C}$ ~40 $^{\circ}\text{C}$) GB11118.1	Caltex RANDO HDZ46 (-25 $^{\circ}\text{C}$ ~40 $^{\circ}\text{C}$)	Tellus 27; Tellus 29	DTE25 (-10 $^{\circ}\text{C}$ ~40 $^{\circ}\text{C}$)	Hyspin AWS 32; Hyspin AWS 46	Nuto H46
Hydraulic Oil L-HV46 (-30 $^{\circ}\text{C}$ ~40 $^{\circ}\text{C}$) GB11118.1-1994		Hydro-kinetic Tellus T27 46	DTE15M (-26 $^{\circ}\text{C}$ ~40 $^{\circ}\text{C}$)	Hyspin AWH46; Nuto	Vnivis N46

● Hydraulic transmission oil (torque converter-transmission oil)

Chinese Brands	Similar Oil Brands				
	CALTEX	MOBIL	FUCHS	ESSO	SHELL

8 # Hydrostatic transmission oil Q/SH303 064	Caltex Delo Gold Multigrade15W-40	Mobile HEIBAWANG1300 (SAE 15W-40)	Titan universal HD15W-40	Standard Torque Fluid G7	Rotella 10W
--	-----------------------------------	-----------------------------------	--------------------------	--------------------------	-------------

● **Gear oil (Axle oil)**

Chinese Brands	Similar Oil Brands (classified by SAE standard, GL-5)				
	CALTEX	FUCHS	MOBIL	ESSO	SHELL
Heavy duty gear oil for automobile (GL-5) 85W-90 GB13895	Caltex Thuban GL5 EP 90	Titan Gear LS90	Mobil Gear oil HD80W-90 (-20℃~40℃); Automobile Gear oil HD85W-90 (-10℃~50℃)	Gear oil GX 85W-90	Spirax EP Heavyduty HD90 HD80w-90

● **Brake fluid**

Chinese Brands	Grade	Similar Oil Brands			
		MOBIL	ESSO	British BP	SHELL
Motor vehicle brake fluids HZY3 GB12981	SAE 1703C	Super performance brake fluid DOT3	Brake fluid	Brake fluid Disc-brake fluid	Donax B

● **Grease**

Chinese Brands	Similar Oil Brands					
	MOBIL	CALTEX	CASTROL	ESSO	British BP	SHELL
ZG-2 or ZG-3 Lithium based lubricant grease GB7324	Mobile grease XHP222	Marfak multi Purpose	LM grease	Ronex MP; Beacon EP 2	Energrease L	Retinax A; Alvania

2.3 The Sketch of Lubricating Points

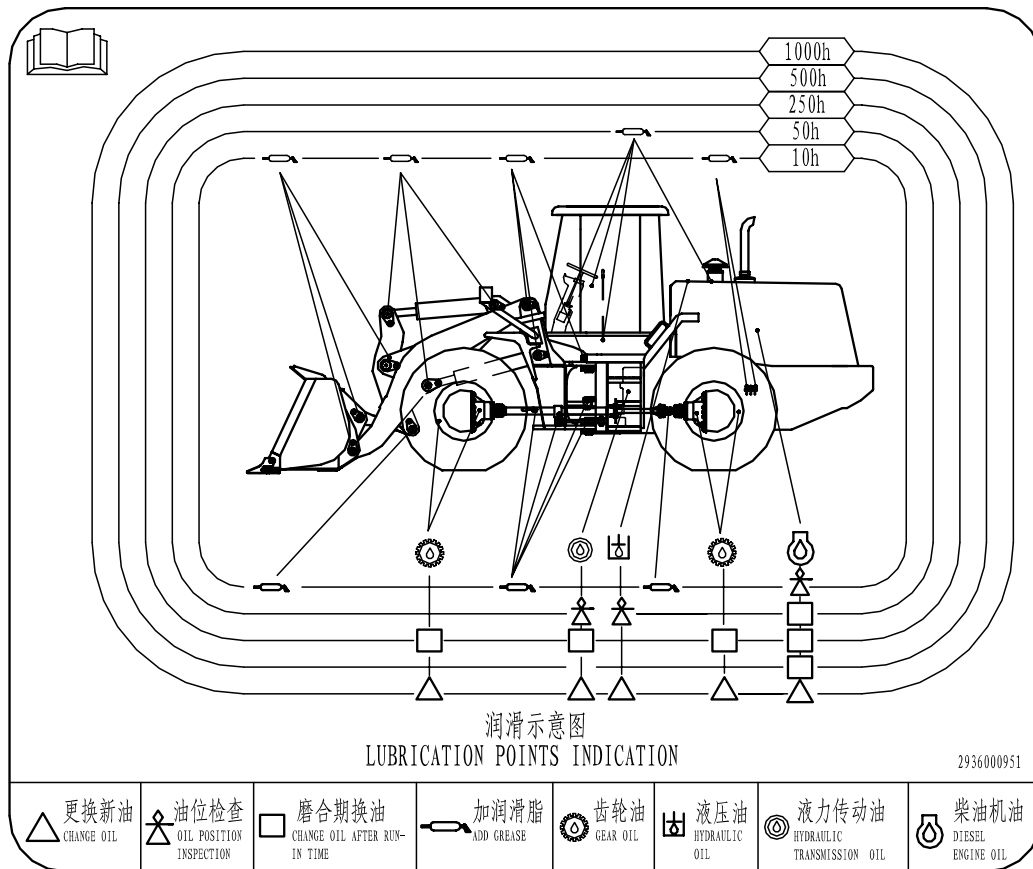

2.4 Detailed Rules of Electric System Maintenance

- If the wire stays in the wet environment or the insulation of it is damaged, the electric system may leakage which will cause hazardous accident.
- Maintenance of components related to the electric system.
 - Check the tension and distress of the fan belt.
 - Check the fluid level of electrolyte in the storage battery.
- **Never** remove or disassemble any electric components installed in the machine.
- **Never** install any electric components other than those specified by the company.
- Be sure to keep the electric system dry when washing the machine or working in rain and snow.
- Avoid the electric system corroding by seawater when working on the seashore.

2.5 Maintenance Tools

Refer to the production containerization list for details of maintenance tools.

2.6 Tightening Torque of Screw

The tightening torques of screw connection of the important parts are listed in the table below. Abide by this table except in special conditions.

No.	Position	Specification	Material or character class	Torque(N.m)
1	Fixing bolts of transmission base	M18×40	8.8	240~280
2	Middle cover bolts of transmission box	M12×30	8.8	125~165
3	Groove nut on both end of output shaft of gear box	M33×1.5	8	320~400
3	Connect bolts between rim and brake plate	M18×1.5×50	8.8	200~250
4	Connect bolts of main driving left and right differential cover	M14×1.5×140	40Cr	180~210
5	Connect bolts between main driven move helical gear and right cover of differential	M16×1.5×55	40Cr	280~330
6	Connect bolts between main driving bearing chock and bracket	M22×90	40Cr	450~550
7	Lock bolts of main driving input flange	M33×1.5	8	320~400
8	Connect bolts between plane frame assembly and rim	M18×1.5	10	264~354
9	Connection between the bracket of main driving and axle shell	M12×1.25×35	10.9	110~130
10	Rim nuts	M18×1.5	35	265~355
11	Connect bolts between brake clip assembly and stent	M20×1.5×56	40Cr	370~470
12	Assembly of driving axle and frame	M24×2×100 M24×2×95	8.8	400~500
13	Supporting bolts in the middle of transmission shaft	M14×1.5×47	40Cr	400~450
14	Connection of engine oil tank and frame	M16×35	8.8	185~265
15	Connection of fuel tank and frame	M24×2×60 M24×2×150	8.8	250~360 320~480
16	Connection of dipper teeth and bucket	M16×40 M16×70	45	193~257

Maintenance content includes the run-in period of a new machine and the periodic maintenance of every 10, 50, 250, 500, 1000 and 2000 hours.

3. CONTENT OF MAINTENANCE

3.1 Every 10 Hours (Days) Service

- Check the sealing performance of work equipment systems such as hydraulic, steering and brake system.
- Check the flexibility and reliability of the brakes.
- Check whether the electric circuit is correct and the electric components are normal.
- Check the oil level in the oil tank and the water level in the water tank.
- Add grease to the fan shaft, jointed point between front and rear frames, driving axles, jointed points of oscillating frame and joint points of work equipment.
- Check if there are other abnormalities.
- Refer to **Operation and Maintenance Manual** of diesel engine for maintenance.

3.2 Every 50 Hours (Week) Service

Carry out the periodic maintenance of every 10 hours with this maintenance operation at the same time.

- Check oil level of the gearbox, hydraulic oil tank and brake booster pump.
- Tighten all connection bolts of transmission axles.
- Check whether all connection bolts of hubs and the brake caliper are loosen.
- Check all connection bolts of teeth for tightening.
- Check and lubricate the accelerator control, parking brake and gearshift control system.

In addition, do the extra maintenance in the first 50 hours as follows:

- Check and clean the air vent of the gearbox. Check and clean the filter cartridge of the oil line system of the torque converter-gearbox.
- Check if there is leakage in the hydraulic system. Check and clean the air vent of the hydraulic reservoir. Check the oil-return filter cartridge of the hydraulic reservoir.
- Check if there is leakage in the brake system. Clean the filter mesh of the oil bowl in the booster pump. Clean the air vent and check the brake fluid. Add them if deficient.

3.3 Every 250 Hours (Month) Service

Carry out the periodic maintenance of every 10 and 50 hours with this maintenance operation at the same time.

- Check the storage battery. Clean surface and terminals of the battery then coat Vaseline lamina.

- Check whether assembling bolts of frames are loose and welding seams are cracked.
- Check whether the front and rear axles, engine and gearbox and frame are loosen.
- Check the tire pressure. Inflation pressure of front tires should be (0.333~0.353)MPa while that of rear tires should be (0.275~0.294)MPa.
- Open the water draining valve in the air tank to drain the water out.

In addition, do the extra maintenance in the first 250 hours as follows:

- Check and clean the air vent of gearbox. Clean the oil pan of gearbox. Replace the suction filter cartridge in the oil pan of gearbox. Replace the filter cartridge in the oil lines of torque converter-gearbox. Replace the gearbox oil.
- Replace the gear oil in the front and rear axles.
- Check if there is leakage in the brake system. Clean the filter mesh of the oil bowl in the booster pump. Clean the air vent and check the brake fluid. Add them if deficient and replace them if necessary.

3.4 Every 500 Hours (Season) Service

Carry out the periodic maintenance of every 10, 50 and 250 hours with this maintenance operation at the same time.

- Check and adjust the clearance of hand brake system.
- Check the wear condition of brake discs and friction discs. Replace them if necessary.
- Clean the silencer of the braking electromagnetic valve.

In addition, do the extra maintenance in the first 500 hours as follows:

- Check if there is leakage in the hydraulic system. Check and clean the air vent of hydraulic reservoir. Replace the oil-return filter cartridge and pilot filter (if assembled) of hydraulic reservoir. Check the quantity and cleanness of hydraulic oil. Filter the oil if possible. Add them if deficient and replace them if necessary.
- Check if there is leakage in the brake system. Clean the filter mesh of the oil bowl in the booster pump. Clean the air vent and replace the brake fluid.

3.5 Every 1000 Hours (Half a Year) Service

Carry out the periodic maintenance of every 10, 50, 250 and 500 hours with this maintenance operation at the same time.

- Clean the oil pan of gearbox. Clean the air vent of gearbox. Replace the suction filter cartridge in the oil pan of gearbox. Replace the filter cartridge in the oil lines of torque converter-gearbox. Replace the gearbox oil.
- Change the gear oil in the front and rear axles.

- Check and clean the filter mesh of the oil bowl in the booster pump. Clean the air vent and replace the brake fluid.
- Check if there is leakage in the hydraulic system. Check and clean the air vent of hydraulic reservoir. Clean the hydraulic reservoir. Replace the filter cartridge of oil-return filter and pilot filter (if assembled).
- Check the clearance and wear condition of the pins and the bushes in every articulated point.

In addition, do the extra maintenance in the first 1000 hours as follows:

- Replace the hydraulic oil. And then replace once every 2000 hours.

3.6 Every 2000 Hours (Year) Service

Carry out the periodic maintenance of every 10, 50, 250, 500 and 1000 hours with this maintenance operation at the same time.

- Check performance of the torque converter and gearbox, differentials of front and rear axles and the wheel side reducers. Disassemble them for checking if necessary.
- Check the sealing performance of multi passage valve and hydraulic tank by measuring the natural sedimentation volume of the cylinders fuel oil, and then check the system pressure. If the natural sedimentation volume is over than its specified value, replace the multi passage valve or hydraulic tank. Contact us for details.
- Check the welded seams of rim and other stress parts and adjust the deformation.

3.7 Alteration

The maintenance principles listed above are the normal requirements. The maintenance time should be determined by the closer one between the two the maintenance schedules. If the working condition is very severe, please shorten the maintenance cycle and increase the maintenance times according to the real conditions.

3.8 Replace the Air-Storage Tank after 3 Years of Service

CHAPTER V THE STRUCTURE AND PRINCIPLE OF MAIN COMPONENTS AND SYSTEM

1 Transmission System

The transmission system includes the hydraulic torque converter, gear box, transmission shaft, front and rear driving axle, wheel and others. The transmission system diagram is shown in the Figure 5-1.

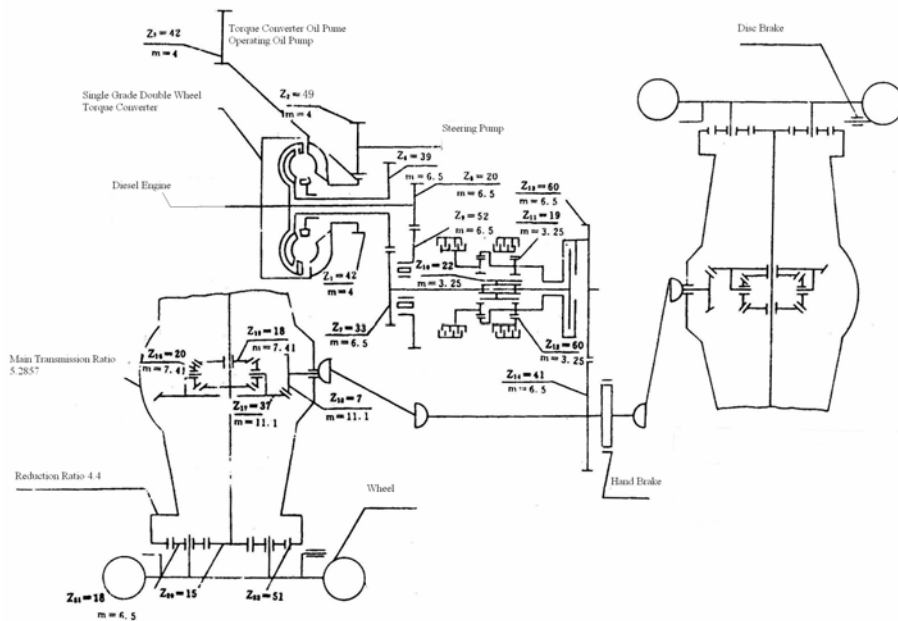

Figure 5-1 Principle Diagram of Transmission System

2 Hydraulic System

As shown in Figure 5-2, the mechanical manual control hydraulic system is composed of a work pump, multi-way valve, lift arm cylinder, bucket cylinder, steering pump, load sensing hydraulic redirector, priority valve, steering cylinder, hydraulic pressure oil tank and pipe attachments. DF25 multi-way valve includes bucket unit and lift-arm unit. The bucket unit includes dumping, neutral and receiving bucket in three positions. The lift-arms unit controls four actions including floating, lowering, neutral and lifting to utilize the work control of loader working device.

As shown in Figure 5-3,5-4, the hydraulic system employs pilot operation and work pump, multi-way

valve, pilot valve, pressure select valve, lift arm cylinder, bucket cylinder, hydraulic pressure oil tank and pipe attachments. D32 multi-way valve is a two unit valve. D32A multi-way valve is a three unit valve. The bucket unit includes dumping, neutral and receiving bucket in three positions. The lift-arms unit controls four actions including floating, lowering, neutral and lifting to utilize the work control of loader working device. The third hydraulic function can be reserves.

The set pressure of the safety valve is 16MPa ~16.5MPa. The overload pressure of the rocker cylinder's large cavity is 18MPa~18.5MPa while that of the small cavity is 12MPa.

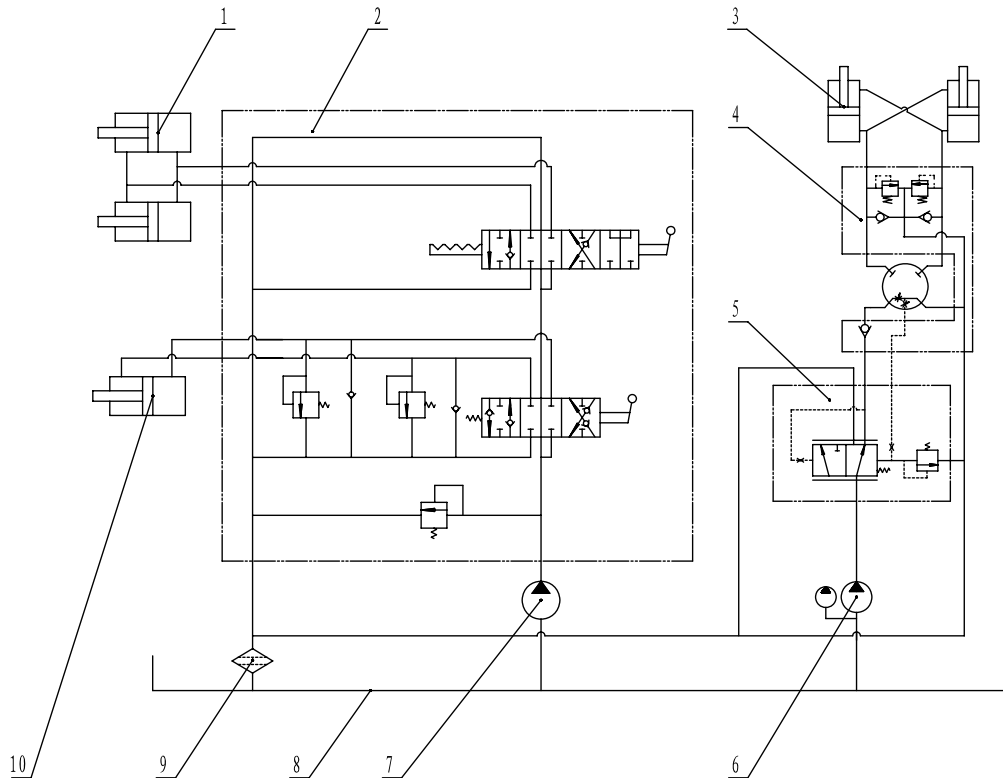

1-Life Arm Cylinder 2-Multi-way Valve 3-Steering cylinder 4-Redirector 5-Priority Valve
 6- Steering and Speed Changing Pump 7-Work Pump 8-Hydraulic Oil Tank
 9-Oil Returning Filter 10- Bucket Cylinder

Figure 5-2 Mechanical and Manual Control Hydraulic System Diagram

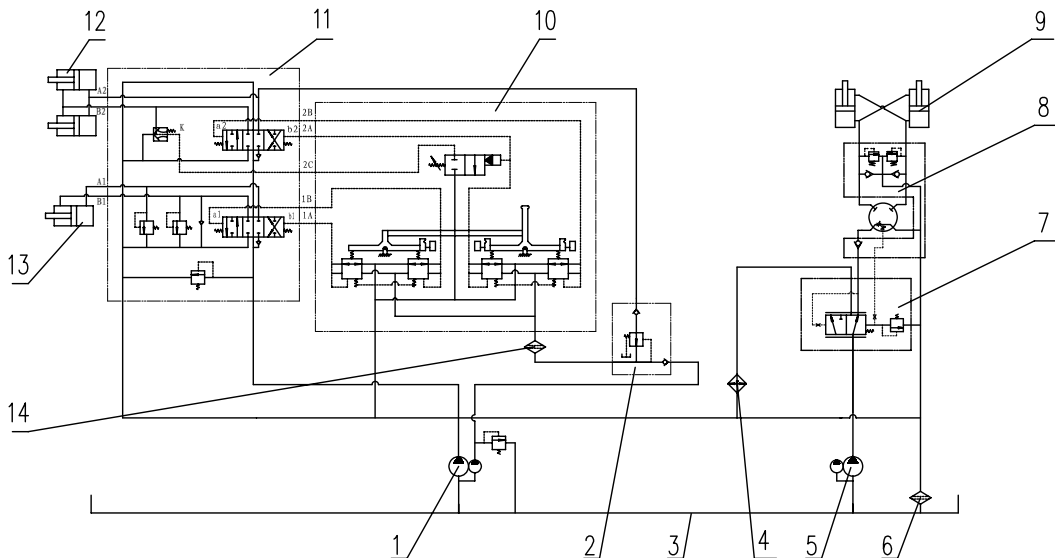

- 1-Work and Pilot Pump 2-Pressure Select Valve 3-Oil Tank 4-Hydraulic Oil Radiator
 5- Steering and Speed Changing Pump 6-Oil Returning Filter 7-Priority Valve 8-Redirector
 9- Steering Cylinder 10-Pilot Valve 11-Multi-way Valve 12-Lift Arm Cylinder
 13-Bucket Cylinder 14-Pilot Filter

Figure 5-3 Two Units Valve Pilot Control Hydraulic System Diagram

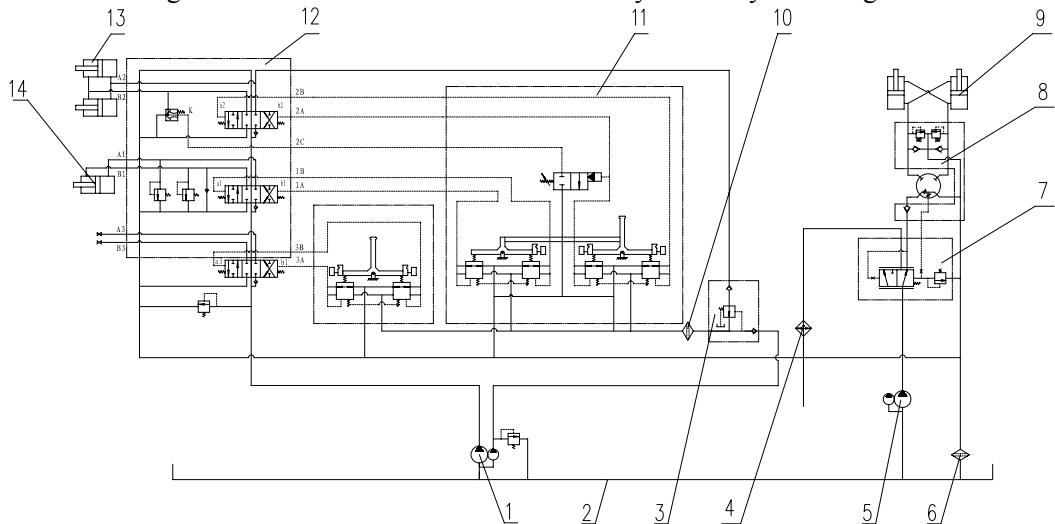

- 1-Work and Pilot Pump 2- Oil Tank 3- Pressure Select Valve 4-Hydraulic Oil Radiator
 5- Steering and speed changing pump 6-Oil returning filter 7-Priority valve 8-Redirector
 9- Steering Cylinder 10-Pilot Filter 11-Pilot Valve 12-Multi-way Valve 13-Lift-arm Cylinder
 14-Bucket Cylinder

Figure 5-4 Three Units Valve Pilot Control Hydraulic System Diagram

3 Brake System

Brake system is used when the machine decelerates, stops or for long-term parking on the level ground or slight incline. The brake system of this machine is composed of a driving brake system and parking brake system as shown in Figure 5-5,5-6.

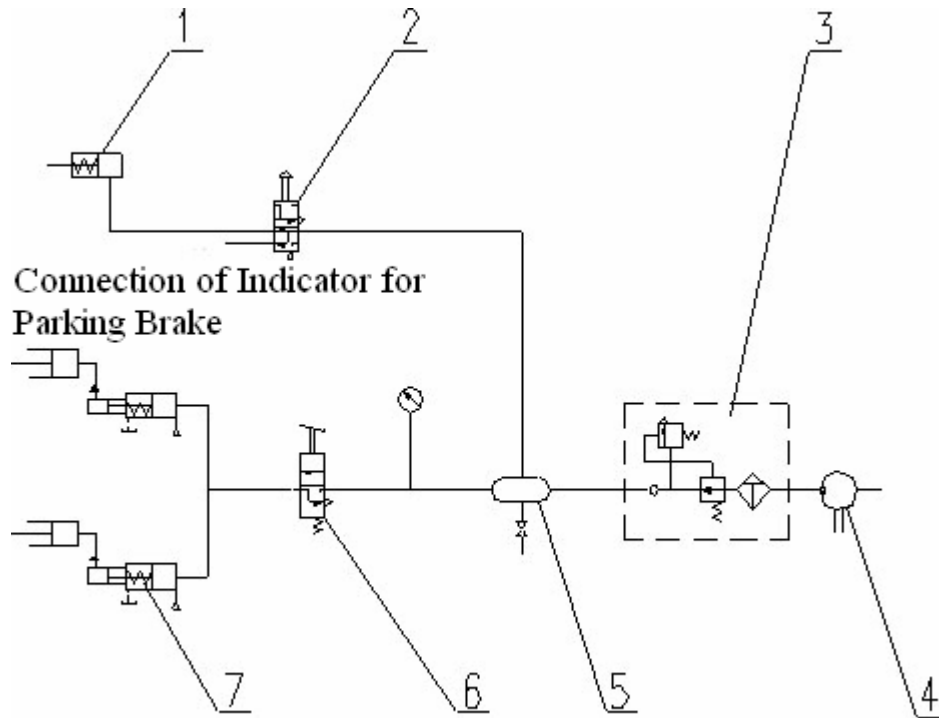

1-Parking Brake Air Chamber 2- Brake Magnetic Valve
 3- Combination Valve of Oil Water Separator 4- Air Compressor 5- Air Tank
 6- Air Brake Valve 7- Air Booster Pump
 Figure 5-5 LG36L Single Brake Pedal Braking Diagram

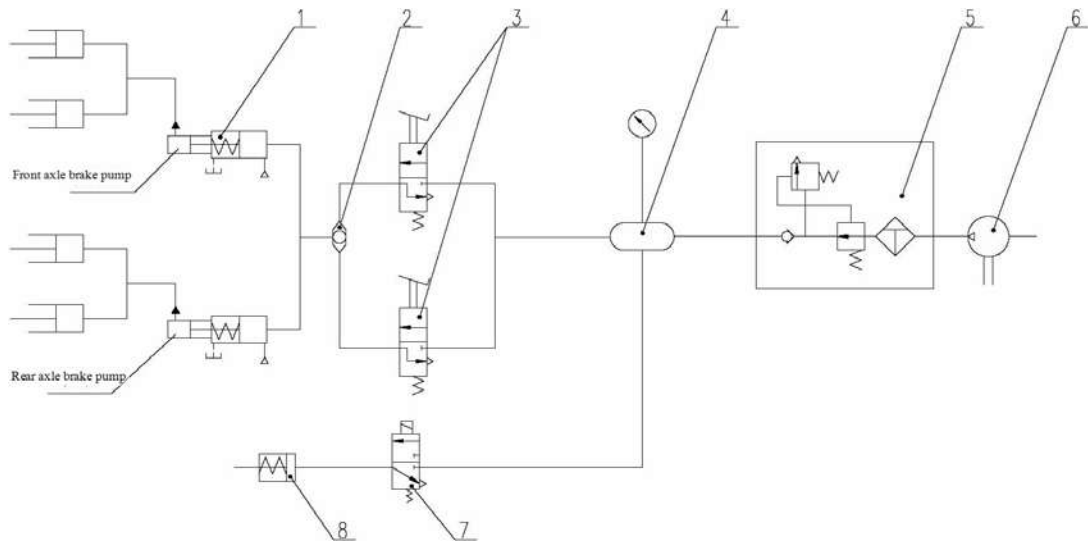

1- Air Booster Pump 2-Shuttle Valve 3- Air Brake Valve 4- Air Tank
 5- Combination Valve of Oil Water Separator 6- Air Compressor 7- Brake Magnetic Valve
 8- Parking Brake Air Chamber
 Figure 5-6 LG936L Double Brake Pedal Braking Diagram

3.1 Driving Brake System(Single Brake Pedal):

As shown in Figure 5-5, this system is the single line, air pushing oil four wheels caliper disk brake system.

When the brake pedal is stepped on during driving, the compressed air in air tank 5 flows through air brake valve 6 into the air chamber of the air booster valve 7. The compressed air pushes the piston of the booster pump to change the oil pressure (oil pressure is about 14MPa). Brake fluid pushes the piston of the caliper disk brake and makes the friction disk contact the brake plate to achieve the purpose of slowing and braking.

Release the brake pedal, and the compressed air of the booster pump drains from the brake valve to the atmosphere and the brake is released.

3.2 Driving Brake System(Single Brake Pedal):

As shown in Figure 5-6, this system is the double brake pedals, air pushing oil four wheels caliper disk brake system using two brake calipers for front and back to increase the safety of whole vehicle.

When the left brake pedal is stepped on during driving, the compressed air in air tank 4 flows through air brake valve 3 and shuttle valve 2 into the air chamber of the air booster pump 1. The compressed air pushes the piston of the booster pump to change the oil pressure (oil pressure is about 14MPa). Brake fluid pushes the piston of the caliper disk brake and makes the friction disk contact with the brake plate to achieve the purpose of slowing and braking. The air pressure is outputted at the same time to cut off the power of gear box.

When the right brake pedal is stepped on during driving, the brake principle is the same as left brake pedal, but the power of transmission box is not cut off.

Release the brake pedal, and the compressed air of the booster pump drains from the brake valve to the atmosphere and the brake is released.

3.3 Parking Brake System

This system employs two different forms: the total hydraulic clamping disc braking system and the total hydraulic pin steering system. During driving, when the pressure of air in brake system is in normal level, rotate the operating button of brake electromagnetic valve slightly, the button will bounce out automatically, and then the compress air in the air tank through the brake magnetic valve to the parking brake air chamber to pull the plug away and release the brake. When stopping, press the operating button of brake magnetic valve, the compress air in the parking brake air chamber through the air draining port of brake magnetic valve to aerospace. Then the brake is pulled up under the spring to arrive to brake. At the same time, send an electric signal to turn on the parking brake indicator, by which to alarm the operator that the vehicle is in the braking condition.

When the system air pressure is lower than 0.4Mpa, the brake magnetic valve will cut off automatically to control the compress air in the parking brake air chamber to drain into the aerospace by hand, so that the emergency brake is utilized to protect the safety of vehicle and people.

4 Electric System

The electric system is composed of a storage battery, starting motor, charge generator, appliance, switch, lamps and other electric instruments.

The system of this machine employs D.C. 24V voltage, negative electrode and single wire lines. The relation of each electric instrument and their working theories refer to the diagram sketch of the electric system as is shown in figure 5-7,5-8,5-9,5-10.

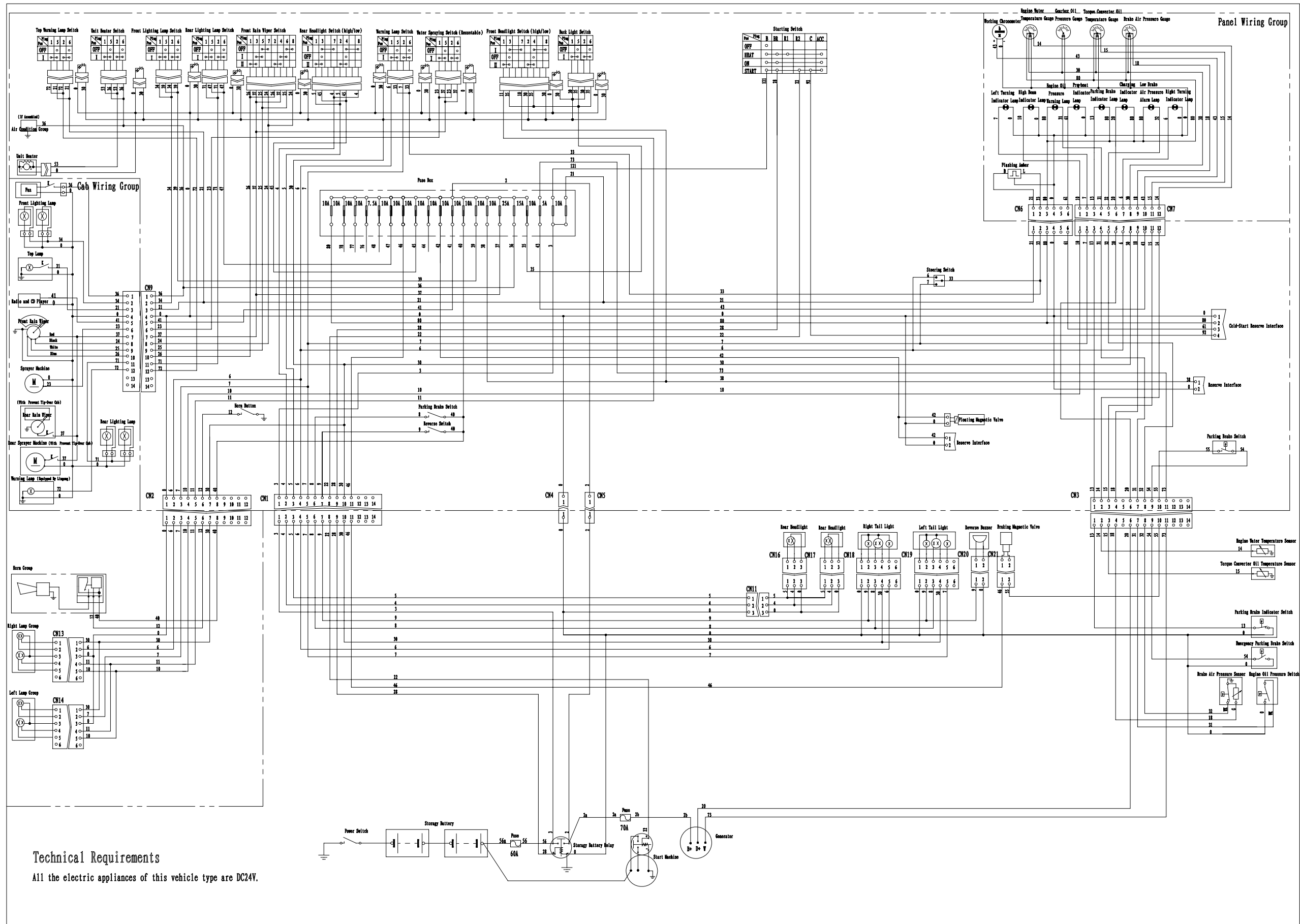

Technical Requirements
 All the electric appliances of this vehicle type are DC24V.

Figure 5-7 Electric System Principle Diagram (Mechanical Operation)

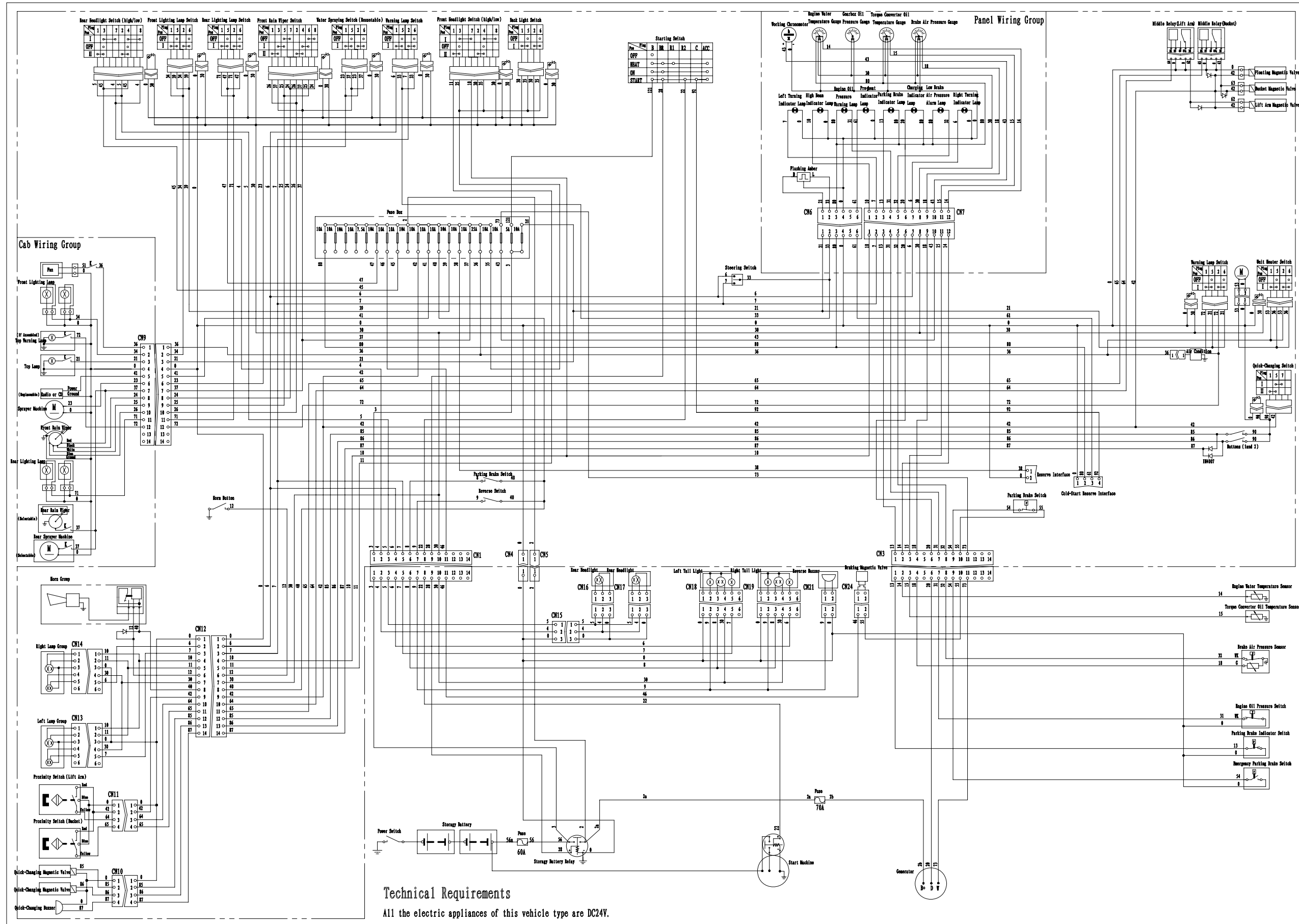

Figure 5-8 LG936L Electric System Principle Diagram (Pilot Operation, Domestic Type,)

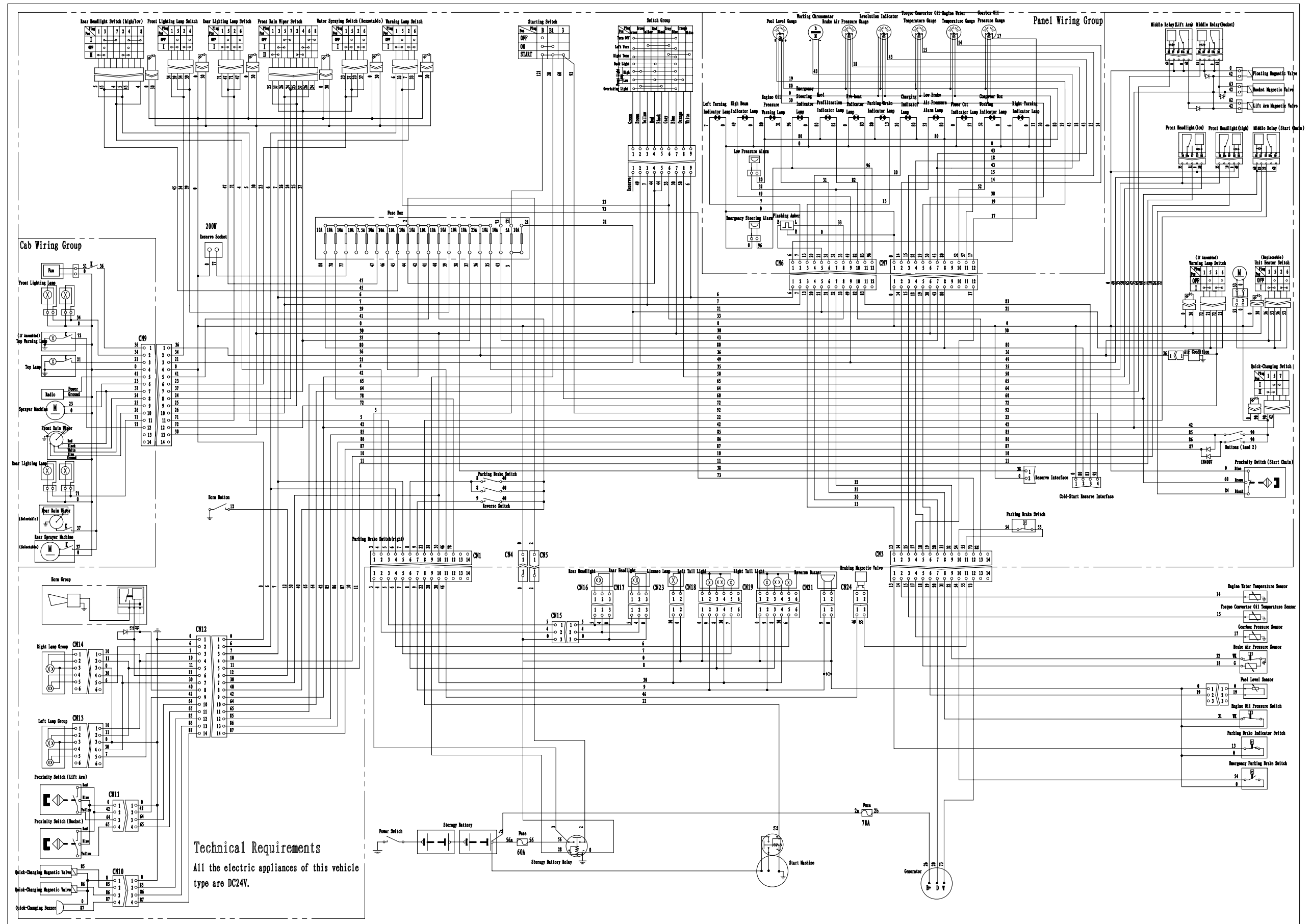

Figure 5-9 LG936L Electric System Principle Diagram with DEUTZ Engine TD226B (Export Type)

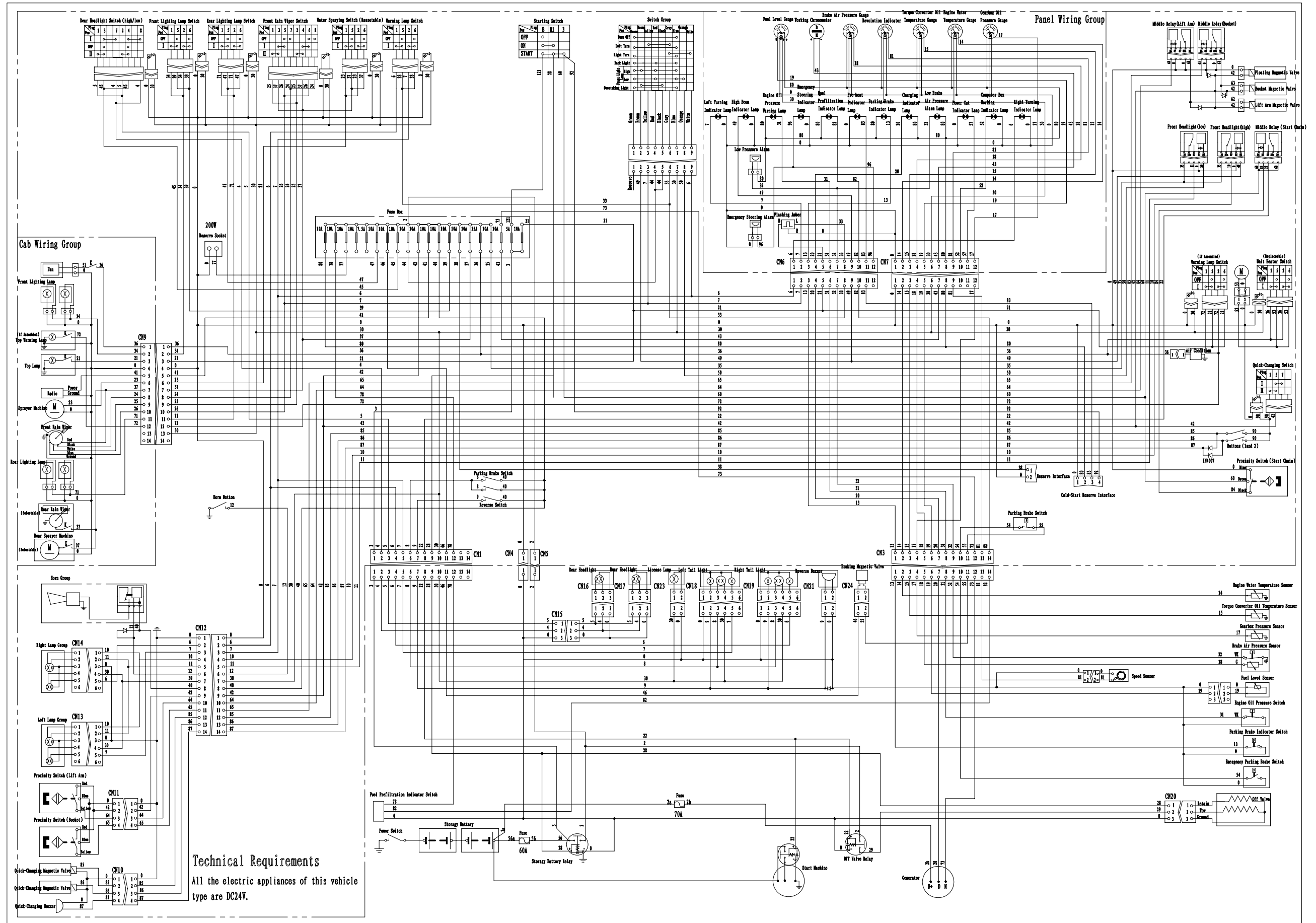

Figure 5-10 Electric System Principle Diagram with Cummins Engine (Export Type)