



Owner's manual & Installation manual
Mode d'emploi et manuel d'installation
Benutzerhandbuch & Installationshandbuch
Manuale dell'utente e manuale di installazione
Gebruikershandleiding en installatiehandleiding
Manual de instrucciones y de instalación
Ägar- & installationshandbok
Instrukcja obsługi i instalacji
Εγχειρίδιο Λειτουργίας & Εγκατάστασης

CZ301E

Bluetooth® CD/USB/MP3/WMA RECEIVER
LECTEUR CD/USB/MP3/WMA Bluetooth®
Bluetooth® -CD/USB/MP3/WMA-RECEIVER
SINTOLETTORE CD/USB/MP3/WMA Bluetooth®
Bluetooth® CD/USB/MP3/WMA-ONTVANGER
RECEPTOR Bluetooth® CD/USB/MP3/WMA
Bluetooth® CD/USB/MP3/WMA-RECEIVER
ODTWARZACZ CD/USB/MP3/WMA
z interfejsem Bluetooth®
Bluetooth® CD/USB/MP3/WMA ΔΕΚΤΗΣ

CAUTIONS:

This appliance contains a laser system and is classified as a "CLASS 1 LASER PRODUCT". To use this model properly, read this Owner's Manual carefully and keep this manual for your future reference. In case of any trouble with this player, please contact your nearest "AUTHORIZED service station". To prevent direct exposure to the laser beam, do not try to open the enclosure.

CAUTION

USE OF CONTROLS OR ADJUSTMENTS OR PERFORMANCE OF PROCEDURES OTHER THAN THOSE SPECIFIED IN THE OWNER'S MANUAL MAY RESULT IN HAZARDOUS RADIATION EXPOSURE.

ADVARSEL.

Denne mærkning er anbragt udvendigt på apparatet og indikerer, at apparatet arbejder med laserstråler af klasse 1, hvilket betyder, at der anvendes laserstråler af svageste klasse, og at man ikke på apparatets yderside kan blive udsat for utilladelig kraftig stråling.

APPARATET BØR KUN ÅBNES AF FAGFOLK MED SÆRLIGT KENDSKAB TIL APPARATER MED LASERSTRÅLER!

Indvendigt i apparatet er anbragt den her gengivne advarselmærkning, som advarer imod at foretage sådanne indgreb i apparatet, at man kan komme til at udsætte sig for laserstråling.

OBS!

Apparaten innehåller laserkomponenten som avger laserstråling överstigande gränsen för laserklass 1.

VAROITUS

Suojakoteloja si saa avata. Laite sisältää laseriodin, joka lähettää näkymätöntä silmille vaarallista lasersäteilyä.

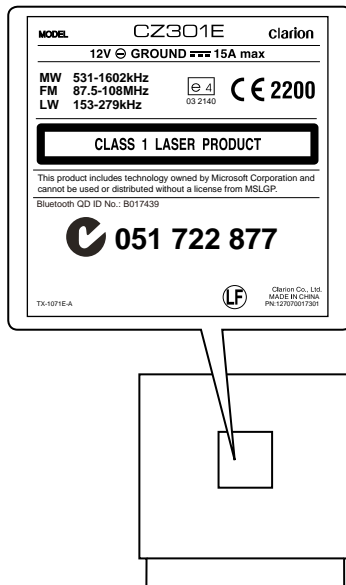

Contents

Thank you for purchasing this **Clarion** product.

- Please fully read this owner's manual before operating this equipment.
- Check the contents of the enclosed warranty card and store it in a safe place with this manual.

1. FEATURES	3
Expanding Systems.....	3
2. PRECAUTIONS	4
INFORMATION FOR USERS:	4
Front Panel / Generalities.....	4
USB Port	4
Remove the DCP	5
Attach the DCP.....	5
Storing the DCP in the DCP Case.....	5
3. CONTROLS	6
Operational Panel.....	6
Names of Buttons.....	6
4. CAUTIONS ON HANDLING	7
Handling Discs	7
5. OPERATIONS	8
System Setup	9
Audio Setup.....	10
Radio Operations	10
Radio Data System Operations.....	11
CD/MP3/WMA Operations	13
USB Operations	16
AUX Operations	16
Bluetooth Operations.....	17
6. TROUBLE SHOOTING	19
7. ERROR DISPLAYS	21
8. SPECIFICATIONS	22
9. INSTALLATION / WIRE CONNECTION GUIDE	23

1. FEATURES

- Built-in Bluetooth® Hands free(HFP) and Audio Streaming(A2DP & AVRCP)
- Front-panel auxiliary input and 2ch RCA output with Subwoofer Control
- MP3/WMA compatible with ID3-TAG display

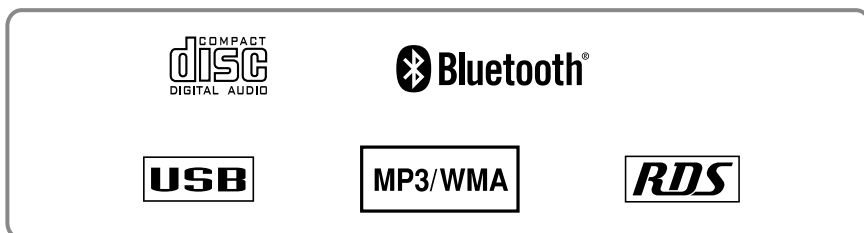

Expanding Systems

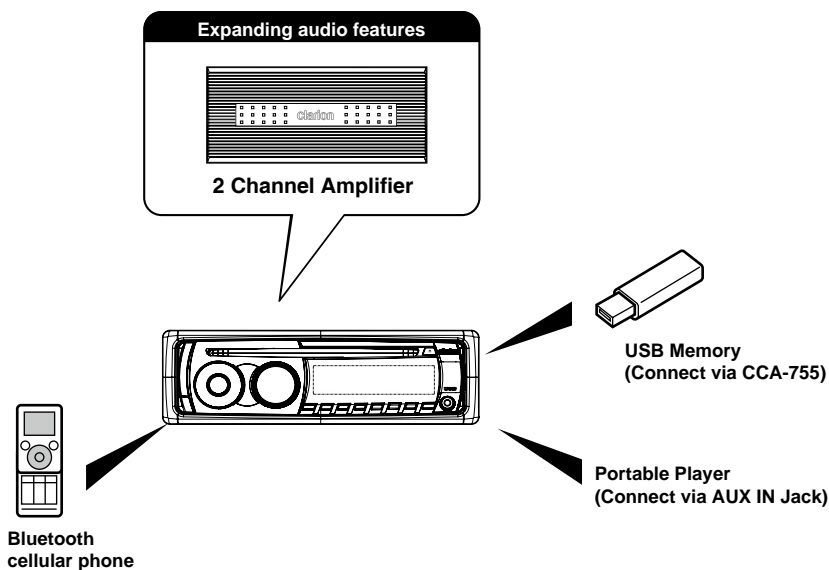

Note:

The items listed outside of the frames are the commercial products generally sold.
CCA-755: Sold by separately.

2. PRECAUTIONS

WARNING

For your safety, the driver should not operate the controls while driving. Also, while driving, keep the volume to a level at which external sounds can be heard.

1. When the inside of the car is very cold and the player is used soon after switching on the heater, moisture may form on the disc or the optical parts of the player and proper playback may not be possible. If moisture forms on the disc, wipe it off with a soft cloth. If moisture forms on the optical parts of the player, do not use the player for about one hour. The condensation will disappear naturally allowing normal operation.
2. Driving on extremely bumpy roads which cause severe vibration may cause the sound to skip.
3. This unit uses a precision mechanism. Even in the event that trouble arises, never open the case, disassemble the unit, or lubricate the rotating parts.

INFORMATION FOR USERS:

Changes or modifications to this product unapproved by the manufacturer will void the warranty and will violate fcc approval.

Front Panel / Generalities

For a longer service life, be sure to read the following cautions.

- Do not allow any liquids on the set from drinks, umbrellas, etc. Doing so may damage the internal circuitry.
- Do not disassemble or modify the set in any way. Doing so may result in damage.
- Do not let cigarettes burn the display. Doing so may damage or deform the body.
- If a problem should occur, have the set inspected at your store of purchase.

Cleaning the body

- Use a soft, dry cloth and gently wipe off the dirt.
- For tough dirt, apply some neutral detergent diluted in water to a soft cloth, wipe off the dirt gently, then wipe again with a dry cloth.
- Do not use benzene, thinner, car cleaner, etc., as these substances may damage the body or cause the paint to peel. Also, leaving rubber or plastic products in contact with the body for long periods of time may cause stains.

USB Port

- The USB memory stick may stick out when inserted, so it may cause danger during driving. When connect USB memory stick to the main unit, please use a USB extension cable(CCA-755).
- The USB memory sticks must be recognized as "USB mass storage class" to work properly. Some models may not operate correctly.

When the memorized data is lost or damaged by any chance, Clarion shall not be liable for any damage.

When using an USB memory stick, we recommend that you backup your data stored on it before using a personal computer etc.

- Data files may be broken when using USB memory sticks in the following situation: When disconnecting the USB memory stick or turning the power off during reading data. When affected static electricity or electric noise. Connect/disconnect the USB memory stick when it is not accessed.
- Connecting with the computer is not covered.

Remove the DCP

The control panel can be detached to prevent theft. When detaching the control panel, keep it in the safety place and prevent scratches.

We recommend taking the DCP (DETACHABLE CONTROL PANEL) with you when leaving the car.

1. Press the [SRC / \cup] button (1 sec.) to turn off the power.
2. Deeply push in [OPEN] button to unlock the DCP.
3. Hold the side popped out, remove the DCP.

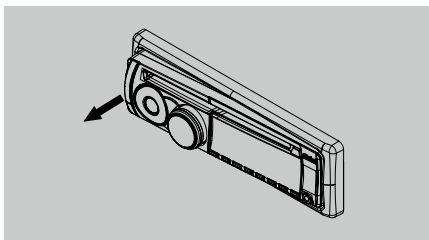

Attach the DCP

1. Hold the DCP and ensure that the panel faces towards you. Set the right side of the DCP into the DCP bracket.
2. Press the left side of the DCP until it locks.

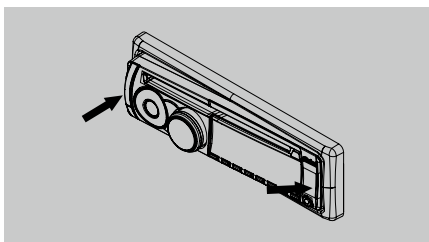

Storing the DCP in the DCP Case

Hold the DCP, as shown in the figure below, and put it into the supplied DCP case.

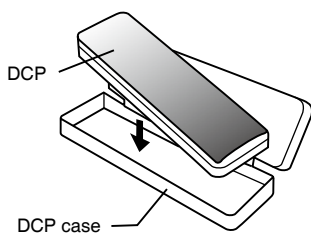

⚠ CAUTION

- The DCP can easily be damaged by shocks. After removing it, be carefully not to drop it or subject it to strong shocks.
- Once the [OPEN] button is pressed and DCP is unlocked, car vibrations can cause the DCP to fall.
- The connector for the main unit and DCP is extremely important. Be careful not to damage it by pressing on it with fingernails, screwdrivers, etc.

Note:

If the DCP is dirty, wipe off the dirt with a soft, dry cloth only.

3. CONTROLS

Operational Panel

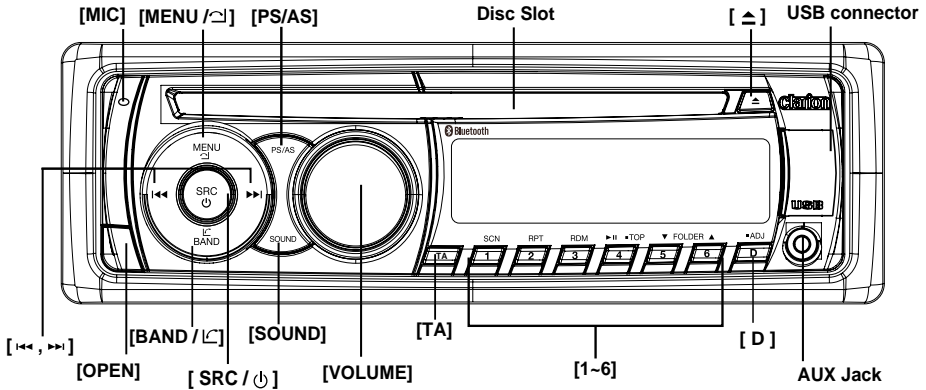

Names of Buttons

[SRC / ⏻] Button

- Power/Toggle the audio source

[BAND / ⏻] Button

- Select tuner band / Dial / Answer

[MENU / ▢] Button

- **MP3/WMA** mode – Search function.
- **BT** mode – Terminate call
- **CD** mode – No function.
- **RADIO** mode – PTY select.
- **AUX** mode – No function.

[▲] Button

- Press to eject disc.

[◀, ▶] Buttons

- Previous / next track
- Search (long press)

[OPEN] Button

- Unlock the front panel.

[PS / AS] Button

- Scan play / Preset scan
- Auto memory store (long press)

[SOUND] Button

- Sound effect setting

[VOLUME] Knob

- Adjust volume level / Confirm (press)

[TA] Button

- Traffic announcement

[1-6] Buttons

- **[1]** Button: Scan play / Preset station 1.
- **[2]** Button: Repeat play / Preset station 2.
- **[3]** Button: Random play / Preset station 3.
- **[4]** Button: Play / Pause / Top play (long press) / Preset station 4.
- **[5]** Button: Previous folder / Preset station 5. 10 tracks down (long press)
- **[6]** Button: Next folder/Preset station 6. 10 tracks up (long press)

[D] Button

- Display switch
- System setup (long press)

[MIC] Hole

- Internal microphone

4. CAUTIONS ON HANDLING

Handling Discs

Handling

- New discs may have some roughness around the edges. If such discs are used, the player may not work or the sound may skip. Use a pen or similar tool to remove any roughness from the edge of the disc.

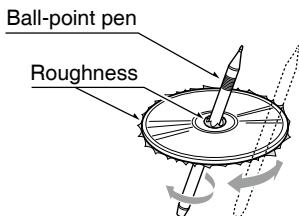

- Never stick labels on the surface of the disc or mark the surface with a pencil or pen.
- Never play a disc with any cellophane tape or other glue on it or with peeling off marks. If you try to play such a disc, you may not be able to get it back out of the player or it may damage the player.
- Do not use discs that have large scratches, are misshapen, cracked, etc. Use of such discs may cause misoperation or damage.
- To remove a disc from its storage case, press down on the center of the case and lift the disc out, holding it carefully by the edges.
- Do not use commercially available disc protection sheets or discs equipped with stabilizers, etc. These may damage the disc or cause breakdown of the internal mechanism.

Storage

- Do not expose discs to direct sunlight or any heat source.
- Do not expose discs to excess humidity or dust.
- Do not expose discs to direct heat from heaters.

Cleaning

- To remove fingermarks and dust, use a soft cloth and wipe in a straight line from the center of the disc to the outer edge.
- Do not use any solvents, such as commercially available cleaners, anti-static spray, or thinner to clean discs.
- After using special disc cleaner, let the disc dry off well before playing it.

On Discs

- Never turn off the power and remove the unit from the car with a disc loaded.

CAUTION

For your safety, the driver should not insert or eject a disc while driving.

5. OPERATIONS

Basic Operations

Note:

- Refer to the diagrams in “3. CONTROLS” when reading this chapter.

CAUTION

When the unit is turned on, starting and stopping the engine with its volume raised to the maximum level may harm your hearings.

Be careful about adjusting the volume.

Power on / off

Notes:

- Start the engine before using this unit.
 - Be careful about using this unit for a long time without running the engine. If you drain the car's battery too far, you may not be able to start the engine and this can reduce the service life of the battery.
- Start the engine. The power button / knob illumination on the unit will light up.



Engine ON
position

- Press the [SRC / ϕ] button on the front panel to turn on the power under standby mode. The unit goes back to the last status after power on.
- Press and hold the [SRC / ϕ] button on the front panel to turn off the power.

CT (Clock Time) display

- The displayed clock data is based on the CT (clock time) data in the RDS signal.

Volume adjustment

Turn the [VOLUME] knob on the front panel. The adjustable range of volume is 0 to 40.

CAUTION

While driving, keep the volume level at which external sounds can be heard.

Playing source selection

Press [SRC / ϕ] button on the front panel repeatedly to choose desired playing source.

Notes:

- Playing source selection means selecting work mode, such as **DISC** mode, **RADIO** mode, **AUX** mode and **BT** mode.

Display system time

Press the [D] button on the front panel to switch the display information between RDS information, system time and playing source.

RESET

Note:

* When the [RESET] button is pressed, frequencies of radio stations, titles, etc. stored in memory are cleared.

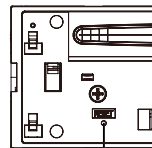

RESET

System Setup

At all mode, press and hold [**D**] button to enter system setup. Press [**◀**] or [**▶**] button to select options, rotate the [**VOLUME**] knob to adjust.

AF: ON/OFF (RADIO mode)

Rotate the [**VOLUME**] knob to choose AF ON or OFF.

REG: ON/OFF (RADIO mode)

Rotate the [**VOLUME**] knob to choose REG ON or OFF.

DX/LO (RADIO mode)

Rotate the [**VOLUME**] knob to choose radio local or distant at radio mode.

- LO: Only stations with strong signal can be received.
- DX: Stations with strong and weak signals can be received.

AUX SENS (AUX mode)

Rotate the [**VOLUME**] knob to choose AUX Input sensitivity LOW, MID or HIGH at AUX mode.

AUTO CON: ON/OFF (BT mode)

Rotate the [**VOLUME**] knob to choose AUTO CON ON or OFF.

PIN CODE

Rotate and press the [**VOLUME**] knob to choose a 4-digit password. Press the [**VOLUME**] knob more than 1 seconds to confirm.

The PIN CODE default setting is "0000".

SCRN SVR: ON/OFF

Rotate the [**VOLUME**] knob to choose SCRNV SVR (screen saver) ON or OFF.

SCROLL: ON/OFF

For track information that is longer than the display panel:

When SCROLL is ON, the LCD will display ID3 TAG information cyclely, e.g: TRACK->FOLDER->FILE->ALBUM->TITLE->ARTIST->TRACK->...

When SCROLL is OFF, the LCD will display one of the ID3 TAG information, the default is TRACK, but user can adjust it to other ID3 TAG information by press [**D**] button.

DIMMER: ON/OFF

Rotate the [**VOLUME**] knob to choose DIMMER ON or OFF.

- ON: LCD dimmer is active when small light of vehicle is turned ON.
- OFF: LCD always maximum brightness regardless of the vehicle small light.

REAR/S-W

Rotate the [**VOLUME**] knob to choose REAR or SUB-WOOFER.

BEEP: ON/OFF

Rotate the [**VOLUME**] knob to choose button beep sound ON or OFF.

MIC SEL (BT mode)

Rotate the [**VOLUME**] knob to choose Microphone EXTERNAL or INTERNAL.

MIC GAIN (BT mode)

Rotate the [**VOLUME**] knob to choose Mic gain: 1, 2, 3, 4, 5.

You can change the gain of MIC when a telephone partner cannot hear your voice.

Audio Setup

Press the **[SOUND]** button to enter sound effect setting mode. First press shows current EQ. Rotate the **[VOLUME]** knob to changes BEAT EQ in this order:

OFF -> B-BOOST -> IMPACT -> EXCITE -> CUSTOM

Rotate the **[VOLUME]** knob to changes CUSTOM, and press the **[VOLUME]** knob, the press **[◀◀]** or **[▶▶]** button to select it including: BAS-G -> BAS-F -> BAS-Q -> MID-G -> MID-F -> MID-Q -> TRE-G -> TRE-F, rotate the **[VOLUME]** knob to select a value.

BAS-G / MID-G / TRE-G: (-7)- (+7)

BAS-F: 60 / 80 / 100 / 200

BAS-Q: 1.0 / 1.25 / 1.5 / 2.0

MID-F: 500 / 1K / 1.5K / 2.5K

MID-Q: 0.5 / 0.75 / 1.00 / 1.25

TRE-F: 10.0K / 12.5K / 15.0K / 17.5K

Press the **[SOUND]** button, then press **[◀◀]** or **[▶▶]** button to select USER preset including:

BALANCE -> FADER -> M-B EX -> LPF (low pass filter) -> S-W VOL (Subwoofer Volume), rotate the **[VOLUME]** knob to select a value.

BALANCE: LEFT 1-7->CENTER->RIGHT 1-7

FADER: FRONT 1-7->CENTER->REAR 1-7

M-BEX: ON/OFF

LPF: THROUGH / 80 / 120 / 160

SUBW VOL: (-6)- (+6)

Radio Operations

Select tuner as playing source

Press **[SRC / ⏪]** button once or more to enter **RADIO** mode.

Select one radio band

Press the **[BAND]** button on the panel to select one radio band among FM1, FM2, FM3, MW and LW.

Manual tuning

During manual tuning, the frequency will be changed in steps.

Press the **[◀◀]** or **[▶▶]** button on the panel to tune in a higher / lower station.

Auto tuning

Press and hold the **[◀◀]** or **[▶▶]** button on the panel to seek a higher / lower station. To stop searching, repeat the operation above or press other buttons having radio functions.

Note:

When a station is received, searching stops and the station is played.

Preset scan

Preset scan receives the stations stored in preset memory in order. This function is useful when searching for a desired station in memory.

1. Press the **[PS/AS]** button.
2. When a desired station is tuned in, press the **[PS/AS]** button again to continue receiving that station.

Note:

- Be careful not to press and hold the **[PS/AS]** button for 1 second or longer, otherwise the auto store function is engaged and the unit starts storing stations.

Auto store

Only stations with sufficient signal strength will be detected and stored in the memory. Press and hold the **[PS/AS]** button (1 sec.) to start automatic station search.

To stop auto store, press other buttons having radio functions.

Notes:

1. After auto store, the previous stored stations will be overwritten.
2. The unit has 5 bands, such as FM1, FM2, FM3, MW and LW. FM3, MW and LW can store by AS function. Each bands can store 6 stations, CZ301E can store 30 stations in total.

Manual store

When one expected radio station has been detected, press and hold number button 1-6 to store it in the memory.

Radio Operations

Recall the stored stations

Press one numeric button among 1 to 6 on the panel to select the corresponding stored station.

Local seeking

When LOCAL seeking is on, only those radio stations with strong radio signal could be received.

To open or close LOCAL function, press and hold the [**D**] button on the front panel, then press [**>>>**] button repeatedly until **LO** or **DX** displays on the screen, and rotate the

[**VOLUME**] knob to select Local or Distant mode.

Note:

The number of radio stations that can be received will decrease after the local seeking mode is on.

Radio Data System Operations

Radio Data System

This unit has a built-in "Radio Data System" decoder system that supports broadcast stations transmitting "Radio Data System" data.

When using the "Radio Data System" function, always set the radio to FM mode.

AF function

The AF function switches to a different frequency on the same network in order to maintain optimum reception.

* The factory default setting is "ON".

1. Set to system setup by long pressing [**D**] button.
2. Press the [**<<<**] or [**>>>**] button to select "AF".
3. Rotate the knob to select "ON" or "OFF".
 - **ON:**
"AF" indicator appears in the display and AF function turns on.
 - **OFF:**
"AF" indicator disappears in the display and AF function turns off.

REG (Regional programme) function

When the REG function is ON, the optimum regional station can be received. When this function is OFF, if the regional station area

switches as you drive, a regional station for that region is received.

* The factory default setting is "ON".

Notes:

- This function is disabled when a national station such as BBC R2 is being received.
 - The REG function ON/OFF setting is valid when the AF function is ON.
1. Set to system setup by long pressing [**D**] button.
 2. Press the [**<<<**] or [**>>>**] button to select "REG".
 3. Rotate the [**VOLUME**] knob to select "ON" or "OFF".

Manually tuning a regional station in the same network

This function is valid when the AF function is ON and the REG function is OFF.

Note:

This function can be used when a regional broadcast of the same network is received.

TA (Traffic Announcement)

In the TA standby mode, when a traffic announcement broadcast starts, the traffic announcement broadcast is received as top priority regardless of the function mode so you can listen to it. Traffic programme (TP) automatic tuning is also available.

- * This function can only be used when “**TP**” appears in the display. When “**TP**” appears, this means that the “Radio Data System” broadcast station being received has traffic announcement programmes.

Setting the TA standby mode

If you press the **[TA]** button, “**TA**” lights in the display and the unit is set into the TA standby mode until a traffic announcement is broadcast. When a traffic announcement broadcast starts, “**TRAF INF**” appears in the display. If you press the **[TA]** button while a traffic announcement broadcast is being received, the traffic announcement broadcast reception is cancelled and the unit goes into the TA standby mode.

Cancelling the TA standby mode

As “**TA**” appears in the display, press the **[TA]** button. The “**TA**” in the display goes off and the TA standby mode is cancelled.

PTY (Programme Type)

This function enables you to listen to a broadcast of the selected programme type even if the unit is on a function mode other than radio.

- * Some countries do not yet have PTY broadcast.
- * In the TA standby mode, a TP station has priority over a PTY broadcast station.

Selecting PTY

Press **[MENU]** button, then rotate the **[VOLUME]** knob to select PTY type, press the **[VOLUME]** knob, the unit begin searching.

CD/MP3/WMA Operations

This unit can play back MP3/WMA files

Notes:

- If you play a WMA file with active DRM (Digital Rights Management), no audio is output (The WMA indicator blinks).

To disable DRM

(Digital Rights Management)

When using Windows Media Player 9/10/11, click on Tool -> Options -> Copy Music tab, then under Copy Settings, unclick the Check box for Copy Project Music. Then, reconstruct files.

Personally constructed WMA files are used at your own responsibility.

Precautions when creating MP3/WMA file

Usable sampling rates and bit rates

1. MP3: Sampling rate 8 kHz-48 kHz, Bit rate 8 kbps-320 kbps / VBR
2. WMA: Bit rate 8 kbps-320 kbps

File extensions

1. Always add a file extension “.MP3”, “.WMA” to MP3, WMA file by using single byte letters. If you add a file extension other than specified or forget to add the file extension, the file cannot be played.
2. Files without MP3/WMA data will not play. The files will be played soundlessly if you attempt to play files without MP3/WMA data.
 - * When VBR files are played, the play time display may differ the play location.
 - * When MP3/WMA files are played, a little no sound part is caused between tunes.

Logical format (File system)

1. When writing MP3/WMA file on a CD-R disc or CD-RW disc, please select “ISO9660 level 1, 2 or Joliet or Romeo” or Apple ISO as the writing software format. Normal play may not be possible if the disc is recorded on another format.
2. The folder name and file name can be displayed as the title during MP3/WMA play but the title must be within 32 single byte alphabetical letters and numerals (including an extension).
3. Do not affix a name to a file inside a folder having the same name.

Folder structure

A disc with a folder having more than 8 hierarchical levels will be impossible.

Number of files or folders

1. Up to 999 files can be recognized per folder. Up to 3000 files can be played.
2. Tracks are played in the order that they were recorded onto a disc. (Tracks may not always be played in the order displayed on the PC.)
3. Some noise may occur depending on the type of encoder software used while recording.

Eject function

Just pressing the [▲] button, ejects the disc even if the power to the unit was not turned on.

Notes:

- If you force a CD into before auto reloading, this can damage the CD.
- If a CD (12 cm) is left ejected for 15 seconds, the CD is automatically reloaded (Auto reload).

CD/MP3/WMA Operations

Listening to a disc already loaded in the unit



Press the [SRC / ] button to select the CD/MP3/WMA mode.

When the unit enters the CD/MP3/WMA mode, play starts automatically.

Loading a CD

Insert a CD into the center of the CD SLOT with facing up. The CD plays automatically after loading.

Notes:

- Never insert foreign objects into the CD SLOT.
- If the CD is not inserted easily, there may be another CD in the mechanism or the unit may require service.
- Discs without the  or  mark and CD-ROMs cannot be played by this unit.
- Some CD-R/CD-RW disc may not be usable.

Pausing play

1. Press the [4] button to pause play. "PAUSE" appears in the display.
2. To resume CD play, press the [4] button again.

Displaying CD titles

This unit can display title data for MP3/WMA disc.

When SCROLL is OFF, each time you press the [D] button to change the title display.

MP3/WMA disc



Track -> Folder -> File title -> Album -> Title
-> Artist -> Track ...

Notes:



- If MP3/WMA disc is not input TAG, "NO TITLE" appears in the display.
- Only ASCII characters can be displayed in Tags.

Selecting a track

Track-up

1. Press the [] button to move ahead to the beginning of the next track.
2. Each time you press the [] button, the track advances ahead to the beginning of the next track.
3. For MP3/WMA disc, press and hold the [6] button (1 sec.) to move ahead to +10 tracks.

Track-down

1. Press the [] button to move back to the beginning of the current track.
2. Press the [] button twice to move back to the beginning of the previous track.
3. For MP3/WMA disc, press and hold the [5] button (1 sec.) to move back to -10 tracks.

Fast-forward/Fast-reverse

Fast-forward

Press and hold the [] button .



Fast-reverse

Press and hold the [] button .

* For MP3/WMA discs, it takes some time until the start of searching and between tracks. In addition, some errors may occur in the play time.

Folder Select

This function allows you to select a folder containing MP3/WMA files and start playing from the first track in the folder.

1. Press the [5] or [6] button.
Press the [6] button to move the next folder. Press the [5] button to move the previous folder.
2. To select a track, press the [] or [] button.

Search Function

1. Press the [MENU] button to enter FOLD SCH mode. Press the [VOLUME] button to enter the folder list search mode.
2. Turn the [VOLUME] knob to select a folder.
3. Press the [VOLUME] button to enter the file list search mode. And then the track list appears in the display.
4. Turn the [VOLUME] knob to select a track.
5. Press the [VOLUME] knob to play.

CD/MP3/WMA Operations

- * When play back MP3 / WMA file, this function is performed in the current folder.

Top function

The top function resets the CD player to the first track of the disc. Press and hold the [4] button (1 sec.) to play the first track (track No. 1) on the disc.

- * In case of MP3/WMA, the first track of the current folder will be played.

Other various play functions

Scan play

This function allows you to locate and play the first 10 seconds of all the tracks recorded on a disc.

Press the [1] button to perform scan play.

Repeat play

This function allows you to play the current track repeatedly or play a track currently being played in the MP3/WMA folder repeatedly.

CD:

1. Press the [2] button once or more until "RPT ON" appears on the LCD to perform repeat play.
2. Press [2] button again to cancel repeat playback, "RPT OFF" appears on the LCD.

MP3/WMA:

1. Press the [2] button once or more until "TRACK RPT" appears on the display to perform repeat play, and "RPT" segment lights on.
2. For MP3/WMA files, press [2] button repeatedly until "FOLD RPT" appears on the display for folder repeat play.
3. Press [2] button repeatedly until "RPT OFF" appears on the display to cancel repeat playback, and "RPT" segment goes off.

Random play

This function allows you to play all tracks recorded on a disc in a random order.

Press the [3] button to perform random play.

Random function activates when jumping to another track.

USB Operations

1. Push the cap of the USB connector to the right. Insert a USB cable (CCA-755) into the USB connector. Insert a USB device into the USB cable.
When connecting a USB device, the unit will read the files automatically.
2. To remove the USB device, you should first select another source or turn off the power, in order to avoid damaging the USB device. Then take off the USB device. Push the cap to the left.
3. Operation is same as MP3/WMA operation.

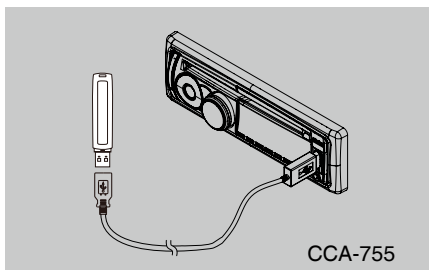

AUX Operations

Press [**SRC** / ϕ] button on the panel to select "**AUX**".

AUX is just for audio content with 3.5mm Jack connector plugged into audio-in socket on the front panel.

AUX Input sensitivity setting

1. Press and hold the [**D**] button (1 sec.).
2. Turn the [**VOLUME**] knob to select "**AUX SENS**".
3. If the output level of connected external audio player is "**HIGH**", rotate [**VOLUME**] knob and choose "**LOW**". And if the output level is "**LOW**", choose "**HIGH**".

Bluetooth Operations

The Bluetooth allows you to utilize your car's built-in audio system for wireless mobile phone or music handsfree communication. Some Bluetooth mobile phones have the audio features, and some portable audio players support Bluetooth feature. This system can play audio data stored in a Bluetooth audio device. The car stereo with Bluetooth will be able to retrieve phonebook contacts, received call, dialed call, missed call, incoming calls, outgoing call and listen to music.

Note:

- Do not leave the microphone of Bluetooth handsfree in the places with wind passing such as air outlet of the air conditioner, etc. This may cause a malfunction.
- If leave it in the places subjected to direct sun, high temperature can cause distortion, discoloration which may result in a malfunction.
- This system will not operate or may operate improperly with some Bluetooth audio players.
- **Clarion** cannot guarantee the compatibility of all mobile phones together with unit.
- Audio playback will be set to the same volume level as set during telephone call. This might cause problems, if extreme volume level is set during telephone call.

Handsfree Operations

Pairing

1. Turn on Bluetooth function of your mobile phone.
2. Enter mobile phone's Bluetooth setup menu.
3. Search for new Bluetooth devices.
4. Select **CZ301** from the pairing list on the mobile phone.
5. Enter "0000" as the password (The password default setting is "0000").
6. After pairing successfully, the unit will enter Bluetooth mode automatically, and "CONNECTED" will appear on the LCD.

Making a call

Operation from Bluetooth menu

Press the [SRC / \oplus] button to switch the source to "BLUETOOTH". Press [MENU / \curvearrowright] button to select a way to make outgoing call:

• Dial Number

1. Press the [MENU / \curvearrowright] button.
2. Press the [VOLUME] knob on the front panel to switch: "SIM", "DIAL", "DIALLED", "MISSED", "RECEIVED", "MEMORY".
3. Press the [VOLUME] knob to confirm the selection, "WAITING" will appear on the LCD.
4. Rotate the [VOLUME] knob to select a number, press the knob to confirm and ready to input the next digit. Repeat the above until all numbers inputted.
5. Press the [BAND / \curvearrowleft] to dial.
6. Press [MENU / \curvearrowright] to terminate call.

• Dialed/Missed/ Received Call History

You can search any Dialed/Missed/Received Call History.

1. Rotate the [VOLUME] knob to select "DIALLED", "MISSED" or "RECEIVED".
2. Press the [VOLUME] knob to enter the selected call history.
3. Rotate the [VOLUME] knob to scroll the contacts.
4. When the contact name or mobile phone No. is displayed, press the [BAND / \curvearrowleft] button to call the mobile phone No. of that contact.
* Press the [MENU / \curvearrowright] button to end the call.

Bluetooth Operations

• Call from Phonebook

User can search the contact name in the phonebook and make call.

1. Rotate the [VOLUME] knob to select "SIM", "MEMORY".
2. Press the [VOLUME] knob to enter the selected phonebook.
3. Rotate the [VOLUME] knob to scroll the contacts.
4. When the contact name is displayed, press the [BAND / L] button to call the mobile phone No. of that contact.
* Press the [MENU / C] button to end the call.

• Answering a call

You can answer an incoming call by pressing the [BAND / L] button.

* Press the [MENU / C] button to reject an incoming call.

Audio Streaming Operations

What is audio streaming?

Audio streaming is a technique for transferring audio data such that it can be processed as a steady and continuous stream. Users can stream music from their external audio player to their car stereo wirelessly and listen to the tracks through the car's speakers. Please consult your nearest **Clarion** dealer for more information on the product of wireless audio streaming transmitter offered.

CAUTION

Please avoid operating your connected mobile phone while audio streaming as this may cause noise or sound choppy on the song playback.

Audio streaming may or may not resume after telephone interrupt as this is dependent on mobile phone.

System will always return to Radio mode if audio streaming is disconnected.

Note:

Be sure to read the chapter "Pairing before proceeding."

Play / Pause a track

1. Push the [4] button to pause audio playback.
2. To resume audio playback, push the [4] knob again.

Selecting a track

Track-up

1. Press the [▶▶] button to move to the beginning of the next track.
2. Each time the [▶▶] button is pressed, playback proceeds to another track in the advancing direction.

Track-down

1. Press the [◀◀] button to move to the beginning of the previous track.
2. Each time the [◀◀] button is pressed, playback proceeds to previous track in the reverse direction.

Note:

Playing order will depend on Bluetooth audio player. When [◀◀] button is pressed, some A2DP devices will restart the current track depends on the duration of playback. During music streaming playback, "A2DP" will be shown on the display. Information about tracks (e.g. the elapsed playtime, song title, etc.) cannot be displayed on this unit. When A2DP device is disconnected, "BT DISCONNECT" will be shown on the display and return to previously selected audio source. Some Bluetooth audio players may not have play / pause synchronized with this unit. Please make sure both device and main unit are in the same play / pause status in **BT MUSIC** mode.

6. TROUBLE SHOOTING

GENERAL

Problem	Cause	Measure
Unit can not power on.	Unit fuse blown.	Replace with new fuse of correct rating.
	Car battery fuse blown.	Replace with new fuse of correct rating.
Unit can not power on. Nothing happens when buttons are pressed. Display is not accurate.	The microprocessor has malfunctioned due to noise, etc.	Turn off the power and remove the DCP. Press the [RESET] button with a thin rod. Note: When the [RESET] button is pressed, turn off the ACC power.* * When the [RESET] button is pressed, frequencies of radio stations, titles, etc. stored in memory are cleared.
No/low audio output.	Improper audio output connection.	Check wiring and correct.
	Volume set too low.	Increase volume level.
	Speakers damaged.	Replace speakers.
	Heavily biased volume balance.	Adjust the channel balance to center position.
	Speaker wiring is in contact with metal part of car.	Insulate all speaker wiring connections.
Poor sound quality or distortion.	Non-standard disc used.	Use a standard disc.
	Speaker power rating does not match unit.	Replace speakers.
	Wrong connections.	Check wiring and correct.
	Speaker is shorted.	Check wiring and correct.
Tel-Mute malfunction	MUTE wire is grounded.	Check the MUTE wiring and correct.
Unit resets itself when engine is off.	Incorrect connection between ACC and Battery.	Check wiring and correct.

DISC Player

Problem	Cause	Measure
Disc cannot be loaded.	Another disc is already loaded.	Eject the disc before loading the new one.
	There is an object installed inside the unit.	Remove the object inside the unit.
Sound skips or is noisy.	Compact disc is dirty.	Clean the compact disc with a soft cloth.
	Compact disc is heavily scratched or warped.	Replace with a compact disc with no scratches.
Sound is bad when power is first turned on.	Condensation may form on the internal lens when the car is parked in a humid place.	Let dry for about 1 hour with power on.

USB Devices

Problem	Cause	Measure
USB device cannot be inserted.	The USB device has been inserted with wrong direction.	Reversing the connection direction of the USB device, try it again.
	The USB connector is broken.	Replace with a new USB device.
USB device is not recognized.	The USB device is damaged.	Disconnect the USB device and reconnect. If the device is still not recognized, try replacing with a different USB device.
	Connectors are loose.	
No sound heard with the display "No File" shown.	No MP3/WMA file is stored in the USB device.	Store these files properly in the USB device.
Sound skips or is noisy.	MP3/WMA files are not encoded properly.	Use MP3/WMA files encoded properly.

Bluetooth

Problem	Cause	Measure
Cannot pair the Bluetooth enabled device with the car audio system.	The device does not support the profiles required for the system.	Use another device to connect.
	The Bluetooth function of the device is not enabled.	Refer to the user manual of the device for how to enable the function.
The audio quality is poor after connection with a Bluetooth-enabled device.	The microphone is not correctly positioned.	Adjust the position of the microphone. For example, stick the microphone onto the dashboard where close to the driver.
	The Bluetooth reception is poor.	Move the device closer to the car audio system or remove any obstacle between the device and the system.

7. ERROR DISPLAYS

If an error occurs, one of the following displays is displayed.
Take the measures described below to solve the problem.

Display	Cause	Measure
ERROR 3	Disc is inserted incorrectly.	Eject the disc then reload it properly.
	The disc format is not supported.	Try another disc.
ERROR 5	This is a failure of deck's mechanism.	Consult your store of purchase.

If an error display other than the ones described above appears, press the **[RESET]** button. If the problem persists, turn off the power and consult your store of purchase.

- * When the **[RESET]** button is pressed, frequencies of radio stations, titles, etc. stored in memory are cleared.

8. SPECIFICATIONS

FM Tuner

Frequency range: 87.5-108.0MHz
 Usable sensitivity: 8dB μ
 Frequency response: 30Hz-15kHz
 Stereo separation: 30dB(1kHz)
 Signal/noise ratio: >55dB

MW Tuner

Frequency range: 531- 1602kHz
 Usable sensitivity (S/N=20dB): 30dB μ

LW Tuner

Frequency range: 153-279kHz
 Usable sensitivity (S/N=20dB): 30dB μ

CD Player

System: Disc digital audio system
 Frequency response: 20Hz-20kHz
 Signal/noise ratio: >80dB
 Total harmonic distortion: Less than 0.1% (1kHz)
 Channel separation: >60dB

MP3/WMA mode

MP3 sampling rate: 8 kHz to 48 kHz
 MP3 bit rate: 8 kbps to 320 kbps / VBR
 WMA bit rate: 8 kbps to 320 kbps
 Logical format: ISO9660 level 1,2
 Joliet or Romeo file system

USB

Specification: USB 1.0/2.0
 Playable audio format:
 MP3(.mp3): MPEG 1/2/Audio Layer-3
 WMA(.wma): Ver 7/8/9.1/9.2

Bluetooth

Specification: Bluetooth Ver. 2.0+EDR
 Profile: HFP (Hands-free Profile)
 PBAP(Phone Book Access Profile)
 A2DP (Advanced Audio Distribution Profile)
 AVRCP (AV Remote Control Profile)
 Send/Receive Sensitivity: Class 2

Audio Amplifier

Maximum power output:
 180W (45W x 4)
 Speaker impedance: 4 Ω (4 to 8 Ω allowable)

Input

Audio input sensitivity:
 High: 320mV (at 1V output)
 Mid: 650mV (at 1V output)
 Low: 1.3V (at 1V output)
 (input impedance 10 k Ω or greater)
 Aux-in level: \leq 2V

General

Power supply voltage:
 14.4VDC (10.8 to 15.6V allowable),
 negative ground
 Pre-Amp output voltage:
 2.0V (CD play mode: 1kHz, 0dB, 10k Ω load)
 Fuse: 15A
 Dimensions of the Main Unit:
 188mm Width x 58mm Height x 190mm Depth
 Weight of the Main Unit: 1.35kg

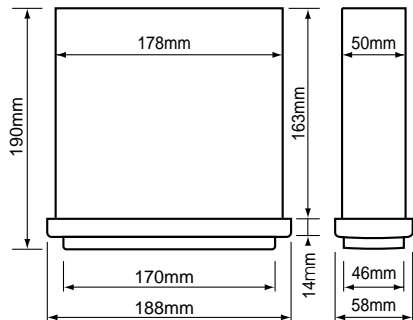

Notes:

- Specifications and design are subject to change without notice for further improvement.

9. INSTALLATION / WIRE CONNECTION GUIDE

CONTENTS

1) Before Starting	23
2) Package Contents	23
3) General Cautions	23
4) Cautions on Installation	24
5) Installing the Source Unit	24
6) Removing the Source Unit	26
7) Wiring and Connections	27
8) Connecting the accessories	28

1) Before Starting

1. This set is exclusively for use in cars with a negative ground 12 V power supply.
2. Read these instructions carefully.
3. Be sure to disconnect the battery terminal before starting. This is to prevent short circuits during installation. (Figure 1)

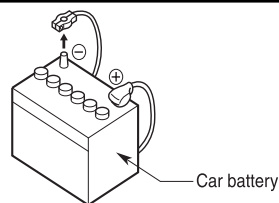

Figure 1

2) Package Contents

Source unit	1	L-key	2
Front panel	1	Wire connector	1
Trim ring	1	DCP case	1
Mounting bracket	1	Owner's manual	1
Special screw	1	Warranty card	1
Rubber cap	1	Special screw (Front panel lock)	1
Screws M5x6 mm	4		

3) General Cautions

1. Do not open the case. There are no user serviceable parts inside. If you drop anything into the unit during installation, consult your dealer or an authorized **Clarion** service center.
2. Use a soft, dry cloth to clean the case. Never use a rough cloth, thinner, benzine, or alcohol etc. For tough dirt, apply a little cold or warm water to a soft cloth and wipe off the dirt gently.

4) Cautions on Installation

1. Prepare all articles necessary for installing the source unit before starting.
2. Install the unit within 30° of the horizontal plane. (Figure 2)
3. If you have to do any work on the car body, such as drilling holes, consult

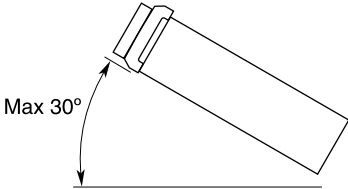

Figure 2

4. your car dealer beforehand.
4. Use the enclosed screws for installation. Using other screws can cause damage. (Figure 3)

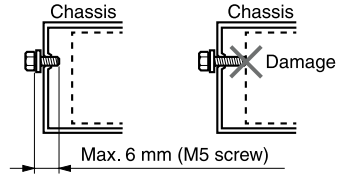

Figure 3

5) Installing the Source Unit

1. Place the mounting bracket into the instrument panel, use a screwdriver to bend each stopper of the mounting bracket inward, then secure the stopper.
2. Wire as shown in Section 7) .
3. Insert the source unit into the mounting bracket until it locks.
4. Take care of the top and bottom of the trim ring and mount it so that all the hooks are locked.

Notes:

1. Some car models require special mounting kits for proper installation. Consult your **Clarion** dealer for details.
2. Fasten the front stopper securely to prevent the source unit from coming loose.

• Console opening dimensions

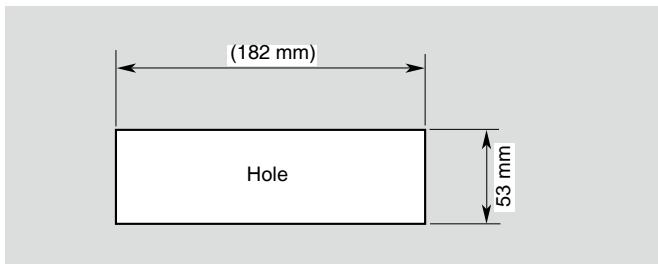

Notes of installation

1. Before installation, please make sure proper connections are conducted and the unit operates normally. Improper connection may result in damage to the unit.
2. Use only accessories designed and manufactured for this unit and other unauthorized accessories may result in damage to the unit.
3. Before installation, please fasten all power cables.
4. DO NOT install the unit in the place where close to hot area to prevent damage to electrical components such as the laser head.
5. Install the unit horizontally. Installing the unit more than 30 degree vertically may result in worse performance.
6. To prevent electric spark, connect the positive pole first and then the negative pole.

7. DO NOT block the cooling fan exit to ensure sufficient heating dissipation of this unit, or it may result in damage to this unit.

Unit Installation

Method A

1. Insert mounting bracket into dash board, choose appropriate mounting tab according to the gap width, bending the mounting tab outwards with a screwdriver to fix the mounting bracket in place.
2. Screw in 1 piece of M4x42 to the hole of the unit back and put on a rubber cap over the screw. (see picture below)
3. Slide the unit into the bracket until you hear a click sound.

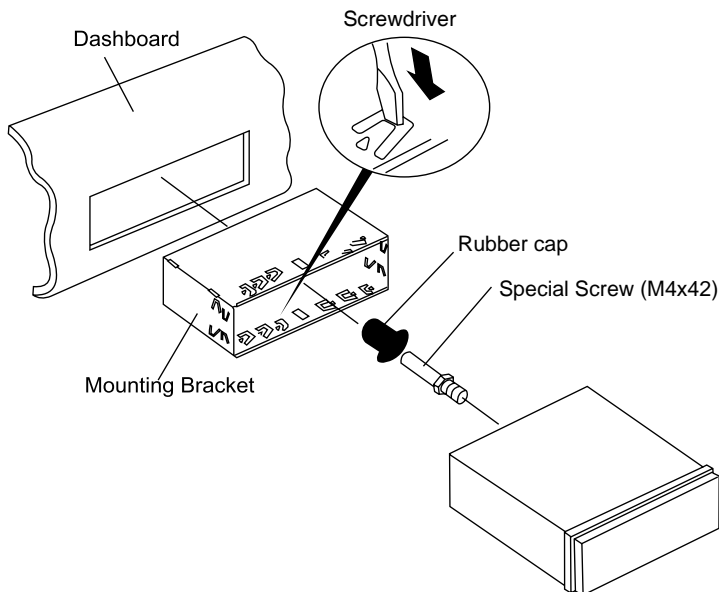

Method B

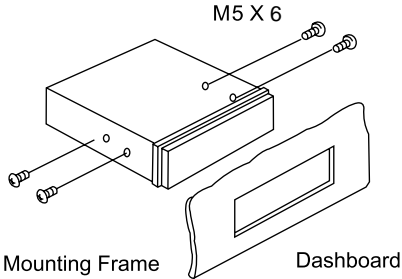
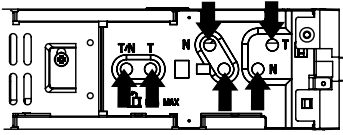

1. Insert this unit directly to the opening of the dashboard.
2. Place M5x6 cylindrical screw through the holes of the mounting frame located inside the opening to holes of the unit and fasten the screws to left & right.

Trim ring installation

Attach the trim ring around the front panel.

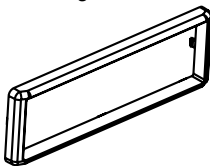

6) Removing the Source Unit

Disassemble trim ring

1. Push the trim ring to right and pull out the right part.

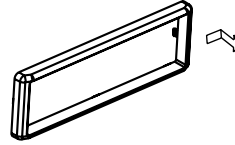

2. Push the trim ring to left and pull out the left part.

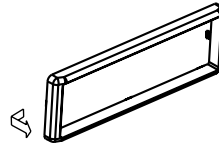

Disassemble the unit

1. Switch off the power.
2. Remove the panel.
3. Remove the trim ring.
4. Insert the removal keys straight back until they lock, then pull the unit out.

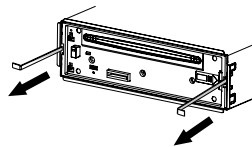

5. Disconnect all the wires.

7) Wiring and Connections

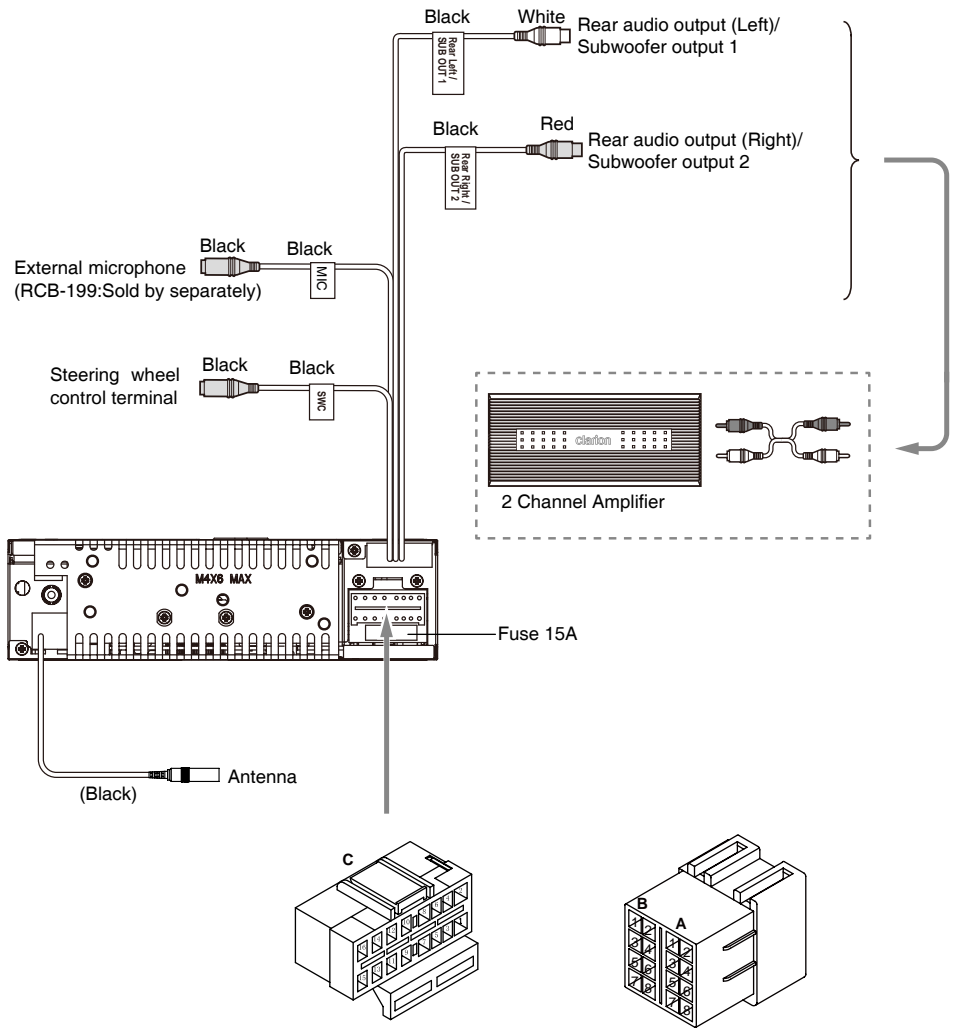

Refer to next page

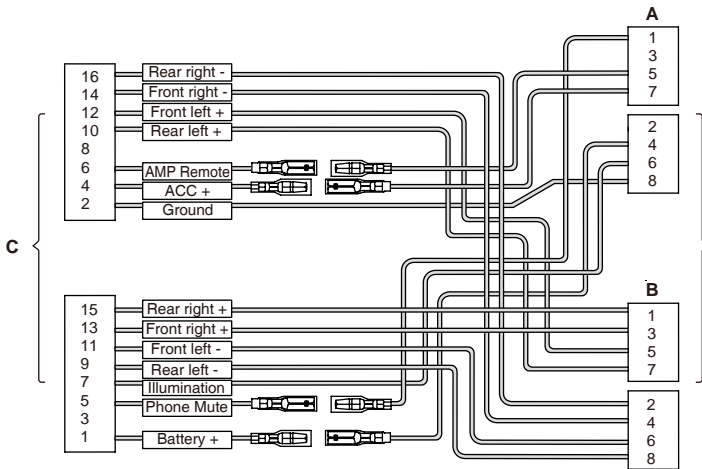

Location	Function	
	Connector A	Connector B
1		Rear right (+) / Purple
2		Rear right (-) / Purple with black stripe
3		Front right (+) / Grey
4	Battery 12V(+) / Yellow	Front right (-) / Grey with black stripe
5	Remote On / Blue with white stripe	Front left (+) / White
6	Illumination / Orange with white stripe	Front left (-) / White with black stripe
7	ACC+ / Red	Rear left (+) / Green
8	Ground / Black	Rear left (-) / Green with black stripe

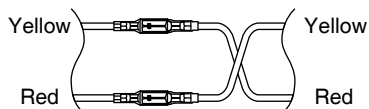

For VW and Audi: Change wiring like above.

8) Connecting the accessories

• Connecting to the external amplifier

External amplifiers can be connected to the 2 channel RCA output connections. Ensure that the connectors are not grounded or shorted to prevent damage to the unit.



English:

Declaration of conformity

We **Clarion** declares that this model CZ301E is following the provision of Directive 1999/5/EC with the essential requirements and the other relevant regulations.

Français:

Déclaration de conformité

Nous, **Clarion**, déclarons que ce modèle CZ301E est conforme aux exigences essentielles et aux autres dispositions pertinentes de la directive 1999/5/CE.

Deutsch:

Konformitätserklärung

Wir, **Clarion**, erklären, dass dieses Modell CZ301E den Bestimmungen der Richtlinie 1999/5/EG im Hinblick auf die grundlegenden Anforderungen und andere relevante Bestimmungen entspricht.

Italiano:

Dichiarazione di conformità

Clarion dichiara che il presente modello CZ301E è conforme ai requisiti essenziali e alle altre disposizioni pertinenti stabiliti dalla direttiva 1999/5/CE.

Nederlands:

Conformiteitsverklaring

Clarion verklaart dat het model CZ301E in overeenstemming is met de essentiële eisen en andere relevante voorschriften van de bepalingen van Richtlijn 1999/5/EC.

Español:

Declaración de conformidad

Clarion declara que este modelo CZ301E cumple con los requisitos esenciales y otras disposiciones aplicables descritos en la Directiva 1999/5/CE.

Svenska:

Intyg om överensstämmelse

Härmed intygar **Clarion** att denna modell CZ301E uppfyller kraven i direktiv 1999/5/EG gällande väsentliga egenskaper och övriga relevanta bestämmelser.

Polski:

Deklaracja zgodności

Firma **Clarion** niniejszym oświadcza, że model CZ301E jest zgodny z istotnymi wymogami oraz innymi odpowiednimi postanowieniami Dyrektywy 1999/5/WE

Ελληνική:

Δήλωση συμμόρφωσης

Εμείς στην **Clarion** δηλώνουμε ότι αυτό το μοντέλο CZ301E ακολουθεί τις προβλέψεις της Οδηγίας 1999/5/EC σχετικά με τις βασικές απαιτήσεις και τους άλλους σχετικούς κανονισμούς.

Italy

Dichiarazione di conformità:

Io mandatario nell' UE: **Clarion** Europe S.A.S. Z.I. du Pré à Varois, Route de Pompey, 54670 Custines, Francia Dichiaro che il prodotto CZ301E è conforme al DM 28-08-1995 ottemperando alle prescrizioni dei DM 25-06-1985 e DM 27-08-1987.

Ministerial authorization FI DM 27-08-1987 n° of protocol: 0071307 date 22/10/2010

Clarion Europe S.A.S.

Z.I. du Pré à Varois, Route de Pompey, 54670 Custines, FRANCE

telephone: +(33)3-83-49-4400 facsimile: +(33)3-83-49-4421

Clarion Co., Ltd.

All Rights Reserved. Copyright © 2010: Clarion Co., Ltd.
Printed in China / Imprimé en Chine / Gedruckt in China
Stampato in Cina / Gedrukt in China / Impreso en China
Tryckt i Kina / Wydruковано w Chinach / Εκτυπώθηκε στην Κίνα

PN:127075013065