

# HQ Pro-Stitcher®

## PREMIUM

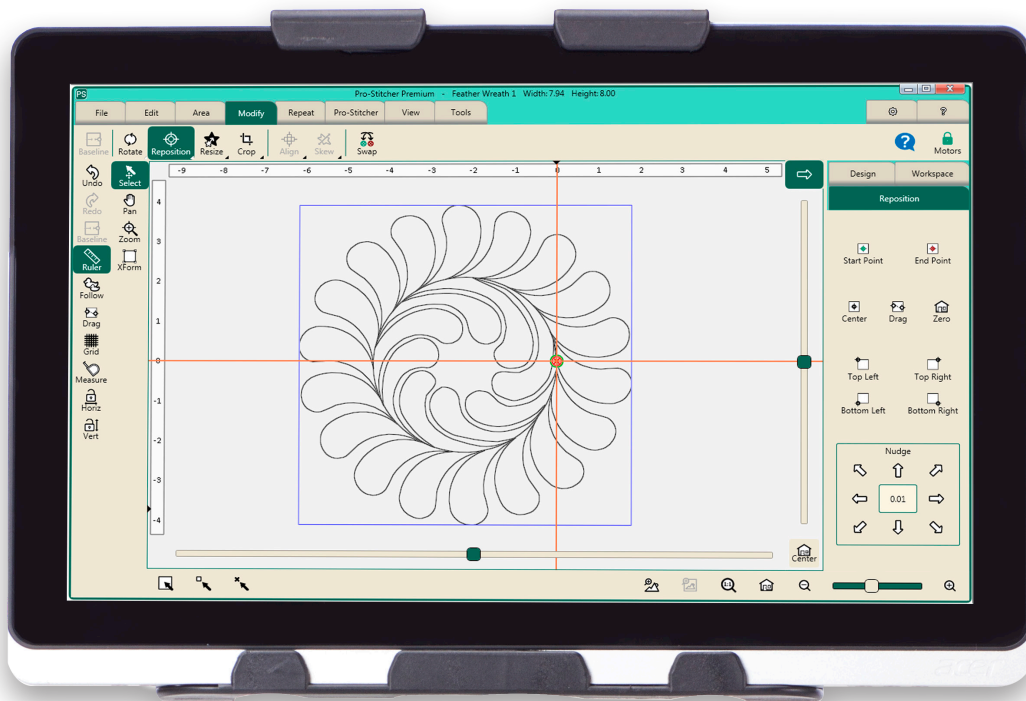

## GETTING STARTED GUIDE

QM30010-1

## Online resources

Download a version of this manual at: <http://www.handiquilter.com/manuals/>

Check for software updates to HQ Pro-Stitcher Premium at: <http://www.handiquilter.com/prostitcher-download/>

Access videos about your Handi Quilter products: <http://www.handiquilter.com/videocatalog/>

Download tutorials for HQ Pro-Stitcher Premium: <http://www.handiquilter.com/education/pro-stitcher/>

Participate in online forums with other Handi Quilter owners: <http://www.handiquilter.com/forum/>

Follow Handi Quilter on Facebook: <https://www.facebook.com/HandiQuilter>

© 2016 Handi Quilter, Inc. All rights reserved.

The information contained in this document is subject to change without notice. If you find any problems in the manual, please report them to us in writing. This document is not warranted to be error-free. Handi Quilter, Inc. assumes no responsibility or liability for any errors or inaccuracies that may appear in the informational content contained in this manual.

Handi Quilter, HQ Infinity, HQ Avanté, HQ Fusion, HQ Simply Sixteen, HQ Sixteen, HQ Sweet Sixteen, and HQ Pro-Stitcher are either trademarks or registered trademarks of Handi Quilter, Inc.

# Table of Contents

---

- Important Safety Instructions ..... 3**
  
- Installation Instructions ..... 7**
  - Congratulations on your HQ Pro-Stitcher® purchase ..... 7
  - Parts List ..... 8
  - Installation (HQ Fusion, HQ Avanté, and HQ Simply Sixteen)..... 11
  - Installation of the X-Rack and Y-Rack ..... 11
  - Y-encoder circuit board replacement ..... 13
  - Installation (HQ Sixteen and HQ Avanté with 4-wheel carriage)..... 22
  - Y-Encoder Assembly Installation (HQ Sixteen only)..... 26
  - Install the power cord retaining clamp (HQ Sixteen only)..... 27
  - C-Pod Replacement (HQ Sixteen only) ..... 28
  - Set Up the New Carriage ..... 29
  - To Attach the Tablet Computer..... 32
  - To turn on and shut down HQ Pro-Stitcher ..... 35
  - Getting started with HQ Pro-Stitcher ..... 36
  
- Troubleshooting ..... 38**
  
- Warranty ..... 44**
  - Warranty Registration Card ..... 47
  - Training Checklist ..... 49

# Important Safety Instructions

---

## Save these instructions

This machine is intended for household or commercial use.

## Disclaimer

Handi Quilter and its Representatives are in no way legally responsible or liable for damage to the HQ Pro-Stitcher when used improperly or not in accordance with the guidelines stated in this manual or when used on machine quilting frames not recommended by Handi Quilter.

## Read all instructions before using

When using any machine, basic safety precautions should always be taken, including the following: Read all instructions before using.

## **WARNING - To reduce the risk of burns, fire, electric shock, or injury to persons:**

The HQ Pro-Stitcher quilting machine should never be left unattended when plugged in. Always unplug the machine from the electric outlet immediately after using and before cleaning.

- Do not allow to be used as a toy. Close attention is necessary when this quilting machine is used by or near children.
- Use this quilting machine only for its intended use as described in this manual. Use only attachments recommended by the manufacturer as contained in this manual.
- Never operate this quilting machine if it has a damaged cord or plug, if it is not working properly, if it has been dropped or damaged, or dropped into water. Return the quilting machine to the nearest authorized dealer or service center for examination, repair, electrical or mechanical adjustment.
- Never operate the machine with any air openings blocked. Keep ventilation openings of the machine free from the accumulation of lint, dust, and loose cloth.
- Never drop or insert any object into any opening.
- Do not use outdoors.
- Do not operate where aerosol (spray) products are being used or where oxygen is being administered.
- To disconnect, shut down the computer, then disconnect all cables.
- Do not unplug by pulling on cord. To unplug, grasp the plug, not the cord.
- Keep fingers away from all moving parts.
- Always unplug the machine from the electrical outlet when removing covers, lubricating, or when making any other user servicing adjustments mentioned in the instruction manual.
- This appliance is not intended for use by persons (including children) with reduced physical, sensory, or mental capabilities, or lack of experience or knowledge, unless they have been given supervision or instruction concerning use of the appliance by a person responsible for their safety.
- Use only the power cord set provided by the manufacturer or a certified replacement set from the manufacturer.

# Read these instructions before using the machine.

## *To use the machine safely*

1. Keep hands and loose clothing away from wheels, gears or other moving parts.
2. Turn the machine off and unplug the cord in the following cases:
  - when you have stopped using the machine
  - when you replace or remove the quilting machine needle or any other part
  - in case of failure when you use the machine
  - when you check or clean the machine
  - when you leave the machine unattended
3. Connect the machine directly to the wall outlet. Do not use extension cords.

## *To increase the life of your machine*

1. Do not store this machine in areas exposed to direct sunlight or high humidity. Never use or store the machine near a heater, an iron, a halogen lamp or other hot things.
2. Clean the computer monitor with a soft, lint-free rag. If necessary, dampen the rag with a small amount of isopropyl alcohol. Do not use any other cleaners on the computer monitor.
3. Use only neutral soaps or detergents to clean the carriage. Benzene, solvents and scouring powders can damage the machine and therefore should never be used.
4. Do not drop or bump the machine.
5. Always consult the manual to replace or fix any other part of the machine.

## *To repair or adjust the machine*

- If the machine breaks down or needs adjustment, first check the troubleshooting chart in the appendix to inspect and adjust the machine yourself.

## Conservez ces consignes

Cette machine est destinée à un usage domestique.

## Avertissement

Handi Quilter et ses représentants ne sont en aucun cas juridiquement responsables des dommages causés à HQ Pro-Stitcher lorsque celle-ci est utilisée de manière inadéquate ou non conforme aux consignes énoncées dans ce manuel ou lorsqu'elle est utilisée sur des cadres de machine à quilter non recommandés par Handi Quilter.

## Lisez toutes les consignes avant d'utiliser le produit

Lorsque vous utilisez une machine, vous devez toujours prendre des précautions de sécurité de base, notamment ce qui suit : lisez toutes les consignes avant d'utiliser le produit.

## **AVERTISSEMENT : pour réduire le risque de brûlures, d'incendie, de choc électrique ou de blessures :**

Ne jamais laisser la machine à quilter HQ Pro-Stitcher sans surveillance lorsqu'elle est branchée. Débranchez toujours la machine de la prise électrique immédiatement après usage et avant de la nettoyer.

- Ne pas l'utiliser comme un jouet. Il est nécessaire de faire preuve de vigilance lorsque cette machine à quilter est utilisée à côté ou à proximité d'enfants.
- Utilisez cette machine à quilter uniquement pour l'usage prévu décrit dans ce manuel. Utilisez uniquement les accessoires recommandés par le fabricant décrits dans ce manuel.
- Ne jamais utiliser cette machine à quilter si le cordon ou la fiche est endommagé, si elle ne fonctionne pas correctement, si on l'a fait tomber ou endommagé, ou si elle est tombée dans l'eau. Renvoyez la machine à quilter au revendeur ou centre de service après-vente agréé le plus proche pour examen, réparation, ou réglage électrique ou mécanique.
- Ne jamais utiliser la machine si des ouvertures d'air sont bloquées. Gardez les ouvertures de ventilation de la machine libérées d'accumulation de peluches, poussières et morceaux de tissu.
- Ne jamais faire tomber ou insérer un objet dans une ouverture.
- Ne pas utiliser à l'extérieur.
- Ne pas utiliser là où des aérosols (vaporisateurs) sont utilisés ou de l'oxygène est administré.
- Pour déconnecter, arrêtez l'ordinateur, puis débranchez tous les câbles.
- Ne pas débrancher en tirant sur le cordon. Pour débrancher, saisir la fiche, non le cordon.
- N'approchez pas les doigts des parties mobiles.
- Débranchez toujours la machine de la prise électrique pour retirer des couvercles, lubrifier, ou pour tout autre réglage d'entretien de l'utilisateur mentionné dans le manuel d'instruction.
- Cet appareil n'est pas destiné à être utilisé par des personnes (y compris les enfants) dotées de facultés physiques, sensorielles, ou mentales réduites, ou manquant d'expérience ou de connaissances, sauf si elles ont été formées et encadrées sur l'utilisation de cet appareil par une personne responsable de leur sécurité.
- Utilisez uniquement le cordon d'alimentation fourni par le fabricant ou une pièce de rechange certifiée par le fabricant.

# Lisez ces consignes avant d'utiliser la machine.

## *Pour utiliser la machine en toute sécurité*

1. N'approchez pas les mains et les vêtements amples des roues, des engrenages ou des autres pièces mobiles.
2. Mettez la machine hors tension et débranchez le cordon dans les cas suivants :
  - lorsque vous avez fini d'utiliser la machine
  - lorsque vous remplacez ou retirez l'aiguille ou une autre pièce de la machine à quilting
  - en cas de défaillance lorsque vous utilisez la machine
  - lorsque vous inspectez ou nettoyez la machine
  - lorsque vous laissez la machine sans surveillance
3. Connectez la machine directement à la prise murale. Ne pas utiliser de rallonges.

## *Pour augmenter la durée de vie de votre machine*

1. Ne pas ranger cette machine dans des endroits exposés à la lumière directe du soleil ou à une forte humidité. Ne jamais utiliser ni ranger la machine à proximité d'un radiateur, d'un fer à repasser, d'une lampe halogène ou d'autres objets brûlants.
2. Nettoyez l'écran d'ordinateur avec un chiffon doux non pelucheux. Au besoin, humidifiez le chiffon avec une petite quantité d'alcool isopropylique. Ne pas utiliser d'autres produits de nettoyage sur l'écran d'ordinateur.
3. Utilisez uniquement des savons ou détergents neutres pour nettoyer le chariot. Le benzène, les solvants et les poudres à récurer peuvent endommager la machine et ne doivent donc jamais être utilisés.
4. Ne pas faire tomber ou cogner la machine.
5. Consultez toujours le manuel pour remplacer ou réparer toute autre pièce de la machine.

## *Pour réparer ou régler la machine*

- Si la machine tombe en panne ou doit être réglée, consultez d'abord les consignes de dépannage figurant en annexe pour inspecter et régler vous-même la machine.

# Installation

---

## Congratulations on your HQ Pro-Stitcher® Premium purchase

Handi Quilter is proud to offer you easy-to-use quilting machines and computer-guided quilting using the latest technology with the best value for your money. We provide inspiration and education to enhance your transition into computer-guided machine quilting.

Because the world of computer-guided quilting is constantly changing, we invite you to keep up with us by checking our website frequently for news, software updates, tutorials, and more.

### Go to [www.HandiQuilter.com](http://www.HandiQuilter.com) for:

- Updates to the HQ Pro-Stitcher software (provided free as long as you own your machine)
- A full-color version of this manual that can be downloaded and printed
- Updates to this manual
- Step-by-step tutorials to help you learn how to use HQ Pro-Stitcher
- Free design downloads
- News about hardware upgrades or new machines
- Links to educational information: webinars, retreats, and more

### Want to be in the know?

Sign up to join the Handi Quilter e-mail Newsletter list to receive notice of updates, upgrades, special offers, contests, new products and free stuff at: [www.HandiQuilter.com/newsletter/subscribe/](http://www.HandiQuilter.com/newsletter/subscribe/).

### Machine packaging information

Keep the carton and packing materials. You will need them in the event that you need to return the machine to the dealer or send it for repair. If you do not pack the machine properly or if you do not use the correct packaging materials, the machine could be damaged. Handi Quilter is not liable for damage that occurs during return shipping.

### Handi Quilter contact information

Handi Quilter, Inc.  
501 N 400 W  
North Salt Lake, Utah 84054

Toll-free phone: (877) 697-8458  
Local phone: (801) 292-7988

Email Address: [HQcares@HandiQuilter.com](mailto:HQcares@HandiQuilter.com)

Website: [www.HandiQuilter.com](http://www.HandiQuilter.com)



## Optional U.S. Grounding

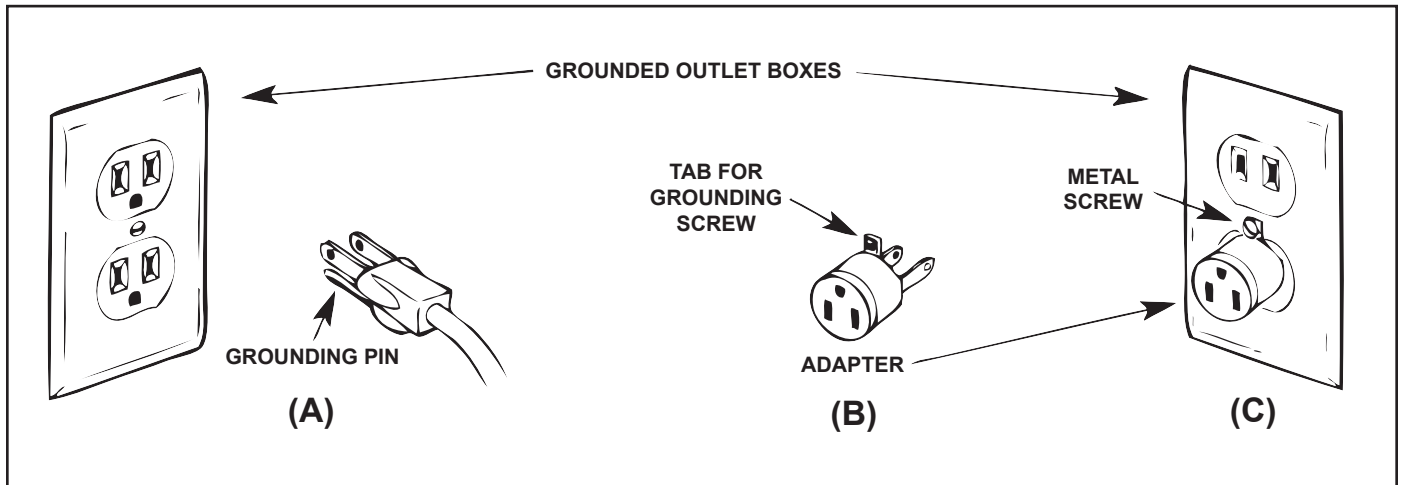



This product is for use on a nominal 120 V or nominal 220 V circuit, and has a grounding plug that looks like the plug illustrated in sketch A above. A temporary adapter, which looks like the adapter illustrated in sketches B and C, may be used to connect this plug to a 2-pole receptacle as shown in sketch B if a properly grounded outlet is not available. The temporary adapter should be used only until a properly grounded outlet can be installed by a qualified electrician. The green colored rigid ear, lug, and the like, extending from the adapter, must be connected to a permanent ground such as a properly grounded outlet box cover. Whenever the adapter is used, it must be held in place by the metal screw.











➡ **IMPORTANT:** In Canada, the use of a temporary adapter is not permitted by the Canadian Electric Code.



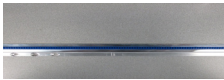







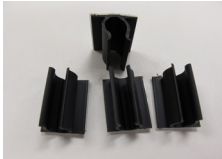

## Parts List

This list shows the parts of the HQ Pro-Stitcher. Items A through Q are for the HQ Avantié (8-wheel carriage version) and HQ<sup>24</sup> Fusion. Items A through U are for the HQ Sixteen and HQ Avantié (4-wheel carriage version). Items G, R, S, or T may not be included or needed.

✎ **NOTE:** The parts photographed in this manual may look different from the ones you received.

Item	Quantity	Photo
A. Blue X-axis Flexirack (12 feet)	1	
B. X-axis Flexirack clamps and screws	4	

C. 3/32-inch drill bit	1	
D. Emergency base-plate repair kit	1	
E. EZ Carriage	1	
F. Computer bracket	1	
G. Y-encoder circuit board	1	
H. Y-axis mounting bracket assembly	1	
I. Power cord assembly		
I-1. 10-foot power cord	1	
I-2. 2-foot power cord (quilting machine to carriage)	1	
I-3. 2-foot power cord (wall to filter box)	1	
I-4. Power filter box (for HQ Avanté or HQ <sup>24</sup> Fusion)	1	
OR		
I-5. Y-power cord (10-foot) (for HQ Sixteen only)	1	

J. Adhesive cable mounting clips	4	
K. USB flash drive	1	
L. Art & Stitch software	1	
M. USB cable	1	
N. Computer power cord	1	
O. Manual engagement/disengagement tool	1	
P. Harness cable		
Q. HQ Pro-Stitcher tablet computer  <b>NOTE:</b> The model of the HQ Pro-Stitcher computer may be different from the one pictured.	1	
R. HQ Sixteen Y-Encoder	1	
S. Power Cord Retaining Clamp	1	
T. 3M Command Adhesive Strips	6	

# Installation (HQ Fusion, HQ Avanté, and HQ Simply Sixteen)

These instructions are for installing HQ Pro-Stitcher on the HQ Fusion, HQ Avanté, and HQ Simply Sixteen (with an 8-wheel Precision-Glide carriage). Handi Quilter recommends installation by an authorized HQ Pro-Stitcher Retailer if available.

## Tools required

- Power drill
- 4mm Allen wrench
- 5mm Allen wrench
- Slotted screwdriver (one large and one small)
- Phillips screwdriver (one large and one small)
- Manual engagement/disengagement tool (*see Parts List, item O*)

## Installation of the X-Rack and Y-Rack

### *To install the X-Rack*

1. Remove the blue 12-foot Flexirack (*see Parts List, item A*) and the Pro-Stitcher carriage (*see Parts List, item E*) from the box.

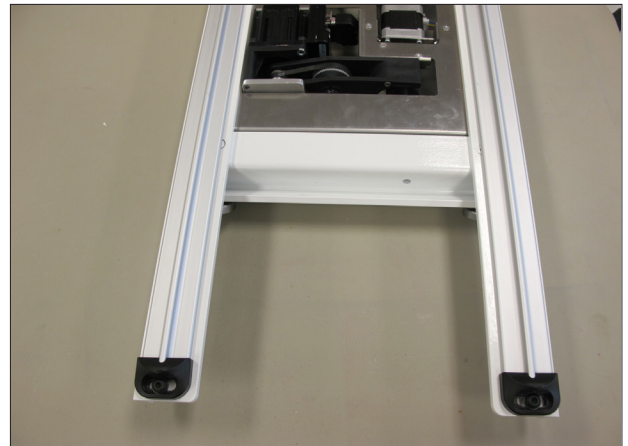

2. Place the Pro-Stitcher carriage on the frame. Starting at one end of the table, begin mounting the blue Flexirack to the front of the table while aligning it to the front white gear on the carriage.

Peel back a few inches of the pink protective layer of the tape. Position the blue Flexirack by aligning it to the white gear as you move down the table. Press down on the blue Flexirack to stick it firmly to the table.

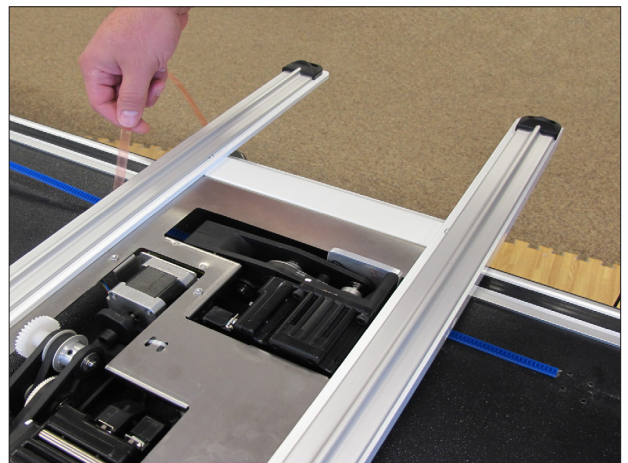

3. Use the carriage as a guide and align the blue Flexirack with the white gear along the length of the table (see arrow at right), removing the pink protective layer and pressing downward on the blue Flexirack while moving down the entire length of the table.

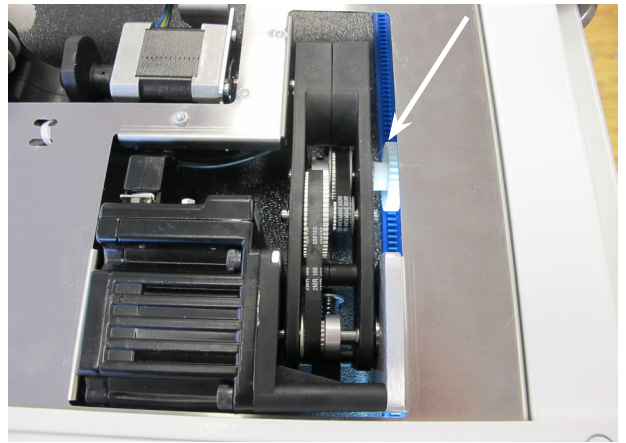

4. Double check the alignment of the carriage white gear with the blue Flexirack by rolling the carriage along the entire length of the table.
5. Trim the Flexirack to length using a knife or wire cutters. The blue Flexirack does not need to extend the full width of the table and can be a couple of inches shorter on either end.



6. At both ends of the blue Flexirack, use two of the small metal clamps (see *Parts List, item B*) to hold the ends firmly in place. The clamps have a hole through the center and a lip on one end. The lip should be on the side opposite the blue Flexirack. Place the clamps where they will be attached and drill pilot holes using the 3/32-inch drill bit and then use a Phillips screwdriver to fasten the clamps on both sides of the Flexirack to the table.

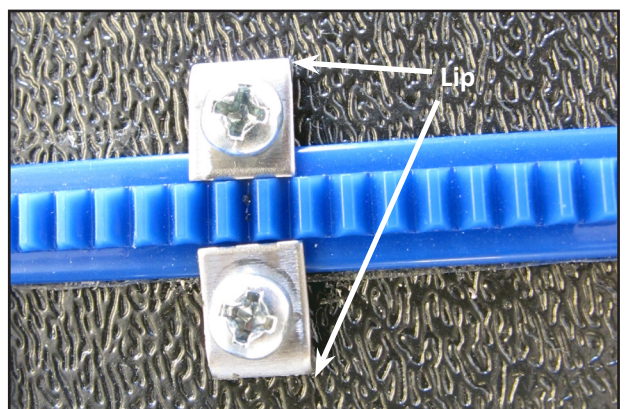
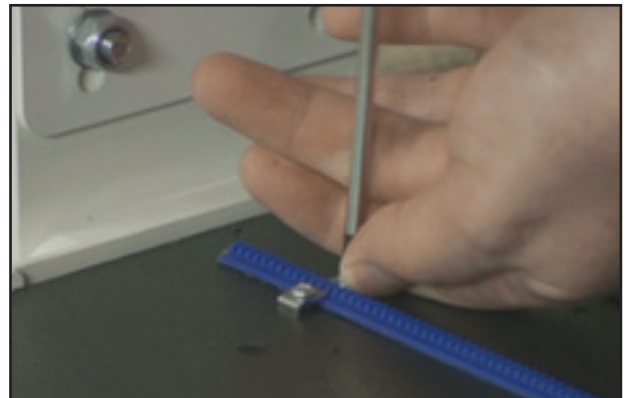

△ **CAUTION:** Do not use the larger drill bit included in the emergency repair kit, as this is the wrong size for the Flexirack clamps.

✍ **NOTE:** As an alternative, use one clamp at each end. Slide the lip of the clamp over the last gear of the blue Flexirack, drill a pilot hole, and screw in place.

### To Install the Y-Rack

1. Carefully lay the quilting machine on its power pod side (the left side, looking from the front).

Underneath the base plates, near the wheels on the C-pod side of the machine (the side with the thread tensioner and guides) there will be either two screws or two holes. If the screws are there, use a large flat screwdriver to remove the screws.



2. Attach the Y-Rack to the bottom of the front and rear base plates. The blue Flexirack should be toward the middle of the machine while the bolt holes should be toward the outside. Use the screws that were removed from the front and rear base plates (or use the two smallest screws in the Base Plate Repair Kit [see *Parts List, item D*])



△ **CAUTION:** Be careful not to over-tighten the screws as the base plate holes will strip easily. In case of accidentally cross-threading or stripping one of the base plate holes, an emergency repair kit (see *Parts List, item D*) has been provided.

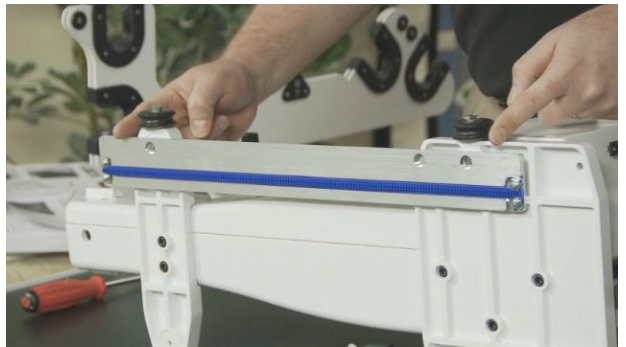

3. If the screws in the base plates do not have slotted heads and a nut driver cannot be fitted over the screw head, use one of the provided slotted screws as a replacement (*see Parts List, item D*) and use a slotted screwdriver to tighten the screws in place.

## Y-encoder circuit board replacement

- **IMPORTANT:** This step is required *only* if the circuit board on the Y-encoder is blue. If the Y-encoder has a black circuit board, skip ahead to the next section.

Replace the Y-encoder circuit board with the one in the package (*see Parts List, item G*) if the circuit board is blue and does not have a 3-pin connector attached. It is held in place with one screw and five connecting pins.

*Replace this style Y-encoder circuit board.*

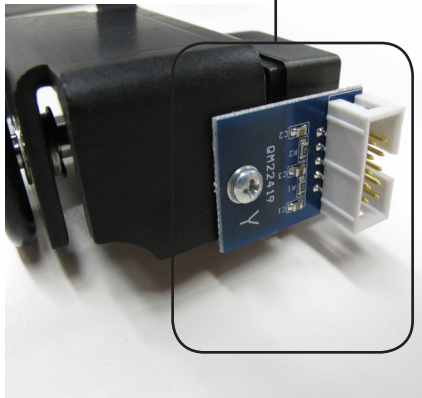

*This style Y-encoder circuit board does not need to be replaced.*

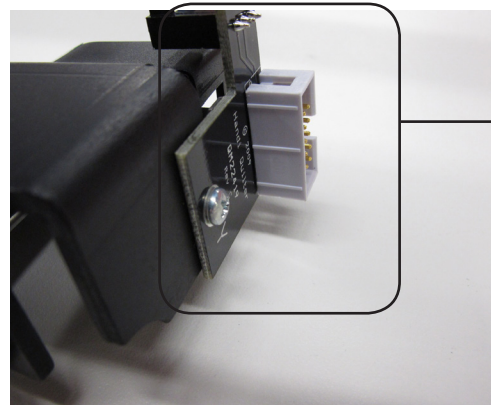

### ***To replace the Y-encoder***

1. Unplug the stitch regulator cable from the Y-encoder.
2. Remove the screw that holds the circuit board in place with a small Phillips screwdriver.

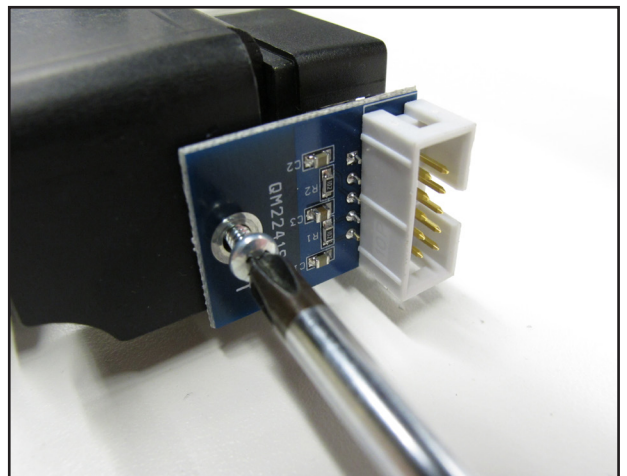

3. Gently pull the circuit board outward toward the front of the quilting machine (the same direction the screw came out).
4. Align the new Y-Encoder circuit board so the five pins on the encoder fit into the five-pin connector on the circuit board and gently push into position. The screw hole on the circuit board should match up with the hole in the encoder housing.

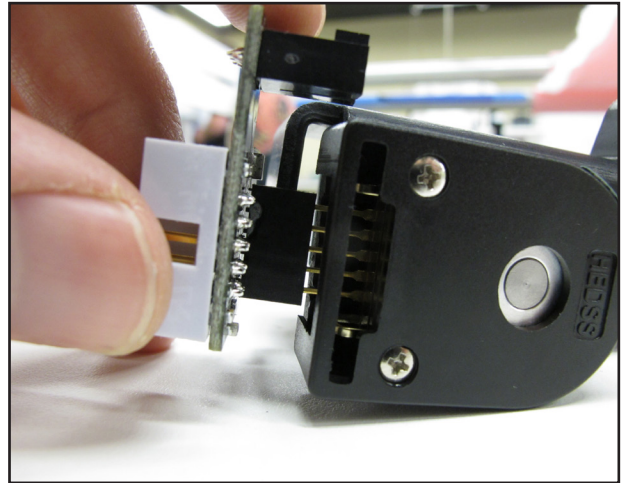

5. Replace the Phillips screw.
6. Plug the stitch regulator cable into the new Y-encoder circuit board.



## To set up the HQ Pro-Stitcher carriage

1. Place the Pro-Stitcher carriage on the frame system with the connectors toward the back of the frame. Carefully lift the quilting machine and place it on the carriage so the wheels engage the white carriage tracks, making sure not to set the wheels on top of the stitch regulator cable. This is easier to do with two people, one at each end of the quilting machine.
2. With one end of the stitch-regulator cable plugged into the machine's C-Pod and the middle connector plugged into the quilting machine's Y-encoder, plug the other end of the cable into the carriage X-encoder.

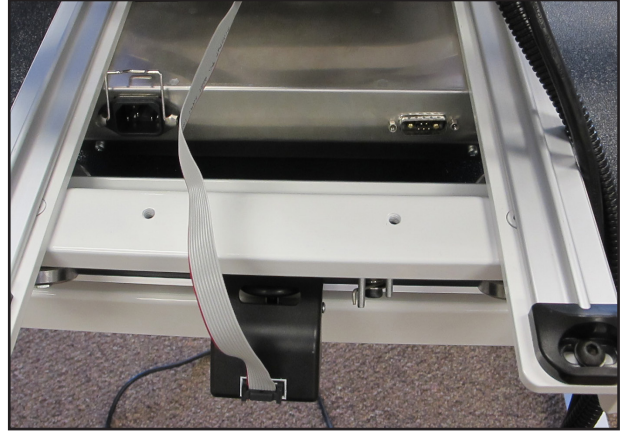

Attach harness cable.

3. Attach one end of the harness cable (see *Parts List, item P*) into the connector on the right side of the power supply. Tighten the side screws. You will plug the other ends to the bracket as part of step 5 when you attach the tablet computer.

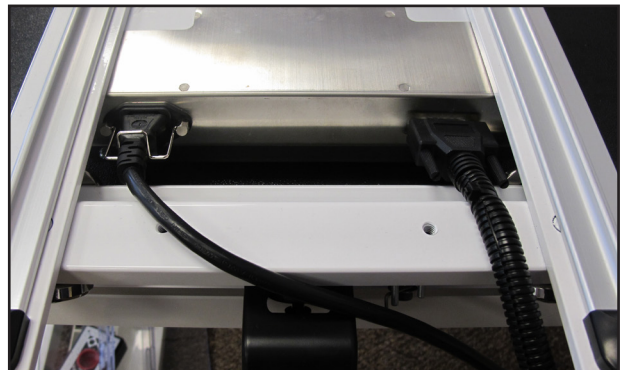

4. Connect one end of the two-foot power cord (see *Parts List, item I-2*) to the carriage power inlet and the other end into the quilting machine's P-pod lower power outlet.
5. If the quilting machine has a power cord attached, remove that cord and set it aside. Plug one end of the 10-foot power cord (*item I-1*) into the quilting machine's P-pod upper power outlet. The other end of the 10-foot power cord plugs into the power filter box (*I-4*). The remaining two-foot power cord plugs into the other end of the power filter box (*I-4*) and into a wall receptacle when the Pro-Stitcher setup is complete. Do not plug into the wall at this time.

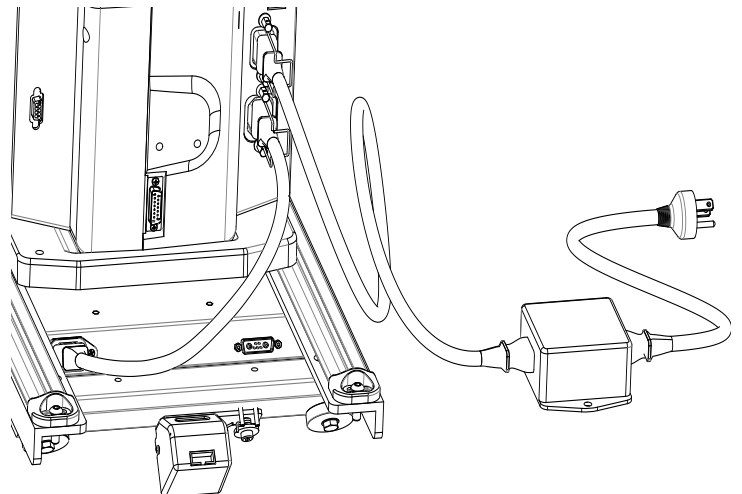

6. The black cables attached to the Pro-Stitcher carriage should be routed up between the rear handles and the quilting machine, toward the right-hand side of the machine (looking at the machine from the back). Attach the cable clips (see *Parts List, item J*) and route the cable accordingly.



7. The small black cable with the black 3-connector clip should be routed underneath the P-Pod and snapped into the quilting machine's Y-encoder.

The two black cables that run from the carriage up to the computer should be clipped into the cable clip under the rear handlebar to help prevent these cables from getting caught on the edges of the carriage.

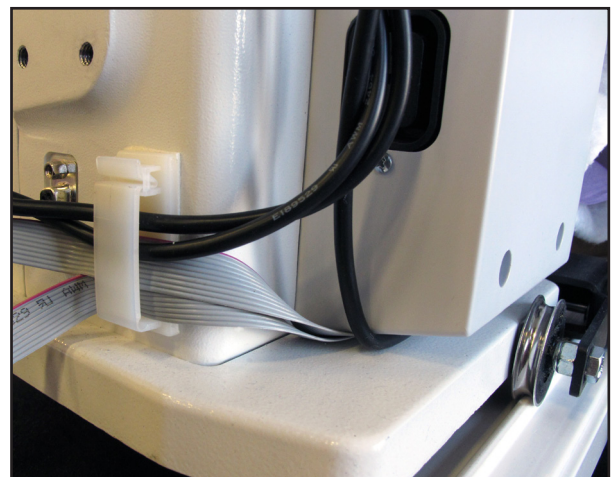

8. Once again verify that the y-axis gear engages the blue Flexirack for the y-axis.

- Do this by looking from the back of the machine between the bottom of the quilting machine and the top of the carriage. If necessary, use the manual engagement/disengagement tool to move the gears so they engage.
- If horizontal adjustment is needed to ensure that at least half the white gear and blue Flexirack are interlocking, loosen the two screws that mount the y-axis bracket to the base plates and push the bracket in the direction necessary while retightening the screws.
- Both screws can be adjusted with the quilting machine on the carriage. Pull the machine to the front to access the front screw and to the rear to access the rear screw.
- Pull the quilting machine to the rear of the carriage and ensure the rear of the Y-axis bracket does not collide with the black plastic track retainer on the rear of the carriage. Adjust the Y-bracket if needed.

➡ **IMPORTANT:** If necessary, use the manual engagement/disengagement tool to move the gears so they engage. Insert the end of the tool into the hole at the front of the EZ Carriage.

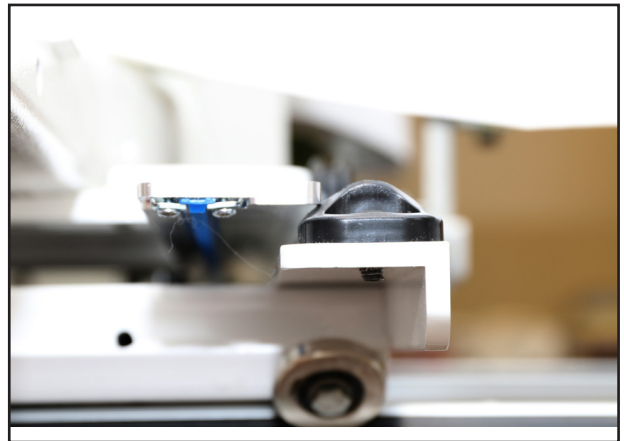
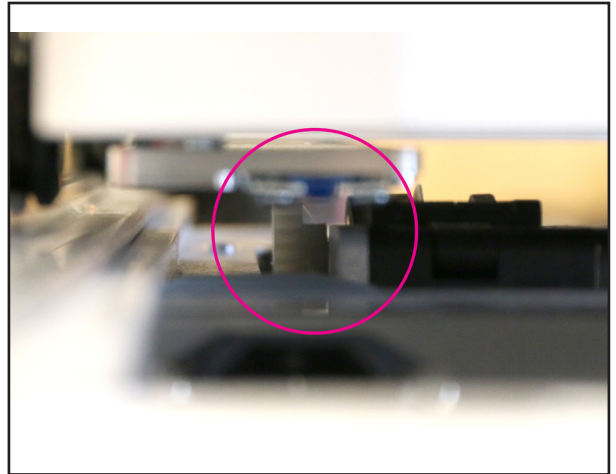

9. With the power cable plugged in and the motors in the engaged position (use the manual engagement/disengagement tool if necessary), ensure that as the quilting machine is moved in both the X and the Y directions, the corresponding gears are rotating as well.

## To attach the tablet computer

1. Disconnect the front handlebar cable from the side of the machine's head. Then remove the handlebars from the front of the quilting machine by removing the three hex-head bolts with a 5mm Allen wrench.

If you're having difficulty reaching the front handlebar cable, first remove two of the hex-head bolts and loosen the third bolt. Then, rotate the handlebar slightly to provide easier access to the handlebar cable.

2. Make sure the three handlebar bolts are in the front handlebar and protruding out the bottom of the handlebar.



3. Position the handlebar over the computer bracket such that the screws go through the three holes in the bracket.

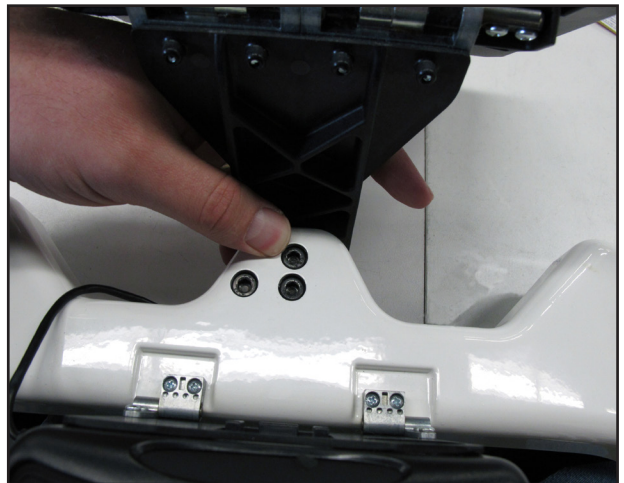

4. Secure the handlebar and bracket in place on the machine head using the three handlebar bolts.

5. The black cable has three connections – two 9-pin serial connectors and one barrel connector for power.



Insert the barrel connector into the center jack located on the bottom edge of the black box that is mounted to the back of the computer bracket. Attach the two 9-pin serial cables to the appropriate ports on the back of the same box, making sure cable connectors are plugged into their corresponding ports on the black box.

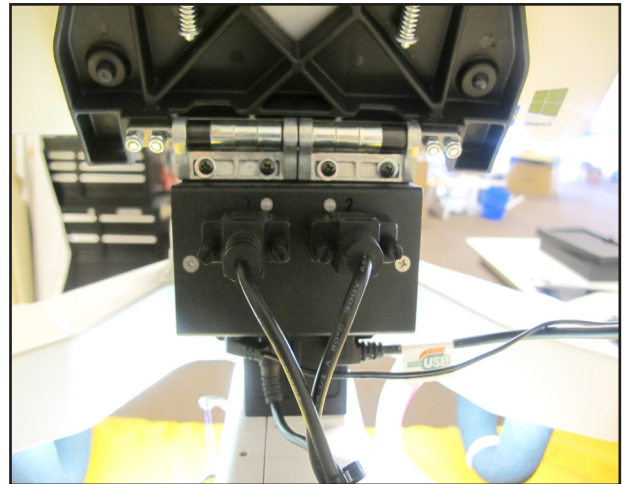

6. Remove the computer from its packaging. Install the computer into the computer bracket by sliding it into the black bracket from the side.



7. With the computer installed in the bracket, connect the USB short cable (see *Parts List, item M*) between the USB port, on the top-left side of the computer (position A) and the black box on the back of the bracket (position E).

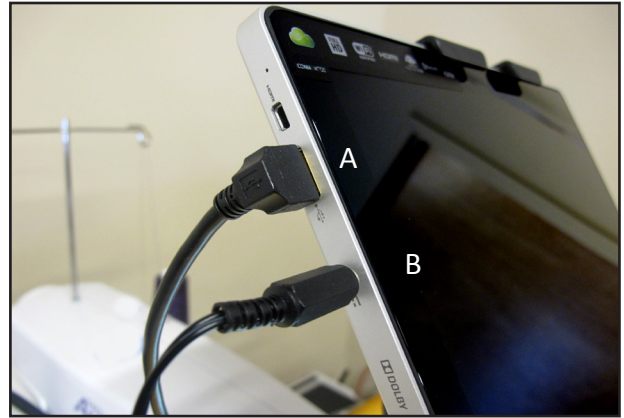

8. Also connect the computer power cord (see *Parts List, item N*) between the computer (position B) and the black box (position C).

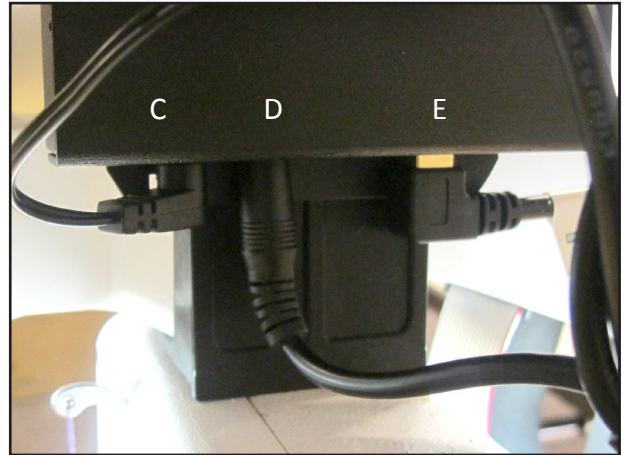

9. The open USB ports on the black box (position F) are for plugging in the USB Flash drive to load designs or update the software, or for plugging in a keyboard or mouse.

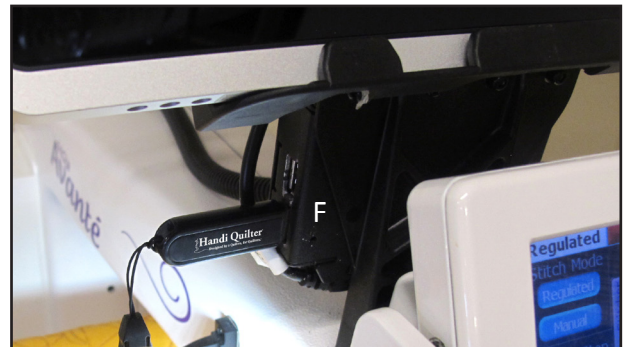

➡ **IMPORTANT:** The tablet shown is the Acer W700 series tablet. Your tablet may be a different make or model. Connect the USB and power cables in their proper location based upon your make and model of tablet.

# Installation (HQ Sixteen and HQ Avanté with 4-wheel carriage)

These instructions are for installing HQ Pro-Stitcher on the HQ Sixteen and HQ Avanté (with a 4-wheel carriage). Handi Quilter recommends installation by an authorized Handi Quilter Representative if available.

## Tools required

- Power drill
- 7/16-inch open end wrench
- 7/16-inch nut driver (or second wrench)
- 4mm Allen wrench
- 5mm Allen wrench
- Manual engagement/disengagement tool (see *Parts List, item O*)
- Slotted screwdriver (one large and one small)
- Phillips screwdriver (one large and one small)
- Knife and/or wire cutters

## Set frame height

Determine whether the quilting machine is placed on a Portable Professional Frame or an HQ Studio Frame and follow the appropriate instructions below.

### If you have a Portable Professional Frame

Portable Professional  
Frame center holes



The Portable Professional Frame (*Pro-Frame*) side arms have three sets of height-adjustment holes. The ideal setting for the HQ Pro-Stitcher is the middle set of holes. This should allow the quilting machine arm to pass freely under the idler bar while keeping the quilt as close as possible to the arm. Use the 7/16-inch wrench to adjust the height if necessary. The ideal height allows just the tip of a finger between the idler pole and the machine.

## If you have an HQ Studio Frame

The HQ Studio Frame may already be adjusted to the ideal height for the HQ Pro-Stitcher carriage. After following the assembly instructions below, if the idler pole (*the lower pole toward the back of the frame*) rubs on the free arm of the quilting machine, adjust the side arms to the next higher position check again and adjust if necessary. The ideal height allows just the tip of a finger between the idler pole and the machine.

## Installation of the X-Rack and Y-Rack

### To install the X-Rack

1. Make sure the front white track is mounted to the table with the 3M Command Strips (*see Parts List, item T*) that have been provided (*unless the front track is already mounted to the table*). Use the carriage as a guide to make sure there is no binding once the front track is mounted to the table.

2. Remove the blue 12-foot Flexirack (*see Parts List, item A*) and the HQ Pro-Stitcher carriage (*see Parts List, item E*) from the box.

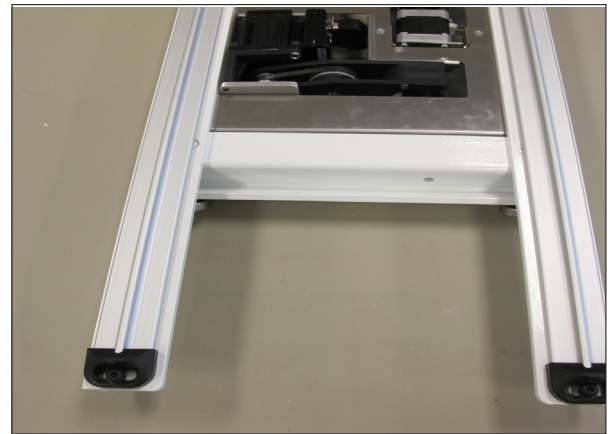

3. Place the HQ Pro-Stitcher carriage on the frame. Starting at one end of the table, begin mounting the blue Flexirack to the front of the table while aligning it to the front white gear on the carriage. Peel back just a few inches of the pink protective layer of the tape. Position the blue Flexirack by aligning it to the white gear as you move down the table. Press down on the blue Flexirack to stick it firmly to the table.





4. Use the carriage as a guide and align the blue Flexirack with the white gear along the length of the table (see arrow at right), removing the pink protective layer and pressing down on the blue Flexirack while moving down the entire length of the table.

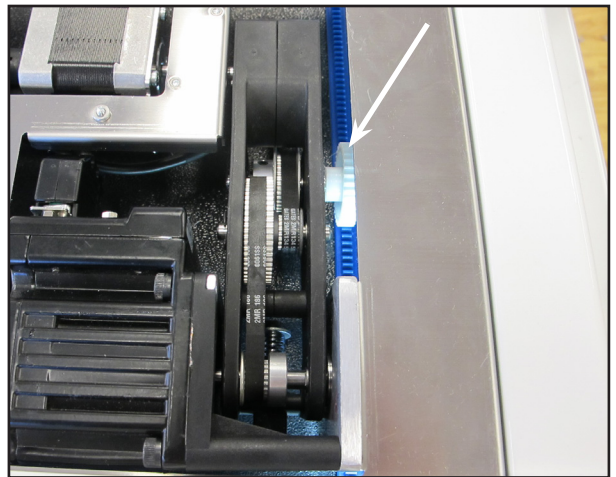

5. Double check the alignment of the carriage white gear with the blue Flexirack by rolling the carriage along the entire length of the table.
6. Trim the Flexirack to length using a knife or wire cutters if necessary (*the blue Flexirack does not necessarily need to extend the full width of the table and can actually be a couple of inches shorter on either end, if desired*).

7. At the ends of the blue rack, use the four small metal clamps (*see Parts List, item B*) to hold the ends firmly in place. The clamps have a hole through the center and a lip on one end. The lip should be on the side opposite the blue Flexirack. Drill pilot holes using the 3/32-inch drill bit and then attach the clamps as shown on either end of the blue Flexirack using a Phillips screwdriver.

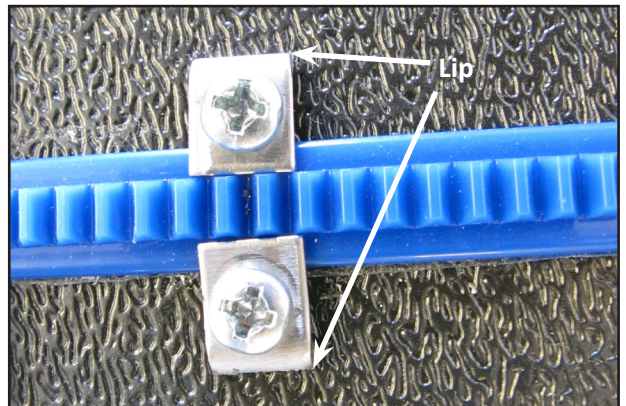

△ **CAUTION:** Do not use the larger drill bit included in the emergency repair kit, as this is the wrong size for the X-rack clamps.

✍ **NOTE:** As an alternative, use one clamp at each end. Slide the lip of the clamp over the last gear of the blue Flexirack, drill a pilot hole, and screw in place.

## To install the Y-Rack

1. Carefully lay the quilting machine on its power pod side (the left side, looking from the front).

Underneath the base plates, near the wheels on the C-pod side of the machine (the side with the thread tensioner and guides) there will be either two screws or two holes. If the screws are there, use a large flat screwdriver to remove the screws.



2. Attach the Y-Rack to the bottom of the front and rear base plates. The blue Flexirack should be toward the middle of the machine while the bolt holes should be toward the outside. Use the screws that were removed from the front and rear base plates (or use the two smallest screws in the Base Plate Repair Kit [see *Parts List, item D*] if your machine had no screws here). If your Y-Rack included 1/8-inch shim washers, place them between the Y-Rack and the machine base plates as shown and gently tighten the screws. If no shims were attached to your Y-Rack, then shim washers are not necessary.

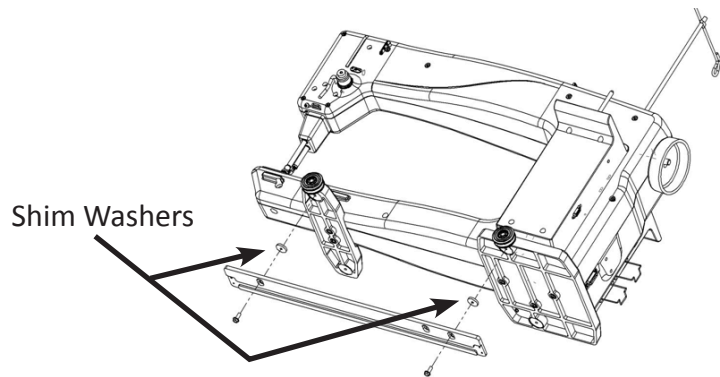

△ **CAUTION:** Be careful not to over-tighten the screws as the base plate holes will strip easily. In case of accidentally cross-threading or stripping one of the base plate holes, an emergency repair kit (see *Parts List, item D*) has been provided.



3. If the screws in the base plates do not have slotted heads and a nut driver cannot be fitted over the screw head, use one of the provided slotted screws as a replacement (see *Parts List, item D*) and use a slotted screwdriver to tighten the screws in place.

## Y-Encoder Assembly Installation (HQ Sixteen only)

Follow the installation guidelines below according to the scenario below (A, B, or C) which describes your situation best.

### A. The HQ Pro-Stitcher is an upgrade to a stitch-regulated HQ Sixteen

1. Determine which Y-encoder your HQ Sixteen has. If you have either of the two Y-encoders pictured at the right (Version 2 or Version 3), you do not need to replace the Y-encoder. However, if your Y-encoder is different from the ones pictured, you have a Version 1 Y-encoder and will need to continue with steps 2 through 5 below.

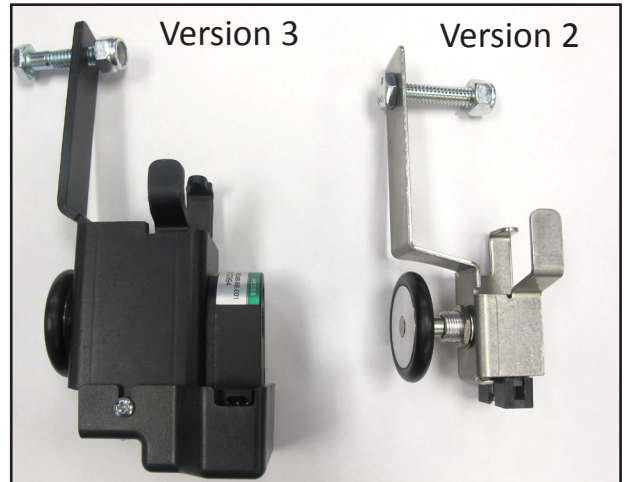

2. Place the HQ Sixteen on its side. Remove the encoder bracket mounting bolt using a 7/16-inch wrench and removing the bolt and bracket that attach the wheel to the rear base plate.

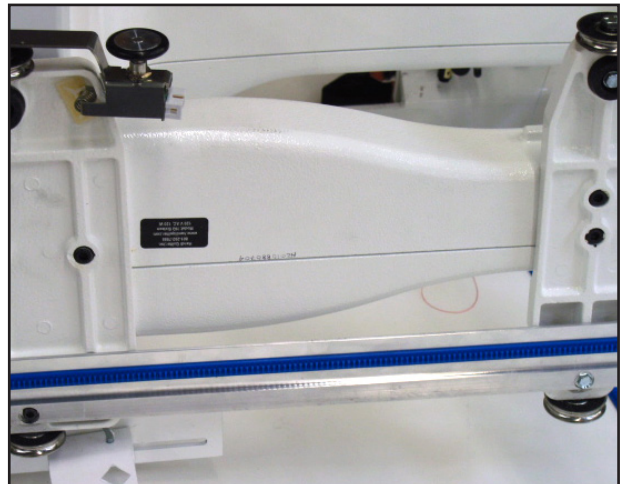

3. Replace the old encoder assembly with the encoder which is provided with the HQ Pro-Stitcher (*see Parts List, item R*), making sure to put the wheel back in place between the nut and the base plate.
4. Tighten the bolt in place with the 7/16-inch wrench. Use the nut to tighten the wheel to the base plate and then, while holding the nut in position with the wrench, tighten the bolt head with another 7/16-inch wrench or nut driver to the point that the encoder bracket can still spring up and down but is not excessively wobbly.
5. Reposition the coil spring between the encoder bracket and the bottom of the base plate. The encoder bracket has a tab that the spring goes around and the base plate will either have a nub built into the casting or a small plastic device designed to entrap the opposite end of the spring.

## B. The HQ Pro-Stitcher is an Upgrade to a Non-Regulated HQ Sixteen

- Follow the instructions for attaching a new Y-encoder assembly that came with the Stitch Regulator Upgrade Kit.

## C. The HQ Pro-Stitcher was originally purchased with a new HQ Sixteen

- No additional installation is required. The correct Y-axis encoder assembly should already be attached to the HQ Sixteen.

## Install the power cord retaining clamp (HQ Sixteen only)

1. Set the HQ Sixteen back up on its wheels and make sure it is unplugged.
2. Remove the four P-Pod mounting screws from the P-Pod (the plastic box on the left side of the HQ Sixteen which contains the power cord receptacle) using a Phillips screwdriver. Note that the bottom-left screw is longer than the other three.
3. Carefully disconnect all three cables from the P-Pod.
4. If working with an upgrade that included a new P-Pod, continue the following steps using the new P-Pod. Otherwise use the P-Pod that was just removed as you perform the remaining steps.
5. Loosen the two screws that mount the power cord receptacle to the plastic P-Pod using a Philips screwdriver and, if the screws include nuts on the opposite end, a wrench or small pliers to hold the nut (the two Phillips head screws are accessible from the exterior of the pod while the nuts are on the interior).
6. Slide the retaining clamp (*see Parts List, item R*) over one end of the new Y-split power cord (*see Parts List, item I*).
7. Insert the power cord into the receptacle on the P-Pod while sliding the two slots on the clamp behind the two screws that were just loosened.
8. Make sure the power cord is fully inserted, and then tighten the two P-Pod screws so they hold the clamp securely against the P-Pod. Insert the small screw included with the retaining clamp into the clamping portion of the retaining clamp and tighten so the clamp is now tight on the power cord.
9. Reconnect the three P-Pod cables and then reattach the P-Pod to the HQ Sixteen head. (Remember that the long screw should be in the bottom-left hole.)

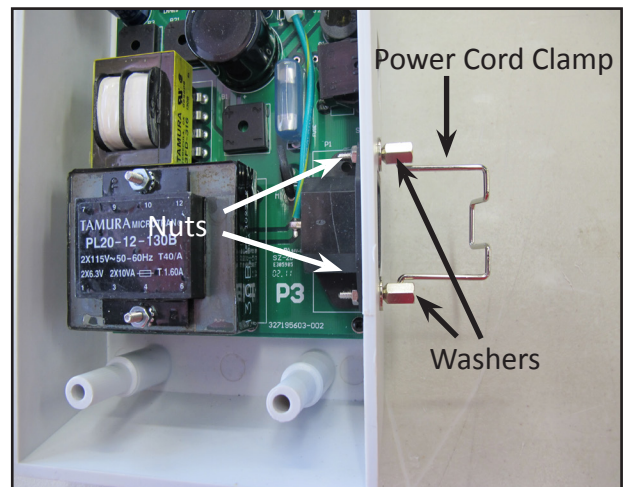

## C-Pod Replacement (HQ Sixteen only)

Some kits will come with a new C-Pod. If the HQ Sixteen was purchased with the HQ Pro-Stitcher, there is no need to install a new C-Pod. Also, any HQ Sixteen stitch-regulated system running version 8.04 or later does not require a C-Pod upgrade. The C-Pod screen identifies the version as it boots up.

△ **CAUTION:** To prevent damage due to electrostatic discharge, use a grounded wrist strap. If a wrist strap is not available, discharge any electrostatic energy on your body by touching any exposed metal (non-painted) portion of the HQ Sixteen prior to and several times during this procedure.

1. Remove the C-Pod from the HQ Sixteen head by removing the four mounting screws with a Phillips screwdriver.
2. Carefully disconnect all cables from the C-Pod, taking care not to touch the bare circuit board.
3. If the new C-Pod includes a Lock Board, skip ahead to step 7.

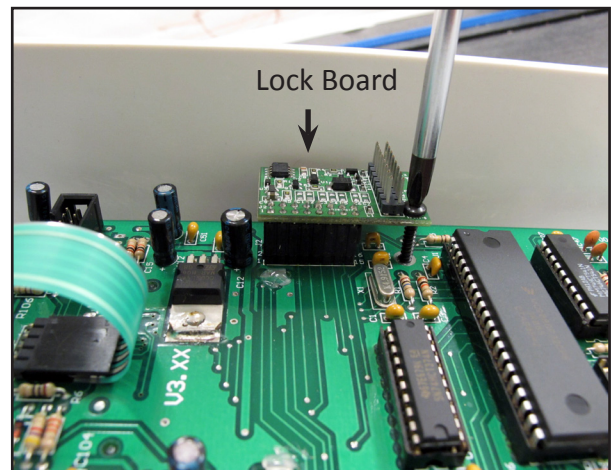

4. Remove the black Phillips screw that holds the lock board in place on the old C-Pod circuit board.
5. On the old C-Pod (*the one just removed from the HQ Sixteen*), gently pull upward on the lock board to remove it from the old C-Pod and press it firmly in place on the new C-Pod. Make sure both rows of pins enter the header on the underside of the Lock Board. The red LED should be located at the top right when looking into the C-Pod.

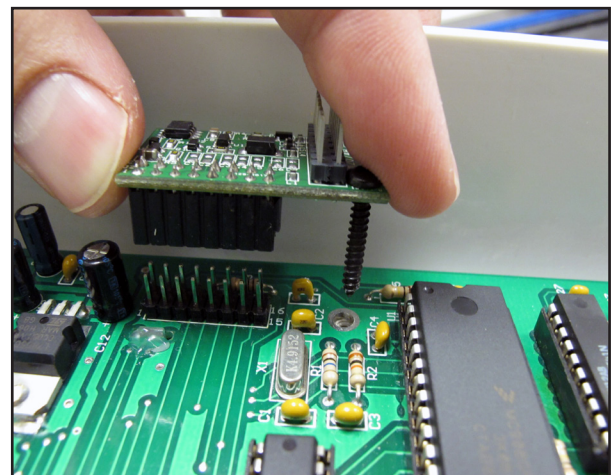

6. Lightly hand-tighten the black Phillips screw through the Lock Board.
7. Attach the internal cables to the new C-Pod.
8. Fasten the C-Pod to the head using the four screws that were removed in step 1.

## Set Up the New Carriage

1. Place the Pro-Stitcher carriage in place on the table tracks if it is not already there.
  - ➡ **IMPORTANT:** If a new set of black wheels was purchased to replace the metal wheels on the quilting machine, please be sure those are installed prior to placing the quilting machine on the Pro-Stitcher carriage. You should not have metal wheels on metal tracks.
2. Carefully lift the quilting machine and place it on the carriage so the wheels engage the carriage tracks (this is easier to do with two people – one at each end of the quilting machine).
3. The Y end of the power cord that is not attached to the P-Pod should be attached to the power supply at the back end of the Pro-Stitcher carriage.
4. Attach one end of the harness cable (*see Parts List, item P*) into the connector on the right side of the power supply. Tighten the side screws. You will plug the other ends to the bracket as part of step 6 when you attach the tablet computer.

Power cord connection

Harness cable connection

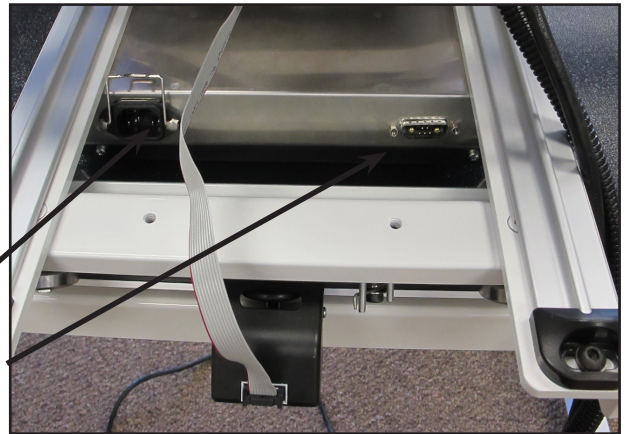

5. Verify that the y-axis gear engages the blue Flexirack for the y-axis.

- Do this by looking from the back of the machine between the bottom of the quilting machine and the top of the carriage. If necessary, use the manual engagement/diseengagement tool to move the gears so they engage.
- If horizontal adjustment is needed to ensure that at least half the white gear and blue Flexirack are interlocking, loosen the two screws that mount the y-axis bracket to the base plates and push the bracket in the direction necessary while retightening the screws.
- Both screws can be adjusted with the quilting machine on the carriage. Pull the machine to the front to access the front screw and to the rear to access the rear screw.
- Pull the quilting machine to the rear of the carriage and make sure the rear of the Y-axis bracket does not collide with the black plastic track retainer on the rear of the carriage. Adjust the Y-bracket if needed.

➡ **IMPORTANT:** If necessary, use the manual engagement/diseengagement tool to move the gears so they engage. Insert the end of the tool into the hole at the front of the EZ Carriage.

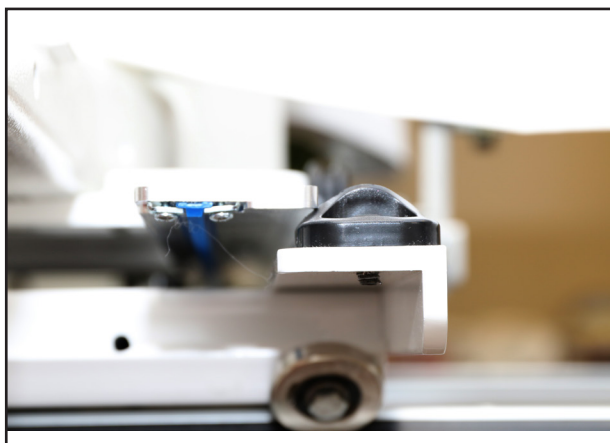
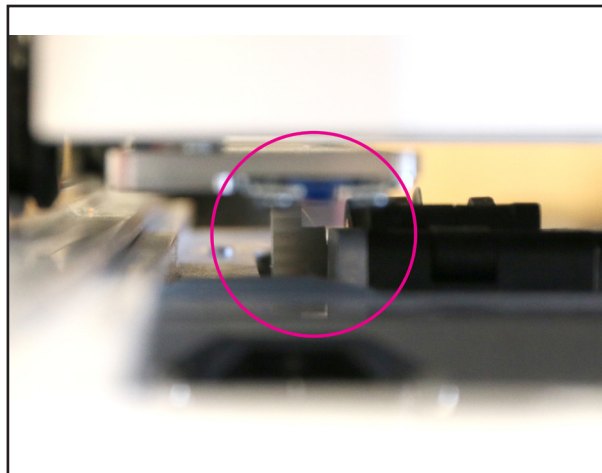

6. Plug one end of the stitch-regulator cable into the rear carriage encoder, and plug the middle connector on the gray stitch-regulator cable into the Y-axis stitch regulator encoder (*the stitch regulator encoder mounted to the rear machine wheel*).

7. Route the final section of the stitch regulator cable around the back of the quilting machine and plug the 9-pin D-sub connector into the C-Pod.

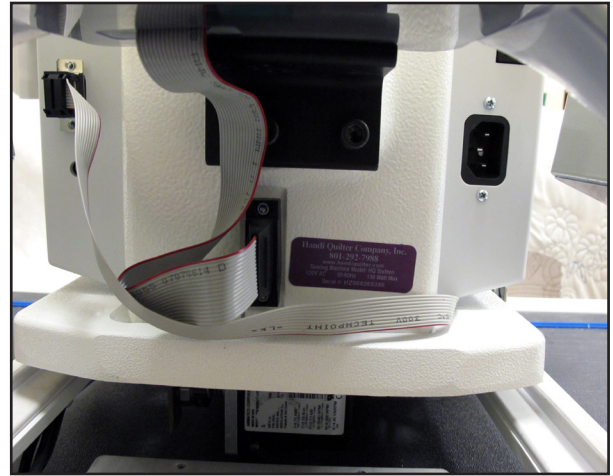

8. The black cables attached to the HQ Pro-Stitcher carriage should be routed up between the rear handles and the quilting machine, toward the right-hand side of the machine (looking at the machine from the back). Place the cable clips as shown and route the cable accordingly.

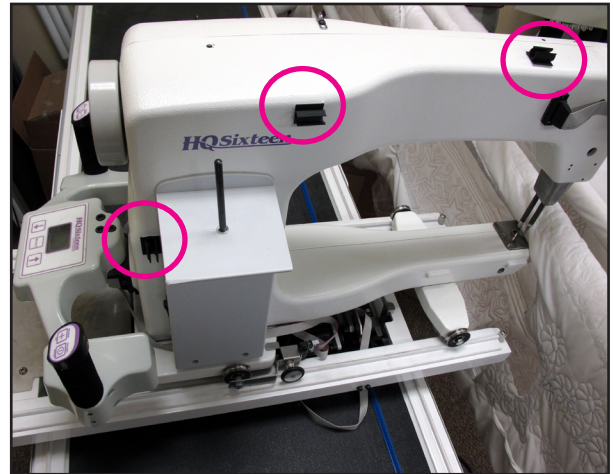

The small black cable with the black 3-connector clip should be routed underneath the P-Pod and snapped into the Stitch Regulator Adapter Board (see *Parts List, item R*) or the 3-pin connector on the V3 encoder board.

 **NOTE:** This image shows the Version 2 encoder and adapter board. The Version 3 encoder does not require an adapter board.



9. With the power cable plugged in and the motors in the engaged position (use the manual engagement/disengagement tool if necessary), ensure that as the HQ Sixteen is moved in both the X and the Y directions that the corresponding gears are rotating as well.



## To attach the tablet computer

1. Remove the front handlebar from the front of the quilting machine, making sure to first disconnect the handlebar D-cable from the side of the head and then remove the three (or two if the handlebar is the HQ Sixteen tilt-screen version) hex-head bolts with a 5mm Allen wrench.
2. **For HQ Sixteen Tilt-screen Handlebars:** Remove the adapter plate that is held in place with one hex-head screw and is revealed after pulling the front handlebar off the HQ Sixteen.
3. Place the black computer bracket (see *Parts List, item F*) on the head so the three holes of the bracket line up with the three holes in the head.

4. **For HQ Sixteen Tilt-screen Handlebars:** Secure the bracket in place by placing the adapter plate on top of the bracket and securing with the short bolt through the hole on the left.

- a. Put the two long bolts in position without the handlebar in place just to ensure that when tightening the short bolt, the long bolts will go through.

- b. Once the short bolt is tightened, remove the two long bolts and position the front handlebar over the adapter plate.

- c. Secure the front handlebar in place with the two long handlebar bolts.

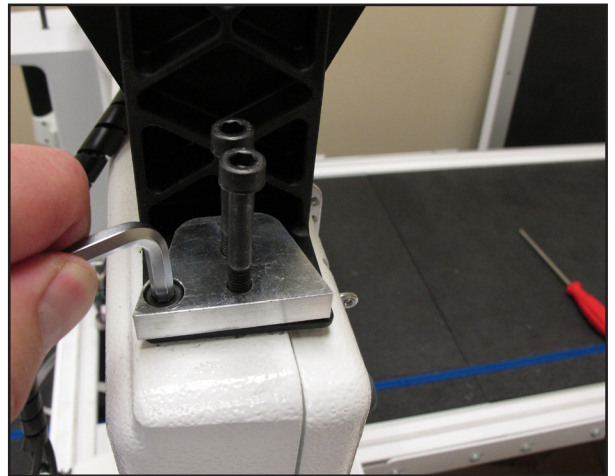

5. **For HQ Avanté and HQ Sixteen non-tilt-screen handlebars:** Position the handlebar over the bracket and secure the handlebar and bracket in place using the three handlebar bolts.

6. The black cable has three connections – two 9-pin serial connectors and one barrel connector for power.



Insert the barrel connector into the center jack (B) located on the bottom edge of the black box that is mounted to the back of the computer bracket. Attach the two 9-pin serial cables to the appropriate ports on the back of the same box, making sure cable connectors are plugged into their corresponding ports on the black box.

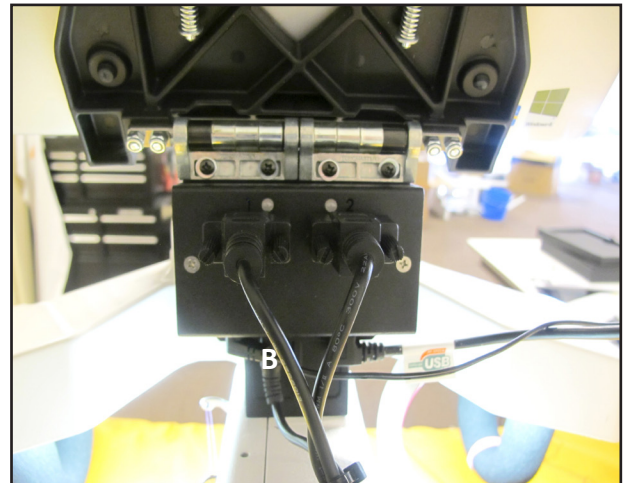

7. Remove the computer from its packaging. Install the computer into the computer bracket by sliding it into the black bracket from the side.



8. With the computer installed in the bracket, connect the USB short cable (see *Parts List, item M*) between the USB port, on the top-left side of the computer (position A) and the black box on the back of the bracket (position E).

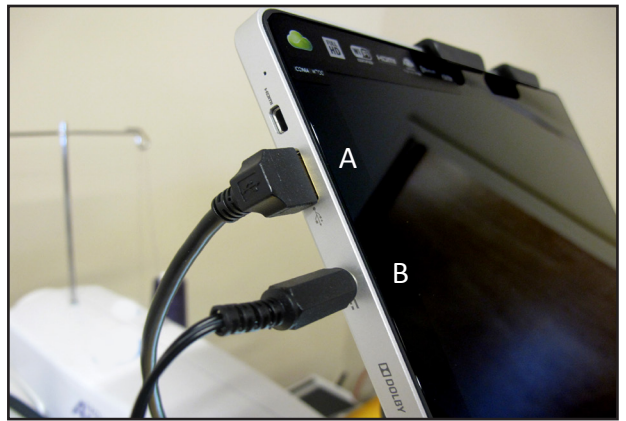

9. Also connect the computer power cord (see *Parts List, item N*) between the computer (position B) and the black box (position C).

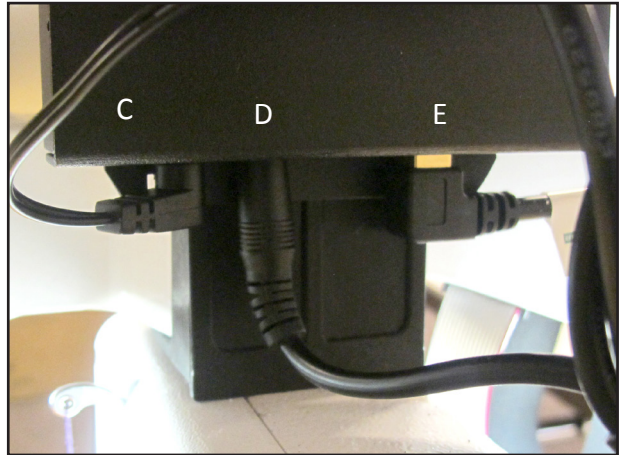

10. The open USB ports on the black box (position F) are for plugging in the USB Flash drive to load designs or update the software, or for plugging in a keyboard or mouse.



- ➡ **IMPORTANT:** The tablet shown is the Acer W700 series tablet. Your tablet may be a different make or model. Connect the USB and power cables in their proper location based upon your make and model of tablet.

# To turn on and shut down HQ Pro-Stitcher

Check that the power cord is plugged into the power supply located at the back of the carriage. Then plug in the barrel-shaped power connector to the bottom of the black box behind the computer and the short power cord from the black box to the computer. If the cable is unplugged, the computer will continue to run on battery power until the charge has been used up.

## *To turn on HQ Pro-Stitcher*

- Press the power switch, usually located at the top-right side of the tablet computer.

## *To shut down HQ Pro-Stitcher*

- Choose **Shut Down** from the Pro-Stitcher menu. Then choose the **Shutdown** button at the bottom of the screen. This shuts down both the Pro-Stitcher software and the tablet computer.
- **IMPORTANT:** If you don't see the Shutdown button, press the power switch on the tablet computer to continue shutting down the Pro-Stitcher computer.
- **IMPORTANT:** If you leave the Pro-Stitcher computer powered on with the power cord unplugged, the computer will begin running off battery power. The computer will shut down when no battery power remains.
- **IMPORTANT:** If the Pro-Stitcher computer is left on for a long period of time, the screen may turn black and enter a sleep mode. Tap the screen or press the Windows button below the screen to turn on the screen again. It may be necessary to drag a finger upward on the start-up screen to access Pro-Stitcher.
- **IMPORTANT:** Disable the auto-rotate feature for your tablet computer so that it only works in landscape, or horizontal, mode. Depending on your computer, you will do this by pressing a button on the top or side of the tablet computer or by using the Microsoft Windows Control Panel Display options. Refer to the owner's manual that came with your tablet computer for more information.

# Getting started with HQ Pro-Stitcher

## *To move the quilting machine after the software has been loaded*

- To move the quilting machine after the software has loaded, the motors should be disengaged. Press the **Disable Motors** button in the upper-right corner of the screen to disengage the motors. Note that the button changes to say Enable Motors.

If you have the EZ Carriage, use the options on the Freehand screen to alternate between computerized quilting and free-motion quilting.

- Choose **Design**, then **Freehand**. Select the **Free Motion** button. Pro-Stitcher automatically raises the quick-release levers to disengage the carriage gears from the Flexirack. Select the **Engaged** button to once again use Pro-Stitcher for computerized quilting.

## If you have a carriage with levers

- ➡ **IMPORTANT:** If you have a carriage with levers, you will need to manually raise the levers for free-motion quilting and lower the levers for computerized quilting with Pro-Stitcher.

*When the carriage levers are up (pictured), the carriage gears are disengaged from the Flexiracks. Do this for free-motion quilting.*



*Move the levers to the down position to use Pro-Stitcher.*

## *To use the USB flash drive*

- A USB flash drive is included with the Pro-Stitcher and is pre-loaded with more than 180 designs. These designs have also been loaded to the drive on the tablet computer, so the USB flash drive is the backup copy of the designs.

*Plug the USB flash drive into one of the USB ports on the left side of the black box mounted behind the Pro-Stitcher computer.*



- **IMPORTANT:** It is not necessary to power down Pro-Stitcher to install or remove the USB flash drive, but take care not to remove the flash drive while the system is saving to or loading from the drive.

### ***To use an external keyboard***

An external keyboard is helpful when using Art & Stitch on the Pro-Stitcher computer. Use a keyboard and mouse (wired or wireless) by attaching them (or the wireless transmitter) to one of the USB ports on the black box behind the computer.

# Troubleshooting

Problem/Symptom	Corrective Measure
<b>No display on the touch-screen monitor</b>	
LED on the power button at the top right-hand side of the screen is on.	The Pro-Stitcher computer is powered off. Press the Power button at the top-right side of the computer to turn it on.
LED on the power button at the top right-hand side of the screen is off.	<p>There is no power to the tablet computer. Ensure the power cord to the Pro-Stitcher is plugged into a powered outlet on one end and the power supply under the carriage on one of the Y branch ends of the power cord. Also check that the round barrel connector is plugged firmly into the mating cable connector under the Pro-Stitcher carriage.</p> <p>If all cables are plugged in properly and the LED remains off, press the Power button on the top-right side of the monitor.</p>
<b>The stitch regulator cable is not connected properly</b>	
The Pro-Stitcher moves but does not stitch.	<p>Make sure the gray flat stitch regulator cable is plugged into the back of the C-Pod, the encoder wheel on the back wheel of the quilting machine, and the encoder wheel on the carriage.</p> <p>Check the black cable that connects the Pro-Stitcher to the machine encoder wheel. This cable has a 3-wire connector at the end that plugs into the machine's stitch regulator encoder circuit board attached to the back left wheel of the quilting machine.</p> <p>Verify the Pro-Stitcher and the quilting machine are communicating with each other by pressing Reconnect Machine in the Settings -&gt; Advanced menu. If the two systems are communicating, pressing the <b>Full Stitch</b> or <b>Half Stitch</b> buttons on the Pro-Stitcher will result in the quilting machine's needle performing that function.</p> <p>Check the gray stitch regulator cable for damage (<i>the end of the cable that plugs into the C-Pod will have one wire clipped – this is normal</i>).</p>

Problem/Symptom	Corrective Measure
<p>The Pro-Stitcher stitches, but the stitch lengths vary and the quilting machine slows down or even stops in some directions.</p>	<p>The problem can be narrowed to a specific encoder wheel by running the quilting machine manually (HQ Sixteen owners will need to press the Switch to Handlebar Control button at the top left-hand corner of the screen to pass control back to the handles). Start the quilting machine from the handlebars in Stitch Regulated mode and only move the machine left and right. Then try only moving front and back. If the quilting machine stops stitching while moving front and back, then the problem is with the encoder mounted to the back of the machine. If it stops stitching left and right then the problem is with the encoder on the carriage. Make sure the encoder wheels roll on the tracks when moving the quilting machine and also that the gray stitch regulator cable is plugged in securely to the encoders.</p>
<p>HQ Sixteen owners: The C-Pod screen is blank or scrambled and the handlebar screens are stuck on a screen that says, "Handlebars Version X.X"</p>	<p>The gray flat stitch regulator cable is plugged in upside-down to one or both of the stitch regulator encoder wheels. Make sure the red stripe on the gray cable is facing up on both encoder connections.</p>
<p><b>An older version of the "Y" encoder is mounted to the HQ Sixteen</b></p>	
<p>The HQ Pro-Stitcher begins to stitch but stops right away.</p>	<p>Make sure the "Y" or "machine" encoder, which is mounted to the back left-hand side (when looking from the front) is the newest version encoder for the HQ Sixteen. The old version has a 2-inch section of black plastic heat shrink encasing a small circuit board where the cable plugs in. The new version does not have that 2-inch section of black heat shrink. If the old encoder is mounted to the machine, then replace it with the new encoder that is included in the HQ Pro-Stitcher accessory bag.</p>
<p><b>The white gears do not engage the blue flexirack</b></p>	
<p>When the quilting machine is pushed by hand, the horizontal and/or vertical crosshair lines do not move.</p>	<p>Make sure the white gears fully engage the blue rack. Use the manual engagement/disengagement tool to adjust. Insert into the hole at the front of the EZ Carriage.</p>



Problem/Symptom	Corrective Measure
<b>The X and/or Y axis gears are only partially engaged</b>	
<p>Stitched designs appear jagged or wobbly. The system may be skipping teeth when running, resulting in a shifting of the design on the quilt.</p> <p>With the Pro-Stitcher powered and motors engaged and enabled (locked in position), pressing the machine side to side or front to back allows a little motion but the white gear does not rotate.</p>	<p>If there is motion in the X-axis (left-right), check the X-axis gear assembly and make sure nothing is preventing the assembly from springing downward and putting pressure on the blue rack. If the motion is in the Y-axis (front/back), make sure the blue rack and the white gear are properly aligned and adjust if necessary by loosening the two Y-axis bracket mounting screws and shifting the Y-axis bracket left/right and re-tightening the screws. If the white gear is not pressing upward enough on the blue rack to fully engage the gears, it may be necessary to install shim washers between the quilting machine base-plates and the Y-axis bracket to drop the bracket a little.</p>
<b>One or more of the pulleys/gears on the X or Y axis assemblies are loose</b>	
<p>Stitched designs appear jagged or wobbly.</p> <p>With the Pro-Stitcher powered and motors engaged and enabled (locked in position), pressing the machine side to side or front to back allows a little motion and the white gear does rotate.</p>	<p>Monitor the motor assembly while engaged and enabled to determine which gear/pulley is slipping. It will most likely be either the gear mounted directly to the motor shaft or the gear mounted to the shaft that drives the white gear. Use the appropriate Allen wrench to tighten both set screws on the gear. The motor gear requires a 1/16" Allen wrench and the larger gear on the drive axle with the white gear requires a 5/64" Allen wrench.</p>
<b>The X and Y tension springs are too loose.</b>	
<p>Gear tooth skipping occurs, causing the stitched design to be shifted in either the X or the Y direction.</p>	<p>The X and Y tension springs may need to be tightened. First make sure the Pro-Stitcher version is 14.01.0043 or newer. Using a 3mm Allen wrench, tighten the bolts (clockwise) running through the center of the two springs in the Pro-Stitcher carriage (one on the X motor assembly and one on the Y motor assembly). Only one or two full rotations is all that is usually required. Tightening more than three turns will likely damage the system. Be careful while tightening not to flex the shaft that the bolt is tightening into or it may break. The quilting machine will need to be removed from the carriage and the carriage turned upside down to access the X tension spring. Test that the springs are not too tight by going to the Freehand screen and pressing the "Engage" or "Free Motion" buttons to rotate the engagement motor a few times. If they are too tight, the motor will slip and not complete its rotation. Loosen the tension spring bolt if this occurs.</p>

Problem/Symptom	Corrective Measure
<b>Lubrication required between white gears and blue rack</b>	
When the Pro-Stitcher carriage levers are engaged squeaking can be heard as the machine is pushed or driven.	Lubricate the teeth of the white plastic gears for both the X and the Y axes by applying a small amount of silicone lubricant to the teeth of the white gears. Do not use a solvent-based or an oil-based lubricant (such as WD-40 or sewing machine oil) as this will attract dust and eventually clog the gears.
<b>Positioning a pattern using the Reset Home button</b>	
When the Reset Home button is pressed, the pattern is not positioned properly.	The Reset Home button is not intended to be used as a re-positioning tool. Reset Home simply makes the current needle position match up with the “X=0, Y=0” point of the pattern. This “0,0” position can vary from pattern to pattern, so the best way to reposition is by using the Area or Reposition tools from the menu.
<b>Quilting machine stuck in a faster speed than selected by Pro-Stitcher</b>	
Stitch length is much smaller than selected, machine running faster than it should.	Something has caused the quilting machine to lock up at a higher speed (tighter SPI) than selected. Rebooting both the quilting machine and the Pro-Stitcher computer should resolve the issue.
<b>No patterns or folders show up in the design library</b>	
The current path is pointing to the wrong drive letter.	<p>Designs are stored on the computer’s hard drive and on the removable USB flash drive. If you are attempting to access designs specifically on the USB flash drive, make sure the USB flash drive is plugged in securely to the Pro-Stitcher computer. Press Cancel if the Open screen is already open, remove the USB flash drive, wait about 15 seconds, and then press the Open button again.</p> <p>The patterns that come pre-loaded on the Handi Quilter USB Flash drive are located in a folder called Designs on the USB flash drive (usually drive D:\ or E:\). From the Open window, select a drive letter by pressing on the arrow button next to the drive you wish to browse. If there is a circle with a ^ symbol on the right-hand side of the button, it means there are more folders in that particular path.</p> <p>If there continues to be nothing showing up on the USB flash drive, plug it into a desktop or laptop computer and verify that the USB flash drive has the desired files on it. If the computer says it wants to reformat the flash drive then the flash drive has gone bad and will need to be replaced. If it opens but there are no files on the flash drive, contact Handi Quilter for replacement files.*</p> <p><i>*Handi Quilter highly recommends backing up all pattern files on a home computer or another disk.</i></p>

Problem/Symptom	Corrective Measure
<b>Jumps between repeated patterns</b>	
Use of any of the Repeat options results in a jump between each pattern	When using the Repeat functions, if the start and/or stop points are within the block of the pattern (i.e. they are not located at the left and right-hand sides of the pattern block) and/or not at the same height, there will be a jump between each repeat of the pattern. This can be corrected by selecting the Point 2 Point box in the Repeat screen.
<b>Error messages</b>	
<b>Motor Error</b> with lightning bolt icon in the top-right corner (may occur with various types of Motor Error messages on the screen).	<p>This will occur with various types of motor errors. Generally they mean that the Pro-Stitcher cannot communicate with the motors. Check that the carriage is plugged in and that the serial cables are connected properly into the box behind the Pro-Stitcher computer. If everything is connected properly and power is on, press the lightning bolt button to attempt to reestablish communication with the motors. The icon will turn to either a red or green motor button once communications are re-established.</p> <p>If this occurs during stitching (possibly due to a large electrostatic discharge (ESD) event or power surge), the Pro-Stitcher will stop moving and wait for the lightning bolt icon to be pressed. If the quilting machine is still stitching at this point, press the STOP button on the handles. Pro-Stitcher does not resume on its own after such a disruption for safety reasons and will require user intervention to resume stitching the design. When communications are reestablished by pressing the lightning bolt button, it will be necessary to re-set the starting point to the position where the stitching stopped and resume stitching from that point. If the tablet touch-screen does not respond after such an ESD or surge event, it may be necessary to re-boot the tablet using the power button. A mouse may be plugged into an available USB port and used to save any work prior to re-booting the tablet.</p>

<b>Problem/Symptom</b>	<b>Corrective Measure</b>
<b>Buffer Underflow</b>	If a message with the words Buffer Underflow appears while stitching, it is an indication that data is not getting to the motors quickly enough. This may be due to something in the computer tying up the CPU. Although it may be possible to resume quilting by simply pressing red X box to close the error message and then pressing the Motor Error lightning bolt button at the top right-hand corner of the screen, it is best to cancel the current design stitch-out, save the pattern, and re-boot the computer. Use the New Start Point function if necessary to resume from where stitching was left off.
<b>System Restore or System Repair</b> message on boot-up.	If a message appears on boot-up (black screen, white text) that asks whether to run System Restore or Start Windows Normally, select Start Windows Normally by using the volume buttons on the tablet to move your selection up or down and use the “Windows” button to select “Start Normally.” The system should resume as normal. The computer will default to the System Restore screen (more of a typical Windows blue/white screen) if you do not select the Start Normally option in time. If this occurs, use the power switch to reboot the computer and try again.

# Warranty

Warranty issued should, whenever possible, first be submitted to the Authorized Representative who completed your service and training. These representatives have been selected for their dedication to customer satisfaction and have been trained in technical service. They also may provide follow-up advice, training, service, accessories, and other services.

HQ Authorized Representatives may offer their own warranties in addition to those offered by the manufacturer, but do not obligate the manufacturer.

## HQ Pro-Stitcher® Premium - Limited Warranty

Handi Quilter, Inc. (*hereinafter HQ*) offers a limited warranty on the HQ Pro-Stitcher (*hereinafter "Product"*) to be free of defects in workmanship and materials under normal use upon the terms and conditions hereinafter set forth:

- (a) **90 day Limited Warranty:** During the first 90 days from date of purchase, HQ will repair any manufacturing defect without charge for parts or labor. All subsequent warranties include parts costs only.
- (b) **Five-year Mechanical Warranty:** For any mechanical failure within this period. Manufacturer will provide free replacement parts, customer pays for labor and shipping.
- (c) **Lifetime Software Update Warranty:** From the date of purchase HQ will provide updates (*minor changes to the HQ Pro-Stitcher software*), free of charge, to the consumer via electronic downloads. These are intended to provide the consumer with the latest software updates for the HQ Pro-Stitcher and are not the same as Upgrades, which will incur a fee to the consumer.
- (d) **Five-year Electronic/Electrical Warranty:** The electric/electronic components are warranted to be free from manufacturing defects for five years from the date of purchase. If any defect is reported within this period, manufacturer will provide free replacement parts, customer pays for labor and shipping. Excludes the

- (e) **Two-year Tablet PC Warranty:** The HQ Pro-Stitcher tablet PC is warranted to be free from manufacturing defects for two years from the date of purchase. For any failure within this period, manufacturer will, at its option: (i) provide replacement parts necessary for repair; or (ii) repair or replace the tablet PC with a comparable product. Replacement parts or tablet PC will be new or serviceably used, and comparable in function and performance to the original part or product. Customer pays for labor and shipping.

This limited warranty stated in sections (b), (c), (d), and (e) above shall be limited solely to the replacement of parts which, in the opinion of HQ are defective in workmanship or material and are returned to HQ, or an authorized repair facility, or such other point or place that may be designated by HQ. All other costs, including cost of freight and shipment for repair under this warranty, shall be the customer's costs.

The product registration form must be completed and received by HQ before warranty is valid.

<https://www.handiquilter.com/productwarranty/>

### Warranty Exclusions

HQ shall have no obligation for any claim under this warranty if the HQ Pro-Stitcher has been misused, abused, neglected, damaged in transit or has been altered from the standard specifications established by HQ, if proper cleaning and maintenance has not been performed, or if the HQ Pro-Stitcher is used on other frame systems or with other machines than those specified by Handi Quilter. No warranties extend beyond the express warranty offered. HQ disclaims all other warranties, express or implied, regarding the Product, including any implied warranties of merchantability or fitness for a particular purpose. In the United States, some laws do not allow the exclusion of the implied warranties.

## **Specific exclusions of warranty limitations include, but are not limited to the following**

- General, consequential, incidental or special damages including damage to fabric or material, the cost of rework or lost profits, the cost of installation or removal of any Products, and any inspection, testing or redesign caused by any defect or by the repair or replacement of Products arising from a defect in any Product.
- Products which are received by HQ improperly packaged, altered, or physically damaged.
- Counterfeit or altered label(s) or stickers.
- Broken pins or connectors
- Stripped screws or nuts
- Connector(s) damaged, cracked, missing or broken.
- Missing, torn or punctured seals(s)
- Any use besides computerized machine quilting applications
- Operator error in the customary use of the Product.
- Internal adjustments, tampering or parts replacement done by anyone except authorized Representatives or customers specifically authorized by Handi Quilter Customer Support or warranty repair personnel on a case by case basis.

The warranty does not cover and the user assumes the risk of and there is hereby excluded any liability to HQ for failure, defects, loss, deterioration, personal injury or damage which are due to: (1) ordinary wear and tear or exposure, (2) abuse, misuse, negligence, operator error, or (3) use of parts, components, or accessories not authorized by HQ.

In no event shall HQ be liable to the purchaser of the Product or to third parties for special or consequential damages, including, but not limited to, death or personal injuries.

HQ does not assume, or authorize any person to assume on its behalf, any other obligation of liability other than that sent forth herein.

Some states do not allow exclusion of limitation of incidental or consequential damages, so above limitation or exclusion may not apply. This warranty gives the purchaser specific legal rights and the purchaser may also have other rights, which may vary from State to State.

### **Exclusive Remedy**

Remedy is limited to the repair or replacement of the defective Product. HQ may elect which remedy or combination of remedies to provide at its sole discretion and shall have a reasonable time, after determining that a defective Product exists, to repair or replace the defective product. Replacement Product may be from new or serviceable used parts. HQ's warranty applies to repairs or replaced Products for the balance of the applicable period of the original warranty or ninety days from the date of shipment of a repaired or replaced Product, whichever is longer.

HQ's entire liability for any defective Product shall in no event exceed the purchase price for the defective Product. This limitation applies even if Handi Quilter cannot or does not repair or replace any defective Product.

## Warranty Claims

Service under the above warranties may be obtained by returning the product, with proof of purchase, to the authorized Representative from whom the product was purchased, a local Representative, or to Handi Quilter Support.

Any product to be returned to the factory, either by customers or Representatives, must be accompanied by a Return Material Authorization Number (RMA). RMAs may be obtained by email ([sales@handiquilter.com](mailto:sales@handiquilter.com)) or by calling customer support at 801-292-7988 or toll-free at 1-877-697-8458. If it is determined that the Product may be defective, an RMA number will be issued with instructions for Product return. An unauthorized return (*a return without an RMA number*) will be shipped back to customer at customer's expense. Authorized returns are to be shipped prepaid and insured in an approved shipping container. The original box and packaging materials should be kept for storing or shipping.

## Shipping Cost

Shipping is the responsibility of the customer.

## Product Service and Maintenance

Periodically use a small brush to clean all lint and threads from under the carriage, track and rack. Keep rack and track clean and clear of any foreign material, build up, or obstruction.

### **Follow HQ Quilting Machine Service and Maintenance for best results with the HQ Pro-Stitcher.**

Replace needles every 2-4 hours (*1-2 per large quilt*) and lubricate hook every 3-4 hours of use (*about every 2nd bobbin change*). Periodically check the thread tensioner. Use small brush to clean out all lint, loose thread or obstructions from the bobbin hook each time you begin to use the HQ Pro-Stitcher and HQ quilting machine.

Servicing is recommended for your HQ quilting machine annually from a qualified representative. Servicing will cover belt tensioning, encoder

positioning, bearing retainers, hook axial play and timing, presser and needle bar adjustment, and internal lubrication to take-up lever, hopping foot levers, bushings/bearings.

### **Handi Quilter, Inc.**

#### **Customer Relations**

**501 N. 400 W.**

**North Salt Lake, UT 84054**

**Toll Free: 1-877-MY-QUILT (697-8458)**

**Local Phone: 801-292-7988**

**HQCares@HandiQuilter.com**

# HQ Pro-Stitcher<sup>®</sup> Premium Warranty Registration

Mail or Fax completed Warranty Registration Card within 30 days of purchase. If you have questions, email [HQcares@HandiQuilter.com](mailto:HQcares@HandiQuilter.com) or call Customer Relations at 1-877-697-8458. Online warranty registration is also available at [HandiQuilter.com](http://HandiQuilter.com).

MAIL: Handi Quilter, Inc.  
Warranty Registration Dept.  
501 N 400 W  
North Salt Lake, Utah 84054  
FAX: 801-294-3011

## HQ Pro-Stitcher Premium Warranty Registration Card

The HQ Pro-Stitcher warranty consists of five-year electronic/electrical, five-year mechanical, two-year tablet PC and lifetime software updates (see detailed warranty information in HQ Pro-Stitcher User Manual). Check with your local HQ Representative for details on service or making warranty claims.

Customer Name:

Company/Business Name (if applicable):

Address:

City, State, Zip:

Daytime Phone:

Evening Phone:

Fax:

Email:

HQ Pro-Stitcher Serial Number:

Order Number (5 digits):

Purchase Date:

Date Product Received:

Location of Purchase (*Shop or Show name, City & State*):

Signature:

Date:

*Cut along dotted line and mail or fax this registration information within 30 days of purchase.*



This page intentionally left blank.

# HQ Pro-Stitcher Premium Training Checklist

Customer Name \_\_\_\_\_ Date of Purchase \_\_\_\_\_

HQ Representative Shop Name \_\_\_\_\_ Date of Training \_\_\_\_\_

## Installation and Set Up

- Rack System
- Carriage System
- Encoder Cables
- Gears Engage in Racks
- Quick Release Mechanism

## HQ Pro-Stitcher Overview

- Disable/Enable Motors
- Pull-up Bobbin Thread
- Zoom/Pan Function
- Refresh
- Half-Stitch
- Follow
- Transform
- Measure areas of the quilt
- Shut Down (Shutdown, Reboot, Exit to Windows)

## Tabs and Ribbon Buttons

- Find drive where designs are located
- Show File with all designs
- Load design
- Design
- Box
- Jump Points
- Start/Stop
- Undo
- Redo
- History

- Baseline
- Loading and Saving a Design
- Create, move, resize Areas
- Rotation (Mirror, Flip, 2-Point)
- Crop (Inside, Outside, Edges)
- Repeat
- Resize
- Skew and Align
- Freehand Record and Mark
- Reposition (by Corner, Center, Start, End, Drag & Drop, Nudge)

## Art & Stitch (if applicable)

- Creating a Design
- Saving a Design
- Loading a Design from outside source
- Passing a Design back and forth from Pro-Stitcher

## Pro-Stitcher Tab

- New Start/End Points
- Jump Points
- Move (Continuous and Stitch)
- Channel Lock
- Trace Outline
- Box
- Area

- Pause
- Emergency Stop

## Settings Tab

- Speed
- Auto Jump
- Stitches-Per-Inch
- Tie Off (Tack and Micro)
- Pullup
- Pause Delay
- Switch to Handlebar Control
- Reconnect Motors
- Reconnect Machine
- Simulation Mode
- Touch Mode
- Quick-Access Toolbar

## Cleaning and Maintenance

- Cleaning Rack
- Maintenance of HQ Machine

## Warranty Review

- Review Manufacturer's Warranty
- Sign Checklist

The items listed above have been explained to me by my HQ Retailer.

I have covered the items listed above with my customer.

Signature of Owner

Signature of Trainer

**Note to the HQ Retailer: Upon completion, please cut along dotted line and fax the signed copy to Handi Quilter at 801-294-3011. It is okay to photocopy this page.**





Designed by a Quilter, for Quilters.®

Handi Quilter, Inc.  
501 N 400 W  
North Salt Lake, UT 84054

1-877-MY-QUILT (697-8458) • [www.HandiQuilter.com](http://www.HandiQuilter.com)

*HQ Pro-Stitcher® is part of the family of innovative quilting products from Handi Quilter®.*



RELEASED JANUARY, 2017

© 2017 Handi Quilter, Inc. All rights reserved. Printed in the U.S.A.