

Introduction

N09200102127

Thank you for buying a MITSUBISHI MIRAGE.

We are confident you will enjoy your vehicle. It has been engineered for optimum performance, durability and comfort. By thoroughly reading this Owner's Manual, you will gain an understanding of the many features that are included in the MIRAGE. The Owner's Manual contains descriptions and illustrations that will assist in the operation and maintenance of your vehicle.

Your Authorized Mitsubishi Motors Dealer will be happy to assist you with any further questions you may have regarding the operation of your vehicle.

Please note that this manual applies to all MIRAGE models and explains all features including options. Some features explained in this manual may not be installed on your vehicle.

Please leave this Owner's Manual in the vehicle at the time of resale. The next owner will appreciate having access to the information contained here.

This manual includes instructions for standard and optional equipment available at the time of printing. Mitsubishi Motors Corporation reserves the right to make changes in design and specifications and to make additions or improvements in its product without assuming any obligation to install these on previously manufactured products.



Information Provided by:

©2014 Mitsubishi Motors Corporation Printed in Thailand

Throughout this manual the words **WARNING** and **CAUTION** appear.

These are reminders to be especially careful. Failure to follow the instructions could result in personal injury or damage to your vehicle.

WARNING

Indicates a strong possibility of severe personal injury or death if instructions are not followed.

CAUTION

Points out hazards or unsafe practices that could cause minor personal injury or damage to your vehicle.

You will see another important symbol:

NOTE Gives helpful information.

WARNING

- **Engine exhaust, some of its constituents, and certain vehicle components contain or emit chemicals known to the State of California to cause cancer and birth defects and reproductive harm. In addition, certain fluids contained in vehicles and certain products of component wear contain or emit chemicals known to the State of California to cause cancer and birth defects or other reproductive harm.**

This vehicle is manufactured by Mitsubishi Motors (Thailand) Co.,Ltd. in Thailand under license from Mitsubishi Motors Corporation.

Table of contents

Overview	1
Quick index	2
General information	3
Seat and restraint systems	4
Features and controls	5
Driving safety	6
Comfort controls	7
For emergencies	8
Vehicle care and maintenance	9
Customer assistance/Reporting Safety Defects	10
Specifications	11
Alphabetical index	12

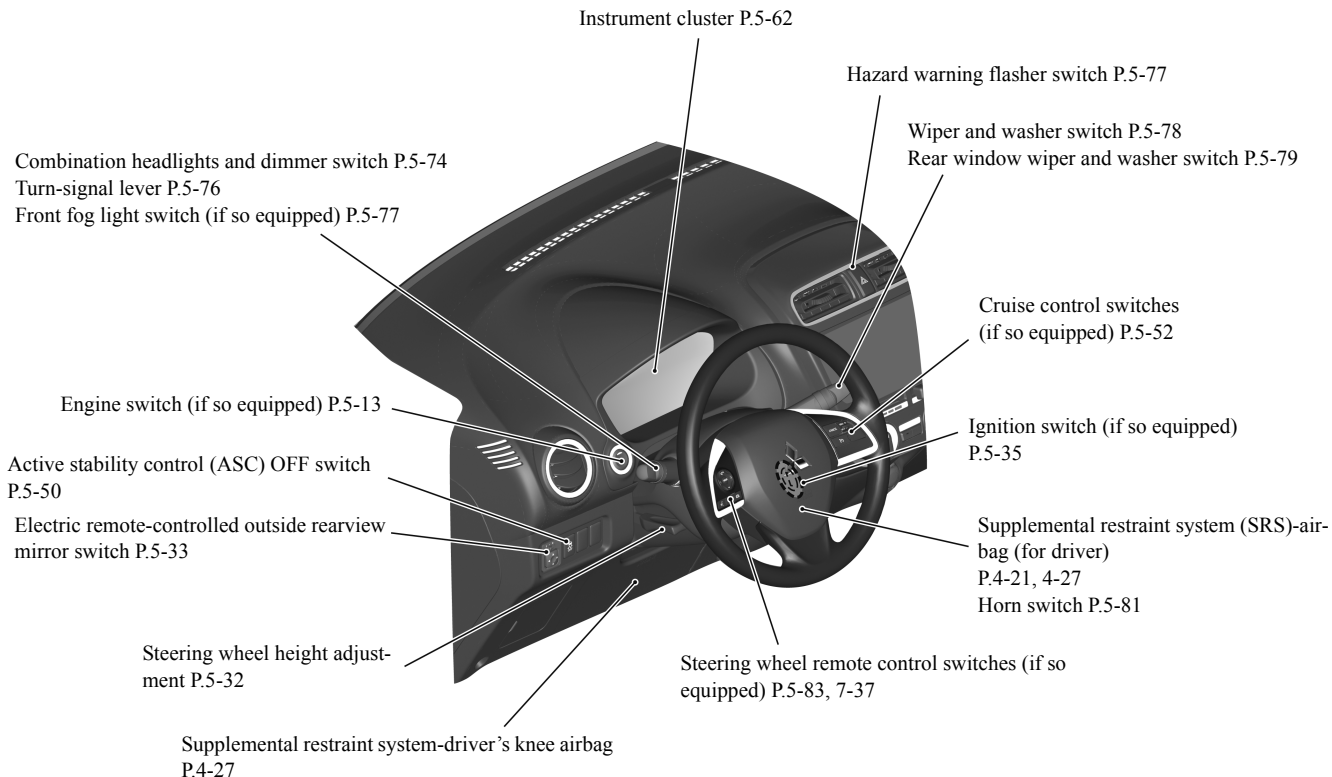

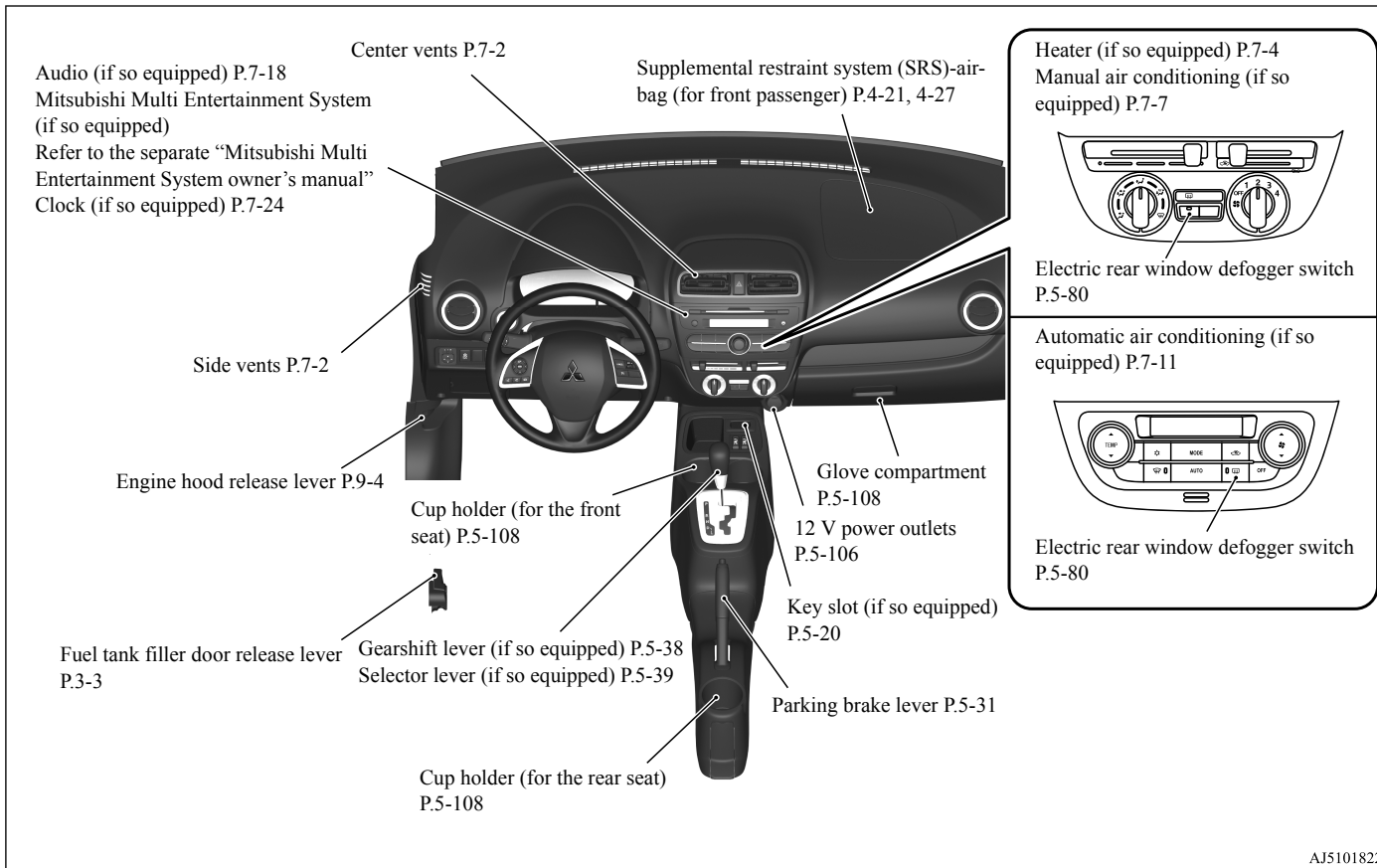

AJ5101822

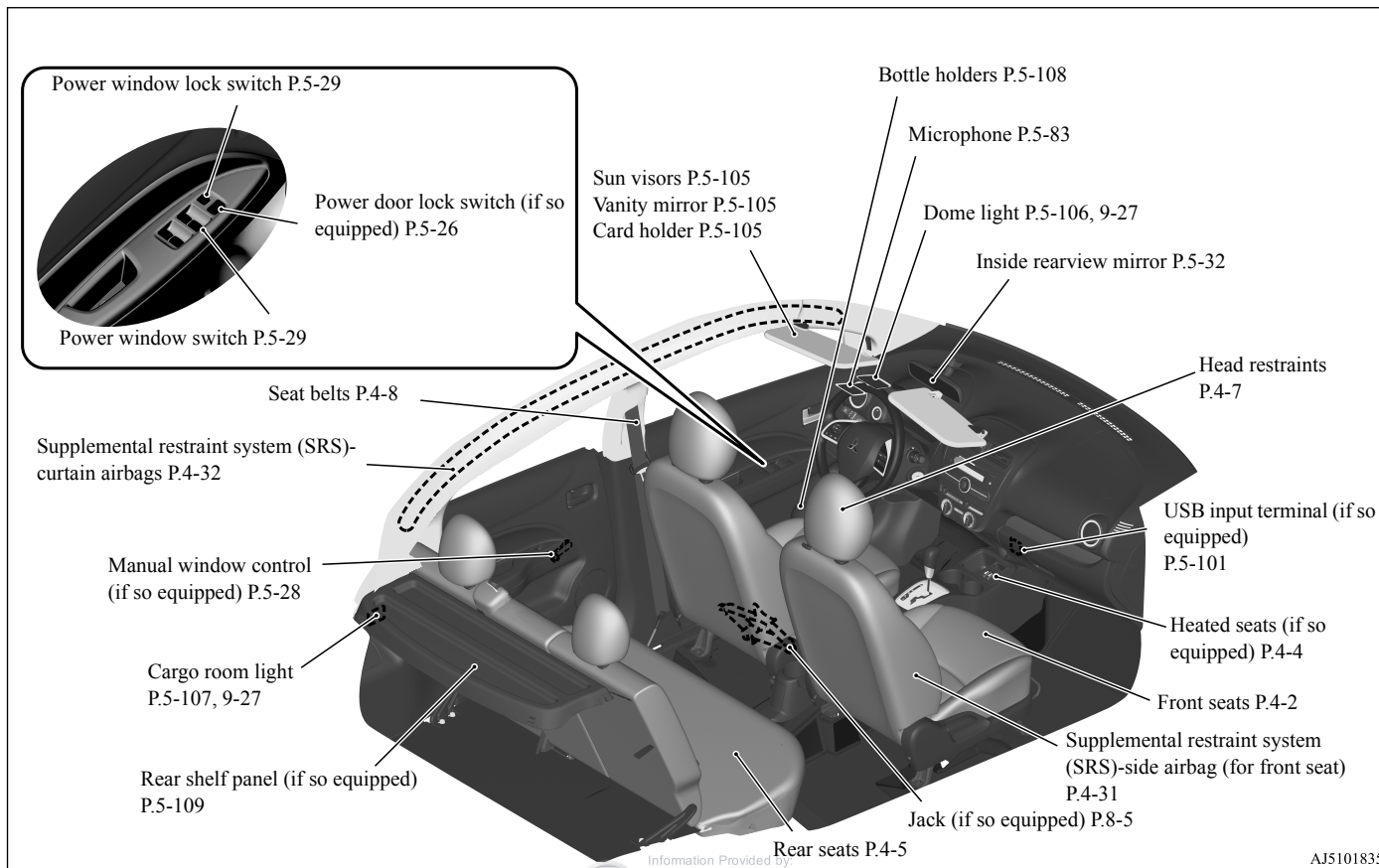

Information Provided by



AJ5101835

Luggage area

N00100500455

Type 1

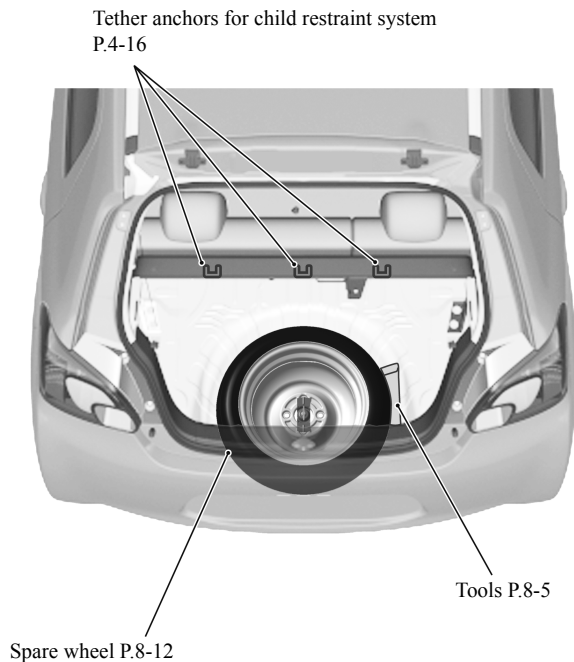

Type 2

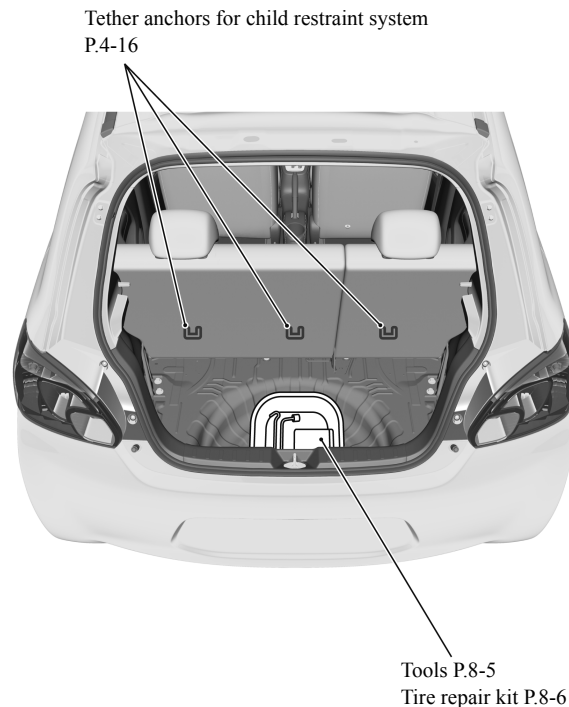

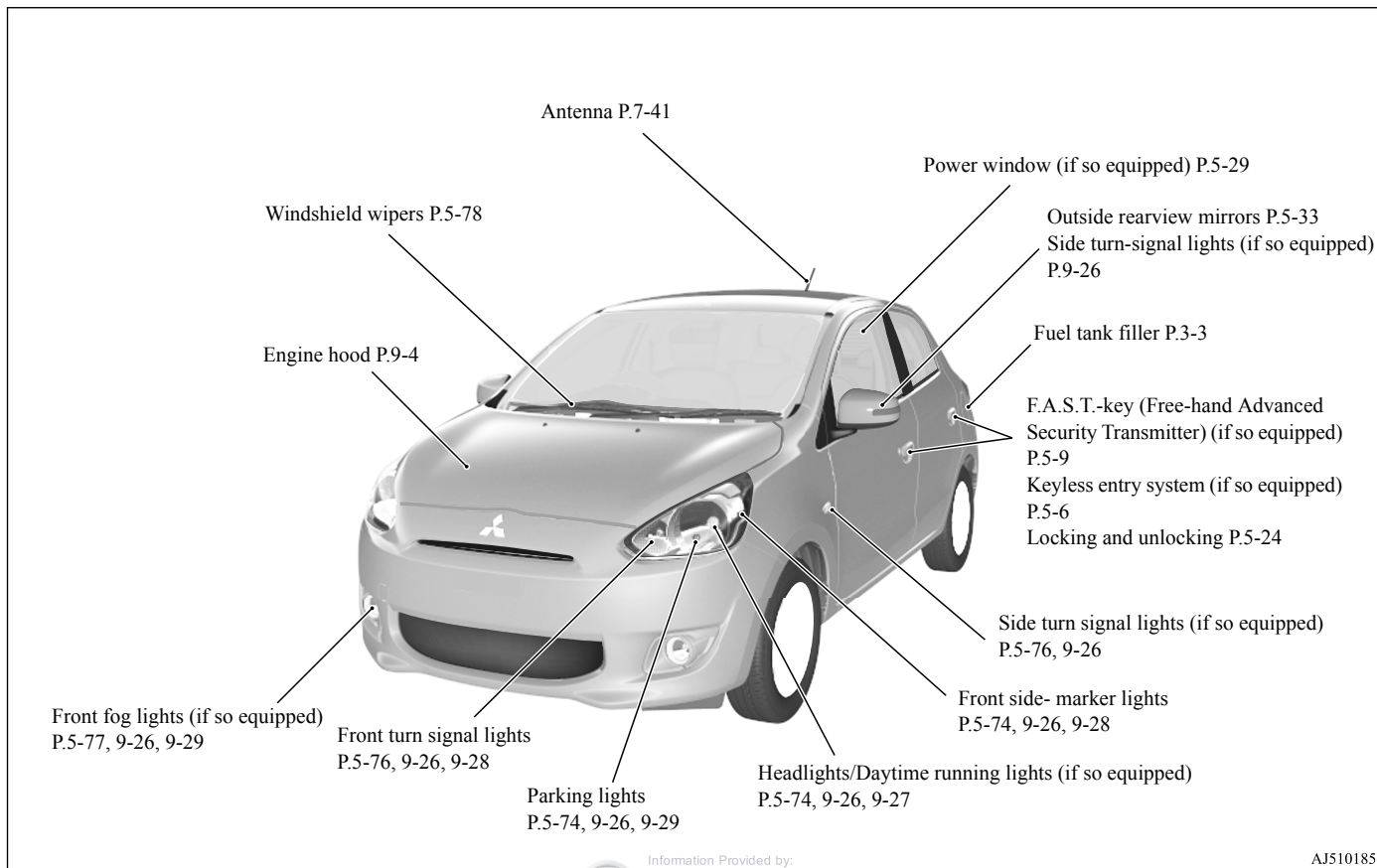

Information Provided by:



AJ5101851

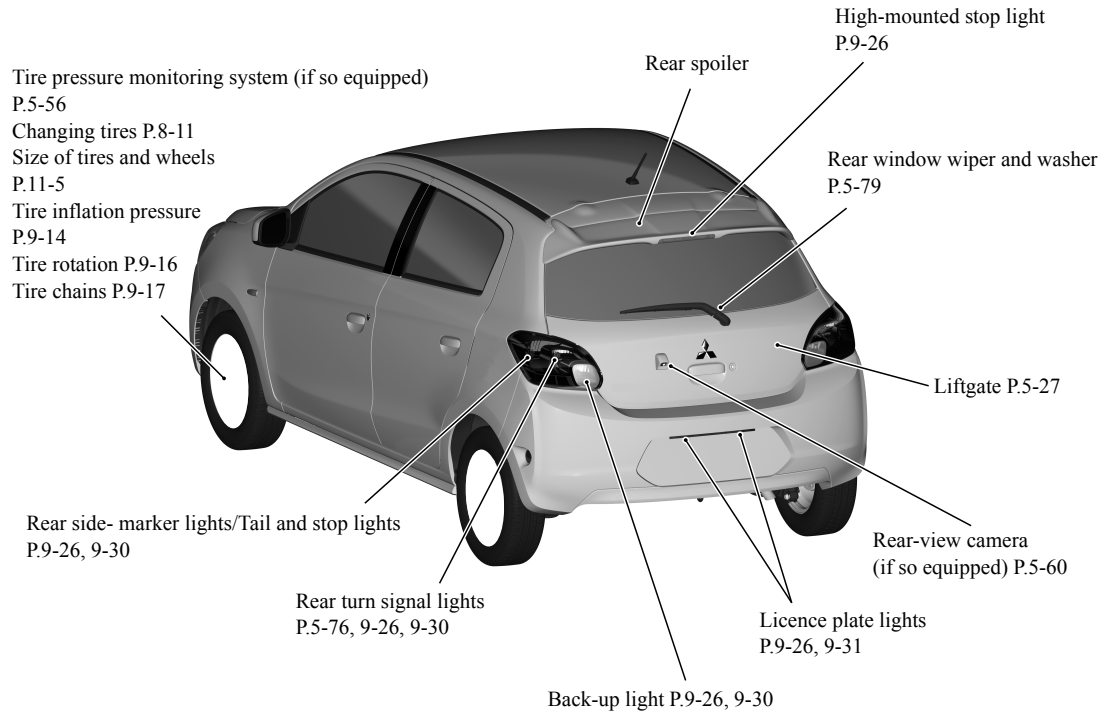



AJ5101864

If this warning light comes on or flashes while you're driving...





NOTE



- These warning lights will come on for a few seconds for a bulb check when the ignition switch is first turned to "ON" or the operation mode is put in ON.

Warning lights	Do this	Ref. Page
 <p>Charging system warning light</p>	<ul style="list-style-type: none"> ● Park your vehicle in a safe place and stop the engine. Contact your Mitsubishi Motors dealer or a repair facility of your choice for assistance. 	<p>P. 5-73</p>
 <p>(Illuminates and intermittent sounds)</p>	<ul style="list-style-type: none"> ● Park your vehicle in a safe place and stop the engine. Contact your Mitsubishi Motors dealer or a repair facility of your choice for assistance. 	<p>P. 5-15</p>
 <p>Oil pressure warning light</p>	<ul style="list-style-type: none"> ● Park your vehicle in a safe place and stop the engine, then check the engine oil level. If the light comes on while the engine oil level is normal, have the system checked at an authorized Mitsubishi Motors dealer or a repair facility of your choice as soon as possible. 	<p>P. 5-73</p>

If this warning light comes on or flashes while you're driving...

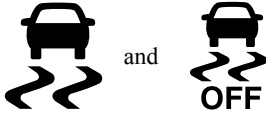

2

Warning lights	Do this	Ref. Page
<p>BRAKE or </p> <p>Brake warning light</p>	<ul style="list-style-type: none"> ● If this light comes on while driving, check to see that the parking brake is fully released. ● If this light stays on after releasing the parking brake, immediately stop and check the brake fluid level. ● If the brake fluid level is correct, there may be a system malfunction. Avoid hard braking and high speed, and contact an authorized Mitsubishi Motors dealer or a repair facility of your choice for assistance. 	<p>P. 5-72</p>
<p></p> <p>Selector lever position indicator in the instrument cluster flashes rapidly (once per second)</p>	<ul style="list-style-type: none"> ● Park your vehicle in a safe place. Idle the engine until the selector lever position indicator stops flashing. If the indicator does not go off, have the system checked at an authorized Mitsubishi Motors dealer or a repair facility of your choice as soon as possible. 	<p>P. 5-42</p>
<p>SERVICE ENGINE SOON or </p> <p>Engine malfunction indicator (“SERVICE ENGINE SOON” or “Check engine light”)</p>	<ul style="list-style-type: none"> ● Although your vehicle will usually be drivable and not need towing, have the engine system checked at an authorized Mitsubishi Motors dealer or a repair facility of your choice as soon as possible. If the vehicle is not drivable, contact emergency roadside assistance at 1-888-648-7820 (for vehicles sold in U.S.A.) or 1-888-576-4878 (for vehicles sold in Canada), an authorized Mitsubishi Motors dealer, or local towing company for assistance. 	<p>P. 5-72</p>
<p></p> <p>Electric power steering system (EPS) warning light</p>	<ul style="list-style-type: none"> ● If this light comes on while the engine is running, it may become harder to turn the steering wheel. Have your vehicle inspected at an authorized Mitsubishi Motors dealer or a repair facility of your choice as soon as possible. 	<p>P. 5-48</p>

Warning lights	Do this	Ref. Page
 <p>Anti-lock braking system warning light</p>	<ul style="list-style-type: none"> ● When this light comes on, the anti-lock braking system is not functioning and only the ordinary braking system is functioning. ● Park your vehicle in a safe place and stop the engine. Test the system as described on page 5-47. ● If the light does not go out after the test, or if it comes on again, we recommend that you have the system checked at an authorized Mitsubishi Motors dealer or a repair facility of your choice as soon as possible. 	<p>P. 5-47</p>
 <p>SRS warning light</p>	<ul style="list-style-type: none"> ● Immediately have the airbag and the pre-tensioner seat belt system checked at an authorized Mitsubishi Motors dealer. 	<p>P. 4-27</p>
 <p>Selector lever position indicator in the instrument cluster flashes slowly (every 2 seconds)</p>	<ul style="list-style-type: none"> ● Have your continuously variable transmission (CVT) checked at an authorized Mitsubishi Motors dealer or a repair facility of your choice as soon as possible. 	<p>P. 5-42</p>
 <p>ASC indicator and ASC OFF indicator</p>	<ul style="list-style-type: none"> ● Park your vehicle in a safe place and stop the engine. Restart the engine and check whether the indicator goes out. ● If the indicator does not go out, or if it comes on again, have your vehicle inspected by an authorized Mitsubishi Motors dealer or a repair facility of your choice as soon as possible. ● When this indicator comes on, the active stability control is not functioning. 	<p>P. 5-51</p>

If this warning light comes on or flashes while you're driving...

2



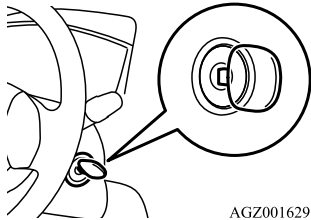
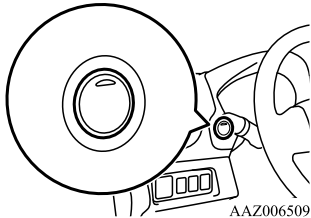

Warning lights	Do this	Ref. Page
 <p>ASC indicator</p>	<ul style="list-style-type: none"> ● Park your vehicle in a safe place and stop the engine. Restart the engine and check whether the indicator goes out. ● If the indicator does not go out, or if it comes on again, have your vehicle inspected by an authorized Mitsubishi Motors dealer or a repair facility of your choice as soon as possible. ● When this indicator comes on, the hill start assist is not functioning. Start off carefully on a steep uphill slope. 	<p>P. 5-46</p>
 <p>Tire pressure monitoring system warning light (if so equipped)</p>	<ul style="list-style-type: none"> ● If the warning light comes on, you should stop and adjust the tires to the proper inflation pressure as soon as possible. (See “Tire inflation pressures” on page 9-14.) Once adjustments have been made, the warning light will go off after a few minutes of driving. ● If the warning light blinks for approximately 1 minute and then remains continuously illuminated, the system is not operating properly. If the system returns to normal, the warning light will go off. If the warning light does not go off, have the vehicle inspected at an authorized Mitsubishi Motors dealer. 	<p>P. 5-56</p>

If this problem occurs...

Problem	Do this	Ref. Page
<p>Unable to turn the key. (except for vehicles equipped with the F.A.S.T.-key)</p>  <p>AGZ001629</p>	<p>From “ACC” to “OFF” Vehicles with continuously variable transmission (CVT): Check the position of the selector lever. The key cannot be removed unless the selector lever is set to the “P” (PARK) position.</p>	<p>P. 5-35</p>
<p>The engine does not start when the engine switch is pressed. (for vehicles equipped with the F.A.S.T.-key)</p>  <p>AAZ006509</p>	<p>Make sure the F.A.S.T.-key is in the vehicle. Vehicles with manual transaxle: Press and hold the clutch pedal all the way down, and then press the engine switch while depressing the brake pedal. Vehicles with continuously variable transmission (CVT): Make sure the selector lever is in the “P” (PARK) position, and then press the engine switch while depressing the brake pedal.</p>	<p>P. 5-16</p>
<p>The F.A.S.T.-key does not operate. (for vehicles equipped with the F.A.S.T.-key)</p>	<p>Use the emergency key to lock and unlock the door. Insert the F.A.S.T.-key into the key slot of the floor console, and then start the engine or change the operation mode.</p>	<p>P. 5-19</p>

If this problem occurs...

2

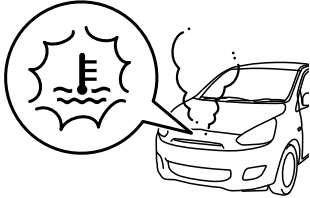
Problem	Do this	Ref. Page
<p>Cannot shift the selector lever from the “P” (PARK) position. (for vehicles with continuously variable transmission (CVT))</p>	<p>Shift the selector lever while pressing the brake pedal. Check that the ignition switch or the operation mode is in ON.</p>	<p>P. 5-39</p>
<p>The windows are fogged up.</p> 	<p>Vehicles equipped with the heater without air conditioning function or the manual air conditioning:</p> <ol style="list-style-type: none"> 1. Set the mode selection dial to the “” or “” position. 2. Turn on the blower. <p>Vehicles equipped with the automatic air conditioning: Push the defogger switch to change the “” mode.</p>	<p>P. 7-6, 7-10, 7-13</p>
<p>The engine does not start. The lights do not come on. The lights are dim. The horn does not honk. The horn sound is weak.</p>	<p>Have the battery checked. Recharge or replace as needed.</p>	<p>P. 8-2, P. 9-10</p>
<p>The high coolant temperature warning light is illuminates.</p>  <p>AAZ006017</p> <p>Steam comes out of the engine compartment.</p>	<p>The engine is overheated. Carefully stop the vehicle in a safe place.</p>	<p>P. 8-4</p>

Problem	Do this	Ref. Page
The vehicle is stuck in sand, mud or snow	Rock your vehicle back and forth to free it.	P. 8-18

⚠ WARNING

- When attempting to rock your vehicle out of a stuck position, be sure that no one is near the vehicle. The rocking motion may cause the vehicle to suddenly lurch forward or backward, possibly injuring bystanders.
- Avoid revving the engine or spinning the wheels. Prolonged efforts to free a stuck vehicle may result in overheating and transaxle failure. If the vehicle remains stuck after several rocking attempts, have a towing service pull the vehicle out.

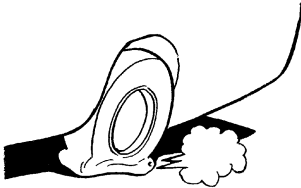
Problem	Do this	Ref. Page
The brakes are not functioning properly after crossing a puddle or stream.	Dry out the brakes by driving slowly while lightly pressing the brake pedal.	P. 6-5
The continuously variable transmission (CVT) makes no shift change when accelerating. The initial movement of the vehicle is slow when the vehicle starts moving. (for vehicles with CVT)	There may be a problem in the CVT. Have the vehicle inspected by an authorized Mitsubishi Motors dealer or a repair facility of your choice.	P. 5-42
<p>A tire is punctured.</p> 	<ol style="list-style-type: none"> 1. Park the vehicle in a safe place where the surface is flat and level. 2. If your vehicles equipped with the tire repair kit, repair the flat tire with tire repair kit. If your vehicles equipped with the spare tire, replace the flat tire with the spare tire. 	P. 8-6, P. 8-11



General information

Fuel selection	3-2
Filling the fuel tank	3-3
Modifications to and racing of your vehicle	3-5
Genuine Mitsubishi Motors parts	3-6
California Perchlorate Materials Requirements	3-7

Fuel selection

N00301000912

Your vehicle is designed to use unleaded gasoline only. It is equipped with a fuel tank filler pipe specifically designed to accept only a small diameter unleaded gasoline dispensing nozzle.

WARNING

- Gasoline is highly flammable and explosive. You could be burned, seriously injured or killed when handling it. Whenever you refuel your vehicle, stop the engine and keep flames, sparks, and smoking materials away from the vehicle. Always handle fuel in well-ventilated outdoor areas.

CAUTION

- Using leaded gasoline in your vehicle will damage the engine, catalytic converter, and the oxygen sensors. Also, using leaded gasoline is illegal, and will void your warranty coverage of the engine, catalytic converter, and oxygen sensors.

Gasoline detergent additives

In the United States, fuel suppliers are required by law to add detergents to their gas-

oline to minimize fuel-injector clogging and minimize intake-valve deposits. Detergent gasoline helps keep your engine in tune and your emission-control system working properly.

Octane requirement

Your vehicle is designed to operate on unleaded gasoline having a minimum octane number of 87 [(MON+RON)/2] or 91 RON.

Oxygenated gasoline

Gasoline sold at some service stations contains oxygenates such as ethanol, although the oxygenates may not be identified by those names. Oxygenates are required in some areas of the country. Such fuel can be used in your vehicle.

Ethanol (Gasohol)

A mixture of up to 10 % ethanol (grain alcohol) and 90 % unleaded gasoline may be used in your vehicle, provided the octane number is at least as high as that recommended for unleaded gasoline.

Methanol

Do not operate your vehicle on gasoline containing methanol (wood alcohol). Using this type of alcohol could adversely affect the vehicle's performance and damage critical parts of the vehicle's fuel system.

Reformulated gasoline

Many areas of the country require the use of cleaner burning fuel referred to as "Reformulated Gasoline".

Reformulated gasoline contains oxygenates and is specially blended to reduce vehicle emissions and improve air quality.

Mitsubishi Motors Corporation strongly supports the use of reformulated gasoline. Properly blended reformulated gasoline has no adverse effect on vehicle performance or the durability of the engine and fuel system.

MMT (methylcyclopentadienyl manganese tricarbonyl)

MMT is a manganese-containing metallic additive that is blended into some gasolines to increase the octane number. Mitsubishi Motors Corporation recommends using gasolines without MMT.

Use of gasolines blended with MMT may adversely affect performance, and cause the malfunction indicator on your instrument panel to come on. If this happens, contact an authorized Mitsubishi Motors dealer or a repair facility of your choice for assistance.

Sulfur in gasoline

Your vehicle may have been designed to satisfy California's low-emission regulations based on clean-burning low-sulfur gasoline. Gasoline sold in parts of the country other than California is allowed to have a higher sulfur content. Using such gasoline could adversely affect the vehicle's catalytic converter and cause the engine malfunction indicator ("SERVICE ENGINE SOON" or "Check engine light") to come on. Illumination of this indicator while using high-sulfur gasoline does not necessarily mean the vehicle's emission-control system is malfunctioning. Your authorized Mitsubishi Motors dealer may suggest using a different, lower-sulfur brand of unleaded gasoline to determine if the problem is fuel-related.

NOTE

- Poor-quality gasoline can cause problems such as hard starting, stalling during idling, abnormal engine noise, and poor acceleration. If you experience any of these problems, try using a different brand of gasoline. If the engine malfunction indicator ("SERVICE ENGINE SOON" or "Check engine light") flashes, have the vehicle inspected as soon as possible by the nearest authorized Mitsubishi Motors dealer or a repair facility of your choice.
- Repeatedly driving short distances at low speeds can cause deposits to form in the fuel system and engine, resulting in hard starting and poor acceleration. If these problems occur, you are advised to add a detergent additive to the gasoline when you refuel the vehicle. The additive will remove the deposits, thereby returning the engine to a normal condition. Be sure to use a Mitsubishi Motors Genuine cleaning additive. Using an unsuitable additive could make an engine malfunction. For details, please contact the nearest authorized Mitsubishi Motors dealer.

Filling the fuel tank

N00301100913

WARNING

- When handling fuel, comply with the safety regulations displayed by garages and filling stations.



WARNING

- Gasoline is highly flammable and explosive. You could be burned, seriously injured or killed when handling it. When refueling your vehicle, always turn the engine off and keep away from flames, sparks, and smoking materials. Always handle fuel in well-ventilated outdoor areas.
- Before removing the fuel tank filler cap, be sure to get rid of your body's static electricity by touching a metal part of the car or fuel pump. Any static electricity on your body could create a spark that ignites fuel vapor.
- Perform the whole refueling process (opening the fuel tank filler door, removing the fuel tank filler cap, etc.) by yourself; do not let any other person near the fuel tank filler. If you allowed a person to help you and that person was carrying static electricity, fuel vapor could be ignited.
- Do not move away from the fuel tank filler until refueling is finished. If you moved away and did something else (for example, sitting on a seat) part-way through the refueling process, you could pick up a fresh charge of static electricity.
- Be careful not to inhale fuel vapor. Fuel contains toxic substances.
- Keep the doors and windows closed while refueling the vehicle. If they were open, fuel vapor could get into the cabin.

Filling the fuel tank

Fuel tank capacity

9.2 gal (35 L)

3

Refueling

1. Before filling with fuel, stop the engine.
2. The fuel tank filler is located on the rear driver side of your vehicle.

The fuel tank filler door can be opened from inside the vehicle with the fuel tank filler door release lever located at the left side of the driver's seat.

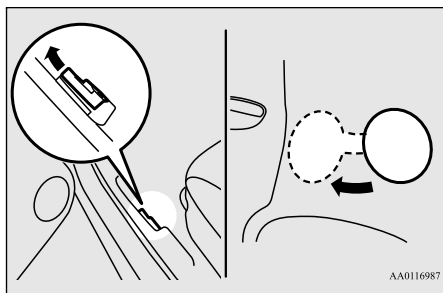

3. Open the fuel tank filler pipe by slowly turning the fuel tank filler cap counter-clockwise.

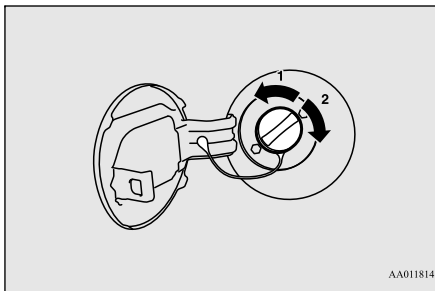

- 1- Remove
- 2- Close

4. While filling with fuel, hang the fuel tank filler cap cord on the hook located on the inside surface of the fuel tank filler door.

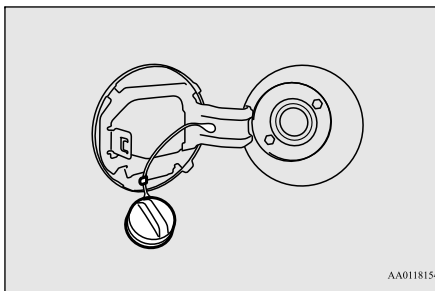

⚠ WARNING

- Since the fuel system may be under pressure, remove the fuel tank filler cap slowly. This relieves any pressure or vacuum that might have built up in the fuel tank. If the fuel tank filler cap is venting vapor or if you hear a hissing sound, wait until the sound stops before removing the fuel tank filler cap. Otherwise, fuel may spray out, injuring you or others.

5. To fill with fuel correctly depends mainly on correct handling of the fuel filler nozzle. Do not tilt the nozzle. Insert the nozzle in the fuel tank filler port as far as it goes.

⚠ CAUTION

- Your vehicle can only be operated using unleaded gasoline. Serious engine and catalytic converter damage will result if leaded gasoline is filled into these vehicles, and consequently, this must never be attempted.

6. When the nozzle stops automatically, do not add more fuel.

⚠ CAUTION

- To avoid fuel spillage and overfilling, do not “top-off” the fuel tank. Spilled fuel could discolor, stain, or crack the vehicle’s paintwork. If fuel spills on the paintwork, wipe it off with a soft cloth.

7. To close, turn the fuel tank filler cap slowly clockwise until you hear clicking sounds, then gently push the fuel tank filler door closed.

⚠ WARNING

- **Make sure the fuel tank filler cap is securely closed. If the fuel tank filler cap were loose, fuel could leak, resulting in a fire.**

⚠ CAUTION

- If you need to replace the fuel tank filler cap, use only the fuel tank filler cap specified for your model vehicle.

📖 NOTE

- If the fuel tank filler cap is not tight while driving, the engine malfunction indicator (“SERVICE ENGINE SOON” or “Check engine light”) may come on when the onboard diagnostic (OBD) system performs a self check.
Always tighten the fuel tank filler cap until you hear at least 3 clicks.
The indicator will go off after several driving cycles. If the indicator does not go off, contact your authorized Mitsubishi Motors dealer or a repair facility of your choice as soon as possible.

Modifications to and racing of your vehicle

N00301600194

This vehicle should not be modified with non-Mitsubishi Motors genuine parts. Mitsubishi Motors designs and manufactures high quality vehicles with an emphasis on safety and durability. Modifications using non-Mitsubishi Motors genuine parts may affect the performance, safety and/or durability of your vehicle, and may violate applicable state and/or federal regulations.

DAMAGE OR PERFORMANCE PROBLEMS RESULTING FROM MODIFICATIONS TO OR RACING OF YOUR



VEHICLE ARE NOT COVERED UNDER WARRANTY.

Examples of modifications to your vehicle that can cause damage or performance problems include the following:

- Failure to use Mitsubishi Motors genuine parts
- Failure to use required fuel and fluids
- Failure to use proper size tires and wheels
- Modification of the fuel, intake, exhaust, emission, suspension, engine, drive train or electrical wiring systems
- Modification of any onboard computer/control module, including reprogramming, or replacing/adding chips to any onboard computer/control module

Review the Warranty and Maintenance Manual for further details regarding warranty coverage.

Installation of accessories

N00301700212

⚠ CAUTION

- Before any electrical or electronic accessories are installed, consult an authorized Mitsubishi Motors dealer.

- The installation of accessories, optional parts, etc., should only be performed within the limits prescribed by law, and in accordance with the guidelines and warnings contained within the documents accompanying this vehicle.
Only Mitsubishi Motors approved accessories should be fitted to your vehicle.
- Improper installation of electrical parts could cause a fire. Refer to the “Modification/alterations to the electrical or fuel systems” section within this owner’s manual.
- Using a cellular phone or radio set inside the vehicle without an external antenna may cause electrical system interference, which could lead to unsafe vehicle operation.
- Tires and wheels which do not meet specifications must not be used.
Refer to the “Specifications” section for information regarding wheel and tire sizes.

⚠ WARNING

- **While driving, do not use a cellular phone in a way that hinders safe driving. Anything, including cellular phone usage, that distracts you from the safe operation of your vehicle increases your risk of an accident.**
Refer to and follow all state and local laws in your area regarding cellular phone usage while driving.

Important point!

Due to the large number of accessory and replacement parts provided by different manufacturers in the market, it is not always possible for an authorized Mitsubishi Motors dealer to check whether the attachment or installation of a non-Mitsubishi Motors genuine parts affects the driving safety of your Mitsubishi-vehicle.

Modification/alterations to the electrical or fuel systems

N00301800183

Mitsubishi Motors manufactures high quality vehicles with an emphasis on safety. It is important to consult an authorized Mitsubishi Motors dealer before installation of any

accessory which may involve modification of the electrical or fuel systems.

⚠ CAUTION

- Please consult an authorized Mitsubishi Motors dealer concerning any such accessory fitment or modification.
If the wires interfere with the vehicle body or improper installation methods are used (protective fuses not included, etc.), electronic devices may be adversely affected, resulting in a fire, vehicle damage, or other accident.

Genuine Mitsubishi Motors parts

N00301400219

Mitsubishi Motors Genuine Parts are designed and manufactured to meet high standards of performance, and are recommended for all of your maintenance needs. Also available from your Mitsubishi Motors dealer are a wide variety of accessories to personalize your new vehicle. Each Mitsubishi Motors vehicle has a selection of Mitsubishi Motors authorized accessories to choose from to tailor your new vehicle to your own personal preference. Your Mitsubishi Motors dealer’s Parts Manager has information on various audio systems, protection items, as well as interior and exterior accessories available for your specific model.



California Perchlorate Materials Requirements

N00300100017

Certain components of this vehicle, such as airbag modules, seat belt pretensioners, and button cell batteries, may contain perchlorate materials.

Special handling may apply. For additional information, see www.dtsc.ca.gov/hazardous-waste/perchlorate.

3

Seat and restraint systems

Seats	4-2
Seats and restraint systems	4-2
Front seats	4-3
Rear seats	4-5
Head restraints	4-7
Seat belts	4-8
Seat belt use during pregnancy	4-12
Seat belt pre-tensioner and force limiter systems	4-13
Child restraint systems	4-14
Maintenance and inspection of seat belts	4-20
Supplemental Restraint System (SRS) - airbag	4-21

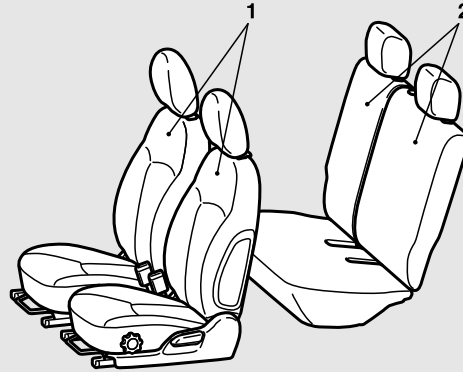

AA1009082

1 - Front seats

- To adjust the seat forward or backward → Page 4-3
- To adjust the seatbacks → Page 4-3
- To adjust the seat height (Driver's seat only, if so equipped) → Page 4-4
- Heated seats (if so equipped) → Page 4-4

2 - Rear seats

- Folding the seatbacks forward → Page 4-6

Seats and restraint systems

N00401600212

Your vehicle has seat belts and other safety features that help protect you and your passengers in an accident.

Seat belts are the most important safety device. When worn properly, seat belts can reduce the chance of serious injury or death in various types of crashes. For added protection during a severe frontal collision, your vehicle has a Supplemental Restraint System (SRS) with airbags for the driver and passengers. The seats, head restraints, and door

locks also are safety equipment, which must be used correctly.

Always check the following before you drive:

- That everyone in your vehicle is properly wearing their seat belt.
- That infants and small children are properly secured in an appropriate child restraint system in the rear seat.
- That all doors are fully closed and locked.
- That seatbacks are upright, with head restraints properly adjusted.

Safety equipment cannot prevent injury or death in all motor vehicle accidents. However, you can help reduce the risk of injury or death by following the instructions in this manual.

Front seats

N00401800403

Position the driver's seat as far back as possible while maintaining a position that still enables you to fully apply the pedals, easily control the steering wheel and safely operate the vehicle.



AA0115746

⚠ WARNING

- Do not attempt to adjust the seat while driving. This can cause loss of vehicle control and result in an accident.
- After adjusting the seat, make sure that seat is securely locked into position.

⚠ WARNING

- To reduce the risk to the driver of serious injury or death during deployment of the driver's airbag, always properly wear the seat belt and adjust the driver's seat as far back as possible while maintaining a position that still enables you to fully apply the pedals, easily control the steering wheel, and safely operate the vehicle.
- To reduce the risk to the front passenger of serious injury or death during deployment of the passenger's airbag, always properly wear the seat belt and adjust the front passenger's seat as far back as possible.
- Always place children 12 years old and under in the rear seat and use appropriate child restraint systems.

⚠ CAUTION

- Make sure that the seat is adjusted by an adult. If it is adjusted by a child, an unexpected accident might occur.
- Do not place a cushion or the like between your back and the seatback while driving. The effectiveness of the head restraints will be reduced in the event of an accident.
- When sliding the seats, be careful not to catch your hand or leg.
- When sliding or reclining the seat rearward, pay careful attention to the rear seat passengers.

To adjust the seat forward or backward

N00401900316

Pull the seat adjusting lever up and slide the seat forward or backward to the desired position. Release the adjusting lever to lock the seat in place.

4

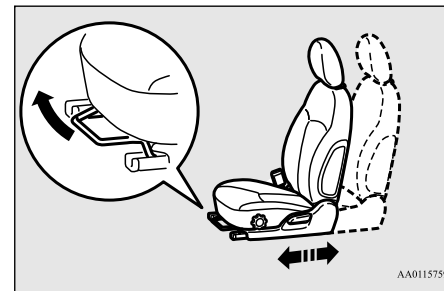

AA0115759

⚠ WARNING

- To make sure that the seat is securely locked, try to move it forward or backward without using the adjusting lever.

To adjust the seatbacks

N00402000369

To adjust the seatback, lean forward slightly, gently pull the seatback lock lever up, then lean backward to a comfortable position and

Front seats

release the lever. The seatback will lock in place.

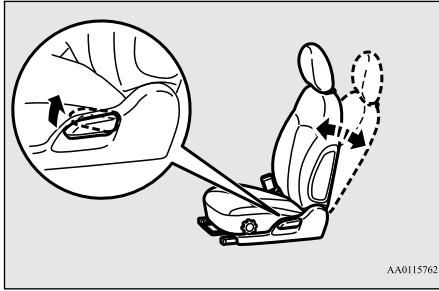

4

⚠ CAUTION

- The reclining mechanism used in the seatback is spring loaded, and will cause the seatback to return quickly to the vertical position when the lock lever is operated. When pulling the lever, sit close to the seatback or hold the seatback with your hand to control its return motion.

⚠ WARNING

- To reduce the risk of serious injury or death in the event of an accident or sudden stop, all seatbacks should be kept in the upright position while the vehicle is in motion. Seat belt performance during an accident can be adversely affected if the seatbacks are reclined. The more a seatback is reclined, the more likely seat belt performance will be adversely affected. If the seat belt is not properly positioned against the body during an accident, there is increased risk you will slide under the belt and receive serious injury or death.

To adjust the seat height (Driver's seat only, if so equipped)

N00402100243

To adjust the seat height, turn the dial as shown in the illustration.

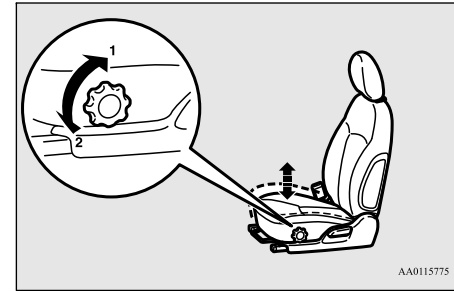

- 1- To move the seat cushion up
- 2- To move the seat cushion down

Heated seats (if so equipped)

N00435601418

The heated seats can be operated by pushing the switch when the ignition switch or the operation mode is in ON. The indicator light (A) will illuminate while the heater is on.

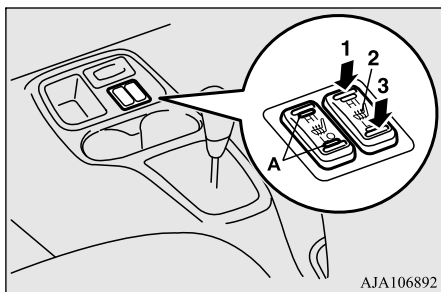

AJA106892

- 1 (HI) - Heater high (for quick heating)
- 2 - Heater off
- 3 (LO) - Heater low (to keep the seat warm)

⚠ WARNING

- **Persons who are unable to feel temperature change or skin pain due to age, illness, injury, medication, alcohol use, fatigue or other physical conditions or who have sensitive skin may suffer burns when using the heated seat even at low temperatures. To reduce the risk of burns, people with such conditions must use care when using the heated seat.**

⚠ CAUTION

- Switch off the heated seats when not in use. Operate the heaters at the “HI” position for quick heating. After the seat has become warm, set the heater switch to the “LO” position to keep it warm. Slight variations in the seat temperature may be felt while using the heated seats. This is caused by the operation of the heater’s internal thermostat and does not indicate a malfunction.
- Do not place heavy objects on the seat or stick pins, needles, or other pointed objects into the seat.
- Do not place a blanket, cushion, or other insulating material on the seat while using the heater; doing so can cause the heater element to overheat.
- When cleaning the seat, do not use benzene, kerosene, gasoline, alcohol, or other organic solvents; doing so can cause damage not only to the surface of the seat, but also to the heater.
- If water or any other liquid is spilled on the seat, allow it to dry thoroughly before attempting to use the heater. Turn the heater off immediately if it appears to be malfunctioning during use.

Rear seats

N00402500221

⚠ WARNING

- **Never adjust the seats to make a cargo area when the vehicle is in motion or on a slope. The seats could move more than necessary or move suddenly causing a serious accident and/or injury.**
- **After folding down a seat or returning a seat back to its original position, make sure the seat is firmly secured. Also check to make sure that the seat belts are in front of the seatbacks, and not caught behind the seatbacks. If the seat is not secured, it could move causing a serious accident and/or injury.**
- **Do not allow anyone to ride in the cargo area while the vehicle is in motion. People who are not properly seated and restrained can be seriously injured or killed in an accident.**
- **The cargo area in the rear of the vehicle should never be used as a play area by children. All children should be properly restrained in a restraint device that offers the maximum protection for their size and age. Refer to “Child restraint systems” on page 4-14.**

4

CAUTION

- In the cargo area, do not load luggage or cargo higher than the top of the seats and make sure that it is firmly secured. Restricted rear vision or flying objects entering the passenger compartment during sudden braking could result in a serious accident and/or injury.
- Seatbacks should always be folded and put back into their normal position by an adult.
- When adjusting the seats, be careful not to catch your hand. Personal injury could result.

Folding the seatbacks forward

N00402901222

The rear seatbacks can be folded forward to provide additional luggage compartment space.

To fold

1. Place each head restraint in its lowest position. (Refer to “Head restraints” on page 4-7.)
2. Make sure that the seat belt for the outboard seating position is passed through the seat belt guide strap (A) and the seat belt guide is fastened as shown in the illustration.

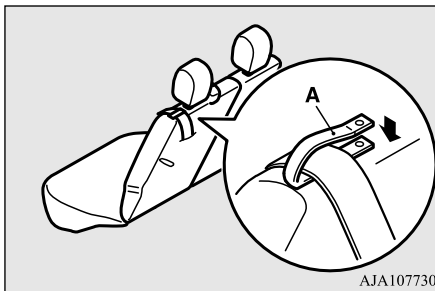

3. Pull the left or right release straps (B), and fold the rear seatbacks forward.

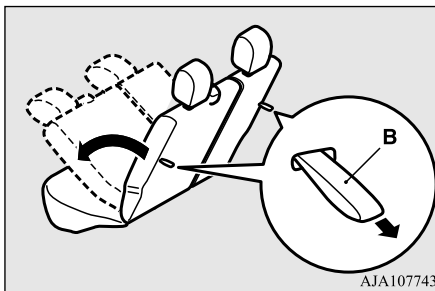
**NOTE**

- If the seat belt interferes with luggage, unfasten the seat belt guide to release the seat belt and store the seat belt latch plate as shown in the illustration.

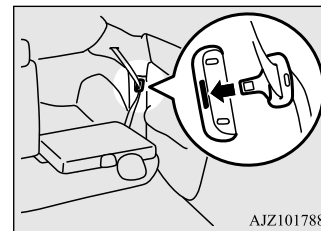
**To return**

1. Make sure that the seat belt for the outboard seating position is passed through the seat belt guide or the seat belt latch plate for the outboard seating position is stored.
2. Raise the seatback until it locks securely into place.
After returning the seatback to its normal position, gently shake the seat and seatback to make sure they are firmly secured.

⚠ WARNING

- After returning the seatbacks to their upright positions, make sure that the seatbacks are locked in place and firmly. Also check to be sure that the rear seat belts are in front of the seatbacks, and not caught behind the seatbacks.

⚠ CAUTION

- Do not grab the seat belt guide to raise the seatback; doing so can cause damage of the seat belt guide and the seatback.

Head restraints

N00404300584

Padded head restraints for the seats can reduce the risk of a whiplash injury if your vehicle is hit from the rear.

The head restraints are equipped in the illustrated position.

To maximize the effectiveness of your head restraint, adjust the front seatback to the upright position, the rear seatback to the normal seating position, and the head restraint to the proper position. Sit back against the seatback with your head close to the head restraint.

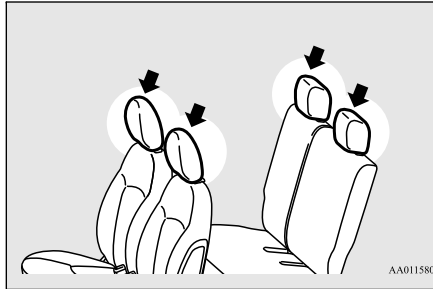
**⚠ WARNING**

- Driving without the head restraints in place can cause you and your passengers serious injury or death in an accident. To reduce the risk of injury in an accident, always make sure the head restraints are installed and properly positioned when the seat is occupied.
- In order to minimize the risk of a neck injury due to a rear impact, the front seatback must be adjusted to the upright position, the rear seatback to the normal seating position, and the head restraint to the proper position before vehicle operation. The driver should never adjust the seat while the vehicle is in motion.
- Never place a cushion or similar device on the seatback. This can adversely affect head restraint performance by increasing the distance between your head and the restraint.

Adjustment of the head restraint height

To reduce the risk of injury in an accident, adjust the head restraint height so that the center of the restraint is at your ear level when seated. Any person too tall for the restraint to reach their ear level when seated should raise the restraint to the highest locked position.

- To raise the restraint, pull it straight up.
- To lower the restraint, push down on it while pressing the lock knob (A) in the direction shown by the arrow.
- After adjusting the height, push down on the restraint to make sure it is locked in position.

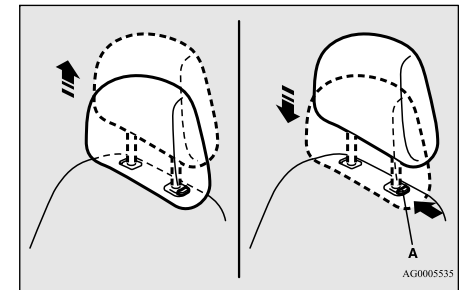

To remove

Press the lock knob (A) in the direction shown by the arrows. Then pull the head restraint up and out of the seatback.

4

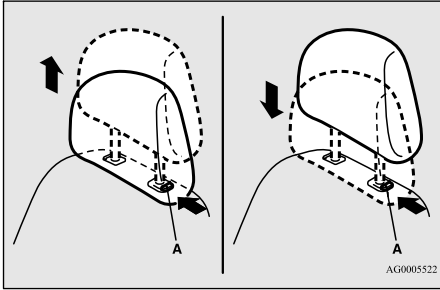

WARNING

- To help minimize the risk of neck injury in the event of an accident, the head restraints must be properly installed and positioned to proper height before vehicle operation.

To install

First check that the head restraint is facing in the right direction as shown in the previous illustration, and then insert it into the seatback. Push the head restraint down while

pressing the lock knob (A) until the restraint locks into place.

CAUTION

- Check that the lock knob (A) is extended out as shown in the illustration. Then pull the head restraint up to make sure that it is locked in place and will not come out of the seatback.

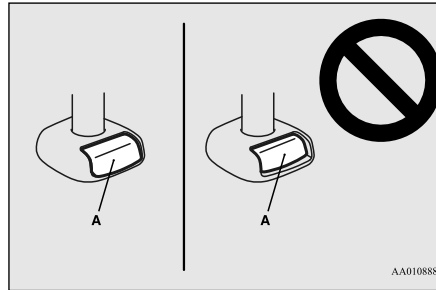

CAUTION

- The shape and size of the head restraint differs according to the seat. Always use the correct head restraint provided for the seat and do not install the head restraint in the wrong direction.

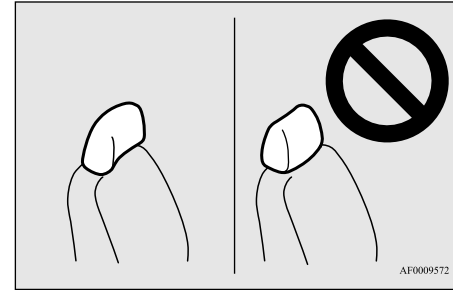

Seat belts

N00406001481

Seat belts are installed in your vehicle to help reduce the risk of injury to the driver and passenger in the event of an accident. Always use the provided seat belts.

Carefully review the following information for proper seat belt usage.

WARNING

- To help reduce the risk of injury or death in an accident, seat belts and child restraint systems must always be used. Refer to “Child restraint systems” on page 4-14 for additional information.
- Never use one seat belt for more than one person.
- Never carry more people in your vehicle than there are seat belts.
- Always adjust the seat belt for a snug fit.

⚠ WARNING

- Always place the shoulder belt over your shoulder and across your chest. Never put it behind you or under your arm.
- Always wear the lap belt as low as possible across your hips, not around your waist.
- Never modify or alter the seat belts in your vehicle.
- To reduce the risk to the driver of serious injury or death during deployment of the driver's airbag, always properly wear the seat belt and adjust the driver's seat as far back as possible while maintaining a position that still enables you to fully apply the pedals, easily control the steering wheel, and safely operate the vehicle.
- To reduce the risk to a front seat passenger of serious injury or death from a deploying airbag, make sure the passenger always wears the seat belt properly, remains seated all the way back and upright in their seat, and moves the seat as far back as possible. Refer to "Supplemental Restraint System (SRS) - airbag" on page 4-21 for additional information.
- Never hold an infant or child in your arms or on your lap when riding in this vehicle even when you are wearing your seat belt. Never place any part of the seat belt you are wearing around an infant or child. Failure to follow these simple instructions creates a risk of serious injury or death to your child in the event of an accident or sudden stop.

⚠ WARNING

- Children 12 years old and under should always ride in the rear seat and be properly restrained. This reduces their risk of serious injury or death in an accident, especially due to a deploying front passenger's airbag. Refer to "Child restraint systems" on page 4-14 for additional information.
- Any child who is too small to properly wear a seat belt must be properly restrained in an appropriate child restraint system.
- Infants MUST be placed in a rear-facing child safety seat and positioned in the rear seat.
- In the event of an accident, all seat belt assemblies, including retractors and attachment hardware, should be inspected by an authorized Mitsubishi Motors dealer to determine whether replacement is necessary.

Seat belt instructions

N00406200460

All seats are equipped with a seat belt which uses one combined lap-and-shoulder belt with an emergency locking retractor.

This system is designed to provide both comfort and safety. It permits full extension and automatic retraction of the belts during normal vehicle operation. A sensing device

inside the belt retractor is designed to lock the retractor in the event of a sudden change in the vehicle's motion.

📖 NOTE

- For instructions on installing a child restraint system using a seat belt, refer to "Installing a child restraint system using the seat belt" on page 4-18.

1. Occupants should always sit back in their seats with their backs against the upright seatback. To reduce the risk of serious injury or death during deployment of the airbag, adjust the driver's seat as far back as possible while maintaining a position that still enables you to fully apply the pedals, easily control the steering wheel, and safely operate the vehicle. The front passenger seat should also be moved as far back as possible. Refer to "Supplemental Restraint System (SRS) - airbag" on page 4-21. Also refer to "To adjust the seat forward or backward" on page 4-3.

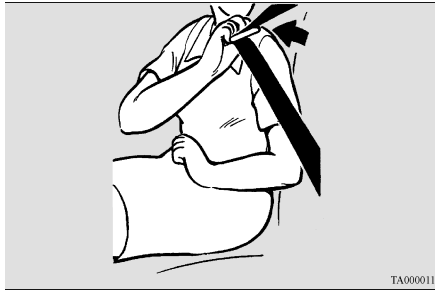

4. The lap part of the belt must always be worn low and snug across the hips. Pull up on the shoulder portion of the belt to take up any slack in the lap belt.



WARNING

- To reduce the risk of serious injury or death in the event of an accident or sudden stop, all seatbacks should be kept in the upright position while the vehicle is in motion. Seat belt performance during an accident can be adversely affected if the seatbacks are reclined. The more a seatback is reclined, the more likely seat belt performance will be adversely affected. If the seat belt is not properly positioned against the body during an accident, there is increased risk you will slide under the belt and receive serious injury or death.

3. Pull the seat belt out slowly while holding the latch plate. Push the latch plate into the buckle until you hear a “click”. Pull up on the belt to be sure the latch plate is locked securely in the buckle.



2. Grasp the latch plate and slide it up the webbing so that it easily pulls across your body.

NOTE

- With the exception of the seat belt for the driver, the seat belts in all other seating positions are equipped with an Automatic Locking Retractor (ALR) function. If you pull the seat belt fully out of the retractor, the retractor will switch to its ALR child restraint installation function (see page 4-18). When the ALR function has been activated, the seat belt will only retract. If this happens, let the belt fully retract, then pull the seat belt back out, repeating steps 1 through 4.

NOTE

- If the seat belt locks up and cannot be pulled out, pull it once with force and let it retract all the way. Then, pull the belt out slowly once again.



⚠ WARNING

- Be sure the lap belt portion fits snugly and is worn as low as possible across the hips, not around the waist. Failure to follow this instruction will increase the risk of serious injury or death in the event of an accident.
- Be sure the seat belt webbing is not twisted when worn. Twisted webbing may adversely affect seat belt performance.

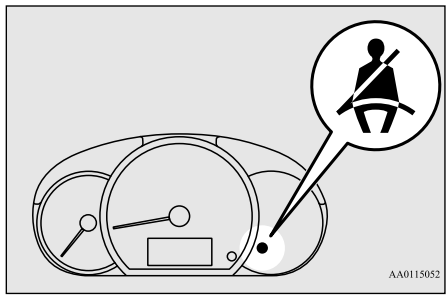

📖 NOTE

- If the seat belt subsequently remains unfastened, the warning light and the tone will issue further warnings each time the vehicle starts moving from a stop.

5. To release the belt, press the button on the buckle and allow the belt to retract. If the belt does not retract smoothly, pull it out and check for kinks or twists in the webbing. Then make sure it remains untwisted as it retracts.

Driver’s seat belt reminder/warning light

N00418400384

A tone and warning light are used to remind the driver to fasten the seat belt.

If the ignition switch is turned to the “ON” position or the operation mode is put in ON without the driver’s seat belt being fastened, a warning light will come on and a tone will sound for approximately 6 seconds to remind you to fasten your seat belt. If the vehicle is driven with the seat belt still unfastened, the warning light will blink and the tone will sound intermittently until the seat belt is fastened.

⚠ WARNING

- In order to reduce the risk of serious injury or death in an accident, always fasten your own seat belt. Do not allow anyone to ride in your vehicle unless he or she is also seated and fastening a seat belt. Children should additionally be restrained in a secure child restraint system.

Front passenger seat belt warning light

N00418300237

The front passenger seat belt warning light is located at shown in the illustration.

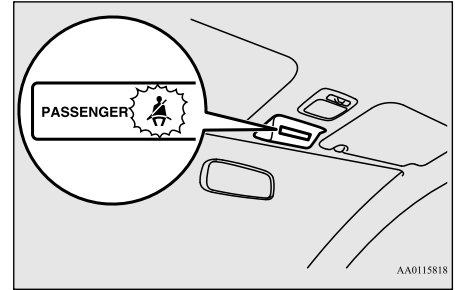

When the ignition switch is turned to the “ON” position or the operation mode is put in ON, this indicator normally comes on and goes off a few seconds later. The light comes on when a person sits on the front passenger seat but does not fasten the

Seat belt use during pregnancy

seat belt. It goes off when the seat belt is subsequently fastened.

⚠ WARNING

- When a child booster seat is used on the front passenger seat, the front passenger seat belt warning light will not come on, if the seat belt is not fastened when the booster seat is used. Confirm that the child is wearing the seat belt properly.
- Do not install any accessory or sticker that makes the light difficult to see.

Adjustable seat belt shoulder anchor (front seats)

N00406300357

The seat belt anchor height can be adjusted. To move the anchor, pull the lock knob (A) and slide the anchor to the desired position. Release the lock knob to lock the anchor into position.

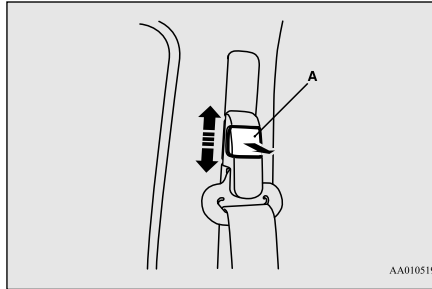

⚠ WARNING

- Always adjust the shoulder belt anchor so that the shoulder belt is positioned across the center of your shoulder without touching your neck. The shoulder belt should not be able to fall off your shoulder. Failure to follow this instruction can adversely affect seat belt performance and increase the risk of serious injury or death in the event of an accident.
- Adjust the shoulder belt anchor only when the vehicle is not in motion.
- Make sure the anchor is securely locked in position after adjusting it.

Seat belt extender

N00406700205

If your seat belt is not long enough, even when fully extended, a seat belt extender

must be obtained. The extender may be used for either of the front seats.

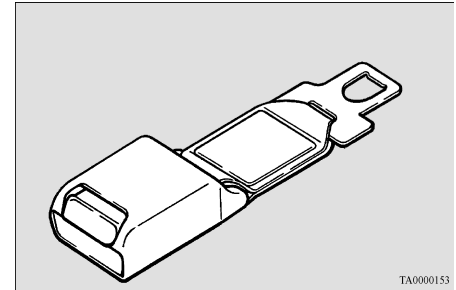

⚠ WARNING

- The extender should only be used if the existing belt is not long enough. Anyone who can use the standard seat belt should not use an extender. Unnecessary use of an extender can adversely affect seat belt performance in an accident.
- When not required, the extender must be removed and stowed.

Seat belt use during pregnancy

N00406800147

Seat belts work for everyone, including pregnant women. Like all occupants, pregnant women are more likely to be seriously injured

or killed in an accident if they do not wear seat belts.

⚠ WARNING

● To reduce the risk of serious injury or death to pregnant women and unborn children in an accident, pregnant women should always wear a seat belt. The lap portion of the seat belt should be worn snug and low across the hips and below the rounding. Consult your doctor if you have any additional questions or concerns.

Seat belt pre-tensioner and force limiter systems

N00417701723

The driver's and front passenger's seats each have a seat belt equipped with a pre-tensioner system and force limiter system.

Pre-tensioner system

The driver and front passenger seat belts are equipped with a seat belt pre-tensioner system. In a moderate-to-severe frontal or side collision, the pre-tensioner system operates simultaneously with the deployment of the front airbags, side airbags or curtain airbags. The seat belt pre-tensioners are located within the seat belt retractors (A). When activated,

the pre-tensioners quickly draw back seat belt webbing and increase seat belt performance.

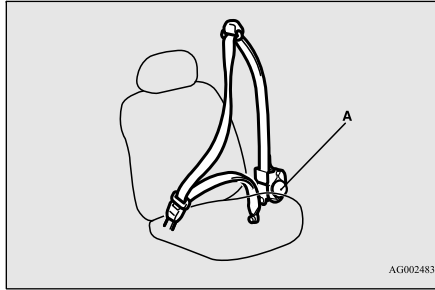

AC60024837

The seat belt pre-tensioner system includes the following components:

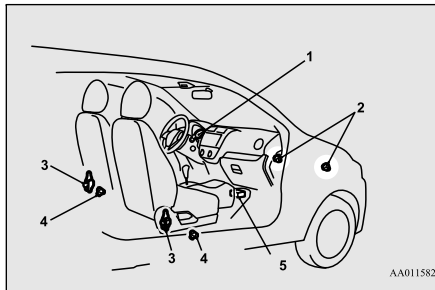

AA0115821

- 1- SRS warning light
- 2- Front impact sensors
- 3- Seat belt pre-tensioner
- 4- Side impact sensors
- 5- Airbag control unit



The airbag control unit monitors the readiness of the electronic parts of the system whenever the ignition switch or the operation mode is under the following conditions. These include all of the items listed above and all related wiring.

[Except for vehicles equipped with the F.A.S.T.-key]

The ignition switch is in the "ON" or "START" position.

[Vehicles equipped with the F.A.S.T.-key] The operation mode is in ON.

The seat belt pre-tensioners will operate under the same conditions as the airbag control unit.

When the seat belt pre-tensioners activate, some smoke is released and a loud noise will be heard. The smoke is not harmful, but care should be taken not to intentionally inhale it, as it may cause some temporary irritation to people with respiratory problems.

The pre-tensioners activate in the event of a moderate-to-severe front or side impact, even if the seat belt is not being worn. The seat belt pre-tensioners may not activate in certain collisions, even though the vehicle may appear to be severely damaged. Such non-activation does not mean that something is wrong with the seat belt pre-tensioner system, but rather that the collision forces were not severe enough to activate the system.

WARNING

- The seat belt pre-tensioner system is designed to work only once. After the seat belt pre-tensioners have been activated, they will not work again. They must promptly be replaced and the entire seat belt pre-tensioner system inspected by an authorized Mitsubishi Motors dealer.

4

SRS warning light

N00408700137

This warning light tells you if there is a problem involving the SRS airbags and/or the seat belt pre-tensioner system. Refer to “SRS warning light” on page 4-27.

Force limiter system

N00408900142

In the event of an accident, the seat belt force limiter system will help reduce the force applied to the driver and front seat passenger.

Child restraint systems

N00407101753

When transporting infants or small children in your vehicle, an appropriate child restraint system must always be used. This is required by law in the U.S. and Canada.

Child restraint systems specifically designed for infants and small children are offered by several manufacturers. Choose only a child restraint system with a label certifying that it complies with Federal Motor Vehicle Safety Standard 213 (FMVSS 213) or Motor Vehicle Restraint Systems and Booster Seats Safety Regulations (RSSR). Look for the manufacturer’s statement of compliance on the box and child restraint system itself.

The child restraint system should be appropriate for your child’s weight and height, and should properly fit your vehicle’s seat.

For detailed information, refer to the instruction manual accompanying the child restraint system.

Guidelines for child restraint system selection

All children should be properly restrained in a restraint device that offers the maximum protection for their size and age.

Be sure to check local, state, or provincial requirements for child size and age that may vary from the recommendations listed below.

- Children less than 1 year old and who weigh 22 pounds (10 kg) or less **MUST** ride in a rear-facing child safety seat that **MUST ONLY** be used in the rear seat.

- Children older than 1 year of age and who weigh less than 40 pounds (18 kg) or who are less than 40 inches (100 cm) tall must be in a forward-facing restraint used only in the rear seat.
- Children who weigh more than 40 pounds (18 kg) or who are more than 40 inches (100 cm) tall, regardless of age, should use a suitable child seat or a booster seat in the rear seat until the vehicle’s lap-and-shoulder belt fits them properly.

WARNING

- All children must be seated in the rear seat, and properly restrained. Accident statistics show that children of all sizes and ages are safer when properly restrained in the rear seat, rather than in the front seat.
- Be sure to select a child restraint system that is appropriate not only for the child’s size and age but also for your vehicle. Some child restraint systems may not fit your vehicle properly.

⚠ WARNING

- Any child who is too large to use a child restraint system should ride in the rear seat and wear the lap-and-shoulder belt properly. The shoulder belt must be positioned over the shoulder and across the chest, not across their neck, and with the lap belt positioned low on the child's hips, not across their stomach. If necessary, a booster seat should be used to help achieve a proper seat belt fit. Follow the booster seat manufacturer's instructions. Only use a booster seat that is certified as complying with Federal Motor Vehicle Safety Standards or Motor Vehicle Restraint Systems and Booster Seats Safety Regulations.
- Never hold an infant or child in your arms or on your lap when riding in this vehicle, even when you are wearing your seat belt. Never place any part of the seat belt you are wearing around an infant or child. Failure to follow these simple instructions creates a risk of serious injury or death to your child in the event of an accident or sudden stop.



⚠ WARNING

- Your vehicle is also equipped with a front passenger's airbag. Never put REAR-FACING CHILD RESTRAINT SYSTEMS or INFANT RESTRAINT SYSTEMS in the front passenger seat. This places the infant too close to the passenger's airbag. During deployment of that airbag, the infant can be seriously injured or killed. Rear-facing child restraint systems or infant restraint systems must only be used in the rear seat.

⚠ WARNING

- FRONT-FACING CHILD RESTRAINT SYSTEMS should be used in the rear seat whenever possible. If one must be used in the front passenger seat, move the seat to the most rearward position and make sure the child stays in the child restraint system, properly restrained. Failure to follow these instructions could result in serious injury or death to the child.



⚠ WARNING

- It is important to use an approved rear-facing infant restraint until the infant is one year old (unless the infant outgrows the seat sooner). This allows the infant's neck and spine to develop enough to support the weight of their head in the event of an accident.
- When installing a child restraint system, follow the instructions provided by the manufacturer and follow the directions in this manual. Failure to do so can result in serious injury or death to your child in an accident or sudden stop.
- After installation, push and pull the child restraint system back and forth, and side to side, to see that it is firmly secured. If the child restraint system is not installed securely, it may cause injury to the child or other occupants in the event of an accident or sudden stop.
- When not in use, keep your child restraint system secured with the seat belt, or remove it from the vehicle, in order to prevent it from being thrown around inside the vehicle during an accident.

📖 NOTE

- Before purchasing a child restraint system, try installing it in the rear seat to ensure proper fit. Due to the location of the seat belt buckles and the shape of the seat cushion, it may be difficult to securely install some manufacturer's child restraint systems. If the child restraint system can be pulled forward or to either side easily on the seat cushion after the seat belt has been tightened, choose another manufacturer's child restraint system. Depending on the seating position in the vehicle and the child restraint system that you have, the child restraint system can be attached using one of the following 2 methods:
 - Attach to the lower anchorage in the rear seat **ONLY** if the child restraint system is compatible with the LATCH system (See page 4-16).
 - Attach to the seat belt (See page 4-18).

Installing a child restraint system using the LATCH (Lower Anchors and Tethers for children) system

N00418800157

Lower anchor locations

The outboard seating positions in the rear seat of your vehicle are equipped with lower anchors for attaching child restraint systems compatible with the LATCH system.

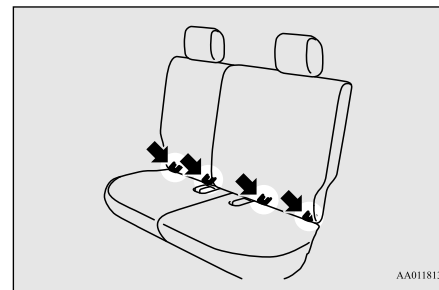

Tether anchor locations

N00418900190

Your vehicle has 3 attachment points on the back of the rear seatbacks. These are for securing a child restraint system tether strap

to each of the 3 rear seating positions in your vehicle.

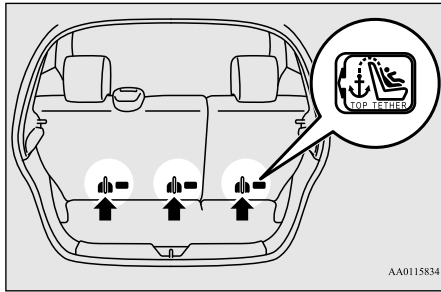

AA0115834

NOTE

- The attachments points are behind slits on the seatback backboard cloth.

Examples of child restraint systems compatible with the LATCH system

N00419000202

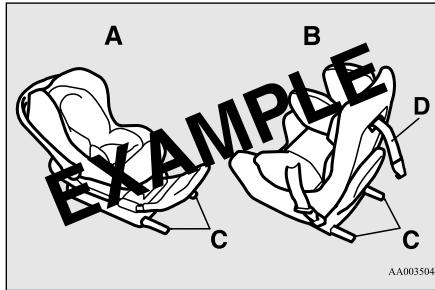

AA0035044

- A- Rear-facing child restraint system
 - B- Front-facing child restraint system
 - C- Child restraint system lower anchor connectors
 - D- Tether strap
- (These are only examples.)

Using the LATCH system

N00419100232

1. In order to securely fasten the tether strap, remove the head restraint from the location where you wish to install the child restraint system.
2. Open the gap a little between the seat cushion (A) and the seatback (B) with your hand to locate the lower anchors (C).



3. Push the anchor connectors (D) on the child restraint system into the lower anchors (C) in accordance with the instructions provided by the child restraint system manufacturer.

Remember, the lower anchors provided with your vehicle are designed to secure suitable child restraint systems compatible with the LATCH system in the outboard positions of the rear seats only. The anchor connectors are NOT designed to secure a suitable child restraint system in the center position of the rear seat.

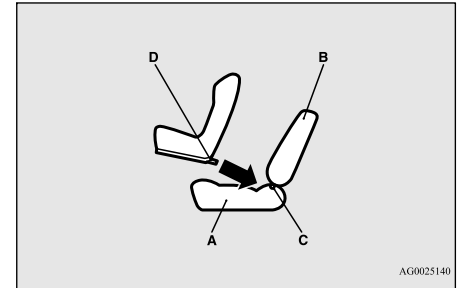

AG0025140

- A- Vehicle seat cushion
- B- Vehicle seatback
- C- Lower anchor
- D- Connector

NOTE

- In order to secure a child restraint system compatible with the LATCH system, you must use the lower anchor points in the out-board positions of the rear seat. To secure a child restraint system in the center position of the rear seat, you must use the vehicle's center seat belt.

WARNING

- If there is any foreign material in or around the lower anchors, remove it before installing the child restraint system. Also, make sure the seat belt is away from, not looped through or otherwise interfering with, the child restraint system. If foreign matter is not removed and/or the seat belt interferes with the child restraint system, the child restraint system will not be secured properly, could detach and move forward in the event of sudden braking or an accident, and could result in injury to the child or other vehicle occupants.
- When the vehicle is moving, do not adjust the seat where the child restraint system is installed.

4. On a vehicle equipped with a rear shelf panel, remove the rear shelf panel from the vehicle. (Refer to "Rear shelf panel" on page 5-109.)

5. Open the slit on the backboard cloth of the seatback, latch the tether strap hook (E) of the child restraint system to the tether anchor bar (F) and tighten the tether strap so it is securely fastened.

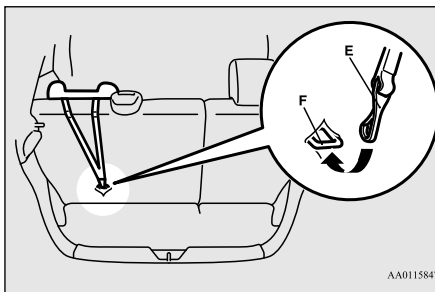

6. Push and pull the child restraint system in all directions to ensure it is firmly secured.

WARNING

- Child restraint system tether anchors are designed only to withstand loads from correctly fitted child restraint systems. Under no circumstances are they to be used for adult seat belts, harnesses, or for attaching other items or equipment to the vehicle.

Installing a child restraint system using the seat belt (with emergency/automatic locking mechanism)

N00407300455

With the exception of the driver, the seat belt in all other seating positions can be converted from normal Emergency Locking Retractor (ELR) mode, to Automatic Locking Retractor (ALR) mode. This means that when you pull the seat belt fully out of the retractor, the retractor will switch to its ALR child restraint installation function. Always use the ALR child restraint installation function when you install a child restraint system using the seat belt.

Children 12 years old and under should always be restrained in the rear seat, whenever possible, although the front passenger seat belt can also be converted to ALR mode.

⚠ WARNING

- When you install a child restraint system using the seat belt, always make sure the retractor has been switched to the ALR child restraint installation function. The ALR function will keep the child restraint system tightly secured to the seat. Failure to convert the retractor to the ALR function may allow the child restraint system to move forward during sudden braking or an accident, resulting in serious injury or death to the child or other occupants.

Installation

1. Place the child restraint system on the seat where you wish to install it.
To help assure proper fitting of the child restraint system, always remove the head restraint.
2. Route the seat belt through the child restraint system according to the instructions provided by the child restraint system's manufacturer. Then insert the seat belt latch plate into the buckle. Make sure you hear a "click" when you insert the latch plate into the buckle.

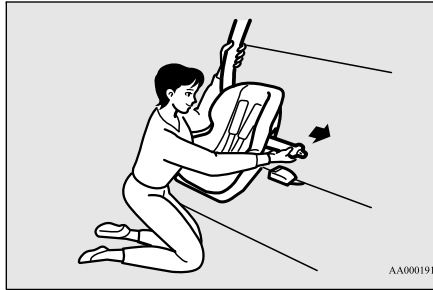

3. To activate the ALR child restraint installation function, slowly pull the shoulder part of the belt all the way out of the retractor until it stops. Then let the belt feed back into the retractor.

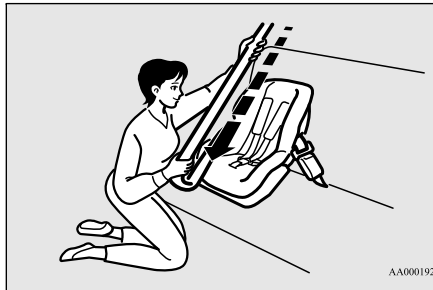

4. After the belt has retracted, tug on it.

If the belt is in the ALR function, you will not be able to pull it out. If the webbing can be pulled out from retractor, the ALR function has not been activated and you will need to repeat steps 3 and 4.

5. After confirming that the belt is locked, grab the shoulder part of the belt near the buckle and pull up to remove any slack from the lap part of the belt allowing the slack to feed into the retractor. Remember, if the lap belt portion is not tight, the child restraint system will not be secure. It may help to put your weight on the child restraint system and/or push on its seat-back while pulling up on the belt (See illustration).

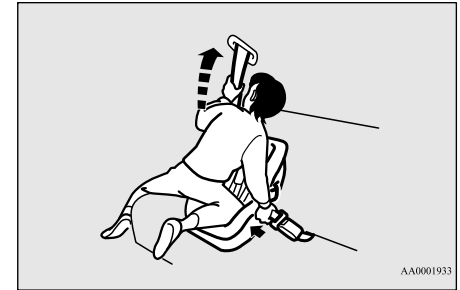

If your child restraint system requires the use of a tether strap, fasten the tether strap in accordance with the following procedures.

6. On a vehicle equipped with a rear shelf panel, remove the rear shelf panel from the vehicle. (Refer to “Rear shelf panel” on page 5-109.)
7. Latch the tether strap hook (A) of the child restraint system to the tether anchor bar (B) and tighten the tether strap so it is securely fastened.

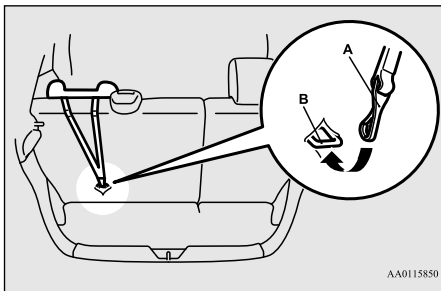

⚠ WARNING

- Child restraint system tether anchors are designed only to withstand loads from correctly fitted child restraint systems. Under no circumstances are they to be used for adult seat belts, harnesses, or for attaching other items or equipment to the vehicle.

8. Before putting your child in the restraint, push and pull the restraint in all directions to be sure it is firmly secure. Do this before each use. If the child restraint system is not firmly secure, repeat steps 1 through 7.
9. To remove a child restraint system from the vehicle and deactivate the ALR mode, remove the child from the restraint. Unlatch the buckle. Then remove the belt from the restraint and let the belt fully retract.
10. Reinstall the head restraint.
Refer to “Head restraints” on page 4-7.

Children who have outgrown child restraint systems

N00407601631

Children who have outgrown a child restraint system should be seated in the rear seat and wear the seat belt. If the shoulder belt crosses their face or neck, and/or the lap belt crosses their stomach, a commercially available booster seat must be used to raise the child so that the shoulder belt crosses their shoulder and the lap belt remains positioned low across their hips. The booster seat should fit the vehicle seat and have a label certifying compliance with Federal Motor Vehicle Safety Standards or Motor Vehicle Restraint

Systems and Booster Seats Safety Regulations.

⚠ WARNING

- Any child who is too small to properly wear a seat belt must be properly restrained in an appropriate child restraint system, to reduce their risk of serious injury or death in an accident.
- A child should never be left unattended in, or unsupervised around, your vehicle. When you leave the vehicle, always take the child out as well.
- Children can die from heat stroke if left or trapped inside the vehicle, especially on hot days.
- Keep your vehicle locked when not in use. Keep your vehicle keys away from children.

Maintenance and inspection of seat belts

N00407000364

The seat belt webbing may be cleaned with mild soap or detergent solution. Do not use an organic solvent. Allow the belts to dry in the shade. Do not allow them to retract until completely dry. Do not attempt to bleach or re-dye the belts. The color may rub off and the webbing strength may be affected.

Regularly check your seat belt buckles and their release mechanisms for positive engagement and release of the latch plate. Check the retractors for automatic locking when in the Automatic Locking Retractor function.

The entire seat belt assembly should be replaced if the webbing shows any obvious cuts, tears, increase in thickness in any section of the webbing from broken fibers, or severe fading from sunlight. All of these conditions indicate a weakening of the belt, which may adversely affect seat belt performance in an accident.

WARNING

- Do not attempt to repair or replace any part of the seat belt assemblies. This work should be done by an authorized Mitsubishi Motors dealer. Failure to have an authorized Mitsubishi Motors dealer perform the work could reduce the effectiveness of the belts and could result in a serious injury or death in an accident.

Supplemental Restraint System (SRS) - airbag

N00407701791

This vehicle is equipped with a Supplemental Restraint System (SRS), which includes airbags for the driver and passengers.

The SRS front airbags are designed to supplement the primary protection of the driver and front passenger seat belt systems by providing those occupants with protection against head and chest injuries in certain moderate to severe frontal collisions. The SRS front airbags, together with sensors at the front of the vehicle and sensors attached to the front seats, form an advanced airbag system.

The SRS driver's knee airbag is designed to supplement the primary protection of the driver's seat belt system. It can reduce the forward movement of the driver's lower legs and provide increased overall body protection in certain moderate to severe frontal collisions.

The SRS side airbags and the curtain airbags are also designed to supplement the seat belts. The SRS side airbags provide the driver and front passenger with protection against chest injuries by deploying the bag on the side impacted in moderate to severe side impact collisions. The SRS curtain airbags provide the driver and passengers on the front seat and rear outboard seat with protection against head injuries by deploying a bag on the side impacted in moderate to severe side impact collisions.

The SRS airbags are NOT a substitute for use of the seat belts. For maximum protection in

all types of accidents, seat belts must ALWAYS be worn by everyone who drives or rides in this vehicle (with infants and small children in an appropriate child restraint system in the rear seat, and older children buckled in the rear seat). Refer to "Child restraint systems" on page 4-14.

WARNING

- **IT IS VERY IMPORTANT TO ALWAYS WEAR YOUR SEAT BELT PROPERLY EVEN WITH AN AIRBAG.**
 - Seat belts help keep the driver and passengers properly positioned. This reduces the risk of injury in all collisions, and reduces the risk of serious injuries or death when the airbags inflate. During sudden braking just before a collision, an unrestrained or improperly restrained driver or passengers can move forward into direct contact with, or within close proximity to, the airbag when it begins to inflate. The beginning stage of airbag inflation is the most forceful and can cause serious injuries or death if the occupant comes in contact with the airbag at this time.
 - Seat belts reduce the risk of injury in rollovers, in rear impact collisions, and in lower-speed frontal collisions because the airbags are not designed to inflate in those situations.

⚠ WARNING

- Seat belts reduce the risk of being thrown from your vehicle in a collision or rollover.
- **IT IS VERY IMPORTANT TO BE PROPERLY SEATED.**
- A driver or front passenger sitting too close to the steering wheel or instrument panel during airbag deployment can be seriously injured or killed.
- Airbags inflate very quickly and with great force. If the driver and front passenger are not properly seated and restrained, the airbag may not provide the proper protection, and can cause serious injuries or death when it inflates.
- To reduce the risk to the driver of serious injury or death due to a deploying driver's airbag, always properly wear your seat belt and adjust the driver's seat as far back as possible, maintaining a position that still allows the driver to have good control of the steering wheel, brake, accelerator, and other vehicle controls.
- To reduce the risk to the front passenger of serious injury or death from a deploying passenger's airbag, make sure the passenger always wears the seat belt properly, remains seated upright and all the way back in the seat, and positions the seat as far back as possible.

⚠ WARNING

- Seat all infants and children in the rear seat, properly restrained in an appropriate child restraint system.
- Airbags inflate very quickly and with great force. Do not sit on the edge of the seat or sit with your lower legs too close to the instrument panel, or lean your head or chest close to the steering wheel or the instrument panel.
- Do not put your feet or legs on or against the instrument panel.

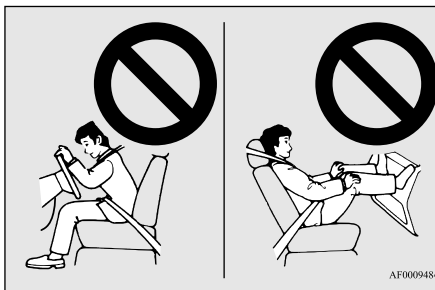

⚠ WARNING

- Infants and small children should never ride unrestrained, or lean against the instrument panel. They should never ride held in your arms or on your lap. They can be seriously injured or killed in an accident, especially when the airbags inflate. Seat all infants and children in the rear seat, properly restrained in an appropriate child restraint system. Refer to "Child restraint systems" on page 4-14.

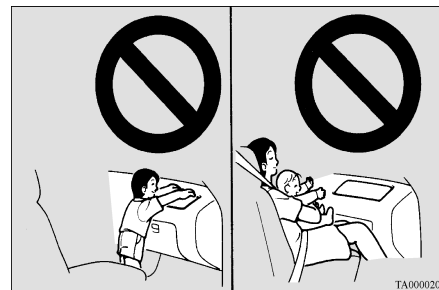

⚠ WARNING

● NEVER put REAR-FACING CHILD RESTRAINT SYSTEMS or INFANT RESTRAINT SYSTEMS in the front passenger seat. This places the infant too close to the passenger’s airbag. During deployment of that airbag, the infant can be seriously injured or killed. Rear-facing child restraint systems or infant restraint systems must only be used in the rear seat.

⚠ WARNING

● FRONT-FACING CHILD RESTRAINT SYSTEMS should be used in the rear seat whenever possible. If they must be used in the front passenger seat, move the seat to the most rearward position and make sure the child stays in the child restraint system, properly restrained. Failure to follow these instructions could result in serious injury or death to the child.

How the Supplemental Restraint System works

N00407800522

The SRS includes the following components:

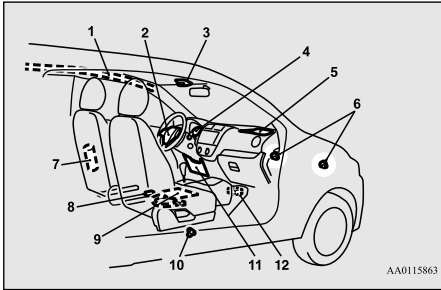

- 1- Curtain airbag modules
- 2- Airbag module (Driver)
- 3- Passenger’s airbag off indicator
- 4- SRS warning light
- 5- Airbag module (Passenger)
- 6- Front impact sensors
- 7- Side airbag modules
- 8- Driver’s seat position sensor
- 9- Passenger’s seat occupant classification sensor system
- 10- Side impact sensors
- 11- Airbag module (Driver’s knee)
- 12- Airbag control unit

⚠ WARNING

● Older children should be seated in the rear seat with their seat belt properly worn, and with an appropriate booster seat if needed. Refer to “Children who have outgrown child restraint systems” on page 4-20.

The airbag control unit monitors the readiness of the electronic parts of the system whenever

the ignition switch or the operation mode is under the following conditions. These include all of the items listed above and all related wiring.

[Except for vehicles equipped with the F.A.S.T.-key]

The ignition switch is in the “ON” or “START” position.

[Vehicles equipped with the F.A.S.T.-key]

The operation mode is in ON.

The airbags will operate under the same conditions as the airbag control unit.

When the impact sensors detect a sufficient front or side impact to deploy the airbag(s), the appropriate airbag(s) will be deployed.

When airbags deploy, some smoke is released accompanied by a loud noise. The smoke is not harmful, but do not intentionally inhale the smoke as it may cause temporary irritation to people with respiratory problems.

An inflated airbag will deflate quickly, so you may not even notice that the airbag was inflated.

Airbag inflation does not prevent the driver from seeing or being able to steer the vehicle, and does not prevent people from leaving the vehicle.

CAUTION

- Airbags inflate very quickly and with great force. In certain situations, contact with an inflating airbag may cause small cuts, abrasions, and bruises.

Event Data Recording

N00418600256

This vehicle is equipped with an event data recorder (EDR).

The main purpose of an EDR is to record, in certain crash or near crash-like situations, such as an airbag deployment or hitting a road obstacle, data that will assist in understanding how a vehicle’s systems performed.

The EDR is designed to record data related to vehicle dynamics and safety systems for a short period of time, typically 30 seconds or less.

The EDR in this vehicle is designed to record such data as:

- How various systems in your vehicle were operating;
- Whether or not the driver and front passenger safety belts were buckled/fastened;
- How far (if at all) the driver was depressing the accelerator and/or brake pedal; and,
- How fast the vehicle was traveling.



These data can help provide a better understanding of the circumstances in which crashes and injuries occur.

NOTE

- EDR data are recorded by your vehicle only if a non-trivial crash situation occurs; no data are recorded by the EDR under normal driving conditions and no personal data (e.g., name, gender, age, and crash location) are recorded. However, other parties, such as law enforcement, could combine the EDR data with the type of personally identifying data routinely acquired during a crash investigation.

To read data recorded by an EDR, special equipment is required, and access to the vehicle or the EDR is needed. In addition to the vehicle manufacturer, other parties, such as law enforcement, that have the special equipment, can read the information if they have access to the vehicle or the EDR.

Driver’s seat position sensor

N00417900223

The driver’s seat position sensor is attached to the seat rail and provides the airbag control unit with information on the seat’s fore-aft position. The airbag control unit controls deployment of the driver’s front airbag in

accordance with the information it receives from this sensor.

If there is a problem involving the driver's seat position sensor, the SRS warning light in the instrument panel will come on. Refer to "SRS warning light" on page 4-27.

⚠ WARNING

- If the SRS warning light comes on, have the vehicle inspected by an authorized Mitsubishi Motors dealer as soon as possible.
- Please observe the following instructions to ensure that the driver's seat position sensor can operate correctly.
 - Adjust the seat to the correct position, and sit well back against the seatback. Refer to "Front seats" on page 4-3.
 - Do not recline the seatback more than necessary when driving.
 - Do not place metallic objects or luggage under the front seat.
- If the vehicle is involved in a severe impact, have the SRS sensor inspected by an authorized Mitsubishi Motors dealer as soon as possible.

Passenger's seat occupant classification sensor system

N00418000364

The passenger's seat occupant classification sensor system is attached to the front passenger seat cushion and provides the airbag control unit with information regarding the occupant on the front passenger seat. The airbag control unit controls deployment of the passenger's front airbag in accordance with the information it receives from this system.

The passenger's front airbag will not deploy in an impact when the system senses no occupant on the front passenger seat or a child in a child restraint system. In this case, the passenger's airbag off indicator will illuminate. Refer to "Passenger's airbag off indicator" on page 4-26.

If there is a problem involving the passenger's seat occupant classification sensor system, the SRS warning light in the instrument panel will come on.

Refer to "SRS warning light" page 4-27.

⚠ WARNING

- If any of the following conditions occur, you should immediately have your vehicle inspected by an authorized Mitsubishi Motors dealer as soon as possible:

⚠ WARNING

- The SRS warning light does not initially come on when the ignition switch or the operation mode is under the following conditions.
 - [Except for vehicles equipped with the F.A.S.T.-key]
The ignition switch is in the "ON" or "START" position.
 - [Vehicles equipped with the F.A.S.T.-key]
The operation mode is in ON.
- The SRS warning light does not go out after several seconds.
- The SRS warning light comes on while you are driving.
- To ensure that the passenger's seat occupant classification sensor system can sense correctly, observe the following instructions. Failure to follow these instructions can adversely affect the performance of the passenger's airbag system.
 - Adjust the seat to the correct position, and sit well back against the seatback. Refer to "Front seats" on page 4-3.
 - Do not recline the seatback more than necessary.
 - Never have more than one person (adult or child) sitting on the seat.
 - Do not place anything between the seat and the floor console.
 - When attaching a child restraint system, secure it firmly.
 - Do not place luggage or other objects on the seat.

⚠ WARNING

- Do not use a seat cover or a cushion.
- Do not modify or replace the seat and seat belt.
- Do not place luggage or other objects under the seat.
- Do not place and use an electronic device such as a computer on the seat.
- Do not place heavy objects on the seat or stick pins, needles, or other objects into it.
- Do not remove the seat cushion skin.
- If any liquid is spilled on the seat, wipe it and dry the seat immediately.
- If the vehicle is involved in a severe impact, have the SRS sensors inspected by an authorized Mitsubishi Motors dealer as soon as possible.

Passenger's airbag off indicator

N00418101359

The passenger's airbag off indicator is located at shown in the illustration.

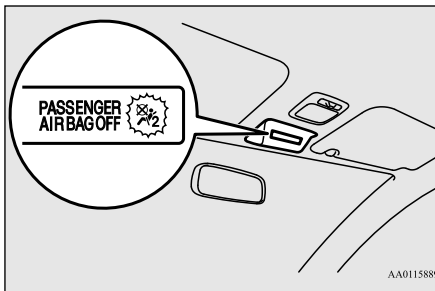

The indicator normally comes on when the ignition switch is turned to the "ON" position or the operation mode is put in ON, and goes out a few seconds later. In the following situations, the indicator will stay on to show that the passenger front airbag is not operational.

- The front passenger seat is not occupied.
- The system senses that a child is using a child restraint system on the front passenger seat.

When the passenger's seat occupant classification sensor system senses there is a person seated in the front passenger seat, the indicator goes out to show that the passenger's front airbag is operational.

⚠ WARNING

- If any of the following conditions occur, you should immediately have the airbag system in your vehicle inspected by an authorized Mitsubishi Motors dealer as soon as possible:
 - The passenger's airbag off indicator comes on when an adult is sitting on the front passenger seat.
 - The passenger's airbag off indicator does not come on when the front passenger seat is not occupied.
 - The passenger's airbag off indicator does not come on when the ignition switch is turned to the "ON" position or the operation mode is put in ON.
 - The passenger's airbag off indicator does not come on when a child is in a child restraint system on the front passenger seat.
 - The passenger's airbag off indicator comes on and goes out repeatedly.
- Do not attach any accessory to your vehicle that makes the passenger's airbag off indicator difficult or impossible to see. You must be able to see the passenger's airbag off indicator and verify the status of the passenger's airbag system.

SRS warning light

N00408300579

There is a Supplemental Restraint System (SRS) warning light on the instrument panel.

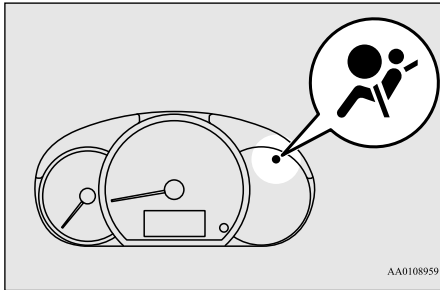

The system checks itself every time the ignition switch is turned to the "ON" position or the operation mode is put in ON. The SRS warning light will come on for several seconds and then go out. This is normal and means the system is working properly.

If there is a problem involving one or more of the SRS components, the warning light will come on and stay on.

The SRS warning light is shared by the SRS airbag and the seat belt pre-tensioner system.

⚠ WARNING

● If any of the following conditions occur, there may be a problem with the SRS airbags and/or seat belt pre-tensioners, and they may not function properly in a collision or may suddenly activate without a collision:

- Even when the ignition switch or the operation mode is in ON, the SRS warning light does not come on or it remains on.
- The SRS warning light comes on while driving.

The SRS airbags and seat belt pre-tensioners are designed to help reduce the risk of serious injury or death in certain collisions. If either of the above conditions occurs, immediately have your vehicle checked by an authorized Mitsubishi Motors dealer.

Driver's and passenger's front airbag system

N00407900321

The driver's airbag is located under the padded cover in the middle of the steering wheel. The front passenger's airbag is contained in the instrument panel above the glove compartment. The driver's airbag and the front passenger's airbag are designed to deploy at the same time. However, the front passen-

ger's airbag does not deploy when the front passenger seat is not occupied or when the system senses that a child is in the child restraint system.

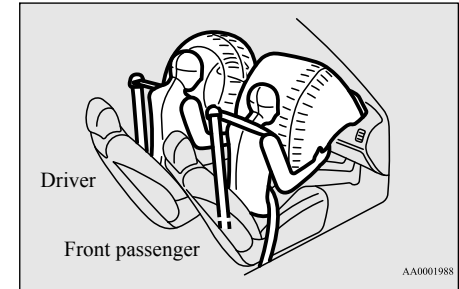

Driver's knee airbag system

N00404500036

The driver's knee airbag is located under the steering wheel. The driver's knee airbag is designed to deploy at the same time as the driver's front airbag.



Deployment of front airbags

N0040800606

The front airbags and driver's knee airbag ARE DESIGNED TO DEPLOY when ...

Head-on collision with a solid wall at speeds of approx. 15 mph (25 km/h) or higher

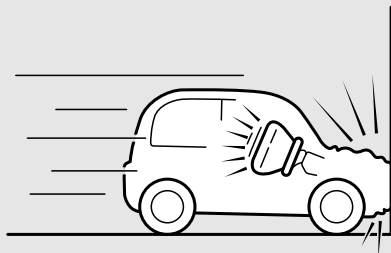

Moderate to severe frontal impact within the shaded area between the arrows

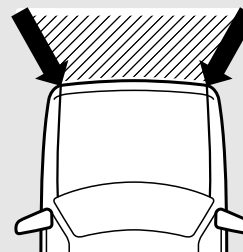

AA1009095

The front airbags and driver's knee airbag are designed to deploy when the vehicle suffers a moderate to severe frontal impact. A typical condition is shown in the illustration to the left.

The front airbags and driver's knee airbag are designed to deploy only in certain moderate to severe frontal collisions within the shaded area between the arrows in the illustration to the right.

The front airbags and driver's knee airbag will deploy if the impact to the vehicle's main structure is above a specific threshold level. The threshold level is approximately 15 mph (25 km/h) for a frontal collision straight into a solid flat wall that does not bend or deform. If the impact to the vehicle's main structure is below this threshold level, the front airbags and driver's knee airbag may not deploy. This threshold level may also be higher if the vehicle hits something that absorbs the impact, either by bending or moving (for example, another stationary vehicle, a pole or a guard rail).

The initial stage of airbag inflation is the most forceful, and can cause serious injury or death if you are too close to the deploying airbag. Accordingly, it is important that you always wear the available seat belt.

The front airbags and driver's knee airbag MAY NOT DEPLOY when ...

In certain types of front collisions, the front airbags and driver's knee airbag may not deploy, even if the deformation of the body seems to be large, because the vehicle's body structure is designed to absorb the impact and deform in order to help protect the occupants. Some typical situations where the front airbags and driver's knee airbag may not deploy are shown in the illustrations.

Since the front airbags and driver's knee airbag do not protect the occupant in all types of frontal collisions, be sure to always wear your seat belts properly.

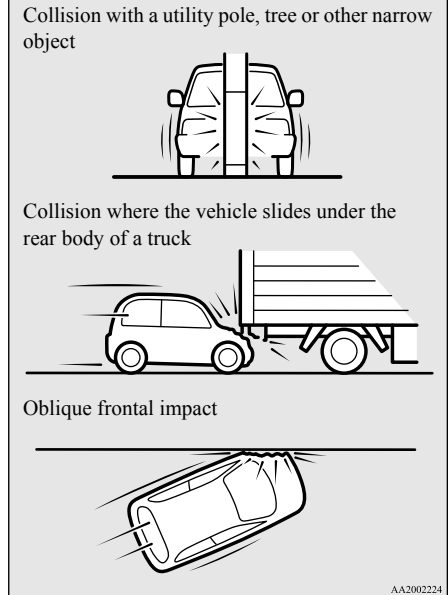

The front airbags and driver's knee airbag ARE NOT DESIGNED TO DEPLOY when ...

The front airbags and driver's knee airbag are not designed to deploy in situations where

Supplemental Restraint System (SRS) - airbag

they cannot provide protection to the occupants.

Some typical situations are shown in the illustration.

4

Since the front airbags and driver's knee airbag do not protect the occupants in all types of collisions, be sure to always wear the your seat belts properly.

Rear end collision to your vehicle



Side collision to your vehicle

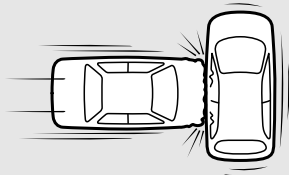

Vehicle rolls onto its side or roof

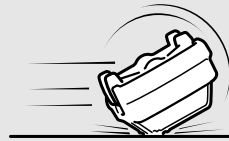

AA2002237

The front airbags and driver's knee airbag **MAY DEPLOY** when

...

The front airbags and driver's knee airbag may deploy if the underside of the vehicle suffers a moderate to severe impact (under-carriage impact). Some typical situations are shown in the illustration.

Since the front airbags and driver's knee airbag may deploy in certain types of unexpected impacts, as shown in the illustrations, and these unexpected impacts can move you out of position, it is important to always wear your seat belts properly. When worn properly, seat belts can help maintain your distance from the airbags when they begin to inflate. The initial stage of airbag inflation is the most forceful and can cause serious injury or death if you are close to the deploying airbag.

Collision with an elevated median/island or curb



Vehicle travels over a deep hole/pothole

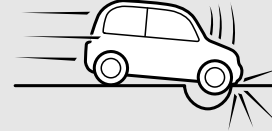

Vehicle drives down a steep slope and hits the ground

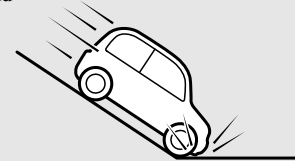

AA2002240

WARNING

- Do not attach anything to the steering wheel's padded cover, such as trim material, badges, etc. These could strike and injure an occupant if the airbag inflates.
- Do not set anything on, or attach anything to, the instrument panel above the glove compartment. Such items could strike and injure an occupant if the airbag inflates.

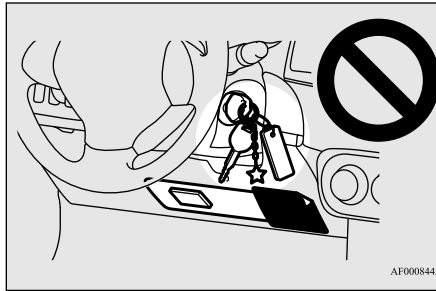
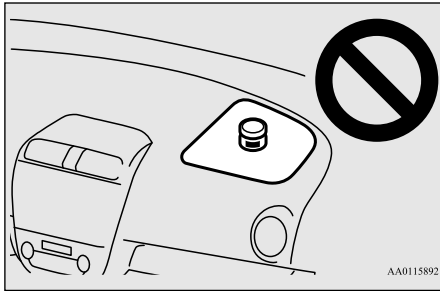

Side airbag system

N00408100421

The side airbags (A) are contained in the driver and front passenger seatbacks.

The side airbag is designed to inflate only on the side of the vehicle that is impacted, even with no passenger in the front seat.

4

⚠ WARNING

- Do not attach accessories to, or put them in front of, the windshield. They could restrict the airbag inflation, or strike and injure an occupant, when the airbag inflates.
- Do not attach additional keys or accessories (hard, pointed or heavy objects) to the ignition key. Such objects could prevent the driver's knee airbag from inflating normally or could be propelled to cause serious injury if the airbag inflates.
- Do not attach accessories to the lower portion of the driver's side instrument panel. Such objects could prevent the driver's knee airbag from inflating normally or could be propelled to cause serious injury if the airbag inflates.

⚠ WARNING

- Do not attempt to remove, install, disassemble or repair the SRS airbags.
- Do not place objects, such as packages or pets, between the airbags and the driver or the front passenger. Such objects can adversely affect airbag performance, or cause serious injury or death when the airbag deploys.
- Immediately after airbag inflation, some parts of the airbag system will be hot. Do not touch them. You could otherwise be burned.
- The airbag system is designed to work only once. After the airbags deploy, they will not work again. They must promptly be replaced and the entire airbag system must be inspected by an authorized Mitsubishi Motors dealer.

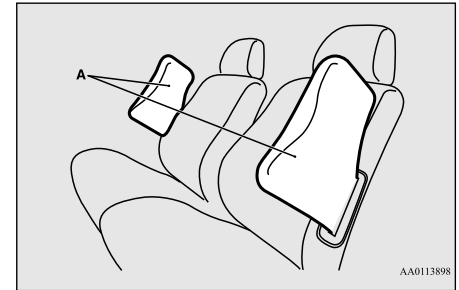

A label is attached to the seatbacks in vehicles equipped with side airbags.

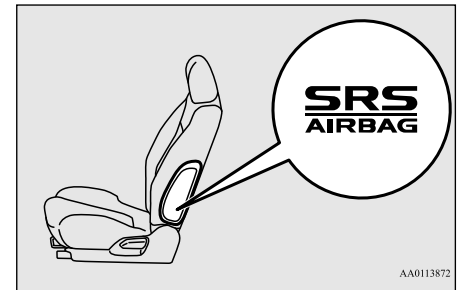

Curtain airbag system

N00419200217

The curtain airbags are contained in the front pillars and roof side rail.

The curtain airbag is designed to inflate only on the side of the vehicle that is impacted, even with no passenger in the seat.

4

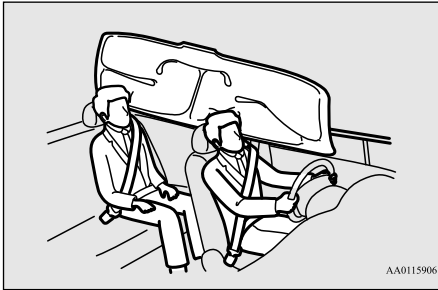

⚠ WARNING

- The side airbags and curtain airbags can cause serious injury or death to anyone too close to the airbag when it deploys. To reduce the risk of injury from a deploying side airbag and curtain airbag, all occupants must be properly restrained and seated well back, upright, and in the middle of the seat. Do not lean against the door.



⚠ WARNING

- In order to reduce the risk of injury from a deploying side airbag, do not allow any rear seat passengers to hold onto the back of either front seat. Special care should be taken with children.
- Do not place any objects around the area where the side airbags deploy. Such objects can interfere with proper side airbag deployment, and cause injury during deployment of the side airbag.
- Do not place stickers, labels or additional trim on the back of either front seat. They can interfere with proper side airbag deployment.

⚠ WARNING

- Do not attach a microphone (A) or any other object around the part where the curtain airbag deploys, such as on the windshield, side door glass or front and rear pillars and roof side rail. When the curtain airbag inflates, the microphone or other object may be hurled with great force or the curtain airbag may not inflate correctly, resulting in death or serious injury.

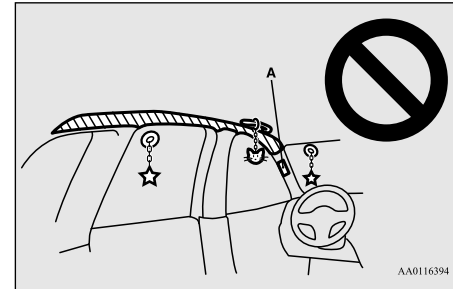

⚠ WARNING

- Do not install seat covers or re-cover seats that have side airbags. Covers can interfere with proper side airbag deployment and adversely affect side airbag performance.

⚠ WARNING

- Never install a rear-facing child restraint system in the front passenger seat. Rear-facing child restraint systems **MUST ONLY** be used in the rear seat.
- Front-facing child restraint systems should also be used **ONLY** in the rear seat. If a front-facing child restraint system must be used in the front passenger seat, move the seat as far back as possible, and make sure that the child stays in the child restraint system, properly restrained and away from the door.
- Do not allow a child to lean against or sit close to the passenger door, even if the child is seated in a child restraint system. The child's head should also not lean against or be close to the section of the seatback where the side airbag and curtain airbag are located. It is dangerous if the side airbag or curtain airbag deploys. Failure to follow all of these instructions could lead to serious injury or death to the child.
- Work done on or in the vicinity of the side airbag or curtain airbag components should be done only by an authorized Mitsubishi Motors dealer. There is a risk of a serious injury or death. Improper work methods can cause accidental side airbag or curtain airbag deployment, or render a side airbag or curtain airbag inoperable. Either of these situations could result in serious injury or death.

Deployment of side airbag and curtain airbag

N00408200536

The side airbag and curtain airbag ARE DESIGNED TO DEPLOY when...

The side airbag and curtain airbag are designed to deploy when the vehicle suffers a moderate to severe side impact to the middle of the passenger compartment. A typical situation is shown in the illustration.

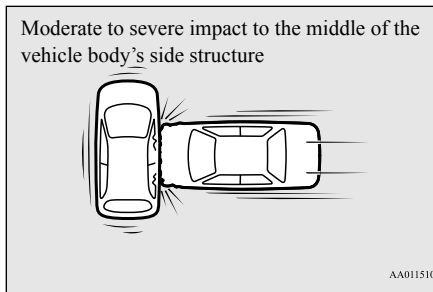

The seat belts in your vehicle are your primary means of protection in an accident. The SRS side airbags and curtain airbags are designed to provide additional protection. Therefore, for your safety and the safety of all

occupants, be sure to always wear your seat belts properly.

The side airbag and curtain airbag MAY NOT DEPLOY when...

In certain types of side collisions, the side airbag and curtain airbag may not deploy, even if the deformation of the body seems to be large, because the vehicle's body structure is designed to absorb the impact and to deform in order to help protect the occupants. Some typical situations where the side airbags and curtain airbags may not deploy are shown in the illustrations on the following page.

Since the side airbags and curtain airbags do not protect the occupant in all types of side collisions, be sure to always wear the seat belts properly.

Side impact in an area away from the passenger compartment

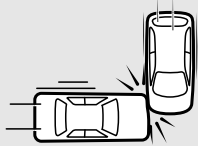

Motorcycle or other similar small vehicle collision with the side of vehicle



Collision with a utility pole, tree or other narrow object

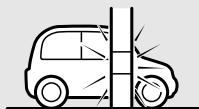

AA2002253

Oblique side impact



Vehicle rolls onto its side or roof



AA3009999

Head-on collision

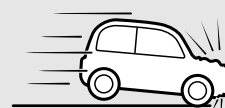

Rear end collision to your vehicle



AA3009103

**The side airbag and curtain airbag
ARE NOT DESIGNED TO
DEPLOY when...**

The side airbag and curtain airbag are not designed to deploy in situations where they cannot provide protection to the occupants. Some typical situations are shown in the illustration.

Since the side airbags and curtain airbags do not protect the occupant in all types of collisions, be sure to always wear your seat belts properly.

SRS servicing

N00408501725

⚠ WARNING

- Any maintenance performed on or near the components of the SRS should be performed only by an authorized Mitsubishi Motors dealer. Do not permit anyone else to do any service, inspection, maintenance or repair on any SRS components or wiring. Similarly, no part of the SRS should ever be handled, removed or disposed by anyone except an authorized Mitsubishi Motors dealer.

Improper work methods on the SRS components or wiring could result in an accidental airbag deployment or could make the SRS inoperable. Either of these situations could result in serious injury or death.

- Do not modify your steering wheel or any other SRS component or related vehicle part. For example, replacement of the steering wheel, or modifications to the front bumper or body structure can adversely affect SRS performance and may lead to injury.
- If your vehicle has received any damage, you should have the SRS inspected by an authorized Mitsubishi Motors dealer to make sure it is in proper working order.

⚠ WARNING

- Do not modify your front seats, center pillar or center console. Such modifications can adversely affect SRS performance and may lead to injury.

Also, if you discover any tear or open seam in the seat fabric near the side airbag, have the seat inspected by an authorized Mitsubishi Motors dealer.

- If you have found any scratch, crack or damage to the portion of the front and rear pillars and roof side rail, you should have the SRS inspected by an authorized Mitsubishi Motors dealer.

📖 NOTE

- When you transfer ownership of the vehicle to another person, we urge you to alert the new owner that it is equipped with the SRS and refer that owner to the applicable sections in this owner's manual.
- If you decide to junk or scrap your vehicle, we urge you to first take it to an authorized Mitsubishi Motors dealer so that the SRS can be made safe for disposal.
- If any of the following parts needs to be modified for use by a handicapped person, the advanced airbag system will be greatly affected. Please consult an authorized Mitsubishi Motors dealer.
 - Driver's seat
 - Front passenger seat
 - Front seat belt

📖 NOTE

- Steering wheel
- Instrument panel

[For vehicles sold in U.S.A.]
 To contact Mitsubishi Motors North America, Inc. call 1-888-648-7820 or write to:
Mitsubishi Motors North America, Inc.
Customer Relations Department
P.O. Box 6400
Cypress, CA 90630-0064

[For vehicles sold in Canada]
 To contact Mitsubishi Motor Sales of Canada, Inc. call 1-888-576-4878 or write to:
Mitsubishi Motor Sales of Canada, Inc.
Customer Relations Department
P.O. Box 41009
4141 Dixie Road
Mississauga, ON L4W 5C9



[For vehicles sold in Puerto Rico]

To contact Mitsubishi Motor Sales of Caribbean, Inc.
call 1-787-251-8715 or write to:
Mitsubishi Motor Sales of Caribbean, Inc.
Customer Service Department
P.O. Box 192216
SAN JUAN PR 00919-2216

[For vehicles sold in Guam]

To contact Triple J Enterprises Inc.
call (671) 649-3673 or write to:
Triple J Enterprises, Inc.
P.O. Box 6066
TAMUNING
GUAM 96931

[For vehicles sold in Saipan]

To contact Triple J Motors
call (670) 234-7133 or write to:
Triple J Motors
P.O. Box 500487
SAIPAN, MP96950-0487

[For vehicles sold in American Samoa]

To contact Pacific Marketing Inc.
call 684 (699) 9140 or write to:
Pacific Marketing, Inc.
P.O. Box 698
PAGO PAGO,
AMERICAN SAMOA AS,
96799

Warning label

N00408600383

Occupant restraint warning labels for the SRS are located in the vehicle as shown in the illustration.

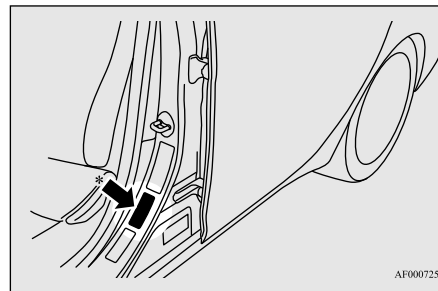
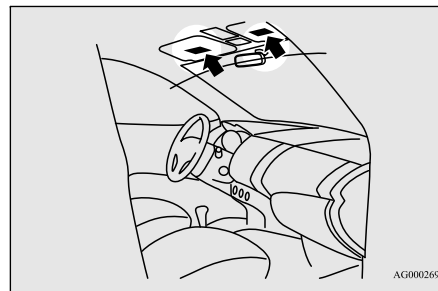

* - Located in the passenger's side as well.

Features and controls

Break-in recommendations	5-2	Rear-view camera (if so equipped).....	5-60
Keys	5-2	Instrument cluster	5-62
Electronic immobilizer (Anti-theft starting system)	5-3	Multi-information display	5-62
Keyless entry system (if so equipped).....	5-6	Indicator and warning light package	5-70
Free-hand Advanced Security Transmitter (F.A.S.T.-key) (if so equipped)	5-9	Indicators	5-71
Door locks	5-24	Warning lights	5-72
Power door locks	5-26	Combination headlights and dimmer switch	5-74
Child safety locks for rear door	5-27	Turn signal lever	5-76
Liftgate	5-27	Hazard warning flasher switch	5-77
Manual window control (if so equipped).....	5-28	Front fog light switch (if so equipped).....	5-77
Power window control	5-29	Wiper and washer switch	5-78
Parking brake	5-31	Electric rear window defogger switch	5-80
Steering wheel height adjustment	5-32	Horn switch	5-81
Inside rearview mirror	5-32	Link System (if so equipped).....	5-81
Outside rearview mirrors	5-33	Bluetooth® 2.0 interface (if so equipped).....	5-81
Ignition switch	5-35	USB input terminal (if so equipped)	5-101
Starting the engine	5-36	Sun visors	5-105
Manual transaxle (if so equipped)	5-38	12 V power outlets	5-106
Continuously variable transmission (CVT) (if so equipped).....	5-39	Interior lights	5-106
Service brake	5-44	Storage spaces	5-107
Hill start assist (if so equipped).....	5-45	Cup holders	5-108
Brake assist system	5-46	Bottle holders	5-108
Anti-lock braking system	5-46	Rear shelf panel (if so equipped).....	5-109
Electric power steering system (EPS)	5-48	Convenience hook	5-109
Active stability control (ASC)	5-49	Assist grips	5-110
Cruise control (if so equipped).....	5-52		
Tire pressure monitoring system (if so equipped)	5-56		

Break-in recommendations

N00508700330

N00508800621

Advanced automobile manufacturing techniques permit you to operate your new vehicle without requiring a long break-in period of low-speed driving.

5 However, you can add to the future performance and economy of your vehicle by observing the following precautions during the first 300 miles (500 km).

Drive your vehicle at moderate speeds during the break-in period.

- Avoid revving the engine.
- Avoid rough driving such as sudden starts, sudden acceleration, prolonged high-speed driving and sudden braking. These would have a detrimental effect on the engine and also cause increased fuel and oil consumption, which could result in malfunction of the engine components. Be particularly careful to avoid full acceleration while in low shift position (low gears).
- Do not overload the vehicle. Stay within the seating capacity. (Refer to “Cargo load precautions” on page 6-10.)
- Do not use this vehicle for trailer towing.

Keys

Type 1

Two keys are provided. The keys fit all locks. Keep one in a safe place as a spare key.

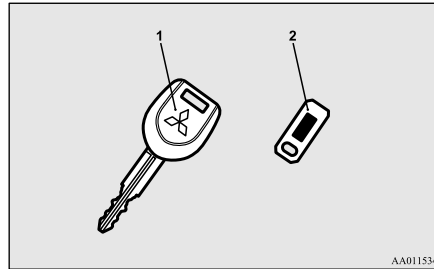

- 1- Key for the electronic immobilizer
- 2- Key number plate

Type 2

Two keys are provided. The keys fit all locks. Keep one in a safe place as a spare key.

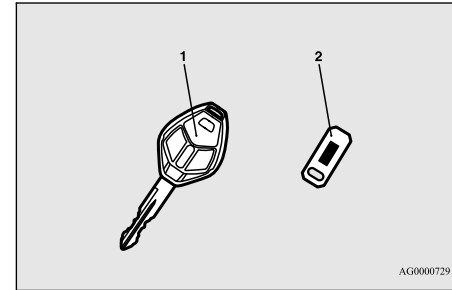

- 1- Key for the electronic immobilizer and keyless entry system
- 2- Key number plate

Type 3

Two F.A.S.T.-keys and two emergency keys are provided. Keep one F.A.S.T.-key and one emergency key in a safe place together as a set of spare keys.

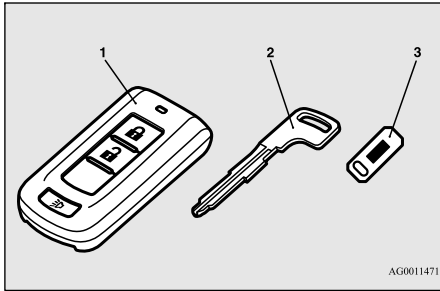

- 1- F.A.S.T.-key
(with electronic immobilizer and keyless entry system function)
- 2- Emergency key
- 3- Key number plate

NOTE

- The keyless entry key and F.A.S.T.-key are a precision electronic device with a built-in signal transmitter. Please observe the following in order to prevent damage.
 - Do not leave where it may be exposed to heat caused by direct sunlight, such as on top of the dashboard.
 - Do not take the remote control transmitter apart.
 - Do not excessively bend the key or subject it to strong impacts.
 - Keep the remote control transmitter dry.
 - Keep away from magnetic objects such as key rings.

NOTE

- Keep away from devices that produce magnetism, such as audio systems, computers and televisions.
- Keep away from devices that emit strong electromagnetic waves, such as cellular phones, wireless devices and high frequency equipment (including medical devices).
- Do not clean with ultrasonic cleaners.
- Do not leave the key where it may be exposed to high temperature or high humidity.
- If you lose your key, to prevent the theft of the vehicle immediately contact an authorized Mitsubishi Motors dealer. If you notify an authorized Mitsubishi Motors dealer of the key number, they can make a new key. The key number is stamped on the key number plate. Keep the key number plate in a safe place separate from the key itself.
- No keys other than those registered in advance can be used to start the engine. Refer to “Electronic immobilizer (Anti-theft starting system)” on page 5-3. Refer to “Free-hand Advanced Security Transmitter (F.A.S.T.-key): “Electronic immobilizer (Anti-theft starting system)” on page 5-20.

NOTE

- When the theft-alarm is in the system operational status, the alarm operates if a door or liftgate is opened after using the key, the door lock knob or the power door lock switch to unlock the vehicle.
- The system does not enter the preparation status if the keyless entry system or the F.A.S.T.-key was not used to lock the vehicle.

Electronic immobilizer (Anti-theft starting system)

N00509100780

[For vehicles equipped with the Free-hand Advanced Security Transmitter (F.A.S.T.-key)]

For information on operations for vehicles equipped with the Free-hand Advanced Security Transmitter (F.A.S.T.-key), refer to “Free-hand Advanced Security Transmitter (F.A.S.T.-key): Electronic immobilizer (Anti-theft starting system)” on page 5-20.

[Except for vehicles equipped with the Free-hand Advanced Security Transmitter (F.A.S.T.-key)]

The electronic immobilizer is designed to significantly reduce the possibility of vehicle theft. The purpose of the system is to immobilize the vehicle if an invalid start is

Electronic immobilizer (Anti-theft starting system)

attempted. A valid start attempt can only be achieved (subject to certain conditions) using a key “registered” to the immobilizer system. All of the keys provided with your new vehicle have been programmed to the vehicle’s electronics.

5

NOTE

- In the following cases, the vehicle may not be able to recognize the registered ID code from the key. This means the engine will not start even when the key is turned to the “START” position.
 - When the key contacts a key ring or other metallic or magnetic object (Type A)
 - When the key grip contacts metal of another key (Type B)
 - When the key contacts or is close to other immobilizer keys (including keys of other vehicles) (Type C)
- In cases like the above, move the offending object(s) away from the key and turn the key back to the “ACC” or “OFF” position. Then try to start the engine again. If the engine does not start, contact an authorized Mitsubishi Motors dealer.

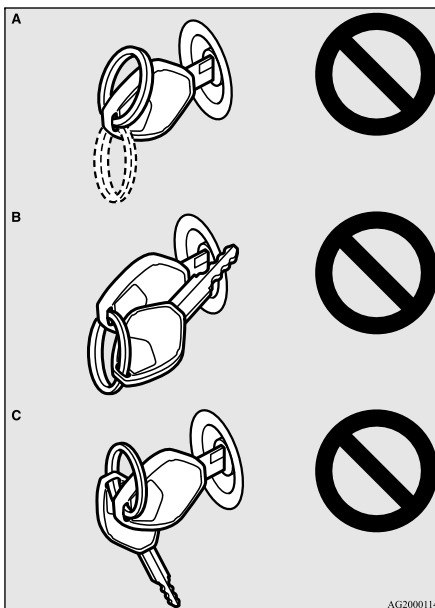

NOTE

- The key may not operate properly when it is near an object or facility that emits strong electromagnetic waves.
- Electronic immobilizer is not compatible with commercially available remote starting systems. Use of commercially available remote starting systems may result in vehicle starting problems and a loss of security protection.

NOTE

- A system failure is suspected when the ignition switch is turned to the “START” position, and the engine does not start. In such a case, contact an authorized Mitsubishi Motors dealer.

CAUTION

- Do not make any alterations or additions to the immobilizer system. Alterations or additions could cause failure of the immobilizer.

Replacement keys

Only keys that have been programmed to the vehicle’s electronics can be used to start the vehicle.

If you lose the key, you can order a key from your authorized Mitsubishi Motors dealer by referring to the key number.

To prevent vehicle theft, the ID code for the vehicle keys must be changed.

Take your vehicle and all remaining keys to your authorized Mitsubishi Motors dealer to have your ID code changed.

Additional keys

To add a key, you must already have 2 registered keys. You need to register the ID code to the vehicle.

Registering the ID code can be done by yourself (except for vehicles sold in Canada), or by your authorized Mitsubishi Motors dealer. For you to register the ID code yourself, follow the “Customer key programming” procedure below.

If you choose to have your authorized Mitsubishi Motors dealer register the ID code, take your vehicle and all remaining keys to your authorized Mitsubishi Motors dealer.

NOTE

- You are provided with 2 keys, but you may register up to 8 keys.

Customer key programming (Except for vehicles sold in Canada)

N00562200139

You can program new keys to the system if you have two valid (already registered) keys and blank immobilizer key (specially cut for

your vehicle at your Mitsubishi Motors dealer) by doing the following:

1. Insert the first valid key into the ignition switch and turn the key to the “ON” position for 5 seconds.
2. Turn the key to the “OFF” position and remove the first key.
3. Within 30 seconds of removing the first key, insert the second valid key into the ignition and turn it to the “ON” position. About 10 seconds later, the immobilizer indicator will start to blink.
4. When the immobilizer indicator starts blinking, turn the second valid key to the “OFF” position and remove it. Within 30 seconds after doing so, insert a blank immobilizer key into the ignition switch and turn it to the “ON” position. Perform this operation no more than 30 seconds after the immobilizer indicator starts blinking. When registration of the ID code is complete, the immobilizer indicator will come on for 3 seconds then go off. If an error occurs, the immobilizer indicator will go off during the procedure.



NOTE

- When the key registration is completed, the immobilizer indicator will come on within 30 seconds of turning the ignition switch to the “ON” position with the blank immobilizer key (specially cut for your vehicle at your Mitsubishi Motors dealer).

5. If you wish to register another key, perform the process again from step 1.

NOTE

- It is not possible to register a key if:
 - the immobilizer indicator goes off during the procedure
 - the immobilizer indicator does not come on within 30 seconds after step 4.
- The procedure will be terminated automatically if:
 - a period of 30 seconds or longer elapses from the moment when the first key is turned to the “OFF” position to the moment when the second key is turned to the “ON” position
 - a period of 30 seconds or longer elapses from the moment when the second key is turned to the “OFF” position to the moment when the blank immobilizer key is turned to the “ON” position
 - more than 20 seconds elapses after the immobilizer indicator starts blinking

General information

N00562300097

Your electronic immobilizer operates on a radio frequency subject to Federal Communications Commission (FCC) Rules (For vehicles sold in U.S.A.) and Industry Canada Rules (For vehicles sold in Canada). This device complies with part 15 of FCC Rules and Industry Canada licence-exempt RSS standard(s).

Operation is subject to the following two conditions.

- This device may not cause harmful interference.
- This device must accept any interference received, including interference that may cause undesired operation of this device.

WARNING

- Changes or modifications not expressly approved by the party responsible for compliance could void the user's authority to operate the equipment.



Keyless entry system (if so equipped)

N00509000923

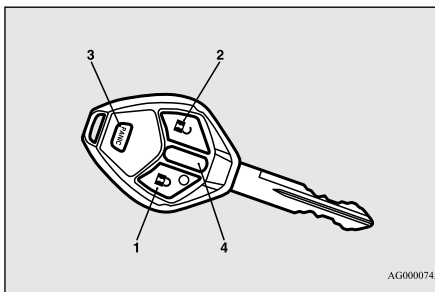
Press the remote control transmitter buttons to lock or unlock the doors and the liftgate. It can also help you signal for attention by setting off the panic alarm.



AG0000745

- 1- LOCK  button
- 2- UNLOCK  button
- 3- PANIC button
- 4- Indicator light

To lock

Press the LOCK button (1) to lock all the doors and the liftgate.

The turn signal lights will also blink once.

NOTE

- If you press the LOCK button (1) twice the horn will sound once.

To unlock

Press the UNLOCK button (2) to unlock the driver's door only.

Within about 2 seconds, press the UNLOCK button one more time to unlock all the doors and liftgate.

The dome light will turn on for 30 seconds. The turn signal lights will also blink twice.

NOTE

- The door and liftgate unlock function can be set so that all doors and liftgate unlock when the UNLOCK button (2) is pressed once. Refer to "Setting of door and liftgate unlock function" on page 5-7.

Answerback function

The horn of the keyless entry system answerback function can be changed as required. This is done with the key removed from the ignition switch.

NOTE

- The answerback function will not operate if any of the doors are open.

Horn deactivation/reactivation

The answerback function can be set in the following three ways.

Each time the answerback function is set, a chime will sound to tell you the condition of the answerback function.

One chime: The horn will not sound.

Two chimes: The horn will sound.

Four chimes: The horn will sound if the LOCK button is pressed twice within 1 second.

1. Remove the key from the ignition switch.
2. Open the driver's door and turn the combination headlights and dimmer switch to the "OFF" position.
3. Press the LOCK button (1) for 4 to 10 seconds and press the UNLOCK button (2) during this time.
4. Release in sequence the UNLOCK and LOCK buttons within 10 seconds of pressing the UNLOCK button in step 3.

Turn signal lights deactivation/reactivation

The turn signal lights answerback function can be changed.

If you want to change the answerback function, please contact an authorized Mitsubishi Motors dealer.

Setting of door and liftgate unlock function

N00543600118

The door and liftgate unlock function can be set to the following two conditions.

Each time the door and liftgate unlock function is set, a chime will sound to tell you the condition of the door and liftgate unlock function.

Number of chimes	Condition
One chime	All doors and the liftgate unlock
Two chimes	Driver's door unlock only

1. Put the operation mode in OFF.
2. Open the driver's door and turn the combination headlights and dimmer switch to the "OFF" position.



Keyless entry system (if so equipped)

3. Press the LOCK button (1) for 4 to 10 seconds and press the UNLOCK button (2) during this time.
4. Release in sequence the LOCK and UNLOCK buttons within 10 seconds of pressing the LOCK button in step 3.

Using the panic alarm

N00543700034

If you are near your vehicle and feel threatened, you may activate the alarm to call attention as follows:

1. Press the PANIC button (3) for more than 1 second.
2. The headlights will blink on and off and the horn will sound intermittently for about 3 minutes.
3. To turn off the alarm, press any button on the remote control transmitter.

Replacement remote control transmitters

N00543800051

Only remote control transmitters programmed with the vehicle's electronics can lock or unlock all doors and the liftgate.

If you lose the remote control transmitter, you can order a remote control transmitter from

Keyless entry system (if so equipped)

your authorized Mitsubishi Motors dealer by referring to the key number.

To prevent vehicle theft, the ID code for the remote control transmitter must be changed.

Take your vehicle and all remote control transmitters to your authorized Mitsubishi Motors dealer to have your ID code changed.

5

Additional remote control transmitters

N00543900078

To add a remote control transmitter, you must already have 1 registered remote control transmitter.

Registering the ID code can be done by your authorized Mitsubishi Motors dealer.

Take your vehicle and any remaining keys to your authorized Mitsubishi Motors dealer.

NOTE

- You are provided with 2 remote control transmitters, but you may register up to 4 remote control transmitters.

General information

N00546100114

Your keyless entry system operates on a radio frequency subject to Federal Communications Commission (FCC) Rules (For vehicles sold in U.S.A.) and Industry Canada Rules

(For vehicles sold in Canada). This device complies with Part 15 of FCC Rules and Industry Canada licence-exempt RSS standard(s).

Operation is subject to the following two conditions.

- This device may not cause harmful interference.
- This device must accept any interference received, including interference that may cause undesired operation of this device.

WARNING

- Changes or modifications not expressly approved by the party responsible for compliance could void the user's authority to operate the equipment.

Procedure for replacing the remote control transmitter battery

N00544100080

1. Before replacing the battery, remove static electricity from your body by touching a metal grounded object.
2. With the Mitsubishi mark facing you, insert the cloth-covered tip of a flat blade screwdriver into the notch in the remote control transmitter case and use it to open the case.

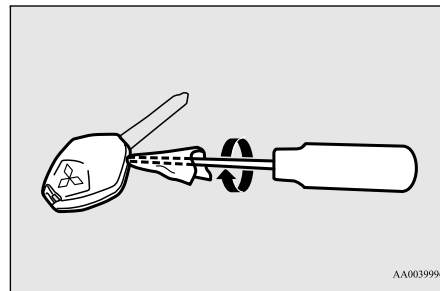

AA0039996

NOTE

- Be sure to perform the procedure with the Mitsubishi mark facing you. If the Mitsubishi mark is not facing you when you open the remote control transmitter case, the buttons may come out.

3. Remove the remote control transmitter from the remote control transmitter case. Then, open the remote control transmitter using the method described in step 2.

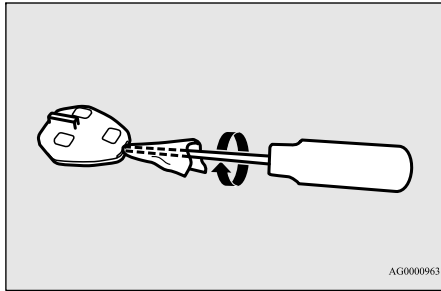

4. Remove the old battery.
5. Install a new battery with the + side (A) down.

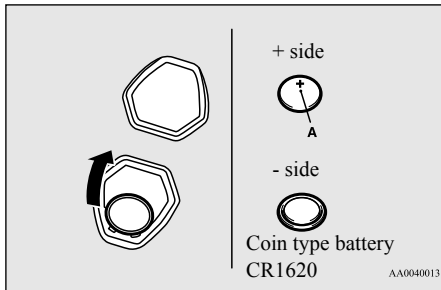

6. Close the remote control transmitter firmly.
7. Place the remote control transmitter in the remote control transmitter case, then securely close the remote control transmitter case.

8. Check the keyless entry system to see that it works.

NOTE

- You may purchase a replacement battery at an electric appliance store.
- An authorized Mitsubishi Motors dealer can replace the battery for you if you prefer.

CAUTION

- When the remote control transmitter case is opened, be careful to keep water, dust, etc. out. Also, do not touch the internal components.

Free-hand Advanced Security Transmitter (F.A.S.T.-key) (if so equipped)

N00503101134

The Free-hand Advanced Security Transmitter (F.A.S.T.-key) enables the doors and the liftgate to be locked and unlocked, the engine to be started and the operation mode to be changed simply by carrying it.

The F.A.S.T.-key can also be used as the remote control transmitter of the keyless entry system.

Refer to “Free-hand Advanced Security Transmitter (F.A.S.T.-key): Keyless entry

system” on page 5-21.

The F.A.S.T.-key must be carried by the driver. The F.A.S.T.-key is required for vehicle operations such as locking and unlocking the doors and the liftgate, starting the engine, and changing the operation mode. When leaving the vehicle, make sure you are carrying the F.A.S.T.-key and then lock the vehicle.

WARNING

- Individuals who use implantable pacemakers or implantable cardiovascular-defibrillators should keep away from the external and internal transmitters. The electromagnetic waves used in the F.A.S.T.-key may affect the operation of implantable pacemakers and implantable cardiovascular-defibrillators.

Free-hand Advanced Security Transmitter (F.A.S.T.-key) (if so equipped)

5

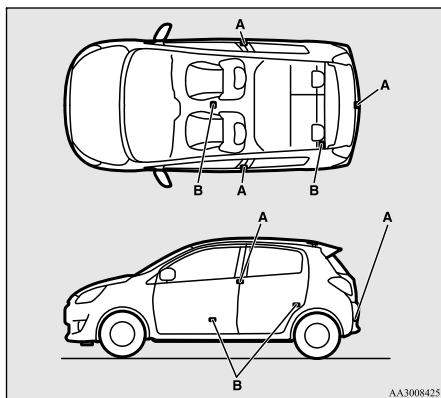

- A- External transmitter
B- Internal transmitter

WARNING

- Individuals using other electro-medical apparatus besides implantable pacemakers and implantable cardiovascular-defibrillators should check with the manufacturer of the apparatus to confirm the effect of the electromagnetic waves used by the F.A.S.T.-key. The electromagnetic waves may affect the operations of the electro-medical apparatus.

The operations possible with the F.A.S.T.-key can be modified as stated below. (Keyless entry operations are possible.) For details, contact an authorized Mitsubishi Motors dealer.

- Enabling only the locking and unlocking of the doors and the liftgate
- Enabling only the starting of the engine
- Deactivating the F.A.S.T.-key

NOTE

- The F.A.S.T.-key uses weak electromagnetic waves.

In cases such as the following, operation may be improper or unstable.

- The vehicle is near a facility that emits strong electromagnetic waves, such as a TV transmitting tower, a power station, a radio station or an airport
- The key is carried together with other communication devices such as cellular phones or radios, or electrical appliances such as computers
- The F.A.S.T.-key touches or is covered by a metal object
- A keyless entry system is being used nearby
- The battery of the F.A.S.T.-key is run down
- The vehicle is in a location with strong electromagnetic waves or noise

NOTE

Use the emergency key in such circumstances.

Refer to “To operate without using the F.A.S.T.-key” on page 5-19.

- The F.A.S.T.-key is constantly performing reception operations in its communication with the vehicle. This means that the battery is always running down, regardless of how often the F.A.S.T.-key is used. The battery life is about 1 to 2 years, depending on the usage conditions.
- Since the F.A.S.T.-key is constantly performing reception operations, the reception of strong electromagnetic waves can accelerate the running down of the battery. Do not place near to electrical appliances such as televisions or computers.

Operating range of the F.A.S.T.-key

N00503200167

When a person enters the operating range of the F.A.S.T.-key while carrying the F.A.S.T.-key and presses the driver's door lock/unlock switch the liftgate switch, verification of the ID code is performed.

The doors and the liftgate can only be locked and unlocked, the engine can only be started and the operation mode can only be changed when the ID codes of the vehicle and F.A.S.T.-key match.

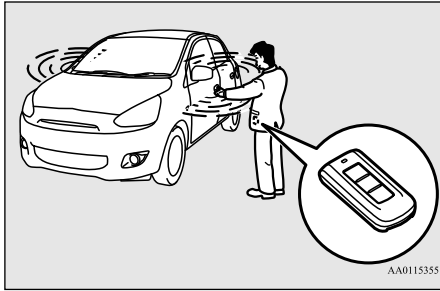

NOTE

- When the battery of the F.A.S.T.-key has run down or there are strong electromagnetic waves or noise in the area, the operating range could decrease or operations could become unstable.

Operating range for locking and unlocking the doors and the lift-gate

The operating range is within about 2.3 feet (70 cm) of the driver's door lock/unlock switch and the liftgate switch.

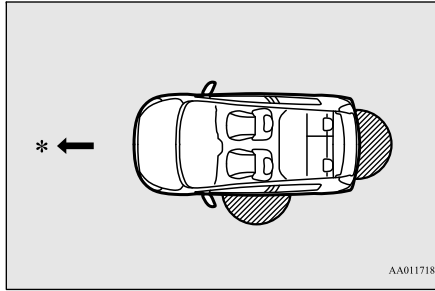

*: Front of the vehicle

: Operating range

NOTE

- Only the doors and the liftgate that detect the F.A.S.T.-key can be locked and unlocked.
- The system may not operate if the F.A.S.T.-key is too close to the windshield, door windows or liftgate.
- Even if the F.A.S.T.-key is within about 2.3 feet (70 cm) of the driver's door switch or the tailgate switch, the system may not operate if the key is close to the ground or in a high position.
- If the F.A.S.T.-key is within the operating range, even a person not carrying the F.A.S.T.-key can lock and unlock the doors or the liftgate by pressing the driver's door switch or the tailgate switch.

Operating range for starting the engine and changing the operation mode

N00503300070

The operating range is the interior of the vehicle.

5

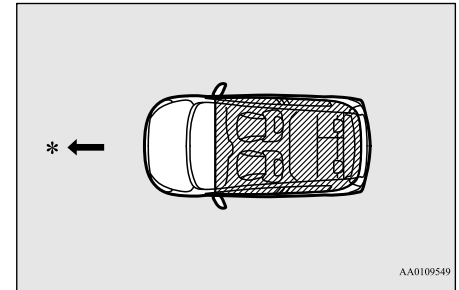

*: Front of the vehicle

: Operating range

NOTE

- Even if the F.A.S.T.-key is within the operating range, it may not be possible to start the engine and change the operation mode if the key is in a storage space such as the glove compartment, on top of the instrument panel, or in the door pocket or luggage compartment.

NOTE

- Even if the F.A.S.T.-key is inside the vehicle, it may not be possible to start the engine and change the operation mode if the key is too close to a door or door window.

5

To operate using the F.A.S.T.-key

N00503400228

To lock

While carrying the F.A.S.T.-key, press the driver's door switch (A), or the liftgate switch (B) within the operating range to lock all the doors and the liftgate.

The turn signal lights will blink once and the buzzer will sound once.

Also refer to "Doors locks", "Power door locks" and "Liftgate" on pages 5-24, 5-26 and 5-27 respectively.

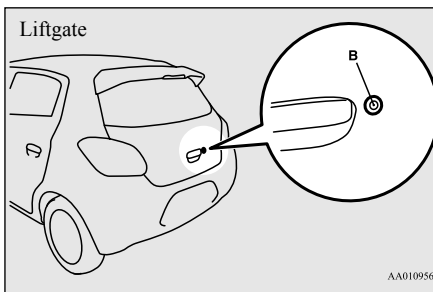
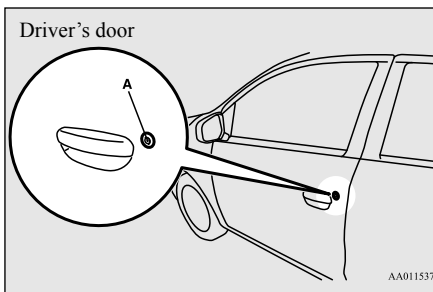

NOTE

- In cases such as the following, the F.A.S.T.-key does not operate.
 - There is a F.A.S.T.-key in the passenger compartment
 - A door or the liftgate is open or ajar
 - The operation mode is not in OFF.
- The time within which locking confirmation is possible can be adjusted. See an authorized Mitsubishi Motors dealer for details.

To unlock

While carrying the F.A.S.T.-key within the operating range, you can unlock the doors and the liftgate by using the F.A.S.T.-key.

The dome light will turn on for 30 seconds. The turn signal lights will blink twice and the buzzer will sound twice.

Also refer to "Door locks", "Power door locks" and "Liftgate" on pages 5-24, 5-26 and 5-27 respectively.

Press the driver's door switch (A) to unlock only the driver's door.

Within about 2 seconds, press the driver's door switch one more time to unlock all the doors and the liftgate.

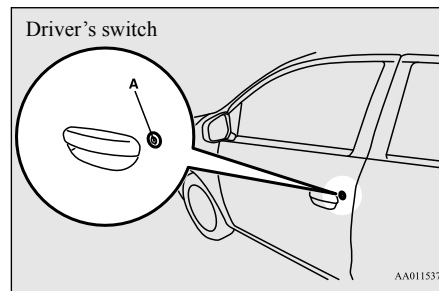

NOTE

- Settings can be changed so that all doors and the liftgate are unlocked automatically by pressing the driver's door switch once. See an authorized Mitsubishi Motors dealer for details.

Press the liftgate switch (B) to unlock all the doors and the liftgate.

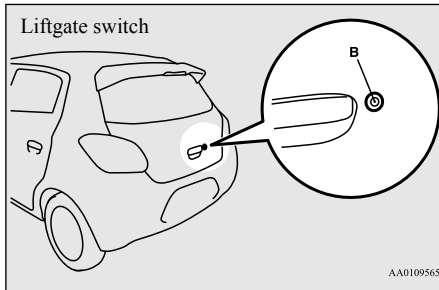

NOTE

- If the doors and the liftgate are unlocked using the driver's door switch when all doors and the liftgate are locked and no doors or the liftgate are opened within about 30 seconds, the doors and the liftgate will automatically re-lock.
- The amount of time after unlocking until the vehicle relocks automatically can be adjusted. See an authorized Mitsubishi Motors dealer for details.

NOTE

- In cases such as the following, the F.A.S.T.-key does not operate.
 - A door or the liftgate is open or ajar
 - The operation mode is not in OFF.
- Functions settings can be modified as stated below. See an authorized Mitsubishi Motors dealer for details.
 - Activating the operation confirmation function (blinking of the turn signal lights) only during locking, or only during unlocking.
 - Deactivating the operation confirmation function (blinking of the turn signal lights) and buzzer.
 - Modifying the number of blinks in the operation confirmation function (blinking of the turn signal lights).
 - Making the buzzer sound when the F.A.S.T.-key is removed from the passenger compartment when all the doors and the liftgate are closed.

Engine switch

N00513500088

To prevent vehicle theft, no F.A.S.T.-keys other than those registered in advance can be used to start the engine. (Electronic immobilizer function)

While carrying the F.A.S.T.-key, the engine switch can be used to start the engine.

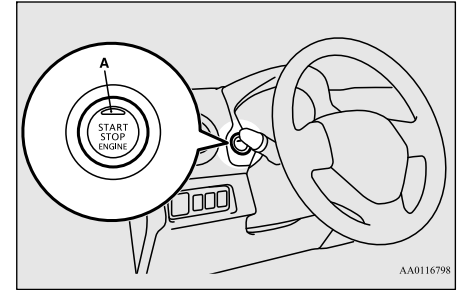

5

CAUTION

- The indicator light (A) will flash orange when there is a problem or malfunction in Free-hand Advanced Security Transmitter. Never drive if the indicator light on the engine switch is flashing orange. Immediately contact your authorized Mitsubishi Motors dealer.
- If the engine switch operation is not smooth and feels like it is sticking, do not operate the switch. Immediately contact an authorized Mitsubishi Motors dealer.

NOTE

- When operating the engine switch, press the switch all the way in. If the switch is not fully pressed, the engine may not start or the operation mode may not change. If the engine switch is pressed correctly, there is no need to hold the engine switch down.



Operation mode of the engine switch and its function

OFF

The indicator light on the engine switch turns off.

5

On vehicles equipped with continuously variable transmission (CVT), the operation mode cannot be put in OFF when the selector lever is in any position other than the “P” (PARK) position.

ACC

Allows operation of some electrical accessories.

The indicator light on the engine switch illuminates orange.

ON

All electrical accessories can be used.

The indicator light on the engine switch illuminates green.

The indicator light turns off when the engine is running.

NOTE

- Your vehicle is equipped with an electronic immobilizer. To start the engine, the ID code which the F.A.S.T.-key sends must match the one registered to the immobilizer computer. (Refer to “Electronic immobilizer (Anti-theft starting system)” on page 5-20)

Changing the operation mode

N0056800025

If you press the engine switch without pressing the brake pedal {continuously variable transmission (CVT)} or the clutch pedal (manual transaxle) while the vehicle is stationary, you can change the operation mode in the order of OFF, ACC, ON, OFF.

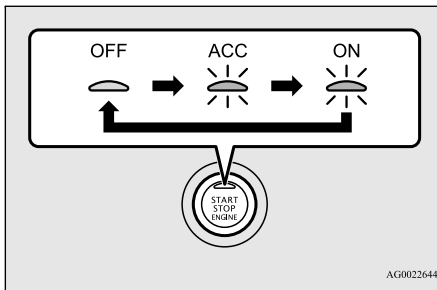

CAUTION

- When the engine is not running, put the operation mode in OFF. Leaving the operation mode in ON or ACC for a long time when the engine is not running may cause the battery to be discharged, making it impossible to start the engine.
- When the battery is disconnected, the current operation mode is memorized. After reconnecting the battery, the memorized mode is selected automatically. Before disconnecting the battery for repair or replacement, make sure to put the operation mode in OFF. Be careful if you are not sure which operation mode the vehicle is in when the battery is run down.
- The operation mode cannot be changed from OFF to ACC or ON if the F.A.S.T.-key is not detected to be in the vehicle. Refer to “Operating range for starting the engine and changing the operation mode” on page 5-11.

ACC power auto-cutout function

N00568101049

When the vehicle is in ACC operation mode for approximately 30 minutes, the ACC power auto-cutout function automatically cuts power to the audio system and other electronic devices that can be used during ACC operation mode.

To enable power after ACC power auto-cut-out function, press the engine switch while in ACC.

NOTE

- It is possible to modify the functions as follows:
 - The time until the power cuts out can be changed to approximately 60 minutes.
 - The ACC power auto-cutout function can be deactivated.
- For details, we recommend you to consult an authorized Mitsubishi Motors dealer.

Warning activation

N00503500216

With the F.A.S.T.-key, warnings are given through buzzers and displayed symbols in order to prevent mistaken operations or vehicle theft.

When a warning operates, be sure to check the vehicle and the F.A.S.T.-key. A warning is also shown if there is a problem in the F.A.S.T.-key.

If the following warning shows, contact an authorized Mitsubishi Motors dealer.

	There is a problem in the F.A.S.T.-key
--	--

	<p>Put the operation mode in OFF and then start the engine again.</p> <p>If the warning is not cancelled, there is a fault in the electronic immobilizer (Anti-theft starting system). Please contact an authorized Mitsubishi Motors dealer.</p>
--	---

If the following warnings show, the light goes off if the correct action is taken.

- The ID codes of the F.A.S.T.-key and the vehicle cannot be verified

	<p>Someone may be carrying a F.A.S.T.-key with a different ID code, or the F.A.S.T.-key may not be within the operating range</p>
	<p>Refer to “F.A.S.T.-key take-out monitoring system” on page 5-15.</p>
	<p>The battery of the F.A.S.T.-key is run down</p>

- A door or the liftgate cannot be locked even when the driver’s door switch or the liftgate switch is pressed.

	Refer to “Key lock-in prevention system” on page 5-16.
	Refer to “Door ajar prevention system” on page 5-16.
	Refer to “Operation mode OFF reminder system” on page 5-16.

F.A.S.T.-key take-out monitoring system

N00559801196



When the operation mode is in any mode other than OFF, and a door is opened and the F.A.S.T.-key is removed from the passenger compartment the ID codes of the F.A.S.T.-key and the vehicle can no longer be verified. When the door is closed, the warning light blinks and the buzzer sounds 4 times as a warning. If the vehicle starts, the inner buzzer sounds once.

NOTE

- The F.A.S.T.-key take-out monitoring system does not function if the F.A.S.T.-key is removed through a window without opening a door.
This setting can be changed.
See an authorized Mitsubishi Motors dealer for details.
- The warning may display even if the F.A.S.T.-key is in the operating range for starting the engine and changing the operation mode. The surrounding environment or electromagnetic waves may make it impossible to verify the ID codes of the F.A.S.T.-key and vehicle.

5

Key lock-in prevention system

N00559900158



When the operation mode is in OFF, the F.A.S.T.-key is left in the passenger compartment, all the doors and the liftgate are closed, and someone tries to lock the vehicle by pressing the driver's door switch or the liftgate switch, the warning light blinks and the buzzer sounds for about 3 seconds as a warning, and the doors and the liftgate cannot be locked.

Door ajar prevention system

N00560000159



When the operation mode is in OFF, and someone tries to lock the vehicle by pressing the driver's door switch or the liftgate switch while one of the doors or the liftgate is not fully closed, the warning light blinks and the buzzer sounds for about 3 seconds as a warning, and the doors and the liftgate cannot be locked.

Operation mode OFF reminder system

N00560100150



When the operation mode is in any mode other than OFF, all the doors and the liftgate are closed, and someone tries to lock the vehicle by pressing the driver's door switch or the liftgate switch, the warning light blinks and the buzzer sounds for about 3 seconds as a warning, and the doors and the liftgate cannot be locked.

Starting and stopping the engine

N00514601357

Tips for starting

- The operation mode can be in any mode to start the engine.
- The starter motor will be turning for up to approximately 15 seconds if the engine switch is released at once. Pressing the engine switch again while the starter motor is still turning will stop the starter motor. The starter motor will be turning for up to approximately 30 seconds while the engine switch is pressed.
If the engine does not start, wait for a while and then attempt to start the engine again. Trying repeatedly with the starter motor still turning will damage the starter mechanism.
- If the engine will not start because the battery is weak or discharged, refer to "Jump-starting the engine" on page 8-2 for instructions.
- A longer warm up period will only consume extra fuel.
The engine is warmed up enough for driving when the low coolant temperature indicator goes out.
Refer to "Low coolant temperature indicator" on page 5-71.

⚠ WARNING

- Never run the engine in a closed or poorly ventilated area any longer than is needed to move your vehicle out of the area. Carbon monoxide gas, which is odorless and extremely poisonous, could build up and cause serious injury or death.

⚠ CAUTION

- Do not push-start the vehicle.
- Do not run the engine at high rpms or drive at high speeds until the engine has had a chance to warm up.

Starting the engine

Your vehicle is equipped with an electronically controlled fuel injection system. This is a system that automatically controls fuel injection. There is usually no need to depress the accelerator pedal when starting the engine.

To prevent battery drain, wait a few seconds between attempts to restart the engine.

1. Make sure all occupants are properly seated with seat belts fastened.
2. Make sure the parking brake is applied.
3. Press and hold the brake pedal down firmly with your right foot.

📖 NOTE

- After the engine has not started for a while, the brake pedal effort needed to start the engine may become greater. If this occurs, depress the brake pedal more firmly than usual.

4. Press and hold the clutch pedal all the way down (manual transaxle).

📖 NOTE

- For vehicles equipped with a manual transaxle, the engine will not start unless the clutch pedal is fully depressed (Clutch interlock). This is a safety feature.

5. On vehicles equipped with manual transaxle, place the gearshift lever in the “N” (Neutral) position.
On vehicles equipped with continuously variable transmission (CVT), make sure the selector lever is in the “P” (PARK) position.

📖 NOTE

- On vehicles equipped with continuously variable transmission (CVT), the engine can only be started when the selector lever is in the “P” (PARK) or “N” (NEUTRAL) position.
For safety reasons, the engine should be started when the selector lever is in the “P” (PARK) position in which the driving wheels lock.

6. Press the engine switch.
7. Confirm that all warning lights and warning displays are functioning properly.

📖 NOTE

- Minor noises may be heard on engine start-up. These will disappear as the engine warms up.

When the engine is hard to start

After several attempts, you may experience that the engine still does not start.

1. Make sure that all electric devices, such as lights, air conditioning blower and rear window defogger, are turned off.

2. While depressing the brake pedal {continuously variable transmission (CVT)} or the clutch pedal (manual transaxle), press the accelerator pedal halfway and hold it there, then crank the engine. Release the accelerator pedal, immediately after the engine starts.
3. If the engine still will not start, the engine could be flooded with too much gasoline. While depressing the brake pedal (CVT) or the clutch pedal (manual transaxle), push the accelerator pedal all the way down and hold it there, then press the engine switch to crank the engine. If the engine does not start after 5 to 6 seconds, push the engine switch to stop cranking the engine, and release the accelerator pedal. Put the operation mode in OFF. Wait a few seconds, and then press the engine switch to crank the engine again while depressing the brake pedal (CVT) or the clutch pedal (manual transaxle), but do not push the accelerator pedal. If the engine fails to start, repeat these procedures. If the engine still will not start, contact your local Mitsubishi Motors dealer or a repair facility of your choice for assistance.

Startability of continuously variable transmission (CVT) vehicles with an ambient temperature of -4 °F (-20 °C) or lower

When the ambient temperature is -4 °F (-20 °C) or lower, it may not be possible to start from a standstill even with the selector lever in the “D” (DRIVE) or “R” (REVERSE) position.

This phenomenon occurs because the transaxle has not warmed up sufficiently; it does not indicate a problem. If this occurs, place the selector lever in the “P” (PARK) position and let the engine idle for at least 10 minutes. The transaxle will warm up, and you will be able to start normally.

Do not leave the vehicle during warm-up operation.

Stopping the engine

N00568200014

⚠ WARNING

- **Do not operate the engine switch while driving except in an emergency. If the engine is stopped while driving, the brake servomechanism will cease to function and braking efficiency will deteriorate. Also, the power steering system will not function and it will require greater manual effort to operate the steering. This could result in a serious accident.**

NOTE

- If you have to bring the engine to an emergency stop while driving, press and hold the engine switch for 3 seconds or more, or press it quickly 3 times or more. The engine will stop and the operation mode will go to ACC.
- On vehicles equipped with continuously variable transmission (CVT), do not stop the engine with the selector lever in any position other than the “P” (PARK) position. If the engine is stopped with the selector lever in any position other than the “P” (PARK) position, the operation mode will go to ACC rather than OFF.
Put the operation mode in OFF after placing the selector lever in the “P” (PARK) position.

1. Stop the vehicle.
2. Fully engage the parking brake while depressing the brake pedal.
3. On vehicles with a manual transaxle, press the engine switch to stop the engine, and then move the gearshift lever to the 1st (on a uphill) or “R” (Reverse) (on a downhill) position.
On vehicles equipped with continuously variable transmission (CVT), move the selector lever to the “P” (PARK) position, and then press the engine switch to stop the engine.

If the F.A.S.T.-key is not operating properly

N00568301054

Insert the F.A.S.T.-key into the key slot of the floor console. Starting the engine and changing the operation mode should be now possible.

Remove the F.A.S.T.-key from the key slot after starting the engine or changing the operation mode.

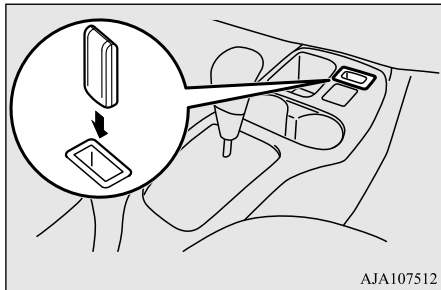

AJA107512

NOTE

- Do not insert into the key slot anything other than the F.A.S.T.-key. This could cause damage or a malfunction.

NOTE

- Remove the object or additional key from the F.A.S.T.-key before inserting the key into the key slot. The vehicle may not be able to receive the registered ID code from the registered key. Therefore, the engine may not start and the operation mode may not change.

F.A.S.T.-key reminder



If the operation mode is in OFF and the driver's door is opened with the F.A.S.T.-key in the key slot, a warning is issued with the warning light and the buzzer buzzing for approximately 3 seconds to remind you to remove the key.

To operate without using the F.A.S.T.-key

N00514800017

Emergency key

N00515201174

The emergency key is built into the F.A.S.T.-key.

When the F.A.S.T.-key cannot be used, such as when the battery of the F.A.S.T.-key or the

vehicle has run down, the emergency key can be used to lock and unlock the passenger's door.

To use the emergency key (A), unlock the lock knob (B) and remove it from the F.A.S.T.-key (C).

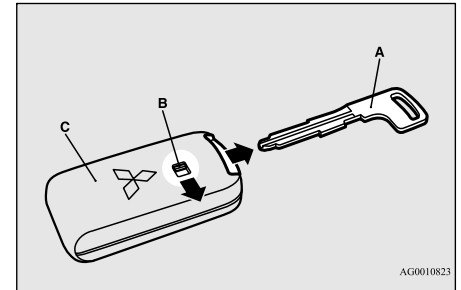

AG0010823

NOTE

- Only use the emergency key in an emergency. When the battery of the F.A.S.T.-key has run down, replace the battery as soon as possible and use it as a F.A.S.T.-key again.
- After using the emergency key, be sure to reinsert it into the F.A.S.T.-key.

Locking and unlocking the passenger's door

Turn the emergency key toward the front of the vehicle to lock the door. After checking

Free-hand Advanced Security Transmitter (F.A.S.T.-key) (if so equipped)

that the door is locked, turn the emergency key back to the center and remove it.

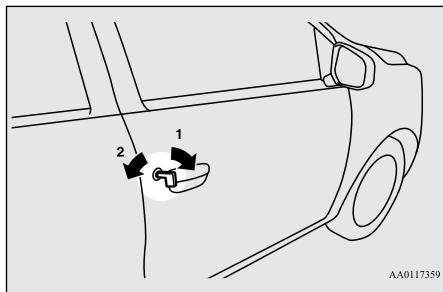

- 1- Lock
- 2- Unlock

Electronic immobilizer (Anti-theft starting system)

N00529600055

The electronic immobilizer is designed to significantly reduce the possibility of vehicle theft. The purpose of the system is to immobilize the vehicle if an invalid start is attempted. A valid start attempt can only be achieved (subject to certain conditions) using a F.A.S.T.-Key “registered” to the immobilizer system.

All of the keys provided with your new vehicle have been programmed to the vehicle’s electronics.

Replacement F.A.S.T.-keys

N00561000042

Only the F.A.S.T.-keys that have been programmed to the vehicle’s electronics can be used to start the vehicle.

If you lose the F.A.S.T.-key, you can order a F.A.S.T.-key from your authorized Mitsubishi Motors dealer by referring to the key number. To prevent vehicle theft, take your vehicle and the remaining F.A.S.T.-keys to an authorized Mitsubishi Motors dealer to have the ID codes reprogrammed.

Additional F.A.S.T.-keys

N00561100056

To add a F.A.S.T.-key, you must already have 2 registered F.A.S.T.-keys. You need to register the ID code to the vehicle.

Registering the ID code can be done by your authorized Mitsubishi Motors dealer. Or it can be done by yourself (except for vehicles sold in Canada).

For you to register the ID code yourself, follow the “Customer F.A.S.T.-key programming” procedure below.

If you choose to have your authorized Mitsubishi Motors dealer register the ID code, take your vehicle and all remaining F.A.S.T.-keys to your authorized Mitsubishi Motors dealer.

NOTE

- You are provided with 2 F.A.S.T.-keys, but you may register up to 4 F.A.S.T.-keys. You can obtain blank F.A.S.T.-keys for your vehicle from your Mitsubishi Motors dealer.

Customer F.A.S.T.-key programming (Except for vehicles sold in Canada)

N00561201201

You can program new F.A.S.T.-keys to the system if you have two valid (already registered) F.A.S.T.-keys and blank (not registered) F.A.S.T.-key.

For F.A.S.T.-key programming, follow the procedures below.

1. Open the driver’s door.

NOTE

- Keep the driver’s door open until F.A.S.T.-key programming is finished. Do not open or close other doors.

2. While carrying the first valid F.A.S.T.-key, put the operation mode in ON. (Perform the following procedure within 30 seconds.)

3. Insert the new F.A.S.T.-key into the key slot.

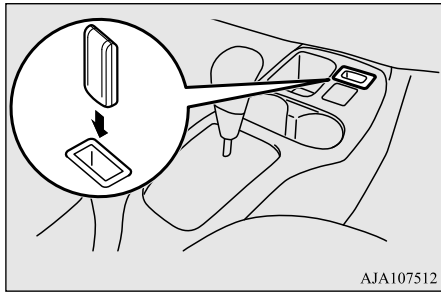

4. With the first valid F.A.S.T.-key, press the UNLOCK button for 4 to 10 seconds and press the LOCK button during this time.
5. Release in sequence the LOCK and UNLOCK buttons within 10 seconds of pressing the LOCK button in step 4. (Perform the following procedure within 30 seconds.)
6. With the second valid F.A.S.T.-key, press the UNLOCK button for 4 to 10 seconds and press the LOCK button during this time.
7. Release in sequence the LOCK and UNLOCK buttons within 10 seconds of pressing the LOCK button in step 6. The immobilizer warning light will blink.

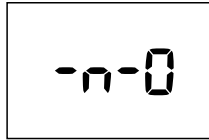

When registration of ID code is complete, the buzzer will sound 3 times and the immobilizer indicator will come on for 30 seconds.

If an error occurs, F.A.S.T.-key programming will be terminated and the buzzer will sound for 3 seconds.

NOTE

- F.A.S.T.-key programming will be terminated if the operation mode is put in OFF before the immobilizer warning light starts blinking.

8. If you wish to register another F.A.S.T.-key, repeat the process from step 1 after the operation mode is put in OFF.

NOTE

- The immobilizer display will go off immediately if the operation mode is put in OFF.
- It is not possible to register a F.A.S.T.-key if the immobilizer warning light goes off during the procedure.

Keyless entry system

N00515500213

Press the remote control transmitter buttons to lock or unlock the doors and the liftgate. It can also help you signal for attention by setting off the panic alarm.

5

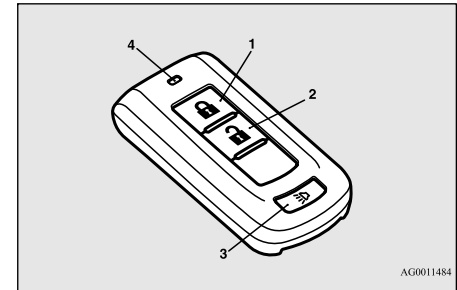

- 1- LOCK (🔒) button
 2- UNLOCK (🔓) button
 3- PANIC button
 4- Operation indicator light

To lock

Press the LOCK button (1) to lock all the doors and the liftgate. The turn signal lights will also blink once.

 **NOTE**

- If you press the LOCK button (1) twice, the horn will sound once.

To unlock

5 Press the UNLOCK button (2) to unlock the driver's door only.

Within about 2 seconds, press the UNLOCK button one more time to unlock all the doors and liftgate.

The dome light will turn on for 30 seconds. The turn signal lights will also blink twice.

 **NOTE**

- The door and liftgate unlock function can be set so that all doors and liftgate unlock when the UNLOCK button (2) is pressed once. Refer to "Setting of door and liftgate unlock function" on page 5-22.

Answerback function

The horn of the keyless entry system answerback function can be changed as required. This is done with the key removed from the ignition switch.

Horn deactivation/reactivation

The answerback function can be set in the following three ways.

- One chime: The horn will not sound.
- Two chimes: The horn will sound.
- Four chimes: The horn will sound if the LOCK button is pressed twice within 1 second.

1. Put the operation mode in OFF.
2. Open the driver's door and turn the combination headlights and dimmer switch to the "OFF" position.
3. Press the LOCK button (1) for 4 to 10 seconds and press the UNLOCK button (2) during this time.
4. Release in sequence the UNLOCK and LOCK buttons within 10 seconds of pressing the UNLOCK button in step 3.

Turn signal light deactivation/reactivation

The turn signal lights answerback function can be changes. If you want to change the answerback function, please contact an authorized Mitsubishi Motors dealer.

Buzzer deactivation/reactivation

The buzzer answerback function can be turned ON or OFF as required.

Setting of door and liftgate unlock function

N0054460098

The door and liftgate unlock function can be set to the following two conditions. Each time the door and liftgate unlock function is set, a chime will sound to tell you the condition of the door and liftgate unlock function.

Number of chimes	Condition
One chime	All doors and the liftgate unlock
Two chimes	Driver's door unlock only

1. Put the operation mode in OFF.
2. Open the driver's door and turn the combination headlights and dimmer switch to the "OFF" position.
3. Press the LOCK button (1) for 4 to 10 seconds and press the UNLOCK button (2) during this time.

4. Release in sequence the LOCK and UNLOCK buttons within 10 seconds of pressing the LOCK button in step 3.

Using the panic alarm

N00544700060

If you are near your vehicle and feel threatened, you can activate the alarm to call attention as follows:

1. Press the PANIC button (3) for more than 1 second.
2. The headlights will blink on and off and the horn will sound intermittently for about 3 minutes.
3. To turn off the alarm, press any button on the remote control transmitter.

NOTE

- The indicator light (4) comes on each time a button is pressed.
- The F.A.S.T.-key can be used from about 40 feet (12 m) away. However, this distance may change if your vehicle is near a TV transmitting tower, a power station, or a radio station.
- If the following conditions are observed after pressing the LOCK (1) or UNLOCK (2) button on the remote control transmitter, the battery in the F.A.S.T.-key may need to be replaced.

NOTE

- The doors and the liftgate cannot be locked or unlocked.
- The panic alarm cannot be operated.
- The indicator light (4) is dim or does not come on.
- If you lose your F.A.S.T.-key, please contact an authorized Mitsubishi Motors dealer for a replacement.
- If you wish to obtain an additional F.A.S.T.-key, please contact an authorized Mitsubishi Motors dealer. A maximum of four F.A.S.T.-key can be programmed for your vehicle.
- To use the new remote control transmitters, it is necessary to register the key with the electronic immobilizer and keyless entry system. Refer to “Electronic immobilizer (Anti-theft starting system): Customer F.A.S.T.-key programming” on page 5-20.

General information

N00562000065

Your F.A.S.T.-key operates on a radio frequency subject to Federal Communications Commission (FCC) Rules (For vehicles sold in U.S.A.) and Industry Canada Rules (For vehicles sold in Canada). This device complies with Part 15 of FCC Rules and Industry Canada licence-exempt RSS standard(s). Operation is subject to the following two conditions.

- This device may not cause harmful interference.
- This device must accept any interference received, including interference that may cause undesired operation of this device.

WARNING

- Changes or modifications not expressly approved by the party responsible for compliance could void the user's authority to operate the equipment.

5

Procedure for replacing the remote control transmitter battery

N00562100066

1. Before replacing the battery, remove static electricity from your body by touching a metal grounded object.
2. With the Mitsubishi mark facing you, insert the cloth-covered tip of a flat blade screwdriver into the notch in the case and use it to open the case.

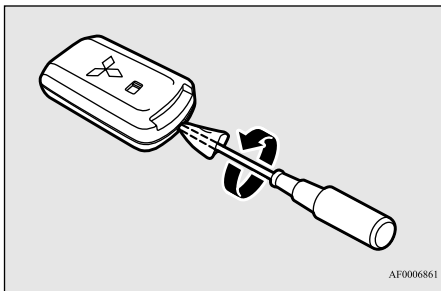

5. Close the case firmly.
6. Check the keyless entry system to see that it works.

NOTE

- You may purchase a replacement battery at an electric appliance store.
- An authorized Mitsubishi Motors dealer can replace the battery for you if you prefer.

NOTE

- Be sure to perform the procedure with the Mitsubishi mark facing you. If the Mitsubishi mark is not facing you when you open the case, the transmitter may come out.

3. Remove the old battery.
4. Install a new battery with the + side (A) up.

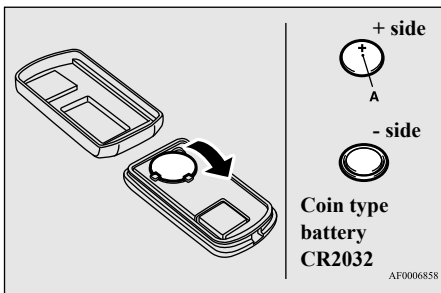

CAUTION

- When the remote control transmitter case is opened, be careful to keep water, dust, etc. out. Also, do not touch the internal components.

Door locks

N00509200547

WARNING

- Make sure all doors are tightly closed and locked while driving.
- Locked doors, in combination with the use of seat belts, can help reduce the risk of ejection in an accident.
- Locked doors can help keep passengers, especially small children, from opening doors and falling out of moving vehicles.
- Locked doors can help prevent outsiders from gaining access to your vehicle when you slow or come to a stop.

WARNING

- Lock your vehicle whenever you leave it. Children who get into unlocked vehicles may not be able to get out. Children trapped inside vehicles can quickly be overcome by heat and suffer serious injury or death due to heat stroke.
- Never leave a child alone in the vehicle. In addition to the risk of heat stroke, children can activate switches and controls, resulting in an injury or fatal accident.
- When closing a door, make sure that the door is fully closed and the door-ajar warning display goes out on the information screen on the multi-information display. If the door is ajar it could open while driving and cause an accident.

To lock and unlock with the key (driver's door)

Turn the key toward the front of the vehicle to lock the door. After checking that the door is locked, turn the key back to the center and remove it.



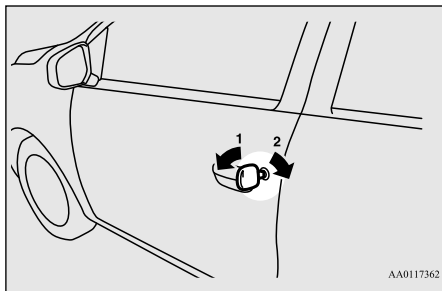

- 1- Lock
- 2- Unlock

To lock or unlock the door from the inside

Move the lock knob to the lock position to lock the door.
All doors should be kept locked while driving.

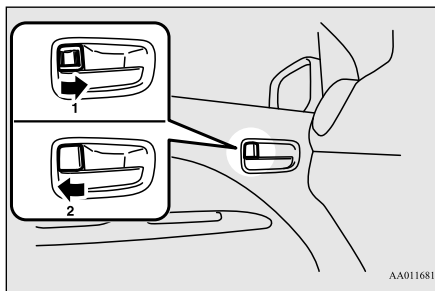

- 1- Lock
- 2- Unlock

The driver's door can be unlocked without using the lock knob by pulling on the inside door handle.

To lock the door without using the key

1. Move the inside lock knob to the locked position.



2. Be sure the keys are not inside the vehicle. Close the door.

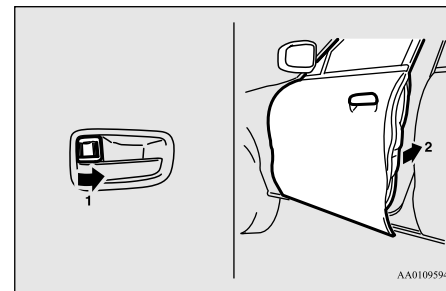

NOTE

- When locking or unlocking with the key, only the driver's door will be locked or unlocked.
To lock or unlock all doors and the liftgate, use the power door lock switches, the keyless entry system or the F.A.S.T-key operation. (if so equipped)
Refer to "Power door locks" on page 5-26, "Keyless entry system" on pages 5-6 and 5-21, and "To operate using the F.A.S.T-key" on page 5-12.
- In vehicles equipped with the F.A.S.T-key, the passenger's door can be locked and unlocked using the emergency key.
Refer to "Emergency key" on page 5-19.

Key reminder system (except for vehicles equipped with the F.A.S.T.-key)

N00549600253

If the ignition switch is turned off and the driver's door is opened with the key in the ignition switch, the key reminder buzzer will sound intermittently to remind you to remove the key.

Lock out protection

N00517300042

If the key is in the ignition switch or the operation mode is in any mode other than OFF when you push the lock knob forward with the driver's door or passenger's door open,

Power door locks

the lock knob will automatically return to the unlocked position.

Operation mode ON reminder system (vehicles equipped with the F.A.S.T.-key)

N00503800150

5

If the driver's door is opened while the engine is stopped and the operation mode is in any position other than OFF, the operation mode ON buzzer will sound intermittently to remind you to put the operation mode in OFF.

Power door locks

N00509300610

NOTE

- When locking or unlocking with the key on the driver's door, only the driver's door will lock or unlock.
- Repeated continuous operation between lock and unlock could activate the power door locking system's built-in protection circuit, and prevent the system from operating. If this occurs, wait about 1 minute before operating the power door lock switch.

To lock and unlock the doors and liftgate

Using the power door lock switch (if so equipped)

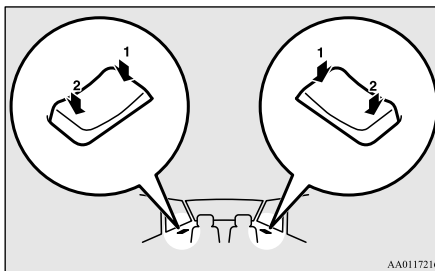

- 1- Lock
- 2- Unlock

All of the doors and the liftgate can be locked or unlocked by pressing the power door lock switch on the driver's or the front passenger door.

To unlock the doors and liftgate

N00563400112

You can select the functions to unlock the doors and liftgate either using the ignition switch or the engine switch, or using the selector lever position {continuously variable transmission (CVT)}.

These functions are not activated when the vehicle is shipped from the factory. To activate or deactivate these functions, please contact your authorized Mitsubishi Motors dealer.

Using the ignition switch or the engine switch

All doors and the liftgate will unlock when the ignition switch is turned to the "OFF" position or the operation mode is put in OFF.

Using the selector lever position {continuously variable transmission (CVT)}

All doors and the liftgate will unlock when the selector lever is moved to the "P" (PARK) position with the ignition switch or the operation mode in ON.

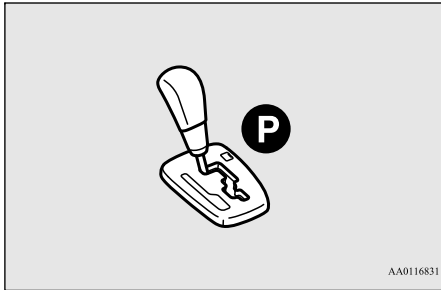

AA0116831

Child safety locks for rear door

N00509400291

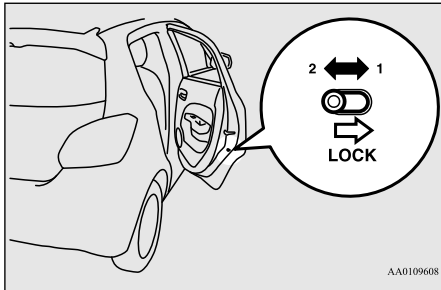

AA0109608

- 1- To lock
- 2- To release

Child safety locks help prevent rear passengers, especially children, from opening the rear door using the inside door handle.

A lock lever for the child safety lock is provided on each rear door.

When the lever is in the lock position (1), the rear door cannot be opened using the inside door handle.

To open the rear door when the child safety lock lever is in the lock position, pull the outside door handle.

When the lever is in the release position (2), the child safety lock is released and the rear door can be opened using the inside door handle.

⚠ WARNING

- Always keep the doors tightly closed and locked when driving. An unlocked door may be accidentally opened by a passenger, especially by a child who could fall out. Also, if the doors are not locked, there is a greater risk of someone being thrown from the vehicle in an accident.

Liftgate

N00510100243

⚠ WARNING

- It is dangerous to drive with the liftgate open since carbon monoxide (CO) gas can enter the passenger compartment. CO is an invisible, odorless gas that can cause unconsciousness and even death.
- When opening and closing the liftgate, make sure that there are no people nearby and be careful not to hit your head or pinch your hands, neck, etc.

5

⚠ CAUTION

- Do not stand behind the exhaust pipe when loading and unloading luggage. Heat from the exhaust could lead to burns.

📖 NOTE

- Locking and unlocking the doors by using the power door lock switch, the keyless entry system or the F.A.S.T.-key operation also locks and unlocks the liftgate. (if so equipped)

Manual window control (if so equipped)

To open

After unlocking the tailgate, pull the tailgate handle upward to open.

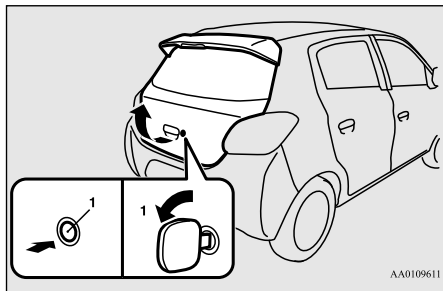

1- Unlock

CAUTION

- Make sure there is no one standing nearby when opening the liftgate.

To close

Pull the liftgate grip (A) downward as illustrated and release it before the liftgate closes completely. Gently slam the liftgate from the outside so that it is completely closed.



CAUTION

- To avoid injuring your hand or arm, do not attempt to close the liftgate without releasing the liftgate grip (A).
- Before starting the vehicle, be sure to confirm that the liftgate is locked. If the liftgate opens while driving the vehicle, objects stored in the luggage compartment could fall out into the road.

NOTE

- Gas struts (B) are installed in the locations illustrated in order to support the liftgate. Please observe the following in order to prevent damage or faulty operation:
 - Do not touch, push or pull the gas struts when closing the liftgate.
 - Do not attach any plastic material, tape, etc., to the gas struts.
 - Do not tie string, etc., around the gas struts.

NOTE

- Do not hang objects on the gas struts.

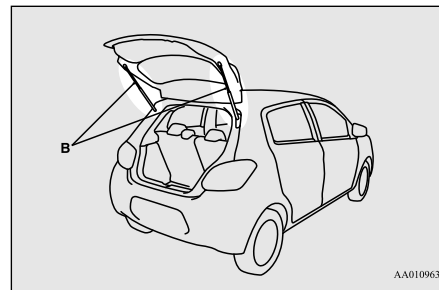

Manual window control (if so equipped)

N00510700021

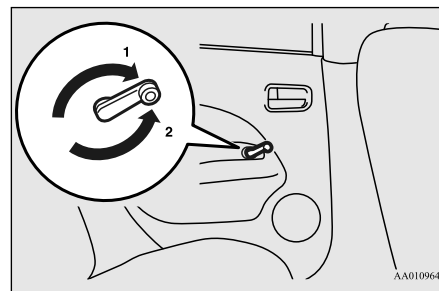

1- To open

2- To close

Power window control

N00510800370

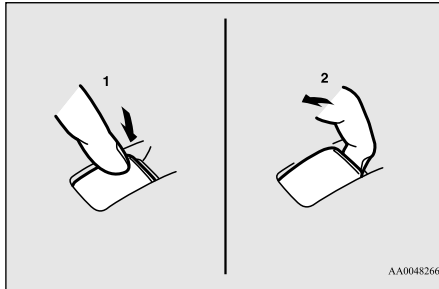

- 1- Open (down)
- 2- Close (up)

AA0048266

NOTE

- Never try to operate the main switch and sub-switch in different directions at the same time. This will freeze the window in position.
- Operating the power windows repeatedly with the engine stopped will run down the battery. Use the window switches only while the engine is running.

WARNING

- Before operating the power windows, make sure that nothing can be trapped (head, hands, fingers, etc.) in the window.

WARNING

- Never leave the vehicle without carrying the key.
- Never leave children or unreliable adults unattended inside the vehicle.

Main switch

N00548700130

The main switch located on the driver's door can be used to operate all the windows. A window can be opened or closed by operating the corresponding switch.

Press the switch down to open the window, and pull up the switch to close it.

If the driver's door window switch is fully pressed down/pulled up, the driver's door window automatically opens/closes completely. (Type 1)

If the driver's door window switch is fully pressed down, the driver's door window automatically opens completely. (Type 2)

If you want to stop the window movement, operate the switch lightly in the reverse direction.

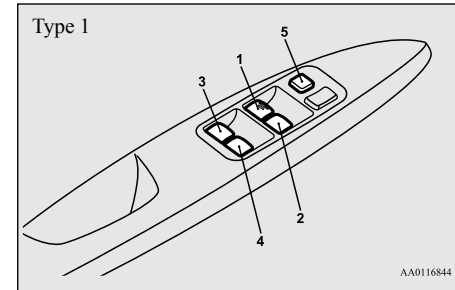

AA0116844

5

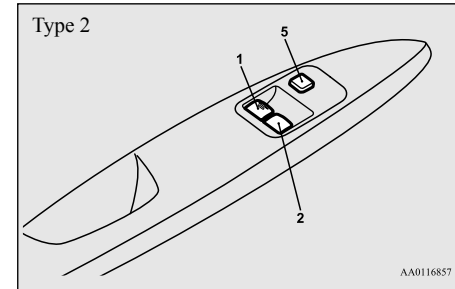

AA0116857

- 1- Driver's door window switch
- 2- Front passenger door window switch
- 3- Left rear door window switch
- 4- Right rear door window switch
- 5- Lock switch

Sub switch

N0054880098

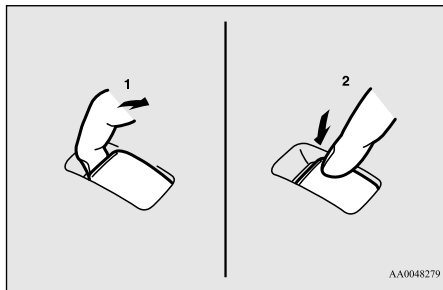

- 1- Close
- 2- Open

Each sub-switch can be used for its own passenger door window, unless the driver's window lock switch is activated.

NOTE

- The rear door windows open only half-way.

Power window timer function

N00548900132

The power windows can be run up or down when the ignition switch or the operation mode is in ON.

The door windows can be opened or closed for a 30-second period after the engine is

stopped. However, once the driver's door or the front passenger's door is opened, the power windows cannot be operated.

Lock switch

N00549000169

When this switch is in the lock mode, the passenger door switches cannot be used to open or close the door windows, and the main switch will open or close only the driver's door window. To unlock the switch, press it again.

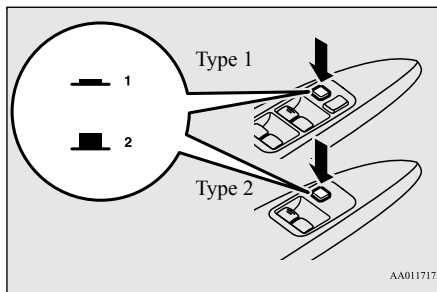

- 1- Lock
- 2- Unlock

WARNING

- Before driving with a child in the vehicle, be sure to lock the window switch to make it inoperative. Children tampering with the switch could easily trap their hands or heads in the window.

Safety mechanism (Driver's door window of Type 1 only)

N00528800122

If a hand or head is trapped, for safety the door window is automatically lowered a little. After the door window is lowered, clear the obstruction, then pull up the switch again to close the door window.

WARNING

- If the battery terminals are disconnected or the fuse for electric window is replaced, the safety mechanism will be cancelled. If a hand or head got trapped, a serious injury could result.

CAUTION

- The safety mechanism is deactivated just before the door window closes. This allows the door window to close completely. Therefore be especially careful that fingers are not trapped in the door window opening.

CAUTION

- The safety mechanism is deactivated while the switch is pulled up. Therefore be especially careful that fingers are not trapped in the door window opening.
- Do not deliberately trap your hands or head in order to activate the safety mechanism. Your hand or head could be trapped and personal injury could result.

NOTE

- The safety mechanism can be activated if the driving conditions or other circumstances cause the door window to be subjected to a physical shock similar to that caused by trapped hand or head.
- If the battery terminals are disconnected or the fuse for electric window is replaced, the safety mechanism will be cancelled and the door window will not automatically open/close completely.
If the window is open, repeatedly raise the driver's door window switch until the window has been fully closed. Following this, release the switch, raise the switch once again and hold it in this condition for at least 1 second, then release it. You should now be able to operate the driver's door window in the normal fashion.

What to do if you hear wind buffeting when driving

N00551400043

Wind buffeting can be described as the perception of pressure on the ears or a booming or rumbling sound. Your vehicle may exhibit wind buffeting when driving with one or both rear door windows down or partially opened. This is a normal occurrence that can be minimized. If the buffeting occurs with the rear door windows open, open the front door windows as well as the rear door windows to minimize the condition.

Parking brake

N00511400399

To park the vehicle, first bring it to a complete stop, fully engage the parking brake, and then move the gearshift lever to 1st (on a uphill) or "R" (Reverse) (on a downhill) position for vehicles equipped with a manual transaxle, set the selector lever to "P" (PARK) position for vehicles equipped with a continuously variable transmission (CVT).

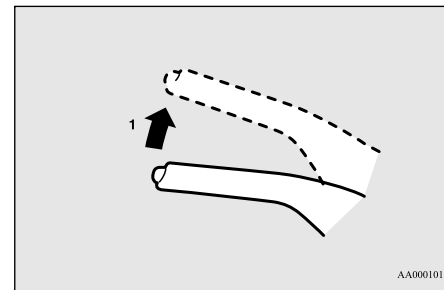
To apply

AA0001018

- 1- Pull the lever up without pushing the button at the end of hand grip.

When the parking brake is set and the ignition switch or the operation mode is in the "ON" position, the brake warning light in the instrument cluster will come on.

Before driving, be sure to release the parking brake.

To deactivate

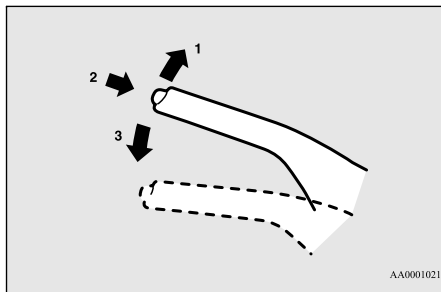

- 1- Pull the lever up slightly.
- 2- Press and hold the button at the end of the hand grip.
- 3- Push the lever downward.

When parking on a hill, set the parking brake, and turn the front wheels toward the curb on a downhill, or away from the curb on an uphill.

CAUTION

- Before driving, be sure that the parking brake is fully released and brake warning light is off.
- If you drive without the parking brake fully released, the warning lamp will illuminate and a buzzer sounds when the vehicle speed exceeds 5 mph (8 km/h).
- If a vehicle is driven without releasing the parking brake, the brakes will be overheated, resulting in ineffective braking and possible brake failure.

Steering wheel height adjustment

N00511501254

To adjust the steering wheel to the desired position, move the lever upward or downward while moving the steering wheel to the desired level.

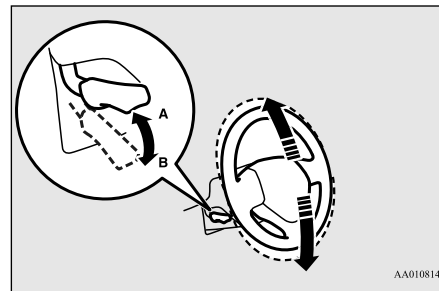

- A- Wheel lock
B- Release

WARNING

- After adjusting, make sure the lever is secured in the locked (A) position.
- Do not attempt to adjust the steering wheel while driving. This can be dangerous.
- When releasing the lever (moving it to the position (B)), be sure to hold the steering wheel firmly. Otherwise, the steering wheel may slip down too suddenly.

Inside rearview mirror

N00511600317

Adjust the inside rearview mirror only after making any seat adjustments so as to have a clear view to the rear of the vehicle.

⚠ WARNING

- Do not attempt to adjust the inside rear-view mirror while driving. This can be dangerous.
Be sure to adjust the mirror before driving.

Adjust the inside mirror to maximize the view through the rear window.

To adjust the vertical mirror position

It is possible to move the mirror up and down to adjust its position.

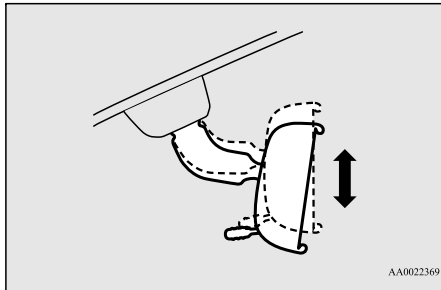

To adjust the mirror position

It is possible to move the mirror up/down and left/right to adjust its position.

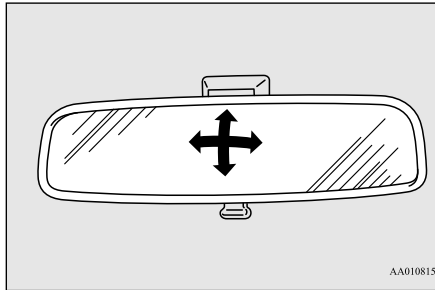

To reduce the glare

The day/night knob (A) at the bottom of the mirror can be used to adjust the mirror to reduce the glare from the headlights of vehicles behind you during night driving.

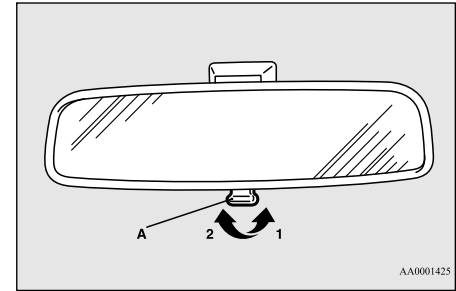

- 1- Daytime position
- 2- Night position

Outside rearview mirrors

N00512200206

Adjust the outside rearview mirrors only after making any seat adjustments so as to have a clear view to the rear of the vehicle.

⚠ WARNING

- Do not attempt to adjust the outside rear-view mirrors while driving. This can be dangerous.
Be sure to adjust the mirrors before driving.

WARNING

- Your passenger's side mirror is convex. The objects you see in the mirror will look smaller and farther away than they appear in a regular flat mirror. Do not use this mirror to estimate the distance of vehicles following you when changing lanes.

5

To adjust the mirror position

N00549100144

The outside rearview mirrors can be adjusted when the ignition switch or the operation mode is in ON or ACC.

Move the lever (A) to the same side as the mirror you wish to adjust.

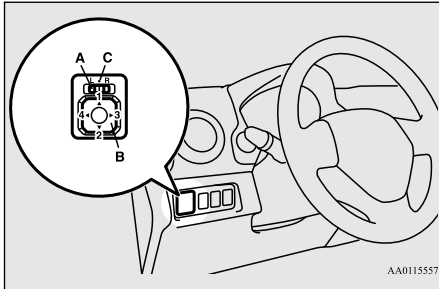

AA0115557

- L- Left outside mirror adjustment
- R- Right outside mirror adjustment

Press the switch (B) to adjust the mirror position.

- 1- Up
- 2- Down
- 3- Right
- 4- Left

NOTE

- After adjusting, return the lever to the "OFF" position (C).

To fold the mirror

N00549200099

The outside mirror can be manually folded in towards the side window to prevent damage when parking in tight locations.

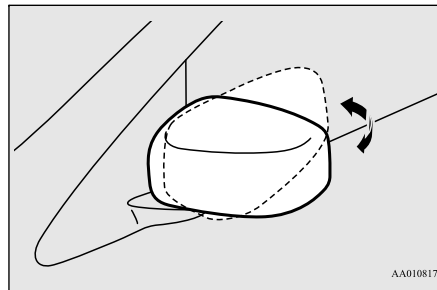

AA0108177

Door mirror heater (if so equipped)

N00549300218

When the rear window defogger switch is pressed with the engine running, the outside rearview mirrors are defogged or defrosted. Current will flow through the heater element inside the mirrors, thus clearing away frost or condensation.

The indicator light (A) will illuminate while the defogger is on.

The heater will be turned off automatically in about 20 minutes.

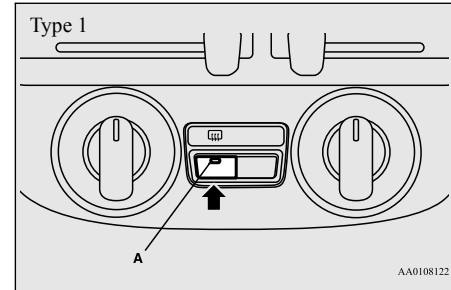

AA0108122

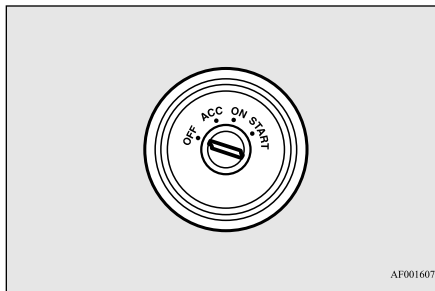
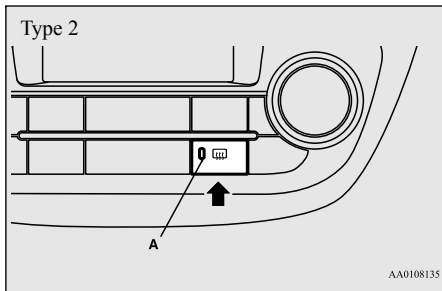

START

Engages the starter. Release the key when the engine starts. It will automatically return to the “ON” position.

NOTE

- Your vehicle is equipped with an electronic immobilizer. To start the engine, the ID code which the transponder inside the key sends must match the one registered to the immobilizer computer. (Refer to “Electronic immobilizer” on page 5-20.)

5

Ignition switch

N00512400686

[For vehicles equipped with the Free-hand Advanced Security Transmitter (F.A.S.T.-key)]

For information on operations for vehicles equipped with the Free-hand Advanced Security Transmitter (F.A.S.T.-key), refer to “Free-hand Advanced Security Transmitter (F.A.S.T.-key): Engine switch” on page 5-13.

[Except for vehicles equipped with the Free-hand Advanced Security Transmitter (F.A.S.T.-key)]

OFF

The engine is off. The key can be inserted and removed only when the switch is in this position.

ACC

Allows operation of some electrical accessories with the engine off.

ON

The engine runs and all accessories can be used.

To remove the key

N00550900201

- Set the selector lever to the “P” (PARK) position {continuously variable transmission (CVT)}.
- Turn the key to the “OFF” position and remove it.

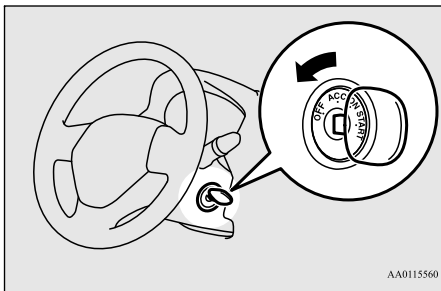

CAUTION

- If the engine is stopped while driving, the brake servomechanism will cease to function and braking efficiency will deteriorate. Also, the power steering system will not function and it will require greater manual effort to operate the steering.
- Do not leave the key in the “ON” position for a long time when the engine is not running, doing so will cause the battery to be discharged.
- Do not turn the key to the “START” position when the engine is running, doing so could damage the starter motor.

Starting the engine

N00512601816

[For vehicles equipped with the Free-hand Advanced Security Transmitter (F.A.S.T.-key)]

For information on operation for vehicles equipped with the Free-hand Advanced Security Transmitter (F.A.S.T.-key), refer to “Free-hand Advanced Security Transmitter (F.A.S.T.-key): Starting and stopping the engine” on page 5-16.

[Except for vehicles equipped with the Free-hand Advanced Security Transmitter (F.A.S.T.-key)]

Tips for starting

- Do not operate the starter motor continuously for longer than 15 seconds as this could run the battery down or damage the starter motor. If the engine does not start, turn the ignition switch back to the “OFF” position, wait a few seconds, and then try again. Trying repeatedly with the engine or starter motor still turning will damage the starter mechanism.
- If the engine will not start because the battery is weak or discharged, refer to “Jump-starting the engine” (on page 8-2) for instructions.
- A longer warm up period will only consume extra fuel. The engine is warmed up enough for driving when the low coolant temperature indicator goes out. Refer to “Low coolant temperature indicator” on page 5-71.



WARNING

- **Never run the engine in a closed or poorly ventilated area any longer than is needed to move your vehicle out of the area. Carbon monoxide gas, which is odorless and extremely poisonous, could build up and cause serious injury or death.**

CAUTION

- Do not push-start the vehicle.
- Do not run the engine at high rpms or drive at high speeds until the engine has had a chance to warm up.
- Release the ignition switch as soon as the engine starts. Otherwise, the starter motor will be damaged.

Starting the engine

This model is equipped with an electronically controlled fuel injection system. This is a system that automatically controls fuel injection. There is usually no need to depress the accelerator pedal when starting the engine. The starter should not be run for more than 15 seconds at a time. To prevent battery drain, wait a few seconds between attempts to restart the engine.

1. Make sure all occupants are properly seated with seat belts fastened.

2. Insert the ignition key.
3. Make sure the parking brake is applied.
4. Press and hold the brake pedal down with your right foot.
5. Press and hold the clutch pedal all the way down (manual transaxle).

NOTE

- On vehicles equipped with manual transaxle, the starter will not operate unless the clutch pedal is fully depressed (Clutch interlock).

6. On vehicles equipped with manual transaxle, place the gearshift lever in the “N” (Neutral) position.

On vehicles equipped with continuously variable transmission (CVT), make sure the selector lever is in the “P” (PARK) position.

NOTE

- On vehicles equipped with CVT, the starter will not operate unless the selector lever is in the “P” (PARK) or “N” (NEUTRAL) position.
For safety reasons, start the engine in the “P” (PARK) position so that the wheels are locked.

7. Turn the ignition switch to the “ON” position and make certain that all warning lights are functioning properly before starting the engine.
8. Turn the ignition switch to the “START” position without pressing the accelerator pedal. Release the key when the engine starts.

NOTE

- Minor noises may be heard on engine start-up. These will disappear as the engine warms up.

When the engine is hard to start

After several attempts, you may experience that the engine still does not start.

1. Make sure that all electric devices, such as lights, air conditioning blower and rear window defogger, are turned off.
2. While depressing the brake pedal {continuously variable transmission (CVT)} or the clutch pedal (manual transaxle), press the accelerator pedal halfway and hold it there, then crank the engine. Release the accelerator pedal, immediately after the engine starts.

3. If the engine still will not start, the engine could be flooded with too much gasoline. While depressing the brake pedal (CVT) or the clutch pedal (manual transaxle), push the accelerator pedal all the way down and hold it there, then crank the engine for 5 to 6 seconds. Return the ignition switch to the “OFF” position and release the accelerator pedal. Wait a few seconds, and then crank the engine again for 5 to 6 seconds while depressing the brake pedal (CVT) or the clutch pedal (manual transaxle), but do not push the accelerator pedal. Release the ignition key if the engine starts. If the engine fails to start, repeat these procedures. If the engine still will not start, contact your local Mitsubishi Motors dealer or a repair facility of your choice for assistance.

Startability of CVT vehicle with ambient temperature of -4 °F (-20 °C) or lower

When the ambient temperature is -4 °F (-20 °C) or lower, it may not be possible to start from a standstill even with the selector lever in the “D” (DRIVE) or “R” (REVERSE) position.

This phenomenon occurs because the transaxle has not warmed up sufficiently; it does

Manual transaxle (if so equipped)

not indicate a problem. If this occurs, place the selector lever in the “P” (PARK) position and let the engine idle for at least 10 minutes. The transaxle will warm up, and you will be able to start normally.

Do not leave the vehicle during warm-up operation.

5

Manual transaxle (if so equipped)

N00512700142

The shift pattern below is shown on the gearshift lever. Press the clutch pedal all the way down while shifting gears.

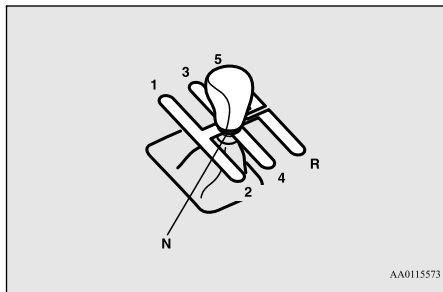

NOTE

- During cold weather, shifting may be difficult until the transaxle lubricant has warmed up. This is normal and not harmful to the transaxle.

To start

Press the clutch pedal all the way down and shift into 1st or “R” (Reverse) position. Then gradually release the clutch pedal while depressing the accelerator pedal.

CAUTION

- Do not move the gearshift lever into reverse while the vehicle is moving forward; doing so will damage the transaxle.
- Do not rest your foot on the clutch pedal because this will cause premature clutch wear or damage.
- Do not coast in the “N” (Neutral) position (illegal in many states).
- Do not use the gearshift lever as a handrest, because this can result in premature wear of the transaxle shift forks.

NOTE

- If it is hard to shift into 1st, depress the clutch pedal a second time; the shift will then be easier.

Information Provided by:



NOTE

- To shift into reverse from 5th gear, move the gearshift lever to the “N” (Neutral) position, and then shift it into reverse.

Proper shift points

N00537400065

Always use care to change the gear with the vehicle speed matched to the engine speed. Proper shifting will improve fuel economy and prolong engine life.

CAUTION

- Avoid downshifting that may cause the tachometer pointer to enter the red zone. This puts the engine at risk of being damaged.

Upshifting

N00512900131

For the best fuel economy and performance in using your manual transaxle, upshift as listed below.

At low altitude locations, shift at the vehicle speeds listed. Upshifting earlier during cruise conditions (relatively steady speeds) will improve your fuel economy.

Shift point	Upshift speeds	
	Acceleration	Cruise
1st gear to 2nd gear	15 mph (24 km/h)	15 mph (24 km/h)
2nd gear to 3rd gear	28 mph (45 km/h)	19 mph (31 km/h)
3rd gear to 4th gear	36 mph (58 km/h)	33 mph (53 km/h)
4th gear to 5th gear	45 mph (72 km/h)	45 mph (72 km/h)

At high altitude locations, upshift as listed below.

Shift point	Upshift speeds
1st gear to 2nd gear	15 mph (24 km/h)
2nd gear to 3rd gear	25 mph (40 km/h)
3rd gear to 4th gear	40 mph (64 km/h)
4th gear to 5th gear	45 mph (72 km/h)

Downshifting

N00513000096

It is recommended that you downshift to a lower gear when needed to maintain the desired speed, according to the table.

Avoid downshifting at too high a speed. The engine may suffer damage.

To maintain a safe speed and prolong brake life, shift down to 2nd or 1st when descending a steep hill.

Downshifting is also important to avoid “lugging” the engine at too low a speed, such as when turning a corner or when driving up a steep hill.

Recommended downshifting speed

Downshifting speed	Shift point
Under 20 mph (32 km/h)	Shift down from current gear to 2nd gear.
20 to 30 mph (32 to 48 km/h)	Shift down from current gear to 3rd gear.

Driving precautions

N00513100244

- Do not use the gearshift lever as a handrest. This can result in premature wear of the transaxle shift forks.

Maximum possible driving speed

Shift points	Maximum possible driving speed
1st gear	28 mph (45 km/h)
2nd gear	53 mph (85 km/h)

Information Provided by:



Shift points	Maximum possible driving speed
3rd gear	78 mph (125 km/h)
4th gear	105 mph (170 km/h)

- The table above shows the maximum recommended driving speed for in each gear. Do not drive near or at these speeds for prolonged periods of time.

5

Continuously variable transmission (CVT) (if so equipped)

N00560200050

The CVT will automatically and continuously change its gear ratio depending on road and driving conditions. This helps achieve smooth driving and excellent fuel efficiency.

DRIVING UPHILL

The transmission prevents unnecessary upshifts even when the accelerator pedal is released and ensures smooth driving.

DRIVING DOWNHILL

According to the conditions, the transmission will automatically shift to a lower gear ratio to achieve stronger engine braking. This may help reduce your need to use the service brake.

5

Selector lever operation

N00560300051

As an additional safety precaution, models equipped with a continuously variable transmission have a shift-lock device that holds the selector lever in the “P” (PARK) position. To move the selector lever from the “P” (PARK) position to another position, follow the steps below.

1. Press and hold the brake pedal down.
2. Move the selector lever to the desired position.

NOTE

- The selector lever cannot be moved from “P” (PARK) to another position if the ignition switch is set to the “OFF” or “ACC” position, or if the key has been removed, or operation mode is in “OFF” or “ACC”, or if the brake pedal is not pressed and held down.

The CVT selects an optimum ratio automatically when the selector lever is in the “D” (DRIVE) position, depending on the speed of the vehicle and the position of the accelerator pedal.

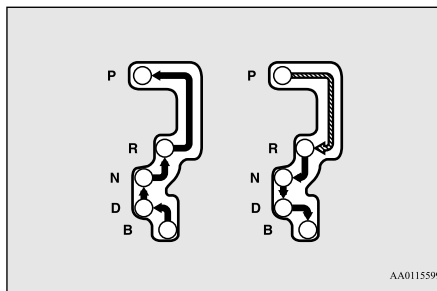

Set the selector lever in the gate to operate while the brake pedal is depressed.



Set the selector lever in the gate to operate.

WARNING

- Always press the brake pedal when shifting the selector lever into a selector position from the “N” (NEUTRAL) position. When beginning to drive, do not shift the selector lever from the “N” (NEUTRAL) position while pressing the accelerator pedal. This will cause the vehicle to “jump” forward or backward.

NOTE

- To prevent mistakes in operating the lever, make sure you stop briefly at each position. After operating, check the position in the multi-information display.
- If the brake pedal is not depressed and held, the shift-lock device activates to prevent the selector lever from being moved from the “P” (PARK) position.
- For a shift indicated by  in the illustration, depress the brake pedal before moving the selector lever. If you attempt to move the selector lever before depressing the brake pedal, the selector lever may not move.

When the selector lever cannot be shifted from the “P” (PARK) position

N00563300049

When the selector lever cannot be shifted from the “P” (PARK) position while the brake pedal is pressed and held down with the ignition switch or the operation mode in ON, the battery may be flat or the shift-lock mechanism may be malfunctioning.

Immediately have your vehicle checked by an authorized Mitsubishi Motors dealer or a repair facility of your choice.

If you need to move the vehicle, shift the selector lever as follows.

1. Make sure the parking brake is fully applied.
2. Stop the engine if it is running.
3. Insert a screwdriver with a cloth over its tip into the notch (A) of the cover. Pry gently as shown to remove the cover.

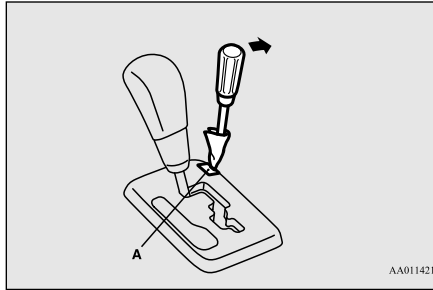

AA0114215

4. Depress the brake pedal with the right foot.
5. Insert a screwdriver in the shift-lock release hole (B). Shift the selector lever to the “N” (NEUTRAL) position while pressing the screwdriver down.

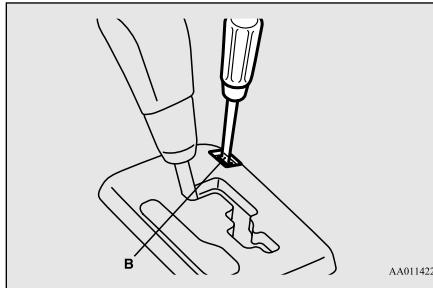

AA0114228

Selector lever position display

N00560400078

When the ignition switch is turned to the “ON” position or the operation mode is put in ON, the selector lever position is shown on the multi-information display.

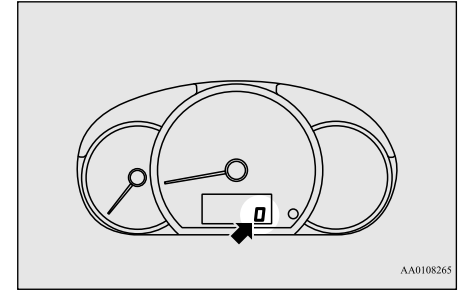

AA0108265

5

Selector lever positions

N00560600067

“P” PARK

This position locks the transmission to prevent the vehicle from moving. The engine can be started from the “P” (PARK) position.

“R” REVERSE

Move the lever to this position only after the vehicle has come to a complete stop.

CAUTION

- Never shift into the “P” (PARK) or “R” (REVERSE) position while the vehicle is in motion. If the lever is shifted into the “P” (PARK) or “R” (REVERSE) position while the vehicle is in motion, the transmission may be damaged.

“N” NEUTRAL

At this position, the transmission is disengaged. It is the same as the neutral position on a manual transaxle and should be used when the vehicle is not moving for an extended length of time during driving, such as in a traffic jam.

WARNING

- Never move the selector lever to the “N” (NEUTRAL) position while driving since you could accidentally slip it into the “P” (PARK) or “R” (REVERSE) position, damaging the transmission.

WARNING

- To prevent the vehicle from rolling when stopped on a slope, the engine should be started in the “P” (PARK) position, not in “N” (NEUTRAL) position.
- To prevent rolling, always keep your foot on the brake pedal when the vehicle is in “N” (NEUTRAL) position, or when shifting into or out of “N” (NEUTRAL) position.

“D” DRIVE

This position is used for most city and highway driving. The transmission will automatically and continuously change its gear ratio depending on road and driving conditions.

CAUTION

- To prevent transmission damage, never shift into the “D” (DRIVE) position from the “R” (REVERSE) position while the vehicle is in motion.

“B” BRAKE

This position is for use when light engine braking at high-speed is needed, or driving up very steep hills and for engine braking at low speeds when descending steep gradients.

When a malfunction occurs in the automatic transaxle

N00549500018

When the selector lever position indicator blinks

N00574601023

When the selector lever position indicator blinks while you are driving, there could be a malfunction in the automatic transaxle system or CVT fluid temperature becomes abnormally high.

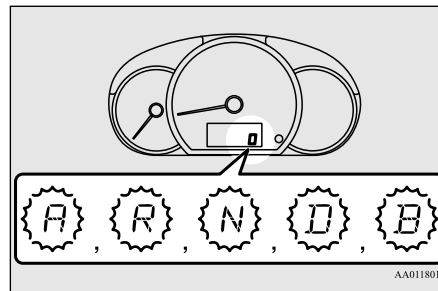

NOTE

- The “A” indicator blinks only if the CVT selector lever switch is broken. It is not seen during normal driving.

⚠ CAUTION

- If a malfunction occurs in the CVT while driving, the indicator will blink. In this case, immediately park your vehicle in a safe place and follow these procedures: [If the indicator blinks rapidly (once per second), the CVT fluid is overheating.] Park your vehicle in a safe place but do not turn off the engine. Move the selector lever to the “P” (PARK) position and open the bonnet. Keep the engine, idling. After a while, move the selector lever into any position other than “P” (PARK) position and confirm that the indicator stops blinking. It is safe to continue driving if the indicator no longer blinks. If the indicator continues blinking or blinks intermittently, have your vehicle inspected at an authorized Mitsubishi Motors dealer or repair facility of your choice. [If the indicator blinks slowly (once per 2 seconds), the CVT safety device may be operating due to a malfunction.] Have the vehicle inspected at an authorized Mitsubishi Motors dealer or repair facility of your choice as soon as possible.

Operation of the CVT

N00560801066

⚠ CAUTION

- Before selecting a position with the engine running and the vehicle stationary, firmly depress the brake pedal to prevent the vehicle from creeping. The vehicle will begin to move as soon as the CVT is engaged, especially when the engine speed or idle speed is high, or with the air conditioning (cooling or heating) operating. Do not release the brake pedal until you are ready to drive away.
- Depress the brake pedal with the right foot at all times. Using the left foot could cause driver movement delay in case of an emergency.
- To prevent sudden acceleration, never run the engine at high rpms when shifting from the “P” (PARK) or “N” (NEUTRAL).
- Operating the accelerator pedal while the other foot is resting on the brake pedal will affect braking efficiency and may cause premature wear of brake pads.
- Use the selector lever in the correct shift position in accordance with driving conditions. Never coast downhill backward in the driving shift position “D” (DRIVE) or coast forward in the “R” (REVERSE) position. Engine stopping and increased brake pedal and steering effort could lead to an accident.

⚠ CAUTION

- Do not rev the engine with the brake pedal pressed when the vehicle is stationary. This can damage the CVT. Also, when you depress the accelerator pedal while holding down the brake pedal with the selector lever in the “D” (DRIVE) position, the engine revolutions may not rise as high as when performing the same operation with the selector lever in the “N” (NEUTRAL) position.

5

Passing acceleration

To gain extra acceleration in “D” (DRIVE) position (when passing another vehicle) push the accelerator to the floor. The CVT will automatically downshift.

Waiting

For short waiting periods, such as at traffic lights, the vehicle can be left in selector lever position and held stationary with the service brake.

For longer waiting periods with the engine running, place the selector lever in the “N” (NEUTRAL) position and apply the parking brake, while holding the vehicle stationary with the service brake.

Service brake

Prior to moving off after having stopped the vehicle, make sure that the selector lever is in “D” (DRIVE) position.

CAUTION

- To avoid transmission overheating, never try to keep your vehicle stationary on a hill by using the accelerator pedal. Always apply the parking brake and/or service brake.
- Do not rev the engine unnecessarily while the vehicle is stationary. Unexpected acceleration may occur if the selector lever is in a position other than “P” (PARK) or “N” (NEUTRAL).

Parking

To park the vehicle, first bring it to a complete stop, fully engage the parking brake, and then move the selector lever to the “P” (PARK) position.

When the CVT makes no speed change

If the CVT does not shift while driving, or your vehicle does not pick up enough speed when starting on an uphill slope, it may be that there is something unusual happening in the transmission, causing a safety device to activate. Have your vehicle checked at an

authorized Mitsubishi Motors dealer or a repair facility of your choice as soon as possible.

Service brake

N00517500318

Brake pedal

Overuse of the brake can cause weakening, resulting in poor brake response and premature wear of the brake pads.

When driving down a long or steep hill, use engine braking by moving the selector lever to “B” (BRAKE) position.

WARNING

- **Do not leave any objects near the brake pedal or let a floor mat slide under it; doing so could prevent the full pedal stroke that would be necessary in an emergency. Make sure that the pedal can be operated freely at all times. Make sure the floor mat is securely held in place.**

CAUTION

- It is important not to drive the vehicle with your foot resting on the brake pedal when braking is not required. This practice can result in very high brake temperatures, premature lining wear, and possible damage to the brakes.

Power brakes

N00517600436

Your vehicle is equipped with power brakes for more braking force with less brake pedal effort.

Your brakes are designed to operate at full capacity, even if the power assist is not being used.

If the power assist is not being used, the effort needed to press the brake pedal is greater.

If you should lose the power assist for some reason, the brakes will still work.

If the power brake unit or either of the two brake hydraulic systems stops working properly, the rest of the brake system will still work, but the vehicle will not slow down as quickly.

You will know this has happened if you find you need to press the brake down farther, or harder when slowing down or stopping, or if the brake warning light and the warning display in the multi-information display come on. Have the brake system repaired at an

authorized Mitsubishi Motors dealer or a repair facility of your choice immediately.

WARNING

- Never coast downhill with the engine OFF. Keep the engine running whenever your vehicle is in motion. If you turn off the engine while driving, the power brake booster will stop working and your brakes will not work as well.
- If the power assist is lost or if either brake hydraulic system stops working properly, take your vehicle to an authorized Mitsubishi Motors dealer or a repair facility of your choice immediately.

Brake pad wear alarm

N00550700124

The disc brakes have an alarm that makes a metallic squeal when the brake pads have worn down enough to need service.

If you hear this sound, have the brake pads replaced at an authorized Mitsubishi Motors dealer or a repair facility of your choice.

WARNING

- Driving with worn brake pads will make it harder to stop, and can cause an accident.

Hill start assist (if so equipped)

N00562600087

The hill start assist makes it easy to start off on a steep uphill slope by preventing the vehicle from moving backwards. It keeps the braking force for about 2 second when you move your foot from the brake pedal to the accelerator pedal.

CAUTION

- Do not overly rely on the hill start assist to prevent backwards movement of the vehicle. Under certain circumstances, even when hill start assist is activated, the vehicle may move backwards if the brake pedal is not sufficiently depressed, if the vehicle is heavily loaded, or if the road is very steep or slippery.
- The hill start assist is not designed to keep the vehicle stopped in place on uphill slopes for more than 2 seconds.
- When facing uphill, do not rely on using the hill start assist to maintain a stopped position as an alternative to depressing the brake pedal. Doing so could cause an accident.

CAUTION

- Do not perform the following operation while the hill start assist is operating. [Except for vehicles equipped with the F.A.S.T.-key] Turn the ignition switch to the “OFF” or “ACC” position. [Vehicles equipped with the F.A.S.T.-key] Put the operation mode in OFF or ACC. The hill start assist could stop operating, which could result in an accident.

To operate

N00562700091

1. Stop the vehicle completely using the brake pedal.
2. Place the selector lever into the “D” position.

NOTE

- When reversing on an uphill slope, place the selector lever into the “R” position.
3. Release the brake pedal and the hill start assist will maintain the braking force applied while stopping for approximately 2 seconds.
 4. Depress the accelerator pedal and the hill start assist gradually will decrease the braking force as the vehicle starts moving.

NOTE

- The hill start assist is activated when all of the following conditions are met.
 - The engine is running.
(The hill start assist will not be activated while the engine is starting or immediately after the engine is started.)
 - The selector lever is in any position other than “P” or “N”.
 - The vehicle is completely stationary, with the brake pedal depressed.
 - The parking brake is released.
- The hill start assist will not operate if the accelerator pedal is depressed before the brake pedal is released.
- The hill start assist also operates when reversing on an uphill slope.
- When the hill start assist is activated, you may feel the operating sound or vibration from under the body.
This is a normal result of the hill start assist operation, and does not indicate a problem.

Warning indicator

N00562800092

If an abnormal condition occurs in the system, the following indicator will turn on.



- ASC indicator

CAUTION

- If the warning is displayed, the hill start assist will not operate. Start off carefully.
- Park your vehicle in a safe place and stop the engine.
Restart the engine and check whether the indicator goes out, in which case the hill start assist is again working normally.
If they remain displayed or reappear frequently, it is not necessary to stop the vehicle immediately, but the vehicle should be inspected by an authorized Mitsubishi Motors dealer or a repair facility of your choice as soon as possible.

Brake assist system

N00567300092

The brake assist system is a device assisting drivers who cannot depress the brake pedal firmly such as in emergency stop situations and provides greater braking force.

If the brake pedal is depressed suddenly, the brakes will be applied with more force than usual.

CAUTION

- The brake assist system is not a device designed to exercise braking force greater than its capacity. Make sure to always keep a sufficient distance between vehicles in front of you without relying too much on the brake assist system.

NOTE

- Once the brake assist system is operational, it maintains great braking force even if the brake pedal is lightly released.
To stop its operation, completely remove your foot from the brake pedal.
- When the brake assist system is in use while driving, you may feel as if the depressed brake pedal is soft, the pedal moves in small motions in conjunction with the operation noise, or the vehicle body and the steering wheel vibrate. This occurs when the brake assist system is operating normally and does not indicate faulty operation. Continue to depress the brake pedal.
- When the anti-lock brake system warning light is illuminated, the brake assist system is not functioning.

Anti-lock braking system

N00517900338

The anti-lock braking system helps prevent the wheels from locking up when braking.

This helps maintain vehicle drivability and steering wheel handling.

Driving hints

- When using the anti-lock brakes (sudden braking), steering is slightly different from normal driving conditions. Use the steering wheel carefully.
- Always keep a safe distance from the vehicle in front of you. Even if your vehicle is equipped with the anti-lock braking system, leave a greater braking distance when:
 - Driving on gravel or snow-covered roads.
 - Driving on uneven road surfaces.
- Operation of anti-lock braking system is not restricted situations where brakes are applied suddenly. This system may also prevent the wheels from locking when you drive over manholes, steel roadwork plates, road markings, or any uneven road surface.
- When the anti-lock braking system is in use, you may feel the brake pedal vibrating and hear a unique sound. It may also feel as if the pedal resists being pressed.
In this situation, simply hold the brake pedal down firmly. Do not pump the brake, which will result in reduced braking performance.

⚠ CAUTION

- The anti-lock braking system cannot prevent accidents. It is your responsibility to take safety precautions and to drive carefully.
- To prevent failure of the anti-lock braking system, be sure all 4 wheels and tires are the same size and the same type.

📖 NOTE

- You may feel the operating sound or vibration from under the body when driving immediately after starting the engine. This is a normal result the anti-lock braking system makes when performing a self-check. It does not indicate a problem.
- The anti-lock braking system can be used after the vehicle has reached a speed over approximately 6 mph (10 km/h). It stops working when the vehicle slows below 3 mph (5 km/h).

Anti-lock braking system warning light

N00531600674

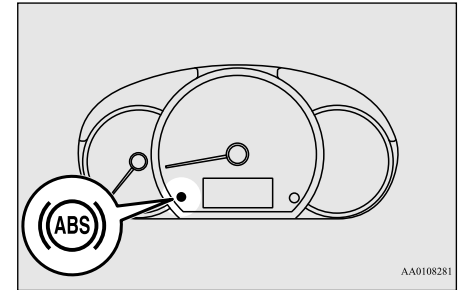

5

If there is a malfunction in the system, the anti-lock braking system warning light will come on.

Under normal conditions, the ABS warning light comes on when the ignition switch is turned to the “ON” position or the operation mode is put in ON and goes off a few seconds later.

⚠ CAUTION

- Any of the following indicates that the anti-lock braking system is not functioning and only the standard brake system is working. (The standard brake system is functioning normally.) If this happens, take your vehicle to an authorized Mitsubishi Motors dealer or a repair facility of your choice.

CAUTION

- When the ignition switch is turned to the “ON” position or the operation mode is put in ON, the warning light does not come on or it remains on and does not go off.
- The warning light comes on while driving

5 If the warning light illuminate while driving

N00531700604

If only the anti-lock braking system warning light illuminate

- Avoid hard braking and high-speed driving. Stop the vehicle in a safe place. Test the system by restarting the engine and driving at a speed of about 12 mph (20 km/h) or higher. If the warning light then remains off during driving, there is no abnormal condition. However, if the warning light does not disappear, or if they come on again when the vehicle is driven, have the vehicle checked by an authorized MITSUBISHI MOTORS dealer or repair facility of your choice as soon as possible.

If the anti-lock braking system warning light and brake warning light illuminate at the same time



The anti-lock braking system and brake force distribution function may not work, so hard braking could make the vehicle unstable.

Avoid hard braking and high-speed driving. Stop the vehicle in a safe place and contact an authorized MITSUBISHI MOTORS dealer or repair facility of your choice.

After driving on icy roads

N00529200080

After driving on snow or icy roads, remove any snow and ice which may have be left around the wheels. On vehicles that have an anti-lock braking system, be careful not to damage the wheel speed sensors (A) or the cables located at each wheel.

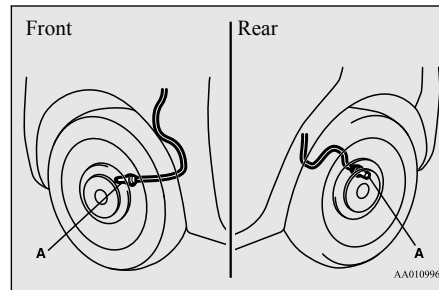

Electric power steering system (EPS)

N00568400074

The power steering system operates while the engine is running. It helps reduce the effort needed to turn the steering wheel.

The power steering system has mechanical steering capability in case the power assist is lost. If the power assist is lost for some reason, you will still be able to steer your vehicle, but you will notice it takes much more effort to steer. If this happens, have your vehicle inspected at an authorized Mitsubishi Motors dealer or a repair facility of your choice.

⚠ WARNING

- Do not stop the engine while the vehicle is moving. Stopping the engine would make the steering wheel extremely hard to turn, possibly resulting in an accident.

📖 NOTE

- During repeated full-lock turning of the steering wheel (for example, while you are manoeuvring the vehicle into a parking space), a protection function may be activated to prevent overheating of the power steering system. This function will make the steering wheel gradually harder to turn. In this event, limit your turning of the steering wheel for a while. When the system has cooled down, the steering effort will return to normal.
- If you turn the steering wheel while the vehicle is stationary with the headlights on, the headlights may become dim. This behavior is not abnormal. The headlights will return to their original brightness after a short while.

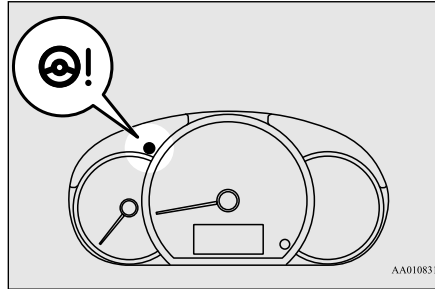
Electric power steering system warning light

If there is a malfunction in the system, the warning light will come on. Under normal conditions, the warning lamp comes on when the ignition switch is turned to the “ON” position or the operation mode is put in ON, and goes off after the engine has started.

⚠ CAUTION

- If the warning light appears while the engine is running, have the vehicle inspected by an authorized Mitsubishi Motors dealer or a repair facility of your choice as soon as possible. It may become harder to turn the steering wheel.

Active stability control (ASC)

N00559100176

The Active stability control (ASC) takes overall control of the anti-lock braking system, traction control function and skid control function to help maintain the vehicle’s control and traction. Please read this section in conjunction with the page on the anti-lock braking system, traction control function and skid control function.

Anti-lock braking system → P.5-46
Traction control function → P.5-50
Skid control function → P.5-50

⚠ CAUTION

- Do not over-rely on the ASC. Even the ASC cannot prevent the natural laws of physics from acting on the vehicle. This system, like any other system, has limits and cannot help you to maintain traction and control of the vehicle in all circumstances. Reckless driving can lead to accidents. It is the driver’s responsibility to drive carefully, This means taking into account the traffic, road and environmental conditions.
- Be sure to use the same specified type and size of tire on all four wheels. Otherwise, the ASC may not work properly.

CAUTION

- Do not install any aftermarket limited slip differential (LSD) on your vehicle. The ASC may stop functioning properly.

NOTE

- An operating sound or vibration may be emitted from under the body in the following situations. The sound or vibration is associated with checking the operations of the ASC. At this time, you may feel a shock from under the body and the brake pedal if you depress it. These do not indicate a malfunction.
- When the ignition switch is turned to the “ON” position or the operation mode is put in ON.
- When the vehicle is driven for a while after the engine is turned on.
- When the ASC is activated, you may feel a vibration in the vehicle body or hear a whining sound from the engine compartment. This indicates that the system is operating normally. It does not indicate a malfunction.
- When the anti-lock braking system warning light is illuminated, the ASC is not active.

Traction control function

N00559200076

On slippery surfaces, the traction control function prevents the drive wheels from spin-

ning excessively, thus helping the vehicle to start moving from a stopped condition. It also provides sufficient driving force and steering performance as the vehicle turns while pressing the acceleration pedal.

CAUTION

- When driving a vehicle on a snowy or icy road, be sure to install snow tires and drive the vehicle at moderate speeds.

Skid control function

N00559300051

The skid control function is designed to help the driver maintain control of the vehicle on slippery roads or during rapid steering maneuvers. It works by controlling the engine output and the brake on each wheel.

NOTE



- The skid control function operates at speeds of about 9 mph (15 km/h) or higher.

ASC OFF switch

N00559400254

The ASC is automatically activated when the ignition switch is turned to the “ON” position or the operation mode is put in ON. You can

deactivate the system by pressing down the “ASC OFF” switch for 3 seconds or longer.

When the ASC is deactivated, the  indicator will turn on. To reactivate the ASC, momentarily press the “ASC OFF” switch; the  indicator is turned off.

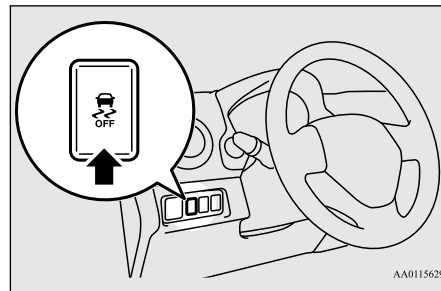

CAUTION

- For safety reasons, the “ASC OFF” switch should be operated when your vehicle is stopped.
- Be sure to keep the ASC on while driving in normal circumstances.

NOTE

- Using the “ASC OFF” switch turns off both the stability control function and the traction control function.

NOTE

- When moving out of mud, sand or fresh snow, pressing the accelerator pedal may not allow the engine speed to increase. In such situations, temporarily turning off ASC with the “ASC OFF” switch will make it easier to move out your vehicle.
- If you continue to press the “ASC OFF” switch after the ASC is turned off, the “mistaken operation protection function” will activate and the ASC will turn back on.

ASC operation indicator or ASC OFF indicator

N00546500118



ASC operation indicator

The indicator will blink when the ASC is operating.





ASC OFF indicator

This indicator will turn on when the ASC is turned off with the “ASC OFF” switch.

CAUTION

- When  indicator blinks, ASC is operating, which means that the road is slippery or that your vehicle’s wheels are beginning to slip. If this happens, drive slower with less accelerator input.

NOTE

- The  indicator may turn on when you start the engine. This means that the battery voltage momentarily dropped when the engine was started. It does not indicate a malfunction, provided that the display goes out immediately.
- When a compact spare tire has been put on your vehicle, the gripping ability of the tire will be lower, making it more likely that the  indicator will blink.

ASC warning indicator

N00546600119

If an abnormal condition occurs in the system, the following indicator will turn on.



ASC indicator



ASC OFF indicator

CAUTION

- The system may be malfunctioning. Park your vehicle in a safe place and stop the engine. Restart the engine and check whether the indicator goes out. If they go out, there is no abnormal condition. If they do not go out or appear frequently, it is not necessary to stop the vehicle immediately, but you should have your vehicle inspected by an authorized Mitsubishi Motors dealer or a repair facility of your choice as soon as possible.

Towing

N00546300031

CAUTION

- When towing the vehicle with only the front wheels or only the rear wheels raised off the ground, do not place the ignition switch in the “ON” position or do not put the operation mode in ON. Placing the ignition switch in the “ON” position or putting the operation mode in ON could cause the ASC to operate, resulting in an accident. Note that the correct towing method depends on the transmission type and the vehicle’s drive configuration. For details, refer to “Towing” on page 8-17.

Cruise control (if so equipped)

N00518300573

Cruise control is an automatic speed control system that keeps a set speed. It can be activated at speeds from about 25 mph (40 km/h). Cruise control does not work at speeds below about 25 mph (40 km/h).

CAUTION

- When you do not wish to drive at a set speed, turn off the cruise control for safety.
- Do not use cruise control when driving conditions will not allow you to stay at the same speed, such as in heavy traffic or on roads that are winding, icy, snow-covered, wet, slippery, on a steep downhill slope.
- On vehicles equipped with manual transaxle, do not move the gearshift lever to the “N” (Neutral) position while driving at a set speed without depressing the clutch pedal. The engine will run too fast and might be damaged.

NOTE

- Cruise control may not be able to keep your speed on uphill or downhills.
- Your speed may decrease on a steep uphill. You may use the accelerator pedal if you want to stay at your set speed.

NOTE

- Your speed may increase to more than the set speed on a steep downhill. You have to use the brake to control your speed. As a result, the set speed driving is deactivated.

Cruise control switches

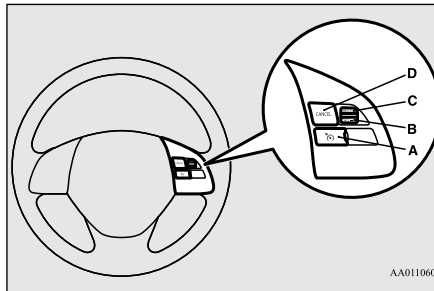

A- CRUISE CONTROL ON/OFF switch

Used to turn on and off the cruise control.

B- SET - switch

Used to reduce the set speed and to set the desired speed.

C- RES + switch

Used to increase the set speed and to return to the original set speed.

D- CANCEL switch

Used to deactivate the set speed driving.

NOTE

- When operating the cruise control switches, press the cruise control switches correctly. The set speed driving may be deactivated automatically if two or more switches of the cruise control are pressed at the same time.

To activate

N00518400385

1. With the ignition switch is in “ON” position or the operation mode is in ON, press the CRUISE CONTROL ON/OFF switch (A) to turn on the cruise control. The indicator in the meter cluster will come on.

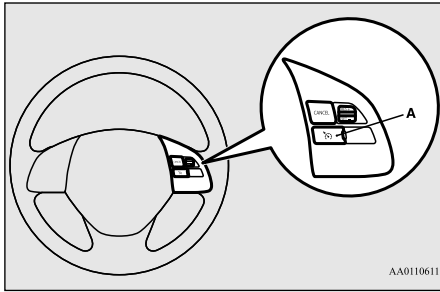

NOTE

- When you release the SET - switch, the vehicle speed will be set.

To increase the set speed

N00518500344

There are 2 ways to increase the set speed.

RES + switch

Press and hold the RES + switch (C) while driving at the set speed, and your speed will then gradually increase.

When you reach your desired speed, release the switch. Your new cruising speed is now set.

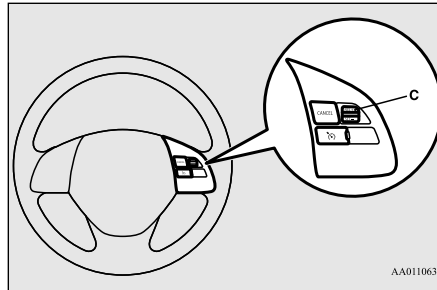

Indicator



2. Accelerate or decelerate to your desired speed, then press and release the SET - switch (B) when the indicator is illuminated. The vehicle will then maintain the desired speed.

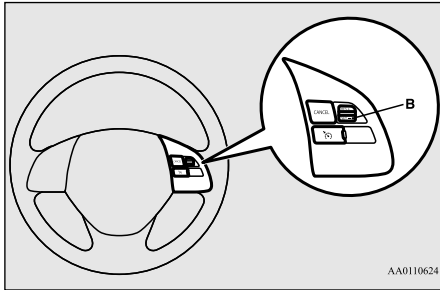

To increase your speed in small amounts, press the RES + switch for less than about 1 second and release it.

Each time you press the RES + switch, your vehicle will go about 1 mph (1.6 km/h) faster.

Accelerator pedal

While driving at the set speed, use the accelerator pedal to reach your desired speed and then press the SET - switch (B) and release the switch momentarily to set a new desired cruising speed.

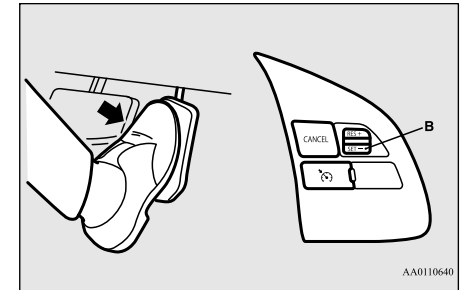

To decrease the set speed

N00518600273

There are 2 ways to decrease the set speed.

Cruise control (if so equipped)

SET - switch

Press and hold the SET - switch (B) while driving at the set speed, and your speed will slow down gradually.

When you reach your desired speed, release the switch. Your new cruising speed is now set.

5

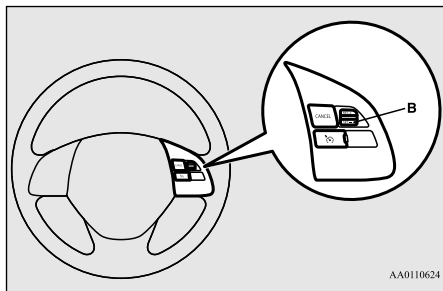

To slow down your speed in small amounts, press the SET - switch for less than about 1 second and release it.

Each time you press the SET - switch, your vehicle will slow down by about 1 mph (1.6 km/h).

Brake pedal

While driving at the set speed, use the brake pedal, which disengages the cruise control,

then press the SET - switch (B) and release the switch momentarily to set a new desired cruising speed.

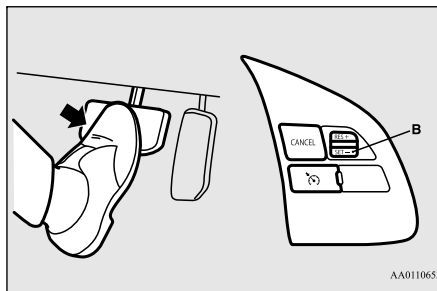

To temporarily increase or decrease the speed

N00541700056

To temporarily increase the speed

Depress the accelerator pedal as you would normally. When you release the pedal, you will return to your set speed.

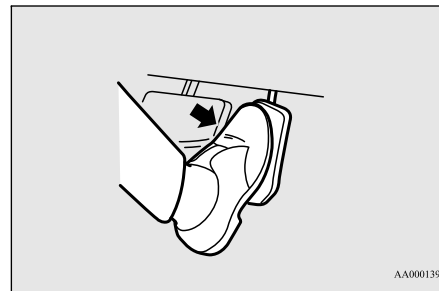

To temporarily decrease the speed

Depress the brake pedal to decrease the speed. To return to the previously set speed, press the RES + switch (C).

Refer to “To resume the set speed” on page 5-55.

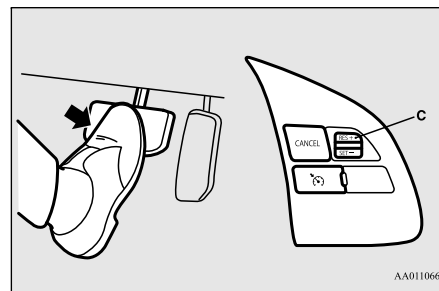

To deactivate

N00518800565

The set speed driving can be deactivated as follows:

- Press the CRUISE CONTROL ON/OFF switch (A). (Cruise control will be turned off.)
- Press the CANCEL switch (D).
- Depress the brake pedal.

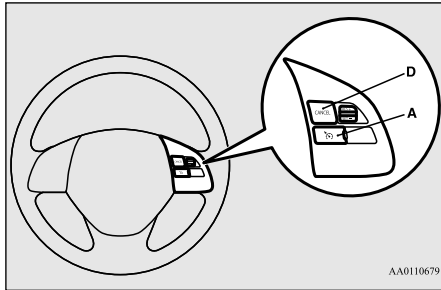

The set speed driving is deactivated automatically in any of the following ways.

- When you depress the clutch pedal (on vehicles equipped with manual transaxle).
- When your speed slows to about 10 mph (15 km/h) or more below the set speed because of a hill, etc.
- When your speed slows to about 25 mph (40 km/h) or less.

- When the active stability control (ASC) starts operating. Refer to “Active stability control (ASC)” on page 5-49.

⚠ WARNING

- **On vehicles equipped with continuously variable transmission (CVT), although the set speed driving will be deactivated when shifting to the “N” (NEUTRAL) position, never move the selector lever to the “N” (NEUTRAL) position while driving. You would have no engine braking and could cause a serious accident.**

Also, the set speed driving may be deactivated as follow:

- When the engine speed rises and approaches the tachometer’s red zone (the red-colored part of the tachometer dial).

⚠ CAUTION

- When the set speed driving is deactivated automatically in any situation other than those listed above, there may be a system malfunction. Press the CRUISE CONTROL ON/OFF switch to turn off the cruise control and have your vehicle inspected by an authorized Mitsubishi Motors dealer or a repair facility of your choice.



To resume the set speed

N00518900306

If the set speed driving is deactivated by the condition described in “To deactivate” on page 5-55, you can resume the previously set speed by pressing the RES + switch (C) while driving at a speed of about 25 mph (40 km/h) or higher.

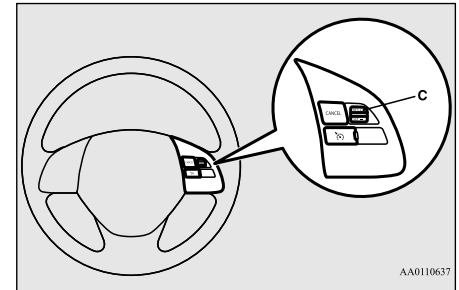

Under either of the following conditions, however, using the switch does not allow you to resume the previously set speed. In these situations, repeat the speed setting procedure:

- The CRUISE CONTROL ON/OFF switch is pressed.
- [Except for vehicles equipped with the F.A.S.T.-key]
Turn the ignition switch to the “OFF” or “ACC” position.
[Vehicles equipped with the F.A.S.T.-key]

Tire pressure monitoring system (if so equipped)

Put the operation mode in OFF or ACC.

- Indicator is turned OFF.

Tire pressure monitoring system (if so equipped)

N00530201553

- 5** The tire pressure monitoring system uses tire inflation pressure sensors (A) on the wheels to monitor the tire inflation pressures. The system only indicates when a tire is significantly under-inflated.

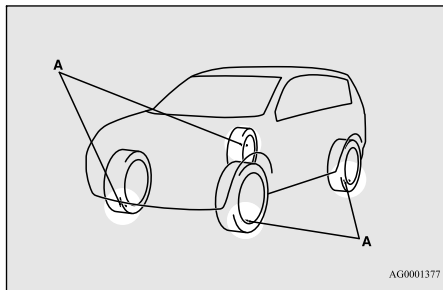

AG0001377

WARNING

- **The compact spare wheel (if so equipped) does not have a tire inflation pressure sensor. When the spare tire is used, the tire pressure monitoring system will not work properly. See an authorized Mitsubishi Motors dealer as soon as possible to replace or repair the original tire.**

NOTE

- The tire pressure monitoring system is not a substitute for regularly checking tire inflation pressures. Be sure to check the tire inflation pressures as described in “Tires” on page 9-12.
- The tire inflation pressure sensor (A) is installed in the illustrated location.
 - On vehicles with Type 1 sensor which has the metallic air valve (B), replace grommet and washer (C) with a new one when the tire is replaced.
 - On vehicles with Type 2 sensor which has the rubber air valve (D), replace rubber air valve (D) with a new one when the tire is replaced.

NOTE

For details, please contact your authorized Mitsubishi Motors dealer.

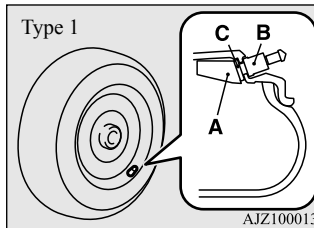

AJZ100013

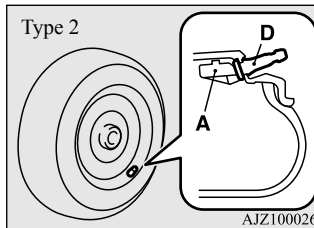

AJZ100026

Tire pressure monitoring system warning light

N00532701347

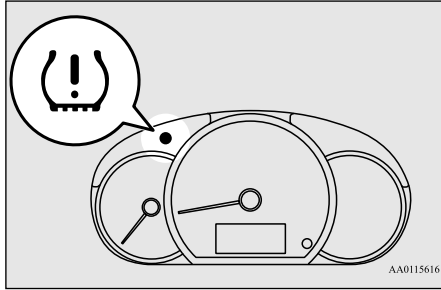

AA0115616

When the ignition switch is turned to the “ON” position or the operation mode is put in ON, the tire pressure monitoring system warning light normally illuminates and goes off a few seconds later.

If one or more of the vehicle tires (except for the spare tire) is significantly under-inflated, the warning light will remain illuminated while the ignition switch or the operation mode is in ON.

Refer to “If the warning light illuminates while driving” on page 5-58 and take the necessary measures.

CAUTION

- If the tire pressure monitoring system warning light does not illuminate when the ignition switch is turned to the “ON” position or the operation mode is put in ON, it means that the tire pressure monitoring system is not working properly. Have the system inspected by an authorized Mitsubishi Motors dealer.

In such situations, a malfunctioning of the system may be preventing the monitoring of the tire pressure. Avoid sudden braking, sharp turning and high-speed driving.

- If a malfunction is detected in the tire pressure monitoring system, the tire pressure monitoring system warning light will blink for approximately 1 minute and then remain continuously illuminated. The warning light will issue further warnings each time the engine is restarted as long as the malfunction exists.

Check to see whether the warning light goes off after few minutes driving.

If it then goes off during driving, there is no problem.

However, if the warning light does not go off, or if it blinks again when the engine is restarted, have the vehicle inspected by an authorized Mitsubishi Motors dealer.

In such situations, a malfunctioning of the system may be preventing the monitoring of the tire pressure. For safety reasons, when the warning light appears while driving, avoid sudden braking, sharp turning and high-speed driving.

Each tire, including the spare (if provided), should be checked monthly when cold and inflated to the inflation pressure recommended by the vehicle manufacturer on the vehicle placard or tire inflation pressure label. (If your vehicle has tires of a different size than the size indicated on the vehicle placard or tire inflation pressure label, you should determine the proper tire inflation pressure for those tires.)

As an added safety feature, your vehicle has been equipped with a tire pressure monitoring system (TPMS) that illuminates a low tire pressure telltale when one or more of your tires is significantly under-inflated.

Accordingly, when the low tire pressure telltale illuminates, you should stop and check your tires as soon as possible, and inflate them to the proper pressure. Driving on a significantly under-inflated tire causes the tire to overheat and can lead to tire failure.

Under-inflation also reduces fuel efficiency and tire tread life, and may affect the vehicle’s handling and stopping ability. Please note that the TPMS is not a substitute for proper tire maintenance, and it is the driver’s responsibility to maintain correct tire pressure, even if under-inflation has not reached the level to trigger illumination of the TPMS low tire pressure telltale.

Tire pressure monitoring system (if so equipped)

Your vehicle has also been equipped with a TPMS malfunction indicator to indicate when the system is not operating properly. The TPMS malfunction indicator is combined with the low tire pressure telltale.

When the system detects a malfunction, the telltale will flash for approximately one minute and then remain continuously illuminated. This sequence will continue upon subsequent vehicle start-ups as long as the malfunction exists.

When the malfunction indicator is illuminated, the system may not be able to detect or signal low tire pressure as intended.

TPMS malfunctions may occur for a variety of reasons, including the installation of replacement or alternate tires or wheels on the vehicle that prevent the TPMS from functioning properly. Always check the TPMS malfunction telltale after replacing one or more tires or wheels on your vehicle to ensure that the replacement or alternate tires and wheels allow the TPMS to continue to function properly.

If the warning light illuminates while driving

N00532800501

1. If the tire pressure monitoring system warning light illuminates, avoid hard braking, sharp steering maneuvers and high speeds. You should stop and adjust the tires to the proper inflation pressure as soon as possible. Adjust the spare tire at the same time. Refer to “Tires” on page 9-12.

NOTE

- When inspecting or adjusting the tire pressure, do not apply excessive force to the valve stem to avoid breakage.
- After inspecting or adjusting the tire pressure, always reinstall the valve cap on the valve stem.
Without the valve cap, dirt or moisture could get into the valve, resulting in damage to the tire inflation pressure sensor.
- Do not use metal valve caps, which may cause a metal reaction, resulting in corrosion and damage of the tire inflation pressure sensors.
- Once adjustments have been made, the warning light will go off after a few minutes of driving.

2. If the tire pressure monitoring system warning light remains illuminated after you have been driving for about 20 minutes after you adjust the tire inflation pressure, one or more of the tires may have a puncture. Inspect the tire and if it has a puncture, have it repaired by an authorized Mitsubishi Motors dealer as soon as possible.

WARNING

- If the warning light illuminates while you are driving, avoid hard braking, sharp steering maneuvers and high speeds. Driving with an under-inflated tire adversely affects vehicle performance and can result in an accident.

CAUTION

- The warning light may not illuminate immediately in the event of a tire blowout or rapid leak.

NOTE

- To avoid the risk of damage to the tire inflation pressure sensors, have any punctured tire repaired by an authorized Mitsubishi Motors dealer. If the tire repair is not done by an authorized Mitsubishi Motors dealer, damage to the tire inflation pressure sensor is not covered by your warranty.

 **NOTE**

- Do not use an aerosol puncture-repair spray on any tire.
Such a spray could damage the tire inflation pressure sensors.
Have any puncture repaired by an authorized Mitsubishi Motors dealer.
- Using the tire repair kit may damage the tire inflation pressure sensor. The vehicle must promptly be inspected and repaired by an authorized Mitsubishi Motors dealer after using the tire repair kit.

The tire pressure monitoring system may not work normally in the following circumstances:

- A wireless facility or device using the same frequency is near the vehicle.
- Snow or ice is stuck inside the fenders and/or on the wheels.
- The tire inflation pressure sensor's battery is dead.
- Wheels other than Mitsubishi Genuine wheels are being used.
- Wheels that are not fitted with tire inflation pressure sensors are being used.
- Wheels whose ID codes are not memorized by the vehicle are used.
- Compact spare tire (if so equipped) is fitted on a road wheel.
- A window tint that affects the radio wave signals is installed.

 **NOTE**

- Tire inflation pressures vary with the ambient temperature. If the vehicle is subjected to large variations in ambient temperature, the tire inflation pressures may be under-inflated (causing the warning light come on) when the ambient temperature is relatively low. If the warning light comes on, adjust the tire inflation pressure.

Whenever the tires and wheels are replaced with new ones

N00532900153

If new wheels with new tire inflation pressure sensors are installed, their ID codes must be programmed into the tire pressure monitoring system. Have tire and wheel replacement performed by an authorized Mitsubishi Motors dealer to avoid the risk of damaging the tire inflation pressure sensors. If the wheel replacement is not done by an authorized Mitsubishi Motors dealer, it is not covered by your warranty.

 **CAUTION**

- The use of non-genuine wheels will prevent the proper fit of the tire inflation pressure sensors, resulting air leakage or damage of the sensors.

General information

N00533000236

Your tire pressure monitoring system operates on a radio frequency subject to Federal Communications Commission (FCC) Rules (For vehicles sold in U.S.A.) and Industry Canada Rules (For vehicles sold in Canada). This device complies with part 15 of FCC

Rules and Industry Canada licence-exempt RSS standard(s).
Operation is subject to the following two conditions.

- This device may not cause harmful interference
- This device must accept any interference received, including interference that may cause undesired operation.

 **WARNING**

- Changes or modifications not expressly approved by the manufacturer for compliance could void the user's authority to operate the equipment.

Rear-view camera (if so equipped)

N00546200144

When the gearshift lever or the selector lever is in the “R” position with the ignition switch or the operation mode is in ON, the rear-view image will be displayed on the screen of the Mitsubishi Multi Entertainment System.

When the gearshift lever or the selector lever is shifted out of the “R” position, the rear-view image will go off.

WARNING

- Never rely solely on the rear-view camera to clear the area behind your vehicle. Always check visually behind and all around your vehicle for persons, animals, obstructions or other vehicles. Failure to do so can result in vehicle damage, serious injury or death.
- The rear-view camera is an aid system for backing up, but it is not a substitute for your visual confirmation.
- The view on the screen is limited, and objects outside the view, such as under the bumper or around either corner of the bumper end, cannot be seen on the screen.

Location of rear-view camera

The rear-view camera (A) is in the liftgate, at the left side of the liftgate handle.

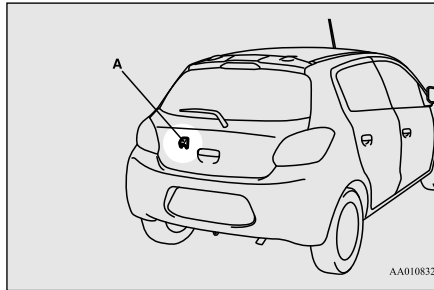

CAUTION

- If the camera lens gets dirty, a clear image cannot be obtained. As necessary, rinse the lens with clean water and gently wipe with a clean, soft cloth.
- To avoid damaging the camera;
 - Do not rub the cover excessively or polish it by using an abrasive compound.
 - Do not disassemble the camera.
 - Do not splash hot water directly on the lens.
 - Do not spray the camera and its surroundings with high-pressure water.
 - Make sure that the liftgate is securely closed when backing up.

Reference lines on the screen

Reference lines and upper surface of the rear bumper (A) are displayed on the screen.

- Red line (B) indicates approximately 20 inches (50 cm) behind the rear bumper.
- Two Green lines (C) indicate approximately 8 inches (20 cm) outside of the vehicle body.
- Short transverse lines (1 to 3) indicate distance from the rear bumper.

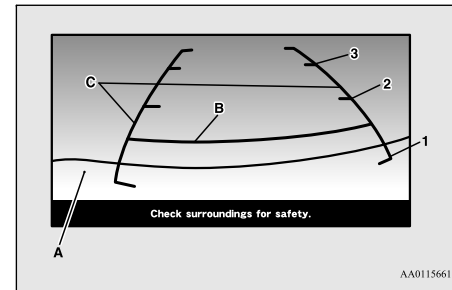

- 1: Approximately at the rear edge of the rear bumper
- 2: Approximately 39 inches (100 cm)
- 3: Approximately 79 inches (200 cm)

CAUTION

- The rear-view camera uses a wide-angle lens. As a result, images and distances shown on the screen are not exact.
- Actual distance may be different from distance indicated by the lines on the screen, depending on the loading condition of the vehicle and road surface condition. The reference lines for distance and vehicle width are based on a level, flat road surface. In the following cases, objects shown on the screen will appear to be farther off than they actually are.
 - When the rear of the vehicle is weighed down with the weight of passengers and luggage in the vehicle. (Case 1)
 - When there is an upward slope at the back. (Case 2)

Case 1

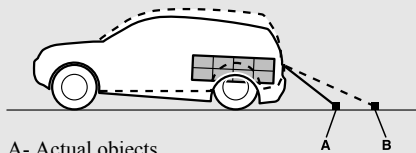

A- Actual objects
B- Objects shown on the screen

AG0027131

Case 2

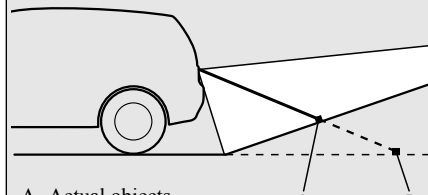

A- Actual objects
B- Objects shown on the screen

AG0027144

CAUTION

- The reference lines for distance and vehicle width are intended to indicate the distance to a flat object such as a level, flat road surface. They may not indicate correct distance depending on the shape of an obstacle. For example, when there is an object behind the vehicle that has upper sections projecting in the direction of the vehicle, the reference lines on the screen will indicate that point A is the farthest point and point B is the closest point to the vehicle. In reality, point A and B are actually the same distance from the vehicle, and point C is farther off than point A and B.

NOTE

- Mirror image is displayed on the screen.
- Monitor brightness is adjusted automatically by sensors.
- It is possible to change the display language of the screen. For details, please refer to the separated owner's manual for "Mitsubishi Multi Entertainment System".
- Under certain circumstances, it may become difficult to see an image on the screen, even when the system is functioning correctly.
 - In a dark area, such as at night.
 - When water drops or condensation are on the lens.
 - When sun light or headlights shine directly into the lens.

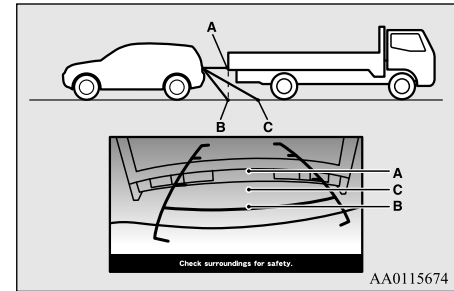

AA0115674

Instrument cluster

N00519000391

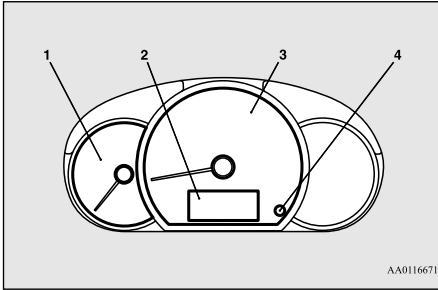

AA0116671

- 1- Tachometer → P.5-62
- 2- Multi-information display → P.5-62
- 3- Speedometer → P.5-62
- 4- Multi-information display switch

Speedometer

N00519100262

The speedometer shows the vehicle speed in miles per hour (mph) or kilometers per hour (km/h).

Type A

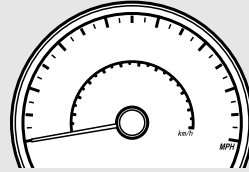

AA0116684

Type B

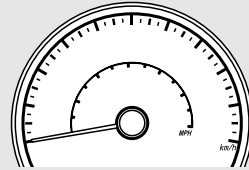

AA0116697

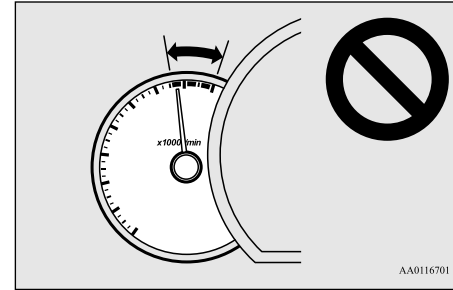

AA0116701

CAUTION

- The red zone indicates an engine speed beyond the range of safe operation. Select the correct shift position (manual transaxle) or selector position (CVT) to control the engine speed so that the tachometer indicator does not enter the red zone.

Multi-information display

N00555001318

The multi-information display displays the odometer, trip odometer, service reminder, fuel remaining, selector lever position, average fuel consumption, driving range, etc.

Tachometer

N00519200292

The tachometer shows engine revolutions per minute. This allows the driver to determine the most efficient selector position and engine speed combinations.

This gauge also assists in evaluating engine performance.



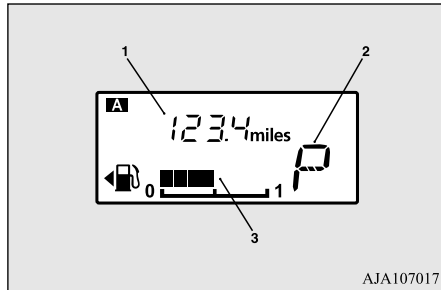

3- Fuel remaining display → P.5-66

NOTE

- When the ignition switch or the operation mode is in OFF, the selector lever position display and fuel remaining display are not displayed.

5

- 1- Information display → P.5-63
 2- Selector lever position display* → P.5-41

Information display

N00574800015

Each time you lightly press the multi-information display switch (A), the display switches in the following order.

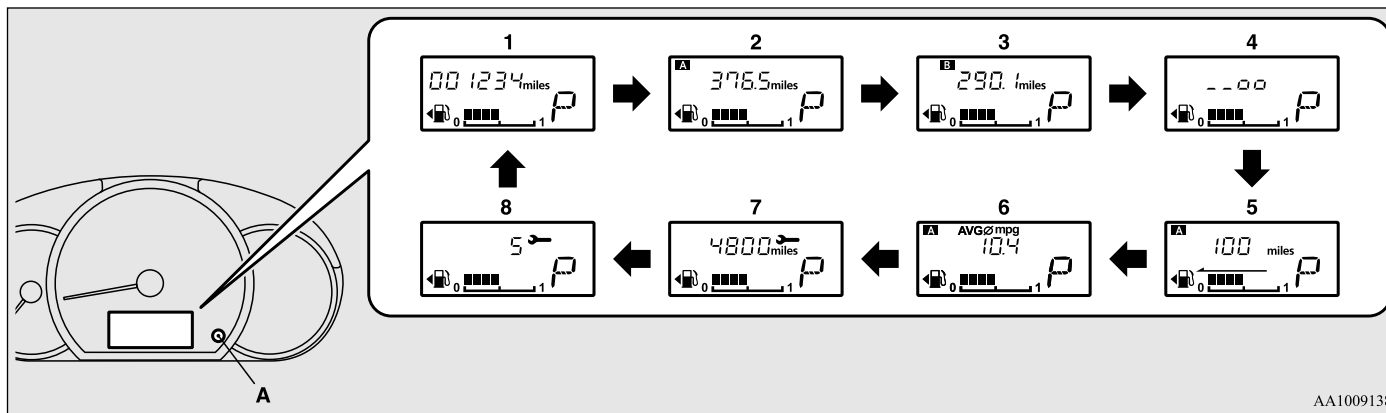

AA1009138

- 1- Odometer → P.5-64
- 2- Trip odometer **A** → P.5-64
- 3- Trip odometer **B** → P.5-64

- 4- Instrument panel light dimmer control → P.5-65
- 5- Driving range display → P.5-65
- 6- Average fuel consumption display → P.5-66

- 7- Service reminder (distance) → P.5-67
- 8- Service reminder (month) → P.5-67

NOTE

- When the ignition switch or the operation mode is in OFF, the driving range display and average fuel consumption display are not displayed.
- While driving, the service reminder is not displayed even if you operate the multi-information display switch.

Odometer

N00574900016

The odometer indicates the total distance the vehicle has traveled.

Trip odometer

N00575000014

The trip odometer indicates the distance traveled between two points.

Usage examples for trip odometer **A**, trip odometer **B**

It is possible to measure two currently traveled distances, from home using trip odometer **A** and from a particular point on the way using trip odometer **B**.

To reset the trip odometer

To return the display to 0, hold down the multi-information display switch for about 1 second or more. Only the currently displayed value will be reset.

Example

If trip odometer **A** is displayed, only trip odometer **A** will be reset.

NOTE

- Both trip odometers **A** and **B** can count up to 9999.9 miles/kilometers. When a trip odometer goes past 9999.9 miles/kilometers, it returns to 0.0 miles/kilometers.
- When disconnecting the battery terminal, the memories of trip odometer displays **A** and **B** are cleared, and their displays return to "0.0 miles/kilometers".

Instrument panel light dimmer control

N00575100015

Each time you press the multi-information display switch (2), there is a sound and the brightness of the instrument panel lights changes.

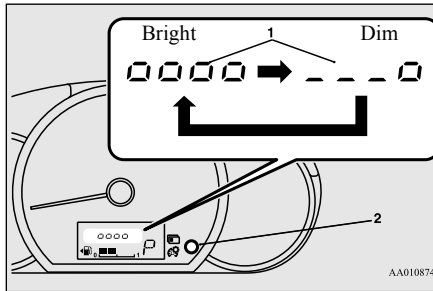

- Brightness level
- Multi-information display switch

NOTE

- You can adjust to 8 different levels for when the parking lights or headlights are illuminated and 8 for when they are not. Each time you reduce two brightness levels, the segment display of the brightness level decreases one by one.

NOTE

- If you press and hold the switch for longer than about 1 second, the brightness automatically scrolls through its different levels, and stops scrolling when you release the switch. Select your desired level of brightness.
- The brightness level of the instruments is stored when the ignition switch is turned to the "OFF" position or the operation mode is put in OFF.

5

Driving range display

N00575200016

This displays the approximate driving range (how many more miles or kilometers you can drive). When the driving range falls below approximately 30 miles (50 km), "---" is displayed.

NOTE

- The driving range is determined based on the fuel consumption data. This may vary depending on the driving conditions and habits. Treat the distance displayed as just a rough guideline.
- When you refuel, the driving range display is updated. However, if you only add a small amount of fuel, the correct value will not be displayed. Fill to a full tank whenever possible.

NOTE

- When your vehicle is stopped on an extremely steep hill, the driving range value may, change. This is due to the movement of fuel in the tank and does not indicate any breakdown.
- The display setting can be changed to the preferred units (miles or km). Refer to “Changing the function settings” on page 5-68.

Average fuel consumption display

N00575300017

This displays the average fuel consumption from the last reset to the present.

The reset mode conditions for the average fuel consumption display can be switched between “Auto reset” and “Manual reset”.

For information on how to change the average fuel consumption display setting, refer to “Changing the function settings” on page 5-68.

NOTE

- The average fuel consumption display can be reset separately in both auto reset mode and manual reset mode.
- “---” is displayed when the average fuel consumption cannot be measured.

NOTE

- The initial (default) setting is “Auto reset mode”.
- Average fuel consumption may vary depend on the driving conditions (road conditions, how you drive, etc).
The actual fuel consumption may differ from the fuel consumption displayed, so treat the fuel consumption displayed as just a rough guideline.
- Disconnecting the battery cable will erase from memory the manual reset mode or auto reset mode setting for the average fuel consumption display.
- The display setting can be changed to the preferred units {mpg, km/L, L/100 km}. Refer to “Changing the function settings” on page 5-68.

Fuel remaining display

N00575400018

The fuel remaining display indicates the fuel level in the fuel tank when the ignition switch or the operation mode in ON.

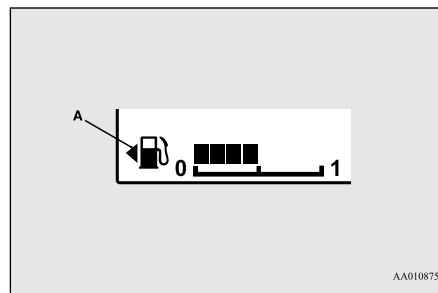

- 1- Full
- 0- Empty

NOTE

- It may take several seconds to stabilize the display after refilling the tank.
- If fuel is added with the ignition switch or the operation mode in ON, the remaining fuel display may incorrectly indicate the fuel level.
- The fuel lid mark (A) indicates that the fuel tank filler door is located on the left side of the vehicle. (Refer to “Filling the fuel tank” on page 3-3.)

Fuel remaining warning display

When the remaining fuel level runs low (one segment is displayed), the last segment of the fuel gauge flashes when the ignition switch is

turned to the “ON” position or the operation mode is changed to ON.

When the remaining fuel level very runs low (no segments displayed), “

If the warning display appears, refuel as soon as possible.

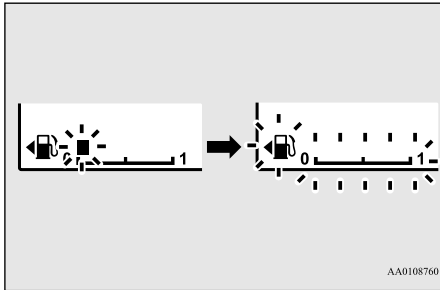

NOTE

- On hills or curves, the display may be incorrect due to the movement of fuel in the tank.

CAUTION

- Running out of gas could damage the catalytic converter. If the warning display appears, refuel as soon as possible.

Service reminder

N00556701266

Displays the approximate time until the next recommended periodic inspection. “---” is displayed when the inspection time has arrived.

NOTE

- The service reminder time can be modified by an authorized Mitsubishi Motors dealer, to adjust for severe usage, etc. Refer to “Severe maintenance schedule” in your vehicle’s Warranty and Maintenance Manual. For further information, please contact your authorized Mitsubishi Motors dealer.

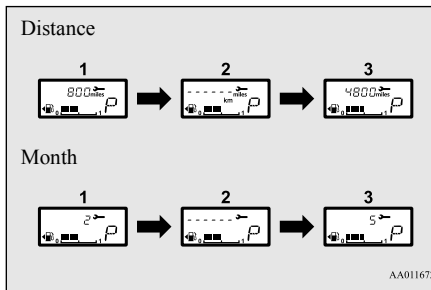

1. Shows the time until the next periodic inspection.

NOTE

- Shows the distance in units of 100 miles (100 km) and the time in units of 1 month.

2. This informs you that a periodic inspection is due. Contact an authorized Mitsubishi Motors dealer or a repair facility of your choice to have the system checked.
3. After your vehicle is inspected at an authorized Mitsubishi Motors dealer, it displays the time until the next periodic inspection.

NOTE

- When the next periodic inspection is approaching, the spanner mark will be displayed whenever the ignition switch is turned from the “LOCK” position to the “ON” position or when the operation mode is changed from OFF to ON.

The spanner mark will continuously be displayed, even on non-service reminder displays (odometer, trip meter, etc.), until the service reminder is reset.

When the service reminder resets, the spanner mark will not be displayed until the next periodic inspection.

To reset

The “---” display can be reset while the ignition switch or the operation mode is in OFF.

1. When you lightly press the multi-information display switch a few times, the information display switches to the service reminder display.

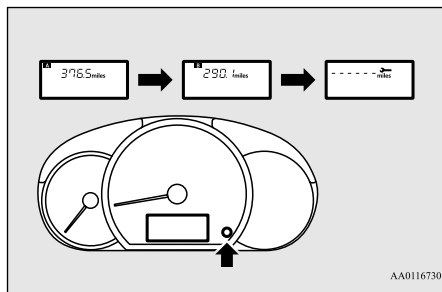

2. Press and hold the multi-information display switch for about 1 second or more to make the spanner mark start flashing. (If there is no operation for about 10 seconds with flashing, the display will revert to its original indication.)

3. With this indicator flashing, if you lightly press the multi-information meter switch, the display switches from “---” to “cLEAR”. After that, the time until the next periodic inspection is shown.

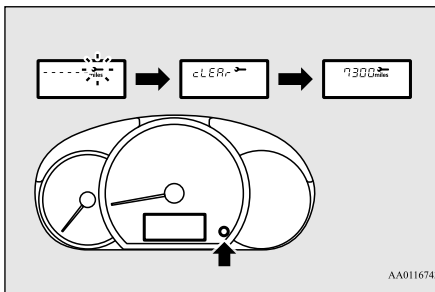

CAUTION

- The customer is responsible for making sure that regular inspections and maintenance and periodic inspections and maintenance are performed. Inspections and maintenance must be performed to prevent accidents and malfunctions.

NOTE

- The “---” display cannot be reset while the ignition switch or the operation mode is in ON.

NOTE

- When “---” is displayed, after a certain distance and a certain period of time, the display is reset and the time until the next periodic inspection is displayed.
- If you accidentally reset the display, consult an authorized Mitsubishi Motors dealer for assistance.

Changing the function settings

N00556800143

When the ignition switch or the operation mode is in ON, the fuel consumption unit, displayed in the multi-information display, and the average fuel consumption reset mode can be modified as desired.

CAUTION

- The driver should not operate the display while the vehicle is in motion.
- When operating the system, stop the vehicle in a safe area.

Changing the reset mode for average fuel consumption

N00575500019

You can change the mode condition for the average fuel consumption display to “Auto reset” or “Manual reset”.

- When you lightly press the multi-information display switch a few times, the information display switches to the driving range display.
Refer to “Information display” on page 5-63.
- Each time you press the multi-information display switch for 1 second or more on driving range display, you can switch reset mode for average fuel consumption.
(A: Auto reset mode, B: Manual reset mode)

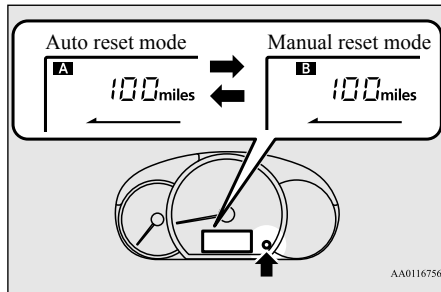

Manual reset mode

- When the average fuel consumption is being displayed, if you hold down the multi-information display switch, these calculations will be reset to zero.
- When the following operation is performed, the mode setting changes automatically from manual to auto.

[Except for vehicles equipped with the F.A.S.T.-key]

Turn the ignition switch to the “ON” position from the “ACC” or “OFF” position.

[For vehicles equipped with the F.A.S.T.-key]

Change the operation mode to ON from ACC or OFF.

Auto reset mode

- When the average fuel consumption is being displayed, if you hold down the multi-information display switch, these calculations will be reset to zero.
- When the engine switch or the operation mode is in the following conditions, the average fuel consumption display will automatically reset.

[Except for vehicles equipped with the F.A.S.T.-key]

The ignition switch has been set to the “ACC” or “OFF” position for about 4 hours or more.

[For vehicles equipped with the F.A.S.T.-key]

The operation mode has been set to ACC or OFF for about 4 hours or more.

NOTE

- The average fuel consumption display can be reset separately for the auto reset mode and for the manual reset mode.
- Disconnecting the battery cable will erase from memory the manual reset mode or auto reset mode setting for the average fuel consumption display.
- The initial (default) setting is “Auto reset mode”.

Changing the fuel consumption display unit

N00557100156

The fuel consumption display unit can be changed. The distance and amount units are also switched to match the selected fuel consumption unit.

- When you lightly press the multi-information display switch a few times, the information display switches to the average fuel consumption display.
Refer to “Information display” on page 5-63.
- Press and hold the multi-information display switch for about 5 seconds or more until buzzer sound is heard twice.

Indicator and warning light package

3. Press and hold the multi-information display switch to switch in sequence from “km/L” → “L/100 km” → “mpg” → “km/L”.

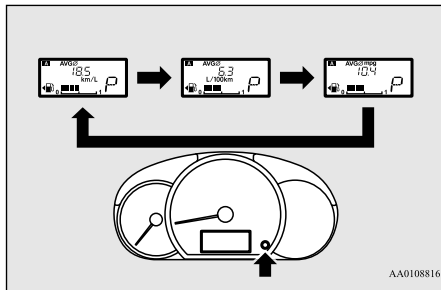

NOTE

- The display units for the driving range, the average fuel consumption are changed, but the units for the indicating needle (speedometer), the odometer, the trip odometer and the service reminder will remain unchanged.
- If the battery is disconnected, the memory of the unit setting is erased and it returns automatically to factory setting.

Fuel consumption	Distance (driving range)
km/L	km
L/100 km	km
mpg	mile (s)

The distance units is also changed in the following combinations to match the selected fuel consumption unit.

Indicator and warning light package

N00519800849

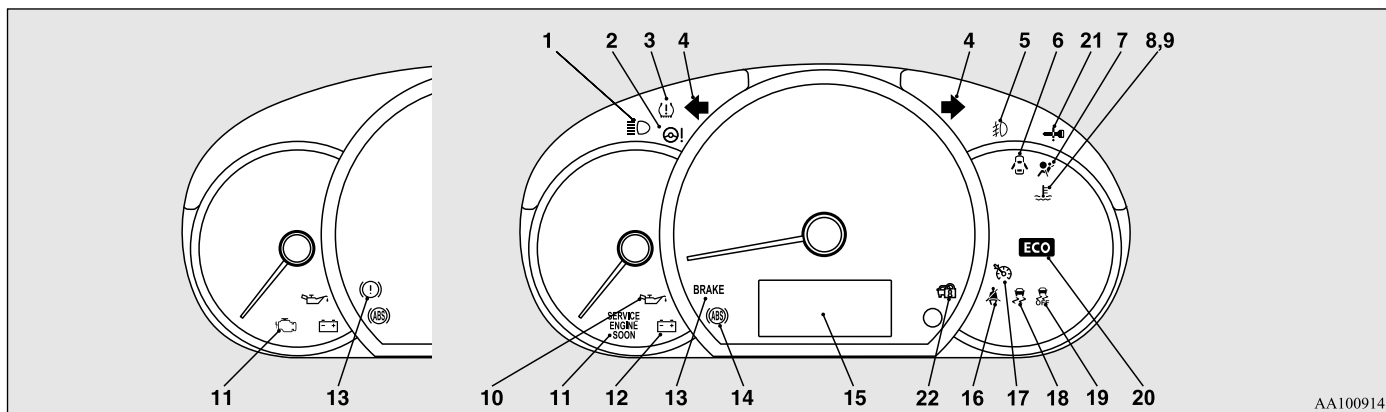

- 1- High beam indicator → P.5-71
- 2- Electric power steering system warning light → P.5-48
- 3- Tire pressure monitoring system warning light (if so equipped) → P.5-57
- 4- Turn signal indicators/Hazard warning lights → P.5-71
- 5- Front fog light indicator (if so equipped) → P.5-71
- 6- Door-ajar warning light → P.5-74
- 7- Supplemental Restraint System (SRS) warning light → P.4-27
- 8- High coolant temperature warning light (red) → P.5-73
- 9- Low coolant temperature indicator (green) → P.5-71
- 10- Oil pressure warning light → P.5-73
- 11- Engine malfunction indicator (“SERVICE ENGINE SOON” or “Check engine light”) → P.5-72
- 12- Charging system warning light → P.5-73
- 13- Brake warning light → P.5-72
- 14- Anti-lock braking system warning light → P.5-47
- 15- Multi-information display → P.5-62
- 16- Driver’s seat belt reminder/warning light → P.4-11
- 17- Cruise control indicator (if so equipped) → P.5-52
- 18- Active stability control (ASC) indicator/warning light → P.5-51, 5-51

- 19- Active stability control (ASC) OFF indicator/warning light → P.5-51, 5-51
- 20- ECO indicator → P.5-71
- 21- For details, refer to “Warning activator” on page 5-15 (if so equipped)
- 22- For details, refer to “Warning activator” on page 5-15 (if so equipped)

Indicators

N00519900127

Turn signal indicators/Hazard warning lights

N00520000216

The arrows will flash in time with the corresponding exterior turn signals when the turn signal lever is used.

Both arrows will flash when the hazard warning flasher switch is pressed.

NOTE

- If the indicator flashes faster than usual or if the indicator stays on without flashing, check for a malfunctioning turn signal light bulb or turn signal connection.

High beam indicator

N00520100086

A blue light comes on when the headlights are on high beam.

Front fog light indicator (if so equipped)

N00520200175

This indicator comes on while the front fog lights are on.

Low coolant temperature indicator - green

N00575600010

This indicator comes on in green while the coolant temperature is low.

NOTE

- When the indicator goes out, this should be used as a rough indication of when the heating starts working.

ECO indicator

N00568800036

This indicator comes on while fuel-efficient driving is achieved.

Warning lights

N00520300147

Brake warning light and buzzer

N00520400526

5

This light comes on when the ignition switch is turned to the “ON” position (engine off) or the operation mode is put in ON.

When the engine is started, the light should go off a few seconds later.

The warning light also illuminates after starting the engine under the following conditions.

- When the parking brake is still applied.
- When the brake fluid level is low.
- When the brake system circuit is not working properly.

When the vehicle is moving at more than 5 mph (8 km/h) and the parking brake applied, a buzzer will sound to inform the driver that the parking brake is not properly release.

Before driving, be sure that the parking brake is fully released and the brake warning light is off.

CAUTION

● If the brake warning light and the Anti-lock braking system warning light are illuminated at the same time, the braking force distribution function will not operate, the vehicle may be destabilized during sudden braking under the following conditions.

- When the brake warning light does not go out even when the parking brake is released.
- When the brake warning light stays on while driving.

If the above occurs, avoid sudden braking and high-speed driving. Park the vehicle in a safe place, and contact an authorized Mitsubishi Motors dealer or a repair facility of your choice as soon as possible.

- The vehicle should be brought to a halt in the following manner when brake performance is deteriorated.
 - Confirm that the vehicle slows down when you press down on the brake pedal harder than usual. In some cases, the brake pedal may go all the way to the floor.
 - Should the brakes fail, use engine braking to reduce your speed and slowly apply the parking brake. Depress the brake pedal to illuminate the stop lights and to alert the vehicles behind you.

Engine malfunction indicator (“SERVICE ENGINE SOON” or “Check engine light”)

N00520500804

This indicator is a part of the onboard diagnostic (OBD) system which monitors the emissions, engine control system or continuously variable transmission (CVT) control system. If a problem is detected in one of these systems, this indicator illuminates or flashes. When the ignition switch is turned to the “ON” position or the operation mode is put in ON, this indicator normally comes on and goes off after the engine has started.

This indicator will come on if the fuel tank filler cap is not properly tightened. If this indicator comes on and stays on after refueling, stop the engine and check that the cap is properly tightened. (Turn the cap clockwise until you hear clicking sounds.)

If this indicator does not go off after several seconds or lights up while driving, have the system checked as soon as possible at an authorized Mitsubishi Motors dealer or a repair facility of your choice.

⚠ CAUTION

- Driving for a long time with the engine malfunction indicator on may cause more damage to the emission control system. This could also affect fuel economy and drivability.
- If this indicator does not come on when the ignition switch is turned to the “ON” position or the operation mode is put in ON, have the system checked at an authorized Mitsubishi Motors dealer or a repair facility of your choice.
- If the engine malfunction indicator comes on while the engine is running, avoid driving at high speeds.
During vehicle operation with the indicator on, the vehicle may not accelerate when you depress the accelerator pedal.
When the vehicle is stationary with the indicator on, you must depress the brake pedal more firmly than usual since the engine idling speed is higher than usual and a vehicle with a CVT has a stronger tendency to creep forward.

📖 NOTE

- Do not disconnect the battery cable when the engine malfunction indicator (“SERVICE ENGINE SOON” or “Check engine light”) is on.
The engine electronic control module stores critical OBD information (especially exhaust emission data), which may be lost if the battery cable is disconnected while the engine malfunction indicator is on. This will make it difficult to diagnose the cause of future problems.

Charging system warning light

N00520600313

This light comes on in the event of a malfunction in the charging system or when the ignition switch is turned to the “ON” position (engine off) or the operation mode is put in ON. When the engine is started, the light should go out. Check to make sure that the light has gone out before driving.

⚠ CAUTION

- If the warning light stays on while the engine is running, park your vehicle in a safe place as soon as possible and contact an authorized Mitsubishi Motors dealer or a repair facility of your choice to have the system checked.

Oil pressure warning light

N00520700170

This light comes on when the engine oil pressure is below normal. If the light stays on while driving, stop the engine as soon as possible. Do not run the engine until the cause of the low oil pressure is corrected.

⚠ CAUTION

- If this light comes on when the engine oil level is not low, have your vehicle checked at an authorized Mitsubishi Motors dealer or a repair facility of your choice.
- This warning light does not show the amount of oil in the crankcase. This can only be determined by checking the oil level with the dipstick with the engine turned off.

High coolant temperature warning light - red

N00575700011

This light comes on in red if the coolant temperature becomes excessively high.

CAUTION

- If the light comes on during vehicle operation, it indicates that the engine is possibly overheating. Continued driving could make the engine fail. Immediately stop the vehicle in a safe place and take appropriate action. (Refer to “Engine overheating” on page 8-4.)

CAUTION

- Before driving, make sure that the door-ajar warning light is off.

NOTE

- When the auto cut-out function of the doom light is been activated, the light goes out automatically after about 30 minutes. Refer to “Dome light” on page 5-106.

NOTE

- The high coolant temperature warning light may illuminate when the vehicle has been driven at high speeds or on hilly roads. This illuminating does not necessarily indicate a problem. It should stop if you keep the engine running for a while or continue driving the vehicle.

Combination headlights and dimmer switch

N00522500736

Headlights

Rotate the switch to operate the lights.

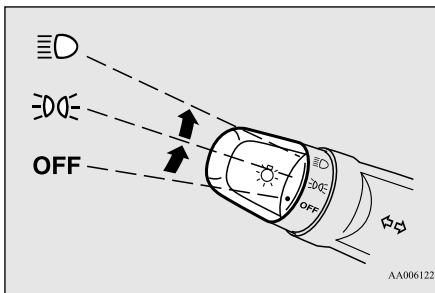

The combinations of switch operations and illuminated lights differ in accordance with the following conditions.

Except for vehicles equipped with daytime running lights

OFF	All lights off
☰☐☐	Parking, tail, front and rear side-marker lights, license plate and instrument panel lights on
☰☐	Headlights and other lights on

Vehicles equipped with daytime running lights

[When the engine is started, and the parking brake is released]

The daytime running lights will be illuminated:

OFF	The daytime running lights illuminated
☰☐☐	The daytime running lights illuminated Parking, tail, front and rear side-marker lights, license plate and instrument panel lights on
☰☐	Headlights and other lights on

Door-ajar warning light and buzzer

N00520900329

This light comes on when any door or the liftgate is open or not completely closed. When the vehicle is moving at more than 5 mph (8 km/h) and any door or the liftgate is open or ajar, a tone will sound 4 times to inform the driver that any door or the liftgate is not properly shut.

NOTE

- Once the daytime running light come on, they do not go out until the ignition switch is turned to the “OFF” or “ACC” position or the operation mode is changed to OFF or ACC.

[When the engine is not running, or when the engine is running but the parking brake is not released]

The engine starts when the lights are off.

OFF	All lights off
	Parking, tail, front and rear side-marker lights, license plate and instrument panel lights on
	Headlights and other lights on

NOTE

- Do not leave the headlights and other lights on for a long period of time when the engine is not running. The battery will run down.

NOTE

- When it rains, or when the vehicle has been washed, the inside of the lens sometimes becomes foggy. This is the same as when window glass mists up on a humid day, and does not indicate a problem. When the light is switched on, the heat will dry out the fog. However, if water collects inside the light, have it checked by an authorized Mitsubishi Motors dealer or a repair facility of your choice.

Light auto-cutout function (headlights and other lights)

N00532600570

- If the following operation is performed with the combination headlights and dimmer switch in the “ ” or “ ” position, the lights automatically turn off.

[Except for vehicles equipped with the F.A.S.T.-key]

The ignition switch is turned to the “OFF” or “ACC” position or the key is removed from the ignition switch and the driver’s door is opened.

[For vehicles equipped with the F.A.S.T.-key]

The operation mode is changed to OFF or ACC and the driver’s door is opened.

- If the following operation is performed with the combination headlights and dimmer switch in the “ ” or “ ” position, the lights automatically turn off after about 3 minutes.

[Except for vehicles equipped with the F.A.S.T.-key]

The ignition switch is turned to the “OFF” or “ACC” position or the key is removed from the ignition switch and the driver’s door is not opened.

[For vehicles equipped with the F.A.S.T.-key]

The operation mode is changed to OFF or ACC and the driver’s door is not opened.

NOTE

- The light auto-cutout function can be deactivated. See your authorized Mitsubishi Motors dealer for details.

When you want to keep the lights on:

If the combination headlights and dimmer switch is turned to the “ ” or “ ” position again after the engine is turned off, the about 3-minute auto-cutout function



Turn signal lever

described above will not work. The lights (the parking lights, tail lights and license plate lights) will stay on and will not turn off automatically.

Headlight reminder buzzer

N00549800226

5

[When using a key to start the engine]

If the driver's door is opened with the key in the "OFF" or "ACC" position or removed from the ignition switch while the lights are on, the tone will sound to remind you to turn off the lights.

[When using the F.A.S.T.-key to start the engine]

If the driver's door is opened with the operation mode is put in OFF or ACC, or if the operation mode is changed to OFF while the lights are on, the tone will sound to remind you to turn off the lights.

In either case, the lights will turn off automatically and so will the tone. Or you can turn the light switch to the "OFF" position to stop the tone.

Dimmer (high/low beam change)

N00549900142

To change the headlights from high beam to low beam and vice versa, pull the turn signal lever to (1). Switch the headlights to low beam as a courtesy whenever there are oncoming vehicles, or when there is traffic moving ahead of you. An illuminated blue light in the instrument cluster indicates when the headlights are on high beam.

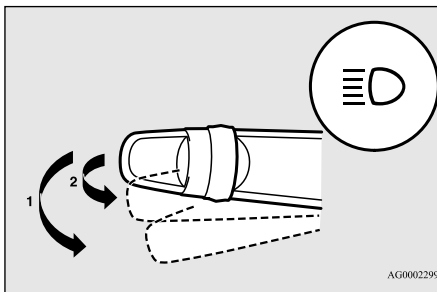

AG0002299

Headlight flasher

N00550000185

You can flash the high beams by pulling the lever gently toward you (2). The lights will go back to normal when you let go. While the high beam is on, you will see a blue light on the instrument panel.



NOTE

- You can flash the high beams by pulling the lever toward you, even if the light switch is off.
- If you turn the lights off with the head lights set to high-beam illumination, the headlights are automatically returned to their low-beam setting when the light switch is next turned to the "D" position.

Turn signal lever

N00522600519

When changing lanes, or to making a gradual turn, hold the lever in the "lane change" position (1). It will return to the neutral position when you let go. Use the full position (2) when making a normal turn. The lever will return to the neutral position when the turn is complete. There may be times when the lever does not return to the neutral position. This usually happens when the steering wheel is turned only slightly. You can easily return the lever by hand.

Also, when you move the lever to (1) slightly then release it, the turn signal lights and the indicator light in the instrument cluster will flash three times.

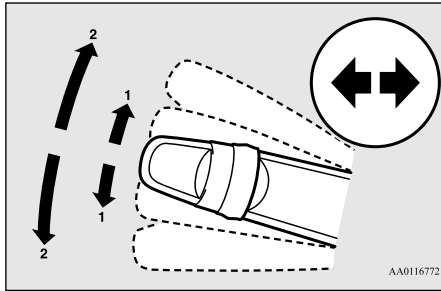

See your authorized Mitsubishi Motors dealer for details.

Hazard warning flasher switch

N00522700318

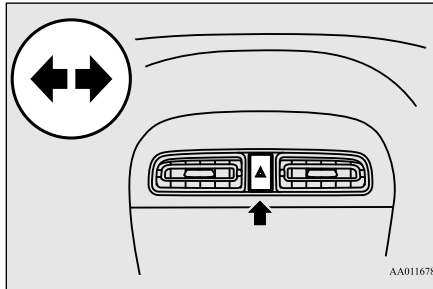

AA0116785

If you press the flasher switch, the turn signals will flash intermittently, and so will the hazard warning lights. This is an emergency warning system and should not be used when the vehicle is in motion, except for emergencies.

If you need to leave your vehicle, the flashers will keep working after the ignition switch is removed or the operation mode is put in OFF.

NOTE

- If the flashers are used for several hours, the battery will run down. This could make it difficult or impossible to restart your vehicle.

Front fog light switch (if so equipped)

N00522800393

The front fog lights illuminate only when the headlights are on low beam.

Turning the knob in the direction of the “ON” position turns on the front fog lights as well as the indicator in the instrument cluster. To turn them off, turn the knob in the direction of the “OFF” position.

The knob will return to the neutral position when it is released.

5

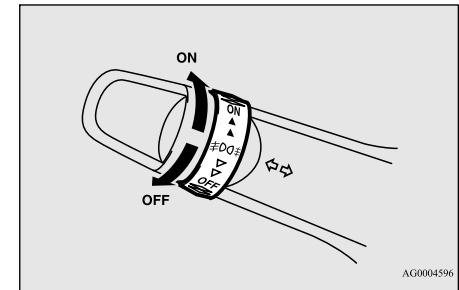

AG0004596

NOTE



- If the headlights are switched to high beam, the front fog lights will go out; they will illuminate again when the headlights are switched back to low beam.

NOTE

- A light in the instrument panel flashes to show when the turn signal lights are working properly. If this light flashes faster than usual, check for a burned out turn signal light bulb or malfunctioning connection in the signal. If the panel light does not come on when the lever is moved, check for a blown fuse or a burned out bulb in the panel. Have the system inspected by your authorized Mitsubishi Motors dealer or a repair facility of your choice.
- It is possible to modify functions as follows:
 - Deactivate the turn signal light 3-flash function for lane changes.
 - Adjust the time required to operate the lever for the 3-flash function.
 - Changing of the tone of a sounding buzzer as the turn signal lights flash.

Wiper and washer switch

NOTE

- If the light switch is rotated to the “OFF” or “” position while the front fog lights are illuminated, they will automatically turn off. They can be turned back on again by rotating the combination headlights and dimmer switch back to “” position, and turning the knob in the direction of the “ON” position.
- Do not use fog lights except in conditions of fog, otherwise excessive light glare may temporarily blind oncoming vehicle drivers.

5

Wiper and washer switch

N00523000666

CAUTION

- If the washer is used in cold weather, the washer fluid sprayed against the glass may freeze, which may hinder visibility. Warm the glass with the defroster before using the washer.

Windshield wipers

The windshield wiper and washer can be operated with the ignition switch or the operation mode is in ON or ACC.

If the blades are frozen to the windshield, do not operate the wipers until the ice has melted

and the blades are freed, otherwise the wiper motor may be damaged.

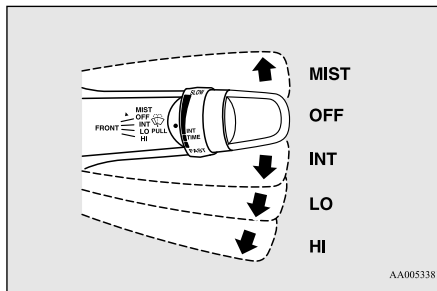

MIST- Misting function

The wipers will operate once.

OFF- Off

INT- Intermittent (Speed sensitive)

LO- Slow

HI- Fast

To adjust intermittent intervals

With the lever in the “INT” (speed sensitive intermittent operation) position, the intermittent intervals can be adjusted by turning the knob (A).

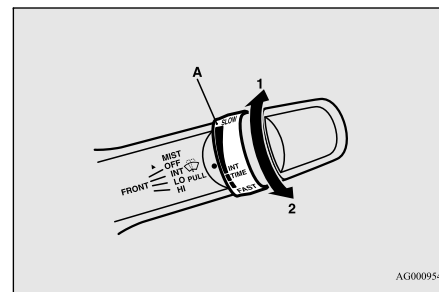

1- Fast

2- Slow

NOTE

- The speed-sensitive-operation function of the windshield wipers can be deactivated. For further information, please contact your authorized Mitsubishi Motors dealer or a repair facility of your choice.

Misting function

The misting function can be used when the ignition switch or the operation mode is in ON or ACC.

The wipers will operate once if the wiper lever is raised to the “MIST” position and released. This operation is useful when it is drizzling, etc. The wipers will continue to operate while the lever is held in the “MIST” position.

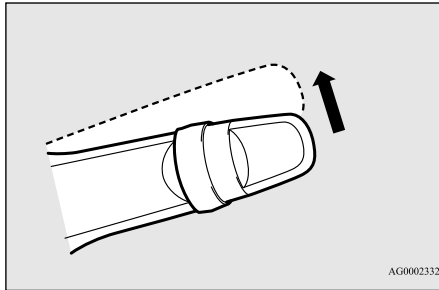

Rear window wiper and washer

N00523200408

The rear window wiper and washer can be operated when the ignition switch or the operation mode is in ON or ACC.

Turn the knob to operate the rear window wiper.

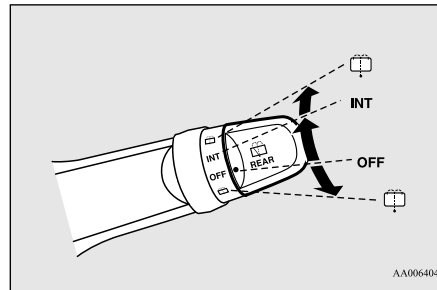

OFF- Off
INT- Intermittent

The wiper operates continuously for several seconds then operates intermittently at intervals of about 8 seconds.



Washer fluid will be sprayed onto the rear window glass while the knob is turned fully in either direction.

When the washer fluid is sprayed, the wiper will automatically operate 2 or 3 times.

Windshield washer

N00504600298

To turn on the windshield washer, pull the lever toward you with the ignition switch or the operation mode is in ON or ACC.

The wipers will wipe automatically several times when the washer fluid is sprayed.

To turn off the spray, release the lever.

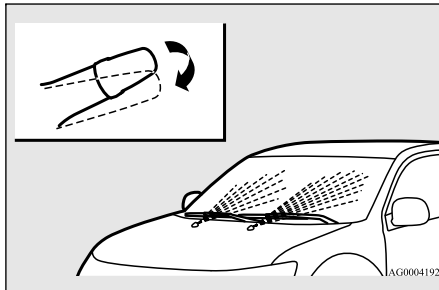

NOTE

- On vehicles with CVT, to ensure a clear rearward view, the wiper perform several continuous operations when the reverse gear is engaged and the switch is in the “INT” position. Following this continuous operation, the wiper will automatically switch to intermittent operation.
- It is possible to modify functions as follows:
 - Adjustment of the interval for intermittent operation.
 - Changing intermittent wiper operation to continuous wiper operation. See your authorized Mitsubishi Motors dealer for details.
- The washer fluid reservoir is located in the engine compartment. Check the fluid level regularly and refill if necessary. (Refer to “Washer fluid” on page 9-9.)

Precautions to observe when using wipers and washers

N00523500254

CAUTION

- If the washer is used in cold weather, washer fluid sprayed onto the glass might freeze, blocking your view. Heat the glass with the defroster before using the washer.

NOTE

- Do not use the wipers when the windshield is dry. This could scratch the glass and wear the wiper blades prematurely.
- Before using the wipers in cold weather, check to be sure that the wiper blades are not frozen to the windshield or rear window. Using the wipers while the blades are frozen could cause the wiper motor to burn out.
- If the wipers are left on the glass out of the parked position and they become blocked by ice or other deposits on the glass, the motor may still burn out even if the wiper switch is OFF. If deposits form on the windshield, park your vehicle in a safe place, turn off the engine, and clean the glass so that the wipers can operate smoothly.
- Avoid using the washer for more than 20 seconds at a time. Do not operate the washer when the washer fluid reservoir is empty or the pump may fail.
- During cold weather, add a recommended washer solution that will not freeze in the washer fluid reservoir. Otherwise the washer may not work or may be damaged.
- Replace the wiper blades when they are worn. Use the proper size replacement blades. For further information, please contact your authorized Mitsubishi Motors dealer.

5

Electric rear window defogger switch

N00523700403

The rear window defogger can be used when the engine is running. The indicator light (A) will come on when you press the electric rear window defogger switch. Electric current will flow through the heating wires on the rear window to help clear away moisture or frost.

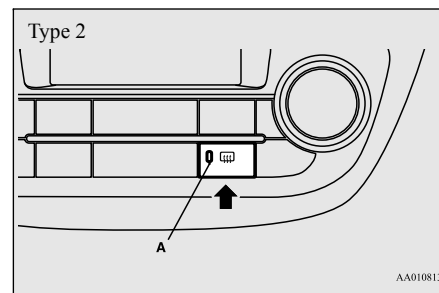
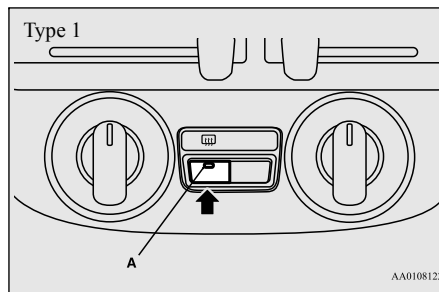

After about 20 minutes of operation, the system will shut off automatically.

To switch the defogger OFF before 20 minutes have passed, press the switch again. The indicator light will go out and the defogger will turn off.

If you need the defogger for more than 20 minutes, press the switch again. This will add 20 more minutes.

CAUTION

- The rear window defogger is not designed to melt snow. Remove any snow manually before using the rear window defogger.
- Use the rear window defogger only after the engine has started and is running. Be sure to turn the defogger switch off immediately after the window is clear to save on battery power.

CAUTION

- Do not place stickers, tape, or other items that are attached with adhesive over the grid wires on the rear window.
- When cleaning the inside rear window, use a soft cloth and wipe lightly over the grid wires.

NOTE

- If your vehicle is equipped with heated mirrors, mist can also be removed from the outside rearview mirrors when the rear window defogger switch is pressed. (Refer to “Door mirror heater” on page 5-34.)

Horn switch

N00523800185

To honk the horn, press around the “” mark on the steering wheel.

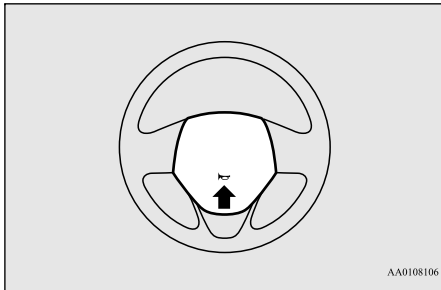

Link System (if so equipped)

N00563700043

The Link System takes control of the devices connected via the USB input terminal or the Bluetooth® 2.0 interface allowing the connected devices to be operated by using the switches in the vehicle or voice commands. See the following section for details on how to operate.

Refer to “Bluetooth® 2.0 interface” on page 5-81.

Refer to “USB input terminal” on page 5-101. Refer to “To play tracks from USB device” on page 7-27.

Refer to “To play tracks from a Bluetooth® device” on page 7-35.

Bluetooth® is a registered trademark of BLUETOOTH SIG, INC.

Link System End User License Agreement

N00563800015

You have acquired a device that includes software licensed by Mitsubishi Motors Corporation from JOHNSON CONTROLS Inc (the automotive experience business unit), and their subsequent 3rd party suppliers. For a complete list of these 3rd party products and



their end user license agreements, please go to the following website.
<http://www.jciblueconnect.com/faq/fulldisclosure.pdf>

Bluetooth® 2.0 interface (if so equipped)

N00563901257

For vehicles equipped with Mitsubishi Multi Entertainment System (MMES)

For information on operations for vehicles equipped with the Mitsubishi Multi Entertainment System (MMES), refer to the separate owner’s manual for details.

Except for vehicles equipped with Mitsubishi Multi Entertainment System (MMES)

The Bluetooth® 2.0 interface allows for making/receiving hands-free calls in the vehicle using a cellular phone compatible with a wireless communication technology commonly known as Bluetooth®. It also allows the user to play music, saved in a Bluetooth® music player, through the vehicle’s speakers. The system is equipped with a voice recognition function, which allows you to make hands-free calls by simple switch and voice

Bluetooth® 2.0 interface (if so equipped)

command operations using a defined voice tree.

The Bluetooth® 2.0 interface can be used when the ignition switch or the operation mode is in ON or ACC.

5 Before you can use the Bluetooth® 2.0 interface, you must pair the Bluetooth® device and Bluetooth® 2.0 interface. Refer to “Connecting the Bluetooth® 2.0 interface and Bluetooth® device” on page 5-87.

Bluetooth® is a registered trademark of BLUETOOTH SIG, INC.

WARNING

- **Although the Bluetooth® 2.0 interface allows you to make hands-free calls, if you choose to use the cellular phone while driving, you must not allow yourself to be distracted from the safe operation of your vehicle. Anything, including cellular phone usage, that distracts you from the safe operation of your vehicle increases your risk of an accident.**
- **Refer to and comply with all state and local laws in your area regarding cellular phone usage while driving.**

NOTE

- For vehicles equipped with the F.A.S.T.-key, if the operation mode is left in ACC, the accessory power will automatically turn off after a certain period of time and you will no longer be able to use the Bluetooth® 2.0 interface. The accessory power comes on again if the engine switch is operated. Refer to “ACC power auto-cutout function” on page 5-14.
- The Bluetooth® 2.0 interface cannot be used if the Bluetooth® device has a dead battery or the device power is turned off.
- Hands-free calls will not be possible if your phone does not have service available.
- If you place the Bluetooth® device in the cargo area, you may not be able to use the Bluetooth® 2.0 interface.
- Some Bluetooth® devices are not compatible with the Bluetooth® 2.0 interface.
- You can confirm the Link System software version by pressing the HANG-UP button 3 times (press and hold 2 times and then press briefly) within 10 seconds.

NOTE

- For detail of the Bluetooth® 2.0 interface, refer to the following website:
[For vehicles sold in U.S.A.]
You can access the Mitsubishi Motors North America website.
[For vehicles sold in Canada]
You can access the Mitsubishi Motors website.
Please read and agree to the “Warning about Links to the Web Sites of Other Companies”, the websites mentioned above may connect you to websites other than the Mitsubishi Motors website.
<http://www.mitsubishi-motors.com/en/products/index.html>
- Software updates by cellular phone/digital audio device manufacturers may change/alter device connectivity.

Steering control switch and microphone → P.5-83

Voice recognition function → P.5-84

Useful voice commands → P.5-85

Speaker enrollment function → P.5-86

Connecting the Bluetooth® 2.0 interface and the Bluetooth® device → P.5-87

Operating a music player connected via Bluetooth® → P.5-91

How to make or receive hands-free calls → P.5-91

Phonebook function → P.5-94

Steering control switch and microphone

N00564000072

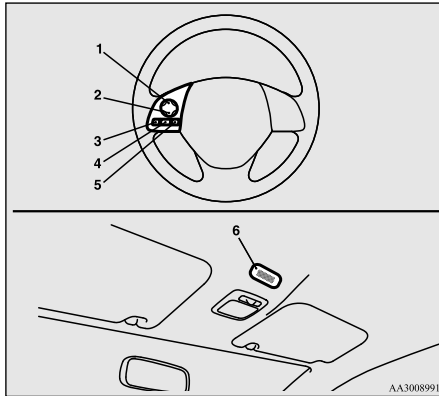

- 1- Volume up button
- 2- Volume down button
- 3- SPEECH button
- 4- PICK-UP button
- 5- HANG-UP button
- 6- Microphone

Volume up button

Press this button to increase the volume.

Volume down button

Press this button to decrease the volume.

SPEECH button

- Press this button to change to voice recognition mode.

While the system is in voice recognition mode, “Listening” will appear on the audio display.

- If you press the button briefly while in voice recognition mode, it will interrupt prompting and allow voice command input.

Pressing the button longer will deactivate the voice recognition mode.

- Pressing this button briefly during a call will enable voice recognition and allow voice command input.

PICK-UP button

- Press this button when an incoming call is received to answer the telephone.
- When another call is received during a call, press this button to put the first caller on hold and talk to the new caller.

- In such circumstances, you can press the button briefly to switch between callers. You will switch to the first caller and the other caller will be put on hold.
- To establish a three-way call in such situations, press the SPEECH button to enter voice recognition mode and then say “Join calls.”

HANG-UP button

- Press this button when an incoming call is received to refuse the call.
- Press this button during a call to end the current call. When another call is on hold, you will switch to that call.
- If this button is pressed in the voice recognition mode, the voice recognition mode will be deactivated.

NOTE

- When you press the SPEECH button to enter voice recognition mode with a cellular phone paired to the system, current information on the cellular phone, such as “remaining battery life,” “signal strength” or “roaming,” will be displayed on the audio display.*
- *: Some cellular phones will not send this information to the Bluetooth® 2.0 interface.

 **NOTE**

- Call waiting and three-way calls can be used by the Bluetooth® 2.0 interface, only if it is possible to use those services with your cellular phone.

5

Microphone

Your voice will be recognized by a microphone in the overhead console, allowing you to make hands-free calls with voice commands.

 **NOTE**

- If a cellular phone is within close proximity of the microphone, it may distort the sound quality. In this case, place the cellular phone as far as possible from the microphone.

Voice recognition function

N00564100086

The Bluetooth® 2.0 interface is equipped with a voice recognition function.

Simply say voice commands and you can perform various operations and make or receive hands-free calls.

With the Bluetooth® 2.0 interface, voice recognition is possible for US English, North

American Spanish, Canadian French and Japanese. The factory setting is “English.”

 **NOTE**

- If the voice command that you say differs from the predefined command or cannot be recognised due to ambient noise or some other reason, the Bluetooth® 2.0 interface will ask you for the voice command again up to 3 times.
- For best performance and further reduction of ambient noise, the vehicle windows should be closed, lower the blower speed and refrain from conversation with your passengers while engaging the voice recognition function.
- Some voice commands have alternative commands.
- Depending on the selected language, some functions may not be available.
- Language can be changed by using the audio control panel besides the following procedure.
For details, refer to “To change the language (vehicles with Bluetooth® 2.0 interface)” on page 7-25.

Selecting the language

1. Press the SPEECH button.
2. Say “Setup.”
3. Say “Language.”

4. The voice guide will say “Select a language: English, Spanish, French or Japanese.” Say the desired language. (Example: “English”)

5. The voice guide will say “English (Spanish, French or Japanese) selected. Is this correct?” Say “Yes.”

If you say “No,” the system will return to Step 4.

 **NOTE**

- The voice guide will repeat the same message twice. The first message is in the current language, and the second message is in the selected language.
- If many entries are registered in the vehicle phonebook, changing the language will take a longer time.
- Changing the language deletes the mobile phonebook imported to the Bluetooth® 2.0 interface. If you wish to use it, you will have to import it again.

6. When the voice guide says “English (Spanish, French or Japanese) selected,” the language change process will be completed and the system will return to the main menu.

Useful voice commands

N00564200016

Help function

N00564300017

The Bluetooth® 2.0 interface is equipped with a help function.

If you say “Help” when the system is waiting for a voice command input, the system will tell you a list of the commands that can be used under the circumstances.

Canceling

N00564400018

There are 2 cancel functions.

If you are at the main menu, say “Cancel” to exit from the Bluetooth® 2.0 interface.

If you are anywhere else within the system, say “Cancel” to return to the main menu.

Confirmation function setting

N00564500019

The Bluetooth® 2.0 interface is equipped with a confirmation function.

With the confirmation function activated, you are given more opportunities than normal to confirm a command when making various settings to the Bluetooth® 2.0 interface. This

allows you to decrease the possibility that a setting is accidentally changed.

The confirmation function can be turned on or off by following the steps below.

1. Press the SPEECH button.
2. Say “Setup.”
3. Say “Confirmation prompts.”
4. The voice guide will say “Confirmation prompts are <on/off>. Would you like to turn confirmation prompts <off/on>.” Answer “Yes” to change the setting or answer “No” to keep the current setting.
5. The voice guide will say “Confirmation prompts are <off/on>” and then the system will return to the main menu.

Security function

N00564600023

It is possible to use a passcode as a security function by setting a passcode of your choice for the Bluetooth® 2.0 interface.

When the security function is turned on, it is necessary to make a voice input of a 4-digit passcode in order to use all functions of the Bluetooth® 2.0 interface, except for reception.

Setting the passcode

Use the following procedure to turn on the security function by setting a passcode.

1. Press the SPEECH button.
2. Say “Setup.”
3. Say “Passcode.”
4. The voice guide will say “Passcode is disabled. Would you like to enable it?” Answer “Yes.” Answer “No” to cancel the setting of the passcode and return to the main menu.
5. The voice guide will say “Please say a 4-digit passcode. Remember this passcode. It will be required to use this system.” Say a 4-digit number which you want to set as a passcode.
6. For confirmation purposes, the voice guide will say “Passcode <4-digit passcode>. Is this correct?” Answer “Yes.” Answer “No” to return to the passcode input in Step 5.
7. When the registration of the passcode is completed, the voice guide will say “Passcode is enabled” and the system will return to the main menu.

NOTE

- Passcode will be required to access the system after the next ignition cycle.

NOTE

- It is required for a little time after engine stop that the entered passcode is actually recorded in the system.
If the ignition switch or the operation mode is made to ACC or ON or the engine is started immediately after engine stop, there is a case when the entered passcode is not recorded in the system. At this time, please try to enter the passcode again.

Entering the passcode

If a passcode has been set and the security function is enabled, the voice guide will say “Hands-free system is locked. State the passcode to continue” when the SPEECH button is pressed to enter voice recognition mode. Say the 4-digit passcode number to enter the passcode.

If the entered passcode is wrong, the voice guide will say “<4-digit passcode>, Incorrect passcode. Please try again.” Enter the correct passcode.

NOTE

- You can reenter the passcode as many times as you want.
- If you have forgotten your passcode, say “Cancel” to quit the voice input mode and then check with an authorized Mitsubishi Motors dealer.

Disabling the passcode

Use the following procedure to turn off the security function by disabling the passcode.

NOTE

- System must be unlocked to disable the passcode.

1. Press the SPEECH button.
2. Say “Setup.”
3. Say “Passcode.”
4. The voice guide will say “Passcode is enabled. Would you like to disable it?” Answer “Yes.”
Answer “No” to cancel the disabling of the passcode and return to the main menu.
5. When the disabling of the passcode is completed, the voice guide will say “Passcode is disabled” and the system will return to the main menu.

Speaker enrollment function

N00564700011

The Bluetooth® 2.0 interface can use the speaker enrollment function to create a voice model for one person per language.

This makes it easier for the Bluetooth® 2.0 interface to recognise voice commands said by you.



You can turn a voice model registered with the speaker enrollment function on and off whenever you want.

Speaker enrollment

N00564800038

It takes about 2 to 3 minutes to complete the speaker enrollment process.

To ensure the best results, run through the process while in the driver’s seat, in an environment that is as quiet as possible (when there is no rain or strong winds and the vehicle windows are closed). Please turn off your phone while in speaker enrollment to prevent interruption of the process.

Use the following procedure for speaker enrollment.

1. Stop your vehicle in a safe area, put the gearshift lever in the “N” (Neutral) position (manual transaxle), or the selector lever in the “P” (PARK) position (continuously variable transmission (CVT)), and pull the parking brake lever.

NOTE

- Speaker enrollment is not possible unless the vehicle is parked. Make sure you park the vehicle in a safe area before attempting speaker enrollment.

2. Press the SPEECH button.

3. Say “Voice training.”
4. The voice guide will say “This operation must be performed in a quiet environment while the vehicle is stopped. See the owner’s manual for the list of required training phrases. Press and release the SPEECH button when you are ready to begin. Press the HANG-UP button to cancel at any time.”
Press the SPEECH button to start the speaker enrollment process.

NOTE

- If you do not start the speaker enrollment process within 3 minutes after pressing the SPEECH button, the speaker enrollment function will time out.
The voice guide will say “Speaker enrollment has timed out.” The system will then beep and the voice recognition mode will be deactivated.

5. The voice guide will prompt for phrase 1. Repeat the corresponding phrase listed in table “Enrollment commands” on page 5-101.
The system will register your voice and then move on to the registration of the next command. Continue the process until all phrases have been registered.

NOTE

- To repeat the most recent voice training command, press and release the SPEECH button.
- If you press the HANG-UP button anytime during the process, the system will beep and stop the speaker enrollment process.

6. When all enrollment commands have been read out, the voice guide will say “Speaker enrollment is complete.” The system will then end the speaker enrollment process and return to the main menu.

NOTE

- Completing the speaker enrollment process will turn on the voice model automatically.
- The commands “Help” and “Cancel” will not work in this mode.

Enabling and disabling the voice model and retraining

N00564900055

You can turn a voice model registered with the speaker enrollment function on and off whenever you want.
You can also retrain the system.
Use the following procedure to perform these actions.

1. Press the SPEECH button.



2. Say “Voice training.”
3. If you have completed a speaker enrollment process once already, the voice guide will say either “Enrollment is enabled. Would you like to disable or retrain?” or “Enrollment is disabled. Would you like to enable or retrain?”
4. When enrollment is “enabled,” the voice model is on; when enrollment is “disabled,” the voice model is off. Say the command that fits your needs.
Say “Retrain” to start the speaker enrollment process and recreate a new voice model. (Refer to “Speaker enrollment” on page 5-86.)

5

Connecting the Bluetooth® 2.0 interface and Bluetooth® device

N00565000170

Before you can make or receive hands-free calls or play music using the Bluetooth® 2.0 interface function, you must pair the Bluetooth® device and Bluetooth® 2.0 interface.

 **NOTE**

- Pairing is required only when the device is used for the first time. Once the device has been paired with the Bluetooth® 2.0 interface, all you need is to bring the device into the vehicle next time and the device will connect to the Bluetooth® 2.0 interface automatically (if supported by the device). The device must have Bluetooth® turned ON to connect.

5

Up to 7 Bluetooth® devices can be paired with the Bluetooth® 2.0 interface.

If multiple paired Bluetooth® devices are available in the vehicle, the cellular phone or music player most recently connected is automatically connected to the Bluetooth® 2.0 interface.

You can also change a Bluetooth® device to be connected.

To pair

To pair a Bluetooth® device with the Bluetooth® 2.0 interface, follow the steps below.

1. Stop your vehicle in a safe area, put the gearshift lever in the “N” (Neutral) position (manual transaxle), or the selector lever in the “P” (PARK) position (continuously variable transmission (CVT)), and pull the parking brake lever.

 **NOTE**

- You cannot pair any Bluetooth® device with the Bluetooth® 2.0 interface unless the vehicle is parked. Before pairing a Bluetooth® device with the Bluetooth® 2.0 interface, confirm that the vehicle is parked in a safe location.

2. Press the SPEECH button.
3. Say “Setup.”
4. Say “Pairing Options.”
5. The voice guide will say “Select one of the following: pair, edit, delete, or list.” Say “Pair.”

 **NOTE**

- If 7 devices have already been paired, the voice guide will say “Maximum devices paired” and then the system will end the pairing process. To register a new device, delete one device and then repeat the pairing process.
(Refer to “Selecting a device: Deleting a device” on page 5-89.)

6. The voice guide will say “Please say a 4-digit pairing code.” Say a 4-digit number. When the confirmation function is on, the system will confirm whether the number said is acceptable. Answer “Yes.” Answer “No” to return to pairing code selection.

 **NOTE**

- Some Bluetooth® devices require a specific pairing code. Please refer to the device manual for pairing code requirements.
- The pairing code entered here is only used for the Bluetooth® connection certification. It is any 4-digit number the user would like to select. Remember the pairing code as it needs to be keyed into the Bluetooth® device later in the pairing process. Depending on the connection settings of the Bluetooth® device, this code may have to be entered each time you connect the Bluetooth® device to the Bluetooth® 2.0 interface. For the default connection settings, refer to the instructions for the device.

7. The voice guide will say “Start pairing procedure on the device. See the device manual for instructions.” Enter in the Bluetooth® device the 4-digit number you have registered in Step 6.

NOTE

- Depending on the Bluetooth® device, it may take a few minutes to pair it with the Bluetooth® 2.0 interface.
- If the Bluetooth® 2.0 interface cannot recognize the Bluetooth® device, the voice guide will say “Pairing has timed out” and the pairing process will be cancelled. Confirm that the device you are pairing supports Bluetooth®, and try pairing it again.
- If you enter the wrong number, the voice guide will say “Pairing failed” and the pairing process will be cancelled. Confirm the number is right, and try pairing it again.

8. The voice guide will say “Please say the name of the device after the beep.” You can assign a desired name for the Bluetooth® device and register it as a device tag. Say the name you want to register after the beep.

NOTE

- When the confirmation function is on, after repeating the device tag you have said, the voice guide will ask “Is this correct?” Answer “Yes.” To change the device tag, answer “No” and then say the device tag again.

9. The voice guide will say “Pairing complete,” after which a beep will be played and the pairing process will end.

Selecting a device

N00565100025

If multiple paired Bluetooth® devices are available in the vehicle, the cellular phone or music player most recently connected is automatically connected to the Bluetooth® 2.0 interface.

You can connect to the other paired cellular phone or music player by following setting change procedures.

To select a cellular phone

1. Press the SPEECH button.
2. Say “Setup.”
3. Say “Select phone.”
4. After the voice guide says “Please say,” the numbers of the cellular phones and device tags of corresponding cellular phones will be read out in order, starting with the cellular phone that has been most recently connected. Say the number of the cellular phone that you want to connect to.

When the confirmation function is on, the system will ask you again whether the phone that you want to connect to is correct. Answer “Yes” to continue and connect to the cellular phone.

Answer “No,” and the voice guide will say “Please say.” Say the number of the phone that you want to connect to.

NOTE

- You can connect to a phone at any time by pressing the SPEECH button and saying the number, even before all of the paired numbers and device tags of corresponding cellular phones are read out by the system.

5. The selected phone will be connected to the Bluetooth® 2.0 interface. The voice guide will say “<device tag> selected” and then the system will return to the main menu.

To select a music player

1. Press the SPEECH button.
2. Say “Setup.”
3. Say “Select music player.”

4. After the voice guide says “Please say,” the numbers of the music players and device tags of corresponding music players will be read out in order, starting with the music player that has been most recently connected.

Say the number of the music player that you want to connect to.

When the confirmation function is on, the system will ask you again whether the music player that you want to connect to is correct. Answer “Yes” to continue and connect to the music player.

Answer “No,” and the voice guide will say “Please say.” Say the number of the music player that you want to connect to.

 **NOTE**

- You can connect to a music player at any time by pressing the SPEECH button and saying the number, even before all of the paired numbers and device tags of corresponding music players are read out by the system.

5. The selected music player will be connected to the Bluetooth® 2.0 interface.

The voice guide will say “<device tag> selected” and then the system will return to the main menu.

Deleting a device

Use the following procedure to delete a paired Bluetooth® device from the Bluetooth® 2.0 interface.

1. Press the SPEECH button.
2. Say “Setup.”
3. Say “Pairing Options.”
4. The voice guide will say “Select one of the following: pair, edit, delete, or list.” Say “Delete.”
5. After the voice guide says “Please say,” the numbers of the devices and device tags of corresponding devices will be read out in order, starting with the device that has been most recently connected. After it completes reading all pairs, the voice guide will say “or all.” Say the number of the device that you want to delete from the system. If you want to delete all paired phones from the system, say “All.”
6. For confirmation purposes, the voice guide will say “Deleting <device tag> <number>. Is this correct?” or “Deleting all devices. Is this correct?” Answer “Yes” to delete the phone(s). Answer “No,” the system will return to Step 4.

7. The voice guide will say “Deleted,” and then the system will end the device deletion process.

 **NOTE**

- If the device deletion process fails for some reason, the voice guide will say “Delete failed” and then the system will cancel deleting the device.

To check a paired Bluetooth® device

N00565200013

You can check a paired Bluetooth® device by following the steps below.

1. Press the SPEECH button.
2. Say “Setup.”
3. Say “Pairing Options.”
4. The voice guide will say “Select one of the following: pair, edit, delete, or list.” Say “List.”
5. The voice guide will read out device tags of corresponding devices in order, starting with the Bluetooth® device that has been most recently connected.
6. After the device tags of all paired Bluetooth® devices have been read, the system will say “End of list, would you like to start from the beginning?”

To hear the list again from the beginning, answer “Yes.”

When you are done, answer “No” to return to the main menu.

NOTE

- If you press and release the SPEECH button and say “Continue” or “Previous” while the list is being read, the system will advance or rewind the list.
Say “Continue” to proceed to the device with the next highest number or “Previous” to return to the phone with the previous number.
- You can change the device tag by pressing and releasing the SPEECH button and then saying “Edit” while the list is being read.
- You can change the phone to be connected by pressing and releasing the SPEECH button and then saying “Select phone” while the list is being read.
- You can change the music player to be connected by pressing and releasing the SPEECH button and then saying “Select music player” while the list is being read.

Changing a device tag

N00565300014

You can change the device tag of a paired cellular phone or music player.

Follow the steps below to change a device tag.

1. Press the SPEECH button.
2. Say “Setup.”
3. Say “Pairing Options.”
4. The voice guide will say “Select one of the following: pair, edit, delete, or list.” Say “Edit.”
5. The voice guide will say “Please say,” and read out the numbers of the Bluetooth® devices and device tags of corresponding devices in order, starting with the Bluetooth® that has been most recently connected.

After all paired device tags have been read, the voice guide will say “Which device, please?” Say the number of the device tag you want to change.

NOTE

- You can press and release the SPEECH button while the list is being read, and immediately say the number of the device tag you want to change.

6. The voice guide will say “New name, please.” Say the name you want to register as a new device tag.
When the confirmation function is on, the voice guide will say “<New device tag>. Is this correct?” Answer “Yes.”
Answer “No,” you can say the new device tag you want to register again.
7. The device tag is changed.



When the change is complete, the voice guide will say “New name saved” and then the system will return to the main menu.

Operating a music player connected via Bluetooth®

N00565400015

For the operation of a music player connected via Bluetooth®, refer to “To play tracks from a Bluetooth® device” on page 7-35.

How to make or receive hands-free calls

N00565500087

You can make or receive hands-free calls using a Bluetooth® compatible cellular phone connected to the Bluetooth® 2.0 interface. You can also use the phonebooks in the Bluetooth® 2.0 interface to make calls without dialing telephone numbers.

To make a call P.5-92
Send function P.5-93
Receiving calls P.5-93
Mute function P.5-93
Switching between hands-free mode and private mode P.5-94

 **NOTE**

- Hands-free calls may not operate correctly when you place or receive the call directly from your cellular phone, instead of using the Bluetooth® 2.0 interface.

5

To make a call

N00565600020

You can make a call in the following 3 ways using the Bluetooth® 2.0 interface:

- By saying a telephone number
- By using the Bluetooth® 2.0 interface's phonebook
- By redialing a telephone number

Making a call by using the telephone number

You can make a call by saying the telephone number.

1. Press the SPEECH button.
2. Say "Dial."
3. After the voice guide says "Number please," say the telephone number.
4. The voice guide will say "Dialing <number recognized>."

The Bluetooth® 2.0 interface will then make the call.

When the confirmation function is on, the system will confirm the telephone number again. To continue with that number, answer "Yes."

To change the telephone number, answer "No." The system will say "Number please" then say the telephone number again.

 **NOTE**

- In the case of English, the system will recognize both "zero" and "oh" (Letter "o") for the number "0."
- The Bluetooth® 2.0 interface supports numbers (0 to 9) and characters (+, # and *).
- The maximum supported telephone number length is as follows:
 - International telephone number: + and telephone numbers (to 18 digits).
 - Except for international telephone number: telephone numbers (to 19 digits).

Making a call using a phonebook

You can make calls using the vehicle phonebook or mobile phonebook of the Bluetooth® 2.0 interface.

For details on the phonebooks, refer to "Phonebook function" on page 5-94.

1. Press the SPEECH button.
2. Say "Call."

 **NOTE**

- If you say "Call" when the vehicle phonebook and the mobile phonebook are empty, the voice guide will say "The vehicle phonebook is empty. Would you like to add a new entry now?"
Answer "Yes," and the voice guide will say "Entering the phonebook - new entry menu." You can now create data in the vehicle phonebook.
Answer "No," the system will return to the main menu.

3. After the voice guide says "Name please," say the name you want to call, from those registered in the phonebook.
4. If there is only 1 match, the system will proceed to Step 5.

If there are 2 or more matches, the voice guide will say "More than one match was found, would you like to call <returned name>." If that person is the one you want to call, answer "Yes."

Answer "No," the name of the next matching person will be uttered by the voice guide.

 **NOTE**

- If you say "No" to all names read by the system, the voice guide will say "Name not found, returning to main menu" and the system will return to the main menu.

5. If only 1 telephone number is registered under the name you just said, the voice guide will proceed to Step 6.

If 2 or more telephone numbers are registered that match the name you just said, the voice guide will say “Would you like to call <name> at [home], [work], [mobile], or [other]?” Select the location to call.

NOTE

- If the name you selected has matching data in the vehicle phonebook but no telephone number is registered under the selected location, the voice guide will say “{home/work/mobile/other} not found for <name>. Would you like to add location or try again?” Say “Try again,” and the system will return to Step 3. Say “Add location” and you can register an additional telephone number under the selected location.
- If the name you selected has matching data in the mobile phonebook but no telephone number is registered under the selected location, the voice guide will say “{home/work/mobile/other} not found for <name>. Would you like to try again?” Answer “Yes,” and the system will return to Step 3. Answer “No,” and the call will be cancelled. Start over again from Step 1.

6. The voice guide will say “Calling <name> <location>” and then the system will dial the telephone number.

NOTE

- When the confirmation function is on, the system will check if the name and location of the receiver are correct. If the name is correct, answer “Yes.” To change the name or location to call, answer “No.” The system will return to Step 3.

Redialing

You can redial the last number called, based on the history of dialed calls in the paired cellular phone.

Use the following procedure to redial.

1. Press the SPEECH button.
2. Say “Redial.”

Send function

N00565700018

During a call, press the SPEECH button to enter voice recognition mode, then say “<numbers> SEND” to generate DTMF tones.

For example, if during a call you need to simulate the pressing of a phone button as a response to an automated system, press the



SPEECH button and speak “1 2 3 4 pound send” and the 1234# will be sent via your cellular phone.

Receiving calls

N00565800035

If an incoming phone call is received while the ignition switch or the operation mode is in ON or ACC, the audio system will be automatically turned on and switched to the incoming call, even when the audio system was originally off.

The voice guide announcement for the incoming call will be output from the front passenger’s seat speaker.

If the CD player or radio was playing when the incoming call was received, the audio system will mute the sound from the CD player or radio and output only the incoming call.

To receive the call, press the PICK-UP button on the steering wheel control switch.

When the call is over, the audio system will return to its previous state.

Mute function

N00565900010

At any time during a call, you can mute the vehicle microphone.

Pressing the SPEECH button and then saying “Mute” during a call will turn ON the mute function and mute the microphone.

Bluetooth® 2.0 interface (if so equipped)

Saying “Mute off” in the same way will turn off the mute function and cancel the mute on the microphone.

Switching between hands-free mode and private mode

N0056600014

The Bluetooth® 2.0 interface can switch between hands-free mode (hands-free calls) and private mode (calls using cellular phone). If you press the SPEECH button and say “Transfer call” during a hands-free call, you can stop the hands-free mode and talk in private mode.

To return to hands-free mode, press the SPEECH button again and say “Transfer call.”

Phonebook function

N0056600018

The Bluetooth® 2.0 interface has 2 types of unique phonebooks that are different from the phonebook stored in the cellular phone. They are the vehicle phonebook and the mobile phonebook.

These phonebooks are used to register telephone numbers and make calls to desired numbers via voice recognition function.

NOTE

- Disconnecting the battery cable will not delete information registered in the phonebook.

Vehicle phonebook

N00566101159

This phonebook is used when making calls with the voice recognition function.

Up to 32 names can be registered in the vehicle phonebook per language.

Also, each entry has 4 locations associated with: home, work, mobile and other. You can register one telephone number for each location.

You can register a desired name as a name for any phonebook entry registered in the vehicle phonebook.

Names and telephone numbers can be changed later on.

The vehicle phonebook can be used with all paired cellular phones.

To register a telephone number in the vehicle phonebook

You can register a telephone number in the vehicle phonebook in the following 2 ways: Reading out a telephone number, and select-

ing and transferring 1 phonebook entry from the phonebook of the cellular phone.

To register by reading out a telephone number

1. Press the SPEECH button.
2. Say “Phonebook.”
3. The voice guide will say “Select one of the following: new entry, edit number, edit name, list names, delete, erase all, or import contact.” Say “New entry.”
4. The voice guide will say “Name please.” Say your preferred name to register it.

NOTE

- If the maximum number of entries are already registered, the voice guide will say “The phonebook is full. Would you like to delete a name?” Say “Yes” if you want to delete a registered name. If you say “No,” the system will return to the main menu.

5. When the name has been registered, the voice guide will say “home, work, mobile, or other?” Say the location for which you want to register a telephone number.

 **NOTE**

- When the confirmation function is on, the voice guide will say “<Location>. Is this correct?” Answer “Yes.”
- If a telephone number has been registered for the selected location, the voice guide will say “The current number is <telephone number>, number please.”
- If you do not want to change the telephone number, say “cancel” or the original number to keep it registered.

6. The voice guide will say “Number please.” Say the telephone number to register it.

 **NOTE**

- In the case of English, the system will recognise both “zero” and “oh” (Letter “o”) for the number “0.”

7. The voice guide will repeat the telephone number you have just read, and then register the number.
- When the telephone number has been registered, the voice guide will say “Number saved. Would you like to add another number for this entry?”
- To add another telephone number for a new location for the current entry, answer “Yes.” The system will return to location selection in Step 5.

Answer “No” to end the registration process and return to the main menu.

 **NOTE**

- When the confirmation function is on, after repeating the telephone number you have read, the voice guide will ask “Is this correct?” Answer “Yes.”
- Answer “No” to return to telephone number registration in step 6.

To select and transfer one phonebook entry from the phonebook of the cellular phone

You can select 1 phonebook entry from the phonebook of the cellular phone and register it in the vehicle phonebook.

 **NOTE**

- Transfer is not permitted unless the vehicle is parked. Before transferring, make sure that the vehicle is parked in a safe location.
- All or part of data may not be transferred, even when the cellular phone supports Bluetooth®, depending on the compatibility of the device.
- The maximum supported telephone number length is 19 digits. Any telephone number of 20 digits or more will be truncated to the first 19 digits.

 **NOTE**

- If telephone numbers contain characters other than 0 to 9, *, # or +, these characters are deleted before the transfer.
- For the connection settings on the cellular phone side, refer to the instructions for the cellular phone.

1. Press the SPEECH button.
2. Say “Phonebook.”
3. The voice guide will say “Select one of the following: new entry, edit number, edit name, list names, delete, erase all, or import contact.” Say “Import contact.”
4. The voice guide will say “Would you like to import a single entry or all contacts?” Say “Single entry.”

The Bluetooth® 2.0 interface will become ready to receive transferred phonebook data.

 **NOTE**

- If the maximum number of entries are already registered, the voice guide will say “The phonebook is full. Would you like to delete a name?” Say “Yes” if you want to delete a registered name.
- If you say “No,” the system will return to the main menu.

Bluetooth® 2.0 interface (if so equipped)

5. After the voice guide says “Ready to receive a contact from the phone. Only a home, a work, and a mobile number can be imported,” the Bluetooth® 2.0 interface will receive the phonebook data from the Bluetooth® compatible cellular phone.

6. Operate the Bluetooth® compatible cellular phone to set it up so that the phonebook entry you want to register in the vehicle phonebook can be transferred to the Bluetooth® 2.0 interface.

NOTE

- If the Bluetooth® 2.0 interface cannot recognise the Bluetooth® compatible cellular phone or the connection takes too much time, the voice guide will say “Import contact has timed out” and then the system will cancel the registration. In such case, start over again from Step 1.
- Pressing the HANG-UP button or pressing and holding the SPEECH button will cancel the registration.

7. When the reception is complete, the voice guide will say “<Number of telephone numbers that had been registered in the import source> numbers have been imported. What name would you like to use for these numbers?”

Say the name you want to register for this phonebook entry.

NOTE

- If the entered name is already used for other phonebook entry or similar to a name used for other phonebook entry, that name cannot be registered.

8. The voice guide will say “Adding <name>.”

When the confirmation function is on, the system will ask if the name is correct. Answer “Yes.”

Answer “No,” the voice guide will say “Name please.” Register a different name.

9. The voice guide will say “Numbers saved.”

10. The voice guide will say “Would you like to import another contact?”

Answer “Yes” if you want to continue with the registration. You can continue to register a new phonebook entry from Step 5.

Answer “No,” the system will return to the main menu.

To change the content registered in the vehicle phonebook

You can change or delete a name or telephone number registered in the vehicle phonebook.

You can also listen to the list of names registered in the vehicle phonebook.

NOTE

- The system must have at least one entry.

[Editing a telephone number]

1. Press the SPEECH button.
2. Say “Phonebook.”
3. The voice guide will say “Select one of the following: new entry, edit number, edit name, list names, delete, erase all, or import contact”. Say “Edit number.”
4. The voice guide will say “Please say the name of the entry you would like to edit, or say list names.” Say the name of the phonebook entry you want to edit.

NOTE

- Say “List names,” and the names registered in the phonebook will be read out in order. Refer to “Vehicle phonebook: Listening to the list of registered names” on page 5-98.

5. The voice guide will say “Home, work, mobile or other?” Select and say the location where the telephone number you want to change or add is registered.

When the confirmation function is on, the system will check the target name and location again. Answer “Yes” if you want to continue with the editing.

Answer “No,” the system will return to Step 3.

- The voice guide will say “Number, please.” Say the telephone number you want to register.

NOTE

- If the telephone number is already registered in the selected location, the voice guide will say “The current number is <current number>. New number, please.” Say a new telephone number to change the current number.

- The voice guide will repeat the telephone number.

When the confirmation function is on, the system will ask if the number is correct.

Answer “Yes.”

Answer “No,” the system will return to the Step 3.

- Once the telephone number is registered, the voice guide will say “Number saved” and then the system will return to the main menu.

NOTE

- If the location where a telephone number was already registered has been overwritten with a new number, the voice guide will say “Number changed” and then the system will return to the main menu.

[Editing a name]

- Press the SPEECH button.
- Say “Phonebook.”
- The voice guide will say “Select one of the following: new entry, edit number, edit name, list names, delete, erase all, or import contact.” Say “Edit name.”
- The voice guide will say “Please say the name of the entry you would like to edit, or say list names.” Say the name you want to edit.

5

NOTE

- Say “List names,” and the names registered in the phonebook are read out in order. Refer to “Vehicle phonebook: Listening to the list of registered names” on page 5-98.

- The voice guide will say “Changing <name>.”

When the confirmation function is on, the system will check if the name is correct. Answer “Yes” if you want to continue with the editing based on this information. Answer “No,” the system will return to Step 4.

- The voice guide will say “Name please.” Say the new name you want to register.
- The registered name will be changed. When the change is complete, the system will return to the main menu.

[Listening to the list of registered names]

1. Press the SPEECH button.
2. Say “Phonebook.”
3. The voice guide will say “Select one of the following: new entry, edit number, edit name, list names, delete, erase all, or import contact.” Say “List names.”
4. Bluetooth® 2.0 interface will read out the entries in the phonebook in order.
5. When the voice guide is done reading the list, it will say “End of list, would you like to start from the beginning?” When you want to check the list again from the beginning, answer “Yes.”
When you are done, answer “No” to return to the previous or main menu.

 **NOTE**

- You can call, edit or delete a name that is being read out.
Press the SPEECH button and say “Call” to call the name, “Edit name” to edit it, or “Delete” to delete it.
The system will beep and then execute your command.
- If you press the SPEECH button and say “Continue” or “Previous” while the list is being read, the system will advance or rewind the list. Say “Continue” to proceed to the next entry or “Previous” to return to the previous entry.

[Deleting a telephone number]

1. Press the SPEECH button.
2. Say “Phonebook.”
3. The voice guide will say “Select one of the following: new entry, edit number, edit name, list names, delete, erase all, or import contact.” Say “Delete.”
4. The voice guide will say “Please say the name of the entry you would like to delete, or say list names.” Say the name of the phonebook entry in which the telephone number you want to delete is registered.

 **NOTE**

- Say “List names,” and the names registered in the phonebook are read out in order. Refer to “Vehicle phonebook: Listening to the list of registered names” on page 5-98.

5. If only one telephone number is registered in the selected phonebook entry, the voice guide will say “Deleting <name> <location>.”
If multiple telephone numbers are registered in the selected phonebook entry, the voice guide will say “Would you like to delete [home], [work], [mobile], [other], or all?”

Select the location to delete, and the voice guide will say “Deleting <name> <location>.”

 **NOTE**

- To delete the telephone numbers from all locations, say “All.”

6. The system will ask if you really want to delete the selected telephone number(s) to go ahead with the deletion, answer “Yes.” Answer “No,” the system will cancel deleting the telephone number(s) and then return to Step 4.
7. When the telephone number deletion is complete, the voice guide will say “<name> <location> deleted” and then the system will return to the main menu.
If all locations are deleted, the system will say “<name> and all locations deleted” and the name will be removed from the phonebook. If numbers still remain under the entry, the name will retain the other associated numbers.

Erasing the phonebook

You can delete all registered information from the vehicle phonebook.

1. Press the SPEECH button.
2. Say “Phonebook.”

3. The voice guide will say “Select one of the following: new entry, edit number, edit name, list names, delete, erase all, or import contact.” Say “Erase all.”

4. For confirmation purposes, the voice guide will ask “Are you sure you want to erase everything from your hands-free system phonebook?” Answer “Yes.”

Answer “No” to cancel the deletion of all registered information in the phonebook and return to the main menu.

5. The voice guide will say “You are about to delete everything from your hands-free system phonebook. Do you want to continue?” Answer “Yes” to continue.

Answer “No” to cancel the deletion of all registered information in the phonebook and return to the main menu.

6. The voice guide will say “Please wait, erasing the hands-free system phonebook” and then the system will delete all data in the phonebook.

When the deletion is complete, the voice guide will say “Hands-free system phonebook erased” and then the system will return to the main menu.

Mobile phonebook

N00566200049

All entries in the phonebook stored in the cellular phone can be transferred in a batch and registered in the mobile phonebook.

Up to 7 mobile phonebooks, each containing up to 1,000 names, can be registered.

The Bluetooth® 2.0 interface automatically converts from text to voice the names registered in the transferred phonebook entries, and creates names.

NOTE

- Only the mobile phonebook transferred from the connected cellular phone can be used with that cellular phone.
- You cannot change the names and telephone numbers in the phonebook entries registered in the mobile phonebook. You cannot select and delete specific phonebook entries, either. To change or delete any of the above, change the applicable information in the source phonebook of the cellular phone and then transfer the phonebook again.

To import a devices phonebook

Follow the steps below to transfer to the mobile phonebook the phonebook stored in the cellular phone.

NOTE

- Transfer should be completed while the vehicle is parked. Before transferring, make sure that the vehicle is parked in a safe location.

NOTE

- The already stored phonebook in the mobile phonebook is overwritten by the stored phonebook in the cellular phone.
- All or part of data may not be transferred, even when the cellular phone supports Bluetooth®, depending on the compatibility of the device.
- Only a home, a work, and a mobile number can be imported.
- The maximum supported telephone number length is 19 digits. Any telephone number of 20 digits or more will be truncated to the first 19 digits.
- If telephone numbers contain characters other than 0 to 9, *, # or +, these characters are deleted before the transfer.
- For the connection settings on the cellular phone side, refer to the instructions for the cellular phone.

1. Press the SPEECH button.
2. Say “Phonebook.”
3. The voice guide will say “Select one of the following: new entry, edit number, edit name, list names, delete, erase all, or import contact.” Say “Import contact.”
4. The voice guide will say “Would you like to import a single entry or all contacts?” Say “All contacts.”

5. The voice guide will say “Importing the contact list from the mobile phonebook. This may take several minutes to complete. Would you like to continue?” Answer “Yes,” transferring to the mobile phonebook the phonebook stored in the cellular phone will start. Answer “No,” the system will return to the main menu.

 **NOTE**

- The transfer may take some time to complete depending on the number of contacts.
- If the Bluetooth® 2.0 interface could not be connected to the Bluetooth® compatible cellular phone, the voice guide will say “Unable to transfer contact list from phone” and then the system will return to the main menu.
- If you press the HANG-UP button or press and hold the SPEECH button during the data transfer, the transfer will be cancelled and the system will return to the main menu.
- If an error occurs during the data transfer, all transfer will be cancelled and the voice guide will say “Unable to complete the phonebook import” and then the system will return to the main menu.
- If there are no contacts in the phonebook, the voice guide will say “There are no contacts on the connected phone.”

6. When the transfer is complete, the voice guide will say “Import complete” and then the system will return to the main menu.

General information

N00566301092

MODEL: MMC FCC ID: CB2MDGMY10
IC: 279B-MDGMY10

Your Bluetooth® 2.0 interface operates on a radio frequency subject to Federal Communications Commission (FCC) Rules (For vehicles sold in U.S.A.) and Industry Canada Rules (For vehicles sold in Canada). This device complies with Part 15 of the FCC Rules and RSS-210 of the Industry Canada Rules. Operation is subject to the following two conditions:

- This device may not cause harmful interference.
- This device must accept any interference received, including interference that may cause undesired operation.

 **CAUTION**

- Changes or modifications made to this equipment not expressly approved by the manufacturer may void the FCC authorization to operate this equipment.

The term “IC:” before the radio certification number only signifies that Industry Canada technical specifications were met.

The antenna used for this transmitter must not be co-located or operating in conjunction with any other antenna or transmitter. End-users and installers must be provided with installation instructions and transmitter operating conditions for satisfying RF exposure compliance.

FCC Notice: This equipment has been tested and found to comply with the limits for a Class B digital device, pursuant to part 15 of the FCC Rules. These limits are designed to provide reasonable protection against harmful interference in a residential installation.

This equipment generates, use and can radiate radio frequency energy and, if not installed and used in accordance with the instructions, may cause harmful interference to radio communications.

However, there is no guarantee that interference will not occur in a particular installation. If this equipment does cause harmful interference to radio or television reception, which can be determined by turning the equipment off and on, the user is encouraged to try to correct the interference by one or more of the following measures:

- Reorient or relocate the receiving antenna.
- Increase the separation between the equipment and receiver.

- Connect the equipment into an outlet on a circuit different from that to which the receiver is connected.
- Consult the dealer or an experienced radio/TV technician for help.

ICES Notice: This Class B digital apparatus complies with Canadian ICES-003.

Enrollment commands

N00566401080

Phrase	English	Spanish	French	Japanese
1	123456789	123456789	123456789	123456789
2	888 555 1212	888 555 1212	888 555 1212	888 555 1212
3	Call	Llamar	Appeler	呼び出し
4	Dial	Marcar	Composer	ダイヤル
5	Setup	Configurar	Configurer	設定
6	Cancel	Cancelar	Annuler	キャンセル
7	Continue	Continuar	Continuer	つぎ
8	Help	Ayuda	Aide	ヘルプ

USB input terminal (if so equipped)

N00566701083

You can connect your USB memory device or iPod* to play music files stored in the USB memory device or iPod. The following explains how to connect and remove a USB memory device or iPod.

*: “iPod” is a registered trademark of Apple Inc. in the United States and other countries.

How to connect a USB memory device

N00566800104

To connect

1. Park your vehicle in a safe place and turn the ignition switch to the “OFF” position or put the operation mode in OFF.
2. Open the glove compartment and remove the connector cable (A, B) from clips (C).

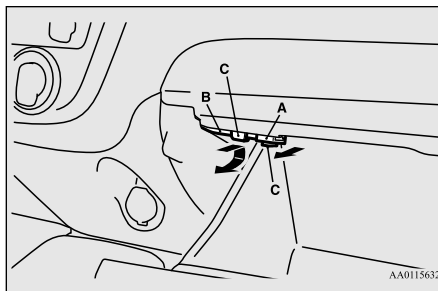

AA0115632

3. Connect a commercially available USB connector cable (D) to the USB memory device (E).

USB input terminal (if so equipped)

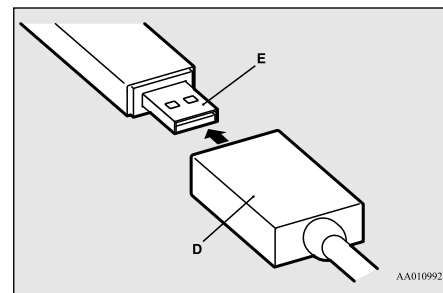

AA0109927

4. Connect the commercially available USB connector cable (D) to the vehicle's connector cable (B).

Be sure to hold the terminal part (A) of the connector cable as shown in the illustration.

5. Fix the connector cable (A, B) on the clips.

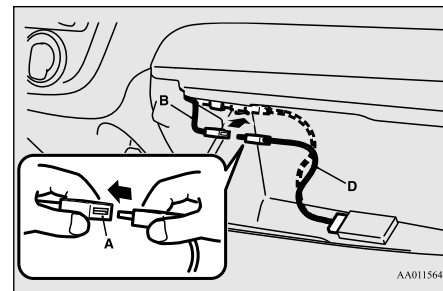

AA0115645

⚠ WARNING

- An open glove compartment door can cause a serious injury or death to the front passenger in an accident, even if the passenger is wearing his/her seat belt. Always keep the glove compartment door closed when driving.

5

📖 NOTE

- Do not connect the USB memory device to the vehicle's connector cable directly. The USB memory device may be damaged.
- When closing the glove compartment, be careful not to trap the connector cable and USB memory device.

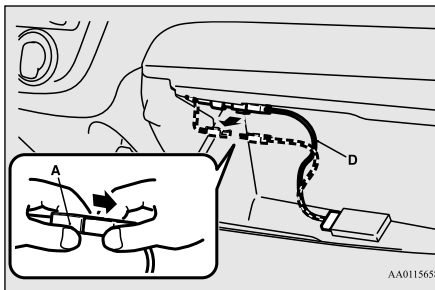

AA0115658

3. Fix the connector cable on the clips and close the glove compartment.

How to connect an iPod

N00566900091

To connect

1. Park your vehicle in a safe place and turn the ignition switch to the "OFF" position or put the operation mode in OFF.
2. Open the glove compartment and remove the connector cable (A, B) from clips (C).

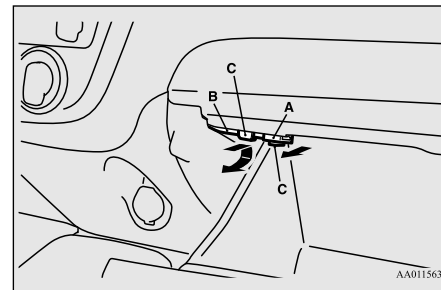

AA0115632

3. Connect the Dock connector (D) to the iPod (E).

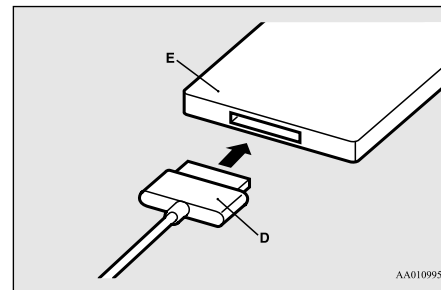

AA0109956

📖 NOTE

- Use a genuine Dock connector from Apple Inc.
On vehicles equipped with Mitsubishi Multi Entertainment System (MMES), refer to the separate "Mitsubishi Multi Entertainment System owner's manual" for details of connection.

- Connect the Dock connector (D) to the connector cable (B).

Be sure to hold the terminal part (A) of the connector cable as shown in the illustration.

- Fix the connector cable (A, B) on the clips.

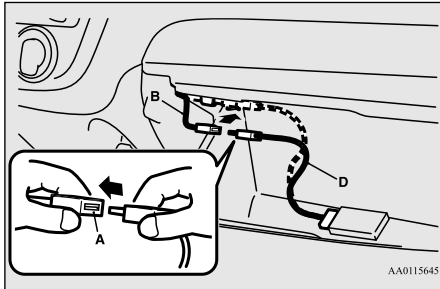

⚠ WARNING

- An open glove compartment door can cause a serious injury or death to the front passenger in an accident, even if the passenger is wearing his/her seat belt. Always keep the glove compartment door closed when driving.

📖 NOTE

- When closing the glove compartment, be careful not to trap the connector cable and iPod.

To remove

- Turn the ignition switch to the “OFF” position or put the operation mode in OFF.

- Remove the Dock connector (D).
Be sure to hold the terminal part (A) of the connector cable as shown in the illustration.

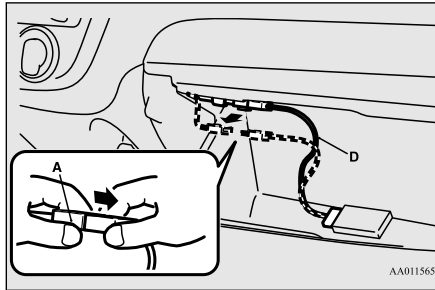

- Fix the connector cable on the clips and close the glove compartment.

Types of connectable devices and supported file specifications

N00567001067

For vehicles equipped with Mitsubishi Multi Entertainment System (MMES)

For details about the types of connectable devices and supported file specifications, refer to the separate owner's manual.

Except for vehicles equipped with Mitsubishi Multi Entertainment System (MMES)

For details about the types of connectable devices and supported file specifications, refer to the following section.

Device types

N00567101143

Devices of the following types can be connected.

Model name		Condition
USB memory device		Storage capacity of 256 Mbytes or more
iPod*	fifth generation	F/W Ver.1.3 or later

USB input terminal (if so equipped)

5

Model name	Condition	
iPod classic*	80GB/180 GB	F/W Ver.1.1.2 or later
	120GB	F/W Ver.2.0.1 or later
	160GB (late 2009)	F/W Ver.2.0.4 or later
iPod nano*	first generation	F/W Ver.1.3.1 or later
	second generation	F/W Ver.1.1.3 or later
	third generation	F/W Ver.1.1.3 or later
	fourth generation	F/W Ver.1.0.4 or later
	fifth generation	F/W Ver.1.0.2 or later
	sixth generation	F/W Ver.1.0 or later
iPod touch*	first generation	F/W Ver.3.1.3 or later
	second generation	F/W Ver.4.2.1 or later
	third generation	F/W Ver.4.3.1 or later
	fourth generation	F/W Ver.4.3.1 or later

Model name	Condition	
iPhone*	iPhone	F/W Ver.3.1.3 or later
	iPhone 3G	F/W Ver.4.2.1 or later
	iPhone 3GS	F/W Ver.4.3.1 or later
	iPhone 4	F/W Ver.4.3.1 or later
iPhone 4S	iPhone 4S	F/W Ver.5.0.1 or later
	Models other than USB memory devices and iPods	Digital audio player supporting mass storage class

On vehicles equipped with the Bluetooth® 2.0 interface, for these connectable device types, “iPod*,” “iPod classic*,” “iPod nano*,” “iPod touch*” and “iPhone*,” refer to the following website:

[For vehicles sold in U.S.A.]

You can access the Mitsubishi Motors North America website.

[For vehicles sold in Canada]

You can access the Mitsubishi Motors website. Please read and agree to the “Warning about Links to the Web Sites of Other Companies”. The websites mentioned above may connect you to websites other than the Mitsubishi Motors website.

<http://www.mitsubishi-motors.com/en/products/index.html>

*: “iPod,” “iPod classic,” “iPod nano,” “iPod touch” and “iPhone” are registered trademarks of Apple Inc. in the United States and other countries.

NOTE

- Depending on the type of the USB memory device or other device connected, the connected device may not function properly or the available functions may be limited.
- It is recommended to use an iPod with firmware updated to the latest version.
- You can charge your iPod by connecting it to the USB input terminal when the ignition switch or the operation mode is in ON or ACC.
- Do not keep your USB memory device or iPod in your vehicle.
- It is recommended that you back up the files in case of data damage.
- Do not connect to the USB input terminal any device (hard disk, card reader, memory reader, etc.) other than the connectable devices specified in the previous section. The device and/or data may be damaged. If any of these devices was connected by mistake, remove it after turning the ignition switch to the “OFF” position or putting the operation mode in OFF.

File specifications

N00567200020

You can play music files of the following specifications that are saved in a USB memory device or other device supporting mass storage class. When you connect your iPod, playable file specifications depend on the connected iPod.

Item	Condition
File format	MP3, WMA, AAC
Maximum number of levels (including the root)	Level 8
Number of folders	700
Number of files	65,535

Sun visors

N00524600353

Pull the sun visor downward (1) to reduce front glare while driving. To reduce side glare, turn the visor to the side (2).

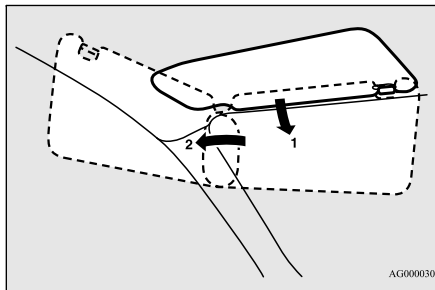

Vanity mirror

A vanity mirror is fitted to the back of the sun visor.

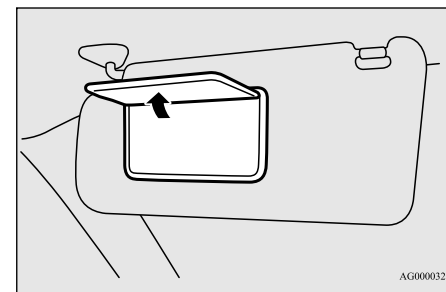

5

Card holder

Cards can be slipped into the holder (A) on the sun visor.

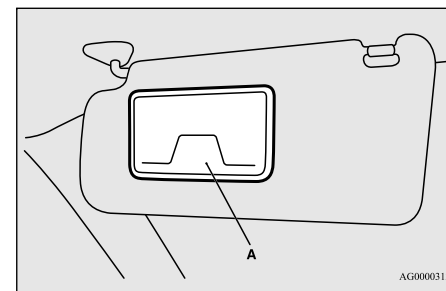

12 V power outlets

N00525000615

⚠ CAUTION

- Be sure to use a “plug-in” type accessory operating at 12 V and at 120 W or less.
- Also be aware that using electronic equipment with the engine off may run the battery down.
- When the power outlet is not in use, be sure to close the power outlet cover. This will prevent the power outlet from becoming clogged and short circuiting.

5

Accessories can be operated while the ignition switch or the operation mode is in ON or ACC.

To use a “plug-in” type accessory, open the cover, and insert the plug in the power outlet.

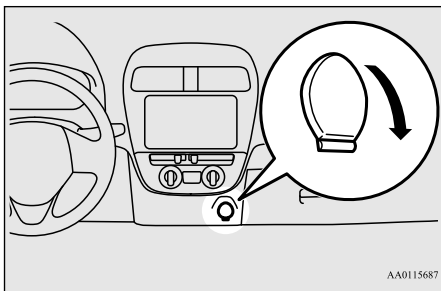

AA0115687

Interior lights

N00525300575

📖 NOTE

- Be aware that leaving the light illuminated with the engine off may run the battery down. Never leave the vehicle without checking that the light is off.

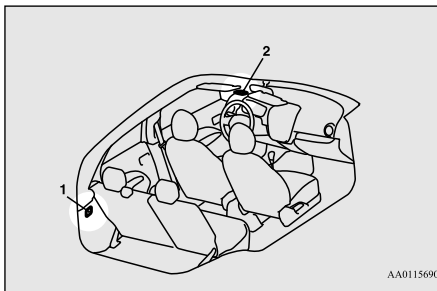

AA0115690

- 1- Cargo room light → P.5-107
- 2- Dome light → P.5-106

Dome light

N00525800235

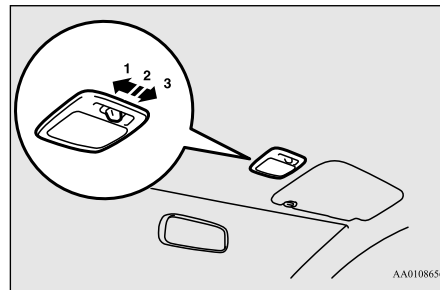

AA0108656

1- (☀)

The light illuminates regardless of whether a door or the liftgate is open or closed.

2- (•)

Delayed off function

The light illuminates when a door or the liftgate is opened. It goes off approximately 30 seconds after the door or liftgate is closed.

However, the light goes off immediately with all doors and the liftgate closed in the following cases:

- When the ignition switch is turned to the “ON” position or the operation mode is put in ON.
- When the power door lock function is used to lock the vehicle.

- When the remote control transmitter of the keyless entry system or the F.A.S.T.-key is used to lock the vehicle.
- When the door lock/unlock switch or liftgate switch is pressed to lock the vehicle while carrying the F.A.S.T.-key.

Auto cut-out function

If the light is left switched on with the ignition switch is in the “OFF” or “ACC” position or the operation mode is in OFF or ACC, and a door or the liftgate is opened, it goes off automatically after approximately 30 minutes.

The light will illuminate again after it automatically goes off in the following cases:

- When the ignition switch is turned to the “ON” position or the operation mode is put in ON.
- When the keyless entry system or the F.A.S.T.-key is operated.
- When all doors and the liftgate are closed.

NOTE

- When the key was used to start the engine: if the key is removed while the doors and liftgate are closed, the light is illuminated and after approximately 30 seconds it goes off.

NOTE

- When the F.A.S.T.-key was used to start the engine: if the operation mode is put in OFF while the doors and liftgate are closed, the light illuminates and after approximately 30 seconds it goes off.
- The time until the light goes off (delayed off) can be adjusted. See your authorized Mitsubishi Motors dealer for details.
- The auto cut-out function cannot be operated when the dome light switch is in the “” position. Also, this function can be deactivated. See your authorized Mitsubishi Motors dealer for details.

3- (○)

The light goes off regardless of whether a door or the liftgate is open or closed.

Cargo room light

N00526100176

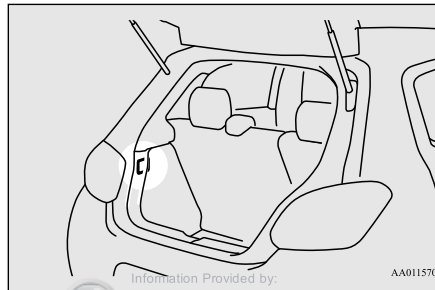

Information Provided by:

AA0115704



The light illuminates when the liftgate is opened, and goes out when the liftgate is closed.

Storage spaces

N00526400528

CAUTION

- Never leave lighters, carbonated drink cans, or spectacles in the cabin when parking the vehicle in hot sunshine. The cabin will become extremely hot, so lighters and other flammable items may catch fire and unopened drink cans (including beer cans) may rupture. The heat may also deform or crack plastic spectacle lenses and other spectacle parts that are made of plastic.
- Keep the lids of storage spaces closed while driving the vehicle. A lid or the contents of a storage space could otherwise cause injuries during a sudden stop.

5

NOTE

- Do not leave valuables in any storage space when leaving the vehicle.

Glove compartment

N00551500275

WARNING

- An open glove compartment door can cause a serious injury or death to the front passenger in an accident, even if the passenger is wearing his/her seat belt. Always keep the glove compartment door closed when driving.

5

To open, pull the lever (A).

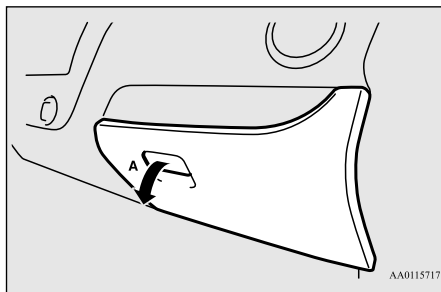

NOTE

- The USB input terminal (if so equipped) is located in the glove compartment. For details, refer to “USB input terminal” on page 5-101.

Cup holders

N00527301433

The cup holder is designed for holding cups or drink-cans securely in its holes.

NOTE

- Plastic bottles may sometimes not fit securely depending on the shape of the bottle. Plastic bottles could fall if driving is done while a plastic bottle is not securely placed, so check that plastic bottles are placed securely or use the bottle holder.

For the front seat

The cup holder is located in front of the floor console.

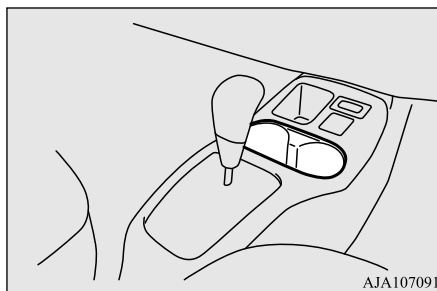

CAUTION

- Do not drink beverages while driving your vehicle. This is distracting and could cause an accident.

For the rear seat

N00537000175

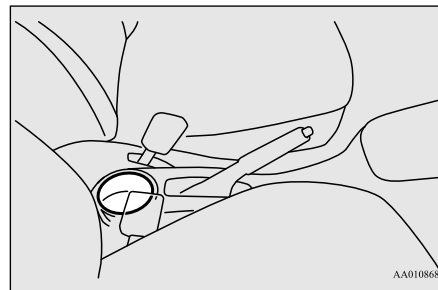

Bottle holders

N00520800065

CAUTION

- Drink beverages while driving your vehicle is distracting and can cause an accident.
- Vibration and shaking while driving may cause beverages to spill. Be very careful, as spilling hot beverages could cause burns.

There are bottle holders located on the front doors.

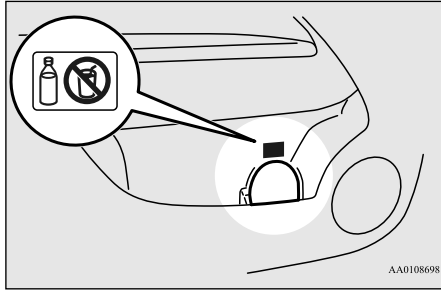

NOTE

- Do not store cup or drink can in the bottle holder.
- Make sure all lids are tightly closed when storing beverages that are in plastic bottles, etc.
- Some beverages may not be stored, depending on the size and shape of the plastic bottles, etc.

Rear shelf panel (if so equipped)

N00528200096

CAUTION

- Do not place luggage or other items on the rear shelf panel. Any items on the rear shelf panel would obstruct your rearward view, and they could fly forward and cause injuries or other mishap in the event of hard braking.

To install

1. Insert the concave portion (A) on the underside of the rear shelf panel into the inside protruding portion (B) of the rear pillar.

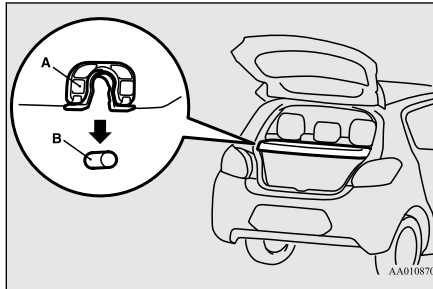

CAUTION

- Lightly push the rear shelf panel to make sure that the concave portion (A) is set firmly in the protruding portion (B) of the liftgate. If the rear shelf panel is not securely locked in place, it could unhook while driving and cause injuries.

2. Hang the strap (C) of the rear shelf panel on the hook (D).

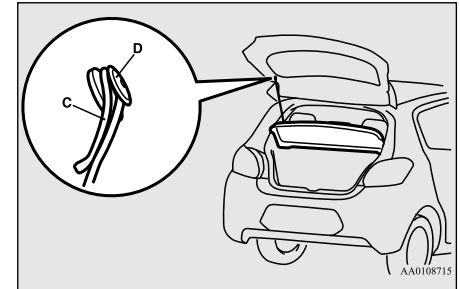

To remove

Follow this procedure in reverse to remove.

Convenience hook

N00574700014

Convenience hook is located on the seatback of the passenger's seat.

5

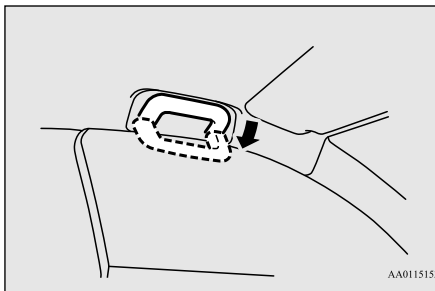
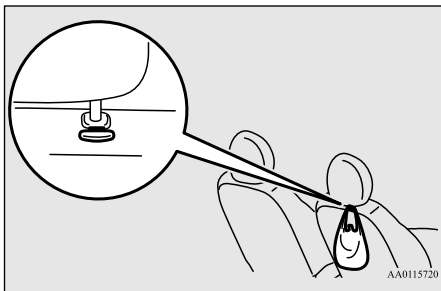

NOTE

- To avoid damage to the convenience hook, do not hang objects that weight more than 9 pounds (4 kg).

CAUTION

- Do not use the assist grips when getting into or out of the vehicle. The assist grips could detach causing you to fall.

Assist grips

N00559000074

These grips are to support the body by hand while seated in the vehicle.

Driving safety

Fuel economy	6-2
Driving, alcohol and drugs	6-2
Floor mat	6-2
Vehicle preparation before driving	6-3
Safe driving techniques	6-4
Driving during cold weather	6-4
Braking	6-5
Parking	6-5
Loading information	6-6
Cargo loads	6-10
Trailer towing	6-10

Fuel economy

N00628800178

Fuel economy is dependent on many factors. Your personal driving habits can have a significant effect on your fuel consumption. Several recommendations for achieving the greatest fuel economy are listed below.

6

- Whenever accelerating from a stop, always accelerate slowly and smoothly.
- When parked for even a short period, do not idle the engine. Shut it off.
- Plan your trips to avoid unnecessary stops.
- Keep your tires inflated to the recommended pressures.
- For freeway driving, maintain a speed of approximately 50 mph (80 km/h) when traffic, roadway and weather conditions safely permit.
- Keep your air filter clean and your vehicle lubricated according to the recommendations in this manual.
- Always keep your vehicle well maintained. A poorly maintained engine wastes fuel and costs money.
- Never overload your vehicle.

Driving, alcohol and drugs

N00628900049

Drunk driving is one of the most frequent causes of accidents.

Your driving ability can be seriously impaired even with blood alcohol levels far below the legal minimum. If you have been drinking, don't drive. Ride with a designated non-drinking driver, call a cab or a friend, or use public transportation. Drinking coffee or taking a cold shower will not make you sober. Similarly, prescription and nonprescription drugs affect your alertness, perception and reaction time. Consult with your doctor or pharmacist before driving while under the influence of any of these medications.

WARNING

- **NEVER DRINK AND DRIVE.**
Your perceptions are less accurate, your reflexes are slower and your judgment is impaired.

Floor mat

N00628600046

The original equipment floor mat provided with your vehicle was specifically designed for your vehicle. Always properly position the floor mat and assure it does not interfere with operation of the pedals. Always use the

retaining clip on the driver's floorboard to secure the floor mat. When used, this clip will help prevent the floor mat from moving forward and possibly interfering with the operation of the pedals. To prevent the floor mat from moving forward and possibly interfering with the operation of the pedals, Mitsubishi genuine floor mats are recommended.

To install the floor mat

N00628700047

1. Place the floor mat to fit the shape of the floorboard.
2. Align the floor mat with the installation holes over the retaining clips.
3. Secure the floor mat with retaining clips.

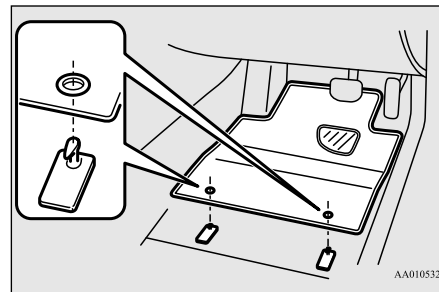

AA0105323

NOTE

- The shape of the mat and the number of retaining clips may vary depending on the vehicle model.

⚠ WARNING

- If a floor mat is the wrong size or is not properly installed, it can interfere with the operation of the pedals. Interference with the pedals can cause unintended acceleration and/or increased stopping distances resulting in a crash and injury. Always make sure the floor mat does not interfere with the accelerator or brake pedal.
- Always use the retaining clip on the driver's floorboard to secure the floor mat.
- Always install the mat with the correct side facing down.
- Never install a second mat over or under an existing floor mat.
- Do not use a floor mat designed for another model vehicle even if it is a Mitsubishi genuine floor mat.
- Before driving, be sure to check the following:
 - Periodically check that the floor mat is properly secured with the retaining clips. If you remove the floor mat while cleaning the inside of your vehicle or for any other reason, always check the condition of the floor mat after it has been reinstalled.
 - While the vehicle is stopped with the engine off, check that the floor mat is not interfering with the pedals by depressing the pedals fully.

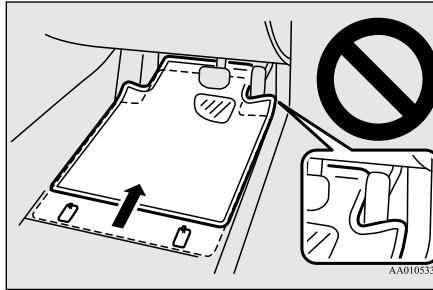

Vehicle preparation before driving

N00629000702

For a safer and more enjoyable trip, always check for the following:

Seat belts and seats

- Before starting the vehicle, make certain that you and all passengers are seated and wearing their seat belts properly (with children in the rear seat, in appropriate restraints), and that all the doors and the liftgate are locked.

- Move the driver's seat as far backward as possible, while keeping good visibility, and good control of the steering wheel, brakes, accelerator, and controls. Check the instrument panel indicators and multi-information display for any possible problem.
- Similarly, the front passenger seat should also be moved as far back as possible.
- Make sure that infants and small children are properly restrained in accordance with all laws and regulations.

Defrosters

Check these by selecting the defroster mode, and set the blower switch on high. You should be able to feel the air blowing against the windshield.

Refer to "Defrosting or defogging (windshield, door windows)" on page 7-10, 7-16.

Tires

Check all the tires for heavy tread wear or uneven wear patterns. Look for stones, nails, glass, or other objects stuck in the tread. Look for any tread cuts or sidewall cracks. Check the wheel nuts for tightness, and the tires (including spare tire) for proper pressure.

Safe driving techniques

Replace your tires before they are heavily worn out.

On vehicles equipped with a tire pressure monitoring system, there is a risk of damage to the tire inflation pressure sensors when the tire is replaced on the rim. Tire replacement should, only be performed by an authorized Mitsubishi Motors dealer.

6

Lights

Have someone watch while you turn all the exterior lights on and off. Also check the turn signal indicators and high-beam indicators on the instrument panel.

Fluid leaks

Check the ground under the vehicle after parking overnight, for fuel, water, oil, or other leaks. Make sure all the fluid levels are correct. Also, if you can smell fuel, you need to find out why immediately and have it fixed.

Safe driving techniques

N00629200137

Even this vehicle's safety equipment, and your safest driving, cannot guarantee that you can avoid an accident or injury. However, if

you give extra attention to the following areas, you can better protect yourself and your passengers:

- Drive defensively. Be aware of traffic, road and weather conditions. Leave plenty of stopping distance between your vehicle and the vehicle ahead.
- Before changing lanes, check your mirrors, your blind spots, and use your turn-signal light.
- While driving, watch the behavior of other drivers, bicyclists, and pedestrians.
- Always obey applicable laws and regulations. Be a polite and alert driver. Always leave room for unexpected events, such as sudden braking.
- If you plan to drive in another country, obey their vehicle registration laws and make sure you will be able to get the right fuel.

Driving during cold weather

N00629400474

- Check the battery. At the same time, check the terminals and wiring. During extremely cold weather, the battery will not be as strong. Also, the battery power level may drop because more power is used for cold starting and driving.

Before driving the vehicle, check to see if the engine runs at the proper speed and if the headlights are as bright as normally. Charge or replace the battery if necessary. During extreme cold weather, it is possible that a very low battery could freeze.

WARNING

- **The battery gives off explosive hydrogen gas. Any spark or flame can cause the battery to explode, which could cause serious injury or death.**
Always wear protective clothes and a face mask when working with your battery, or let a skilled mechanic do it.

- Warm the engine sufficiently. After starting the engine, allow a short warm-up time to distribute oil to all cylinders. Then drive your vehicle slowly.
- Stay at low speeds at first so that the manual transaxle oil or the automatic transaxle fluid has time to spread to all the lubrication points.
- Manual transaxle can be harder to shift in cold weather conditions. This is normal and shifting will get easier as the transaxle warms up.
- Check the engine antifreeze.
If there is not enough coolant because of a leak or from engine overheating, add Mitsubishi Motors Genuine Super Long Life Coolant Premium or equivalent.

Please read this section in conjunction with the “Engine coolant” on page 9-7.

⚠ WARNING

- **Never open the radiator cap when the radiator is hot. You could be seriously burned.**

Braking

N00629500521

All parts of the brake system are critical to safety. Have the vehicle serviced by an authorized Mitsubishi Motors dealer or a repair facility of your choice at regular intervals according to the “WARRANTY AND MAINTENANCE MANUAL”.

When brakes are wet

Check the brake system while driving at a low speed immediately after starting, especially when the brakes are wet, to confirm they work normally.

A film of water can be formed on the brake discs or brake drums, and prevent normal braking after driving in heavy rain or through large puddles, or after the vehicle is washed. If this occurs, dry the brakes out by driving slowly while lightly depressing the brake pedal.

When driving in cold weather

On snowy roads, ice can form on the braking system, making the brakes less effective. While driving in such conditions, pay close attention to surrounding vehicles and to the condition of the road surface. From time to time, lightly depress the brake pedal and check how effective the brakes are.

When driving downhill

It is important to take advantage of the engine braking by downshifting while driving on steep downhill roads in order to prevent the brakes from overheating.

Parking

N00629600333

Parking on a hill

When parking on a hill, set the parking brake, and turn the front wheels toward the curb on a downhill, or away from the curb on an uphill. If necessary, apply chocks to the wheels.

For vehicles equipped with manual transaxle

Place the gearshift lever into the “R” (Reverse) position when parking on a downhill slope, into the 1st position when parking on an uphill slope.

For vehicles equipped with continuously variable transmission (CVT)

Be sure that the parking brake is firmly set when parked and that the selector lever is in the “P” (PARK) position.

When parking on a hill, it is important to set the parking brake before moving the selector lever to the “P” (PARK) position. This prevents loading the parking brake against the transaxle. When this happens, it is difficult to move the selector lever out of the “P” (PARK) position.

Parking with the engine running

Never leave the engine running while you take a short nap or rest. Also, never leave the engine running in a closed or poorly ventilated place.

⚠ WARNING

- Leaving the engine running risks injury or death from accidentally moving the gear-shift lever (manual transaxle) or the selector lever (CVT) or from the accumulation of toxic exhaust fumes in the passenger compartment.

6

Where you park

Your front bumper can be damaged if you scrape it over curbs or parking stop blocks. Be careful when traveling up or down steep slopes where your bumper can scrape the road.

⚠ WARNING

- Do not park your vehicle in areas where combustible materials such as dry grass or leaves can come in contact with a hot exhaust, since a fire could occur.

Do not keep the steering wheel fully turned for a long time

More effort could be required to turn the steering wheel. Refer to “Electric power steering system (EPS)” on page 5-48.

When leaving the vehicle

Always carry the key and lock all doors and the liftgate when leaving the vehicle unattended.

Always try to park your vehicle in a well lit area.

Loading information

N00629900424

It is very important to know how much weight your vehicle can carry. This weight is called the vehicle capacity weight and includes the weight of all occupants, cargo, non-factory-installed options, if any, being towed. The tire and loading information placard located on the driver’s door sill of your vehicle will show how much weight it may properly carry.

⚠ WARNING

- Never overload your vehicle. Overloading can damage your vehicle, adversely affect vehicle performance, including handling and braking, cause tire failure, and result in an accident.

It is important to familiarize yourself with the following terms before loading your vehicle:

- Vehicle maximum load on the tire: load on an individual tire that is determined by distributing to each axle its share of the maximum loaded vehicle weight and dividing by two.
- Vehicle normal load on the tire: load on an individual tire that is determined by distributing to each axle its share of the curb weight, accessory weight, and normal occupant weight and dividing by two.
- Maximum loaded vehicle weight: the sum of -
 - (a) Curb weight;
 - (b) Accessory weight;
 - (c) Vehicle capacity weight; and
 - (d) Production options weight.
- Curb weight: the weight of a motor vehicle with standard equipment including the maximum capacity of fuel, oil, and coolant.
- Accessory weight: the combined weight (in excess of those standard items which may be replaced) of automatic transmission, power steering, power brakes, power windows, power seats, radio, and heater, to the extent that these items are available as factory- installed equipment (whether installed or not).
- Vehicle capacity weight: the rated cargo and luggage load plus 150 lbs (68 kg)* times the vehicle’s designated seating capacity.

- Production options weight: the combined weight of those installed regular production options weighing over 5 lbs (2.3 kg) in excess of those standard items which they replace, not previously considered in curb weight or accessory weight, including heavy duty brakes, ride levelers, roof rack, heavy duty battery, and special trim.
 - Normal occupant weight: 150 lbs (68 kg)* times the number of specified occupants. (In your vehicle the number is 3)
 - Occupant distribution: Occupant distribution within the passenger compartment (In your vehicle the distribution is 2 in front, 1 in second row seat)
- *: 150 lbs (68 kg) is the weight of one person as defined by U.S.A. and Canadian regulations.

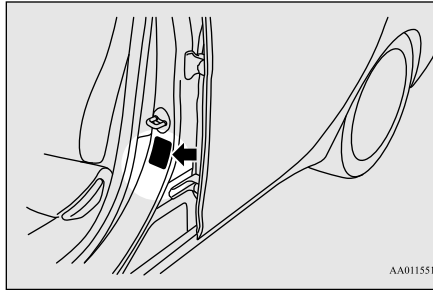

This placard shows the maximum number of occupants permitted to ride in your vehicle as well as “the combined weight of occupants and cargo” (A), which is called the vehicle capacity weight. This placard also tells you the size and recommended inflation pressure for the original equipment tires on your vehicle. For more information, refer to “Tires” on page 9-12.

Tire and loading information placard

N00630100396

The tire and loading information placard is located on the inside sill of the driver’s door.

EXAMPLE

TIRE AND LOADING INFORMATION RENSEIGNEMENTS SUR LES PNEUS ET LE CHARGEMENT			
SEATING CAPACITY / NOMBRE DE PLACES		TOTAL	FRONT / AVANT
			REAR / ARRIERE
The combined weight of occupants and cargo should never exceed XXX kg or lbs. Le poids total des occupants et du chargement ne doit jamais dépasser XXX kg ou lbs.			
TIRE PNEU	SIZE DIMENSIONS	COLD TIRE PRESSURE PRESSION DES PNEUS A FROID	SEE OWNER'S MANUAL FOR ADDITIONAL INFORMATION
FRONT AVANT		kPa, psi	A
REAR ARRIERE		kPa, psi	
SPARE DE SECOURS		kPa, psi	

AF0015463



Steps for Determining Correct Load Limit

N00630201277

1. Locate the statement “The combined weight of occupants and cargo should never exceed XXX kg or XXX lbs.” on your vehicle’s placard.
2. Determine the combined weight of the driver and passengers that will be riding in your vehicle.
3. Subtract the combined weight of the driver and passengers from XXX kg or XXX lbs.
4. The resulting figure equals the available amount of cargo and luggage load capacity. For example, if the “XXX” amount equals 1400 lbs. and there will be five 150 lbs. passengers in your vehicle, the amount of available cargo and luggage load capacity is 650 lbs. $(1400 - 750 (5 \times 150) = 650 \text{ lbs.})$
5. Determine the combined weight of luggage and cargo being loaded on the vehicle. That weight may not safely exceed the available cargo and luggage load capacity calculated in Step 4.
6. If your vehicle will be towing a trailer, load from your trailer will be transferred to your vehicle. Consult this manual to determine how this reduces the available cargo and luggage load capacity of your vehicle.

NOTE

- The above steps for determining correct load limit were written in accordance with U.S.A. regulations. Your vehicle cannot tow a trailer, so step 6 is irrelevant.

NOTE

- The following table shows examples on how to calculate total cargo/load capacity of your vehicle with varying seating configurations and number and size of occupants. This table is for illustration purposes only and may not be accurate for the seating and load capacity of your vehicle.
- For the following example the combined weight of occupants and cargo should never exceed 865 lbs (392 kg).

Occupants			Combined weight of occupants and cargo from Tire Placard	MINUS	Combined Occupant's weight	=	AVAILABLE Cargo/Luggage and Trailer Tongue Weight
TOTAL	FRONT	REAR					
<u>EXAMPLE 1</u>			865 lbs (392 kg)	minus	Occupant 1: 200 lbs (91 kg) Occupant 2: 130 lbs (59 kg) Occupant 3: 160 lbs (73 kg) Occupant 4: 100 lbs (45 kg) Occupant 5: 80 lbs (36 kg) <hr/> TOTAL WEIGHT: 670 lbs (304 kg)	=	195 lbs (88 kg)
5	2	3					
<u>EXAMPLE 2</u>			865 lbs (392 kg)	minus	Occupant 1: 210 lbs (95 kg) Occupant 2: 180 lbs (82 kg) Occupant 3: 150 lbs (68 kg) <hr/> TOTAL WEIGHT: 540 lbs (245 kg)	=	325 lbs (147 kg)
3	2	1					
<u>EXAMPLE 3</u>			865 lbs (392 kg)	minus	Occupant 1: 200 lbs (91 kg) Occupant 2: 200 lbs (91 kg) <hr/> TOTAL WEIGHT: 400 lbs (182 kg)	=	465 lbs (210 kg)
2	2	0					

AJM100083

- Under a maximum loaded vehicle condition, gross axle weight ratings (GAWR's) for the front and rear axles must not be exceeded. For further information on GAWR's, vehicle loading, see the "Specifications" section of this manual.

Cargo loads

N00629700435

Cargo load precautions

N00630300082

To determine the cargo load capacity for your vehicle, subtract the weight of all vehicle occupants from the vehicle capacity weight.

6 For additional information, if needed, refer to “Steps for Determining Correct Load Limit” on page 6-8.

DO NOT USE the Gross Vehicle Weight Rating and Gross Axle Weight Rating numbers listed on the safety certification label (A) located on the inside sill of the driver’s door as the guide for passengers and/or cargo weight.

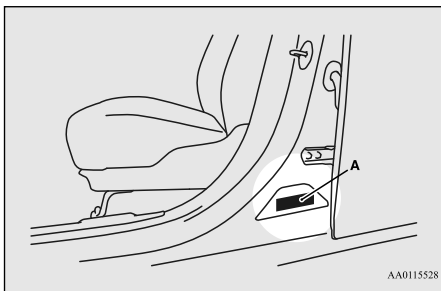

AA0115528

⚠️ WARNING

- To reduce the risk of serious injury or death, the combined weights of the driver, passengers and cargo and must never exceed the vehicle capacity weight.
- Exceeding the vehicle capacity weight will adversely affect vehicle performance, including handling and braking, and may cause an accident.
- Do not load cargo or luggage higher than the top of the seatback. Be sure that your cargo or luggage cannot move when your vehicle is in motion.
Having either the rear view blocked, or your cargo being thrown inside the cabin if you suddenly have to brake can cause a serious accident or injury or death.
- Put cargo or luggage in the cargo area of your vehicle. Try to spread the weight evenly.

Trailer towing

N00629800306

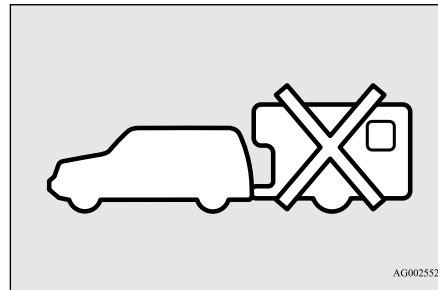

AG0025528

⚠️ WARNING

- Do not use this vehicle for trailer towing. It may not be possible to maintain control or adequate braking.

Comfort controls

Vents	7-2
Heater without air conditioning function (if so equipped)	7-4
Manual air conditioning (if so equipped)	7-7
Automatic air conditioning (if so equipped).....	7-11
Important air conditioning operating tips	7-17
Air purifier (if so equipped).....	7-18
AM/FM electronically tuned radio with CD player (if so equipped)	7-18
To play tracks from USB device (if so equipped)	7-27
To play tracks from a Bluetooth® device (vehicles with Bluetooth® 2.0 interface)	7-35
Steering wheel audio remote control switches (if so equipped)	7-37
Error codes	7-38
Handling of compact discs	7-40
Antenna	7-41
General information about your radio	7-42

Vents

N00729900278

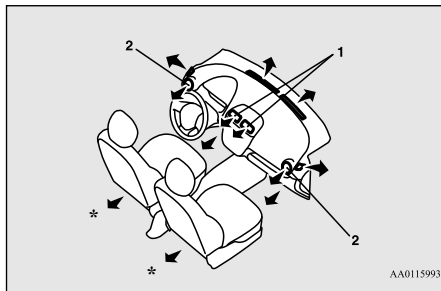

- *: Optional equipment
- 1- Center vents
- 2- Side vents

Air flow and direction adjustments

N00730200330

Center vents

Move the knob (A) to make adjustments.

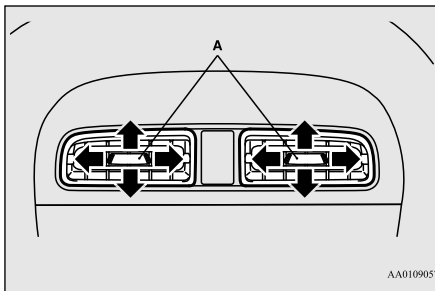

Side vents

When the dimple (A) is pressed, the vents open.
To close the vents, press the dimple on the opposite side.
Change the direction of the air flow by turning the vent itself.

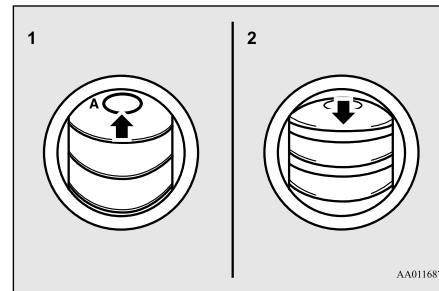

- 1- Open
- 2- Close

NOTE

- On rare occasions, air from the vents of an air-conditioned vehicle may be foggy. This is only moist air cooling suddenly and does not indicate a problem.
- Do not let drinks or other liquids get into the vents as they could prevent the air conditioning from operating normally.

Changing the mode selection

N00736400594

To change the position and amount of air flowing from the vents, turn the mode selection dial. Refer to “Mode selection dial” on page 7-5, 7-7.

On vehicles with the automatic air conditioning, press the MODE switch or defogger

switch. (Refer to “MODE switch” on page 7-13, “Defogger switch” on page 7-13.) These symbols are used in the next several illustrations to demonstrate the quantity of air coming from the vents.

- : Small amount of air from the vents
- ➔ : Medium amount of air from the vents
- ➡ : Large amount of air from the vents

Face position

Air flows only to the upper part of the passenger compartment.

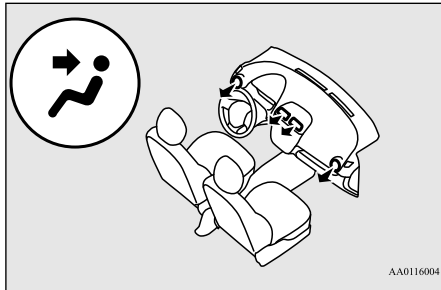

Foot/Face position

Air flows to the upper part of the passenger compartment, and flows to the leg area.

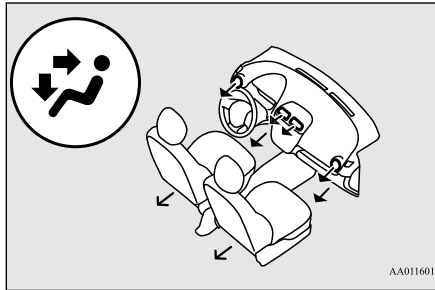

NOTE

- With the mode selection dial between the “↗” and “↘” positions, air flows mainly to the upper part of the passenger compartment. With the mode selection dial between the “↖” and “↙” positions, air flows mainly to the leg area.

Foot position

Air flows mainly to the leg area.

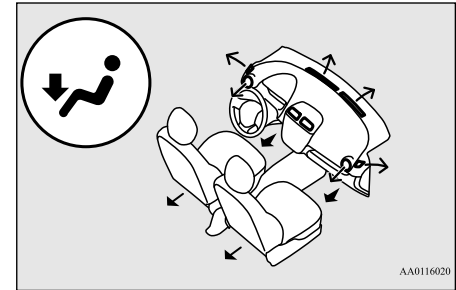



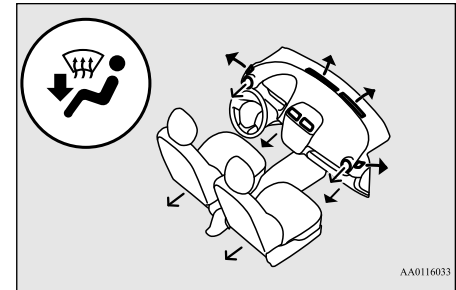

Foot/Defroster position

Air flows to the leg area, the windshield and the door windows.



Heater without air conditioning function (if so equipped)

NOTE

- With the mode selection dial between the “” and “” positions, air flows mainly to the leg area. With the mode selection dial between the “” and “” positions, air flows mainly to the windshield and the door windows.

Defroster position

7

Air flows mainly to the windshield and the door windows.

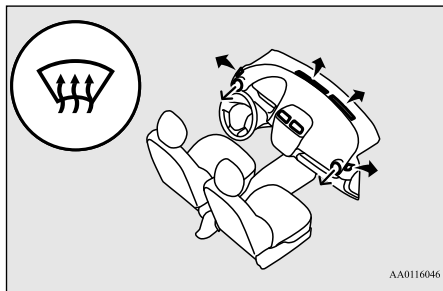

Heater without air conditioning function (if so equipped)

N00737700031

The heater can only be used while the engine is running.

Control panel

N00737800032

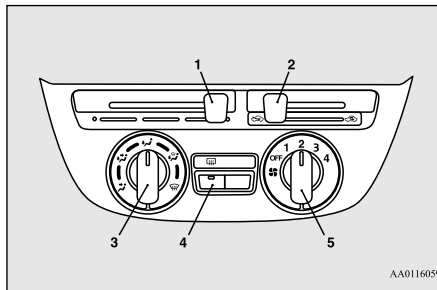

- 1- Temperature control lever
- 2- Air selection lever
- 3- Mode selection dial
- 4- Electric rear window defogger switch
→ P. 5-80
- 5- Blower speed selection dial

Blower speed selection dial

N00737900033

When the ignition switch is in the “ON” position, select the blower speed by turning the blower speed selection dial.

Turning the dial clockwise will increase the blower speed; turning the dial counterclockwise will decrease it. When the dial is set to the “OFF” position, all fan-driven airflow will stop.

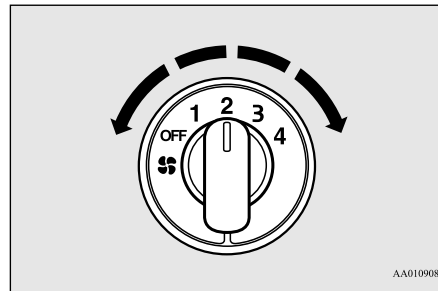

Temperature control lever

N00738000057

The temperature control lever is used to select the desired air temperature.

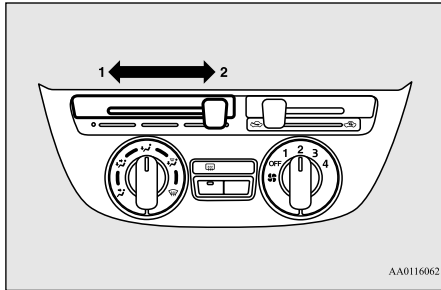

- 1- Cooler
- 2- Warmer

Mode selection dial

N00738100061

To change the amount of air flowing from the vents, turn the mode selection dial. Refer to “Changing the mode selection” on page 7-2.

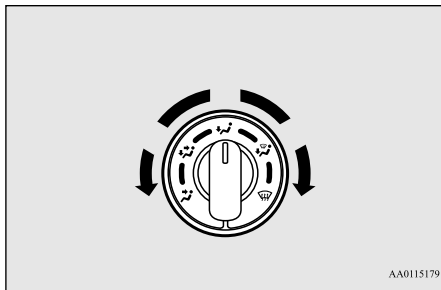



AA0115179

Air selection lever

N00738200046

Normally, use the outside air position to keep the windshield and side windows clear and to quickly remove fog or frost from the windshield.

To change the air selection, use the air selection lever.

- “” Outside air
- “” Recirculated air

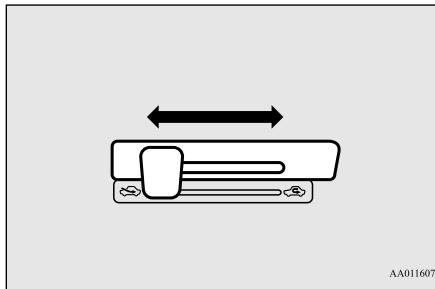

AA0116075

If the outside air is dusty or contaminated in some way, use the recirculation position. Switch to the outside air position every now and then to keep the windows from fogging up.

CAUTION

- Using recirculated air for a long time may cause the windows to fog up.

Operating the system

N00738300047

Heating

Set the mode selection dial to the “” position and set the air selection lever to the outside air position.

Set the temperature control lever to the desired temperature. Select the desired blower speed to fit your needs.

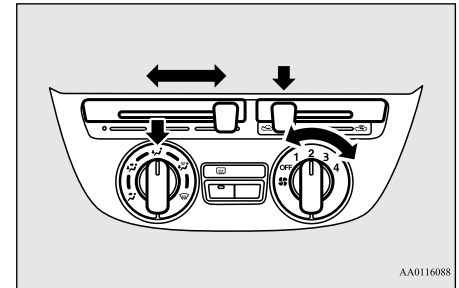

AA0116088

NOTE

- For quick heating, set the blower speed at the 3rd position.

Combination of unheated air and heated air

N00738400035

Set the mode selection dial to the positions shown in the illustration and set the air selection lever to the outside air position.

The air flow will be directed to the leg area and the upper part of the passenger compartment. Set the desired blower speed.

Warm air flows to the leg area and unheated or slightly warm air (depending upon the position of the temperature control lever) flows to the upper part of the passenger compartment.

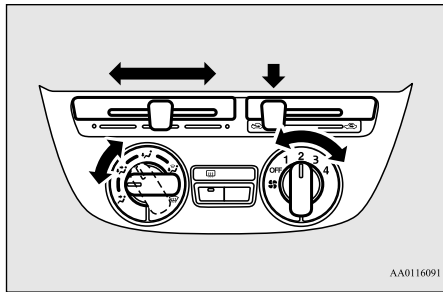

Defrosting or defogging (windshield, door windows)

N00738500081

CAUTION

- For safety, make sure you have a clear view through all the windows.

Set the mode selection dial (between “” and “”) to remove frost or mist from the windshield and door window.

For ordinary defrosting

Use this setting to keep the windshield and door windows clear of mist, and to keep the leg area heated (when driving in rain or snow).

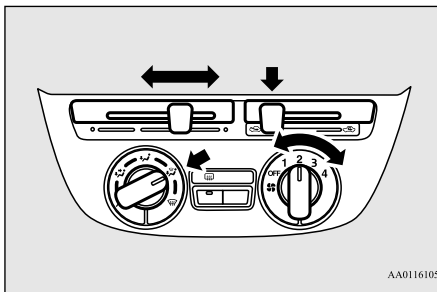

1. Set the mode selection dial to the “” position.

2. Set the air selection lever to the outside air position.
3. Select your desired blower speed by turning the blower speed selection dial.
4. Select your desired temperature by setting the temperature control lever.

For quick defrosting

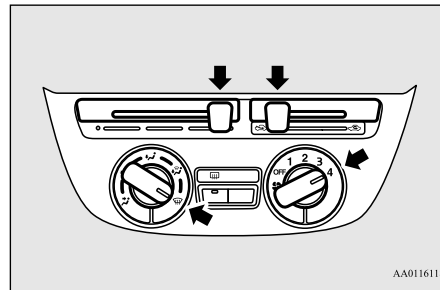

1. Set the mode selection dial to the “” position.
2. Set the air selection lever to the outside air position.
3. Set your blower to the maximum speed.
4. Set the temperature to the highest position.

NOTE

- To defog quickly, direct the air flow from the side vents toward the door windows.

Manual air conditioning (if so equipped)

N00730300344

The air conditioning can only be used while the engine is running.

Control panel

N00730500304

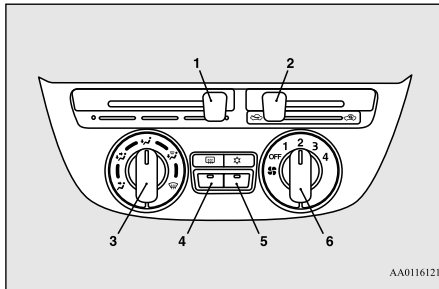

- 1- Temperature control lever
- 2- Air selection lever
- 3- Mode selection dial
- 4- Electric rear window defogger switch → P.5-80
- 5- Air conditioning switch
- 6- Blower speed selection dial

Blower speed selection dial

N00736500205

When the ignition switch or the operation mode is in ON, select the blower speed by turning the blower speed selection dial. Turning the dial clockwise will increase the blower speed; turning the dial counterclockwise will decrease it. When the dial is set to the “OFF” position, all fan-driven airflow will stop.

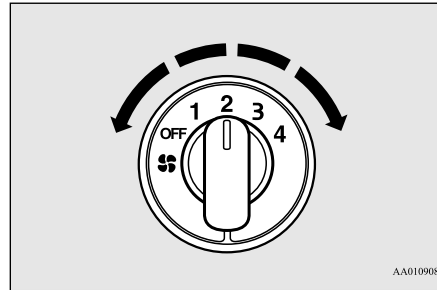

Temperature control lever

N00736600248

The temperature control lever is used to select the desired air temperature.

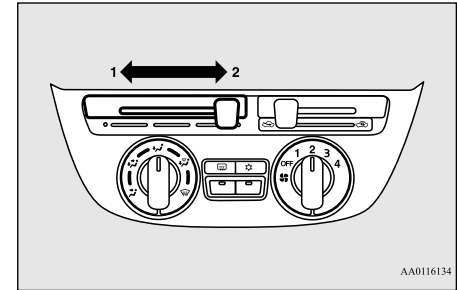

- 1- Cooler
- 2- Warmer

7

NOTE

- While the engine coolant temperature is low, the temperature of the air from the heater will be cool/cold until the engine warms up, even if you have selected warm air with the lever.

Mode selection dial

N00736700223

To change the amount of air flowing from the vents, turn the mode selection dial. Refer to “Changing the mode selection” on page 7-2.

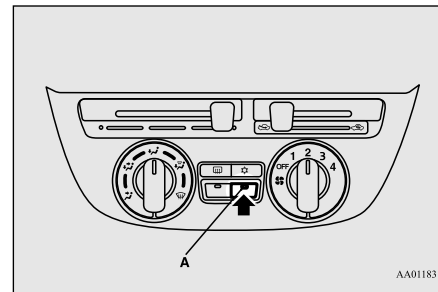
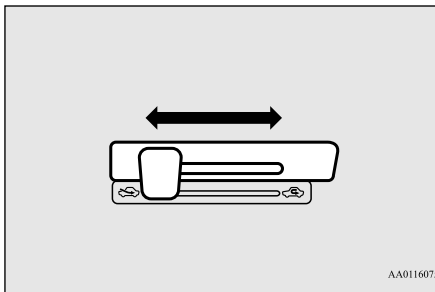
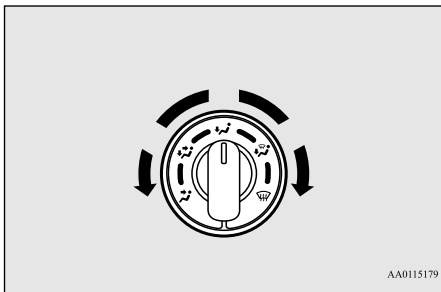

7

Air selection lever

N00736800413

Normally, use the outside air position to keep the windshield and side windows clear and to quickly remove fog or frost from the windshield.

To change the air selection, use the air selection lever.

- “” Outside air
- “” Recirculated air

If the outside air is dusty or contaminated in some way, use the recirculation position. Switch to the outside air position every now and then to keep the windows from fogging up.

CAUTION

- Using recirculated air for a long time may cause the windows to fog up.

Air conditioning switch

N00731000478

Push the switch, and the air conditioning compressor will turn on. The air conditioning indicator light (A) will come on.

Push the switch again and the air conditioning compressor will stop and the indicator light (A) goes off.

CAUTION

- Using the air conditioning slightly increases the engine idle speed. Therefore, make sure your foot is firmly on the brake pedal when shifting the transaxle into drive.

Operating the air conditioning system

N00731100264

Heating

Set the mode selection dial to the “” position and set the air selection lever to the outside air position.

Set the temperature control lever to the desired temperature. Select the desired blower speed to fit your needs.

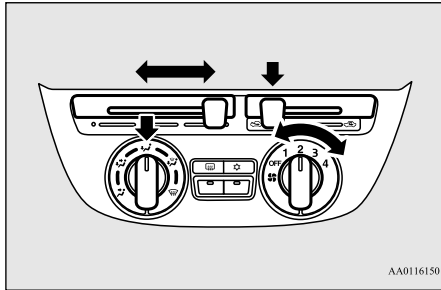

NOTE

- For quick heating, set the blower speed at the 3rd position.

Cooling

N00731200340

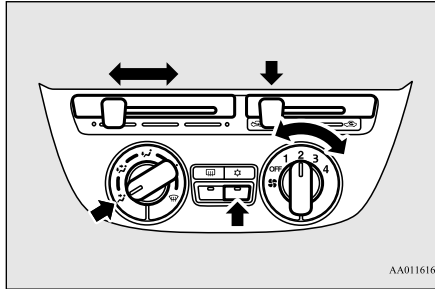

1. Set the mode selection dial to the “” position.
2. Set the air selection lever to the outside air position.
3. Push the air conditioning switch.
4. Change the temperature by setting the temperature control lever.
5. Set the desired blower speed.

NOTE

- If the outside air is dusty or contaminated in some way, set the air selection lever to the recirculation position. Let in some outside air from time to time for good ventilation.
- To cool the leg areas, set the mode selection dial to the “” position.

Combination of unheated air and heated air

N00731300282

Set the mode selection dial to the positions shown in the illustration and set the air selection lever to the outside air position.

The air flow will be directed to the leg area and the upper part of the passenger compartment. Set the desired blower speed. Warm air flows to the leg area and unheated or slightly warm air (depending upon the position of the temperature control lever) flows to the upper part of the passenger compartment.

7

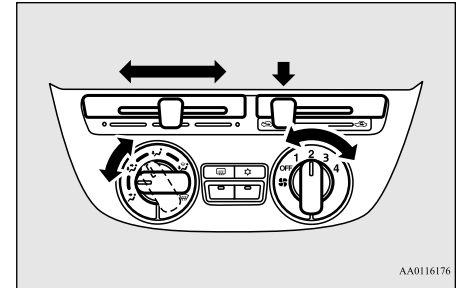

Defrosting or defogging (windshield, door windows)

N00731400560

⚠ CAUTION

- For safety, make sure you have a clear view through all the windows.

7 Set the mode selection dial (between “☀” and “☔”) to remove frost or mist from the windshield and door window.

For ordinary defrosting

Use this setting to keep the windshield and door windows clear of mist, and to keep the leg area heated (when driving in rain or snow).

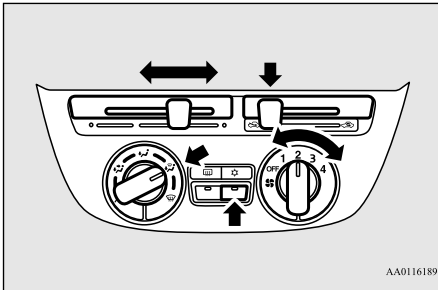

1. Set the mode selection dial to the “☔” position.

2. Set the air selection lever to the outside air position.
3. Select your desired blower speed by turning the blower speed selection dial.
4. Select your desired temperature by setting the temperature control lever.
5. Push the air conditioning switch.

For quick defrosting

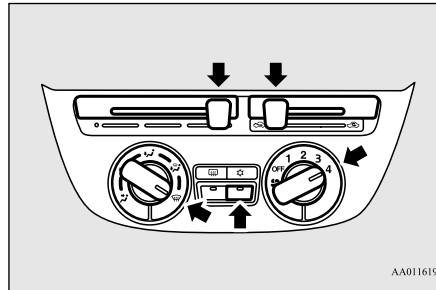

1. Set the mode selection dial to the “☔” position.
2. Set the air selection lever to the outside air position.
3. Set your blower to the maximum speed.
4. Set the temperature to the highest position.
5. Push the air conditioning switch.

📖 NOTE

- When defrosting, do not set the temperature control dial near the maximum cool position. This would blow cool air on the window glass and fog it up.

📖 NOTE

- To defog quickly, direct the air flow from the side vents toward the door windows.

Automatic air conditioning (if so equipped)

N00731500301

The air conditioning can only be used while the engine is running.

Control panel

N00711801624

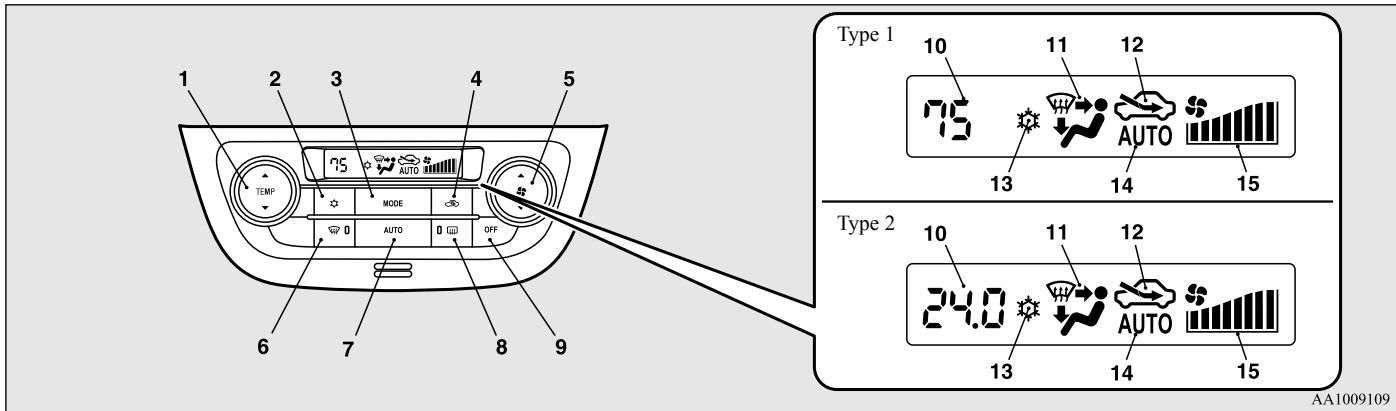

7

- 1- Temperature control switch
- 2- Air conditioning switch
- 3- MODE switch
- 4- Air selection switch
- 5- Blower speed selection switch
- 6- Defogger switch
- 7- AUTO switch
- 8- Electric rear window defogger switch

→ P.5-80

- 9- OFF switch
- 10- Temperature display
- 11- Mode selection display
- 12- Air selection indicator
- 13- Air conditioning indicator
- 14- AUTO indicator
- 15- Blower speed display

NOTE

- There is an interior air temperature sensor (A) in the illustrated position. Never place anything over the sensor, since doing so will prevent it from functioning properly.

NOTE

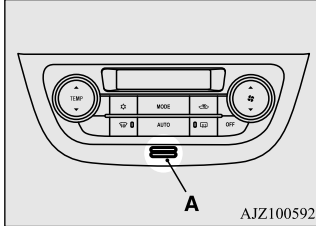

- A sound will be made every time you push any of the switches.

7

Blower speed selection switch

N00736900179

Press ▲ of the blower speed selection switch to increase the blower speed.

Press ▼ of the blower speed selection switch to decrease the blower speed.

The selected blower speed will be shown in the display (A).

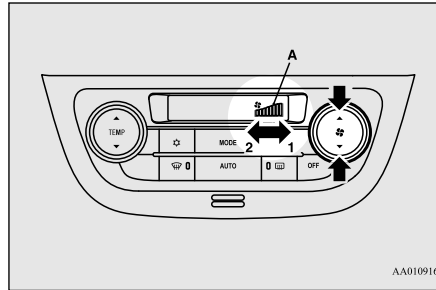

- 1- Increase
- 2- Decrease

Temperature control switch

N00737000324

Press ▲ or ▼ of the temperature control switch to the desired temperature.

The selected temperature will be shown in the display (A).

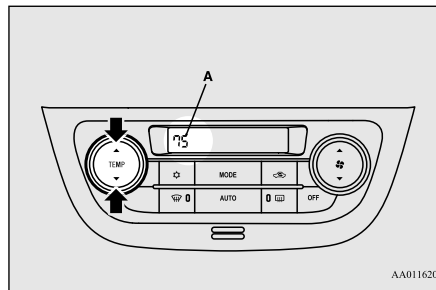

NOTE

- While the engine coolant temperature is low, the temperature of the air from the heater will be cool/cold until the engine warms up, even if you have selected warm air with the switch.

To prevent the windshield and windows from fogging up, the vent mode will be changed to “” and the blower speed will be reduced.

- When the temperature is set to the highest or the lowest setting under the AUTO operation, the air selection and the air conditioning will be automatically changed as follows.

- Quick Heating (When the temperature is set to the highest setting)

Outside air will be introduced and the air conditioning will stop.

If the air selection and the air conditioning are operated manually after an automatic changeover, manual operation will be selected.

- Quick Cooling (When the temperature is set to the lowest setting)

Inside air will be recirculated and the air conditioning will operate.

The above indicates the factory settings. You can personalize the air selection switch and air conditioning switch to match your personal preferences.

Contact your Mitsubishi Motors dealer or a repair facility of your choice for assistance.

Refer to “Personalizing the air conditioning switch (Changing the function setting)” on page 7-15.

Refer to “Personalizing the air selection (Changing the function setting)” on page 7-14.

MODE switch

N00737100208

To change the amount of air flowing from the vents, press the MODE switch. Each time the MODE switch is pressed, the mode changes to the next one in the following sequence: “” → “” → “” → “” → “”.

The selected mode is shown in the display (A). Refer to “Changing the mode selection” on page 7-2.

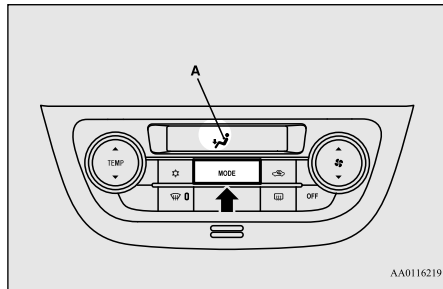

Defogger switch

N00703400015

When this switch is pressed, the mode changes to the “” mode. The indicator light (A) will come on. The selected mode is shown in the display (B). Refer to “Changing the mode selection” on page 7-2.

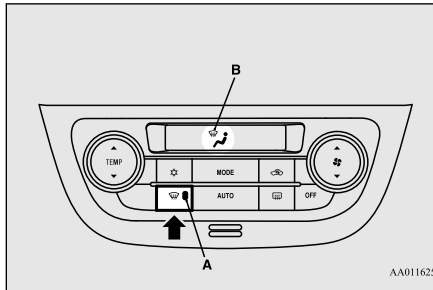

NOTE

- When the defogger switch is pressed, the air conditioning system automatically operates and outside air (as opposed to recirculated air) is selected.

Refer to “Defrosting or defogging (windshield, door windows)” on page 7-16.

Air selection switch

N00737200368

Normally, use the outside air position to keep the windshield and side windows clear and to quickly remove fog or frost from the windshield.

To change the air selection, simply press the air selection switch.

The selected position will be shown in the display (A).

- Outside air: “” indicator is ON
Outside air is introduced into the passenger compartment.
- Recirculated air: “” indicator is ON
Air is recirculated inside the passenger compartment.

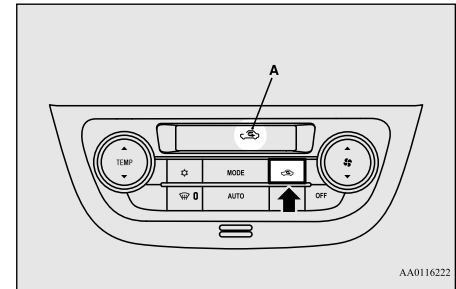

When the air conditioning turns on, the air selection is controlled automatically. When

Automatic air conditioning (if so equipped)

the air conditioning turns off, the air selection automatically goes back to the outside air position.

If high cooling performance is desired, or if the outside air is dusty or contaminated in some way, use the recirculation position. Switch to the outside air position every now and then to keep the windows from fogging up.

CAUTION

- Using recirculated air for a long time may cause the windows to fog up.

NOTE

- If you press the AUTO switch to select automatic control after manual operation, the air selection switch will also be automatically controlled.

Personalizing the air selection (Changing the function setting)

N0076000089

You can change the following functions to match your preference.

- Enable automatic air control:
When the AUTO switch is pressed, the air selection switch will also be automatically controlled.

- Disable automatic air control:
Even when the AUTO switch is pressed, the air selection switch will not be automatically controlled.
- Changing the settings
Press the air selection switch for about 10 seconds or longer.
When the setting has changed, the system will beep and the “” indicator will flash.
 - When the setting has changed from enabled to disabled, the system will beep three times and the indicator will flash three times.
 - When the setting has changed from disabled to enabled, the system will beep two times and the indicator will flash three times.

NOTE

- The factory setting is “Enable automatic air control”.
- When the defogger switch is pressed, the air selection will automatically change to the outside air position, even if the system is set to “Disable automatic air control”, in order to prevent windows from fogging up.

Air conditioning switch

N00737300343

Push the switch, and the air conditioning compressor will turn on. The “” indicator will be shown in the display (A).

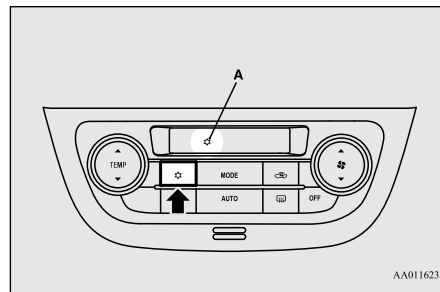

AA0116235

Push the switch again and the air conditioning compressor will stop and the indicator goes off.

CAUTION

- Using the air conditioning slightly increases the engine idle speed. Therefore, make sure your foot is firmly on the brake pedal when shifting the transaxle into drive.

Personalizing the air conditioning switch (Changing the function setting)

N00759800090

You can change the following functions to match your preference.

- **Enable automatic air conditioning control:**
When the AUTO switch is pressed, or when the temperature control switch has been set to the minimum temperature, the air conditioning switch is automatically controlled.
- **Disable automatic air conditioning control:**
The air conditioning switch is not automatically controlled, unless the air conditioning switch is used.
- **Changing the settings**
Press the air conditioning switch for about 10 seconds or longer.
When the setting has changed, the system will beep and the “⚙️” indicator will flash.
 - When the setting has changed from enabled to disabled, the system will beep three times and the indicator will flash three times.
 - When the setting has changed from disabled to enabled,

the system will beep two times and the indicator will flash three times.

NOTE

- The factory setting is “Enable automatic air conditioning control”.
- When the defogger switch is pressed, the air conditioning will run automatically, even if the system is set to “Disable automatic air conditioning control”, in order to prevent windows from fogging up.

AUTO switch

N00703500016

When the AUTO switch is pressed, the mode selection, blower speed adjustment, recirculated/outside air selection, temperature adjustment, and air conditioner ON/OFF status are all controlled automatically. The “AUTO” indicator will be shown in the display (A).

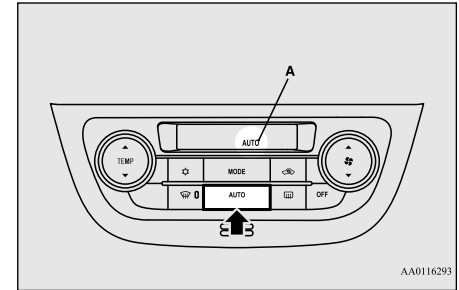

AA0116293

7

OFF switch

N00703600017

Push the switch to turn off the air conditioning system.

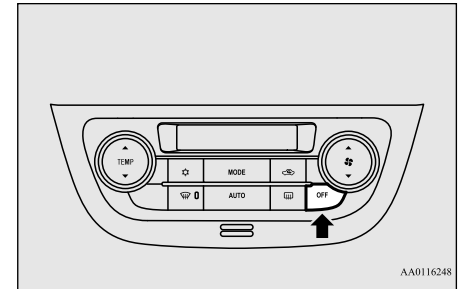

AA0116248

Operating the air conditioning system (automatic mode)

N00731700361

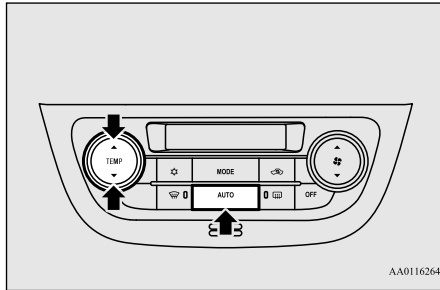

In normal conditions, use the system in the AUTO mode and follow these procedures:

1. Push the AUTO switch.
2. Set the temperature control switch to the desired temperature. The temperature can be set within a range of around 61 to 89 (Type 1) or 17 to 31 (Type 2).

The vents, recirculation/outside air, blower speed, temperature adjustment and ON/OFF of air conditioning will be controlled automatically.

NOTE

- Set the temperature at about 75 (Type 1) or 24 (Type 2) under normal conditions.

Operating the air conditioning system (manual mode)

N00731800115

Blower speed and vent mode may be controlled manually by setting the blower speed selection switch and the MODE switch to the desired positions. To return to automatic operation, press the AUTO switch.

Defrosting or defogging (windshield, door windows)

N00732400466

CAUTION

- For safety, make sure you have a clear view through all the windows.

To remove frost or mist from the windshield and door windows, use the MODE switch or defogger switch (“” or “”).

For ordinary defrosting

Use this setting to keep the windshield and door windows clear of mist, and to keep the

leg area heated (when driving in rain or snow).

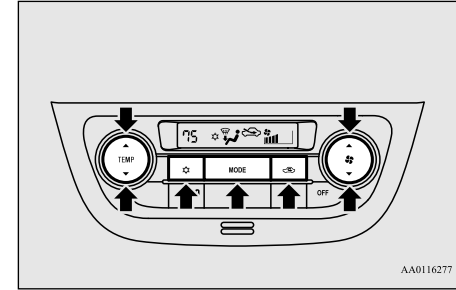

1. Set the MODE switch to the “” position.
2. Set the air selection switch to the outside air position.
3. Select your desired blower speed by pressing the blower speed selection switch.
4. Select your desired temperature by pressing the temperature control switch.
5. Push the air conditioning switch.

For quick defrosting

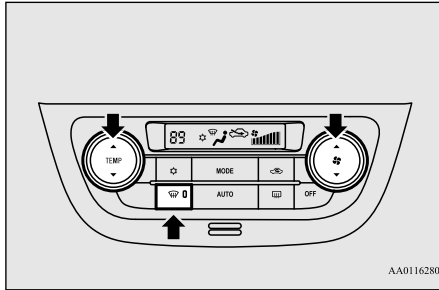

1. Push the defogger switch to change to the “☸” position.
2. Set your blower to the maximum speed.
3. Set the temperature to the highest position.

NOTE

- While the mode selection is set “☸” position, the air conditioning compressor will run automatically. The outside air position will also be selected automatically.
- If the mode selection is set “☸” position, you cannot turn the air conditioning off or select the recirculation position. This prevents the windows from fogging up.
- To defog quickly, direct the air flow from the side vents toward the door windows.
- When defrosting, do not set the temperature to the maximum cool position. This will blow cool air on the window glass and fog it up.

Important air conditioning operating tips

N00733700336

1. Park the vehicle in the shade whenever possible. Parking in the hot sun makes the vehicle interior extremely hot which then requires more time to cool. If it is necessary to park in the sun, open the windows for the first few minutes of air conditioning to expel the hot air.
2. Afterwards, keep the windows closed when the air conditioning is in use. The entry of outside air through open windows will reduce cooling efficiency.
3. When running the air conditioning, make sure the air intake, which is located in front of the windshield, is free of obstructions such as leaves. Leaves collected in the air-intake chamber may reduce air flow and plug the water drains.

Air conditioning system refrigerant and lubricant recommendations

If the air conditioning seems less effective than usual, the cause might be a refrigerant leak.

Have the system inspected by your authorized Mitsubishi Motors dealer or a repair facility of your choice.

CAUTION

- The air conditioning system in your vehicle must be charged with the refrigerant HFC-134a and the lubricant ZXL 200PG. Use of any other refrigerant or lubricant will cause severe damage and may require replacing your vehicle’s entire air conditioning system.
The release of refrigerant into the atmosphere is not recommended.
The new refrigerant HFC-134a in your vehicle is designed not to harm the earth’s ozone layer. However, it may contribute slightly to global warming.
It is recommended that the old refrigerant be saved and recycled for future use.

During a long period of disuse

The air conditioning should be operated for at least five minutes each week, even in cold weather. This includes the quick defrosting mode. Operating the air condition system weekly maintains lubrication of the compressor internal parts to keep the air conditioning in the best operating condition.

Air purifier (if so equipped)

Air purifier (if so equipped)

N00733800180

The air conditioning system is equipped with an air filter to remove pollen and dust.

The air filter's ability to collect pollen and dirt is reduced as it becomes dirty, so replace it periodically. For the maintenance interval, refer to the "WARRANTY AND MAINTENANCE MANUAL".

7

NOTE

- Operation in certain conditions such as driving on a dusty road and frequent use of the air conditioning can lead to reduction of service life of the filter. When you feel that the air flow is lower than normal or when the windshield or windows start to fog up easily, replace the air filter.

Contact your Mitsubishi Motors dealer or a repair facility of your choice for assistance.

AM/FM electronically tuned radio with CD player (if so equipped)

N00734302131

The audio system can only be used when the ignition switch or the operation mode is in ON or ACC.

NOTE

- To listen to the audio system while the engine is not running, turn the ignition switch to the "ACC" position or put the operation mode in ACC.

For vehicles equipped with the F.A.S.T.-key, if the operation mode is left in ACC, the accessory power will automatically turn off after a certain period of time and you will no longer be able to use the audio system. The accessory power comes on again if the engine switch is operated with it in the "ACC" position. Refer to "ACC power auto-cutout function" on page 5-14.

- If a cellular phone is used inside the vehicle, it may create noise in the audio equipment. This does not mean that anything is wrong with your audio equipment. In such a case, use the cellular phone at a place as far away as possible from the audio equipment.
- If foreign objects or water get into the audio equipment, or if smoke or a strange odor comes from it, immediately turn off the audio system and have it checked at an authorized Mitsubishi Motors dealer or a repair facility of your choice. Never try to repair it yourself. Avoid using the audio system until it is inspected by a qualified person.
- If the audio system is damaged by foreign objects, water, or fire, have the system checked by a qualified Mitsubishi Motors technician.

Volume and tone control panel

N00711900729

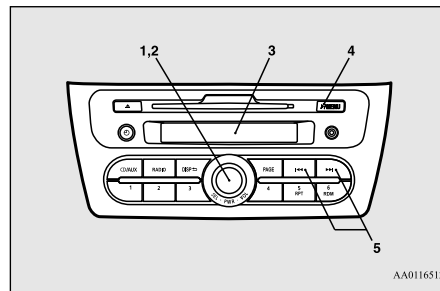

AA0116512

- 1- PWR (On-Off) switch
- 2- VOL (Volume control) knob
- 3- Display
- 4- /MENU (Mode change) button
- 5- Sound control button

To adjust the volume

N00712000411

Turn the VOL knob clockwise to increase the volume; counterclockwise to decrease the volume.

The status will be displayed in the display.

To adjust the tone

N00712100685

Press the **MENU** button to select BASS → TREBLE → FADER → BALANCE → Sound control mode off.

BASS (Bass tone control)

Press the sound control button either **◀◀** or **▶▶** to select the desired bass level.

TREBLE (Treble tone control)

Press the sound control button either **◀◀** or **▶▶** to select the desired treble level.

FADER (Front/Rear balance control) (if equipped with rear speakers)

Press the sound control button either **◀◀** or **▶▶** to balance the volume of sound from the front and the rear speakers.

BALANCE (Left/Right balance control)

Press the sound control button either **◀◀** or **▶▶** to balance the volume of sound from the left and the right speakers.

NOTE

- The sound control mode will be canceled when the another mode is selected or no adjustment is performed for more than 10 seconds.
- In a two-speakers vehicle, keep the FADER setting in the middle position. Since no rear speakers are connected, adjusting the FADER setting toward the “REAR” side will result in a loss of sound output.

Radio control panel and display

N00734900915

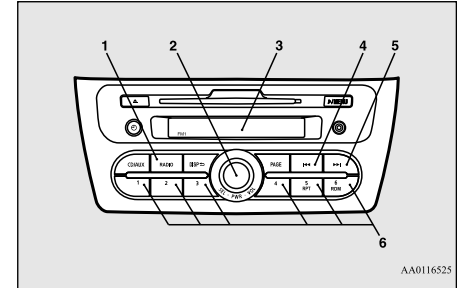

AA0116525

7

- 1- RADIO (AM/FM selection) button
- 2- PWR (On-Off) switch
- 3- Display
- 4- Seek (Down-seek) button
- 5- Seek (Up-seek) button
- 6- Memory select buttons

To listen to the radio

N00735000926

1. Press the PWR switch or the RADIO button to turn on the radio.
Press and hold the PWR switch for 2 seconds or longer to turn off the radio.
2. Press the RADIO button to select the desired band (AM/FM1/FM2).

AM/FM electronically tuned radio with CD player (if so equipped)

3. Press the seek button to tune to a station, or press one of the memory select buttons to tune in to a station memorized for that button.

Refer to “Automatic tuning”, “Manual tuning” or “To enter frequencies into the memory”.

To tune the radio

7

Manual tuning

The frequency changes every time the seek button is pressed. Press the button to select the desired station.

Automatic tuning

After keeping the seek button depressed until it beeps, release the button, and the selected station reception will start.

To enter frequencies into the memory

As many as 6 AM and 12 FM stations can be entered into the memory.

To store a frequency in the memory, follow these steps:

1. Press the seek button to tune to the frequency you wish to keep in the memory.
2. Press one of the memory select buttons until it beeps.
The sound will be momentarily interrupted while the frequency is being entered into the memory. The number of the button matching the entry in the memory as well as the frequency is displayed.
3. The preset memory setting is retrieved by pressing the button and then releasing it within 1 second.

CD control panel and display

N00735300756

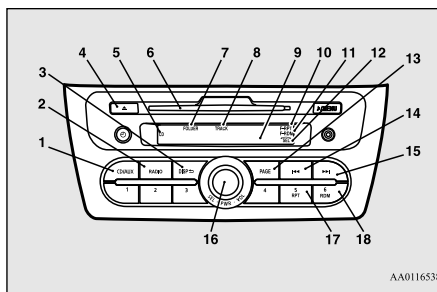

AA0116538

- 1- CD (CD mode changeover) button
- 2- RADIO button
- 3- DISP (Display)/↵ (Return) button
- 4- CD eject button
- 5- CD indicator
- 6- Disc-loading slot

- 7- FOLDER indicator
- 8- TRACK indicator
- 9- Display
- 10- RPT (Repeat)/F-RPT (Folder repeat mode) indicator
- 11- RDM (Random mode)/F-RDM (Folder random mode) indicator
- 12- SEL (Select) indicator
- 13- PAGE (Title scroll) button
- 14- ◀◀ (Fast-reverse/Track down) button
- 15- ▶▶ (Fast-forward/Track up) button
- 16- PWR (On-Off)/SEL (Select) switch
- 17- RPT (Repeat) button
- 18- RDM (Random) button

To listen to a CD

N00735501087

To set a disc

1. Insert the disc with the label facing up.
When a disc is inserted, the CD indicator will come on and the CD player will begin playing even if the radio is being used. The CD player will also start playback when the CD button is pressed with a disc in the player or with a disc set in the Disc-loading slot, even if the radio is being used.

2. To stop the CD, turn off the power by pressing the PWR switch for 2 seconds or longer, or change over to the radio mode by pressing the RADIO button, or eject the disc by pressing the eject button.

NOTE

- For information on adjusting the volume and tone, refer to “To adjust the volume” on page 7-18 and “To adjust the tone” on page 7-19.
- 3 inches (8 cm) compact disc cannot be played on this CD player.
- For information concerning the handling of compact discs, refer to “Handling of compact discs” on page 7-40.

To eject a disc

When the CD eject button is pressed, the disc automatically stops and is ejected.

NOTE

- If you do not remove the disc before 15 seconds have elapsed, the CD player will automatically reload the disc and stop.

To listen to a music CD

Press the CD button if a disc is already in the CD player. The CD player will enter CD

mode and start playback. The track number and the playing time will appear on the display. The tracks in the disc will be played continuously.

To listen to an MP3 CD

This CD player allows you to play MP3 (MPEG Audio Layer-3) files recorded on CD-ROMs, CD-Rs (recordable CDs), and CD-RWs (rewritable CDs) in ISO9660 Level 1/Level 2, Joliet, and Romeo formats. Each disc can hold up to 255 files in up to 100 folders, up to a maximum of 16 levels. The ID3 tag information can be displayed during MP3 playback. For information concerning ID3 tags, refer to “CD text and MP3 title display” on page 7-23.

1. Insert a disc containing MP3 files into the slot.
2. Press the CD button if a disc is already in the CD player.
The display shows “READING”, then playback will begin.

NOTE

- While listening to a disc on which CD-DA (CD-Digital Audio) and MP3 files have both been recorded, you can switch between reading of the CD-DA, reading of the MP3 files, and the external audio input mode by pressing the CD button for 2 seconds or longer (until you hear a beep).
For information on the external audio input, refer to “To use the external audio input function” on page 7-26.
- With a disc that contains both CD-DA and MP3 files, the CD-DA files are automatically played first.
- The playback sound quality differs depending on the encoding software and the bit rate. For details, refer to the user manual of your encoding software.
- Depending on file/folder configurations on a disc, it may take some time before playback starts.
- MP3 encode software and writing software are not supplied with this unit.
- You may encounter trouble in playing an MP3 or displaying the information of MP3 files recorded with certain writing software or CD recorders (CD-R/RW drivers).
- If you record too many folders or files other than MP3 onto a disc, it may take some time before playback starts.
- This unit does not record MP3 files.
- For information on CD-Rs/RWs, refer to “Notes on CD-Rs/RWs” on page 7-41.

⚠ CAUTION

- Attempting to play a file not in the MP3 format which has the “.mp3” file name may produce noise from the speakers and speaker damage, and can damage your hearing.

Folder selection order/MP3 file playback order (Example)

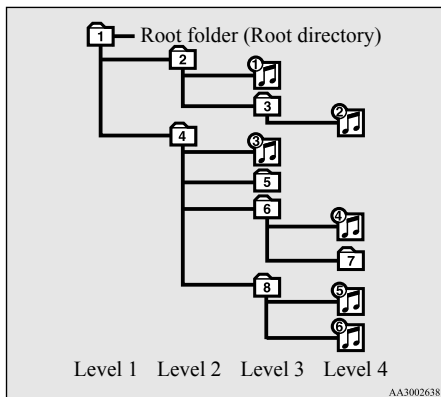

Folder selection
in the order

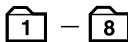

File selection
in the order



To fast-forward/reverse the disc

Fast-forward

The disc is fast-forwarded while the ►►| button is held down. Playback will begin once the button is released.

Fast-reverse

The disc is fast-reversed while the |◄◄ button is held down. Playback will begin once the button is released.

To select a desired track

Track up

The disc will skip as many songs as the number of times the button ►►| is pressed. The display window will display the track number of the track selected.

Track down

The disc will skip as many songs as the number of times the button |◄◄ is pressed. The display window will display the track number of the track selected.

To find a file (MP3 CDs only)

Operate the SEL switch to select desired file. When this mode is activated by pressing the SEL switch, the SEL indicator will be displayed in the display.

Press the SEL switch :To start this mode or to select the folder or file.

Turn the SEL switch :To show the folder or file

📖 NOTE

- To cancel the selection, press the ↵ button to return to the previous step.
- If no operation is performed for 10 seconds or more or other button is operated after the SEL switch has been turned, searching of the desired file is canceled.
- If no operation is performed for 5 seconds or more after the file is displayed, playback starts.
- When the SEL indicator is not shown on the display and the SEL switch is operated, the volume adjustment is activated.

To repeat tracks

To repeat a track

Press the RPT button to repeat the same track. If the RPT button is pressed, the RPT indicator will come on.
To exit this mode, press the button again.

To repeat songs in the same folder (MP3 CDs only)

While a song is playing, press the RPT button for 2 seconds or longer (until you hear a beep). The F-RPT indicator will come on and the disc will repeat all the songs in the folder that contains the song currently playing.
To exit this mode, press the button again.

NOTE

- With a disc that contains both CD-DA and MP3 files, the repeat mode causes only files of the same format (CD-DA only or MP3 files only) to be repeated.

To change the order of tracks for playback

Random playback for a disc (music CDs only)

If the RDM button is pressed, the RDM indicator will come on and the tracks that are played will be selected at random.
To exit this mode, press the button again.

Random playback for a folder (MP3 CDs only)

If the RDM button is pressed, the F-RDM indicator will come on and the tracks that are played will be selected at random from the folder that is currently selected.
To exit this mode, press the button again.

Random playback for all folders on a disc (MP3 CDs only)

Press the RDM button for 2 seconds or longer (until you hear a beep). The RDM indicator will come on and the tracks that are played will be selected at random from all folders on the disc currently selected.
To exit this mode, press the button again.

NOTE

- With a disc that contains both CD-DA and MP3 files, the random mode causes only files of the same format (CD-DA only or MP3 files only) to be played in a random sequence.

CD text and MP3 title display

N00752100179

This CD player can display CD text and MP3 titles, including ID3 tag information.

CD text

The CD player can display disc and track titles for discs with converted disc and track title information. Press the DISP button repeatedly to make selections in the following sequence: disc name → track name → normal display mode.

NOTE

- The display can show up to 11 characters. If a disc name or track name has more than 11 characters, press the PAGE button to view the next 11 characters.
- When there is no title information to be displayed, the display shows “NO TITLE”.
- Characters that the CD player cannot display are shown as “•”.

MP3 titles

The CD player can display folder and file titles for discs with converted folder and file information. Press the DISP button repeatedly to make selections in the following sequence: folder name → file name → normal display mode.

ID3 tag information

The CD player can display ID3 tag information for files that have been recorded with ID3 tag information.

1. Press the DISP button for 2 seconds or longer to switch to the ID3 tag information.
2. Press the DISP button repeatedly to make selections in the following sequence: album TAG → track TAG → artist TAG → normal display mode.

NOTE



- To return from ID3 tag information to the folder name, press the DISP button again for 2 seconds or longer.
- When there is no title information to be displayed, the display shows “NO TITLE”.

NOTE

- The display can show up to 11 characters. If a folder name, track name, or item of ID3 tag information has more than 11 characters, press the PAGE button to view the next 11 characters.
- Characters that the CD player cannot display are shown as “*?”.

To display the clock

N0070260010

Press the  button to switch the clock mode. To exit the clock mode, press the  button.

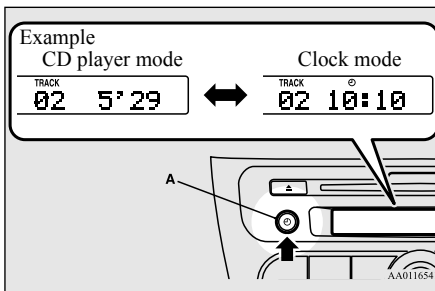

A-  (Clock) button

NOTE

- While the clock mode is selected, the display will switch to the applicable operation display whenever the CD player, external audio input mode or radio, etc. is operated. Then, if no entries are made for 7 seconds, the display will automatically return to the clock mode.

To adjust the clock

N00702700011

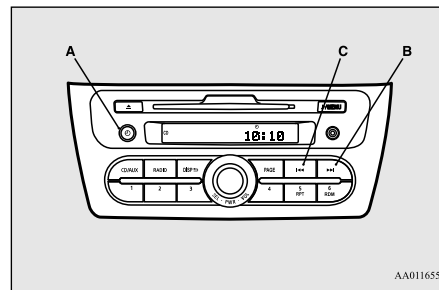



AA0116554



A-  (Clock) button

B-  (Clock adjustment up) button

C-  (Clock adjustment down) button

1. Press and hold the  button and the clock display flashes.
2. Press the  or  button to adjust the “hours” digit.

If you keep pressing the button, fast-forward begins.

- When the “hours” digit is adjusted, press the  button to flash the “minutes” digit. Press the  or  button to adjust the “minutes” digit.

If you keep pressing the button, fast-forward begins.

- When the time is set, press the  button to stop the clock display from flashing.



 **NOTE**

- Reset the time after the battery terminals are disconnected and reconnected.
- Seconds do not appear in the clock display, but after adjusting the “minutes” setting, the clock begins to operate from 0 seconds.

To confirm the version number of the Gracenote DB (vehicles with a Bluetooth® 2.0 interface)

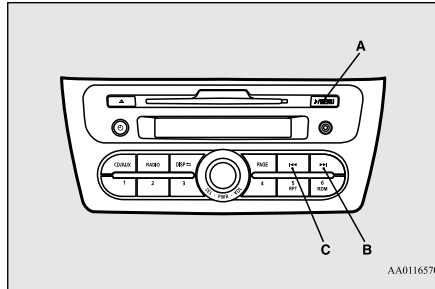

N00702800012



- A-  /MENU button
- B-  button
- C-  button

- Press and hold the  /MENU button until you hear a beep. “GracenoteDB” will appear on the display.

Each time the  /MENU button is pressed, this switches in the order Gracenote DB, PHONE SET and cancel.



- Press the  or  buttons several times to select “DB Version” and then press the  /MENU button to determine. The Gracenote DB version is displayed.

To change the language (vehicles with Bluetooth® 2.0 interface)

N00702900013

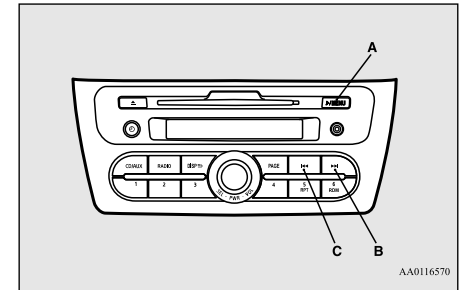

It is possible to set the language used for voice control.



- A-  /MENU button
- B-  button
- C-  button

- Press and hold the  /MENU button until you hear a beep. “GracenoteDB” will appear on the display.

- Press the  /MENU button to select “PHONE SET”.

Then press the  or  buttons several times to select “LANGUAGE” and then press the  /MENU button to determine.

3. Press the ►►| or |◄◄ buttons to select “LangChg YES” and then press the **♪**/MENU button to determine.
4. Press the ►►| or |◄◄ buttons to select language and then press the **♪**/MENU button to determine.
5. Press the ►►| or |◄◄ buttons to select “LangSet YES” and then press the **♪**/MENU button to determine.

7 To use the external audio input function

N0070300011

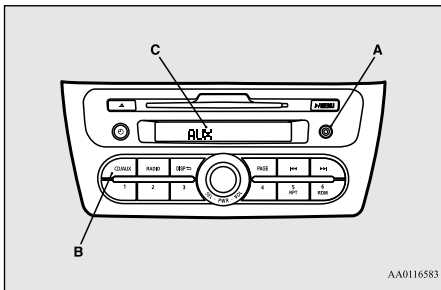

AA0116583

- A- Auxiliary Audio connector (Mini-jack)
- B- AUX button
- C- Display

You can listen to commercially available audio equipment, such as a portable audio system, from your vehicle’s speakers, by con-

necting the audio equipment to the auxiliary audio connector.

NOTE

- Use a stereo mini-jack connector to connect the audio equipment to the auxiliary audio connector.

To activate the external audio input mode

1. Connect the headphone port of the portable audio system to the auxiliary audio connector using a commercially available connection cord.
2. Press the AUX button several times to switch to the AUX mode. The display will show “AUX” and then the external audio input mode will be activated.
3. To deactivate the external audio input mode, press the AUX button to switch to another mode.

CAUTION

- Do not operate the connected audio equipment while driving. This could distract you and an accident might occur.

NOTE

- The connected audio equipment cannot be adjusted using the vehicle’s audio system.
- Depending on the connected audio equipment, it may produce noise from the speakers.
- Use the connected audio equipment’s own power source, such as its battery. Noise may be produced from the speakers if the connected audio equipment is used while charging it using the accessory socket of the vehicle.
- Do not activate the external audio input mode when no audio equipment is connected. Otherwise, noise may be produced from the speakers.
- Connect audio equipment when the external audio input mode is deactivated or lower the vehicle’s speaker volume before connecting it. Noise may be produced from the speakers if audio equipment is connected after the external audio input mode is activated.
- Compared to the CD player mode and radio mode, the vehicle’s speaker volume will be lower in the external audio input mode. Therefore, be careful when switching from the external audio input mode to the CD player mode or radio mode since the speaker volume will be higher.
- Do not use excessive force on the connection cord. Otherwise, the cord and connectors may be damaged.

NOTE

- If the connection cord alone is left connected to the auxiliary audio connector, noise may be produced from the speakers.
- For information on how to connect and operate the commercially available audio equipment, refer to the owner's manual for the commercially available audio equipment.

To play tracks from USB device (if so equipped)

N00762200056

You can connect your iPod or USB memory device to the USB input terminal and play music files stored in the iPod or USB memory device.

See the following section for the types of connectable devices and supported files. Refer to "Types of connectable devices and supported file specifications" on page 5-103. See the following sections for the connecting methods, "How to connect an iPod" on page 5-102 and "How to connect a USB memory device" on page 5-101.

If your vehicle is equipped with a Bluetooth® 2.0 interface, you can play music files in your iPod or USB memory device via voice operation.

Refer to "To play iPod tracks via voice operation" on page 7-29 and "To play USB mem-

ory device tracks via voice operation" on page 7-35.

NOTE

- A file protected by copyright might not be able to playback.
- It is recommended to adjust the equalizer of the connected device to 0 db or neutral.

iPod control panel and display

N00762300060

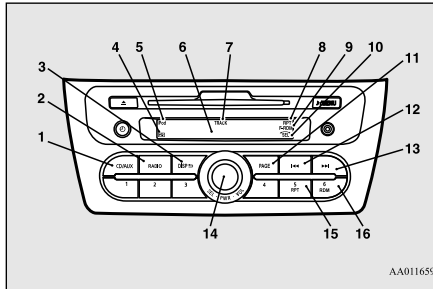

- 1- CD (Mode changeover) button
- 2- RADIO button
- 3- DISP (Title display)/↩ (Return) button
- 4- (USB device active) indicator
- 5- iPod indicator
- 6- Display
- 7- TRACK indicator
- 8- RPT (Repeat mode) indicator

- 9- RDM (Random mode)/F-RDM (Folder random mode) indicator
- 10- SEL (Select) indicator
- 11- PAGE (Title scroll) button
- 12- ◀◀ (Fast-reverse/Track down) button
- 13- ▶▶ (Fast-forward/Track up) button
- 14- PWR (On-Off)/SEL (Select) switch
- 15- RPT (Repeat) button
- 16- RDM (Random) button

To play from an iPod

N00762400087

1. Press the PWR switch to turn on the audio system. The system turns on in the last mode used.
2. Connect your iPod to the USB input terminal. Refer to "How to connect an iPod" on page 5-102.
3. Press the CD button several times to switch to the iPod mode. The input mode changes as follows every time the CD button is pressed: CD mode → iPod mode → Bluetooth® mode (if so equipped) → AUX mode → CD mode. The iPod indicator are illuminated and then the iPod mode will be activated.
4. Once the device is selected, playback starts and (USB device active) indicator appears on the display.



To play tracks from USB device (if so equipped)

NOTE

- Depending on the condition of your iPod, it may take a longer time before the playback starts.

5. To stop the playback, press the RADIO button or CD button to switch to a different mode.

NOTE

- Buttons on the iPod are disabled while the iPod is connected to the audio system.
- To adjust the volume and tone, refer to “To adjust the volume” on page 7-18 and “To adjust the tone” on page 7-19.

To fast-forward/reverse the track

N00762500033

To fast-forward/reverse the current track, press the ►► button or ◀◀ button.

Fast-forward

To fast-forward the current track, press the ►► button. While the button is kept pressed, the track will be fast-forwarded.

Fast-reverse

To fast-reverse the current track, press the ◀◀ button. While the button is kept pressed, the track will be fast-reversed.

To select a desired track

N00762600034

Track up

Press the ►► button repeatedly until the desired track number appears on the display.

Track down

Press the ◀◀ button repeatedly until the desired track number appears on the display.

NOTE

- Pressing the ◀◀ button once during the song will cause the audio system to restart playback from the beginning of the song.

To find a track from the iPod menu

N00762700077

You can select desired tracks from the “Playlists”, “Artists”, “Albums”, “Songs” or

“Genre” (vehicles with Bluetooth® 2.0 interface) menus on your iPod.

Operate the SEL switch to select desired tracks.

The selected menu or category or track is shown in the display.

When this mode is activated by pressing the SEL switch, the SEL indicator will be displayed in the display.

Press the SEL switch :To start this mode or to select the menu or category or track.

Turn the SEL switch :To show the menu or category or track.

NOTE

- To cancel the selection, press the ↵ button to return to the previous step.
- If no operation is performed for 10 seconds or more or other button is operated after the SEL switch has been pressed, searching of the desired tracks is canceled.
- If no operation is performed for 5 seconds or more after the track is displayed, playback starts.
- When the SEL indicator is not shown on the display and the SEL switch is operated, the volume adjustment is activated.

To play the same track repeatedly

N00762800023

Press the RPT button during playback to show “RPT” in the display.
To exit this mode, press the button again.

To play tracks in random order

N00762900024

Press the RDM button to show “RDM” in the display.
The iPod randomly selects tracks from the current category and plays the selected tracks.
To exit this mode, press the button again.

To play tracks in each album in random order

N00763000035

Press and hold the RDM button until you hear a beep to show “F-RDM” in the display.
The iPod randomly selects tracks in the album from the current category and play the selected tracks.
To exit this mode, press the button again.

To switch the display

N00763100049

You can display the track titles, artist names, genre and album titles recorded in the iPod.
The display changes as follows every time the DISP button is pressed during playback:

Album title → Track name → Artist name → Genre (vehicles with Bluetooth® 2.0 interface) → Normal display.

NOTE

- Up to 11 characters are shown in the display at once. If the title is cut off in the middle, press the PAGE button. The next characters are displayed every time this button is pressed.
- If no title is stored, “NO TITLE” is shown in the display.
- Characters that cannot be displayed are substituted by “.”.

To play iPod tracks via voice operation (vehicles with Bluetooth® 2.0 interface)

N00763200040

Desired tracks can be selected and played from your iPod by “Artist”, “Album”, “Playlist” and “Genre” using voice commands.
For information concerning the voice recognition function or speaker registration function, refer to “Bluetooth® 2.0 interface” on page 5-81.
The following explains how to prepare for voice operation and play the tracks.

Preparation for voice operation

N00763300067

To use the voice operation, press the SPEECH button (A) first.

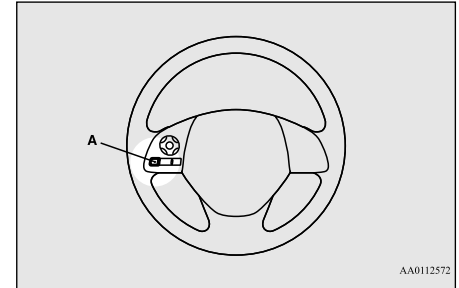

7

To search by artist name

N00763400039

1. Say “Play” on the main menu.

NOTE

- The Bluetooth® 2.0 interface starts recognizing the connected device.
If the connected device cannot be recognized or a connection error occurs, the Bluetooth® 2.0 interface starts an appropriate voice guide. Follow the voice guide.

To play tracks from USB device (if so equipped)

2. After the voice guide says “Would you like to play by Artist, Album, Playlist or Genre?,” say “Artist”.

NOTE

- If you say “Artist <name>,” you can skip step 3.

3. After the voice guide says “What Artist would you like to play?,” say the artist name.
4. If there is only one match, the system proceeds to step 6.
5. If there are two or more matches, the voice guide will say “More than one match was found, would you like to play <artist name>?” If you say “Yes,” the system proceeds to step 6.
If you say “No,” the next matching artist is uttered by the system.

NOTE

- If you say “No” to three or all artist names uttered by the system, the voice guide will say “Artist not found, please try again” and the system returns to step 2.
- Search time depends on the number of songs on your connected device. Devices containing a large number of songs may take longer to return search results.

6. After the voice guide says “Playing <artist name>,” the system creates a playlist index for the artist.

NOTE

- If the confirmation function is active, the voice guide confirms if the artist name is correct. If the artist name is correct, say “Yes”. If not, say “No”. After the voice guide says “Artist not found, please try again,” the system returns to step 2.

7. The system exits the voice recognition mode and starts playback.

To search by album title

N00763500030

1. Say “Play” on the main menu.

NOTE

- The Bluetooth[®] 2.0 interface starts recognizing the connected device.
If the connected device cannot be recognized or a connection error occurs, the Bluetooth[®] 2.0 interface starts an appropriate voice guide. Follow the voice guide.

2. After the voice guide says “Would you like to play by Artist, Album, Playlist or Genre?,” say “Album”.

NOTE

- If you say “Album <title>,” you can skip step 3.

3. After the voice guide says “What Album would you like to play?” say the album title.
4. If there is only one match, the system proceeds to step 6.
5. If there are two or more matches, the voice guide will say “More than one match was found, would you like to play <album title>?” If you say “Yes,” the system proceeds to step 6.
If you say “No,” the name of the next matching album is uttered by the system.

NOTE

- If you say “No” to three or all album titles uttered by the system, the voice guide will say “Album not found, please try again” and the system returns to step 2.

6. After the voice guide says “Playing <album title>,” the system creates a playlist index for the album title.

 **NOTE**

- If the confirmation function is active, the voice guide confirms if the album title is correct. If the album title is correct, say “Yes”. If not, say “No”. After the voice guide says “Album not found, please try again,” the system returns to step 2.

7. The system exits the voice recognition mode and starts playback.

To search by playlist

N00763600031

1. Say “Play” on the main menu.

 **NOTE**

- The Bluetooth® 2.0 interface starts recognizing the connected device. If the connected device cannot be recognized or a connection error occurs, the Bluetooth® 2.0 interface starts an appropriate voice guide. Follow the voice guide.

2. After the voice guide says “Would you like to play by Artist, Album, Playlist or Genre?,” say “Playlist”.

 **NOTE**

- If you say “Playlist <playlist>,” you can skip step 3. If the device has no playlist, the voice guide will say “There are no playlists stored on device” and the system returns to step 2.

3. After the voice guide says “What Playlist would you like to play?,” say the playlist name.
4. If there is only one match, the system proceeds to step 6.
5. If there are two or more matches, the voice guide will say “More than one match was found, would you like to play <playlist>?” If you say “Yes,” the system proceeds to step 6. If you say “No,” the next matching playlist name is uttered by the system.

 **NOTE**

- If you say “No” to three or all playlist names uttered by the system, the voice guide will say “Playlist not found, please try again” and the system returns to step 2.

6. After the voice guide says “Playing <playlist>,” the system creates an index for the playlist.

 **NOTE**

- If the confirmation function is active, the voice guide confirms if the playlist name is correct. If the playlist name is correct, say “Yes”. If not, say “No”. After the voice guide says “Playlist not found, please try again,” the system returns to step 2. Refer to “Confirmation function setting” on page 5-85.

7. The system exits the voice recognition mode and starts playback.

To search by genre

N00763700032

1. Say “Play” on the main menu.

 **NOTE**

- The Bluetooth® 2.0 interface starts recognizing the connected device. If the connected device cannot be recognized or a connection error occurs, the Bluetooth® 2.0 interface starts an appropriate voice guide. Follow the voice guide.

2. After the voice guide says “Would you like to play by Artist, Album, Playlist or Genre?,” say “Genre”.

 **NOTE**

- If you say “Genre <type>,” you can skip step 3.

To play tracks from USB device (if so equipped)

3. After the voice guide says “What Genre would you like to play?,” say the music type.
4. If there is only one match, the system proceeds to step 6.
5. If there are two or more matches, the voice guide will say “More than one match was found, would you like to play <genre>?” If you say “Yes,” the system proceeds to step 6.
If you say “No,” the next matching genre is uttered by the system.

NOTE

- If you say “No” to three or all genres uttered by the system, the voice guide will say “Genre not found, please try again” and the system returns to step 2.

6. After the voice guide says “Playing <genre>,” the system creates an index for the genre.

NOTE





- If the confirmation function is active, the voice guide confirms if the genre is correct. If the genre is correct, say “Yes”. If not, say “No”. After the voice guide says “Genre not found, please try again,” the system returns to step 2. Refer to “Confirmation function setting” on page 5-85.

7. The system exits the voice recognition mode and starts playback.

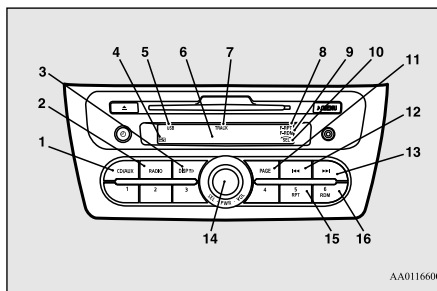
USB control panel and display

N00763900063



- 1- CD (Mode changeover) button
- 2- RADIO button
- 3- DISP (Title display)/ (Return) button
- 4-  (USB device active) indicator
- 5- USB indicator
- 6- Display
- 7- TRACK indicator
- 8- RPT (Repeat mode)/F-RPT (Folder repeat mode) indicator
- 9- RDM (Random mode)/F-RDM (Folder random mode) indicator
- 10- SEL (Select) indicator
- 11- PAGE (Title scroll) button
- 12-  (Fast-reverse/Track down) button
- 13-  (Fast-forward/Track up) button

- 14- PWR (On-Off)/SEL (Select) switch
- 15- RPT (Repeat) button
- 16- RDM (Random) button

To play from a USB memory device

N00764000087

1. Press the PWR switch to turn on the audio system. The system turns on in the last mode used.
2. Connect your USB memory device to the USB input terminal.
Refer to “How to connect a USB memory device” on page 5-101.
3. Press the CD button several times to switch to the USB mode. The input mode changes as follows every time the CD button is pressed: CD mode → USB mode → Bluetooth® mode (if so equipped) → AUX mode → CD mode.
The USB indicator are illuminated and then the USB mode will be activated.
4. Once the device is selected, playback starts and  indicator appears on the display.

NOTE

- Depending on the condition of your USB device, it may take a longer time before the playback starts.

5. To stop the playback, press the RADIO button or CD button to switch to a different mode.

NOTE

- To adjust the volume and tone, refer to “To adjust the volume” on page 7-18 and “To adjust the tone” on page 7-19.

Supported compressed music files

N00764100105

This audio can play MP3, WMA and AAC files recorded in a USB memory device. This audio supports up to 65,535 files in 700 folders on 8 levels.

Folder selection order/file playback order (example)

The folder and file hierarchy in the USB memory device is shown below.

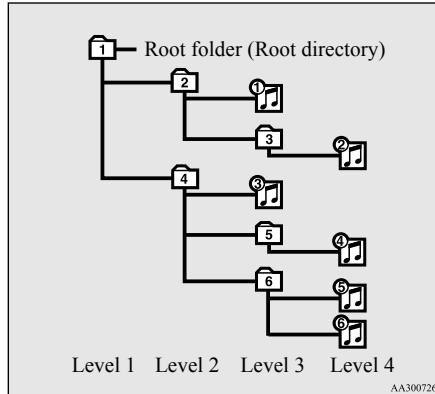

Folder selection

In the order

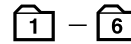

File selection

In the order



NOTE

- If a file protected by copyrights is played, the file will be skipped.

To fast-forward/reverse the track

N00764200034

To fast-forward/reverse the current track, press the ►►| button or |◄◄ button.

Fast-forward

To fast-forward the current track, press the ►►| button. While the button is kept pressed, the track will be fast-forwarded.

Fast-reverse

To fast-reverse the current track, press the |◄◄ button. While the button is kept pressed, the track will be fast-reversed.

To select a file

N00764300035

Track up

Press the ►►| button repeatedly until the desired file number appears on the display.

Track down

Press the |◄◄ button repeatedly until the desired file number appears on the display.

NOTE

- Pressing the |◄◄ button once during the song will cause the audio system to restart playback from the beginning of the file.

To play tracks from USB device (if so equipped)

To find a file

N00703100012

Operate the SEL switch to select desired file. When this mode is activated by pressing the SEL switch, the SEL indicator will be displayed in the display.

Press the SEL switch :To start this mode or to select the folder or file.

Turn the SEL switch :To show the folder or file.

NOTE

- To cancel the selection, press the  button to return to the previous step.
- If no operation is performed for 10 seconds or more or other button is operated after the SEL switch has been turned, searching of the desired file is canceled.
- If no operation is performed for 5 seconds or more after the file is displayed, playback starts.
- When the SEL indicator is not shown on the display and the SEL switch is operated, the volume adjustment is activated.

To play the same file repeatedly

N00764500024

Press the RPT button to show “RPT” in the display. To cancel this mode, press the button again.

To play the files in the same folder repeatedly

N00764600038

Press and hold the RPT button until you hear a beep to show “F-RPT” in the display. All tracks in the current folder are played repeatedly. To exit this mode, press the button again.

To play a folder in random order

N00764700039

Press the RDM button to show “F-RDM” in the display. The audio randomly selects tracks from the current folder and plays the selected tracks. To exit this mode, press the button again.

To play all folders in random order

N00764800030

Press and hold the RDM button until you hear a beep to show “RDM” in the display. The audio randomly selects tracks from all folders and plays the selected tracks.

To exit this mode, press the button again.

To switch the display

N00765100043

You can displays titles with tag information.

Folder title

The display changes as follows every time the DISP button is pressed during playback: Folder name → File name → Normal display.

Tag information

1. Press and hold the DISP button until you hear a beep.
2. The display changes as follows every time the DISP button is pressed briefly: Album TAG → Track TAG → Artist TAG → Genre TAG (vehicles with Bluetooth® 2.0 interface) → Normal display.

NOTE

- Press and hold the DISP button again until you hear a beep, and the tag information display returns to the folder title display.
- Up to 11 characters are shown in the display at once. If the title is cut off in the middle, press the PAGE button. The next characters are displayed every time this button is pressed.

NOTE

- If no title is stored, “NO TITLE” is shown in the display.
- Characters that cannot be displayed are substituted by “.”.

To play USB memory device tracks via voice operation (vehicles with Bluetooth® 2.0 interface)

N00765200073

Desired tracks can be selected and played from your USB memory device by “Artist”, “Album”, “Playlist” and “Genre” using voice commands.

For information concerning the voice recognition function or speaker registration function, refer to “Bluetooth® 2.0 interface” on page 5-81.

The playback sequence of tracks is the same as when an iPod is connected. Refer to the “To play iPod tracks via voice operation” on page 7-29.

Preparation for voice operation

To use the voice operation, press the SPEECH button (A) first.

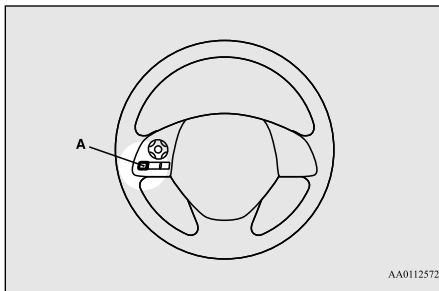

AA0112572

To play tracks from a Bluetooth® device (vehicles with Bluetooth® 2.0 interface)

N00765300104

You can wirelessly connect a digital audio player or cellular phone supporting Bluetooth® to listen to the tracks on the connected device.

Refer to “Bluetooth® 2.0 interface” for the connecting method, etc. on page 5-81.

The following explains the basic playback method.

NOTE

- Depending on the connected device, operation of the connected device is limited to its available functions.
- Depending on the connected device, the device may not operate correctly.
- A file protected by copyright might not be able to playback.
- It is recommended to adjust the equaliser of the connected device to 0 db or neutral.
- The voice operation is not available to access music files on the connected Bluetooth® device.

7

Bluetooth® device control panel and display

N00765400062

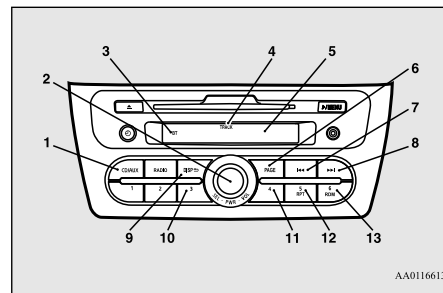

AA0116613

- 1- CD (Mode changeover) button
- 2- PWR (On-Off) switch
- 3- BT (Bluetooth®) indicator

To play tracks from a Bluetooth® device (vehicles with Bluetooth® 2.0 interface)

- 4- TRACK indicator
- 5- Display
- 6- PAGE (Title scroll) button
- 7- **1◀◀** (Fast-reverse/Track down) button
- 8- **▶▶1** (Fast-forward/Track up) button
- 9- DISP (Title display) button
- 10- Play/Pause button
- 11- Stop button
- 12- RPT (Repeat) button
- 13- RDM (Random) button

7

To listen to tracks from a device connected via Bluetooth®

N00765500089

1. Press the PWR switch to turn on the audio system. The system turns on in the last mode used.
2. Press the CD button several times to switch to the BT-A (Bluetooth®) mode. The input mode changes as follows every time the CD button is pressed: CD mode → iPod mode → Bluetooth® mode (if so equipped) → AUX mode → CD mode. The BT indicator are illuminated and then the BT-A mode will be activated.
3. Connect your Bluetooth® device. Refer to “Connecting the Bluetooth® 2.0 interface and Bluetooth® device” on page 5-87.
4. Playback starts automatically.

NOTE

- Depending on the connected device, the playback may not start automatically. In this case, operate the connected device to start the playback.

To stop the playback (if supported by the device)

N00765600035

To stop the playback, press the Stop button.
To restart the playback, press the Play/Pause button.

To pause the playback (if supported by the device)

N00765700036

To pause the playback, press and hold the Play/Pause button until you hear a beep.
To restart the playback, press the Play/Pause button.

To fast-forward/reverse the track (if supported by the device)

N00703200013

To fast-forward/reverse the current track, press the **▶▶1** button or **1◀◀** button.

Fast-forward

To fast-forward the current track, press the **▶▶1** button. While the button is kept pressed, the track will be fast-forwarded.

Fast-reverse

To fast-reverse the current track, press the **1◀◀** button. While the button is kept pressed, the track will be fast-reversed.

To select a track (if supported by the device)

N00765800037

Track up

Press the **▶▶1** button repeatedly until the desired file number appears on the display.

Track down

Press the **1◀◀** button repeatedly until the desired file number appears on the display.

NOTE

- Pressing the **1◀◀** button once during the song will cause the audio system to restart playback from the beginning of the file.

To play the same track repeatedly (if supported by the device)

N00765900038

Press the RPT button several times to switch to show “RPT” in the display.

The mode changes as follows every time the RPT button is pressed:

No display (not repeat) → RPT (repeat same track) → F-RPT (repeat all tracks) → No display

To exit this mode, press the button again.

To play the all tracks repeatedly (if supported by the device)

N00703300014

Press the RPT button several times to switch to show “F-RPT” in the display.

The mode changes as follows every time the RPT button is pressed:

No display (not repeat) → RPT (repeat same track) → F-RPT (repeat all tracks) → No display

All tracks in the Bluetooth® device are played repeatedly.

To exit this mode, press the button again.

To play tracks in random order (if supported by the device)

N00766000023

Press the RDM button to show “RDM” in the display.

The system randomly selects and plays tracks from all tracks in the Bluetooth® device.

To exit this mode, press the button again.

To switch the display (if supported by the device)

N00766200041

The system can display tag information.

1. Press the DISP button.
2. The display changes as follows every time the DISP button is pressed:
Album title → Title name → Artist name
→ Genre → Normal display

NOTE

- Up to 11 characters are shown in the display at once. If the title is cut off in the middle, press the PAGE button. The next characters are displayed every time this button is pressed.
- If no title is stored, “NO TITLE” is shown in the display.
- Characters that cannot be displayed are substituted by “•”.

Steering wheel audio remote control switches (if so equipped)

N00714800484

The remote control switches are located on the left side of the steering wheel.

These switches can be used when the ignition switch or the operation mode is in ON or ACC.

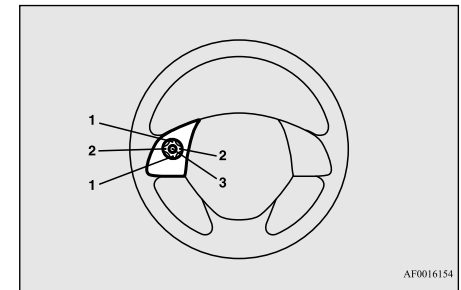

- 1- Vol + key, - key
Adjust audio functions and the mobile phone function volume.
- 2- CH ▼ key, ▲ key
Select CD and other audio source tracks and radio stations.
Hold down to skip up and down through tracks.

Error codes

3- MODE key

Hold down to turn the audio function ON/OFF. Additionally, each time this is pressed, this switches the audio source.

The order of switching is as shown below.

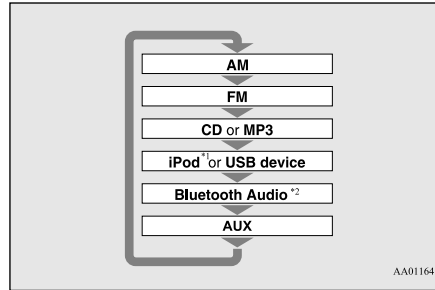

*1: An iPod cable (available separately) is required.

*2: Requires a separately-purchased Bluetooth-capable audio device (vehicles with a Bluetooth[®] 2.0 interface).

7

Error codes

N00736100780

If an error code appears in the display, take action in accordance with the table below.

Audio system

Error display	Item	Repair
CHECK DISC	Disc is not loaded correctly, or condensation on disc.	Insert disc with label facing up. Remove moisture from disc.
DISC ERROR	Disc is dirty, scratched, or deformed; or excessive vehicle vibration.	Clean or replace disc. Retry when vibrations stop.

Error display	Item	Repair
INTERNAL E	Loading or eject error. Pick-up is out of position.	Eject disc and reload. If disc will not eject, bring your vehicle to your authorized Mitsubishi Motors dealer or a repair facility of your choice for repair.
HEAT ERROR	Internal protection against high temperatures.	Allow radio to cool by waiting about 30 minutes.
ERROR DC	Foreign material is inside of radio or amplifier.	Bring your vehicle to your authorized Mitsubishi Motors dealer or a repair facility of your choice for repair.

iPod (if so equipped)

Error display	Item	Repair
NO SONG	There are no playable music files.	Record music files in the iPod.
VER ERROR	The iPod or its software cannot be recognized.	Connect a supported iPod.

USB memory device (if so equipped)

Error display	Item	Repair
FILE ERROR	The file cannot be played.	The file is protected by copyrights, etc. An error is displayed for several seconds, and then the next playable file is played automatically.
UNSUPPORTED (first) → DEVICE (after)	The USB memory device cannot be recognized.	Remove the USB memory device.
UNSUPPORTED (first) → FORMAT (after)	The USB memory device format cannot be recognized.	Remove the USB memory device.

Handling of compact discs

Error display	Item	Repair
USB BUS PWR	An overcurrent or other power-supply error has occurred.	Remove the USB memory device. Have the vehicle inspected at an authorized Mitsubishi Motors dealer or a repair facility of your choice.
LSI ERROR	Internal device errors	Have the vehicle inspected at an authorized Mitsubishi Motors dealer or a repair facility of your choice.

Handling of compact discs

N00734100340

- 7**
- Use only the type of compact discs that have the mark shown in the illustration below. (Playback of CD-R or CD-RW discs may cause problems.)



- The use of special shaped, damaged compact discs (like cracked discs) or low-quality compact discs (like warped discs or burrs on the discs) such as those shown will damage the CD player.

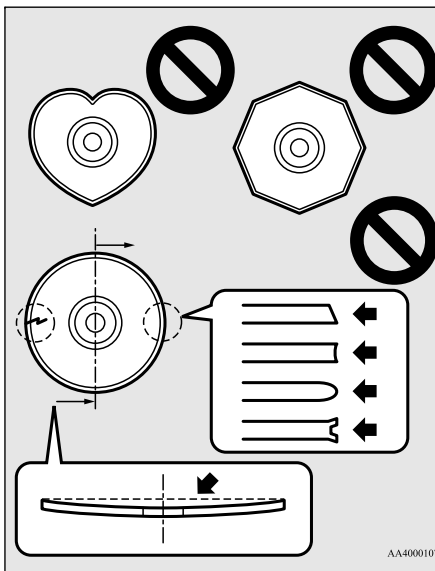

- In the following circumstances, moisture can form on compact discs and inside the audio system, preventing normal operation.

- When there is high humidity (for example, when it is raining).
- When the temperature suddenly rises, such as right after the heater is turned on in cold weather.

In this case, wait until the moisture has had time to dry out.

- When the CD player is subjected to violent vibrations, such as during off-road driving, the tracking may not work.
- When storing compact discs, always store them in their separate cases. Never place compact discs in direct sunlight, or in any place where the temperature or humidity is high.
- Never touch the flat surface of the disc where there isn't a label. This will damage the disc surface and could affect the sound quality. When handling a compact disc, always hold it by the outer edge and the center hole.

- To clean a disc, use a soft, clean, dry cloth. Wipe directly from the center hole toward the outer edge. Do not wipe in a circle. Never use any chemicals such as benzene, paint thinner, a disc spray cleaner, or an anti-static agent on the disc.
- Do not use a ball point pen, felt pen, pencil, etc. to write on the label surface of the disc.
- Do not put additional labels or stickers on compact discs. Also, do not use any compact disc on which a label or sticker has started to peel off or any compact disc that has stickiness or other contamination left by a peeled-off label or sticker. If you use such a compact disc, the CD player may stop working properly and you may not be able to eject the compact disc.

Notes on CD-Rs/RWs

N00751900066

- You may have trouble playing back some CD-R/RW discs recorded on CD recorders (CD-R/RW drives), either due to their recording characteristics or dirt, fingerprints, scratches, etc. on the disc surface.
- CD-R/RW discs are less resistant to high temperatures and high humidity than ordinary music CDs and can therefore be damaged and rendered unplayable if left inside your vehicle for a long time.

- Depending on the combination of the writing software, the CD recorder (CD-R/RW drive), and the disc used to create a CD-R/RW, the disc might not play successfully.
- This player cannot play the CD-R/RW discs if the session is not closed.
- This player cannot play CD-R/RW discs which contain data other than CD-DA or MP3 data (Video CD, etc.).
- Be sure to observe the handling instructions for the CD-R/RW disc.

WARNING

- **Operating the CD player in a manner other than specifically instructed herein may result in hazardous radiation exposure. Do not remove the cover and attempt to repair the CD player by yourself. In case of malfunction, contact an authorized Mitsubishi Motors dealer or a repair facility of your choice.**

Antenna

N00734201508

To remove

Turn the pole (A) counterclockwise.

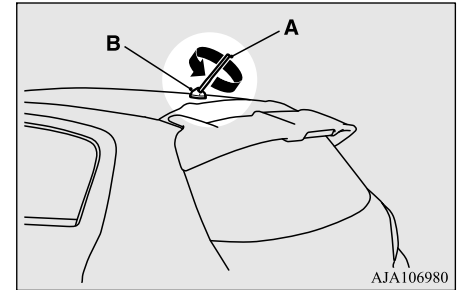

To install

Screw the pole (A) clockwise into the base (B) until it is securely retained.

NOTE

- Be sure to remove the roof antenna in the following cases:
 - When using an automatic car wash
 - When covering your vehicle with a car cover
 - When driving into a structure that has a low ceiling.

General information about your radio

N00733900455

Your vehicle's radio receives both AM and FM stations.

The quality of your reception is affected by distance, obstacles, and signal interference.

Signal transmission

7

FM signals do not follow the earth surface nor are they reflected by the upper atmosphere. For this reason, FM broadcasts cannot be received over long distances. AM signals follow the earth's surface and are reflected by the upper atmosphere. For this reason, AM broadcasts can be received over longer distances.

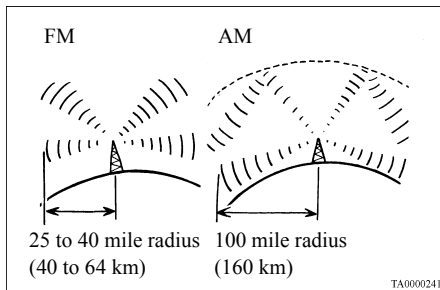

Weak reception (fading)

Because of the limited range of FM signals and the way FM waves transmit, you may experience weak or fading FM reception. When the broadcast is blocked by mountains or similar obstructions, reception can be disturbed.

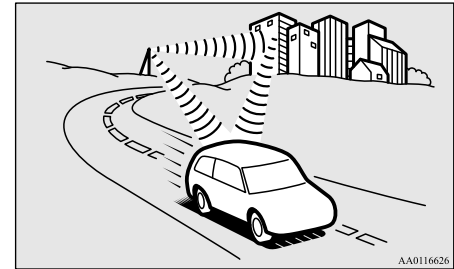

Reflection

The reason why one can hear FM but not AM in parking garages, under bridges etc., is that FM signals, unlike AM signals, are reflected by solid objects such as buildings, etc. Because FM signals are easily reflected by buildings, this can also cause reception disturbances.

The direct signal from the broadcast station reaches the antenna slightly before the reflected signal. This time difference may cause some reception disturbance or flutter. This problem occurs primarily in urban areas.

Cross modulation

If one listens to a weak station and is in the vicinity of another strong station, both stations might be received simultaneously.

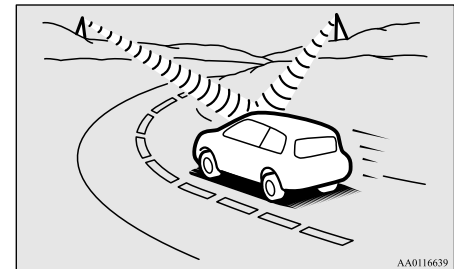

FM stereo reception

Stereo reception requires a high quality broadcast signal. This means that types of disturbances mentioned previously become more marked and the reception range is somewhat diminished during stereo reception.

Causes of disturbances

FM reception is affected by the electrical systems of vehicles in the vicinity, especially those without an electronic noise suppression device. The disturbance is even greater if the station is weak or poorly tuned.

FM reception is not as sensitive to electrical disturbances as AM. AM reception is sensitive to electrical disturbances such as power lines, lightning and other types of similar electrical phenomena.

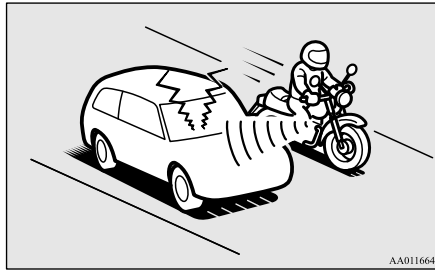

For emergencies

If the vehicle breaks down	8-2
Jump-starting the engine	8-2
Engine overheating	8-4
Jack and tools	8-5
Tire repair kit (if so equipped)	8-6
How to change a tire (Vehicles equipped with spare tire)	8-11
Towing	8-17
Operation under adverse driving conditions	8-18
Fuel Pump Shut-off System	8-20

If the vehicle breaks down

If the vehicle breaks down

N00836300233

If your vehicle breaks down on the road, move to the shoulder and turn on the hazard warning flashers. If there is no shoulder, or the shoulder is not safe, drive in the right lane slowly with the hazard lights flashing until you come to a safe stopping place. Keep the flashers flashing.

If the engine stops/fails

8

If the engine stops, there will be no power assist to the steering and brakes, making these difficult to use.

- The brake booster will not work, so the brakes will not grip well. The brake pedal will be harder to press than usual.
- Since there is no power steering assist, the steering wheel will be hard to turn.

When the engine fails at the intersection

Get help from your passengers, bystanders, etc. to push the vehicle and move it to a safe area.

Jump-starting the engine

N00836400768

If the engine cannot be started because the battery is weak or dead, you can start it with the battery from another vehicle using jumper cables.

WARNING

- To reduce the risk of igniting flammable gas that may be emitted from the battery, carefully read this section before jump-starting the vehicle.
- Do not try to start your vehicle by pushing or towing. This can cause an accident resulting in serious injury or death and can damage the vehicle.

NOTE

- Do not use jumper cables if they have damage or corrosion.

1. Take off any metal jewelry such as watch bands or bracelets that might create an accidental electrical contact.
2. Position the vehicles close enough together so that the jumper cables can reach, but be sure the vehicles aren't touching each other.

CAUTION

- Check the other vehicle. It must have a 12-volt battery. If the other system isn't 12-volt, both systems can be damaged.

3. You could be injured if the vehicles move. Set the parking brake firmly on each vehicle. Put an automatic transaxle or CVT in "P" (PARK) or a manual transaxle in "N" (Neutral).
4. Turn the ignition switch to the "OFF" position or put the operation mode in OFF.

NOTE

- Turn off all lights, heater, and other electrical loads. This will avoid sparks and help save both batteries.

5. Make sure your battery electrolyte is at the proper level. (Refer to "Battery" on page 9-10.)

WARNING

- If the electrolyte fluid is not visible, or looks frozen, DO NOT ATTEMPT JUMP STARTING!!
The battery might split open or explode if the temperature is below the freezing point or if it is not filled to the proper level.

6. Connect one end of one jumper cable ① to the positive (+) terminal of the discharged battery (A), and then connect the other end ② to the positive (+) terminal of the booster battery (B).

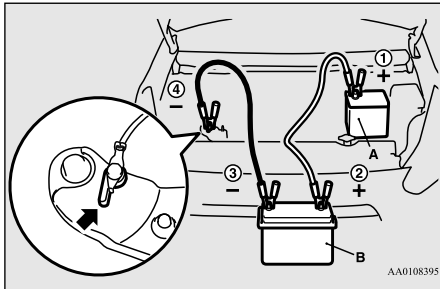

⚠ WARNING

- Make sure that the jumper cables and your clothing are clear of the cooling fans and drive belts. Entanglement with the fans or belts can cause serious personal injury.

📖 NOTE

- Open the terminal cover before connecting the jumper cable to the positive terminal of the battery.
(Refer to “Battery” on page 9-10.)

📖 NOTE

- Use the proper cables suitable for the battery size.
Otherwise heat damage to the cables could result.

7. Connect one end of the other jumper cable ③ to the negative (-) terminal of the booster battery (B), and then connect the other end ④ to the designated ground location of the vehicle with the discharged battery (A) at the point farthest from the battery.

⚠ WARNING

- Be sure to follow the proper order when connecting the batteries, of:
①→②→③→④
- Make sure that the connection ④ is made to the correct designated location (as shown in the illustration) properly. If the connection is directly made to the negative (-) terminal of the battery, the flammable gases from inside the battery might catch fire and explode, causing personal injury.
- When connecting the jumper cable, do not connect the positive (+) cable to the negative (-) terminal. Sparks can make the battery explode.

8. Start the engine in the vehicle providing the boost. Let the engine idle a few minutes, then start the engine in the vehicle with the discharged battery.
9. After the engine is started, disconnect the cables in the reverse order from the way you connected them.

Charging the battery by using an external battery charger

⚠ WARNING

- Always remove the battery from your vehicle when the battery is charged by an external battery charger.
- Keep sparks, cigarettes, and flames away from the battery because the battery could explode.
- Keep your work area well vented when charging or using the battery in an enclosed space.
- Remove all the caps before charging the battery.
- Electrolyte (battery acid) is made of corrosive diluted sulfuric acid. If electrolyte comes in contact with your hands, eyes, clothes, or the painted surface of your vehicle, thoroughly flush with water. If electrolyte gets in your eyes, flush them immediately and thoroughly with water, and get prompt medical attention.

WARNING

- Always wear protective clothing and goggles when working near the battery.
- Keep the battery out of the reach of children.

As your vehicle has anti-lock brakes

If you drive your vehicle with a low battery charge after the engine has been started by using jumper cables, the engine may misfire. This can cause the anti-lock braking system warning light to blink on and off. This is only due to the low battery voltage. It is not a problem with the brake system. If this happens, fully charge the battery and ensure the charging system is operating properly.

Engine overheating

N00836500365

If the high coolant temperature warning light illuminates during the engine is running, the engine may be overheating. If this happens:

1. Stop the vehicle in a safe place. Turn on the hazard warning flashers.
2. With the engine still running, carefully raise the engine hood to vent the engine compartment.

3. Check that the cooling fan is running. If the fan is not turning, stop the engine immediately and contact an authorized Mitsubishi Motors dealer or a repair facility of your choice for assistance.

WARNING

- To avoid personal injury, keep hands, hair, jewelry and clothes away from the cooling fan. The cooling fan can start at any time.

4. If you see steam or spray coming from under the hood, turn off the engine.
5. If you do not see steam or spray coming from under the hood, leave the engine on until the high coolant temperature warning light goes off. After the high coolant temperature warning light has gone off, you can start driving again. If the high coolant temperature warning light stays on, turn off the engine.

WARNING

- Before raising the engine hood, check to see if there is steam or spray coming from under the hood. Steam or spray coming from an overheated engine could seriously scald you.
Do not open the hood until there is no steam or spray.

6. When you do not see any more steam or spray, open the hood. Look for obvious leaks, such as a split radiator hose. Be careful as components will be hot. Any leak source must be repaired.
7. If there is no obvious leak source, check the coolant level in the engine coolant reserve tank. If there is none, or if it is too low, slowly add coolant.
8. If the engine coolant reserve tank needs coolant, you will probably also need to add coolant to the radiator. Do not loosen or remove the radiator cap until the engine has cooled down.

WARNING

- Removing the radiator cap could scald you with escaping hot water or steam. When checking the radiator level, cover the cap with a cloth before trying to remove it. Turn it slowly counterclockwise, without pressing down, to the first notch. The pressure in the system will then be let out. When the pressure is COMPLETELY LET OUT, press down and keep turning the cap counterclockwise until it comes off.

9. Start the engine, and slowly add coolant, up to the bottom of the filler neck. Use plain water if you have to (and replace it with the right coolant as soon as possible).

10. Replace the radiator cap and tighten it fully. Check the coolant temperature warning light. You can start driving again when the high coolant temperature warning light does not come on.
11. Have the system inspected by your authorized Mitsubishi Motors dealer or a repair facility of your choice.

Jack and tools

N00836600379

Storage

The tools are stored beneath the floor board of the cargo area. The jack (if so equipped) is stored under the driver's seat.

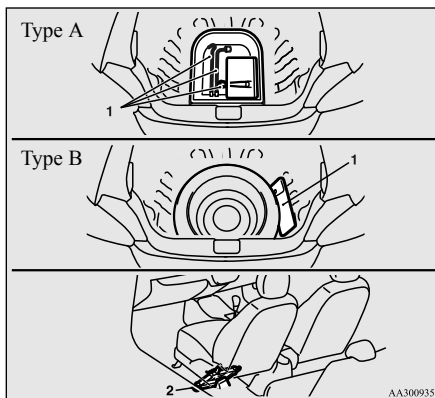

- 1- Tools
- 2- Jack (if so equipped)

Tools

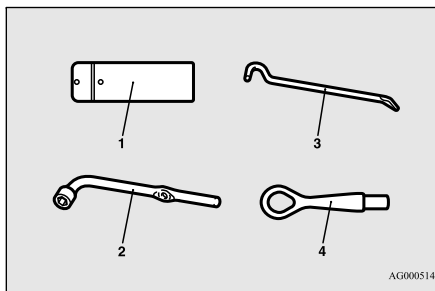

- 1- Tools bag
- 2- Wheel nut wrench

- 3- Jack bar
- 4- Towing hook

Jack (if so equipped)

Before removing or storing the jack, move the driver's seat fully forward to access the jack from the rear seat area. (Refer to "Front seat" on page 4-3.)

CAUTION

- Never access, remove or store the jack from the front of the driver's seat. Doing so could damage electrical wires under the driver's seat.

8

To remove

Turn the shaft end of the jack in the direction (1) until the jack fully retracts and remove the jack from the holder (A).

To store

Put the jack in the holder (A) and turn the shaft end of the jack in the direction (2) by hand until the jack is firmly secured.



Tire repair kit (if so equipped)

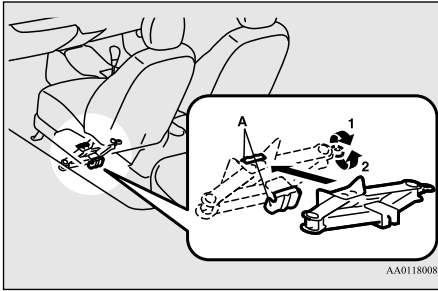

8

⚠ WARNING

- After storing the jack in place, make sure the jack is securely fixed in the holder. If the jack is not fixed securely, it may move and hit an occupant in an accident resulting in serious injury or death. Also the jack may move forward during driving and could interfere with driver's pedal operation causing an accident.

Tire repair kit (if so equipped)

N00800400015

The tire repair kit can be used to temporarily repair a minor puncture in tread area caused by a nail, screw or similar object. Therefore, a spare tire is not provided.

⚠ WARNING

- The tire repair kit may not permanently seal a punctured tire. Have the tire repaired as soon as possible.
- Using the tire repair kit may damage the wheel and/or the tire inflation pressure sensor for the tire. The vehicle must promptly be inspected and repaired by an authorized Mitsubishi Motors dealer after using the tire repair kit.
- Use only the Mitsubishi Motors genuine tire repair kit. Sealant in other repair kits may not sufficiently seal the tire puncture.

Tire repair kit storage

N00800500016

The tire repair kit is stored beneath the floor board of the cargo area.



- 1- Tire repair kit which consists of 2 to 5.
- 2- Tire compressor
- 3- Tire sealant bottle
- 4- Speed restriction sticker
- 5- Bag

How to use the tire repair kit

N00800600017

⚠ WARNING

- Never use the tire repair kit under in any of the situations listed below. The tire cannot be repaired by the tire repair kit. If any of these situations occurs, please contact an authorized Mitsubishi Motors dealer or a repair facility of your choice.
 - More than one tire is punctured.

⚠ WARNING

- The puncture hole has a length or width of 1/7 inch (4 mm) or greater.
- The tire is punctured in the side wall (A), not in the tread (B).
- The vehicle has been driven with the tire almost completely flat.
- The tire has completely slipped over the wheel rim and come off the wheel.
- The wheel is damaged.
- A bump, cut or crack is on the tire.
- The tire sealant's expiration date has passed. (The expiration date is shown on the bottle label (C).)
- The ambient temperature is below -40 °F (-40 °C) or above 140 °F (60 °C).

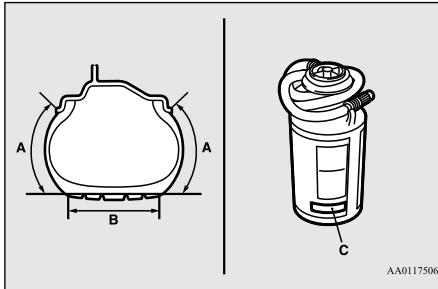
**⚠ WARNING**

- The tire sealant can cause health damage if swallowed. If you accidentally swallow it, drink as much water as possible and immediately seek medical attention.
- If the tire sealant gets in your eyes or on your skin, rinse it away with lots of water. If you still sense an abnormality, seek medical attention.
- Consult a doctor immediately if any allergic reactions occur.
- Do not allow children to touch the tire sealant.

⚠ CAUTION

- If the vehicle body is contaminated by the tire sealant, wipe the tire sealant off immediately with a wet cloth.
- Immediately wash clothes contaminated with tire sealant. The tire sealant may not be removed from the clothes.

📖 NOTE

- Do not pull out an object, such as a nail or screw, that penetrates the punctured tire.
- Move the vehicle so that the tire valve is positioned away from the point where the tire touches the ground. If the valve is near the point where the tire touches the ground, the sealant may not enter the tire easily.

1. Park the vehicle on a safe, flat and level place.
2. Set the parking brake firmly.
3. On vehicles equipped with manual trans-axle, stop the engine and move the gear-shift lever to the "R" (Reverse) position. On vehicles equipped with continuously variable transmission (CVT), move the selector lever to the "P" (PARK) position, and stop the engine.
4. Turn on the hazard warning flashers and set up a warning sign, such as a warning triangle or flashing signal lamp, at an adequate distance from the vehicle, and have all your passengers leave the vehicle.
5. Take out the tire repair kit. Make sure that the compressor switch is OFF.
6. Shake the tire sealant bottle well.

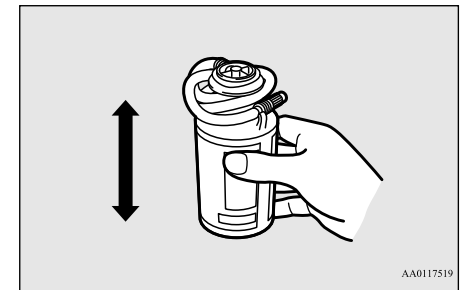

Tire repair kit (if so equipped)

NOTE

- In cold conditions (when the ambient temperature is 32 °F {0 °C} or lower), thickening of the tire sealant can make the tire sealant hard to squeeze out of the bottle. Warm the bottle between your hands inside the vehicle.

7. Take the valve cap (D) off the tire valve (E).

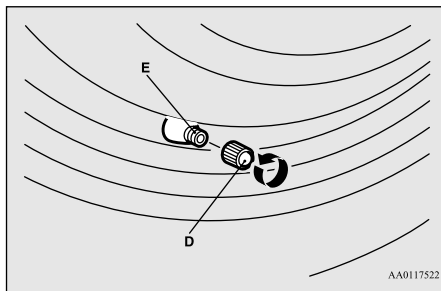

8. Unwind the bottle hose (F) from around the sealant bottle.

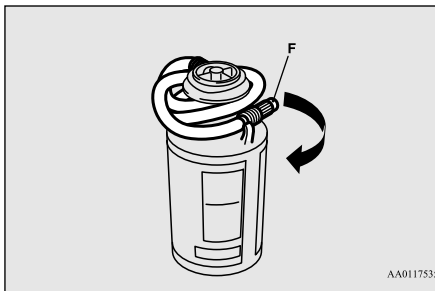

9. Pull out the compressor's hose (G) from the bottom of the compressor and securely attach it to the valve (H) of the bottle by turning it clockwise until tight.

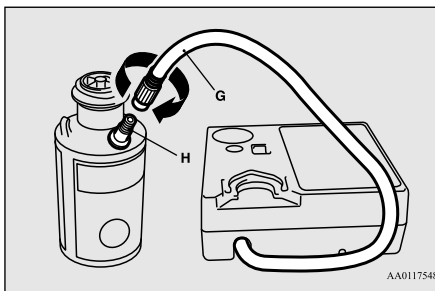

10. Install the bottle onto the compressor.

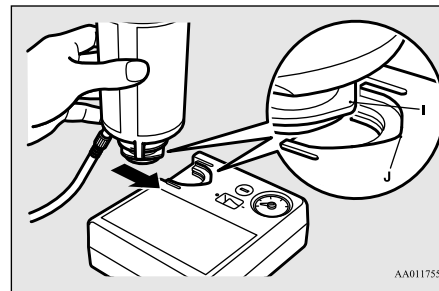

NOTE

- When installing the bottle, align the projection (I) on the bottle with the indentation (J) in the compressor.

11. Securely attach the bottle hose (F) to the tire valve (E).

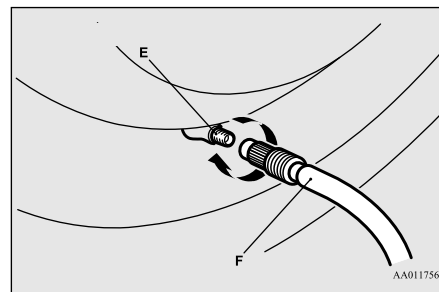

⚠ CAUTION

- If the bottle hose is not attached securely, the tire sealant will leak out from the tire valve and the tire may not inflate to the specified pressure.

12. Pull out the compressor's power cord (K), insert the plug on the cord into the 12 V power outlet (L), and then turn the ignition switch or the operation mode to the ACC position. (Refer to "12V power outlet" on page 5-106.)

Turn ON the compressor switch (M) and inject all of the tire sealant and inflate the tire to the specified pressure. (Refer to "Tire inflation pressures" on page 9-14.)

If there is a gap between the tire and wheel, push the tread area toward the center of the wheel to close the gap before running the compressor.

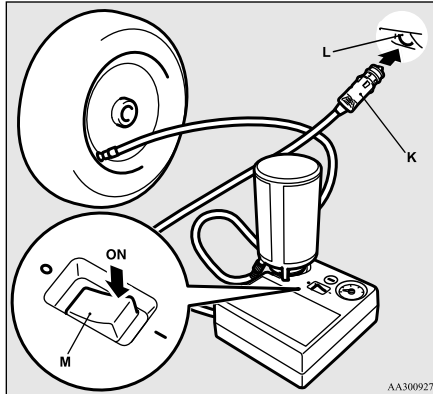
**⚠ WARNING**

- Do not place your hand or fingers between the tire and wheel while inflating the tire. Your hand or fingers may become caught between the tire and wheel.

⚠ CAUTION

- The supplied compressor is designed only for inflation of your vehicle tires.
- The compressor is designed to run on a vehicle's 12 V power supply. Do not connect it to any other power source.
- The compressor is not waterproof. If you use it in rain, make sure water does not get on it.

⚠ CAUTION

- Any sand or dust sucked into the compressor could make the compressor break down. Do not place the compressor directly on any sandy or dusty surface when using it.
- Do not disassemble or modify the compressor. Also, do not subject the air pressure gauge to shock. It could malfunction.

13. Affix the speed restriction sticker (N) to the three-diamond mark on the steering wheel.

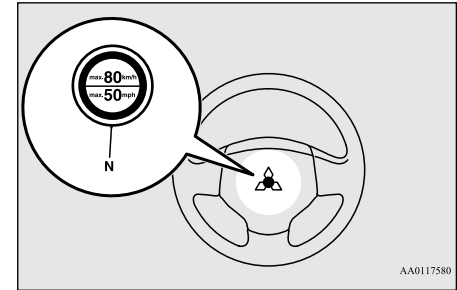
**⚠ CAUTION**

- Do not affix the sticker anywhere except the specified position on the pad of the steering wheel. Affixing the sticker in an incorrect position could prevent the SRS airbag from deploying properly.

Tire repair kit (if so equipped)

14. Check and adjust the tire pressure with reference to the air pressure gauge on the compressor. If you overinflate the tire, release air by pressing the pressure release switch (O) on the compressor.

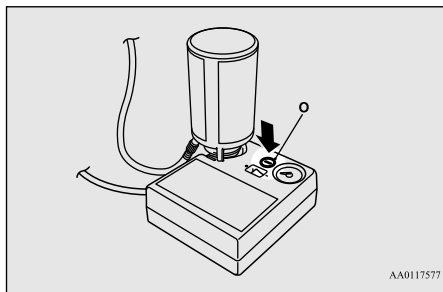

8

⚠ CAUTION

- The surface of the compressor will get hot while the compressor is running. Do not keep the compressor running continuously for more than 10 minutes. After using the compressor, wait for the compressor to cool before using it again.
- If the compressor becomes sluggish or hot while operating, it is overheating. Immediately place the switch in the OFF position and let the compressor cool down for at least 30 minutes.

📖 NOTE

- If the tire pressure does not rise to the specified level within 10 minutes, the tire may be so severely damaged that the tire sealant cannot be used for emergency repair. Do not drive the vehicle. Please contact an authorized Mitsubishi Motors dealer or a repair facility of your choice.

15. Turn OFF the compressor switch, then pull the power cord plug out of the 12 V power outlet.

📖 NOTE

- At this point the puncture hole is not sealed yet. Air will continue to leak through the puncture hole until the emergency repair procedure is completed (through step 17 or step 18 of these instructions).

16. When you have inflated the tire to the specified pressure, stow the compressor and bottle in the vehicle and promptly start driving the vehicle so that the tire sealant can spread evenly in the tire. Drive with great care. Do not exceed a speed of 50 mph (80 km/h). Observe local speed limits.

⚠ CAUTION

- If you sense any abnormality while driving, stop the vehicle and contact an authorized Mitsubishi Motors dealer or a repair facility of your choice. Otherwise the tire pressure may drop before the emergency repair procedure is completed, rendering the vehicle unsafe to drive.

17. After driving for 10 minutes or 3 miles (5 km), park the vehicle in a safe place. Remove the air compressor from the stowed position. Check the tire pressure using the air pressure gauge on the compressor. If the tire pressure has not dropped, the emergency repair procedure is complete. Proceed to step 19. If the tire pressure is insufficient, inflate the tire to the specified pressure again and drive the vehicle carefully without exceeding a speed of 50 mph (80 km/h). Before driving, make sure that the compressor is stowed.

⚠ CAUTION

- If the tire pressure is lower than the minimum permitted pressure (18 psi {130 kPa}), the tire cannot successfully be repaired with the tire sealant. Do not drive the vehicle any further. Contact an authorized Mitsubishi Motors dealer or a repair facility of your choice.

18. After driving for 10 minutes or 3 miles (5 km) again, check the tire pressure using the air pressure gauge on the compressor. If the tire pressure has not dropped, the emergency repair procedure is complete. Before driving, make sure that the compressor is stowed. You must still not exceed a speed of 50 mph (80 km/h). Observe local speed limits.

NOTE

- If the tire pressure has dropped below the specified level when you check it at the end of the repair procedure, do not drive the vehicle any further. Contact an authorized Mitsubishi Motors dealer or a repair facility of your choice.
- In cold conditions (when the ambient temperature is 32 °F {0 °C} or lower), the time and driving distance required until completion of the repair can become longer than in warmer conditions, and the tire pressure may drop below the specified level even after you have inflated the tire the second time and subsequently driven the vehicle. If this happens, inflate the tire to the specified pressure once more, drive for about 10 minutes or 3 miles (5 km), then check the tire pressure again. If the tire pressure has again dropped below the specified level, stop driving the vehicle and contact an authorized Mitsubishi Motors dealer or a repair facility of your choice.

19. Immediately drive with great care to an authorized Mitsubishi Motors dealer or a repair facility of your choice and have the tire repair/replacement performed.

NOTE

- Please give the empty sealant bottle to an authorized Mitsubishi Motors dealer or dispose of the sealant bottle according to regulations for the disposal of chemical waste.
- To purchase a new tire sealant bottle, contact an authorized Mitsubishi Motors dealer.

How to change a tire (Vehicles equipped with spare tire)

N00836900819

WARNING

- The jack should not be used for any purpose other than to change a tire.
- Never get under the vehicle or put any portion of your body under the vehicle while it is supported by the jack.

Before changing a tire, first stop your vehicle in a safe, flat location.

1. Park the vehicle on level and stable ground.
2. Set the parking brake firmly.

3. On vehicles equipped with manual trans-axle, stop the engine and move the gear-shift lever to the “R” (Reverse) position. On vehicles equipped with continuously variable transmission (CVT), move the selector lever to the “P” (PARK) position, and stop the engine.
4. Turn on the hazard flashers and set up a warning triangle, flashing signal light, etc., at an adequate distance from the vehicle, and have all your passengers exit the vehicle.
5. To prevent the vehicle from rolling when it is raised on the jack, place chocks or blocks (A) at the tire that is diagonally opposite from the tire (B) you are changing.

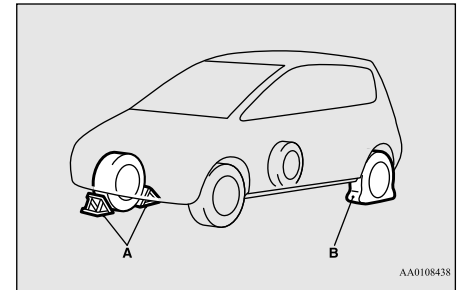

WARNING

- Be sure to apply chocks or blocks to the correct tire when jacking up the vehicle. If the vehicle moves while jacked up, the jack could slip out of position, leading to an accident.

NOTE

- The chocks shown in the illustration do not come with your vehicle. It is recommended that you purchase chocks or blocks and keep them in the vehicle for use if needed.
- If chocks or blocks are not available, use stones or any other objects that are large enough to hold the wheel in position.

6. Get the jack, bar and wheel nut wrench ready.

(Refer to “Jack and tools” on page 8-5.)

Spare tire information

N00849600344

Compact spare tire

The compact spare tire is stowed beneath the floor board of the cargo area. It is designed to save space in the cargo area. Its lighter weight makes it easier to use if a flat tire occurs.

WARNING

- Tires, including spare tire, degrade over time with age even when they are not being used. It is recommended that tires over 6 years generally be replaced even if damage is not obvious.

CAUTION

- While the compact spare tire is stowed, the inflation pressure should be checked at least once a month to assure that it remains at the recommended inflation pressure. See the tire and loading information placard attached to the driver’s door sill. Refer to “Tire and loading information placard” on page 11-3.
- Driving with an improperly inflated tire can cause an accident. If you have no choice but to drive with an under-inflated tire, keep your speed down and avoid sudden steering or braking, if possible. Inflate the tire to the correct pressure as soon as possible. Refer to “Tire inflation pressures” on page 9-14.
- The compact spare tire should be used only temporarily. While the compact spare tire is being used, the tire pressure monitoring system will not function properly. Have the tire replaced or repaired at an authorized Mitsubishi Motors dealer or a repair facility of your choice as soon as possible.
- Do not go over 50 mph (80 km/h) when driving with the compact spare tire.
- Avoid sudden starting and braking when driving with the compact spare tire.

CAUTION

- Do not drive through automatic car washes and over obstacles that could possibly damage the underside of your vehicle. Because the compact spare tire is smaller than the original tire, there is less clearance between the ground and your vehicle.
- Because the compact spare tire is designed only for your vehicle, do not use it on any other vehicle.
- Do not put the compact spare tire on a different wheel, and do not put standard tires, snow tires, wheel covers or trim rings on the compact spare wheel. Otherwise, you could damage these parts or other parts on your vehicle.
- Do not use tire chains with your compact spare tire. Using a chain could cause damage to your vehicle and loss of the chains.

To remove spare tire

N00849700286

1. Lift up the floor board of the cargo area.
2. To remove the spare tire, remove the installation clamp (A) by turning it counterclockwise.

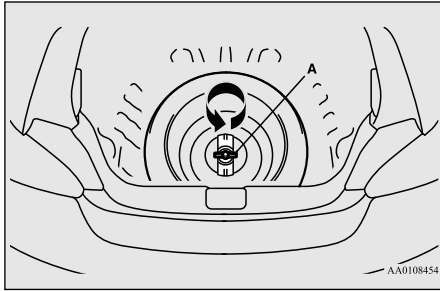

NOTE

- The flat tire with a normal size wheel cannot be stored beneath the floor board. Store the flat tire in the cargo area.

To change a tire

N00849800447

1. On vehicles with wheel covers, first remove the covers (refer to “Wheel covers” on page 8-16). Then, loosen the wheel nuts with the wheel nut wrench. Do not remove the wheel nuts yet.

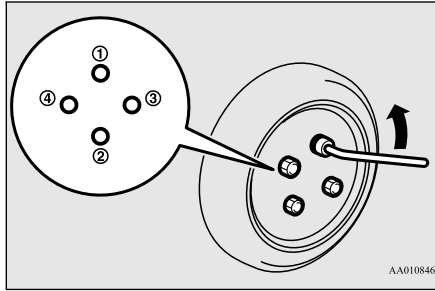

2. Place the jack under one of the jacking points (A) shown in the illustration. Use the jacking point closest to the tire you wish to change.

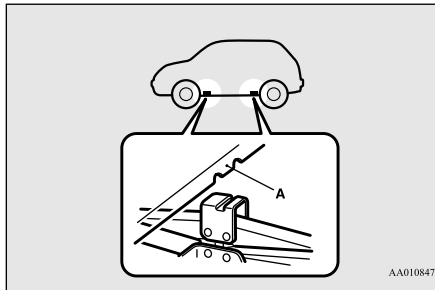

WARNING

- Set the jack only at the positions shown here. If the jack is set at a wrong position, it could dent your vehicle or the jack might fall over and cause personal injury.

WARNING

- Do not use the jack on a tilted or soft surface. Otherwise, the jack might slip and cause personal injury. Always use the jack on a flat, hard surface. Before setting the jack, make sure there are no sand or pebbles under the jack base.

NOTE

- Put the spare wheel under the vehicle body near the jack. This makes it safer if the jack slips out of position.

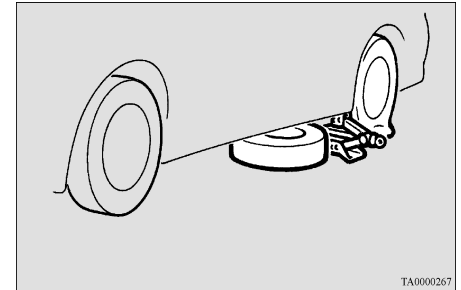

3. Rotate the jack by hand until the flange portion (B) fits in the groove (C) at the top of the jack.

How to change a tire (Vehicles equipped with spare tire)

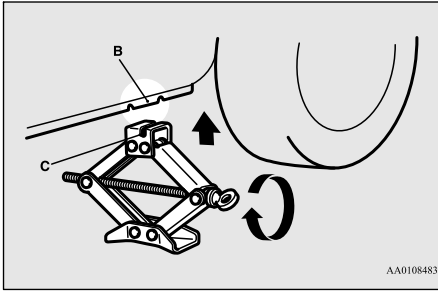

8

4. Insert the bar (D) into the wheel nut wrench (E). Then put the end of the bar into the shaft's jack end, as shown in the illustration.

Slowly rotate the wheel nut wrench until the tire is raised slightly off the ground surface.

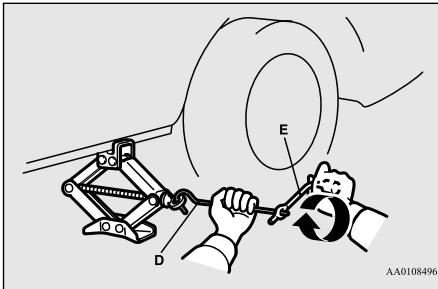

⚠ WARNING

- Stop jacking up the vehicle as soon as the tire is raised off the ground. It is dangerous to raise the vehicle any higher.
- Do not get under your vehicle while using the jack.
- Do not bump the raised vehicle or leave it sitting on the jack for a long time. Both are very dangerous.
- Do not use a jack except the one that came with your vehicle.
- The jack should not be used for any purpose other than to change a tire.
- No one should be in your vehicle when using the jack.
- Do not start or run the engine while your vehicle is on the jack.
- Do not turn the raised wheel. The tires that are still on the ground could turn and make your vehicle fall off the jack.

5. Remove the wheel nuts with the wheel nut wrench, then take the wheel off.

⚠ CAUTION

- Handle the wheel carefully when changing the tire, to avoid scratching the wheel surface.

6. Clean out any mud, etc. on the hub surface (F), hub bolts (G) or in the installation holes (H) in the wheel, and then mount the spare tire.

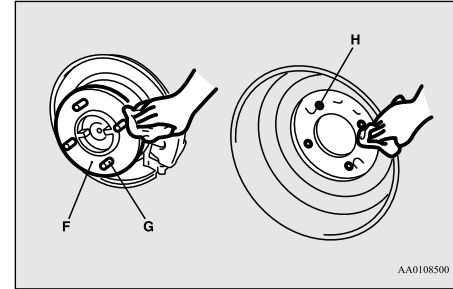

⚠ WARNING

- Mount the spare wheel with the valve stem (I) facing outward. If you cannot see the valve stem (I), you have installed the wheel backwards. Operating the vehicle with the spare wheel installed backwards can cause vehicle damage and result in an accident.

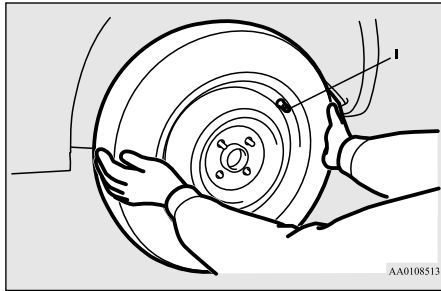

7. Install the wheel nuts with their tapered ends facing inward, then tighten by hand until the wheel is no longer loose.

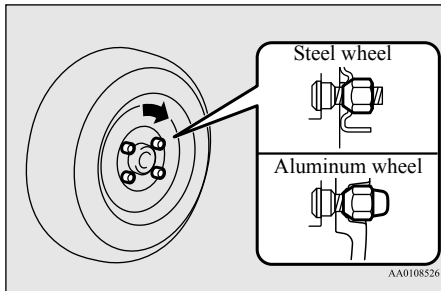

CAUTION

- Never apply oil to either the wheel bolts or the nuts or they will tighten too much.

8. Lower the vehicle slowly until the tire touches the ground, by rotating the wheel nut wrench counterclockwise.

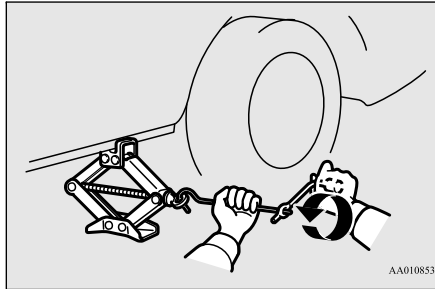

9. Tighten the nuts in the order shown in the illustration until each nut has been tightened to the torque listed here.
65 to 80 ft-lb (88 to 108 N•m)

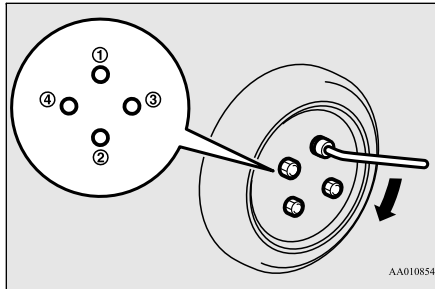

CAUTION

- Never use your foot or a pipe extension to apply added force to the wheel nut wrench when tightening the wheel nuts. If you do so, you can over-tighten the wheel nuts and damage the wheel, wheel nuts and hub bolts.

10. Lower the jack all the way and remove it.
11. Check the tire inflation pressure. The recommended tire pressure for your vehicle is listed on the tire and loading information placard attached to the driver's door sill as shown in the illustration. Refer to "Tire inflation pressures" on page 9-14.

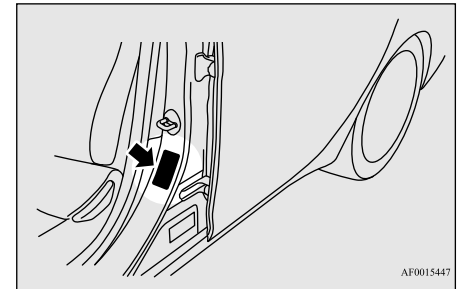

How to change a tire (Vehicles equipped with spare tire)

⚠ CAUTION

- Driving with an improperly inflated tire can cause an accident. If you have no choice but to drive with an under-inflated tire, keep your speed down and avoid sudden steering or braking, if possible. Inflate the tire to the correct pressure as soon as possible. Refer to “Tire inflation pressures” on page 9-14.
- After changing the tire and driving the vehicle about 620 miles (1,000 km), retighten the wheel nuts to make sure that they have not come loose.
- If the steering wheel vibrates when driving after changing the tire, have the tire checked for balance at an authorized Mitsubishi Motors dealer or a repair facility of your choice.
- Do not mix one type of tire with another or use a different size from the one listed. This would cause early wear and poor handling.

To store the flat tire or spare tire, jack, bar and wheel nut wrench

N00850000175

Store the flat tire in the cargo area. Reverse the removing procedure when storing the spare tire, jack, bar and wheel nut wrench.

Refer to “To remove the spare tire” on page 8-12 and “Jack and tools” on page 8-5.

8-16 For emergencies

Wheel cover (if so equipped)

N00849400225

To remove

Wrap the tip of the bar with a cloth, insert it into the notch provided in the wheel cover, and pry the cover away from the wheel. Using the same procedure at the other wheel cover notches, work the wheel cover away from the wheel to remove it completely.

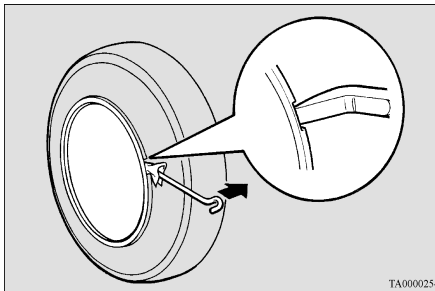

NOTE

- The wheel cover is made of plastic. Be careful when prying it off.

⚠ CAUTION

- Trying to remove the wheel cover with only your bare hands can seriously injure your fingers.

To install

⚠ CAUTION

- Before installing the wheel cover to the wheel, make sure that the tabs (A) on the back of the wheel cover correctly engage the ring (B) to prevent the wheel cover from coming off. Do not install a wheel cover that has broken tabs.

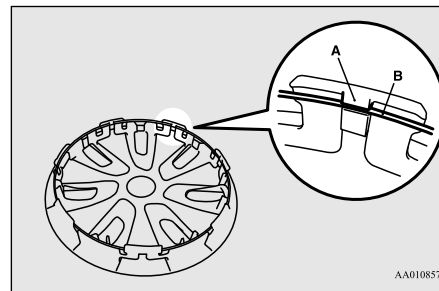

1. Align the tire air valve (C) and the wheel cover notch (D).

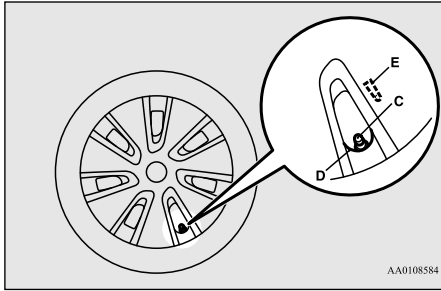

AA0108584

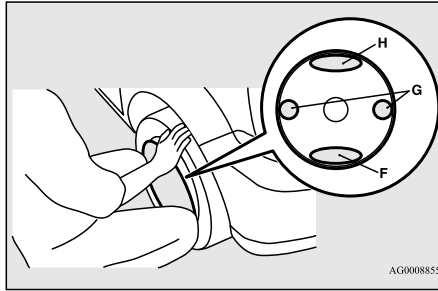

AG0008855

NOTE

- Full wheel covers have a symbol mark (E) provided on the reverse side to show the air valve location.

Before installing the wheel cover to the wheel, make sure that the opening with the symbol mark is correctly aligned with the air valve.

2. Push the bottom (F) of the wheel cover into the wheel.
3. Gently push in both sides (G) of the wheel cover and hold them in place with both knees.
4. Gently tap around the circumference of the wheel cover at the top (H), then push the wheel cover into place.

Towing

If your vehicle needs to be towed

N00837000888

If towing is necessary, we recommend you to have it done by a commercial tow truck service.

When towing is required, transport the vehicle using a tow truck.

Incorrect towing equipment could damage your vehicle.

CAUTION

- Do not attempt to be towed by another vehicle with a rope.

NOTE

- Do not use the tie-down hooks for towing. These hooks are provided only for the purpose of transporting the vehicle itself.
- Your vehicle cannot tow any other vehicle.

There may be local regulations concerning towing in your area. Obey the regulations of the area where you are driving your vehicle.

A

B Do not tow CVT vehicles with this style.

C

D

E

AA2002123

Towing the vehicle by a tow truck

⚠ CAUTION

- This vehicle must not be towed by a tow truck using sling lift type equipment (Type A) as illustrated. Using a sling lift will damage the bumper and front end.
- Do not tow continuously variable transmission (CVT) vehicles with the driving wheels on the ground (Type B) as illustrated. If the vehicle is towed like this, the continuously variable transmission (CVT) fluid may not reach all parts of the transmission, thus damaging it.
If you tow CVT vehicles, use Type C, D or E equipment.
- If the manual transaxle is malfunctioning or damaged, transport the vehicle with the driving wheels on a carriage (Type C, D or E) as illustrated.

⚠ CAUTION

- If the vehicle is towed with the ignition switch in the “ON” position or the operation mode in ON and only the front wheels or only the rear wheels raised off the ground (Type B or C), the Active Stability Control (ASC) may operate, resulting in an accident. When towing the vehicle with the rear wheels raised, turn the ignition switch to the “ACC” position or put the operation mode in ACC. When towing the vehicle with the front wheels raised, keep the ignition switch or the operation mode as follows.
[Except for vehicles equipped with the F.A.S.T.-key]
The ignition switch is in “OFF” or “ACC” position.
[Vehicles equipped with the F.A.S.T.-key]
The operation mode is in OFF or ACC.

Towing with rear wheels off the ground (Type B - M/T vehicles only)

Set the gearshift lever to the “N” (Neutral) position.

Secure the steering wheel in a straight-ahead position with a rope or tie-down strap.

Towing a front-wheel drive vehicle with front wheels off the ground (Type C)

Release the parking brake.

Place the gearshift lever in the “N” (Neutral) position (manual transaxle) or the selector lever in the “N” (NEUTRAL) position (CVT).

Operation under adverse driving conditions

N00837200750

If your vehicle becomes stuck in sand, mud or snow

If your vehicle becomes stuck in snow, sand, or mud, it can often be moved by a rocking motion. Rock your vehicle back and forth to free it.

Do not rev the engine or spin the wheels. Constant efforts to free a stuck vehicle can cause overheating and transaxle failure. Let the engine idle for a few minutes to cool the transaxle before trying again.

If your vehicle is still stuck after several rocking attempts, call for a commercial tow truck service.

⚠ WARNING

- When trying to rock your vehicle out of a stuck position, make sure that there are no people nearby. The rocking motion can make your vehicle suddenly lurch forward or backward, and injure any bystanders.

On wet roads**⚠ CAUTION**

- Avoid flooded roads. Water is often deeper than it looks, and you could be seriously hurt by driving into flood water.
- When driving in rain, on water-covered roads, or through a car wash, water could get into the brake discs and make them fail temporarily. In such cases, lightly press the brake pedal to see if they are working properly. If they are not, press the pedal lightly several times while driving to dry the brake pads or linings, then check them again.
- When driving in rain, a layer of water may form between the tires and the road surface (hydroplaning). This loosens your tires' grip on the road, making it difficult to steer or brake properly. When driving on a wet road:
 - Drive your vehicle at a safe speed.
 - Do not drive on worn tires.
 - Always keep the tires at the correct inflation pressures.

On snowy or icy roads

- When driving on a road covered with snow or ice, use snow tires. Tire chains cannot be used on your vehicle. There may be state or local regulations about using snow tires. Always check the regulations in your local area before using them. Refer to "Snow tires" on page 9-17 and "Tire chains" on page 9-17.
- Drive slowly. Do not make sudden starts or stops, sharp turns, or slam on the brakes.
- Allow extra distance between your vehicle and the vehicle in front of you, and avoid sudden braking.
- If a skid occurs when the accelerator pedal is depressed, take your foot off the pedal. Steer gently in the direction of the skid.
- Your vehicle is equipped with an anti-lock braking system (ABS). Hold the brake pedal down firmly and keep it depressed. Do not pump the brake pedal which will result in reduced braking performance.
- After parking on snowy or icy roads, it may be difficult to move your vehicle due to the brake being frozen. Depress the accelerator pedal little by little to move the vehicle when safe to do so.

⚠ CAUTION

- Do not depress the accelerator pedal rapidly. The vehicle could start moving when it breaks free from the ice, possibly resulting in an accident.

On a bumpy or rutted road

- Drive as slow as possible when driving on bumpy, rutted roads or over potholes etc.

⚠ CAUTION

- Driving on bumpy, rutted roads or over potholes can damage the tires and wheels. Wheels with low-profile tires or under-inflated tires are especially at risk for damage.
- The vehicle's body, bumper, muffler and other parts may be damaged if the vehicle is:
 - driven over a step (for example, at the entrance or exit of a parking lot);
 - parked too closely against a curb or parking block, or by the side of a road with curbstones;
 - driven on a steep slope.

Fuel Pump Shut-off System

N00860600031

WARNING

- **Before attempting to restart the engine after a collision, always inspect the ground under the vehicle for leaking fuel. If a fuel leak is found or a fuel odor is detected, do not restart the engine.**
- **Mitsubishi Motors recommends that your vehicle be inspected by an authorized Mitsubishi Motors dealer after any collision.**

8

In the event of a collision causing frontal air-bag deployment, the fuel pump shut-off system will activate to stop fuel supply to the engine.

Vehicle care and maintenance

Service precautions	9-2
Catalytic converter	9-3
Engine hood	9-4
View of the engine compartment	9-5
Engine oil and oil filter	9-5
Engine coolant	9-7
Air cleaner filter	9-8
Manual transaxle oil (if so equipped)	9-9
Continuously variable transmission (CVT) fluid (if so equipped)	9-9
Washer fluid	9-9
Brake fluid	9-10
Battery	9-10
Tires	9-12
Clutch pedal free play (if so equipped)	9-18
Brake pedal free play	9-18
Parking brake	9-18
Wiper blades	9-19
Emission-control system maintenance	9-19
General maintenance	9-20
For cold and snowy weather	9-21
Fusible links	9-22
Fuses	9-22
Replacement of light bulbs	9-26
Vehicle care precautions	9-31
Cleaning the inside of your vehicle	9-32
Cleaning the outside of your vehicle	9-33

Service precautions

N00937300387

Taking regular care of your vehicle will preserve its value and appearance as long as possible.

You can do some of the maintenance work yourself, and the rest should only be performed by an authorized Mitsubishi Motors dealer or a repair facility of your choice. If you discover a malfunction or other problem, have it corrected by an authorized Mitsubishi Motors dealer or a repair facility of your choice.

This section describes the maintenance inspections that you can do yourself, if you so desire. Follow the instructions and precautions for each procedure.

⚠ WARNING

- When checking or servicing the inside of the engine compartment, be sure the engine is stopped and has had a chance to cool down.
- If you need to work in the engine compartment with the engine running, be especially careful that your clothing, hair, etc. does not get caught in the fan, drive belts, or other moving parts.

⚠ WARNING

- The fan can turn on automatically even if the engine is not running. Turn the ignition switch to the “OFF” position or put the operation mode in OFF to be safe while you work in the engine compartment.
- Do not smoke or allow open flames around fuel or the battery. The fumes are flammable.
- Be extremely careful when working around the battery. It contains poisonous and corrosive sulfuric acid.
- Do not get under your vehicle while it is on a jack. Always use properly rated automotive jack stands.
- Handling your vehicle’s parts and materials in the wrong way can injure you. Ask an authorized Mitsubishi Motors dealer or a repair facility of your choice if you have questions.



**MITSUBISHI
MOTORS**

**DIAMOND CARE
PROTECTION PLAN**

Information Provided by:



Have you purchased the Mitsubishi Motors Diamond Care Protection Plan? The Plan supplements your new vehicle warranties. See your authorized Mitsubishi Motors dealer for details.

If your vehicle is raised with a garage jack

Only use the designated positions shown in the illustration.

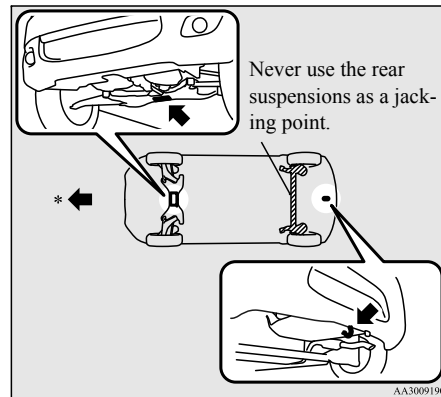

*- Front of the vehicle

⚠ WARNING

- Set a garage jack only at the position shown here. If the garage jack is set a wrong position, it could damage your vehicle and/or your vehicle might fall from the jack causing injury or death.
- Do not use the jack on a tilted or soft surface. Otherwise, the jack might slip and cause personal injury. Always use the jack on a flat, hard surface. Before setting the jack, make sure there are no sand or pebbles under the jack base.

Catalytic converter

N00937400450

The catalytic converter requires you to use unleaded fuel only. Leaded gasoline will destroy the emission-control effectiveness of the converter.

Normally, the catalytic converter does not require maintenance. However, it is important to keep the engine properly tuned for the converter to continue to work properly.

⚠ CAUTION

- Damage to the catalytic converter can result if your vehicle is not kept in proper operating condition. If the engine malfunctions or misfires, or if your vehicle performance suffers, have it serviced promptly. Running your vehicle when it is overheated may result in damage to the converter and vehicle.

⚠ WARNING

- Do not park or run your vehicle in areas where combustible materials such as dry grass or leaves can come in contact with a hot exhaust, since a fire could occur.
- Do not put undercoat paint on the catalytic converter.

To reduce the possibility of catalytic converter damage:

- Use UNLEADED GASOLINE ONLY of the type of recommended in the “Fuel selection”.
- Do not drive with an extremely low fuel level. Running out of gas could damage the catalytic converter.
- Do not try to start the engine by pushing or towing the vehicle. If the battery is weak or run down, use jumper cables to properly start the engine.

- Do not idle the engine with any spark plug wires disconnected or removed, such as when performing diagnostic tests.
- Do not idle the engine for a long time if it is idling roughly or otherwise obviously malfunctioning.
- To prevent the catalytic converter from being damaged from unburned gas, do not race the engine when stopping the engine.
- Stop driving the vehicle if you think the performance is noticeably low, or the engine has a malfunction such as with the ignition, etc. If you are not able to stop driving immediately, slow down and drive for only a short time. Have your vehicle checked at an authorized Mitsubishi Motors dealer or a repair facility of your choice as soon as possible.
- In unusual situations involving major engine problems, a burning odor may indicate severe and abnormal catalytic converter overheating. If this occurs, stop in a safe place, shut the engine off and let the vehicle cool. Once the engine is cool, immediately take your vehicle to a dealer or a repair facility of your choice for service.

Engine hood

N00937501575

To open

Use the engine hood release lever (located under the instrument panel near the driver's door) to unlock the engine hood.

Pull the lever toward you to release the engine hood latch.

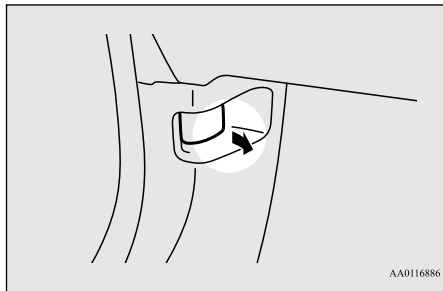

9

WARNING

- Never use the release lever to unlatch the engine hood while the vehicle is in motion.
- Do not drive your vehicle unless the engine hood is locked.

Release the lever and lift the engine hood.

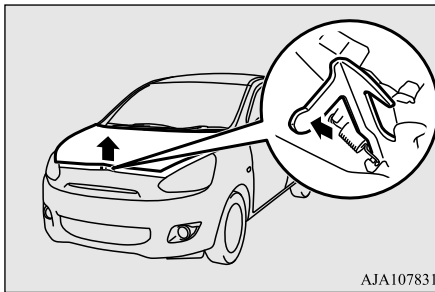

NOTE

- To prevent damage to the engine hood and wipers, make sure the wipers are at resting position when you open the engine hood.

Support the engine hood with the hood prop. Insert the hood prop securely in the opening under the hood marked with an arrow.

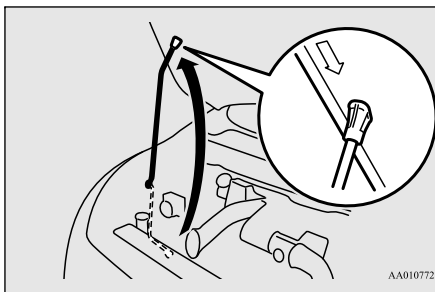

CAUTION

- Always insert the support prop into the hole specially made for it. Propping the engine hood at any other place could cause the prop to slip out and lead to an accident.
- The hood prop can fall out if the hood is lifted by a strong wind.

To close

Unlatch the prop from the engine hood and put it back in its retainer.

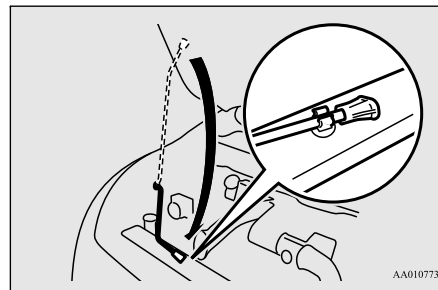

Slowly lower the engine hood about 8 inches (20 cm), then let it drop from its own weight.

CAUTION

- Be careful not to trap your hands or fingers when closing the engine hood.

CAUTION

- Make sure the engine hood is firmly closed before driving.
If you drive without the engine hood completely closed, it could open up while driving.

NOTE

- If this does not close the engine hood properly, drop it again from a slightly higher position.
- Do not push down strongly on the engine hood. Depending on how strongly or where you push down, you could create a dent in the vehicle body.

View of the engine compartment

N00937600713

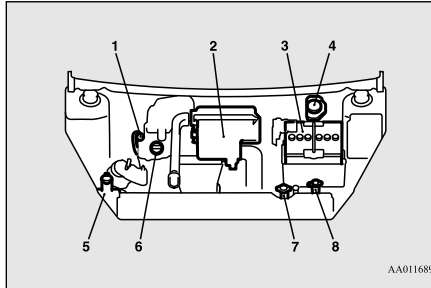

- 1- Engine oil level dipstick
- 2- Air cleaner filter
- 3- Battery
- 4- Brake fluid
- 5- Windshield and rear window washer fluid reservoir
- 6- Engine oil filler cap
- 7- Radiator cap
- 8- Engine coolant reserve tank

Engine oil and oil filter

N00937702011

To check and refill engine oil

It is normal for an engine to use oil. You may need to add oil between the recommended oil change intervals. Before starting the engine, check the engine oil level. Refill if necessary.

To check the oil level, remove the dipstick, wipe it off, and gently reinsert it all the way. Slowly pull the dipstick straight out and check the oil level by checking the upper surface of the dipstick. The oil level must not go above the line on the dipstick.

NOTE

- If it is difficult to verify the oil level, wipe off the dipstick and reinsert it. Wait a moment and then recheck the oil level by checking the upper surface of the dipstick.

If the level does not reach the line which shows the minimum amount of oil required, remove the oil filler cap on the engine valve cover, and fill to within the “Good” range.

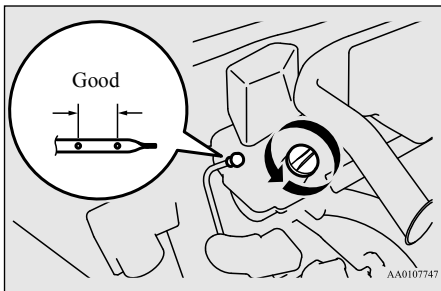

CAUTION

- Overfilling will cause oil aeration and loss of oil pressure, which could damage the engine.

WARNING

- Used engine oil is poisonous, and can damage your skin. Prolonged and repeated contact may cause serious skin disorders, including dermatitis and cancer. Do not let used oil touch your skin and wash thoroughly after working with it.
- Keep used oil out of the reach of children.

NOTE

- Engine oil consumption is greatly influenced by payload, engine speed, etc.

NOTE

- The engine oil will deteriorate rapidly if the vehicle is subjected to severe conditions (for example, repeated operation on rough roads, in mountainous regions, on roads with many uphill and downhill gradients, or over short distances). Consequently, the oil will require earlier replacement in accordance with the schedule in the “WARRANTY AND MAINTENANCE MANUAL”.

Engine oil identification mark

Mitsubishi Motors recommends using only engine oils with the ILSAC certification symbol on the front of the container.

ILSAC certification symbol



TA0000313

If you cannot find oils with the ILSAC certification symbol, use an API classification SN or higher oil with the following label.

This mark appears on the top of the oil container and tells you two important things about the oil.

API service symbol

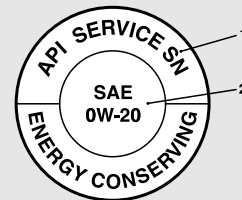

AH0000849

- 1- The upper part indicates the quality of the oil.
- 2- The center part indicates the SAE grade of the oil viscosity.

Recommended engine oil viscosity

Use engine oil with the proper thickness for the outdoor temperatures where you will be driving.

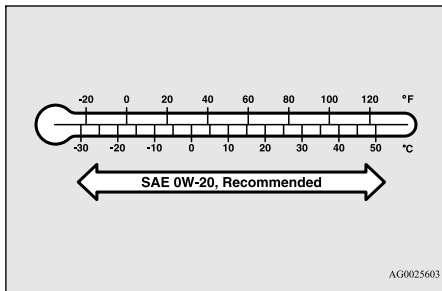

Mitsubishi Motors Genuine 0W-20 Synthetic Engine Oil is recommended for optimum fuel economy and cold weather starting.

If Mitsubishi Motors Genuine 0W-20 Synthetic Engine Oil is not available, 5W-20 grade oils displaying the ILSAC certification can be used.

However, Mitsubishi Motors Genuine 0W-20 Synthetic Engine Oil should be used at the next oil change to maintain optimum fuel economy and cold weather starting.

To replace the oil filter

The oil filter should be replaced at the time or mileage specified in the “WARRANTY AND MAINTENANCE MANUAL”.

Only use high quality replacement filters on this vehicle. The manufacturer’s specifications for Genuine Mitsubishi oil filters

require that the filter can withstand a pressure of 256 psi (1.8 MPa). A Genuine Mitsubishi oil filter is the best replacement filter.

Follow the installation instructions printed on the filter.

Engine coolant

N00937800597

To check the coolant level

The engine coolant reserve tank (A) lets you quickly see when you need to add coolant. When the engine is cold, the level of the coolant in the reserve tank should be between the FULL and LOW marks. The radiator usually stays full so there is no reason to remove the radiator cap (B) except when you check the coolant freeze point or replace the antifreeze coolant.

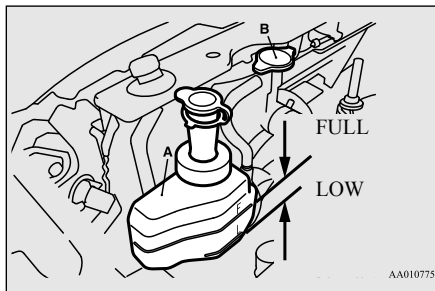

To add coolant

Use “Mitsubishi Motors Genuine Super Long Life Coolant Premium” or equivalent*.

*: similar high quality ethylene glycol based non-silicate, non-amine, non-nitrate and non-borate coolant with long life hybrid organic acid technology

Mitsubishi Motors Genuine Coolant provides excellent protection against corrosion and rust formation on all metals, including aluminum, and prevents clogs in some parts of the engine.

If you need to add coolant often, or if the level in the reserve tank does not drop when the engine cools, the cooling system should be pressure-tested for leaks. Take your vehicle to an authorized Mitsubishi Motors dealer or a repair facility of your choice for testing.

CAUTION

- Do not use alcohol or methanol antifreeze or any engine coolants that contain them. Using the wrong antifreeze can corrode aluminum parts.

CAUTION

- The required concentration of anti-freeze differs depending on the expected ambient temperature.
Above -31 °F (-35 °C) : 50 % concentration of anti-freeze
Below -31 °F (-35 °C) : 60 % concentration of anti-freeze
You can check the concentration level with a gauge from an automotive supply store, or your authorized Mitsubishi Motors dealer or service station can check it for you.
- Do not use water to adjust the concentration of coolant.
- Do not top off the tank with plain water only. Water by itself boils at a lower temperature and does not stop rust or freezing. If the water freezes, it will damage your cooling system. Do not use tapwater. It can cause corrosion and rust.

Radiator cap

The radiator cap must be sealed tight to prevent losing coolant, which may result in engine damage. Only use a Genuine Mitsubishi Parts radiator cap, or an approved equivalent.

WARNING

- **Wait for the engine to cool down before opening the radiator cap. Otherwise hot steam or boiling coolant could spray up from the radiator and scald you.**

Points to remember

- Do not overfill the reserve tank.
- Your vehicle uses a special radiator cap that stays sealed and lets the coolant flow from the reserve tank back to the radiator when the engine cools down. If you need to change the cap, use the exact same kind.
- Check the coolant freeze point in the radiator with the proper gauge, and only when it is safe. If you add antifreeze, the contents of the reserve tank must be protected against freezing.
- Keep the front of the radiator and condenser clean.
- If the engine coolant temperature does not rise after the engine is warmed-up, take your vehicle to an authorized Mitsubishi Motors dealer or a repair facility of your choice to have the thermostat checked, and replaced if necessary.

Air cleaner filter

N00937900413

The air cleaner filter will get dirty and dusty from use and not filter properly. Replace it with a new filter using the schedule in the “WARRANTY AND MAINTENANCE MANUAL”.

1. Unclamp the cover. Open up the top of the cover and take out the air cleaner filter.

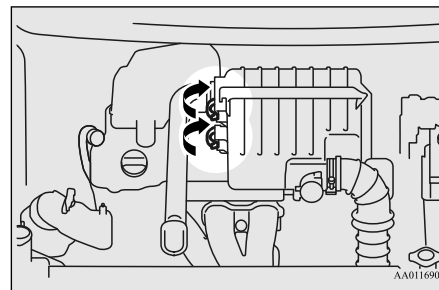

2. Replacing the air cleaner filter and put the cover back on in its original position.

NOTE

- Genuine Mitsubishi Motors Parts are recommended when replacing the air cleaner filter.
- Make sure that the connector is properly reconnected.
- After replacing the air cleaner filter, make sure that the hinges at the bottom of cover are firmly set.

⚠ CAUTION

- Take care not to scratch the engine air flow sensor when removing the air cleaner cover.

Manual transaxle oil (if so equipped)

N00938200181

Whenever the manual transaxle oil level is checked, add oil to maintain the proper level, if necessary. Refill or change with the oil according to the table below.

Oil type

Lubricant	Mitsubishi Motors Genuine NEW MULTI GEAR OIL ECO API Classification GL-4
Viscosity range	SAE 75W-80

Continuously variable transmission (CVT) fluid (if so equipped)

N00938101129

The continuously variable transmission (CVT) should be maintained and serviced by an authorized Mitsubishi Motors dealer or a repair facility of your choice to obtain the best performance and longest life. It is important that the transmission fluid is kept at the correct level.

Fluid type

Use only “Mitsubishi Motors Genuine CVTF-J4” transmission fluid to ensure optimum transmission performance.

⚠ CAUTION

- Using the improper transaxle fluid may damage the transaxle.

Special additives

Do not use any fluid additives to the transmission.

Washer fluid

N00938601339

The windshield and rear window washer fluid reservoir is in the engine compartment. Check the washer fluid level at regular intervals and add washer fluid to reservoir if necessary. Open the reservoir cap and check the level of washer fluid. The washer fluid level should be kept approximately 5 cm below the upper surface of the reservoir.

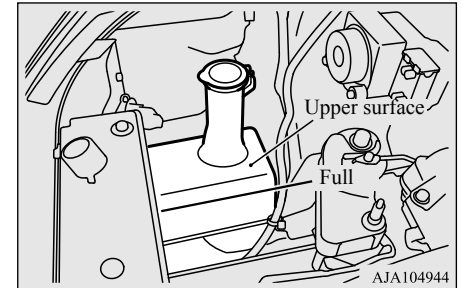

When freezing weather is anticipated, flush out the water in the reservoir by operating the pump. Fill the reservoir with windshield antifreeze (not radiator antifreeze), and operate the system for a few seconds to flush out the residual water.

Brake fluid

N00938700274

To check the fluid level

The fluid level must be between the “MAX” and “MIN” marks on the reservoir.

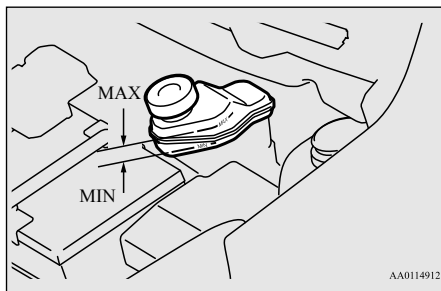

AA0114912

The fluid level falls slightly with wear of the brake pads, but this does not indicate any abnormality.

The fluid in the master cylinder should be checked when doing other work under the engine hood. The brake system should also be checked for leaks at the same time.

If the fluid level falls noticeably in a short length of time, it indicates leaks from the brake system.

If this occurs, have the vehicle checked by an authorized Mitsubishi Motors dealer or a repair facility of your choice.

Fluid type

Use the brake fluid conforming to DOT 3 or DOT 4. The reservoir cap must be tightly sealed to keep dirt and water out.

⚠ CAUTION

- Do not let any petroleum-based fluid touch, mix with, or get into the brake fluid. This will damage the seals.
- Be careful when handling brake fluid. It can damage painted surfaces.
- Use only the listed brake fluid. Different brands of brake fluid have different additives, and these can cause a chemical reaction. Do not mix brands of brake fluid.
- Keep the reservoir tank cap closed to keep the brake fluid from evaporating.

Battery

N00939100943

The condition of the battery is very important for quick starting and to keep the vehicle's electrical system working properly. Check the battery regularly.

Checking battery electrolyte level

N00901500072

The electrolyte level must be between the limits shown on the outside of the battery. Fill it with distilled water as needed. The inside of the battery is divided into several compartments. Take the cap off of each compartment and fill to the mark.

Do not fill above the top line because a spill during driving could cause damage.

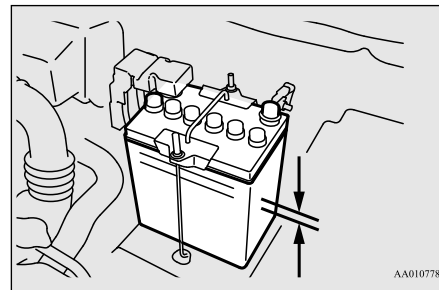

AA0107789

⚠ WARNING

- If the battery goes flat, be sure to check the battery electrolyte level before connecting booster cables.
- After checking the battery electrolyte level, make sure the caps are fitted securely.

⚠ WARNING

- If any of the caps has a loose fit, replace the battery.

During cold weather

N00901600060

The battery is weaker in cold temperatures. This has to do with its chemical and physical properties and is why a very cold battery, especially one with a low charge, will have a hard time starting your vehicle.

It is recommended that you have your battery and charging system checked by an authorized Mitsubishi Motors dealer or a repair facility of your choice before the start of cold weather. If necessary, have it charged. This will provide more reliable starting, and longer battery life.

Disconnection and connection

N00901701130

To disconnect the battery cable, stop the engine. Disconnect the negative (-) terminal first, then the positive (+) terminal. To reconnect the battery, first connect the positive (+) terminal and then the negative (-) terminal, before starting the vehicle.

📖 NOTE

- Open the terminal cover (A) before disconnecting or connecting the positive (+) terminal of the battery.
- Loosen the nut (B) and then disconnect the battery cable from the positive (+) terminal.

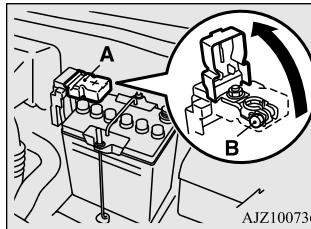
**⚠ WARNING**

- Never disconnect the battery while the engine is running, or you could damage the vehicle's electrical parts.
- Never short-circuit the battery. This could cause it to overheat and be damaged.
- Keep sparks, cigarettes, and flames away from the battery because the battery could explode.
- Electrolyte (battery acid) is made of corrosive diluted sulfuric acid. If it spills on nearby parts, it can crack, stain, or discolor them. And if it gets on your skin or in your eyes, it can cause burns or blindness. Please observe the following handling instructions:

⚠ WARNING

- If electrolyte gets on plastic parts or other nearby parts, wipe it off with a soft cloth or chamois soaked in a solution of water and neutral detergent then immediately rinse the affected parts with plenty of water.
- If electrolyte gets on your hands or clothes, rinse thoroughly with water. If electrolyte gets in your eyes, flush them with water immediately and get immediate medical attention.
- Open doors and windows in any closed space where you may be charging or working with the battery.
- Always wear protective clothing and goggles when working with the battery, or have a skilled automobile technician do it.
- If you are quick-charging your battery, first disconnect the battery cables.
- In order to prevent a short-circuit, be sure to disconnect the negative (-) terminal first, and reconnect it last.
- Battery posts, terminals and related accessories contain lead and lead compounds. Wash hands after handling.

📖 NOTE

- Check each battery terminal for corrosion. You can stop more corrosion by washing with a solution of baking soda and water. Grease the posts and clamps after cleaning or tightening them.

 **NOTE**

- Check to see that the battery is securely installed and cannot be moved. Also check each terminal for tightness.
- If you will not be driving your vehicle for a long period of time, remove the battery and store it in a place where the battery fluid will not freeze. The battery only should be stored with a full charge.
- Before cleaning the battery, tighten all the filler port caps to keep dirt and moisture out.

Tires

N00939200566

 **WARNING**

- **Driving with tires that are worn, damaged or improperly inflated is dangerous. These type tire conditions will adversely affect vehicle performance. These type tire conditions can also cause a tread separation or blowout which may result in an accident causing serious injury or death.**
- **Tires, including spare tire, degrade over time with age even when they are not being used. It is recommended that tires over 6 years generally be replaced even if damage is not obvious.**

It is important to familiarize yourself with the following terms:

- **Cold tire pressure:**
 - The measured pressure after the vehicle has been parked for at least three hours, or
 - The measured pressure when the vehicle is driven less than 1 mile (1.6 km) after having been parked for three hours.
- **Maximum pressure:** the maximum permissible cold tire inflation pressure for this tire.
- **Recommended inflation pressure:** the inflation pressure for optimum tire performance.
- **Intended outboard sidewall:**
 - The sidewall that contains a whitewall, bears white lettering or bears manufacturer, brand, and/or model name molding that is higher or deeper than the same molding on the other sidewall of the tire, or
 - The outward facing sidewall of an asymmetrical tire that has a particular side that must always face outward when mounted on a vehicle.
- **Passenger car tire:** a tire intended for use on passenger cars, multipurpose passenger vehicles, and trucks that have a gross vehicle weight rating (GVWR) of 10,000 pounds or less.
- **Light truck (LT) tire:** a tire designated by its manufacturer as primarily intended for use on lightweight trucks or multipurpose passenger vehicles.
- **Tread:** portion of a tire that comes into contact with the road.
- **Tread rib:** a tread section running circumferentially around a tire.
- **Tread separation:** pulling away of the tread from the tire carcass.
- **Carcass:** the tire structure, except tread and sidewall rubber which, when inflated, bears the load.
- **Sidewall:** portion of a tire between the tread and bead.
- **Section width:** the linear distance between the exteriors of the sidewalls of an inflated tire, excluding elevations due to labeling, decoration, or protective bands.
- **Bead:** the part of the tire that is made of steel wires, wrapped or reinforced by ply cords and that is shaped to fit the rim.
- **Ply:** a layer of rubber-coated parallel cords.
- **Cord:** the strands forming the plies in the tire.
- **Rim:** a metal support for a tire or a tire and tube assembly upon which the tire beads are seated.
- **Rim diameter:** nominal diameter of the bead seat.

- Groove: the space between two adjacent tread ribs.

Tire Markings

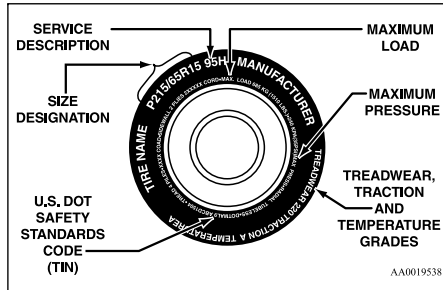

Size Designation

EXAMPLE: P215/65R15

P	Passenger car tire size based on U.S.A. design standards
215	Section width in millimeters (mm)
65	Aspect ratio in percent (%) Ratio of section height to section width of tire.
R	Construction code <ul style="list-style-type: none"> • “R” means radial construction. • “D” means diagonal or bias construction.

15	Rim diameter in inches (in)
----	-----------------------------

NOTE

- European/Japanese metric tire sizing is based on European/Japanese design standards. Tires designed to these standards have the tire size molded into the sidewall beginning with the section width. The letter “P” is absent from this tire size designation. Example: 215/65R15 96H.
- LT (Light Truck) -metric tire sizing is based on U.S.A. design standards. The size designation for LT-metric tires is the same as for P-metric tires except for the letters “LT” that are molded into the sidewall preceding the size designation. Example: LT235/85R16.
- Temporary spare tires are high pressure compact spares designed for temporary emergency use only. Tires molded to this standard have the letter “T” molded into the sidewall preceding the size designation. Example: T145/80D18 103M.

Service Description

EXAMPLE: 95H

95	Load index A numerical code associated with the maximum load a tire can carry.
----	---

H	Speed symbol A symbol indicating the range of speeds at which a tire can carry a load corresponding to its load index under certain operating conditions. The maximum speed corresponding to the speed symbol should only be achieved under specified operating conditions. (i.e. tire pressure, vehicle loading, road conditions and posted speed limits)
---	--

Maximum Load

Maximum load indicates the maximum load this tire is designed to carry.

WARNING

- **Overloading of your tire is dangerous. Overloading can cause tire failure, affect vehicle handling, and increase your stopping distance. Use tires of the recommended load capacity for your vehicle. Never overload them.**

Maximum Pressure

Maximum Pressure indicates the maximum permissible cold tire inflation pressure for this tire.

Tire Identification Number (TIN)

The TIN may be found on one or both sides of the tire but the date code may only be on one side. Look for the TIN on the outboard side of tires as mounted on the vehicle. If the TIN is not found on the outboard side then you will find it on the inboard side of the tire.

EXAMPLE: DOT MA L9 ABCD 1504

DOT	Department of Transportation This symbol certifies that the tire is in compliance with the U.S. Department of Transportation tire safety standards, and is approved for highway use.
MA	Code representing the tire manufacturing location. (2 digits)
L9 ABCD	Code representing the tire size. (2 digits) Code used by tire manufacturer. (1 to 4 digits)

15	Number representing the week in which the tire was manufactured. (2 digits)
04	Number representing the year in which the tire was manufactured. (2 digits)

Treadwear, Traction and Temperature Grades

Treadwear

The treadwear grade is a comparative rating based on the wear rate of the tire when tested under controlled conditions on a specified government test course. For example, a tire graded 150 would wear one and one-half ($1\frac{1}{2}$) times as well on the government course as a tire graded 100. The relative performance of tires depends upon the actual conditions of their use, however, and may depart significantly from the norm due to variations in driving habits, service practices and differences in road characteristics and climate.

Traction

The traction grades, from highest to lowest, are AA, A, B and C. Those grades represent the tire's ability to stop on wet pavement as measured under controlled conditions on

specified government test surfaces of asphalt and concrete. A tire marked C may have poor traction performance.

Temperature

The temperature grades are A (the highest), B and C, representing the tire's resistance to the generation of heat and its ability to dissipate heat when tested under controlled conditions on a specified indoor laboratory test wheel. Sustained high temperature can cause the material of the tire to degenerate and reduce tire life, and excessive temperature can lead to sudden tire failure. The grade C corresponds to a level of performance which all passenger car tires must meet under the Federal Motor Vehicle Safety Standard No. 109. Grades B and A represent higher levels of performance on the laboratory test wheel than the minimum required by law.

Tire inflation pressures

N00939300903

Proper tire inflation pressure is essential for the safe and satisfactory operation of your vehicle. The wrong tire pressure will cause problems in three major areas:

- Safety

Too little pressure increases flexing in the tire and can cause tire failure. Too much pressure can cause a tire to lose its ability to cushion shock. Objects on the road and potholes could then cause tire damage that may result in tire failure.

- **Economy**

The wrong tire pressure can cause uneven wear patterns in the tire tread. These abnormal wear patterns will reduce the tread life, and the tire will have to be replaced sooner.

Too little pressure also makes it harder for the tire to roll, and this uses up more fuel.

- **Ride comfort and vehicle stability**

The superior riding experience built into your vehicle partly depends on the correct tire pressure. Too much pressure gives an uncomfortable and jarring ride. Too little pressure feels as if your vehicle is slow to respond.

Unequal tire pressures can make steering your vehicle uneven and unpredictable.

The tire pressure for your vehicle under normal driving conditions is listed on the placard attached to the driver's door sill.

(Refer to "Tire and loading information placard" on page 11-3.)

The recommended inflation pressures under normal driving conditions should be used for the tires listed below.

Item	Tire size	Front	Rear
Normal tire	165/65R14	240 kPa, 35 psi	240 kPa, 35 psi
Compact spare wheel (if so equipped)	T115/70D14	420 kPa, 60 psi	

Tire pressures should be checked, and adjusted if necessary, at least once a month. Pressures should be checked more often whenever weather temperatures change severely, because tire pressures change with outdoor temperatures. The pressures listed are always "cold inflation pressure".

Cold inflation pressure is measured after the vehicle has been parked for at least three hours or is driven less than 1 mile (1.6 km) after having been parked for three hours.

Cold inflation pressure must not go above the maximum values molded into the tire sidewall. After driving several miles, your tire inflation pressure may increase 2 to 6 psi (14 to 41 kPa) from the cold inflation pressure. Do not let air out of the tires to get back to the

specified cold pressure, or your tires will be too low.

Check your tires each time you refuel. If one tire looks lower than the others, check the pressure for all of them.

You should also take the following safety precautions:

- Keep your tires inflated to the recommended pressures. (See the tire and loading information placard attached to the driver's door sill.)
- Stay within the recommended load limits.
- Make sure that the weight of any load in your vehicle is evenly distributed.
- Drive at safe speeds.
- After filling your tires to the correct pressure, check them for damage and air leaks. Be sure to reinstall the caps on the valve stems.

Replacing tires and wheels

N00939600430

CAUTION

- Avoid using different size tires from the one listed and the combined use of different types of tires, as this can affect driving safety. Refer to "Tires and wheels" on page 11-5.

CAUTION

- If your vehicle is equipped with a tire pressure monitoring system, only Mitsubishi Motors Authorized wheels should be used. Use of another type of wheel risks air leaks and sensor damage, as it will not be possible to install the tire pressure sensor properly.

Tire maintenance

N00939700141

The following maintenance steps are recommended:

- Check tire pressures regularly.
- Have regular maintenance done on the wheel balance and front and rear suspension alignment.
- Rotate your tires regularly as described in the “Tire rotation” section on page 9-16.

Tread wear indicator

N00939800184

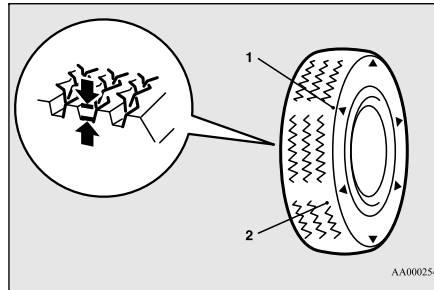

AA0002549

- 1- Location of the tread wear indicator
- 2- Tread wear indicator

Tread wear indicators are built into the original equipment tires on your vehicle to help you know when your tires should be replaced. Many states have laws requiring that you replace your tires at this point.

These indicators are molded into the bottom of the tread grooves and will appear when the tire tread is worn down to 1/16 inch (1.6 mm).

When the bands appear next to one another in two or more places, replace your tires.

NOTE

- Tire wear indicators can have different marks and locations depending on the tire manufacturer.

Information Provided by:

**Tire rotation**

N00939900521

To even out the wear on your tires and make them last longer, Mitsubishi Motors Corporation recommends that you rotate your tires at the mileage listed in the “WARRANTY AND MAINTENANCE MANUAL”.

However, the timing for tire rotation may vary according to your vehicle condition, road surface conditions, and your own personal driving habits. Any time you notice unusual wear, rotate your tires as soon as possible.

When rotating tires, check for uneven wear, damage, and wheel alignment. Abnormal wear is usually caused by a wrong tire pressure, wheels that are not aligned properly, wheels that are out-of-balance, or severe braking.

Check with an authorized Mitsubishi Motors dealer or a repair facility of your choice to find out the reason for uneven tread wear.

The first tire rotation is the most important one. It will allow all your tires to wear evenly.

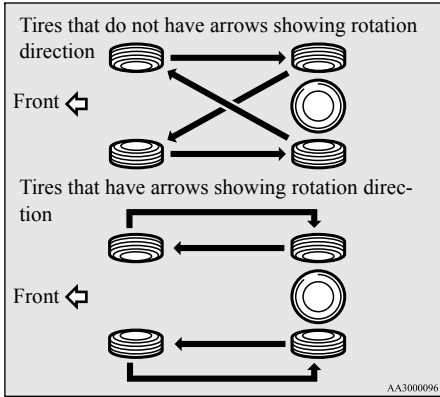

⚠ CAUTION

- If the tires have arrows (A) indicating the correct direction of rotation, swap the front and rear tires on the left-hand side of the vehicle and the front and rear tires on the right-hand side of the vehicle separately. Keep each tire on its original side of the vehicle. When installing the tires, make sure the arrows point in the direction in which the wheels will turn when the vehicle moves forward. Any tire whose arrow points in the wrong direction will not perform to its full potential.

Snow tires

N0094000418

In some areas of the country, snow tires are required for winter driving. If snow tires are required in your area, you must choose snow tires of the same size and type as the original tires provided with your vehicle. Snow tires should also be installed on all four wheels. Otherwise your safety and vehicle handling can be reduced. Even where laws may permit it, snow tires should not be operated at sustained speeds over 75 mph (120 km/h).

⚠ CAUTION

- A compact spare tire (if so equipped) can be installed temporarily in place of a tire that has been removed during the tire rotation. However, it must not be included in the regular tire rotation sequence.

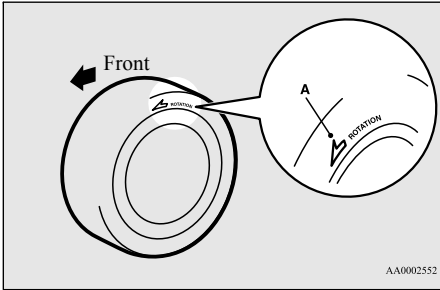

⚠ CAUTION

- If your vehicle is equipped with a tire pressure monitoring system, only Mitsubishi Motors Authorized wheels should be used. Use of another type of wheel risks air leaks and sensor damage, as it will not be possible to install the tire pressure sensor properly.

⚠ CAUTION

- Avoid the combined use of different types of tires. Using different types of tires can affect vehicle performance and safety.

Tire chains

N00940100116

⚠ CAUTION

- Tire chains cannot be used on your vehicle. The clearance between the chains and the body is not sufficient to allow proper clearance, and the vehicle body might be damaged.



Clutch pedal free play (if so equipped)

Clutch pedal free play (if so equipped)

N00940200090

To check the clutch pedal free play (A), turn off the engine and press the pedal until you feel resistance.

Clutch pedal free play:

.4 to .6 inch (11 to 16 mm)

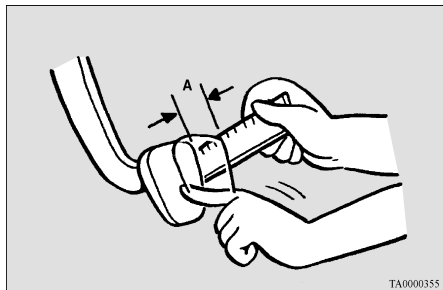

If the free play is not within these limits, take your vehicle to an authorized Mitsubishi Motors dealer or a repair facility of your choice for adjustment.

Brake pedal free play

N00940300336

To check the brake pedal free play (A), turn off the engine and press the brake pedal sev-

eral times with your foot. Then press the pedal down with your fingers until you first feel resistance.

Brake pedal free play:

.1 to .3 inch (3 to 8 mm)

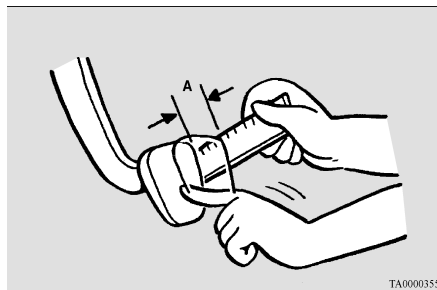

If the free play is not within these limits, take your vehicle to an authorized Mitsubishi Motors dealer or a repair facility of your choice for adjustment.

Parking brake

N00940400252

Parking brake lever stroke

Check the parking brake lever travel occasionally. To check this, pull the lever up

slowly and count the number of clicks of the ratchet.

Parking brake lever stroke:

7 to 9 notches (clicks)

(Parking brake adjustment when pulled with the force of 200 N)

Also check to see if the lever stays gripped by the ratchet after pulling.

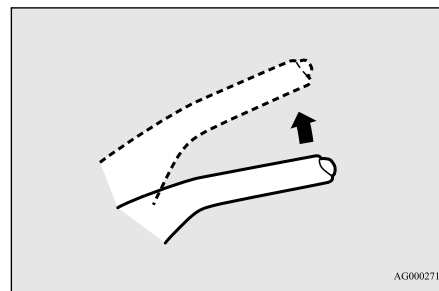

⚠ WARNING

- Continued operation of the vehicle with the parking brake lever out of adjustment may result in the vehicle moving when unattended.

Wiper blades

N00940700138

Check the wiper blades occasionally. Clean them regularly to remove deposits of salt and road film. Use a sponge or cloth and a mild detergent or non-abrasive cleaner to clean the blades and glass areas.

Replace the blades if they continue to streak or smear.

NOTE

- Do not run the wipers on dry glass for a long time. This wears out the rubber and can scratch the glass.

During cold weather

If the blades are frozen to the windshield or rear window, do not operate the wipers until the ice has melted and the blades are freed, otherwise the wiper motor may be damaged.

Emission-control system maintenance

N00940800328

Your vehicle is equipped with an emission-control system that meets all the requirements of the U.S. Environmental Protection Agency

and Environment Canada. The emission-control system is made of:

- a positive crankcase ventilation system
- an evaporative emission-control system
- an exhaust emission-control system

To be sure the emission-control system works properly, have your vehicle inspected and maintained by an authorized Mitsubishi Motors dealer or a repair facility of your choice. This should be done at the time or mileage specified in the “WARRANTY AND MAINTENANCE MANUAL”.

These, and all the other “general” maintenance services listed in this manual, need to be performed to keep your vehicle running properly and reliably.

You should also have an inspection and service any time you suspect a malfunction.

NOTE

- To meet government regulations and promote cleaner air, your vehicle is equipped with an onboard diagnostic system (OBD). The engine electronic control module that controls OBD functions stores various data (especially about the exhaust emissions). This data will be erased if the battery cable is disconnected, which could make a rapid diagnosis difficult. Do not disconnect the battery cable when the engine malfunction indicator (“SERVICE ENGINE SOON” or “Check engine light”) is ON.

Spark plugs

N00940900228

Spark plugs must fire properly for good engine performance and emission-control. Do not reuse them by cleaning or regapping. Change them at the mileage listed in the “WARRANTY AND MAINTENANCE MANUAL”.

NOTE

- Use the spark plugs listed under “Engine specifications” on page 11-4 or plugs that are exactly the same. Other plugs could cause engine damage, performance problems or radio noise.

Fuel hoses

N0094100040

Check the hose surfaces for any heat and mechanical damage, hard and brittle rubber, cracking, tears, cuts and abrasions. Pay special attention to the hoses closest to high heat sources such as the exhaust manifold. Check all the hose connections, such as clamps and couplings, to make sure they are secure and that there are no leaks. If you see any wear or damage, replace the hoses immediately.

Intake valve clearance

N00950100050

Have the valve clearance checked at an authorized Mitsubishi Motors dealer at the mileage specified in the “WARRANTY AND MAINTENANCE MANUAL”.

If the engine sounds abnormally loud, have adjustments made by an authorized Mitsubishi Motors dealer.

Fuel system (tank, pipe line and connection, and fuel tank filler cap)

N00941300173

Check these regularly for damage or leaks in the fuel lines and connections. Check the fuel tank filler cap for damage or looseness. Pay special attention to the fuel lines closest to

high heat sources such as the exhaust manifold.

WARNING

- If you see a fuel leak or if you smell fuel, do not run the engine. Any spark (including from the ignition), flame or smoking material could cause an explosion or fire. Call an authorized Mitsubishi Motors dealer or a repair facility of your choice for assistance.

Evaporative emission control system (except evaporative emission canister)

N00941400187

If the fuel-vapor vent line is clogged or damaged, the fuel-vapor mixture will escape, polluting the air.

Have the system checked at an authorized Mitsubishi Motors dealer at the mileage specified in the “WARRANTY AND MAINTENANCE MANUAL”.

General maintenance

N00941500292

The next pages list the maintenance service recommended by Mitsubishi Motors Corporation. In addition to the general maintenance that needs to be performed at the times listed,

there are other parts which do not usually need regular maintenance.

But, if any of these parts stops working properly, your vehicle performance could suffer. Have these items checked if you notice a problem with them.

If you have any questions, see your authorized Mitsubishi Motors dealer for assistance.

Disc brake pads

N00941600059

Good brakes are essential for safe driving. Check the brake pads for wear. For good braking performance, replace the brake pads with the same type pads as the originals.

Brake hoses

N00941700076

Brake hoses and tubing should be checked for:

- Severe surface cracking, scuffing or worn spots. If the fabric casing of the hose is showing through any cracks or worn spots in the rubber hose cover, the hose should be replaced. The brakes can fail if the hose wears through.
- Improper installation may cause twisting, or wheel, tire or chassis interference.

Ball joint, steering linkage seals and drive shaft boots

N0094180077

Check the following parts for damage and grease leaks:

- Ball joint boots of the front suspension and steering linkage
- Bellows on both ends of the drive shaft

Exhaust system

N00942200111

WARNING

- **Carbon monoxide gas from your vehicle's exhaust is poisonous. Breathing these fumes can cause unconsciousness or death.**

The best way to keep carbon monoxide gas from entering inside your vehicle is to have the engine exhaust system properly serviced. Have a competent mechanic inspect the complete exhaust system and nearby body areas for broken, damaged, deteriorated, or mispositioned parts if you notice any of the following:

- A change in the sound of the exhaust system
- The smell of exhaust fumes inside the vehicle

- The underside or rear of the vehicle is damaged

Also check the exhaust system each time the vehicle is raised for lubrication, oil changes, or required service. Any open seams or loose connections could let dangerous exhaust fumes seep into the luggage and passenger compartments.

Check for any of the following conditions:

- Check for holes or exhaust gas leaks caused by corrosion or damage.
- Check the joints and connections for looseness or exhaust gas leaks.
- Check the rubber hangers and brackets for damage.

Hood lock release mechanism and safety catch

N00942500127

The hood lock release mechanism and hood safety catch should be checked, cleaned, and oiled when needed for easy movement and to prevent rust and wear. Use Multipurpose Grease NLGI Grade 2 sparingly for all sliding parts of the hood latch and release lever. Work the grease into the hood lock mecha-

nism until all the movable surfaces are covered.

Also, put a light coat of the same grease on the safety catch wherever moving parts touch.

For cold and snowy weather

N00942600102

Ventilation slots

The ventilation slots in front of the windshield should be brushed clear after a heavy snowfall so that the operation of the heating and ventilation systems will not be impaired.

Weatherstripping

To prevent freezing of the weatherstripping on the doors, engine hood, etc., they should be treated with silicone grease.

Additional equipment (For regions where snow is encountered)

It is a good idea to carry a shovel or a short-handled spade in the vehicle during the winter so that you can clear away snow if you get stranded. A small hand-brush for sweeping

Fusible links

snow off the vehicle and a plastic scraper for the windshield, side and rear window are also useful.

Fusible links

N00942700305

The fusible links will melt to prevent a fire if a large current attempts to flow through certain electrical systems.

In case of a melted fusible link, see your authorized Mitsubishi Motors dealer or a repair facility of your choice for inspection and replacement.

9 For the fusible links, please refer to “Fuse load capacities” on page 9-22.

WARNING

- Fusible links must not be replaced by any other device. Failing to fit the correct fusible link may result in fire in the vehicle, property destruction and serious or fatal injuries at any time.

Fuses

N00942800902

Fuse block location

To prevent damage to the electrical system from short-circuiting or overloading, each

9-22 Vehicle care and maintenance

individual circuit is equipped with a fuse. The fuse blocks are located in the passenger compartment and in the engine compartment.

Passenger compartment

The fuse block in the passenger compartment is located in front of the driver’s seat at the position shown in the illustration.

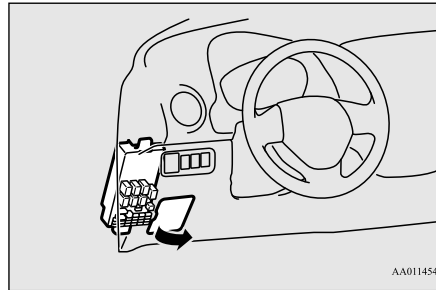

Engine compartment

In the engine compartment, the fuse block is located as shown in the illustration. While pressing the tab (A or B), pull up the cover.

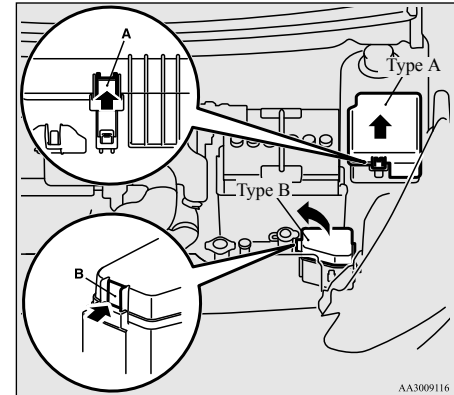

Fuse load capacities

N00954801342

This fuse list shows the names of the electrical systems and their fuse capacities. There are spare fuses in the fuse block in the engine compartment. Always replace a blown fuse with one of the same capacity as the original.

Passenger compartment fuse location table

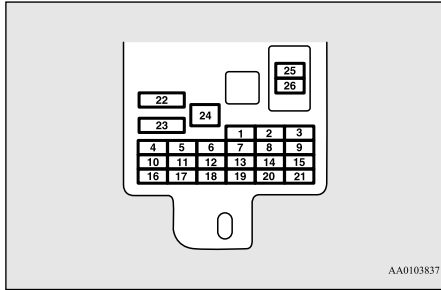

No.	Symbol	Electrical system	Capacity
1		Tail light (left)	7.5 A
2		Cigarette lighter	15 A
3		Ignition coil	10 A
4		Starter motor	7.5 A
5	—	—	—
6	—	—	—
7		Tail light (right)	7.5 A
8		Outside rearview mirrors	7.5 A
9		Engine control unit	7.5 A
10		Control unit	7.5 A

No.	Symbol	Electrical system	Capacity
11		Rear fog light	10 A
12		Door lock	15 A
13		Interior light (Dome light)	15 A
14		Rear window wiper	15 A
15		Gauges	7.5 A
16		Relay	7.5 A
17		Heated seats	20 A
18	OPTION	Option	10 A
19		Heated outside rearview mirrors	7.5 A
20		Windshield wiper	20 A
21		Back-up light	7.5 A
22		Defogger	30 A
23		Heater	30 A
24	—	—	—
25		Radio	10 A
26		Electronic controlled unit	15 A

● Some fuses may not be installed on your vehicle, depending on the vehicle model or specifications.



● The table above shows the main equipment corresponding to each fuse.

Engine compartment fuse location table

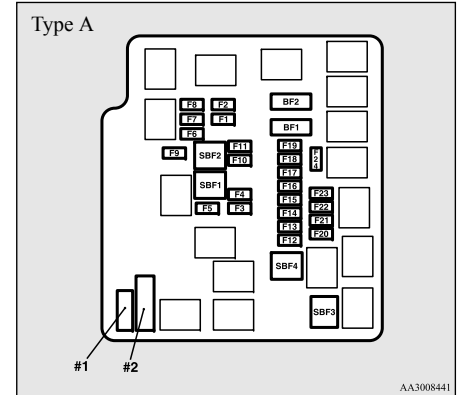

No.	Symbol	Electrical system	Capacity
SBF1		Radiator fan motor	40 A*
SBF2		Anti-lock braking system	30 A*
SBF3		Ignition switch	40 A*
SBF4		Power window control	40 A*

No.	Sym- bol	Electrical system	Capac- ity
BF1	A/T	DC-DC (P/T)	30 A
BF2	♪	DC-DC (AUDIO)	30 A
F1	☹	Headlight (low beam) (left)	10 A
F2	☹	Headlight (low beam) (right)	10 A
F3	☹	Headlight (high beam) (left)	10 A
F4	☹	Headlight (high beam) (right)	10 A
F5	♫	Horn	10 A
F6	☹	Front fog lights	15 A
F7	☹	Daytime running lights	10 A
F8	—	—	—
F9	—	—	—
F10	🔋	Battery current sensor	7.5 A
F11	—	—	—
F12	STOP	Stop lights (Brake lights)	15 A
F13	🔌	Ignition coil	7.5 A
F14	🔌	Engine control	7.5 A

No.	Sym- bol	Electrical system	Capac- ity
F15	🔌	Alternator	7.5 A
F16	⚠	Hazard warning flasher	10 A
F17	A/T	Automatic trans-axle	15 A
F18	⚙	Air conditioning	10 A
F19	🔌	ETV	15 A
F20	🔌	Starter	7.5 A
F21	A/T	CVT oil/pump	15 A
F22	🔌	Fuel pump	15 A
F23	🔌	Engine	20 A
F24	A/T	Automatic trans-axle	7.5 A
#1	—	Spare fuse	20 A
#2	—	Spare fuse	30 A

*: Fusible link

- Some fuses may not be installed on your vehicle, depending on the vehicle model or specifications.
- The table above shows the main equipment corresponding to each fuse.

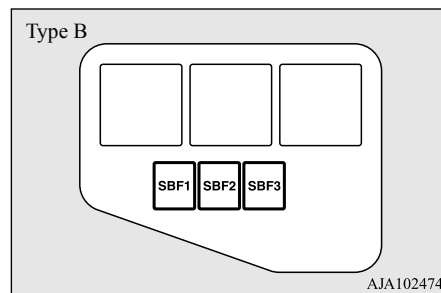

No.	Sym- bol	Electrical system	Capac- ity
SBF1	☹	PTC heater	40 A*
SBF2	☹	PTC heater	40 A*
SBF3	☹	PTC heater	40 A*

*: Fusible link

- Some fuses may not be installed on your vehicle, depending on the vehicle model or specifications.
- The table above shows the main equipment corresponding to each fuse.

The fuse block does not contain spare 7.5 A, 10 A or 15 A fuses. If one of these fuses burns out, substitute with the following fuse.

7.5 A: Outside rearview mirrors
10 A: Option

15 A: Cigarette lighter

When using a substitute fuse, replace with a fuse of the correct capacity as soon as possible.

Identification of fuse

Capacity	Color
7.5 A	Brown
10 A	Red
15 A	Blue
20 A	Yellow
30 A	Green (fuse type) /Pink (fusible link type)
40 A	Green (fusible link type)

Fuse replacement

N00954900131

1. Before replacing a fuse, always turn off the electrical item concerned to the fuse and turn the ignition switch to the "OFF" position or put the operation mode in OFF.
2. There is a fuse remover (A) in the engine compartment fuse block.

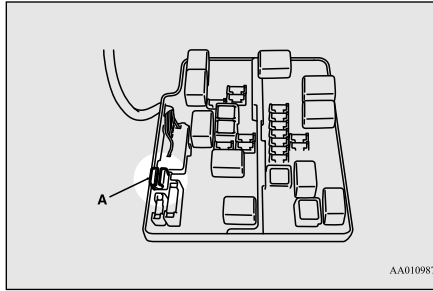

3. Clamp it on the fuse you wish to remove, and pull the fuse straight out from the fuse block.

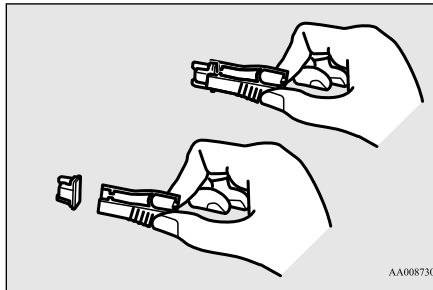

4. Use the fuse location diagrams and the matching tables, to check the fuse that is related to the problem. If the fuse is not blown, something else must be causing the problem. Have the system inspected by your authorized Mitsubishi Motors dealer or a repair facility of your choice.

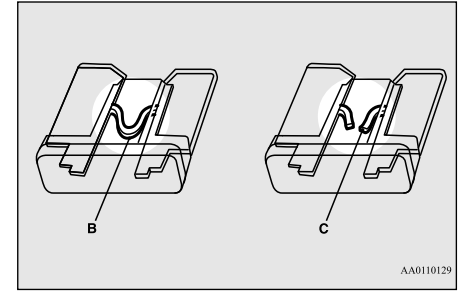

- B- Fuse is OK
C- Blown fuse

5. Insert a new fuse of the same capacity securely into the appropriate slot.

CAUTION

- Never use a fuse with a capacity greater than the one listed or any substitute, such as wire, foil etc. This would cause the circuit wiring to heat up and could cause a fire.
- If the replacement fuse blows again after a short time, have the electrical system checked by an authorized Mitsubishi Motors dealer or a repair facility of your choice to find and correct the cause.

Replacement of light bulbs

N00942900349

Before replacing the bulb, be sure the light is off. Do not touch the glass part of the new bulb with your bare fingers; the oil from your skin will stay on the glass and dim or destroy the bulb when it gets hot.

CAUTION

- Bulbs are extremely hot immediately after being turned off. When replacing the bulb, wait for it to cool sufficiently before touching it. You could otherwise be burned.
- Handle halogen light bulb with care. The gas inside halogen light bulb is highly pressurized, so dropping, knocking, or scratching a halogen light bulb can cause it to shatter.
- Never hold the halogen light bulb with a bare hand, dirty glove, etc. The oil from your hand could cause the bulb to break the next time the headlights are used. If the glass surface is dirty, clean it with alcohol and let it dry completely before installing the bulb.

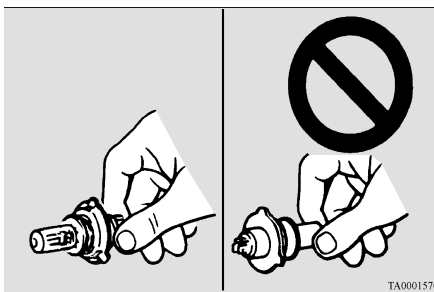

TA0001570

NOTE

- If you are unsure of how to carry out the work as required, it is recommended that these procedures be carried out by an authorized Mitsubishi Motors dealer or a repair facility of your choice.
- Be careful not to scratch the vehicle body when removing a light and lens.
- When it rains, or when the vehicle has been washed, the inside of the lens sometimes becomes temporarily foggy. This is the same phenomenon as when window glass mists up on a humid day, and does not indicate a functional problem. When the light is switched on, the heat will remove the fog. However, if water gathers inside the light, please have it checked by an authorized Mitsubishi Motors dealer or a repair facility of your choice.

Bulb capacity

N00943000132

The bulb should only be replaced with a new bulb with the same rating and type. The type and rating are listed on the base of the bulb.

Outside

N00950301929

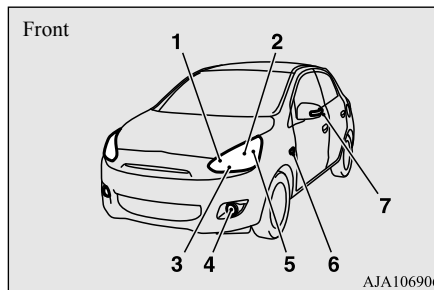

AJA106906

	Description	Watt-age	ANSI Trade No. or Bulb type
1	Front turn signal light	27 W	#1156NA
2	Headlight/Day-time running light (if so equipped)	60/55 W	HB2
3	Parking light	5 W	W5W

Description		Wattage	ANSI Trade No. or Bulb type
4	Front fog light (if so equipped)	55 W	H11
5	Front side-marker light	5 W	W5W
6	Side turn signal light (on fender, if so equipped)	5 W	—
7	Side turn signal light (on outside rearview mirror, if so equipped)	—	—

NOTE

- It is not possible to repair or replace only the bulb for the side turn signal light (on fender). Check with an authorized Mitsubishi Motors dealer or a repair facility of your choice when the light needs to be repaired or replaced.
- The side turn signal light (on outside rearview mirror) uses an LED rather than the bulb. For repair and replacement, contact an authorized Mitsubishi Motors dealer or a repair facility of your choice.

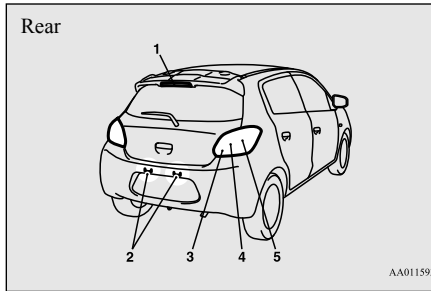

Item	Wattage	ANSI trade No. or bulb type
1	High-mounted stop light	—
2	License plate light	5 W
3	Back-up light	21 W
4	Rear turn signal light	21 W
5	Rear side-marker light, and tail and stop light	21/5 W

NOTE

- The high-mounted stop light uses an LED rather than the bulbs. For repair and replacement, contact an authorized Mitsubishi Motors dealer or a repair facility of your choice.

Inside

N00950400646

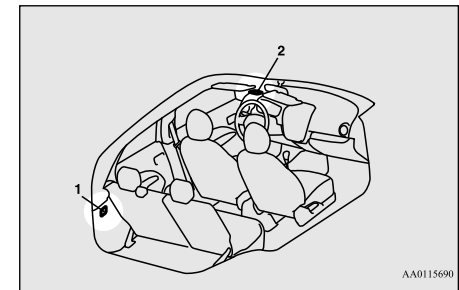

Item	Wattage
1	Cargo room light
2	Dome light

Headlights/Daytime running lights (if so equipped)

N00901800121

- Pull out the connector (A), and then remove the sealing cover (B).

Replacement of light bulbs

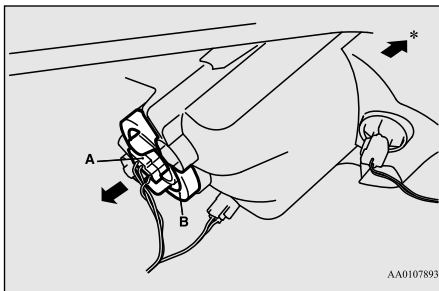

*- Front of the vehicle

2. Unhook the spring (C), which secures the bulb, and then remove the bulb (D).

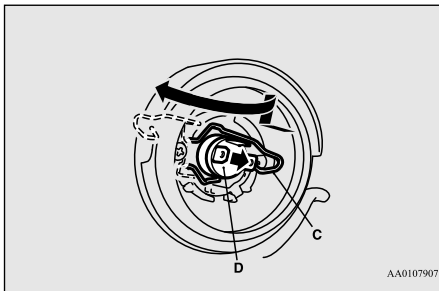

3. To install the bulb, perform the removal steps in reverse.

Headlight aim adjustment

N00943200352

The alignment of the headlights should be checked by an authorized Mitsubishi Motors dealer or a repair facility of your choice.

Front side-marker lights

N00917300554

1. Turn the socket (A) counterclockwise to remove it.

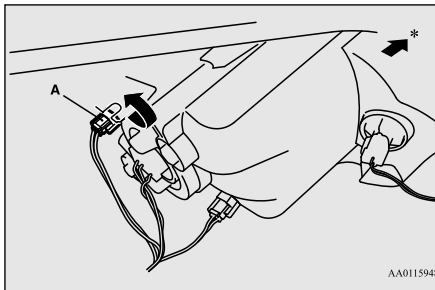

*- Front of the vehicle

2. Pull the bulb out of the socket.

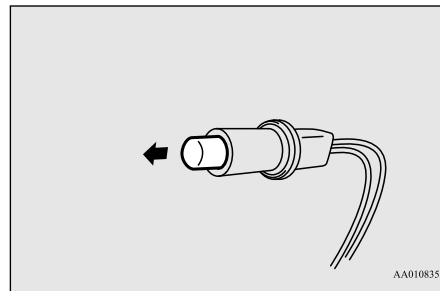

3. To install the bulb, perform the removal steps in reverse.

Front turn signal lights

N00943400370

1. Turn the socket (A) counterclockwise to remove it.

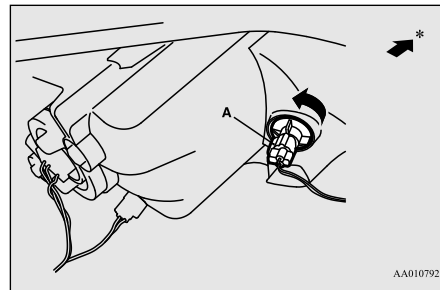

*- Front of the vehicle

9

2. Remove the bulb from the socket by turning it counterclockwise while pressing in.

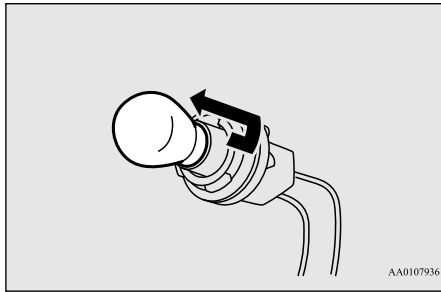

3. To install the bulb, perform the removal steps in reverse.

Parking lights

N00917300567

1. Turn the socket (A) counterclockwise to remove it.

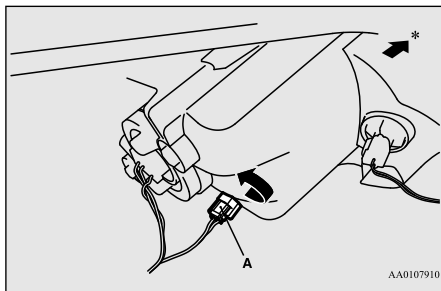

*- Front of the vehicle

2. Pull the bulb out of the socket.

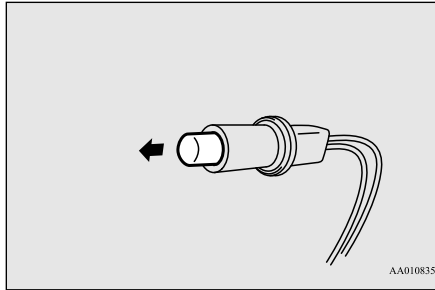

3. To install the bulb, perform the removal steps in reverse.

Front fog lights (if so equipped)

N00943600763

1. To create enough work space, turn the steering wheel all the way in the direction opposite to the side you wish to replace.

2. Remove the clips/bolts (A) to turn up the cover (B).

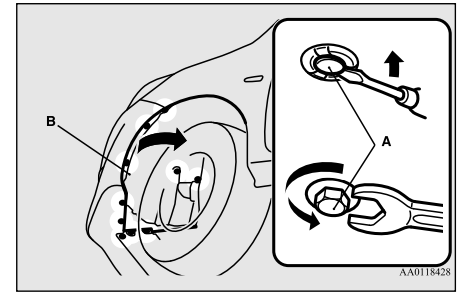

3. While pressing the tab (C), pull out the connector (D).

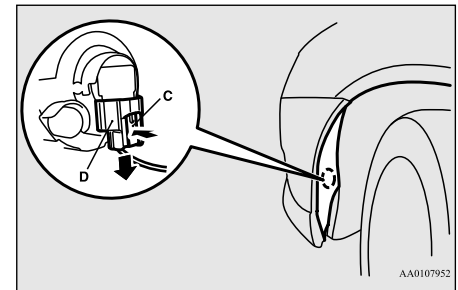

Replacement of light bulbs

4. Turn the bulb (E) counterclockwise to remove it.

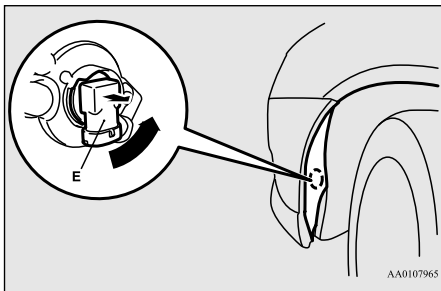

5. To install the bulb, perform the removal steps in reverse.

NOTE

- When refitting each of the clips, first insert part (F) of the clip into the hole and then press part (G) into it.

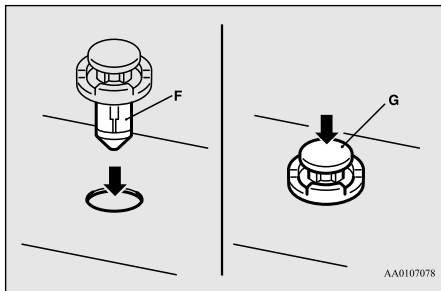

Rear combination lights

N00943700490

1. Open the liftgate.
(Refer to “Liftgate” on page 5-27.)
2. Remove the screws (A) that hold the light unit.

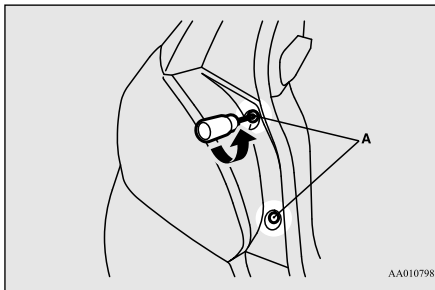

3. Move the light unit toward the rear of the vehicle to unfix the notch (B) and pin (C).

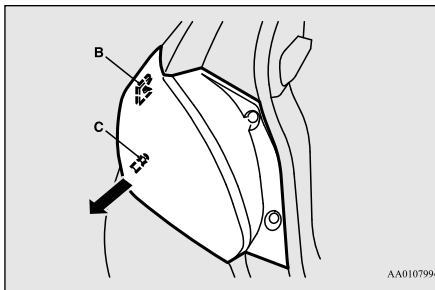

4. Turn the socket counterclockwise to remove it.

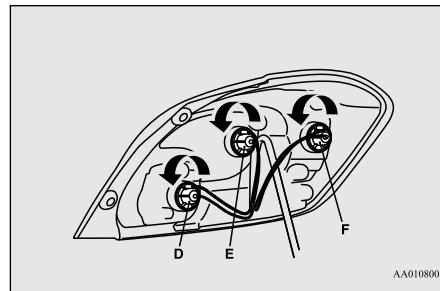

- D- Back-up light
- E- Rear turn signal light
- F- Rear side-marker light, and tail and stop light

5. Remove the bulb from the socket by turning it counterclockwise while pressing in.

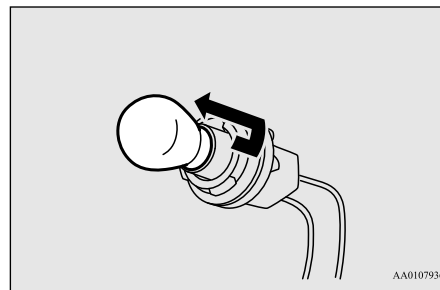

6. To install the bulb, perform the removal steps in reverse.

NOTE

- When mounting the lamp unit, align the notch (G) and pin (H) on the lamp unit with the clip (I) and hole (J) in the body.

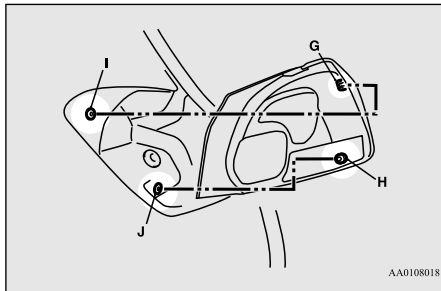

License plate light

N00944000403

1. Remove the screws (A) that hold the light unit and remove the light unit.

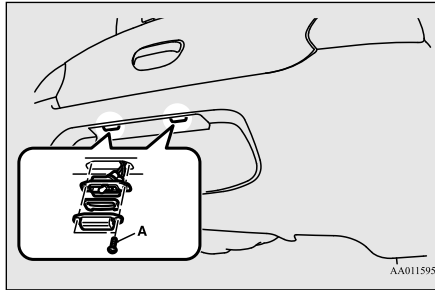

2. Turn the socket counterclockwise to remove it.

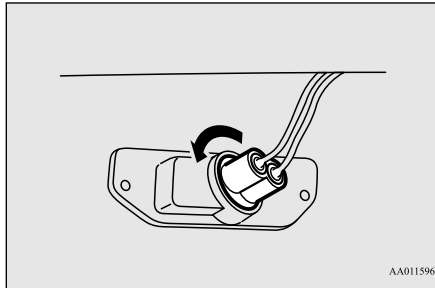

3. Pull the bulb out of the socket.

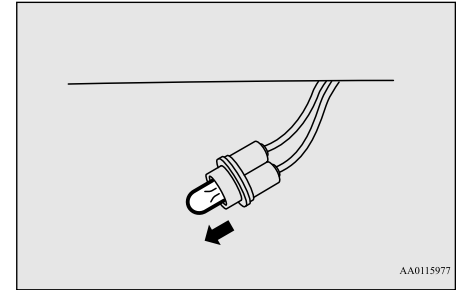

4. To install the bulb, perform the removal steps in reverse.

9

Vehicle care precautions

N00945100166

In order to maintain the value of your vehicle, perform regular maintenance using the proper materials and procedures. Be sure to use only those materials and procedures that meet your local environmental pollution control regulations. Choose the materials you will use carefully, to be sure that they do not contain corrosives. If you are not sure, contact an authorized Mitsubishi Motors dealer for help in choosing these materials.

CAUTION

● Cleaning products can be dangerous. Some are poisonous and others are highly flammable. Some are dangerous if you breathe their fumes in a closed space. When you use anything in a container to clean your vehicle, be sure to follow the instructions. Always open your vehicle doors or windows when you're cleaning the inside. Never use the following chemicals to clean your vehicle:

- Gasoline
- Carbon Tetrachloride
- Benzine
- Kerosene
- Naphtha
- Acetone
- Turpentine
- Paint Thinner
- Lacquer Thinner
- Nail Polish Remover

These can all be dangerous, and they all can damage your vehicle.

Cleaning the inside of your vehicle

N00945200095

After washing the inside of your vehicle with any cleaner, wipe it dry in a shady, well ventilated area.

CAUTION

● Do not use organic substances (solvents, benzine, kerosene, alcohol, gasoline, etc.) or alkaline or acidic solutions. These chemicals can cause discoloring, staining or cracking of the surface. If you use cleaners or polishing agents, make sure their ingredients do not include the substances mentioned above.

NOTE

● Always read the instructions on the cleaner label.

Plastic, vinyl leather, fabric and flokked parts

N00945300142

1. Lightly wipe these off with a soft cloth soaked in a 3% solution of gentle soap and water.
2. To rinse, dip the cloth in fresh water, wring it out well, and wipe off all the soap.

NOTE

● Do not use cleaners, conditioners, and protectants containing silicones or wax. Such products, when applied to the instrument panels or other parts, may cause reflections on the windshield and obscure vision. Also, if such products get on the switches of the electrical accessories, it may lead to failure of these accessories.

Upholstery

N00945500128

1. To maintain the value of your new vehicle, maintain the upholstery carefully and keep the interior clean. Use a vacuum cleaner and brush to clean the seats. If stained, vinyl and synthetic leather should be cleaned with an appropriate cleaner. Cloth fabrics can be cleaned with either upholstery cleaner or a 3% solution of gentle soap in lukewarm water.
2. Clean the carpeting with a vacuum cleaner and remove any stains with carpet cleaner. Oil and grease can be removed by lightly dabbing with a clean white cloth and spot remover.

NOTE

- If fuzzing is difficult to remove from the seat upholstery, draw a suitable defuzzing brush over the surface in one direction.

Genuine leather (if so equipped)

N00945600187

1. To clean, lightly wipe the leather with a soft cloth soaked in a 5% solution of gentle soap and water.
2. To rinse, dip the cloth in fresh water, wring it out well, and wipe off all the soap.
3. To preserve and protect, use a leather protecting agent on the genuine leather surface.

NOTE

- If genuine leather is wet with water, wipe it with a dry, soft cloth. If left damp, mildew may grow.
- The genuine leather surface can be damaged if brushed with a nylon or synthetic fiber brush.
- Organic solvents such as benzene, kerosene, alcohol, gasoline, or acid or alkaline solvents can discolor the genuine leather surface and should not be used.
- Genuine leather can mildew if not kept clean. Clean up any oil stains immediately.

NOTE

- The genuine leather surface may harden and shrink if it is exposed to the direct sunlight for long hours. When your vehicle is parked, place it in the shade as much as possible.
- When the temperature of the vehicle interior rises in summer, vinyl products left on the genuine leather seat may deteriorate and stick to the seat.

Cleaning the outside of your vehicle

N00945700058

To protect your vehicle's finish, wash it often and thoroughly. If desired, you may wax your vehicle using a nonabrasive automobile wax.

Foreign material

N00945800033

Industrial pollution, road tar, bird droppings, tree sap, insect remains, sea water and other foreign matters can damage the finish on your vehicle.

Generally, the longer any foreign material stays on the finish, the worse the damage. Wash your vehicle as soon as possible whenever the finish gets soiled.

Washing

N00945900630

Chemicals contained in the dirt and dust picked up from air, rain, snow, or road surfaces can damage the paint and body of your vehicle if left on.

Frequent washing and waxing is the best way to protect your vehicle from this damage.

Do not wash the vehicle in direct sunlight. Park the vehicle in the shade and spray it with water to remove dust. Next, using plenty of clean water and a car washing mitt or sponge, wash the vehicle from top to bottom.

Use a mild car washing soap if necessary. Rinse thoroughly and wipe dry with a chamomise or soft cloth. After washing the vehicle, carefully clean the joints and flanges of the doors, hood, etc., where dirt is likely to remain.

9

CAUTION

- When washing the underside of your vehicle or the wheels, wear a pair of gloves to protect your hands.
- Never spray or splash water on the electrical parts in the engine compartment. This may damage them. Be careful also when washing the underbody to ensure that water does not enter the engine compartment.

CAUTION

- Avoid automatic car washers that use rotating brushes. These brushes may scratch the paint surface and make it dull. Scratches are more noticeable on darker colored vehicles.
- Some hot water washing equipment uses high pressure and heat to clean your vehicle. Because hot water can damage plastics parts and seep inside your vehicle, make sure you do the following when using such equipment:
 - Keep the washing nozzle at least 28 inches (70 cm) away from the vehicle body.
 - When washing around the door glass, hold the nozzle at a distance of more than 28 inches (70 cm) and at a right angle to the glass surface.
- Make sure to do the following when using an automatic car wash, with help from either this manual or the car wash operator, to avoid damaging your vehicle:
 - Fold the outside rearview mirrors.
 - Remove the antenna.
 - Tape the wiper arm assembly.
 - If your vehicle is equipped with a rear spoiler, check with the car wash operator before using the car wash.

During cold weather

Salt and other chemicals spread on winter roads in some geographical areas can have a

detrimental effect on the vehicle underbody. You should flush the underbody with a high pressure hose every time you wash the outside of your vehicle.

Take special care to remove mud or other debris which could trap and hold salt and moisture.

After washing your vehicle, wipe off all waterdrops from the rubber parts around the doors to prevent the doors from freezing.

NOTE

- When the door is frozen, opening it by force may tear off or crack the rubber gasket installed around the door. Pour warm water to melt the ice. Be sure to thoroughly wipe off the water after opening the door. To prevent freezing of the weatherstripping on the doors, hood, etc., treat with silicone lubricant.

Waxing

N0094600234

Wax your vehicle once or twice a year, or when water does not bead up on the paint.

Use a soft cloth to put a small amount of wax on the painted surfaces. After the wax has dried, polish with a dry soft cloth.

Do not wax your vehicle in direct sunlight.

You should wax when the painted surfaces are cool.

CAUTION

- Waxes containing high abrasive compounds should not be used. These waxes remove rust and stain effectively from the paintwork, but are harmful to the finish of the paint, because they also remove paint/clearcoat. They are also harmful to other glossy surfaces such as the grille, trim, moldings, etc.
- Do not use gasoline, benzene, kerosene or paint thinners to remove road tar or other dirt from the vehicle surface.
- Do not put wax on the areas having black matte coating because it can cause uneven discoloration, patches, blurs, etc. If these get wax on them, wipe the wax off right away with a soft cloth and warm water.

Polishing

N00946100046

If painted surfaces have been severely damaged and lost their original luster and color tone, polish the surface lightly with a fine polishing compound. Avoid limiting your polishing to the damaged surface only; polish a somewhat wider area, moving the polishing cloth in one direction. After polishing, flush the compound from the surface and apply a coat of wax to regain a beautiful luster.

Damaged paint

N00946200092

Small cracks and scratches in the paint coat should be touched up as soon as possible with touch-up paint to prevent corrosion.

Check body areas facing the road or the tires carefully for damage to the paint caused by flying stones, etc. The paint code number for your vehicle can be found on the vehicle information code plate on the front passenger door sill.

Cleaning plastic parts

N00946300194

Use a sponge or chamois to clean these parts. If a vehicle wax sticks to a gray or black rough surface of the bumper, molding or lights, the surface may appear white in color. In this case, wipe it off using lukewarm water and a soft cloth or chamois.

CAUTION

- Do not use a scrubbing brush or other rough scrubber as these may damage the plastic surface.
- Do not use wax containing compounds (polishing powder) which may damage the plastic surface.

CAUTION

- Do not let plastic parts get soiled with gasoline, oil, brake fluids, engine oils, greases, paint thinner, and sulfuric acid (battery electrolyte), as such substances will cause stains, cracks, or discoloration.

If any of these get on a plastic part, wipe them up with a soft cloth or chamois and a mild solution of soap and water. Then rinse them immediately with water.

Chrome parts

N00946400052

To prevent spots and corrosion of chrome parts, wash with water, dry thoroughly, and apply a nonabrasive automotive wax. If the chrome is severely damaged or pitted, use a commercially available chrome polish.

Aluminum wheels (if so equipped)

N00946500183

1. Remove dirt using a wet sponge.
2. Use a mild detergent on any dirt that cannot be removed easily with water. Rinse off the detergent after washing the wheel.
3. Dry the wheel thoroughly using a chamois leather or a soft cloth.

CAUTION

- Do not use a brush or other hard implement on the wheels.
- Do not use any cleaner that contains an abrasive substance or is acidic or alkaline. Doing so could cause the coating on the wheels to peel or become discolored or stained.
- Do not directly apply hot water using a steam cleaner or by any other means.
- Contact with seawater or road salt used for de-icing can cause corrosion. Rinse off such substances as soon as possible.

Window glass

N00946600054

The window glass can usually be cleaned using only a sponge and water. Glass cleaner can be used to remove wax, oil, grease, dead insects, etc. After washing the glass, wipe it dry with a clean, dry, soft cloth.

Wiper blades

N00946700068

Use a soft cloth and glass cleaner to remove grease, dead insects, etc., from the wiper blades.

Replace the wiper blades when they no longer clean the windshield and rear window properly.

Engine compartment

N00947000071

Never spray or splash water on the electrical accessories in the engine compartment. This puts the engine at risk of being damaged.

Do not bring the circumferential parts, the plastic parts and so on into contact with sulfuric acid (battery electrolyte) which may crack, stain or discolor them.

If they are in contact, wipe off with soft cloth, chamois or the like and an aqueous solution of neutral detergent then immediately rinse the affected parts with plenty of water.

Customer assistance/Reporting Safety Defects

Consumer information (For vehicles sold in U.S.A.)	10-2
Reporting Safety Defects	10-2
Important facts to know in case of an accident	10-4

Consumer information (For vehicles sold in U.S.A.)

N01047100171

This information is provided in compliance with the requirements of the National Highway Traffic Safety Administration, Department of Transportation. It provides the purchasers and/or prospective purchasers with information on reporting safety defects.

Uniform tire quality grading

DOT quality grades - All passenger vehicle tires must conform to Federal Safety Requirements in addition to these grades. The specific grade rating in each grade category is shown on the side wall of the tires on your vehicle.

Treadwear

The treadwear grade is a comparative rating based on the wear rate of the tire when tested under controlled conditions on a specified government test course. For example, a tire graded 150 would wear one and one-half ($1\frac{1}{2}$) times as well on the government course as a tire graded 100. The relative performance of tires depends upon the actual conditions of

their use, however, and may depart significantly from the norm due to variations in driving habits, service practices and differences in road characteristics and climate.

Traction AA, A, B, C

The traction grades, from highest to lowest, are AA, A, B and C. Those grades represent the tire's ability to stop on wet pavement as measured under controlled conditions on specified government test surfaces of asphalt and concrete. A tire marked C may have poor traction performance.

WARNING

- The traction grade assigned to this tire is based on straight-ahead braking traction tests, and does not include acceleration, cornering, hydroplaning, or peak traction characteristics.

Temperature A, B, C

The temperature grades are A (the highest), B and C, representing the tire's resistance to the generation of heat and its ability to dissipate heat when tested under controlled conditions on a specified indoor laboratory test wheel. Sustained high temperature can cause the

material of the tire to degenerate and reduce tire life, and excessive temperature can lead to sudden tire failure. The grade C corresponds to a level of performance which all passenger car tires must meet under the Federal Motor Vehicle Safety Standard No. 109. Grades B and A represent higher levels of performance on the laboratory test wheel than the minimum required by law.

WARNING

- The temperature grade for this tire is established for a tire that is properly inflated and not overloaded. Excessive speed, underinflation, or excessive loading, either separately or in combination, can cause heat buildup and possible tire failure.

Reporting Safety Defects

N01047201528

If you believe that your vehicle has a defect which could cause a crash or could cause injury or death, you should immediately inform the National Highway Traffic Safety Administration (NHTSA) in addition to notifying Mitsubishi Motors North America, Inc.

If NHTSA receives similar complaints, it may open an investigation, and if it finds that a safety defect exists in a group of vehicles, it may order a recall and remedy campaign. However, NHTSA cannot become involved in individual problems between you, your dealer, or Mitsubishi Motors North America, Inc.

To contact NHTSA, you may call the Vehicle Safety Hotline toll-free at 1-888-327-4236 (TTY: 1-800-424-9153); go to <http://www.safercar.gov>; or write to:

NHTSA Headquarters
1200 New Jersey Avenue, SE
West Building
Washington, DC 20590

You can also obtain other information about motor vehicle safety from <http://www.safercar.gov>.

For vehicles sold in U.S.A.

To contact Mitsubishi Motors North America, Inc. call 1-888-648-7820 or write to:

Mitsubishi Motors North America, Inc.
Customer Relations Department
P.O. Box 6400
Cypress, CA 90630-0064

For vehicles sold in Canada

If you live in Canada, and you believe that your vehicle has a safety defect, you should immediately notify Transport Canada, in addition to notifying Mitsubishi Motor Sales of Canada, Inc. You may write to:

Transport Canada
330 Sparks Street
Tower C
Ottawa, Ontario K1A 0N5

To contact Mitsubishi Motor Sales of Canada, Inc. call 1-888-576-4878 or write to:

Mitsubishi Motor Sales of Canada, Inc.
Customer Relations Department
P.O. Box 41009
4141 Dixie Road
Mississauga, ON L4W 5C9

For vehicles sold in Puerto Rico

To contact Mitsubishi Motor Sales of Caribbean, Inc. call 1-787-251-8715 or write to:

Mitsubishi Motor Sales of Caribbean, Inc.
Customer Service Department
P.O. Box 192216
SAN JUAN PR 00919-2216

For vehicles sold in Guam

To contact Triple J Enterprises Inc.



Important facts to know in case of an accident

call (671)649-3673 or write to:

Triple J Enterprises, Inc.
P.O. Box 6066
TAMUNING
GUAM 96931

For vehicles sold in Saipan

To contact Triple J Motors
call (670)234-7133 or write to:

Triple J Motors
P.O. Box 500487
SAIPAN, MP96950-0487

For vehicles sold in American Samoa

To contact Pacific Marketing Inc.
call 684(699)9140 or write to:

Pacific Marketing, Inc.
P.O. Box 698
PAGO PAGO,
AMERICAN SAMOA AS, 96799

Important facts to know in case of an accident

N01047300232

We hope you will never be involved in an accident, but there is always that potential danger. So, please be sure to buckle up and drive safely.

In the event of an accident

- Remain calm.
- Check for injuries. Report all injuries to the police, and, if necessary, call for an ambulance.
- Record all the details of the accident. This will provide you with accurate records of the accident for discussions with your insurance company and other persons who may be acting on your behalf.

Key information to discuss with your insurance company

- Understand your repair estimate before approving repairs.
- Choosing the repair shop and the brands of parts that they use on your vehicle is your decision.

- Ask for genuine Mitsubishi Motors parts. Many times, to save money, your insurance company will recommend imitation parts that do not meet the original specifications of fit, finish, corrosion resistance or workmanship.

Mitsubishi Motors built-in protection

The strength and integrity built into your Mitsubishi vehicle is the result of a specific design referred to as “Energy Management”. Individual body parts are designed to act as one unit in the event of an accident. Shock waves are absorbed by protective panels or are channeled around the passenger compartment. This important feature is possible because high tensile steel is used in Mitsubishi panels and structural parts, something that cannot be guaranteed by the manufacturers of imitation parts. All Genuine Mitsubishi body panels and support brackets are designed and constructed as important protection features in the event of an accident. By replacing body parts with non-Genuine Mitsubishi Motors parts, your vehicle may no longer meet original equipment specifications.

Consumer rights (For vehicles sold in U.S.A.)

As a consumer requesting repair on your vehicle, you have consumer rights. Across the country, State Insurance Commissioners have begun considering rules on the use of non-OEM parts. This could mean that repair shops will have to disclose to the consumer when they intend to use non-OEM parts. Since regulations are not consistent on this point, remember you have a choice. So, if you want genuine Mitsubishi Motors parts, you may have to specifically request them. Make certain your insurance company understands imitations are not to be used in the repair of your vehicle. You deserve the best genuine Mitsubishi Motors parts.

Genuine Mitsubishi Motors parts

Genuine Mitsubishi Motors parts are built with the high quality and durability standards you expect. Genuine Mitsubishi Motors replacements parts are your guarantee that your vehicle will have all the technological advantages and maintain the style and protection of a brand new Mitsubishi Motors.

Remember to ask for genuine Mitsubishi Motors parts.





Information Provided by:

DEALER
E-PROCESS

Specifications

Vehicle labeling	11-2
Vehicle dimensions	11-3
Vehicle weights	11-3
Engine specifications	11-4
Battery	11-4
Tires and wheels	11-5
Capacity	11-5

Vehicle labeling

N01147400742

Keep a record of the chassis number and vehicle identification number. Such information will assist police if your vehicle is stolen.

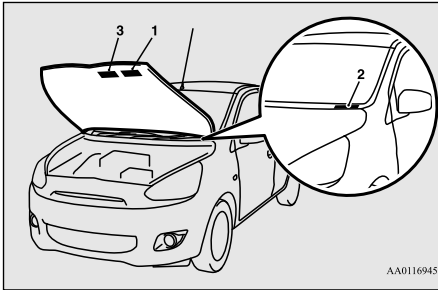

11

1 - Vehicle emission control information label

The vehicle emission control information label is affixed on the underside of the engine hood.

2 - Vehicle identification number plate

The vehicle identification number is stamped on the plate riveted to the left front corner of the vehicle body. It is visible from outside of the vehicle through the windshield.

3 - Air conditioning label

The air conditioning label is affixed on the inside panel of the engine hood.

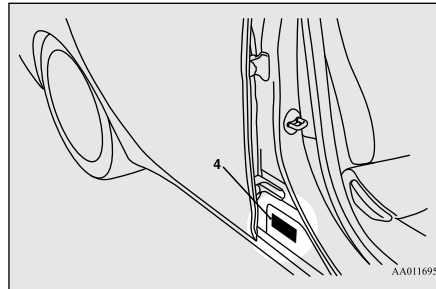

4 - Vehicle information code plate

The vehicle information code plate is located on the front passenger door sill.

Chassis number

The chassis number is stamped on the bulkhead as shown in the illustration.

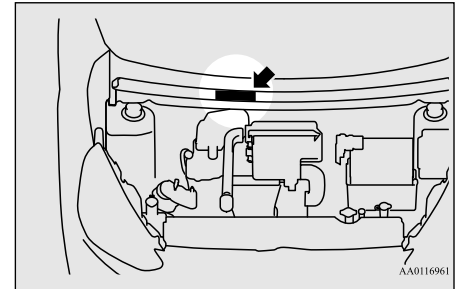

Engine serial number

The engine serial number is stamped on the cylinder block as shown in the illustration.

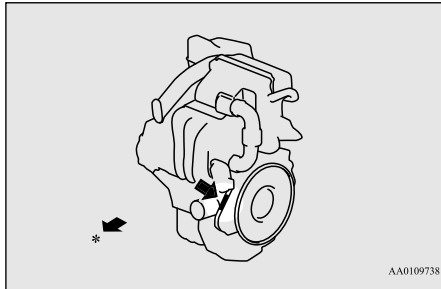

*- Front of the vehicle

Tire and loading information placard

N01148100616

The tire and loading information placard is located on the driver's door sill.

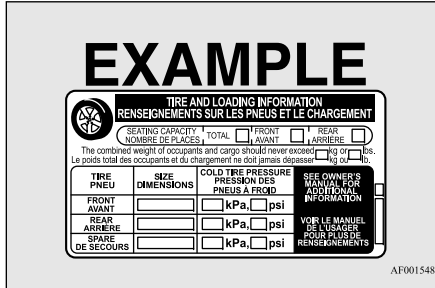
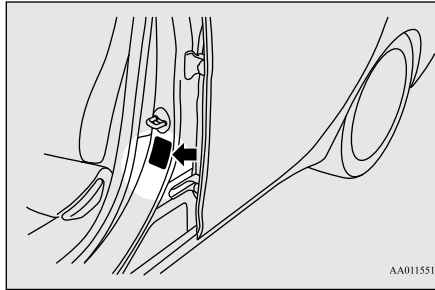

Certification label

N01148200242

The certification label is located on the driver's door sill.

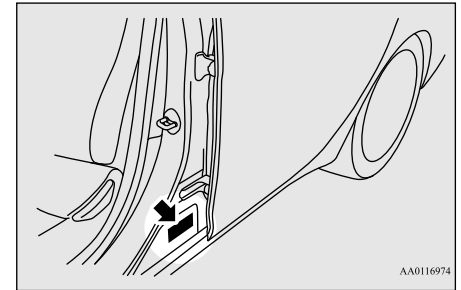

Vehicle dimensions

N01147501577

Overall length	148.8 in (3,780 mm)
Overall width	65.6 in (1,665 mm)
Overall height	59.4 in (1,510 mm)
Wheel base	96.5 in (2,450 mm)

Vehicle weights

N01147600917

Item	M/T	CVT
Gross vehicle weight rating	2,910 lb (1,320 kg)	3,020 lb (1,370 kg)



Engine specifications

Item		M/T	CVT
Gross axle weight rating	Front	1,609 lb (730 kg)	
	Rear	1,477 lb (670 kg)	
Vehicle capacity weight		827 lb (375 kg)	
Seating capacity		5 persons	

GVWR: maximum total weight (load) limit specified for the vehicle

GAWR: maximum weight (load) limit specified for the front or rear axle

Seating capacity: the maximum number of occupants

Engine specifications

N01147700514

Engine model	3A92	
Engine displacement	72.8 CID (1,193 cm ³)	
No. of cylinders and cylinder arrangement	Inline-3	
Bore	2.95 in (75.0 mm)	
Stroke	3.54 in (90.0 mm)	
Compression ratio	10.5:1	
Thermostat valve opening temperature	189 °F (87 °C)	
Spark plugs	NGK	LZFR5BI-11
Spark plug gap	.040 to .043 in (1.0 to 1.1 mm)	
Firing order	1-3-2	

Battery

N01147800296

55D23L (356CCA/99RC)

Battery is a 12 volt type.



Tires and wheels

N01147900747

PCD: Pitch Circle Diameter (installation holes)

Tire	165/65R14	
Wheel	Size	14 x 4 1/2J
	PCD	3.93 in (100 mm)
	Offset	1.81 in (46 mm)

NOTE

- Contact an authorized Mitsubishi Motors dealer for details on the combination used on your vehicle.
- These tires satisfy vehicle loading conditions described in this owner's manual.

Capacity

N01148002130

Item	Capacity	Lubricants
Fuel (approximate)	9.2 gal (35 L)	Refer to "Fuel selection" on page 3-2
Engine oil	Oil pan	Engine oils displaying the ILSAC certification mark ("starburst" symbol) on the container. If these oils are not available, an API classification SN or higher can be used.
	Oil filter	
Manual transaxle	1.7 qt (1.6 L)	Mitsubishi Motors Genuine NEW MULTI GEAR OIL ECO API classification GL-4 SAE 75W-80
Continuously variable transmission (CVT)	7.4 qt (7.0 L)	Refer to "Continuously variable transmission (CVT) fluid" on page 9-9.
Brake	As required	Conforming to Brake fluid DOT3 or DOT4
Hood lock release mechanism and safety catch	As required	Multipurpose type grease NLGI Grade 2
Engine coolant {Includes .53 qt (0.5 L) in reserve tank}	M/T	Mitsubishi Motors Genuine Super Long Life Coolant Premium or equivalent*
	CVT	

Capacity

Item	Capacity	Lubricants
Washer fluid	2.6 qt (2.5 L)	—
Refrigerant (air conditioning)	Refer to the “Air conditioning label” on page 11-2.	HFC-134a

*: similar high quality ethylene glycol based non-silicate, non-amine, non-nitrate and non-borate coolant with long life hybrid organic acid technology

A

Accessory (installation) 3-5
 Active stability control (ASC)..... 5-49
 Air bag 4-21
 Air cleaner filter 9-8
 Air conditioning
 Automatic air conditioning 7-11
 Important air conditioning operating tips.. 7-17
 Manual air conditioning 7-7
 Air purifier..... 7-18
 Aluminum wheels..... 9-35
 Antenna
 Roof antenna 7-41
 Anti-lock braking system..... 5-46
 Assist grip..... 5-110
 Audio
 AM/FM electronically tuned radio with
 CD player 7-18
 Error codes..... 7-38
 Handling of compact discs..... 7-40
 Automatic air conditioning 7-11

B

Back-up light
 Bulb capacity 9-26

Ball joint, steering linkage seals and drive
 shaft boots 9-21
 Battery 9-10
 Charging system warning light 5-73
 Checking battery electrolyte level 9-10
 Disconnection and connection 9-11
 During cold weather 9-11
 Specification 11-4
 Bluetooth® 2.0 interface 5-81
 Bottle holders..... 5-108
 Brake
 Fluid 11-5
 Brake assist system..... 5-46
 Braking 6-5
 Anti-lock braking system 5-46
 Hose 9-20
 Pad wear alarm 5-45
 Parking brake..... 5-31
 Pedal..... 5-44
 Pedal free play 9-18
 Power brakes 5-44
 Service brake 5-44
 Warning lights 5-72
 Break-in recommendations..... 5-2
 Bulb capacity 9-26

C

California Perchlorate Materials
 Requirements..... 3-7

Capacities 11-5
 Card holder 5-105
 Cargo loads 6-10
 Cargo room light
 Bulb capacity 9-27
 Catalytic converter 9-3
 Certification label 11-3
 Charging system warning light 5-73
 Child restraint systems 4-14
 Child safety locks for rear door 5-27
 Cleaning
 Inside of your vehicle 9-32
 Outside of your vehicle 9-33
 Clutch
 Pedal free play 9-18
 Consumer information..... 10-2
 Continuously variable transmission (CVT)... 5-39
 Fluid..... 9-9, 11-5
 Selector lever operation 5-40
 Selector lever positions..... 5-41
 Convenience hook..... 5-109
 Coolant (engine)..... 9-7, 11-5
 Cruise control 5-52
 Cup holders..... 5-108



Alphabetical index

D

Daytime running lights	
Bulb capacity	9-26
Defogger (rear window)	5-80
Defrosting or defogging (windshield, door windows).....	7-10, 7-16
Dimensions	11-3
Dimmer (high/low beam change)	5-76
Disc brake pads	9-20
Dome light	
Bulb capacity	9-27
Door-ajar warning buzzer	5-74
Door-ajar warning light	5-74
Doors	
Lock.....	5-24
Power door locks.....	5-26
Driving during cold weather	6-4
Driving, alcohol and drugs.....	6-2

E

Electric power steering system (EPS) ...	5-48
Electric rear window defogger switch ...	5-80
Electronic immobilizer (Anti-theft starting system).....	5-3, 5-20
Emission-control system maintenance ..	9-19
Engine	

Compartment.....	9-5
Coolant	9-7, 11-5
High coolant temperature warning light....	5-73
Hood.....	9-4
Oil and oil filter	9-5, 11-5
Overheating.....	8-4
Serial number	11-2
Specification.....	11-4
Engine hood	9-4
Engine switch	5-13
Error codes	7-38
Exhaust system	9-21

F

Floor mat.....	6-2
Fluid	
Brake fluid	11-5
Continuously variable transmission (CVT) fluid.....	9-9, 11-5
Engine coolant.....	9-7, 11-5
Manual transaxle.....	11-5
Washer fluid.....	9-9, 11-5
Fluid capacities and lubricants.....	11-5
Free-hand advanced security transmitter (F.A.S.T.-key)	5-9
Front fog lights	
Bulb capacity.....	9-26
Indicators	5-71

Replacement	9-29
Switch	5-77
Front seat adjustment	4-3
Front side-marker lights	
Bulb capacity	9-26
Replacement	9-28
Front turn signal light	
Bulb capacity	9-26
Replacement	9-28
Fuel	
Filling the fuel tank.....	3-3
Fuel economy.....	6-2
Fuel hoses.....	9-20
Fuel remaining warning display	5-66
Fuel selection	3-2
Tank capacity.....	11-5
Fuel Pump Shut-off System	8-20
Fuel remaining display	5-66
Fuses	9-22
Fusible links.....	9-22

G

General maintenance	
Maintenance.....	9-20
General vehicle data.....	11-3
Genuine parts	3-6
Glove compartment.....	5-108

H

Hazard warning flasher switch 5-77
 Hazard warning lights 5-71
 Head restraints..... 4-7
 Headlights
 Bulb capacity 9-26
 Dimmer 5-76
 Headlight flasher 5-76
 Switch 5-74
 Heater without air conditioning function . 7-4
 High beam indicator..... 5-71
 High coolant temperature warning light 5-73
 High-mounted stop light
 Bulb capacity 9-26
 Hill start assist 5-45
 Hood lock release mechanism and safety
 catch..... 9-21
 Hook
 Convenience hook 5-109
 Horn switch..... 5-81

I

If the vehicle breaks down 8-2
 Ignition switch..... 5-35
 Important facts to know in case of an accident
 10-4

Indicator and warning light package 5-70
 Indicators 5-71
 Information display 5-63
 Inside rearview mirror..... 5-32
 Instrument panel light dimmer control.. 5-65
 Interior lights 5-106

J

Jack
 Garage jack up position..... 9-2
 Storage..... 8-5
 Jump-starting the engine 8-2

K

Key slot..... 5-19
 Keyless entry system 5-6, 5-21
 Keys 5-2

L

Labeling 11-2
 License plate light
 Bulb capacity 9-26
 Replacement 9-31
 Liftgate 5-27
 Link System..... 5-81
 Loading information 6-6

Lubricants 11-5

M

Malfunction indicator light 5-72
 Manual air conditioning..... 7-7
 Manual transaxle..... 5-38
 Oil..... 9-9, 11-5
 Shift points..... 5-38
 Manual window control..... 5-28
 Modifications to and racing of your vehicle..
 3-5
 Multi-information display 5-62

O

Octane rating 3-2
 Oil
 Engine oil 9-5, 11-5
 Manual transaxle oil..... 9-9, 11-5
 Oil pressure warning light..... 5-73
 Operation mode 5-14
 Operation under adverse driving conditions..
 8-18
 Outside rearview mirrors 5-33
 Overheating..... 8-4

P

Parking 6-5

Alphabetical index

Parking brake lever stroke	9-18
Parking brake	5-31, 9-18
Parking lights	
Bulb capacity	9-26
Replacement	9-29
Polishing.....	9-34
Power brakes.....	5-44
Power outlet.....	5-106
Power windows	5-29
Puncture (Tire changing)	8-11

R

Radio	
AM/FM electronically tuned radio with CD player	7-18
General information about your radio	7-42
Rear combination lights	
Bulb capacity	9-26
Replacement	9-30
Rear seats	4-5
Rear shelf panel.....	5-109
Rear side-marker lights	
Bulb capacity	9-26
Replacement	9-30
Rear turn signal light	
Bulb capacity	9-26
Replacement	9-30
Rear-view camera	5-60

Rearview mirror	
Inside rearview mirror	5-32
Outside rearview mirrors	5-33
Replacement of light bulbs.....	9-26
Replacing tires and wheels	9-15
Reporting Safety Defects	10-2

S

Safe driving techniques.....	6-4
Seat belts.....	4-8
Adjustable seat belt shoulder anchor .	4-12
Child restraint systems.....	4-14
Front passenger seat belt warning light.....	4-11
Maintenance and inspection	4-20
Seat belt extender	4-12
Seat belt force limiter system	4-14
Seat belt instructions	4-9
Seat belt pre-tensioners.....	4-13
Seat belt use during pregnancy	4-12
Seats	4-2
Front seats	4-3
Head restraints	4-7
Heated seats.....	4-4
Seats and restraint systems	4-2
Service brake	5-44
Service precautions	9-2
Side turn signal light	
Bulb capacity	9-26

Snow tires	9-17
Spark plugs	9-19
Starting the engine	5-36
Steering	
Electric power steering system (EPS)	5-48
Steering wheel height adjustment	5-32
Stop lights	
Bulb capacity	9-26
Replacement	9-30
Storage spaces	5-107
Sun visors	5-105
Supplemental Restraint System	4-21
How the Supplemental Restraint System works	4-23
Maintenance service	4-35

T

Tail light	
Bulb capacity	9-26
Replacement	9-30
Tank capacity	11-5
Tire	
Inflation pressures	9-14
Maintenance.....	9-16
Quality grading	10-2
Replacing tires and wheels	9-15
Rotation.....	9-16
Size (tire and wheel)	11-5
Snow tires.....	9-17

To change a tire	8-11
Tread wear indicator	9-16
Tire pressure monitoring system.....	5-56
Tire repair kit	8-6
Tires	9-12
Tire and loading information placard	11-3
Tire chains	9-17
Tools	8-5
Storage	8-5
Towing	8-17
Trailer towing.....	6-10
Turn signal light	
Indicators.....	5-71
Lever.....	5-76

U

USB input terminal	5-101
How to connect a USB memory device....	5-101
How to connect an iPod.....	5-102

V

Vanity mirror	5-105
Vehicle care precautions.....	9-31
Vehicle dimensions.....	11-3
Vehicle labeling.....	11-2
Vehicle preparation before driving.....	6-3

Vehicle weights.....	11-3
Vents	7-2

W

Warning lights	5-72
Washer	
Fluid	9-9, 11-5
Rear window washer	5-79
Switch.....	5-78, 5-79
Washing	9-33
Waxing	9-34
Weights	11-3
Wheel	
Covers.....	8-16
Specification.....	11-5
Wiper	
Rear window wiper	5-79
Switch.....	5-78, 5-79
Wiper blades.....	9-19

NOTE

Name of Owner	Date of Purchase
Address of Owner	Model of Vehicle
Name and Address of Dealer	Vehicle Identification Number

Maintenance record

Service Performed	Date	Kilometers Miles	Inspection and Maintenance Item