

Table of contents

1	Foreword	5
1.1	Notes on the documentation	5
1.2	Safety instructions	6
1.3	Documentation Issue Status	7
1.4	Marking of ELX terminals	8
2	Product overview	12
2.1	ELX3312 - Introduction	12
2.2	ELX3314 - Introduction	13
2.3	Technical data	14
2.4	Intended use	16
3	Mounting and wiring	17
3.1	Special conditions of use for ELX terminals	17
3.2	Installation notes for ELX terminals	17
3.3	Arrangement of ELX terminals within a bus terminal block	19
3.4	Installation position and minimum distances	22
3.5	Installation of ELX terminals on mounting rails	23
3.6	Connection	25
3.6.1	Connection system	25
3.6.2	Wiring	26
3.6.3	Proper line connection	27
3.6.4	Shielding and potential separation	27
3.6.5	ELX3312 - Contact assignment	28
3.6.6	ELX3314 - Contact assignment	30
3.7	Disposal	31
4	Basic function principles	32
4.1	EtherCAT basics	32
4.2	Notices on analog specifications	32
4.2.1	Full scale value (FSV)	32
4.2.2	Measuring error/ measurement deviation	32
4.2.3	Temperature coefficient tK [ppm/K]	33
4.2.4	Single-ended/differential typification	34
4.2.5	Common-mode voltage and reference ground (based on differential inputs)	37
4.2.6	Dielectric strength	37
4.2.7	Temporal aspects of analog/digital conversion	38
4.3	Basics of thermoelectricity and thermocouples	41
4.4	Measurement of thermocouples (with measurement uncertainties)	43
4.5	Use of grounded thermocouples	55
5	Parameterization and programming	56
5.1	Basics of the measurement functions	56
5.2	Data processing	56
5.3	Settings	57
5.3.1	Presentation, index 0x80n0:02	57
5.3.2	Siemens bits, index 0x80n0:05	58

5.3.3	Undershoot and overshoot of the measuring range (underrange, overrange)	58
5.3.4	Notch filter (conversion times)	58
5.3.5	Limit 1 and Limit 2.....	59
5.3.6	Calibration.....	59
5.3.7	Producer Codeword.....	60
5.4	Operation with an external cold junction.....	61
5.5	Interference from equipment	62
5.6	Wire break detection.....	62
5.7	Process data.....	62
5.7.1	Selection of process data	62
5.7.2	Default process image	65
5.7.3	Variant Predefines PDO	66
5.7.4	Sync Manager.....	67
5.8	TwinSAFE SC.....	68
5.8.1	TwinSAFE SC - operating principle	68
5.8.2	TwinSAFE SC - configuration	68
5.8.3	TwinSAFE SC process data of ELX320x-0090	72
5.9	Object description and parameterization	73
5.9.1	Restore object.....	73
5.9.2	Configuration data	74
5.9.3	Configuration data (vendor-specific).....	75
5.9.4	Input data	76
5.9.5	Output data	76
5.9.6	Information and diagnostic data.....	77
5.9.7	Standard objects (0x1000-0x1FFF).....	77
6	Appendix	82
6.1	EtherCAT AL Status Codes	82
6.2	UL notice	82
6.3	FM notice.....	83
6.4	Support and Service	84

1 Foreword

1.1 Notes on the documentation

Intended audience

This description is only intended for the use of trained specialists in control and automation engineering who are familiar with the applicable national standards.

It is essential that the documentation and the following notes and explanations are followed when installing and commissioning these components.

It is the duty of the technical personnel to use the documentation published at the respective time of each installation and commissioning.

The responsible staff must ensure that the application or use of the products described satisfy all the requirements for safety, including all the relevant laws, regulations, guidelines and standards.

Disclaimer

The documentation has been prepared with care. The products described are, however, constantly under development.

We reserve the right to revise and change the documentation at any time and without prior announcement.

No claims for the modification of products that have already been supplied may be made on the basis of the data, diagrams and descriptions in this documentation.

Trademarks

Beckhoff®, TwinCAT®, TwinCAT/BSD®, TC/BSD®, EtherCAT®, EtherCAT G®, EtherCAT G10®, EtherCAT P®, Safety over EtherCAT®, TwinSAFE®, XFC®, XTS® and XPlanar® are registered trademarks of and licensed by Beckhoff Automation GmbH. Other designations used in this publication may be trademarks whose use by third parties for their own purposes could violate the rights of the owners.

Patent Pending

The EtherCAT Technology is covered, including but not limited to the following patent applications and patents: EP1590927, EP1789857, EP1456722, EP2137893, DE102015105702 with corresponding applications or registrations in various other countries.



EtherCAT® is registered trademark and patented technology, licensed by Beckhoff Automation GmbH, Germany.

Copyright

© Beckhoff Automation GmbH & Co. KG, Germany.

The reproduction, distribution and utilization of this document as well as the communication of its contents to others without express authorization are prohibited.

Offenders will be held liable for the payment of damages. All rights reserved in the event of the grant of a patent, utility model or design.

1.2 Safety instructions

Safety regulations

Please note the following safety instructions and explanations!
Product-specific safety instructions can be found on following pages or in the areas mounting, wiring, commissioning etc.

Exclusion of liability

All the components are supplied in particular hardware and software configurations appropriate for the application. Modifications to hardware or software configurations other than those described in the documentation are not permitted, and nullify the liability of Beckhoff Automation GmbH & Co. KG.

Personnel qualification

This description is only intended for trained specialists in control, automation and drive engineering who are familiar with the applicable national standards.

Description of instructions

In this documentation the following instructions are used.
These instructions must be read carefully and followed without fail!

DANGER

Serious risk of injury!

Failure to follow this safety instruction directly endangers the life and health of persons.

WARNING

Risk of injury!

Failure to follow this safety instruction endangers the life and health of persons.

CAUTION

Personal injuries!

Failure to follow this safety instruction can lead to injuries to persons.

NOTE

Damage to environment/equipment or data loss

Failure to follow this instruction can lead to environmental damage, equipment damage or data loss.



Tip or pointer

This symbol indicates information that contributes to better understanding.

1.3 Documentation Issue Status

Version	Comment
1.3.0	<ul style="list-style-type: none"> • Chapter <i>Basic function principles</i> added • Chapter <i>Parameterization and programming</i> added • Chapter <i>Disposal</i> added • FM notice regarding ANSI/ISA EX added • Chapter <i>Marking of ELX terminals</i> updated • Technical data updated • Design of the safety instructions adapted to IEC 82079-1 • New title page
1.2.0	<ul style="list-style-type: none"> • Contact assignment extended with sensor illustration • Chapter <i>Arrangement of ELX terminals within a bus terminal block</i> updated • Chapter <i>Marking of ELX terminals</i> updated • Technical data updated
1.1.0	<ul style="list-style-type: none"> • Chapter <i>Arrangement of ELX terminals at the bus terminal</i> updated
1.0.1	<ul style="list-style-type: none"> • Layout updated
1.0	<ul style="list-style-type: none"> • Technical data updated
0.3	<ul style="list-style-type: none"> • Technical data updated • Chapter <i>Mounting and Wiring</i> updated
0.2	<ul style="list-style-type: none"> • Chapter <i>Intended use</i> added
0.1	<ul style="list-style-type: none"> • First preliminary version (for internal usage only)

1.4 Marking of ELX terminals

Name

An ELX terminal has a 15-digit technical designation, composed of

- family key
- type
- software variant
- revision

example	family	type	software variant	revision
ELX1052-0000-0001	ELX terminal	1052: two-channel digital input terminal for NAMUR sensors, Ex i	0000: basic type	0001
ELX9560-0000-0001	ELX terminal	9560: power supply terminal	0000: basic type	0001

Notes

- The elements mentioned above result in the **technical designation**. ELX1052-0000-0001 is used in the example below.
- Of these, ELX1052-0000 is the order identifier, commonly called just ELX1052 in the "-0000" revision. "-0001" is the EtherCAT revision.
- The **order identifier** is made up of
 - family key (ELX)
 - type (1052)
 - software version (-0000)
- The **Revision** -0001 shows the technical progress, such as the extension of features with regard to the EtherCAT communication, and is managed by Beckhoff. In principle, a device with a higher revision can replace a device with a lower revision, unless specified otherwise, e.g. in the documentation. Associated and synonymous with each revision there is usually a description (ESI, EtherCAT Slave Information) in the form of an XML file, which is available for download from the Beckhoff website. The revision has been applied to the terminals on the outside, see *ELX1052 with date code 3218FMFM, BTN 10000100 and Ex marking*.
- The hyphen is omitted in the labeling on the side of the terminal. Example:
Name: ELX1052-0000
Label: ELX1052₀₀₀₀
- The type, software version and revision are read as decimal numbers, even if they are technically saved in hexadecimal.

Identification numbers

ELX terminals have two different identification numbers:

- date code (batch number)
- **Beckhoff Traceability Number**, or BTN for short (as a serial number it clearly identifies each terminal)

Date code

The date code is an eight-digit number given by Beckhoff and printed on the ELX terminal. The date code indicates the build version in the delivery state and thus identifies an entire production batch, but does not distinguish between the terminals in a batch.

Structure of the date code: **WW YY FF HH**
 WW - week of production (calendar week)
 YY - year of production
 FF - firmware version
 HH - hardware version

Example with date code: 02180100:
 02 - week of production 02
 18 - year of production 2018
 01 - firmware version 01
 00 - hardware version 00

Beckhoff Traceability Number (BTN)

In addition, each ELX terminal has a unique **Beckhoff Traceability Number (BTN)**.

Ex marking

The Ex marking can be found at the top left on the terminal:

II 3 (1) G Ex ec [ia Ga] IIC T4 Gc
 II (1) D [Ex ia Da] IIIC
 I (M1) [Ex ia Ma] I
 IECEx BVS 18.0005X
 BVS 18 ATEX E 005 X

Examples

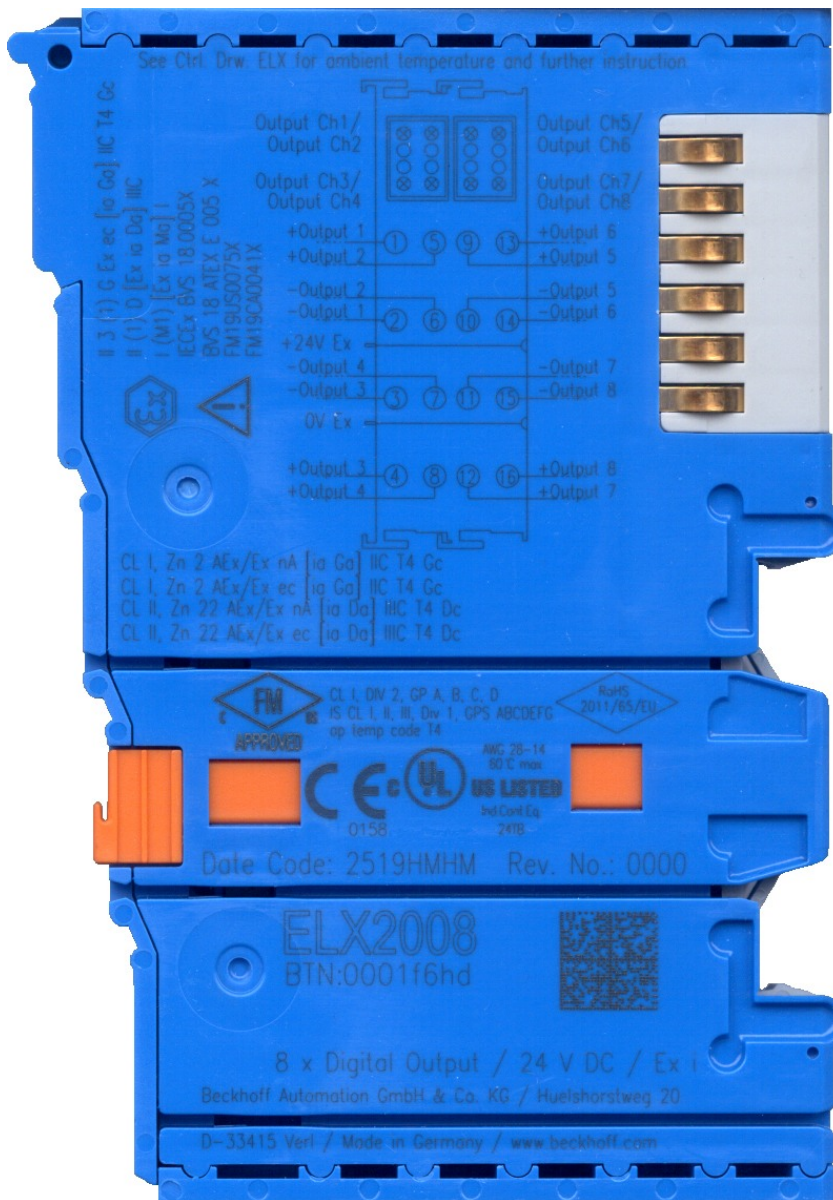

Fig. 1: ELX2008-0000 with date code 2519HMHM, BTN 0001f6hd and Ex marking



Fig. 2: ELX9560-0000 with date code 12150000, BTN 000b000 and Ex marking



Fig. 3: ELX9012 with date code 12174444, BTN 0000b0si and Ex marking

2 Product overview

2.1 ELX3312 - Introduction

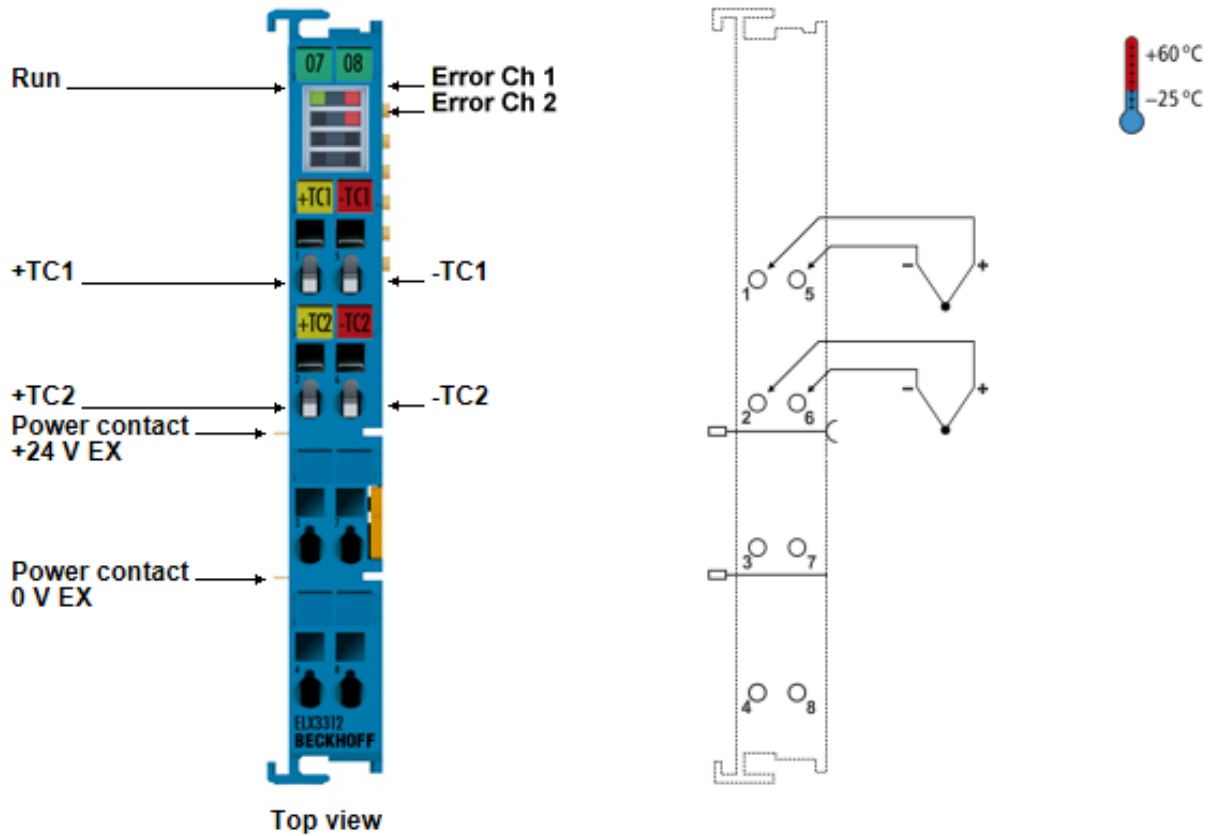

Fig. 4: ELX3312 - 2-channel analog input terminal for thermocouples, 16 bit, Ex i

The ELX3312 analog input terminal allows the direct connection of thermocouples located in hazardous areas classified Zone 0/20 or 1/21. The circuitry of the ELX3312 can operate sensors with 2-wire technology. Linearization is possible over the entire freely selectable temperature range. The error LEDs indicate a broken wire. Compensation for the cold junction is achieved through internal temperature measurement. Millivolt measurement is also possible with ELX3312.

2.2 ELX3314 - Introduction

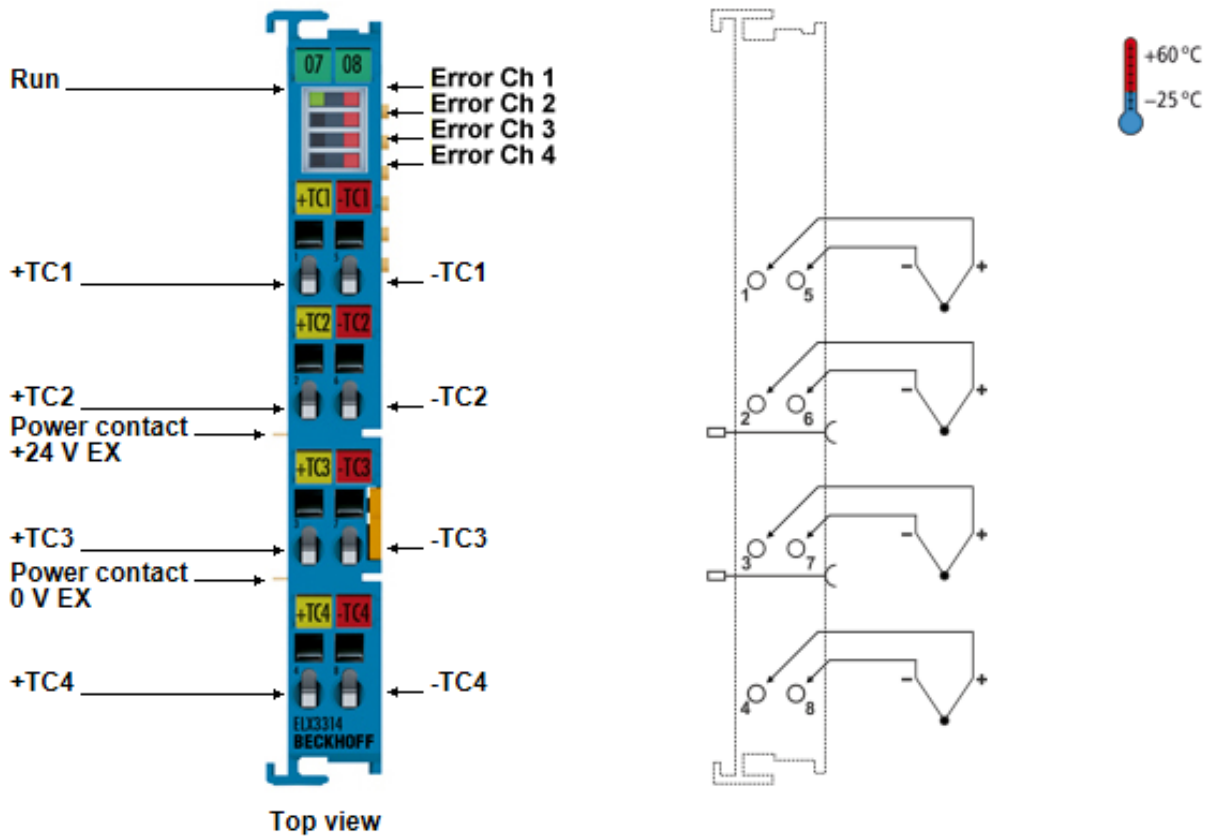

Fig. 5: ELX3314 - 4-channel analog input terminal for thermocouples, 16 bit, Ex i

The ELX3314 analog input terminal allows the direct connection of thermocouples located in hazardous areas classified Zone 0/20 or 1/21. The circuitry of the ELX3314 can operate sensors with 2-wire technology. Linearization is possible over the entire freely selectable temperature range. The error LEDs indicate a broken wire. Compensation for the cold junction is achieved through internal temperature measurement. Millivolt measurement is also possible with ELX3314.

2.3 Technical data

Technical data	ELX3312-0000	ELX3314-0000
Technology	temperature measurement	
Sensor types	thermocouples type B, C, E, J, K, L, N, R, S, T, U (default: Type K)	
Number of inputs	2 (differential)	4 (differential)
Connection method	2-wire	2-wire
Measuring range (depending on sensor type):	type B: +200 ... +1820°C type C: 0 ... +2320°C type E: -270 ... +1000°C type J: -210 ... +1200°C type K: -270 ... +1370°C (default) type L: -50 ... +900°C type N: -270 ... +1300°C type R: -50 ... +1750°C type S: -50 ... +1750°C type T: -270 ... +400°C type U: -50 ... +600°C voltage measurement: ±30...±75 mV	
Resolution	0.1°C per digit	
Measuring error	< ±0.3 % (relative to full scale value)	
Internal resistance	≥ 10 kΩ typ. (differential)	
Input filter limit frequency	typical 1 kHz, depending on sensor length, conversion time, sensor type	
Conversion time	adjustable: 50...5000 ms (default: 270 ms)	adjustable: 50...5000 ms (default: 310 ms)
Supply voltage electronics	via E-Bus (5 V _{DC}) and Power Contacts (24 V _{DC} Ex, feeding by ELX9560)	
Current consumption from the E-Bus	typically 70 mA	
Current consumption from Power Contacts	typically 10 mA + load (ELX9560 power supply)	
Special features	limit value monitoring, digital filter and characteristic curve linearization integrated	
Bit width in the process image	2 x 32 bit input	4 x 32 bit input
Electrical isolation	1500 V (E-Bus / field voltage)	
Weight	app. 60 g	
Permissible ambient temperature range during operation	-25°C ... + 60°C	
Permissible ambient temperature range during storage	-40°C ... + 85°C	
Permissible relative humidity	95%, no condensation	
Permissible air pressure (operation, storage, transport)	800 hPa to 1100 hPa (this corresponds to a height of approx. -690 m to 2000 m over sea level assuming an international standard atmosphere)	
Dimensions (W x H x D)	app. 15 mm x 100 mm x 70 mm (width aligned: 12 mm)	
Mounting [► 23]	on 35 mm mounting rail conforms to EN 60715	
Vibration / shock resistance	conforms to EN 60068-2-6 / EN 60068-2-27	
EMC immunity / emission	conforms to EN 61000-6-2 / EN 61000-6-4	
Protect. class	IP20	
Permissible installation position	See chapter Installation position and minimum distances [► 22]	
Approvals / markings	CE, UL, ATEX, IECEx, cFMus	

Technical data for explosion protection		ELX3312-0000, ELX3314-0000	
Ex marking	ATEX	II 3 (1) G Ex ec [ia Ga] IIC T4 Gc II (1) D [Ex ia Da] IIIC I (M1) [Ex ia Ma] I	
	IECEX	Ex ec [ia Ga] IIC T4 Gc [Ex ia Da] IIIC [Ex ia Ma] I	
	cFMus	AIS Class I, II, III, Division 1, Groups A thru G Class I, Division 2, Groups A, B, C, D Class I, Zone 2, AEx/Ex ec [ia Ga] IIC T4 Gc [AEx/Ex ia Da] IIIC T4	
Certificate numbers		IECEX BVS 18.0005X BVS 18 ATEX E 005 X FM19US0075X, FM19CA0041X	
Power supply		Invariable in connection with ELX9560	
Field interfaces		U _o = 4.94 V I _o = 0.5 mA P _o = 0.5 mW Characteristic curve: linear	
Reactance (without consideration of the simultaneousness)		L_o	C_o
	Ex ia I	100 mH	1000 µF
	Ex ia IIA	100 mH	1000 µF
	Ex ia IIB	100 mH	1000 µF
	Ex ia IIC	100 mH	100 µF
	Ex ia IIIC	100 mH	1000 µF

2.4 Intended use

WARNING

Endangering the safety of persons and equipment!

The ELX components may only be used for the purposes described below!

CAUTION

Observe ATEX and IECEx!

The ELX components may only be used in accordance with the ATEX directive and the IECEx scheme!

The ELX terminals extend the field of application of the Beckhoff bus terminal system with functions for integrating intrinsically safe field devices from hazardous areas. The intended field of application is data acquisition and control tasks in discrete and process engineering automation, taking into account explosion protection requirements.

The ELX terminals are protected by the type of protection "Increased safety" (Ex e) according to IEC 60079-7 and must only be operated in hazardous areas of Zone 2 or in non-hazardous areas.

The field interfaces of the ELX terminals achieve explosion protection through the type of protection "intrinsic safety" (Ex i) according to IEC 60079-11. For this reason, only appropriately certified, intrinsically safe devices may be connected to the ELX terminals. Observe the maximum permissible connection values for voltages, currents and reactances. Any infringement can damage the ELX terminals and thus eliminate the explosion protection.

The ELX terminals are open, electrical equipment for installation in lockable cabinets, enclosures or operating rooms. Make sure that access to the equipment is only possible for authorized personnel.

CAUTION

Ensure traceability!

The buyer has to ensure the traceability of the device via the Beckhoff Traceability Number (BTN).

3 Mounting and wiring

3.1 Special conditions of use for ELX terminals

WARNING

Observe the special conditions of use for the intended use of Beckhoff ELX terminals in potentially explosive areas (ATEX directive 2014/34/EU)!

- The certified components are to be installed in a suitable housing that guarantees an ingress protection of at least IP54 in accordance with EN 60079-0 and EN 60529! The prescribed environmental conditions during installation, operation and maintenance are thereby to be taken into account! Inside the housing, pollution degree 1 and 2 are permissible.
- If the temperatures during rated operation are higher than 70°C at the feed-in points of cables, lines or pipes, or higher than 80°C at the wire branching points, then cables must be selected whose temperature data correspond to the actual measured temperature values!
- Observe the permissible ambient temperature range of -25 to +60°C of Beckhoff ELX terminals!
- Measures must be taken to protect against the rated operating voltage being exceeded by more than 40% due to short-term interference voltages! The power supply of the ELX9560 power supply terminal must correspond to overvoltage category II according to EN 60664-1
- The individual terminals may only be unplugged or removed from the bus terminal system if all supply voltages have been switched off or if a non-explosive atmosphere is ensured!
- The connections of the ELX9560 power supply terminal may only be connected or disconnected if all supply voltages have been switched off or if a non-explosive atmosphere is ensured!
- Address selectors and switches may only be adjusted if all supply voltages have been switched off or if a non-explosive atmosphere is ensured!

3.2 Installation notes for ELX terminals

NOTE

Storage, transport and mounting

- Transport and storage are permitted only in the original packaging!
- Store in a dry place, free from vibrations.
- A brand new ELX terminal with a certified build version is delivered only in a sealed carton. Therefore, check that the carton and all seals are intact before unpacking.
- Do not use the ELX terminal if
 - its packaging is damaged
 - the terminal is visibly damaged or
 - you cannot be sure of the origin of the terminal.
- ELX terminals with a damaged packaging seal are regarded as used.

WARNING

Observe the accident prevention regulations

During mounting, commissioning, operation and maintenance, adhere to the safety regulations, accident prevention regulations and general technical rules applicable to your devices, machines and plants.

CAUTION

Observe the erection regulations

Observe the applicable erection regulations.

NOTE**Protect the terminals against electrostatic discharge (ESD)**

Electronic components can be destroyed by electrostatic discharge. Therefore, take the safety measures to protect against electrostatic discharge as described in DIN EN 61340-5-1 among others. In conjunction with this, ensure that the personnel and surroundings are suitably earthed.

NOTE**Do not place terminals on E-bus contacts**

Do not place the ELX terminals on the E-bus contacts located on the right-hand side. The function of the E-bus contacts can be negatively affected by damage caused by this, e.g. scratches.

NOTE**Protect the terminals against dirt**

To ensure the functionality of the ELX terminals they must be protected against dirt, especially on the contact points. For this reason use only clean tools and materials.

NOTE**Handling**

- It is forbidden to insert conductive or non-conductive objects of any kind into the interior of the housing (e.g. through the ventilation slots in the housing).
- Use only the openings provided in the housing front and appropriate tools to actuate the spring-loaded terminal contacts on the front side for attaching connection cables to the terminal; see chapter [Wiring](#) [► 26].
- The opening of the housing, the removal of parts and any mechanical deformation or machining of an ELX terminal are not permitted!

If an ELX terminal is defective or damaged it must be replaced by an equivalent terminal. Do not carry out any repairs to the devices. For safety reasons repairs may only be carried out by the manufacturer.

NOTE**Contact marking and pin assignment**

The colored inscription labels above the front connection contacts shown in the illustrations in the introduction chapter are only examples and are not part of the scope of delivery!

A clear assignment of channel and terminal designation according to the chapter contact assignment to the actual terminal point can be made via the lasered channel numbers 1 to 8 on the left above the respective terminal point as well as via the laser image.

Observe any possible polarity dependency of connected intrinsically safe circuits!

3.3 Arrangement of ELX terminals within a bus terminal block

⚠ WARNING

Observe the following instructions for the arrangement of ELX terminals!

- ELX signal terminals must always be installed behind an ELX9560 power supply terminal, without exception!
- Only signal terminals of the ELX series may be installed behind an ELX9560 power supply terminal!
- Multiple ELX9560 power supply terminals may be set in one terminal block as long as one ELX9410 is placed before each additional ELX9560!
- An ELX9410 power supply terminal must not be mounted to the right of an ELX9560 nor to the left of any ELX signal terminal!
- The last terminal of each ELX segment is to be covered by an ELX9012 bus end cover, unless two ELX9410 power supply terminals are installed in direct succession for continuing the same terminal segment with standard Beckhoff EtherCAT terminals (e.g. EL/ES/EK)!

Examples for the arrangement of ELX terminals

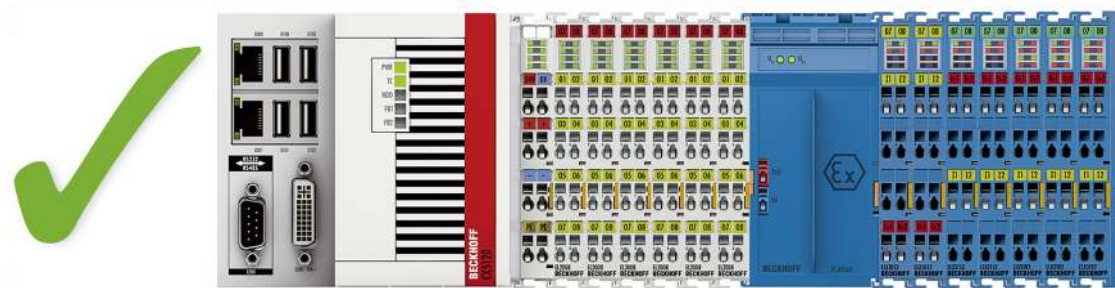

Fig. 6: Valid arrangement of the ELX terminals (right terminal block).

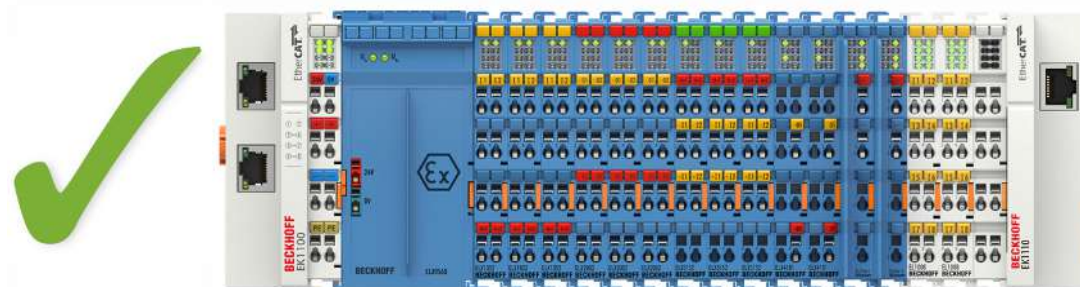

Fig. 7: Valid arrangement - terminals that do not belong to the ELX series are set before and after the ELX terminal segment. The separation is realized by the ELX9560 at the beginning of the ELX terminal segment and two ELX9410 at the end of the ELX terminal segment.

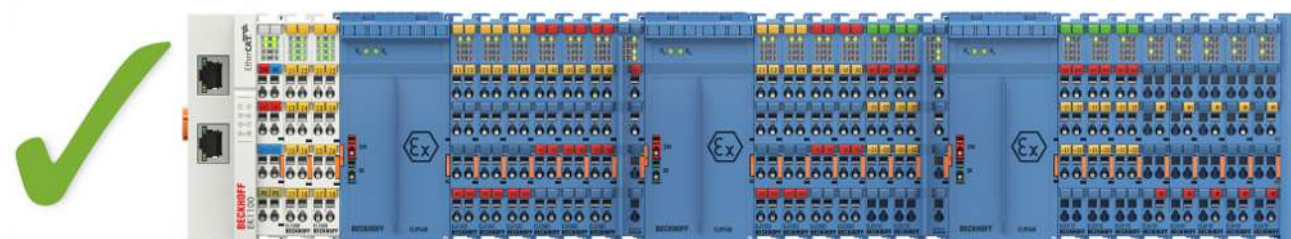

Fig. 8: Valid arrangement - multiple power supplies by ELX9560, each with an upstream ELX9410.

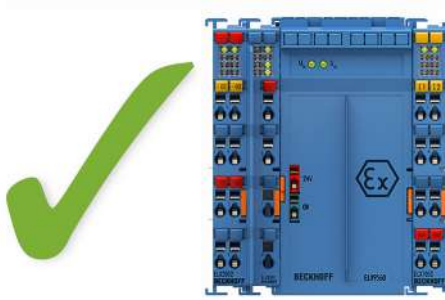

Fig. 9: Valid arrangement - ELX9410 in front of an ELX9560 power supply terminal.

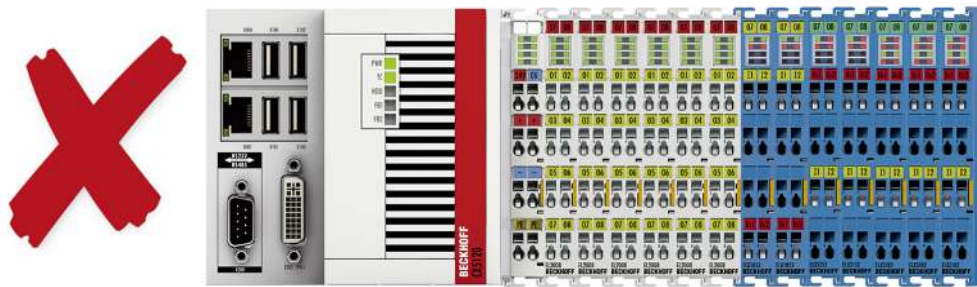

Fig. 10: Invalid arrangement - missing ELX9560 power supply terminal.

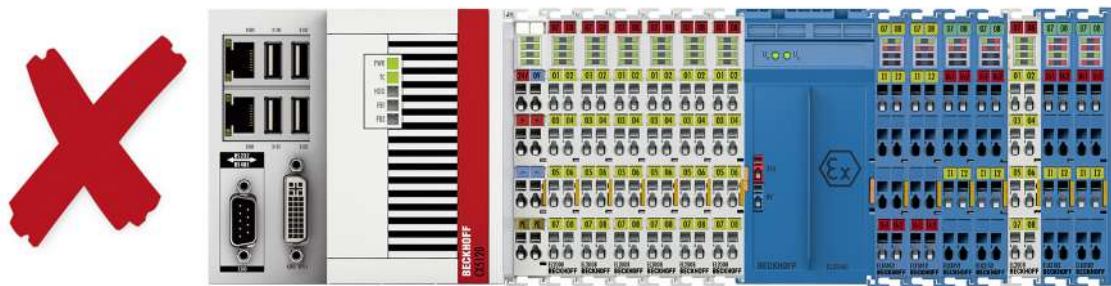

Fig. 11: Invalid arrangement - terminal that does not belong to the ELX series within the ELX terminal segment.

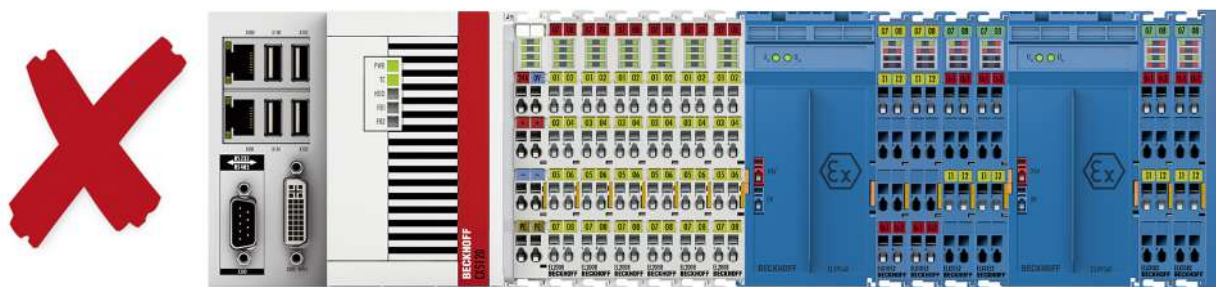

Fig. 12: Invalid arrangement - second ELX9560 power supply terminal within the ELX terminal segment without an upstream ELX9410.

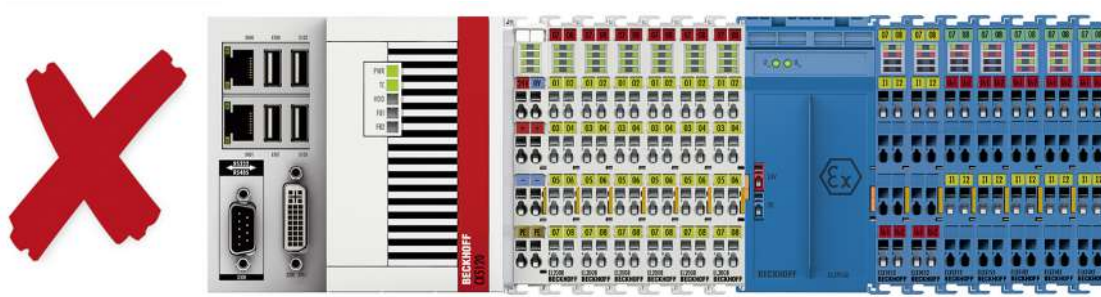

Fig. 13: Invalid arrangement - missing ELX9012 bus end cover.

NOTE

Observe the maximum output current of the ELX9560

When configuring the ELX terminal segment, please note the maximum available output current of the ELX9560 power supply terminal in accordance with the specified technical data. If required, an additional power supply terminal ELX9560 with an upstream ELX9410 connected (see mounting examples) must be installed or a completely new terminal block must be assembled.

3.4 Installation position and minimum distances

Installation position

For the prescribed installation position the mounting rail is installed horizontally and the mating surfaces of the ELX terminals point toward the front (see illustration below). The terminals are ventilated from below, which enables optimum cooling of the electronics through convection. The direction indication “down” corresponds to the direction of positive acceleration due to gravity.

Minimum distances

Observe the following minimum distances to ensure optimum convection cooling:

- above and below the ELX terminals: 35 mm (required!)
- besides the bus terminal block: 20 mm (recommended)

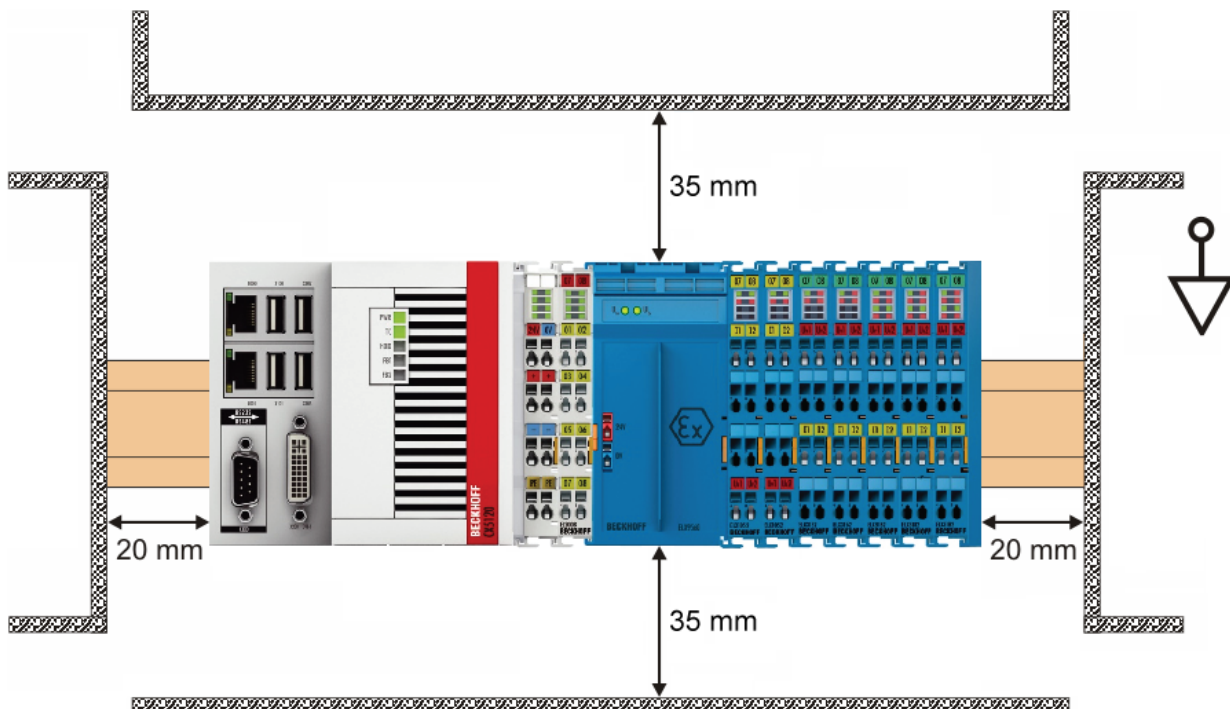

Fig. 14: Installation position and minimum distances

⚠ WARNING

Observe the minimum separation distances according to IEC 60079-14!

Observe the prescribed minimum separation distances between intrinsically safe and non-intrinsically safe circuits according to IEC 60079-14.

3.5 Installation of ELX terminals on mounting rails

⚠ WARNING

Risk of electric shock and damage of device!

Bring the bus terminal system into a safe, powered down state before starting installation, disassembly or wiring of the bus terminals!

⚠ CAUTION

Danger of injury due to power contacts!

For your own protection, pay attention to careful and careful handling of the ELX terminals. In particular, the left side mounted, sharp-edged blade contacts pose a potential risk of injury.

Assembly

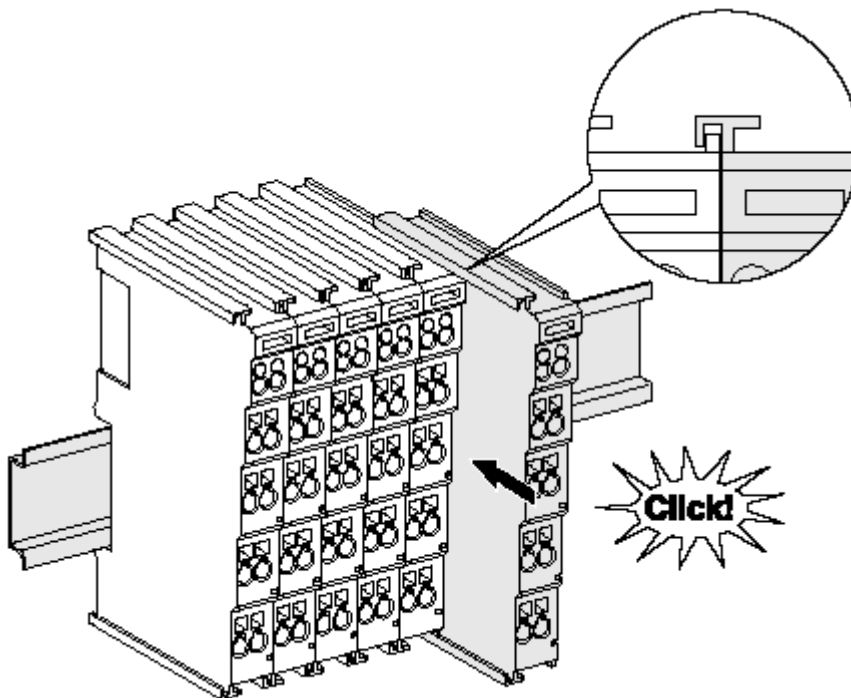

Fig. 15: Attaching on mounting rail

The bus coupler and bus terminals are attached to commercially available 35 mm mounting rails (DIN rails according to EN 60715) by applying slight pressure:

1. First attach the fieldbus coupler to the mounting rail.
2. The bus terminals are now attached on the right-hand side of the fieldbus coupler. Join the components with tongue and groove and push the terminals against the mounting rail, until the lock clicks onto the mounting rail.

If the terminals are clipped onto the mounting rail first and then pushed together without tongue and groove, the connection will not be operational! When correctly assembled, no significant gap should be visible between the housings.

● Fixing of mounting rails

i The locking mechanism of the terminals and couplers extends to the profile of the mounting rail. At the installation, the locking mechanism of the components must not come into conflict with the fixing bolts of the mounting rail. To mount the mounting rails with a height of 7.5 mm under the terminals and couplers, you should use flat mounting connections (e.g. countersunk screws or blind rivets).

Disassembly

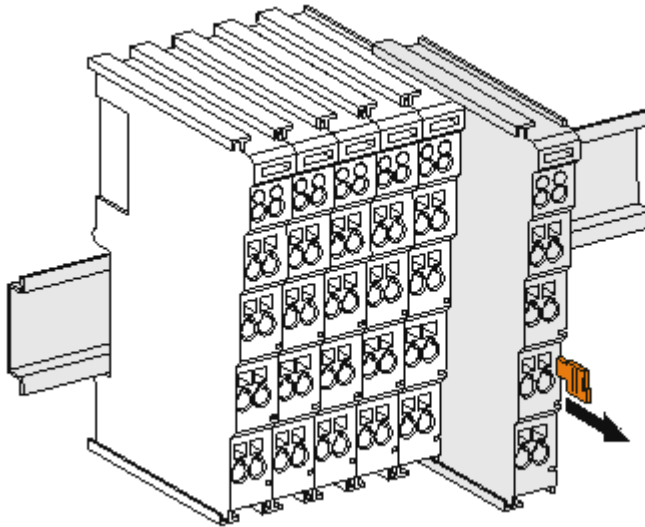

Fig. 16: Disassembling of terminal

Each terminal is secured by a lock on the mounting rail, which must be released for disassembly:

1. Pull the terminal by its orange-colored lugs approximately 1 cm away from the mounting rail. In doing so for this terminal the mounting rail lock is released automatically and you can pull the terminal out of the bus terminal block easily without excessive force.
2. Grasp the released terminal with thumb and index finger simultaneous at the upper and lower grooved housing surfaces and pull the terminal out of the bus terminal block.

Connections within a bus terminal block

The electric connections between the Bus Coupler and the Bus Terminals are automatically realized by joining the components:

- The six spring contacts of the E-Bus deal with the transfer of the data and the supply of the Bus Terminal electronics.
- The power contacts deal with the supply for the field electronics and thus represent a supply rail within the bus terminal block.
The power contacts of the ELX terminals are supplied by the ELX9560 power terminal. This interrupts the power contacts and thus represents the beginning of a new supply rail.

i Power Contacts

During the design of a bus terminal block, the pin assignment of the individual Bus Terminals must be taken account of, since some types (e.g. analog Bus Terminals or digital 4-channel Bus Terminals) do not or not fully loop through the power contacts.

3.6 Connection

3.6.1 Connection system

⚠ WARNING

Risk of electric shock and damage of device!

Bring the bus terminal system into a safe, powered down state before starting installation, disassembly or wiring of the bus terminals!

The terminals of ELXxxxx series include electronics and connection level in a single enclosure.

Standard wiring

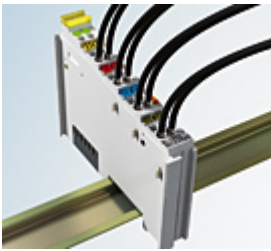

Fig. 17: Standard wiring

The terminals of ELXxxxx series feature integrated screwless spring force technology for fast and simple assembly.

High Density Terminals (HD Terminals)



Fig. 18: *High Density Terminals*

The Bus Terminals from these series with 16 connection points are distinguished by a particularly compact design, as the packaging density is twice as large as that of the standard 12 mm Bus Terminals. Massive conductors and conductors with a wire end sleeve can be inserted directly into the spring loaded terminal point without tools.

Ultrasonically "bonded" (ultrasonically welded) conductors

● Ultrasonically "bonded" conductors

i It is also possible to connect the Standard and High Density Terminals with ultrasonically "bonded" (ultrasonically welded) conductors. In this case, please note the tables concerning the wire-size width below!

3.6.2 Wiring

⚠ WARNING

Risk of electric shock and damage of device!

Bring the bus terminal system into a safe, powered down state before starting installation, disassembly or wiring of the bus terminals!

Terminals for standard wiring

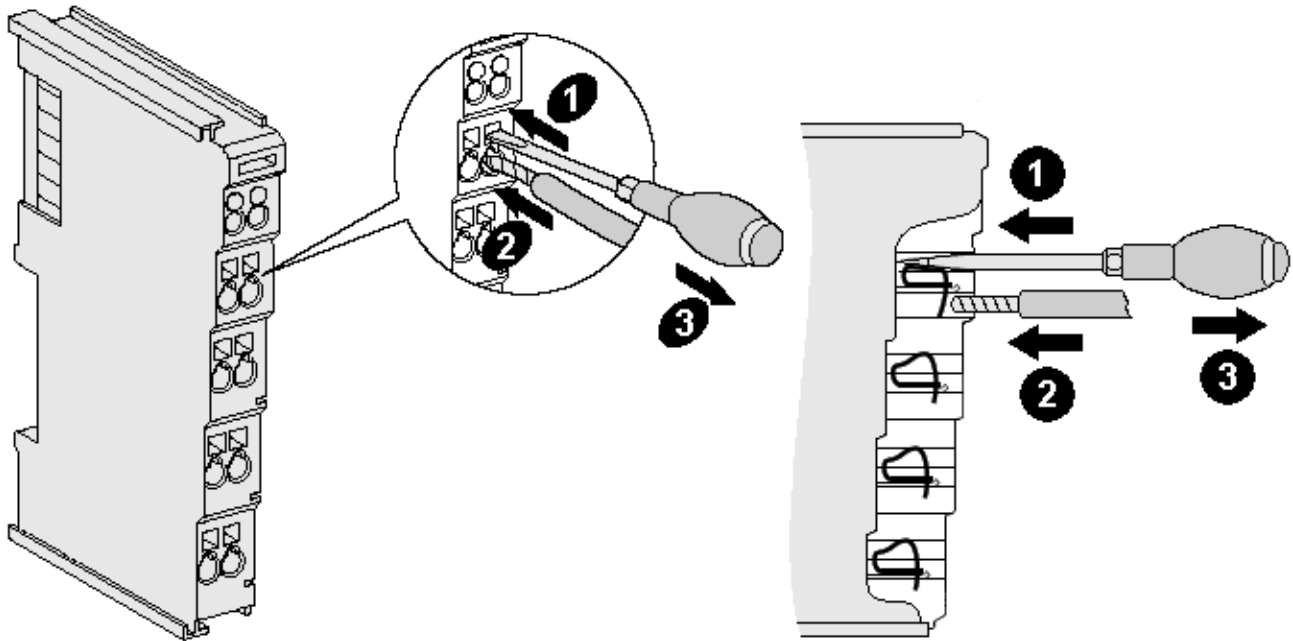

Fig. 19: Connecting a cable on a terminal point

Up to eight terminal points enable the connection of solid or finely stranded cables to the Bus Terminal. The terminal points are implemented in spring force technology. Connect the cables as follows:

1. Open a terminal point by pushing a screwdriver straight against the stop into the square opening above the terminal point. Do not turn the screwdriver or move it alternately (don't toggle).
2. The wire can now be inserted into the round terminal opening without any force.
3. The terminal point closes automatically when the pressure is released, holding the wire securely and permanently.

Observe the requirements for connecting cables and cross sections according to IEC 60079-7 and IEC 60079-11. See the following tables for the suitable wire size width.

Terminal housing	Standard wiring	ELX9560
Wire size width (single core wires)	0.08 ... 2.5 mm ²	0.14 ... 1.5 mm ²
Wire size width (fine-wire conductors)	0.08 ... 2.5 mm ²	0.14 ... 1.5 mm ²
Wire size width (conductors with a wire end sleeve)	0.14 ... 1.5 mm ²	0.14 ... 1.0 mm ²
Wire stripping length	8 ... 9 mm	8 ... 9 mm

NOTE

Maximum screwdriver width for ELX9560

Use a screwdriver with a maximum width of 2 mm to wire the ELX9560 power supply terminal. Wider screwdrivers can damage the terminal points.

High Density Terminals (HD Terminals) with 16 terminal points

The conductors of the HD Terminals are connected without tools for single-wire conductors using the direct plug-in technique, i.e. after stripping the wire is simply plugged into the terminal point. The cables are released, as usual, using the contact release with the aid of a screwdriver. See the following table for the suitable wire size width.

Terminal housing	High Density Housing
Wire size width (single core wires)	0.08 ... 1.5 mm ²
Wire size width (fine-wire conductors)	0.25 ... 1.5 mm ²
Wire size width (conductors with a wire end sleeve)	0.14 ... 0.75 mm ²
Wire size width (ultrasonically "bonded" conductors)	only 1.5 mm ²
Wire stripping length	8 ... 9 mm

3.6.3 Proper line connection

Always connect only one wire per terminal point.

When using fine-wire conductors it is recommended to connect them with wire end sleeves in order to establish a safe, conductive connection.

In addition, make sure that the pin assignment is correct to prevent damage to the ELX terminals and the connected devices.

3.6.4 Shielding and potential separation



Shielding

Encoder, analog sensors and actors should always be connected with shielded, twisted paired wires.

⚠ CAUTION

Observe installation requirements in areas of potentially explosive atmospheres!

During installation, observe the requirements for cables, shielding and earth potential equalization in areas of potentially explosive atmospheres according to IEC 60079-11, IEC 60079-14 and IEC 60079-25.

⚠ WARNING

Ensure potential separation of the 24 V Ex busbar!

In any case, make sure that the galvanic isolation made by the ELX9560 between the 24 V Ex busbar (power contacts +24 V Ex and 0 V Ex) and other system potentials (if applicable also functional or protective earths) is not removed.

3.6.5 ELX3312 - Contact assignment

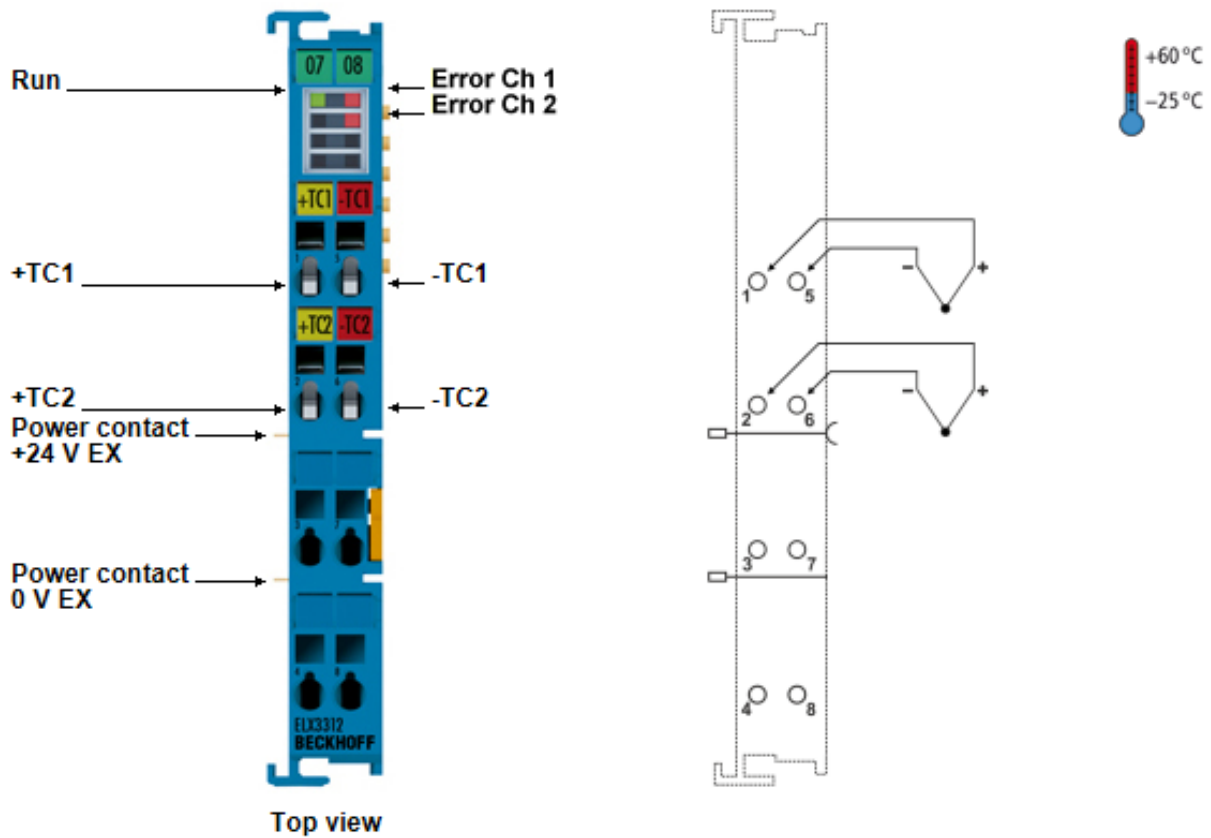

Fig. 20: ELX3312 - Contact assignment

Terminal point		Description
Name	No.	
+TC1	1	Channel 1: Input +TC1 (TC voltage measurement)
+TC2	2	Channel 2: Input +TC2 (TC voltage measurement)
	3	not implemented
	4	not implemented
-TC1	5	Channel 1: Input -TC1 (TC voltage measurement)
-TC2	6	Channel 2: Input -TC2 (TC voltage measurement)
	7	not implemented
	8	not implemented

LED displays

LED	Color	Meaning	
Run	green	This LED indicates the terminal's operating state:	
		off	State of the EtherCAT State Machine: INIT = initialization of the terminal or BOOTSTRAP = function for firmware updates of the terminal
		flashing	State of the EtherCAT State Machine: PREOP = function for mailbox communication and different standard-settings set
		single flash	State of the EtherCAT State Machine: SAFEOP = verification of the Sync Manager channels and the distributed clocks. Outputs remain in safe state
		on	State of the EtherCAT State Machine: OP = normal operating state; mailbox and process data communication is possible
Error Ch 1	red	The measurement value of channel 1 is in an invalid range of the characteristic curve. Possible short circuit or wire breakage at channel 1.	
Error Ch 2	red	The measurement value of channel 2 is in an invalid range of the characteristic curve. Possible short circuit or wire breakage at channel 2.	

3.6.6 ELX3314 - Contact assignment

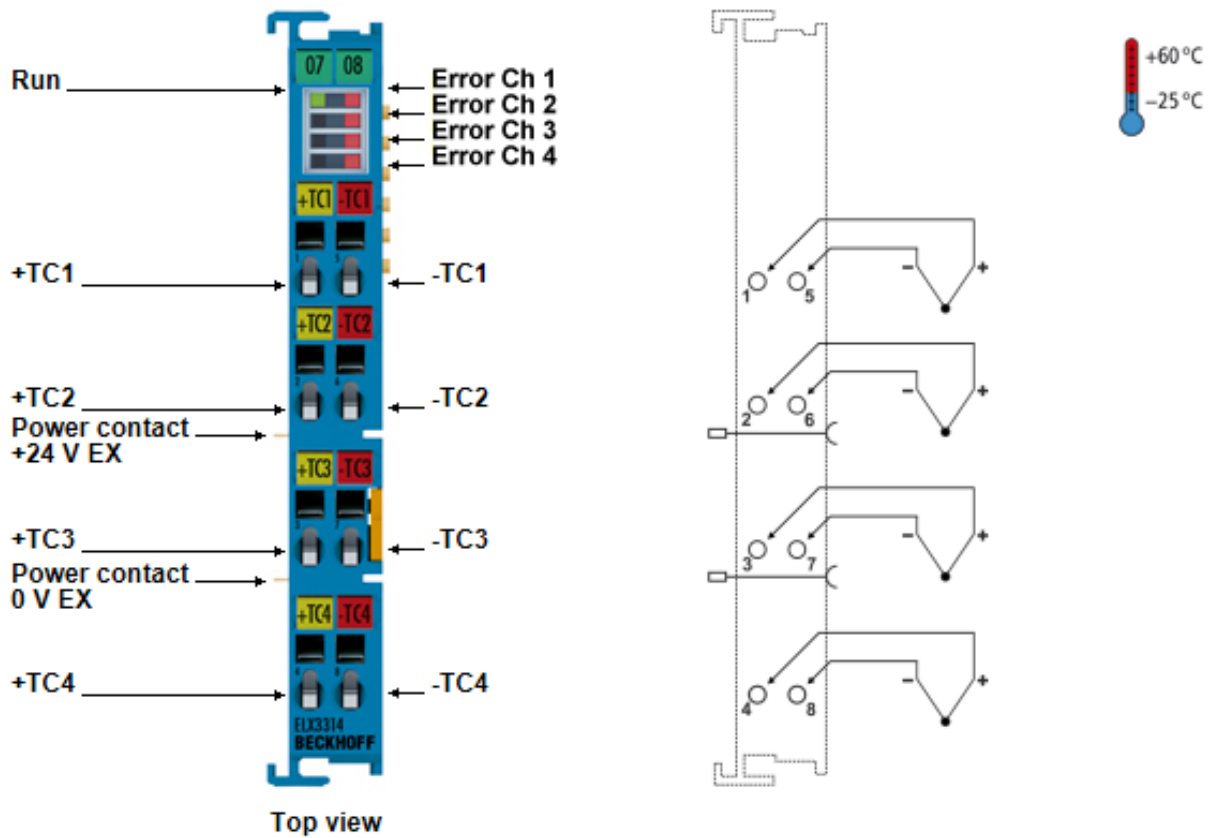

Fig. 21: ELX3314 - Contact assignment

Terminal point		Description
Name	No.	
+TC1	1	Channel 1: Input +TC1 (TC voltage measurement)
+TC2	2	Channel 2: Input +TC2 (TC voltage measurement)
+TC3	3	Channel 3: Input +TC3 (TC voltage measurement)
+TC4	4	Channel 4: Input +TC4 (TC voltage measurement)
-TC1	5	Channel 1: Input -TC1 (TC voltage measurement)
-TC2	6	Channel 2: Input -TC2 (TC voltage measurement)
-TC3	7	Channel 3: Input -TC3 (TC voltage measurement)
-TC4	8	Channel 4: Input -TC4 (TC voltage measurement)

LED displays

LED	Color	Meaning	
Run	green	This LED indicates the terminal's operating state:	
		off	State of the EtherCAT State Machine: INIT = initialization of the terminal or BOOTSTRAP = function for firmware updates of the terminal
		flashing	State of the EtherCAT State Machine: PREOP = function for mailbox communication and different standard-settings set
		single flash	State of the EtherCAT State Machine: SAFEOP = verification of the Sync Manager channels and the distributed clocks. Outputs remain in safe state
		on	State of the EtherCAT State Machine: OP = normal operating state; mailbox and process data communication is possible
Error Ch 1	red	The measurement value of channel 1 is in an invalid range of the characteristic curve. Possible short circuit or wire breakage at channel 1.	
Error Ch 2	red	The measurement value of channel 2 is in an invalid range of the characteristic curve. Possible short circuit or wire breakage at channel 2.	
Error Ch 3	red	The measurement value of channel 3 is in an invalid range of the characteristic curve. Possible short circuit or wire breakage at channel 3.	
Error Ch 4	red	The measurement value of channel 4 is in an invalid range of the characteristic curve. Possible short circuit or wire breakage at channel 4.	

3.7 Disposal



Products marked with a crossed-out wheeled bin shall not be discarded with the normal waste stream. The device is considered as waste electrical and electronic equipment. The national regulations for the disposal of waste electrical and electronic equipment must be observed.

4 Basic function principles

4.1 EtherCAT basics

Please refer to the [EtherCAT System Documentation](#) for the EtherCAT fieldbus basics, also available as [PDF file](#) from the download area of your ELX terminal on <https://www.beckhoff.com/ELXxxxx>.

4.2 Notices on analog specifications

Beckhoff I/O devices (terminals, boxes, modules) with analog inputs are characterized by a number of technical characteristic data; refer to the technical data in the respective documents.

Some explanations are given below for the correct interpretation of these characteristic data.

4.2.1 Full scale value (FSV)

An I/O device with an analog input measures over a nominal measuring range that is limited by an upper and a lower limit (initial value and end value); these can usually be taken from the device designation. The range between the two limits is called the measuring span and corresponds to the equation (end value - initial value). Analogous to pointing devices this is the measuring scale (see IEC 61131) or also the dynamic range.

For analog I/O devices from Beckhoff the rule is that the limit with the largest value is chosen as the full scale value of the respective product (also called the reference value) and is given a positive sign. This applies to both symmetrical and asymmetrical measuring spans.

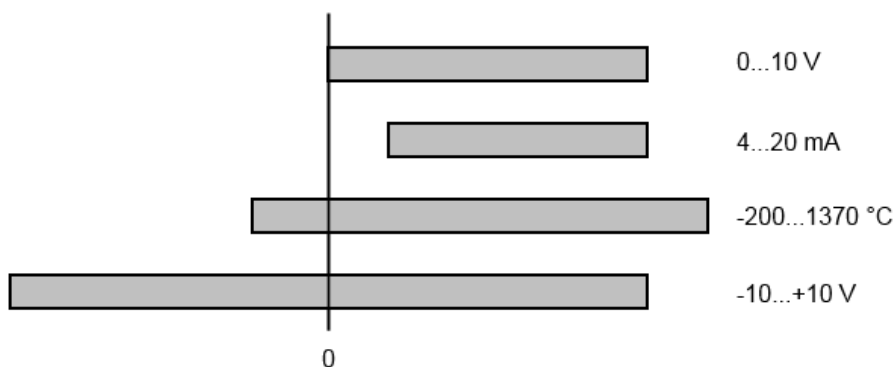

Fig. 22: Full scale value, measuring span

For the above **examples** this means:

- Measuring range 0...10 V: asymmetric unipolar, full scale value = 10 V, measuring span = 10 V
- Measuring range 4...20 mA: asymmetric unipolar, full scale value = 20 mA, measuring span = 16 mA
- Measuring range -200...1370 °C: asymmetric bipolar, full scale value = 1370 °C, measuring span = 1570 °C
- Measuring range -10...+10 V: symmetric bipolar, full scale value = 10 V, measuring span = 20 V

This applies to analog output terminals/ boxes (and related Beckhoff product groups).

4.2.2 Measuring error/ measurement deviation

The relative measuring error (% of the full scale value) is referenced to the full scale value and is calculated as the quotient of the largest numerical deviation from the true value ('measuring error') referenced to the full scale value.

$$\text{Measuring error} = \frac{\left| \text{max. deviation} \right|}{\text{full scale value}}$$

The measuring error is generally valid for the entire permitted operating temperature range, also called the 'usage error limit' and contains random and systematic portions of the referred device (i.e. 'all' influences such as temperature, inherent noise, aging, etc.).

It is always to be regarded as a positive/negative span with \pm , even if it is specified without \pm in some cases.

The maximum deviation can also be specified directly.

Example: Measuring range 0...10 V and measuring error $< \pm 0.3\%$ full scale value \rightarrow maximum deviation ± 30 mV in the permissible operating temperature range.

● Lower measuring error

i Since this specification also includes the temperature drift, a significantly lower measuring error can usually be assumed in case of a constant ambient temperature of the device and thermal stabilization after a user calibration.

This applies to analog output devices.

4.2.3 Temperature coefficient tK [ppm/K]

An electronic circuit is usually temperature dependent to a greater or lesser degree. In analog measurement technology this means that when a measured value is determined by means of an electronic circuit, its deviation from the "true" value is reproducibly dependent on the ambient/operating temperature.

A manufacturer can alleviate this by using components of a higher quality or by software means.

The temperature coefficient, when indicated, specified by Beckhoff allows the user to calculate the expected measuring error outside the basic accuracy at 23 °C.

Due to the extensive uncertainty considerations that are incorporated in the determination of the basic accuracy (at 23 °C), Beckhoff recommends a quadratic summation.

Example: Let the basic accuracy at 23 °C be $\pm 0.01\%$ typ. (full scale value), $tK = 20$ ppm/K typ.; the accuracy A35 at 35 °C is wanted, hence $\Delta T = 12$ K

$$G35 = \sqrt{(0.01\%)^2 + (12K \cdot 20 \frac{\text{ppm}}{\text{K}})^2} = 0.026\% \text{ full scale value, typ}$$

Remarks: ppm $\triangleq 10^{-6}$ % $\triangleq 10^{-2}$

4.2.4 Single-ended/differential typification

For analog inputs Beckhoff makes a basic distinction between two types: *single-ended* (SE) and *differential* (DIFF), referring to the difference in electrical connection with regard to the potential difference.

The diagram shows two-channel versions of an SE module and a DIFF module as examples for all multi-channel versions.

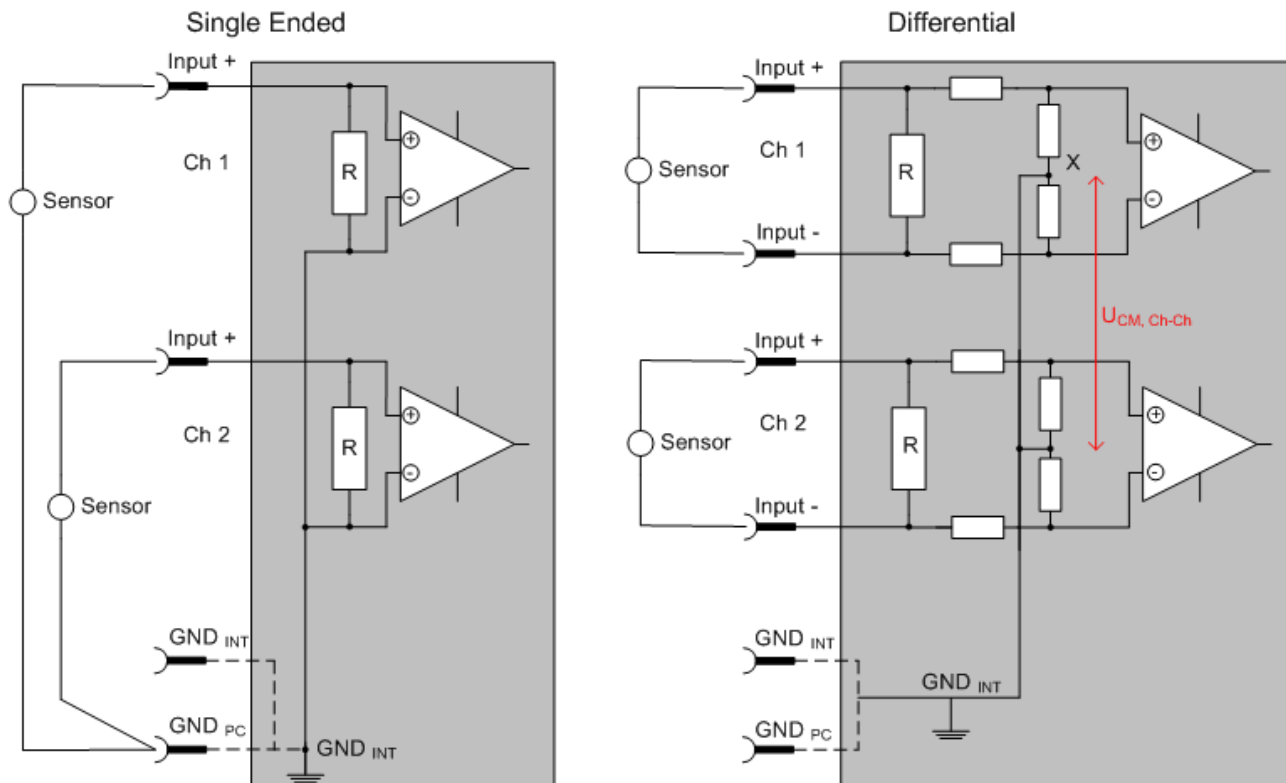

Fig. 23: SE and DIFF module as 2-channel version

Note: Dashed lines indicate that the respective connection may not necessarily be present in each SE or DIFF module. Electrical isolated channels are operating as differential type in general, hence there is no direct relation (voltaic) to ground within the module established at all. Indeed, specified information to recommended and maximum voltage levels have to be taken into account.

The basic rule:

- Analog measurements always take the form of voltage measurements between two potential points. For voltage measurements a large R is used, in order to ensure a high impedance. For current measurements a small R is used as shunt. If the purpose is resistance measurement, corresponding considerations are applied.
 - Beckhoff generally refers to these two points as input+/signal potential and input-/reference potential.
 - For measurements between two potential points two potentials have to be supplied.
 - Regarding the terms “single-wire connection” or “three-wire connection”, please note the following for pure analog measurements: three- or four-wire connections can be used for sensor supply, but are not involved in the actual analog measurement, which always takes place between two potentials/wires. In particular this also applies to SE, even though the term suggest that only one wire is required.
- The term “electrical isolation” should be clarified in advance. Beckhoff IO modules feature 1..8 or more analog channels; with regard to the channel connection a distinction is made in terms of:
 - how the channels WITHIN a module relate to each other, or
 - how the channels of SEVERAL modules relate to each other.

- The property of electrical isolation indicates whether the channels are directly connected to each other.
- Beckhoff terminals/ boxes (and related product groups) always feature electrical isolation between the field/analog side and the bus/EtherCAT side. In other words, if two analog terminals/ boxes are not connected via the power contacts (cable), the modules are effectively electrically isolated.
 - If channels within a module are electrically isolated, or if a single-channel module has no power contacts, the channels are effectively always differential. See also explanatory notes below. Differential channels are not necessarily electrically isolated.
- Analog measuring channels are subject to technical limits, both in terms of the recommended operating range (continuous operation) and the destruction limit. Please refer to the respective terminal/ box documentation for further details.

Explanation

• differential (DIFF)

- Differential measurement is the most flexible concept. The user can freely choose both connection points, input+/signal potential and input-/reference potential, within the framework of the technical specification.
- A differential channel can also be operated as SE, if the reference potential of several sensors is linked. This interconnection may take place via the system GND.
- Since a differential channel is configured symmetrically internally (cf. Fig. SE and DIFF module as 2-channel variant), there will be a mid-potential (X) between the two supplied potentials that is the same as the internal ground/reference ground for this channel. If several DIFF channels are used in a module without electrical isolation, the technical property V_{CM} (common-mode voltage) indicates the degree to which the mean voltage of the channels may differ.
- The internal reference ground may be accessible as connection point at the terminal/ box, in order to stabilize a defined GND potential in the terminal/ box. In this case it is particularly important to pay attention to the quality of this potential (noiselessness, voltage stability). At this GND point a wire may be connected to make sure that $V_{CM,max}$ is not exceeded in the differential sensor cable. If differential channels are not electrically isolated, usually only one $V_{CM,max}$ is permitted. If the channels are electrically isolated this limit should not apply, and the channels voltages may differ up to the specified separation limit.
- Differential measurement in combination with correct sensor wiring has the special advantage that any interference affecting the sensor cable (ideally the feed and return line are arranged side by side, so that interference signals have the same effect on both wires) has very little effect on the measurement, since the potential of both lines varies jointly (hence the term common mode). In simple terms: Common-mode interference has the same effect on both wires in terms of amplitude and phasing.
- Nevertheless, the suppression of common-mode interference within a channel or between channels is subject to technical limits, which are specified in the technical data.
- Further helpfully information on this topic can be found on the documentation page *Configuration of 0/4..20 mA differential inputs* (see documentation for the EL30xx terminals, for example).

• Single Ended (SE)

- If the analog circuit is designed as SE, the input/reference wire is internally fixed to a certain potential that cannot be changed. This potential must be accessible from outside on at least one point for connecting the reference potential, e.g. via the power contacts (cable).
- In other words, in situations with several channels SE offers users the option to avoid returning at least one of the two sensor cables to the terminal/ box (in contrast to DIFF). Instead, the reference wire can be consolidated at the sensors, e.g. in the system GND.
- A disadvantage of this approach is that the separate feed and return line can result in voltage/ current variations, which a SE channel may no longer be able to handle. See common-mode interference. A V_{CM} effect cannot occur, since the module channels are internally always 'hard-wired' through the input/reference potential.

Typification of the 2/3/4-wire connection of current sensors

Current transducers/sensors/field devices (referred to in the following simply as 'sensor') with the industrial 0/4-20 mA interface typically have internal transformation electronics for the physical measured variable (temperature, current, etc.) at the current control output. These internal electronics must be supplied with energy (voltage, current). The type of cable for this supply thus separates the sensors into *self-supplied* or *externally supplied* sensors:

Self-supplied sensors

- The sensor draws the energy for its own operation via the sensor/signal cable + and -. So that enough energy is always available for the sensor's own operation and open-circuit detection is possible, a lower limit of 4 mA has been specified for the 4-20 mA interface; i.e. the sensor allows a minimum current of 4 mA and a maximum current of 20 mA to pass.
- 2-wire connection see Fig. *2-wire connection*, cf. IEC60381-1
- Such current transducers generally represent a current sink and thus like to sit between + and – as a 'variable load'. Refer also to the sensor manufacturer's information.

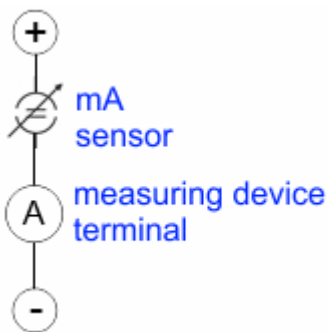

Fig. 24: 2-wire connection

Therefore, they are to be connected according to the Beckhoff terminology as follows:

preferably to '**single-ended**' inputs if the +Supply connections of the terminal/ box are also to be used - connect to +Supply and Signal

they can, however, also be connected to '**differential**' inputs, if the termination to GND is then manufactured on the application side – to be connected with the right polarity to +Signal and –Signal. It is important to refer to the information page *Configuration of 0/4..20 mA differential inputs* (see documentation for the EL30xx terminals, for example)!

Externally supplied sensors

⚠ WARNING

An external supply of sensors / actuators, which are connected to signal terminals of the ELX series is not permitted!

In terms of intrinsic safety, all signal terminals of the ELX series are energy-supplying, associated equipment. For this reason, connected sensors or actuators are supplied exclusively via the respective channel of the terminal and must not be externally supplied in any form (e.g. via an additional, external supply voltage).

This limitation is also independent of whether the additional, external supply is energy limited in the sense of IEC 60079-11.

Connecting any externally powered, intrinsically safe circuits to a ELX signal terminal contradicts the intended use and the specified technical data for explosion protection. The explosion protection provided by the specified type of protection thus automatically expires.

4.2.5 Common-mode voltage and reference ground (based on differential inputs)

Common-mode voltage (V_{cm}) is defined as the average value of the voltages of the individual connections/ inputs and is measured/specified against reference ground.

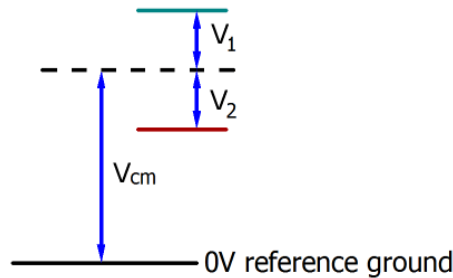

Fig. 25: Common-mode voltage (V_{cm})

The definition of the reference ground is important for the definition of the permitted common-mode voltage range and for measurement of the common-mode rejection ratio (CMRR) for differential inputs.

The reference ground is also the potential against which the input resistance and the input impedance for single-ended inputs or the common-mode resistance and the common-mode impedance for differential inputs is measured.

The reference ground is usually accessible at or near the terminal/ box, e.g. at the terminal contacts, power contacts (cable) or a mounting rail. Please refer to the documentation regarding positioning. The reference ground should be specified for the device under consideration.

For multi-channel terminals/ boxes with resistive (=direct, ohmic, galvanic) or capacitive connection between the channels, the reference ground should preferably be the symmetry point of all channels, taking into account the connection resistances.

Reference ground samples for Beckhoff IO devices:

1. Internal AGND fed out: EL3102/EL3112, resistive connection between the channels
2. 0V power contact: EL3104/EL3114, resistive connection between the channels and AGND; AGND connected to 0V power contact with low-resistance
3. Earth or SGND (shield GND):
 - EL3174-0002: Channels have no resistive connection between each other, although they are capacitively coupled to SGND via leakage capacitors
 - EL3314: No internal ground fed out to the terminal points, although capacitive coupling to SGND

4.2.6 Dielectric strength

A distinction should be made between:

- Dielectric strength (destruction limit): Exceedance can result in irreversible changes to the electronics
 - Against a specified reference ground
 - Differential
- Recommended operating voltage range: If the range is exceeded, it can no longer be assumed that the system operates as specified
 - Against a specified reference ground
 - Differential

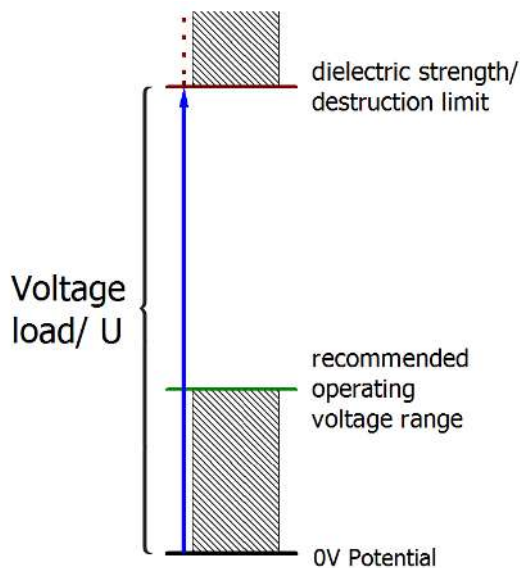

Fig. 26: Recommended operating voltage range

The device documentation may contain particular specifications and timings, taking into account:

- Self-heating
- Rated voltage
- Insulating strength
- Edge steepness of the applied voltage or holding periods
- Normative environment (e.g. PELV)

4.2.7 Temporal aspects of analog/digital conversion

The conversion of the constant electrical input signal to a value-discrete digital and machine-readable form takes place in the analog Beckhoff EL/KL/EP input modules with ADC (analog digital converter). Although different ADC technologies are in use, from a user perspective they all have a common characteristic: after the conversion a certain digital value is available in the controller for further processing. This digital value, the so-called analog process data, has a fixed temporal relationship with the “original parameter”, i.e. the electrical input value. Therefore, corresponding temporal characteristic data can be determined and specified for Beckhoff analogue input devices.

This process involves several functional components, which act more or less strongly in every AI (analog input) module:

- the electrical input circuit
- the analog/digital conversion
- the digital further processing
- the final provision of the process and diagnostic data for collection at the fieldbus (EtherCAT, K-bus, etc.)

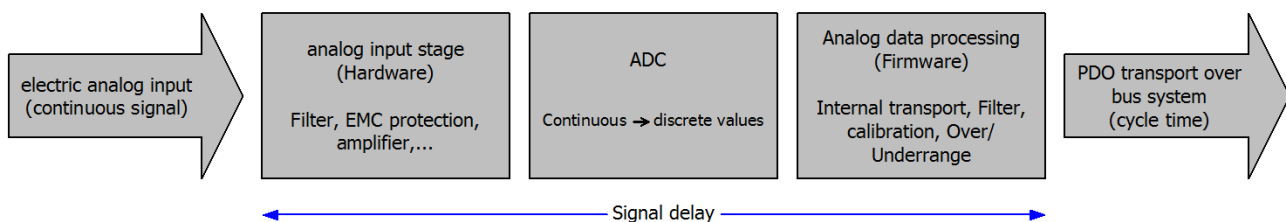

Fig. 27: Signal processing analog input

Two aspects are crucial from a user perspective:

- “How often do I receive new values?”, i.e. a sampling rate in terms of speed with regard to the device/channel
- What delay does the (whole) AD conversion of the device/channel cause?
I.e. the hardware and firmware components in its entirety. For technological reasons, the signal characteristics must be taken into account when determining this information: the run times through the system differ, depending on the signal frequency.

This is the “external” view of the “Beckhoff AI channel” system – internally the signal delay in particular is composed of different components: hardware, amplifier, conversion itself, data transport and processing. Internally a higher sampling rate may be used (e.g. in the deltaSigma converters) than is offered “externally” from the user perspective. From a user perspective of the “Beckhoff AI channel” component this is usually irrelevant or is specified accordingly, if it is relevant for the function.

For Beckhoff AI devices the following specification parameters for the AI channel are available for the user from a temporal perspective:

1. Minimum conversion time [ms, µs]

This is the reciprocal value of the maximum **sampling rate** [sps, samples per second]:

Indicates how often the analog channel makes a newly detected process data value available for collection by the fieldbus. Whether the fieldbus (EtherCAT, K-bus) fetches the value with the same speed (i.e. synchronous), or more quickly (if the AI channel operates in slow FreeRun mode) or more slowly (e.g. with oversampling), is then a question of the fieldbus setting and which modes the AI device supports.

For EtherCAT devices the so-called toggle bit indicates (by toggling) for the diagnostic PDOs when a newly determined analog value is available.

Accordingly, a maximum conversion time, i.e. a smallest sampling rate supported by the AI device, can be specified.

Corresponds to IEC 61131-2, section 7.10.2 2, “Sampling repeat time”

2. Typical signal delay

Corresponds to IEC 61131-2, section 7.10.2 1, “Sampling duration”. From this perspective it includes all internal hardware and firmware components, but not “external” delay components from the fieldbus or the controller (TwinCAT).

This delay is particularly relevant for absolute time considerations, if AI channels also provide a time stamp that corresponds to the amplitude value – which can be assumed to match the physically prevailing amplitude value at the time.

Due to the frequency-dependent signal delay time, a dedicated value can only be specified for a given signal. The value also depends on potentially variable filter settings of the channel.

A typical characterization in the device documentation may be:

2.1 Signal delay (step response)

Keywords: Settling time

The square wave signal can be generated externally with a frequency generator (note impedance!)

The 90 % limit is used as detection threshold.

The signal delay [ms, µs] is then the time interval between the (ideal) electrical square wave signal and the time at which the analog process value has reached the 90 % amplitude.

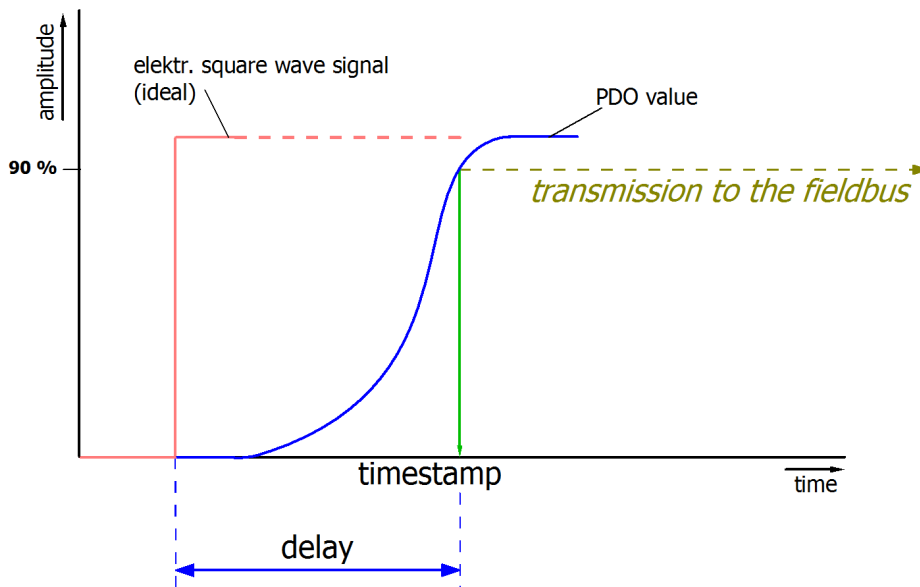

Fig. 28: Diagram signal delay (step response)

2.2 Signal delay (linear)

Keyword: Group delay

Describes the delay of a signal with constant frequency

A test signal can be generated externally with a frequency generator, e.g. as sawtooth or sine. A simultaneous square wave signal would be used as reference.

The signal delay [ms, μ s] is then the interval between the applied electrical signal with a particular amplitude and the moment at which the analog process value reaches the same value.

A meaningful range must be selected for the test frequency, e.g. 1/20 of the maximum sampling rate.

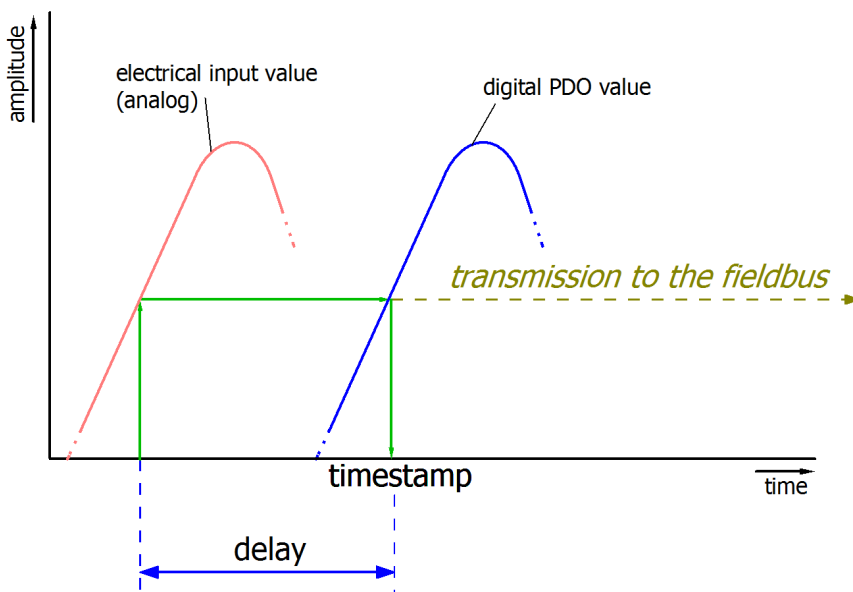

Fig. 29: Diagram signal delay (linear)

3. Additional Information

May be provided in the specification, e.g.

- Actual sampling rate of the ADC (if different from the channel sampling rate)
- Time correction values for run times with different filter settings
- etc.

4.3 Basics of thermoelectricity and thermocouples

The thermocouple terminals can evaluate thermocouples of the types E, J, K, N, R, S und T. The characteristic curves are linearized and the reference temperature determined directly within the terminal. Temperatures are output in 1/10°C, for example (device-dependent). The terminal is fully configurable via the Bus Coupler or the control system. Different output formats may be selected or own scaling activated. In addition, linearization of the characteristic curve and determination and calculation of the reference temperature (temperature at the terminal connection contacts) can be switched off.

Measuring principle of the thermocouple

Thermocouples can be classified as active transducers. They exploit the thermo-electric effect (Seebeck, Peltier, Thomson). A voltage referred to as thermovoltage occurs over the length of a cable with different temperatures at both ends. It is an unambiguous function of the temperature and the material. In a "TC element" this effect is utilized by operating two different conductor materials in parallel (see following fig.)

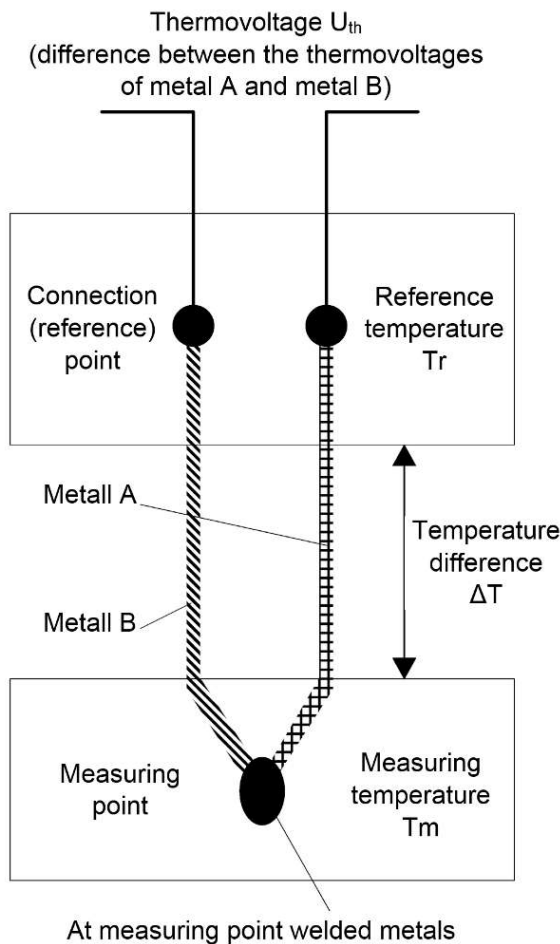

Fig. 30: Principle of the thermocouple

Example

In the following example, the voltage U_{th} is given which is present at a type-K thermocouple at the temperature T_m .

$$U_{th} = (k_{NiCr} - k_{Ni}) \times \Delta T$$

with

$$\Delta T = T_m - T_v$$

A type-K thermocouple consists of a junction of a nickel-chrome alloy and nickel, where k_{NiCr} and k_{Ni} represent the thermoelectric coefficients of nickel-chrome and nickel respectively. By adapting the equation according to T_m , the sought-after temperature can be calculated from the voltage measured across the

thermocouple. Based on the difference to the cold junction temperature, the temperature at the measurement point can be determined to an accuracy of better than one tenth of a Kelvin with the aid of the above thermocouple equation.

● Sensor circuit

i A modification of the sensor circuit with additional devices such as change over switches or multiplexer decreases the measure accuracy. We strongly advise against such modifications.

Internal conversion of the thermovoltage and the reference voltage

Since the coefficients are determined at a reference temperature of 0°C, it is necessary to compensate for the effect of the reference temperature. This is done by converting the reference temperature into a reference voltage that depends on the type of thermocouple, and adding this to the measured thermovoltage. The temperature is found from the resulting voltage and the corresponding characteristic curve.

$$U_k = U_m + U_r$$

$$T_{\text{out}} = f(U_k)$$

Overview of suitable thermocouples

The following thermocouples are suitable for temperature measurement:

Type (according to EN60584-1)	Element	Implemented temperature range	Color coding (sheath - plus pole - minus pole)
B	Pt30%Rh-Pt6Rh	600°C to 1820°C	gray - gray - white
C ¹	W5%Re-W25%Re	-18°C to 2316°C	not defined
E	NiCr-CuNi	-100°C to 1000°C	violet - violet - white
J	Fe-CuNi	-100°C to 1200°C	black - black - white
K	NiCr-Ni	-200°C to 1370°C	green - green - white
L ²	Fe-CuNi	-200°C to 900°C	blue - red - blue
N	NiCrSi-NiSi	-100°C to 1300°C	pink - pink - white
R	Pt13%Rh-Pt	0°C to 1767°C	orange - orange - white
S	Pt10%Rh-Pt	0°C to 1760°C	orange - orange - white
T	Cu-CuNi	-200°C to 400°C	brown - brown - white
U ²	Cu-CuNi	-200°C to 600°C	brown - red - brown

¹) not standardized according to EN60584-1

²) according to DIN 43710

● Maximum cable length to the thermocouple

i Without additional protective measures, the maximum cable length from the EtherCAT Terminal to the thermocouple is 30 meters. For longer cable lengths, suitable surge protection should be provided.

4.4 Measurement of thermocouples (with measurement uncertainties)

In the measuring range of a given thermocouple type, a measured voltage is converted internally into a temperature according to the set transformation. Since the channel internally measures a voltage, the corresponding measurement error in the voltage measurement range must be taken as a basis.

The following tables with the specification of the thermocouple measurement are only valid when using the internal cold junction.

The ELX331x can also be used with an external cold junction if required. The uncertainties must then be determined for the external cold junction by the application. The temperature value of the external cold junction must then be communicated to the ELX331x via the process data for its own calculation.

The effect on the measurement of the thermocouples must then be calculated on the plant side.

The specifications of the internal cold junction and the measuring ranges given here are only valid if the following times for thermal stabilization at constant ambient temperature are observed:

- after power on: 60 minutes
- after changing wiring/plugs: 15 minutes

Specification of the internal cold junction measurement

Measuring mode		Cold junction
Basic accuracy: Measuring error at 23°C, with averaging		< ±2.5°C
Temperature coefficient	Tc	< 25 mK/K

Specification thermocouple type B

Temperature measurement thermo-couple		Type B
Used electrical measuring range		±75 mV
Measuring range, technically usable		+200°C ≈ 0.178 mV ... +1820°C ≈ 13.820 mV
Full scale value (FSV)		+1820°C
Measuring range, recommended		+750°C ... +1800°C
PDO LSB		0.1/0.01°C/digit, depending on PDO setting Note: Internally, 16 bits are calculated on the measuring range end value. Depending on the thermocouple set, there are value jumps > 0.01°C at "Resolution 0.01°C"; Type B: app. 0.06°C
Uncertainty in the recommended measuring range, with averaging	@ 23°C ambient temperature	± 3.7 K ≈ ± 0.20 % _{FSV}
	@ 55°C ambient temperature	± 5.1 K ≈ ± 0.28 % _{FSV}
Temperature coefficient (change of measured value with change of terminal ambient temperature)		Since the value is strongly dependent on the sensor temperature, as can be seen in the specification plot below, it can be derived from the specification plot. For a better approximation, the measurement uncertainty at T _{amb} = 39°C is also shown as the average value between 23°C and 55°C to illustrate the non-linear relation.

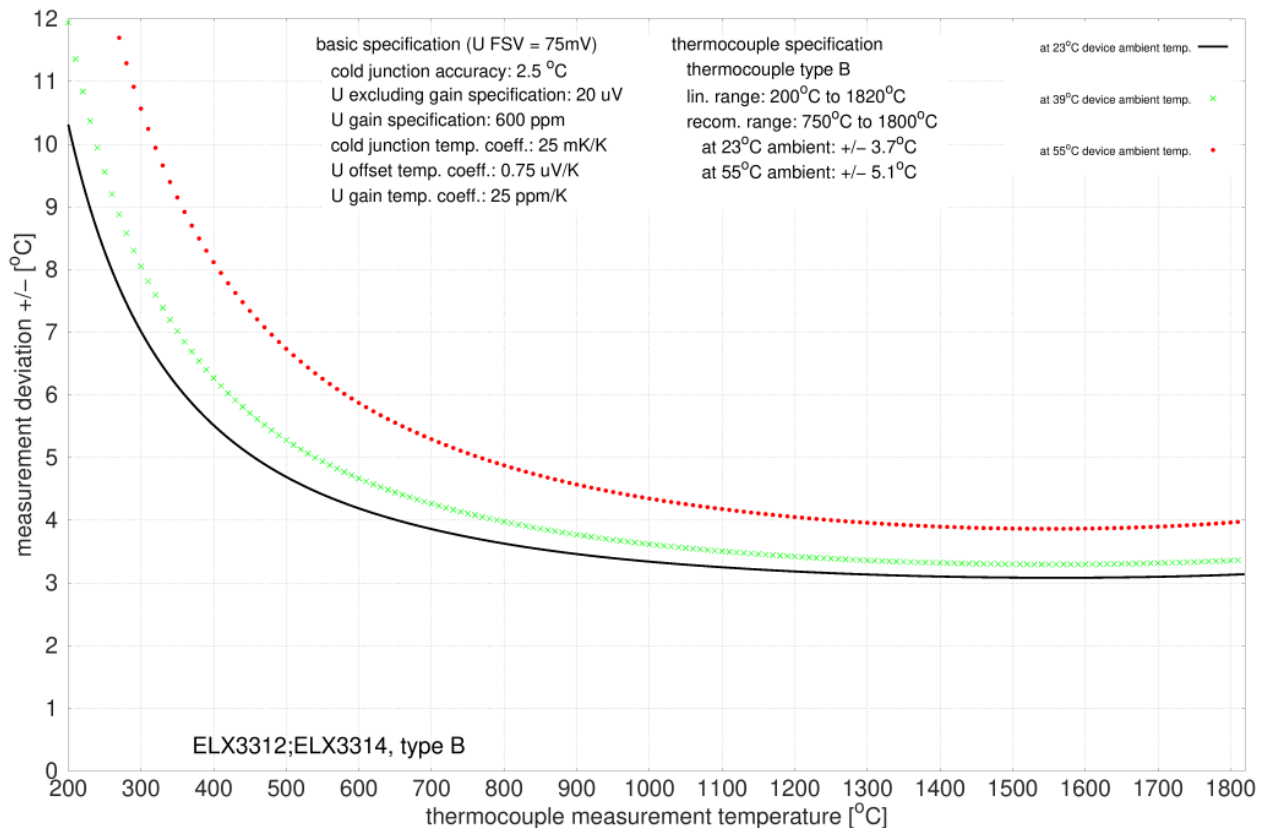

Fig. 31: Measurement uncertainty for thermocouple type B

Specification thermocouple type C

Temperature measurement thermo-couple		Type C
Used electrical measuring range		±75 mV
Measuring range, technically usable		0°C ≈ 0 mV ... +2320°C ≈ 37.107 mV
Full scale value (FSV)		+2320°C
Measuring range, recommended		0°C ... +2000°C
PDO LSB		0.1/0.01°C/digit, depending on PDO setting Note: Internally, 16 bits are calculated on the measuring range end value. Depending on the thermocouple set, there are value jumps > 0.01°C at "Resolution 0.01°C"; Type C: app. 0.07°C
Uncertainty in the recommended measuring range, with averaging	@ 23°C ambient temperature	± 3.4 K ≈ ± 0.15 % _{FSV}
	@ 55°C ambient temperature	± 4.2 K ≈ ± 0.18 % _{FSV}
Temperature coefficient (change of measured value with change of terminal ambient temperature)		Since the value is strongly dependent on the sensor temperature, as can be seen in the specification plot below, it can be derived from the specification plot. For a better approximation, the measurement uncertainty at T _{amb} = 39°C is also shown as the average value between 23°C and 55°C to illustrate the non-linear relation.

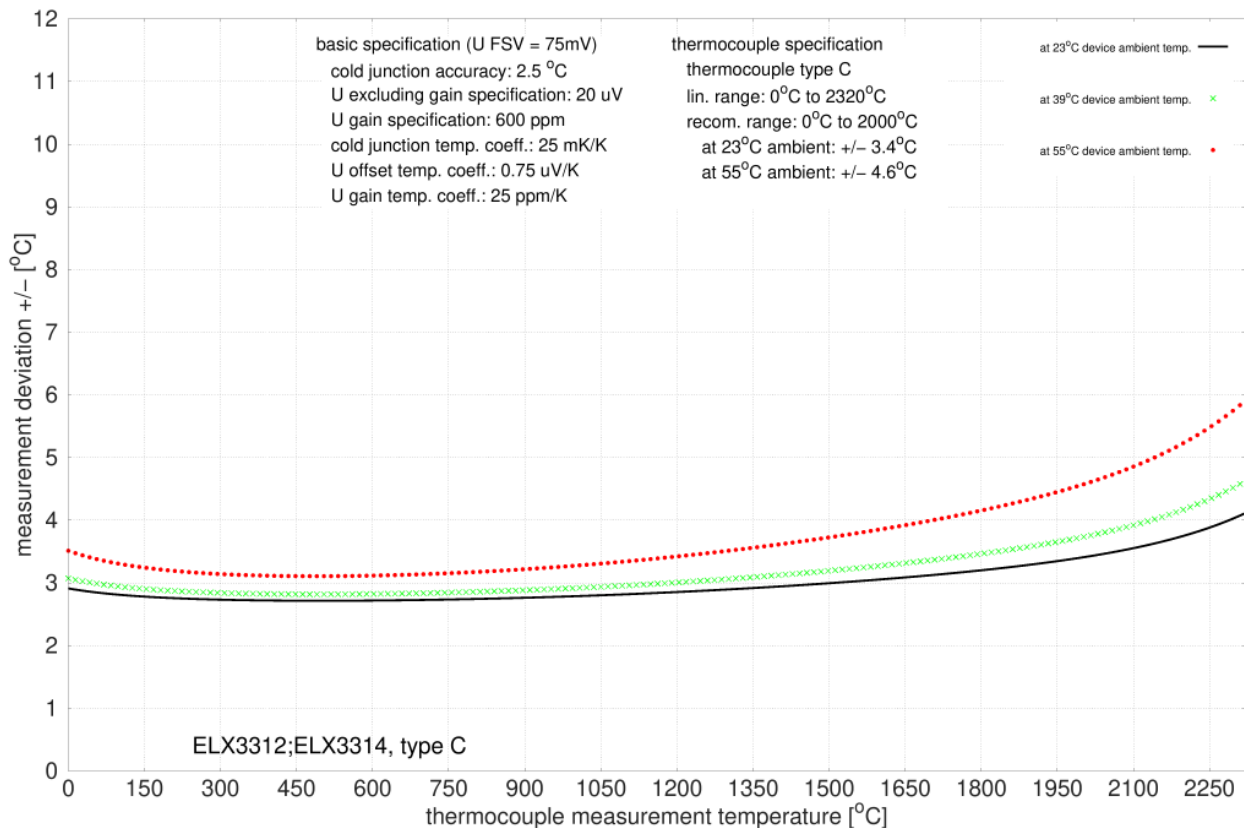

Fig. 32: Measurement uncertainty for thermocouple type C

Specification type E thermocouple

Temperature measurement thermo-couple		Type E
Used electrical measuring range		±75 mV
Measuring range, technically usable		-270°C ≈ -9.835 mV ... +1000°C ≈ 76.372 mV
Full scale value (FSV)		+1000°C
Measuring range, recommended		0°C ... +1000°C
PDO LSB		0.1/0.01°C/digit, depending on PDO setting Note: Internally, 16 bits are calculated on the measuring range end value. Depending on the thermocouple set, there are value jumps > 0.01°C at "Resolution 0.01°C"; Type E: app. 0.03°C
Uncertainty in the recommended measuring range, with averaging	@ 23°C ambient temperature	± 2.6 K ≈ ± 0.26 % _{FSV}
	@ 55°C ambient temperature	± 2.8 K ≈ ± 0.28 % _{FSV}
Temperature coefficient (change of measured value with change of terminal ambient temperature)		Since the value is strongly dependent on the sensor temperature, as can be seen in the specification plot below, it can be derived from the specification plot. For a better approximation, the measurement uncertainty at T _{amb} = 39°C is also shown as the average value between 23°C and 55°C to illustrate the non-linear relation.

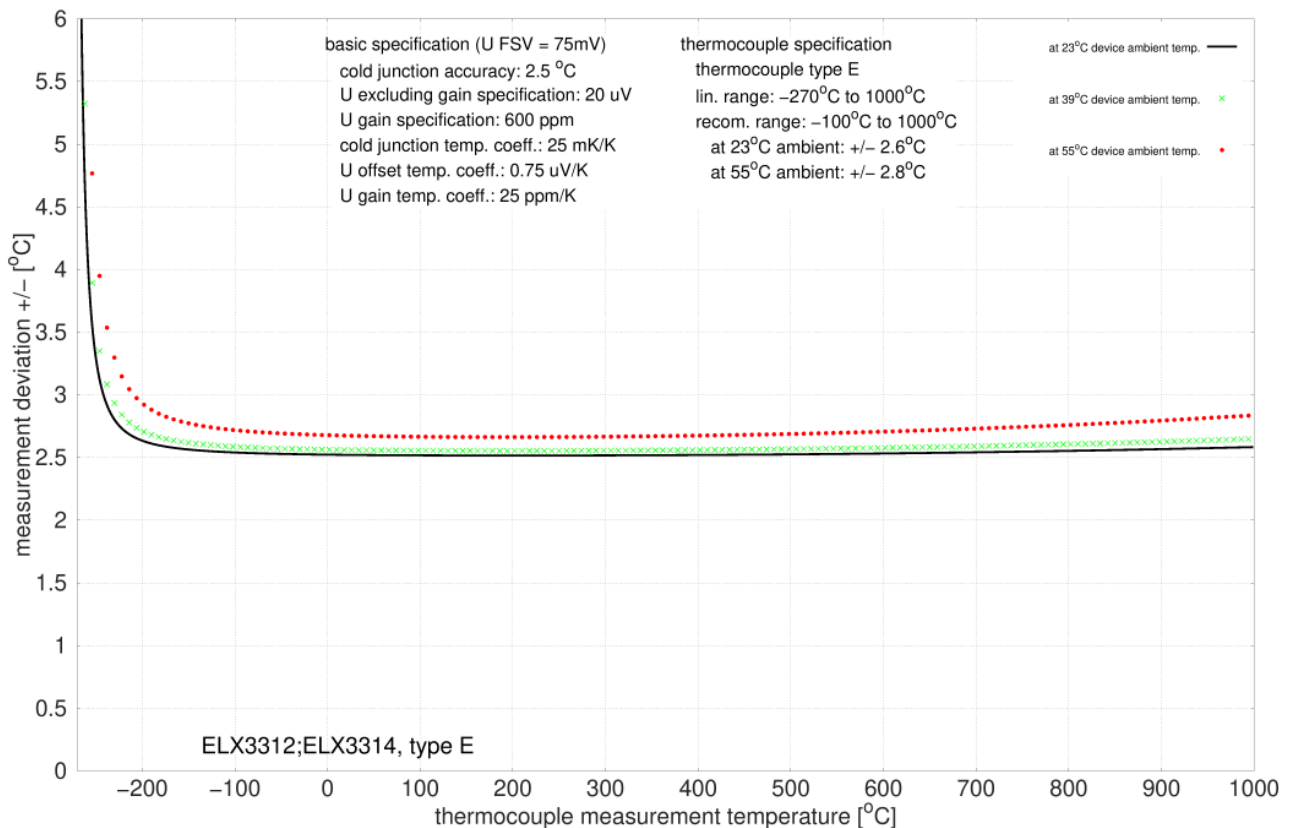

Fig. 33: Measurement uncertainty for type E thermocouple

Specification type J thermocouple

Temperature measurement thermo-couple		Type J
Used electrical measuring range		±75 mV
Measuring range, technically usable		-210°C ≈ -8.095 mV ... +1200°C ≈ 69.553 mV
Full scale value (FSV)		+1200°C
Measuring range, recommended		-100°C ... +1200°C
PDO LSB		0.1/0.01°C/digit, depending on PDO setting Note: Internally, 16 bits are calculated on the measuring range end value. Depending on the thermocouple set, there are value jumps > 0.01°C at "Resolution 0.01°C"; Type J: app. 0.04°C
Uncertainty in the recommended measuring range, with averaging	@ 23°C ambient temperature	± 2.6 K ≈ ± 0.22 % _{FSV}
	@ 55°C ambient temperature	± 2.9 K ≈ ± 0.24 % _{FSV}
Temperature coefficient (change of measured value with change of terminal ambient temperature)		Since the value is strongly dependent on the sensor temperature, as can be seen in the specification plot below, it can be derived from the specification plot. For a better approximation, the measurement uncertainty at T _{amb} = 39°C is also shown as the average value between 23°C and 55°C to illustrate the non-linear relation.

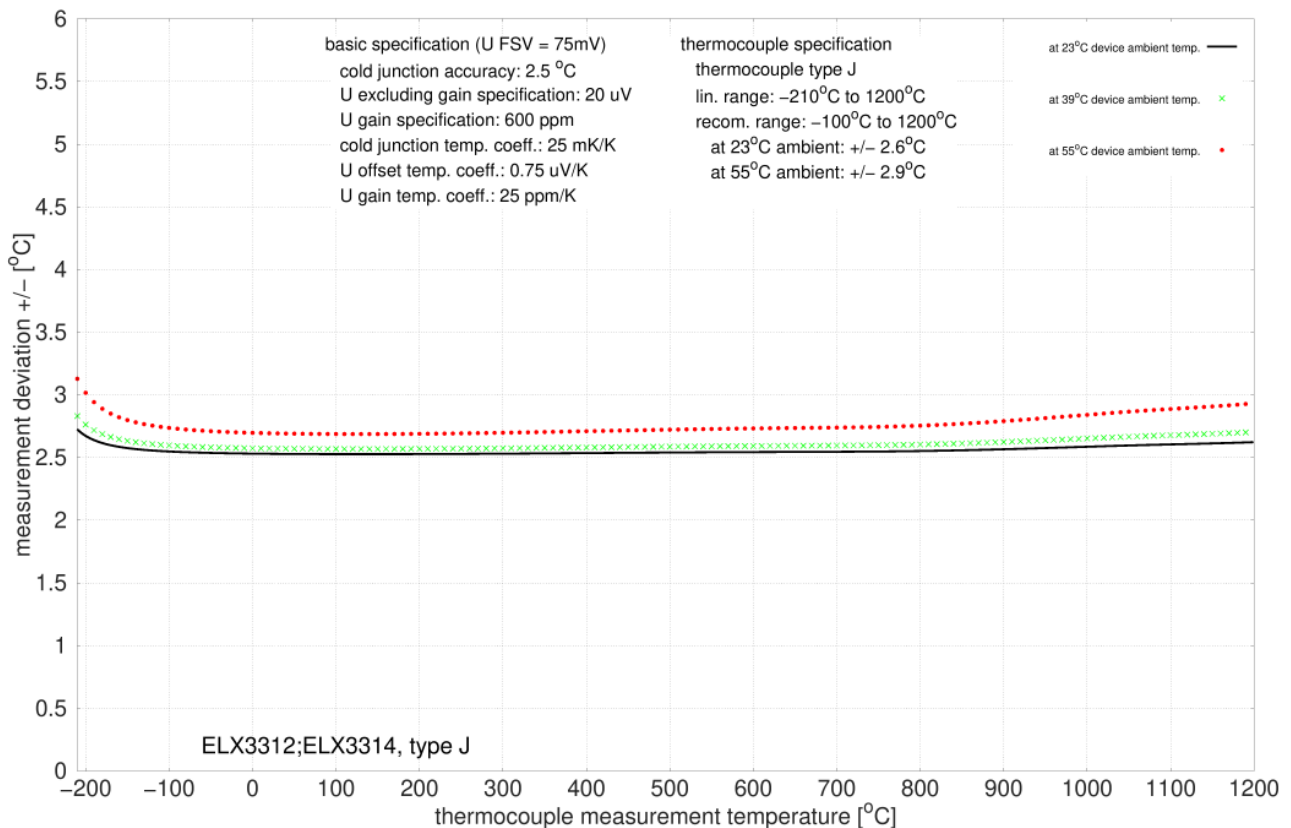

Fig. 34: Measurement uncertainty for type J thermocouple

Specification type K thermocouple

Temperature measurement thermo-couple		Type K
Used electrical measuring range		±75 mV
Measuring range, technically usable		-270°C ≈ -6.458 mV ... +1372°C ≈ 54.886 mV
Full scale value (FSV)		+1372°C
Measuring range, recommended		-100°C ... +1200°C
PDO LSB		0.1/0.01°C/digit, depending on PDO setting Note: Internally, 16 bits are calculated on the measuring range end value. Depending on the thermocouple set, there are value jumps > 0.01°C at "Resolution 0.01°C"; Type K: app. 0.04°C
Uncertainty in the recommended measuring range, with averaging	@ 23°C ambient temperature	± 2.7 K ≈ ± 0.20 % _{FSV}
	@ 55°C ambient temperature	± 3.1 K ≈ ± 0.23 % _{FSV}
Temperature coefficient (change of measured value with change of terminal ambient temperature)		Since the value is strongly dependent on the sensor temperature, as can be seen in the specification plot below, it can be derived from the specification plot. For a better approximation, the measurement uncertainty at T _{amb} = 39°C is also shown as the average value between 23°C and 55°C to illustrate the non-linear relation.

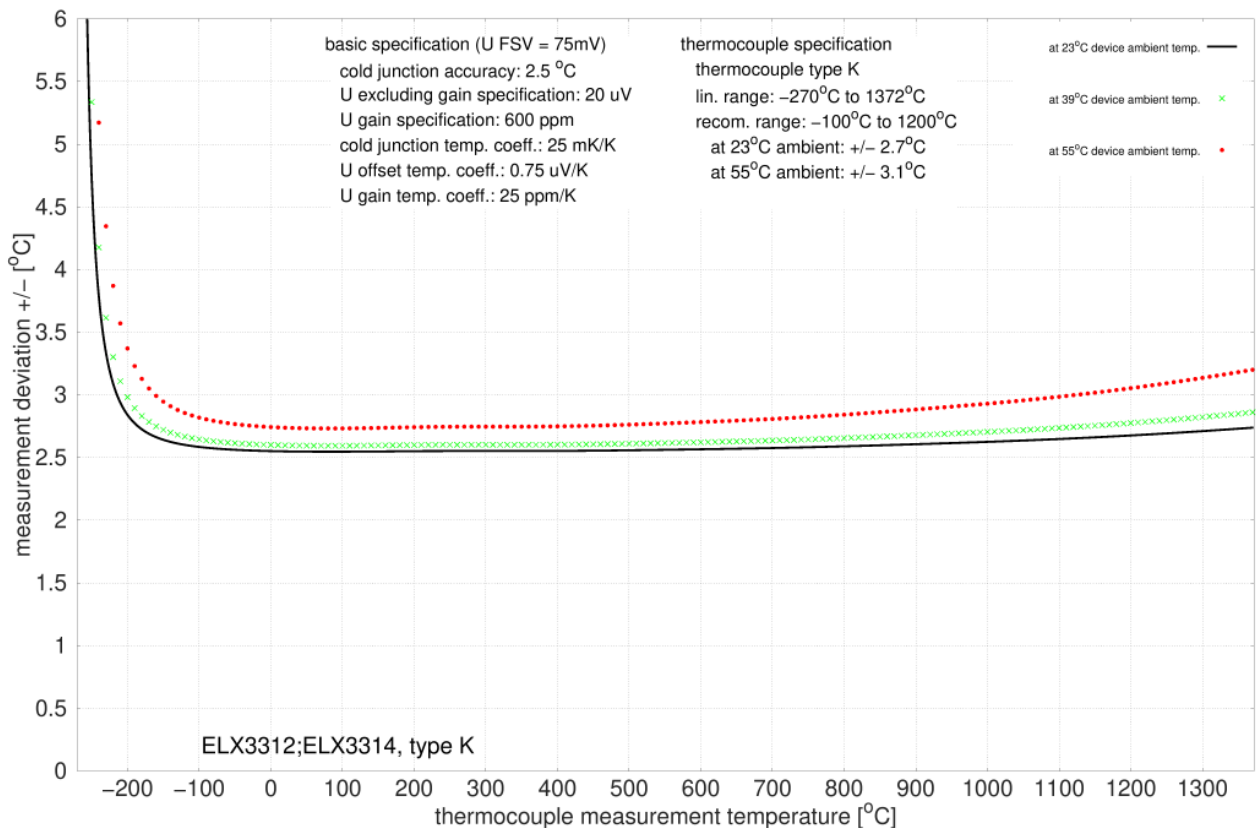

Fig. 35: Measurement uncertainty for type K thermocouple

Specification type L thermocouple

Temperature measurement thermo-couple		Type L
Used electrical measuring range		±75 mV
Measuring range, technically usable		-50°C ≈ -2.510 mV ... +900°C ≈ 52.430 mV
Full scale value (FSV)		+900°C
Measuring range, recommended		0°C ... +900°C
PDO LSB		0,1/0,01°C/digit, depending on PDO setting Note: Internally, 16 bits are calculated on the measuring range end value. Depending on the thermocouple set, there are value jumps > 0.01°C at "Resolution 0.01°C"; Type L: app. 0.03°C
Uncertainty in the recommended measuring range, with averaging	@ 23°C ambient temperature	± 2.6 K ≈ ± 0.29 % _{FSV}
	@ 55°C ambient temperature	± 2.8 K ≈ ± 0.31 % _{FSV}
Temperature coefficient (change of measured value with change of terminal ambient temperature)		Since the value is strongly dependent on the sensor temperature, as can be seen in the specification plot below, it can be derived from the specification plot. For a better approximation, the measurement uncertainty at T _{amb} = 39°C is also shown as the average value between 23°C and 55°C to illustrate the non-linear relation.

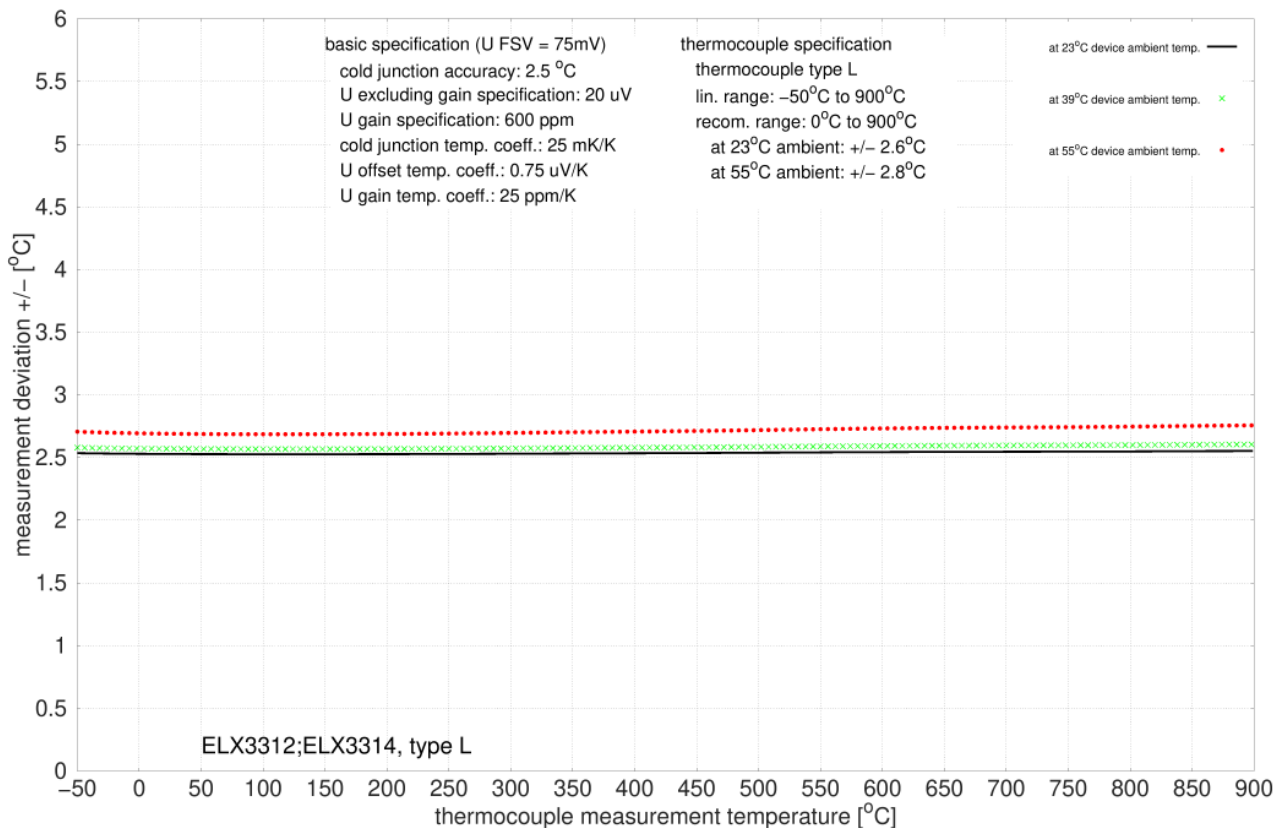

Fig. 36: Measurement uncertainty for type L thermocouple

Specification type N thermocouple

Temperature measurement thermo-couple		Type N
Used electrical measuring range		±75 mV
Measuring range, technically usable		-270°C ≈ -4.345 mV ... +1300°C ≈ 47.513 mV
Full scale value (FSV)		+1300°C
Measuring range, recommended		0°C ... +1200°C
PDO LSB		0.1/0.01°C/digit, depending on PDO setting Note: Internally, 16 bits are calculated on the measuring range end value. Depending on the thermocouple set, there are value jumps > 0.01°C at "Resolution 0.01°C"; Type N: app. 0.04°C
Uncertainty in the recommended measuring range, with averaging	@ 23°C ambient temperature	± 2.6 K ≈ ± 0.20 % _{FSV}
	@ 55°C ambient temperature	± 3 K ≈ ± 0.23 % _{FSV}
Temperature coefficient (change of measured value with change of terminal ambient temperature)		Since the value is strongly dependent on the sensor temperature, as can be seen in the specification plot below, it can be derived from the specification plot. For a better approximation, the measurement uncertainty at T _{amb} = 39°C is also shown as the average value between 23°C and 55°C to illustrate the non-linear relation.

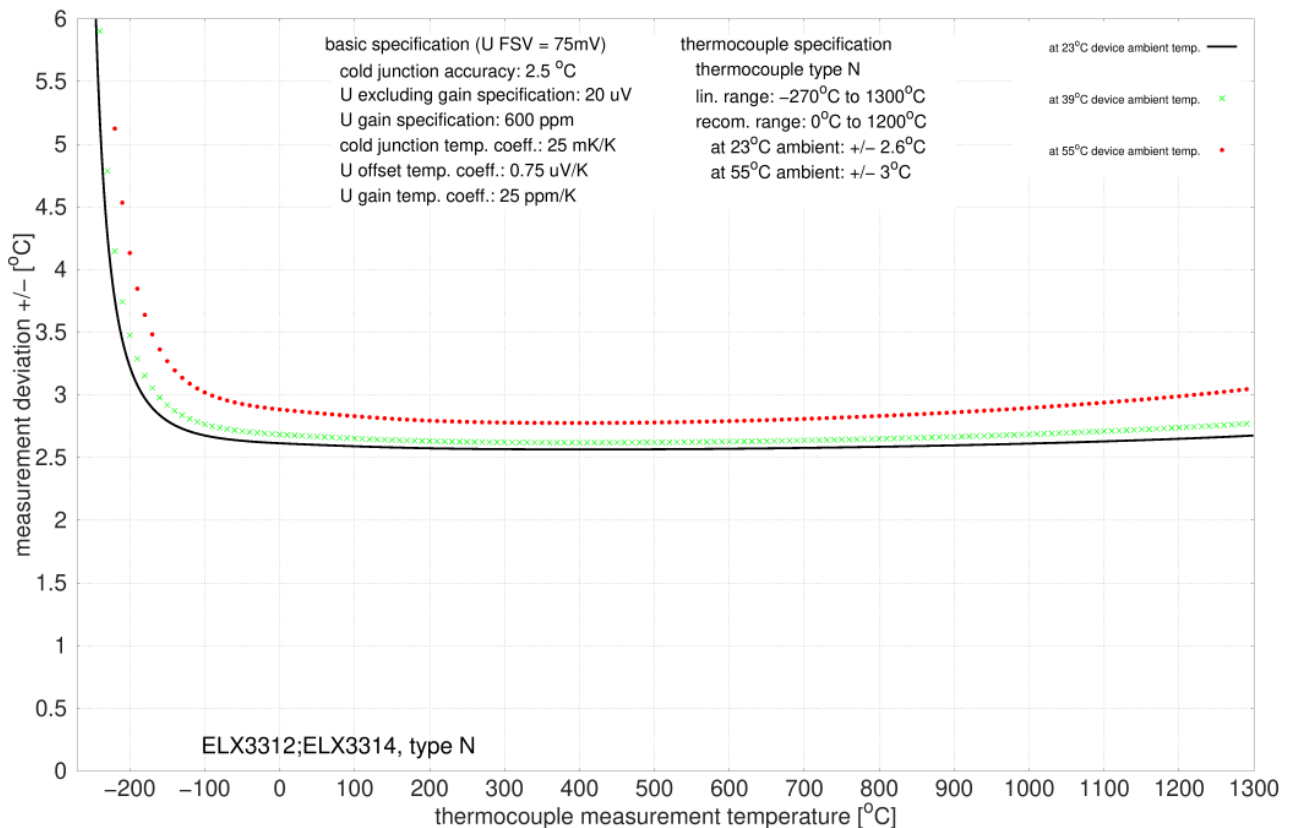

Fig. 37: Measurement uncertainty for type N thermocouple

Specification type R thermocouple

Temperature measurement thermo-couple		Type R
Used electrical measuring range		±75 mV
Measuring range, technically usable		-50°C ≈ 0.226 mV ... +1768°C ≈ 21.101 mV
Full scale value (FSV)		+1768°C
Measuring range, recommended		+250°C ... +1700°C
PDO LSB		0.1/0.01°C/digit, depending on PDO setting Note: Internally, 16 bits are calculated on the measuring range end value. Depending on the thermocouple set, there are value jumps > 0.01°C at "Resolution 0.01°C"; Type R: app. 0.05°C
Uncertainty in the recommended measuring range, with averaging	@ 23°C ambient temperature	± 3,3 K ≈ ± 0,19 % _{FSV}
	@ 55°C ambient temperature	± 4,3 K ≈ ± 0,24 % _{FSV}
Temperature coefficient (change of measured value with change of terminal ambient temperature)		Since the value is strongly dependent on the sensor temperature, as can be seen in the specification plot below, it can be derived from the specification plot. For a better approximation, the measurement uncertainty at T _{amb} = 39°C is also shown as the average value between 23°C and 55°C to illustrate the non-linear relation.

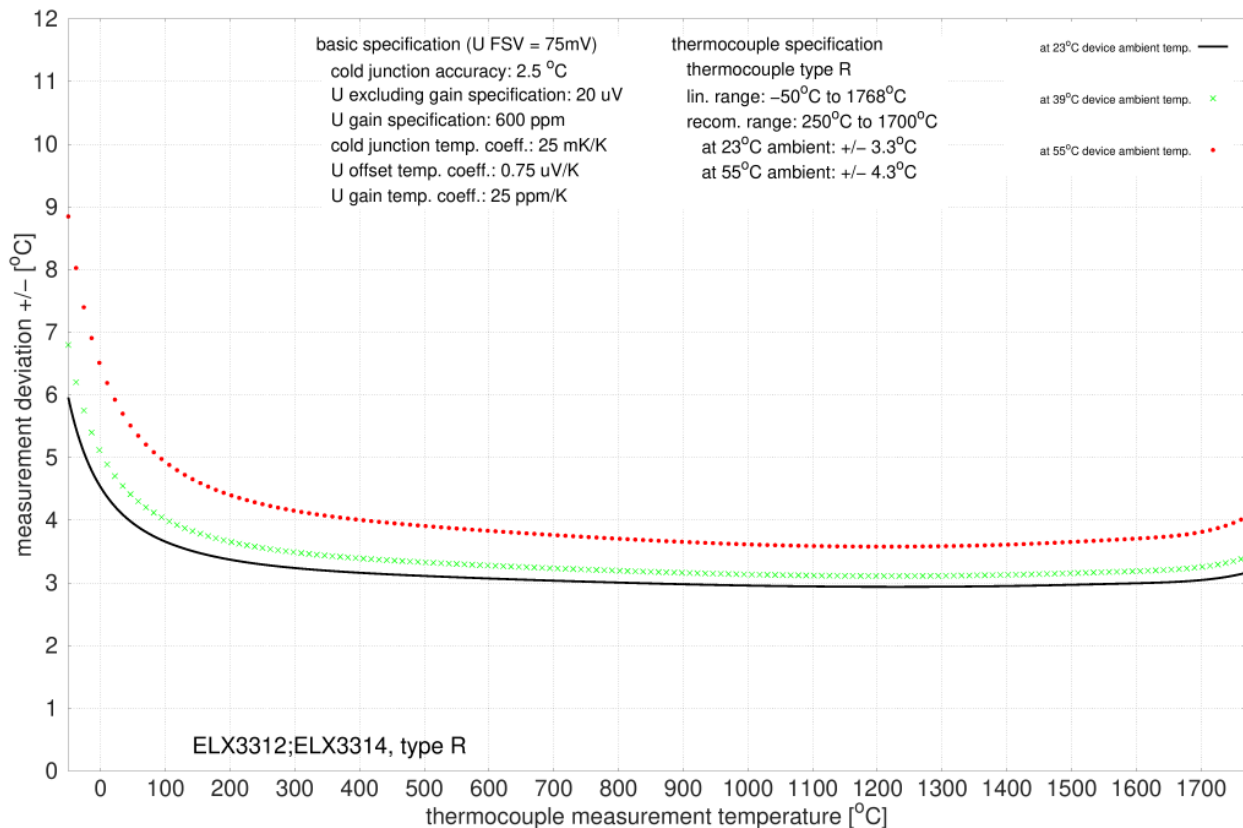

Fig. 38: Measurement uncertainty for type R thermocouple

Specification type S thermocouple

Temperature measurement thermo-couple		Type S
Used electrical measuring range		±75 mV
Measuring range, technically usable		- 50°C ≈ -0.236 mV ... +1768°C ≈ 18.693 mV
Full scale value (FSV)		+1768°C
Measuring range, recommended		+250°C ... +1700°C
PDO LSB		0.1/0.01°C/digit, depending on PDO setting Note: Internally, 16 bits are calculated on the measuring range end value. Depending on the thermocouple set, there are value jumps > 0.01°C; at "Resolution 0.01°C"; Type S: app. 0.05°C
Uncertainty in the recommended measuring range, with averaging	@ 23°C ambient temperature	± 3.4 K ≈ ± 0.19 % _{FSV}
	@ 55°C ambient temperature	± 4.4 K ≈ ± 0.25 % _{FSV}
Temperature coefficient (change of measured value with change of terminal ambient temperature)		Since the value is strongly dependent on the sensor temperature, as can be seen in the specification plot below, it can be derived from the specification plot. For a better approximation, the measurement uncertainty at T _{amb} = 39°C is also shown as the average value between 23°C and 55°C to illustrate the non-linear relation.

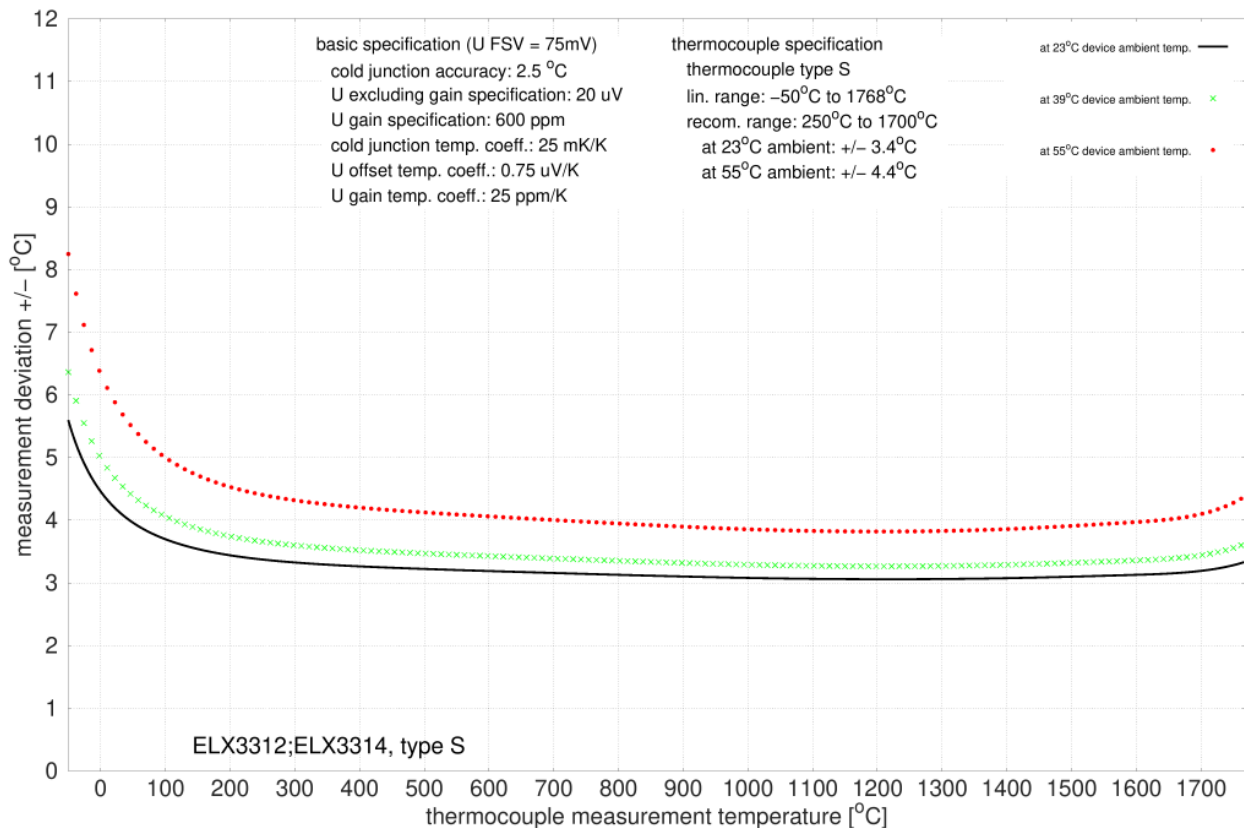

Fig. 39: Measurement uncertainty for type S thermocouple

Specification type T thermocouple

Temperature measurement thermo-couple		Type T
Used electrical measuring range		±75 mV
Measuring range, technically usable		-270°C ≈ -6.258 mV ... +400°C ≈ 20.872 mV
Full scale value (FSV)		+400°C
Measuring range, recommended		-100°C ... +400°C
PDO LSB		0.1/0.01°C/digit, depending on PDO setting
Uncertainty in the recommended measuring range, with averaging	@ 23°C ambient temperature	± 2.6 K ≈ ± 0.65 % _{FSV}
	@ 55°C ambient temperature	± 2.9 K ≈ ± 0.73 % _{FSV}
Temperature coefficient (change of measured value with change of terminal ambient temperature)		Since the value is strongly dependent on the sensor temperature, as can be seen in the specification plot below, it can be derived from the specification plot. For a better approximation, the measurement uncertainty at T _{amb} = 39°C is also shown as the average value between 23°C and 55°C to illustrate the non-linear relation.

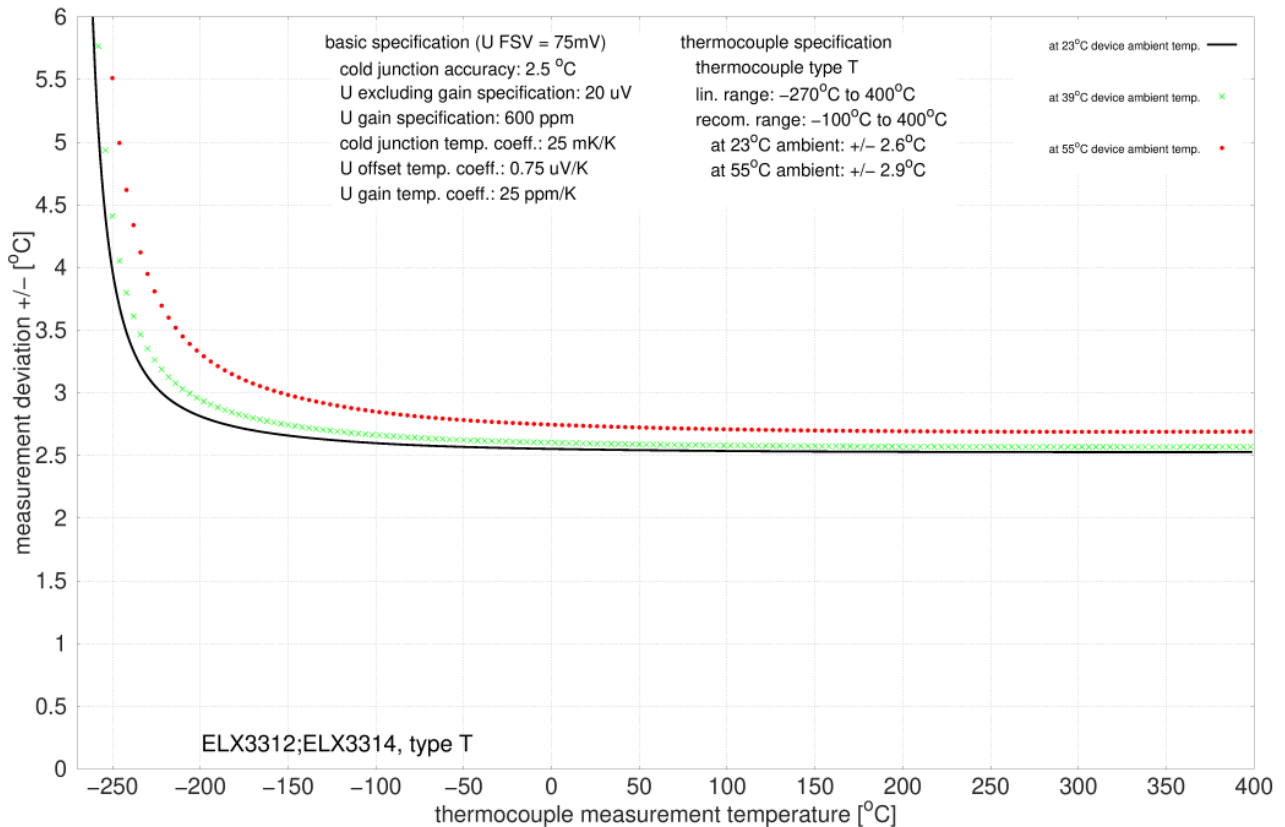

Fig. 40: Measuring uncertainty for type T thermocouple

Specification type U thermocouple

Temperature measurement thermo-couple		Type U
Used electrical measuring range		±75 mV
Measuring range, technically usable		-50°C ≈ -1.850 mV ... +600°C ≈ 34.310 mV
Full scale value (FSV)		+600°C
Measuring range, recommended		0°C ... +600°C
PDO LSB		0.1/0.01°C/digit, depending on PDO setting Note: Internally, 16 bits are calculated on the measuring range end value. Depending on the thermocouple set, there are value jumps > 0,01°C at "Resolution 0.01°C"; Type U: app. 0.02°C
Uncertainty in the recommended measuring range, with averaging	@ 23°C ambient temperature	± 2.6 K ≈ ± 0.43 % _{FSV}
	@ 55°C ambient temperature	± 2.7 K ≈ ± 0.45 % _{FSV}
Temperature coefficient (change of measured value with change of terminal ambient temperature)		Since the value is strongly dependent on the sensor temperature, as can be seen in the specification plot below, it can be derived from the specification plot. For a better approximation, the measurement uncertainty at T _{amb} = 39°C is also shown as the average value between 23°C and 55°C to illustrate the non-linear relation.

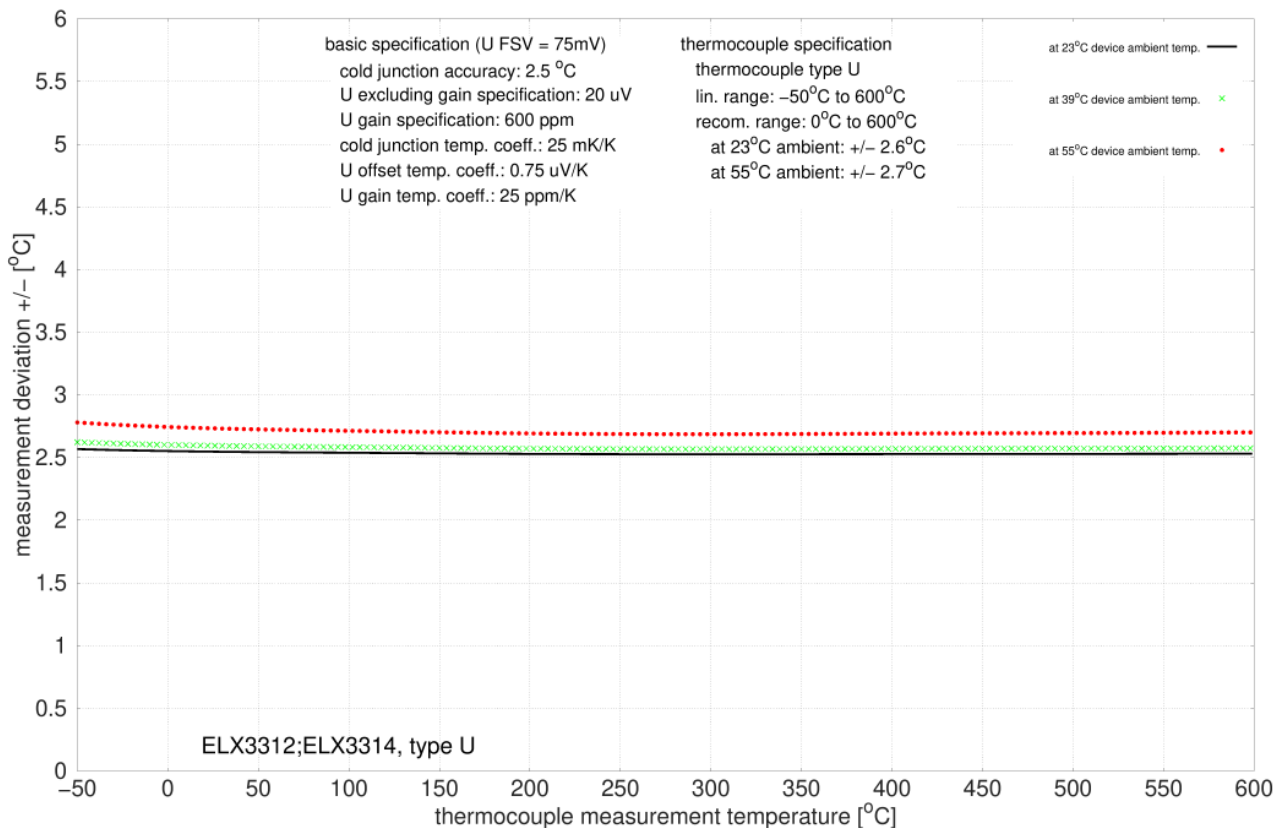

Fig. 41: Measuring uncertainty for type U thermocouple

4.5 Use of grounded thermocouples

WARNING

Grounding and shielding

Although it is basically possible to use grounded thermocouples with an ELX331x, maintaining explosion protection requires separate consideration of the grounding concept, the number of grounded thermocouples and the type of grounding and shielding. The requirements of IEC 60079-11, IEC 60079-14 and IEC 60079-25 as well as other standards and regulations must be observed.



For grounded thermocouples use only one ELX331x per ELX9560

If grounded thermocouples are used, measurement errors may occur when using several ELX331x behind one ELX9560. It is recommended to use only one ELX331x per ELX9560 if the use of grounded thermocouples is intended.

5 Parameterization and programming

5.1 Basics of the measurement functions

The measuring functions of the ELX331x can be described as follows:

- The internal electronics records the differential voltage of a channel between the respective terminal points +TCn and -TCn.
- This measured variable is the voltage resulting from the thermoelectric effect at the measuring point of the sensor, provided that no further thermoelectric transitions or external voltages are applied.
- The reference junction of the respective channel is located in the immediate vicinity of the two associated terminal points inside the device; the reference temperature is continuously determined electronically.
- The change of the differential voltage as a function of the temperature is - depending on the thermocouple - typically in the range of a few μV to mV and is detected precisely by the electronics.
- Measurement and comparison temperatures are calculated internally using characteristic curves stored for the selectable thermocouple types and a temperature is output as the process date.
- Data processing is subject to IIR/FIR filters on the software side, if activated.
- Wire breakage detection is performed by injecting a low DC current (below 1 mA) into the respective channel at regular intervals.

5.2 Data processing

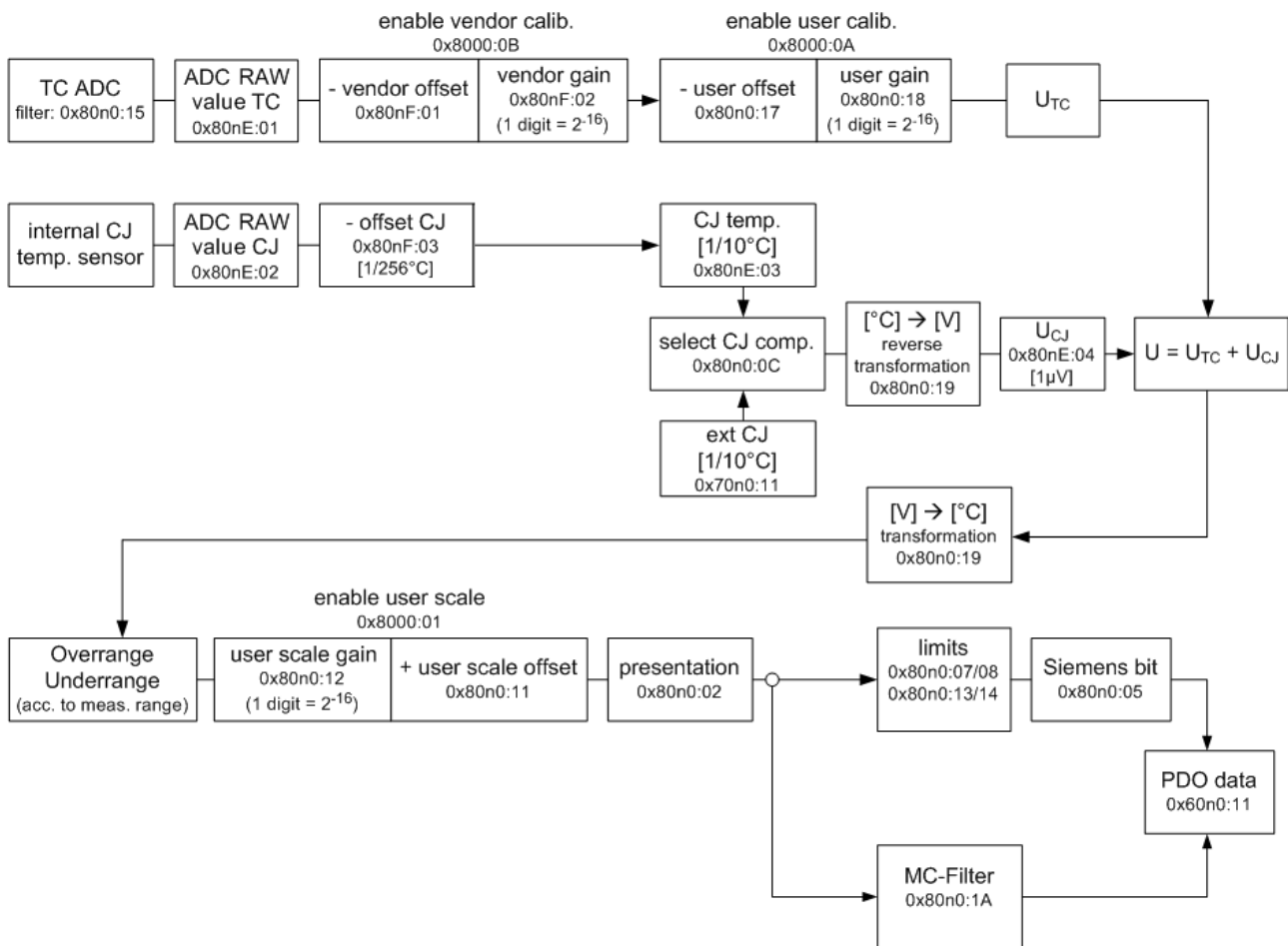

Fig. 42: ELX331x - Data flow

5.3 Settings

5.3.1 Presentation, index 0x80n0:02

In the delivery state, the measured value is output in increments of 1/10° C in two's complement format (signed integer).

Index [0x80n0:02](#) [▶ 74] offers the possibility to change the method of representation of the measured value.

Measured value	Output (hexadecimal)	Output (signed integer, decimal)
-200.0 °C	0nF830	-2000
-100.0 °C	0nFC18	-1000
-0.1 °C	0nFFFF	-1
0.0 °C	0n0000	0
0.1 °C	0n0001	1
100.0 °C	0n03E8	1000
200.0 °C	0n07D0	2000
500.0 °C	0x1388	5000
850.0 °C	0x2134	8500
1000.0 °C	0x2170	10000

Signed Integer

The measured value is presented in two's complement format.
Maximum presentation range for 16 bit = -32768 ... +32767

Example

$1000\ 0000\ 0000\ 0000_{bin} = 0x8000_{hex} = -32768_{dec}$
 $1111\ 1111\ 1111\ 1110_{bin} = 0nFFFE_{hex} = -2_{dec}$
 $1111\ 1111\ 1111\ 1111_{bin} = 0nFFFF_{hex} = -1_{dec}$
 $0000\ 0000\ 0000\ 0001_{bin} = 0n0001_{hex} = +1_{dec}$
 $0000\ 0000\ 0000\ 0010_{bin} = 0n0002_{hex} = +2_{dec}$
 $0111\ 1111\ 1111\ 1111_{bin} = 0x7FFF_{hex} = +32767_{dec}$

Absolute value with MSB as sign

The measured value is output in magnitude-sign format.
Maximum presentation range for 16 bit = -32767 ... +32767

Example

$1111\ 1111\ 1111\ 1111_{bin} = 0nFFFF_{hex} = -32767_{dec}$
 $1000\ 0000\ 0000\ 0010_{bin} = 0x8002_{hex} = -2_{dec}$
 $1000\ 0000\ 0000\ 0001_{bin} = 0x8001_{hex} = -1_{dec}$
 $0000\ 0000\ 0000\ 0001_{bin} = 0n0001_{hex} = +1_{dec}$
 $0000\ 0000\ 0000\ 0010_{bin} = 0n0002_{hex} = +2_{dec}$
 $0111\ 1111\ 1111\ 1111_{bin} = 0x7FFF_{hex} = +32767_{dec}$

High resolution (1/100°C)

The measured value is output in 1/100°C steps.

As a result, the maximum measuring range is limited to $32767_{dec} * (1/100)°C = 327.67°C$, but can be extended by the user scaling!

5.3.2 Siemens bits, index 0x80n0:05

If this bit (index 0x80n0:05 [▶ 74]) is set, status displays are shown for the lowest three bits. In the error case *overrange* or *underrange*, bit 0 is set.

5.3.3 Undershoot and overshoot of the measuring range (underrange, overrange)

$U_k > U_{k_{max}}$: Index 0x60n0:02 [▶ 76] and index 0x60n0:07 [▶ 76] (overrange and error bit) are set. The linearization of the characteristic curve is continued with the coefficients of the overrange limit up to the limit stop of the A/D converter or to the maximum value of 0x7FFF.

$U_k < U_{k_{max}}$: Index 0x60n0:01 [▶ 76] and index 0x60n0:07 [▶ 76] (underrange and error bit) are set. The linearization of the characteristic curve is continued with the coefficients of the underrange limit up to the limit stop of the A/D converter or to the minimum value of 0x8000.

For overrange or underrange the red error LED is switched on.

5.3.4 Notch filter (conversion times)

The ELX331x terminals are equipped with a digital filter. The filter performs a notch filter function and determines the conversion time of the terminal. It is enabled via index 0x80n0:06 [▶ 74] parameterized via index 0x80n0:15 [▶ 74]. The higher the filter frequency, the faster the conversion time.

● Index 0x80n0:06



The filter function is always active even if the bit is not set, since this is obligatory for the measurement process!

● The filter characteristics are set via index 0x8000:15



The filter frequencies are set for all channels of the ELX331x terminals centrally via index 0x8000:15 [▶ 74] (channel 1). The corresponding indices 0x8010:15 of the ELX3312 or 0x8010:15, 0x8020:15, 0x8030:15 of the ELX3314 have no parameterization function.

● Conversion time



The conversion time is determined as follows:

No. of active channels * no. of measurements * no. of filter periods + computing time
= conversion time

Example for ELX3312 (2 channels)

3 measurements (thermocouple, wire breakage, cold junction), filter 50 Hz

2 channels * 3 measurements * (1/50 Hz) + 6 ms ≈ 126 ms

Example for ELX3314 (4 channels)

3 measurements (thermocouple, wire breakage, cold junction), filter 50 Hz

4 channels * 3 measurements * (1/50 Hz) + 12 ms ≈ 252 ms

5.3.5 Limit 1 and Limit 2

Limit 1 and limit 2, index 0x80n0:13, index 0x80n0:14

A temperature range can be set that is limited by the values in the indices [0x80n0:13 \[► 74\]](#) and [0x80n0:14 \[► 74\]](#). If the limit values are overshoot, the bits in indices [0x60n0:03](#) and [0x60n0:05](#) are set.

The temperature value is entered with a resolution of 0.1°C.

Example

Limit 1= 30°C

Value index [0x80n0:13 \[► 74\]](#) = 300

5.3.6 Calibration

Vendor calibration, index 0x80n0:0B

The vendor calibration is enabled via index [0x80n0:0B \[► 74\]](#). Parameterization takes place via the indices:

- [0x80nF:01 \[► 75\]](#): Vendor offset calibration thermocouple
- [0x80nF:02 \[► 75\]](#): Vendor gain calibration thermocouple
- [0x80nF:03 \[► 75\]](#): Vendor CJ offset calibration

● Vendor and user calibration

i User calibration (index [0x80n0:0A \[► 74\]](#)) should only be performed instead of the vendor calibration (index [0x80n0:0B \[► 74\]](#)), but this is generally only necessary in exceptional cases.

User scaling, index 0x80n0:01

The user scaling is enabled via index [0x80n0:01 \[► 74\]](#). Parameterization takes place via the indices

- [0x80n0:11 \[► 74\]](#): User scaling offset
The offset describes a vertical shift of the characteristic curve by a linear amount.
At a resolution of 0.1°, 1 digit_(dec) corresponds to an increase in measured value by 0.1°
At a resolution of 0.01°, 1 digit_(dec) corresponds to an increase in measured value by 0.01
- [0x80n0:12 \[► 74\]](#): User scaling gain
The default value of 65536_(dec) corresponds to gain = 1.
The new gain value for 2-point user calibration after offset calibration is determined as follows:
Gain_{new} = reference temperature / measured value x 65536_(dec)

User calibration, index 0x80n0:0A

User calibration is enabled via index [0x80n0:0A \[► 74\]](#). Parameterization takes place via the indices

- [0x80n0:17 \[► 74\]](#): User offset calibration thermocouple
- [0x80n0:18 \[► 74\]](#): User gain calibration thermocouple

Calculation of process data

● Calibration

i The concept *calibration*, which has historical roots at Beckhoff, is used here even if it has nothing to do with the deviation statements of a calibration certificate. Actually, this is a description of the vendor or customer calibration data/adjustment data used by the device during operation in order to maintain the assured measuring accuracy.

The terminal constantly records measured values and saves the raw values from its A/D converter in the ADC raw value objects 0x80nE:01, 0x80nE:02. After each recording of the analog signal, the correction calculation takes place with the vendor and user calibration data as well as the user scaling, if these are activated (see following picture).

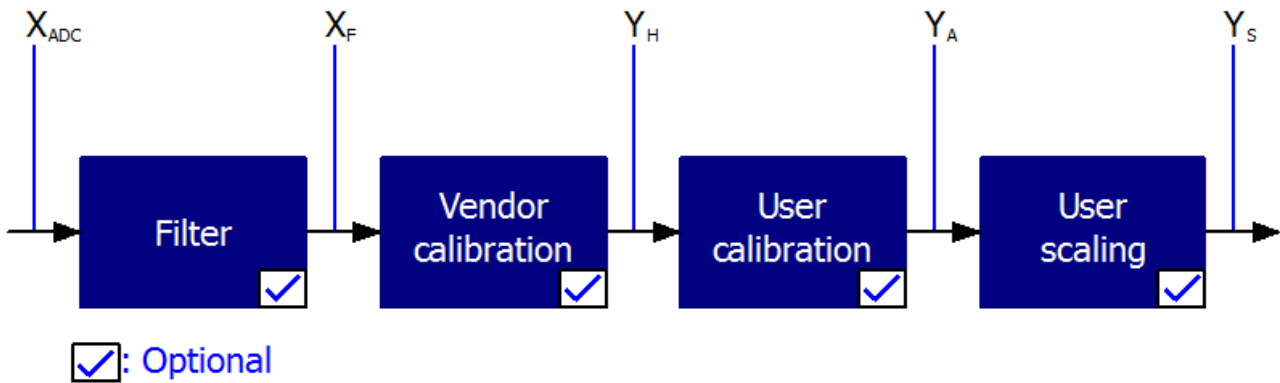

Fig. 43: Calculation of process data

Calculation

Calculation	Designation
X_{ADC}	Output of the A/D converter
X_F	Output value after the filter
$Y_H = (X_{ADC} - B_H) \times A_H \times 2^{-14}$	Measured value after vendor calibration,
$Y_A = (Y_H - B_A) \times A_A \times 2^{-14}$	Measured value after vendor and user calibration
$Y_S = Y_A \times A_S \times 2^{-16} + B_S$	Measured value following user scaling

Key

Name	Designation	Index
X_{ADC}	Output value of the A/D converter	0x80nE:01
X_F	Output value after the filter	-
B_H	Vendor calibration offset (not changeable)	0x80nF:01
A_H	Vendor calibration gain (not changeable)	0x80nF:02
B_A	User calibration offset (can be activated via index 0x80n0:0A)	0x80n0:17
A_A	User calibration gain (can be activated via index 0x80n0:0A)	0x80n0:18
B_S	User scaling offset (can be activated via index 0x80n0:01)	0x80n0:11
A_S	User scaling gain (can be activated via index 0x80n0:01)	0x80n0:12
Y_S	Process data for controller	-

Measurement result

The accuracy of the result may be reduced if the measured value is smaller than 32767 / 4 due to one or more multiplications.

Also see about this

Configuration data (vendor-specific) [▶ 75]

5.3.7 Producer Codeword

Producer Codeword

The vendor reserves the authority for the basic calibration of the terminals. The Producer codeword is therefore at present reserved.

5.4 Operation with an external cold junction

For temperature measurement with an external reference point/cold junction, the value 2 (external process data) must be set in object `0x80n0:0C` [▶ 74]. The thermocouple is not connected directly to the terminal in this case (the cold junction compensation would take place internally in the case of direct connection), but rather it is coupled to the terminal via a connecting cable.

In this case, the temperature T_v is sensed by a temperature sensor at the cold junction and fed to the process via the fieldbus master and fieldbus as a variable (external) (see fig. *External cold junction*). The reference data are written into index `0x70n0:11` [▶ 77].

Alternative to cold junction measurement

i As an alternative to the procedure described above, the cold junction can be maintained at a defined temperature through ice water (0°C), for example. In this case, the temperature is known without measurement of the cold junction temperature (Fig. *External cold junction*) and can be reported to the ELX331x via the process data.

Ensure measurement accuracy

i The user has to ensure, that an application of external cold junction measurement have no negative effect to the measurement accuracy.

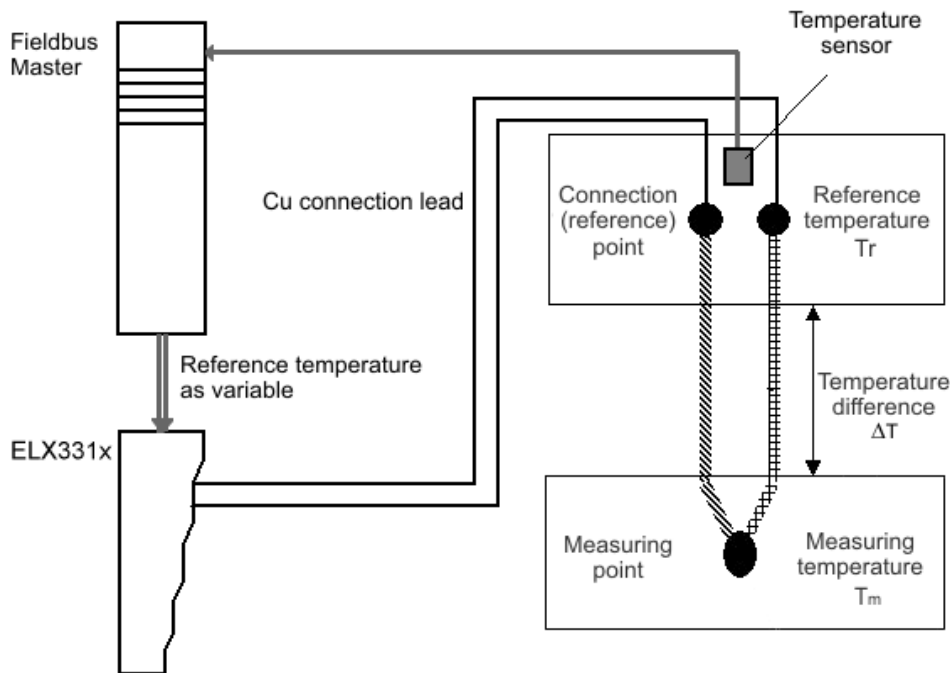

Fig. 44: External cold junction

⚠ WARNING

Take explosion protection precautions for temperature sensors in explosion-hazardous areas!

The external temperature sensor for the reference temperature may be installed in explosion-hazardous areas. In this case, appropriate explosion protection precautions must be taken for this temperature sensor.

5.5 Interference from equipment

When operating the ELX331x analog EtherCAT terminals, high frequency superimposed signals from interfering devices (e.g. proportional valves, stepper motors or DC motor output stages) can be picked up by the terminal. In order to guarantee interference-free operation, we recommend the use of separate power supply units for the terminals and the interference-causing devices.

5.6 Wire break detection

The ELX331x terminals provide a wire break detection of the connected thermocouple. A periodical testing current of up to 1 mA will be given to the thermocouple for detection. No voltage measurement takes place during test.

Due to particular cases, the testing current could have a disturbing effect, the wire break detection can be disabled by CoE object [0x80n0:0E \[▶ 74\]](#) (Disable wire break detection).

5.7 Process data

This section describes the individual PDOs and their content. A PDO (Process Data Object) is a unit on cyclically transmitted process values. Such a unit can be an individual variable (e.g. the temperature as a 16-bit value) or a group/structure of variables. The individual PDOs can be activated or deactivated separately in the TwinCAT System Manager. The 'Process data' tab is used for this (visible only if the terminal is selected on the left). A change in the composition of the process data in the TwinCAT System Manager becomes effective only after restarting the EtherCAT system.

5.7.1 Selection of process data

The process data of the ELX3312 are set up in the TwinCAT System Manager. The PDOs can be activated or deactivated separately. The 'Process data' tab is used for this (visible only if the terminal is selected on the left).

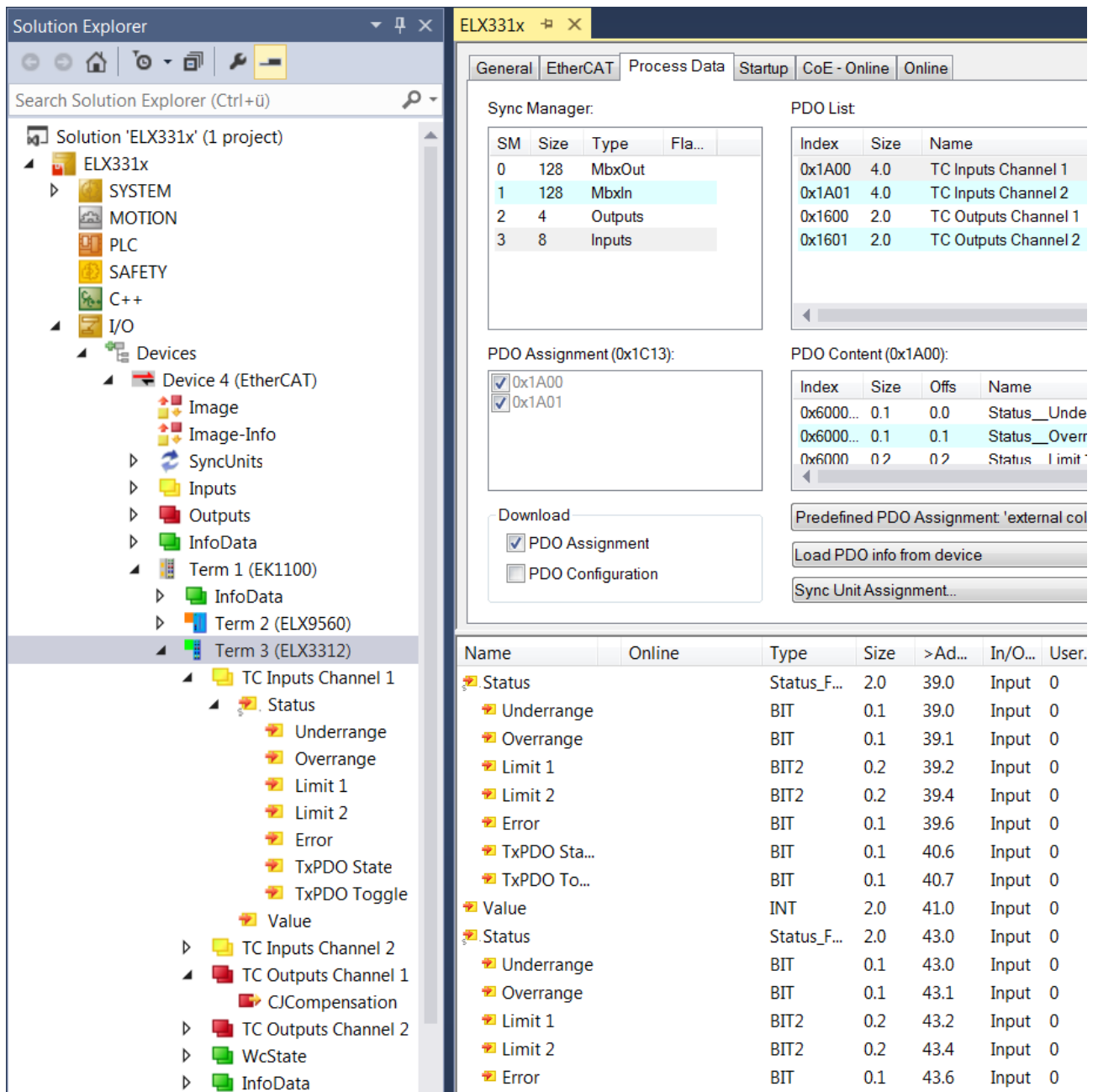

Fig. 45: ELX3312 - Process data

In the case of the EL3312, two sets of process data are available, one for each measurement channel.

- **Underrange:** Measurement is below range
- **Overrange:** Range of measurement exceeded ("Cable break" together with "Error")
- **Limit 1*:** Limit value monitoring 0: ok, 1: Limit value overshoot, 2: Limit value undershot
- **Limit 2*:** Limit value monitoring 0: ok, 1: Limit value overshoot, 2: Limit value undershot
- **Error:** The error bit is set if the process data is invalid (cable break, over-range, under-range)
- **TxPDO State:** Validity of the data of the associated TxPDO (0 = valid, 1 = invalid).
- **TxPDO Toggle:** The TxPDO toggle is toggled by the slave when the data of the associated TxPDO is updated. This allows the currently required conversion time to be derived.
- **CJCompensation:** Externally measured temperature of the reference measuring point for cold junction compensation

For detailed information on settings and operating modes, please read the chapter *Process data and operating modes*.

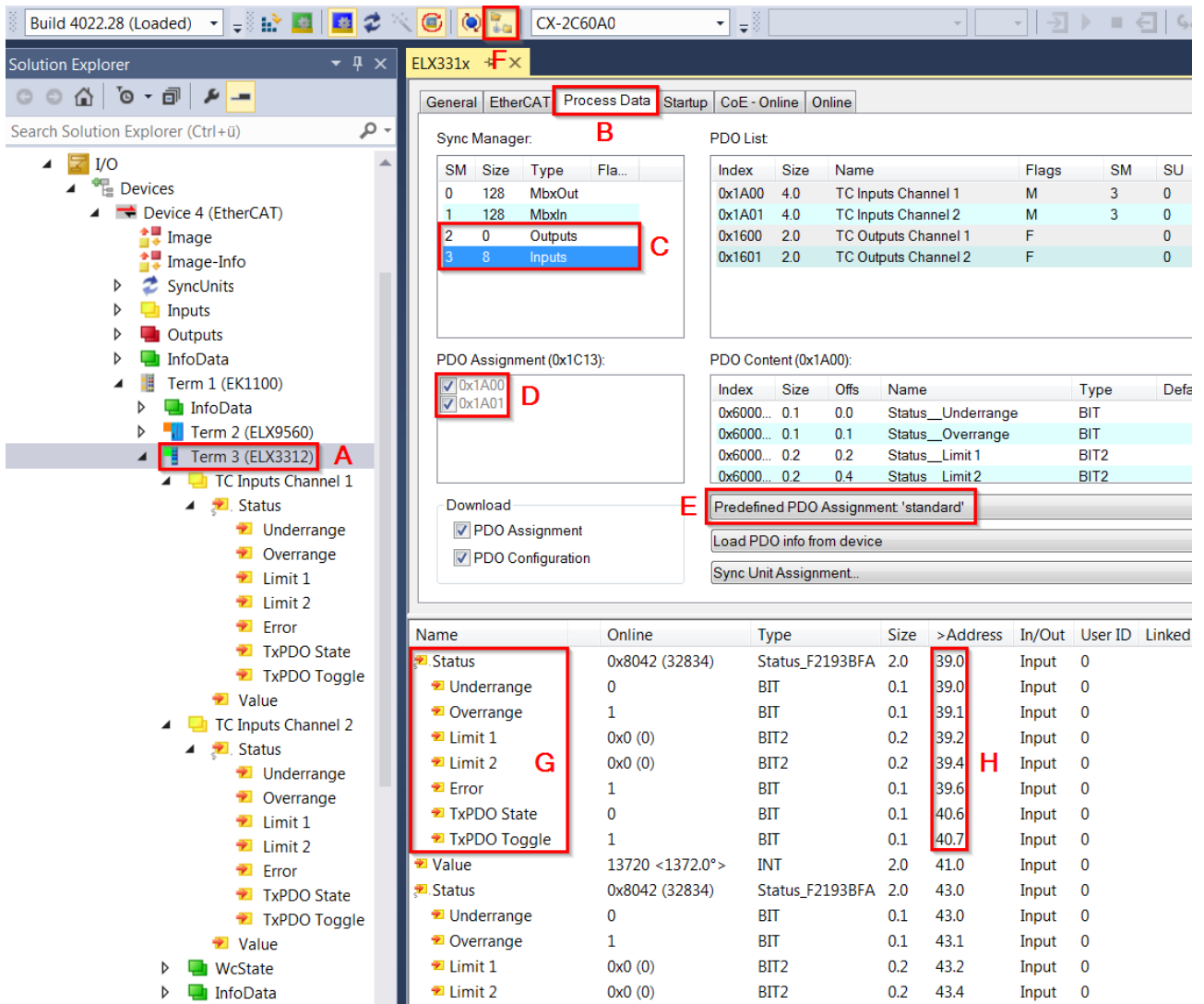

Fig. 46: ELX3312 – Process data selection in TwinCAT

If the terminal is selected in the System Manager (A), the *Process data* tab (B) shows the PDO selection. The two SyncManagers of the inputs (SM3) and outputs (SM2) can be changed (C). If one of the two is clicked on, the PDO possible for this SyncManager appears underneath it (D). PDOs that are already activated have an activated checkbox in front of them; this is activated by clicking on it.

The process data which then belong to the device are listed underneath it (G). So that the individual bit meanings are visible, e.g. in the *Status* status word, and can be separately linked (G), *ShowSubVariables* must be activated in the System Manager (F). The bit position at which the subvariables are located in the status or control word *Ctrl* can be taken from the address overview (H) or the following information.

Predefined PDO Assignment

In order to simplify the configuration, typical configuration combinations of process data are stored in the device description. The predefined configurations can be selected in the process data overview. Therefore the function is available only if the ESI/XML files are saved in the system ([downloadable from the Beckhoff website](#)).

The following combinations are possible (see also Fig. *ELX3312 -Process data selection in TwinCAT*, E):

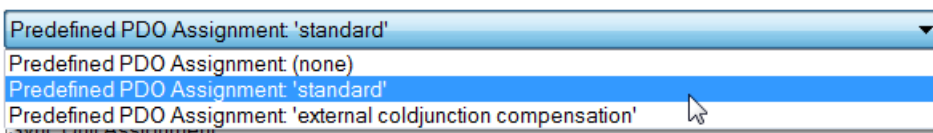

Fig. 47: ELX331x - selection Predefined PDO Assignment

- standard (default setting):
Load calculation: 32-bit integer load value as final value according to the calculation specifications in the CoE, no further conversion necessary in the PLC.
- external coldjunction compensation: activation of CJCompensation.

5.7.2 Default process image

The default process image is standard.

Name	Online	Type	Size	>Address	In/Out	User ID	Linked to
Status	0x8042 (32834)	Status_F2193BFA	2.0	95.0	Input	0	
Value	13720 <1372.0°>	INT	2.0	97.0	Input	0	
Status	0x0042 (66)	Status_F2193BFA	2.0	99.0	Input	0	
Value	13720 <1372.0°>	INT	2.0	101.0	Input	0	
Status	0x8042 (32834)	Status_F2193BFA	2.0	103.0	Input	0	
Value	13720 <1372.0°>	INT	2.0	105.0	Input	0	
Status	0x0042 (66)	Status_F2193BFA	2.0	107.0	Input	0	
Value	13720 <1372.0°>	INT	2.0	109.0	Input	0	
WcState	0	BIT	0.1	1522.1	Input	0	
InputToggle	1	BIT	0.1	1524.1	Input	0	
State	8	UINT	2.0	1602.0	Input	0	
AdsAddr	5.44.96.160.5.1:1008	AMSADDR	8.0	1604.0	Input	0	

Fig. 48: ELX3314 - Default process image

Function of the variables

Variable Group	Variable	Meaning
TC Inputs Channel x	Status	The status word (SW) is located in the input process image, and is transmitted from terminal to the controller. For explanation see the entries in the object overview, index 0x6000 see " Bit - meaning of the status word "
	Value	calculated 16-bit INT with corresponding unit - index 60n0:11 (0 ≤ n ≤ 3; for 4 channels)
WcState	WcState	For each EtherCAT slave with cyclical process data, the master indicates by means of a so-called Working-Counter (WcState) whether the slave is participating successfully and trouble-free in cyclical process data traffic. 0: valid real-time communication in the last cycle 1: Invalid real-time communication
	Input Toggle	Variable toggles every successful slave cycle of the slave.
InfoData	State	State of the EtherCAT device. In normal operating state the slave must be in OP (0x0008 (8 _{dec})).
	AdsAddr	AmsNet address of the EtherCAT device from AmsNetId (in this case: 192.168.0.20.5.1) and port (in this case: 1003)

Bit - meaning of the Status Word

Bit	SW.15	SW.14	SW.13-SW.7	SW.6	SW.5 - SW.4	SW.3-SW.2	SW.1	SW.0
Name	TxPDO Toggle	TxPDO State	-	Error	Limit 2	Limit 1	Overrange	Underrange
Meaning	toggles 0->1->0 for each updated dataset	Validity of the data of the associated Tx-PDO 0: valid 1: invalid.	-	Collective display of errors	Limit value monitoring 0: ok, 1: Limiting area exceeded 2: Limiting area fallen below		Measuring range exceeded or Wire breakage (if together with Error)	Measuring range fallen below

Obere Tabelle im obigen Fragment durch untere Tabelle ersetzen!

i EtherCAT System Documentation

Please refer to the [EtherCAT System Documentation](#) for the EtherCAT fieldbus basics, also available as [PDF file](#) from www.beckhoff.com.

5.7.3 Variant Predefines PDO

An EtherCAT device usually offers several different process data objects (PDO) for input and output data, which can be configured in the System Manager, i.e. they can be activated or deactivated for cyclic transmission.

From TwinCAT 2.11, for suitable EtherCAT devices (as per ESI/XML description) the process data for input and output can be activated simultaneously through suitable predefined sets via "Predefined PDO assignment".

The ELX331x devices have the following Predefined PDO sets in the *Process data* tab (EL3314 shown in the example):

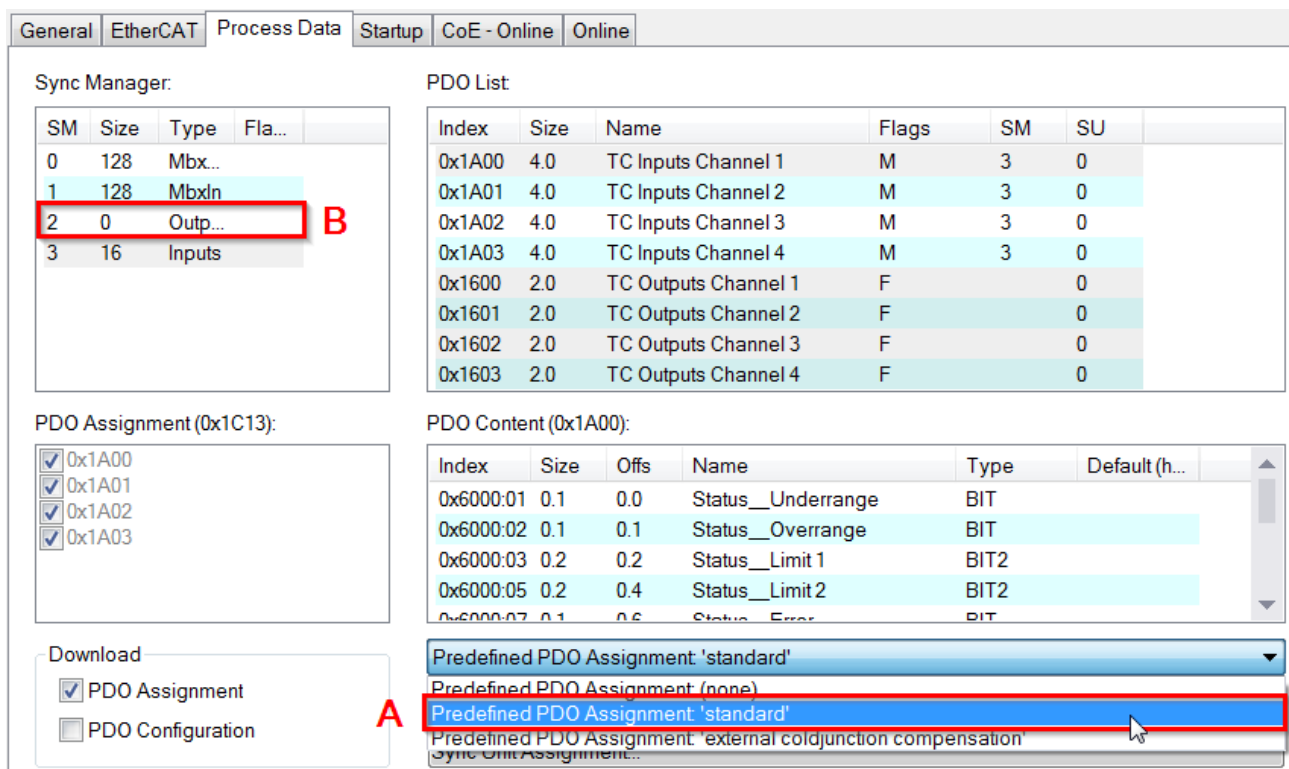

Fig. 49: TwinCAT System Manager with predefined PDO option *Standard*

In the *Standard* option [A], the input PDOs 0x1A0n are activated for the corresponding input channels. The output PDOs 0x160n of Sync Manager 2 [B] are disabled.

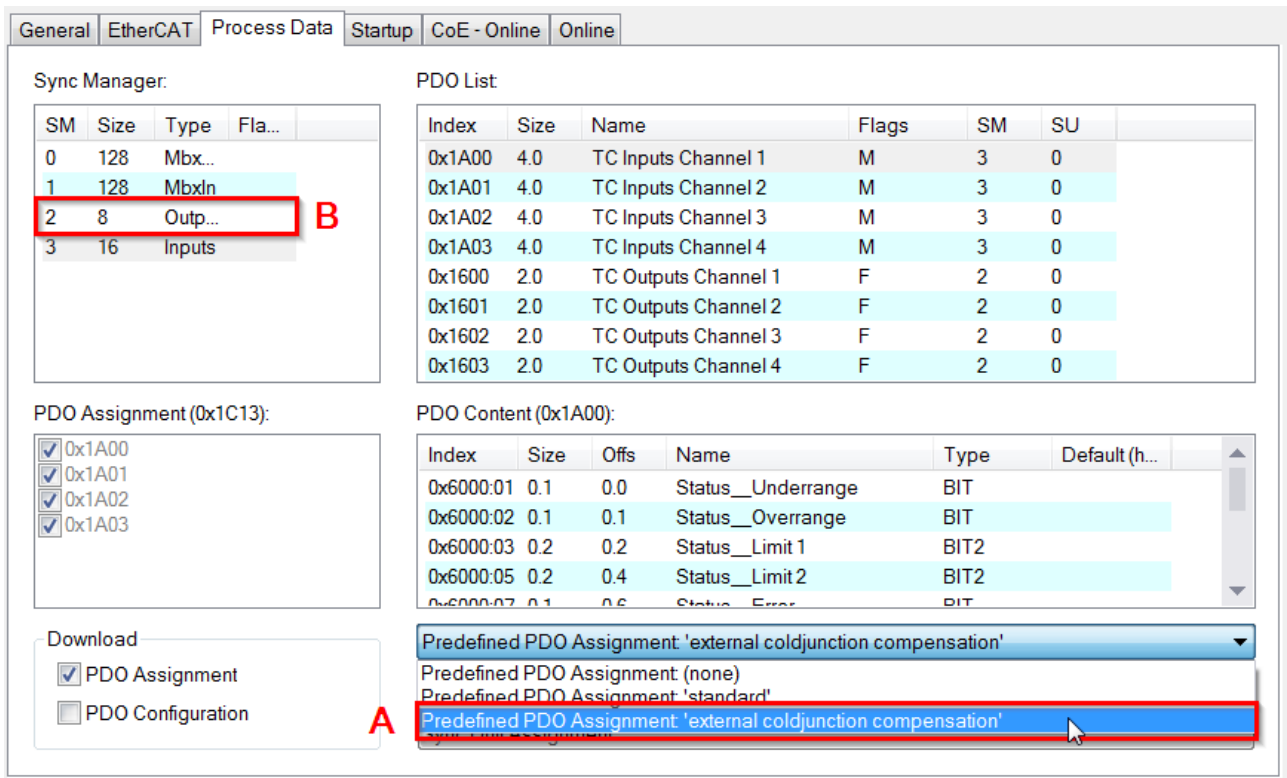

Fig. 50: TwinCAT System Manager with the predefined PDO selection *External Compensation*

In the *External Compensation* option [A] (or with *ColdJunction Compensation*), the input and output PDOs 0x1A0n / 0x160n of the respective channels are enabled.

5.7.4 Sync Manager

PDO allocation (for channel 1 - 4, 0 ≤ n ≤ 3)

SM2, PDO assignment 0x1C12				
Index	Index of excluded PDOs	Size (byte.bit)	Name	PDO content
0x160n	-	2.0	TC Outputs Channel n	Index 0x70n0:11 [▶ 77] - CJCompensation

SM3, PDO Assignment 0x1C13				
Index	Index of excluded PDOs	Size (byte.bit)	Name	PDO content
0x1A0n (default)	-	4.0	TC Inputs Channel n	Index 0x60n0:01 [▶ 76] - Underrange Index 0x60n0:02 [▶ 76] - Overrange Index 0x60n0:03 [▶ 76] - limit 1 (not EL3318) Index 0x60n0:05 [▶ 76] - limit 2 (not EL3318) Index 0x60n0:07 [▶ 76] – Error Index 0x60n0:0F [▶ 76] - TxPDO Status Index 0x60n0:10 - TxPDO Toggle Index 0x60n0:11 [▶ 76] - Value

5.8 TwinSAFE SC

5.8.1 TwinSAFE SC - operating principle

The TwinSAFE SC (Single Channel) technology enables the use of standard signals for safety tasks in any networks of fieldbuses. To do this, EtherCAT Terminals from the areas of analog input, angle/displacement measurement or communication (4...20 mA, incremental encoder, IO-Link, etc.) are extended by the TwinSAFE SC function. The typical signal characteristics and standard functionalities of the I/O components are retained. TwinSAFE SC I/Os have a yellow strip at the front of the housing to distinguish them from standard I/Os.

The TwinSAFE SC technology enables communication via a TwinSAFE protocol. These connections can be distinguished from the usual safe communication via Safety over EtherCAT.

The data of the TwinSAFE SC components are transferred via a TwinSAFE protocol to the TwinSAFE logic, where they can be used in the context of safety-relevant applications. Detailed examples for the correct application of the TwinSAFE SC components and the respective normative classification, which were confirmed/calculated by TÜV SÜD, can be found in the [TwinSAFE application manual](#).

5.8.2 TwinSAFE SC - configuration

The TwinSAFE SC technology enables communication with standard EtherCAT terminals via the Safety over EtherCAT protocol. These connections use another checksum, in order to be able to distinguish between TwinSAFE SC and TwinSAFE. Eight fixed CRCs can be selected, or a free CRC can be entered by the user.

By default the TwinSAFE SC communication channel of the respective TwinSAFE SC component is not enabled. In order to be able to use the data transfer, the corresponding TwinSAFE SC module must first be added under the Slots tab. Only then is it possible to link to a corresponding alias device.

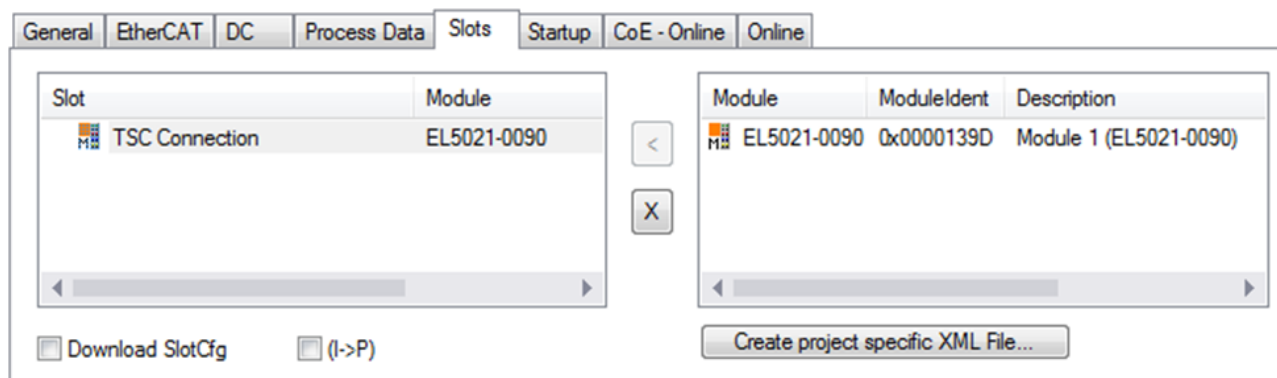

Fig. 51: Adding the TwinSAFE SC process data under the component, e.g. EL5021-0090

Additional process data with the ID TSC Inputs, TSC Outputs are generated (TSC - TwinSAFE Single Channel).

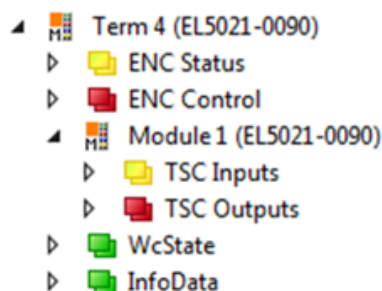

Fig. 52: TwinSAFE SC component process data, example EL5021-0090

A TwinSAFE SC connection is added by adding an alias devices in the safety project and selecting TSC (TwinSAFE Single Channel)

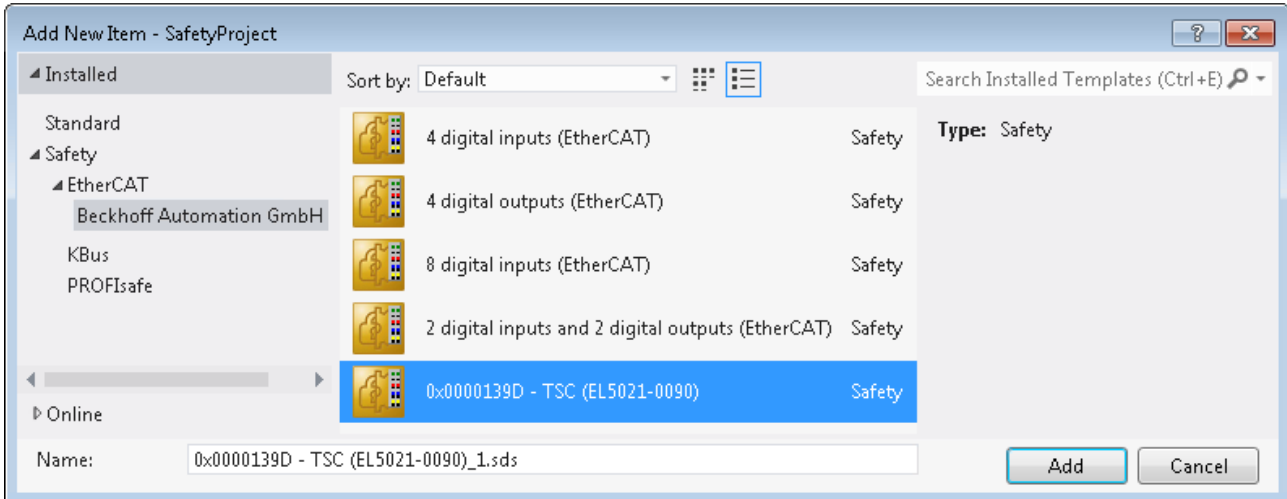



Fig. 53: Adding a TwinSAFE SC connection

After opening the alias device by double-clicking, select the Link button  next to *Physical Device*, in order to create the link to a TwinSAFE SC terminal. Only suitable TwinSAFE SC terminals are offered in the selection dialog.

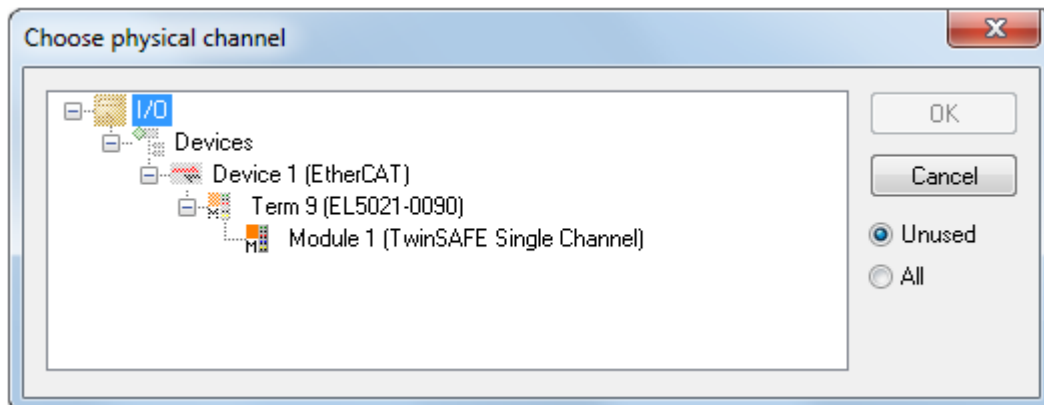

Fig. 54: Creating a link to TwinSAFE SC terminal

The CRC to be used can be selected or a free CRC can be entered under the Connection tab of the alias device.

Entry Mode	Used CRCs
TwinSAFE SC CRC 1 master	0x17B0F
TwinSAFE SC CRC 2 master	0x1571F
TwinSAFE SC CRC 3 master	0x11F95
TwinSAFE SC CRC 4 master	0x153F1
TwinSAFE SC CRC 5 master	0x1F1D5
TwinSAFE SC CRC 6 master	0x1663B
TwinSAFE SC CRC 7 master	0x1B8CD
TwinSAFE SC CRC 8 master	0x1E1BD

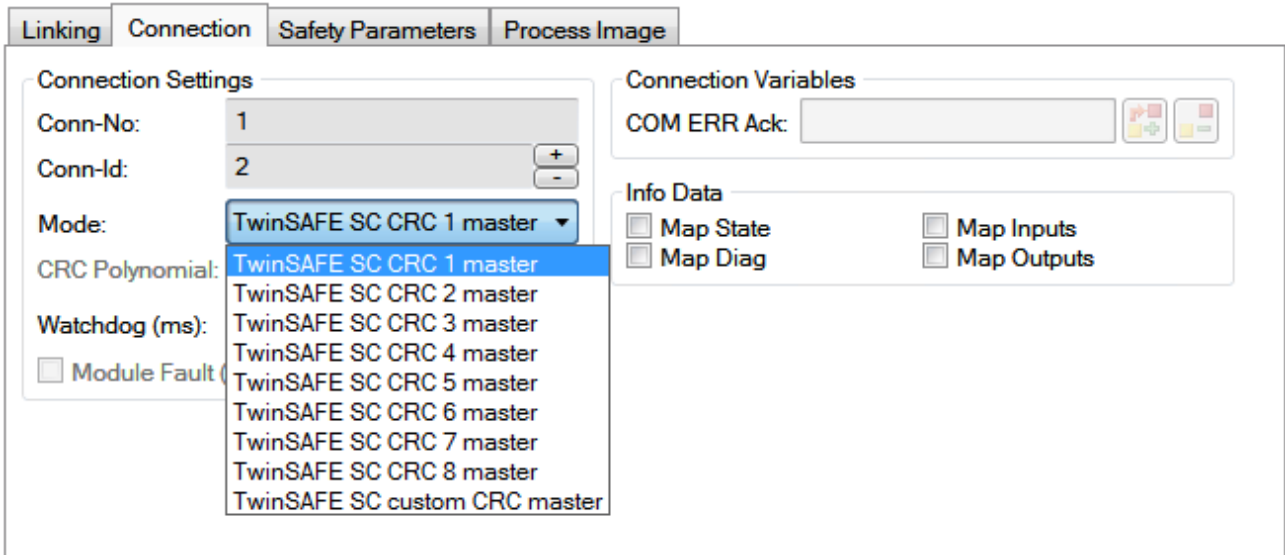

Fig. 55: Selecting a free CRC

These settings must match the settings in the CoE objects of the TwinSAFE SC component. The TwinSAFE SC component initially makes all available process data available. The *Safety Parameters* tab typically contains no parameters. The process data size and the process data themselves can be selected under the *Process Image* tab.

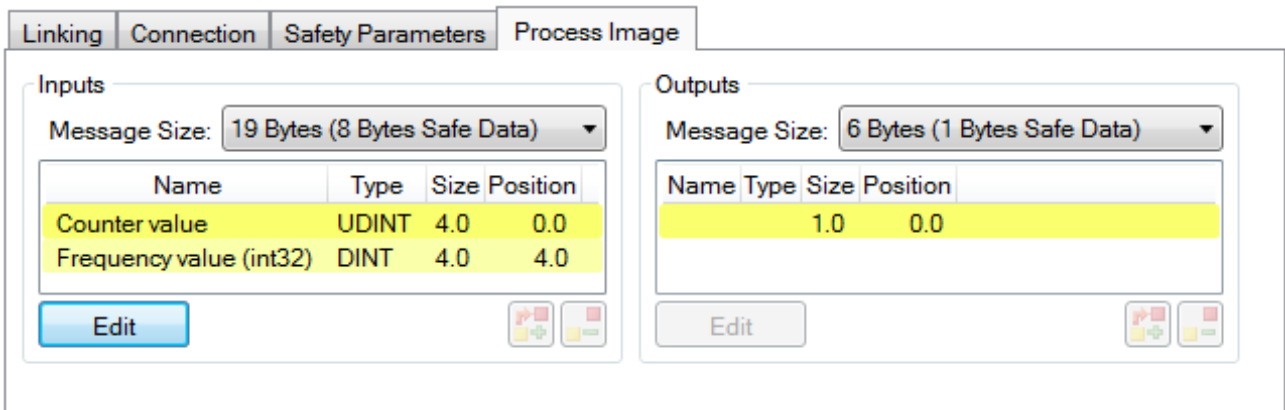

Fig. 56: Selecting the process data size and the process data

The process data (defined in the ESI file) can be adjusted to user requirements by selecting the *Edit* button in the dialog *Configure I/O element(s)*.

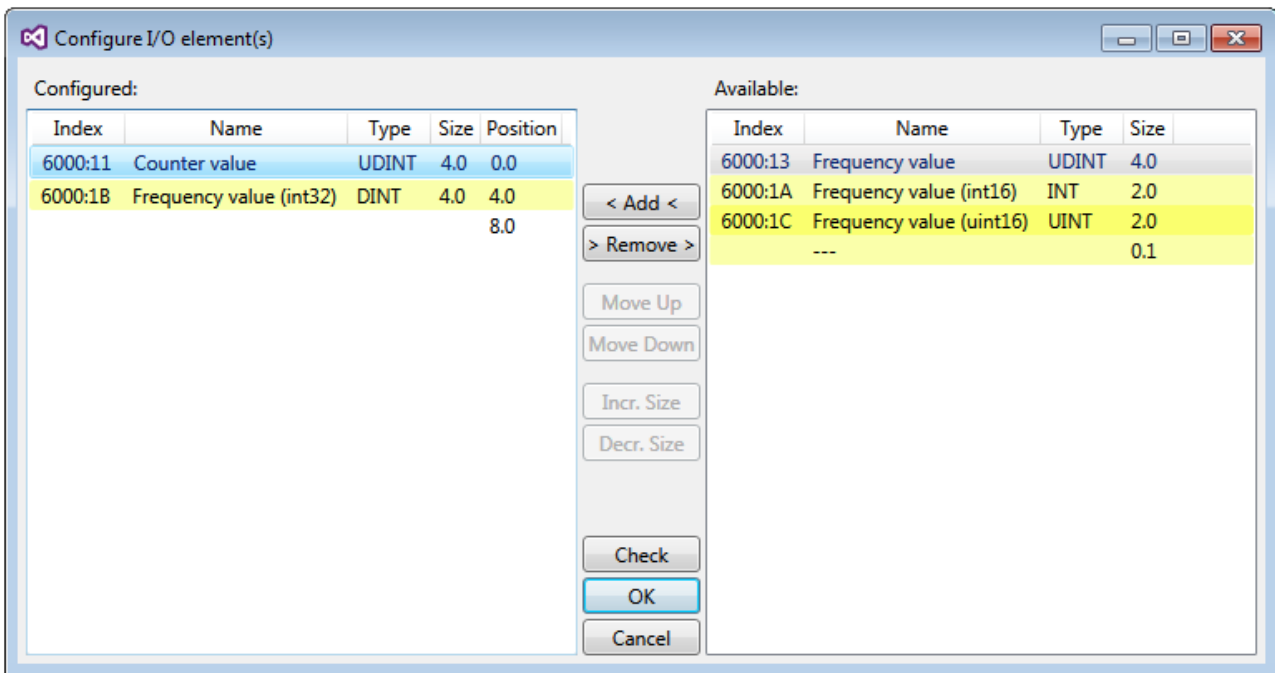

Fig. 57: Selection of the process data

The safety address together with the CRC must be entered on the TwinSAFE SC slave side. This is done via the CoE objects under *TSC settings* of the corresponding TwinSAFE SC component (here, for example, EL5021-0090, 0x8010: 01 and 0x8010: 02). The address set here must also be set in the *alias device* as *FSoE* address under the *Linking* tab.

Under the object 0x80n0:02 Connection Mode the CRC to be used is selected or a free CRC is entered. A total of 8 CRCs are available. A free CRC must start with 0x00ff in the high word.

8010:0	TSC Settings	RW	> 2 <
8010:01	Address	RW	0x0000 (0)
8010:02	Connection Mode	RW	TwinSAFE SC CRC1 master (97039)

Fig. 58: CoE objects 0x8010:01 and 0x8010:02

● Object *TSC Settings*

i Depending on the terminal, the index designation of the configuration object *TSC Settings* can vary. Example:

- EL3214-0090 and EL3314-0090, TSC Settings, Index 8040
- EL5021-0090, TSC Settings, Index 8010
- EL6224-0090, TSC Settings, Index 800F

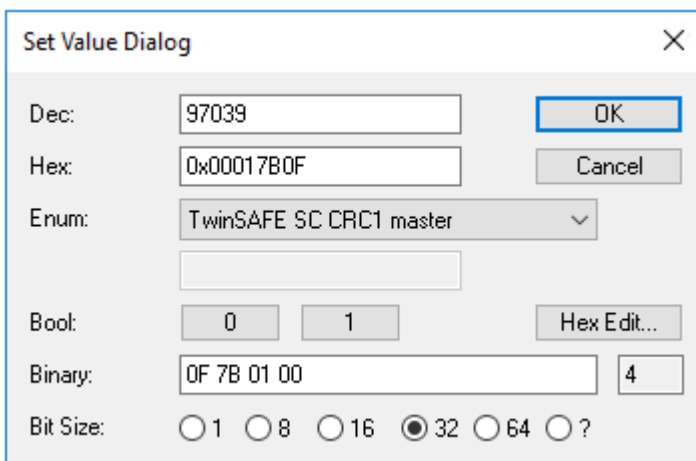

Fig. 59: Entering the safety address and the CRC

i TwinSAFE SC connections

If several TwinSAFE SC connections are used within a configuration, a different CRC must be selected for each TwinSAFE SC connection.

5.8.3 TwinSAFE SC process data of ELX320x-0090

The ELX320x-0090 transmit the following process data to the TwinSAFE logic:

Index	Name	Type	Size
6000:11	RTD Module 1.Value	INT	2.0
6010:11	RTD Module 2.Value	INT	2.0
6020:11*	RTD Module 3.Value	INT	2.0
6030:11*	RTD Module 4.Value	INT	2.0

*) Only valid for ELX3204-0090

The process data of all channels are transmitted by default. Via the *Process Image* tab, the other data types of the frequency value can be selected or completely deselected in the Safety Editor.

Depending on the version of TwinCAT 3.1, process data can be renamed automatically when linking to the Safety Editor.

5.9 Object description and parameterization

i EtherCAT ESI Device Description (XML)

The display matches that of the CoE objects from the EtherCAT ESI Device Description (XML). We recommend downloading the latest XML file from the download area of your ELX terminal on <https://www.beckhoff.com/ELXxxx> and installing it according to installation instructions.

i Parameterization via the CoE list (CAN over EtherCAT)

The EtherCAT device is parameterized via the CoE-Online tab (double-click on the respective object) or via the Process Data tab (allocation of PDOs). Please note the following general CoE notes when using/manipulating the CoE parameters:

- Keep a startup list if components have to be replaced
- Differentiation between online/offline dictionary, existence of current XML description
- use “CoE reload” for resetting changes

5.9.1 Restore object

Index 1011 Restore default parameters

Index (hex)	Name	Meaning	Data type	Flags	Default
1011:0	Restore default parameters	Restore default parameters	UINT8	RO	0x01 (1 _{dec})
1011:01	SubIndex 001	If this object is set to "0x64616F6C" in the set value dialog, all backup objects are reset to their delivery state.	UINT32	RW	0x00000000 (0 _{dec})

5.9.2 Configuration data

Index 80n0 TC Settings (for Ch. 1 - 4 ($0 \leq n \leq 3$))

Index (hex)	Name	Meaning	Data type	Flags	Default
80n0:0	TC Settings	Maximum subindex	UINT8	RW	0x1A (26 _{dec})
80n0:01	Enable user scale	User scaling is active.	BOOLEAN	RW	0x00 (0 _{dec})
80n0:02	Presentation	0: Signed presentation, 0.1°C/digit 1: Absolute value with MSB as sign (signed amount representation), 0.1°C/digit 2: High resolution (0.01°C/digit)	BIT3	RW	0x00 (0 _{dec})
80n0:05	Siemens bits	The S5 bits are displayed in the three low-order bits	BOOLEAN	RW	0x00 (0 _{dec})
80n0:06	Enable filter	This setting generally activates the basic filters in object 0x80n0:15. In the ELX331x these are technically realized in the ADC and can therefore not be switched off, even if they are set to "disabled" in the object.	BOOLEAN	RW	0x01 (1 _{dec})
80n0:07 ¹	Enable limit 1	Limit 1 enabled	BOOLEAN	RW	0x00 (0 _{dec})
80n0:08	Enable limit 2	Limit 2 enabled	BOOLEAN	RW	0x00 (0 _{dec})
80n0:0A	Enable user calibration	Enabling of the user calibration	BOOLEAN	RW	0x00 (0 _{dec})
80n0:0B	Enable vendor calibration	Enabling of the vendor calibration	BOOLEAN	RW	0x01 (1 _{dec})
80n0:0C	Coldjunction compensation	0: internal 1: no Cold junction compensation is not active 2: Extern process data Cold junction compensation takes place via the process data (resolution [1/10]°C)	BIT2	RW	0x00 (0 _{dec})
80n0:0E	Disable wire break detection	0: Wire break detection is active 1: Wire break detection is not active	BOOLEAN	RW	0x00 (0 _{dec})
80n0:11	User scale offset	User scaling offset	INT16	RW	0x0000 (0 _{dec})
8000:12	User scale gain	User scaling gain. The gain is represented in fixed-point format, with the factor 2^{-16} . The value 1 corresponds to 65536 (0x00010000)	INT32	RW	0x00010000 (65536 _{dec})
80n0:13	Limit 1	First limit value for setting the status bits (resolution 0.1 °C)	INT16	RW	0x0000 (0 _{dec})
80n0:14 ¹	Limit 2	Second limit value for setting the status bits (resolution 0.1 °C)	INT16	RW	0x0000 (0 _{dec})

Index (hex)	Name	Meaning	Data type	Flags	Default
80n0:15	Filter settings	This object determines the basic digital filter settings. The possible settings are sequentially numbered. 0: 2,5 Hz SYNC3 8: 200 Hz SYNC3 20: 50/ 60 Hz 1: 5 Hz SYNC3 9: 400 Hz SYNC3 21: 50 Hz 2: 10 Hz SYNC3 10: 800 Hz SYNC3 22: 60 Hz 3: 16,6 Hz SYNC3 11: 2 kHz SYNC3 13: 100 Hz 4: 20 Hz SYNC3 16: 2,5 Hz 24: 200 Hz 5: 50 Hz SYNC3 17: 5 Hz 25: 400 Hz 6: 60 Hz SYNC3 18: 10 Hz 26: 800 Hz 7: 100 Hz SYNC3 19: 16,6 Hz 27: 2 kHz	UINT16	RW	0x0000 (0 _{dec})
80n0:17	User calibration offset	User calibration offset	INT16	RW	0x0000 (0 _{dec})
80n0:18	User calibration gain	User calibration gain	UINT16	RW	0xFFFF (65535 _{dec})
80n0:19	TC Element	Thermocouple Implemented temperature range 0: Type: K -270°C to 1372°C 1: Type: J -210°C to 1200°C 2: Type: L -50°C to 900°C 3: Type: E -270°C to 1000°C 4: Type: T -270°C to 400°C 5: Type: N -270°C to 1300°C 6: Type: U -50°C to 600°C 7: Type: B 200°C to 1820°C 8: Type: R -50°C to 1768°C 9: Type: S -50°C to 1768°C 10: Type: C 0°C to 2329°C 100: ± 30 mV (1 µV resolution) 101: ± 60 mV (2 µV resolution) 102: ± 75 mV (4 µV resolution) 250: no evaluation	UINT16	RW	0x0000 (0 _{dec})
80n0:1A ⁴⁾	MC filter	The ELX331x has an optional additional software filter in the microcontroller (MC), which can be parameterized via this setting 0: Inactive 3: IIR 3 6: FIR 8 1: IIR 1 4: IIR 4 7: FIR 16 2: IIR 2 5: FIR 4 8: FIR 32	UINT16	RW	0x0000 (0 _{dec})

Index 80n0 TSC Settings (only EL331x-0090)

Index (hex)	Name	Meaning	Data type	Flags	Default
80n0:0	TSC Settings ▶ 68]	Max. subindex	UINT8	RO	0x02 (2 _{dec})
80n0:01	Address	TwinSAFE SC Address	UINT16	RW	0x0000 (0 _{dec})
80n0:02	Connection Mode	Selection of TwinSAFE SC CRC	UINT32	RO	0x00000000 (0 _{dec})

5.9.3 Configuration data (vendor-specific)

Index 80nF TC Vendor data (for Ch. 1 - 4 (0 ≤ n ≤ 3))

Index (hex)	Name	Meaning	Data type	Flags	Default
80nF:0	TC Vendor data	Maximum subindex	UINT8	RO	0x03 (3 _{dec})
80nF:01	Calibration offset TC	Thermocouple offset (vendor calibration)	INT166	RW	0x002D (45 _{dec})
80nF:02	Calibration gain TC	Thermocouple gain (vendor calibration)	UINT16	RW	0x5B9A (23450 _{dec})
80nF:03	CJ offset 1/256°	Cold junction offset [Pt1000] (vendor calibration)	UINT32	RW	0x0000 (0 _{dec})

5.9.4 Input data

Index 60n0 TC Inputs (for Ch. 1 - 4 ($0 \leq n \leq 3$))

Index (hex)	Name	Meaning	Data type	Flags	Default
60n0:0	TC Inputs	Maximum subindex	UINT8	RO	0x11 (17 _{dec})
60n0:01	Underrange	Value below measuring range.	BOOLEAN	RO	0x00 (0 _{dec})
60n0:02	Overrange	Measuring range exceeded.	BOOLEAN	RO	0x00 (0 _{dec})
60n0:03	Limit 1	Limit value monitoring 0: not activated 1: limit range exceeded 2: limit range undershot	BIT2	RO	0x00 (0 _{dec})
60n0:05	Limit 2	Limit value monitoring 0: not activated 1: limit range exceeded 2: limit range undershot	BIT2	RO	0x00 (0 _{dec})
60n0:07	Error	The error bit is set if the value is invalid (wire breakage, overrange, underrange).	BOOLEAN	RO	0x00 (0 _{dec})
60n0:0F	TxPDO State	Validity of the data of the associated TxPDO (0 = valid, 1 = invalid).	BOOLEAN	RO	0x00 (0 _{dec})
60n0:10	TxPDO Toggle	The TxPDO toggle is toggled by the slave when the data of the associated TxPDO is updated.	BOOLEAN	RO	0x00 (0 _{dec})
60n0:11	Value	Analog input value	INT16	RO	0x0000 (0 _{dec})

Index 60n0 TSC Slave Frame Elements (ELX3312-0090: n=2, ELX3312-0090: n=4)

Index (hex)	Name	Meaning	Data type	Flags	Default
60n0:0	TSC Slave Frame Elements [► 68]	Max. subindex	UINT8	RO	0x06 (6 _{dec})
60n0:01	TSC__Slave Cmd	reserved	UINT8	RO	0x00 (0 _{dec})
60n0:02	TSC__Slave ConnID	reserved	UINT16	RO	0x0000 (0 _{dec})
60n0:03	TSC__Slave CRC_0	reserved	UINT16	RO	0x0000 (0 _{dec})
60n0:04	TSC__Slave CRC_1	reserved	UINT16	RO	0x0000 (0 _{dec})
60n0:05	TSC__Slave CRC_2	reserved	UINT16	RO	0x0000 (0 _{dec})
60n0:06	TSC__Slave CRC_3	reserved	UINT16	RO	0x0000 (0 _{dec})

5.9.5 Output data

Index 70n0 TC Outputs (for Ch. 1 - 4 ($0 \leq n \leq 3$))

Index (hex)	Name	Meaning	Data type	Flags	Default
70n0:0	TC Outputs	Maximum subindex	UINT8	RO	0x11 (17 _{dec})
70n0:11	CJCompensation	Temperature of the cold junction (resolution in 1/10 °C) (index 0x80n0:0C, comparison via the process data)	INT16	RO	0x0000 (0 _{dec})

Index 70n0 TSC Master Frame Elements (ELX3312-0090: n=2, ELX3314-0090: n=4)

Index (hex)	Name	Meaning	Data type	Flags	Default
70n0:0	TSC Master Frame Elements	Max. subindex	UINT8	RO	0x03 (3 _{dec})
70n0:01	TSC__Master Cmd	reserved	UINT8	RO	0x00 (0 _{dec})
70n0:02	TSC__Master ConnID	reserved	UINT16	RO	0x0000 (0 _{dec})
70n0:03	TSC__Master CRC_0	reserved	UINT16	RO	0x0000 (0 _{dec})

5.9.6 Information and diagnostic data

Index 80nE TC Internal data (for Ch. 1 - 4 ($0 \leq n \leq 3$))

Index (hex)	Name	Meaning	Data type	Flags	Default
80nE:0	TC Internal data	Maximum subindex	UINT8	RO	0x04 (4 _{dec})
80nE:01	ADC raw value TC	ADC raw value thermocouple	UINT32	RO	0x00000000 (0 _{dec})
80nE:02	ADC raw value CJ	ADC raw value cold junction	UINT32	RO	0x00000000 (0 _{dec})
80nE:03	CJ temperature	Cold junction temperature (resolution [1/10]°C)	INT16	RO	0x0000 (0 _{dec})
80nE:04	CJ voltage	Cold junction voltage (resolution 1 µV)	INT16	RO	0x0000 (0 _{dec})

Index F000 Modular device profile

Index (hex)	Name	Meaning	Data type	Flags	Default
F000:0	Modular device profile	General information for the modular device profile	UINT8	RO	0x02 (2 _{dec})
F000:01	Module index distance	Index spacing of the objects of the individual channels	UINT16	RO	0x0010 (16 _{dec})
F000:02	Maximum number of modules	Number of channels	UINT16	RO	0x0004 (4 _{dec})

Index F008 Code word

Index (hex)	Name	Meaning	Data type	Flags	Default
F008:0	Code word	currently reserved	UINT32	RW	0x00000000 (0 _{dec})

Index F010 Module list (for Ch. 1 - 4 ($1 \leq n \leq 4$))

Index (hex)	Name	Meaning	Data type	Flags	Default
F010:0	Module list	Maximum subindex	UINT32	RW	0x0n (n _{dec})
F010:0n	SubIndex 00n	TC Profile	UINT32	RW	0x0000014A (330 _{dec})

5.9.7 Standard objects (0x1000-0x1FFF)

The standard objects have the same meaning for all EtherCAT slaves.

Index 1000 Device type

Index (hex)	Name	Meaning	Data type	Flags	Default
1000:0	Device type	Device type of the EtherCAT slave: the Lo-Word contains the CoE profile used (5001). The Hi-Word contains the module profile according to the modular device profile.	UINT32	RO	[]

Index 1008 Device name

Index (hex)	Name	Meaning	Data type	Flags	Default
1008:0	Device name	Device name of the EtherCAT slave	STRING	RO	[]

Index 1009 Hardware version

Index (hex)	Name	Meaning	Data type	Flags	Default
1009:0	Hardware version	Hardware version of the EtherCAT slave	STRING	RO	00

Index 100A Software version

Index (hex)	Name	Meaning	Data type	Flags	Default
100A:0	Software version	Firmware version of the EtherCAT slave	STRING	RO	01

Index 1018 Identity

Index (hex)	Name	Meaning	Data type	Flags	Default
1018:0	Identity	Information for identifying the slave	UINT8	RO	0x04 (4 _{dec})
1018:01	Vendor ID	Vendor ID of the EtherCAT slave	UINT32	RO	0x00000002 (2 _{dec})
1018:02	Product code	Product code of the EtherCAT slave	UINT32	RO	[]
1018:03	Revision	Revision number of the EtherCAT slave; the low word (bit 0-15) indicates the special terminal number, the high word (bit 16-31) refers to the device description	UINT32	RO	[]
1018:04	Serial number	Serial number of the EtherCAT slave; the low byte (bit 0-7) of the low word contains the year of production, the high byte (bit 8-15) of the low word contains the week of production, the high word (bit 16-31) is 0	UINT32	RO	0x00000000 (0 _{dec})

Index 10F0 Backup parameter handling

Index (hex)	Name	Meaning	Data type	Flags	Default
10F0:0	Backup parameter handling	Information for standardized loading and saving of backup entries	UINT8	RO	0x01 (1 _{dec})
10F0:01	Checksum	Checksum across all backup entries of the EtherCAT slave	UINT32	RO	0x00000000 (0 _{dec})

Index 160n RxPDO-Map (for Ch. 1 - 4 (0 ≤ n ≤ 3))

Index (hex)	Name	Meaning	Data type	Flags	Default
160n:0	RxPDO-Map Ch. n+1	PDO Mapping RxPDO n+1	UINT8	RO	0x01 (1 _{dec})
160n:01	SubIndex 001	n. PDO Mapping entry (object 0x70n0 (TC Outputs Ch. n+1), entry 0x11 (CJCompensation))	UINT32	RO	0x70n0:11, 16

Index 160n TSC RxPDO-Map Master Message (ELX3312-0090: n=2, ELX3314-0090: n=4)

Index (hex)	Name	Meaning	Data type	Flags	Default
160n:0	TSC RxPDO-Map Master Message	PDO Mapping RxPDO	UINT8	RW	0x04 (4 _{dec})
160n:01	SubIndex 001	1. PDO Mapping entry (object 0x7040 (TSC Master Frame Elements), entry 0x01 (TSC__Master Cmd))	UINT32	RW	0x7040:01, 8
160n:02	SubIndex 002	2. PDO Mapping entry (8 bits align)	UINT32	RW	0x0000:00, 8
160n:03	SubIndex 003	3. PDO Mapping entry (object 0x7040 (TSC Master Frame Elements), entry 0x03 (TSC__Master CRC_0))	UINT32	RW	0x7040:03, 16
160n:04	SubIndex 004	4. PDO Mapping entry (object 0x7040 (TSC Master Frame Elements), entry 0x02 (TSC__Master ConnID))	UINT32	RW	0x7040:02, 16

Index 1A0n TxPDO-Map (for Ch. 1 - 4 (0 ≤ n ≤ 3))

Index (hex)	Name	Meaning	Data type	Flags	Default
1A0n:0	TxPDO-MapCh.1	PDO Mapping TxPDO 1	UINT8	RO	0x09 (9 _{dec})
1A0n:01	SubIndex 001	1. PDO Mapping entry (object 0x60n0 (TC Inputs Ch.1), entry 0x01 (Underrange))	UINT32	RO	0x60n0:01, 1
1A0n:02	SubIndex 002	2. PDO Mapping entry (object 0x60n0 (TC Inputs Ch.1), entry 0x02 (Overrange))	UINT32	RO	0x60n0:02, 1
1A0n:03	SubIndex 003	3. PDO Mapping entry (object 0x60n0 (TC Inputs Ch.1), entry 0x03 (Limit 1))	UINT32	RO	0x60n0:03, 2
1A0n:04	SubIndex 004	4. PDO Mapping entry (object 0x60n0 (TC Inputs Ch.1), entry 0x05 (Limit 2))	UINT32	RO	0x60n0:05, 2
1A0n:05	SubIndex 005	5. PDO Mapping entry (object 0x60n0 (TC Inputs Ch.1), entry 0x07 (Error))	UINT32	RO	0x60n0:07, 1
1A0n:06	SubIndex 006	6. PDO Mapping entry (7 bits align)	UINT32	RO	0x0000:00, 7
1A0n:07	SubIndex 007	7. PDO Mapping entry (object 0x60n0 (TC Inputs Ch.1), entry 0x0F (TxPDO State))	UINT32	RO	0x60n0:0F, 1
1A0n:08	SubIndex 008	8. PDO Mapping entry (object 0x180n (TxPDO-ParCh.1), entry 0x09 (TxPDO-Toggle))	UINT32	RO	0x180n:09, 1
1A0n:09	SubIndex 009	9. PDO Mapping entry (object 0x60n0 (TC Inputs Ch.1), entry 0x11 (Value))	UINT32	RO	0x60n0:11, 16

Index 1A0n TSC TxPDO-Map Slave Message (ELX3312-0090: n=2, ELX3314-0090: n=4)

Index (hex)	Name	Meaning	Data type	Flags	Default
1A0n:0	TSC TxPDO-Map Slave Message	PDO Mapping TxPDO	UINT8	RW	0x0A (10 _{dec})
1A0n:01	SubIndex 001	1. PDO Mapping entry (object 0x6040 (TSC Slave Frame Elements), entry 0x01 (TSC__Slave Cmd))	USINT8	RW	0x6040:01, 8
1A0n:02	SubIndex 002	2. PDO Mapping entry (object 0x6000 (ENC Inputs), entry 0x11 (Counter value))	INT16	RW	0x6000:11, 16
1A0n:03	SubIndex 003	3. PDO Mapping entry (object 0x6040 (TSC Slave Frame Elements), entry 0x03 (TSC__Slave CRC_0))	UINT16	RW	0x6040:03, 16
1A0n:04	SubIndex 004	4. PDO Mapping entry (object 0x6010 (ENC Inputs), entry 0x11 (Counter value))	INT16	RW	0x6010:11, 16
1A0n:05	SubIndex 005	5. PDO Mapping entry (object 0x6040 (TSC Slave Frame Elements), entry 0x04 (TSC__Slave CRC_1))	UINT16	RW	0x6040:04, 16
1A0n:06	SubIndex 006	6. PDO Mapping entry (object 0x6020 (ENC Inputs), entry 0x11 (Counter value))	INT16	RW	0x6020:11, 16
1A0n:07	SubIndex 007	7. PDO Mapping entry (object 0x6040 (TSC Slave Frame Elements), entry 0x05 (TSC__Slave CRC_2))	UINT16	RW	0x6040:05, 16
1A0n:08	SubIndex 008	8. PDO Mapping entry (object 0x6030 (ENC Inputs), entry 0x11 (Counter value))	INT16	RW	0x6030:11, 16
1A0n:09	SubIndex 009	9. PDO Mapping entry (object 0x6040 (TSC Slave Frame Elements), entry 0x06 (TSC__Slave CRC_3))	UINT16	RW	0x6040:06, 16
1A0n:0A	SubIndex 010	10. PDO Mapping entry (object 0x6040 (TSC Slave Frame Elements), entry 0x02 (TSC__Slave ConnID))	UINT16	RW	0x6040:02, 16

Index 1C00 Sync manager type

Index (hex)	Name	Meaning	Data type	Flags	Default
1C00:0	Sync manager type	Using the sync managers	UINT8	RO	0x04 (4 _{dec})
1C00:01	SubIndex 001	Sync-Manager Type Channel 1: Mailbox Write	UINT8	RO	0x01 (1 _{dec})
1C00:02	SubIndex 002	Sync-Manager Type Channel 2: Mailbox Read	UINT8	RO	0x02 (2 _{dec})
1C00:03	SubIndex 003	Sync-Manager Type Channel 3: Process Data Write (Outputs)	UINT8	RO	0x03 (3 _{dec})
1C00:04	SubIndex 004	Sync-Manager Type Channel 4: Process Data Read (Inputs)	UINT8	RO	0x04 (4 _{dec})

Index 1C12 RxPDO assign (für Ch. 1 - 8 ($1 \leq n \leq 8$))

Index (hex)	Name	Meaning	Data type	Flags	Default
1C12:0	RxPDO assign	PDO Assign Outputs	UINT8	RW	0x0n (n_{dec})
1C12:0n	Subindex 00n	n. allocated RxPDO (contains the index of the associated RxPDO mapping object)	UINT16	RW	0x160n

Index 1C13 TxPDO assign (for Ch. 1 - 8 ($1 \leq n \leq 8$))

Index (hex)	Name	Meaning	Data type	Flags	Default
1C13:0	TxPDO assign	PDO Assign Inputs	UINT8	RW	0x0n (n_{dec})
1C13:0n	Subindex 00n	n. allocated TxPDO (contains the index of the associated TxPDO mapping object)	UINT16	RW	0x1A0n

Index 1C32 SM output parameter

Index (hex)	Name	Meaning	Data type	Flags	Default
1C32:0	SM output parameter	Synchronization parameters for the outputs	UINT8	RO	0x07 (7_{dec})
1C32:01	Sync mode	Current synchronization mode: <ul style="list-style-type: none"> 0: Free Run 1: Synchron with SM 2 Event 2: DC-Mode - Synchron with SYNC0 Event 3: DC-Mode - Synchron with SYNC1 Event 	UINT16	RW	0x0000 (0_{dec})
1C32:02	Cycle time	Cycle time (in ns): <ul style="list-style-type: none"> Free Run: Cycle time of the local timer Synchron with SM 2 event: Master cycle time DC mode: SYNC0/SYNC1 Cycle Time 	UINT32	RW	0x00000000 (0_{dec})
1C32:03	Shift time	Time between SYNC0 event and output of the outputs (in ns, DC mode only)	UINT32	RW	0x00000000 (0_{dec})
1C32:04	Sync modes supported	Supported synchronization modes: <ul style="list-style-type: none"> Bit 0 = 1: free run is supported Bit 1 = 1: Synchron with SM 2 event is supported Bit 3:2 = 10: DC mode is supported Bit 5:4 = 01: Output shift with SYNC1 event (only DC mode) Bit 14 = 1: dynamic times (measurement through writing of 0x1C32:08) 	UINT16	RO	0x8007 (32775_{dec}) 0xC001 (EL3318)
1C32:05	Minimum cycle time	Minimum cycle time (in ns)	UINT32	RO	0x00000000 (0_{dec})
1C32:06	Calc and copy time	Minimum time between SYNC0 and SYNC1 event (in ns, DC mode only)	UINT32	RO	0x00000000 (0_{dec})
1C32:08	Command	<ul style="list-style-type: none"> 0: Measurement of the local cycle time is stopped 1: Measurement of the local cycle time is started <p>The entries 0x1C32:03, 0x1C32:05, 0x1C32:06, 0x1C32:09, 0x1C33:03, 0x1C33:06 ▶ 81, 0x1C33:09 are updated with the maximum measured values. For a subsequent measurement the measured values are reset</p>	UINT16	RW	0x0000 (0_{dec})
1C32:09	Delay time	Time between SYNC1 event and output of the outputs (in ns, DC mode only)	UINT32	RO	0x00000000 (0_{dec})
1C32:0B	SM event missed counter	Number of missed SM events in OPERATIONAL (DC mode only)	UINT16	RO	0x0000 (0_{dec})
1C32:0C	Cycle exceeded counter	Number of occasions the cycle time was exceeded in OPERATIONAL (cycle was not completed in time or the next cycle began too early)	UINT16	RO	0x0000 (0_{dec})
1C32:0D	Shift too short counter	Number of occasions that the interval between SYNC0 and SYNC1 event was too short (DC mode only)	UINT16	RO	0x0000 (0_{dec})
1C32:20	Sync error	The synchronization was not correct in the last cycle (outputs were output too late; DC mode only)	BOOLEAN	RO	0x00 (0_{dec})

Index 1C33 SM input parameter



Index (hex)	Name	Meaning	Data type	Flags	Default
1C33:0	SM input parameter	Synchronization parameters for the inputs	UINT8	RO	0x07 (7 _{dec})
1C33:01	Sync mode	Current synchronization mode: <ul style="list-style-type: none"> • 0: Free Run • 1: Synchron with SM 3 event (no outputs available) • 2: DC - Synchron with SYNC0 Event • 3: DC - Synchron with SYNC1 Event • 34: Synchron with SM 2 event (outputs available) 	UINT16	RW	0x0000 (0 _{dec})
1C33:02	Cycle time	as 0x1C32:02 [▶ 81]	UINT32	RW	0x00000000 (0 _{dec})
1C33:03	Shift time	Time between SYNC0 event and reading of the inputs (in ns, only DC mode)	UINT32	RW	0x00000000 (0 _{dec})
1C33:04	Sync modes supported	Supported synchronization modes: <ul style="list-style-type: none"> • Bit 0: free run is supported • Bit 1: Synchron with SM 2 Event is supported (outputs available) • Bit 1: Synchron with SM 3 Event is supported (no outputs available) • Bit 3:2 = 10: DC mode is supported • Bit 5:4 = 10: input shift through local event (outputs available) • Bit 5:4 = 101: input shift with SYNC1 event (no outputs available) • Bit 14 = 1: dynamic times (measurement through writing of 0x1C32:08 [▶ 81] or 0x1C33:08) 	UINT16	RO	0x8007 (32775 _{dec}) 0xC001 (EL3318)
1C33:05	Minimum cycle time	as 0x1C32:05 [▶ 81]	UINT32	RO	0x00000000 (0 _{dec})
1C33:06	Calc and copy time	Time between reading of the inputs and availability of the inputs for the master (in ns, only DC mode)	UINT32	RO	0x00000000 (0 _{dec})
1C33:08	Command	as 0x1C32:08 [▶ 81]	UINT16	RW	0x0000 (0 _{dec})
1C33:09	Delay time	Time 0x1 between SYNC1 event and reading of the inputs (in ns, only DC mode)	UINT32	RO	0x00000000 (0 _{dec})
1C33:0B	SM event missed counter	as 0x1C32:11 [▶ 81]	UINT16	RO	0x0000 (0 _{dec})
1C33:0C	Cycle exceeded counter	as 0x1C32:12 [▶ 81]	UINT16	RO	0x0000 (0 _{dec})
1C33:0D	Shift too short counter	as 0x1C32:13 [▶ 81]	UINT16	RO	0x0000 (0 _{dec})
1C33:20	Sync error	as 0x1C32:32 [▶ 81]	BOOLEAN	RO	0x00 (0 _{dec})

6 Appendix

6.1 EtherCAT AL Status Codes

For detailed information please refer to the [EtherCAT system description](#).

6.2 UL notice

	<p>Application Beckhoff EtherCAT modules are intended for use with Beckhoff's UL Listed EtherCAT System only.</p>
	<p>Examination For cULus examination, the Beckhoff I/O System has only been investigated for risk of fire and electrical shock (in accordance with UL508 and CSA C22.2 No. 142).</p>
	<p>For devices with Ethernet connectors Not for connection to telecommunication circuits.</p>

Basic principles

Two UL certificates are met in the Beckhoff EtherCAT product range, depending upon the components:

1. UL certification according to UL508. Devices with this kind of certification are marked by this sign:



2. UL certification according to UL508 with limited power consumption. The current consumed by the device is limited to a max. possible current consumption of 4 A. Devices with this kind of certification are marked by this sign:

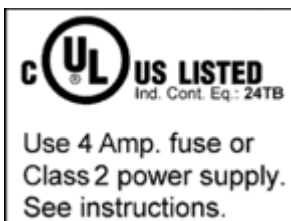

Almost all current EtherCAT products (as at 2010/05) are UL certified without restrictions.

Application

If terminals certified *with restrictions* are used, then the current consumption at 24 V_{DC} must be limited accordingly by means of supply

- from an isolated source protected by a fuse of max. 4 A (according to UL248) or
- from a voltage supply complying with *NEC class 2*.
A voltage source complying with *NEC class 2* may not be connected in series or parallel with another *NEC class 2* compliant voltage supply!

These requirements apply to the supply of all EtherCAT bus couplers, power adaptor terminals, Bus Terminals and their power contacts.

6.3 FM notice

Special notice regarding ANSI/ISA Ex

WARNING

Observe the permissible range of application!

The I/O modules of the ELX series may only be used in potentially explosive areas of Class I, Division 2, Group A, B, C, D or in non-explosive areas!

WARNING



Consider the *Control Drawing ELX* documentation!

When installing the I/O modules of the ELX series, be sure to read the *Control Drawing ELX* documentation, which is available in the download area of your ELX terminal on <https://www.beckhoff.com/ELXxxxx>!

6.4 Support and Service

Beckhoff and their partners around the world offer comprehensive support and service, making available fast and competent assistance with all questions related to Beckhoff products and system solutions.

Beckhoff's branch offices and representatives

Please contact your Beckhoff branch office or representative for local support and service on Beckhoff products!

The addresses of Beckhoff's branch offices and representatives round the world can be found on her internet pages: <https://www.beckhoff.com>

You will also find further documentation for Beckhoff components there.

Beckhoff Support

Support offers you comprehensive technical assistance, helping you not only with the application of individual Beckhoff products, but also with other, wide-ranging services:

- support
- design, programming and commissioning of complex automation systems
- and extensive training program for Beckhoff system components

Hotline: +49 5246 963 157
Fax: +49 5246 963 9157
e-mail: support@beckhoff.com

Beckhoff Service

The Beckhoff Service Center supports you in all matters of after-sales service:

- on-site service
- repair service
- spare parts service
- hotline service

Hotline: +49 5246 963 460
Fax: +49 5246 963 479
e-mail: service@beckhoff.com

Beckhoff Headquarters

Beckhoff Automation GmbH & Co. KG

Huelshorstweg 20
33415 Verl
Germany

Phone: +49 5246 963 0
Fax: +49 5246 963 198
e-mail: info@beckhoff.com
web: <https://www.beckhoff.com>

Table of figures

Fig. 1	ELX2008-0000 with date code 2519HMHM, BTN 0001f6hd and Ex marking	9
Fig. 2	ELX9560-0000 with date code 12150000, BTN 000b000 and Ex marking	10
Fig. 3	ELX9012 with date code 12174444, BTN 0000b0si and Ex marking	11
Fig. 4	ELX3312 - 2-channel analog input terminal for thermocouples, 16 bit, Ex i	12
Fig. 5	ELX3314 - 4-channel analog input terminal for thermocouples, 16 bit, Ex i	13
Fig. 6	Valid arrangement of the ELX terminals (right terminal block).	19
Fig. 7	Valid arrangement - terminals that do not belong to the ELX series are set before and after the ELX terminal segment. The separation is realized by the ELX9560 at the beginning of the ELX terminal segment and two ELX9410 at the end of the ELX terminal segment.	19
Fig. 8	Valid arrangement - multiple power supplies by ELX9560, each with an upstream ELX9410. ...	19
Fig. 9	Valid arrangement - ELX9410 in front of an ELX9560 power supply terminal.....	20
Fig. 10	Invalid arrangement - missing ELX9560 power supply terminal.....	20
Fig. 11	Invalid arrangement - terminal that does not belong to the ELX series within the ELX terminal segment.	20
Fig. 12	Invalid arrangement - second ELX9560 power supply terminal within the ELX terminal segment without an upstream ELX9410.....	20
Fig. 13	Invalid arrangement - missing ELX9012 bus end cover.	21
Fig. 14	Installation position and minimum distances	22
Fig. 15	Attaching on mounting rail	23
Fig. 16	Disassembling of terminal.....	24
Fig. 17	Standard wiring.....	25
Fig. 18	High Density Terminals.....	25
Fig. 19	Connecting a cable on a terminal point	26
Fig. 20	ELX3312 - Contact assignment	28
Fig. 21	ELX3314 - Contact assignment	30
Fig. 22	Full scale value, measuring span	32
Fig. 23	SE and DIFF module as 2-channel version	34
Fig. 24	2-wire connection.....	36
Fig. 25	Common-mode voltage (V _{cm}).....	37
Fig. 26	Recommended operating voltage range.....	38
Fig. 27	Signal processing analog input.....	38
Fig. 28	Diagram signal delay (step response)	40
Fig. 29	Diagram signal delay (linear)	40
Fig. 30	Principle of the thermocouple	41
Fig. 31	Measurement uncertainty for thermocouple type B	44
Fig. 32	Measurement uncertainty for thermocouple type C	45
Fig. 33	Measurement uncertainty for type E thermocouple	46
Fig. 34	Measurement uncertainty for type J thermocouple.....	47
Fig. 35	Measurement uncertainty for type K thermocouple	48
Fig. 36	Measurement uncertainty for type L thermocouple	49
Fig. 37	Measurement uncertainty for type N thermocouple.....	50
Fig. 38	Measurement uncertainty for type R thermocouple.....	51
Fig. 39	Measurement uncertainty for type S thermocouple	52
Fig. 40	Measuring uncertainty for type T thermocouple	53
Fig. 41	Measuring uncertainty for type U thermocouple	54

Fig. 42	ELX331x - Data flow	56
Fig. 43	Calculation of process data	60
Fig. 44	External cold junction.....	61
Fig. 45	ELX3312 - Process data.....	63
Fig. 46	ELX3312 – Process data selection in TwinCAT	64
Fig. 47	ELX331x - selection Predefined PDO Assignment.....	64
Fig. 48	ELX3314 - Default process image	65
Fig. 49	TwinCAT System Manager with predefined PDO option Standard	66
Fig. 50	TwinCAT System Manager with the predefined PDO selection External Compensation.....	67
Fig. 51	Adding the TwinSAFE SC process data under the component, e.g. EL5021-0090	68
Fig. 52	TwinSAFE SC component process data, example EL5021-0090	68
Fig. 53	Adding a TwinSAFE SC connection	69
Fig. 54	Creating a link to TwinSAFE SC terminal	69
Fig. 55	Selecting a free CRC	70
Fig. 56	Selecting the process data size and the process data	70
Fig. 57	Selection of the process data	71
Fig. 58	CoE objects 0x8010:01 and 0x8010:02.....	71
Fig. 59	Entering the safety address and the CRC	71

More Information:
www.beckhoff.com/ELXxxxx

Beckhoff Automation GmbH & Co. KG
Hülshorstweg 20
33415 Verl
Germany
Phone: +49 5246 9630
info@beckhoff.com
www.beckhoff.com

