



# User Manual

**Rider 320**



# Table of Contents

<b>Getting Started</b> .....	<b>4</b>	Reset Data .....	25
Your Rider 320 .....	4	View Firmware Version .....	25
Accessories .....	5	ANT+ / BLE Sensors.....	26
Status Icons.....	5	Altitude.....	28
Step 1: Charge Your Rider 320 .....	6	Personalize User Profile .....	29
Step 2: Turn On Rider 320 .....	6	Personalize Bike Profile .....	30
Step 3: Initial Setup .....	6	<b>Bryton Active App</b>	
Step 4: Acquire Satellite		<b>Advanced Settings</b> .....	<b>32</b>
Signals .....	7	System Language .....	32
Step 5: Ride Your Bike with		Grid Setting.....	32
Rider 320 .....	7	Altitude Calibration .....	33
Reboot Rider 320 .....	7	Notifications .....	34
Share Your Records.....	8	<b>Appendix</b> .....	<b>35</b>
Auto Sync Tracks to		Specifications.....	35
Bryton Active App.....	9	Battery Information.....	36
Bryton Update Tool.....	10	Install Rider 320 .....	38
<b>View History</b> .....	<b>11</b>	Install Speed/Cadence/ Dual Sensor (Optional).....	39
View Exercise/Training Record.....	11	Install Heart Rate Belt (Optional) .....	40
Delete History .....	11	Wheel Size and Circumference .....	41
History Flow.....	12	Basic Care For Your Rider 320 .....	42
<b>Settings</b> .....	<b>13</b>	Data Fields.....	43
Data Page .....	13		
Smart Lap .....	15		
Set Alert .....	16		
Smart Pause .....	16		
Data Record .....	17		
GPS System .....	18		
Change System Settings .....	19		
Bluetooth .....	22		
Configure Auto Scroll .....	23		
Enable File Saving Mode .....	23		
Start Reminder .....	24		
View Memory Usage.....	24		



# WARNING

Always consult your physician before you begin any training. Please read the details in Warranty and Safety Information guide in the package.

## Australian Consumer Law

Our goods come with guarantees that can not be excluded under the New Zealand and Australian Consumer Laws. You are entitled to a replacement or refund for a major failure and for compensation for any other reasonably foreseeable loss or damage. You are also entitled to have the goods repaired or replaced if the goods fail to be of acceptable quality and the failure does not amount to a major failure.

## Video Tutorial

For a step-by-step demonstration of device and Bryton Active App, please scan QR code below to check Bryton Video Tutorials.



<https://www.youtube.com/brytonactive>

# Getting Started

This section will guide you through the basic preparations before you start using your Rider 320.

## Your Rider 320

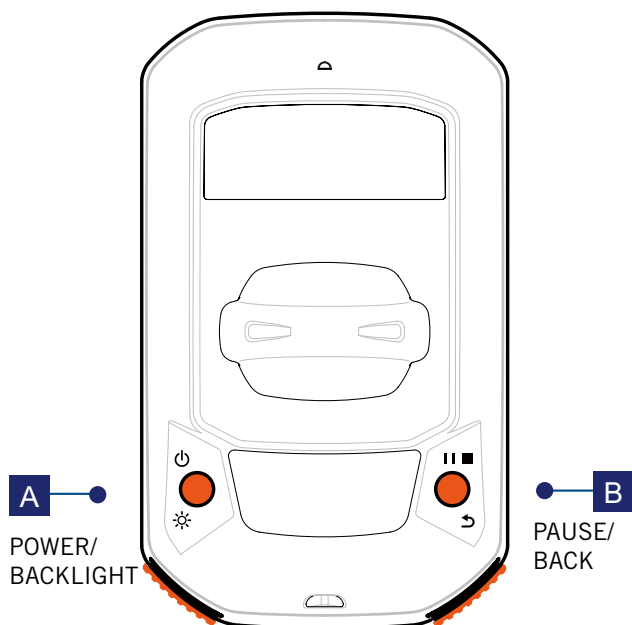

**A**  
POWER/  
BACKLIGHT

**B**  
PAUSE/  
BACK

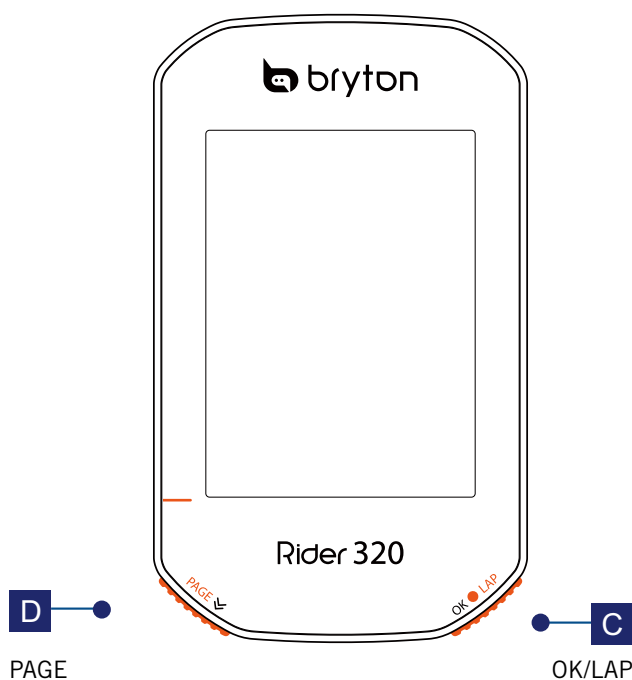

**D**  
PAGE

**C**  
OK/LAP

### **A** Power/Backlight ( )

- Press to turn the device on.
- Press to turn on/off the backlight while the device is on.
- Long press to turn the device off .

### **B** BACK ( )

- In Cycling mode, press to enter Menu page.
- In Menu, press to return to the previous page or cancel an operation.
- When recording, press to pause recording and enter the Menu.

### **C** OK/LAP( )

- In Menu, press to enter submenu or confirm a selection.
- In Cycling mode, press to start recording. When recording, press to mark the lap.

### **D** PAGE ( )

- In Cycling mode, press to switch meter screen pages.
- In Menu, press to scroll through the menu options.

# Accessories









The Rider 320 comes with the following accessories:









- USB cable
- Bike mount

Optional items:

- Smart Heart Rate Sensor
- Smart Speed Sensor
- Smart Cadence Sensor
- Smart Speed / Cadence Dual Sensor
- Race Mount-Rider
- Sport Mount

## Status Icons

Icon	Description
<b>Bike Type</b>	
	Bike 1
	Bike 2
<b>GPS Signal Status</b>	
	No signal (bot fixed)
	Weak signal
	Strong signal
<b>Power Status</b>	
	Full battery
	Half battery
	Low battery

Icon	Description
	Heart Rate Sensor is active
	Cadence Sensor is active
	Speed Sensor is active
	Dual Sensor is active
	Power Meter is active
	Log Record in progress
	Recording is paused
	Current speed is faster/slower than average speed.

**NOTE:** Only the active icons are displayed on the screen.

# Step 1: Charge your Rider 320

Connect Rider 320 to a PC to charge the battery for at least 4 hours. Unplug the device when it is fully charged.

- You may see a white screen when the battery is really low. Keep the device plugged for several minutes, it will automatically turn-on after battery is properly charged.
- The temperature suitable for charging battery is 0°C~40°C. Beyond this temperature range, charging will be terminated and the device will draw power from battery.

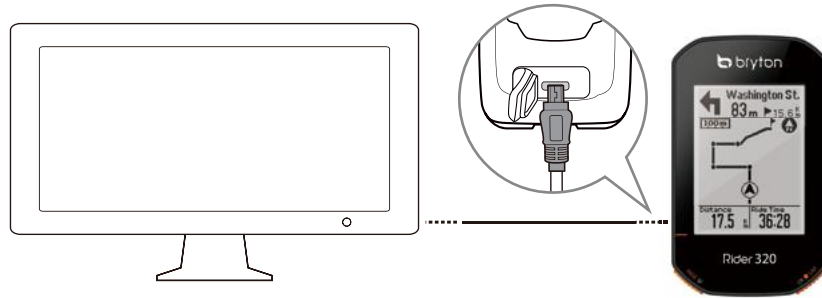

# Step 2: Turn On Rider 320

Press  to turn on the device.

# Step 3: Initial Setup

When turning Rider 320 on for the first time, you will need to follow on screen instructions to complete setup.

1. Select the display language.
2. Select the unit of measurement.

## NOTE:



- Only when you choose English for the display language, you will need to select the unit of measurement. Otherwise, default would be metric unit.
- To change the device language, pair your device with the Bryton Active App and in the app navigate to Settings > General > System Language. For more information on changing device language, please refer to page 32.

## Step 4: Acquire Satellite Signals

Once the Rider 320 is turned on, it will automatically search for satellite signals. It may take 30 to 60 seconds to acquire signals. Please make sure you acquire the satellite signal for the first time use.

The GPS signal icon (  /  ) appears when GPS is fixed.

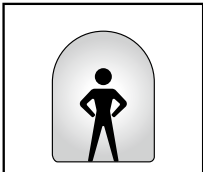
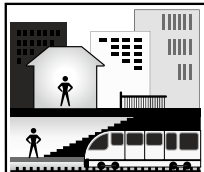
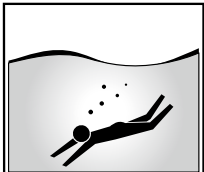
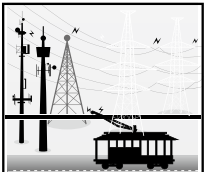
- If the GPS signal is not fixed, an  icon appears on the screen.
- Please avoid the obstructed environments since they might affect the GPS reception.

				
Tunnels	Inside rooms, building, or underground	Under water	High-voltage wires or television towers	Construction sites and heavy traffic



**NOTE:** To improve the GPS accuracy, you can set 1 sec mode as your recording frequency ([page 17](#)).

## Step 5: Ride Your Bike with Rider 320

### • Free ride:



In meter view, measurement starts and stops automatically in sync with the movement of the bicycle.

### • Start an exercise and record your data:

In meter view, press  to start recording, press  to pause recording and enter the Menu. Then, choose  to save your workout data.

**NOTE:** If you continue to proceed without pressing  to record, Rider 320 would pop up a reminder to ask you to record when motion of bike is detected. To set the frequency of start reminder, please go to [page 24](#).

## Reboot Rider 320

To reboot the Rider 320, press two keys (  /  ) at the same time.

# Share Your Records

## Upload Your Tracks to Brytonactive.com

1. Sign up/log in Brytonactive.com
  - a. Go to <https://active.brytonsport.com>.
  - b. Register a new account or use your current account to log in.
2. **Connect to PC**

Turn on your Rider 320 and connect it to your computer by USB cable.
3. **Share Your Records**
  - a. Click "+" on the upper right corner.
  - b. Drop FIT, BDx, GPX file(s) here or Click "Select files" to upload tracks.
  - c. Click "Activities" to check uploaded tracks.

## Share Your Tracks to Strava.com

1. **Sign up/log in on Strava.com**
  - a. Go to <https://www.strava.com>.
  - b. Register a new account or use your current account to log in.
2. **Connect to PC**

Turn on your Rider 320 and connect it to your computer by USB cable.
3. **Share Your Records**
  - a. Click "+" on the top right corner of Strava page and then click "File".
  - b. Click "Select Files" and select FIT files from Bryton device.
  - c. Enter information about your activities and then click "Save & View".



# Auto Sync Tracks to Bryton Active App

No more uploading tracks manually after riding. Bryton Active App automatically syncs your track after pairing with your GPS device.

a. Scan QR code below to download Bryton Active App or go to Google Play/App Store to search Bryton Active App. Then, log in or create an account.



<http://download.brytonsport.com/inst.html>



b. Go to Settings>Device Manager>"+">Rider 320 to add your GPS device.

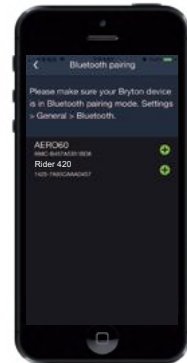

c. Check if UUID shown on app is the same as your device. Add "Yes" to confirm adding. If it is wrong UUID, press NO to add it again.

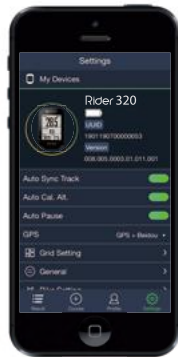
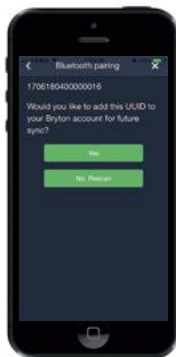

**Note:** Each device has its own unique UUID. You can find it on the back of the device.

d. Successfully added ! Turn on Auto Now, new tracks will be automatically uploaded to Bryton Active App.

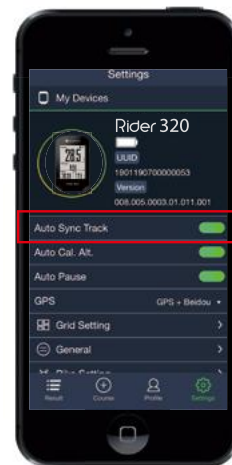

**NOTE:** Bryton Active App syncs with Brytonactive.com. If you already have brytonactive.com account, please use the same account to log in to Bryton Active App and vice versa.

# Bryton Update Tool

Bryton Update Tool is the tool for you to update firmware.

1. Go to <http://www.brytonsport.com/#/supportResult?tag=BrytonTool> and download Bryton Update Tool.
2. Follow the on-screen instructions to install Bryton Update Tool.

## Update Firmware

Bryton releases a new firmware version on irregular basis to add new functions or correct bugs for better and more stable performance. It is recommended that you update firmware once new firmware available. Firmware updates usually take longer to download and install. Do not remove USB cable during firmware updating.

# View History

You can view exercise record on your device right after your ride, and delete any unwanted record to gain more storage.

## View Exercise/Training Record

Rider 320 provides graphical track summary, detail workout data, lap data and graphical analysis for you to have a better idea of your workout performance.

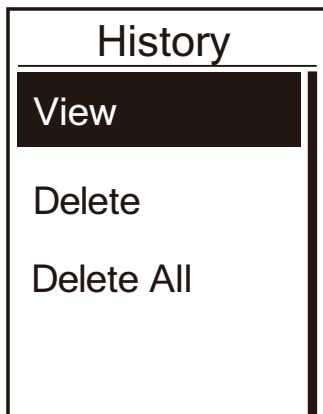

To view your history:

1. In the main screen, press **PAGE** to select **View History** and press **OK** to enter.
2. Press **OK** to enter **View**.
3. Press **PAGE** to select a record and press **OK** to view more detail info.

**NOTE:** You can also upload your history to [brytonactive.com](http://brytonactive.com) or Bryton Active App to keep track of all your ride data.

## Delete History



To delete your history:

1. In the main screen, press **PAGE** to select **View History** and press **OK** to enter.
2. Press **PAGE** to select **Delete** and press **OK** to enter.
3. Press **PAGE** to select a record and press **OK** to delete the selected history.
4. A “Backup data to web first. Delete ?” message appears on the screen. To delete the data, press **PAGE** to select **Yes** and press **OK** to confirm.

# History Flow

ride = Ride Time

09/19 21:44	⬆️
00:02:25	ride
3.69	km
39	kcal
04	laps
<b>More</b>	1/20

Record#/Total records

AVG	MAX	
75.6	75.6	kmh
39	39	bpm
19	19	rpm

The arrow appears only when there is lap in this record..

Lap 01	00:49
0.25	km
81.4	kmh
13	kcal
0	bpm
0	rpm

# Settings

In Settings, you can customize Exercises settings, GPS system, General settings, Sensor settings, Altitude, Bike and User profile. You can also customize most used device settings via Bryton Active App.

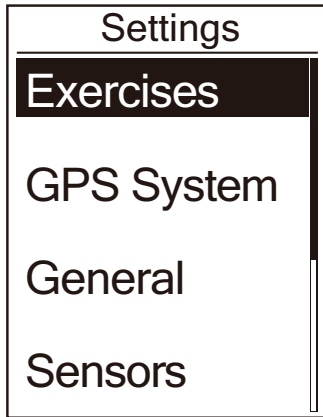

1. In the main screen, press **PAGE** to select **Settings**.
2. Press **OK** to enter **Settings** menu.

## Data Page

You can set the display settings for the Meter and Lap or you can customize data page via Bryton Active App. Please refer to [page 32](#) to learn how to do it.

### Meter Display

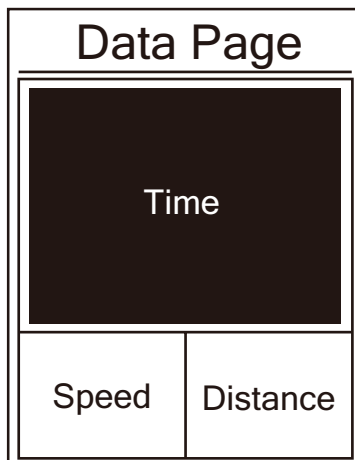

3-grid display

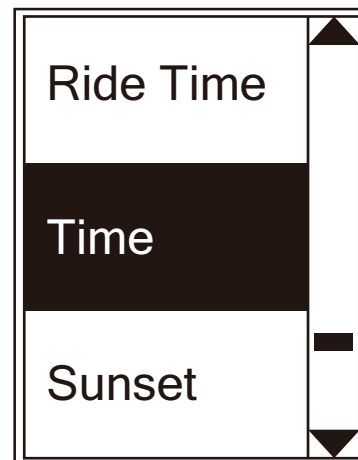

Item selection

1. In the Settings menu, press **OK** to enter **Exercises** and press **OK** again to enter **Data Page**.
2. Press **OK** to enter **Data Page** and change **Auto** to **Manual** and press **OK** to confirm selection.
3. Press **PAGE** to select **Data Page** and press **OK** to enter.
4. Press **PAGE** to select **Data Page 1**, **Data Page 2**, **Data Page 3**, **Data Page 4** or **Data Page 5** and press **OK** to enter the selected page.
5. Press **PAGE** to select the number of **Data Fields** you need and press **OK** to confirm.
6. Press **PAGE** to select the data you would like to make change and press **OK** to confirm.
7. Press **PAGE** to select the desired **Category** and press **OK** to confirm.
8. Press **PAGE** to select the desired data and press **OK** to confirm.
9. Press **EXIT** to exit this menu.

**NOTE:** The number of data fields shown on the screen depends on the “Data fields” selection.



2-grid display



3-grid display

**NOTE:** If Data Page is set to **Auto**, Rider 320 will automatically adjust its data field display when detecting the paired sensors.

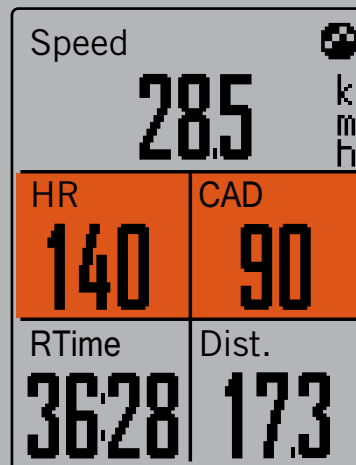

## Lap Display

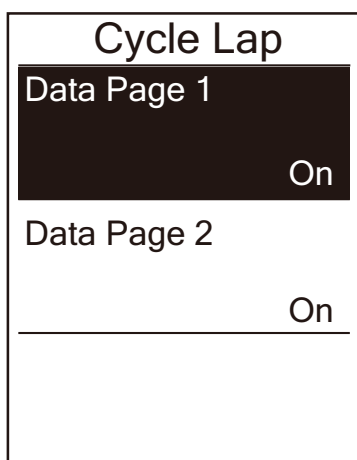

1. In the Settings menu, press **OK** ●LAP to enter **Exercises > Data Page**.
2. Press **PAGE** ∨ and then **OK** ●LAP to enter **Lap**.
3. Press **OK** ●LAP to enter **Data Fields**.
4. Press **PAGE** ∨ to select the number of **Data Fields** you need and press **OK** ●LAP to confirm.
5. Press **PAGE** ∨ to select the data you would like to make change and press **OK** ●LAP to confirm.
6. Press **PAGE** ∨ to select the desired **Category** and press **OK** ●LAP to confirm.
7. Press **PAGE** ∨ to select the desired data and press **OK** ●LAP to confirm.
8. Press **↩** ||■ to exit this menu.

# Smart Lap

With Smart Lap feature, you can use your device to automatically mark the lap at a specific location or after you have traveled a specific distance.

## Lap by Location

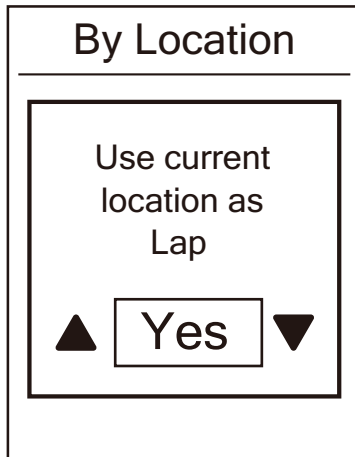

1. In the Settings menu, press **OK** ●LAP to enter **Exercises**. Press **▶||■** and then **OK** ●LAP to select **Smart Lap**.
2. Press **OK** ●LAP to enter editing menu. Press **▶||■** to select **Location** and press **OK** ●LAP to confirm.
3. A “ Use current location as Lap” message pops up on the screen. Press **OK** ●LAP to confirm this setting.
4. Press **▶||■** to exit this menu.

**NOTE:** If the GPS signal is not fixed, a “No GPS Signal. Searching GPS, please wait” message appears on the screen. Check if GPS is on and make sure you step outside to acquire signal.

## Lap by Distance

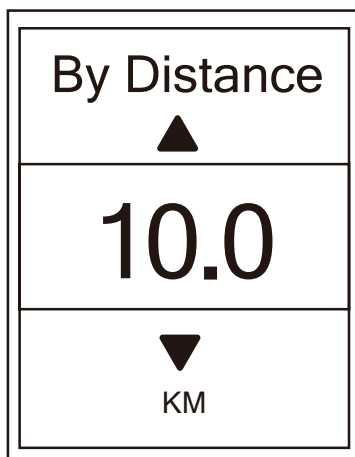

1. In the Settings menu, press **OK** ●LAP to enter **Exercises**. Press **▶||■** and then **OK** ●LAP to select **Smart Lap**.
2. Press **OK** ●LAP to enter editing menu. Press **PAGE** ∨ to select **Distance** and press **OK** ●LAP to confirm.
3. Press **PAGE** ∨ to select your desired distance and press **OK** ●LAP to confirm.
4. Press **▶||■** to exit this menu.

# Set Alert

With the Alert feature, the device displays a message to notify you if:

- your heart rate exceeds or drops below a specific number of beats per minute (bpm).
- you exceeds or drop below a custom speed setting during your ride.
- your cadence speed exceeds or drops below a specific number of revolutions of the crank arm per minute (rpm).
- you reach a certain amount of distance for the long workouts.
- you reach a certain amount of time for the long workouts.

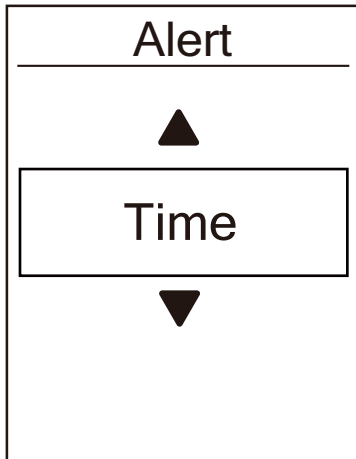

1. In the Settings menu, press **OK** ● **LAP** to enter **Exercises**. Press **PAGE** ⌵ and then **OK** ● **LAP** to select **Alert**.
2. Press **OK** ● **LAP** to enter editing menu. Press **PAGE** ⌵ to select **Time, Distance, Speed, HR, or Cadence** and press **OK** ● **LAP** to configure the necessary settings.
3. Press **PAGE** ⌵ to select your desired settings and press **OK** ● **LAP** to confirm.
4. Press **↩** ■ to exit this menu.

# Smart Pause

When you have a lot of obstacles along your route such as traffic lights, crosswalk, etc., this can really impact your recorded data. When the function is activated, the time and distance will automatically pause once you stop moving and resume once you start riding to enhance your data efficiency.

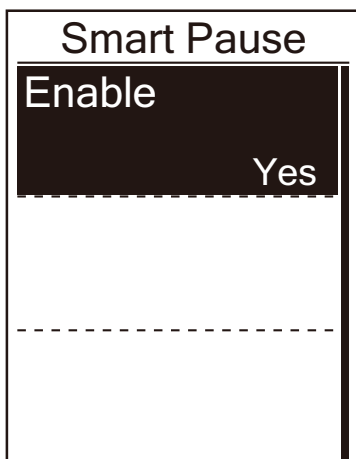

1. In the Settings menu, press **OK** ● **LAP** to enter **Exercises**. Press **PAGE** ⌵ and then **OK** ● **LAP** to select **Smart Pause**.
2. Press **OK** ● **LAP** to enter submenu and press **PAGE** ⌵ to select **Yes** and press **OK** ● **LAP** to confirm.
3. Press **↩** ■ to exit this menu.



# Data Record

With Data Record function, you can set your odometer and activate 1 second mode to get more accurate data.

## Set ODO

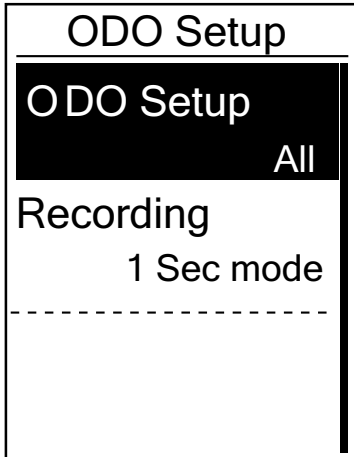

1. In the Settings menu, press **OK** ●LAP to enter **Exercises**. Press. **PAGE** ∨ and then **OK** ●LAP to select **Data Record**.
2. Press **OK** ●LAP to enter **ODO Setup** and press **PAGE** ∨ to select desired setting and press **OK** ●LAP to confirm.
3. Press **↵** ■■ to exit this menu.

**NOTE:** **ALL** means the odometer would show the cumulative distance of all trips; **Recorded** would only show the cumulative distance of recorded trips.

**NOTE:** If you would like to reset ODO, please refer to [page 31: Reset ODO](#).

## Enable 1sec Mode

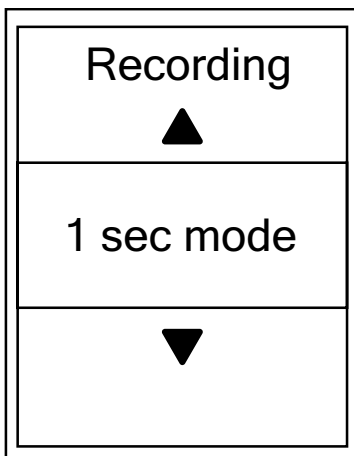

1. In the Settings menu, press **OK** ●LAP to enter **Exercises**. Press. **PAGE** ∨ and then **OK** ●LAP to select **Data Record**.
2. Press **PAGE** ∨ and then press **OK** ●LAP to enter **Recording**.
3. Press **PAGE** ∨ to select 1 sec mode and press **OK** ●LAP to confirm.
4. Press **↵** ■■ to exit this menu.

# GPS System

Rider 320 has full GNSS (Global Navigation Satellite System) support including GPS , GLONASS (Russia), BDS (China), QZSS (Japan) and Galileo (EU). You can select the suitable GPS Mode according to your location to enhance accuracy or suit your needs.

## Choose Different Satellite Navigation System

This setting allows you to switch between different satellite navigation systems to suit you best.

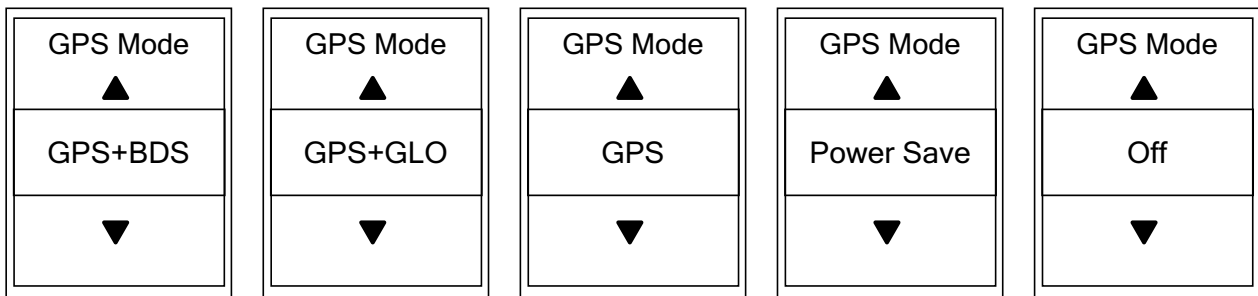

1. In the Settings menu, press **PAGE** and then press **OK** to select **GPS System**.
2. Press **OK** to enter **GPS Mode**.
3. In the GPS Mode menu, press **PAGE** to select the desired GPS mode and press **OK** to confirm.
  - **GPS+Beidou** : GPS + BeiDou Navigation Satellite System.  
By April 2018, BeiDou is offering service in the Asia-Pacific region. Choose this combination if you're in this region for best accuracy.
  - **GPS+Glonass** : GPS + GLONASS Navigation Satellite System.  
Glonass is the second navigational system working with global coverage and of comparable precision. Choose this combination if you're in NON Asia-Pacific region for best accuracy.
  - **GPS+Gal+QZ** : GPS+Galileo+QZSS Navigation Satellite System.  
Consume less power than the two selection above, with sufficient accuracy for normal use.
  - **Power Save** : Trade-off accuracy to achieve maximum battery life. Use this mode in open sky.
  - **Off** : Turn-off GPS function. Choose this to save power when GPS signal is not available, or when GPS information is not required (such as indoor use).
4. Press **ESC** to exit this menu.

### NOTE:

- Enabling either GLONASS or BDS also activates GPS, QZSS and Galileo satellite navigation system
- To view step by step tutorial video, please click [How To Change GPS System](#).

# Change System Settings

You can customize the device system setting such as backlight off, key tone, sound, time/unit, on-screen display language.

## Backlight off

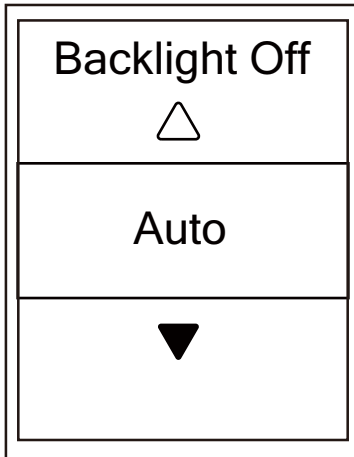

1. In the Settings menu, press **PAGE** and then press **OK** to select **General**.
2. Press **OK** to enter **System**.
3. Press **OK** to enter **Backlight Off**.
4. Press **PAGE** to select desired setting and press **OK** to confirm.
5. Press **ESC** to exit this menu.

## Key Tone

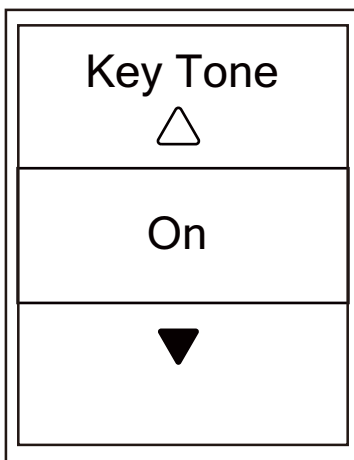

1. In the Settings menu, press **PAGE** and then press **OK** to select **General**.
2. Press **OK** to enter **System**.
3. Press **PAGE** to select **Key Tone** and press **OK** to confirm.
4. Press **ESC** to exit this menu.

## Sound

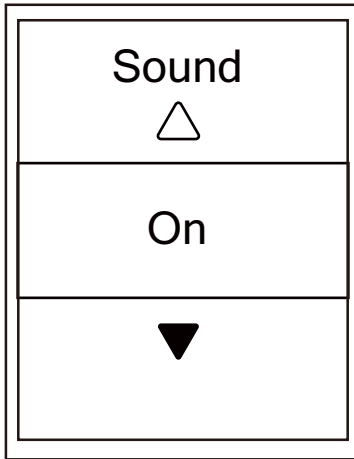

1. In the Settings menu, press **PAGE** and then press **OK** to select **General**.
2. Press **OK** to enter **System**.
3. Press **OK** to select **Sound** and press **OK** to confirm.
4. Press **PAGE** to select desired setting and press **OK** to confirm.
5. Press **➔** to exit this menu.

## Time/Unit

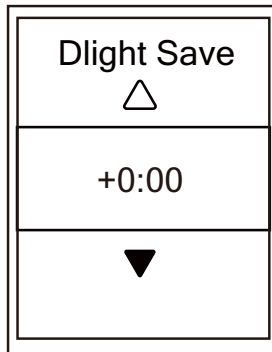

Daylight Save

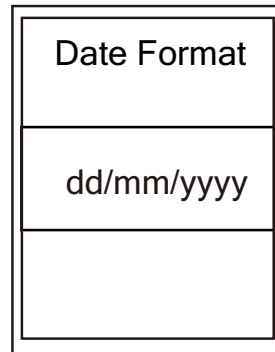

Date format

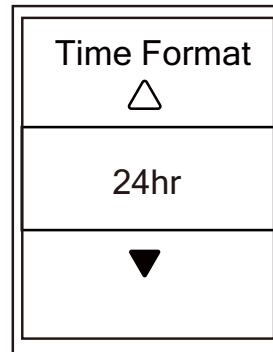

Time format

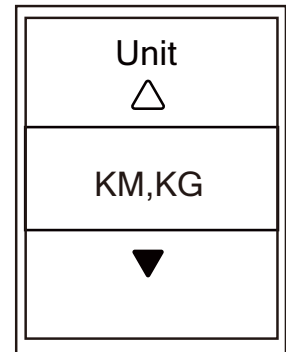

Unit

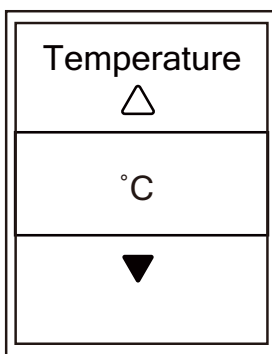

Temperature

1. In the Settings menu, press **PAGE** and then press **OK** to select **General**.
2. Press **OK** to enter **System**.
3. Press **PAGE** to select **Time/Unit** and press **OK** to confirm.
4. Press **PAGE** to select setting you would like to edit and press **OK** to confirm.
5. Press **PAGE** to select the desired setting/format and press **OK** to confirm.
6. Press **➔** to exit this menu.

# Contrast

You can adjust contrast on your device.

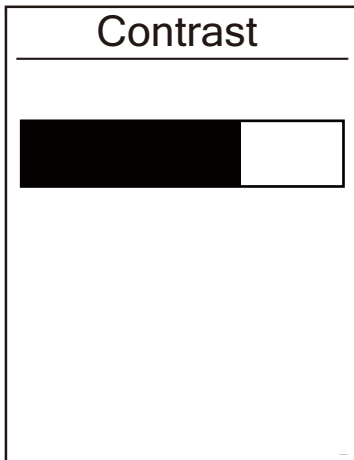

1. In the Settings menu, press **PAGE** ⌵ and then press **OK** ● **LAP** to select **General**.
2. Press **OK** ● **LAP** to enter **System**.
3. Press **PAGE** ⌵ to select **Contrast** and press **OK** ● **LAP** to confirm.
4. Press **PAGE** ⌵ to adjust desired contrast.
5. Press **↩** ■ to exit this menu.

# Bluetooth

Before pairing Rider 320 with your bluetooth enabled mobile phone, make sure the bluetooth function of your mobile phone and Rider 320 is turned on.

## Enable Bluetooth

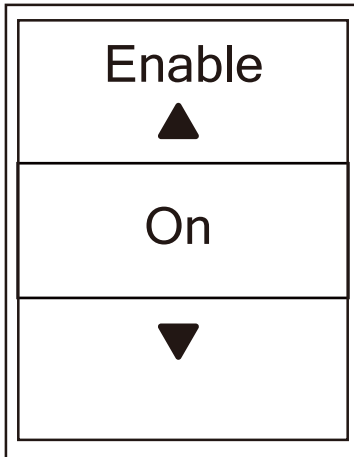

1. In the Settings menu, press **PAGE** ⌵ and then press **OK** ● **LAP** to select **General**.
2. Press **PAGE** ⌵ to select **Bluetooth** and press **OK** ● **LAP** to confirm.
3. Press **PAGE** ⌵ to turn on/off bluetooth.
4. Press **➔** ■■ to exit this menu.

# Configure Auto Scroll

When the feature is enabled, the device will automatically switch pages at the preset time.

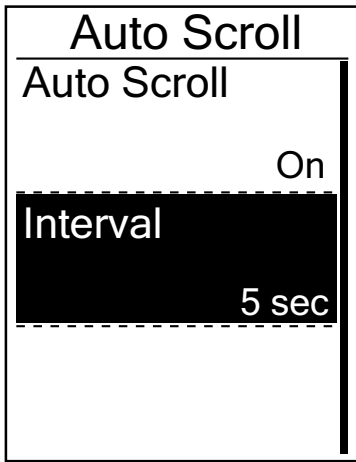

1. In the Settings menu, press **PAGE** and then press to select **General**.
2. Press **PAGE** to select **Auto Scroll** and press **OK** to confirm.
3. Press **PAGE** to select the setting that you want to change and press **OK** to enter its submenu.
  - Auto scroll: enable/disable the auto switch.
  - Interval: set the interval time.
4. Press **ESC** to exit this menu.

# Enable File Saving Mode

When the feature is enabled, the device will automatically overwrite from your oldest records when memory storage is full.

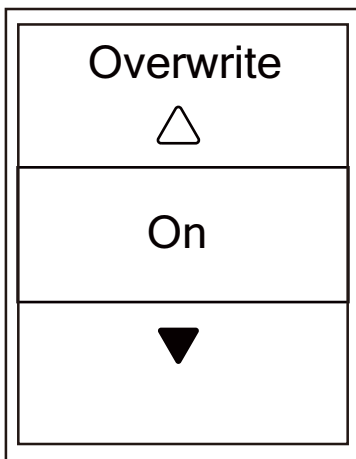

1. In the Settings menu, press **PAGE** and then press **OK** to select **General**.
2. Press **PAGE** to select **File Saving** and press **OK** to confirm.
3. Press **PAGE** to select **“On”** to enable device to overwrite history.
4. Press **ESC** to exit this menu.

# Start Reminder

When Rider 320 detects the motion of your bike, it would pop up a reminder to ask you if you would like to record or not. You can set the frequency of start reminder.

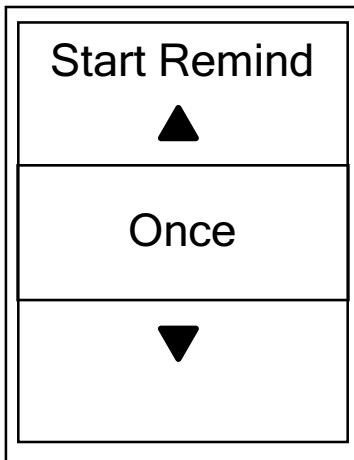

1. In the Settings menu, press **PAGE** and then press **OK** to select **General**.
2. Press **PAGE** to select **Start Remind** and press **OK** to confirm.
3. Press **PAGE** to select desired setting and press **OK** to confirm.
4. Press **➔** to exit this menu.

# View Memory Usage

View the storage status of the device.

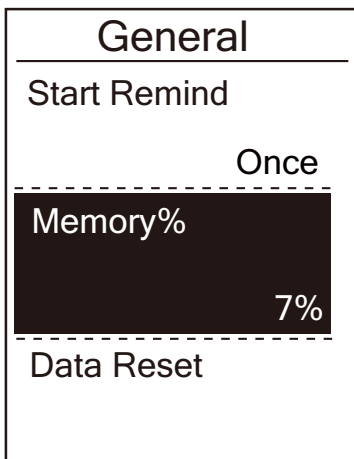

1. In the Settings menu, press **PAGE** and then press **OK** to select **General**.
2. Press **PAGE** to select **Memory** and press **OK** to confirm. The storage status is displayed on the screen.
3. Press **➔** to exit this menu.



# Reset Data

You can restore your Rider 320 to factory settings.

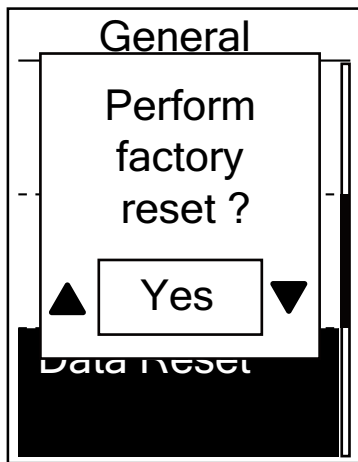

1. In the Settings menu, press **PAGE** and then press **OK** to select **General**.
2. Press **PAGE** to select **Data Reset** and press **OK** to confirm.
3. Press **PAGE** to select **“YES”** and press **OK** to confirm factory reset.
4. Press **➔** to exit this menu.

**NOTE:** Factory reset operation will restore device to factory default settings. In addition to deleting all the tracks, it will also delete pre-paired sensors but will not remove UUID from the account you added in.

# View Firmware Version

You can view your device current firmware version.

1. In the Settings menu, press **PAGE** and then press **OK** to select **General**.
2. Press **PAGE** to select **About** and press **OK** to confirm.  
Current firmware version is displayed in the screen.
3. Press **➔** to exit this menu.

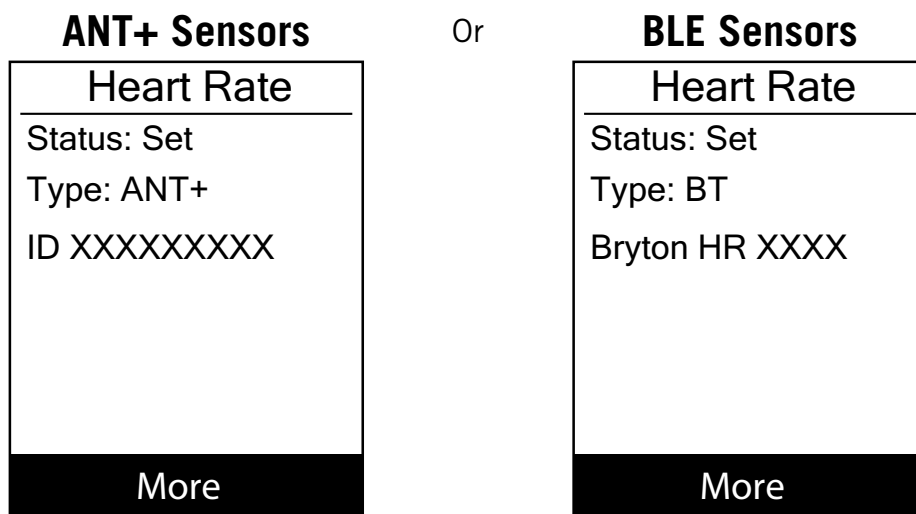
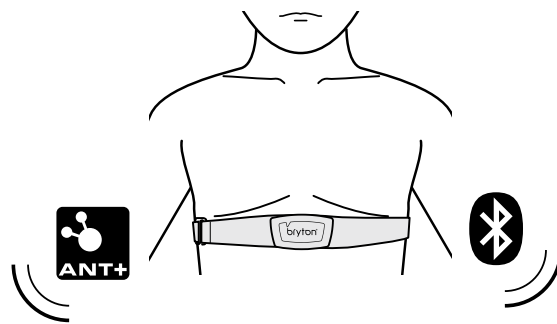
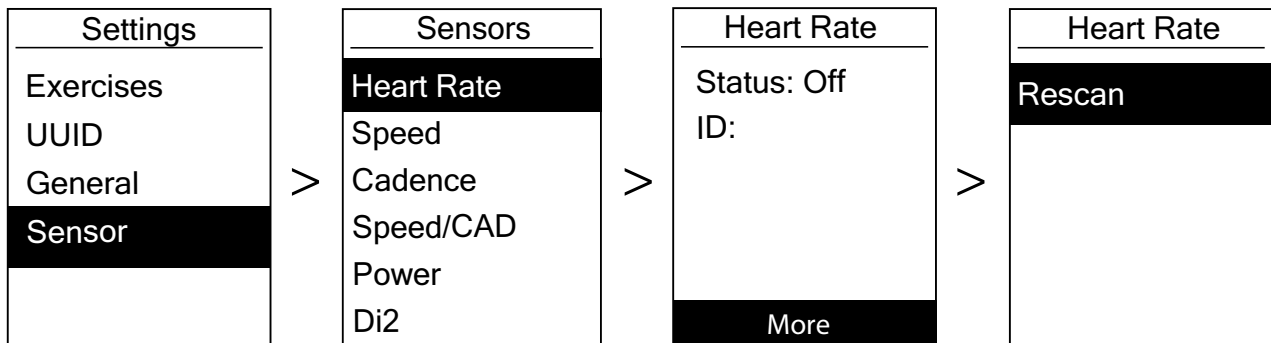

# ANT+/ BLE Sensors

Rider 320 is compatible with both ANT+ and BLE sensors. You can customize the respective sensor settings such as rescan the sensor to pair with your device or enable/disable the function.



1. In the Settings menu, press **PAGE** to select **Sensor** and press **OK** to confirm.
2. Press **PAGE** to select **Heart Rate, Speed, Cadence, Speed/CAD** or **Power Meter** and press **OK** to confirm selection.
3. To pair sensors with your device, please have the Bryton Smart sensors installed first, wearing the Heart Rate sensor or rotating the crank and wheel a few times to wake up the Bryton Smart Sensors.
4. Press **OK** to enter submenu. Press **PAGE** to select desired setting and press **OK** to confirm.
  - **Rescan:** rescan to detect the sensor for pairing with your device.
  - **Turn on / Turn off:** enable / disable the sensor.
5. Press **ESC** to exit this menu.

**NOTE:**

- Please refer to [page 39-40](#) for sensors installation.
- While pairing your speed/cadence sensor/the heart rate belt and power meter, please make sure there is no other cadence/speed sensor/power meter within 5m.
- Bryton smart sensors can only be paired when they are awake, or they would go back to sleep to preserve power.
- When the heart rate monitor is paired, the ,  heart rate icon appears on the main screen. When cadence sensor is paired, the cadence sensor icon  appears on the main screen.
- After pairing, your Bryton devices automatically connect to Bryton Smart Sensors each time when the sensors are awake.

**NOTE:**

Rider 320 provides 2 bike profiles. Each profile has its respective sensor setting. Simply activate the bike you choose you ride in Bike Profile setting and you are ready to go. Please refer to [page 30](#) to learn how to activate the bike.

# Altitude

After receiving GPS signal, the Rider 320 will calibrate altitude automatically based on GPS altitude data. You can also set the altitude setting for the current location and four other locations manually.

## Current Altitude

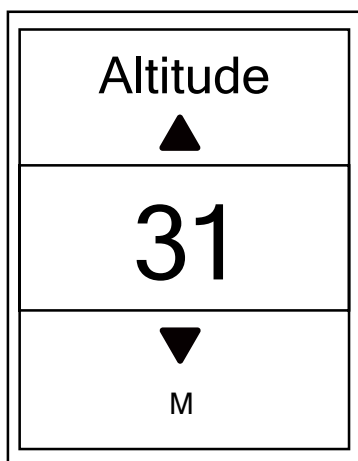

1. In the Settings menu, press **PAGE** and then press **OK** to select **Altitude**.
2. Press **OK** to enter **Altitude**.
3. Press **PAGE** to adjust value of current altitude and press **OK** to confirm.
4. Press **ESC** to exit this menu.

**NOTE:** The value of altitude on the meter mode will be changed once current altitude is adjusted.

**NOTE:** Current Altitude can also be adjusted via Bryton Active App. Please go to [page 33](#) to learn how to calibrate altitude.

## Other Location Altitude

With other locations altitude setting, you can save a value of altitude of your planned location, and do calibration once you are in the appointed position.

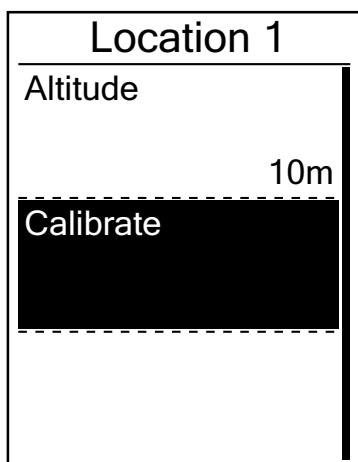

1. In the Settings menu, press **PAGE** and then press **OK** to select **Altitude**.
2. Press **PAGE** to select **Location 1**, **Location 2**, **Location 3**, **Location 4** or **Location 5** and press **OK** to enter.
3. To set altitude of the location, press **OK** to enter **Altitude**.
4. Press **PAGE** to adjust value of altitude and press **OK** to save.
5. To calibrate the set altitude, press **PAGE** to select **Calibrate** and press **OK** to confirm.
6. Press **ESC** to exit this menu.

# Persnalize User Profile

You can change your personal information.

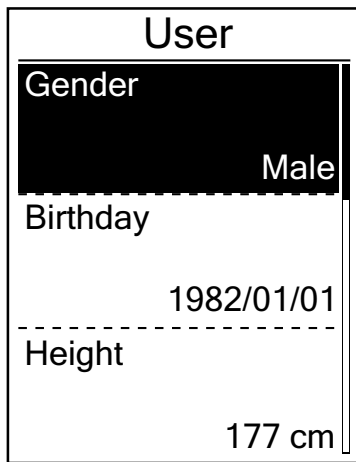

The screenshot shows a menu titled "User" with three sections: "Gender" with the value "Male", "Birthday" with the value "1982/01/01", and "Height" with the value "177 cm".

1. In the Settings menu, press **PAGE** ⌵ and then press **OK** ● **LAP** to select **Profile**.
2. Press **OK** ● **LAP** to enter **User Profile**. A message of "Input correct profile as it might affect analysis." pops up. Press **OK** ● **LAP** to confirm after reading message.
3. Press **PAGE** ⌵ to select setting that you want to edit and press **OK** ● **LAP** to enter its submenu.
  - Gender : select your gender.
  - Birthday: set your Birthday.
  - Height: set your height.
  - Weight: set your weight.
  - Max HR: set your maximum heart rate.
  - LTHR: set your lactate threshold heart rate.
  - FTP: set your functional threshold power.
  - MAP: set your maximum aerobic power.
4. Press **PAGE** ⌵ to select the desired setting and press **OK** ● **LAP** to confirm.
5. Press **➔** **||||** to exit this menu.

**NOTE:** Please enter correct personal information since it might affect analysis.

# Personalize Bike Profile

You can customize and view your bicycle(s) profile.

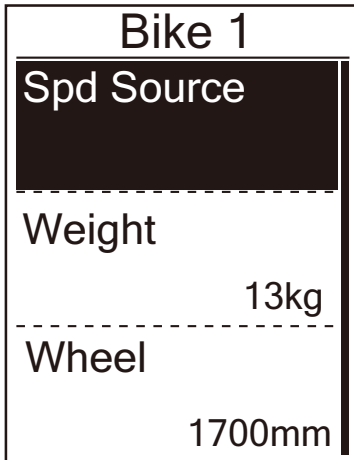

1. In the Settings menu, press **PAGE** and then press **OK** to select **Profile**.
2. Press **OK** to select **Bike Profile** and press **OK** to enter.
3. Press **PAGE** to select setting that you want to edit and press **OK** to enter its submenu.
  - Spd Source: set the priority of the speed sources
  - Weight: set the bike weight.
  - Wheel: set the bike wheel size.
  - Activate: select to activate the bike.
4. Press **PAGE** to adjust the desired setting and press **OK** to confirm.
5. Press **ESC** to exit this menu.

**NOTE:** For details on wheel size, see “Wheel Size and Circumference” on [page 41](#).

## View Bike Profile

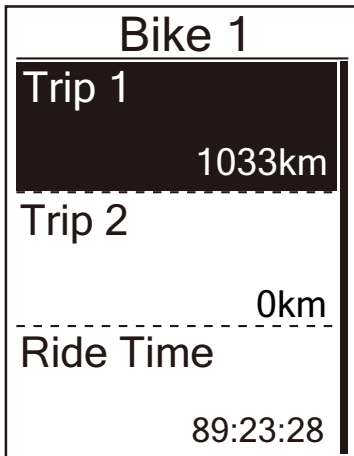

1. In the Settings menu, press **PAGE** and then press **OK** to select **Profile**.
2. Press **PAGE** to select **Bike Profile** and then press **OK** to enter.
3. Press **PAGE** to select **Overview** and press **OK** to enter its submenu.
4. Press **PAGE** to select your desired bike and press **OK** to confirm.
5. Press **PAGE** to view more data of the selected bike.
6. Press **ESC** to exit this menu.

## Adjust Odometer

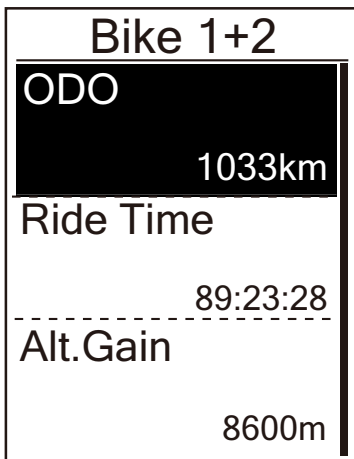

1. In the Settings menu, press **PAGE** and then press **OK** to select **Profile**.
2. Press **PAGE** to select **Bike Profile** and then press **OK** to enter.
3. Press **PAGE** to select **Overview** and press **OK** to enter its submenu.
4. Press **PAGE** to select **Bike 1+2** and press **OK** to confirm.
5. Press **OK** enter into ODO setting page.
6. Press **PAGE** to adjust ODO and press **OK** to confirm.
7. Press **➔** to exit this menu.

## Reset ODO

You can reset the distance of Trip 1, Trip 2 and odometer.

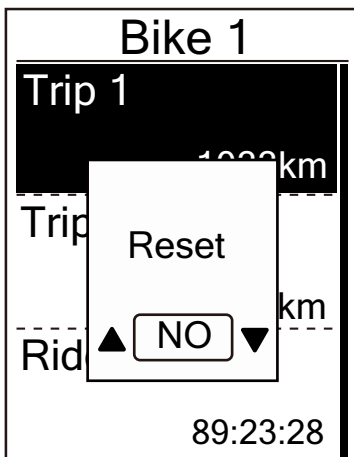

1. In the Settings menu, press **PAGE** and then press **OK** to select **Profile**.
2. Press **PAGE** to select **Bike Profile** and then press **OK** to enter.
3. Press **PAGE** to select **Overview** and press **OK** to enter its submenu.
4. Press **PAGE** to select the desired bike and press **OK** to confirm.
5. Press **PAGE** to select trip 1 or trip 2 and press **OK** to confirm.  
If you select Bike 1+2, please select ODO.
6. A message “Reset” pops up on the device. Press **PAGE** to select “YES” and press **OK** to confirm or press **PAGE** to set ODO to the desired number.
7. Press **➔** to exit this menu.

**NOTE:** Trip 1, Trip 2 means cumulative mileage recorded before you reset it. They are 2 separate distance measurements. You are free to use Trip 1 or Trip 2 to record, for example, weekly total distance and use another to record, for example, monthly total distance.

# Bryton Active App Advanced Settings

After pairing your Rider 320 with Bryton Active App, you will have access to System Language, Grid Setting, Altitude Calibration and Notifications.

## System Language

You can change device language via Bryton Active App.

1. Pair Rider 320 with Bryton Active App
2. Go to **Settings > General > System Language** in Bryton Active App.
3. Select your preferred language.
4. Rider 320 will reboot with the updated language settings

## Grid Setting

You can customize your data page manually.

1. Pair Rider 320 with Bryton Active App
2. Tap **Settings > Grid Setting** in Bryton Active App
3. Turn on your preferred pages and enter the page.
4. Tap < or > to change the number of grids.
5. Tap data grid to change ride data.

**NOTE:** To learn how to pair Rider 320 with Bryton Active App, please check page 9.



# Altitude Calibration

After receiving GPS signal, the Rider 320 will calibrate altitude automatically based on GPS altitude data. Altitude can also be changed manually or automatically updated by turning on the Auto Calibrate Altitude feature on the Bryton Active App.

1. Pair Rider 320 with Bryton Active App.

2-1. Calibrate Altitude Manually

- a. Select **Alt. Cal** in Bryton Active App.
- b. Bryton Active App will show the current location's altitude. Altitude can also be manually adjusted by pressing **PAGE** or tap on the number to input manually.
- c. Press **Calibrate** to make change as suggested.
- d. Press **OK** to calibrate altitude data on the device.

2-2. Auto Calibrate Altitude via Bryton Active App

- a. In Bryton Active App, select **Settings > Auto Cal. Alt.**

**NOTE:** To learn how to pair Rider 320 with Bryton Active App, please check page 9.

# Notifications

After pairing your compatible smartphone using Bluetooth Smart wireless technology with Rider 320 , you can receive phone call, text and email notifications on your Rider 320.

## 1. IOS Pairing

- a. Go to **Settings > General > Bluetooth** to turn on Bluetooth on Rider 320.
- b. Go to your phone **Settings > Bluetooth** and enable Bluetooth.
- c. Go to the Bryton Active app and choose **Settings > Device Manager > +** .
- d. Select and add your device by pressing **+**.
- e. Tap **Pair** to pair your device with your phone. (For iOS only).

### **NOTE:**

If notifications don't work, please go to your phone "Settings>Notifications" and check if you have allowed notifications in compatible messages and email apps or go to social applications and check if you have turned on notifications in your application settings.

## 1. Android Pairing

- a. Go to **Settings > General > Bluetooth** to turn on Bluetooth on Rider 320.
- b. Go to your phone **Settings > Bluetooth** and enable Bluetooth.
- c. Go to the Bryton Active app and choose **Settings > Device Manager > +** .
- d. Select and add your device by pressing **+**.

## 2. Allow Notification Access

- a. Tap "Settings>Notification".
- b. Tap "OK" to enter setting to allow Notification Access for Bryton app.
- c. Tap "Active" and select "OK" to allow notification access for Bryton.
- d. Go back to Notification settings.
- e. Select and enable In-coming Calls, Text Messages and Emails by tapping each item.

# Appendix

## Specifications

### Rider 320

Item	Description
Display	2.3" FSTN positive transfective dot-matrix LCD
Physical Size	49.9 X 83.9 X 16.9mm
Weight	67g
Operating Temperature	-10°C ~ 60°C
Battery Charging Temperature	0°C ~ 40°C
Battery	Li polymer rechargeable battery
Battery Life	35 hours with open sky
ANT+™	Featuring certified wireless ANT+™ connectivity. Visit <a href="http://www.thisisant.com/directory">www.thisisant.com/directory</a> for compatible products. 
GNSS	Integrated high-sensitivity GNSS receiver with embedded antenna
BLE Smart	Bluetooth smart wireless technology with embedded antenna; 2.4GHz band OdBm
Water Resistant	Water resistant to a depth of 1 meter for up to 30 minutes.
Barometer	Equipped with barometer

### Smart Speed Sensors

Item	Description
Physical size	36.9 x 34.8 x 8.1 mm
Weight	6 g
Water Resistance	Incidental exposure to water of up to 1 meter for up to 30 minutes.
Transmission range	3m
Battery life	Up to 1 year
Operating temperature	-10°C ~ 60°C
Radio frequency/protocol	2.4GHz / Bluetooth 4.0 and Dynastream ANT+ Sport wireless communications protocol.

#### NOTE:

Accuracy may be degraded by poor sensor contact, electrical, magnetic interference and distance from the transmitter.

To avoid magnetic interference, it is recommended that you change location, clean or replace chain.

## Smart Cadence Sensor

Item	Description
Physical size	36.9 x 31.6 x 8.1 mm
Weight	6 g
Water Resistance	Incidental exposure to water of up to 1 meter for up to 30 minutes.
Transmission range	3m
Battery life	Up to 1 year
Operating temperature	-10°C ~ 60°C
Radio frequency/protocol	2.4GHz / Bluetooth 4.0 and Dynastream ANT+ Sport wireless communications protocol

### NOTE:

Accuracy may be degraded by poor sensor contact, electrical, magnetic interference and distance from the transmitter.

## Smart Heart Rate Monitor

Item	Description
Physical size	63 x 34.3 x 15 mm
Weight	14.5 g (sensor) / 31.5g (strap)
Water Resistance	Incidental exposure to water of up to 1 meter for up to 30 minutes.
Transmission range	3m
Battery life	Up to 2 years
Operating temperature	0°C ~ 50°C
Radio frequency/protocol	2.4GHz / Bluetooth 4.0 and Dynastream ANT+ Sport wireless communications protocol

### NOTE:

Accuracy may be degraded by poor sensor contact, electrical, magnetic interference and distance from the transmitter.

## Battery Information

### Smart Speed Sensor and Smart Cadence Sensor

Both sensors contain a user-replaceable CR2032 battery.

Before using sensors:

1. Locate the circular battery cover on the back of sensors.
2. Use your finger to press and twist cover counter-clockwise so the indicator on the cover points to unlock icon (🔓).
3. Remove the cover and battery tab.
4. Use your finger to press and twist cover clockwise so the indicator on the cover points to locked icon (🔒).

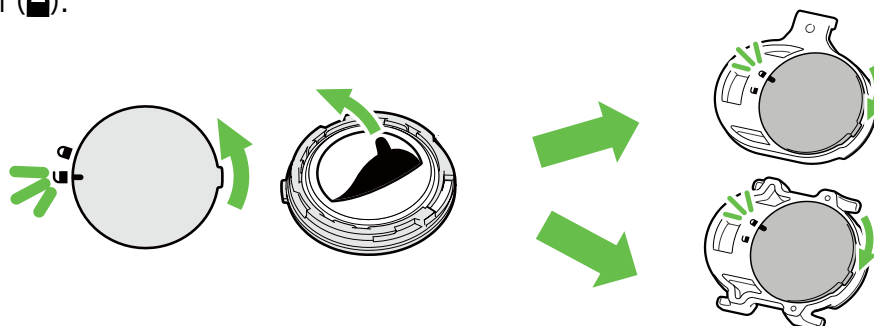

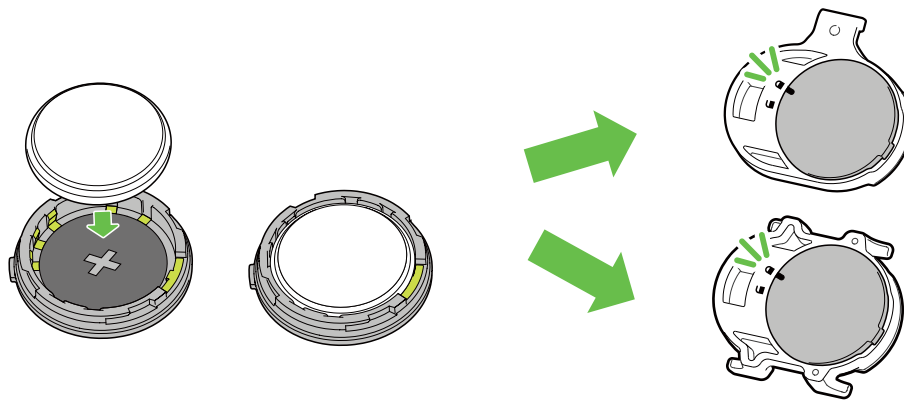

To replace the battery:

1. Locate the circular battery cover on the back of sensors.
2. Use your finger to press and twist cover counter-clockwise so the indicator on the cover points to unlock icon (🔓).
3. Remove the battery and insert new battery with positive connector first into the battery chamber.
4. Use your finger to press and twist cover clockwise so the indicator on the cover points to locked icon (🔒).

**NOTE:**

- When installing a new battery, if the battery is not placed with the positive connector first, the positive connector will easily deform and malfunction.
- Be careful not to damage or lose the O-ring gasket on the cover.
- Contact your local waste disposal department to properly dispose of used batteries.

## Smart Heart Rate Monitor

The heart rate monitor contains a user-replaceable CR2032 battery.

To replace the battery:

1. Locate the circular battery cover on the back of the heart rate monitor.
2. Use a coin to twist the cover counter-clockwise.
3. Remove the cover and battery.
4. Insert the new battery, with the positive connector facing upward and lightly press it.
5. Use a coin to twist the cover clockwise.

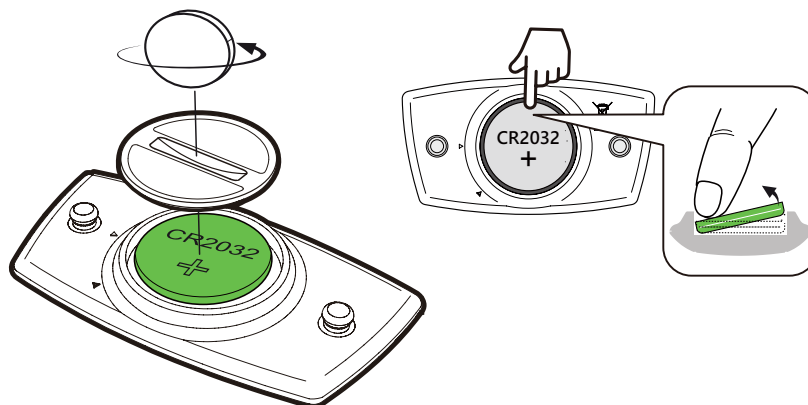

**NOTE:**

- Be careful not to damage or lose the O-ring gasket.
- Contact your local waste disposal department to properly dispose of used batteries.

# Install Rider 320

## Use Bike Mount to Mount Rider 320

1

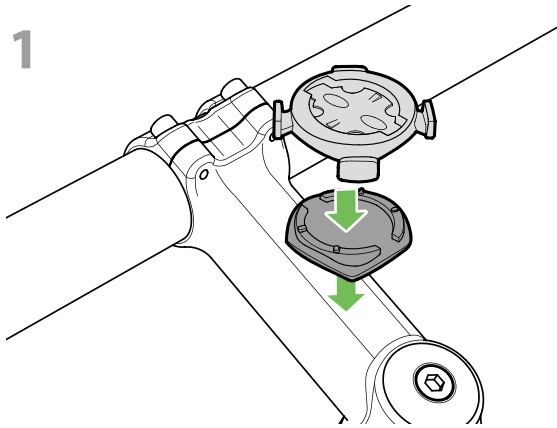

2

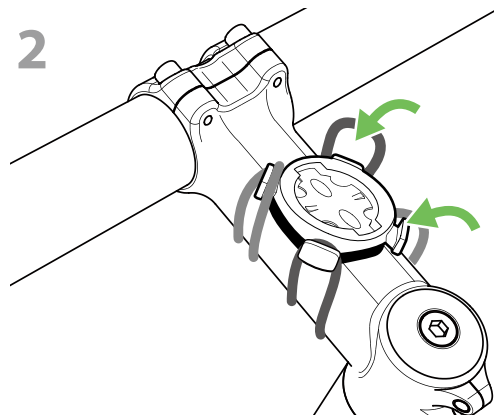

3

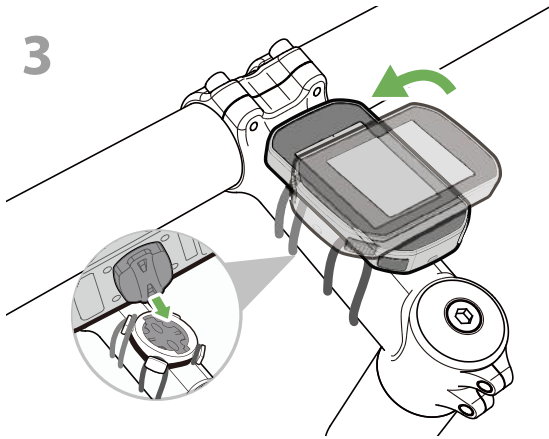

4

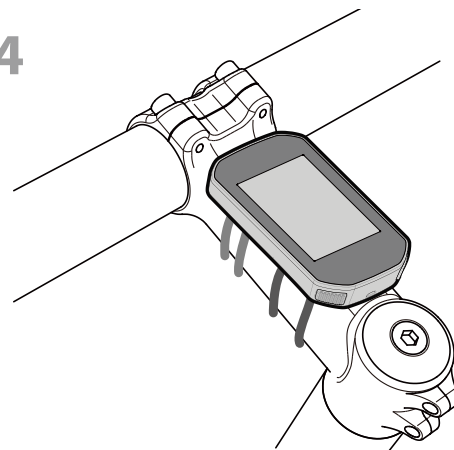

### (Optional)

1

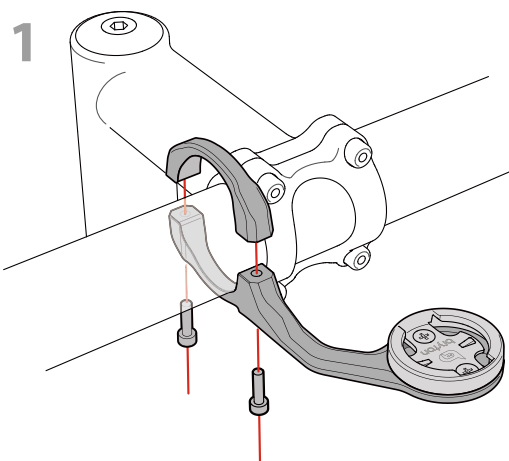

2

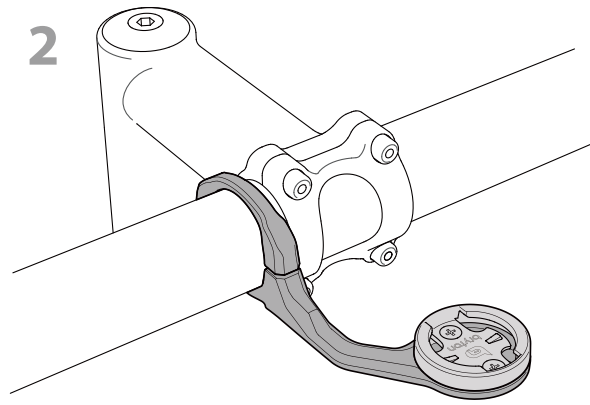

# Install Speed/Cadence/Dual Sensor (Optional)

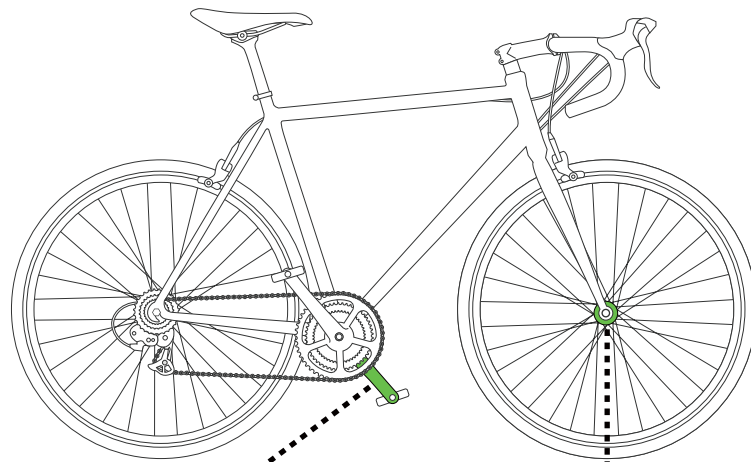

Cadence Sensor

Speed Sensor

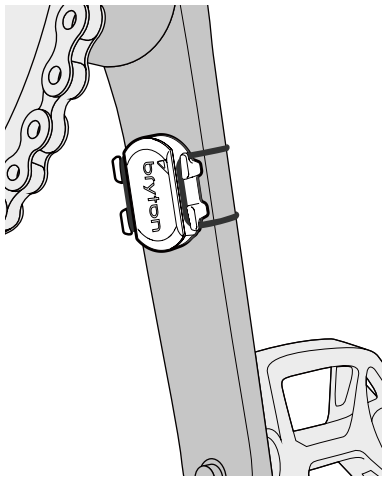

+



+



+

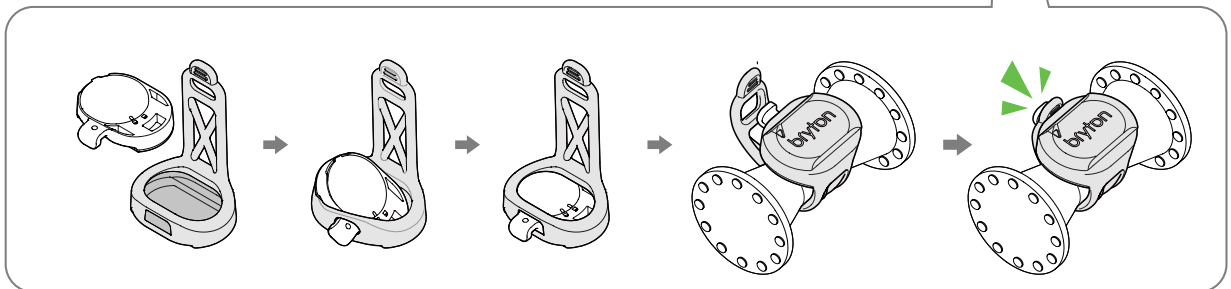
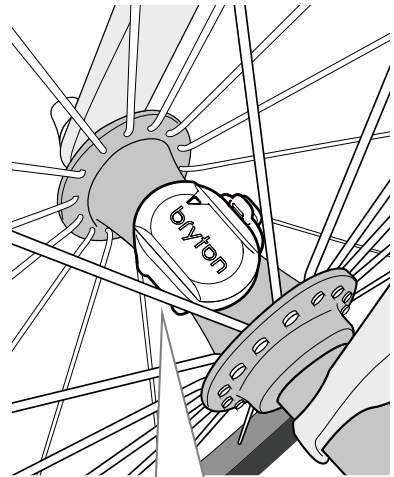

## NOTE:

- Once sensors waken, the LED blinks twice. The LED continues to blink when you continue to pedal for pairing. After around 15 blinks, it will stop blinking. If not used for 10 minutes, sensor would go into sleep mode to preserve power. Please complete the pairing during the time the sensor is awake.

# Install Heart Rate Belt (Optional)

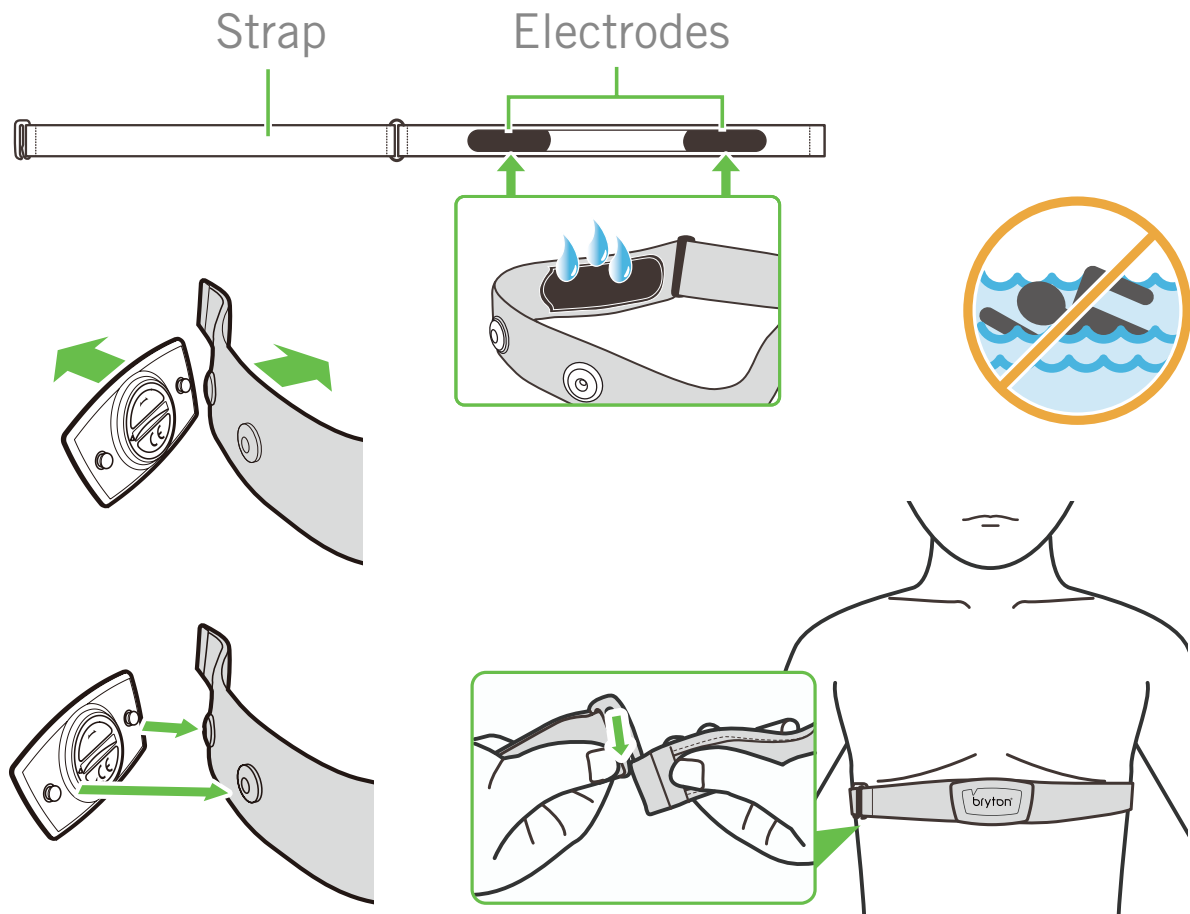

## NOTE:

- In cold weather, wear appropriate clothing to keep the heart rate belt warm.
- The belt should be worn directly on your body.
- Adjust the sensor position to the middle part of the body (wear it slightly below the chest). The Bryton logo shown on the sensor should be facing upward. Tighten the elastic belt firmly so that it will not turn loose during the exercise.
- If the sensor cannot be detected or the reading is abnormal, please warm up for about 5 minutes.
- If the heart rate belt is not used for a period of time, remove the sensor from the heart rate belt.

**NOTE:** Improper battery replacement may cause an explosion. When replacing a new battery, use only the original battery or a similar type of battery specified by the manufacturer. Disposal of the used batteries must be carried out in accordance to the regulations of your local authority.



For better environmental protection, waste batteries should be collected separately for recycling or special disposal.



# Wheel Size and Circumference

The wheel size is marked on both sides of the tires.

Wheel Size	L (mm)
12x1.75	935
12x1.95	940
14x1.50	1020
14x1.75	1055
16x1.50	1185
16x1.75	1195
16x2.00	1245
16x1-1/8	1290
16x1-3/8	1300
17x1-1/4	1340
18x1.50	1340
18x1.75	1350
20x1.25	1450
20x1.35	1460
20x1.50	1490
20x1.75	1515
20x1.95	1565
20x1-1/8	1545
20x1-3/8	1615
22x1-3/8	1770
22x1-1/2	1785
24x1.75	1890
24x2.00	1925
24x2.125	1965
24x1(520)	1753
24x3/4 Tubular	1785
24x1-1/8	1795
24x1-1/4	1905
26x1(559)	1913
26x1.25	1950
26x1.40	2005
26x1.50	2010
26x1.75	2023
26x1.95	2050
26x2.10	2068
26x2.125	2070
26x2.35	2083

Wheel Size	L (mm)
26x3.00	2170
26x1-1/8	1970
26x1-3/8	2068
26x1-1/2	2100
650C Tubular 26x7/8	1920
650x20C	1938
650x23C	1944
650x25C 26x1(571)	1952
650x38A	2125
650x38B	2105
27x1(630)	2145
27x1-1/8	2155
27x1-1/4	2161
27x1-3/8	2169
27.5x1.50	2079
27.5x2.1	2148
27.5x2.25	2182
700x18C	2070
700x19C	2080
700x20C	2086
700x23C	2096
700x25C	2105
700x28C	2136
700x30C	2146
700x32C	2155
700C Tubular	2130
700x35C	2168
700x38C	2180
700x40C	2200
700x42C	2224
700x44C	2235
700x45C	2242
700x47C	2268
29x2.1	2288
29x2.2	2298
29x2.3	2326

# Basic Care For Your Rider 320

Taking good care of your device will reduce the risk of damage to your device.

- Do not drop your device or subject it to severe shock.
- Do not expose your device to extreme temperatures and excessive moisture.
- The screen surface can easily be scratched. Use the non-adhesive generic screen protectors to help protect the screen from minor scratches.
- Use diluted neutral detergent on a soft cloth to clean your device.
- Do not attempt to disassemble, repair, or make any modifications to your device. Any attempt to do so will make the warranty invalid.

# Data Fields

Category	Data Fields	Description of Data Fields
Energy	Calorie	The number of total calories burned.
	Kilojoules	The accumulated power output in kilojoules for the current activity.
Altitude	Altitude	The height of your current location above or below sea level.
	Max Altitude	The highest height of your current location above or below sea level which the rider achieved for the current activity.
	Alt. Gain	The total altitude distance gained during this current activity.
	Alt. Loss	The total altitude lost during this current activity.
	Gradient	The calculation of altitude over distance.
	Uphill	The total distance traveled while ascending.
Distance	Downhill	The total distance traveled while descending.
	Distance	The distance travelled for current activity.
	Odometer	The accumulated total distance until you reset it.
	LapDistance	The distance traveled for the current lap.
	LLapDist.	The distance traveled for the last finished lap.
Speed	Trip 1/Trip 2	Cumulative mileage recorded before you reset it.They are 2 separate trip measurements. You are free to use Trip 1 or Trip 2 to record,for example, weekly total distance and use another to record, for example, monthly total distance.
	Speed	The current rate of change in distance.
	Avg Speed	The average speed for current activity.
	Max Speed	The maximum speed for current activity.
	LapAvgSpd	The average speed for the current lap.
	LapMaxSpd	The maximum speed for the current lap.
Time	LLapAvgSpd	The average speed for the last finished lap.
	Time	Current GPS Time.
	Ride Time	The time spent on riding for current activity.
	Trip Time	Total time spent for current activity.
	Sunrise	The time of sunrise based on your GPS location.
	Sunset	The time of sunset based on your GPS location.
	LapTime	The stopwatch time for the current lap.
	LLapTime	The stopwatch time for the last finished lap.
Cadence	Lap Count	The number of laps finished for the current activity.
	Cadence	The current rate at which rider is pedalling the pedals
	Avg CAD	The average cadence for current activity.
	Max CAD	The maximum cadence for current activity.
	LapAvgCad	The average cadence for the current lap.
	LLapAvgCad	The average cadence for the last finished lap.

Category	Data Fields	Description of Data Fields
HR	Heart Rate	The number of times your heart beats per minute. It requires compatible HR sensor pairing connection to your device.
	Avg HR	The average heart rate for current activity.
	Max HR	The maximum heart rate for current activity.
	MHR %	Your current heart rate divided by Maximum Heart Rate. MHR means that the maximum number of beats made by your heart in 1 minute of effort. (MHR is different from Max HR. You will need to set MHR in User Profile)
	LTHR%	Your current heart rate divided by Lactate Threshold Heart Rate. LTHR means that the average heart rate while in the intense exercise at which the blood concentration of lactate begins to exponentially increase. (You will need to set LTHR in User Profile)
	MHR Zone	The current range of your Maximum Heart Rate Percentage heart rate (Zone 1 to Zone 75).
	LTHR Zone	The current range of your Lactate Threshold Heart Rate Percentage (Zone 1 to Zone 7).
	LapAvgHR	The average heart rate for the current lap.
	LLapAvgHR	The average heart rate for the last finished lap.
	Lap MHR%	The average of MHR% for the current lap.
Lap LTHR%	The average of LTHR% for the current lap.	
Temp	Temp.	The current temperature.
Power	Power	Current Power in Watt.
	Avg Power	The average power for the current activity.
	Max Power	The maximum power for the current activity.
	LapAvgPw	The average power for the current lap.
	LapMaxPw	The maximum power for the current lap.
	3s power	3 seconds average of power
	10s power	10 seconds average of power
	30s power	30 seconds average of power
	NP (Normalized Power)	An estimate of the power that you could have maintained for the same physiological "cost" if your power had been perfectly constant, such as on an ergometer, instead of variable power output.
	TSS (Training Stress Score)	Training Stress Score is calculated by taking into account both the intensity such as IF and the duration of the ride. A way of measuring how much stress is put on the body from a ride.
	IF (Intensity Factor)	Intensity Factor is the ratio of the normalized power(NP) to your Functional Threshold Power(FTP). An indication of how hard or difficult a ride was in relation to your overall fitness.
	SP (Specific Power)	Power-to-weight ratio
FTP Zone	The current range of your Functional Threshold Power Percentage (Zone1 to Zone 7).	

Category	Data Fields	Description of Data Fields
Power	MAP Zone	The current range of your Maximum Aerobic Power Percentage (Zone 1 to Zone 7).
	MAP%	The current power divided by your Maximum Aerobic Power.
	FTP%	The current power divided by your functional threshold power.
	Lap NP	Normalized power of the current lap
	Last Lap NP	Normalized power of the last lap
	LLapAvgPw	The average power output for the last finished lap.
	LlapMaxPw	The maximum power for the last finished lap.
	Left Power	Current left leg power
	Right Power	Current right leg power
	3s Left Power	3 seconds average of left leg power
	10s Left Power	10 seconds average of left leg power
	30s Left Power	30 seconds average of left leg power
	3s Right Power	3 seconds average of right leg power
	10s Right Power	10 seconds average of right leg power
	30s Right Power	30 seconds average of right leg power
Pedal Analysis	3s Avg PB	3 seconds average power balance.
	CurPB-LR	The current left/right power balance.
	AvgPB-LR	The average left/right power balance for the current activity.
	CurTE-LR	The current left/right percentage of how efficiently a rider is pedaling.
	MaxTE-LR	The maximum left/right percentage of how efficiently a rider is pedaling.
	AvgTE-LR	The average left/right percentage of how efficiently a rider is pedaling.
	CurPS-LR	The current left/right percentage of how evenly a rider is applying force to the pedals throughout each pedal stroke.
	MaxPS-LR	The maximum left/right percentage of how evenly a rider is applying force to the pedals throughout each pedal stroke.
	AvgPS-LR	The average left/right percentage of how evenly a rider is applying force to the pedals throughout each pedal stroke.



#### RF Exposure Information (MPE)

This device meets the EU requirements and the International Commission on Non-Ionizing Radiation Protection (ICNIRP) on the limitation of exposure of the general exposure requirements, this equipment must be operated in a minimum of 20 cm separation distance to the user.

Hereby, Bryton Inc. declares that the radio equipment type Bryton product is in compliance with Directive 2014/53/EU. The full text of the EU declaration of conformity is available at the following internet address:

[http://www.brytonsport.com/download/Docs/CeDocs\\_Rider320.pdf](http://www.brytonsport.com/download/Docs/CeDocs_Rider320.pdf)



Designed by Bryton Inc.

Copyright © 2018 Bryton Inc. All rights reserved.

7F, No.75, Zhouzi St., Neihu Dist., Taipei City 114, Taiwan (R.O.C.)