

CHILTON'S **THE**
ELECTRONIC
ENGINEER

An automatic tester that doesn't get lost in a 'rat's nest'

VOL. 30 NO. 6
JUNE 1971

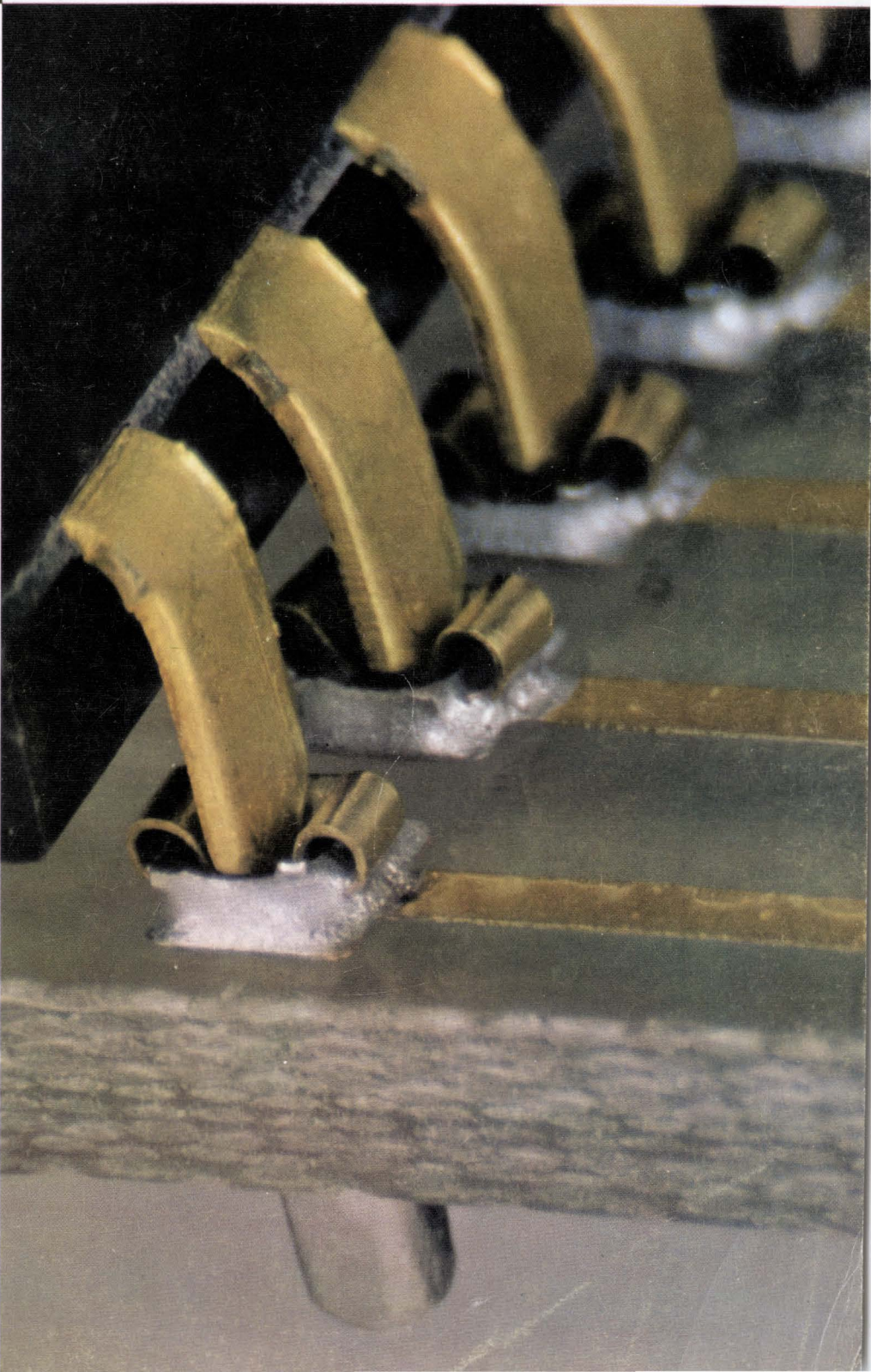

**Memory course—bulk
storage**

What's new in connectors

**Two-way data system
invades the home**

Mini-sized PC socket offers repeat plug-ins and good contact



**Leave my power supply system alone!
You can get your own in only 9 days from Acopian.**

"I tried struggling through that old power supply system catalog. It was like a jigsaw puzzle, hunting for the pieces I needed for my new power system. There had to be a better way.

"Then I remembered the Acopian hotline. I called it. I told them the DC voltages and currents I wanted. Discussed panel size. Meters. Switches. And other accessories.

"They gave me a firm price. Right on the phone. It was a lot less than I expected. I had our buyer phone in the P.O. And Acopian designed,

built, tested and shipped it in nine days. Completely wired.

"So go order your own Acopian power system . . . It's easy!"

**HOW TO ORDER
ACOPIAN POWER SYSTEMS**

- Call Acopian collect
- Tell us the outputs and accessories you need
- Get a firm price
- Shipment of completely wired system will be made in 9 days.

For immediate service, call the Acopian hotline: (215) 258-5441. For literature, write Acopian Corp., Easton, Pa. 18042. And remember, Acopian also offers 82,000 different DC power modules, every one shipped with this tag . . .



Circle Reader Service #1

Aluminum Electrolytic Capacitors

THE CRITIC'S 'LYTICS

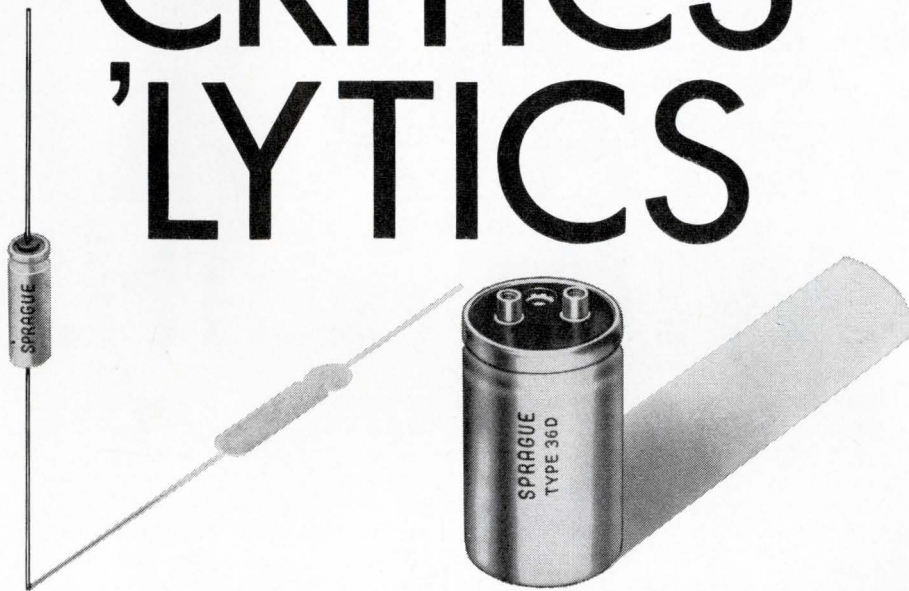

Be critical. Specify Sprague Powerlytic[®] Capacitors for maximum capacitance in minimum space.

Type 39D Tubular Case

Case sizes from $\frac{1}{2}$ " x $1\frac{1}{8}$ " to 1" x $3\frac{5}{8}$ ". Operate at temperatures up to 85 C. Unique construction—anode and cathode terminals are welded—no riveted or pressure connections—prevents open circuits, even in microvolt signal range. Standard ratings include capacitance values to 18,000 μ F, voltages from 3 to 450 VDC.

Write for Engineering Bulletin 3415.

Type 36D Cylindrical Case

Improved materials and processes now permit extended capacitance ratings. New, large case size, 3" x $8\frac{5}{8}$ ", allows capacitance values up to 650,000 μ F. Ideal in applications such as computer power supplies, industrial controls, high gain amplifiers. Low equivalent series resistance, low leakage current, excellent shelf life.

Write for Engineering Bulletin 3431C.

*Technical Literature Service, Sprague Electric Co.
233 Marshall Street, North Adams, Mass. 01247*

Popular ratings are available for fast delivery from your Sprague Industrial Distributor.

THE BROAD-LINE PRODUCER OF ELECTRONIC PARTS



RAYTHEON SEMICONDUCTOR. OUR OP AMPS HAVE PARAMETERS WITH TEETH.

Our new products are taking a chunk out of the operational amplifier market with parameters that are easy on designers and tough on competition. All of our dc parameters are specified over the entire voltage range — with no fall-off.

The new RM4131. It's unique in bipolar IC's, with input offset voltage of 2 mV maximum and 0.7 mV typical. Input offset current of 10 namp maximum and 2 namp typical. This high gain op amp has slew rates four times that of 709's and 741's. Typically 2 volts per microsecond with unity gain bandwidth of 4 MHz. And if low current drain at 20 V of 1.6 milliamps maximum is still not enough to put the RM4131 on your purchase order the large voltage signal gain should. It's typically 106 db from 3 to 20 volts.

The new RM4132. It cuts power dissipation by two orders of magnitude and needs no external bias or compensation. This proprietary micropower op amp has typical current drain as low as 22 μ A. At maximum, 35 μ A. Input offset current is reduced to 0.7 namp. It maintains unity gain bandwidth of 150 KHz. And it means further perfection in your battery operated circuits.

Proprietary linear circuits is one of our great strengths. But it's not our only strength. We're rapidly adding to our extensive line of off-the-shelf linear circuits as well. We provide the tightest parameter specs you can get in monolithic op amps, differential and dual comparators, voltage regulators, line receivers, and sense amplifiers. All available now at franchised Raytheon Semiconductor distributors.

Raytheon Semiconductor has changed. We have a new technical team. And new development programs providing new design tools. We're working on things like new digital analog interfacing that allow active switching and amplifying. Greater integration of external parts in voltage regulators. Greater circuit stability from improvements in temperature tracking. And we're going beyond the parameters established for slew rates, offset voltage, noise, bias current and offset current.

If you haven't been keeping up with us lately you've got a surprise coming. Write for our complete IC catalog and see. Raytheon Semiconductor, 350 Ellis Street, Mountain View, California 94040. (415) 968-9211.



CHOMP!

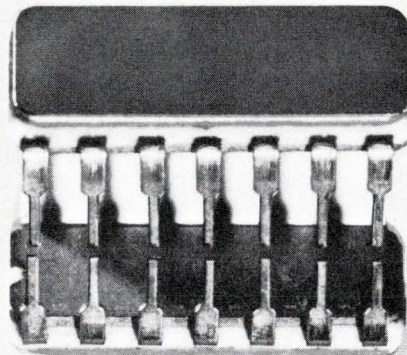

Circle Reader Service #3

THE ELECTRONIC ENGINEER

June 1971 Vol. 30 No. 6

Cover: Top left. The business end of Teradyne's N131 Computer-Operated Network Test System, described on p. 46, is staring at you. Self-programming, it simplifies network testing, no matter what the interconnection density.

Bottom Right. Repeated plug-ins for DIPs, LEDs, transistors, and so on, are made possible with these new miniature PC sockets—Berg's Minisert™. One of a number of important connectors discussed on p. 29, this versatile socket consists of a specially designed, heat-treated spring within a tin-plated, drawn copper square cup.

6 Editorial	41 Communications	82 Systems New Products
10 Up to Date	46 New Product Feature	84 Lab New Products
16 Western Column	49 Course	86 Microworld New Products
18 Calendar	69 IC Ideas	89 Literature
22 Speak Up	75 New Product Feature	94 Advertising Index
24 Microworld	76 New Products	96 International Corner
29 Design Feature		

24 SPEED/POWER CHART FOR DIGITAL ICs By Lynda Rothstein

Plotted for typical propagation delay in nanoseconds versus average power dissipation in milliwatts per gate, here is the latest updated version of our annual digital IC chart.

29 THEY'VE GOT CONNECTIONS By Smedley B. Ruth

Smaller, improved, and more versatile, the new generation of connectors are examined in this survey. Whether you're working with ICs or flat flexible cables or other components, the newest approaches in each category are discussed here.

41 CABLE COMMUNICATIONS: LOS GATOS EXPERIMENT By Sheldon Edelman

Data in the home? Some 1500 families in Los Gatos, Calif., are participating in an experiment that may have far-reaching sociological and political implications, in addition to waking up the sleeping CTV industry.

49 MEMORIES COURSE—PART 5

Where sheer mass of material handled and cost are the two most important considerations, the answer is, of course, the bulk memory—the work horse of the memory system. From the oldest paper cards, through to the newest, optical/thermal, we cover all the bulk memory techniques.

- **Introduction** By Steve Thompson
- **Punched paper cards** By Dr. J. A. Carlson
- **Paper tape** Contributed by Tally Corp.
- **Magnetic Tape** By Edward S. Kinney
- **Optical/thermal mass memory** By Harold Dell
- **Magnetic discs** By William Bertrando
- **Silicon drum** By Dale A. Mrazek
- **Dynamic MOS RAMs** By B. D. Broeker
- **Domain wall memory** By Berne D. Broadbent

69 IC IDEAS

- **Zero crossing uses logic gates** By Stuart Culp
 - **Sinusoidal frequency halving** By Marvin K. Vander Kooi
 - **Frequency divider from a clocked R-S flip-flop** By Jozef Sabol
 - **Speed up your precision rectifier** By Allen Cole
-



KEPCO TALKS POWER SUPPLY TECHNOLOGY:

THE HYBRID PRINCIPLE ... FOR HIGH VOLTAGE

In the usual series-regulated power supply circuit, the *series pass elements* suffer the maximum electrical stress. Their job is to absorb all variations, transients and noise so that these undesirables are filtered from the output. In the course of this, the series pass element often finds itself subject to excess currents, voltage and power dissipation, both transient and sustained.

When transistors are used for the series pass element, the power supply designer builds into his circuit elements to keep the operating parameters within acceptable safe operating regions. For instance, auxiliary feedback is customarily supplied to limit current. Switching techniques may be used to limit dissipation and often transistors are series connected to share a high voltage stress.

For the control of high voltage (200 volts and up), the protection costs and complexity begin to approach the limit of practicality.

To achieve linear control of high voltage, Kepco has long-advocated the combination of vacuum tubes and transistors—even IC's—into a hybrid circuit where the greater tolerance of tubes for high voltage recommend their advantageous use as the series pass element. Tubes, compared to high voltage transistors, are much more tolerant of occasional overloads, will operate safely with far fewer protectors and operate without complaint at voltage levels that strain the resources of a semiconductor junction.

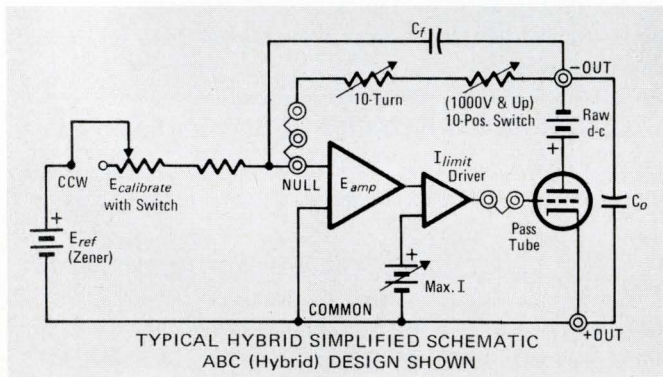

The result is an extremely reliable, simple, high-voltage power supply using far fewer components than would a fully transistorized version and consequently a more dependable design.

The Kepco hybrid principal is found in the HB Series: 0-525 volts up to 260 watts; the BHK and OPS Series: autocrossover voltage/current regulators and operational supplies, 0-500, 0-1000 and 0-2000 volts, 200 watts and 20 watts, and the ABC (Hybrid) line: 0-200 volts to 0-2500 volts, 10 watts.

KEPCO®

Write Dept. DM-19

KEPCO, INC. • 131-38 SANFORD AVENUE • FLUSHING, N.Y. 11352
(212) 461-7000 • TWX #710-582-2631

THE ELECTRONIC ENGINEER

June 1971
Vol. 30 No. 6

K. Robert Brink..... Publisher
Alberto Socolovsky..... Editor
John E. Hickey, Jr..... Managing Editor
Smedley B. Ruth..... Associate Editor
Sheldon Edelman..... Western Editor S. F.
Stephen A. Thompson..... Western Editor L. A.
Arthur J. Boyle..... Technical Editor
John McNichol..... Assistant Editor
Dr. O. M. Salati..... Consultant
Anne Axe..... Editorial Assistant
Alice C. Bach..... Editorial Assistant
Lynda Rothstein..... Editorial Assistant
Deborah P. Wilkins..... Editorial Assistant
Mae Moyer..... Editorial Reader Service
Andrew Mittelbrunn..... Chilton Art Director
Phau Featherson..... Artist
George Baker..... Washington News Bureau
Neil Regeimbal..... Washington News Bureau

Executive and Editorial Offices:
One Decker Square, Bala-Cynwyd, Pa. 19004
Tel. (215) SH 8-2000

Address Mail to:
56th & Chestnut Sts., Philadelphia, Pa. 19139

Western Offices:
Stephen A. Thompson
3727 W. 6th St., #202, Los Angeles, Calif. 90005
Tel. (213) DU 7-1271

Sheldon Z. Edelman
199 First St. Rm. 335, Los Altos, Calif. 94022
Tel. (415) 941-6655

Chilton Officers & Directors: R. E. McKenna, President; J. Kofron, C. W. Hevner, Sr. Vice Presidents; W. A. Barbour, R. H. Groves, K. Robert Brink, Publishing Vice Presidents; James Miades, Treasurer; J. A. Montgomery, Jr., Secretary; T. J. Casper, S. H. Collmann, J. P. Kushnerick, R. O. Nelson, E. C. Beaudet, W. A. Phair, D. Acton.

Monthly publication of Chilton Company, Chestnut & 56th Sts., Phila., Pa. 19139. (Area Code 215) SHerwood 8-2000. Controlled circulation postage paid at Philadelphia, Pa. \$1 a copy. Subscription rates U. S. and U. S. Possessions: 1 yr. \$12.00; 2 yrs. \$20.00. Canada 1 year \$14.00; 2 yrs. \$25.00. All other countries 1 yr. \$20.00; 2 yrs. \$35.00. © Chilton Company 1971. Title Reg. U.S. Patent Office. Reproduction or reprinting prohibited except by written authorization. Microfilm reproductions of **The Electronic Engineer** and its predecessors, **Electronic Industries** and **Tele-Tech**, may be obtained from University Microfilms, 313 N. First St., Ann Arbor, Mich.

The Chilton Electronics and Instrumentation Group
The Electronic Engineer
Instruments and Control Systems
Instrument & Apparatus News
Medical Electronic News
Electronic Components News

Chilton

Circuit breakers for MIL-SPEC equipment:

Two new military specifications have just expanded your design options. In fact, you may now be able to fill all your MIL-Spec breaker requirements from a single source. All of the breakers shown here are available in DC, 60-Hz, and 400-Hz models. All (with one exception) can be had in single- and multi-pole configurations. With a choice of time delays. Or in-

stantaneous trip. And the option of built-in auxiliary switches. Worth investigating. Which we invite you to do by writing us for any or all of the product bulletins mentioned below. Heinemann Electric Company, 2806 Brunswick Pike, Trenton, N. J. 08602. Or Heinemann Electric (Europe) GmbH, 4 Düsseldorf, Jägerhofstrasse 29, Germany.

5058

now you have a much greater choice.

MIL-C-55629. Series AM1: a new, lower-cost version of our popular AM12 breaker. Available in current ratings from 0.020 to 50 amp. Bulletin 3306.

Series JA: compact, lightweight, with a good-looking white toggle handle as standard. Top current rating of 30 amp. Bulletin 3350.

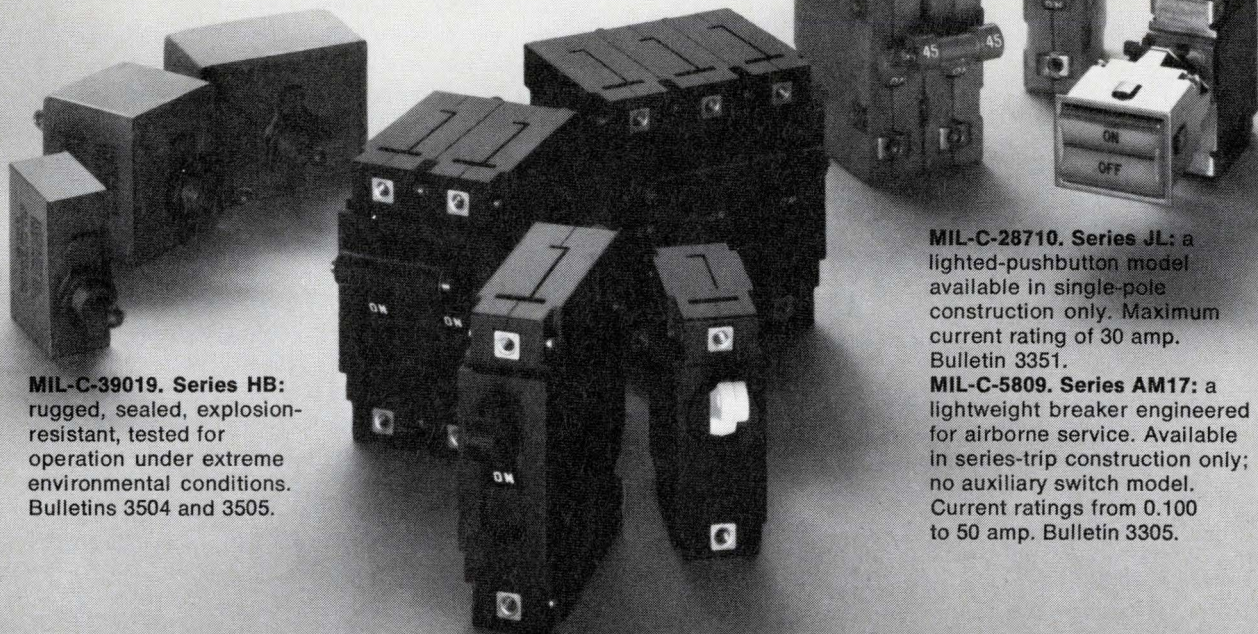

MIL-C-39019. Series HB: rugged, sealed, explosion-resistant, tested for operation under extreme environmental conditions. Bulletins 3504 and 3505.

MIL-C-28710. Series JL: a lighted-pushbutton model available in single-pole construction only. Maximum current rating of 30 amp. Bulletin 3351.

MIL-C-5809. Series AM17: a lightweight breaker engineered for airborne service. Available in series-trip construction only; no auxiliary switch model. Current ratings from 0.100 to 50 amp. Bulletin 3305.

HEINEMANN

When the potatoes are passed around . .

Last month, Representative Robert N. Giaimo (D.-Conn.) delivered the keynote speech before the Council of Engineers and Scientists (CESO) in San Diego. Mr. Giaimo's address expressed concern (he has sponsored legislation to aid science and technology) and contained a warning. This magazine both applauds and supports his concern—and believes his warning must be heeded. For this reason, we are excerpting here parts of Mr. Giaimo's address.

Alberto Socolovsky, Editor

Our failure to protect the scientific and technological community is hurting this nation in many ways. For instance, . . . the annual public investment in each scientist and engineer in industry averages \$50,000. Think what this means—the 65,000 scientists and engineers now unemployed represent the waste of \$3.25 billion in public funds.

. . . Unfortunately, it is not hard to understand why the unemployment crisis in the scientific and technological community has been ignored for too long. How important are 65,000 jobless scientists and engineers, some people say, when compared to the total unemployment picture? How tragic is it that engineers must pump gas and physicists must drive taxicabs when millions of other Americans cannot find jobs at all? I submit . . . that this situation is both important and tragic (because) . . . for every highly skilled scientist and engineer put out of work, several unskilled workers will lose their jobs. The time has come for all Americans to realize the close relationship between unemployment in the laboratory and unemployment on the production line. . . . Yet you are treated by this nation as if you were merely products to be used and then thrown away.

Unfortunately, the Federal Government has never recognized the fact that it has a special responsibility to protect our scientific resources because of its massive influence on (their) deployment and utilization.

. . . I have been heartened by the number of proposals introduced in this Congress to help you and your colleagues. This shows, I believe, a growing awareness of your plight.

. . . The legislation which I feel has the greatest chance of success in this Congress is the Conversion Research and Education Act of 1971, which Senator Edward Kennedy of Massachusetts and I have introduced.*

. . . I have several reasons for being optimistic about this legislation . . . I like (it) because it is good legislation, but I like it even more because I think it can pass.

. . . Congress (is trying to) solve this serious problem and end, once and for all, the national disgrace of technical unemployment. Now I want to tell you what you must do.

First of all, you cannot sit still. You are caught in a period of change, and you must make every effort to adapt to the situation. When institutions both in and out of government offer

* This Act would establish three national policies:

First, scientists and engineers must have continuing opportunities for employment in positions commensurate with their professional and technical skills.

Second, federal support and civilian research and development should be raised to and maintained at the level of defense-related research and development.

Third, the total federal investment in science and technology should increase at the same rate as the Gross National Product.

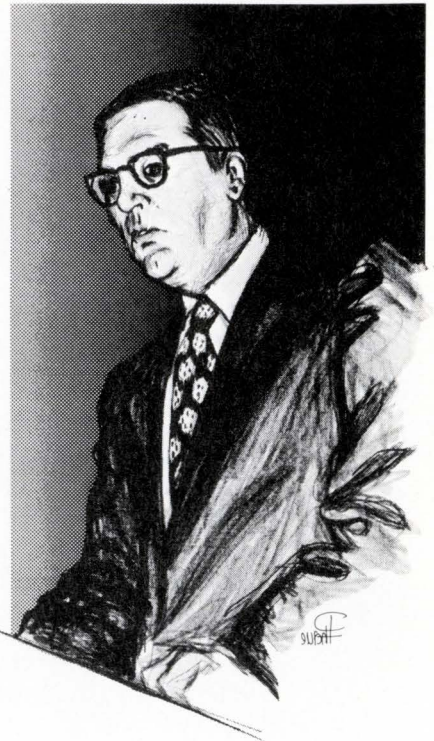

Representative Robert N. Giaimo

opportunities (to renew, update and extend your skills throughout your careers), you must take advantage of them. When they do not, you must demand them. It is as simple as that.

Second, the time has come for you and your colleagues to realize (that) the days when you could sit back and wait for research money to come rolling in are over. The appropriations process has many similarities to the dining room at a boardinghouse. When the potatoes are being passed around, if you don't speak up you won't get any.

There has been a tendency among you and your colleagues to act as if you were above politics, above government, above the battle for appropriations. Well, let me tell you something: you are not. If you want to start the money flowing again, you are going to have to climb down from the ivory tower, step into the arena, roll up your sleeves and fight for funds just like every other interest group in this country. As a member of the appropriations committee, I know what you are up against. The education lobby is fighting for funds. The poverty brokers are demanding more, the defense lobby, all of these and other groups are pleading with the federal government for more and more money. Just like in the boardinghouse, if you don't speak up, you won't get any.

Furthermore, the time has come for many of you . . . to stop acting as though political actions were a dirty word. I (referred to) several bills now before Congress which deal with technical unemployment. Without (your vigorous support) these bills will not be worth the paper they are printed on.

That . . . is political action. It is not a dirty word; it is a necessity under our form of government. You must become more active in the Capitol, in the state houses, and at the polls. You must support your representatives who are acting in your best interests and oppose those who are not. You must convince the American people and their government that your cause is just and your needs real. For if you do not help yourselves, who will?

with what we know
about capacitors
we could write
a book...

so we did!



If you specify or buy capacitors you'll find the Aerovox Product Specifier for Electrical and Electronic Components the handiest thing that's come off the press since money. Between the covers we've included basic technical data, application data, Mil Spec and industry data along with detailed product information on multi-layer ceramic, paper, film, mica, oil filled, high voltage, SCR, EDC, feed-thru, disc and high voltage multiplier capacitors. In addition we have included technical information on our capabilities in thick and thin film microcircuits, RFI/EMI filters, and active and passive wave filters.

It's brand new, it's up-to-date and best of all... it's FREE for the asking. So if you specify and buy capacitors, filters, or microcircuits, you'll want your own personal copy of this all important Aerovox catalog. Your copy is waiting for you; write for one today or call your local Aerovox representative.

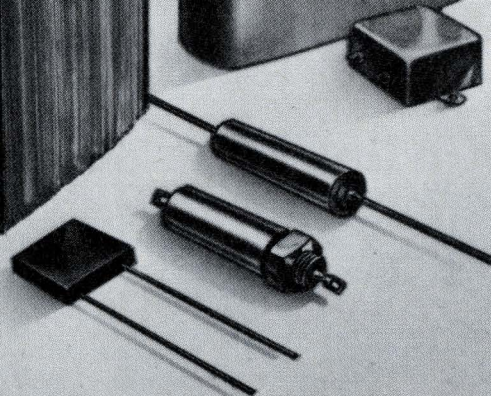
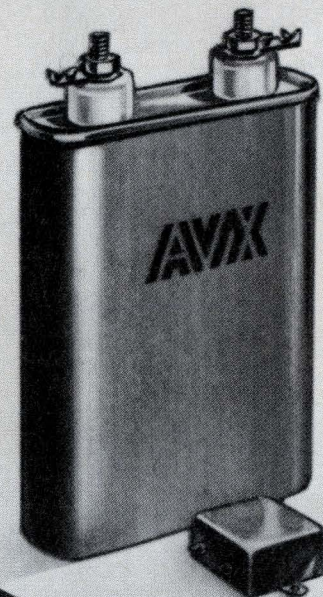

AVX Aerovox®

AEROVOX CORPORATION, NEW BEDFORD, MASSACHUSETTS 02741 • TEL. 617-994-9661
PLANTS IN: NEW BEDFORD, MA., OLEAN & FRANKLINVILLE, N.Y., MYRTLE BEACH, S.C. AND HAMILTON, ONT., CANADA

THE NICE THING ABOUT OUR 54/74

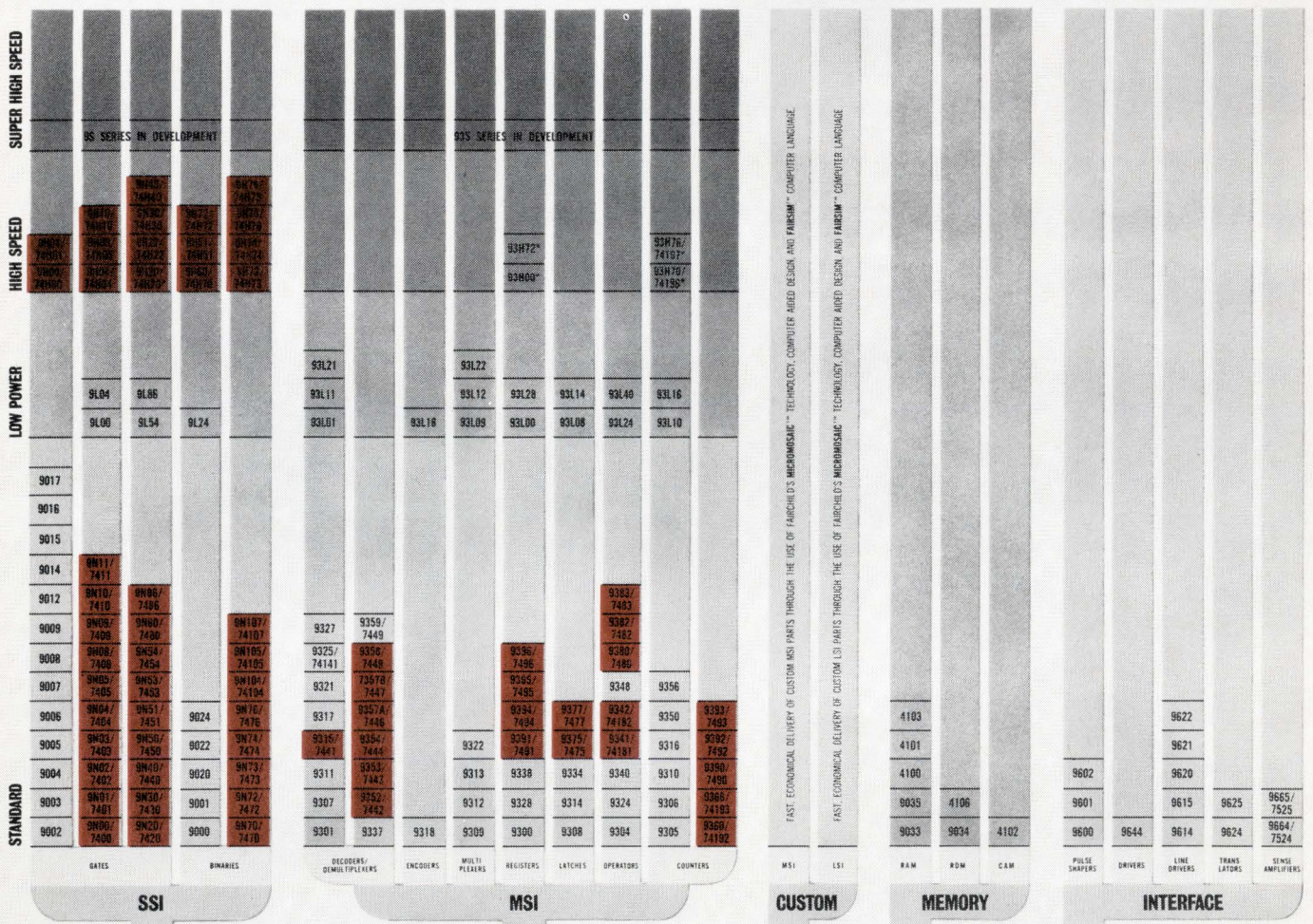

**FAIRCHILD
TTL FAMILY**

From the Fairchild TTL Family Tree, our 54/74 series is another example of how we offer the freedom-loving designer the broadest range of products, packages, and speed/power trade-offs.

TTLs: YOU CAN GET THEM.

Hurting for 54/74's? You don't have to do business with delinquents. Instead, consider Fairchild. We will deliver the goods.

We're in the 54/74 business all the way.

To you, that means:

1. Our distributor and factory warehouses are fully stocked. You can get delivery on most circuits within a week.
2. We've always been big in ceramic packaging. Now all of our 14-pin SSI gates and flipflops are available in ceramic *and* plastic.
3. We have a broad line of 54/74 TTL devices available now. Even more on the way. For you? Freedom of choice and packaging.
4. We offer package pricing flexibility in keeping with the breadth of line.

Now a major supplier of second-source devices like the 54/74, we still continue our crusade for design freedom by constantly adding to our already vast family of proprietary TTL devices. The Big Tree.

So if you're suffering from severe 54/74 deprivation, get immediate relief. In the package you want. From our factory or from any of our more than 70 distributor locations throughout the country. And send for our new 54/74 Data Sheet Catalog.

Currently available Fairchild 54/74 Devices

SSI Standard Gates

9N00/5400, 7400	9N09/5409, 7409	9N51/5451, 7451
9N01/5401, 7401	9N10/5410, 7410	9N53/5453, 7453
9N02/5402, 7402	9N11/5411, 7411	9N54/5454, 7454
9N03/5403, 7403	9N20/5420, 7420	9N60/5460, 7460
9N04/5404, 7404	9N30/5430, 7430	9N86/5486, 7486
9N05/5404, 7405	9N40/5440, 7440	
9N08/5408, 7408	9N50/5450, 7450	

SSI Standard Binaries

9N70/5470, 7470	9N74/5474, 7474	9N105/54105, 74105
9N72/5472, 7472	9N76/5476, 7476	9N107/54107, 74107
9N73/5473, 7473	9N104/54104, 74104	

SSI High Speed Gates

9H00/74H000	9H05/74H05	9H22/74H22
9H01/74H01	9H10/74H10	9H30/74H30
9H04/74H04	9H20/74H20	9H40/74H40

SSI High Speed Binaries

9H50/74H50	9H73/74H73	9H78/74H78
9H51/74H51	9H74/74H74	
9H72/74H72	9H76/74H76	

MSI Decoders / Demultiplexers

9315/5441, 7441	9354/5444, 7444	9358/5448, 7448
9352/5442, 7442	9357A/5446, 7446	
9353/5443, 7443	9357B/5447, 7447	

MSI Registers

9391/5491, 7491	9395/5495, 7495	
9394/5494, 7494	9396/5496, 7496	

MSI Latches

9375/5475, 7475	9377/5477, 7477	
-----------------	-----------------	--

MSI Operators

9341/54181, 74181	9380/5480, 7480	9383/5483, 7483
9342/54182, 74182	9382/5482, 7482	

MSI Counters

9360/74192	9390/7490	9393/7493
9366/74193	9392/7492	

FAIRCHILD
SEMICONDUCTOR

Mass memory bubbles

When Bell Labs first reported on magnetic bubbles, they were using orthoferites. Next, they shifted to garnets as a medium for bubble devices. Garnets not only enabled Bell Labs to increase bubble density more than 100 to 1, but they were simple to use.

Bell Labs has successfully demonstrated circuits based on two deposition methods. The epitaxial garnet has been deposited on non-magnetic substrates by both liquid-phase epitaxy and chemical vapor deposition.

Through these improvements in material technology, operation of a 10,404 step Y-bar shift register, with a storage density of 1 million b/in.² has been achieved with one such liquid-phase epitaxial film. With the realization of a bubble register of this capacity, Bell Labs has a fundamental building block for a bubble mass memory.

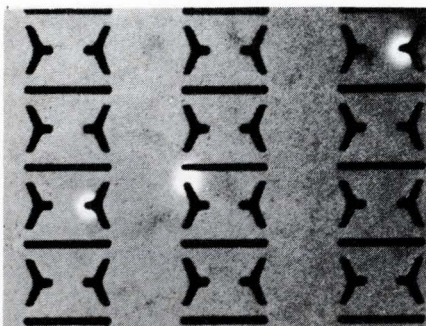

Magnified magnetic bubbles (the light circles) are moving through a circuit pattern formed on a thin epitaxial film of uniaxial garnet. One bubble, somewhat elongated, can be seen in transition from one pole to the next in the center of the photo. The bubbles are 0.003 in. in diameter.

Bell Labs has also done experimental work on a "coincident block" mass memory organization which uses the major-minor format. In this organization, processed garnet chips with storage capacities of 20,000 bits are interconnected to provide random access to blocks of sequential data.

Of this technology, Jack A. Morton, vice president in charge of Electronics Technology at Bell Labs, said, "Magnetic bubbles constitute a technology of

identical particles which can do logic, memory and switching, without changing homogeneous structure. We have a material-process system which promises adaptability and we are routinely making 1000-b shift registers at a density of 1.6 Mb/in.². Just recently we operated a register having 10,000 b with good margins. We require $< 0.5 \mu\text{W/B}$, corresponding to 6W for a 15-Mb bubble file."

Ending shocking experiences

We've all read and heard about patients in hospitals and in doctors' offices being killed by electrical shock. This problem has evoked a flurry of possible solutions for isolating the patient from this hazard.

Gilson Medical Electronics Inc., Middleton, Wis., has devised a system they call Isolop which uses short range telemetry to transmit test data from the patient to receiver and display unit. What makes this system unique, however, is the way it is powered.

Energy to operate the patient's transmitter comes from solar cells. These solar cells use a light from the receiver to supply operating power. This eliminates the necessity for batteries which must be replaced and are a source of corrosion in medical equipment if allowed to decay over a period of time.

The sketch shows how the patient is isolated from electrical power with a telemetering system. The isolated transmitter derives its energy from a solar cell.

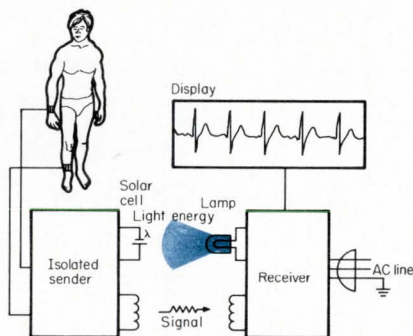

Cleaner air through electronics

You may be breathing cleaner air, thanks to Figaro Engineering Inc.'s (Kobe, Japan) deoxidizing gas-sensing semiconductor marketed under the trademark TGS.

Composed of oxidized metals such as tin oxide and zinc oxide, the gas-sensing semiconductor decreases in electrical resistance when it encounters deoxidizing gases such as hydrogen, carbon monoxide, methane, propane, alcohol, volatile oil, and acetylene. Many times this resistance change is great enough for use without amplification.

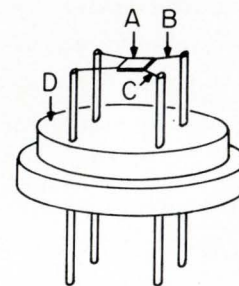

- A. Sensor
- B. Heater line for thermal compensation
- C. Electrode
- D. Base

Over 40 patents have been applied for to cover this deoxidizing gas semiconductor detector, eight of which have been awarded.

By combination with various electro-mechanical devices, TGS can be used as a detector or controller. The gas sensor increases its conductivity as soon as it comes into contact with a gas and then returns to its original resistance value when the gas has been removed.

This semiconductor, unlike many others, can withstand up to 50,000 hours of continuous exposure to steam with no change in characteristics. There are potential applications for the device in environmental pollution control as well as its present use as a normal gas sensor.

Circle Reader Service #364

C-LINE PROGRAMMABLE UNI-JUNCTION TRANSISTORS

guaranteed stability
from -55°C to $+125^{\circ}\text{C}$...

PUTs you a step ahead in design flexibility.

Unitrode offers the only 100V PUT type and the only type with guaranteed stability from -55°C to $+125^{\circ}\text{C}$. We also offered the first PUT in a hermetically sealed TO-18.

With Unitrode's Programmable Unijunction Transistors (PUTs), you're freed from the restricting fixed values of conventional UJTs. Simply by varying external resistor values, you can program E_{ta} , R_{BB} , I_p and I_v to meet your particular needs in timing, pulse, sweep and sensing circuits, oscillators and SCR triggers. The highest voltage, hermetic package and greatest temperature stability are three good reasons for specifying Unitrode PUTs. Three more are nano-amp leakage for long interval timing, low cost, and a strong applications engineering staff ready to help. PUT more design freedom at your fingertips; order any of six types directly off the shelf.

For fast action, call Sales Engineering collect at (617) 926-0404
Unitrode Corporation, 580 Pleasant St., Watertown, Mass. 02172.

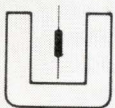

UNITRODE quality takes the worry out of paying less.

Unitrode Corporation, Inquiry Processing Dept. 6D
37 Newbury Street, Boston, Massachusetts 02116

Please send free samples of PUT checked below (including data sheet).

Check for Sample	Unitrode Type No.	Forward Voltage Rating Volts max.	Peak Point Current μa max.	Valley Point Current μa min.	Check for Sample	Unitrode Type No.	Forward Voltage Rating Volts max.	Peak Point Current μa max.	Valley Point Current μa min.
<input type="checkbox"/>	2N6119 ¹	40	2.0@10V ³	70@10V ⁴	<input type="checkbox"/>	2N6138	100	10@10V ⁵	40@10V ⁶
<input type="checkbox"/>	2N6120 ²	40	0.15@10V ³	25@10V ⁴	<input type="checkbox"/>	U13T3	100	2.0@10V ³	70@10V ⁴
<input type="checkbox"/>	2N6137	40	10@10V ⁵	40@10V ⁶	<input type="checkbox"/>	U13T4	100	0.15@10V ³	25@10V ⁴

1. Formerly U13T1 2. Formerly U13T2 3. $R_G=1\text{M}\Omega$ 4. $R_G=10\text{K}\Omega$ 5. $T=-55^{\circ}\text{C}$, $R_G=10\text{K}$ 6. $T=+125^{\circ}\text{C}$, $R_G=10\text{K}$

NAME _____ TITLE _____
COMPANY _____
ADDRESS _____
CITY _____ STATE _____ ZIP _____

The FCC makes its mind up? . . . Insiders close to the FCC's inner workings expect a decision within the next couple of months on the highly-charged data communications area. Such firms as MCI and Datran have petitioned the FCC to open up the rich data communications market to competition over the protests of the established common carriers like AT&T and Western Union.

IEEE leader appointed . . . Spotlighting medical care as one of the new priorities for electronics was the appointment of Donald G. Fink, general manager of the IEEE, to select advisory board on Redeploying Scientists and Engineers in the Health Care Field. This committee was recently created by the President's Advisory Council on Management Improvement, which is supported by the Bureau of the Budget's Office of Executive Management.

Unemployment survey . . . To assess the extent of un- and under-employment among engineers, the National Science Foundation has contracted with the Engineers Joint Council to conduct a survey. The \$65,000 survey will contact some 100,000 members of various engineering societies from a total of 450,000 engineers to find if they're working as engineers, and whether their employment is full-time or part-time.

Where to go . . . As part of the administration's \$42 million re-employment package, the Department of Labor has designated 14 areas for special job-finding assistance to engineers. To qualify, the professional must have been laid off from the aerospace or defense industries, have been employed in the industries for 12 of the last 24 months or permanently attached to it, and have been employed in one of the 14 areas. The areas are Huntsville, Ala.; Los Angeles, Orange County, San Diego, and San Jose, Calif.; Cape Kennedy, Fla.; Atlanta, Ga.; Wichita, Kan.; Boston, Mass.; St. Louis, Mo.; Long Island, N.Y.; Philadelphia, Pa.; Dallas and Fort Worth, Tex.; and Seattle, Wash. For specific addresses contact your local State Employment Office.

Job feedback . . . Results from the first two Philadelphia Workshops, co-sponsored by the American Institute of Aeronautics and Astronautics and the Federal Department of Labor, indicate that 49% of the attendees were employed within two months of their participation in the program. According to C. C. Miesse, director of the AIAA Workshop, 30% continued in aerospace while 19% found "challenging positions in other fields."

Seller beware . . . Tom Ingman, president of Powertec Inc., blames not only poor business conditions and the availability of lower cost components, including ICs, for forcing lower power supply prices. Another major factor is that the design engineer can buy a lot of circuitry for \$30, only to find that a power supply to drive it will cost him more. The power supply being a major cost, he must shop for the best price instead of stringing along with "good old Brand X" simply because it's been reliable in the past.

Pill-less therapy . . . While still in the experimental stages, scientists and engineers are anxious about the prospect of using electronics to control heart rate, blood pressure, and even glandular secretions. Relying on a new technique, "bio-feedback training," and the fact that the involuntary nervous system can be voluntarily controlled, researchers use powerful amplifiers to let the patient see or hear the rhythms or conditions of his internal organs. With this feedback, patients have been able to successfully lower their heart rates and blood pressure by a type of mental concentration.

Industry standard for capacitors . . . The Electronic Industries Association is drafting an industry standard for metal cased paper and/or film dielectric SCR commutating capacitors to cover popular ratings, sizes, and measurements. Current range will be 10 to 100 A rms, and ratings will include peak charging voltage and maximum operating frequency. Qualified persons are invited to contribute technical support to W. M. Robinson, Chairman, EIA Working Group p-2.2, Cornell-Dubilier Elect., 1605 Rodney French Blvd., New Bedford, Mass.

Too much money . . . Backing his contention that \$100k and up complex logic testers are unnecessary for testing IC memories, President Bill Mow of Macrodata is selling the MD-100 memory exerciser (cost—\$13,700) which functionally tests to 5 MHz. According to Mow, Macrodata consistently finds failure rates of manufacturer-passed packages higher than 20%. The low tester price should cut user and manufacturer test costs by an order of magnitude and make 1¢/bit a more realistic target, says Mow.

Musing over Munich's "Systems 71" . . . Because the October 1970 Tokyo Computer exhibition was such a success for American participants (the U.S. Department of Commerce reported an immediate \$2.5 million in sales) the U.S. Government has big plans for the November Munich Fair, "Systems 71." The Fair will commemorate the quarter century anniversary of the invention of the computer. Since the Tokyo event occurred, a projected \$54 million in first year sales has been generated and the Munich Fair is expected to do as well. There's room for 65 exhibitors, so if you'd like more information on this, contact Andre Williams at the Department of Commerce, (202) 967-2425.

New manufacturing process . . . Signetics Corp. has announced a new manufacturing process for MOS ICs. In addition, they predict that the process will be extremely useful in the manufacture of linear ICs, high voltage discrete devices and small-signal microwave transistors. Dubbed D-MOS, the process makes use of a double diffusion of channel and source impurities through the source opening in the oxide. This results in extremely short channel lengths (less than 1 micron) for higher speed operation but without the attendant voltage breakdown problems. Signetics predicts that it will be a year before they have the process in production, but they are currently making laboratory-type devices with it.

THE GREAT DAC DEAL

Tear out this ad and show it to some of the boys in your lab. It's an offer you can't pass up.

OUR OFFER: We'll send you your choice of any of our standard data conversion modules absolutely free — for a 30-day evaluation. Check your DAC's performance and compare competitive prices. In that way you'll learn some eye-opening facts about the new Philbrick and its ever-growing capabilities. Then, 30 days after you've plugged our D/A or A/D converter in your system we'll contact you. When we learn you like it, we'll apply the cost of your evaluation unit against your initial order — at the same discount price you earn through quantity purchases. If it doesn't perform to spec, return it. No questions asked . . . no hassle. One outstanding thing you'll discover when you plug in a Philbrick DAC is that it was "human engineered." Pins and bits are in sequential order. You get DIP pin compatibility. Features include $< \pm 0.002\% / \% \Delta V$; power supply rejection ratio, unequalled temperature stability and buffered input to reduce sink current. Eight standard models with 8 to 14 bit resolution. Custom D/A and A/D's? You bet! We can produce hundreds of customer specified DAC's usually within four weeks on OEM quantity orders. And Philbrick DAC's are low-priced, too. From our general purpose DAC's to the highly sophisticated deglitched models like a 14-bit binary $\pm 1/2$ LSB, deglitched output of < 10 mV p-p and < 200 nsec update rate. You get the best price/performance ratio. Philbrick power modules insure optimum performance and guarantee dependability. To help select your free trial evaluation module, send for our data packet containing all the details on Philbrick Data Conversion Modules. Contact your local field engineer or write Teledyne Philbrick, Allied Drive at Route 128, Dedham, Mass. 02026. TWX: (710) 348-6726. TELEX: 92-4438. Cable: TELEPHIL.

*PHILBRICK 4022 AND 4023
GENERAL PURPOSE 10-BIT
BINARY DAC'S. MAXIMUM
LINEARITY $\pm 1/2$ LSB. BOTH
EXHIBIT LOW DRIFT (LESS THAN
40 ppm/°C). THE 4022 CURRENT
OUTPUT IS 0 TO +2 mA. THE 4023
VOLTAGE OUTPUT IS ZERO TO -10V
BOTH CAN BE USED UNIPOLAR
OR BIPOLAR BY EXTERNAL
CONNECTIONS. PRICES ARE
\$27 AND \$29 IN SINGLE UNITS.*

*PHILBRICK 4103, 4104 AND 4105
HIGH PERFORMANCE 12-10-8-BIT
A/D CONVERTERS. IDEAL FOR
HIGH SPEED CONVERSION OF $< 30 \mu$ sec.
LINEARITY OF $\pm 1/2$ LSB. BOTH
SERIAL AND PARALLEL OUTPUT
AVAILABLE. ALL EXHIBIT LOW
DRIFT (LESS THAN 20 ppm/°C).
LOW PROFILE PACKAGING.
PRICE: \$275 FOR
12-BITS IN
SINGLES*

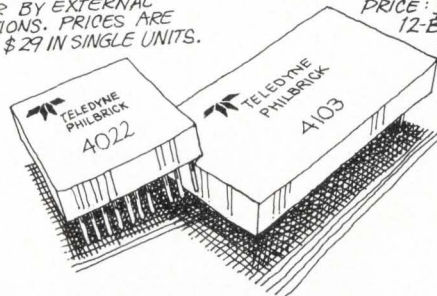

**FOR ROUND-THE-CLOCK
TOLL-FREE READY DATA
DIAL 800-225-7883**

TELEDYNE PHILBRICK
DATA CONVERSION



Fall In!! With Monitor's Fet Amplifiers

- Fast Settling 1 usec to .01%
- High Power Output 200 milliamperes
- High CMR 106 db
- Low Voltage Drift 5 $\mu\text{V}/^\circ\text{C}$
- Low Input Current 10 pico amperes
- Low Price \$12 unit price

Phone 215-646-8100
TWX 510-661-1520
Fort Washington, Penna. 19034

JOIN THE NEWEST DIVISION OF MONITOR'S ANALOG ARMY . . . THE MONIMODULE DIVISION. Why not fight with the finest when MONITOR'S MONIMODULE product line provides the ultimate in high-performance, low-cost FET amplifiers? Whether your requirement is instrumentation, signal scaling, or buffering, MONITOR has the amplifier that can best do the job for you at the lowest possible cost. The MONIMODULE can win your battle; call or write us now to find out what we can do for you.



THE ELECTRONIC ENGINEER • June 1971

Circle Reader Service #10

Standards gap . . . France, Britain, and West Germany have entered into an agreement to standardize their electronic components and establish a certification plan. According to Dr. Lewis M. Branscomb, director of the Department of Commerce's National Bureau of Standards, actions like this will further handicap U.S. electronic products, because "American industry is woefully under-represented in the international standards machinery."

Voice directs mail . . . Under the sponsorship of the U.S. Postal Service, RCA has developed an experimental device called the Numeric Speech Translator. Spoken ZIP code commands will be used to sort parcel past packages. This voice system requires no keypunching as does the present system in which one operator places an item on a conveyor belt while another must punch its ZIP code into a sorting machine.

Engineering employment conference . . . To answer such provocative questions as "What can be done about the thousands of unemployed engineers?" and "Can engineers change gears? the National Society of Professional Engineers will sponsor a two-day fact-finding conference, June 17-18, in Wash., D.C. For more information on "Engineering Employment—A Paradox," featuring among others Sen. Edward M. Kennedy, Dr. Myron Tribus (formerly with the Department of Commerce), and K. E. Kid-

doo (Lockheed personnel director) contact NSPE, 2029 K St., N.W., Wash., D.C. 20006.

Bits of information . . . Teledyne Semiconductor is the new name for two consolidated Teledyne divisions: Amelco and Continental Device Corp. . . . **A new engineering standard (RS-378)** developed by the Electronic Industries Association (EIA) for measuring the levels of oscillator radiation from fm and tv receivers was adopted by the Federal Communications Commission (FCC) . . . **Communication in transportation** is the subject of a seminar organized for June 14-17 by the EIA. Participants include officials from the Department of Transportation and the FCC.

A domestic communications satellite system proposed by Fairchild of Hiller Corp. can cut the costs of long distance telephone service to one-tenth of today's rates, the FCC was informed . . . **EIA reports color TV sales up 27.4%** in March 1971 over the same month last year. All consumer electronic categories show increases in the first quarter of 1971.

RCA has entered the glass business with the opening of a \$19 million TV bulk and faceplate plant in Circleville, Ohio . . . **The Mariner 8 and 9** spacecrafts will be controlled by Honeywell's guidance and stabilization systems. The two Mariners will explore Mars . . . **Bell Labs** has developed a digital transmission system, the T2, to provide economical service over distances up to 500 miles. It should be available for commercial service in 1972.

TEST TRANSISTORS AND DIODES

WHILE STILL IN CIRCUIT!



Check conduction and cut off on NPN and PNP transistors and diodes without unsoldering. This unusual portable tester saves valuable time in labs and on production and test lines. Complete with extending leads.

Ask for your **FREE** **SC-4**.....\$72.50

CATALOG! TOOLS FOR INSTRUMENT ASSEMBLY

ORYX TELVAC TELVAC INSTRUMENT COMPANY 18531 VENTURA BLVD TARZANA, CALIF. 91356

Circle Reader Service #30

TOOL KITS FOR ELECTRONIC TECHNICIANS



Industrial kit JTK-2 above (44 pieces) only \$44.50 (delivered). Write for new tool catalog.

JENSEN TOOLS AND ALLOYS 4117 N. 44th Street, Phoenix, Arizona 85018

Circle Reader Service #31



Isolationist

Nobody likes line transients. Lab engineers hate them. Computer people get very upset when line transients flop their Flip-Flops. Now, you don't have to put up with that nonsense anymore. Our new little shielded "Isolationist" will give you high common mode rejection, stop high frequency line transients, put an end to 60 cycle leakage current and break AC ground loops . . . simply and economically. 0.1 to 2KVA units (to 0.0005 pfd. coupling capacity) are available from stock to 8 weeks. Write for our catalog.

 **CEA**, a division of Berkleonics, Inc.
1221 S. SHAMROCK AVENUE, MONROVIA, CALIFORNIA 91016 TELEPHONE: (213) 359-9261

Circle Reader Service #11

Tired of smoking your RF generator?



Sierra's 470A high-power signal generator gives you automatic protection against no-load conditions.

Our 470A series give you stable RF power from 50 MHz to 1800 MHz. If you need 2400 MHz, ask us about that, too. The direct-reading power meter tells you your wattage (up to 50) at a glance. They can put out CW or a pulse-modulated signal. So they're perfect for development, test and service work on RF and microwave gear, for RFI susceptibility experiments and antenna pattern ranges. Get a Sierra 470A on your bench and you'll never smoke another generator.

The final oscillator tube (the only tube; everything else is solid state) is so easy to replace you can get back on the air in under a minute.

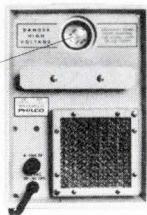

For additional information, write or call:
Sierra Electronic Operation
 3885 Bohannon Drive
 Menlo Park, Ca. 94025
 (415) 322-7222
 TWX 910-373-1282

PHILCO 

Sierra manufactures a complete line of transmission, data and RF instruments for the communications industry.

Untapped resources

Former aerospace engineer Sam Suth of the St. Regis Paper Co., West Nyack, New York, presented an interesting paper at a recent conference on the use of digital computers in process control. His paper described an adaptive process control system in a paper mill. He prefaced his speech with a remark that only two years ago he had been in aerospace, with no knowledge of the paper business. However, since then he has found, through use of his aerospace experience, that saving 0.26 lb. of paper per ream adds \$200,000 per year to profits.

Sam's work was roundly praised, although more than a dozen attendees prefaced their conversations with the remark, "I can't believe he came from aerospace!" Sam's success is no surprise to me. His failure would have been astonishing.

It was tragic to have heard some speakers say that they do not have the people available to implement systems they can economically justify. Others stated that, for any task, it is better to have one \$20,000 per year man than two \$10,000 per year men. And still others claimed that businesses need "systems programmers" to successfully choose computer systems or to buy from small manufacturers, while a great concentration of exactly that kind of talent is walking the streets today.

Men who have built and controlled the most complex systems ever can certainly contribute to automating processes. And yet there are many rationalizations for not hiring them: they are too highly paid; they don't understand our problems. They are paid well for a reason—they are good. If management flinches at the challenge of redirecting the efforts of men who have spent years solving "unsolved" problems, it is tired indeed.

These men are capable of understanding and responding to any corporate format or set of ground rules. Try one. Tell him your corporate facts of life; get him on board; and watch him go to work for you. Congratulations to the St. Regis Paper Co. for their insight into the fact that a good man is a good man, regardless of the company name on the building.



Western Editor



Some think their working day is a real challenge. Some don't.

If you sat for eight hours sticking tiny little components into even tinier little holes, you might not be too excited about your job either.

But, even if people don't like the work, there are machines that do, the Dyna/Pert electronic component inserting machines from USM.

Dyna/Pert offers an entire line of component inserting equipment from small bench models, to semi-automatic units, to totally automated conveyor systems. Many of them can be either NC or computer controlled. Dyna/Pert also has automatic sequencing systems and DIP inserters.

What's more, Dyna/Pert machines don't take coffee breaks, call in sick or look for new jobs. They just keep on producing at up-time rates in excess of 90%.

A Dyna/Pert machine will even pay for itself after a short period of time, and then start paying you. So don't you think it's time you woke up to Dyna/Pert?

For further information contact your local USM office, or write USM Corporation, Dyna/Pert Dept., Machinery Division, 181 Elliott St., Beverly, Mass. 01915.

Visit the USM display at Booth 3600 during Nep/Con East.



USM Corporation
Machinery Division

The Productivity People

Custom Now

So you won't have to pay later

The design looks perfect . . . but then, somewhere something goes wrong. A defective part, an improper assembly, or maybe it was the installation in the field. It's impossible to avoid all imperfections - the problem is that few companies are willing to take the time and money to root out the problems before they put their product on the market.

As experts in the field of reconstituted mica capacitors, our experience shows that the greatest single cause for capacitor failure is a short in the dielectric material. Consequently we precisely inspect and grade all of our dielectric material **before** production. Because of our meticulous quality control, Custom Mica Capacitors are absolutely the finest quality capacitors of their kind available on the market today. **We pay now so you won't have to pay later.**

Our engineering staff is ready to work with you to produce evaluation units, write or call today:



CMR, wrap and fill

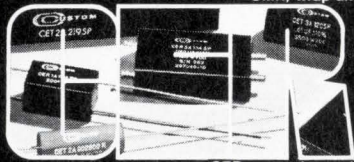

CER, epoxy housed

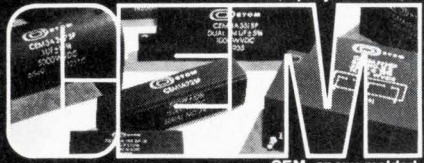

CEM, epoxy molded



CUSTOM ELECTRONICS, Inc.
Brown St., Oneonta, N. Y. 13820
PH: 607-432-3880 TWX 510-241-8292

Circle Reader Service #14

JUNE						
13	14	15	16	17	18	19
20	21	22	23	24	25	26
27	28	29	30			

June 14-17: 47th Annual Convention of the Electronic Industries Association, Arlington Park Towers Hotel, Arlington Heights, Ill. Addtl. Info.—EIA, P. R. Dept. 2001 Eye St., N.W., Washington, D.C. 20006.

June 15-17: National Electronic Packaging and Production Conference (NEPCON '71 EAST) and the 1st **East Coast SEMICONDUCTOR/IC PROCESSING & PRODUCTION CONFERENCE/EXHIBITION**, New York Coliseum, New York, New York. Addtl. Info.—Don Peterson Industrial and Scientific Conference Management, Inc., 222 West Adams St., Chicago, Illinois 60606

June 15-18: Seminar on Thick Film Hybrid Technology, Unitek Corp., Monrovia, Calif. Addtl. Info.—Unitek/Weldmatic Div., Seminars Coordinator, 1820 South Myrtle Ave., Monrovia, Calif. 91016

June 17-18: "Engineering Employment—A Paradox" Conference, Statler Hilton Hotel, Washington, D.C. Addtl. Info.—National Society of Professional Engineers, 2029 K St., N.W., Washington D.C. 20006.

June 22-25: Seminar on Monolithic I. C. Technology, Unitek Corporation, Monrovia, Calif. Addtl. Info.—Unitek/Weldmatic Div., Seminars Coordinator, 1820 South Myrtle Ave., Monrovia, Calif. 91016.

June 27-30: 1971 Consumer Electronics Show, McCormick Place, Chicago, Illinois. Addtl. Info.—Consumer Products Division, Electronics Industries Association, 2001 Eye St., N.W., Washington, D.C. 20006.

June 27-July 1: Design Automation Workshop, Shelburne Hotel, Atlantic City, N.J. Addtl. Info.—R. B. Hitchcock, Sr., IBM, Box 218, Yorktown Heights, N.Y. 10598.

JULY						
			1	2	3	
4	5	6	7	8	9	10
11	12	13	14	15	16	17
18	19	20	21	22	23	24
25	26	27	28	29	30	31

July 13-15: International Symposium on Electromagnetic Compatibility, Bellevue Stratford Hotel, Philadelphia, Pa. Addtl. Info.—Ralph Showers, Moore Sch. of EE, Univ. of Penna., Philadelphia, Pa. 19104.

July 19-20: Summer Computer Simulation Conference, Boston Sheraton Hotel, Boston, Mass. Addtl. Info.—Michael McCarthy, Wharton Sch. of Finance, Univ. of Penna., Philadelphia, Pa. 19104.

CALENDAR

July 25-30: ISA's 1971 Research Conference on Instrumentation Science, Hobart and William Smith Colleges, Geneva, N.Y. Addtl. Info.—Instrument Society of America, Education Services Dept., 400 Stanwix St., Pittsburgh, Pa. 15222.

AUGUST						
1	2	3	4	5	6	7
8	9	10	11	12	13	14
15	16	17	18	19	20	21
22	23	24	25	26	27	28
29	30	31				

Aug. 11-13: Joint Automatic Control Conference, Washington University, St. Louis, Mo. Addtl. Info.—R. W. Brockett, Pierce Hall, Harvard Univ., Cambridge, Mass. 02138.

Aug. 23-28: International Federation for Information Processing (IFIP) Conference, Ljubljana, Yugoslavia. Addtl. Info.—U.S. Committee for IFIP Congress 71, Box 4197, Grand Central Post Office, New York, N.Y. 10017.

Aug. 23-28: European Microwave Conference, Royal Inst. of Tech., Stockholm, Sweden. Addtl. Info.—H. Steyskal, European Microwave Conf., Fack 23 104 50 Stockholm 80, Sweden.

Aug. 24-27: Western Electronic Show and Convention (WESCON), Cow Palace, San Francisco, Calif. Addtl. Info.—Don Larson, WESCON, 3600 Wilshire Blvd., Los Angeles, Calif. 90005.

'71 and '72 Conference Highlights

WESCON—Western Electronic Show & Convention, Aug. 24-27; San Francisco, Calif.

NEC—National Electronics Conference, Oct. 18-20; Chicago, Ill.

NEREM—Northeast Electronics Research & Engineering Meeting, Nov. 3-5; Boston, Mass.

IEEE International Convention and Exposition will be called INTERCON '72. It will take place on March 20-23, at the New York Coliseum and New York Hilton.

Product noise and vibration reduction . . .

This is only one of a number of training seminars being sponsored this year by B&K Instruments Inc. Scheduled for June 8 to 10, this seminar covers such topics as transducers, signal processing and data storage, real-time analysis, and computer interface. There's another one on industrial noise control scheduled for June 15-17. We'll be keeping you posted on future seminars to be held at the B&K Instruments facility in Cleveland, Ohio.

Circle Reader Service #271

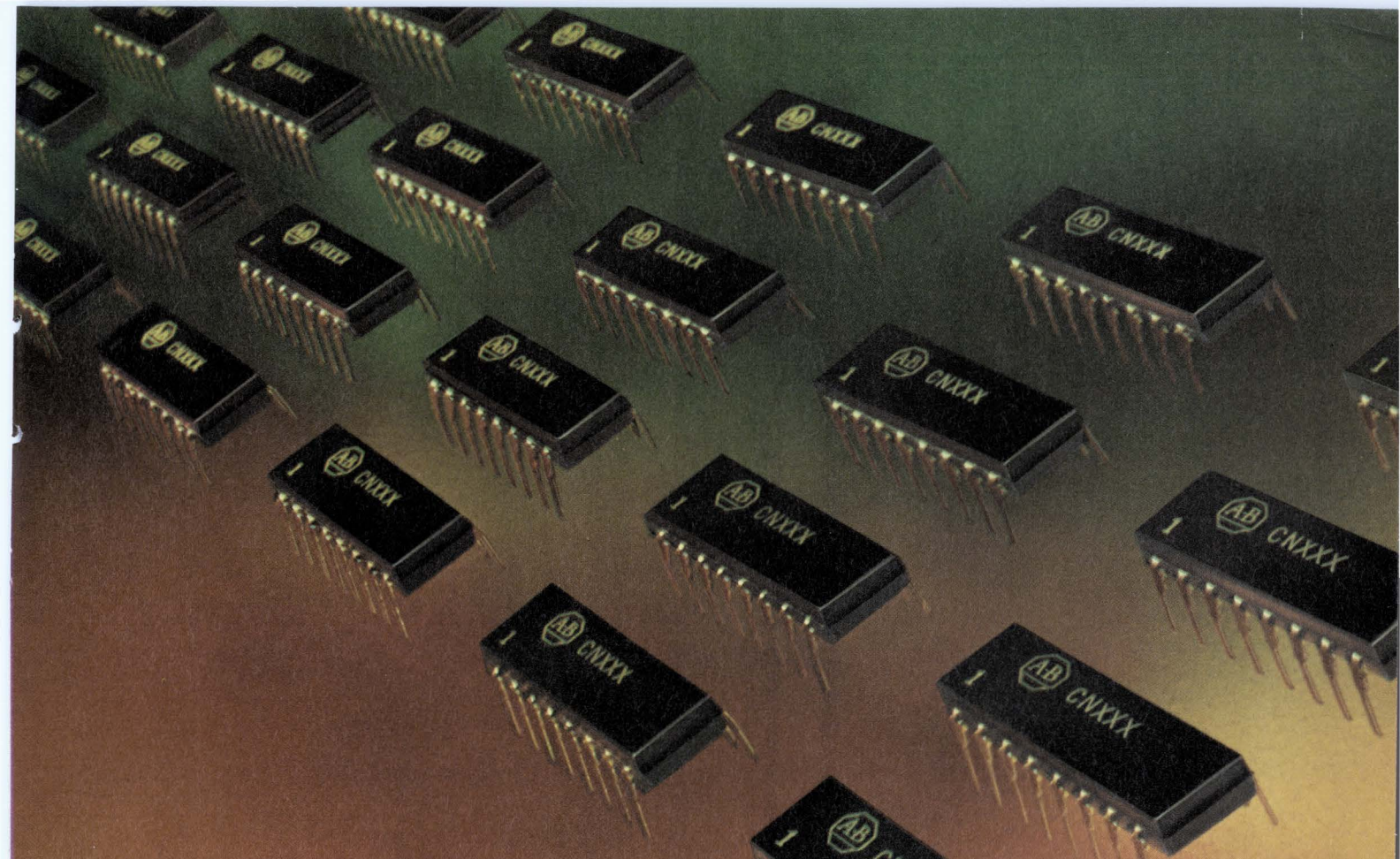

The Allen-Bradley cermet corps: versatile standard packages containing R/C circuitry designed to your needs.

The need: compact R/C networks in DIP's for terminator applications in new generation computer designs. To meet the circuit board space crunch, Allen-Bradley combines resistors and capacitors in a package compatible with automatic insertion equipment. These cermet networks save space and attachment costs. Packaged in dual in-line molded packs that lock out the environment and

match your IC's. Lead frames with built-in stand-offs are weldable or solderable. Volume production available.

SELECTED SPECIFICATIONS

TOLERANCES	Absolute to $\pm .5\%$
TRACKING	Excellent
RESISTANCE RANGE	10 ohms to 10 megs, standard; 1 ohm to 100 megs, special
CAPACITANCE RANGE	To 60,000 pF per cm ²
TCR	As low as ± 100 ppm/ $^{\circ}$ C
CALIBRATION	Abrasive or laser
LEAD SPACING	100 mil standard

Investigate the advantages of Allen-Bradley cermet R/C networks. For information write: Marketing Department, Electronics Division, Allen-Bradley Co., 1201 South Second Street, Milwaukee, Wisconsin 53204. Export office: 1293 Broad St., Bloomfield, N. J. 07003 U.S.A. In Canada: Allen-Bradley Canada Ltd., 135 Dundas Street, Galt, Ontario.

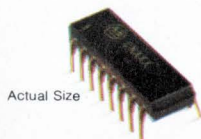

Actual Size

EC71-4 © Allen-Bradley 1971

Circle Reader Service #15

NEW DIMENSION ELECTRONICS
ALLEN-BRADLEY



Circle Reader Service #16 →

Custom(er) Cable Constructions by Chester

Behind every foot of multi-conductor cable produced by our Chester Cable Operations, are the vast resources, technical skills and virtually unlimited facilities of Cities Service. From the basic copper ore to the finished product, every care is exercised in strict quality control to assure you of dependable and practical cable construction to fulfill your most exacting requirements.

The samples of Plasticote® multi-conductor cables shown on these pages are but a few of the thousands of "specials" produced for our many customers. No matter what your needs in conductors, insulations or jackets, check first with Chester . . . we know you'll be more than pleased with the results.

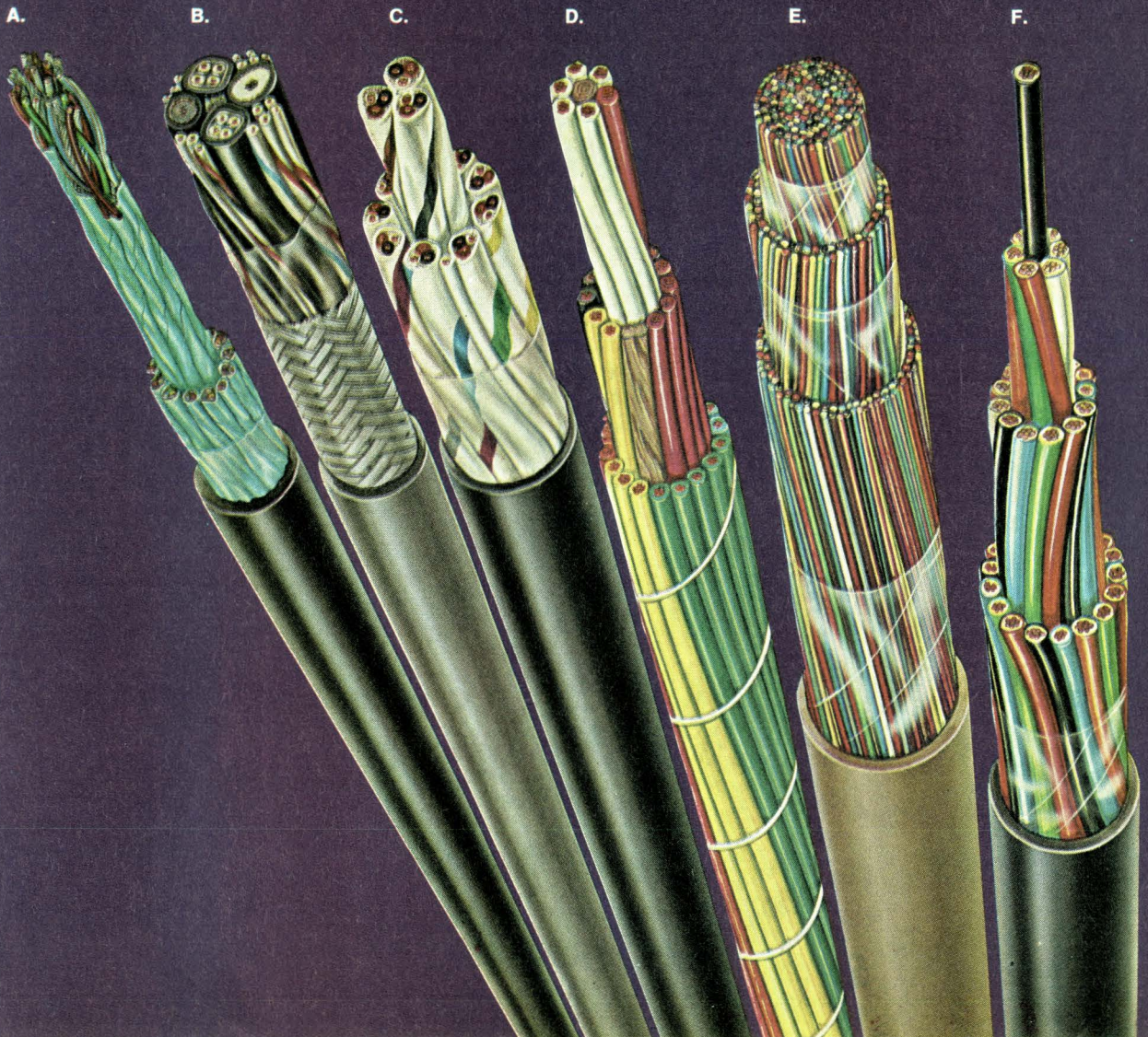

A. RECORDING STUDIO: Audio sound cable: 25 shielded pairs, stranded copper conductors, low loss insulation, twisted with uninsulated drain wire, isolated aluminum tape shields, cabled, PVC jacket.

B. TV CAMERA MFR.: Camera control cable for Audio and Video signals: a composite of PVC and polyethylene insulated conductors, cabled, overall braid shield, PVC jacket.

C. AIRCRAFT SIMULATOR MFR.: Control cable: 12 triples shielded jacketed, stranded copper conductors, PVC insulated, individual shield jacket color coded, cabled overall PVC jacket.

D. ELEVATOR MFR.: Control cable: 35 conductors, stranded copper, PVC insulated, conductors coded by colors and printed numbers, cabled with open binder; individual conductors U/L listed.

E. INTERCOM EQUIPMENT MFR.: 250 conductor inter-office communication and signaling cable: solid bare copper, PVC insulation, paired, cabled, PVC jacket; U/L listed.

F. ELECTRIC UTILITY CO.: Station control cable for general use: 37 conductors, stranded, polyethylene and PVC insulated, color coded, cabled, overall tough PVC jacket; per NEMA/IPCEA Specifications.

G. LARGE CITY: Communication cable: 50 pairs, polyethylene insulated, cabled, continuous layer of copper shielding tape, PVC jacket; per spec. IMSA-19-2, 600 volts.

H. LEADING SHIPBUILDER: shipboard cable: stranded conductors, nylon-jacketed PVC insulation, pairs shielded and jacketed, cabled, PVC jacket, and aluminum braid armor overall; per spec. MIL-C-915.

I. U. S. GOVERNMENT: Coaxial cable: type RG-218/U, solid copper conductor, polyethylene insulated, copper braid shield, PVC jacket; per spec. MIL-C-17/79.

J. BROADCASTING COMPANY: Remote control broadcasting cable: stranded conductors, polyethylene insulation, pairs & triples shielded and jacketed, cabled, PVC jacket overall.

K. COMPUTER MFR.: Computer control cable: 55 conductors, stranded copper conductors, PVC insulated, formed into 7 groups of 7 conductors, cabled, PVC jacket; U/L listed.

L. MACHINERY MFR.: Bus drop cable: 3 PVC insulated stranded conductors, with split uninsulated grounding conductor, cabled, overall PVC jacket; U/L listed; per NEC.



CITIES SERVICE COMPANY
CHESTER CABLE OPERATIONS
CHESTER, NEW YORK 10918
PHONE: (914) 469-2141 TWX (914) 469-9801

Engineering unemployment

Sir:

The defeat of the SST symbolized the most significant commitment of Americans and our leaders towards the reorientation of our priorities. This reorientation includes budget cuts for NASA and defense research and development. It is safe to assume that this trend is substantial and of long duration.

As a former engineer I hold no special identification with the interests of the environmentalists or the aerospace and defense contractors. However from my recently acquired vantage point outside this economic upheaval I view the plight of my former colleagues with empathy and sorrow. They are clearly the martyrs in this holy war waged by the ecologists and pacifists.

What I find particularly frustrating are the ad hoc and glib solutions offered to reemploy these engineers who are on the whole highly trained and educated.

Some say we should make them into teachers. But demographers tell us there

are and will be too many teachers. Also the salaries are much lower and the skills required for teaching do not fully tap the full capabilities of engineers.

Some say we should reemploy them in the peaceful application of engineering such as transportation, health services and urban reconstruction. To some extent this can be done but in many cases, perhaps most cases, the engineer trained in one specialization cannot be retrained in another. More important however is the fact that the jobs created for engineers will not equal those eliminated. Space and defense contracts had vast engineering inputs because the systems produced were few and complex. On the other hand the ecologist's application of engineers is largely on smaller projects produced many times. The television for example has very little engineering in it when compared to a radar system. Well then where can engineers be employed quickly and efficiently so as to tap the full value of their ability?

I believe a program could be estab-

lished to train engineers to be management scientists within 6 to 12 months. This new field requires the application of analytical and mathematical concepts which are either familiar to or easily learned by most engineers. After this training program the government would assist them in obtaining positions as management consultants, technological forecasters, long range planners, operations research analysts, new product managers, business planners and a host of other positions created by the new awareness of corporate executives that quantifying the intangible is a profitable exercise. The important point is that the engineer is more than a specialist. He is a trained analytic mind. I would guess that of the 50,000 engineers who are presently unemployed at least 10,000 could be reabsorbed very effectively with such a program.

Jay Freeman
New Products Manager
Ideal Corporation
New York, N.Y.

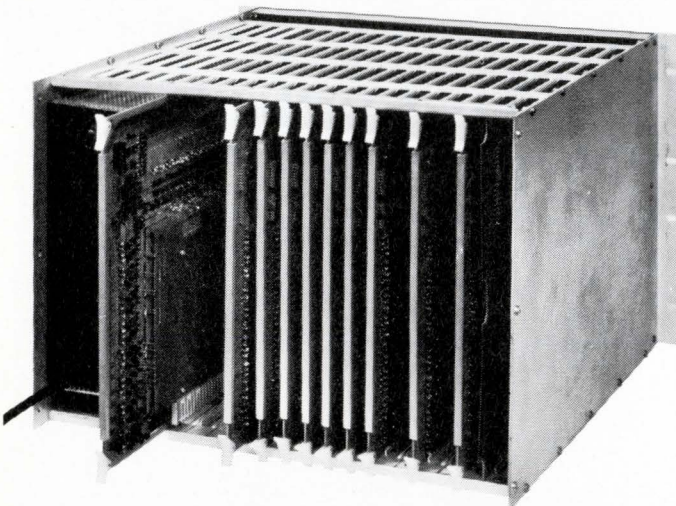

MINI-MASS™* ELIMINATES TRADE-OFFS OF SIZE, SPEED, OR ECONOMY!

This is the ultimate memory system for storing large blocks of random data. 12¼" of panel height houses an entire 1,179,648 bit memory system. The Mini-Mass™ can be configured as a 32K x 36, 65K x 18, 131K x 9. Capacities start at 16K x 18 or 8K x 36 and can be expanded by simply inserting a single PC board for each 4K increment. Data save, byte control, power supply, systems enclosure, temperature tracking and wide range lithium core arrays are *standard* features. Field expan-

sion is ultra fast and ultra simple. Remember, the memory controller is built to address 65K words. By using two (2) controllers, the word length can be doubled to 36 bits with 32K words or you can operate as two separate 32K x 18 memory systems in the same enclosure. The entire I/O wiring for 65K x 18 is contained on two (2) 86 pin connectors and four (4) 86 pin connectors for two (2) 32K x 18 or a 32K x 36 unit.

For all memory requirements, call or write today:

* 750 NANOSECOND FULL CYCLE TIME
325 NANOSECOND ACCESS TIME

STANDARD MEMORIES
INCORPORATED
A Subsidiary of Applied Magnetics Corporation

15130 Ventura Boulevard
Sherman Oaks, California 91403
(213) 788-3010 TXW 910-495-1738

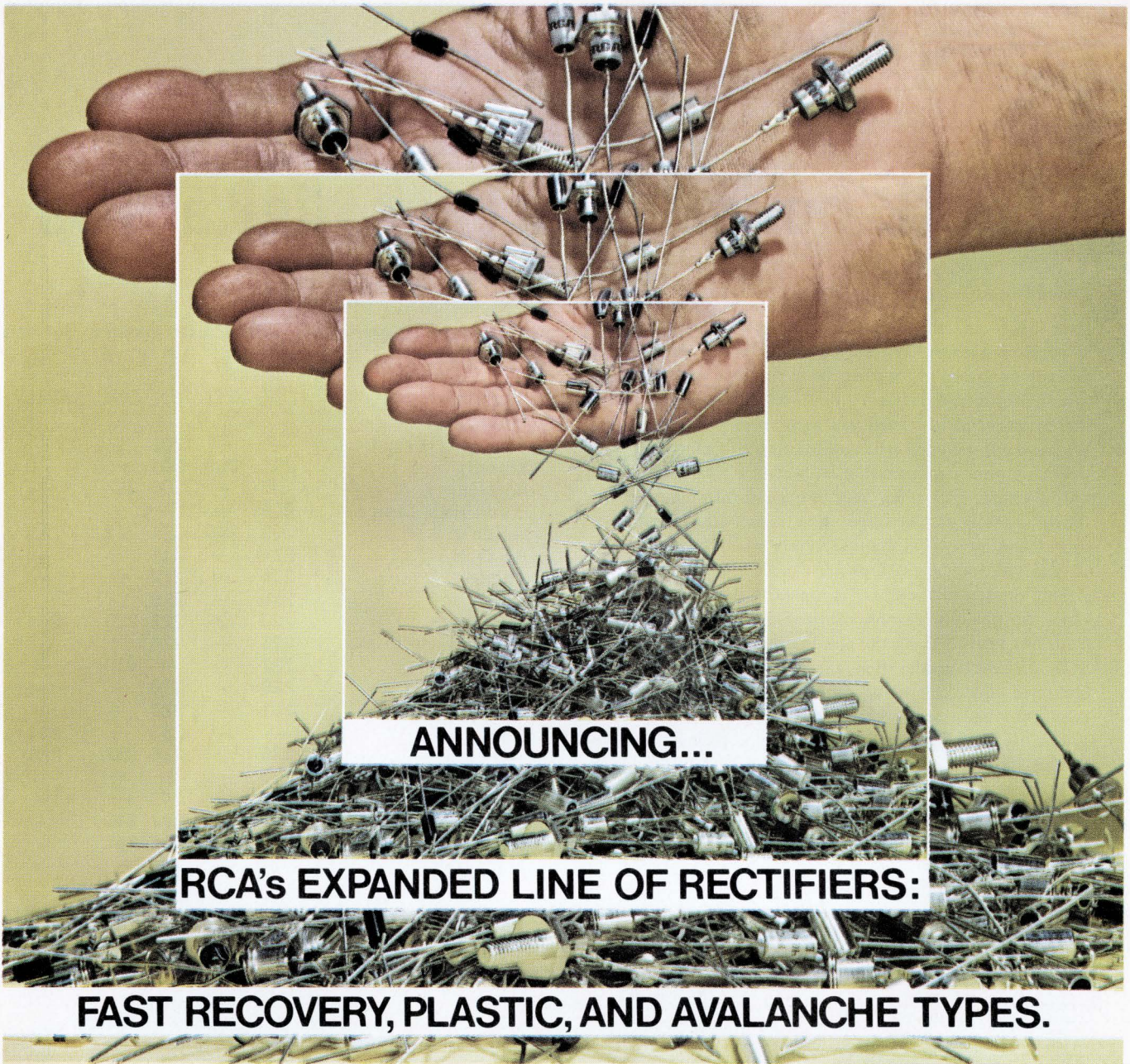

ANNOUNCING...

RCA's EXPANDED LINE OF RECTIFIERS:

FAST RECOVERY, PLASTIC, AND AVALANCHE TYPES.

Here they are: production quantities of RCA's new fast-recovery silicon rectifiers, rugged plastic rectifiers, and hermetically-sealed controlled avalanche rectifiers. Constructed to the highest standards of quality and reliability, these and the many others in RCA's established rectifier line are immediately available to fill your application needs.

Make use of RCA's 1- and 3-ampere diffused junction silicon rectifiers (DO-26 and modified DO-4 packages) in high-speed inverters, choppers, and other high-frequency applications. Use RCA's 1- and 1.5-ampere plastic rectifiers (DO-15 package) in home entertainment equipment, industrial controls, appliance controls, and light industrial equipment. In instruments where reliable transistor protection is required, use RCA's hermetically-sealed (DO-26) controlled avalanche rectifiers.

For more details, call your local RCA Representative or your RCA Distributor, or write: RCA, Commercial Engineering, Section 59F/UR10, Harrison, N.J. 07029. International: RCA, 2-4 rue du Lièvre, 1227 Geneva, Switzerland, or P.O. Box 112, Hong Kong.

Rectifier	Max. Repetitive Peak Reverse Voltage (VRRM) (V)	Maximum Forward Current Avg. (I _F) (A)	(RMS) (A)	Peak Surge** Non-Repetitive I _{FSM} (A)	Reverse Recovery Time (trr) (μs)	Package	Capability
TA7892-TA7895*	200-800	1.0	1.5	35	0.5	DO-26	fast recovery
TA7898-TA7901	200-800	3.0	4.5	75	0.5	modified DO-4	fast recovery
TA7996, TA7802-TA7806*	100-1,000	1.0		35		plastic DO-15	general-purpose
1N5391-1N5399	50-1,000	1.5		50		plastic DO-15	general-purpose
40808	600	.5		35		DO-26	controlled avalanche (700-1100 V)
40809	800	.5		35		DO-26	controlled avalanche (900-1300 V)

*RCA Developmental types

**For one-half cycle of applied voltage (f = 60 Hz)

RCA Solid State

Speed/power chart for digital ICs

Lynda Rothstein, Editorial Assistant

Here it is folks—the updated version of your annual digital IC specifying chart. We have plotted typical propagation delay in nanoseconds against the average power dissipation (usually for a 50% duty cycle) in milliwatts per gate. All of the commercial ICs listed are bipolar monolithic devices. We have not included MOS and hybrids.

Each circuit configuration is indicated by a colored dot on the chart, each color representing a different type (as shown in the key). The larger dots indicate the popular circuits made by several manufacturers which have the same or nearly the same speed/power characteristics.

This version of the chart is minus Philco-Ford and Sylvania, for obvious reasons, shortening the listing somewhat from last year. Taking the elimination of Philco-Ford and Sylvania into consideration, the DTL and RTL devices have remained much the same as last year, while there have been a few additions to TTL, ECL and specials.

The list has been prepared to help you pick out individual ICs shown on the chart. The number next to the manufacturer corresponds to the number of a circuit configuration shown on the chart. For more information on specific products, circle the number next to the manufacturer and under the product type that interests you on the Reader Service Number Chart.

For more information, use these Reader Service numbers

Company	DTL	RTL	TTL	ECL	Specials
Advanced Micro Devices	—	—	201	—	—
Amelco	202	203	204	—	—
Amperex	205	—	206	207	—
Continental Device	208	—	—	—	—
Fairchild	209	210	211	212	213
Harris	214	—	215	—	—
Hughes	216	—	217	—	—
ITT	218	—	219	—	—
Motorola	220	221	222	223	224
National	225	—	226	—	—
RCA	227	—	—	228	—
Raytheon	229	—	230	—	—
SGS/Varadyne	231	—	232	—	—
Siemens	—	—	233	—	234
Signetics	235	—	236	237	238
Siliconix	239	—	—	—	—
Sprague	—	—	240	—	—
Stewart-Warner	241	—	242	243	—
Texas Instruments	244	245	246	247	—
Transitron	—	—	248	—	—

BIPOLAR DIGITAL LOGIC CHART

DTL

- 1 Amperex FCJ 111, 201
- 2 Amperex FJC 121, 131, 191, 211
- 3 Amperex FCJ 221
- 4 Amelco HNIL 300
- 5 Continental Device HNIL DTL 330BG, CG
- 6 Amperex LPDTL 9040
- 7 RCA CD2200
- 8 Amperex FJC 101
- 9 Amperex FCH 231
- 10 Amelco 6041-6047
- 11 Amperex FCH 101, 121, 141, 151, 181, 201
- 12 Texas Instruments MOD-DTL 53, 73
- 13 Amperex FCH 111, 131, 161, 171, 191, 211
- 14 Signetics SE/NE100
- 15 Fairchild DT_L 930
- 16 Hughes HSM 930 J
- 17 ITT 930
- 18 RCA CD2300
- 19 Harris 930 hardened circuits
- 20 Raytheon 930
- 21 Siliconix S1830, 930
- 22 Stewart-Warner SW930
- 23 Texas Instruments 15930, 15830
- 24 Raytheon 200 series
- 25 Signetics SP600A
- 26 National DTL DM930
- 27 Siliconix A01, A41
- 28 Harris 200, 300, 500
- 29 Fairchild 9950
- 30 SGS/Varadyne 9950
- 31 Siliconix SC 126/426
- 32 Motorola MDTL MC930/830, MCE930

RTL

- 1 Texas Instruments 17,900L, 17,800L
- 2 Fairchild LPRT_L 9910
- 3 Motorola mW MRTL MC908, mW MRTL MC808/708, mW MRTL MC808P/708P
- 4 Amelco 100
- 5 Fairchild RT_L 900,9990
- 6 Motorola MRTL MC900/800, MRTL MC700, MC800P/700P

TTL

- 1 Amelco 500-509
- 2 Amelco 530-548
- 3 Fairchild 9L00
- 4 National 54L
- 5 Texas Instruments 54L/74L
- 6 Amperex FJH 231, 251
- 7 Amperex FJJ 111, 121, 191
- 8 Signetics NE/SE400J
- 9 Amelco 570-587
- 10 Signetics S/N8400
- 11 Amperex FJJ 131
- 12 Amperex FJJ 101
- 13 Amperex FJH 101A, 101B
- 14 Amperex FJH 121A, 121B
- 15 Amperex FJH 151, 161, 171, 181, 221
- 16 Siemens FLH 100 series
- 17 Amperex FJH 101, 111, 121, 131, 241
- 18 Hughes HSM 5400/7400
- 19 ITT 5400/7400
- 20 Signetics S5400, N7400
- 21 Sprague 54/74
- 22 Transitron 54/74
- 23 Amperex FJH 141
- 24 Amperex FJJ 181
- 25 Motorola Mtl I, MC500/400
- 26 Transitron TTL Series I
- 27 Raytheon Ray I
- 28 Stewart-Warner SW 9601
- 29 Fairchild 9000
- 30 ITT 9000
- 31 Advanced Micro Devices 9600, 96L00, 2600, 26L00
- 32 SGS/Varadyne T100
- 33 Fairchild LP MSI 93L00 series
- 34 Advanced Micro Devices 93L00 LP MSI
- 35 Amperex FHH 101A, 101, 121A, 121B, 141A, 141B, 161A, 161B, 181A, 181B
- 36 Motorola MTTL II MC2100/2000, MTTL III MC3100/3000, MTTL MCE54H00/74H00
- 37 Harris 54HR (hardened TTL family)
- 38 Raytheon Ray II
- 39 Signetics 8H, 54H/74H
- 40 Sprague 54H/74H
- 41 Texas Instruments 54H/74H
- 42 Transitron 54H/74H, Series II
- 43 National 74H
- 44 Fairchild 9300
- 45 Advanced Micro Devices 9300 MSI,

- 93L00 LP MSI, 2501
- SGS/Varadyne T150
- 24 Raytheon Ray III
- 25 Texas Instruments 54/74
- Signetics TTL S/N 8800
- Fairchild 54/74
- National 54/74 DM 7000,8000
- 26 Amperex FJJ 211 (7493), FJJ 251 (7492), FJJ 141 (7490), FJJ 101 (7441), FJJ 191 (7480)
- Stewart-Warner SW 5400/7400 series
- Motorola MTTL MCB5400, MCB5400F, MC5400/7400
- Advanced Micro Devices 54/74 MSI, 8800 MSI
- Sprague US7500, US8500, USS/USN9600
- 27 Amelco 525-529 (TTL 1/4 mW gate, 1 μ sec prop. delay)
- 28 Texas Instruments 54S/74S
- 29 Signetics S/N 8200
- Sprague USS/USN8200

ECL

- 1 Motorola MECL MC300/350
- Stewart-Warner SW300, and 350 Series ECL I
- 2 Motorola MECL 10,000
- RCA CD2160
- 3 Signetics ECL II
- Motorola MECL II MC1200/1000
- Stewart-Warner SW1000, and 1200 Series ECL II
- 4 RCA CD2150
- 5 Fairchild 9500 Series temperature compensated intermediate speed
- Texas Instruments 2500
- Amperex GH Family
- 6 Amperex FKH 111, GU Family
- 7 Motorola MECL III, MC1660
- 8 Fairchild 95H00 temperature compensated high speed
- 9 Amperex FS Family

SPECIALS

- 1 Motorola MHTL MC660
- 2 Signetics LU300K, SU300G/K
- 3 Signetics LU and SP300A
- 4 Fairchild CTL I
- 5 Fairchild CTL II
- 6 Siemens LSL (FZH Series)

For a copy of this article, circle 249 on the Reader Service Card.

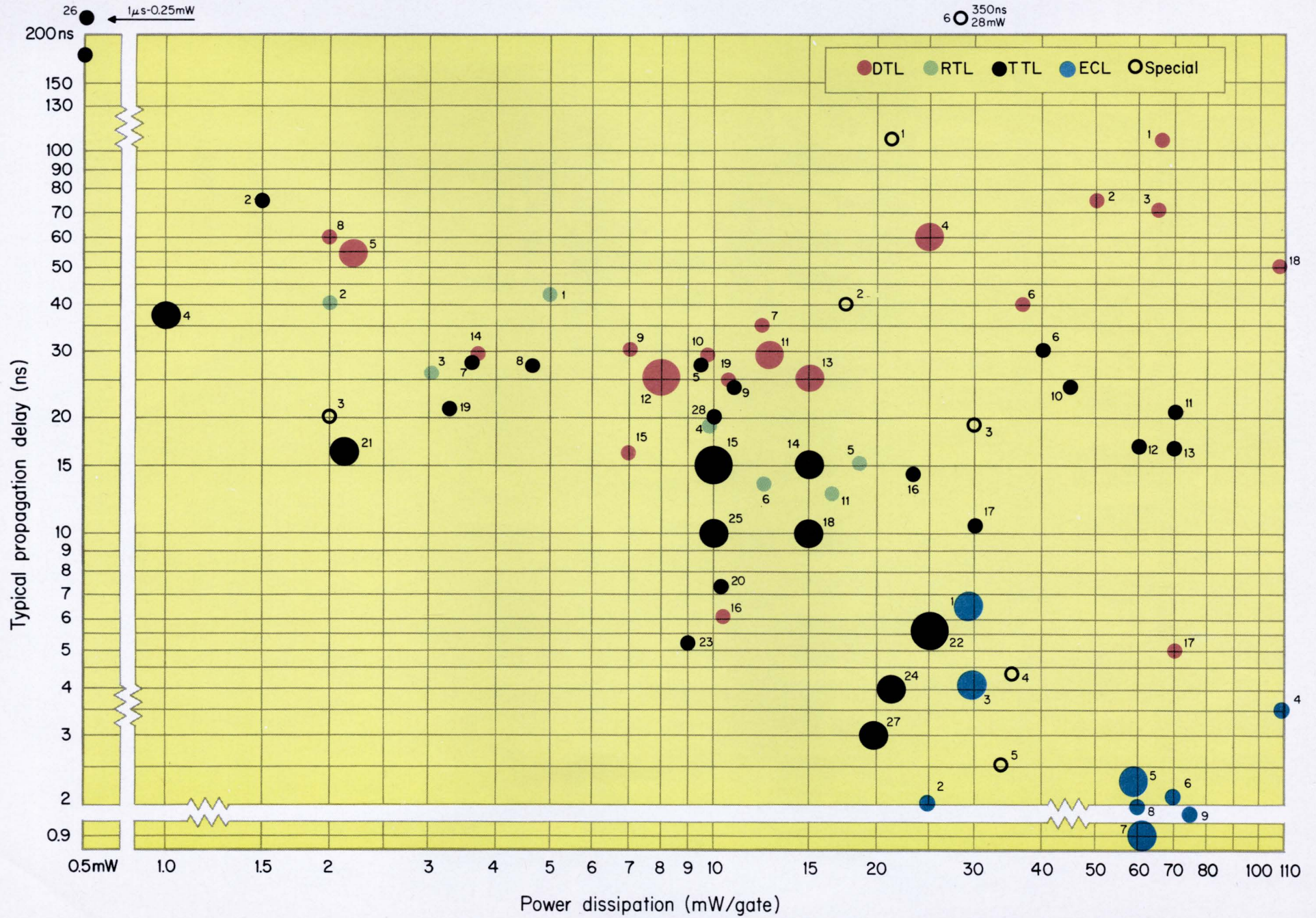

DATAPAC BUILDS AND SELLS MORE ROMS FOR MORE APPLICATIONS THAN ANYONE ELSE IN THE WORLD

Datapac Read-Only Memory Systems are unique in their design to let you easily change individual bits, words or an entire memory in the field. Datapac ROMs are available in a wide choice of models, sizes and configurations. Capacities from 1K to 1 Megabit. Word lengths to 80 bits. Speeds as fast as 200 Nsec. Cycle and 75 Nsec. Access. Off the shelf delivery—50,000 MTBF. Mil Spec compatible. And 1.5c per bit. Write today for our FREE brochure containing the complete Datapac story.

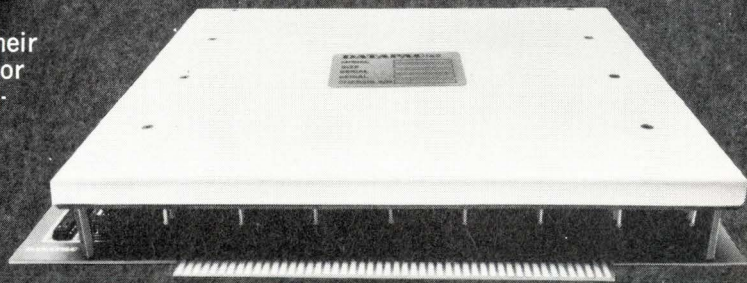

DATAPAC INCORPORATED

3839 S. Main St., Santa Ana, Calif. 92702, Tel. (714) 546-7781

"#1 in the field"

Everything about this MOS/LSI packaging concept is economical, including our connector. And you can rely on that.

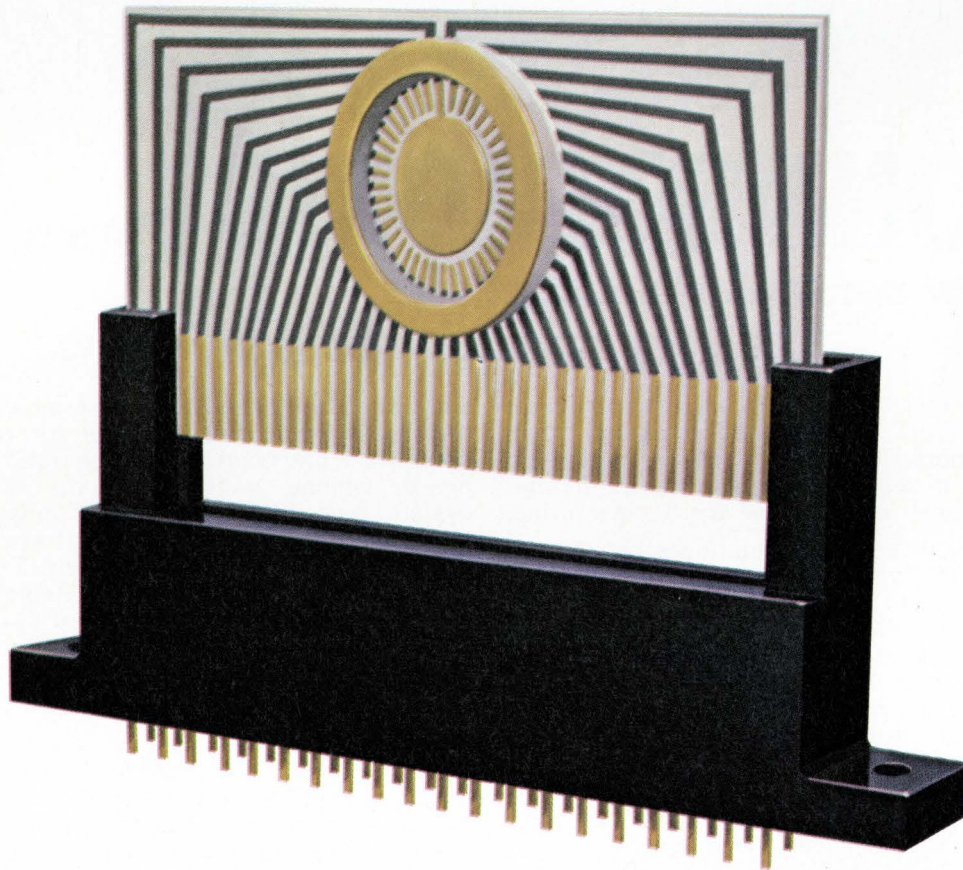

Our edgemount connector is specifically designed to help you take advantage of the economy and flexibility in leadless IC substrate packaging.

You get *all* the substrate advantages: low initial cost, greater packaging density, easy insertion/extraction, quick replaceability. And the low per line cost of our connector matches the package's economy. Now, that's cost savings all the way.

Can you depend on it? Yes. Because our connector is designed to give reliable, uniform contact with every pad across the substrate. In addition, posts are rigidly

molded in the block on .050" staggered centers, with no exposed bent metal.

For specs and information on this connector and new substrate packaging concepts, write:

**AMP Incorporated, Industrial Division,
Harrisburg, Pa. 17105**

AMP
INCORPORATED

Manufacturing and Direct Sales Facilities in: Australia,
Canada, France, Great Britain, Holland, Italy, Japan, Mexico,
Puerto Rico, Spain, Sweden, United States and West Germany.

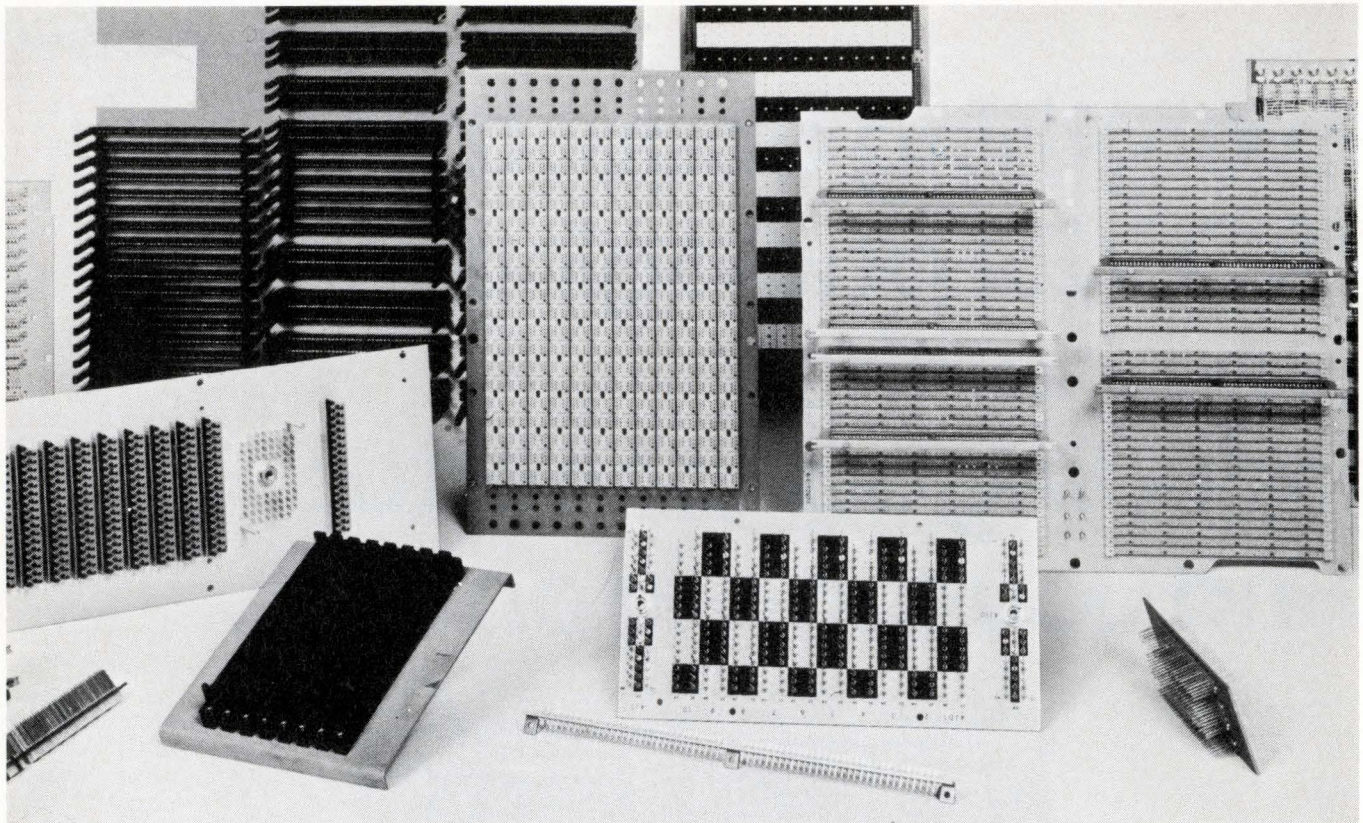

CONNECTRONICS...

a new packaging concept for
solving interconnecting problems

From Elco. It's the Total Packaging Concept that helps you with your interconnecting design, then picks the right components for the job and puts them all together. To give you the best-performing total package back panel assembly at the lowest price.

No longer must you face a bewildering array of card cage, guide, panel, contact and input/output components, and evaluate specs vs. cost on the components that qualify. Nor must you establish quality control standards and inventory control on these parts. Nor make up a step-by-step production timetable. And watch the cost of your finished package mount because of unexpected labor costs. Or miss deadlines because of unforeseen design and manufacturing snags. Not when Elco's CONNECTRONICS specialists and N/C machinery can do the job. From concept to finished package.

All you do is furnish us with a drawing of the daughter card. Tell us how many cards you need. And give us voltage and ground requirements, cage mounting dimensions and a wire list. Then sit back.

We'll pick the right connectors from our hundreds of thousands of standard connector designs. And choose the right back panel. Perhaps it'll be our Variplate™ back panel, the interconnector that provides bussing and voltage and ground planes, accepts individual components in any configuration. And acts as a structural member as well.

Or, if the back panel must be a mounting frame for p.c. board edge connectors or for rack and panel connectors, and must provide the rigidity that phenolic boards cannot, we'll furnish the Elco Variframe™ system. If your interconnecting configuration is standardized and your wiring changes are minimal, we'll use our Variboard™ interconnector. This system lets us do just about anything. Like mounting connectors or components directly on printed circuit boards. Or mounting connectors in plated-through or unplated holes. Mixing wired and printed circuits. And mounting boards on mother boards.

To complete the package, our specialists will select the compatible I/O section, then terminate the package. Automatically . . . N/C . . . or a combination of both. Whichever is the most economical for you. Based on price/performance and delivery, you'll get the best interconnecting total package system available.

For more information on CONNECTRONICS, the Elco Total Packaging Concept, write:

Elco, Willow Grove Division,
Willow Grove, Pa. 19090 (215) 659-7000

Elco, Huntingdon Division,
Huntingdon, Pa. 16652 (215) 659-7000

Elco, Pacific Division, 2200 Park Place,
El Segundo, Calif. 90245 (213) 675-3311



Operations in USA, Australia, Belgium, Canada, Denmark, England, France, Germany, Israel and Japan. Sales offices throughout the world.
Copyright © 1971 Elco Corp. All rights reserved.

They've got CONNECTIONS

Spurred by the need for connectors and terminations to handle the popular IC packages, plus flexible cable and other components, the industry has developed new and different connectors and connection concepts.

Smedley B. Ruth, Associate Editor

Normally, a connector new product announcement might read something like this—"The x-y-z company announces the addition of a 56-pin model to their line of rack and panel connectors," or "The a-b-c-company has announced the availability of a highly versatile connector on 0.100 in. spacing. It will take its place in the company's standard line of PC connectors," etc., etc., etc.

Although connectors of this type have been useful and will continue to hold an important place in the industry for some time to come, they cannot fully meet the needs of the industry today and of the near future. So, let's discuss some of those needs and see what the manufacturers are doing to meet them.

Smaller, improved and more versatile connectors and/or termination methods are needed to handle the plethora of different IC packages (including components packaged in IC-like DIPs) being used. One answer to this is the strip connector, several versions of which are now available. These are usually strips of insulators (housings) that contain contacts complete with tails. Some are fixed in length while others may be easily cut to any desired length. Some come in single strips, while others are sold in dual strips that may be cut apart. All have a singular advantage—flexibility: they may be positioned on a board as needed and if your requirements change from, say a 14-pin DIP to a 16-pin unit, you merely cut your strips to suit. Handy, and it saves on inventory. But, before you abandon your conventional IC socket, be careful that the strips you buy meet your mechanical requirements and that good engineering practices are applied in their design. For example, is the lead-in designed for easy IC insertion?

Another approach to the problem of how to reduce costs is about to be announced by Elco. Designed for back-panel

packaging systems, their Series 6317 Economist connector has individual solderless-wrap-type contacts that are press-fit into plated-thru holes on a PC board and an insulator that then snaps over the contacts. With this approach you can reduce the total package cost by using printed wiring for most of the circuitry and bussing. This greatly reduces the number of solderless wrap connections. In addition, if you would still like to be able to make circuit changes after the equipment is built, this concept lets you do it. Thus, you have the advantages of both solderless wrapping (versatility) and printed wiring (economy and reliability).

Since we're discussing solderless wrapping, it seems an appropriate time to mention another innovation soon to be announced. Although details of Ansley's new Signapoint termination system have not yet been released, I can tell you that it will compete with Gardner Denver's Wire Wrap and AMP's Termi-Point. It is a powdered metal ferule that terminates component leads to posts, bus bars or other component leads by means of a pneumatic hand tool or semi-automatic machine. It will terminate wires 30 AWG or smaller (either solid or stranded) to miniature posts (of any configuration) to centers as small as 0.100 in. And, it's a natural for terminating DIPs via the "dead bug" method.

The "dead bug" approach

While we are on the "dead bug" (a DIP mounted upside down) approach, let's look at still another new method that was introduced at NEPCON 71 West. Berg's Flip-Dip™ mounting method is based on a simple procedure for staking posts onto a circuit board and using a special template to load and position DIPs during wave soldering. This method lets you visually inspect the connection, and eliminates the need for gold or silver plating of contacts and IC leads. With it, the IC packages are protected against

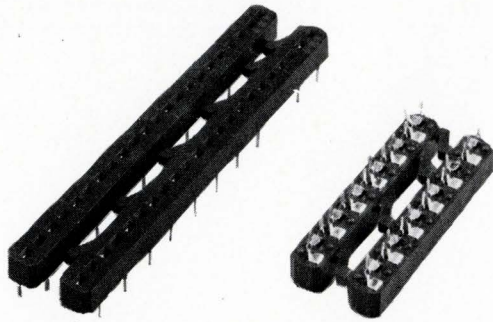

Low profile DIP strip receptacle recently introduced by AMP can be wave or dip soldered to PC boards. Retaining detents on the contact posts allow the receptacles to be self-retaining when inserted into mounting holes. The strips are retained on a "breakaway ladder" which lets you separate them for use on any convenient spacing.

Signapoint termination system, soon to be introduced by Ansley, is actually a powdered metal component which terminates component leads to posts, bus bars or other component leads.

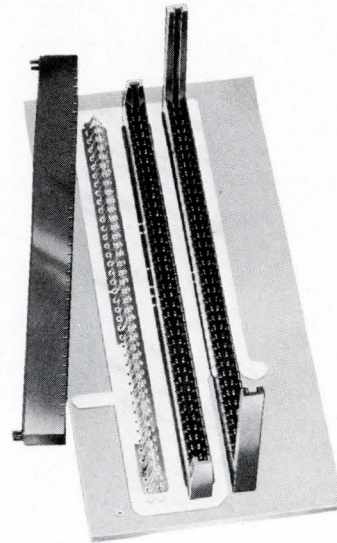
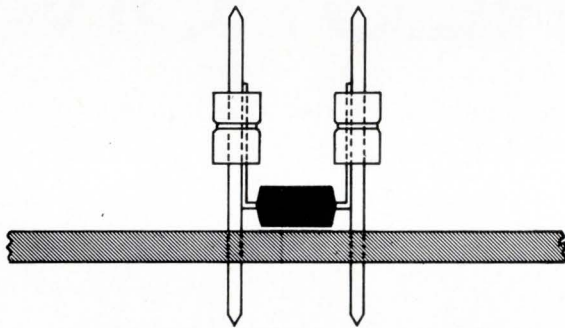

Economist connector from Elco has contacts that are press-fit into plated-thru holes on the PC board. The insulator is then snapped over the contacts. Damaged contacts are easily replaced without harming the adjacent contacts or the insulator. Ground and voltage planes are also available.

heat-induced failures and the stress of insertion forces. Other features are its low cost and the ability to mass mount or individually replace DIPs.

Another system that uses the inverted DIP method is Elfab's DIP-PAC. This design comes in standard sizes of 30, 60, 90, 120, 150, and 180 DIP positions on a board. The board provides an integrated ground and voltage plane on the wiring side connected to dummy pins or specified DIP locations, while the tail side is arranged for automatic wiring. Contacting fingers let you invert the DIP and plug it into the system.

Still another solderless method of mounting DIPs (and other components) is SAE's DipStik system. Consisting of four basic parts, it lets you mount up to five (88 pins total) DIPs in three easy steps. It provides high capacitance, low impedance ground and power planes so necessary for many of today's applications. It also provides EMI shielding through the use of a metal cover that surrounds the solderless wrap pins and envelops the insulator body.

The impedance-crosstalk problem

Since that old familiar word impedance was just mentioned, let's look at it for a time. Actually, it's the problem of impedance matching that we should discuss, as more and more you must work with equipment that operates at higher and higher frequencies, and with pulses having rise times measured in picoseconds. Thus, an impedance mismatch at a connector can cause serious problems. And crosstalk must also be controlled. It has been the practice

in the past to use standard coaxial connectors on the PC cards, but in the last year or two it has become increasingly evident that another solution must be found for use in high-speed systems. Contact and insulator designs must be improved to solve the problem. Texas Instruments and AMP have been pioneers in developing a solution. TI has a matched impedance edgeboard connector that can be used both as an impedance matching or a crosstalk control device and as a normal connector. Mechanically similar to standard edgeboard connectors, it is electrically almost equivalent to coaxial connectors.

AMP's contributions include connectors (with chevron-shaped contacts) that combine the best features of both coaxial and PC board connectors. They are available in 50 and 75 Ω families with VSWRs as low as 1.06 at 5 GHz, crosstalk as low as -80 dB and signal centerlines down to 0.050 in.

Zero insertion force connectors are also thought to offer a solution to some shielding and impedance matching problems. With this type of connector, the PC board or male member of the connector is placed in a female member which has one movable side. The movable side is then tightened or brought into contact with the male member by some method, such as screws or a cam locking device.

The zero insertion force concept is also useful in large memory planes and large testing connectors. And, it will probably solve a wear (on the substrate) problem in the new connectors for leadless substrates,

Remember that high density rack and panel connector

Continued on page 33

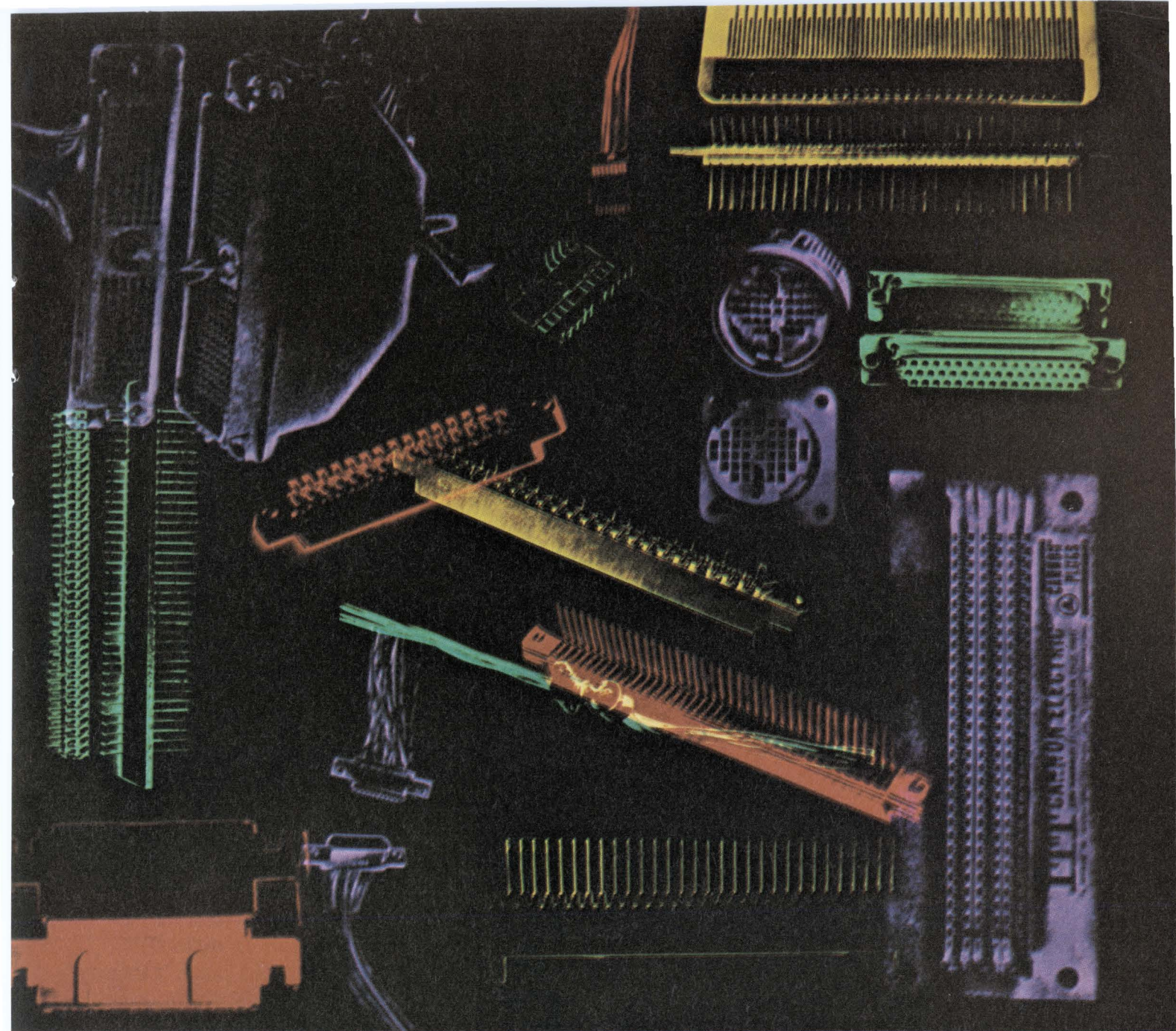

There are more reasons to buy Cannon than other EDP connectors. One is DL.

ITT Cannon now offers you a full line of EDP connectors. Printed circuit, input/output, flexible cable, microminiature—you'll find them all at Cannon. And some you won't find anywhere else. Like our exclusive DL's—multiple-wire rectangular connectors with cam-actuated spring contacts. They feature low cost, low mating force and low contact wear. Their crimp and wire-wrapping terminations make them ideal for I/O, cord-to-cord, and cord-to-panel applications.

Other input/output connectors you'll be interested in are our low cost Burgun-D subminiature rectangulars, and CL's (circulars combining low mating with high contact force).

Some of the other reasons why Cannon means

EDP are: low-cost, versatile backplane assemblies; bottom preloaded plate connectors; MIL-C-21097 edgecard connectors; low-cost circulars; FLEX-LOC cable connectors; and microminiature rectangulars, circulars and strip configurations, including the 50MIL for memory core applications.

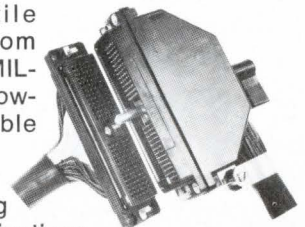

We've just shown you some of the reasons for connecting Cannon with all your EDP requirements. For others, contact ITT Cannon Electric, International Telephone and Telegraph Corporation, 666 East Dyer Road, Santa Ana, California 92702 (714) 557-4700.

2048 Bit Kit

**Introducing the MM6305,
a 2048 bit field programmable ROM.**



Last month we introduced a 1024 bit field programmable ROM. This month we outdid ourselves.

The new 6305 uses the reliable fusible-link technology requiring only 90 mA for programming. Believe it or not, no special equipment is required, *any* test equipment can do it. Or, if you like, we'll sell you a portable programmer that you can throw in a suitcase and plug into any electrical outlet.

Our new MM6305 is designed to be pin-for-pin compatible with our 1024 and 2048 mask programmable ROMs. That means you can be busy working on that prototype or preliminary design with one of our programmable ROMs while we're

booming ahead on your volume ROM requirements. That will cut weeks off your design cycle, dollars off your costs and get your boss off your back.

Think what you can do with this large bit capacity. Cut preliminary logic design to a few hours, utilize maximum flexibility in microprogramming techniques, develop and checkout higher accuracy look-up tables on the spot.

A few other good things about the MM6305 include an access time of 40 nsec, .25mW/bit power dissipation, and it's DTL/TTL compatible. It is organized 512 words by 4 bits with full address decoding included on the chip. Want to know the price? It's a low 5¢ a bit in small quantities — available NOW, in full mil temperature range (MM5305) and 0° to 70°C (MM6305).

MM6305 Highlights

40 nsec access time
.2 mW/bit
512 words by 4 bits
16 pin DIP
Programmed by ANY test equipment

Pick a winner, write, call, TWX or telex for full data. Do it quick!

Monolithic Memories



Monolithic Memories, Inc., 1165 East Arques Avenue, Sunnyvale, Ca 94086
(408) 739-3535 TWX: 910-339-9229 Telex 346 301

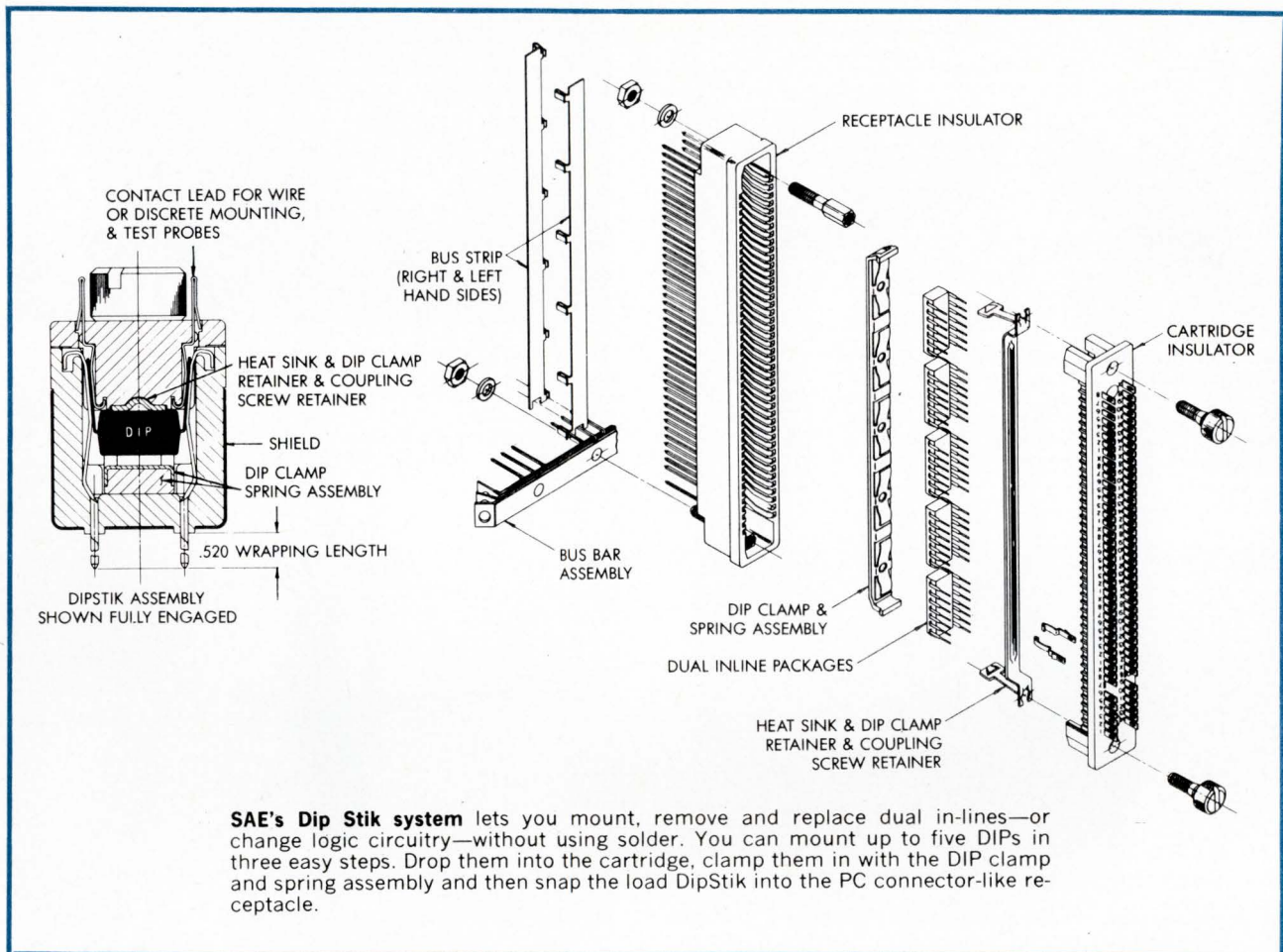

you dreaded using because of the time and effort (and sometimes muscle) it took to mate and unmate it? Well, how about the new DL series connector from ITT Cannon? It has 156 cam-actuated contacts. As these contacts are not actuated until *after* they are mated, high engagement forces and contact wear are eliminated.

Flat cable connectors

Flat flexible cable (FFC) is becoming increasingly popular and, understandably, more and more companies are developing connectors to be used with it. Being flat, these cables are easily stacked, conserving valuable space. But, unfortunately, most of the FFC connectors are relatively thick in the vertical dimension. This is one of the factors that dictates how many can be stacked in a given space. Thus, Ansley's newly introduced Flexstrip connector should be popular. Its three-piece construction includes contacts on a strip, a strain relief, and the connector shell. The contacts are on 0.100 in. centers (horizontally) and when the connectors are stacked one on the other, the contacts are also on 0.100 in. centers in the vertical dimension.

One controversial point with all of these FFC connectors is the actual method of termination: soldering; brazing; welding (both through the insulation and to stripped conductors); various insulation piercing methods (by crimping, penetrating with knife-edge contacts, and so forth); or, by stripping the conductors and molding them to form the connector itself. All of these methods with their advantages and disadvantages have their advocates and opponents.

And now still another method from Berg is about to join

the growing list. It has the following features: termination directly to stripped conductors; dual contact points on each conductor; a built-in, easy-to-use strain relief; non-critical conductor-to-conductor tolerances of the flat cable; and easy termination without expensive tools. There are four parts to the new assembly—a wedge and strain relief, a wire seat, the contact, and a contact housing. The wedge houses a stripped conductor in grooves on 0.050 in. center-to-center spacing. The plastic housing loosely holds the contacts and guides them into the grooves of the wedge.

Flatpack connector

A lot of attention has been given to connectors for DIP ICs, but what about flatpacks? Are there connectors to accommodate them? One such connector is the Becon carrier connector introduced late last year by Teledyne Kinetics. Part of the Becon PC connector line, the flatpack model can mount seven 10-lead or five 14-lead flatpacks to PC boards of any thickness. With it you can change individual flatpacks without de-soldering or you can move the entire connector.

There is no need to solder or drill holes. The flatpacks are held in place by spring contacts, which snap in easily.

Are terminals connectors?

In the electronics industry, it has been the practice to use the term connector to describe a multicontact unit as opposed to single conductor terminals or splices. Now, however, so many more designers are beginning to use female terminals (attached to the PC board by various meth-

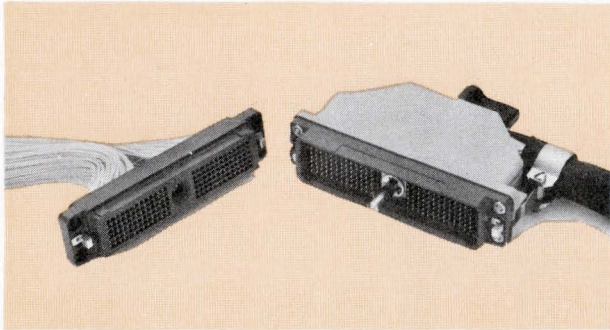

Cam-actuated contacts are featured in ITT Cannon's DL Insta-Mate rack and panel connector. As the connector is mated, the center cam actuator shaft is unlocked, permitting engagement with almost no mating force. After engagement the shaft is rotated, shifting the hermaphrodite contacts into a mated position with high mating force.

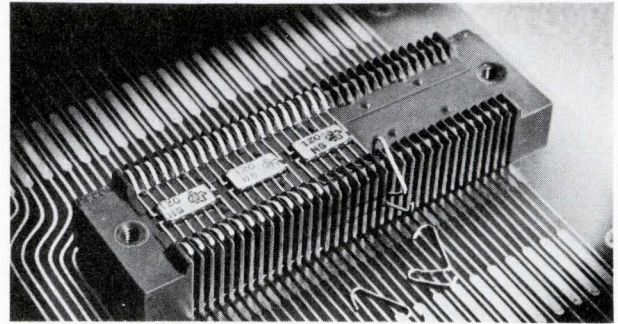

These carrier-connectors let you install flatpacks on PC boards without soldering or hole drilling. You can mount and connect seven 10-lead or five 14-lead flatpacks (or a mixture of both) to PC boards with Teledyne Kinetics' BECON connector. Gold-plated BeCu spring contacts snap in easily to exert 100-g force.

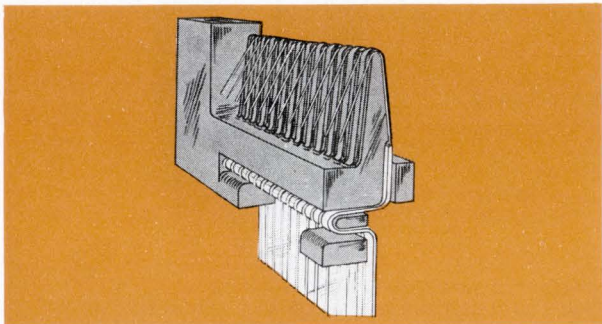

With **Berg's flat flexible cable connector**, termination is made directly to stripped conductors, without expensive tools. You merely thread the exposed conductors through the wedge and strain relief, assemble the wire seat, and attach the wedge to the contact housing and secure.

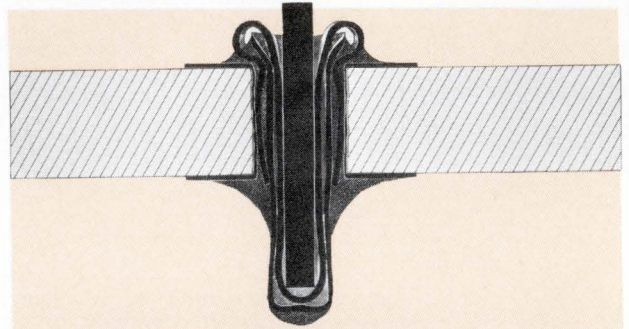

Minisert (also shown on the cover), another Berg product, has a heat-treated spring within a square cup socket. The spring is actually soldered to the board to improve contact reliability. The tin-plated, drawn copper square cup allows room for solder to wick up to the top pad.

ods) in place of female multi-pin connectors, that this definition isn't always a truly descriptive one. These terminals generally extend through the board so that their tails may be solderless wrapped or soldered, or whatever method you choose (with many of these terminals you may avoid soldering by press-fitting). Ground bushings may sometimes be included when a reliable ground return is needed. These terminals, when used to mount DIPS or PC boards, might be thought of as female connectors *sans* housing. And this, of course, helps to cut costs because you aren't paying for a relatively expensive insulator.

Berg has made several contributions in this area—including two part designs (a BeCu spring and a brass housing), and most recently the Minisert miniature PC socket (see cover photo), which provides repeated pluggability for DIPS, lamps, transistors, and so forth. This pluggable socket's design provides positive retention in the circuit board before soldering and spring-to-board electrical contact after soldering. The cup and spring extension is designed so that solder can be drawn to the top surface of a two-sided board, producing a solder fillet on the top pad without overflow into the socket. The two-piece socket accepts both round or flat leads.

Although they don't protrude through the board, AMP's new DIP and transistor receptacles also provide an economical and reliable means for meeting the pluggability requirements of ICs and transistors. Both come in strip form and can be installed by a high-speed automatic insertion machine, on a variety of grid patterns. The DIP leads accept flat leads and the transistor lead receptacles take round leads.

An economy line of card edge connectors from the same company uses an insulator that is extruded, loaded with contacts and then cut. It's much cheaper to change the positions with an extruded insulator than it is with a molded part. And, they tell me that they also have a connector whose insulator is made of paper.

So what else is new!

We understand that there is some pressure to improve connector termination methods to use aluminum conductors. There has been much speculation in this area, but possibly it will soon be a reality.

Then there's the new brush contact from Bendix that has to be seen to be believed. The concept involves the meshing of two wire brushes so that electrical contact is made between the sides of the wires. The many wires in contact with each other provide several parallel paths for current flow. The hermaphroditic contact design results in low electrical resistance.

Also from Bendix, long strictly a screw machine pin and socket user, is a new stamped and formed contact that meets performance requirements which were established for screw machine contacts.

Another approach to the current connection problem that looks promising is Cambion's Integrated Socket concept where you can take a handful of sockets and a frame and build only what you need. It reduces the number of connections needed and you can add to it as necessary. The socket is an 80-pin dual-in-line type. No PC is needed for support, as a means of mounting is molded into the ends of the socket.

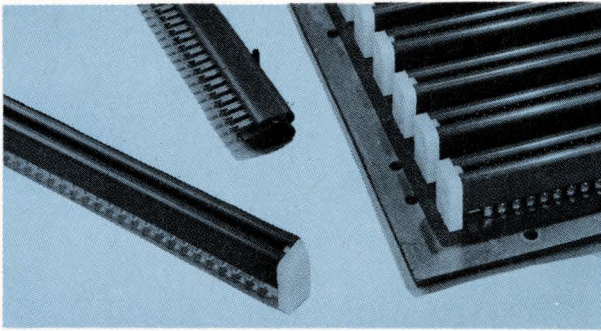

AMP's economy line of card edge connectors uses an insulator that is extruded, loaded with contacts and then cut. It's cheaper to change the positions with an extruded insulator than it is if you have a molded insulator. Two styles of snap-in card guides are available. Designed for dip or wave soldering, the contact posts are tin plated.

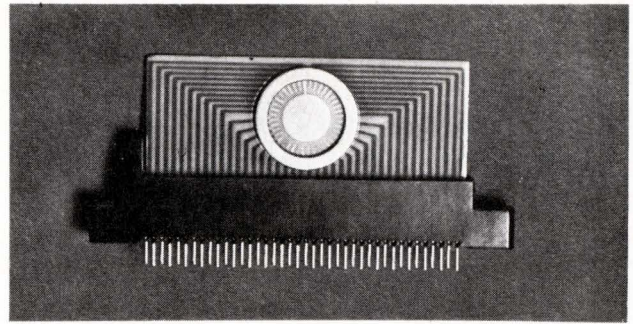

Ceramic substrate connector from Winchester provides a reliable means for connecting 1 x 2-in. pluggable MSI/LSI ceramic circuit devices. A built-in guide assures proper substrate seating. Expect to see more of this type connector being introduced this year by various manufacturers.

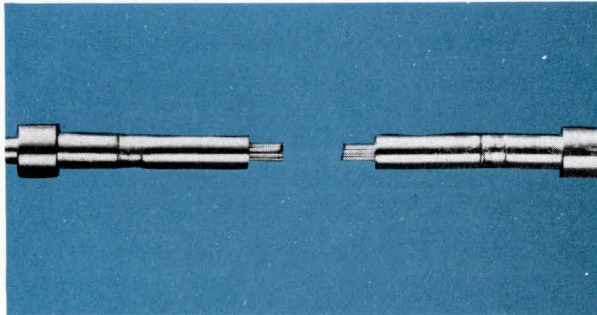

Brush contact concept from Bendix involves the meshing of two wire brushes. Electrical contact is made between the sides of the wires. The large number of wires in contact with each other provides parallel paths for current flow. The contact design is, of course, hermaphroditic.

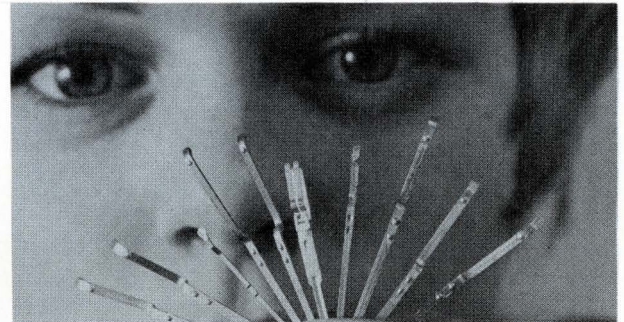

Although not new, use of the gold dot concept, shown here on Sylvania's contacts, may well become more popular this year. Use of the gold dots is said to extend contact life and to eliminate porosity problems which may occur in gold plated contacts. And, it saves on the amount of gold used.

It's what's happening

The term pluggable has been used many times, perhaps too many, but it's what's happening. It seems that everything nowadays contains pluggable items—autos, TV sets, washers, modular homes, computers, and on and on. And, pluggable items mean more connectors. However, the connector manufacturers are finding that price for these markets is critical; their customers want $\frac{1}{4}$ or $\frac{1}{2}$ cent a line connectors (gosh, remember those military contracts?). So how are the connector companies going to be able to meet these demands? Only one way they say—if the users will do away with their hangups; their prejudices.

They say that you must seriously consider using new plastic materials in place of metals in connector applications—it's often possible. Devise new and more modern ways to meet new requirements, e.g. Have you seen the Diacon package? (*The Electronic Engineer*, Feb. 1971, p. 27.) It is a new package that simplifies the overall operation of mounting complex ICs. Constructed as a female receptacle, it is mounted directly onto pins from PC boards, saving the cost of a socket. Don't automatically insist on precious metal or other high cost materials for contacts. In short, approach your problem with an open mind.

Acknowledgements

Many people supplied information for this report, but I would like to especially thank Bob Harwood, Homer Henschen and Richard O'Neill of AMP; Terry Leen, Henry Pessah and Bennett Brachman of Amphenol; D. J. Crimmins and Bill Sinclair of Ansley; Bob Gabor of AP Inc.;

Pat Moran of Bendix; Bill Walkup of Cambion; Stanley Hurst of Elco; Jerry Selvin of ITT Cannon; Joe Rose of Scanbe; and Waite Barre of Sylvania.

For more information concerning the connector products manufactured by the following companies, circle the appropriate reader service numbers. Also, see page 80.

Company	Reader Service No.
AMP	250
Amphenol	251
Ansley	252
AP Inc.	253
Bendix	254
Berg	255
Burndy	256
Cambion	257
Diacon	363
Elco	258
Elfab	259
Gardner-Denver	260
ITT Cannon	261
Kings	262
Reliable	263
SAE	264
Scanbe	265
Sylvania	266
Teledyne Kinetics	267
Texas Instruments	268
Viking	269
Winchester	270

INFORMATION RETRIEVAL

Connectors, Packaging

Memories are Better Than Ever..

Yes, memories are better than ever – the MCM4064L MTTL 64-Bit RAM proves it! Organized as a 16-word by 4-bit array, the MCM4064L features an access time of less than 60 ns, all for 50% less than what you have been paying.

Address decoding is incorporated on chip providing 1-of-16 decoding from four address lines. Separate Data In and Data Out lines, together with a Chip Enable, provide for easy expansion of Memory capacity. A Write Enable is provided to enable data presented at the Data In lines to be entered at the addressed storage cells. When writing, Data Out is the complement of Data In.

Let's take a look at a typical system using the MCM4064L as a main frame store of 128-words by 16-bits. Total devices involved are 32 MCM4064L RAMs, 9 MC7404P Hex Inverters, and 1 MC4006P 1-of-8 Decoder.

To directly address the 128 words of memory would require seven address inputs. Since the MCM4064L has four address inputs, expansion is achieved by connecting the Chip Enable inputs of each device in a row, treating the system as an 8 row by 4 column array, and driving the 8 row lines with a 1-of-8 decoder (MC4006P).

Address lines A0 thru A3 are brought to all memory devices in the system via address drivers using a TTL fanout of 8. Each inverter/driver represents four, one for each bit A0 thru A3; thus sixteen inverters are required. The same scheme is used for the data input and output buffers. The four address bits A0 thru A3 are common to each memory and are used to address the corresponding word in each MCM4064L.

The output bit lines in each column are wire-ORed because the devices chosen by the Chip Enable signal are dominant. Lines B1 thru B4 in the leftmost column are brought out to four inverter/buffers as are the four data lines in the other three columns.

Other organizations can be used but in wire-ORing MCM4064L outputs, eight was chosen as an optimum trade-off between decreasing decoding time versus increasing access time due to capacitance. The system provides a total access time of less than 100 ns typical and interestingly, a typical cycle time of less than 85 ns.

Data is written into the memory by selecting one memory device in each row with the Chip Enable as was done for the read operation.

... at **MOTOROLA**

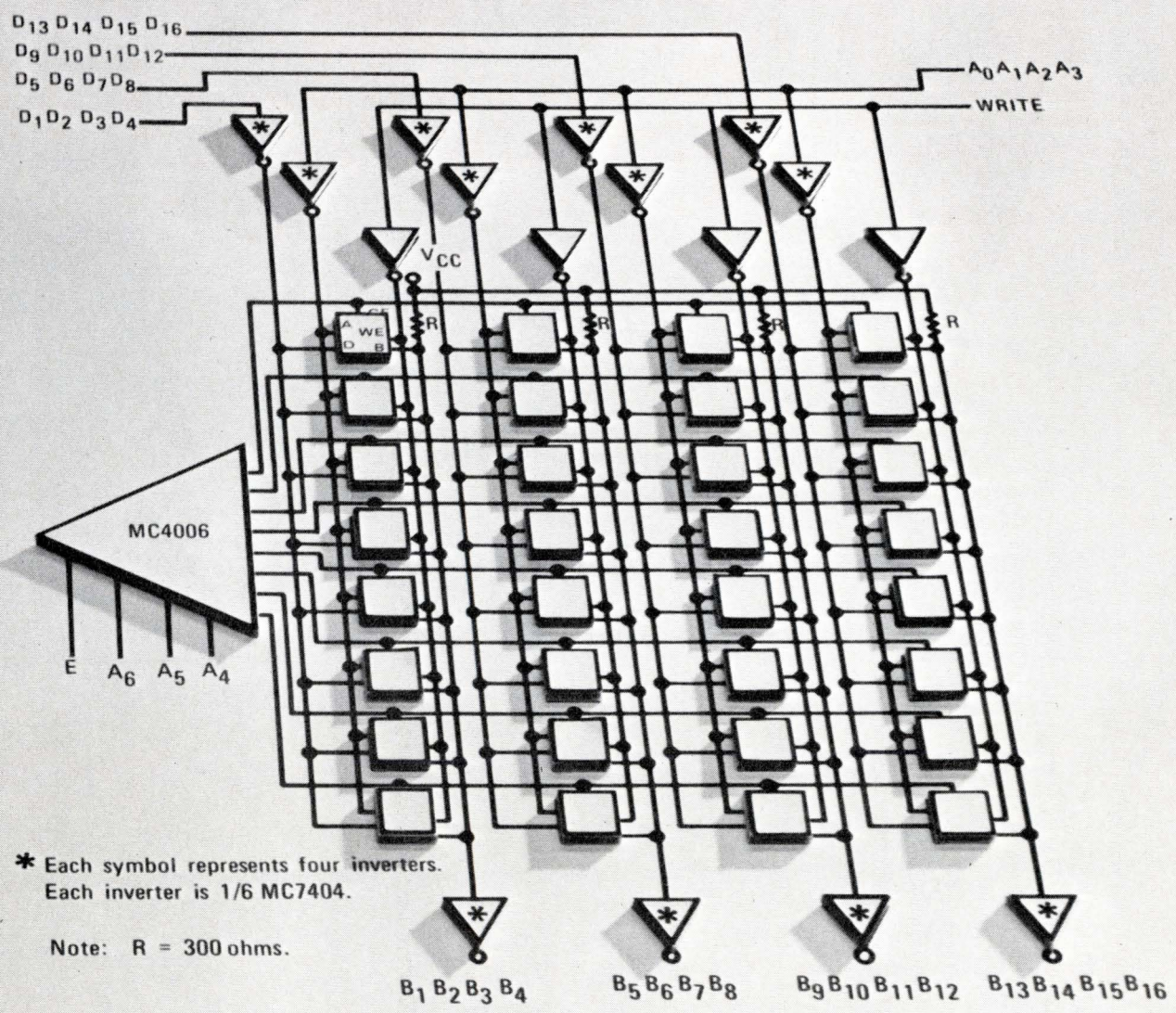

* Each symbol represents four inverters.
 Each inverter is 1/6 MC7404.

Note: $R = 300$ ohms.

128-WORD BY 16-BIT HIGH SPEED BUFFER MEMORY

This application demonstrates the versatility of the MCM4064L. Write for complete specifications to Motorola Semiconductor Products, Inc., P.O. Box 20912, Phoenix, Arizona 85036. We'll include another application describing a 512-word by 8-bit memory.

And to prove that speed isn't costly, the MCM4064L is now available at a 100-up price of \$11.55. Evaluate now and you'll see that Memories are better than ever . . . at Motorola.

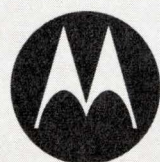

MOTOROLA MEMORIES

IC Systems for the 70's!

Circle Reader Service #24

The Year

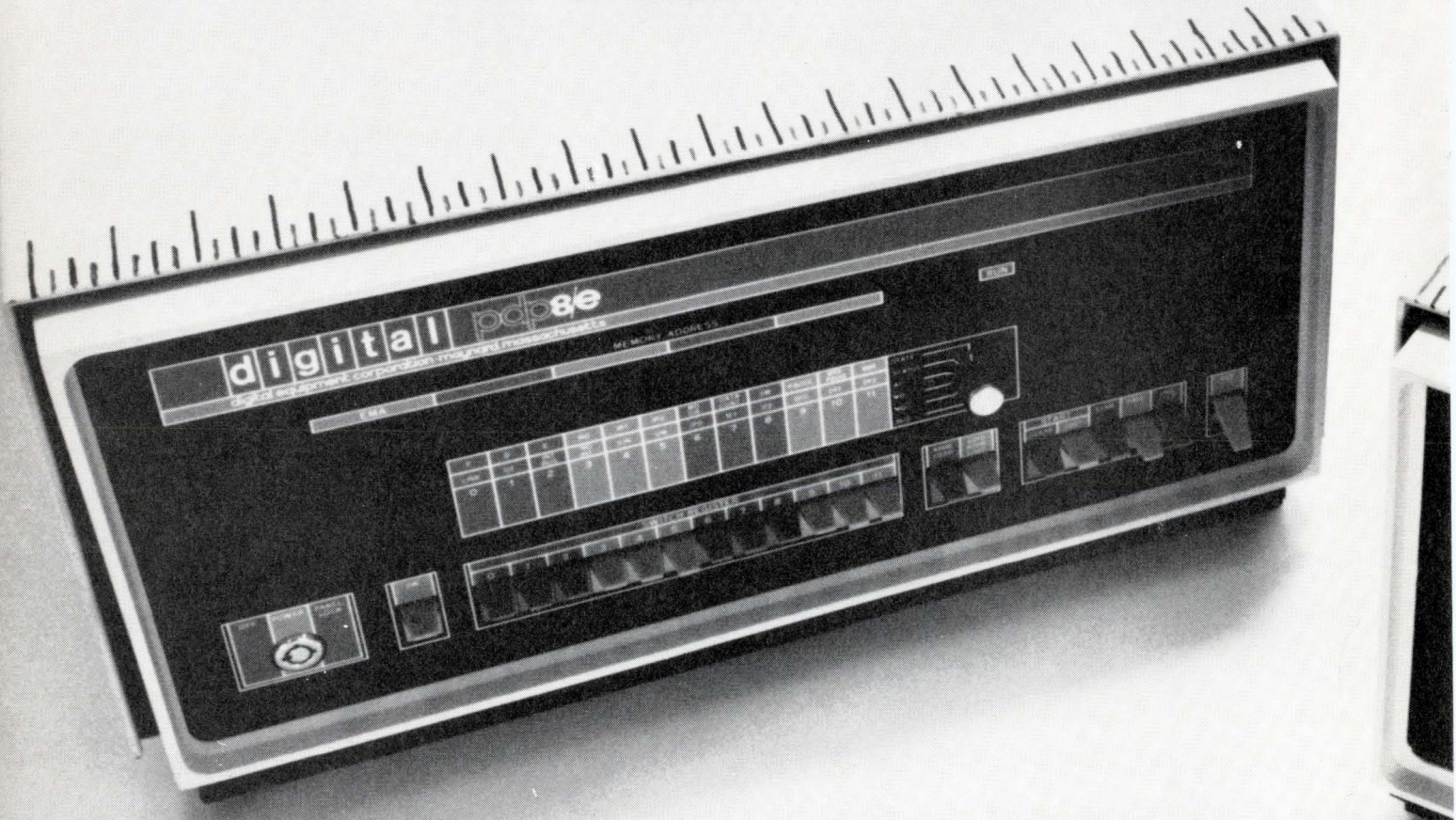

Sooner or later, almost every computer company gets around to comparing itself to DIGITAL. And for good reason. DIGITAL has delivered over 10,000 small computers; more minis than all other computer companies combined.

Sure it's nice to be the manufacturer everyone tries to measure up to. But it's a responsibility too. Being the yardstick means always having the best. The best processors, the best peripherals, the best software. And we do.

But take a closer look at what it takes to be best.

Like service. DIGITAL has over 1400 sales and service engineers in 65 locations around the world.

Or software and peripherals. DIGITAL offers more than 70 small computer peripherals – all the usuals, plus specials available only from us. And the most extensive software library and the most active users' society.

Cost performance? Our PDP-8/e and 11 have the broadest cost/performance range in the industry and we'll prove it any way you like.

We could go on but you get the point. Sooner or later everyone has to measure up. To us.

Digital Equipment Corporation, Main Street, Maynard, Mass. 01754 (617) 897-5111.

digital

More than 10,000 mini-computers delivered.

Circle Reader Service #42

rdsticks

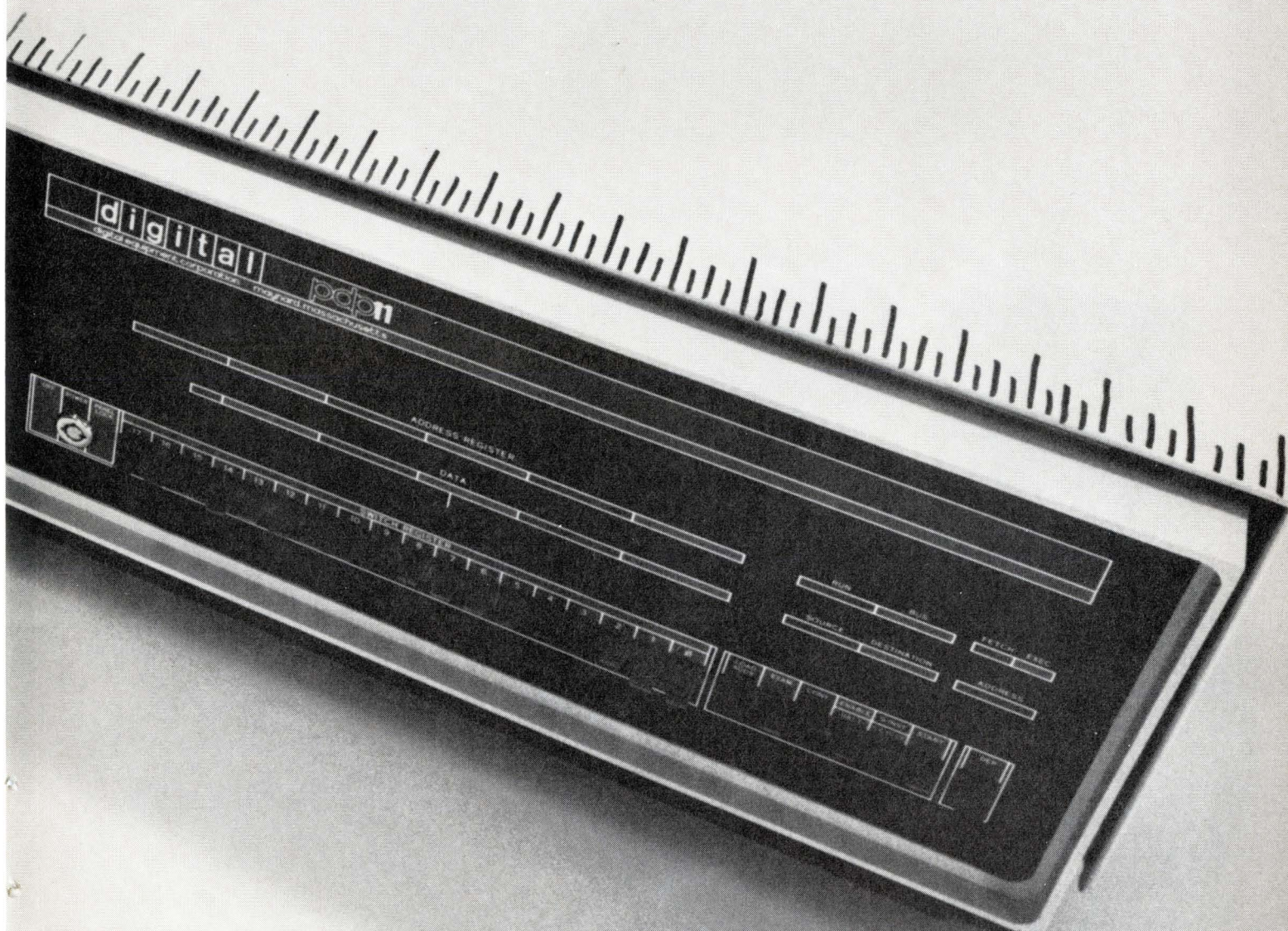

From the same design and manufacturing team who brought you the industry's most respected op amps and converters.

Our new line is the best and most complete — from the low cost 432 (2% accuracy, slewing rate 45v/usec.) to the high performance 422 (3db bandwidth to 5MHz, slewing rate 120v/usec.) The 427 offers accuracy of 0.1% full scale and offset drift of only 0.2mv/°C. Model 530 is the first complete IC multiplier, with 1% accuracy. And there are others.

It can be confusing, especially if you know how many things multipliers can do besides computation.

Like rectification, phase-sensitive demodulation, automatic level control, rms power measurement, phase-locked loops.

So while we were building our multipliers, we wrote a booklet — a 16-page guide to the theory and applications of multipliers which is extremely helpful, surprisingly impartial, and free. It's called "Evaluating, Selecting, & Using Multiplier Circuit Modules for Signal Manipulation & Function Generation," but just ask for "the multipliers booklet." Analog Devices, Inc., Norwood, Mass. 02062. (617) 329-4700.



 **ANALOG
DEVICES**

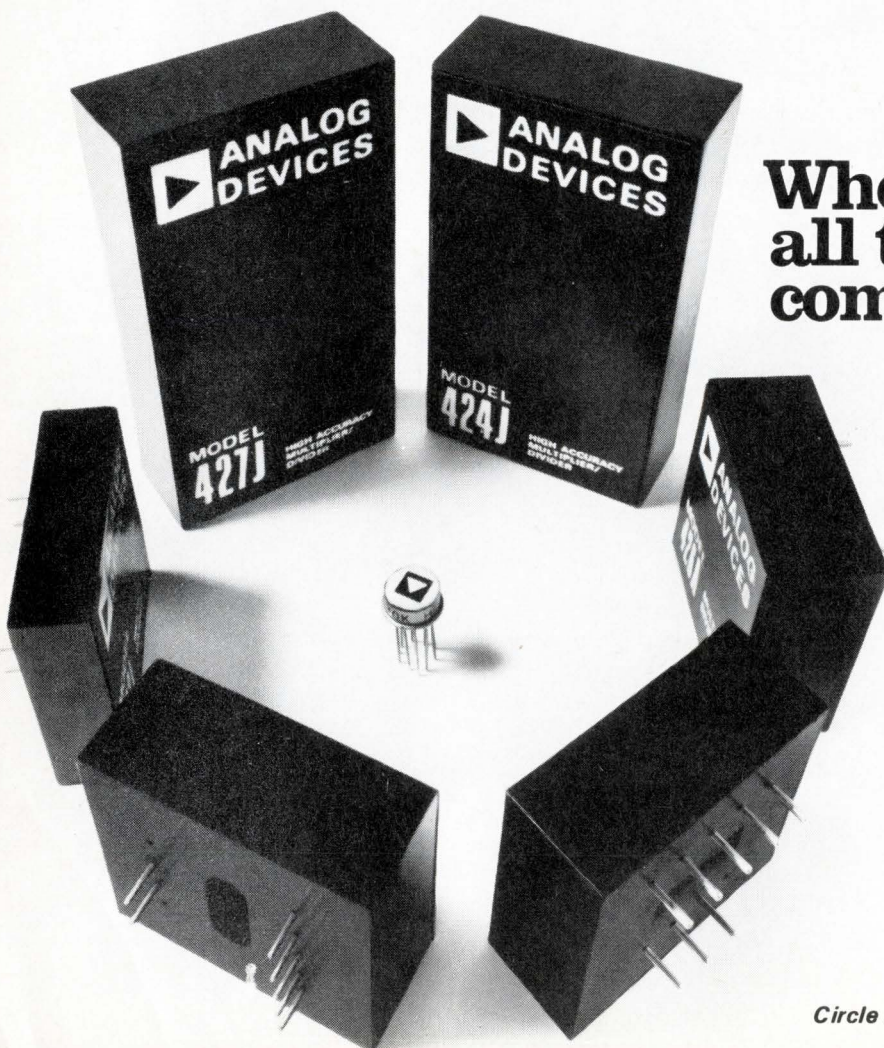

**Where did
all the multipliers
come from?**

CABLE COMMUNICATIONS:

the Los Gatos experiment

A little town in California is signaling the start of a new era in communications.

Sheldon Edelman, *Western Editor—San Francisco*

It looks as though the Federal Communications Commission will reopen the doors to expansion of the cable-TV industry. In particular, the probable lifting of the top-100-markets' restriction, and the new requirement for local program origination have paved the way for new growth by system operators, and thus also by equipment suppliers as well.

Even non-CTV electronics firms—firms which previously spurned that industry as too crude to appreciate their capabilities—have caught the sweet scent of the dollar. (For instance, \$115 million for line equipment last year with a projected \$600 million by 1980.) The CTV industry itself, somewhat dazzled by its own vision of the future, has begun to refer to itself, in a more general way, as a broadband cable-communications industry—and rightly so.

The top-100 markets' restriction of 1968 (together with certain other rulings) brought the cable-TV industry's growth to a halt. Cable systems were forbidden to import signals into the top 100 market areas. These markets were defined by their percentage of television households, and thus represented the major metropolitan areas of the country. This freeze shows definite signs of a thaw.

The FCC has further ruled that by spring of this year, every CTV system with more than 3500 subscribers must have facilities for program origination. Now, this implies some type of two-way communications capability. The locally originated material must be processed through the same equipment as that used to process, and start the distribution of, off-the-air signals. This head-end equipment is generally at the master receiving site, and this site is usually remotely located. But the local-origination studios must be convenient to the people who will use them. Thus, the system must be able to ship the studio signals upstream to the head-end for distribution to the subscribers via the main, downstream trunk.

The average cable system has less than 2000 subscribers right now, but this figure is expected to pass 6000 by 1980. Further, operating systems now total less than 2500, but are expected to be well in excess of 4000 by 1980. In fact, by that year almost 40% of the television homes in this country will be served by cable. So it's clear that the new rulings have vast implications for the growth of the cable-communications industry.

Who needs two-way?

You do. I do. Our towns and cities do. The cable-TV industry has long boasted of the services it could provide if given the chance to do so. Cable systems can change what is now a wasted appliance—a TV set—into an exciting piece of home electronic equipment.

And we're not talking just about 30 channels of off-the-air and locally originated entertainment. Remember, the doors are now open: we're talking about electronic delivery of mail and newspapers, armchair shopping, fire and burglar alarms, automatic meter reading and billing, municipal and inter-school communications, and so on.

But perhaps the most important cable-system service of all is the possibility of getting a true and immediate response—from a huge portion of our population—to questions of national interest via response terminals in each subscriber's home. An individual will at least be able to have his opinion heard, even though he may not be able to "holler" as loudly as the next man.

These services—which, by the way, are being pressed for by city councils across the nation—need a two-way communications capability, which can handle data communications, most probably under computer control. Such services also need a quiet, relatively inexpensive (\$200-\$300) hard-copy printer in each home*.

Two-way at Los Gatos

Since its merger with H & B American last September, TelePrompTer has been the largest system operator in the country. The corporation chose Los Gatos for two-way transmission experiments presumably because that system with its current 1500 subscribers (and hopes for another 2000) and 27-channel capability is fairly typical of a modern plant (in operation since December, 1968).

At Los Gatos, TelePrompTer is learning about the real problems associated with retrofitting or adapting an existing, one-way system for two-way operation—and such retrofitting will be common in the future. And though data transmission has been attempted by a few other operators in the past, no one has tried it with a 1-Mb/s data rate as at Los Gatos.

*Apparently, such a printer is definitely on its way, according to TelePrompTer spokesman at Los Gatos, Calif.

Now, the available downstream cable-spectrum spans 54 to about 300 MHz: 54 to 88 MHz for TV channels 2 through 6; 88 to 108 MHz for the fm band; nine midband channels between 120 and 174 MHz; and 174 to 216 MHz for TV channels 7 through 13. The super-band channels round out the spectrum, starting at 216 MHz and running up to perhaps 300 MHz.

The upstream spectrum, for subscriber-originated communications, sits in the frequency range below 54 MHz. In the Los Gatos system, the upstream spectrum spans 5 to 35 MHz, which is about typical for an upstream allocation in any two-way cable system.

A system's amplifiers and some of its passive components are unilateral, but the cable itself is, of course, bilateral. So it's possible to use crossover filters to steer the upstream signals around the downstream amplifiers, and vice versa. Such filters operate bilaterally and serve to separate a wide spectrum of signals into low and high frequency groups. Similarly, such filters combine, on a common output line, low frequency and high frequency inputs. And the Los Gatos system was retrofitted for two-way operation in this way, using Fairchild MOD upstream amplifiers and crossover filters; the downstream trunk uses Jerrold equipment. This type of retrofitting means that the system needs only one cable, which is much less expensive than having separate cable and amplifier systems for the upstream and downstream signals.

Since the cable losses at the upstream frequencies are much less than at the higher, downstream frequencies, the system needs fewer upstream than downstream amplifiers. But every downstream amplifier location still needs a pair of crossover filters. The trick is to reduce to a minimum the number of filters needed, because they introduce phase problems.

Color TV and data errors

In theory, the full band from about 5 to 54 MHz is available for upstream work. But in practice, it is necessary to introduce a guard band of 19 MHz between the lowest downstream channel (54 MHz) and the highest upstream channel (which is thus at about 35 MHz). This is necessary in order to build, at a reasonable cost, crossover filters with suitable phase and amplitude characteristics.

The gain-phase characteristic of such filters dictates their group-delay performance. If the filter's group delay varies with frequency, it causes group-delay distortion. And in the transmission of a color-TV signal, group-delay distortion causes a time differential to appear between the luminance signal and the chrominance signal that is 3.58-MHz higher in frequency.

When this time delay is long enough—about 200 ns—you see on your TV screen the "funny-paper" effect: a mis-registration between the brightness (luminance) and color (chrominance) information. And this same phenomenon—group-delay distortion—causes distortion in data transmission. The time delays caused by the crossover filters are additive, thus the need to reduce the number of filters needed.

Continued on page 44

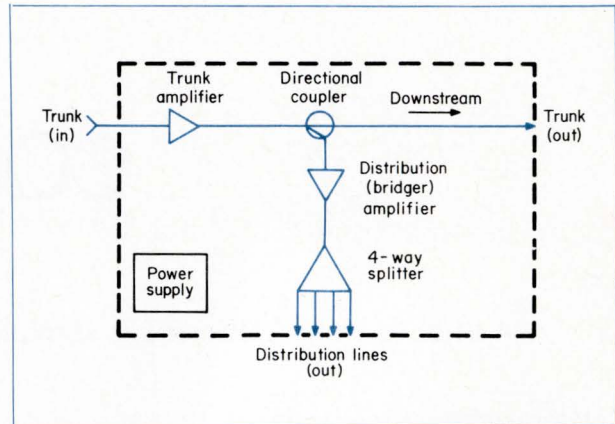

One-way street. The backbone of any cable TV system is a downstream trunk line that carries programming from the head-end receiving site for distribution to subscribers' homes. Trunk amplifiers are spaced at 1300- to 1800-ft intervals. This illustration shows a bridging station, which houses a distribution ("bridging") amplifier in addition to the trunk amplifier. Such a station provides several feeder lines. And subscribers' taps attached to such feeder lines will not disturb the main trunk line.

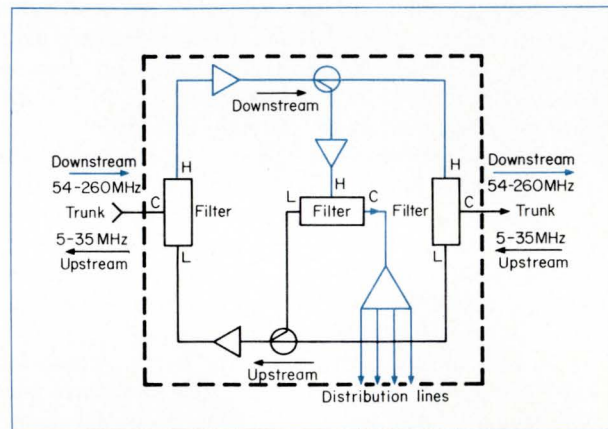

One cable, two directions. Frequency-division multiplexing via filters allows both upstream and downstream signals on a single cable. The crossover filters have a low-pass corner at 35 MHz, and a high-pass corner at 54 MHz. Here, the upstream and downstream paths and components are shown in different colors; the downstream portion is the same as shown in the bridging-station illustration for a one-way system. In the Los Gatos system, the components needed to retrofit for two-way operation are add-ons, external (except for one filter) to the downstream station equipment. (At Los Gatos, the upstream amplifiers are Fairchild MOD AR-20's, and the crossover filters are Type FD-1's. The downstream equipment is manufactured by Jerrold.) But the unitized construction shown here has the advantage that the manufacturer's design staff has total control of package performance, and probably will be commonly used in future retrofits.

For more information on Fairchild MOD AR-20's and Type FD-1's, **Circle Reader Service #272**

For more information on the Jerrold product line,

Circle Reader Service #273

Production people.
 Lab specialists.
 Q.C. technicians.
 Circuit designers.
 And researchers.

There's a Krohn-Hite
 Function Generator to
 meet all their needs.

Dependably.
 Accurately.
 Economically.

Prices start at \$295 and
 end at \$550.
 Featuring solid versatility
 and down-to-earth
 performance.

Models cover the
 frequency range of 0.002
 HZ to 5 MHz. Wavemak-
 ing capability for sine,
 square, triangle, and
 plus or minus ramps;
 positive, negative pulses,
 and sawtooth outputs.
 And a host of other im-
 portant features, too.
 Something for everyone.

Learn more about
 the unique aspects of this
 Function Generator line,
 write: The Wavemakers,
 Krohn-Hite Corporation,

580 Massachusetts
 Avenue, Cambridge,
 Mass. 02139. Phone:
 (617) 491-3211.
 TWX: 710-320-6583.
 Wavemakers par
 excellence.



OSCILLATORS / FILTERS / AC SOURCES / FUNCTION GENERATORS / AMPLIFIERS
 OVERSEAS SALES OFFICES: BELGIUM, C. N. Rood s. a.; DENMARK, SC Metric A/S; FRANCE, Antares; GERMANY, Nucletron Vertriebs-GMBH; HOLLAND, C. N. Rood n. v.; ITALY, Dott. Ing. Mario Vianello; SWEDEN, Teleinstrument; ISRAEL, R. D. T. Elect. Eng. Ltd.; JAPAN, Shoshin Shoji Kaisha, Ltd.; AUSTRALIA, Sample Electronics (Vic.) Pty., Ltd.; G. B., B & K Inst. Ltd.

Functions for everyone.



Circle Reader Service #26

Pat. Applied For

Shown approx. same size.

The Los Gatos system has encountered exactly this problem. The number of crossover filters have been reduced so that the luminance-chrominance delay is now acceptable. As of this writing, a 120-ns delay has been reached along a 3.9-mile-long trunk between a test home and the studio.

The time delay was measured by comparing a 'scope photo of the time positions of the luminance and chrominance signals as received at the studio with a reference photo made at the source (test home). Any time-position shift between the two photos is the result of delays added by the filters. The luminance signal was set to 31 MHz, and the chrominance signal to 34.58 MHz. Because the cutoff frequency of the crossover filters is 35 MHz, this was a worst-case test.

The crossover filters caused another problem. Full-bandwidth sweep testing of the entire system through 20 amplifiers and 5.5 miles of downstream trunk, between the head-end and the test home, showed that the filters disturbed the flatness of the system's downstream amplitude response. Reducing the number of filters from 54 to 40 in this run corrected the problem. The response is now flat within ± 1.5 dB, and acceptable, although such a run without filters could be held to ± 0.75 -dB flatness.

The result of these tests is that the system is now running with full downstream capability while simultaneously transmitting three color-signals upstream.

Data tests to begin

Although some critics say that a 1-Mb/s data rate is too high, TelePrompTer feels that it is entirely practical. And the company envisions a future system in which data can enter the upstream cable at any point for transmission to the head-end, where it would be turned around and sent downstream to wherever it has to go.

First tests of data transmission at Los Gatos will use a word generator as the data source. A modulator will convert the 1-Mb/s data to a 4-MHz-wide rf signal on the upstream trunk. This data signal, variable in level and modulation depth, will be used to check error rates.

The downstream spectrum at Los Gatos includes a 4-MHz slot to transmit data to the test home. So TelePrompTer actually will be testing a two-way interactive data-handling system.

The home terminal used in these tests will be a general-purpose prototype. Later, it can be altered to perform specific services in the home: meter reading; security alarms; and so forth. (As of this writing, the first data-transmission test results are not yet available.)

Multi-subscriber data transmission

Later this year, TelePrompTer, working with Hughes, plans a full-blown test of two-way data transmission in a 25-subscriber network. This test will include some hard-copy printers—models aimed ultimately at the low-cost market. Each home data terminal will have its own small memory (probably MOS), which will hold its inputs until in-

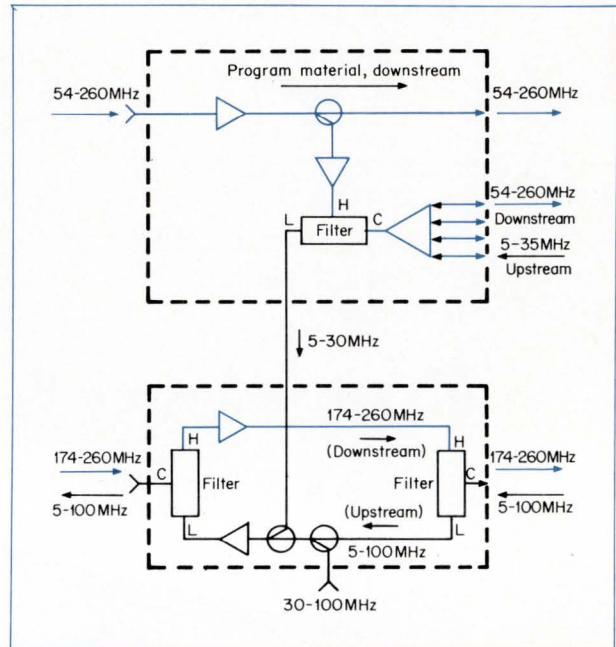

Extending the spectrum. This is a dual-cable system in which one cable carries the normal, 54-260 MHz, downstream programming, while the other carries dual-directional (upstream and downstream) communications. Thus, industrial users could have available the full cable spectrum for up- and downstream traffic, while home subscribers still have the 5-35 MHz region for their upstream use (feeder lines in upper part of illustration). Further, the number of crossover filters needed is greatly reduced as compared to those needed in other schemes. This method will probably be investigated at Los Gatos.

terrogated under control of a central computer (probably a PDP-11). Even though the subscriber's memory access is controlled by a central computer, the memory will be scanned often enough so that the subscriber feels he has continuous data transmission available.

By the end of 1972, TelePrompTer hopes to have a similar system fully equipped for several thousand subscribers—only 18 months after the simple beginning at Los Gatos.

Thanks to . . .

. . . Tom Ritter, director of research and development for TelePrompTer (Lompoc, Calif.), and Bill Wagner, manager, TelePrompTer of Los Gatos, for generous contributions of their scarce time.

INFORMATION RETRIEVAL
Communications,
Data acquisition and processing

This new IEC 10 MHz Function Generator has a couple of things going for it!

(like sweep & phase lock)



IEC
INTERSTATE
ELECTRONICS
CORPORATION

A Subsidiary Of A-T-O Inc.

Dept. 7000, Box 3117
Anaheim, Calif. 92803
(714) 772-2811,
TWX 714-776-0280
Telex Nos.
655443, 655419

And that's not all. Sweep and phase-lock are just two of the numerous features that distinguish this new IEC 0.0005 Hz to 10 MHz all-purpose test instrument. For example, trigger/gate, and calibrated output attenuation. The F55. The Great One. Top of the Series 50 line that includes four other brand new function generators. What do they have in common besides superb performance? 10 MHz capability, fixed and variable offset, variable width pulses as well as fixed width pulses and ramps, simpler man/machine interface and much, much easier maintainability. That's what. Plus the special features of each model, such as the sweep and phase-lock blend of the F55.

Depending on requirements, there's a particular Series 50 model that's exactly right for your needs. And priced accordingly, from \$595 up. Like a look? Call, TWX, write or wire our John Norburg at Interstate today. Ask for a demonstration. Get a new IEC Function Generator going. For you.

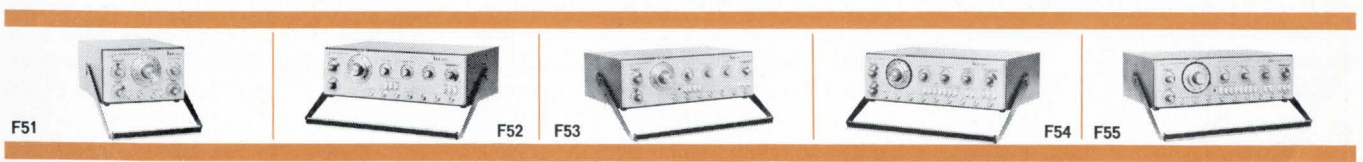

COMPUTER CONTROL

comes to network testing

Arthur J. Boyle, Technical Editor

The manufacturers of electronic equipment continue to cram more and more complex circuits into any given space. As they do, the problems of testing these crowded quarters grow very rapidly to unmanageable proportions. Consider, for example, testing the backpanel of a moderately complex piece of digital equipment. How do you test it with a reasonable degree of confidence? You can continuity check it with an ohmmeter, but this takes an inordinate amount of time. And, when you finish, all you know is that you do have continuity where you are supposed to have it. You do not know if any extra connections have been made; if for example, two supposedly separate circuits have been shorted together.

One approach to this problem is not to test at all at the subassembly level. You assume the backpanel is correctly wired and try to catch any errors during the final checkout of the equipment. Troubleshooting and repair time soon make this a very unattractive alternative.

A better way

Teradyne Inc. of Boston, Mass., faced many of these same problems in the manufacture of the computer-controlled test systems which they produce for a wide variety of applications. With their experience in the application of computer control to testing problems, they reasoned that they should be able to come up with a sensible solution. Well, they have done just that. And in addition to solving their own production problems, they have added the N131 Network Tester to their product line.

The N131 is a computer-operated test system which will test either 1152, 2304 or 3456 pins (interconnection points) depending on the configuration of the system. It tests a complex interconnection



Circle Reader Service #362

system of 2000 pins in just about 30s, and in addition to continuity, it checks for any short circuits which might exist.

The N131 system consists of the test instrument itself, a Teradyne M365 computer, a Teletype ASR-33 or -35 and a CartiFile magnetic tape unit. Operation is simple, and the communication between computer and operator is in an easy-to-understand format. Because of the system's self-learn capability, no programming is required when you begin to test a new network.

Five Teletype commands control the entire operation of the N131. They instruct it to 1) learn a new interconnect system, 2) print a run list, 3) test a unit, 4) output a program from memory to mag tape, and 5) load a program from tape into memory.

Easy to operate

As an example of the system operation, let's assume you have two production lines turning out backpanels for two different pieces of equipment. One of these is an established unit, and the other represents a new addition to your

product line. When the first new backpanel comes off the line, you connect it to the N131 and command the system to learn the new panel. In a time about equal to testing time (30 s for 2000 pins), the computer maps the interconnection pattern for the panel. The next step is to command the computer to print a run list. This list shows all the interconnections in the panel. You can then compare the run list with the original engineering documentation to verify if the panel was wired correctly. When you are satisfied that the computer has the correct interconnection pattern stored in memory, the job of testing successive panels becomes fairly simple. You connect them to the N131, and command the system to test them. The computer matches the new connection pattern against the stored one and prints out any differences. The printout, in conjunction with the run list, will usually allow you to pinpoint the error in minutes, instead of the hours it might normally take. When you are finished testing the new backpanels you output that program to magnetic tape and load in the stored pattern for the other panel.

The system has a nominal testing rate of 50 kHz. The voltage levels used are 5 V and ground, with a DTL driver/detector on each pin. You can use the system for testing backpanels, wiring harnesses for PC board cages, multilayer PC boards and most other interconnection system you might run across.

As mentioned earlier, the maximum number of points which a standard system will test is 3456. Teradyne says that they can supply larger systems on special order. The smallest system, 1152 pins, is priced at \$48,500. You can add more capability in groups of 1152 pins for about \$10,000 each up to the 3456 maximum. Teradyne Inc., 183 Essex Boston, Mass. 02111.

Circle Reader Service #362

75 MFD/30 VOLT DC CAPACITORS

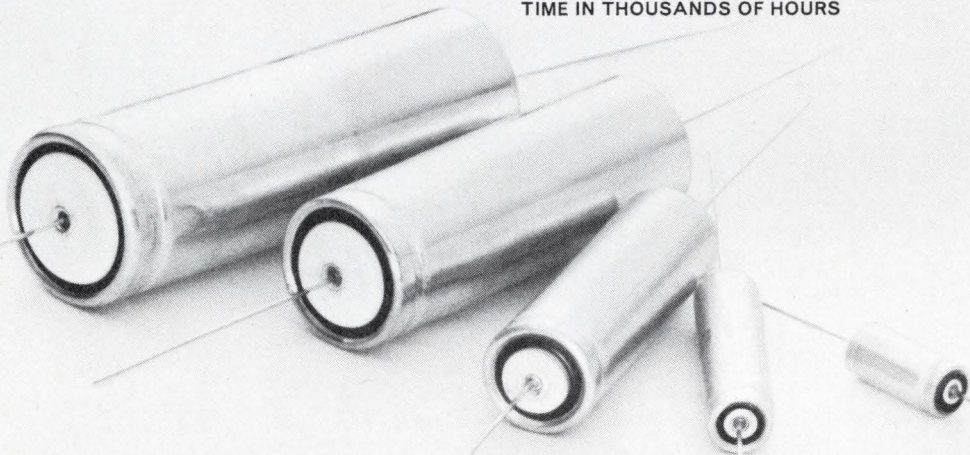
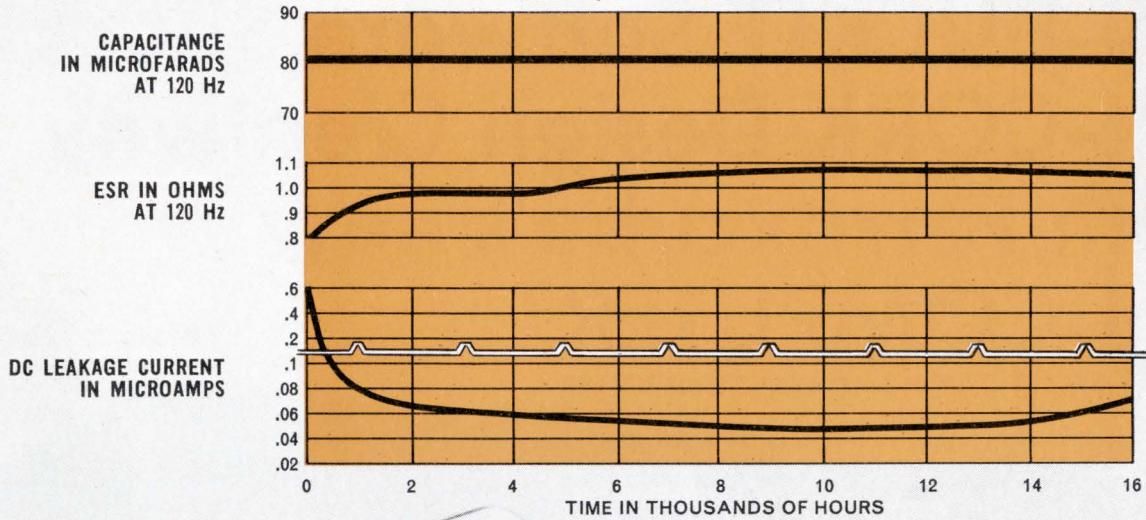

Our new TCG capacitor has curves you can't resist.

The curves tell at a glance the typical life story of one of our new TCG aluminum electrolytic capacitors. But there's more to a TCG than life curves. There are 45 case sizes, with safety vent protection where required; capacitances from 2 to 22,000 mfd; voltages from 3 to 450 VDC; and a -40 to $+85^{\circ}\text{C}$ temperature range.

Add to these a high C/V in a small package. Plus outstanding electrical and physical characteristics. And you've got our new TCG. Find out more by writing for Bulletin 4-307. Eighteen pages of data . . . and some curves that will open your eyes. Popular ratings available from authorized Mallory distributors.



MALLORY CAPACITOR COMPANY
 a division of P. R. MALLORY & CO. INC.
 Box 372, Indianapolis, Indiana 46206; Telephone: 317-636-5353

Electrical and electronic components • sequence timers • metallurgical products • batteries

UN-BURDEN System Costs UN-BUCKLE Software Shackles UN-CORK Design Creativity with Ferroxcube's new UN-COMPUTER™

PROGRAMMABLE DIGITAL DATA CONTROLLER

FOR: PROCESS CONTROL, DATA ACQUISITION, DATA REDUCTION, DATA MANIPULATION, BUSINESS SYSTEMS, SCIENTIFIC INSTRUMENTATION, DATA-LINK INTERFACING, DIAGNOSTIC TESTING, DATA RETRIEVAL & EDITING

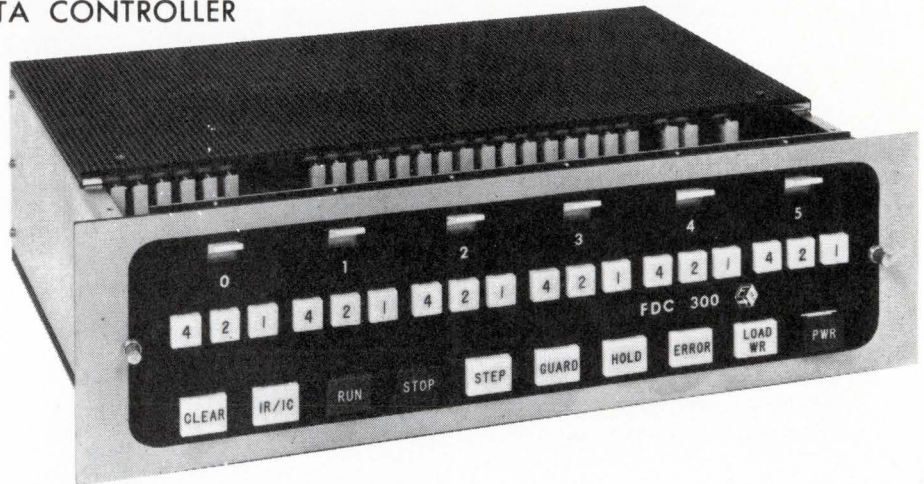

The odds are 2 to 1 that your system doesn't need a minicomputer. That's right—in 2 out of 3 applications, you can save from \$5,000 to \$15,000 per system, and get *more* interface flexibility . . . *higher* reliability . . . *lower* software costs (if any!) . . . and *much greater* freedom from hardware restraints—by designing around Ferroxcube's unique, completely modular **UN-COMPUTER™**.

UN-COMPUTERS do *more*—and let *you* do more—than arithmetically oriented, general-purpose machines, with their over-committment to the

central-processor interface. Check the **UN-COMPUTER's** block diagram. When you consider that *every block is an independent option*, you'll understand why we say that, for many applications, the minicomputer is a tragic misfit.

The **UN-COMPUTER** is backed by the most comprehensive software package in its class . . . and by an alert, imaginative, *responsive* interface-engineering team. (They've even developed software for moderate-speed arithmetic routines—*sans* processor!) Call them for a conference on *your* plans. Or write for their mind-bending, un-shackling *DESIGN FILE on UN-COMPUTING*.

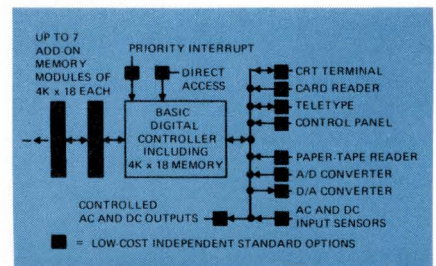

It's free—and it'll sell you on UN-COMPUTERS . . . UN-DOUBTEDLY.

CALL TODAY! (914) 246-2811

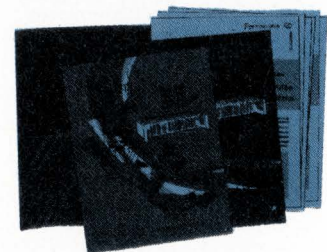

FERROXCUBE CORPORATION / SAUGERTIES, N. Y.

NORTH AMERICAN PHILIPS COMPANY

MEMORIES:

Bulk storage

Steve Thompson, Western Editor, Los Angeles

In parts 3 and 4 of our course, we were concerned with computer mainframe memories. These are the storage locations which hold the program and data with which the computer is currently working. Now, in part 5, we are going to turn our attention to a different application—bulk memories.

You can think of mainframe memories as being the reference books on your desk. As you work on a design, you constantly refer to them for information. If you carry the analogy a bit farther, bulk memories would be equivalent to your company library. When you start a new project, you go to the library (bulk storage) for new reference

books (blocks of data) and transfer them to your desk (your mainframe storage.) The important considerations in a bulk memory are how much information it can store and at what cost. Access time is not as important as in the mainframe because the computer does not go to the memory as often. Also, when a bulk memory is accessed, large blocks of data are transferred, rather than just the contents of one or two locations.

The graph below shows a number of bulk memory types differentiated by access time and by cost. If you look at the graph, you will find a no-man's land between cores and discs/drums. A market exists for the engineer-entrepreneur who develops a cost effective memory with an access time between 1 μ s and 1 ms.

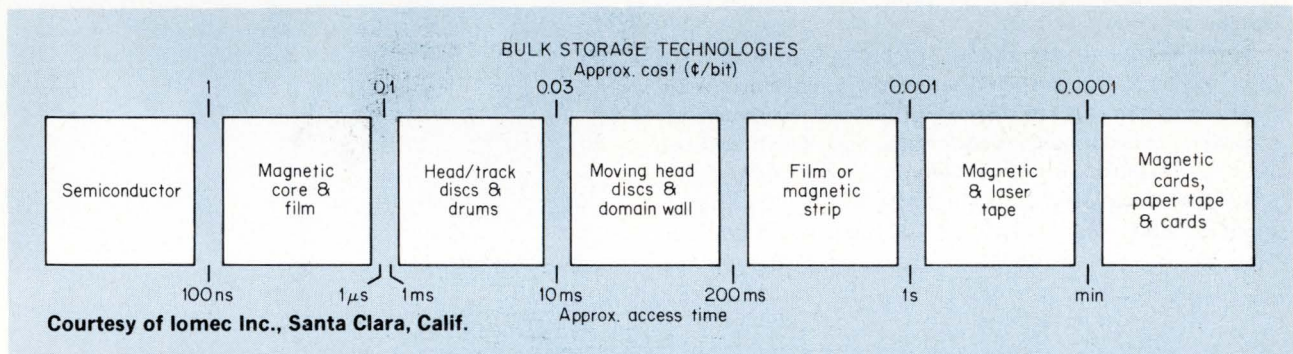

Punched paper cards

Dr. J. A. Carlson, IBM General Systems Div., Rochester, Minn.

The punched paper card has a long history as a means of conveying input. The Jacquard mechanism, developed in 1801, was the first device to use punched cards. The mechanism controlled the operation of a loom, and the punched cards generated the weaving pattern. Later, in 1833, Babbage's design of a mechanical computer used Jacquard cards as input. In 1880's, Dr. Herman Hollerith developed

the first card machines to be used in data processing for the U.S. Census Bureau, and in 1896 he started the Tabulating Machine Co., which became a part of IBM Corp.

James Powers also developed data processing machines while working for the Census Bureau. They were used in the 1910 census, and in 1911 he formed the Powers Accounting Machine Co., now the Univac Division of Sperry-Rand.

Both IBM and Univac adopted 3 1/4 by 7 3/8 in cards with

45 columns of 12 holes. Univac used each column to store two six-bit characters, producing a 90-column card. The present 80-column, 12-hole card, was introduced by IBM in 1928. These cards featured rectangular instead of round holes to match the parallel brush reading technique. Billions of these cards are used each year.

A smaller, 32-column, 18-hole card was introduced by IBM in 1969. The 18 rows are divided into three groups of six holes each. This gives the card, in effect 96 columns. Because it measures only 2 5/8 by 3 1/4 in., the card significantly reduces storage and machine size.

Since punched cards may also carry color coded or printed information, these cards represent a circulating bulk storage that humans and data-processing systems may interact with. Pre-printed cards sell at about \$1 or \$0.87 per thousand for 80- and 96-column types, respectively. If each hole location is a potential bit, that approaches 0.0001¢/bit.

Unit records and files

Since a card can be physically separated from the others, each card becomes a unit record. Assembled records, in turn, constitute a file. Small files are called decks, though some program decks have thousands of cards. Card files allow manual access and modification, which is very advantageous in preparing computer programs. Other examples of files are payrolls, inventories, name and address lists, and parts on order.

A "field" is a group of consecutive columns containing specific data such as a name or number. It can range from one to all the columns on the card. When a computer reads a card, it stores the fields in its own memory fields for subsequent processing. Computers may also compose cards by transferring fields to cards via an output card punch.

A minimum unit record data-processing system consists of a keypunch, sorter, and accounting machine. With these, cards are punched; files are sequenced, combined, or separated; calculations are performed; and reports and results are printed out. A minimum system costs about \$24,000 or rents for about \$350 per month. Larger, higher speed systems cost \$55,000 or \$1,400 per month and up. They can operate at speeds up to 2,000 cards/min for

reading and sorting, and 500 cards/min for punching. Lower priced computer systems tend to displace the larger unit record card systems.

Punched cards represent the predominant form of bulk storage in data-processing from 1890 to about 1960, and still represent a low-cost, versatile approach to data processing for the smaller user. Since card machines are limited by speed other forms of bulk storage have become more economical as volume and card handling increase.

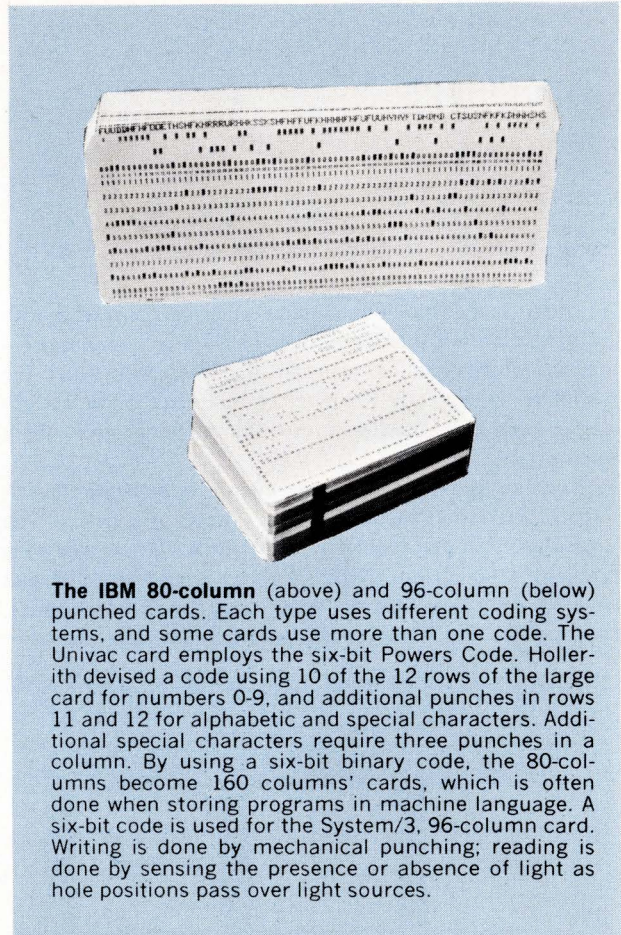

The IBM 80-column (above) and 96-column (below) punched cards. Each type uses different coding systems, and some cards use more than one code. The Univac card employs the six-bit Powers Code. Hollerith devised a code using 10 of the 12 rows of the large card for numbers 0-9, and additional punches in rows 11 and 12 for alphabetic and special characters. Additional special characters require three punches in a column. By using a six-bit binary code, the 80-columns become 160 columns' cards, which is often done when storing programs in machine language. A six-bit code is used for the System/3, 96-column card. Writing is done by mechanical punching; reading is done by sensing the presence or absence of light as hole positions pass over light sources.

Paper tape

Contributed by Tally Corp., Kent, Wash.

Think of a paper tape as an extended paper card. Punching rates are about 400 characters per second (cps) for cards and 300 cps for tape. Cards can be read at speeds up to 3,000 cps, and tape, up to 1,000 cps. However, the effective rates for cards are somewhat lower than these numbers, because indicator information is needed at the beginning of each card and unused portions are also processed. Choosing between the two types of memory media is based on the application, not on speed.

If your problem is handling recorded data with message lengths less than the capacity of a card, consider cards as the storage media. The chief advantage of cards is that they can be easily sorted, merged, and rearranged without re-recording. On the other hand, paper tape is desirable for recording variable record lengths with no efficiency loss. Tape data offers ease of handling and storage, and relative safety from loss. Simultaneous preparation of tapes and original documents saves an encoding step.

If you can work serially at reading rates less than 1,000

cps and writing rates below 300 cps for long and short messages, paper tape is the most cost-effective answer. When serial read/write requirements go higher, magnetic tape becomes attractive.

Paper tape readers sense the presence or absence of holes, either mechanically or photoelectrically. (The classic starwheel mechanical reader is shown in the figure.) Tape transport, inertia, and contact bounce limit their reliable reading speed to 150 cps. Paper tearing can also be a problem. Photoelectric readers operate in the 300-1,000 cps area. Although they are gaining popularity because of cost reductions and speed, these readers are limited by response time of the photocell and tape transport mechanisms.

One in. wide, eight channel tape is standard, though five, six and seven channel types are also used. Depending on the reader's sensing method, a paper tape is good for between 300-3,000 passes. If more passes are anticipated, you should switch to Mylar™ tape or an equivalent, which is good for up to 50,000 passes.

One of the leading uses of paper tape is in the machine tool industry in numerical control machines. They are also widely used in process control, automatic testing, input to digital computers, and automatic message transmission applications.

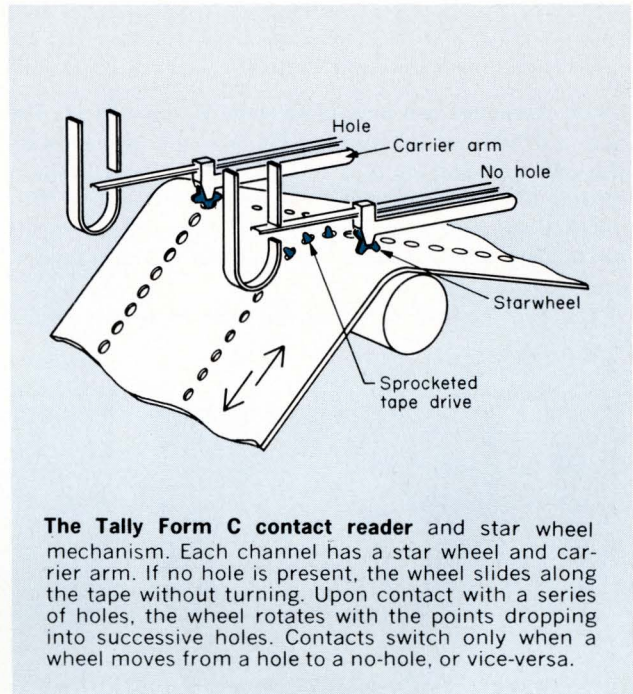

The Tally Form C contact reader and star wheel mechanism. Each channel has a star wheel and carrier arm. If no hole is present, the wheel slides along the tape without turning. Upon contact with a series of holes, the wheel rotates with the points dropping into successive holes. Contacts switch only when a wheel moves from a hole to a no-hole, or vice-versa.

Magnetic tape

Edward S. Kinney,

Computer Products Div., Ampex Corp., Culver City, Calif.

Magnetic tape has been used in all storage areas, and for longer than any other media in EDP except paper cards and paper tape. Of all the storage media, it is the more efficient in terms of cost per bit and total storage space for archival storage. Among the most suitable applications for magnetic tape are infrequently queried master files and non-volatile archival storage, such as address files and geophysical data. The advantages include its applicability to offline data retrieval and processing, and the availability of low-cost, low-speed tape.

It is easy to design a tape-processed file. New installations become operational quickly and subsequent upgrading of tape performance does not require CPU reprogramming. Those EDP tasks requiring auditing functions, and most sorting algorithms, are performed more efficiently when mag tape is the storage and manipulation media.

Although mag tape system costs much more than a paper card or paper tape system, it provides a speed advantage. When information can be organized into independent blocks that do not require much cross-referencing, tape is a satisfactory and inexpensive storage method. When programs require skipping around from block to block, the linear nature of tape and the time required to pass over irrelevant data blocks make it inefficient, and discs and

drums begin to come into their own.

Since mag tape is used as a communication media between processors, standards have evolved which govern the mechanical properties of the tape and the information formatting. Two standardized forms of tape are used for data interchange: 1/2-in. computer grade on reels, and 0.150-in. tape in cassettes. Most tape is the 1/2-in. standard. A reel of tape should be considered as a sub-assembly consisting of the reel, write enable ring, mag tape, and the BOT (beginning of tape) and EOT (end of tape) markers.

Manufacturers certify the usable area of the tape. This process usually includes writing an all-1's pattern at the certification density of 200, 556, or 800 bits/in. or 3,200 flux changes/in. and determining bit "drop outs" or "drop ins" on a read-after-write basis. An important factor is surface resistance which must be controlled to reduce static electricity that builds up during operation.

In operation, mag tape has only two magnetic states representing saturation of the magnetic particles in either of two possible directions. There are three basic tape formats. Seven and nine track formats are standard (six or eight bits plus a parity bit), though an eight track format is sometimes used. The standard length of a reel of tape is 2,400 ft. Up to 1,600 bits/in. can be recorded at tape speeds up to 200 in./s. This means that up to 4×10^8 bits can be stored on a tape with an average access time of 72 s. Tape costs about \$12-15/reel, or about 0.001¢/bit.

Data is usually written in blocks, with appropriate

check characters and inter-block gaps of about 3/4 in. The gaps provide time for stopping the tape after a read process, and time for the tape to come up to speed prior to reading the first character in the next block of data. This imposes severe acceleration and deceleration requirements on the tape, which the tape can meet, but the reels cannot, even empty.

The two methods to buffer the reels from the capstan

system are illustrated. There are significant advantages to the vacuum storage method since the mass of air is negligible at most tape speeds. Thus, transient loading or pressure on the tape is minimal. Economical, mechanical buffering can be effectively used below 24 in./s. Any system requiring extensive intermittent tape motion should use vacuum buffering to significantly reduce tape wear.

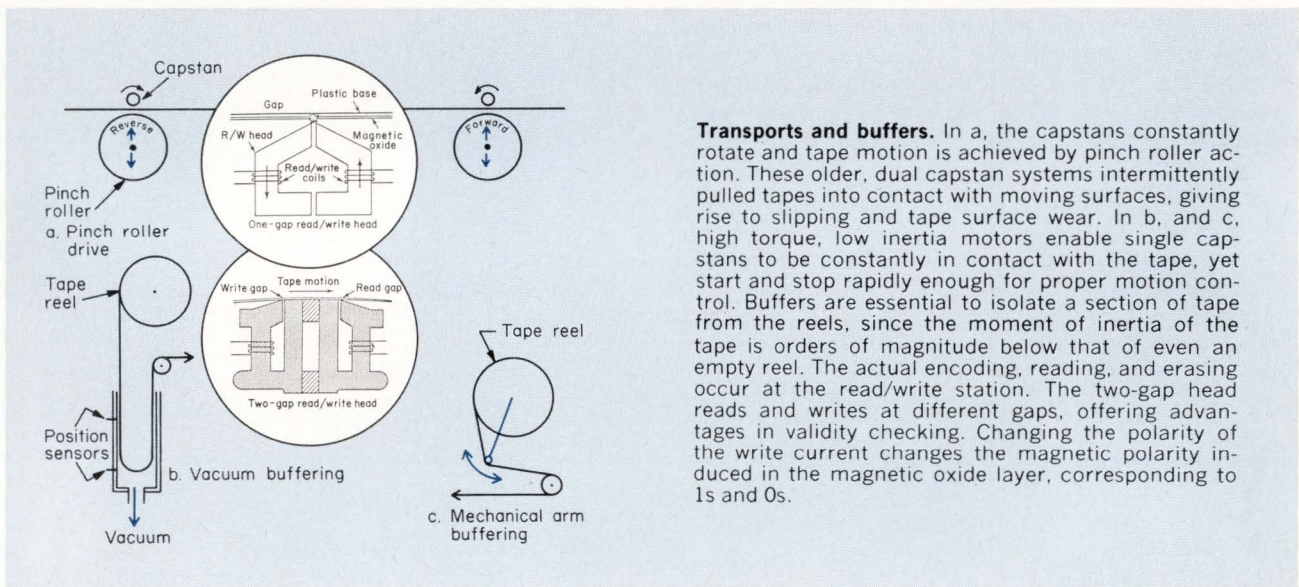

Transports and buffers. In a, the capstans constantly rotate and tape motion is achieved by pinch roller action. These older, dual capstan systems intermittently pulled tapes into contact with moving surfaces, giving rise to slipping and tape surface wear. In b, and c, high torque, low inertia motors enable single capstans to be constantly in contact with the tape, yet start and stop rapidly enough for proper motion control. Buffers are essential to isolate a section of tape from the reels, since the moment of inertia of the tape is orders of magnitude below that of even an empty reel. The actual encoding, reading, and erasing occur at the read/write station. The two-gap head reads and writes at different gaps, offering advantages in validity checking. Changing the polarity of the write current changes the magnetic polarity induced in the magnetic oxide layer, corresponding to 1s and 0s.

Optical/thermal mass-memory

Harold Dell, Precision Instrument Co., Palo Alto, Calif.

The UNICON® (unidensity coherent laser radiation) mass-memory system is a peripheral memory for large and medium scale computers. It can write, store, and retrieve 10¹² bits online. This is the equivalent of 10,000 reels of 800 b/in. mag tape. User costs are less than 0.0002c/bit. The system reads and writes archival-type records, which are permanent and easily updated.

A finely focused laser beam writes binary data in an extremely dense format on a special recording medium called Data Strip™. The system uses 400 strips, housed in 16 groups of 25, with provisions for an additional 50 strips.

To write, a lens focuses the laser beam onto an area which is a few microns square. Incoming data modulates the beam such that a 1 intensifies it, causing it to vaporize a minute hole in the strip's metallic surface, while a 0 does not cause any hole. Thus, we have an optical/thermal recorder.

The strip, which is mounted on a revolving drum, allows

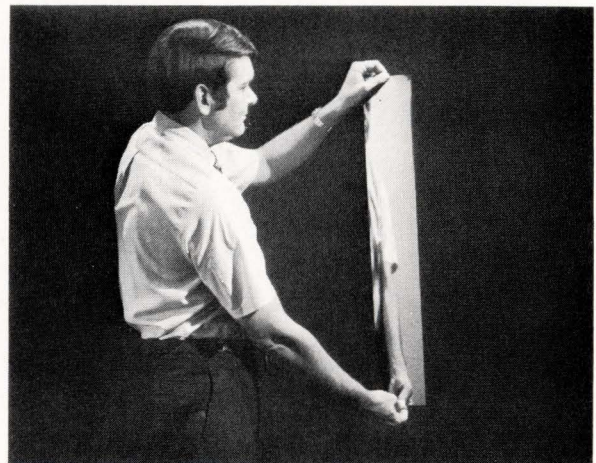

A Data Strip™ is a polyester sheet with a thin metallic coating. It is 31.25 x 4.75 x 0.007 in. One strip stores 26.8 million b/in², or 2.88 billion bits for the entire strip.

262,460 bits to be written serially along a track the length of the strip. A beam lens carriage moves incrementally across the strip, writing up to 11,000 sequential tracks.

To read, beam intensity is maintained at the write-0 level and directed at the desired track. Reflected light from the strip, or lack of light from vaporized portions, constitutes the serial read data pattern. Through a read-while-write verification capability, a portion of the reflected laser

beam is used to check written data by comparing it to the original input. The uncorrected error rate averages one error in 10^8 bits.

Average access time for a mounted strip is 150 ms. It takes a maximum of 8.6 s to change a strip on the drum. The data rate between the system and the host computer is 4 million b/s.

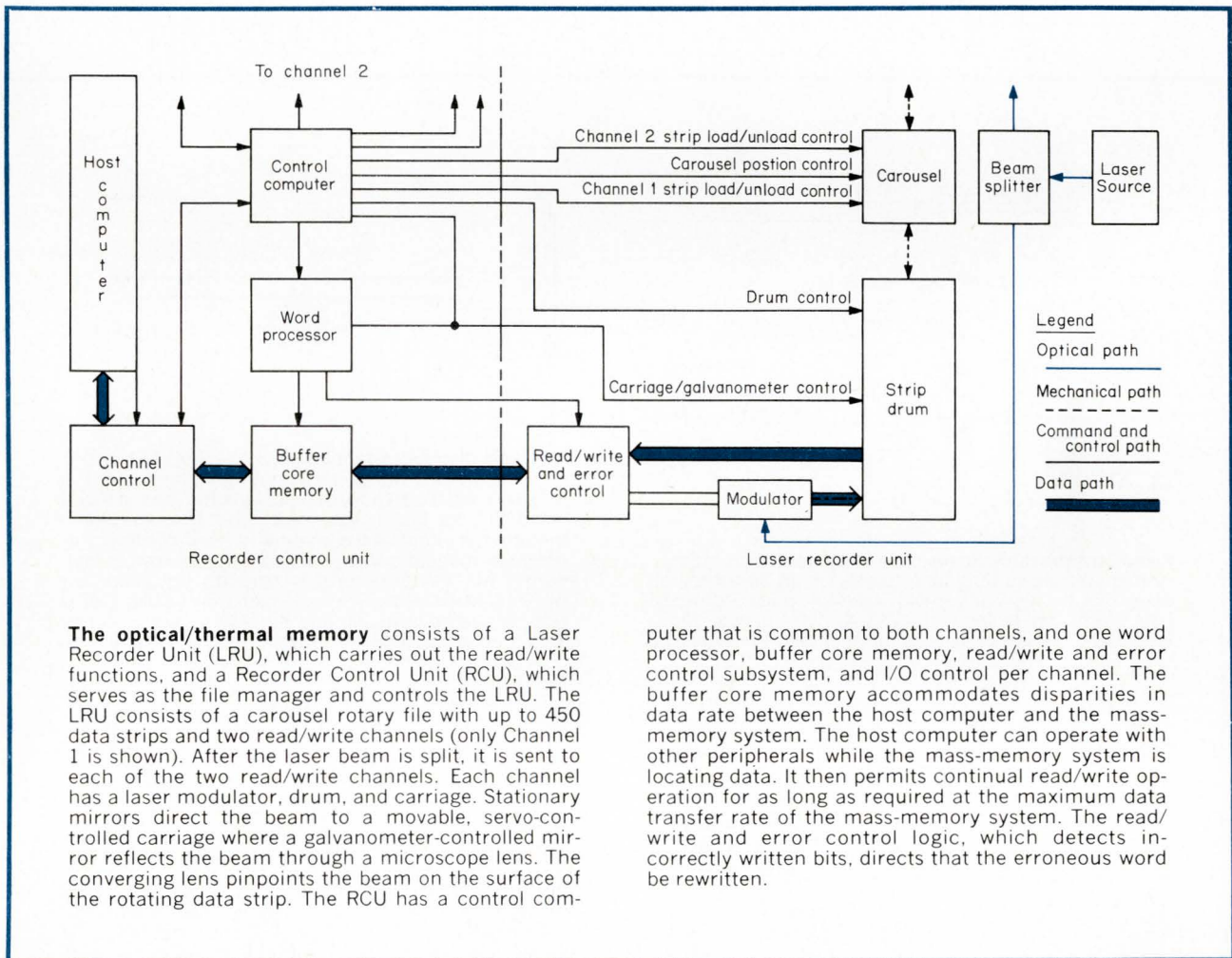

Magnetic discs

William Bertrando, Applied Magnetics Corp., Goleta, Calif.

Disc and mag tape memories use similar codes to store data. These codes can be either one of two types: non-return to zero (NRZ) or phase modulation. Although both store digital data on the surface of a magnetic medium,

discs can be used as computer main memory extensions and on-line memory banks, because the average access time is about 10 ms. Discs are finding increased usage as fast-access concentrators for visually or graphically displayed data.

There are two types of disc memories: head-per-track (fixed head), and movable head. Both types of heads are designed to "fly" 20 to 100 μ in. above the disc which may move at relative speeds near 120 mph.

By saving on heads, which are precision devices, movable head memories are less expensive. Some of this saving is offset by the cost of a precision head-positioning assembly. The average access time for a fixed-head disc is the time for one-half a revolution. This is much faster than a movable-head disc, because the movable-head disc must add the time it takes to first position the head over the proper track. Movable-head discs have a flexibility advan-

tage because they can be removed from the drive assembly and stored, or transported to other locations for use with compatible disc drives.

Movable-head types have been the most popular, especially with large computer users. With the advent of mini-computers, lower head costs, and faster access time requirements, fixed-head disc usage is projected to increase rapidly. Naturally, as disc diameter increases, storage capacity increases. Discs up to 40 in. in diameter are available. Generally, while the price of a disc memory increases as storage density increases, the cost per stored bit decreases.

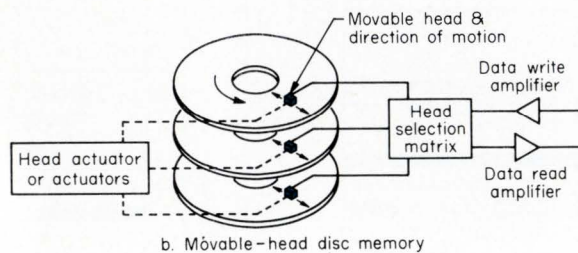
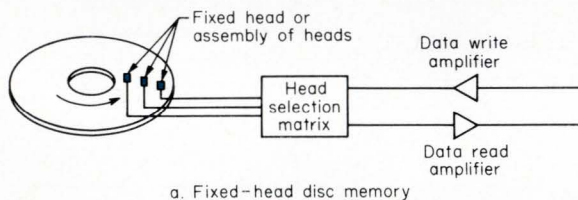

Fixed and movable heads. The fixed-head disc memory has stationary magnetic heads, or an assembly of from one to 16 heads (head module), placed directly over each data track in the usable disc surface. Movable-head memories have only one head per surface, which moves radially to the proper track.

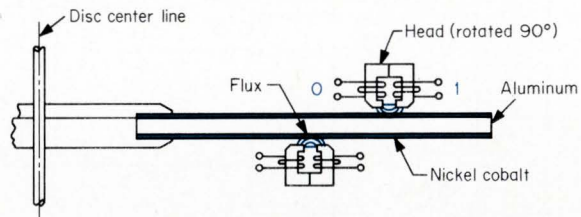

Magnetic disc cross-section. Nickel-cobalt is the normal disc coating with a hard coating applied over this magnetic material to form a surface for "flying" (and "landing") the heads. Passing current through one or the other winding of the magnetic head creates a directional magnetic flux at the head gap, which magnetizes the disc area directly beneath the head. The two possible directions are assigned bit values 1 or 0. Bits are read by sensing and amplifying emf changes in the core windings produced by flux reversals as they pass by the head.

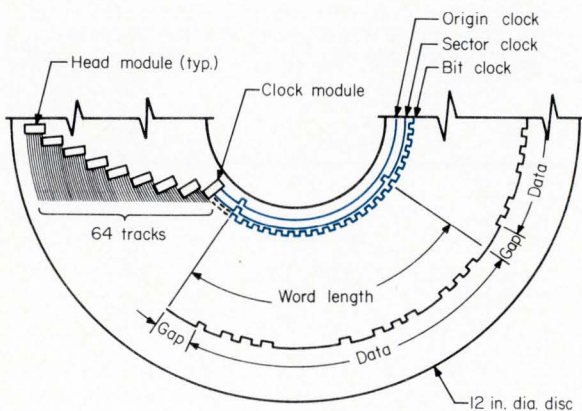

Disc organization. This typical fixed-head disc memory uses eight head modules of nine heads each. The ninth head in each module is a spare. In addition to the 64 data track heads, a clock module contains three heads for the origin, sector, and bit clock tracks. The origin clock is an "index" or "marker" that occurs once every revolution. The sector clock indicates the start of a word or block of data. The bit clock indicates a bit cell and may occur from 16,000 to over 100,000 times per revolution, depending on the memory. Clocks are calibrated information, so the typical disc is delivered with the clocks written on the disc in the customer's format.

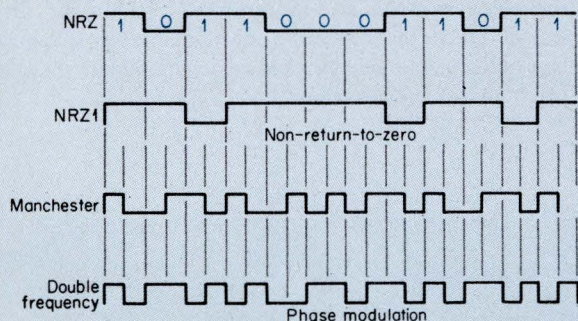

Coding techniques for recording data. The NRZ format separates into "straight" NRZ and NRZ1 (invert, or change on 1's). In straight NRZ, which is the most common, a flux transition indicates a change from a 0 to a 1, or vice versa. The electronics for determining bit cell contents are complex, because it is difficult to determine which way the flux transitions occur, and data is not self-clocking.

In NRZ1, flux transitions occur only when a 1 is recorded. This eliminates the ambiguity of the straight NRZ method, since signals will only occur for 1's and not for 0's. The electronics for determining bit cell position are also complex, but the complexity is justified because both types of NRZ increase the bit density by a factor of two compared to phase modulation.

Phase-modulation coding is separated into Manchester and double-frequency techniques. Both techniques require at least one flux transition per bit. In Manchester, the write signal for a 1 is high during the first half of the bit cell and low during the second half. It is reversed for a 0. In double frequency, a 1 requires two transitions per bit and a 0 requires one. Phase modulation has a built-in clock, which simplifies read electronics, however, there are twice as many flux transitions as NRZ, so the information density is only one-half.

The silicon drum

Dale A. Mrazek,¹ National Semiconductor Corp., Santa Clara, Calif.

Solid-state counterparts of small disc and drum memories have become practical with MOS/LSI. Because most of the control logic is provided on the monolithic chip, the otherwise very high logic "overhead" is kept to a reasonable level. Costs are a penny a bit, or less, up to several hundred kilobits. In the megabit range, cost-effectiveness depends on rapid access, minimum data-transfer delays, and operating modes geared to the parent processor.

Basic "silicon drum"

The first figure shows a silicon rendition of a drum memory. This simple organization for tens of kilobits can be extended by adding more registers in parallel, or using longer registers. Neither method is practical beyond hundreds of kilobits. Adding parallel registers complicates the switching matrices; longer registers increase access time and force the control logic to keep track of several 0-bit locations per block.

The clock frequency is modulated in large systems to minimize power dissipation. This modulation, however, is inefficient if many blocks are stored synchronously. Clock modulation means the registers are operated as a low idle frequency (about 500 Hz). When a register is addressed, that register is operated with a much faster clock to make an access or transfer. High/low frequency ratios such as 2 MHz/2 kHz reduce average power dissipation from about 0.5 mW to about 1.5 μ W/bit in large systems.

Word-parallel memories

Today's megabit systems are based on the bit-block par-

allel approach, because most processors use that format. When n synchronous registers operate in parallel, each clock period represents an n -bit block address. All register inputs or outputs must be enabled and the serial/parallel conversions completed in one clock period.

Because a memory with 256 blocks of 512, 16-bit words would take 8,192 registers lined up, the 2D organization is abandoned in favor of 3D; that is, several synchronous storage planes are used. With this approach, access and transfer times come out to be well under a millisecond. Clock modulation is efficient in this case, because there are many parallel-accessed registers per plane, and the counter control monitors the same 0-bit location everywhere. Each individual block requires n I/O switches.

One very serious problem with a memory such as this is that large numbers of MOS outputs cannot be bus-connected and operate at high speed. In order to overcome the high capacitive loading on the driving output, the clock period, must be extended.

A solution to this problem is the tri-state logic concept, originated by the author and his co-workers. The output element has three logic states: 0 or 1 when the output is enabled, or a high-impedance state when it is disabled. The third state is almost an open circuit, so only microamperes of leakage flow through the package's data-bus output pin. When enabled, MOS outputs can source or sink many such leakage currents. When eight outputs are bus-connected, any one can drive the bus and a TTL load at up to 2.5 MHz.

Only a few packages are needed, since the devices do not have to be sub-multiplexed. They can be connected 128-wide to the major bus and switched by the address bits de-

fining the module size. Speed decreases in proportion to the additional connections. For 128 outputs, the maximum is about 500 kHz. At this rate, worst-case access and transfer times will range from about 1 ms for 256-word blocks, to 4 ms for 1024-word blocks, which is fast for a peripheral memory.

Cost effectiveness

As capacity increases into the megabit range, register

storage enters the gray area where speed versus cost determines the technology choice. One rule of thumb states that the cost ratio can increase as the square root of the speed improvement ratio. An order of magnitude improvement in speed makes the memory worth three times as much.

The MOS memory soon bumps into still faster memory technologies, such as bipolar RAMs. If bipolar arrays should reach the capacities of dynamic MOS registers, block storage can be reworked to accommodate them, still resulting in a "silicon drum."

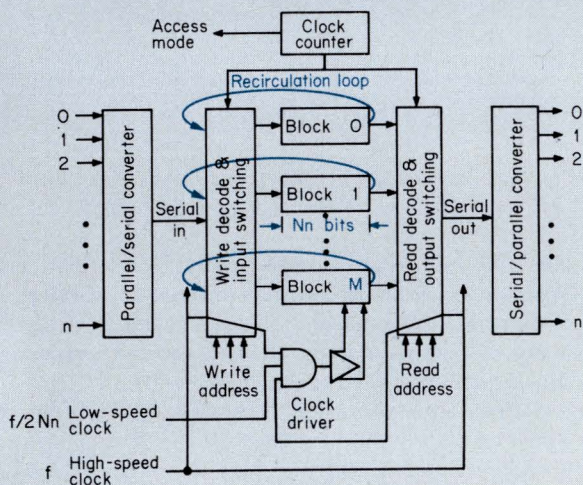

Generic drum-type memory. Each of M synchronously clocked registers serially stores an entire block of N words, n bits long. Data recirculates, simulating drum rotation. Access is made by detecting the 0-bit location (bit 0 of word 0) of the block with the counter. The input or output of the selected register is enabled when the 0 bit is at the output. During write, old data is dumped by gating off the recirculation input. The gate on the clock driver minimizes power dissipation through clock modulation. Average access time is one-half a complete recirculation, or $0.5 TN$, where T is the clock period. Transfer time after input or output enable is TN , since the clock rate is the serial bit rate. Only the addressed block recirculates at the high frequency, f, during an access and data transfer. Access and transfer are completed within one or two low-frequency clock periods when f is a multiple of the lower one. Generally, f is chosen for optimum data transfer. A minimum safe clock rate for data retention determines the low frequency. The low frequency can be a few kilohertz, and f, a few megahertz. Each register needs a driver. You must tradeoff unused drivers for short registers versus increased access time for larger registers.

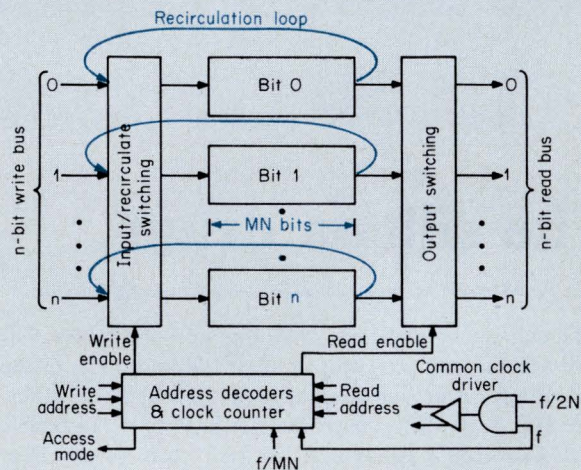

Bit-parallel, block-parallel storage. A synchronous array of n registers with M blocks of N words simplifies I/O switching, eliminates the parallel-serial converters, and reduces delays, but may prevent clock modulation from keeping power dissipation low. To access one of M blocks circulating through all registers requires a counter-decoder logic network that enables the switching when the 0-bit of the addressed block is at the register input for write or output for read. Access time improves because M blocks of N words will probably be shorter than Nn-long registers. Transfer time shortens by a factor of n, since the clock rate is the word rate, rather than the bit rate. Logic complexity grows with M and the common clock frequency precludes clock modulation. Memory delays are shortened, but not to an optimum level.

Dynamic MOS RAMs for bulk memories

B. D. Broeker, Semiconductor Products Div., Motorola Inc., Phoenix, Ariz.

Integrated shift registers can provide inexpensive, reasonably fast, sequential access bulk memories. Based on power and cost, dynamic registers are preferred over static registers, but both have the same drawback as other bulk storage techniques. There is an uncertain delay time before getting to a random memory address.

Dynamic RAMs overcome this drawback. The MOS dynamic RAM, which requires low standby power, gives rapid access to any location. When sequential access to blocks of data is desired, the peripheral logic that runs the dynamic

devices can be reduced to an insignificant factor, once the random starting point is determined.

Unlike the dynamic shift register, much I/O circuitry is required on the chip to interface with the dynamic RAM cell. This reduces the size advantage of the RAM, particularly for smaller memories. The advantage at 1024 bits is marginal; at 2048 or 4096 bits, it is important.

Going through the design of a bulk memory system as shown in the figure, demonstrates the versatility of dynamic RAMs, which are economically feasible for bulk memories, as well as minicomputer mainframes.

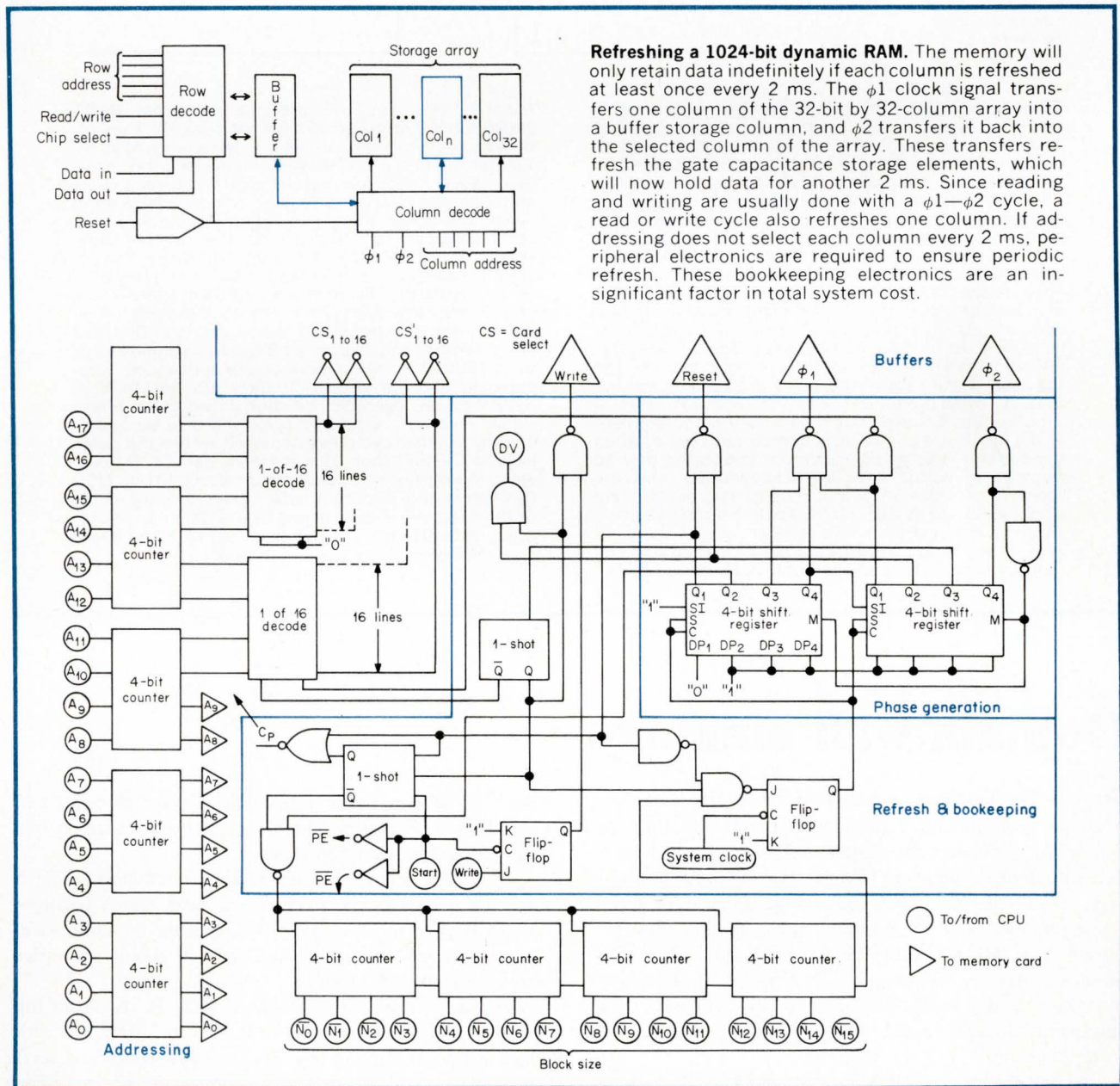

Refreshing a 1024-bit dynamic RAM. The memory will only retain data indefinitely if each column is refreshed at least once every 2 ms. The ϕ_1 clock signal transfers one column of the 32-bit by 32-column array into a buffer storage column, and ϕ_2 transfers it back into the selected column of the array. These transfers refresh the gate capacitance storage elements, which will now hold data for another 2 ms. Since reading and writing are usually done with a ϕ_1 — ϕ_2 cycle, a read or write cycle also refreshes one column. If addressing does not select each column every 2 ms, peripheral electronics are required to ensure periodic refresh. These bookkeeping electronics are an insignificant factor in total system cost.

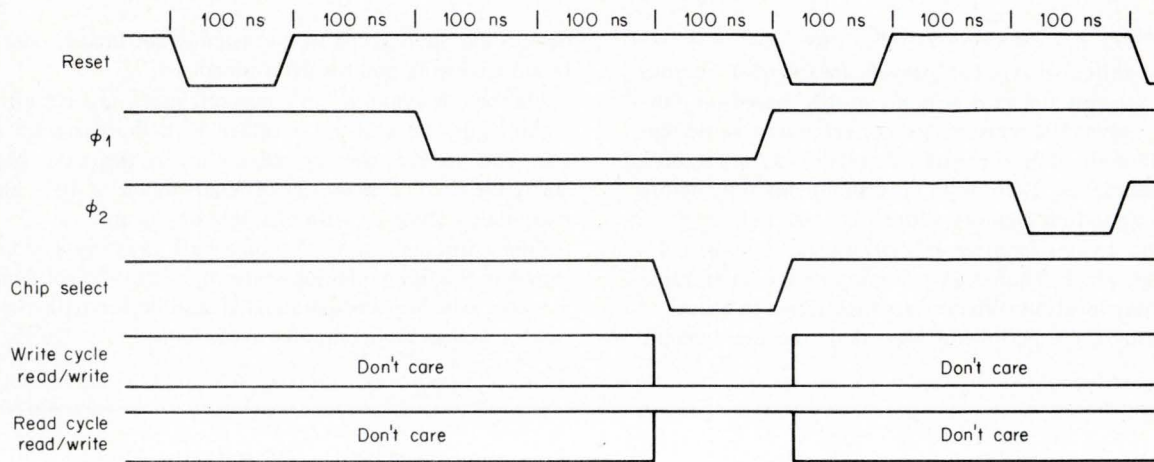

Control logic for 1-megabyte storage system. This system offers a random starting point and sequential access to blocks of data. It is organized as 256K words by 32 bits ($K = 1024$), totaling 8,388,608 bits. It outputs four bytes (eight bits each) simultaneously. Bulk memories usually access a block of data, so the address inputs are a starting location and the block size. After a startup time of about $1\frac{1}{2}$ cycles, data words appear sequentially at a rate of one word (four bytes) per cycle (about 800 ns). The storage devices are arranged 32 to a card, with 16 cards per "cage" and 16 cages per system. The eight most significant address bits drive two one-of-16 decoders, which select one card in the 16 by 16 array. The 10 least significant bits go directly to the memory devices. The five least significant of these bits are the column addresses, while the other five are the row addresses. A synchronous counter is loaded with the complement of the block size and is incremented each cycle. When the counter reaches its maximum count, the desired number of words have been sequenced, and the memory provides an output. The carry-ahead enable signal stops the system clock. To derive phase signals ϕ_1 and ϕ_2 , an eight-bit shift register obtains the eight 100-ns segments. Word 01111111 is loaded into the register. The 0 shifts to the right as 1's back fill. The

required logic functions are obtained from NAND gates as the 0 propagates down the register. The outputs from the memory are later inverted with MOS-to-TTL translators. A DATA VALID signal tells the processor when the output data is valid for a read cycle and when the input data may be removed for a write cycle. The phase signal-generation circuit is also a clock controller, which ties into the refresh book-keeper. The simple refresh circuit increments the address counter and starts a read cycle once every 62.4 μ s, to ensure that every five-bit column address has one refresh cycle every 2 ms. The absolute address in the counter is unimportant, since only the first five bits determine the column address. In normal read or write operations, the memories are sequenced automatically and the refresh circuitry has no function. By using a retriggerable one-shot, keyed to the phase signal generator, a refresh cycle will only be generated if no other cycle has occurred within the pulse time of the one shot. This memory has 22 IC packages. The only other circuits required are TTL to MOS translators and 32 output buffer gates. The total cost of the TTL control logic is just over \$100 in low quantities, or 0.001¢/bit. The major costs are in the board and hardware used to contain the electronics.

Domain wall memory

Berne D. Broadbent, Digital Development Corp., San Diego, Calif.

A unique property of ferromagnetic material is that it consists of small regions called domains, each of which acts like an individual magnet. Taking advantage of this property, memory devices can be constructed which store information by means of the motion of the transition area (referred to as domain walls) between domains. These domain wall devices are emerging as versatile, reliable low-maintenance, non-mechanical memories for compact bulk storage at moderate speed. The appropriate size range is from thousands to billions of bits.

One such domain wall motion memory is the DYNA-

BIT™ It uses magnetic wire as the storage element, and the domain walls propagate down the wire, much as bits propagate through a shift register.

Bit density is limited by the minimum domain size. Each domain has its own demagnetizing field, which becomes larger than its threshold field, H_n , at some minimum size, causing the domain walls to collapse. Available memories contain about 1,000 b/in³.

The larger the external magnetic field, H , the faster the domain moves, and the faster the bit rate. Materials with high values of H_n and low values of H_w (threshold level for wall motion) are used to maximize the bit rate. The

Chip

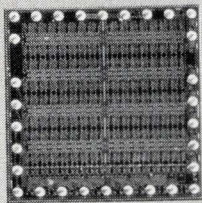

This is a 64 word by 2 bit memory chip. Very fast: twenty nanoseconds access time. Uses very little power: less than half a milliwatt per bit. Very low cost: less than any other memory chip in its speed range. Very immediate delivery. It is hermetically sealed. Its thirty solder points make it easy to assemble automatically into either single or multiple chip arrays. It is undecoded. That means we can do worst case testing at the

chip level and improve package level yield and reliability. We run more than 250,000 tests on each chip before packaging. And our Phoenix production facility is now turning out these chips at the rate of five million bits per day.

**Take two of these
and what do you get?**

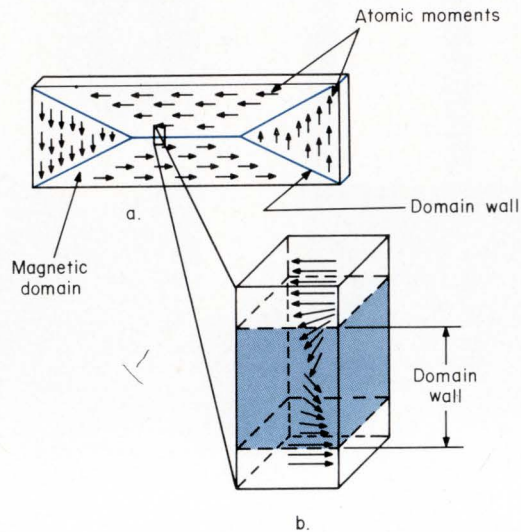

Ferromagnetic material consists of small regions, called domains, each acting like a tiny magnet. When unmagnetized, their poles are randomly oriented, giving a net magnetization of zero to the material. When subjected to a magnetic field, the magnetic moments of the domain tend to align with each other, giving a net magnetization to the material.

The small arrows in a. represent moments of groups of atoms whose exchange forces (caused by interactions of spinning electrons in adjacent atoms) have caused them to become aligned within their domains. Localized fields align the moments in a minimum energy configuration. In a., one such configuration contains four major local orientations. Lines between domains are referred to as domain walls. The wall is a region of finite width where many moments provide a more or less smooth transition between two domain orientations, as in b. Because the atomic moments within the wall are partially displaced, relatively little energy is required to cause the wall to move.

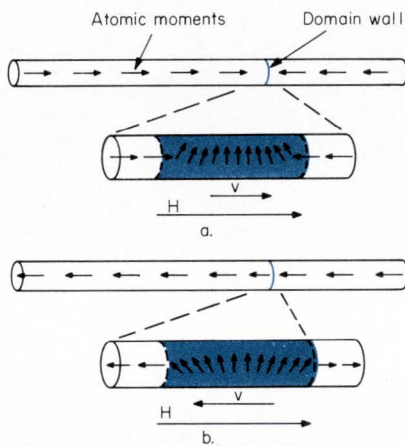

Domain wall motion in a magnetic wire. In a., the wall is placed in an external magnetic field, H. The effect is to align the atomic moments with the field. Moments on the right of the wall move to oppose H, while moments on the left try to align themselves with H. The net result is that the wall moves with velocity, v, in the direction of H. When H exceeds a wall motion threshold, H_w , wall velocity is:

$$v = C(H - H_w)$$

where C is a material velocity constant, typically 13,000 cm/s for each Oersted of propagation field. In b., the domain moments point away from the wall. Wall velocity is still given by the formula, but is in a direction opposite to H.

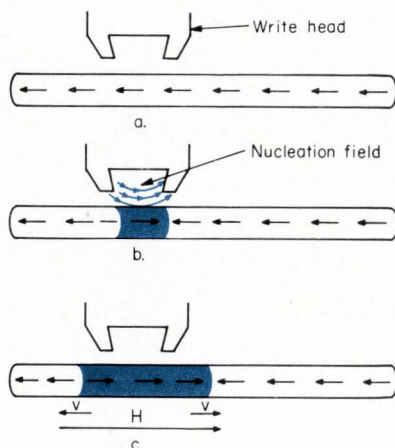

Domain nucleation. Information may be written into a magnetic media by "nucleating" a 180° reversed magnetic domain. The wire in a. is initially magnetized on one direction. In b., the field produced by the write head is greater than the nucleation (switching) field of the wire, H_n , so it nucleates a reversed magnetic domain. If H is larger than H_w , the walls will move apart and the domain will grow as in c. There are two distinct fields applied: a nucleation field strong enough to create a domain in the wire, and the motion field which is sufficient to cause wall motion, but no nucleation. Thus, the range where domain walls move is when $H_n > H > H_w$. If H is greater than H_n , spurious walls are created. Typical values of these thresholds are an H_n of 30 Oe, and an H_w of 8 Oe, for fine magnetic wire.

ChipPak

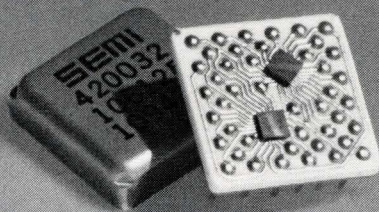

Here you have two of those chips joined in a 128 word by 2 bit memory component. Access time is still twenty nano-seconds and power consumption is still less than half a milliwatt per bit. Cost is still less than any other memory component in its speed range. We keep the cost down with automated package assembly and automated chip joining. Labor cost is practically nil. The package is ideal for memory products

because of its high lead access per unit area. Thirty-six leads require only four tenths of a square inch. If this module meets your needs, you can get immediate delivery from Intermark Electronics—or from our factory in Phoenix.

Take twenty of these and what do you get?

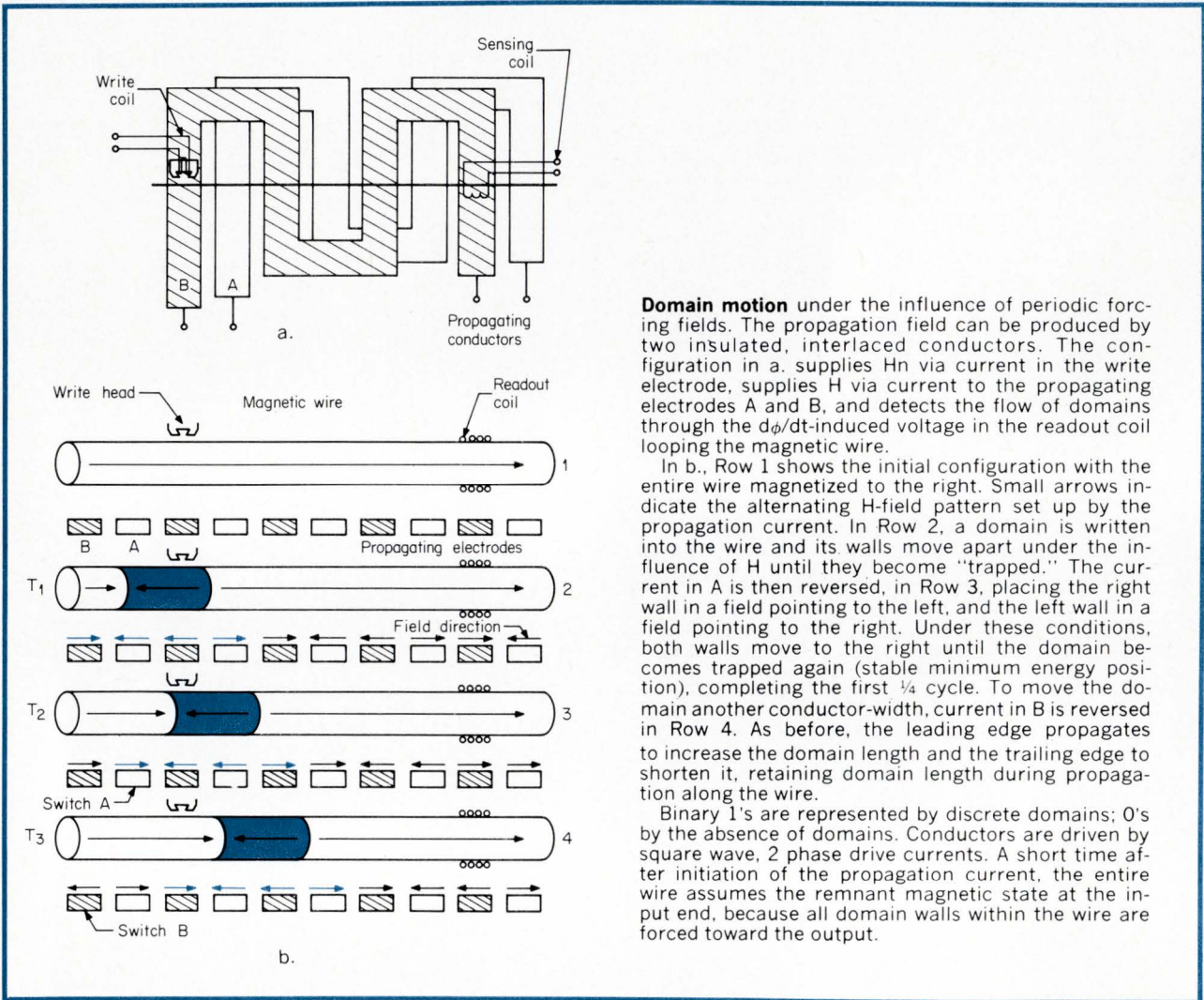

Domain motion under the influence of periodic forcing fields. The propagation field can be produced by two insulated, interlaced conductors. The configuration in a. supplies H_w via current in the write electrode, supplies H via current to the propagating electrodes A and B, and detects the flow of domains through the $d\phi/dt$ -induced voltage in the readout coil looping the magnetic wire.

In b., Row 1 shows the initial configuration with the entire wire magnetized to the right. Small arrows indicate the alternating H-field pattern set up by the propagation current. In Row 2, a domain is written into the wire and its walls move apart under the influence of H until they become "trapped." The current in A is then reversed, in Row 3, placing the right wall in a field pointing to the left, and the left wall in a field pointing to the right. Under these conditions, both walls move to the right until the domain becomes trapped again (stable minimum energy position), completing the first $1/4$ cycle. To move the domain another conductor-width, current in B is reversed in Row 4. As before, the leading edge propagates to increase the domain length and the trailing edge to shorten it, retaining domain length during propagation along the wire.

Binary 1's are represented by discrete domains; 0's by the absence of domains. Conductors are driven by square wave, 2 phase drive currents. A short time after initiation of the propagation current, the entire wire assumes the remnant magnetic state at the input end, because all domain walls within the wire are forced toward the output.

rate may be varied by changing the propagation pulse rate, leading to synchronous or asynchronous operation. Rates up to 200,000 b/s are available.

Storage is non-volatile; domains can remain at rest indefinitely. Shifting may occur in either direction, giving first-in-first-out (FIFO) or last-in-first-out (LIFO) operation or any combination.

Readout is effectively NDRO. After being read, a bit continues to the end of the magnetic wire. Space between the sense head and the end of the wire allows data retrieval after a power failure. A reverse shift of one step restores the data byte which was to be read prior to loss of power. Temperature is no problem over the range of 0 to 120°C.

Since data is serially accessed, a tradeoff exists between average access time to a word and the length of a band of wire. Band length determines access time, independent of

the total memory size. The capability to store and discharge data at different rates leads to buffering applications.

Other applications include shift registers, recirculation registers, and flip-flop registers. The memory is erasable, making it desirable for security applications. Some types of memory elements are removable and portable. Large memories are easy to mechanize because only a single set of driving circuitry, plus appropriate selection switching is required. Ⓢ

INFORMATION RETRIEVAL

Computers and peripherals, Digital design

ChipPakCard

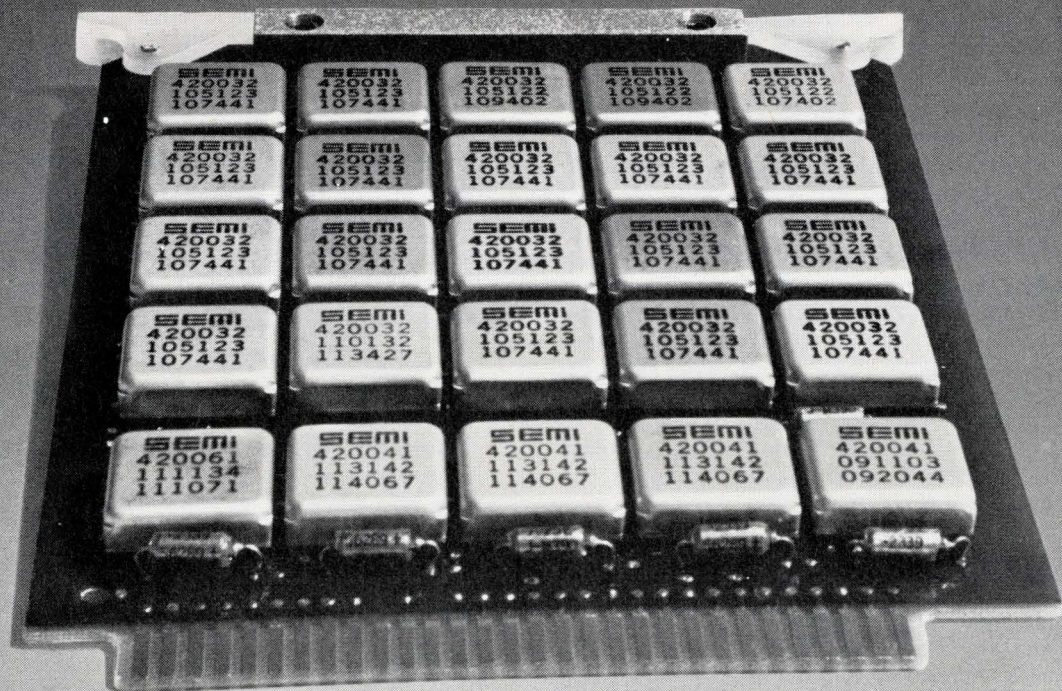

This is a memory system card. It contains the memory address register, decoding, storage sense amplifiers, write amplifiers, output buffers, interleaving capability and all the controls necessary for complete memory function. It is available in word sizes from 128 to 8192 and bit sizes of 1, 2, 4, 8, 9, 10, 12 and 16. Any number of these cards can be wired together to form a larger memory system of any desired word or bit size. Power consumption is less

than one milliwatt per bit. Guaranteed access times are 100 ns, 200 ns or 300 ns. And again, the prices are lower than any other memory cards in the same speed range. And they're available now, either from our Phoenix factory or from Intermark Electronics. **Take seventy-two of these and what do you get?**

NOW... a COURSE on the New technology of optoelectronics

Compiled by the editors of *The Electronic Engineer*, this is truly the definitive course on OPTOELECTRONICS. It is a practical and tested demonstration which will enable you to master even the most complex assignments, many of which can now be solved for the first time!

The Course is an essential technological contribution to all those involved in the research, design, development and engineering of electronic components, circuits, systems, equipment and services. Completing this Course will enable the engineer to acquire a thorough and professional knowledge of optics and at the same time to qualify as a skilled buyer of optoelectronic components. Some of the subjects covered in the Course are:

- The background on Optoelectronics . . .
- Physics of light—as applied to semiconductors . . .
- Physical definitions of optoelectronic terms . . .
- Materials—for both sources and detectors . . .
- Sources — Light-emitting diodes — Materials, efficiency . . .
- Detectors—Photoconductors (or photoresistors) photodiodes—Materials, efficiency . . .
- Amplifiers—Phototransistors, photoFETS—Materials, efficiency, sensitivity . . .

The Course also includes many simplified, practical applications for optoelectronic components such as light choppers, modulators, signal isolators, card and paper-tape readers, counters, sorters and detectors.

This complete, authoritative and timely Course in Optoelectronics costs just \$4.00 postpaid and includes an examination for those who wish to qualify. All who pass the examination will receive a Certificate of Completion from *The Electronic Engineer*. To get your copy simply send check, cash or money order to Course Editor, *The Electronic Engineer*, One Decker Square, Bala Cynwyd, Pa. 19004.

E-6

Send me your new Course on Optoelectronics at a cost of \$4.00 per copy. Payment is enclosed. Send the Course to me at:

NAME _____

ADDRESS _____ COMPANY _____

CITY _____ STATE _____ ZIP _____

Check here if you want special quantity prices E-6

NOW...Hear this

In your own home or office:
A one hour discussion on...

“SELECTING MAIN FRAME MEMORIES”

If you missed the Computer Designer's Conference in Los Angeles, you can still get the latest information available on MAIN FRAME MEMORIES, a topic generating great interest throughout the industry. The 2½ hour discussion has been tape recorded and edited into 1 hard hour of authoritative, factual information on the state of the art by this panel of industry leaders:

- Robert Noyce, President, Intel Corp.
- Linder Hobbs, President, Hobbs Associates
- Philip Harding, Memory Systems Development, Electronic Memories
- Cloyd Marvin, Vice President, Four-Phase Systems, Inc.
- Edward Schwartz, Advanced Systems Engineering, Lockheed Electronics

The report presents an up-to-date review on the relative cost/performance trade-offs of all main frame memories. In addition, the tape recording answers such questions as: “What does the future hold for plated wire, core, semiconductor and other technologies?” . . . “Where are associative memories headed?” . . . “What about volatility and reliability?” . . . “Will memories be marketed more as components or as systems?” . . . “Is price per bit important?” And more.

Why not get your own complete cassette recording of this remarkable session? This report on Main Frame Memories is available nowhere else. Hear it at home, your office or in meetings with business associates.

1-hour cassette recordings may be purchased at \$6.00 per copy. To get yours, fill out the order form and mail with your check or money order to *The Electronic Engineer* at One Decker Square, Bala-Cynwyd, Pa. 19004.

Because this is a limited edition, we suggest that you order now while tapes are available.

E-6

Enclosed is my check or money order for \$ _____ for _____ tape recording(s) at a cost of \$6.00 each. Send as soon as possible to:

Name _____

Address _____ Company _____

City _____ State _____ Zip _____

E-6

ChipPakCardBox

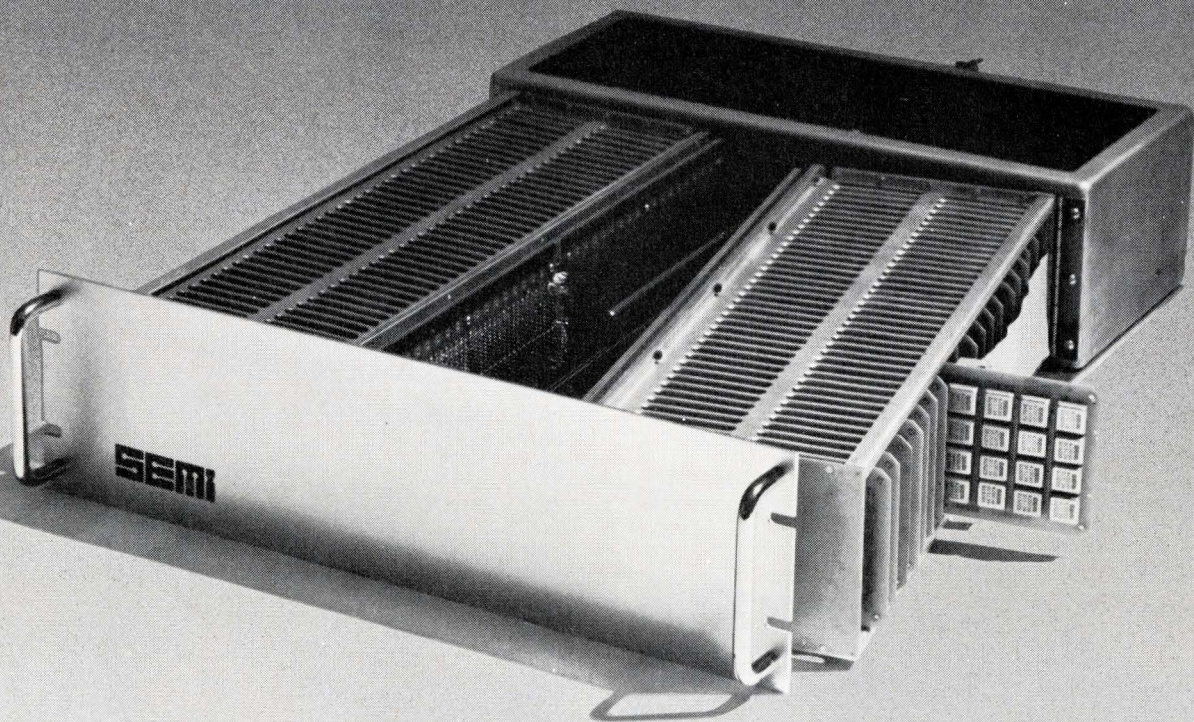

This is a 125 ns access time 32K Byte memory system. But it can be built to any desired word size or bit length with very little effort. If 125 ns access time isn't needed for your system, we can save you money with a 225 ns or 325 ns version. At any of the three speeds, you'll find our price is lower than any other equivalent memory system. And you'll also find that we consume less than half the power of any system of equivalent speed. We can supply these systems with a customized interface to meet your

specific needs. And we offer a single bit error correction and double bit error detection option, a re-try option, a failed card reporting option, a self-test option, a cooling option and a power supply option. The inherent high reliability of semiconductor products combined with the utilization of error correction and detection systems, re-try and a failed card reporting system make unscheduled interruption a thing of the past. All systems are field expandable to 131K Bytes. Okay. Now if you've read the three preceding right hand pages, then you know about our low-cost, high-speed chip. Which goes into our low-cost,

high-speed pak. Which goes into our low-cost, high-speed card. Which goes into our low-cost, high-speed system. So let's talk. For more information call or write our main office in Phoenix or phone our nearest regional sales office: Boston (617) 227-4444; Chicago (312) 529-7019; Los Angeles (213) 672-1400; New York (212) 288-8429; Philadelphia (609) 234-0185; San Francisco (415) 592-8137.

An affiliate of Electronic Memories & Magnetics Corporation
3883 No. 28th Ave., Phoenix,
Ariz. 85017. Phone (602) 263-0202

SEMI

semiconductor electronic memories, inc.
International Semiconductor Corp.
France, 20 Rue Gambetta, Paris
92 Boulogne, France
Phone 825-95-55

The Magn

HP's got a great new idea in counters: buy one that just fits your specific application — without paying for extras you'll never use. Yet make your choice from a family of six counters with a wide range of unique features, at prices so low you'll wonder how we did it.

You'll get all the things you expect from our 5326 and 5327 family of counters: totalizing, frequency, ratio, period and time interval measurements, in a range of 50 MHz or 550 MHz.

In addition, they let you perform tasks no counters could handle before.

For instance, you can now do IC logic timing testing simply and economically with 15 picosecond resolution. HP's unique time interval averaging mode makes it possible! (Request HP Application Note 129 for the story.) Price is just \$1195 for a 50 MHz unit and \$1795 for the 550 MHz model with this powerful time interval capability.



ificent Six.

For just \$355 more you can get a counter with a DVM built in. So you can do things like measure rise times more rapidly, simply and accurately than with a scope. And you can check external dc voltages with it, too. Add a \$60 HP 11096A Probe if you need rf voltage measurements.

Want programming capability? Our options will permit remote control of all front panel functions, including trigger levels and attenuators.

Computer interface is easy and costs less than ever.

Suppose you just want the basics? Our frill-free models will supply them with trouble-free, simple operation. They'll cost you \$950 for 50 MHz, \$1495 for 550 MHz.

Your HP field engineer has the 5326/27 data sheet that tells the complete story about these precise new counters. Or write to Hewlett-Packard, Palo Alto, California 94304; Europe: 1217 Meyrin-Geneva, Switzerland.

02102



HEWLETT  PACKARD

Counters that promise a lot and deliver it all.

Circle Reader Service #36

POWERTEC WINS POWER RACE

**With Record Low Prices For New,
High Performance OEM Series**

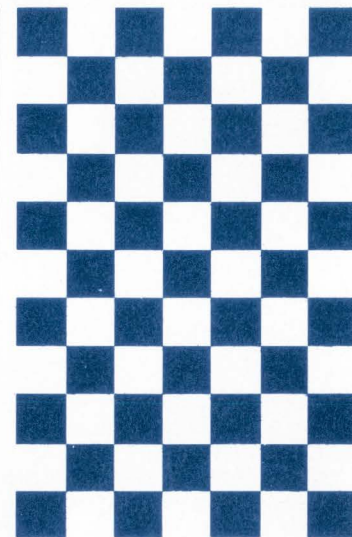
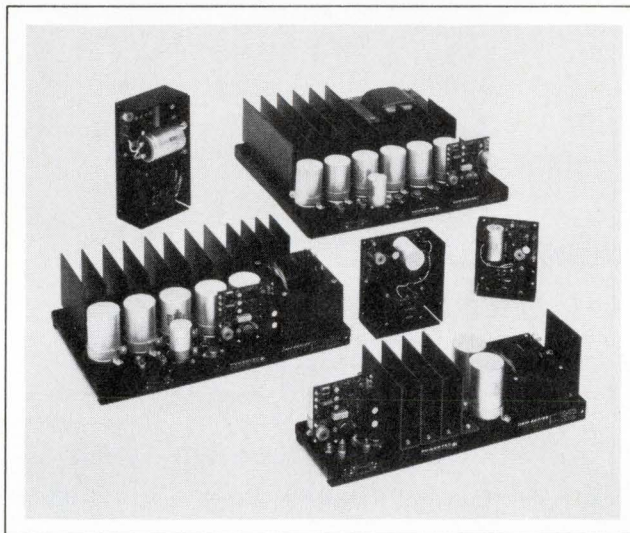
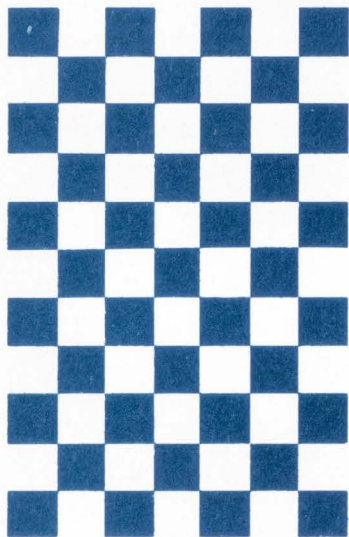

ALL MODELS DELIVERABLE FROM STOCK IN 24 HOURS

Leading the power supply industry with new low prices, top performance and reliability, Powertec's new OEM Series offers 7 popular voltages, in six basic sizes, with 42 power output combinations and is main frame, peripheral and instrument rated.

Available from stock, the OEM Series is a "no frills" fundamental new design — not a price cut, loss leader! Don't take a chance on an also-ran! Get a winner from THE power people at THE power house — Powertec. Request free application data and catalog.

Model Number	*(5)		*(15)		*(24)			Unit Price
	5V	6V	12V	15V	18V	20V	24V	
2B(*)	3A	2.5A	1.5A	1.3A	1.0A	1.0A	1.0A	\$24.95
2C(*)	6A	5A	3.0A	2.8A	2.0A	2.3A	2.3A	\$44.00
2D(*)	12A	10A	6.5A	6.0A	4.5A	5.0A	5.0A	\$75.00
2E(*)	25A	23A	15A	14A	10A	12A	11A	\$129.00
2F(*)	50A	46A	30A	28A	20A	24A	22A	\$219.00
2G(*)	75A	68A	45A	42A	30A	36A	33A	\$299.00

- REGULATION: Line $\pm .05\%$, Load $\pm .05\%$
- INPUT: 115 VAC $\pm 10V$ 47-63Hz
- RIPPLE: 1mv RMS (5 & 15V), 3mv RMS (24V)

- O.L. PROTECTION: Current limit/foldback
- RESPONSE: 50 μ sec typical
- TEMPERATURE: 0°C to 40°C derated to 71°C

POWERTEC INC. an Airtronics subsidiary
9168 De Soto Ave., Chatsworth, California 91311 (213) 882-0004 TWX 910-494-2092

THIS MONTH'S IDEAS

PAGE

Zero crossing detector uses logic gates.....	70
Sinusoidal frequency halving.....	70
Frequency divider from a clocked R-S flipflop.....	72
Speed up your precision rectifier.....	72

VOTE

for the one you like best
Write the number of the Idea you like best in the box
on the inquiry card and send it to us.

SEND us practical, reproducible ideas that are original with you
and have been implemented with linear or digital ICs.

If we publish your idea, you win a check for \$25.00.

If our readers vote yours the best of the issue in which it appears,

you have your choice of a Simpson 270 or Triplet 602 multimeter.

After 12 issues, our readers will vote on the best idea for all 12 issues.

The winner gets his choice of either a Hewlett-Packard 1206A or a Tektronix 5103N oscilloscope.

Submit your IC Ideas to:
Alberto Socolovsky, Editor
THE ELECTRONIC ENGINEER
Chestnut & 56th Sts.
Philadelphia, Pa. 19139

HOW YOU VOTED

In our January issue, we published our IC Idea winners for the year, and asked you to select "the best of the best." Well, the ballots are in and have been tabulated, and we have a winner. Selected as the best IC Idea of the year was "Zero-beat detector" by Tim K. Aaltonen.

The circuit, as you may remember, is a simple and inexpensive way to adjust two frequencies to within several Hertz of each other.

Mr. Aaltonen, our prize-winning author, is a consulting engineer in New Rochelle, N.Y. As his prize, he has selected the Tektronix 5103N scope.

Zero crossing detector uses logic gates

Stuart Culp, General Electric Co., Utica, N.Y.

It is often necessary in digital systems to detect zero crossing or to generate timing signals from an ac source. And in most of these applications, special power supply voltages are not available. In this case, a sync signal for a TV system was to be provided from a 400 Hz power supply.

Resistors R_1 , R_2 , R_3 and the internal pullup resistor of G_1 bias G_1 in a quasi-linear mode. Capacitor C_1 turns this network into a low pass filter which rejects signals above 400 Hz in this particular design. The 20 V pk-to-pk input signal is provided by an extra winding on the power transformer. Gate G_2 sharpens the corners of the squared signal, and along with R_4 provides positive feedback to the input of G_1 —an essential feature to eliminate hash or oscillations at zero crossover. Gate G_2 also acts as an output buffer.

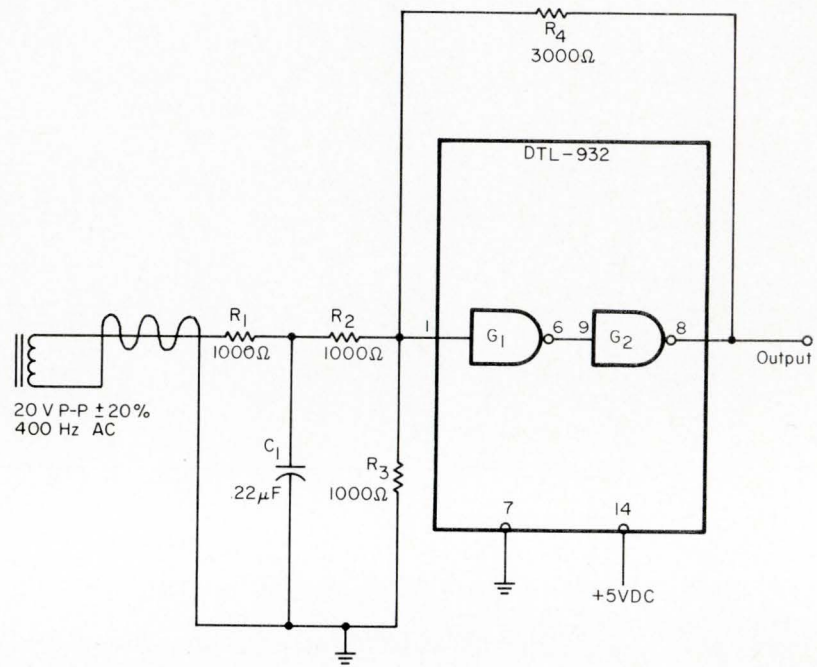

To vote for this IC Idea, circle 975 on the Reader Service Card

Sinusoidal frequency halving

Marvin K. Vander Kooi, Fairchild Semiconductor, Mountain View, Calif.

Most frequency halving circuits use digital techniques which destroy the sinusoidal nature of the input waveform. If you need a sine wave output, you must rebuild it with diode shaping networks or filters. This circuit preserves the sinusoidal rate of change of the waveform and gives you a sine wave output at one half the input frequency.

The $\mu A795$ and the two halves of the $\mu A747$ form a standard square root circuit. The output from this circuit is the positive square root of the absolute value of the input voltage. Since the square root of the absolute value of $0.5-0.5 \cos \omega t$ is equal to the absolute value of $\cos \frac{1}{2} \omega t$, the only remaining problem is to eliminate the absolute value feature. The inverter for alternate lobes is an op amp used alternately as a voltage follower and a xl inverter under control of FF_1 .

The FETS Q_1 and Q_2 do the actual analog switching of the inputs to the amplifier.

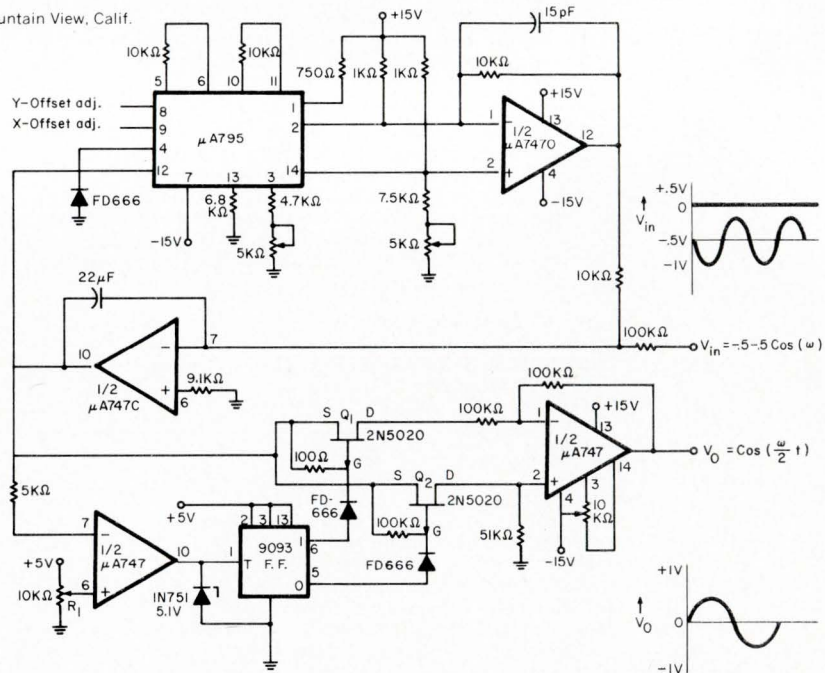

Potentiometer R_1 sets the precise trigger point of the flipflop by setting the voltage reference to the

comparator. The output wave form is a 1 V peak sinusoid at exactly one half the input frequency.

To vote for this IC Idea, circle 976 on the Reader Service Card

15C07 CM2100 RL80.81/82.83 RA
 AMS6001 08C05 CM2150 EA1400
 GE4096 RA10256 3101 IM5502 FM55
 INTEL1601 256 BIT RAM MM6505 MK400
 TMS3401-LC UA2556/3556 SMA1001 25
 RAM18A 2501 MM102X9 256 RAM RR5
 AMS10241 30C06 INTEL1601 CM24001
 INTEL1101 IM5501 MK4001P RR5100/61
 MK4003P AMS40961E RM51 CM1900 MC
 IM7501 INTEL1103 RAM0064 9035 MK400
 MCM1173L RR5120/6120 TMS4008JC RAM
 SMA2001 2508 RAM50A INTEL1601 AM9
 AMS0328E/T 9033 IM5503 3102 MC40
 6550/7550 RAM29A AMS0329E/T RM52
 CM24002 3530 MCM2372L 1024 RAM
 TMS4003JC RAM89 AMS1288E/T 4027
 RAM30023 RAM88 MC1170 4101 AMS1289E/T 41
 MC1036/7 RAM30024 RAM84A INTEL1601 RAM28
 AMS6001 08C05 CM2150 EA1400 4103 INTEL110
 GE4096 RA10256 3101 IM5502 FM5512 6550/7550
 INTEL1601 256 BIT RAM MM6505 MK4002P RL80.81/
 TMS3401-LC UA2556/3556 SMA1001 2301 AMS0329E/
 RAM18A 2501 MM102X9 256 RAM RR5510/6110 CM24
 AMS10241 30C06 INTEL1601 CM24001 4100 RA64803 3
 INTEL1101 IM5501 MK4001P RR5100/6100 RAM28A MCM
 MK4003P AMS40961E RM51 CM1900 MOSTOR100 1024 R
 IM7501 INTEL1103 RAM0064 9035 MK4006P INTEL1101 AI
 MCM1173L RR5120/6120 TMS4008JC RAM49A TMS4003JC R
 SMA2001 2508 RAM50A INTEL1601 AMS0161 15C07 CM2100
 AMS0328E/T 9033 IM5503 3102 MC4004/5 RAM30023 RAM

MACRODATA OFFERS "GALLOPING" 1's & 0's FOR SEMICONDUCTOR MEMORIES...

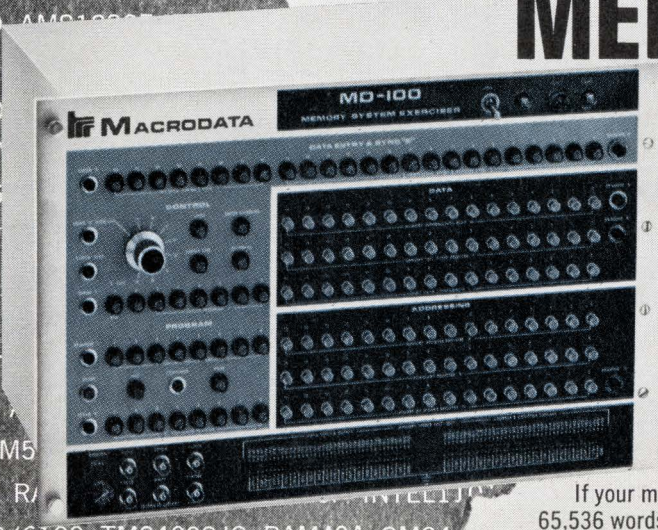

**OR YOU CAN GENERATE
YOUR OWN
WORST CASE PATTERNS.**

With our MD100 semiconductor memory tester, walking 1's and 0's are furnished as part of the package . . . in fact, they've been improved to the point that we now call them "galloping" 1's and 0's. Try them on your favorite memory. Macrodata has available a library of test routines tailored specifically for semiconductor memories.

If your memory falls within 1 word by 1 bit, or up to 65,536 words by 16 bits the MD100 has everything you need to test it, be it RAM, ROM or Shift Register, in chips, packages, memory card sub-systems, or final systems form.

We provide, and take full responsibility for, the "Personality Cards" to test each specific memory and their matching firmware. Up to 5mHZ continuous rep rate (200NS cycle time) and down to 10NS memory access time can be resolved. All systems variables, in any combination (min, nominal, max — through millions of patterns) can be run sequentially and continuously in any order.

The MD100 is a **complete** semiconductor memory system exerciser priced at \$13,750.00 with your choice of 2 standard Personality Cards.

Circle the reader number below for complete technical specifications. For faster service call the main plant (213) 882-8880.

Macrodata Company
Test Systems Division
20440 Corisco Street
Chatsworth, California
91311



Frequency divider from a clocked R-S flipflop

Jozef Sabol, Technical University of Prague, Prague, Czechoslovakia

You can use this improved toggle mode flipflop as a frequency divider over a wide range of frequencies and pulse widths.

Unlike the standard clocked R-S flipflop (solid lines), this modified version (dashed lines) cannot go to an indeterminate state. The feedback from integrating networks R_1C_1 and R_2C_2 causes sufficient delay to ensure that the outputs of both G_1 and G_2 cannot be low at the same time. This holds true as long as $T < 0.6RC$, where T is the width of the input pulse and RC is the time constant of the integrating networks. The circuit can also be triggered from pulses having arbitrary width as long as the time constant $R_{in}C_{in}$ is less than the RC time constant. You will find that the circuit operates reliably at rates up to several MHz.

To vote for this IC Idea, circle 977 on the Reader Service Card

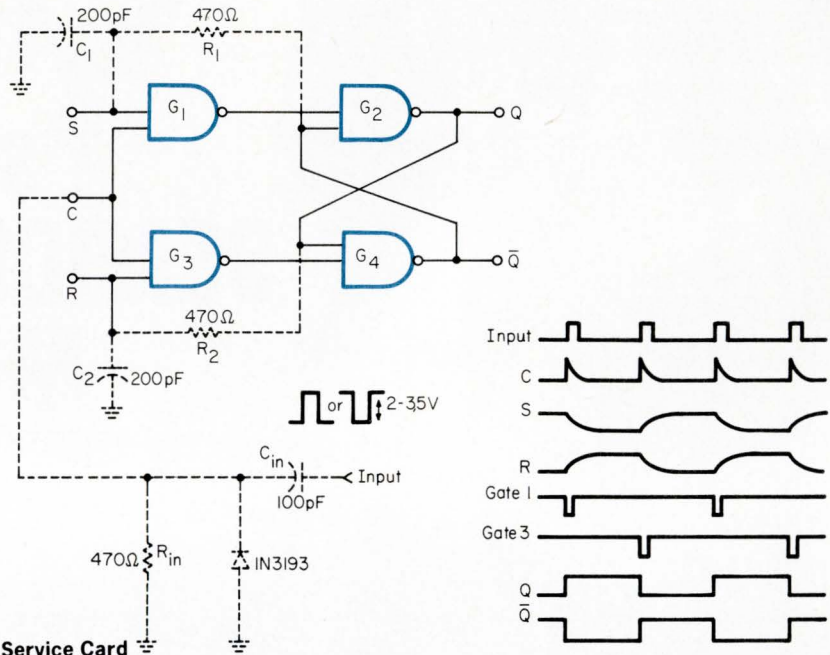

Speed up your precision rectifier

Allen Cole, Avionic and Digital Equipment Ltd., Midlothian, Scotland.

If you have occasion to design a precision rectifier, don't forget that old standby, the 709 op amp. The circuit shown here takes advantage of the 709's programmable frequency compensation to give a fast slew rate in the "dead zone" of what is otherwise a conventional precision rectifier.

As the input voltage crosses 0 V, the output swings between $+V_f$ and $-V_f$, where V_f is the forward voltage drop of the diodes. When this happens, the op amp is effectively open loop, and the detection threshold is about V_f/A_v (A_v is the open loop voltage gain of the op amp). If $R_f = R_i$, the frequency compensation must be for 0 dB gain. With this compensation, the accuracy of the rectifier is considerably reduced above about 10 kHz because the open loop gain is low, and more importantly, the slew rate is also low.

This circuit overcomes the limitation by changing the compensation to improve the performance in the open loop dead zone. The output compensation capacitor for 0 dB operation is connected to the feedback resistor side of the diode. The minimum allowable value, 3 pF, is between pin 6 and pin 5. In the normal

To vote for this IC Idea, circle 978 on the Reader Service Card

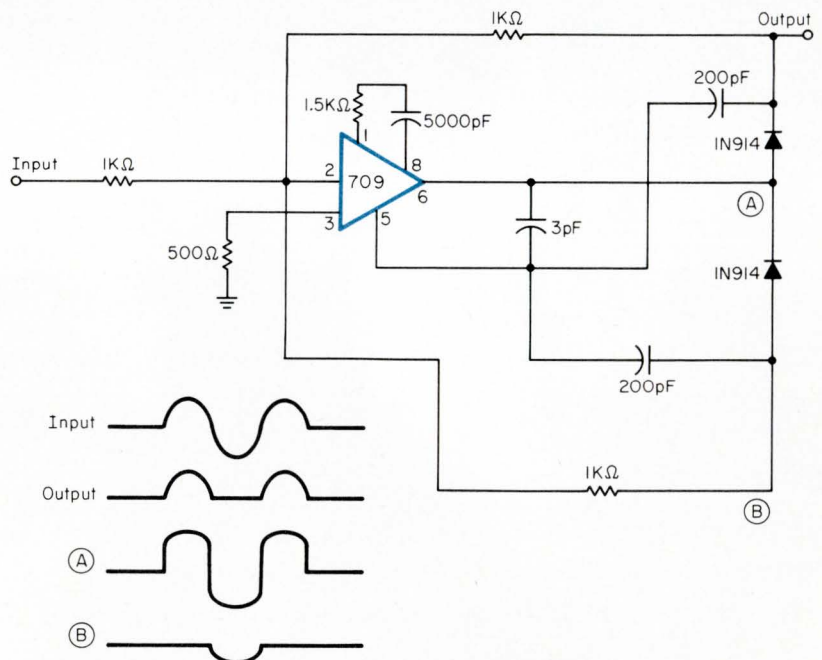

operation portion of the cycle, when one of the diodes is forward biased, the compensation capacitor consists of 3 pF and one of the 200 pF's in parallel. This gives the correct value for 0 dB operation.

In the open loop portion of the cycle, the compensation capacitor is 3 pF. This simple addition to the circuit extends its usefulness, especially at low levels, from 10 kHz to about 50 kHz.

QUADRI... ON THE MOVE!

AND NOW "Q" CORE...THE FIRST MAJOR ADVANCEMENT IN MAGNETIC ROM SINCE 1952!

... THE UNIQUE NEW PROPRIETARY "Q" CORE represents the ultimate in reliability. It eliminates the inherent mechanical and electrical weaknesses of the "U" and "E" Cores.

WHY IS "Q" CORE UNIQUE?

- Quick change, pluggable matrix. How fast can *you move*?
- Yes, it can be altered in the field faster than any other system!
- Need a system than can drive a complete library of programs?
- The 13" x 11" card holds up to 100,000 bits with cycle times of 200 nanoseconds!

And, one of the really outstanding features is the off-the-shelf delivery schedule.

Call or write today:

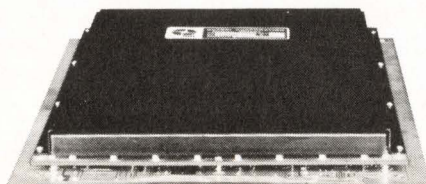

**QUADRI
CORPORATION**
2950 WEST FAIRMONT
PHOENIX, ARIZONA 85017
(602) 263-9555

only a BUSS fuseholder could have so many quality features squeezed into such a small package

Space Saver!

Made for installation in D-hole to prevent turning in panel

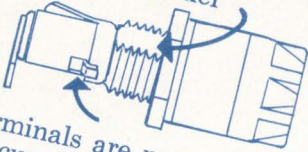

Terminals are mechanically secured in holder as well as soldered

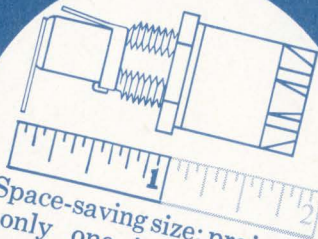

Space-saving size: projects only one inch behind panel, only 1-25/32 inches overall length

Space Saver!

Easy-grip bayonet-type knob - sturdy compression spring assures good contact



Knob grips fuse so that fuse is withdrawn when knob is removed

BUSS

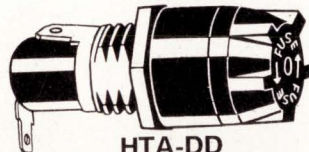

FUSEHOLDERS



Knob has break-out hole to allow use of test probe

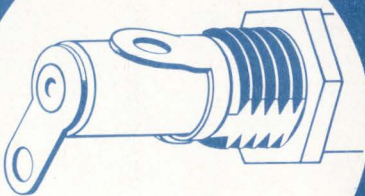

Solder Terminals (HTA)

Rated for 15 amps at any voltage up to 250

Dielectrically capable of withstanding 1500 volts A.C. between terminals and between terminals and panel

For more information on the HTA Fuseholder and the complete BUSS QUALITY line of small dimension fuses, fuseholders, and fuse-blocks, write for BUSS Bulletin SFB.

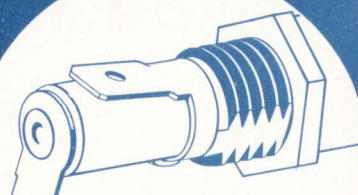

3/16" Quick-Connect Terminals (HTA-DD)

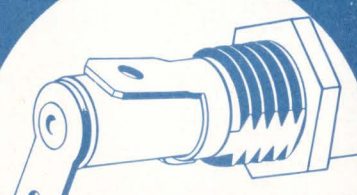

1/4" Quick-Connect Terminals (HTA-HH)

BUSSMANN MFG. DIVISION,
McGraw-Edison Co., St. Louis, Mo. 63107

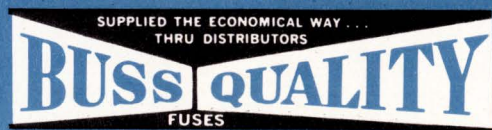

NEW PRODUCTS

Analog multipliers for the economy-minded

Analog multipliers have long been attractive to circuit designers for a wide variety of applications. The one feature which has held back their application in many cases has been their relatively high cost. Recently, however, two firms have introduced variable transconductance-type multipliers, which are aimed at opening new markets by virtue of their low price tags.

The AD530 from Analog Devices has the distinction of being the first complete monolithic multiplier to hit the market. While previous IC units required an external op amp in the feedback loop, the only outboard components used with the AD530 are some trimming potentiometers to set gain and offsets.

You can get the device in two versions, the 530J with 2% of full scale accuracy, and the 530K which has a 1% accuracy spec. Both versions have ± 10 V, 5 mA output, 1-MHz small signal

bandwidth, 750-kHz full power response, 45-V/ μ s slew rate and a minimum 7-M Ω input resistance.

In 100 piece lots, the AD530J is \$20 each, while the 530K is \$30. Analog Devices, Route 1 Industrial Park, Norwood, Mass. 02062.

The second new multiplier on the market is the M416 from Intronic. Comparing the M416 with the AD530 illustrates the discrete vs monolithic approach to circuit design. With the M416, Intronic is able to hold the tolerances a little tighter for better accuracy, but it costs money to do it. The M416 gives you a guaranteed overall accuracy of 0.5% of full scale, but it costs \$65 each in 1-9 quantities. While this is lower than most other discrete multipliers, you will have to trade off accuracy vs price according to your application. Some other specs of interest include a 6-V/ μ s slew rate, a bandwidth of 750 kHz and full power bandwidth of

100 kHz. The output is also ± 10 V, 5 mA. Intronic Inc., 57 Chapel St., Newton, Mass. 02158.

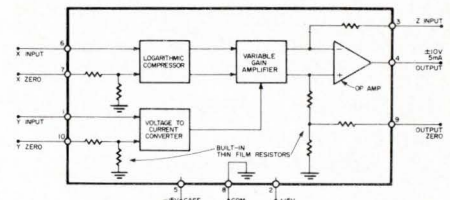

For more information on the AD530
Circle Reader Service #275

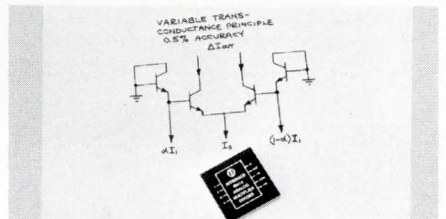

For more information on the M416
Circle Reader Service #276

LIQUID CRYSTAL DISPLAYS

This display consists of a thin layer of normally transparent liquid crystal ma-

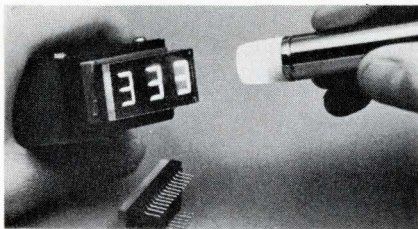

terial between two electrodes. When an electric field is applied, the material becomes turbulent, reflecting and scattering amb. light. Optel Corp., Box 2215, Princeton, N.J. 08540.

Circle Reader Service #277

GLASS DELAY LINE

Model 1024 digital delay line is 10.24 μ s long and operates at 100 MHz. Only $2\frac{1}{8} \times \frac{5}{8} \times \frac{5}{8}$ in. It can be used as a computer memory storing 1024 bits. About \$0.05/bit in 1000-piece quan. Isomet Corp., 103 Bauer Dr., Oakland, N.J. 07436.

Circle Reader Service #278

DIGITAL MULTIPLEXER

Dijitscan 2000 is a compact, digital scanner that accepts multiple BCD inputs and provides them sequentially at the output. Pivan Data Systems, Inc., 6955 N. Hamlin Ave., Lincolnwood, Ill. 60645.

Circle Reader Service #279

SENSOR ASSEMBLY

These optical pairs are a combination of two thick film arrays. One array con-

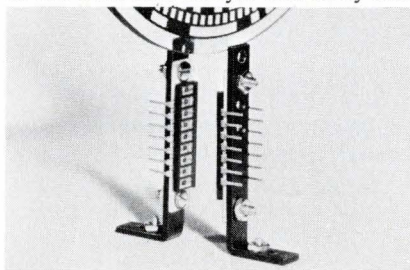

tains gallium arsenide LEDs; the other one of several types of phototransistors. Less than \$3.00/pr. in quan. HEI, Inc., Jonathan Industrial Ctr., Chaska, Minn. 55318.

Circle Reader Service #280

SILICON DIODE RECTIFIERS

New 12 A encapsulated silicon diodes are roughly $\frac{1}{2}$ the cost of equivalent-

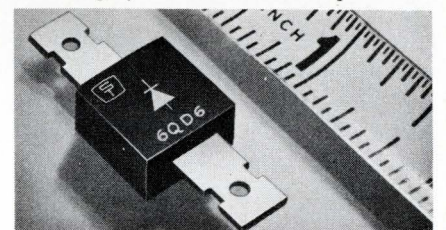

rated stud type devices. The 6QD series units are available in seven peak inverse voltage ratings from 50 to 1000 V. Sarkes Tarzian, Inc., 415 N. College Ave., Bloomington, Ind. 47401.

Circle Reader Service #281

CASSETTE COPIER

This portable high-speed cassette copier duplicates the contents of a master cassette once every 2 $\frac{1}{2}$ min. Model 521 resembles an attache case and can copy from 1 to 50 cassettes. MCA Technology Inc., 13035 Saticoy St., No. Hollywood, Calif. 91605.

Circle Reader Service #282

ILLUMINATED SWITCHES

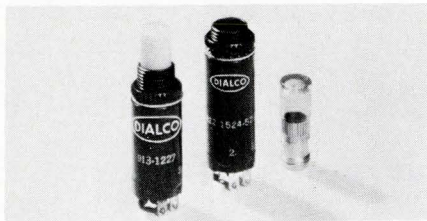

Designed for rear panel mounting, these push-button switches mount in a $\frac{3}{8}$ in. hole. They are available with either neon (Series 913) or incandescent lamps (Series 922). Dialight Corp., 60 Stewart Ave., Brooklyn, N.Y. 11237.

Circle Reader Service #283

MAGNET WIRE

New precision wrapped magnet wire is for applications in high reliability circuitry. It uses a 32 AWG silver plated conductor wrapped with Kapton. The OD is held to 0.0155 ± 0.001 in. Connecta Data, Inc., Box 355, Eatontown, N.J. 07724.

Circle Reader Service #284

DC TACHOMETERS

These two new tachometers are both brush type units having high linearity, 0.1%. They are temperature compensated to 0.01%/°C from -25° to $+175^{\circ}$ C. Harowe Servo Controls, Inc., Westtown Rd. at West Chester Pike, West Chester, Pa. (215) 692-2700.

Circle Reader Service #285

FET OP AMP

Model 163A FET op amp has a dc gain of 100,000, full power response of 100 kHz, and a $6 \text{ V}/\mu\text{s}$ slew rate. Dynamic Measurements Corp., 6 Lowell Ave., Winchester, Mass. 01890.

Circle Reader Service #286

FIBER OPTIC SCANNER

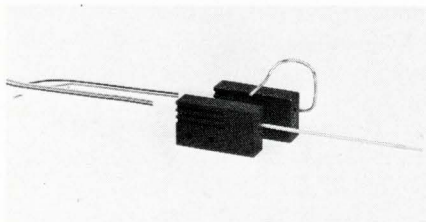

This fiber optic "Nano-Skanner" can detect a mark as small as 0.001 in. in dia. In field tests it has obtained repeatability of object position to 0.000005 in. Skan-A-Matic, P.O. Drawer 68, Skaneateles, N.Y. 13152. (315) 685-3473.

Circle Reader Service #287

CERAMIC CAPACITOR

Mono-Kap 50, 100 and 200 Vdc capacitors come in six sizes (0.100 x 0.100; 0.150 x 0.150; 0.200 x 0.200; 0.300 x 0.300, 0.400 x 0.400 and 0.500 x 0.500) and four dielectrics: NPO, N, Z5U, and general purpose. USCC/Centralab, 2151 N. Lincoln St., Burbank, Calif. 91504.

Circle Reader Service #288

FLATTED TOGGLE SWITCHES

These miniature toggle switches with flatted handles have a current rating of 5 A at 115 Vac. Prices start at \$2.15 ea. (SPDT) and \$2.65 ea. (DPDT) in single lots. Alcoswitch, Box 1348, Lawrence, Mass. 01842.

Circle Reader Service #289

POWER TRANSISTORS

PT-5501 series transistors, have turn-off times of $< 700 \text{ ns}$ at 50 A, $V_{CE}^{(sat)}$ of $< 0.5 \text{ V}$ at 50 A and guaranteed h_{FE} at 100 A. PowerTech, Inc., 9 Baker Court, Clifton, N.J. 07011. (201) 478-6205.

Circle Reader Service #290

CRYSTAL OSCILLATOR

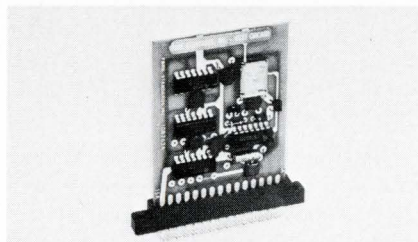

Model CQ plug-in oscillator provides a precise frequency or time base for counters or other instruments. Output frequencies available from it extend from 40 Hz through 15 MHz, at accuracies to 0.005% (50 ppm). Fork Standards, Inc., 205 Main St., West Chicago, Ill. 60185 (312) 231-3511.

Circle Reader Service #291

Reed switch. The R1-12/01 offers a combination of extreme uniformity, high reliability and maximum economy. Amperex Electronic Corp., Hicksville, N.Y.

Circle Reader Service #292

Thumbwheel switches. Decimal points on 1776 series switches and on spacers of other series are now lighted. Electronic Engineering Co. of Calif., Santa Ana, Calif.

Circle Reader Service #293

POWER DETECTOR

Model 3020 is an rf directional power detector for monitoring transmitter output in the vhf and uhf communication bands. Complete coverage is offered in the freq. range of 108-400 MHz with a power rating of either 50 or 150 W. Coaxial Dynamics, Inc., 13100 Enterprise Ave., Cleveland, Ohio 44135. (216) 267-2233.

Circle Reader Service #294

LOW-POWER DISPLAY

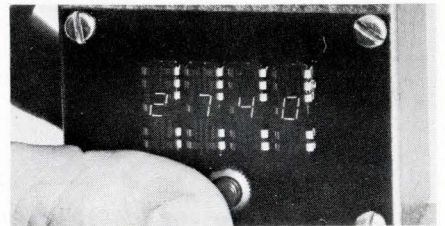

MAN 4 is a 7-segment ss unit that provides a visible display with inputs as low as 1 mA and 1.65 V. \$7.50 ea. (1,000 quan.). Monsanto Electronic Special Products, 10131 Bubb Rd., Cupertino, Calif. 95014. (408) 257-2140.

Circle Reader Service #295

MICA PAPER CAPACITOR

The CEM is a reconstituted mica paper capacitor that is encased in molded epoxy for critical operating environments. It weighs about 40 g/in.³. Custom Electronics, Inc., EE-18, Browne St., Oneonta, N.Y. 13820.

Circle Reader Service #296

SELF-DECODING READOUT

The Major-64 accepts directly any four, five or six line binary code signal and rapidly selects and projects any one of 64 images on an integral screen. Major Data Corp., 891 W. 18th St., Costa Mesa, Calif. 92627.

Circle Reader Service #297

POWER THYRISTOR SCR'S

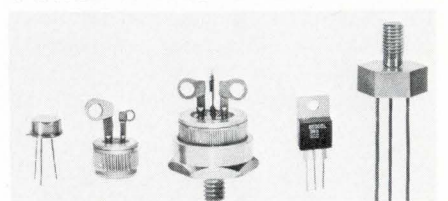

These new unilateral power thyristor SCRs have load current ratings from 0.8 to 35 A and voltage ratings from 30 to 800 V. Gate sensitivities range from 1-10 mA to 1-25 mA. ECC Corp., Box 669, 1011 Pamela Dr., Euless, Tex. 76039. (817) 267-1601.

Circle Reader Service #298

READ IT DIGITALLY AT 10 TIMES SCOPE ACCURACY

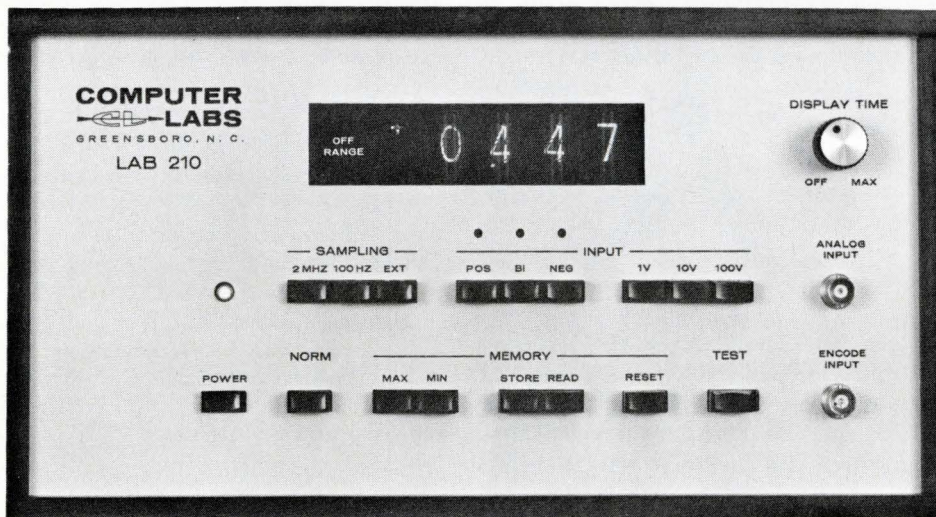
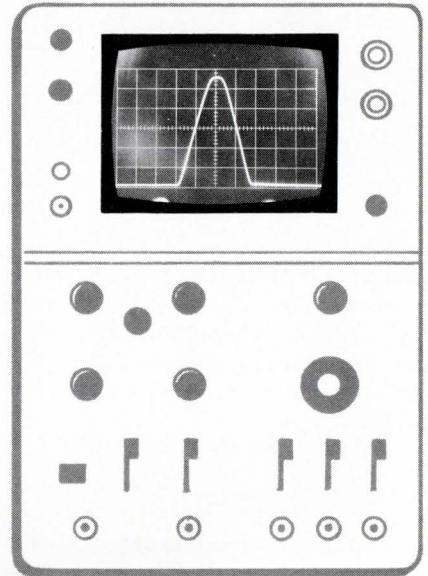

Measure pulse heights with a DVM instead of a scope? Now you can with the new LAB 210 TRANSIVERTER. It's a 10-bit A/D (encoding rates to 2 MHz) with a Nixie tube display showing four significant digits, \pm sign, and over-range indication. That's 10 times scope accuracy . . . and a lot more readability! If you need a memory, too, you can have 100 words on an optional plug-in module. Or maybe you'd rather plug in an optional transient detector for maximum or minimum de-

tection-and-hold. And if you need an analog output, you can have an optional D/A module, too.

That gives you **five** precision instruments in one:

- A/D converter
- ac DVM
- 100-word memory
- Transient detector for max/min
- D/A converter

Check for more information on this totally new measuring instrument.

COMPUTER LABS 

1109 South Chapman Street / Greensboro, North Carolina 27403 / (919) 292-6427 / TWX 510 922-7954

HIGH VOLTAGE DIVIDERS

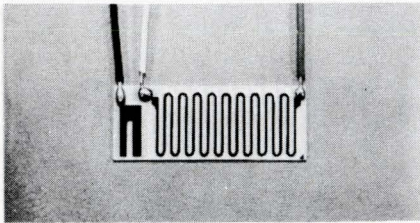

Thick film multi-megohm, tapped resistors on flat substrates offer advantages in hv circuits. Close tracking of individual elements is obtained among resistors differing in value by factors of as much as several thousand. Airco Speer Electronics, Packard Rd. at 47th St., Niagara Falls, N.Y. 14302. (716) 285-9381.

Circle Reader Service #299

DC POWER SUPPLIES

Three encapsulated supplies, Models 906, 903, and 905, provide ± 5 V output at 250, 500, and 1000 mA, respectively. Used to excite monolithic ic logic circuits, they operate from a nom. 115 Vac at 50 to 400 Hz. No. 906 is \$38.00; No. 903 is \$47.00; No. 905 is \$66.00. Analog Devices, Inc., 221 Fifth St., Cambridge Mass. 02142. (617) 492-6000.

Circle Reader Service #300

PC PACKAGING CONCEPT

Multiflex packaging concept combines the techniques of multilayer and flexible circuit construction, resulting in pcs that can be made to bend or twist at any location. Lockheed Electronics Co., Inc., Data Products Div., 6201 E. Randolph St., Los Angeles, Calif. 90040.

Circle Reader Service #301

PUSHBUTTON SWITCHES

These miniature switches are available in std., watertight and round base models. The std. and watertight switches are rated at 5 A, 125 Vac and 28 Vdc, res. load. The round base switch is rated at 3 A, 125 Vac and 28 Vdc, res. load. Cutler-Hammer, Inc., 4201 N. 27th St., Milwaukee, Wis. 53216.

Circle Reader Service #302

ISOLATOR

Optically coupled isolator (SSC-600) has a neon bulb, dropping resistor and Si photocell that operates from 115 Vac line. Output current is 200 μ A. \$4.00 ea. (100 quan.). Solar Systems, Inc., 8124 N. Central Park, Skokie, Ill. 60076.

Circle Reader Service #303

FLAT FLEXIBLE CABLE

Signaflo® transmission cables offer all the advantages of flat, flexible cable and provide closely controlled characteristic impedance, propagation velocity, crosstalk and attenuation. Flex-Strip® cables offer easy, economical replacements for individual round wires in a wide range of current carrying applications. Ansley Corp., Old Easton Rd., Doylestown, Pa. 18901.

Circle Reader Service #304

HIGH VOLTAGE SCRs

New C602 high power semiconductor is designed for phase control of hv dc motors and replacement of ac contactors in higher voltage ac lines. Rated at 2600 V and 600 A average, it is housed in a rugged pressure mounted Press Pak featuring 1-in. creepage. General Electric, Electronics Park, Mail Drop 49, Syracuse, N.Y. 13201.

Circle Reader Service #305

NEON PILOT ASSEMBLIES

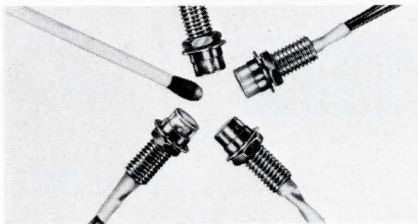

Miniature assembly mounts in a $\frac{1}{4}$ in. hole. The BNM-2R pilot includes a built-in series resistor for 120 Vac operation. \$0.59 ea. (1000 units). Alcolite Div., Alco Electronic Products Inc., Box 1348, Lawrence, Mass. 01842. (617) 686-3887.

Circle Reader Service #306

DC-DC CONVERTER

PWR-101 converter accepts a 24 V input and provides a 200 V output. Designed for use with neon-type indicators, it has many other applications. General Dynamics, Electro Dynamic Div., Box 2566, Orlando, Fla. 32802.

Circle Reader Service #307

AC SWITCHES

Long life (over 500,000 operations) series 780000 miniature, momentary action, plunger type switches are for use in home appliances, computer hardware cabinetry and communications equipment. Littlefuse, Inc., 800 E. Northwest Hwy, Des Plaines, Ill. 60016.

Circle Reader Service #308

For quick information use the reader service card inside the back cover.

ALUMINIZED ALLOYS

Aluminized Kovar® and Westro 42 sealing alloys are for chemical etching or stamping of ic lead frames. The alloys are available in sheet and strip, fully coated or striped. Westinghouse Electric Corp., Westinghouse Bldg., Pittsburgh, Pa. 15222.

Circle Reader Service #309

OPEN-FRAME REED RELAY

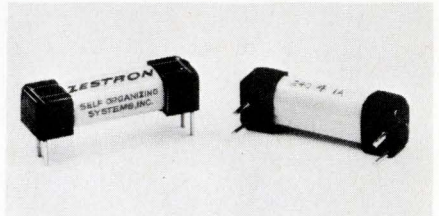

Overall size of the Series 240 is only 0.20 h x 0.25 w x 0.77 l, with pins brought out on the std. 0.1 x 0.7 in. pattern for pc board mounting. It is useful for computer applications. Self-Organizing Systems, Inc., Box 9918, Dallas, Tex. 75214. (214) 276-9487.

Circle Reader Service #310

PRECISION OSCILLATORS

These variable frequency oscillator subassemblies are useful in ssb transceivers, spectrum analyzers, selective voltmeters and specialized test equipments. Standard models include freq. ranges between 2.5 MHz to 6.0 MHz. TRW Inc., Davis & Copewood Sts., Camden, N.J. 08103. (609) 465-5500.

Circle Reader Service #311

TRANSISTOR SOCKET

This $\frac{1}{4}$ -turn Teflon, TO-18 transistor socket, featuring four angled leads (three active, and one passive-serving as a convenient dummy tie-point lead), mounts in an unchamfered punched "D" hole for improved pullout resistance. Overall dimensions of socket No. 027-1706 are 0.281 in dia. and it's 0.430 in. long. Sealectro Corp., 225 Hoyt St., Mamaroneck, N.Y. 10543.

Circle Reader Service #312

LIGHT EMITTING DICE

These PD5033 gallium phosphide dice have an emission at 570 nm and a typ. light output of 300 ft-L at 10 mA. The 25-mil sq. dice are suitable for use in indicator lamps and custom design film arrays and readouts. Ferranti Electric, Inc., E. Bethpage Rd., Plainview, N.Y. 11803.

Circle Reader Service #313

THESE ARE NOT JUST "HI-REL" RECTIFIERS. THEY ARE

Centralab PRIME! Microglass Rectifiers

Briefly, here's what the PRIME' "label" means:

We've initiated a new Program for Reliability, Integrity, and Manufacturing Efficiency for all of our products. Now all Centralab Semiconductor products — incorporating improved designs — are manufactured to JAN quality levels for inherent reliability.

Special conditioning and selection provides products at four levels of reliability — at realistic prices to fit individual needs.

One of our PRIME' grades will meet any OEM requirement.

PRIME' grades are:

PRIME' 1—For critical applications requiring maximum reliability and where repair or replacement is impossible. 100% conditioning, testing and data profiling — in excess of JAN-TX quality provisions.

PRIME' 2—For military and industrial applications requiring JAN-TX or equivalent parts.

PRIME' 3—For applications requiring JAN parts.

PRIME' 4—For commercial and industrial electronics requiring JEDEC or equivalent parts.

PRIME' is proving itself. Compare the "A" versions of our newly-registered PRIME' fast-recovery rectifiers against those previously available:

1N3611
thru
1N3613

1N4001
thru
1N4005

1N4245
thru
1N4249

1N5185
thru
1N5190

1N5185A
thru
1N5190A

HFR-5
thru
HFR-20



**CENTRALAB
SEMICONDUCTOR**

Division • GLOBE-UNION INC.
4501 NORTH ARDEN DRIVE
EL MONTE, CALIFORNIA 91734

JEDEC Type Number	Case Type	Electrical Specifications @ 25°C					Maximum Ratings		
		Peak Reverse Voltage PRV	Maximum Forward Voltage Drop @ $I_F = I_O$ V_F	Maximum Reverse Current I_r @ PRV		Maximum Reverse Recovery Time t_r	Maximum Junction Capacitance @ $V_R = 0$ Volts	Average Rectified Current I_O @ 25°C	Surge Current I_{FM}
				25°C	100°C				
Volts	Volts	µA	µA	n sec	pf	Amps	Amps		
1N5185	20	50	1.1	5	100	250	600	3	80
1N5186	20	100	1.1	5	100	250	400	3	80
1N5187	20	200	1.1	5	100	250	320	3	80
1N5188	20	400	1.1	5	100	300	240	3	80
1N5189	20	500	1.1	5	100	350	200	3	80
1N5190	20	600	1.1	5	100	400	160	3	80
1N5185A	20	50	1.1	2	80	250	400	4	80
1N5186A	20	100	1.1	2	80	250	300	4	80
1N5187A	20	200	1.1	2	80	250	250	4	80
1N5188A	20	400	1.1	2	80	250	200	4	80
1N5189A	20	500	1.1	2	80	250	160	4	80
1N5190A	20	600	1.1	2	80	300	120	4	80

Contact us now for a comprehensive data package describing the program in detail.

NEW PRODUCTS

TERMINAL JUNCTION SYSTEM

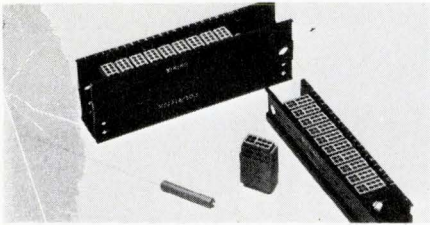

Qualified to Mil-T-81714A, these terminal junction systems have environmental "insert" modules that lock into tracks for use in high reliability and extreme environmental applications. Viking Industries, Inc., 21001 Nordhoff St., Chatsworth, Calif. 91311.

Circle Reader Service #314

SUBSTRATES CONNECTOR

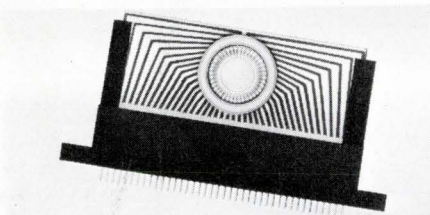

Designed to accept 0.040 in. thick single-sided ceramic substrates, the basic edge-mount connector is available in the popular 40-position configuration with contacts on 0.050 in. centers. AMP Incorporated, Harrisburg, Pa. 17105.

Circle Reader Service #315

30 CONTACT CONNECTOR

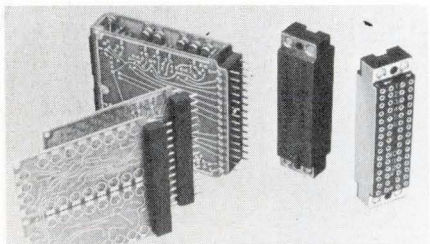

This female connector accepts a 30 contact male PC header, or two 15 contact PC headers. This approach allows either individual or multiple PCB connection. Contact spacing is 0.156 in. Connector Operation, Control Data Corp., 31829 La Tienda Rd., Westlake, Calif. 91361. (213) 889-3535.

Circle Reader Service #316

PCB edge connectors. These connectors have 15/64 in. long dip solder tails for through connection of multiple board layers. Cinch Mfg. Co., Elk Grove Village, Ill.

Circle Reader Service #317

BREADBOARDING STRIP

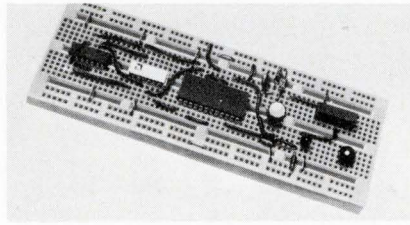

With Super-strip, components are easily inserted and securely held by pressure; no soldering is needed. Components are reclaimable, and the strip is reusable. \$18.00 (1-9). AP Inc., 72 Corwin Dr., Painesville, Ohio 44077. (216) 357-5597.

Circle Reader Service #318

MULTI-PIN CONNECTOR

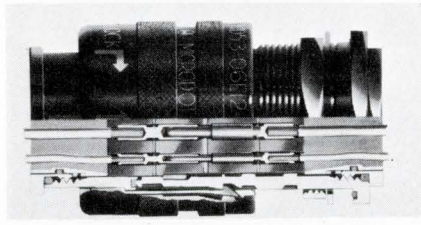

New connector can handle 20-gauge wire and up to 85 contacts. Four sizes are available: shell sizes 9, 12, 15, and 18 containing 13, 31, 55, and 85 contacts respectively. Microdot Inc., 220 Pasadena Ave., South Pasadena, Calif.

Circle Reader Service #319

SOLDERLESS WRAP BOARDS

Two new general purpose boards let you mix 14-, 16-, 24-, and 36-pin IC sockets in any desired arrangement. The boards contain all holes for mounting, but are provided without sockets. They are consistent with the format of the company's 715 line of cards. Cambridge Thermionic Corp., 445 Concord Ave., Cambridge, Mass. 02138.

Circle Reader Service #320

LSI SOCKET

This dual in-line socket accepts 40 lead ICs with 0.600 in. between rows. Solder pocket, PC or solderless wrap termination. Insulator is glass filled nylon with polarization notch and mounting holes. Socket height above the board is 0.310 in. max. \$3.55 to \$1.31. Augat Inc., 33 Perry Ave., Attleboro, Mass. 02703. (617) 222-2202.

Circle Reader Service #321

Interested in connectors? See "They've got connections" on p. 29.

MINIATURE CONNECTORS

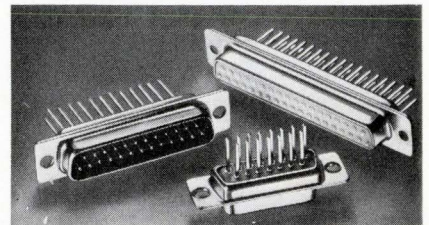

These D-subminiature rack and panel connectors come with 0.025 in.² solderless wrap tails. They are available in 9, 15, 25, 37 and 50 contact sizes. Cinch Mfg. Co., a division of TRW Inc., 1501 Morse Ave., Elk Grove Village, Ill. 60007.

Circle Reader Service #322

FLAT CABLE CONNECTOR

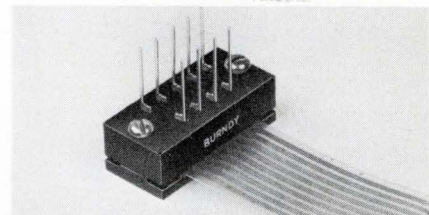

With the new Tapecon™ connector you just place the cable between connector halves and tighten two screws to skive the insulation and make electrical contact with the conductors. Burndy Corp., Norwalk, Conn. 06852.

Circle Reader Service #323

INTERCONNECTION SYSTEM

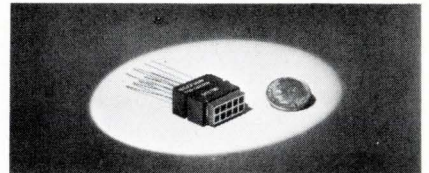

These miniature modules (Mil-T-81714 type) are for PC board or black box mounting. They provide I/O source including internal contact bussing to suit your applications. Appleton Electric Co., 1701 Wellington Ave., Chicago, Ill. 60657.

Circle Reader Service #324

DIP SOCKETS

Precision series of 14- and 16-pin universal DIL sockets for automatic solderless wrapping feature closed entry contacts with a large positive area of contact surface. The low profile Series 41000 has front removable contacts. Dynatech Corp., 1225 E. Wakeham Ave., Santa Ana, Calif. 92702.

Circle Reader Service #325

LOW POWER TTL CRAM COURSE.

Low power TTL isn't exactly a household word yet among design engineers. So we'd like to offer a quick summary of low power TTL. What it is. Who uses it. Why. Why not. Plus, a list of our products.

After reading this page, you'll probably decide to specify low power for your next system. (If not, you'll at least have lots of cocktail party material.)

PART ONE: A DEFINITION

Low power TTL is an offshoot of the 54/74 family which is fully compatible with DTL and TTL. It is specifically designed for applications requiring very low power dissipation.

PART TWO: WHO USES IT

The military's been using low power TTL for four years, but it's also catching on in portable equipment, data terminals and other industrial applications as well.

PART THREE: ADVANTAGES

Low power TTL offers several nice advantages over standard TTL logic.

First, even at frequencies of 12MHz the devices dissipate very low power and generate less heat on the chip. As a result, low power TTL has proven to be much more reliable than standard TTL. (If you don't believe us, ask NASA.)

Then there's power savings. Typically, low power TTL gives you a *factor of 10* power savings over standard TTL. Which means you can use a 2.5A power supply, for example, instead of a 25A supply. Which means you save money.

Speaking of saving money, perhaps the biggest single advantage to using low power TTL is the money you save in your overall systems costs.

For example, low power TTL eliminates the need for a fan. Which eliminates the need for a thermostat. Which eliminates the need for a filter. And so on and so forth. (In fact, one of our customers says that the fan alone costs them enough money that even if they had to pay 200% more for low power devices in their systems, their overall systems costs would still be less expensive!)

PART FOUR: PRODUCTS

Right now, we have 21 off-the-shelf low power TTL devices (including four MSI functions):
DM54L00/DM74L00 Quad 2-Input NAND Gate

DM54L01/DM74L01	Quad 2-Input NAND Gate, Open Collector
DM54L02/DM74L02	Quad 2-Input NOR Gate
DM54L03/DM74L03	Quad 2-Input NAND Gate, Open Collector
DM54L04/DM74L04	Hex Inverter
DM54L10/DM74L10	Triple 3-Input NAND Gate
DM54L20/DM74L20	Dual 4-Input NAND Gate
DM54L30/DM74L30	Eight-Input NAND Gate
DM54L51/DM74L51	Dual 2-Wide AND-OR-INVERT Gate
DM54L54/DM74L54	Four-Wide 3-2-2-3-Input AND-OR-INVERT Gate
DM54L55/DM74L55	Two-Wide 4-Input AND-OR-INVERT Gate
DM54L71/DM74L71	R-S Flip Flop
DM54L72/DM74L72	J-K Flip Flop
DM54L73/DM74L73	Dual J-K Flip Flop
DM54L74/DM74L74	Dual D Flip Flop
DM54L78/DM74L78	Dual J-K Flip Flop
DM54L86/DM74L86	Quad EXCLUSIVE-OR Gate
DM54L90/DM74L90	Decade Counter
DM54L93/DM74L93	Binary Counter
DM54L95/DM74L95	Four-Bit Right Shift Left Shift Shift Register
DM76L70/DM86L70	Eight-Bit Serial-In Parallel-Out Shift Register

(NOTE: All devices are available in cavity-dip, molded-dip and flat-pack configurations.)

We also plan to announce some Tri-State* MSI low power devices.

This ends our cram course. If you'd like to learn more, we'll be happy to send you a free copy of our full course — the liberally-diagrammed, specifications-packed, 36-page National Low Power TTL Brochure. Plus any of our Tri-State or 54/74 product data.

For yours, write, phone, TWX or cable us today. National Semiconductor Corporation, 2900 Semiconductor Drive, Santa Clara, California 95051. Phone (408) 732-5000. TWX (910) 339-9240. Cable: NATSEMICON.

*Tri-State is a Trademark of National Semiconductor Corporation

NATIONAL

D/A CONVERTER

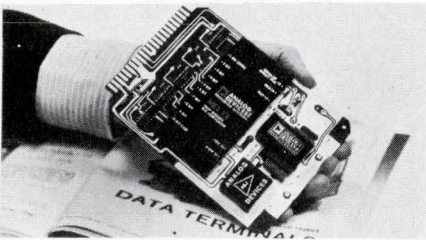

Model DAC-10D is for CRT graphic display applications where it will translate computer commands into deflection signals for writing the graphics CRT presentations. Analog Devices, Pasto-riza Div., 221 Fifth St., Cambridge, Mass. 02142.

Circle Reader Service #125

MEMORY SYSTEM

SEMS 8 (Severe Environment Mem-ory System applications) is a non-vol-atile, DRO ferrite core system organized in a 3-wire, 3D setup. Access time of 450 ns and cycle time of 1.2 μ s. Elec-tronic Memories, 12621 Chadron Ave., Hawthorne, Calif. 90250.

Circle Reader Service #126

DIGITAL DATA SYSTEM

The 7100 system for industrial data logging and alarm scanning handles 1000 channels of low and high-level process signals. Westronics, Inc., 2605 McCart St., Ft. Worth, Tex. 76110.

Circle Reader Service #127

1500 LPM CHAIN PRINTER

The LP 3500 attains speeds from 1240 to 1500 lpm using 48 characters and 132 columns. Potter Instrument Co., Inc., 532 Broad Hollow Rd., Melville, N.Y. 11746.

Circle Reader Service #128

DISK DRIVE

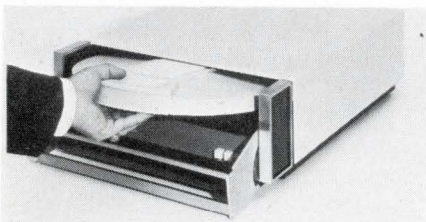

The Mod 321 memory drive unit is for use with minicomputers. It holds one std. IBM 2315 removable disk car-tridge or equivalent. Each cartridge pro-vides 12 million bits of memory at a recording density of 1100 bpi. Unicomp, Inc., 18219 Parthenia St., Northridge, Calif. 91324. (213) 886-7722.

Circle Reader Service #129

KEYBOARD

MK-37/2040 teletypewriter-con-figuration keyboard is designed for high-speed data transmission and has additional function keys for use in a CRT display terminal. Features include the full, 128 ASCII codes, 12 additional function keys, two-key rollover and er-ror and data lockout. Data Electronics Corp., Burlington, Mass. 01803.

Circle Reader Service #130

CORE MEMORY STACK

Designed for use in the small memo-ries of desk calculators and other com-pact data processing equipment, this memory stack costs only 2.5 cents/bit in production quantities. Ampex Corp., 9937 W. Jefferson Bldg., Culver City, Calif. 90230. (213) 836-5000.

Circle Reader Service #131

THERMAL PRINT HEAD

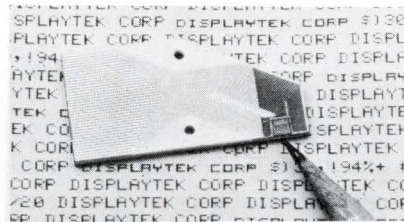

The DC-1157 is especially appro-priate for the new low cost electronic calculators and for computer and tele-communication terminals, electric type-writers and strip printers. Displaytek Corp., 1103 Expressway Tower, Dallas, Tex. 75206. (214) 369-8226.

Circle Reader Service #132

MULTIPLYING DAC

The MP1012 DACPACTM, a 0.015% accuracy 12-bit multiplying D/A con-verter, is for any use where the analog output must be a digitally-scaled replica of the reference input. It may also be used as a normal D/A converter. Ana-logic Corp., Audubon Rd., Wakefield, Mass. 01880.

Circle Reader Service #133

TICKET PRINTER

Available in either rack-mount or portable instrument case, the Model 2014C accepts BCD information for as many as 10 columns simultaneously. It is for applications that require printing on IBM-size tickets. Digitron Corp., 2544 W. Main St., Norristown, Pa. 19401. (215) 277-5800.

Circle Reader Service #134

COMMUNICATIONS TERMINAL

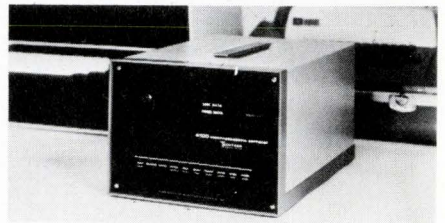

The 4100 is an on-line cassette loaded magnetic tape terminal, plug com-patible with Teletypewriter, keyboard-printer and CRT display terminals. It is also for stand alone operation. Techtran Industries, Inc., 580 Jefferson Rd., Rochester, N.Y. 14623. (716) 271-7953.

Circle Reader Service #135

TAPE EDITOR

This tape editor (8-channel ASCII) has both off-line and on-line appli-cations. It provides five levels of editing and transmission control: character, word, line, block and record. Special Systems, Inc., 10419 Fawcett St., Ken-sington, Md. 20795.

Circle Reader Service #136

SERIAL IMPACT PRINTER

Model 100 is for use as a component of a data terminal, communications printer, remote batch processor, I/O printer for minicomputers or automatic text editing typewriter. I/O Devices, Inc. 9 Skyline Dr., Montville, N.J. 07045.

Circle Reader Service #137

MINICOMPUTER



Micro 1600 is a microprogrammable minicomputer which stores logic in an IC control memory. Microdata Corp., 644 E. Young St., Santa Ana, Calif. 92705.

Circle Reader Service #138

ASCII CODE GENERATOR

This unit generates all 128 characters of the 7-bit ASCII Code. It is wired for positive logic with a bounce-free TTL-compatible output. \$98.00. Mechanical Enterprises Inc., 5249 Duke St., Alex-andria, Va. 22304. (703) 751-3030.

Circle Reader Service #139

SS KEYBOARD

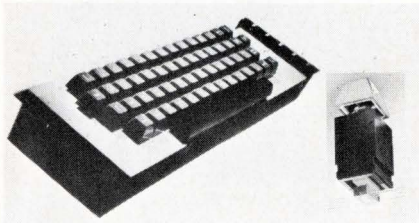

Heart of the FS-300 keyboard is a Fero-Snap™ ferrite key switch. Using only one moving part, each key switch opens and closes a magnetic path, generating code at the key by transformer action. Fort Electronic Products, 133 Brimbal Ave., Beverly, Mass. 01915.

Circle Reader Service #340

MINICOMPUTER

The EPI-118 minicomputer has a 900 ns cycle time and is expandable from 4 k to 32 k, 18-bit words. With selected peripheral interfaces, the basic 4 k system sells for \$5,900.00. Electronic Processors, Inc., 5050 S. Federal Blvd., Englewood, Colo. 80110.

Circle Reader Service #341

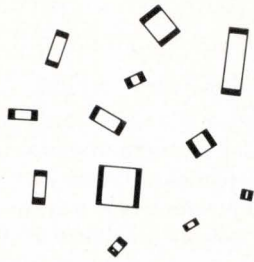

**NEW SIZES
NEW PRICES IN
CHIP CAPACITORS!**

Announcing the 1971 line of Ceramolithic® chip capacitors from USCC/CENTRALAB! Capacitance ranges — 1.0pF to .47Mfd in 50, 100 and 200 VDC ratings in sizes from .050" x .050" x .040". Lowest industry prices. New faster delivery — most catalog sizes now available off the shelf. Your choice of NPO or W dielectrics which meet or exceed the applicable portions of MIL-C-11015 and MIL-C-39014. The exclusive Ceramolithic® construction and 100% testing ensures highest reliability.

For free copies of new 1971 Catalog and Applications Manual, write USCC/CENTRALAB, 2151 N. Lincoln St., Burbank, Calif. 91504, (213) 843-4222 — or circle information retrieval number below.



U.S. CAPACITOR CORPORATION



CENTRALAB Electronics Division • GLOBE-UNION INC.

Circle Reader Service #47

If you need
**TIME CODE
EQUIPMENT**

look to
Chrono-log
for

high performance,
integrated-
circuit
Time
Code
Generators, Time
Code Readers
and Automatic

Tape Search Controls used for time correlation of data recorded on analog tape and oscillographs.

Let our 15 years of experience in time code equipment work for you. Write or call Chrono-log Corp., 2583 West Chester Pike, Broomall, Pa. 19008. Phone: (215) 356-6771.



Circle Reader Service #45

Varflex invites you to . . .

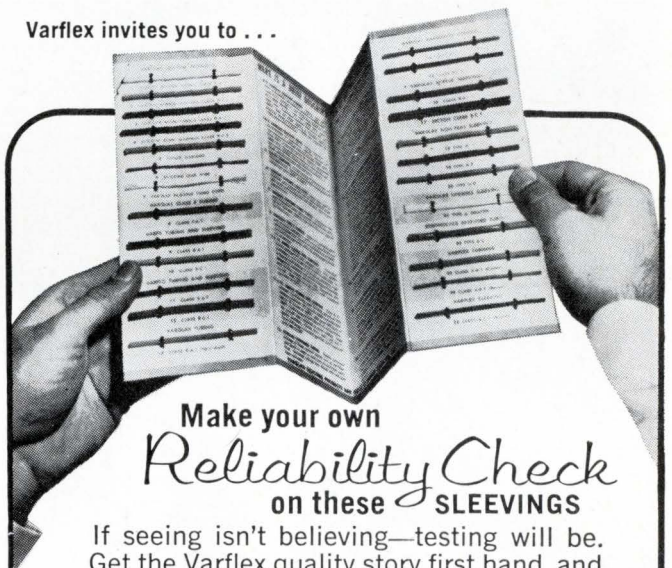

Make your own
Reliability Check
on these **SLEEVINGS**

If seeing isn't believing—testing will be. Get the Varflex quality story first hand, and you can count on exactly the same quality every time you order.

Send today for your free folder containing test-length samples of **Silicone, Varglas, Varfil, and Varflo** flexible insulating sleeveing and tubing.

Let us know how we can serve you.

Send For Free Folder of Actual Test Samples



506 W. Court Rome, New York

Circle Reader Service #46

RF POWER METER



Model 42AD Digital Microwattmeter is a MF to K band (200 kHz to 12.4 GHz) power meter. The 3 1/2 digit readout has a free-running display period of 250 ms, but it may be triggered as fast as every 10 ms for systems use where only BCD outputs are required. \$1,100.00. Boonton Electronics Corp., Parsippany, N.J. 07054.

Circle Reader Service #342

MOS MEMORY EXERCISER

The MD100 uses "personality cards" with test sequences specifically designed for the system under test. The exerciser is micro-programmed to provide test sequences at speeds up to 5 MHz. \$13,000.00. Macrodata Systems, Test Div., 20440 Corisco St., Chatsworth, Calif. 91311.

Circle Reader Service #343

WATTMETER CAL SYSTEM

This system uses standard instrumentation and a new wattmeter calibrator module (designed Model 5058), to calibrate four terminal wattmeters, ranging in sensitivity from 0.05 W to 14,000 W at freqs. of 50, 60, 400 and 1000 Hz. The system is designed such that you can vary the power factor from unity to zero (phase angle 0° to 90°), for complete wattmeter calibrations. RFL Industries, Inc., Boonton, N.J. 07005.

Circle Reader Service #344

POCKET DVM

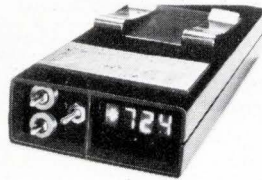

Model 20 gives you 3 dc voltage ranges plus auto polarity and autoranging. The unit measures 7.6 x 1.2 x 3.2 in. and weighs 1.1 lb. The self-contained battery provides up to 8 h operation. \$750.00. Kruger Eckels, Inc., Box 681, So. Pasadena, Calif. 91030.

Circle Reader Service #345

3-DIGIT VOLTMETER

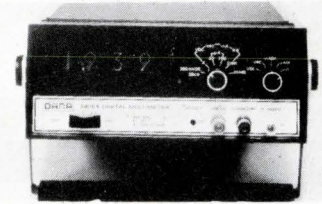

Model 3860A has five dc ranges with accuracies of $\pm 0.1\%$ of the measured reading and within $\pm 0.05\%$ of full scale for a 90 day period. A three-pole active filter is combined with dual-slope integration to provide normal mode rejection of 60 dB at or near line frequency. \$350.00. Dana Laboratories, Inc., 2401 Campus Dr., Irvine, Calif. 92664.

Circle Reader Service #346

PORTABLE DIGITAL VOM

Model 460 has 26 switch selectable ranges available for a wide variety of testing situations. These include 5 ac and dc voltages, 5 ac and dc currents and six resistance ranges with accuracy from $\pm 0.1\%$ of reading, ± 1 digit. \$395.00. Simpson Electric Co., 5200 W. Kinzie St., Chicago, Ill. 60644.

Circle Reader Service #347

FLICK.

The great American switch.

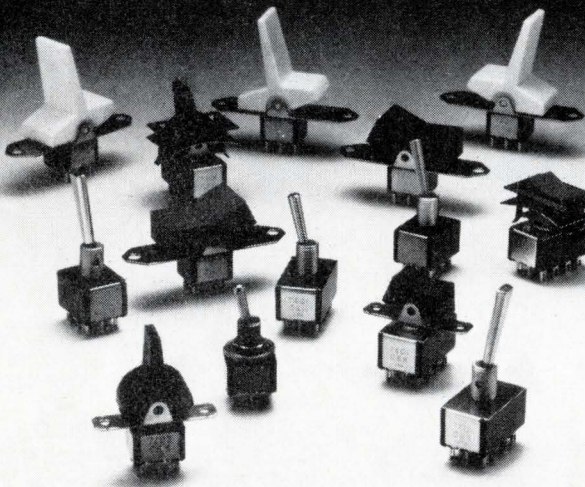

The most complete line of UL listed subminiature switches.

Subminiature toggles, rockers and paddle handles by C&K. The most complete line. All models and all options UL listed. Best quality. Best price. Best delivery to any place in the world. Now there's a switch. Get the catalog (#700).

C&K COMPONENTS, INC.

103 Morse Street, Watertown, Mass. 02172

TEL: (617) 926-0800 - TWX: 710 327 0460

The great American switch company.

Also supplied: Pushbutton catalog (#800) Rotary Print Switch catalog (#900)

Circle Reader Service #48

Tel. (617) 222-3726

Pylon

REPLACEABLE POGO

CONTACTS

- ROUND, CONICAL AND FLAT TIPS
- LOW AND UNIFORM RESISTANCE
- GOLD PLATED • LONG LIFE
- SPRING-LOADED CONTACTS DESIGNED TO BE PLUGGED INTO A MATING SOCKET
- REPLACEABLE POGOS ARE AVAILABLE FOR CENTERLINE SPACING OF .050" UPWARD
- SINGLE, BOARD MOUNTED OR COMPLETE ACTUATING SYSTEMS

**PYLON COMPANY, INC. — 57 Newcomb St.
ATTLEBORO, MASSACHUSETTS 02703**

Circle Reader Service #49

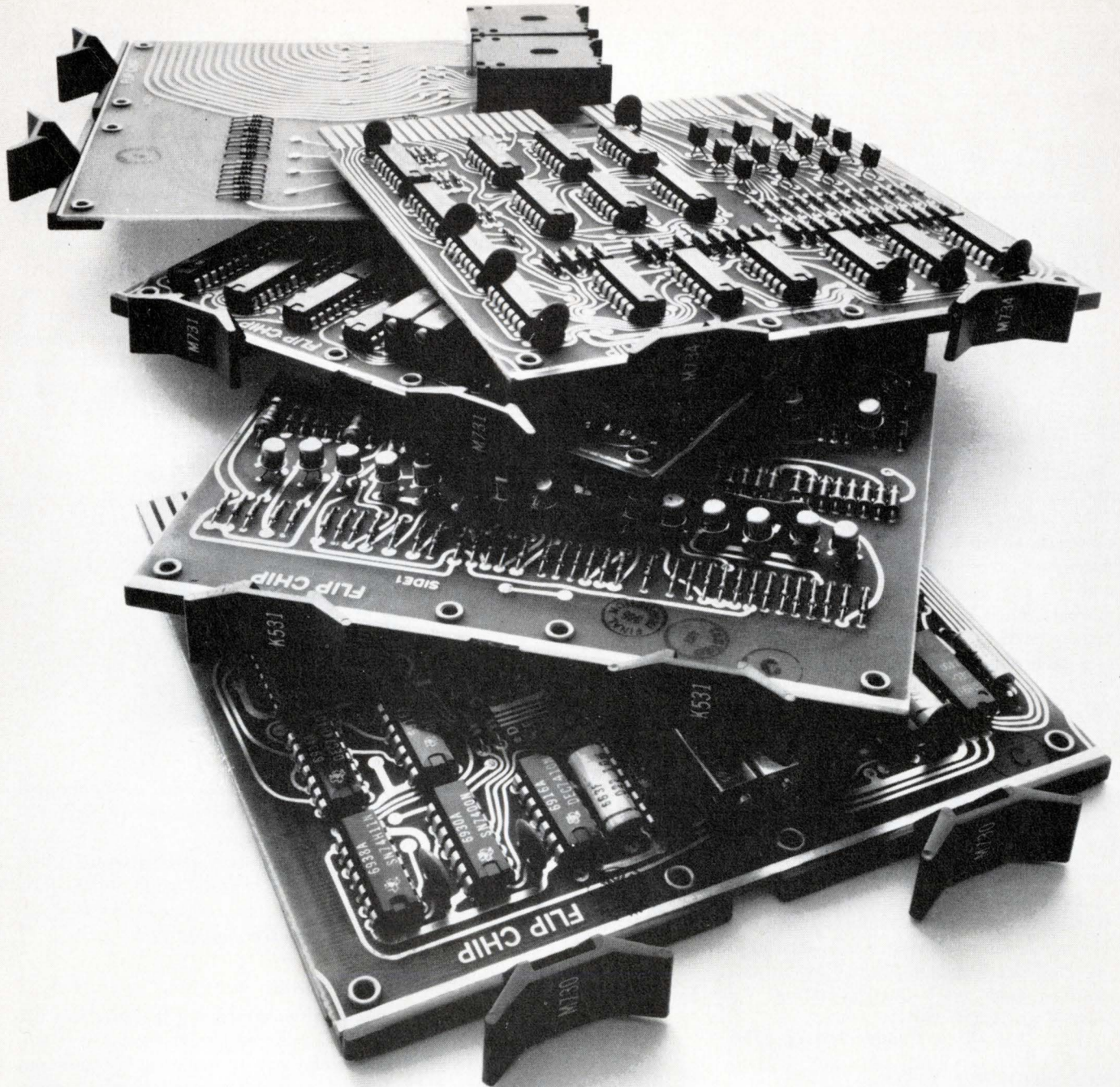

The fastest, slowest, broadest line of modules available.

If you're interfacing a computer, you want your modules fast, and Digital gives it to you. The M series is at 10 MHz, and the line is complete. More than 100 physically, electrically, and logically compatible modules that can combine into just about any function you could want. The same modules, in fact, that we use in our latest computers.

But if you're building a laboratory controller, or a machine controller, or want to replace those relays, you may want the slowest module you can find. And Digital gives you that, too. The K-series is designed to operate at 100 KHz, immune from electrical noise, and this line, too, is complete. Better than 70 mutually compatible modules. The same as we use in our industrial controllers.

Plus the hardware. Digital provides cabinets, connectors, plug-in boards, power supplies—

the works. We have handbooks we'd be glad to send you free. One for the M-series. One for the K-series. One fast. One slow. Write.

DIGITAL EQUIPMENT CORPORATION, Maynard, Massachusetts, Telephone: (617) 897-5111 / ALABAMA, Huntsville / CALIFORNIA, Anaheim, Los Angeles, and Palo Alto / COLORADO, Denver / CONNECTICUT, New Haven / DISTRICT OF COLUMBIA, Washington (College Park, Md.) / FLORIDA, Cocoa / GEORGIA, Atlanta / ILLINOIS, Chicago / MASSACHUSETTS, Cambridge and Maynard / MICHIGAN, Ann Arbor / MINNESOTA, Minneapolis / MISSOURI, St. Louis / NEW JERSEY, Parsippany and Princeton / NEW MEXICO, Albuquerque / NEW YORK, Centereach (L.I.), New York City, and Rochester / NORTH CAROLINA, Chapel Hill / OHIO, Cleveland and Dayton / PENNSYLVANIA, Philadelphia and Pittsburgh / TENNESSEE, Knoxville / TEXAS, Dallas and Houston / UTAH, Salt Lake City / WASHINGTON, Seattle / AUSTRALIA, Brisbane, Melbourne, Perth, and Sydney / CANADA, Edmonton, Alberta; Carleton Place, Ottawa; Toronto, Ontario; and Montreal, Quebec / ENGLAND, London, Manchester, and Reading / FRANCE, Paris / GERMANY, Cologne and Munich / HOLLAND, The Hague / ITALY, Milan / JAPAN, Tokyo / SWEDEN, Stockholm / SWITZERLAND, Geneva.

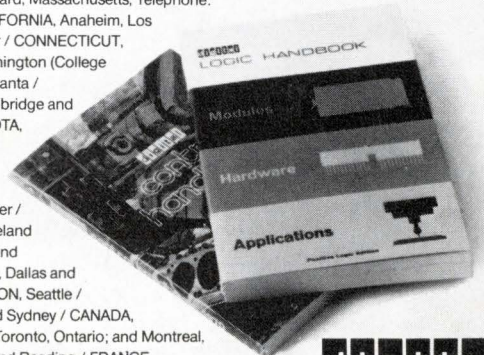

digital
MODULES · COMPUTERS

ICs FOR MODEMS

These two new circuits are the SN75150, a dual line driver

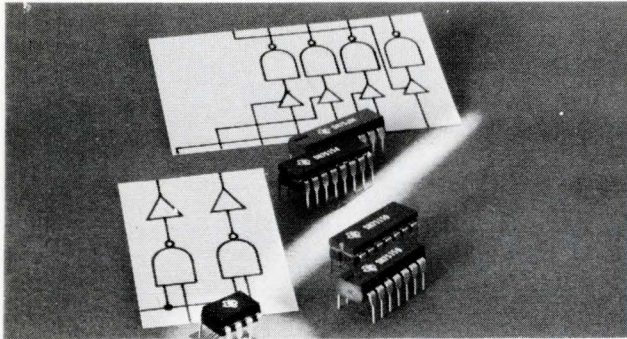

and the SN75154, a quad line receiver. Both meet EIA RS-232C specifications. The SN75154 receiver includes a dual power supply. This lets you operate it from a +12 V supply, normally used for telephone lines or from a +5 V supply used with TTL/DTL systems. Outputs for the SN75150 driver are current-limited for short-circuit protection to ± 25 V. Output voltage levels are nominally ± 6 V and the outputs will drive capacitive loads < 2500 pF. Texas Instruments Incorporated, Inquiry Answering Service, Box 5012, M/S 308, Dallas, Tex. 75222. **Circle Reader Service #355**

LINE DRIVER/RECEIVER SERIES

The QC 7820/8820 and QC 7830/8830 devices operate on a single 5 V power supply and are guaranteed to operate over the full military temp. range. The QC 7830/8830 driver performs the dual four input NAND and AND function. The outputs are balanced and designed to drive line pairs with impedances of 50Ω to 500Ω , or single-ended lines. The QC 7820/8820 receiver has two separate receivers on one silicon chip. The inputs can be connected to coaxial or twisted pair lines, and they accept small differential signals, while rejecting large common mode ones. Qualidyne Corp., 3699 Tahoe Way, Santa Clara, Calif. 95051.

Circle Reader Service #356

MOS SHIFT REGISTER

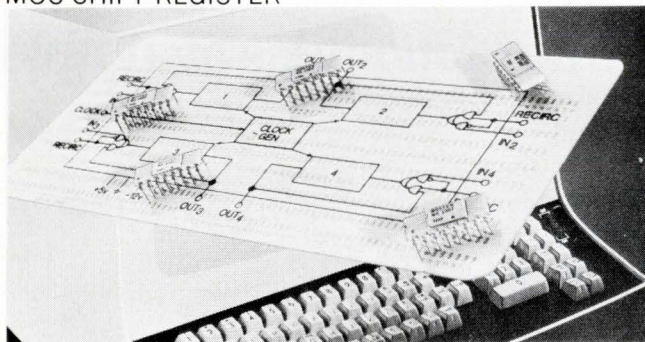

The MK 1007 P is a quad, 80-bit MOS dynamic shift register that provides full TTL/DTL compatibility at all inputs and outputs, including the single-phase clock. You will find it useful in line memories of CRT display devices and in the buffer memory units of punched card readers. Features include a clock frequency range of 10 kHz to 2.5 MHz and recirculate logic on the chip at each of the four inputs. \$13.50 ea. in quan. of 100 or more. Mostek Corp., 1400 Upfield Dr., Carrollton, Tex. 75006. (214) 242-1494.

Circle Reader Service #357

NEW MOS PROCESS

This new manufacturing process is known as rmos (Refractory Metal Oxide Semiconductor). It uses molybdenum as the gate metal and because moly can withstand in excess of 1100°C without melting, it can be applied before diffusion is performed. This results in self-alignment between the gate and diffused region and thus provides minimum gate-to-source and gate-to-drain capacitance. The first products to be offered are the GER 1507 and the GER 2507, dual 100-bit dynamic shift registers and the GER 1101, which is a 256-bit memory array. GE Integrated Circuits Dept., Electronics Park, Syracuse, N.Y.

Circle Reader Service #358

BEAM LEAD OP AMPS

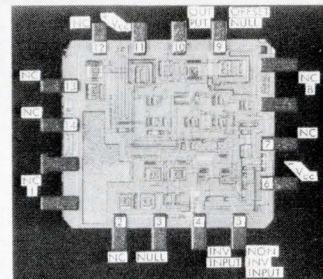

The RC741BL and RM741BL are commercial and military versions of a high gain, internally compensated operational amplifiers. Because of the advantages of one-step bonding of gold plated beam leads, these nitride passivated pretestable chips are particularly suited for hybrid applications. Raytheon Semiconductor, 350 Ellis St., Mountain View, Calif. 94040.

Circle Reader Service #359

FUNCTION GENERATOR IC

The 566 is a voltage controlled oscillator that produces two outputs simultaneously: a buffered square wave and a buffered triangular wave. Frequency of oscillation is determined by an external resistor, a capacitor, and the voltage applied to the control terminal. The oscillator can be programmed over a 10-to-1 frequency range by proper selection of the external resistance, and it can be modulated over a 10-to-1 range by the control voltage. \$6.00 ea. (100-999 quan.). Signetics Corp., 811 E. Arques Ave., Sunnyvale, Calif. 94086. (408) 739-7700.

Circle Reader Service #360

DATA ACQUISITION SYSTEM IN A MODULE

The DAS-16 interfaces directly with DEC, Data General, Hewlett Packard, Varian and most other minicomputers. The unit contains an eight or sixteen channel multiplexer, sample and hold amplifier, A/D converter, system sequencer (with all necessary control and interface logic) and a solid-state read-out which displays the multiplexer address and the A/D output value. Because of the random and sequential addressing employed, individual channels may be sampled at rates consistent with their particular bandwidth. Output coding can be binary or BCD, with word lengths of 8, 10 or 12 bits. Prices start at \$990. Varadyne Systems, 1020 Turnpike St., Canton, Mass. 02021. (617) 828-6395.

Circle Reader Service #361

Electronic Memories gently draws your attention to an off-the-shelf planar stack so small that it will fit most commonly used printed circuit boards.

We built this one to solve our problems with the mini-computer people—and their problems as well. Yes, it's low cost: competitive with any other low cost planar stack on the market. Yes, it's off-the-shelf: we can deliver in volume in sixty days or less.

But the main point is this: the size is so small that you can fit this baby on just about any type of PC board. It's 1/2" high x 6" wide x 6 1/2" deep. And in that little package you get 4K x 18 bits of core storage. At a price no semiconductor can match. To the mini-computer designer, this means an immediate core memory source regardless of the system's physical room for storage area.

The stack will operate at either 700 or 800 nanoseconds, depending on whether you order 18 or 20-mil diameter core. Extended temp cores are standard for operation from 0 to 70° C.

The rather unusual "folded" design gives you almost fifteen percent decrease in drive line inductance. Winding impedance and uniformity compares favorably to the compact frame designs. Much better than other planars.

Incidentally, we held a contest to find a good name for this stack. It is now called the EM 2220. Just goes to prove that we know more about core than about fancy names.

Here and Now: EM 2220 is in limited production for off-the-shelf delivery. Come in and we'll show them to you. Figure about sixty days for volume orders.

EM Electronic Memories is a division of Electronic Memories & Magnetics Corporation, 12621 Chadron Avenue, Hawthorne, California 90250, (213) 644-9881.

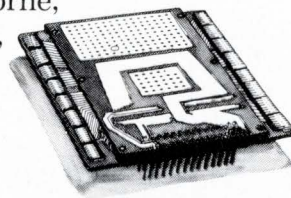

("I still think a couple of 'incredibles' would help.")

How does Tantalum look without its military jacket? A lot better in the budget.

Take a solid tantalum capacitor out of the military specs and you notice one thing immediately.

Hardly any loss in reliability. And a big drop in price.

When you figure you can get KEMET® E Series dipped solid tantalums for about what you'd pay for aluminum electrolytics, you can start to see all sorts of problems disappear.

Rejects dwindle. Shelf life lengthens. Operational life soars.

KEMET E Series tantalums come in four case sizes from 0.175" diameter to 0.400" with plug in leads on either .125" or .250" precision centers. 0.1 to 330uf, up to 50 volts. Off the shelf delivery on standard values.

Talk to your Union Carbide Sales Representative about them. Or write us at Union Carbide, Components Department, Box 5928, Greenville, South Carolina 29606. Telephone: (803) 963-7421.

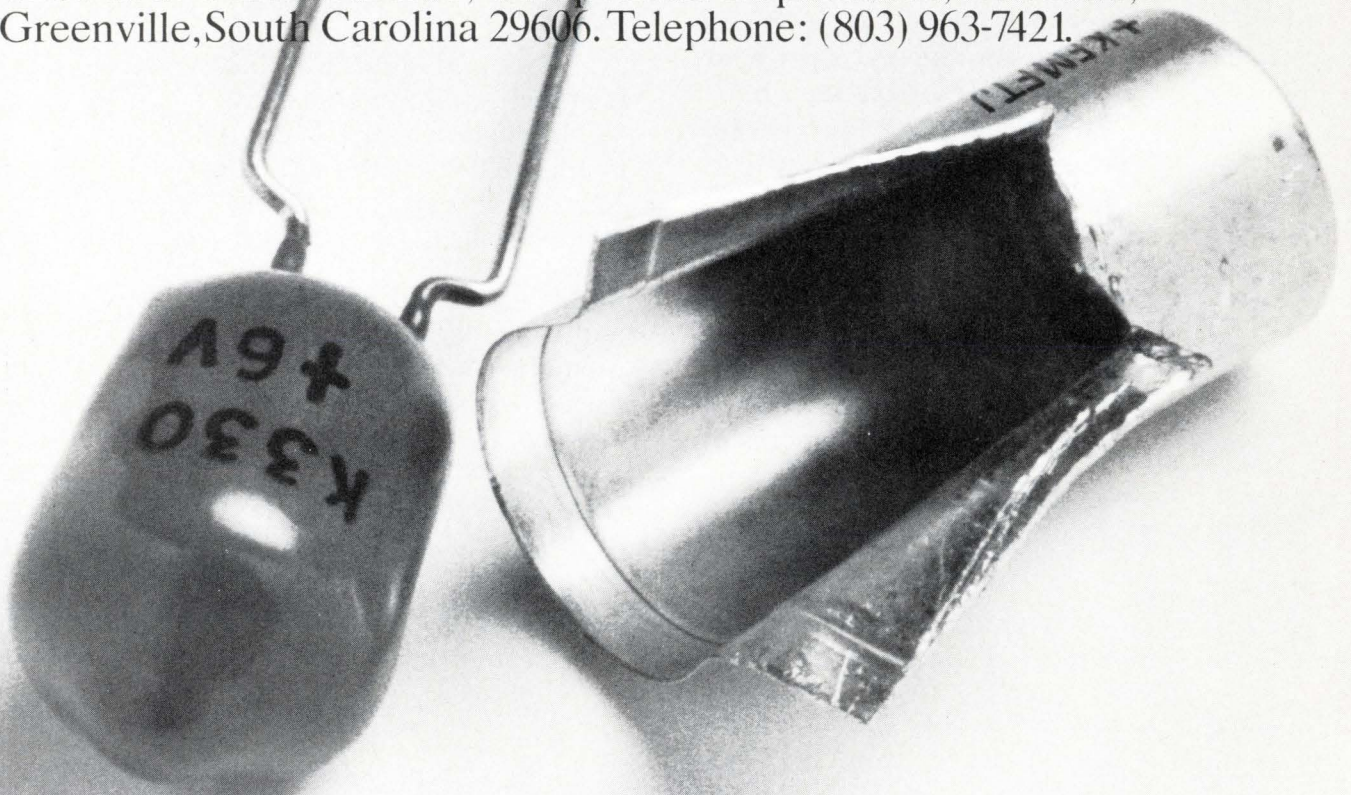

Guide to ROM systems

This 22-page brochure includes a brief introduction to ROMs and a discussion of three of the most common applications: data tables, micro-programming, and character generation. You will also find the theory of

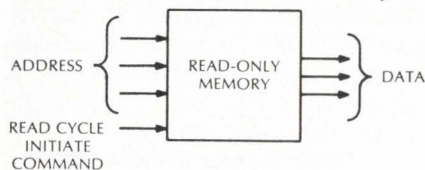

operation behind the company's braided transformer read-only memories, and a listing of standard products available. Memory Technology, 83 Boston Post Rd., Sudbury, Mass. 01776.

Circle Reader Service #374

Capacitors and resistors

Short form catalog EPD DSF-1 includes performance specs for several new capacitors and resistors. Performance characteristics, physical descriptions, and military designations for the glass and glass-ceramic capacitors and glass tin-oxide film resistors are provided. Corning Electronics, Corning, N.Y. 14830.

Circle Reader Service #375

Oscillators

Covering new products in the frequency control field, this 82-page catalog gives you information on such items as voltage-controlled oscillators and temperature-compensated oscillators in low profile miniature sizes. It's divided into sections by product, and each is preceded by a discussion of engineering design limits and suggested applications. Performance characteristics, specs, and prices are provided as well. Greenray Industries Inc., 840 W. Church Rd., Mechanicsburg, Pa. 17055.

Circle Reader Service #376

Regulated power supplies manual

A comprehensive 37-page catalog has been organized to provide the reader with a convenient power supply reference manual. Operating specs, selection tips and design parameters are included in the literature, as are schematics and a handy color-coded index to facilitate selection. Power/Mate Corp., 514 S. River St., Hackensack, N.J. 07601.

Circle Reader Service #377

Low power TTL

The 54L/74L family is the subject of this 36-page catalog describing the complete line of low power TTL ICs. The devices described include NAND, NOR gates, AND-OR invert gates, flip-flops, EXCLUSIVE-OR gates, shift registers, and low power 883. Absolute maximum ratings, guaranteed operating conditions, test circuits, connection diagrams, and physical dimensions are given for each product. National Semiconductor Corp., 2900 Semiconductor Dr., Santa Clara, Calif. 95051.

Circle Reader Service #378

Optical communications links

An innovation in the transmission of digital and analog information, these OCLs are easily installed and eliminate cable runs, microwave transmitters, and the need for FCC licenses. Three models are discussed in this 4-page brochure: low and high speed digital units, for computer/remote terminal links and digitized multiplexed audio links, and an analog version for such applications as video transmission. University Instruments Corp., 5541 Central Ave., Boulder, Colo. 80301.

Circle Reader Service #379

Dice and wafers

This interesting and well-illustrated 16-page catalog describes the manufacturer's complete line of semiconductor dice and wafers by device type number. It covers JFETS of all sorts, MOSFETS, dual transistors, and flip-chip circuits. There is also a dice index and cross-reference guide that lists the manufacturer's nearest replacement die for any given type number. Intersil Inc., 10900 N. Tantau Ave., Cupertino, Calif. 95014.

Circle Reader Service #380

700 Standard statistical program

This is the instruction manual that teaches you how to solve statistical problems with a Wang 700 calculator. The calculator is loaded with a tape cassette prerecorded with statistical programs. Among the important functions in this package are the calculation of standard deviation, Gaussian distribution, correlation functions, chi-square distributions, and the error function. Wang Laboratories Inc., 836 North St., Tewksbury, Mass. 01876.

Circle Reader Service #381

Circle Reader Service #53 →

“O”T.C. Capacitor
 “O”T.C. Capacitor
 “O”T.C. Capacitor
 “O”T.C. Capacitor
 “O”T.C. Capacitor
 “O”T.C. Capacitor
 “O”T.C. Capacitor
 “O”T.C. Capacitor
 “O”T.C. Capacitor

±10 PPM/°C
-55°C to +85°C
Accurate to ±.01%

Part of EAI's component capability includes:
 thick-film amplifiers, filters, analog/digital
 function modules, hybrid function modules,
 precision capacitors . . .

EAI precision components

193 Monmouth Parkway
 West Long Branch, New Jersey 07764
 (201) 229-1100

RMC

TEMPERATURE COMPENSATING SOLDER-INS

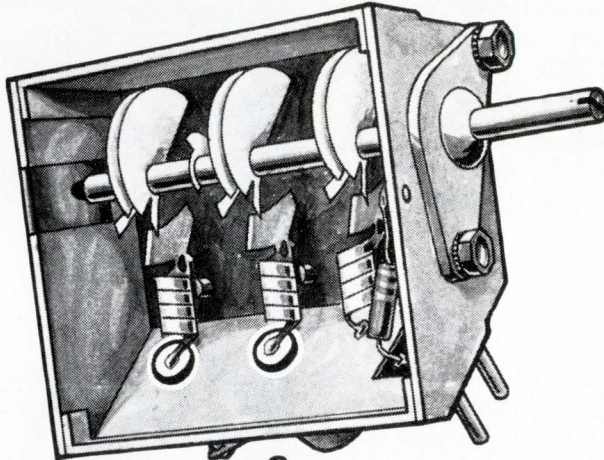

for UHF APPLICATIONS

SPECIFICATIONS

CAPACITANCE: Within tolerance @ 1 MC and 25°C

CAPACITANCE TOLERANCES: ±5%, ±10% or ±20% (but not less than ±.25 pf)

WORKING VOLTAGE: 500 VDC

INSULATION RESISTANCE: Greater than 7500 Megohms @ 500 VDC

FLASH TEST: 1000 VDC for 1 second

ELECTRODE: Pretinned for assured solderability

These new solder-in capacitors are designed for use in UHF applications requiring the absolute minimum in lead inductance effects. Solder-ins are available in a wide range of temperature coefficients in capacities from 1.5 to 105 pfd.

If your application requires special physical or electrical characteristics, contact RMC's Engineering Department.

Write today on your company letterhead for your copy of the RMC Catalog.

VISIT BOOTH 3C12-3C18 IEEE SHOW

DISCAP
CERAMIC
CAPACITORS

RMC

RADIO MATERIALS COMPANY

A DIVISION OF P. R. MALLORY & CO., INC.

GENERAL OFFICE: 4242 W. Bryn Mawr Ave., Chicago 46, Ill.

Two RMC Plants Devoted Exclusively to Ceramic Capacitors

FACTORIES AT CHICAGO, ILL. AND ATTICA, IND.

Solid state timers

The TD-10 series timers, available as "time delay on energization" and "internal" timing functions, are the subject of a 10-pager. The timers combine cradle relays with solid state timing circuits to provide timing from 0.1 to 300 seconds with ±2% repeat accuracy. Included in the catalog are specs, schematics, and mounting dimensions. Allied Control Co., Inc., 100 Relay Rd., Plantsville, Conn. 06479.

Circle Reader Service #396

Function modules

"Function Modules Instrumentation," is described in a 24-pager that covers standard analog function modules for the design of industrial control, monitoring and computational systems. The modules, each of which performs a specific function, fall into five basic groups—input signal conversion, algebraic functions, dynamic response, logic functions, and output signal conversion. Compatible with each other and with other instrumentation, they can also be interfaced with computers. Bell & Howell, Control Products Div., 706 Bostwick Ave., Bridgeport, Conn. 06605.

Circle Reader Service #397

Thermal analysis system

The unique and conventional features of a low-cost differential thermal analysis system are detailed in a short form brochure. The system's main feature is its advanced solid-state electronic design which makes it available for \$2,850 and hence puts it within reach of research labs., testing and quality control facilities, and teaching programs. Voland Corp., 31 Centre Ave., New Rochelle, N.Y. 10801.

Circle Reader Service #398

Standards and publications

The following three items are among the recent new or revised standards and publications now available from the EIA: Reel Packaging of Components with Axial Leads, \$1.00; Fixed Film, Dielectric Capacitors in Metallic and non-Metallic Cases for DC Application, \$4.80; and User's Guidelines for Quality and Reliability Assurance of LSI Components, \$1.20. Write to Electronic Industries Assoc., 2001 Eye St., NW, Washington, D.C. 20006.

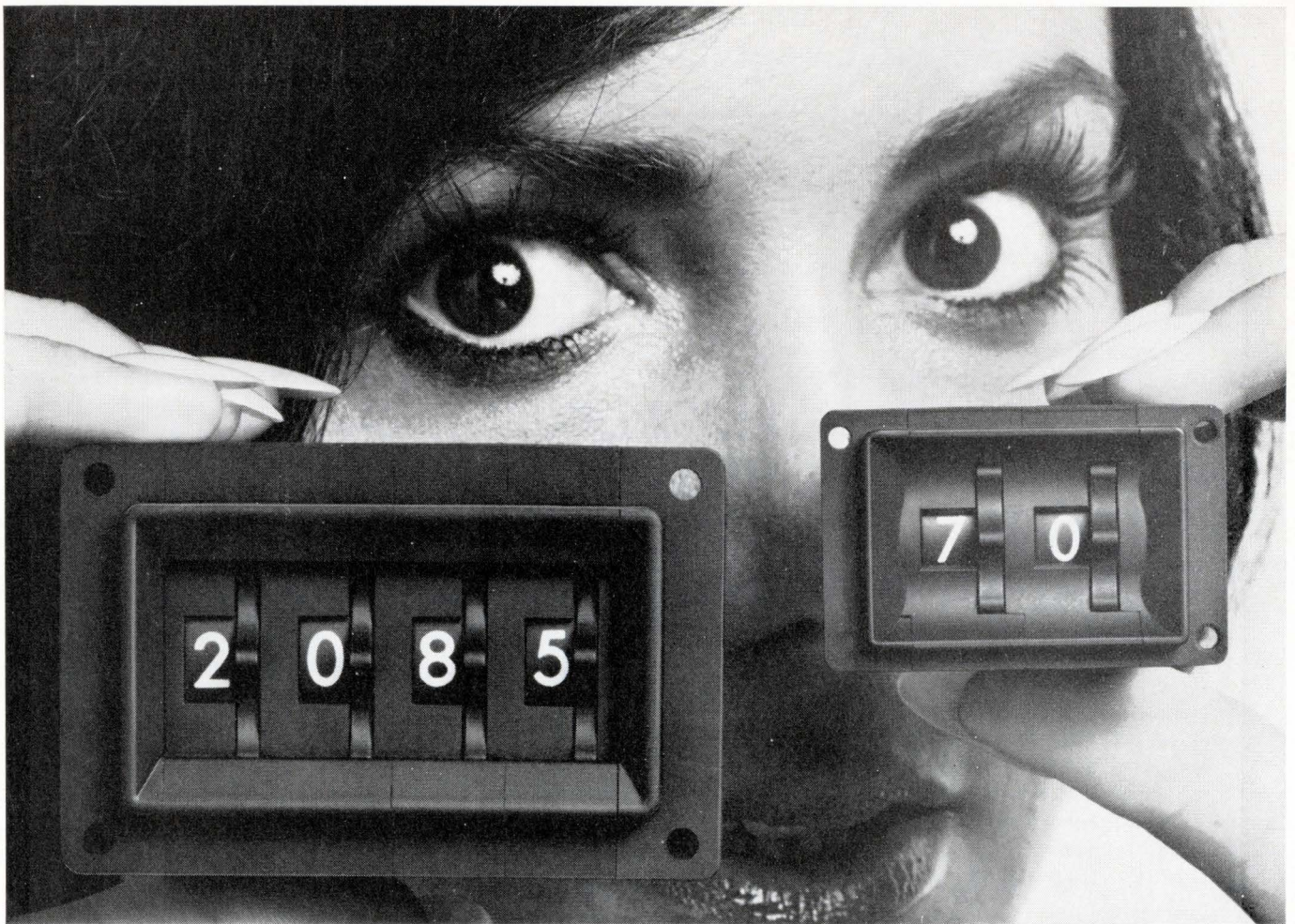

What Do You People See In Digitran Switches?

You see what you're switching. Nice big digits. And you can see tremendous space advantages. A typical four-unit "MINISWITCH" consumes only 2.76" in length x 1.15" in height. You can't do that with four rotary switches.

Our Thumbwheel switches are modularized. It's easy to see that we can supply a switching system with any number of digits you want without any special tooling. See also, the ease and versatility of terminating our Thumbwheels. Printed Circuit boards extending out the back can be mated with connectors or easily solder-wired to plated-thru holes. You can have "wire wrap" terminals or simple wire leads. You also can see the possibilities of interconnecting and mounting I.C. components or discretes on these or modified P/C boards.

Now, about the things you can't see in our switches. You can't see our coding capability, but in our new catalog, we list dozens of standard codes and have hundreds of others in our files. You can't see the positive and audible "click" between each switching position. You can't see the quality controls that guarantee a million accurate switching operations. And the thousands of application problems we've solved.

So, see for yourself and send for our new complete catalog. And show us your need for a sample and we'll send you one. After all, seeing is believing.



DIGISWITCH®
medium sized—
sealed or unsealed
8, 10, 12 or 16
positions

MINISWITCH® miniature—sealed
or unsealed 8 or 10 positions

THE DIGITRAN COMPANY

A Division of Becton, Dickinson and Co. **B-D**

855 So. Arroyo Pkwy., Pasadena, Calif. 91105 Phone (213) 449-3110 TWX 910-588-3794

MOS ICs

Although the 80 pages of this catalog are available as individual spec sheets, their collection into a single source makes this book very valuable. Pattern selection tables have been added to the information on ROMs. There are schematics and connection diagrams for

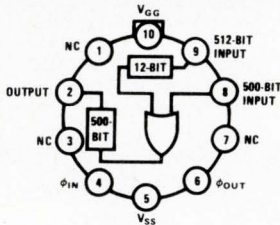

shift registers and clock drivers, as well as input and performance graphs for analog switches. Applications, definitions of terms, and code conversion tables are among the extras you'll find. National Semiconductor Corp., 2900 Semiconductor Dr., Santa Clara, Calif. 95051.

Circle Reader Service #365

Digital tape transports

Products and services offered by this company are outlined for you in this 12-page brochure. If you're looking for digital tape transports, more than 300 IBM-compatible models are offered. Their characteristic features include 45 and 74 in./s transports, a 7-in. reel unit, an incremental single capstan servo, and incremental rates up to 1000 steps/s. You have your choice of 7- and 9-track operation and three reel sizes. Peripheral Equipment Corp., 9600 Irondale Ave., Chatsworth, Calif. 91311.

Circle Reader Service #366

Digital ICs

RCA's COS/MOS CD4000A series ICs featuring low voltage designs (from 3 V to 15 V) are discussed in a handy fold-out brochure. The guide covers the new A series, which is unilaterally interchangeable with the currently available CD4000 series, and, in addition, makes possible designs requiring ICs that operate at low supply voltages with good electrical performance, high reliability, and simplified circuitry. RCA/Commercial Engineering, Harrison, N.J. 07029.

Circle Reader Service #367

MSI handbook

For digital systems designers this handbook is a must. The 100-page book provides specs, descriptions, and typical applications of MSI ICs. Vol. 2 of the Designer's Choice Logic handbooks, this book covers shift and buffer registers, gating steering and decoding arrays, and decoder/driver displays, among others. As with Vol. 1, this edition is fully supplemented with schematics and diagrams, and graphs illustrating special characteristics. Signetics Corp., 811 E. Arques Ave., Sunnyvale, Calif. 94086.

Circle Reader Service #368

Dc power supply guide

You can find the most suitable power supply for your requirements by using this 36-page dc power supply selection guide. Whether your application requires constant voltage power supplies, a constant current output, or a crossover between constant voltage and con-

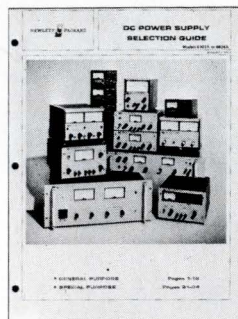

stant current, you'll find the necessary information outlined in tables as well as specs which include performance ratings, special features, options, and outline drawings. Hewlett-Packard Co., 1601 California Ave., Palo Alto, Calif. 94304.

Circle Reader Service #369

Analog gate selection chart

Here's a design aid to help you select an appropriate gate for a specific analog application. Schematics and characteristics are given for the complete line of JFET analog gates, and you're given available package types, temperature grades, and specifying information. Teledyne Semiconductor, 1300 Terra Bella Ave., Mountain View, Calif. 94040.

Circle Reader Service #370

Micro 400 reference manual

First of all, the Micro 400 is a general purpose minicomputer with a starting price of \$3,250. This includes a 1K x 8 core memory, front panel, enclosure, and power supply. This reference manual, 75 pages long, contains all the necessary general information as well as computer references, details on preliminary programming, and interface information. Microdata Corp., 644 E. Young St., Santa Ana, Calif. 92705.

Circle Reader Service #371

Electronic calculator

Here is a solid-state electronic unit featuring a 14-digit readout and recallable memory. In this short brochure, you'll find a summary of features which explains the decimal-comma system, memory, mechanical features, capacity, and functions. As for capabilities, it performs the four basic functions as well as multiplying and dividing by a constant, accumulation of products and quotients, and automatic squaring and square root extraction. SEACO Computer-Display Inc., 2800 W. Kingsley Rd., Garland, Tex. 75040.

Circle Reader Service #372

Consumer circuits

You may be surprised at the size of TI's consumer circuit line. For example, for a color TV system you'll find the following: voltage regulators for varactor tuners, ICs for automatic tuning, sound system amps, video i-f amplifiers, power

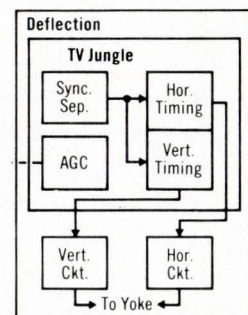

supplies, TV jungles, and chrominance ICs. And you'll find similar selections for such applications as a-m/fm radio-phonos systems. Texas Instruments Inc., Box 5012, M/S 308, Dallas, Tex. 75222.

Circle Reader Service #373

Your next DVM could cost too much! ...unless you have the whole picture

How do we know?

Recently we surveyed a number of aerospace, electronics and industrial firms to see how they were using their DVM's. Half of the DVM's weren't being used to their full capacity, \$3000 instruments were doing the job that a \$1400 instrument could do, and \$1400 instruments were doing the job that could be handled by a \$400 instrument. We even found analog instruments being used where digital instruments could do the job more efficiently.

That prompted us to take a hard look at our product line. Shouldn't there be a DVM for every application — from production lines to sophisticated metrology labs?

We started by adding a 3-digit DVM . . . ideal for use in the simplest of applications. We introduced two new 4-digit instruments to cover systems and bench use, then capped it off with two 5-digit instruments for the more critical applications where that extra digit is mandatory.

A complete line of associated hardware and plug-ins was developed for millivolt, AC voltage, and megohm measurements, plus BCD and programming for systems work. For the time being, the job's done . . . the industry's most complete line of DVM's . . . 3-, 4- and 5-digit instruments from \$350 to \$6500 . . . to fit every budget . . . for every conceivable application.

Which one suits you best? Write for our new brochure, or better still, ask for a demonstration and *get the whole picture!*

Of course, we're still making the 5700 . . . the standard of the industry . . . the DVM that's good enough to calibrate other DVM's.

DANA[®]

Digital Voltmeters
When test and measurement count

Dana Laboratories, Incorporated
2401 Campus Drive
Irvine, California 92664
(714) 833-1234



MODEL 3800: Measures dc volts, ac volts, ohms and dc current . . . 100% overrange . . . 0.1% dc accuracy . . . 1000 M Ω input resistance . . . 100 μ V dc resolution . . . 6 dc current ranges . . . 100 KHz bandwidth . . . 60 dB noise rejection . . . BCD output optional . . . 6 month stability . . . \$395 (dc-ohms only, \$350).
Circle number 60

Model 4700: Industry's lowest cost 4-digit programmable multimeter. Autoranging. \$985.
Circle number 61

Model 4800: 1 μ V resolution. 9 ohm ranges (1 Ω -100 M Ω) RMS AC converter. Systems compatible. \$1395-\$2200.
Circle number 62

Model 5300: Industry's Lowest cost 5-digit DVM. 1 μ V resolution. Rack mount or bench configuration. Excellent noise rejection. Filter plus integrator. Systems interface. \$1275-\$2400.
Circle number 63

Model 5800: Ultimate in measurement capability. 0.1 μ V resolution. RMS AC converter. AC-AC ratio. 77 readings/sec. 0.003% dc accuracy. 9 ohm ranges. \$3150-\$6500.
Circle number 64

Advertisers—June 1971

No liability is assumed for errors or omissions.
This Index is published for a convenience.

ACOPIAN CORP.	IFC
Mort Barish Associates, Inc.	
AEROVOX CORP.	7
Lescarboua Advertising, Inc.	
ALLEN-BRADLEY CO.	19
Hoffman-York, Inc.	
AMF INC., POTTER & BRUMFIELD DIV.	95
Fuller & Smith & Ross, Inc.	
AMP, INC.	27
Aitkin-Kynett Co., Inc.	
ANALOG DEVICES, INC.	40
Kalb & Schneider, Inc.	
BUSSMANN MFG. DIV.	74
Henderson Advertising Co.	
CEA, DIV. OF BERKLEONICS, INC.	15
Jansson Adv. Inc.	
CENTRALAB SEMICONDUCTOR.	79
Gordon & Baldwin Adv.	
CITIES SERVICE CO., CHESTER CABLE OPERATIONS.	20, 21
Lewis Advertising	
CHRONO-LOG CORP.	83
Mort Barish Associates, Inc.	
C & K COMPONENTS, INC.	84
Van Christo Associates, Inc.	
COMPUTER LABS.	77
John Talbot & Associates	
CUSTOM ELECTRONICS.	18
Laux Advertising, Inc.	
DANA LABORATORIES.	93
Rose Associates	
DATAPAC, INC.	26
Enyart & Rose	
DIGITAL EQUIPMENT CORP.	38, 39
Creamer, Trowbridge, Case & Basford, Inc.	
DIGITAL EQUIPMENT CORP.	85
Kalb & Schneider, Inc.	
DIGITRAN CO.	91
Jansson Advertising, Inc.	
EDMUND SCIENTIFIC CO.	96
Walter S. Chittick Co., Inc.	
ELCO CORPORATION.	28
Mort Barish Associates, Inc.	
ELECTRONIC ASSOCIATES, INC.	89
M S D Adv.	
ELECTRONIC MEMORIES.	87
Gumpertz, Bentley & Dolan	
FAIRCHILD SEMICONDUCTOR.	8, 9
Carson/Roberts/Inc.	
FERROXCUBE CORP.	40
Ferroxcube Marketing Services Group	
GERMAN AMERICAN CHAMBER OF COMMERCE.	96
Wörten	
HEINEMANN ELECTRIC COMPANY.	5
Thomas R. Sundheim Inc.	
HEWLETT-PACKARD.	66, 67
Lennen & Newell/Pacific	
INTERSTATE ELECTRONICS CORP.	45
Leland Oliver Co., Inc.	
ITT CANNON.	31
Mac Manus, John & Adams, Inc.	
JENSEN TOOLS & ALLOYS/TELVAC INSTRUMENT CO.	15
Sheldon W. Gates	

KEPCO, INC.	4
Weiss Advertising	
KROHN-HITE CORP.	43
Ingalls Associates, Inc.	
MACRODATA CO.	71
Alden Adv. of Calif., Inc.	
MALLORY CAPACITOR CO.	47
Aitkin-Kynett Co., Inc.	
MONITOR SYSTEMS, AN AYDIN CO.	14
Ridgway Philips Co.	
MONOLITHIC MEMORIES.	32
Regis McKenna, Inc.	
MOTOROLA SEMICONDUCTOR PRDTS., INC.	36, 37
E. B. Lane & Associates, Inc.	
NATIONAL SEMICONDUCTOR.	81
Chiat/Day, Inc.	
PHILCO FORD CORP., Sierra Electronic Operation.	16
POTTER & BRUMFIELD DIV., AMF, INC.	101
Fuller & Smith & Ross, Inc.	
POWERTEC, INC.	68
C G A Associates	
PYLON COMPANY.	84
American Line-A-Graph Corp.	
QUADRI CORP.	73
M B Advertising	
RCA.	BC, 23
Al Paul Lefton Co., Inc.	
RADIO MATERIALS CO.	90
M. M. Fisher Assoc., Inc.	
RAYTHEON SEMICONDUCTOR.	2
Durel Advertising	
SEMICONDUCTOR ELECTRONIC MEMORIES, INC.	59, 61, 63, 65
Gumpertz, Bentley & Dolan	
SPRAGUE ELECTRIC CO.	1
The Harry P. Bridge Co.	
STANDARD MEMORIES, INC.	22
M B Advertising	
TEKTRONIX, INC.	IBC
Dawson Inc.	
TELVAC INSTRUMENT CO./JENSEN TOOLS & ALLOYS.	15
Sheldon W. Gates	
TELEDYNE PHILBRICK.	13
Ingalls Associates, Inc.	
UNION CARBIDE CORP.	88
Cargill, Wilson & Acree, Inc.	
UNITRODE CORP.	11
Impact Advertising, Inc.	
USCC/CENTRALAB.	83
Brown Clark Elkus & Moses, Inc.	
USM DYNAPERT DEPT., Industrial Machinery Div.	17
Klein, Kurlan, Barr & Ross	
VARFLEX CORP.	83
Barlow/Johnson, Inc.	

THE ELECTRONIC ENGINEER

DISTRICT SALES MANAGERS

EDWARD G. SHAUD
BALA-CYNWYD, (Pa.) 19004
One Decker Square
(Area Code 215) SHERWOOD 8-2000

JOSEPH DRUCKER
BRYCE GRAY, JR.
NEW YORK 10017—100 East 42nd St.
(Area Code 212) OXFORD 7-3400

JOHN W. BERNHARDT
CHICAGO 60606—120 S. Riverside
Plaza
(Area Code 312) 782-1400

G. T. ALFANO
NEEDHAM HEIGHTS, MASS. 02194—
570 Hillside Ave.
(Area Code 617) 444-0010

TERRENCE D. BUCKLEY
THOMAS R. BORIS
LOS ANGELES 90005—3727 W.
Sixth St. # 202
(Area Code 213) DUNKIRK 7-1271

RALPH PETERSEN
LOS ALTOS (San Francisco) 94022
199 First St., Room 335
(Area Code 415) 941-6655

RICHARD DUTE
CLEVELAND 44114—601 Rockwell Ave.
(Area Code 216) SUPERIOR 1-2860

NEWTON B. COLLINSON
ATLANTA 30309—1776 Peachtree St.
N.W.
(Area Code 404) 872-4723

MICHAEL D. CORLEY
DALLAS 75206—Meadows Bldg.
Expressway at Milton
(Area Code 214) EMERSON 3-6426

HAROLD E. MOTT
R. DENT SHILLINGLAW
Houston 77027
4151 Southwest Freeway
Suite 735
(Area Code 713) 621-7550

INTERNATIONAL BUSINESS OFFICES

London, S. W. 1 Max F. Holsinger
67-68 Jermyn St., St. James's Dir. European Sales
TRA 6318-9 Roy V. C. Hall, A. Berg
Cables WHIP LONDON S.W. 1

Manchester 22 D. I. Goulden
Haletop, Wythenshawe Civic Centre MERCURY 3293

4 Dusseldorf-Rath E. Hillerbrand, R. Schomburg,
Eitelstrasse 32 W. Heckelmann

Dusseldorf 652031-32
Cables WHIP DUSSELDORF

Paris, Be S. Brown-Joussard
70 Rue de Ponthieu ELYsees 65-77
Cables UIIP PARIS 16e

Tokyo C. T. Sakaguchi
Room 814, Togin Bldg., Marunouchi
CPO Box No. 1572 Tel: 211-3506-3509
Cables CLARENESAKA TOKYO

BUSINESS STAFF

K. ROBERT BRINK
Publisher

BERNARD M. GITTELMAN
Advertising Sales Manager

DENNIS J. PERKINS
Promotion Manager

LOUIS L. MARINES
Marketing Services Manager

WARREN OWENS
Director of Production

B. A. TATUM
Production Assistant

WILLIAM HOWAT
Circulation Director

JAMES F. NAGY
Circulation Manager

JOSEPH P. BABCOCK
Reader Service Manager

JOHN H. KOFRON
Chilton Research Services

C. R. WILHIDE
Washington Vice-President

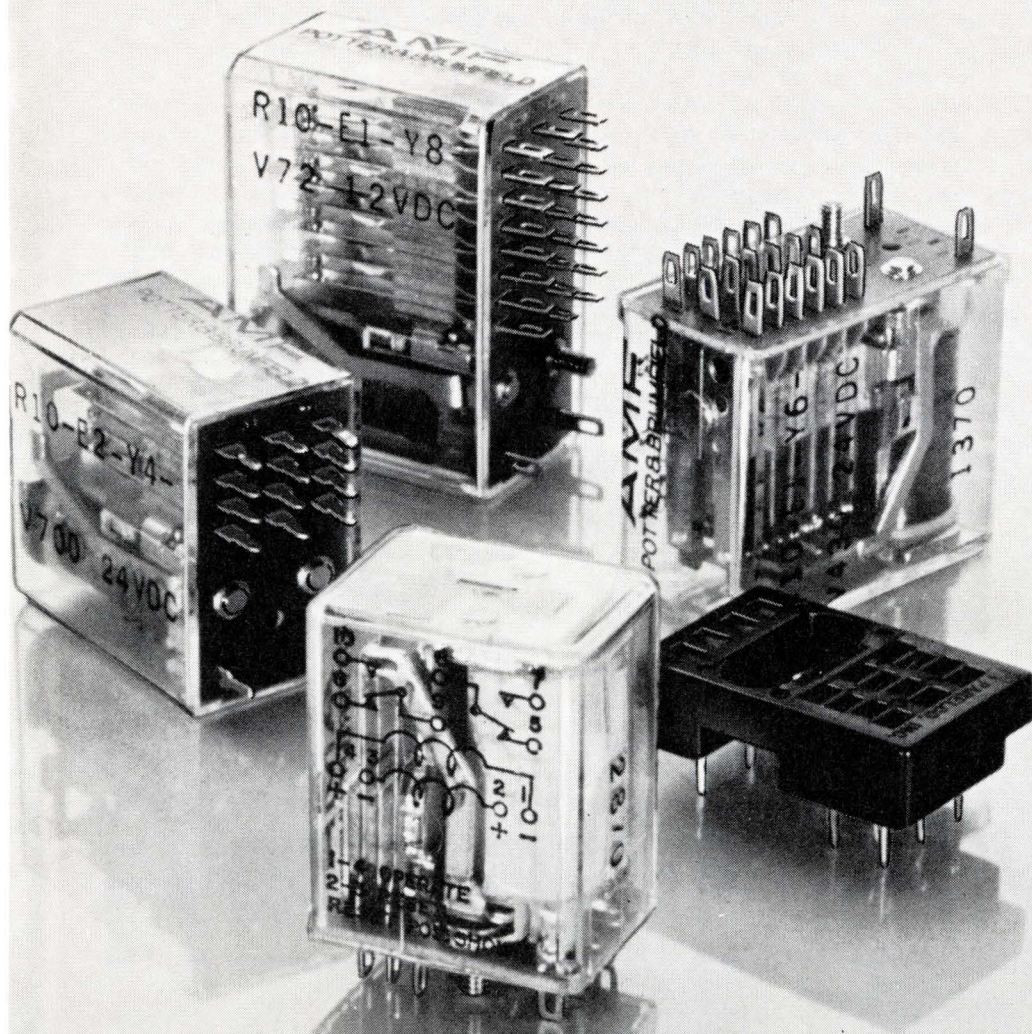

R10: Our compact, multi-purpose relay.

You might say P&B designed it
to be many things to many people.

Copiers, computer peripherals, business machines, precision instruments—you'll find our R10 in a multitude of applications requiring a compact, reliable, multi-pole relay. That's because it probably gives you more design options than any other single relay.

Consider these choices: Contact arrangements up to 8PDT. Ratings from dry circuit to 10 amperes. Six styles of contacts, including bifurcated. Sockets with solder or printed circuit terminals including one for mounting the relay horizontal to a printed circuit board—all with or without grounding provisions.

Mechanical life up to 100 million operations. Electrical life ranges from 100,000 to 100 million operations depending on load and voltage. Coils for DC operation from 3.0V to 115V can be supplied. AC-operated R10 relays to 2 Form C are also available. R10 relays have Underwriters' Laboratories' Component Recognition, File 42810.

The single lot price for a 4PDT, 2 amperes R10 relay is only \$3.60. Quantity discounts apply.

Order R10 relays from leading electronic parts distributors or call your P&B representative. For a complete, 194-page relay catalog, write Potter & Brumfield Division of AMF Incorporated, Princeton, Indiana 47570. Telephone: (812) 385-5251.

AMF
POTTER & BRUMFIELD

P&B performance. Nothing else comes close.

Capacitors

This new series of capacitors offers the designer a range of capacitances from 2.2 to 330 μ F, with a tolerance of $\pm 20\%$ and a working voltage range from 40 to 6.3 Vdc. Operating ambient temperature range is from -80° to 125° C. Failure rate is 0.02% per 1,000 hours at rated voltage and 25° C ambient temperature. Philips, Box 523, Eindhoven, The Netherlands.

Circle Reader Service #415

Oscillator and amplifier devices

The product information supplied in this 24-page catalog on Gunn and avalanche diodes and transistors is fully supplemented with descriptive material. The first section, for example, provides data on basic mechanisms and oscillator design. Graphs illustrate electrical and performance characteristics; there's design information accompanied by schematics; and there are diagrams to illustrate the properties discussed. AEI Semiconductors Ltd., Carholme Rd., Lincoln, England.

Circle Reader Service #416

Semiconductors

More than 500 pages long, this catalog gives you detailed information on germanium and silicon transistors and diodes. An introductory section provides a summary of types, accessory information, nomenclature for semiconductors, mounting and soldering instructions, and an explanation of technical data. A very comprehensive catalog, the information is presented in both English and German and is offered to you by Allgemeine Elektrizitäts-Gesellschaft, AEG-Telefunken, Fachbereich Halbleiter, Vertrieb, 7100 Heilbronn, Postfach 1042, Germany.

Circle Reader Service #417

Plugs and sockets

The plugs and sockets and cables described here are for use in medical electronic equipment. Dimensional drawings accompany each photo and product description. Characteristics are listed in chart form. Perena, Siege Social: 16, Boulevard de Charonne, Paris -XX^e, France.

Circle Reader Service #418

Digital measuring instruments

How to select a digital voltmeter or multimeter and a discussion of the general principles of conversion precede the first section of this 120-page catalog. The counters-frequency meters and panel meters sections follow information discussions also. Complete product data is provided for each model, including description, specs, packaging, and explanatory diagrams and graphs. Schneider Electronique, 12 Rue Louis Bertrand, 94-IVRY, France.

Circle Reader Service #419

Oscillator mini-style

The components that make up this oscillator, the crystal and a micro-electronic IC comprised of transistors, resistors, and capacitors, are all packaged within a TO-5 transistor can less than 9 mm in diameter and 7 mm high. It will provide accurate and stable frequency control, operating in any frequency between 10 MHz and 22 MHz. Marconi Communication Systems Ltd., Marconi House, Chelmsford, Essex, England.

Circle Reader Service #420

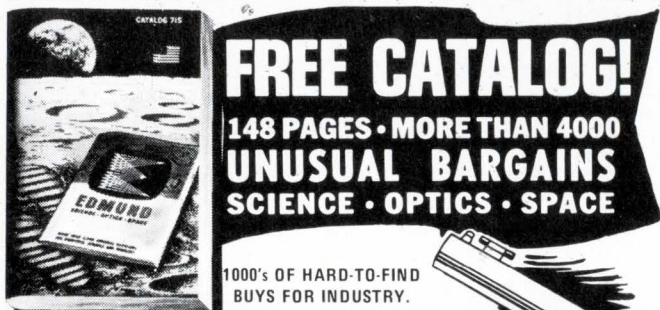

FREE CATALOG!
148 PAGES • MORE THAN 4000 UNUSUAL BARGAINS
SCIENCE • OPTICS • SPACE

1000's OF HARD-TO-FIND BUYS FOR INDUSTRY.

Speed your work! Improve quality! Cut development and production costs! Completely new edition loaded with on-the-job helps, quality control aids, unique items available nowhere else. 148 easy-to-read pages packed with new products, charts, diagrams, illustrations. A treasure house of optical and scientific equipment available direct from stock for industry, research labs, design engineers, experimenters, hobbyists.

AMERICA'S GREATEST ONE-SOURCE MARKET PLACE
 Hard-to-get surplus bargains. Ingenious scientific tools. Thousands of components: lenses, prisms, wedges, mirrors, mounts, accessories of all descriptions. Hundreds of instruments: lasers, comparators, magnifiers, microscopes, projectors, telescopes, binoculars, photo attachments, black light equipment and the largest selection of unique lighting items in the country.

ORDER DIRECT WITH ABSOLUTE CONFIDENCE
 Edmund ships more than 5,000 orders monthly to the country's largest industrials. Every item completely guaranteed. You must be satisfied with any purchase or return it in 30 days for your money back. Shop the catalog of America's largest Science-Optics-Space Mart. Send for your free copy today. Absolutely no obligation. Request FREE catalog "EE".

EDMUND SCIENTIFIC CO.
 300 EDSCORP BLDG.
 BARRINGTON, NEW JERSEY 08007

MAIL COUPON FOR GIANT FREE CATALOG!

EDMUND SCIENTIFIC CO.
 300 Edscorp Building, Barrington, N. J. 08007
 Please send Free Giant Catalog "EE"

NAME _____
 COMPANY _____
 ADDRESS _____
 CITY _____ STATE _____ ZIP _____

Circle Reader Service #58

Interkama'71



October 14-20, 1971

5th International Congress with Exhibition for Instrumentation and Automation – the international industrial and commercial center for instrumentation and automation – research and development – at the new fair grounds.

Düsseldorf

Information: German American Chamber of Commerce, Inc. 666 5th Avenue, New York, N.Y. 10019 (212) 582-7788
 German American Chamber of Commerce of Chicago
 77 East Monroe Street, Chicago, I 11. 60603 (312) 782-8557



Circle Reader Service #59

THE ELECTRONIC ENGINEER • June 1971

SAVE \$\$\$ // GAIN performance

over any other 50-MHz, plug-in oscilloscope.

50-MHz oscilloscope with:

5-mV dual-trace amplifier and delaying sweep	\$2200
5-mV dual-trace amplifier and single time base	1900
5-mV single-trace amplifier and single time base	1650

AND LOOK AT THESE BONUSES:

- 3 plug-in compartments and mainframe mode switching
- 6-1/2-inch CRT — 50% larger than 8 x 10 cm CRT's
- time bases have 5 ns/div sweep rate
- amplifiers and time bases accurate within 2%
- high writing-rate CRT gives a brighter trace

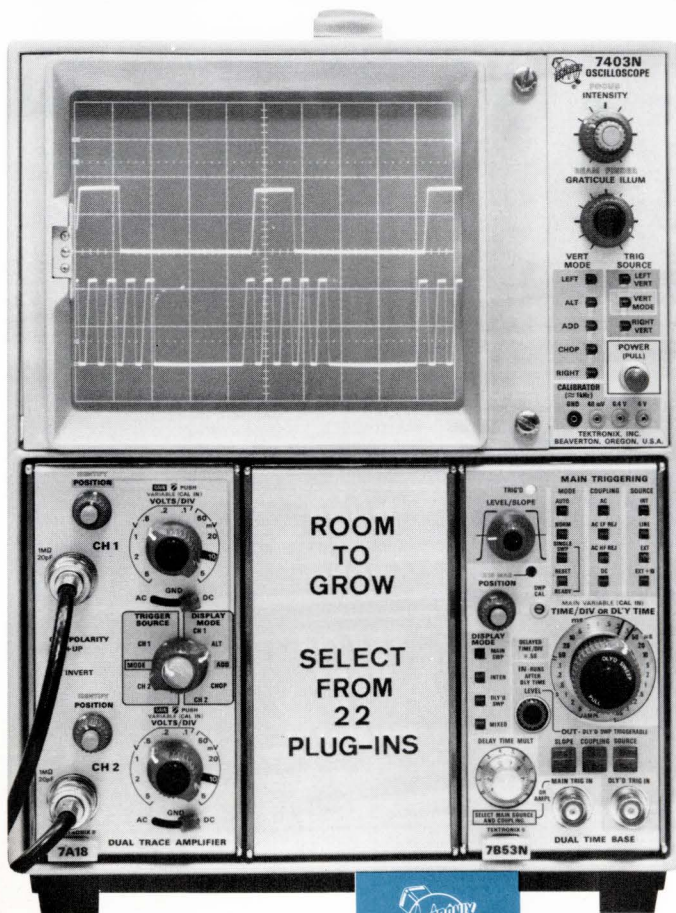

If you wish, select a plug-in for the second vertical compartment to give you 10 μ V/div at 1 MHz or 1 mV/div at 55 MHz or 1 mA/div at 55 MHz or another dual-trace unit for 4-trace capability, etc., etc. Plug-in prices start at a low \$250. Call your nearby Tektronix field engineer today for a demonstration.

7403N Oscilloscope	\$950
7A18 Dual-Trace Amplifier, Option 1	\$500
7A15 Single-Trace Amplifier	\$250
7B53N Dual Time Base	\$750
7B50 Time Base	\$450

U.S. Sales Prices FOB Beaverton, Oregon

Available in U.S. through the Tektronix lease plan.

TEKTRONIX®

committed to
technical excellence
Circle Reader Service #65

From RCA, the world's leader in power devices...new power hybrid circuits for your needs

OP AMPS AND LINEAR AMPS HC-1000, TA7625A, and TA7926

Up to 7 A peak current

- Servos
- Tape drivers
- Stepper motors
- Linear motors
- Magnetic deflection
- HF amplifiers to 100 kHz

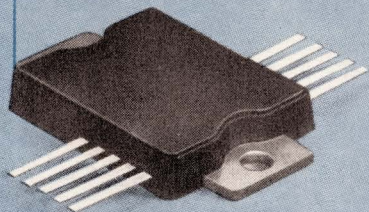

HIGH CURRENT POWER ARRAYS TA7631 and TA7632

IC levels to 300 amperes

- High power inverters
- Power supply regulators
- Variable-speed inductance motors
- Stepper motors

HIGH GAIN CURRENT AMPLIFIER PAIRS TA8141

Dual 5 A Darlington

- Hammer drivers
- Solenoid drivers
- Stepper motors

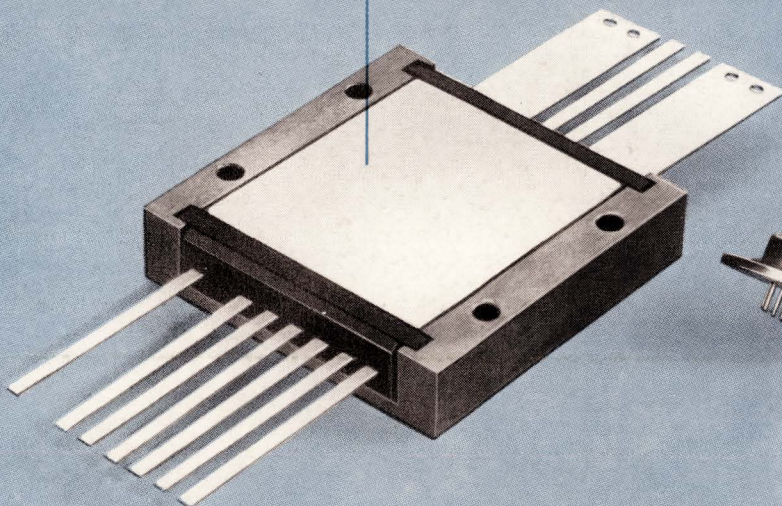

SERIES REGULATORS TA7955, TA7956, and TA7957

5, 8, and 12 volts

- 4 A current capability
- Integral crowbar trigger
- Booster capability to 12A

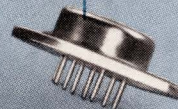

If your design requires power amplifiers, or power control circuits, or power supplies or something else you don't see here, call your local RCA Representative. For a copy of catalog 2L1149, along with product sheets detailing design concepts on various RCA power hybrid circuits, write: RCA, Commercial Engineering, Section 59F /UC3, Harrison, N.J. 07029. International: RCA, Sunbury-on-Thames, U.K., or P.O. Box 112, Hong Kong.

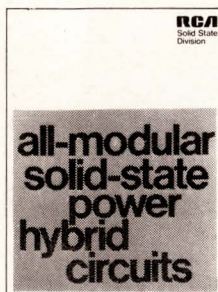

RCA
Solid State