



Birthing Bed

Model LD304

stryker®

Operations Manual



For Parts or Technical Assistance:
USA: 1-800-327-0770 (option 2)
Canada: 1-888-233-6888



Table of Contents

Introduction	5
Intended Use	5
Product Description	5
Product Illustration	5
Specifications	6
Warning / Caution / Note Definition	7
Symbols	8
Summary of Safety Precautions	9
Safety Tips and Guidelines	9
Unpacking Instructions	11
Operation Guide	12
Operating Siderails	12
Using the Siderail Control Panel Lights	12
Locking Out the Siderail Controls	12
Outside Siderail Controls	13
Inside Siderail Controls	15
Communication Pendant	17
Motion Pendant	18
Motion Pendant With Nurse Call	19
Using the Brake/Steer Pedals	20
Using the Manual Motor Hand Crank	20
Activating Instant CPR	20
Removing the Head Board	20
Night Light	20
Nurse Call Battery	21
Using the Labor Grips	21
Using the Optional Labor Bar	21
Optional Lumbar Pillow and Perineal Wedge	21
Adjustable Seat Depth (Optional)	22
Removing the Foot Section	22
Operating the Glideaway Foot Rests/Optional Calf Supports	22
Birthing Bed Positioning	23
Delivery Table Positioning	23
Trendelenburg Positioning	23
Pelvic Tilt	23
Operating the 3-Stage Permanently Attached I.V. Pole	24
Cleaning	26
Warranty	27
Limited Warranty	27

Table of Contents

To Obtain Parts and Service 27

Service Contract Coverage 27

Service Contract Programs 28

Return Authorization. 28

Damaged Merchandise 28

International Warranty Clause. 28

Introduction

INTENDED USE

This manual is designed to assist you with the operation of Stryker Model LD304 Birthing Bed. Carefully read this manual thoroughly before using the equipment or beginning maintenance on it. To ensure safe operation of this equipment, it is recommended that methods and procedures be established for educating and training staff on the safe operation of this bed.

PRODUCT DESCRIPTION

This product is an electrically operated maternity bed designed for general patient care use. Major functions include: raising and lowering of the litter, raising and lowering of the head and foot end portions and Tendelenburg-like functionality.

PRODUCT ILLUSTRATION

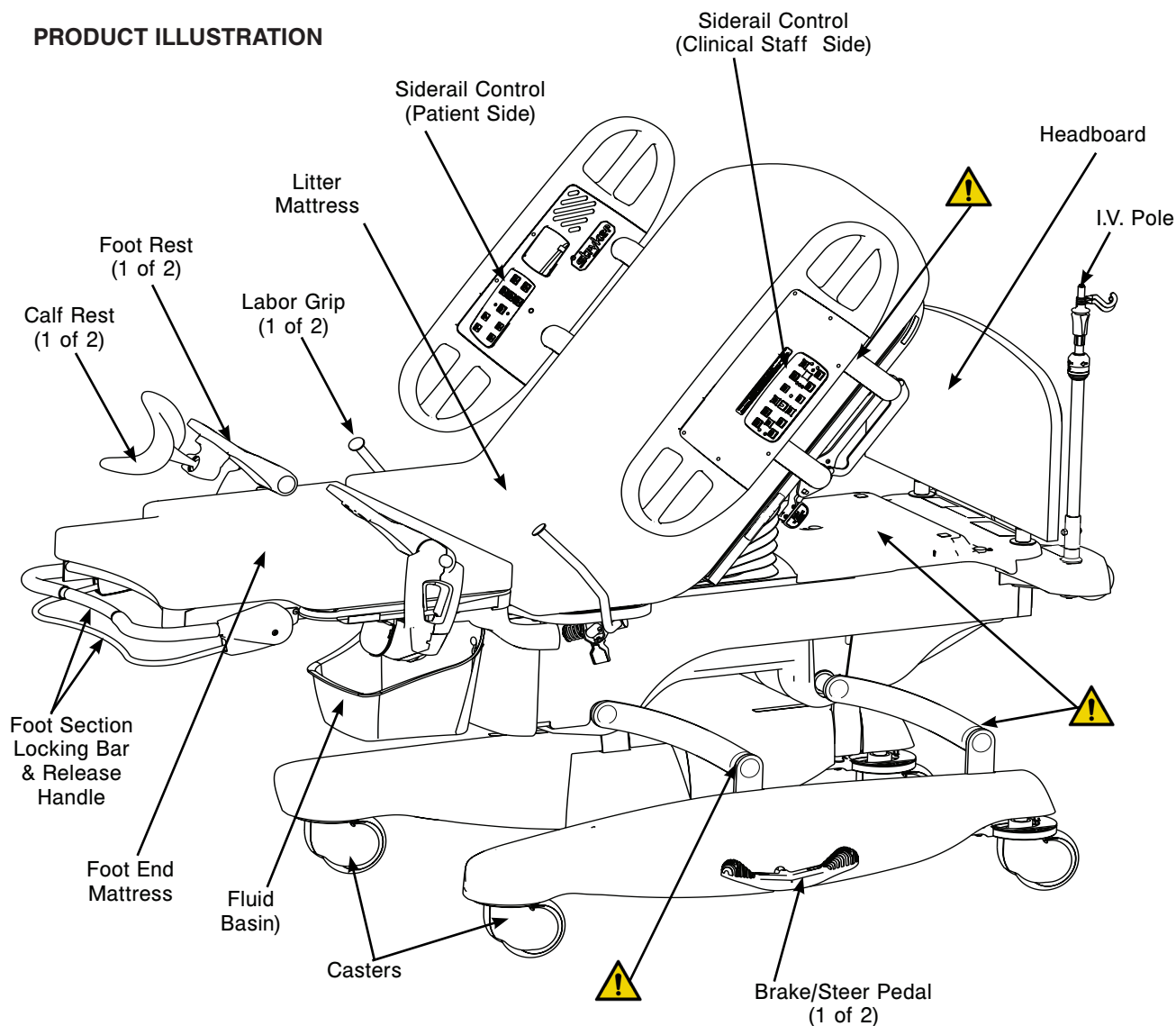





WARNING

Potential pinch points

[Return To Table of Contents](#)

Introduction

SPECIFICATIONS

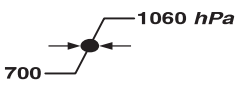
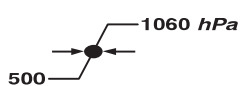
	Safe Working Load		
	Note: Safe Working Load indicates the sum of the patient, mattress, and accessory weight.	500 pounds	227 kilograms
Weight of Product	Standard Configuration	475 pounds	215 kilograms
	All Options/Accessories	525 pounds	238 kilograms
Bed Length / Width	Siderails Up	93" x 41"	236 cm x 104 cm
	Siderails Down	93" x 37"	236 cm x 94 cm
Bed Height (to top of seat) (with 6" casters)	Low	17.5"	44 cm
	High	35.5"	90 cm
Mattress Size	Head	49.5" x 33" x 5"	126 cm x 84 cm x 13 cm
	Foot	30" x 30" x 3"	76 cm x 76 cm x 8 cm
	Patient Sleep Surface	81"	206 cm
Foot Section Travel Height	Up	0"	0 cm
	Down	7"	17.8 cm
Break-Away Point from Wall		60"	152 cm
Critical Angles		Maximum Elevation: Head 70°, Trendelenburg 8°	
Caster Size		6" Standard; 8" Optional	
Electrical		Standard 4 motor function: Head-Bed-Foot-Trendelenburg 120 VAC, 60 Hz, 10 Amp Optional: 230 VAC ~, 50/60 Hz, 10 Amp Current leakage less than 300 microamperes (per UL 60601-1). Hospital grade plug and 3-wires heavy duty cord. Compatible with non-flammable anesthetic agents and oxygen by nasal catheter or mask type.	
Rated Duty Cycle		5% / hr. (Continuous Operation with Short-Time Loading)	
Environmental Conditions	Operation	Storage and Transportation	
Temperature			
Relative Humidity			
Atmospheric Pressure			

Stryker reserves the right to change specifications without notice.

Specifications listed are approximate and may vary slightly from unit to unit or by power supply fluctuations.

Introduction

WARNING / CAUTION / NOTE DEFINITION

The words WARNING, CAUTION, and NOTE carry special meanings and should be carefully reviewed.



WARNING

Alerts the reader about a situation, which if not avoided, could result in death or serious injury. It may also describe potential serious adverse reactions and safety hazards.



CAUTION

Alerts the reader of a potentially hazardous situation, which if not avoided, may result in minor or moderate injury to the user or patient or damage to the equipment or other property. This includes special care necessary for the safe and effective use of the device and the care necessary to avoid damage to a device that may occur as a result of use or misuse.

Note

This provides special information to make maintenance easier or important instructions clearer.

Symbols



Warning, Refer to Service/Maintenance Manual



Alternating Current



Type B Equipment: Equipment providing a particular degree of protection against electric shock, particularly regarding allowable leakage current and reliability of the protective earth connection.

Class 1 Equipment: Equipment in which protection against electric shock does not rely on **basic insulation** only, but which includes an additional safety precaution in that means are provided for the connection of the **equipment** to the protective earth conductor in the fixed wiring of the installation in such a way that **accessible metal parts** cannot become live in the event of a failure of the **basic insulation**.

IPX4

Protection from liquid splash



Dangerous Voltage Symbol



Protective Earth Terminal



Potential Equalization Symbol



Medical Equipment Classified by Underwriters Laboratories Inc. with Respect to Electric Shock, Fire, Mechanical and Other Specified Hazards Only in Accordance with UL 60601-1, First Edition (2003) and CAN/CSA C22.2 No. 601.1-M90 with updates 1 and 2.



Safe Working Load Symbol



Caution: Electrostatic Sensitive



Warning: Non-Protectively Earthed, Potential for Risk of Electric Shock



In accordance with **European Directive 2002/96/EC** on Waste Electrical and Electronic Equipment (**WEEE**), this symbol indicates that the product must not be disposed of as unsorted municipal waste, but should be collected separately. Refer to your local distributor for return and/or collection systems available in your country.

Summary of Safety Precautions

SAFETY TIPS AND GUIDELINES

Before operating the Stryker LD304 Birthing Bed, it is important to read and understand all information in this manual. Carefully read and strictly follow the safety guidelines listed on this page.

It is important that all users have been trained and educated on the inherent hazards associated with the usage of electric beds.

To ensure its proper use and the safety of patients and staff, the LD304 Birthing Bed has been marked with the following caution and warning labels:

DANGER	Explosion Hazard - Do Not use in the presence of flammable anesthetics
CAUTION	This unit is equipped with a hospital grade attachment plug. Grounding reliability can be achieved only when equipment is connected to equivalent receptacle.
CAUTION	Electrical shock hazard. Do not remove cover panels. Refer all servicing to qualified personnel.
CAUTION	Disconnect the power cord while using the manual hand crank.

WARNINGS

- Powered bed mechanisms can cause serious injury. Operate bed only when all persons are clear of the mechanisms.
- To help reduce the number and severity of falls by patients, always leave the bed in the lowest position when the patient is unattended.
- When raising the siderails, listen for the “click” that indicates the siderail has locked in the up position. Pull firmly on the siderail to ensure it is locked into position. Siderails are not intended to be a patient restraint device. It is the responsibility of attending medical personnel to determine the degree of restraint and the siderail positioning necessary to ensure a patient will remain safely in bed. The intermediate position should be used only to assist the patient during ingress and egress from the bed.
- Always apply the caster brakes when a patient is getting on or off the bed. Always keep the caster brakes applied when a patient is on the bed (except during transport). Serious injury could result if the bed moves while a patient is getting in or out of bed. After the brake pedal is applied, push on the bed to ensure the brakes are locked. When moving the bed, put the pedal in the steer position. This locks the swivel motion of the right foot end caster and makes the bed easier to move.
- The instant CPR release is for emergency use only. Before activating the instant CPR, verify all persons and equipment are away from the area below and around the Fowler (back rest) section of the bed or serious personal injury or damage to the equipment could occur.
- Prior to placing weight on the foot section, verify the locking bar has been lowered and locked. The foot section locking bar is not designed for use as a grasping bar or other patient assist device.
- When large spills occur in the area of the circuit boards, 110 volt cables and motors, immediately unplug the bed power cord from the wall socket. Remove the patient from the bed and clean up the fluid. Have maintenance completely check the bed. Fluids can have an affect on operational capabilities of any electrical product. **Do Not** put the bed back into service until it is completely dry and has been thoroughly tested for safe operation.
- To avoid entanglement, possibly resulting in frayed power cords and risk of electrical shock, wrap the bed power cord around the roller bumpers at the head end of the bed during transport.
- There is a possible fire hazard when using oxygen administering equipment of other than the nasal, mask, or 1/2-bed-length tent type. Oxygen tent should not extend below the mattress support platform. Siderails must be kept outside of the oxygen tent.

CAUTIONS

- Do not steam clean or hose off the bed. Do not immerse any part of the bed. The internal electric parts may be damaged by exposure to water. Hand wash all surfaces of the bed with warm water and mild detergent. Dry thoroughly. Inspect the mattress cover after each use. Discontinue use if any cracks or rips are found in the cover which may allow fluids to enter the mattress. Exposure to fluids may cause injury to patient and/or user.

[Return To Table of Contents](#)

Summary of Safety Precautions



CAUTIONS (CONTINUED)

- Preventative maintenance should be performed at a minimum of annually to ensure all bed features are functioning as designed. Close attention should be given to safety features including, but not limited to:
 - Safety side latching mechanisms
 - Caster braking system
 - Frayed electrical cords and components
 - Leakage current 300 microamperes max.
 - Protective earth ground impedance 100 milliohms max.
 - No controls or cabling entangled in bed mechanisms
 - All electrical controls return to off or neutral position when released
 - For additional maintenance information, refer to your maintenance manual.
- Always unplug bed during service or cleaning. When working under the bed with the bed in the high position, always place blocks under the litter frame and set the brakes to prevent injury in case the Bed Down switch is accidentally pressed.
- Hand wash all surfaces of the bed with warm water and mild detergent. Dry thoroughly. **Do Not Steam Clean, Pressure Wash, Hose Off or Ultrasonically Clean.** Using these methods of cleaning is not recommended and may void this product's warranty.

Inspect the mattress cover after each use. Discontinue use if any cracks or rips are found in the cover which may allow fluids to enter the mattress. Exposure to fluids may cause injury to patient and/or user.
- To avoid injury, unplug the bed power cord from the wall socket before using the manual hand crank.
- The LD304 Birthing Bed is equipped with a hospital grade plug for protection against electric shock hazard. It must be plugged directly into a properly grounded three-prong receptacle. Grounding reliability can be achieved only when a hospital grade receptacle is used.
- To avoid damage, the weight of the I.V. bags should not exceed 40 pounds.
- To avoid damage while transporting the bed, verify the I.V. pole is at a low enough height to allow it to pass safely through door openings.
- I.V. poles should not be used as a bed push/pull device.
- The cleanliness and integrity of both ground chains must be maintained to minimize static build-up and discharge.

Setup Procedures

UNPACKING INSTRUCTIONS

Refer to unpacking instructions attached to the bed inside the crate.

It is important that the LD304 Birthing Bed is working properly before it is put into service. The following list will help ensure each part of the bed is tested.

Plug the bed power cord into a properly grounded, hospital grade wall receptacle. During transport, the bed power cord should be wrapped around the roller bumpers at the head end of the bed.

CAUTION

The LD304 Birthing Bed is equipped with a hospital grade plug for protection against electric shock hazard. It must be plugged directly into a properly grounded three-prong receptacle. Grounding reliability can be achieved only when a hospital grade receptacle is used.

1. Ensure the siderails raise and lower smoothly and lock in the up position.
2. Ensure the brakes hold when the brake pedal is engaged.
3. Test each function on the (optional) hand pendant and verify each function is working properly.

Beds equipped with nurse communication siderail control option only:

1. Plug the interface cable into the 37 pin connector in the litter frame at the head end of the bed, and into the "Patient Station", "Head Wall", "Dock Station", or equivalent (whichever applies).
2. Run through each function on the siderail control panels and verify each function is working properly.

Note

To prevent a low battery condition when the bed is not plugged in, position the cord out switch at the head end of the bed to the off position. The switch is identified by the label shown below. If the switch is not positioned as shown below and the bed power cord and pendant cord are unplugged, the life of the back-up battery will be significantly reduced.

If the **Power LED** (located on the outside of both siderails) is flashing, the 9V Nurse Call battery needs to be replaced. The battery is located at the head end of the bed. No tools are required to replace the battery. Unplug the bed power cord from the Power Source and replace the battery. After replacing the battery, verify the **Power LED** is no longer flashing and operates normally when the different light settings are selected. Properly dispose of the old battery in accordance with local regulations.

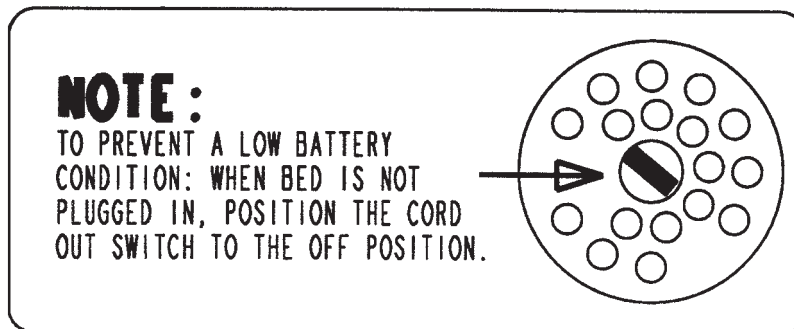

Operation Guide

OPERATING SIDERAILS

To engage the head end siderail, pull upward to attain full height. When the siderail is being raised, it does not lock in the intermediate position. To lower the siderail, push in the release handle and rotate the siderail until it locks in the intermediate position. To lower the siderail, push in the release handle again and rotate the siderail until it is completely lowered.

WARNING

When raising the siderails, listen for the “click” that indicates the siderail has locked in the raised position. Pull firmly on the siderail to ensure it is locked into position. Siderails are not intended to be a patient restraint device. It is the responsibility of attending medical personnel to determine the degree of restraint and the siderail positioning necessary to ensure a patient will remain safely in the bed. The intermediate position should be used only to assist the patient during ingress and egress from the bed.

Note

To activate the siderail bypass mechanism, the siderail must be fully lowered. If the siderail is not completely lowered, the siderail will lock in the intermediate position when it is raised.

USING THE SIDERAIL CONTROL PANEL LIGHTS



The bed is equipped with lights to illuminate the head end siderail control panels and the red nurse call switches. Five settings are available for the control panel lights. Press the backlight button once to turn on the lights at low intensity, again to change to medium intensity, a third time to change to high intensity, a fourth to leave just the nurse call light on, and a fifth time to turn all siderail lights off.

LOCKING OUT THE SIDERAIL CONTROLS

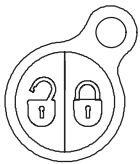

The lock out feature disables the siderail bed motion controls. Lock out buttons are located on the outside of both siderails. Lock out the bed motion controls by depressing the button once. The bed motion lockout LED will light. Reactivate the controls by pressing the button again.

Operation Guide

OUTSIDE SIDERAIL CONTROLS

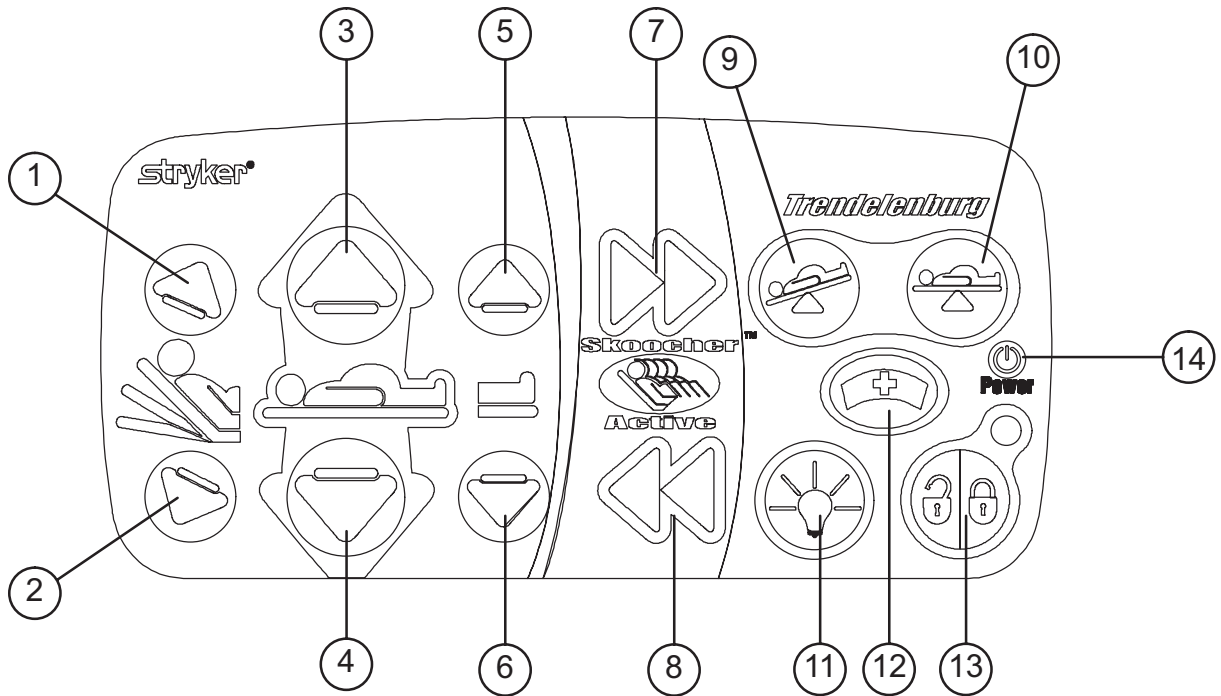

1. Press to raise the fowler (back section).
2. Press to lower the fowler (back section).
3. Press to raise the litter.
4. Press to lower the litter.
5. Press to raise the foot section.
6. Press to lower the foot section.

Note

When the bed is at a low height and the **"Foot Down"** button is pressed, the litter may raise automatically to provide adequate clearance. The **"Bed Up"** LED on the siderail will flash to indicate activation.

7. Press to increase the seat depth (optional function).
8. Press to decrease the seat depth (optional function).

Note

If the Fowler (back section) angle is below 35°, pressing the button to decrease the seat depth will cause the Fowler to raise to 35° before the seat depth decreases. Once the Fowler (back section) is elevated to 35° or greater, the **"Skoosher Active"** LED will light and the seat depth can be changed.

Operation Guide

OUTSIDE SIDERAIL CONTROLS (CONTINUED)

9. Push to lower the head end of the bed (Trendelenburg position). This function is also used for pelvic tilt.

Note

When the bed is at a low height and the Trendelenburg button is pressed, the litter may raise automatically to provide adequate clearance. The **"Bed Up"** LED on the siderail will flash to indicate activation.

10. Push to raise the head end of the bed and/or return the bed to level.

11. Push repeatedly to toggle the siderail lights to different settings:

- A. Low
- B. Medium
- C. High
- D. Nurse Call Only
- E. Off

12. Press to activate Nurse Call.

13. Push to lock out all bed motion. Push again to unlock. The LED will light when bed motion is locked.

14. Lights when the bed is plugged into the power source. Blinks if the Nurse Call battery needs to be replaced.

Operation Guide

INSIDE SIDERAIL CONTROLS

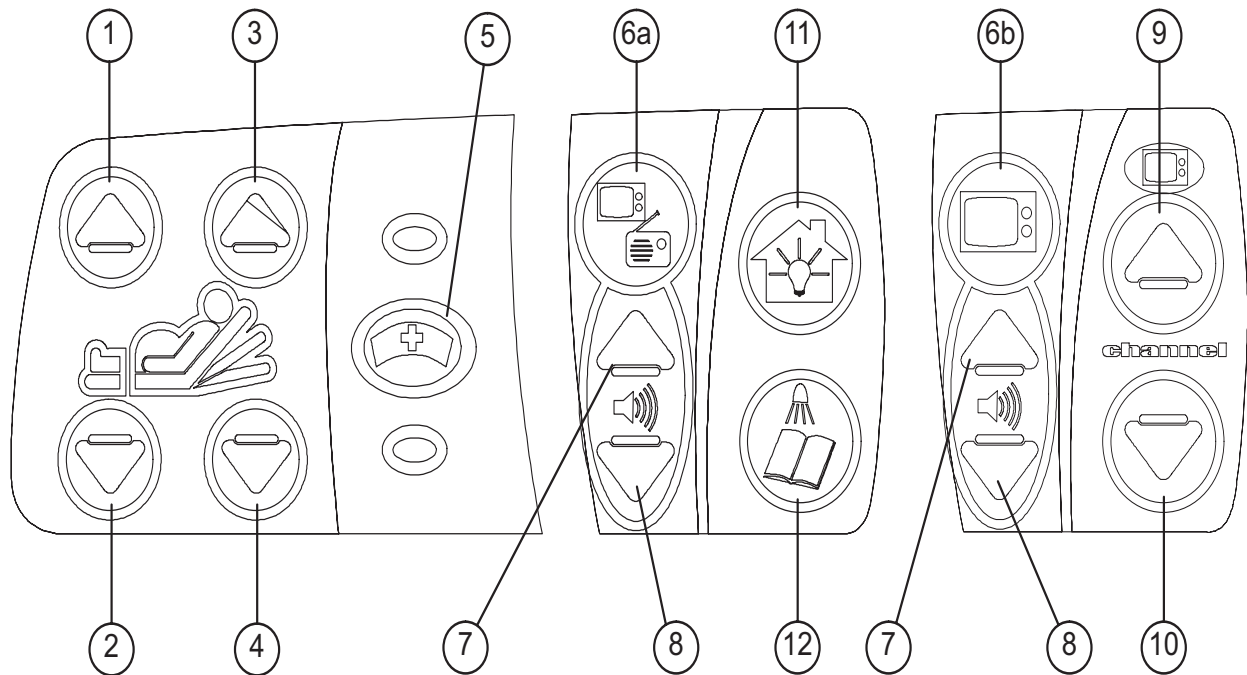

1. Press to raise the foot section.
2. Press to lower the foot section.
3. Press to raise the fowler (back section).
4. Press to lower the fowler (back section).
5. Press to activate the Nurse Call (optional function).
6. a) Press to turn on and off the TV or radio and to select a channel (TV/Radio - optional function).
b) Press to turn the TV on and off (Smart TV - optional function).
7. Press to increase the volume of the TV or radio (optional function).
8. Press to decrease the volume of the TV or radio (optional function).
9. Press to change (increase) the TV channel number (optional function).
10. Press to change (decrease) the TV channel number (optional function).
11. Press to turn on the room light. Press again to turn off the room light (optional function).
12. Press to turn on the reading light. Press again to turn off the reading light (optional function).

Operation Guide

INSIDE SIDERAIL CONTROLS (CONTINUED)

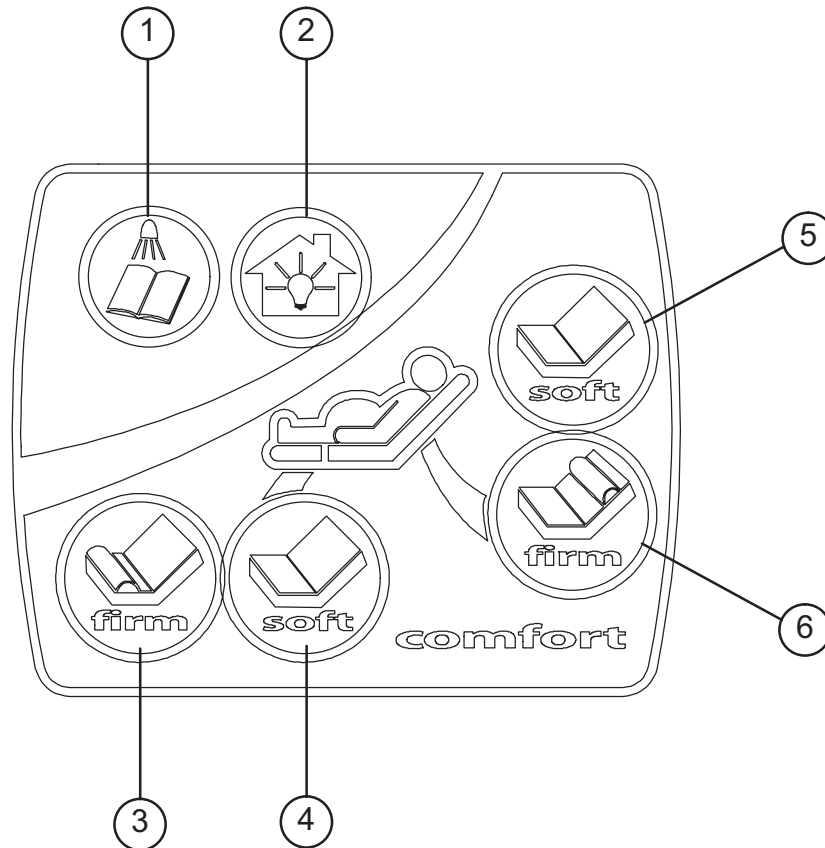

1. Press to turn on the reading light. Press again to turn off the reading light (optional function).
2. Press to turn on the room light. Press again to turn off the room light (optional function).
3. Push for more support to the patient's seat section (optional function).
4. Push for less support to the patient's seat section (optional function).
5. Push for less support to the patient's lower back (optional function).
6. Push for more support to the patient's lower back (optional function).

Operation Guide

COMMUNICATION PENDENT

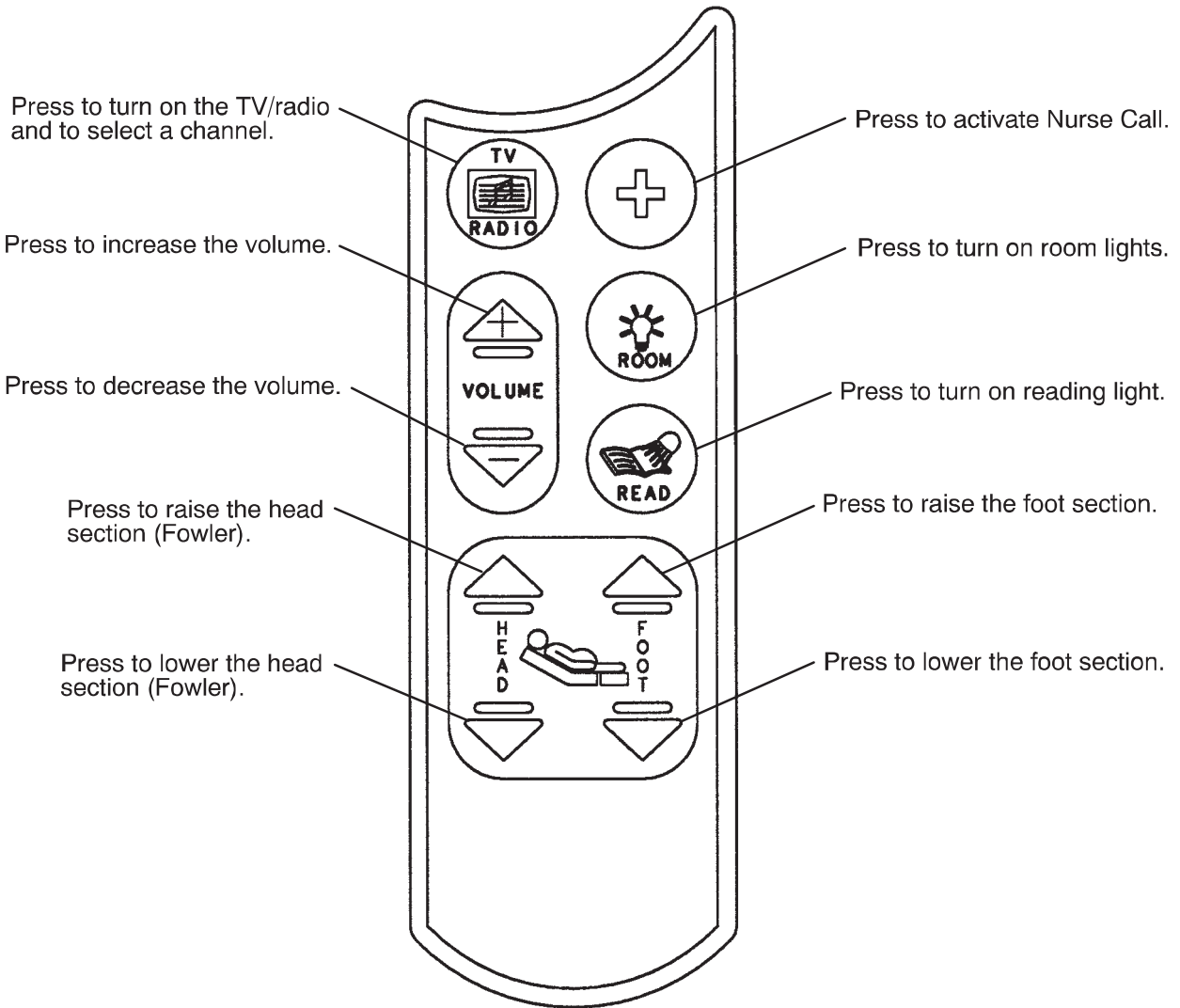

Operation Guide

MOTION PENDANT

Press to lower head end (Trendelenburg) or utilize pelvic tilt.

Press to raise the head end from Trendelenburg and/or return the bed to level.

Press to raise head section.

Press to lower head section.

Press to raise height of bed.

Press to raise foot section.

Press to lower foot section.

Press to lower height of bed.

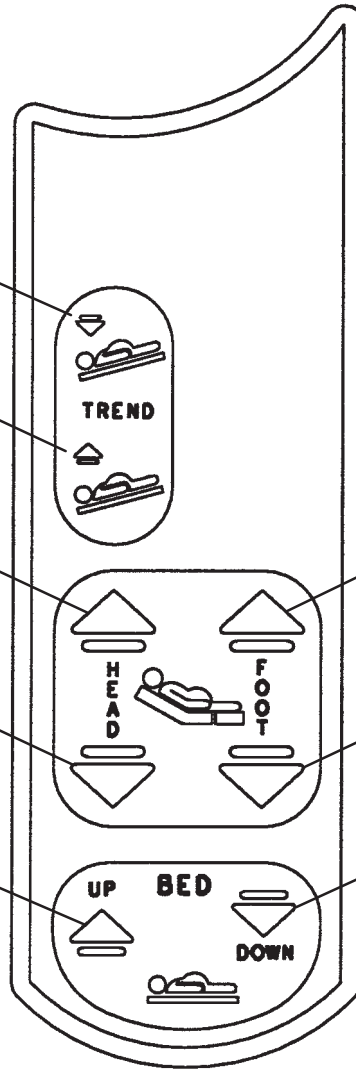

Operation Guide

MOTION PENDANT WITH NURSE CALL

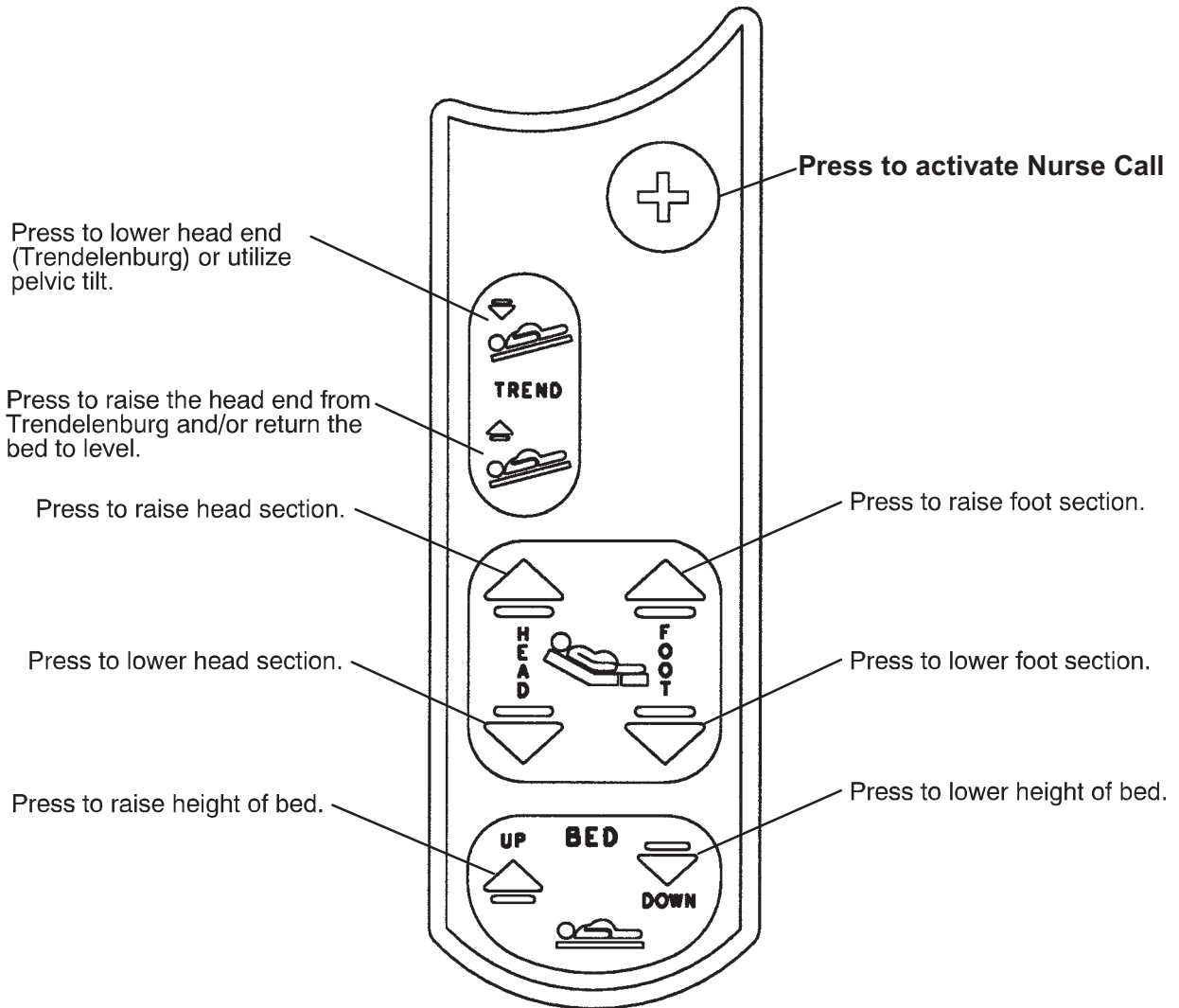

Operation Guide

USING THE BRAKE/STEER PEDALS

The brake/steer pedals are located at the center of the base frame on both sides of the bed.

- To engage the brakes, fully depress the head end side of the pedal. To disengage the brakes, depress the foot end side of the pedal until the pedal is in the neutral (Level) position.
- To engage the steer function, fully depress the foot end pedal until the steer wheel engages. To disengage the steer function, depress the head end side of the pedal until neutral position.

Note

The steer function locks the foot end, right side caster to make the bed easier to maneuver forward and backward. Put the pedal in the neutral position when maneuvering the bed from side to side.

USING THE MANUAL MOTOR HAND CRANK

CAUTION

To avoid injury, unplug the bed power cord from the wall socket before using the manual hand crank.

A manual override is available for the bed lift and trend motors to allow the caregiver to position the bed when the power cord is not plugged into the wall socket. Insert the crank into either of the sockets at the head end of the bed and rotate the crank until the desired bed position is reached.

ACTIVATING INSTANT CPR

The CPR release lever is located at the head section on both sides of the bed. To activate the CPR release, grasp the lever and squeeze tightly. The fowler (back section) will lower to the lowest position instantly.

WARNING

The instant CPR release is for emergency use only. Before activating the instant CPR, verify all persons and equipment are away from the area below and around the fowler (back section) section of the bed or serious personal injury or damage to the equipment could occur.

REMOVING THE HEAD BOARD

To remove the head board, lift it straight up and off the bed. To replace the head board, align the plastic inserts on the bottom of the head board with the slots at the head end of the bed and lower the head board until it completely seats in the slots.

NIGHT LIGHT

The bed is equipped with a night light to illuminate the floor area around the bed. The night light will automatically activate when the light in the room becomes dim enough.

Operation Guide

NURSE CALL BATTERY

To prevent a low battery condition when the bed is not plugged in, position the cord out switch at the head end of the bed to the off position. The switch is identified by the label shown below. If the switch is not positioned as shown below and the bed power cord and pendant cord are unplugged, the life of the backup battery will be significantly reduced.

If the **Power LED** (located on the outside of both siderails) is flashing, the 9 V Nurse Call battery needs to be replaced. The battery is located at the head end of the bed. No tools are required to replace the battery. Unplug the bed power cord from the wall socket and replace the battery. After replacing the battery, verify the **Power LED** is no longer flashing and operates normally when the different light settings are selected. Properly dispose of the old battery in accordance with local regulations.

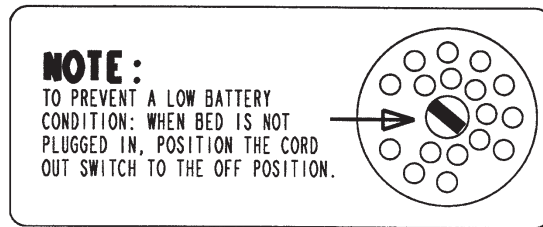

USING THE LABOR GRIPS

To position the labor grips, grasp the handle and pull the grip out and up above the mattress until the mechanism locks into position. To lower the grips, pull the lever to release the grip and, as it begins to rotate, release the lever and lower the grip to the stored position.

USING THE OPTIONAL LABOR BAR

To use the labor bar, insert it into the sockets located on each side of the litter at the pivot point for the foot pans. The labor bar can be used by the patient to aid with various birthing positions such as squatting or kneeling. The optional Stryker labor bar is rated to support 250 pounds.

OPTIONAL LUMBAR PILLOW AND PERINEAL WEDGE

Use the one-touch lumbar and seat buttons on the siderail to adjust the amount of support given to the patient's lumbar and seat areas if the bed is equipped with this option.

Note

Be sure the locating pins on the underside of the mattress are inserted in the holes in the metal seat support.

Operation Guide

ADJUSTABLE SEAT DEPTH (OPTIONAL)

To accommodate patients of different sizes, the depth of the seat can be adjusted up to 4 inches (from 12.5 to 8.5 inches).

- The fowler (back section) must be raised to a minimum of 35° before the seat depth can be changed. Once the fowler (back section) is elevated to 35°, the “SKOOCHER ACTIVE” LED on the outside of the siderail will light and the seat depth can be changed. When the fowler (back section) is lowered (either electrically or using the emergency CPR release), the bed will automatically adjust the seat depth to 12.5”.

- To reduce seat depth, depress the  button on the siderail to move the fowler (back section) toward the foot end of the bed. Release the button when the desired seat depth is attained.

- To increase seat depth, press the  button to move the fowler (back section) toward the head end of the bed.

REMOVING THE FOOT SECTION

- Before removing the foot section, put the foot rests into position above the foot mattress and place the patient’s feet in the contoured foot rests. To remove the foot section, squeeze the red release handle at the foot end of the bed and raise the locking bar to the full up position until it latches in place. The foot section will now slide straight off the bed.

Note

If the foot section mattress is placed with the perineal edge toward the floor, it will stand independently.

- To reinstall the foot section of the bed, set the foot mattress back on the bed and slide it straight toward the main mattress. The locking bar can only be lowered when the foot section is in the “locking zone”, approximately 2" from the main mattress. Squeeze the red release handle and lower the locking bar into the locked position. As the locking bar is lowered, the gap between the mattresses will narrow to ease installation. The LD304 foot section is designed to lift and support a 300 pound load.

OPERATING THE GLIDEAWAY FOOT RESTS/OPTIONAL CALF SUPPORTS

- Rotate the foot rest into position by pulling it out and up over the foot end mattress until it clicks into place. Ensure the foot rest is securely locked in the upright position by grasping and attempting to move it.
- After they are in position, the foot rests are adjustable six ways:

1. Abduct/Adduct (pivoting)

Pivoting in and out allows the clinician to position the patient’s feet and legs at the desired width. To use the Abduct/Adduct feature, squeeze the gray release handles located at the foot end of the bed. Pivot the foot rest into the desired position and release the handle to lock the foot rest in that position.

Note

For emergency situations, the foot rests will pivot to 90°. Hold on to the release handle and pivot the foot rest out. Beyond 36° the foot rest will not lock into position.

Operation Guide

OPERATING THE GLIDEAWAY FOOT RESTS/ATTACHABLE CALF SUPPORTS (CONTINUED)

2. In/Out

The in/out motion allows the clinician to adjust the foot rests to comfortably accommodate patients of different heights. Squeeze either of the two purple triggers at the opening on the foot upright and slide the foot rest to the desired position. Release the trigger to lock the foot rest in position.

3. Up/Down

The foot end high/low adjustment allows the foot end of the bed to be positioned up to 7" below the top of the seat mattress to accommodate different sized patients when the foot rests calf supports or labor bar are being used. The foot end high/low adjustment is on the outside siderail controls (refer to Outside Siderail Controls section).

- To switch between the foot rest and calf support positions, press the purple button at the bottom of the gray footrest and rotate the foot rest to the desired position.
- To store the footrests, press the purple button at the bottom of the gray foot support and position the foot support as shown in the following diagram. The footrest cannot be stowed unless it's in this position. To ensure the most effective storage, the calf supports should be positioned inside the storage notch.

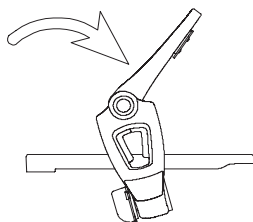

Foot Rest Store Position

WARNING

Prior to placing weight on the foot section, verify the locking bar has been lowered and locked. The foot section locking bar is not designed for use as a grasping bar or other patient assist device.

BIRTHING BED POSITIONING

- Position the patient's feet in the foot rests.
- Raise or lower the foot rests to a position comfortable for the patient.
- Remove the foot section and tuck the drape into the fluid basin.
- Raise the bed to a comfortable height by pressing the "Bed-Up" control on the siderail and position the patient's perineum out and over the edge of the seat section.

DELIVERY TABLE POSITIONING

- Slide the patient down to the perineal edge.
- Lower the foot section to its lowest position.
- Position the attached calf supports and place the patient's legs in the supports.

TRENDELENBURG POSITIONING

Lower the fowler (back section) by pressing the control on the siderail or by squeezing the CPR lever. Press the Trendelenburg button on the siderail or the control pendant to lower the head end of the bed to the desired angle.

PELVIC TILT

Use the Trendelenburg button on the siderail or the control pendant to provide additional pelvic tilt and comfort for the patient when the Fowler (back section) is raised.

[Return To Table of Contents](#)

Operation Guide

OPERATING THE 3-STAGE PERMANENTLY ATTACHED I.V. POLE

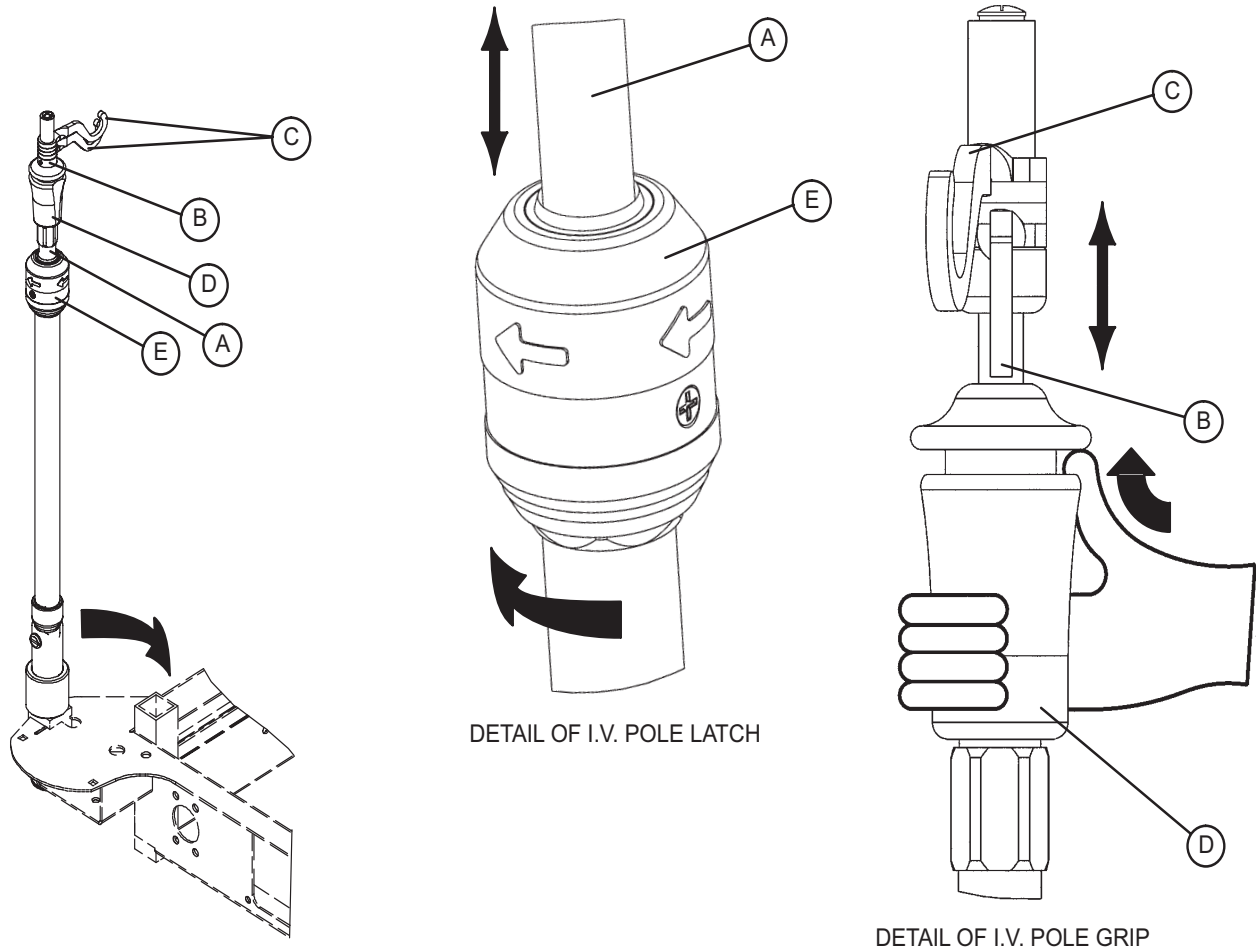

Note

The 3-stage, permanently attached I.V. pole can only be installed at the head end of the bed.

To use the 3-stage permanently attached I.V. pole:

1. Lift and pivot the pole from the storage position and push Down until it is locked into the receptacle.
2. To raise the height of the pole, pull Up on the telescoping portion (A) until it locks into place at its fully raised position.
3. For a higher I.V. pole, pull up on section (B). Release section (B) at any desired height and it will lock into place.
4. Rotate the I.V. hangers (C) to the desired position and hang the I.V. bags.
5. To lower the I.V. pole, push up on the red portion of grip (D) while holding on to section (B) until it lowers. Turn latch (E) clockwise until section (A) lowers.

CAUTION

- To avoid damage, the weight of the I.V. bags should not exceed 40 pounds.
- To avoid damage while transporting the bed, verify the I.V. pole is at a low enough height to allow it to pass safely through door openings.

Preventative Maintenance

- _____ All fasteners secure.
- _____ All welds intact, not cracked or broken.
- _____ No bent or broken tubing or sheet metal.
- _____ No debris in casters.
- _____ All casters secure and swivel properly.
- _____ Engage brake pedal and push on the bed to ensure all casters lock securely.
- _____ Steer caster latches properly.
- _____ Siderails move and latch properly.
- _____ Fowler operates properly.
- _____ Fowler (back rest) Slide operates properly.
- _____ Bed Up/Down operates properly.
- _____ Foot section operates properly.
- _____ Foot uprights operate properly.
- _____ Trendelenburg operates properly.
- _____ I.V. pole intact and operating properly.
- _____ No rips or cracks in mattress cover.
- _____ Lubricate where required.
- _____ Replace Nurse Call 9V battery (annually).
- _____ Power cord not frayed.
- _____ No cables worn or pinched.
- _____ All electrical connections tight.
- _____ All grounds secure to the frame.
- _____ Ground impedance not more than 100 milliohms.
- _____ Current leakage not more than 300 microamps.
- _____ Ensure ground chains are clean, intact, and have at least two links touching the floor.

Bed Serial Number:		

Completed by: _____ Date: _____

Note

It is strongly recommended that preventative maintenance should be performed annually at a minimum. A preventative maintenance program should be established for all Stryker Medical equipment. Preventative maintenance may need to be performed more frequently based on the usage level of the product.

Cleaning

Hand wash all surfaces of the bed with warm water and mild detergent. **Dry Thoroughly.** Do not steam clean or hose off the LD304 Birthing Bed. Do not immerse any part of the bed. Some of the internal parts of the bed are electric and may be damaged by exposure to water.

Suggested cleaners for bed surfaces:

- Quaternary Cleaners (active ingredient - ammonium chloride)
- Phenolic Cleaners (active ingredient - o - phenylphenol)
- Chlorinated Bleach Solution (5.25% - less than 1 part bleach to 100 parts water)

Avoid over-saturation and ensure the product does not stay wet longer than the chemical manufacturer's guidelines for proper disinfecting.

CAUTION

Some Cleaning Products are Corrosive in Nature and May Cause Damage to the Product if Used Improperly. If the products described above are used to clean Stryker patient care equipment, measures must be taken to insure the beds are wiped with clean water and thoroughly dried following cleaning. Failure to properly rinse and dry the beds will leave a corrosive residue on the surface of the bed, possibly causing premature corrosion of critical components. Failure to follow the above directions when using these types of cleaners may void this product's warranty.

For mattress cleaning and disinfecting, use warm water and a neutral detergent. A sodium hypochlorite solution can also be used for cleaning. If using a chlorinated bleach solution (5.25%) dilute to less than 2 parts bleach to 100 parts water.

WARNING

Mattresses must be completely dried after cleaning. Failure to thoroughly rinse and dry mattress surfaces after cleaning may cause damage to the mattress and may void this product's warranty.

Warranty

LIMITED WARRANTY

Stryker Medical Division, a division of Stryker Corporation, warrants to the original purchaser the LD304 Birthing Bed to be free from defects in material and workmanship for a period of One (1) years after date of delivery. Stryker's obligation under this warranty is expressly limited to supplying replacement parts and labor for, or replacing, at its option, any product which is, in the sole discretion of Stryker, found to be defective. If requested by Stryker, products or parts for which a warranty claim is made shall be returned prepaid to the factory. Any improper use or any alteration or repair by others in such manner as in Stryker's judgment affects the product materially and adversely shall void this warranty. Any repair of Stryker products using parts not provided or authorized by Stryker shall void this warranty. No employee or representative of Stryker is authorized to change this warranty in any way.

Stryker Medical Bed products are designed for a 15 year expected service life under normal use, conditions, and with appropriate periodic maintenance as described in the maintenance manual for each device. Stryker warrants to the original purchaser that the welds on its Bed products will be free from structural defects for the expected 15 year life of the Bed product as long as the original purchaser owns the product.

This statement constitutes Stryker's entire warranty with respect to the aforesaid equipment. **Stryker makes no other warranty or representation, either expressed or implied, except as set forth herein. There is no warranty of merchantability and there are no warranties of fitness for any particular purpose. In no event shall Stryker be liable here under for incidental or consequential damages arising from or in any manner related to sales or use of any such equipment.**

TO OBTAIN PARTS AND SERVICE

Stryker products are supported by a nationwide network of dedicated Stryker Field Service Representatives. These representatives are factory trained, available locally, and carry a substantial spare parts inventory to minimize repair time. Simply call your local representative, or call Stryker Customer Service USA at 1-800-327-0770, Canada 1-888-233-6888.

SERVICE CONTRACT COVERAGE

Stryker has developed a comprehensive program of service contract options designed to keep your equipment operating at peak performance at the same time it eliminates unexpected costs. We recommend that these programs be activated before the expiration of the new product warranty to eliminate the potential of additional equipment upgrade charges.

A Service Contract helps to:

- Ensure equipment reliability.
- Stabilize maintenance budgets.
- Diminish downtime.
- Establish documentation for JCAHO.
- Increase product life.
- Enhance trade-in value.
- Address risk management and safety.

Warranty

SERVICE CONTRACT PROGRAMS

Stryker offers the following service contract programs:

Service Agreement Options *	Gold	Silver	Parts	Labor	PM
Annually scheduled preventative maintenance	X				X
All parts	X	X	X		
All labor and travel	X	X		X	
Unlimited emergency service calls	X	X		X	
Priority one contact: two hour phone response	X	X	X	X	
Most repairs completed within 3 days	X	X		X	
JCAHO documentation	X	X		X	X
On-site record of PM & emergency service	X				X
Factory-trained Stryker service technician	X	X		X	X
Stryker authorized parts used	X	X	X	X	X
Service during regular business hours (8–5)	X	X	X	X	X

* Does not include maintenance due to abuse or for any disposable items. Stryker reserves the right to change options without notice.

Stryker Medical also offers personalized service contracts.
Pricing is determined by age, location, model and condition of product.

**For more information on our service contracts,
please call your local representative.**

RETURN AUTHORIZATION

Merchandise cannot be returned without approval from the Stryker Customer Service Department. An authorization number will be provided which must be printed on the returned merchandise. Stryker reserves the right to charge shipping and restocking fees on returned items. **Special, modified, or discontinued, items not subject to return.**

DAMAGED MERCHANDISE

ICC Regulations require that claims for damaged merchandise must be made with the carrier within fifteen (15) days of receipt of merchandise. **Do not accept damaged shipments unless such damage is noted on the delivery receipt at the time of receipt.** Upon prompt notification, Stryker will file a freight claim with the appropriate carrier for damages incurred. Claim will be limited in amount to the actual replacement cost. In the event that this information is not received by Stryker within the fifteen (15) day period following the delivery of the merchandise, or the damage was not noted on the delivery receipt at the time of receipt, the customer will be responsible for payment of the original invoice in full. Claims for any short shipment must be made within thirty (30) days of invoice.

INTERNATIONAL WARRANTY CLAUSE

This warranty reflects U.S. domestic policy. Warranty outside the U.S. may vary by country. Please contact your local Stryker Medical representative for additional information.

UNITED STATES
Stryker Medical
3800 E. Centre Ave.,
Portage, Michigan USA
49002

CANADA
Stryker Canada
45 Innovation Drive
Hamilton, Ontario Canada
L9H 7L8

EC	REP
----	-----

European Representative
Stryker France
ZAC Satolas Green Pusignan
Av. De Satolas Green
69881 MEYZIEU Cedex
France

stryker[®]