

SAMSUNG

Technical Report

Virtualized Radio Access Network

Architecture, Key technologies and Benefits

Contents

03 Introduction

04 Virtualized and Disaggregated RAN Architecture

Futureproof architecture for the Next Generation 5G networks
Benefits of Virtualized and Disaggregated RAN Architecture

1 1 Key Technologies for Telco Quality

1 3 Introduction of Virtualized DU in 5G Networks

1 4 Next Step

Introduction

Taking IT domain advantages while keeping Telco domain quality

Today, Samsung stands as the largest supplier of 5G NR commercial solutions to Korea's three mobile operators. This includes both 5G Radio and Core Network solutions, leveraging 3GPP-defined disaggregated RAN and virtualized Central Unit (vCU) architecture. The first of these deployments launched in Korea in April 2019 and it has also been deployed with two operators in the US. These first successful steps have generated considerable momentum for Samsung's 5G efforts, and we are now aiming to keep up the pace with plans over the next year to begin deploying fully virtualized 5G networks for the first round of fast movers looking to innovate their networks. Next steps include containerization of all protocol layers

– both non-real time and real time – in order to deliver a new dimension of agility and flexibility to operators while doing away with the traditional requirement for dedicated baseband hardware. End-users will continue to enjoy the ever-evolving best-in-class service quality over the air, as Samsung incorporates its know-how accumulated over 20 years in the most competitive wireless markets into its software-based solutions. Key algorithms, such as wireless channel estimation, detection, and scheduling, are being implemented in a resource-efficient manner, without performance degradation through advanced software techniques that enable real time signal and packet processing on commercial off-the-shelf server hardware.

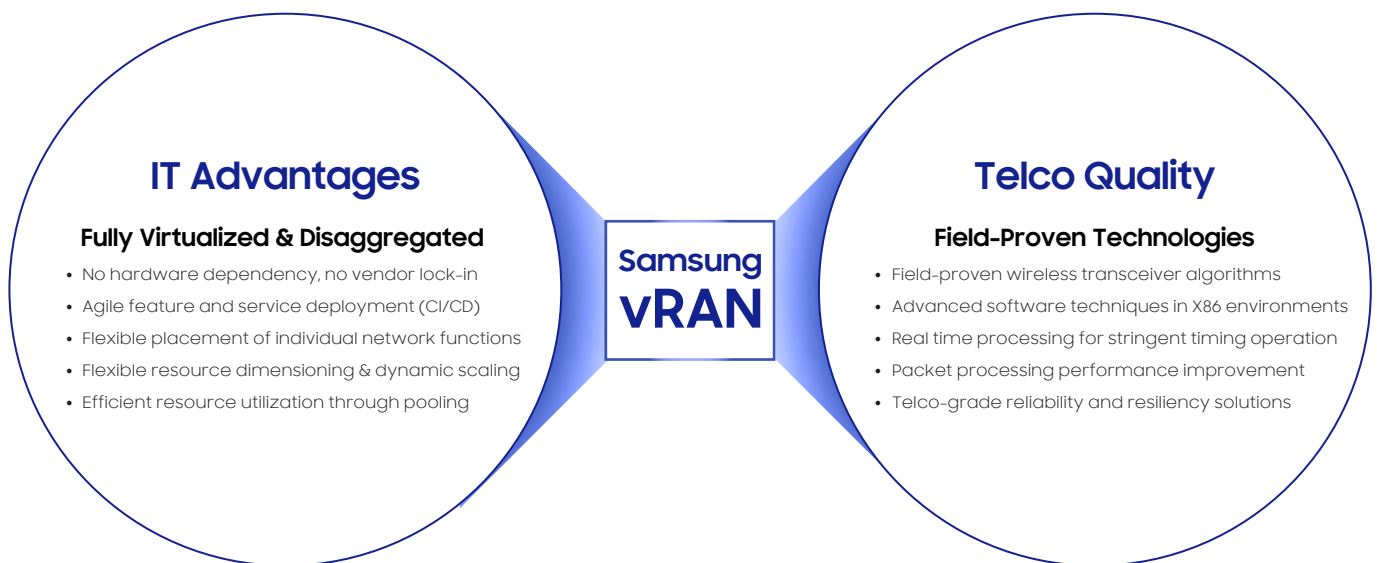

Virtualized and Disaggregated RAN Architecture

Virtualized and Disaggregated RAN Architecture Overview

Futureproof architecture for Next Generation 5G networks

Moving into the 5G era, a wide variety of new technologies and services will be rapidly introduced. These include LTE-NR Dual Connectivity (EN-DC), NR-NR Dual Connectivity (NR-DC), millimeter wave (mmWave) spectrum, Network Function Virtualization (NFV), Containerized Network Functions, massive Machine Type Communications (mMTC), Ultra Reliable Low Latency Communication (URLLC), Multi-Access Edge Computing (MEC), Network Slicing and Vertical Services, just to name a few. Conventional access systems provide a static network architecture which suffers from some fairly challenging limitations in terms of supporting many of these technologies and services. Consequently, a new 5G access system architecture, referred to as 'Disaggregated RAN', aims to overcome many of these challenges by breaking up monolithic network

features into smaller components that can be individually re-located as needed without hindering their ability to work together to provide network services. Virtualization, on the other hand, transitions each of these functions from dedicated hardware to software components, allowing for flexible scaling, as well as rapid and continuous evolution, so that networks can meet the evolving demands of new and existing services with minimal impact to CAPEX and OPEX. The new 5G access system architecture has four distinct characteristics which will be described in the following section along with the benefits provided in comparison with legacy hardware solutions. I.e., CU (Central Unit) / DU (Distributed Unit) split, CU-CP (Control Plane) / CU-UP (User Plane) split, CU virtualization and DU virtualization.

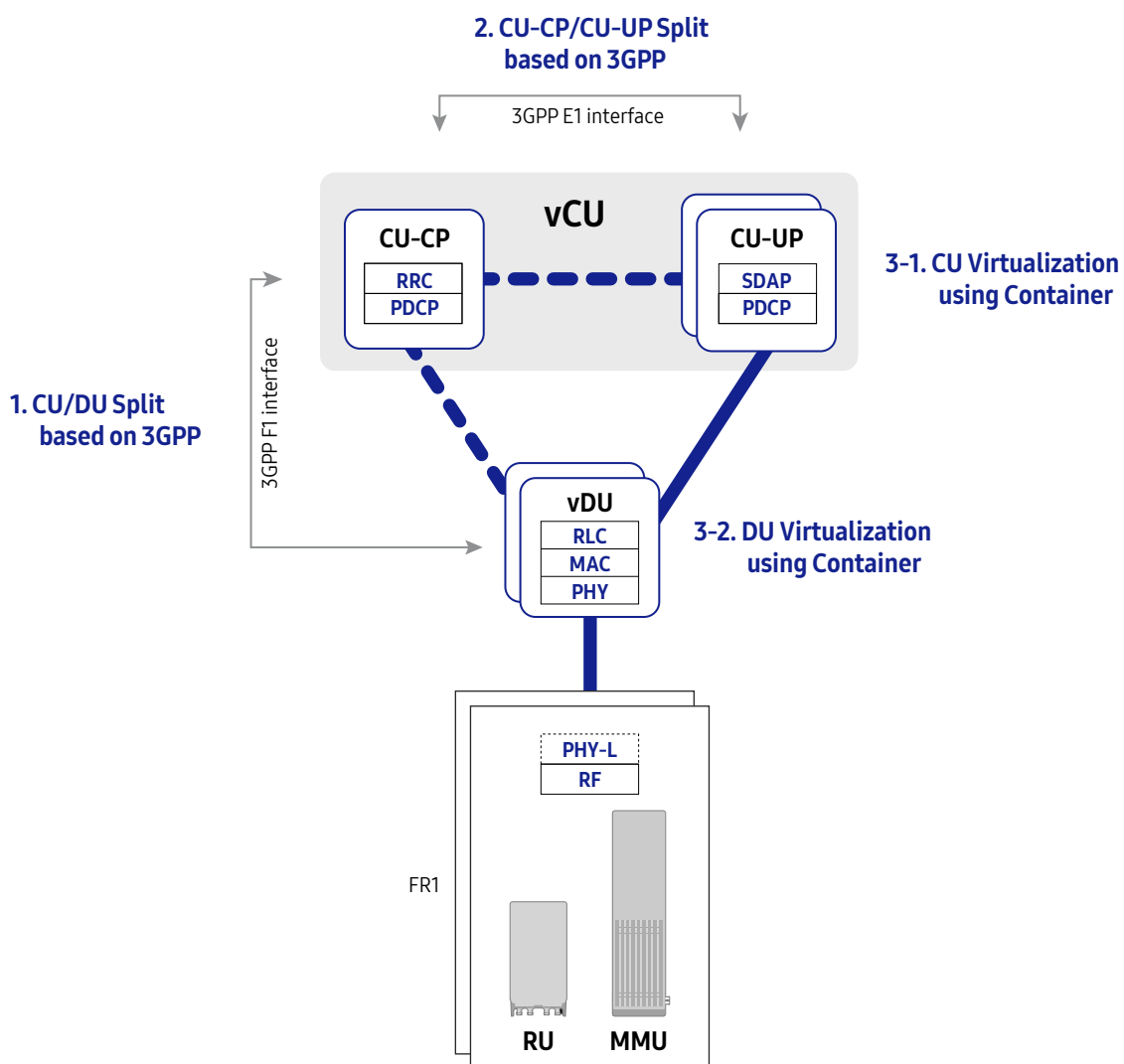

Figure 1-1. Virtualized and disaggregated RAN architecture

1 CU/DU Split Architecture

gNB is split into CU and DU for the scalability and DU offloading

In order to overcome an explosion in traffic usage, 5G largely makes use of higher frequency bands than LTE. Doing so introduces challenges in coverage due to the inverse relationship between frequency and cell coverage. Typically, small coverage cells result in more frequent handovers for mobile users and this risks impacting quality of experience if not appropriately managed. If we can increase the number of cells being managed by each individual base station (gNB), then a greater number of handovers can be handled through intra-gNB mobility which has a significantly smaller impact than inter-gNB mobility since the device's anchor point remains the same. By separating this functionality from the Digital Unit (DU) and centralizing it towards the Central Unit (CU), we can increase the number of cells being managed by each CU, and thus maximize the ratio of intra- vs inter-gNB handovers. At the same time, higher frequency bands also allow the use of wider bandwidth carriers and thus gNBs need considerably more traffic processing capacity compared to LTE eNBs. Compounding on this, when Dual Connectivity is widely used in 5G networks, devices may connect to two different gNBs, but only one of these (the anchor DU) is responsible for processing the split data streams (via Packet Data Convergence Protocol, or PDCP). Thus the PDCP load is concentrated on the PDCP anchor DU, which creates a load imbalance and inefficient resource usage between the PDCP anchor DU (over-utilized) and the non-anchor DU (under-utilized). To mitigate this load imbalance, PDCP aggregation needs to be off-loaded to the CU in a more central site where pooling /resource sharing can efficiently handle the task. For these reasons, 5G deployments are best served by a separated CU that is more centrally located from the DU.

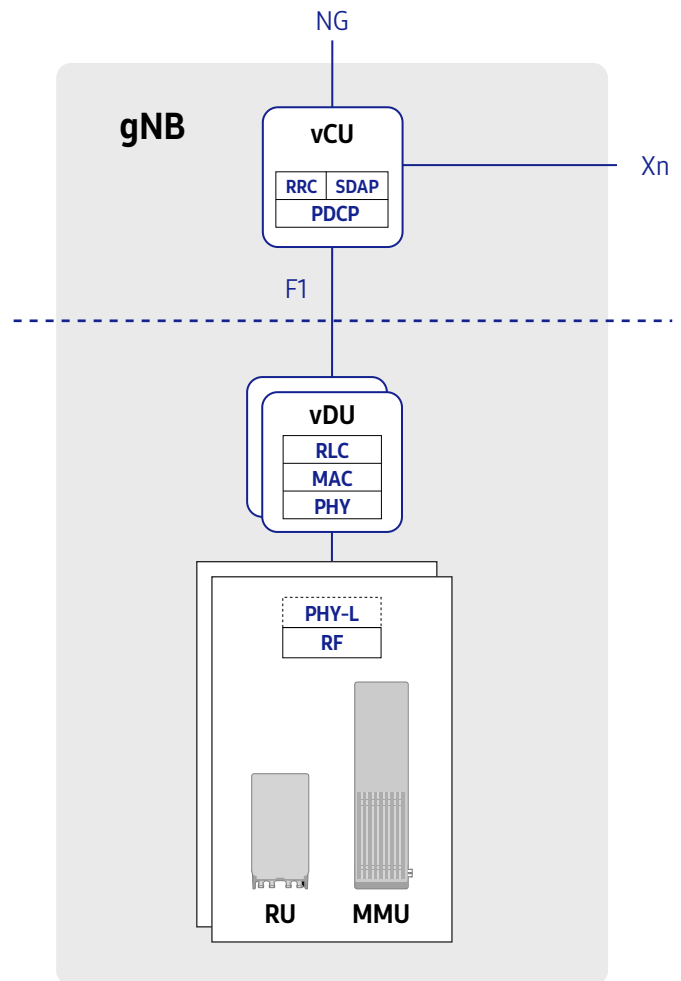

Figure 1-2. CU/DU split architecture

CU (Central Unit)

- Non-Real time processing such as RRC, PDCP is off-loaded to the central site and the RRC, PDCP resource pool is shared between multiple DUs.
- CU can accommodate multiple DUs to build a large scale gNB.
- CU is typically virtualized on COTS server for the scalability and flexibility.

DU (Distributed Unit)

- Real time processing such as RLC, MAC, PHY, RF need to remain close to the local site.
- DU is also virtualized on COTS server for business agility.

2 CU-CP/CU-UP Split Architecture

gNB-CU is split into CP and UP for flexible dimensioning and topology

New 5G services based around massive Machine Type Communications (mMTC), Ultra Reliable and Low Latency Communications (URLLC), Fixed Wireless Access (FWA), and new industry verticals will generate unique traffic patterns compared to typical mobile data service. Conventional DUs with fixed Control and User Plane (CU/UP) resources, which are typically designed to accommodate such 'typical mobile data services', are not well-suited to support the newer traffic patterns. Instead, a more flexible capability to dimension and scale directly in-line the traffic requirements of new types of services is needed. In particular, as Network Slicing and MEC are introduced, the UP should be divisible into multiple entities and allocated wherever needed for optimization of each specific services.

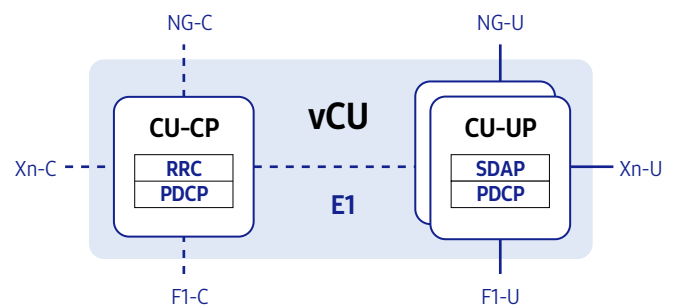

Figure 1-3. CU-CP/CU-UP split architecture

3 CU/DU Virtualization

CU and DU are virtualized for the enhanced scalability, flexibility and resource efficiency

Along with CU/DU split and CU-CP/CU-UP split, container technology can further enhance scalability, flexibility and resource efficiency.

3-1 CU Virtualization

Each component in the vCU can have its own flavor (size) for flexible dimensioning. Traffic loads for control and user planes are balanced between each plane's components separately to maximize resource usage efficiency. Each component can be scaled on-demand or automatically based on current load status.

3-2 DU Virtualization

Each component in the vDU can have its own flavor (size) for flexible dimensioning. DU components can be scaled out if additional cells are deployed.

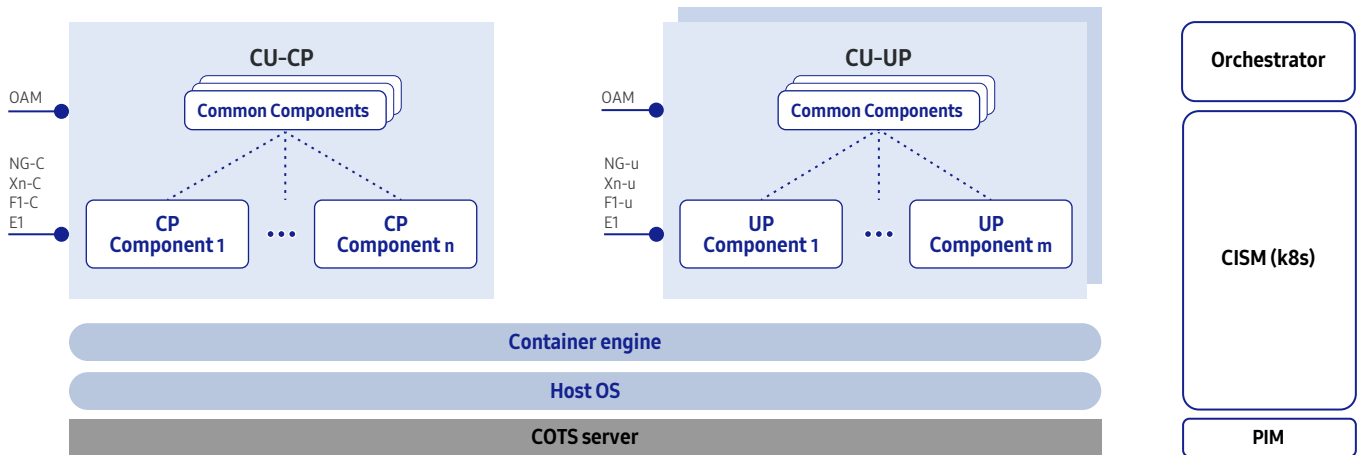

Figure 1-4. CU virtualization architecture

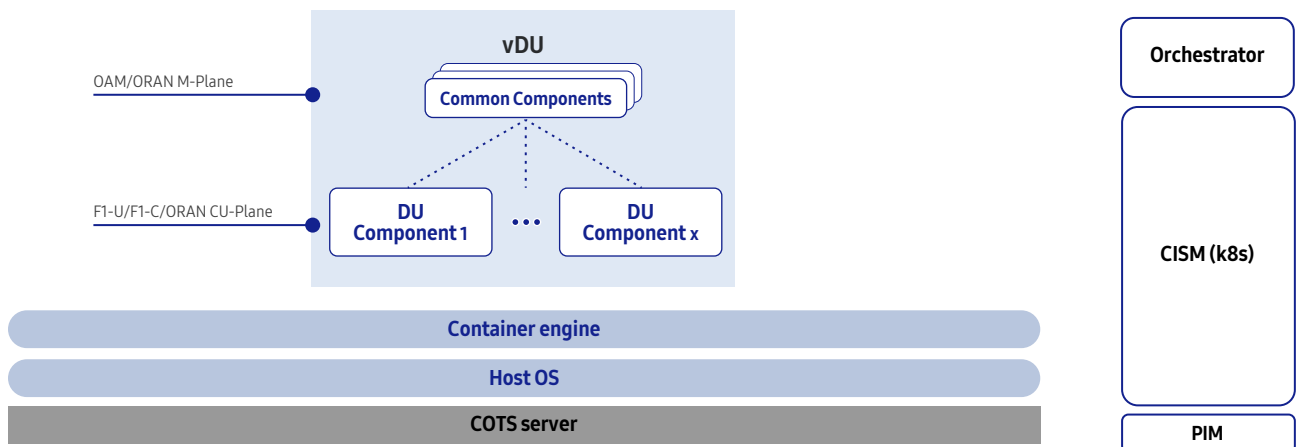

Figure 1-5. DU virtualization architecture

Benefits of Virtualized and Disaggregated RAN Architecture

Network evolution through Software upgrade

In traditional, hardware-oriented network solutions, the deployment of new standards, features and services often requires replacement of hardware, particularly when there are changes to lower layer protocols or when there is a need for increased processing capacity. With virtualization of the RAN, in which L1/L2 functions are implemented purely through software, the expensive and time-consuming process of hardware replacement can be avoided. Furthermore, as capacity requirements grow due to increased traffic demand, generic off-the-shelf compute hardware can be added to the resource pool – a much more cost-effective proposition than swapping older proprietary hardware for newer proprietary hardware. The end result is that operators are better able to manage and maximize the lifecycle of their hardware, match forecasted growth to CAPEX and reduce overall costs of ownership.

Adoption of well-developed IT technologies

Through the implementation of Network Function Virtualization, operators can deploy and manage their network utilizing well-developed IT principles such as Software-Defined Networking, life-cycle management and CI/CD to minimize CAPEX and OPEX.

Scalable gNB beyond DU boundary

With a CU/DU split, the gNB can be scaled flexibly from small (single DU size) to large (accommodating multiple DUs, up to 2048 cells), agnostic of DU hardware types for various deployment environment (e.g. rural, dense urban, D-RAN, C-RAN, Smallcell, mmWave). This is in contrast to conventional DU architecture, which would present limitations on gNB scale based on the capacity of individual DU hardware.

Mobility optimized architecture

In conventional aggregated RAN, as users move around the boundary of different cells being served by different gNBs, service quality can often be degraded due to frequent inter-gNB handovers and packet forwarding between DUs. On the other hand, each CU in a disaggregated RAN can accommodate a much larger number of cells for each gNB, and itself becomes the mobility anchor point, greatly reducing the number of anchor point handovers that occur as users move between cells. For users, the key benefit is a noticeably improved quality of experience and more reliable mobility as inter-gNB handovers and packet forwarding is reduced within the broader CU coverage footprint. When UE moves to neighbor cell, intra-gNB HO of CU/DU split architecture has no RRC/PDCP anchor change, no traffic forwarding during HO procedure and no HO signaling toward the Core Networks compared to inter-gNB HO of conventional DU architecture.

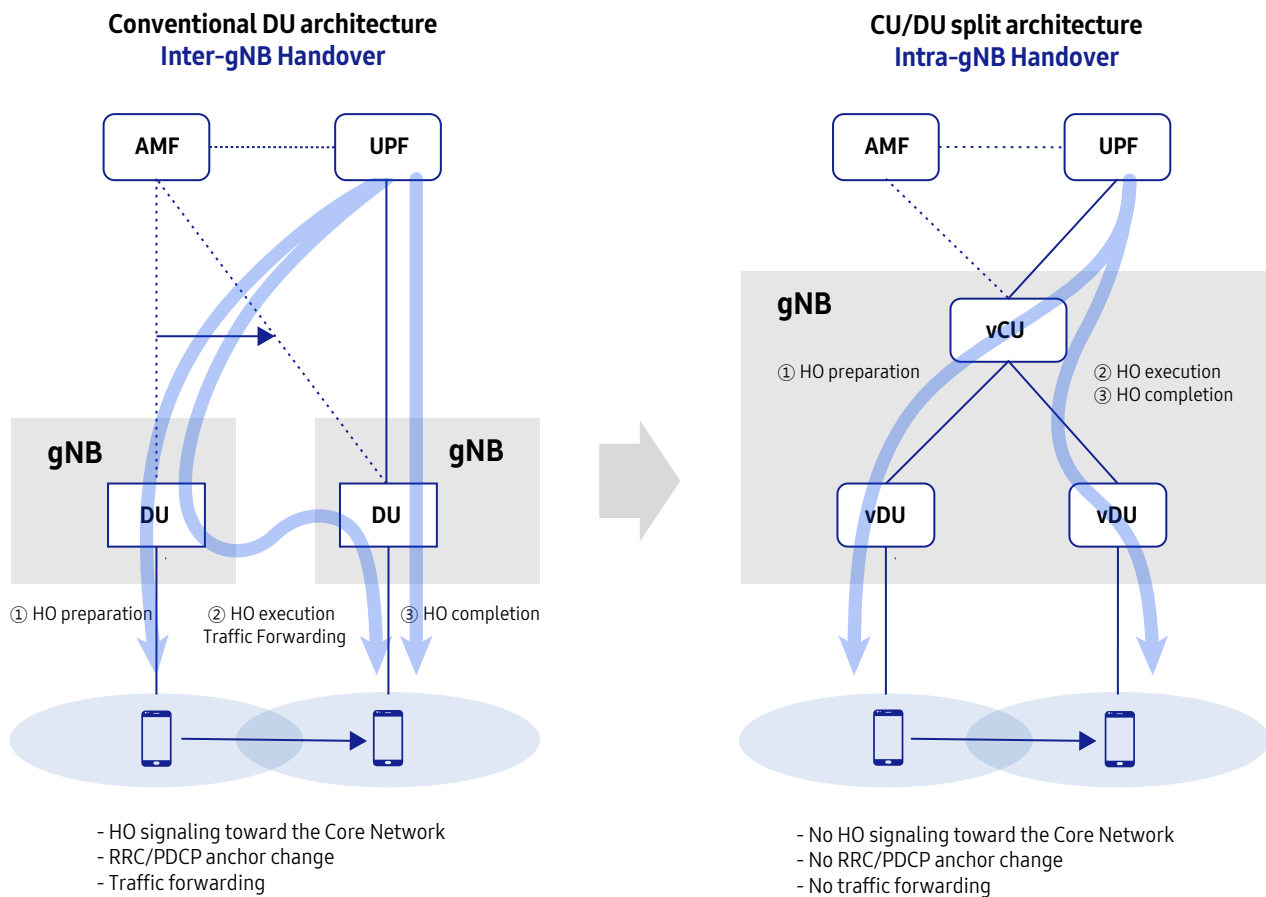

Figure 1-6. Mobility optimized architecture

Flexibility in CU-UP deployment

User plane of CU can be sliced into multiple CU-UPs to support network slicing and multiple CU-UPs can be deployed in independent locations while single CU-CP is deployed in the central site. For the network slicing and MEC scenarios such as low latency services or local-break out applications, CU-UP can be located close to DU while CU-UP for eMBB service remains in central site for the high capacity.

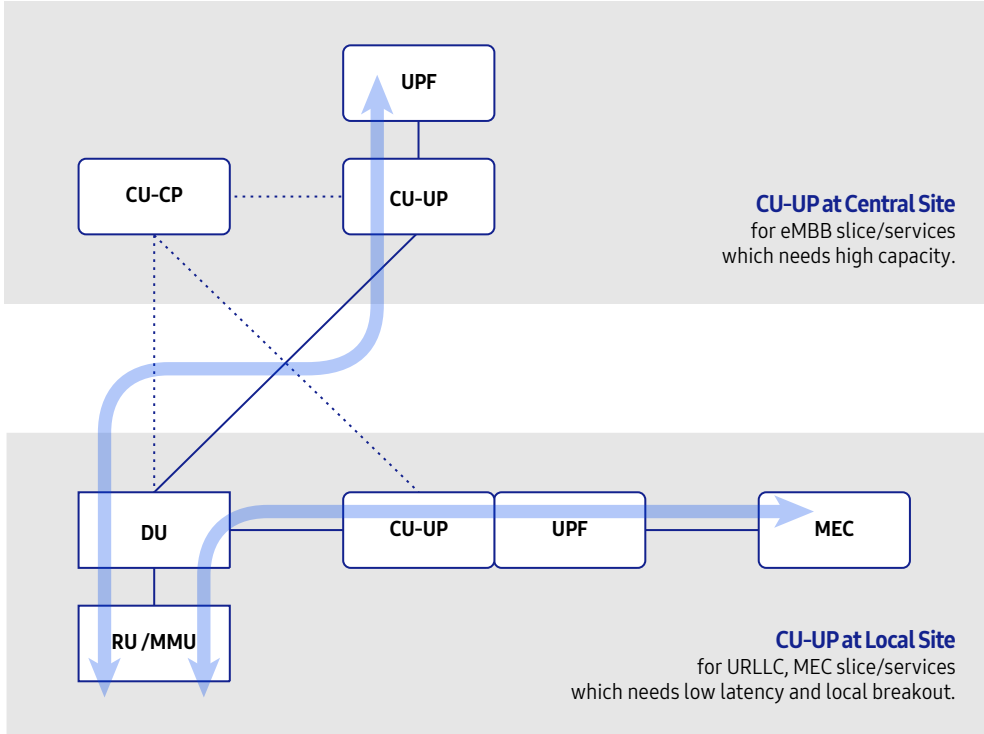

Figure 1-7. Flexibility in CU-IP deployment

CP/UP independent dimensioning and scaling

With CP/UP split along with CU virtualization, CP/UP separated resource allocation and scaling enables to adapt to the traffic patterns which varies according to the services. (FWA, eMBB, mMTC etc.) For 5G network, traffic pattern will be complicated because new services with different usage will be introduced. Conventional dimensioning typically designed for mobile service traffic pattern cannot adapt to these various traffic patterns of the new services. For example, mMTC services have high control traffic load and low user traffic load. FWA services have low control traffic load and high user traffic load. Flexible dimensioning and scaling of virtualized and disaggregated RAN well adapted to various traffic patterns can bring resource efficiency as well.

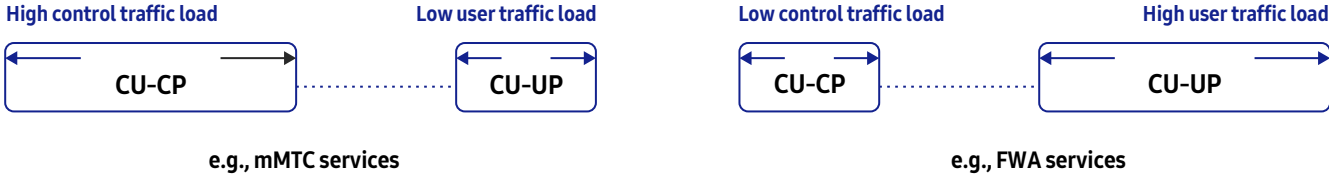

Figure 1-8. CP/UP independent dimensioning and scaling

Resource efficiency via resource pooling

In some modern networks today, a centralized RAN (C-RAN) architecture has been implemented in order to provide benefits in terms of resource pooling, reduce hardware requirements and footprint at the edge and simplify network operations and management overall. However, conventional DUs create a type of hard-limit in the benefit that can be gained from a C-RAN deployment due to the fixed capacity of each DU and the static boundary between each piece of hardware. Through virtualization of the DU functionality and separation of the network function from the hardware resources it requires, we gain the ability to flexibly allocate and scale resources independently and in a far more granular manner. For example, a conventional DU can experience severe load imbalance in some situations, such as separate DUs assigned between rural and urban areas, or in the case of anchor versus non-anchor DUs in a Dual Connectivity scenario. If we can instead pool the hardware resources independently of each DU function, we can flexibly assign resources to each DU only as needed, mitigating the potential for load imbalance to occur. Overall, this means that fewer resources are required due to gains in statistical multiplexing, i.e. there is less need to provide emergency overload capacity individually for each DU. The flexible dimensioning and scale in/out features of vRAN which enable efficient resource pooling are described in the following section.

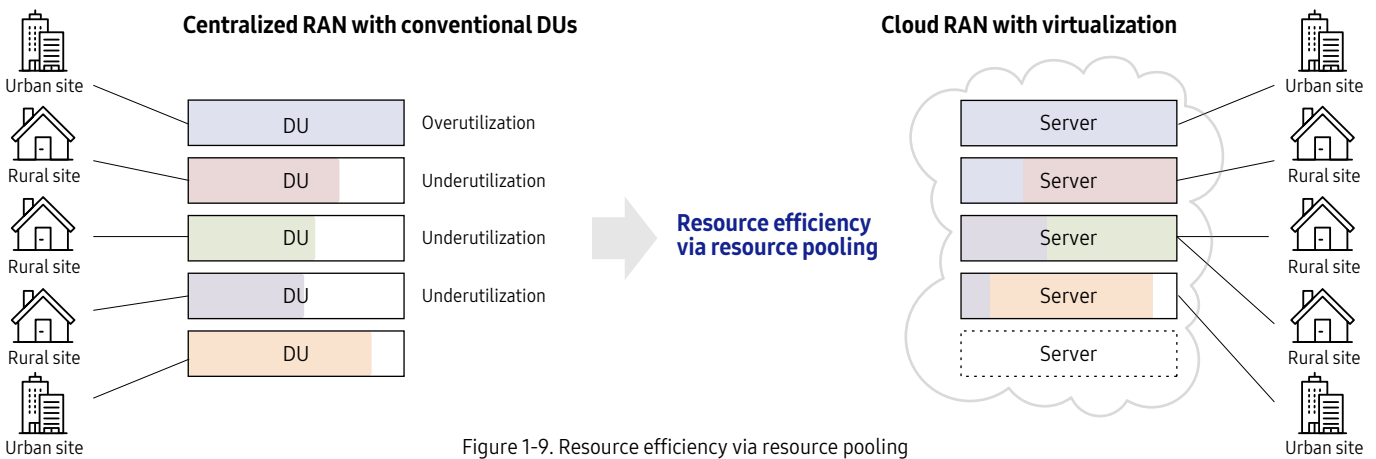

Figure 1-9. Resource efficiency via resource pooling

Flexible dimensioning with multiple flavors

vCU (CU-CP, CU-UP) and vDU consist of several components. Specific components have a flavor set for flexible dimensioning. A flavor defines the amount of resources to support certain capacity or performance. vCU&vDU can be built with various combination of flavors considering required network performance and capacity. This flexible dimensioning based on network virtualization enables optimization in constructing networks in terms of resources such as CPU core and memory.

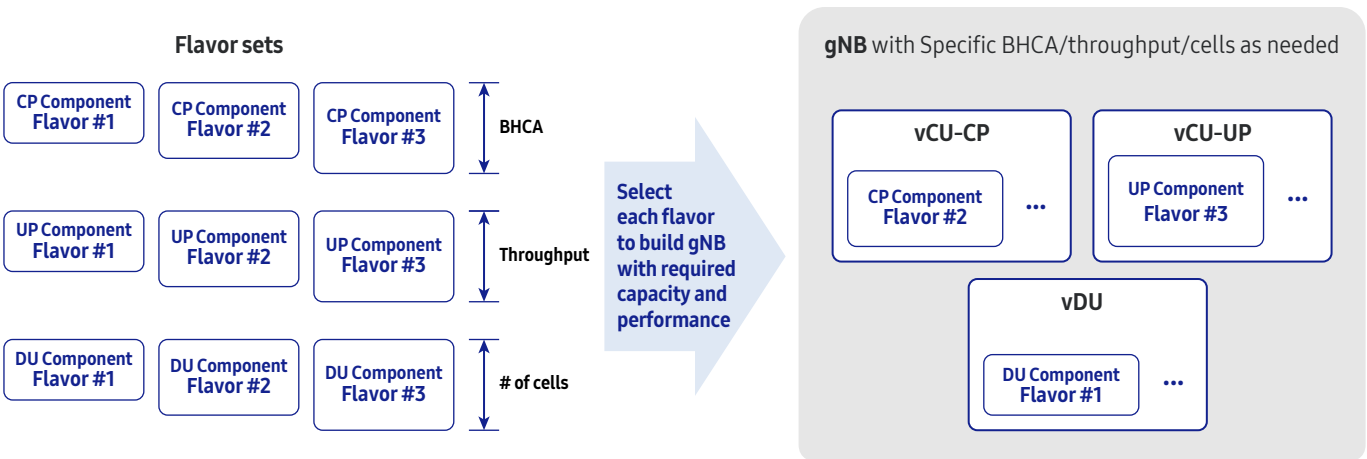

Figure 1-10. Flexible dimensioning with multiple flavors

Automatic/on-demand scale in/out of vCU

According to the each control/user traffic decreases and increases, CP Component and UP Component can be scaled in/out automatically or on-demand manner. This scale in/out enables dynamic resource adaptation to control/user traffic change respectively. Furthermore, because each components share common resources for scaling, resources can be utilized efficiently.

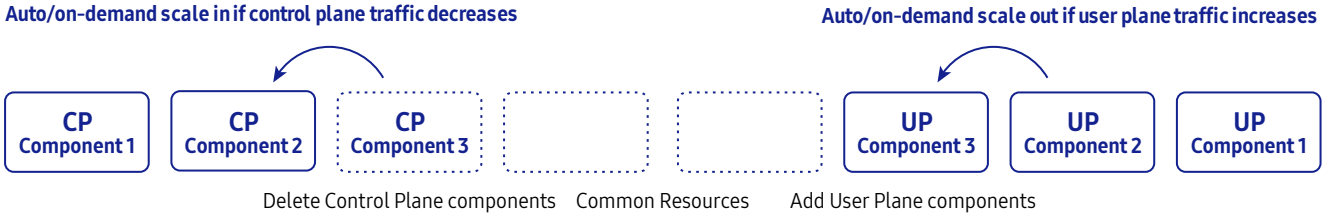

Figure 1-11. Automatic/manual scale in/out of vCU

On-demand scale in/out of vDU

As vDU support on-demand scaling for the DU Component, it does not have to be allocated HW resource of maximum vDU capacity for further network growth at initial deployment stage. Instead, it can start with a number of DU Components only required for the initial deployment. When more cells are required, vDU can increase its cell capacity by scaling-out the DU Component.

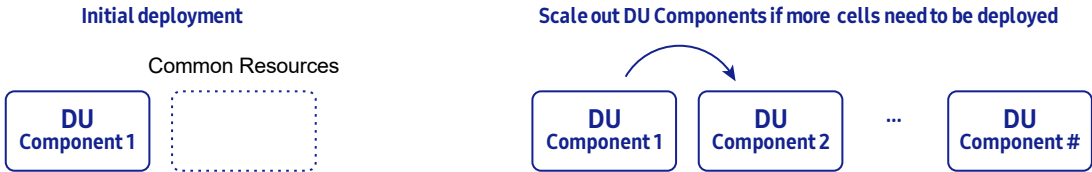

Figure 1-12. On-demand scale in/out of vDU

Key Technologies for Telco Quality

As we have discussed, virtualized and disaggregated architecture can generate a considerable number of benefits for RAN, from business agility and scalability to deployment flexibility and resource usage efficiency. In order for this concept of software-based RAN (and its associated benefits) to be realized, the service quality of the vRAN - as perceived by the user - must remain comparable to that of a dedicated hardware-based RAN. Commercial-grade wireless link performance and system reliability are key factors for a successful transition away from dedicated hardware. In this area, Samsung leans on its considerable global development experience to implement field-proven L1/L2 algorithms using state-of-the-art virtualization technologies to prevent performance degradation.

Field-proven Telco Experience into Samsung vRAN



L1/L2 acceleration on x86 server

The physical layer and MAC layer of a RAN consist of a set of functions with very high computational complexity: channel estimation and detection, Successive Interference Cancellation (SIC) for MIMO, Forward Error Correction (FEC), scheduling algorithms that handle resource allocation between users with different QoS requirements and channel conditions, and so on. Intel's Advanced Vector Extension (AVX) instruction set can be applied to many of these functions - especially those related to signal processing that involve vector operations. To further increase the capacity of the vDU, some computation-intensive task with repetitive structures, such as FEC, may be off-loaded to an FPGA, which can be optionally installed into a COTS server via a PCIe interface.

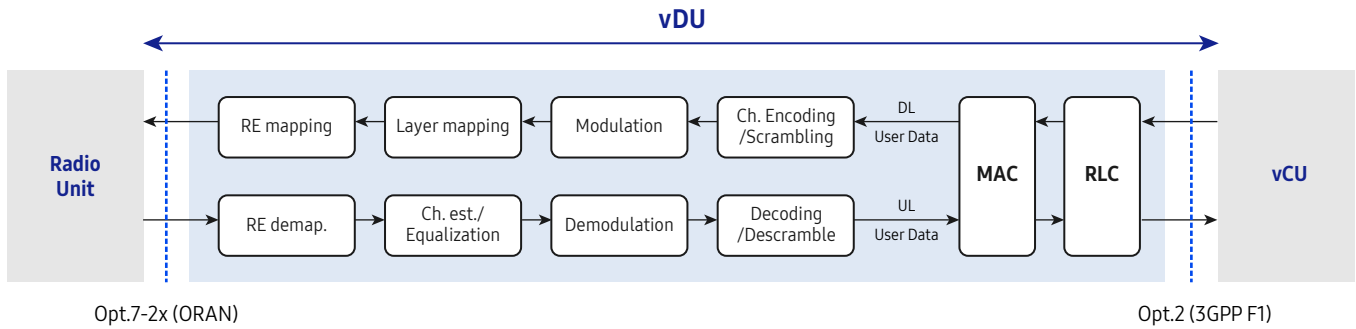

Figure 2-1. L1/L2 functions in vDU

Real time processing technique

User data received from the vCU (i.e. the downlink PDCP packets) passes through a chain of processes in the vDU to become physical layer packets. For successful transmission of these packets over the air, all processing must be completed before the designated time slot begins. Similarly in the uplink, the vDU recovers the information bit stream from the received uplink signals through channel estimation, demodulation and channel decoding, and sends a HARQ feedback to the corresponding user device within the given time budget. In order to meet this timing-stringent operation requirement, L1/L2 tasks in the vDU are carefully designed to be scheduled and completed. IT application software in general show unpredictable response times with a large deviation from the average. The figure below shows how such jittery processing times can affect vDU operation. In the case of conventional task scheduling, generated packets can frequently end up being discarded due to such unexpected delay, degrading link performance due to high packet loss rates.

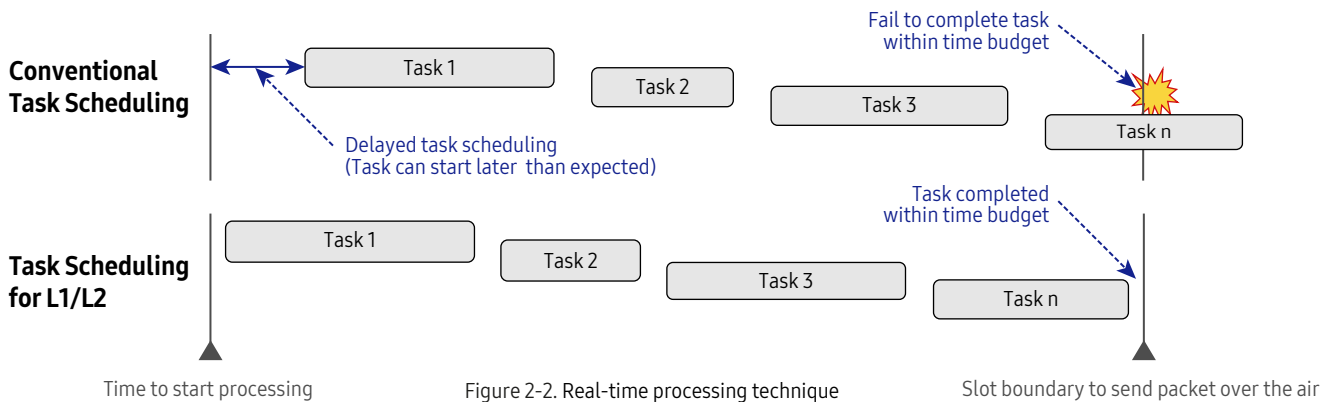

Figure 2-2. Real-time processing technique

Performance and capacity optimization

Efficient use of compute resources, as well as accelerated packet processing and networking, are crucial for a competitive vRAN design considering the large amount of data that vRAN must handle. One simple way to see this is to compare the fronthaul bandwidth to the user traffic rate. For example, in 16-QAM, just four bits of user data turns into a pair of I/Q samples composed of about 20 bits to ensure reasonable performance in a noisy, fading channel. In essence, vRAN needs a much higher packet handling capability for the radio-side interface than its backhaul interface. To get the best performance and capacity from x86-based COTS servers, Samsung vRAN adopts various virtualization techniques, including core pooling and pinning, DPDK and SR-IOV.

Telco grade reliability and availability

In modern society, it is easy to identify a growing reliance on communications across a variety of sectors, including business, finance and public safety. If a mobile communication service becomes unavailable for even a short period of time, serious collateral damage can result in terms of social disorder and monetary losses. To avoid such chaotic outcomes, each component of a network must maintain a high standard of telco-grade service availability and reliability - and the vRAN is no exception to this. Basic fault recovery and redundancy features commonly available in the IT domain are no sufficient. Samsung vRAN applies enhanced or newly designed health checks, fault recovery and geo-redundancy techniques to minimize service outages.

Introduction of Virtualized DU in 5G Networks

Virtualized DU for Network Slicing

Through network slicing, 5G networks can effectively and efficiently provide a wide variety of different service types (e.g., eMBB, URLLC, mMTC, etc.) in a given cell. Each network slice has its own service and performance requirement profile. For example, URLLC requires very low millisecond-scale latency and very high reliability in comparison to eMBB, where latency and reliability requirements are more relaxed but bandwidth is a key concern. In the case of mMTC on the other hand, individual traffic volumes are much lower, but

reliable device density is of prime importance. 5G networks must be capable of efficiently allocating hardware and radio resources for each of these separate services on a per-slice basis. While a traditional DU may be effective in the deployment of a large number of high-bandwidth, wideband NR cells thanks to the high performance of dedicated hardware technologies such as application-specific integrated circuits (ASICs), as networks begin to target more diverse service types virtualized DUs capable of flexibly adapting to customized traffic profiles will prove to be a valuable and cost-efficient approach.

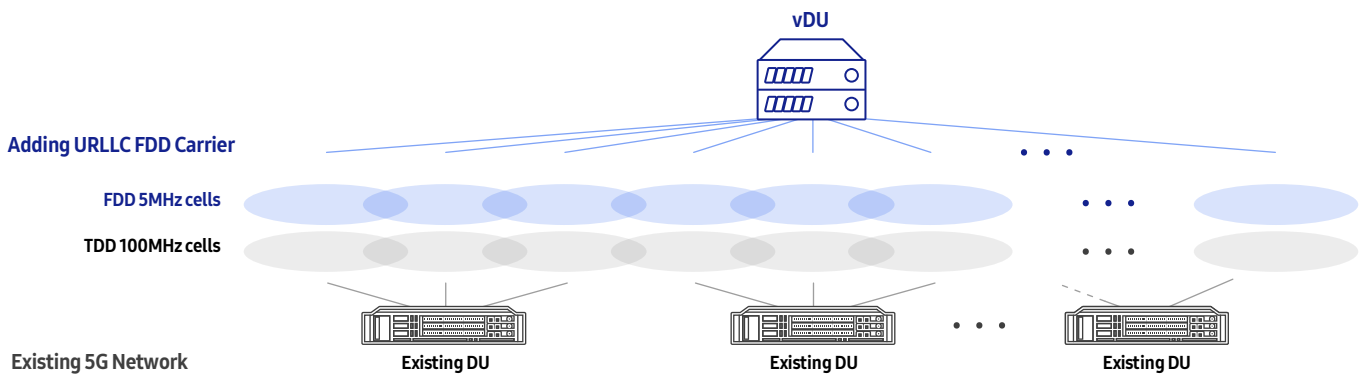

Virtualized DU can support large number of narrowband cells with small number of servers using resource pooling

Figure 3-1. Virtualized DU for network slicing

DU Separation for Secure Network Slice

Some network slice could need dedicated DUs separated from existing DUs to serve services like eMBB. For example, a security service could need extremely high security level to need separate

DU not to eavesdrop traffic packets. In the following diagram, on top of existing NR network, Virtualized DU is deployed for secure service slice. You can notice that RU is shared between two DUs through common layer.

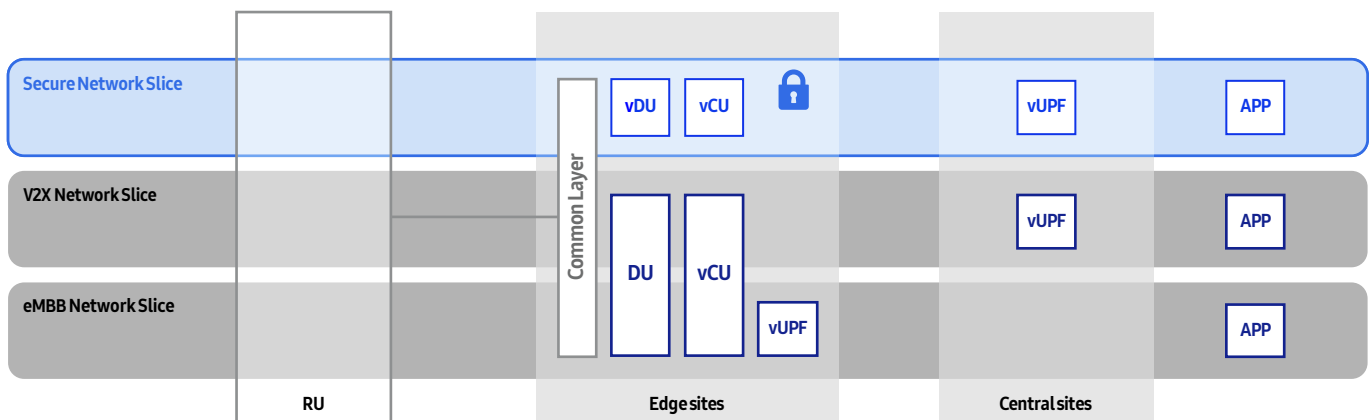

Figure 3-2. DU separation for security network slice

Next Step

In 2019, the stability and performance of Samsung vCU was proven through the massive deployment and commercial operation of 5G RAN in Korea and with major North American service providers. Samsung vCU is now evolving further towards containerization and additional enhancements to performance and quality. A containerized vDU will target global customers for commercial deployments in 2020, with an initial solution to target FDD deployments and introduction of support for NSA-to-SA migration, as well as Massive MIMO on TDD. These advanced features and services are targeted for support without the need for hardware replacement. Samsung strongly believes its future-proof RAN solution will form the cornerstone of 5G innovation and the expansion of our customers' business opportunities.

Abbreviations

3GPP	3rd Generation Partnership Project	MMU	Massive MIMO Unit
AMF	Access and Mobility Management Function	NR	New Radio
AVX	Advanced Vector Extension	OPEX	Operational Expenditure
CAPEX	Capital Expenditure	PDCP	Packet Data Convergence Protocol
CI/CD	Continuous Integration/Continuous Delivery	PHY	Physical Layer
CISM	Container Infrastructure Service Management	PHY-L	Physical Layer-Low
CP	Control Plane	PIM	Physical Infrastructure Management
CRAN	Centralized RAN	RAN	Radio Access Network
CU	Central Unit	RF	Radio Frequency
DPDK	Data Plane Development Kit	RLC	Radio Link Control
DRAN	Distributed RAN	RRC	Radio Resource Control
DU	Distributed Unit	RU	Radio Unit
eMBB	enhanced Mobile Broadband	SDAP	Service Data Adaptation Protocol
FEC	Forward Error Correction	SR-IOV	Single-Root Input/Output Virtualization
FECFR	Frequency Range	TDD	Time Division Duplex
FWA	Fixed Wireless Access	UE	User Equipment
gNB	5th Generation NodeB	UP	User Plane
HARQ	Hybrid Automatic Repeat Request	UPF	User Plane Function
k8s	kubernetes	URLLC	Ultra Reliable Low Latency Communication
MAC	Medium Access Control	vCU	virtualized Central Unit
MEC	Multi-access Edge Computing	VM	Virtual Machine
mMTC	massive Machine Type Communication	vRAN	virtualized RAN

SAMSUNG

About Samsung Electronics Co., Ltd.

Samsung inspires the world and shapes the future with transformative ideas and technologies. The company is redefining the worlds of TVs, smartphones, wearable devices, tablets, digital appliances, network systems, and memory, system LSI, foundry and LED solutions.

Address : 129 Samsung-ro, Yeongtong-gu, Suwon-si Gyeonggi-do, Korea

© 2019 Samsung Electronics Co., Ltd.

All rights reserved. Information in this leaflet is proprietary to Samsung Electronics Co., Ltd. and is subject to change without notice. No information contained here may be copied, translated, transcribed or duplicated by any form without the prior written consent of Samsung Electronics.

www.samsungnetworks.com

www.youtube.com/samsung5G