

General Product Catalogue 2021

For refrigeration, air conditioning, and heat pumps





Note

The components listed in this catalogue are not released for use with caustic, poisonous or flammable substances. Emerson Climate Technologies GmbH cannot be held responsible for any damage caused by using these substances.

General Information

Technical data provided herein is collected with scrutiny. However, errors and misprinting remain reserved. The technical data is presented for informational purposes only and they are not to be construed as warranties or guarantees, express or implied, regarding the products or services described or their use or applicability.

Technical data may be updated; should you require confirmation with respect to a specific value, please contact Emerson Climate Technologies GmbH and clearly state the information you require.

Emerson Climate Technologies GmbH and/or its affiliates (collectively "Emerson") shall not be liable for errors in the stated capacities, dimensions, etc., as well as typographic errors. Products, specifications, designs and technical data contained in this document are subject to modification by us without prior notice. Illustrations are not binding.

Emerson does not assume responsibility for the selection, use or maintenance of any product. Responsibility for proper selection, use and maintenance of any product remains solely with the purchaser and end-user.

The information given herein is based on data and tests which Emerson Climate Technologies GmbH believes to be reliable. Such information is intended for use by individuals having the appropriate technical knowledge and skills, at their own discretion and risk. Our products are designed and adapted for stationary application. When using our products in mobile applications, our products might fail. The suitability for such mobile applications has to be assured by the plant manufacturer; for this purpose appropriate tests might be necessary.

Scroll Compressors

- Comfort

• ZR Copeland™ Scroll Compressor Range for R513A, R407C and R134a	12
• YP Copeland Scroll Compressor Range for R32	16
• ZP Copeland Scroll Compressor Range for R410A	18
• ZP Copeland Scroll Air Conditioning Compressor Range, Optimized for Seasonal Performance	22
• ZPD & ZRD Copeland Scroll Digital Compressor Ranges for R513A, R410A and R407C	24
• YPV Copeland Scroll Variable Speed Compressor Ranges for R32	28
• XPV & ZPV Copeland Scroll Variable Speed Compressor Ranges for R410A	30
• YH Copeland Scroll Fixed Speed Compressor Range for A2L Refrigerants R454C and R452B	32
• ZH Copeland Scroll Fixed Speed Compressor Range for R410A and R407C	34
• YHV Copeland Scroll Variable Speed Compressor Ranges for A2L Refrigerants R452B and R454B	38
• XHV & ZHW Copeland Scroll Variable Speed Compressor Ranges for R410A	40
• ZH Copeland Scroll For Heat Recovery and High Condensing Applications for R134a	42
• ZRH(V) & YRH(V) Copeland Scroll Horizontal Compressor Ranges for R513A, R454C, R407C and R134a	44

- Refrigeration

• YB and YBD Copeland Scroll Compressor Range for Medium Temperature Refrigeration for Low GWP Refrigerants Classified as A2L	52
• ZB & ZBD Copeland Scroll Compressor Ranges for Medium Temperature Refrigeration	56
• ZF & ZFD Copeland Scroll Compressor Ranges for Low Temperature Refrigeration	62
• ZS, ZB & ZF*KA Copeland Scroll Small Compressor Range for Low and Medium Temperature Applications	70
• ZO & ZOD Copeland Scroll Compressor Ranges for R744-Subcritical Refrigeration	74
• Sound Shell for Copeland Scroll Compressors	76

Semi-Hermetic Reciprocating Compressors

- K and L Reciprocating Compressor Range	80
- Discus™ Reciprocating Compressor Range	86
- Discus Digital (3Cylinder) Reciprocating Compressor	92
- Copeland Compressor Electronics for Copeland Stream Semi-Hermetic Compressors	98
- Copeland Stream with Compressor Electronics, Semi-Hermetic Reciprocating Compressors	100
- Copeland Stream Digital with Compressor Electronics for Continuous Capacity Modulation	106
- Copeland Stream Compressors with Compressor Electronics for R744-Transcritical Applications	112
- Copeland Stream Compressors with Compressor Electronics for R744-Subcritical Applications	116
- Service Compressors for 4 and 6 Cylinder S-Series and Discus Reciprocating Compressors	118

Refrigeration Units

- Copeland Large Outdoor Refrigeration Units	122
- Copeland Outdoor Refrigeration Units for R744-Transcritical Applications	126
- Copeland ZX Outdoor Refrigeration Units for A2L Refrigerants	128
- Copeland ZX Outdoor Refrigeration Units with Scroll Compressors	132
- Copeland Small ZX Outdoor Refrigeration Units with Scroll Compressors	140
- Copeland ZX Indoor Refrigeration Units with Scroll Compressors	142
- Copeland Scroll Indoor Refrigeration Units for Refrigeration	144
- Copeland Scroll Digital Receiver Unit HLR	156
- Semi-Hermetic Refrigeration Units K/L	162
- Refrigeration Units with Semi-Hermetic Discus Compressors	166
- Refrigeration Units with Semi-Hermetic Stream Compressors	170
- Compressor Motor Codes Table	175

Controls*

- Electrical Control Valves	180
- Electronic Controllers and Sensors	192
- Thermo™- Expansion Valves	208
- Solenoid Valves	232
- Mechanical Pressure Regulators	242
- Pressure Controls and Thermostats	248
- System Protectors and Moisture Indicators	272
- Oil Management Components	292
- Suction Accumulators and Ball Valves	304
- Appendix	310
- Alco Keyword Register	316

* Full range of A2L released products can be found in each chapter



Pioneering Technologies for Best-in-Class Products

Emerson is a global technology and engineering company providing innovative solutions for customers in industrial, commercial, and residential markets. Emerson Commercial and Residential Solutions, one of Emerson's business platforms, provides advanced solutions for heating, ventilation, air conditioning and refrigeration, while ensuring human comfort and health, protecting food quality and safety, advancing energy efficiency, and creating sustainable infrastructure.

For more than 80 years we have been introducing innovative technology to the market, from the first semi-hermetic and hermetic compressors in the 1940s and 1950s, over the high efficiency Discus™, air conditioning and heating scroll compressors in the 1980s and 1990s, to the new Stream semi-hermetic compressors, the digital scroll compressor and the variable speed scroll with drive technology of today.

Based on this, we have developed an unequalled range of solutions for the refrigeration and air conditioning markets. In recent years, we have become a major solutions provider to the heat pump industry. Our range of Copeland™ compressors is engineered for higher efficiency, lower sound levels, superior durability and unsurpassed reliability. They allow the integration of new and environmentally-friendly refrigerants into your systems, while seamlessly improving efficiency and performance levels. Alco Controls™ is the leading provider of precision mechanical controls for the refrigeration and air conditioning markets, and together with the range of Emerson electronic controls we continue to pioneer the control of refrigerant flow with innovative design, keeping system performance optimization central to our product development.

More than 1,250 employees develop and deliver Emerson's high-class technology and manufacture our products in four European plants: Belgium, Northern Ireland and the Czech Republic (two plants). R&D centers in Welkenraedt (Belgium) and Mikulov (Czech Republic) enable new developments not only to meet our customers' requirements, but also to redefine the limits of technology.

With sales offices in Germany, France, Spain, Italy, the United Kingdom, Scandinavia, Benelux, Poland, as well as in Eastern Europe and Russia, Emerson supports its European customers in a lean and efficient manner, supporting the industry with advanced technology, technical support and training services.



Our 2021 product catalogue gives a comprehensive overview of Emerson, Copeland and Alco Controls products. Take a look and discover our broad product ranges including these innovations:

- New YP and YPV scroll compressors for cooling-only and reversible systems up to 700kW for R32
- New YH and YHV scroll compressors for low GWP refrigerants R454C and R452B
- New ZRH*KTR, ZRHV*KTR, YRH*KTE and YHRV*KTE horizontal scroll compressors for R513A, R454C, R407C and R134a, for the specific needs of transport air conditioning.
- New YB and YBD scroll compressors for medium temperature refrigeration for low GWP refrigerants such as R455A, R454A, R454C, as well as R1234yf (YB only)
- New line of ZX outdoor refrigeration units for A2L refrigerants, with fix speed and digital capacity modulation, for medium temperature applications

More in-depth technical data is available through our user-friendly Copeland and Alco selection software tools accessible via our web page www.climate.emerson.com/en-gb. For individual consultancy and service please contact your European sales office.



Supporting Your Transition to Sustainable Refrigerant Solutions

The F-Gas regulation is one of the dominating challenges of our industry today, posing new limitations to refrigerant choice and impacting system architecture. As the phasedown of HFCs continues globally, the challenge is to identify truly sustainable alternatives that maximize the environmental, economic, and operational benefits. Emerson's broad portfolio of solutions includes natural options such as CO₂ (R744) and propane (R290), as well as HFO and HFO blends to address these needs. The pros and cons of all options must be taken into consideration.

At Emerson, we don't believe that "one refrigerant fits all." Our comprehensive portfolio of products and solutions designed for a variety of refrigerants enables our customers to find the right fit for their architecture and create efficient, F-Gas-compliant, future-proof systems.

Emerson offers the broadest selection of compressors on the market, leveraging the use of multiple technologies and refrigerants — including natural and low-GWP options—to ensure end-users achieve the best seasonal efficiencies.

Solutions for Low GWP A2L HFO Refrigerants

Emerson offers long-term alternatives to system owners and contractors through our solutions with A2L refrigerants:

- New Copeland™ scroll YP and YPV compressors for cooling-only and reversible systems up to 700kW for R32. R32 is expected to become the most used low GWP refrigerant to replace R410A in commercial air conditioning and heating in Europe, thanks to its wide availability, performances, favorable cost and low charge.
- New YH fixed speed scroll compressors for R454C and R452B, for residential heating applications
- New YHV variable speed scroll compressors for R452B and R454B, for residential heating applications
- New YB and YBD line of standard and digital scroll compressors for medium temperature refrigeration, for R455A, R454A, R454C
- New generation of Copeland ZX outdoor refrigeration units for A2L refrigerants, equipped with YB and YBD scroll compressors
- A full range of controls and electronics, fully released for A2L refrigerants

Compared to previous systems with A1 refrigerants, systems with A2L refrigerants require additional system safety measures because of their slight flammability. Emerson marks all compressors/units that are qualified for A2L refrigerants with a sticker indicating the usage of flammable refrigerants. Therefore, for systems using such flammable refrigerants, a dedicated risk assessment must be carried out by the user to ensure compliance with all applicable legislation and regulations such as, but not limited to EN 378.



Solutions for Natural Refrigerants

R290 has zero ozone depletion potential, negligible global warming potential, as well as excellent thermodynamic properties. It has long been known for its good refrigerating performance, but also for its flammability and, consequently, implies strict considerations for manufacturers in terms of system design and operation. R290 systems require in average half the charge of hydrofluorocarbons (HFCs). Emerson offers R290 fixed speed and variable scroll compressors for refrigeration, heating and air conditioning, both in stationery and transport applications. Please refer to our separate R290 Product Guides for more information.

R744 is a leading option for environmental reasons, and it can be a winner for power consumption as developments of component technology and application methods continue to reveal potential performance gains. The system pressures are much higher than in conventional systems, and all Emerson components are designed accordingly. Emerson offers a wide portfolio of innovative products tailored for CO₂ refrigeration systems. Please refer to our separate CO₂ Product Guide for more information.

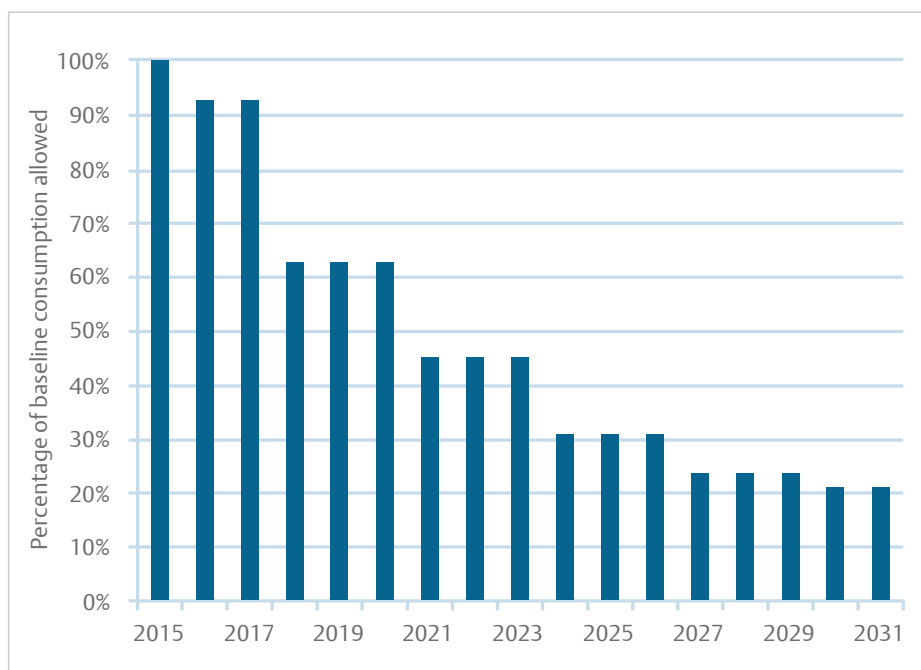

EU HFC Phase Down Steps



Copeland™ Scroll Compressors

With the launch of scroll technology in the mid 1980s, Emerson revolutionized the market setting new standards in the air conditioning industry. Since then, Copeland scroll has become the reference not only in air conditioning but in refrigeration and heating applications too. Thousands of customers trust our proprietary technology: today, over 100 million Copeland scroll compressors are installed worldwide, more than any other scroll compressor brand. Copeland scroll compressors range from 1.5 to 60 hp and are designed to work with all the main refrigerants, including CO₂. With compressors built in both vertical and horizontal versions and capable of digital modulation, Emerson has expanded the capability of scroll technology to new heights.

Additional innovations such as Enhanced Vapor Injection, the new Variable Speed scroll with drive technology for heat pump compressors or the design

of the Emerson sound shell give manufacturers, installers and end users the right tools to reduce the carbon footprint of their installations, optimize system design, efficiency, sound and reliability, while ensuring long equipment lifetime and minimizing capital and operating costs.

Applications for scroll compressors continue to grow thanks to innovation and adaptation. Industry as a whole has embraced its responsibility to put the environment first in its list of priorities, and this has led to strategic imperatives such as the need to introduce larger capacity scrolls with improved seasonal performance, modulated systems and products designed for use with low GWP refrigerants such as “natural” compounds (R744, R290), R32 and HFO blends. Emerson is staying abreast of these challenges by successfully further developing its technologies in each of these areas.



Copeland™ Mobile App: Compressor Replacement at your Fingertips

The Copeland Mobile app provides service technicians with on-the-go access to Emerson's database of product information for Copeland compressors. The users now have direct access to more than 3,000 models of (service) compressors for air conditioning, heating and refrigeration applications on their mobile phones.

Directly linked to Select Online Software database, the app helps find cross reference service replacements for the searched compressor models and gives access to a large network of official wholesalers, across Europe.

The Copeland Mobile app features:

- WebApp, linked to Select Online
- Model Search/ Barcode scanning
- Replacement model cross-reference
- Auto-fill model recommendations
- Where to buy search
- Full parts, accessories and bill of materials listings
- Complete air conditioning, heating and refrigeration compressor model information
- Metric units' conversion

The app is available in 3 languages and can be accessed both in desktop version and mobile via Apple Store or Android Play Store.

Find more details about our mobile apps at: <https://climate.emerson.com/en-gb/tools-resources/mobile-apps>





Comfort Applications

Comfort Applications

For decades, Emerson has driven advancement in the air conditioning and heat pump industry, leading the field with engineering products and systems that maximize the comfort of office and living spaces – while minimizing costs and inefficiencies.

Copeland™ scroll compressors are designed to deliver the highest performance in residential and commercial applications. Thanks to the widest selection of scroll compressors optimized for air conditioning and heating, it has never been easier to match all desired applications with the highest efficiency and reliability. The capacity of our single scrolls ranges from 1.5 to 60hp and they can reach an overall capacity of 180 hp per circuit when combined in even and uneven tandems and trios. Whether your need is a cooling optimized, heating optimized or reversible unit, you will find the most advanced technology within our range.

One of the most important recent innovations for comfort applications has been the introduction of variable speed technology. It was first introduced with the ZHW compressors (featuring Enhanced Vapor Injection), as a solution for residential heat pump applications. In addition to the R410A ZHW and XHV ranges for residential applications, and the R410A XPV and ZPV variable speed ranges for commercial comfort, we now also offer

alternatives with a lower global warming potential for the same applications. Increasingly stringent regulations, like F-Gas, are leading the shift towards low GWP refrigerants in conjunction with the requirements for maximizing the energy efficiency and driving the HVACR market towards more sustainable choices. Browse this catalogue to find out more about our compressors for R454C and R452B, suitable for heat pumps, plus the R32-optimized range for chillers, reversible units, precision cooling systems and rooftops.

We have extended our range of horizontal scroll compressors for transport air conditioning applications to include natural and low-GWP options. Their design and modulation capabilities are well suited for the needs of the passenger transport market.

ZR Copeland™ Scroll Compressor Range for R513A, R407C and R134a

ZR Copeland scroll compressors were developed for comfort and process/precision cooling applications using R513A, R407C and R134a.

Applied in the air conditioning and comfort industry for water chillers, rooftops and close control unit applications, scroll compressors are now the most used compression technology replacing reciprocating and screw compressors due to its undeniable superiority. Several, fully Copeland qualified, multiple compressor assemblies (tandem and trio) are available to allow the use of Copeland scroll compressors into large capacity systems (ex. up to 500kW air cooled chillers) able to deliver optimal comfort, low operating cost with higher seasonal efficiency (SEER). To support the new market needs of customers, Emerson offers scroll compressors for R513A, a low-pressure refrigerant with a low GWP of 631. These ranges are able to reach 5K Superheat which allows better system performance optimization and cost.

The range of products goes from the ZR18 (1.5hp) to the ZR380 (30hp) for R407C and R134a and from ZR24KRE (2hp) to ZR190KRE (15hp) for R513A, R407C and R134a.



ZR scroll compressor

ZR Scroll Compressor Line-up R407C

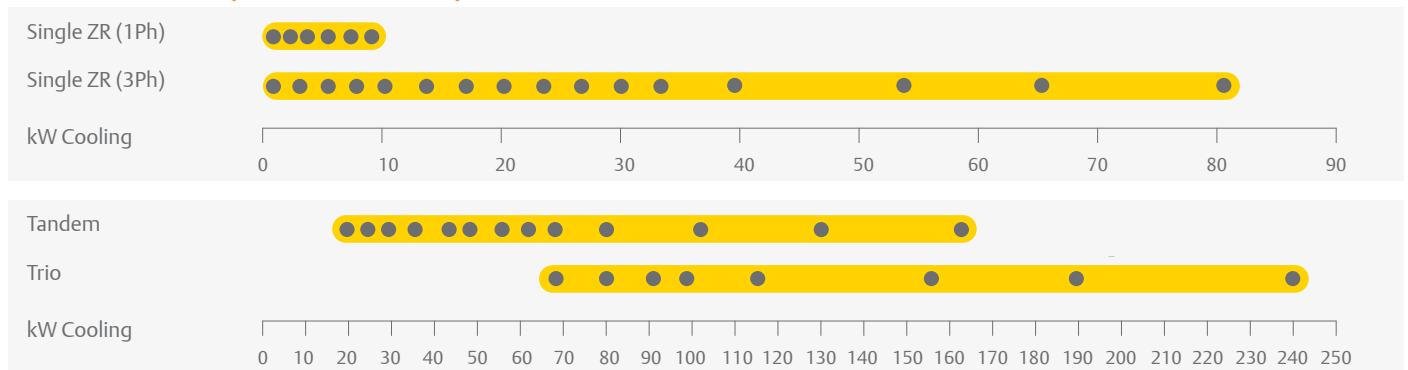

Conditions EN12900: Evaporating 5°C, Condensing 50°C, Superheat 10K, Subcooling 0K

ZR Scroll Compressor Line-up R513A

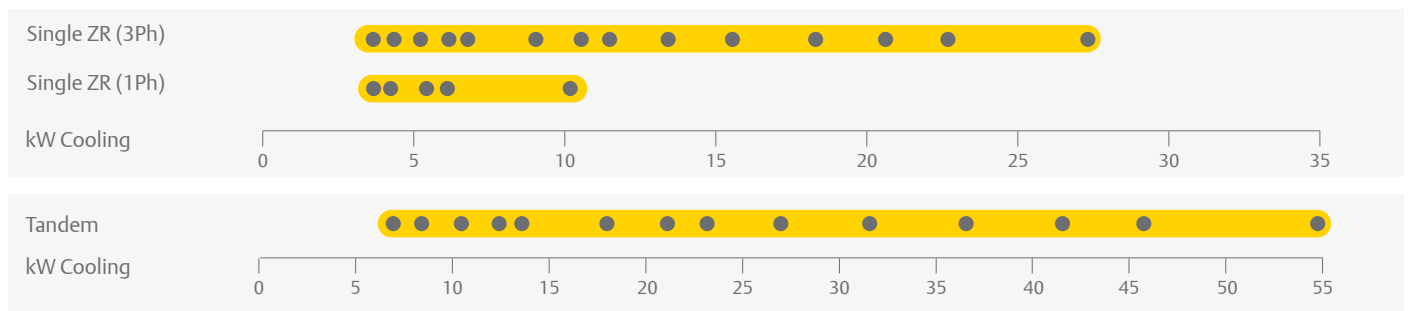

Conditions EN12900: Evaporating 5°C, Condensing 50°C, Superheat 10K, Subcooling 0K

Features and Benefits

- Copeland scroll axial and radial compliance for superior reliability and efficiency
- Wide scroll line-up for R407C, R134a and R513A
- Low TEWI (Total Equivalent Warming Impact)
- Low sound and vibration level
- Low oil circulation rate
- Copeland qualified tandem and trio configurations for superior seasonal efficiency (SEER)

Maximum Allowable Pressure (PS)

- ZR24 to ZR81:
Low side PS 21 bar(g) / High Side PS 29 bar(g)
- ZR94 to ZR380:
Low side PS 20 bar(g) / High Side PS 32 bar(g)

Operating Envelope R407C

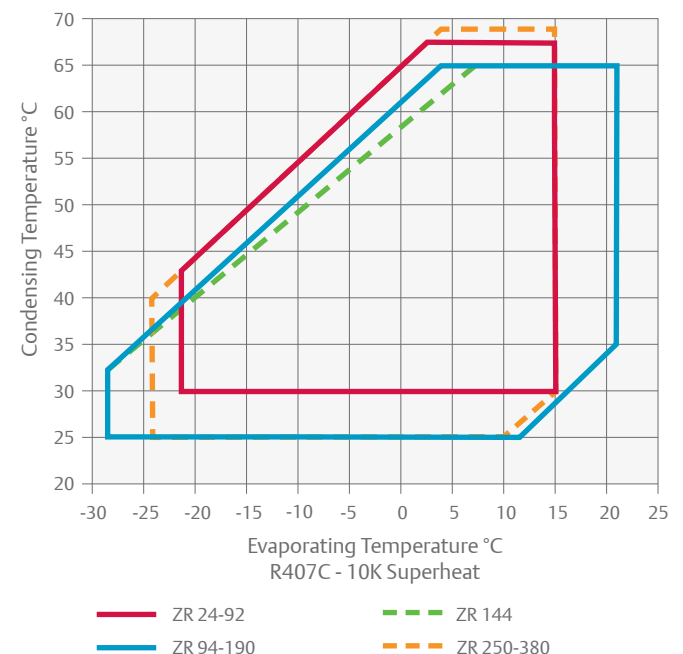

Operating Envelope R513A

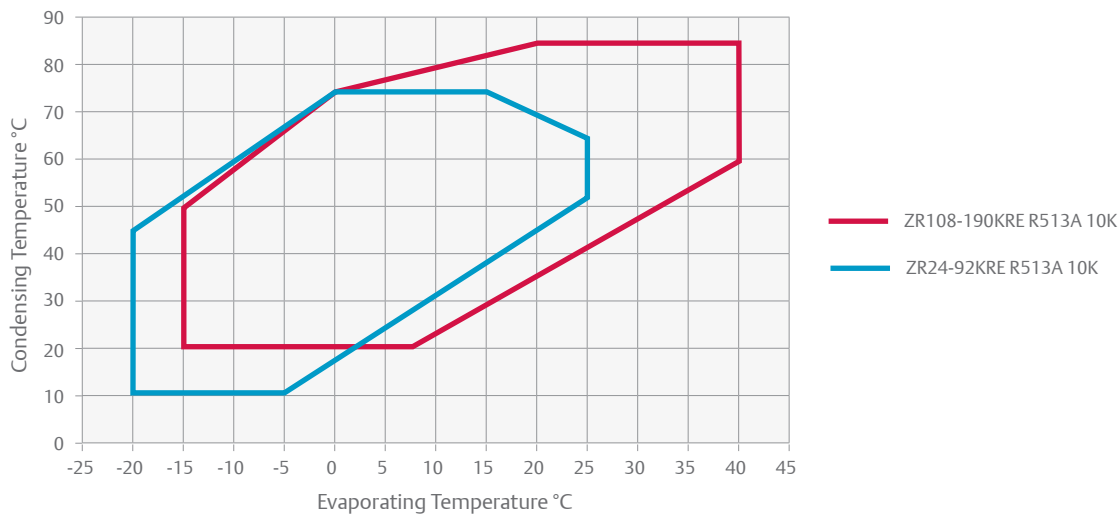

Technical Overview ZR* KRE

Models	Nominal hp	R513A/R134a Capacity (kW)	R407C Capacity (kW)	EER	Displacement (m ³ /h)	Stub Suction (inch)	Stub Discharge (inch)	Oil Quantity (l)	Length/Width/Height (mm)	Net Weight (kg)	Motor Version/Code		Maximum Operating Current (A)		Locked Rotor Current (A)		Sound Pressure @1 m (dBA) ***
											1 Ph*	3 Ph**	1 Ph*	3 Ph**	1 Ph*	3 Ph**	
ZR24KRE	2.0	3.5	5.0	3.0	5.9	3/4	1/2	0.7	239/245/364	25	PFJ	TFD	13	5	58	26	54
ZR28KRE	2.5	4.2	5.9	2.9	6.8	3/4	1/2	1.1	239/245/364	27	PFJ	TFD	13	7	61	32	54
ZR36KRE	3.0	5.2	7.6	3.1	8.6	3/4	1/2	1.2	239/245/387	29	PFJ	TFD	16	7	82	40	55
ZR42KRE	3.5	6.2	8.9	3.2	10.0	3/4	1/2	1.1	239/245/400	28	PFJ	TFD	19	9	97	46	56
ZR48KRE	4.0	6.9	10.3	3.1	11.4	7/8	1/2	1.5	239/245/417	29		TFD		10		50	57
ZR61KRE	5.0	9.0	13.0	3.2	14.4	7/8	1/2	1.9	246/257/438	37		TFD		13		66	58
ZR69KRE	5.5	10.2	14.3	3.2	16.2	7/8	1/2	1.9	246/257/438	43	PFJ		36		150		59
ZR72KRE	6.0	10.6	15.4	3.4	17.1	7/8	1/2	1.9	246/257/438	40		TFD		13		74	61
ZR81KRE	6.5	11.6	16.6	3.2	18.8	7/8	3/4	1.8	246/257/443	39		TFD		14		101	61
ZR92KRE	8.0	13.5	18.8	3.2	21.4	7/8	3/4	1.9	246/257/443	40		TFD		16		102	65
ZR108KRE	9.0	15.8	23.0	3.2	25.0	1 3/8	7/8	3.3	281/285/533	60		TFD		18		111	63
ZR125KRE	10.0	18.4	27.0	3.3	29.1	1 3/8	7/8	3.3	264/285/533	61		TFD		20		118	63
ZR144KRE	12.0	20.8	30.9	3.2	33.2	1 3/8	7/8	3.3	281/285/533	61		TFD		22		118	64
ZR160KRE	13.0	22.9	33.4	3.1	36.4	1 3/8	7/8	3.4	281/285/552	65		TFD		28		140	68
ZR190KRE	15.0	27.4	39.3	3.1	43.3	1 3/8	7/8	3.4	281/285/552	66		TFD		35		174	71

Conditions EN12900 : Evaporating 5°C, Condensing 50°C, Superheat 10K, Subcooling 0K
* 1 Ph: 230V/ 50Hz

** 3 Ph: 380-420V/ 50Hz

*** @ 1m: sound pressure level at 1m distance from the compressor, free field condition
Preliminary data

Technical Overview ZR* KCE

Models	Nominal hp	R407C Capacity (kW)	EER	Displacement (m ³ /h)	Stub Suction (inch)	Stub Discharge (inch)	Oil Quantity (l)	Length/Width/Height (mm)	Net Weight (kg)	Motor Version/ Code		Maximum Operating Current (A)	Locked Rotor Current (A)	Sound Pressure @1 m (dBA) ***
										3 Ph**	3 Ph**			
ZR108KCE	9.0	23.0	3.4	25.0	1 3/8	7/8	3.3	281/285/533	60	TFD		18	111	63
ZR125KCE	10.0	27.0	3.4	29.1	1 3/8	7/8	3.3	264/285/533	61	TFD		20	118	63
ZR144KCE	12.0	30.9	3.4	33.2	1 3/8	7/8	3.3	281/285/533	61	TFD		22	118	64
ZR160KCE	13.0	33.4	3.2	36.4	1 3/8	7/8	3.4	281/285/552	65	TFD		28	140	67
ZR190KCE	15.0	39.3	3.2	43.3	1 3/8	7/8	3.4	281/285/552	66	TFD		35	174	69
ZR250KCE	20.0	52.2	3.2	56.6	1 5/8	1 3/8	4.7	427/376/726	139	TWD		42	225	72
ZR310KCE	25.0	65.0	3.2	71.4	1 5/8	1 3/8	6.8	447/390/724	160	TWD		52	272	74
ZR380KCE	30.0	80.1	3.4	87.5	1 5/8	1 3/8	6.3	447/427/724	177	TWD		63	310	77

Conditions EN12900 : Evaporating 5°C, Condensing 50°C, Superheat 10K, Subcooling 0K
** 3 Ph: 380-420V/ 50Hz

*** @ 1m: sound pressure level at 1m distance from the compressor, free field condition
Models ZR22K3E-ZR48K3E, ZR61KCE and ZR61KCE-ZR81KCE are available as service compressors

Capacity Data

Condensing Temperature 50°C															
R513A		Cooling Capacity (kW)						R513A		Power Input (kW)					
		Evaporating Temperature (°C)								Evaporating Temperature (°C)					
Model	-15	-10	-5	0	+5	+10	+15	Model	-15	-10	-5	0	+5	+10	+15
ZR24KRE	1.3	1.7	2.2	2.8	3.5	4.4	5.3	ZR24KRE	1.3	1.3	1.2	1.2	1.2	1.2	1.2
ZR28KRE	1.6	2.1	2.7	3.4	4.2	5.1	6.2	ZR28KRE	1.4	1.4	1.4	1.4	1.4	1.4	1.4
ZR36KRE	2.1	2.7	3.4	4.2	5.2	6.4	7.8	ZR36KRE	1.8	1.8	1.7	1.7	1.7	1.7	1.7
ZR42KRE	2.4	3.1	4.0	5.0	6.2	7.5	9.1	ZR42KRE	2.0	2.0	2.0	2.0	2.0	2.0	2.0
ZR48KRE	2.8	3.6	4.5	5.6	6.9	8.4	10.3	ZR48KRE	2.3	2.3	2.3	2.3	2.3	2.3	2.3
ZR61KRE	3.5	4.6	5.9	7.3	9.0	11.0	13.2	ZR61KRE	2.9	2.9	2.9	2.8	2.8	2.8	2.9
ZR69KRE**	4.0	5.2	6.6	8.2	10.2	12.4	14.9	ZR69KRE**	3.2	3.2	3.2	3.2	3.2	3.2	3.2
ZR72KRE	4.2	5.4	6.9	8.6	10.6	12.9	15.5	ZR72KRE	3.3	3.3	3.2	3.2	3.2	3.2	3.2
ZR81KRE	4.8	6.1	7.6	9.4	11.6	14.2	17.1	ZR81KRE	3.8	3.8	3.8	3.7	3.7	3.7	3.7
ZR92KRE	5.7	7.1	8.9	11.0	13.5	16.4	19.8	ZR92KRE	3.8	3.9	4.0	4.1	4.2	4.4	4.5
ZR108KRE	6.3	8.1	10.3	12.9	15.9	19.4	23.5	ZR108KRE	4.8	4.8	4.9	4.9	4.9	4.9	4.9
ZR125KRE	6.8	9.1	11.8	14.9	18.5	22.6	27.4	ZR125KRE	5.5	5.6	5.6	5.7	5.7	5.7	5.7
ZR144KRE	8.2	10.6	13.4	16.8	20.7	25.3	30.6	ZR144KRE	6.4	6.4	6.4	6.5	6.5	6.6	6.7
ZR160KRE	8.0	11.1	14.6	18.5	22.9	28.1	34.0	ZR160KRE	7.2	7.2	7.2	7.2	7.2	7.3	7.4
ZR190KRE	10.1	13.6	17.60	22.2	27.4	33.5	40.5	ZR190KRE	9.0	9.0	9.0	9.0	9.0	9.0	9.0

Conditions: Suction Superheat 10K / Subcooling 0K

** Single Phase only

Preliminary data

Condensing Temperature 50°C															
R134a		Cooling Capacity (kW)						R134a		Power Input (kW)					
		Evaporating Temperature (°C)								Evaporating Temperature (°C)					
Model	-15	-10	-5	0	+5	+10	+15	Model	-15	-10	-5	0	+5	+10	+15
ZR108KCE		8.1	10.3	12.8	15.7	19.1	23.0	ZR108KCE		4.6	4.6	4.7	4.7	4.7	4.7
ZR125KCE		9.1	11.8	14.8	18.3	22.3	26.9	ZR125KCE		5.3	5.4	5.4	5.4	5.5	5.5
ZR144KCE		11.2	14.3	17.5	21.0	24.8	29.0	ZR144KCE		6.1	6.3	6.3	6.3	6.3	6.4
ZR160KCE		11.1	14.5	18.3	22.7	27.8	33.6	ZR160KCE		6.8	6.9	6.9	7.0	7.0	7.2
ZR190KCE		13.6	17.5	22.0	27.2	33.1	40.1	ZR190KCE		8.5	8.5	8.6	8.6	8.6	8.7
ZR250KCE		18.4	23.2	28.9	35.5	43.3	52.2	ZR250KCE		10.9	10.9	11.0	11.1	11.2	11.4
ZR310KCE		22.3	28.3	35.2	43.3	52.8	63.7	ZR310KCE		13.3	13.5	13.6	13.7	13.9	14.1

Conditions: Suction Superheat 10K / Subcooling 0K

Condensing Temperature +50°C															
R407C		Cooling Capacity (kW)						R407C		Power Input (kW)					
		Evaporating Temperature (°C)								Evaporating Temperature (°C)					
Model	-15	-10	-5	0	+5	+10	+15	Model	-15	-10	-5	0	+5	+10	+15
ZR24KRE		2.6	3.3	4.1	5.0	6.1	7.3	ZR24KRE		1.8	1.8	1.7	1.7	1.7	1.7
ZR28KRE		3.0	3.8	4.8	5.9	7.2	8.6	ZR28KRE		2.0	2.0	2.0	2.0	1.9	1.9
ZR36KRE		4.0	5.0	6.2	7.6	9.2	11.0	ZR36KRE		2.4	2.4	2.4	2.4	2.4	2.4
ZR42KRE		4.6	5.9	7.3	8.9	10.8	12.8	ZR42KRE		2.9	2.9	2.8	2.8	2.8	2.8
ZR48KRE		5.4	6.8	8.4	10.3	12.5	14.9	ZR48KRE		3.2	3.2	3.2	3.2	3.1	3.1
ZR61KRE		7.1	8.8	10.8	13.0	15.6	18.7	ZR61KRE		4.0	4.0	4.0	4.1	4.1	4.1
ZR69KRE**		7.8	9.6	11.8	14.3	17.3	20.6	ZR69KRE**		4.9	4.8	4.7	4.5	4.3	4.1
ZR72KRE		8.0	10.1	12.5	15.4	18.6	22.2	ZR72KRE		4.7	4.7	4.7	4.7	4.7	4.7
ZR81KRE		8.2	10.6	13.3	16.6	20.3	24.6	ZR81KRE		5.3	5.3	5.3	5.3	5.3	5.4
ZR92KRE		9.6	12.2	15.2	18.8	22.9	27.6	ZR92KRE		6.0	6.1	6.2	6.2	6.2	6.2
ZR108KCE/KRE		12.2	15.3	18.9	23.0	27.9	33.4	ZR108KCE/KRE		6.8	6.8	6.9	6.9	6.9	6.9
ZR125KCE/KRE		14.0	17.7	22.0	27.0	32.6	39.1	ZR125KCE/KRE		8.0	8.0	8.0	8.1	8.1	8.1
ZR144KCE/KRE			20.1	25.2	30.9	37.4	44.8	ZR144KCE/KRE			9.1	9.1	9.1	9.1	9.2
ZR160KCE/KRE		15.9	20.8	26.7	33.4	41.3	50.3	ZR160KCE/KRE		10.3	10.3	10.3	10.3	10.4	10.4
ZR190KCE/KRE		19.8	25.5	31.9	39.3	47.7	57.3	ZR190KCE/KRE		12.2	12.3	12.3	12.3	12.4	12.5
ZR250KCE		27.5	34.5	42.7	52.2	63.2	75.8	ZR250KCE		15.9	16.0	16.1	16.3	16.4	16.6
ZR310KCE		33.5	42.4	52.8	65.0	79.1	95.4	ZR310KCE		20.0	20.0	20.0	20.2	20.4	20.6
ZR380KCE		40.1	51.8	64.9	80.1	97.6	118.0	ZR380KCE		23.9	24.1	24.3	24.4	24.6	24.9

Conditions: Suction Superheat 10K / Subcooling 0K

ZR* KRE Tandem Model Overview

Model	Tandem Assembly	Cooling Capacity (kW)		
		R407C	R513A	R134a
Even Tandem				
ZRT 48 KRE	2 x ZR24 KRE	10.0	7.0	7.2
ZRT 56 KRE	2 x ZR28 KRE	11.8	8.4	8.3
ZRT 72 KRE	2 x ZR36 KRE	15.2	10.4	10.5
ZRT 84 KRE	2 x ZR42 KRE	17.7	12.4	12.1
ZRT 96 KRE	2 x ZR48KRE	20.6	13.8	13.2
ZRT 122 KRE	2 x ZR61KRE	26.0	18.0	17.5
ZRT 144 KRE	2 x ZR72KRE	30.7	21.2	21.0
ZRT 162 KRE	2 x ZR81KRE	33.1	23.2	23.6
ZRT 184 KRE	2 x ZR92KRE	37.5	27.0	26.7
ZRT 216 KRE	2 x ZR108KRE	45.3	31.6	31.3
ZRT 250 KRE	2 x ZR125KRE	53.2	36.8	36.5
ZRT 288 KRE	2 x ZR144KRE	60.9	41.6	42.0
ZRT 320 KRE	2 x ZR160KRE	65.8	45.8	45.4
ZRT 380 KRE	2 x ZR190KRE	77.4	54.8	54.3

Conditions EN 12900: Evaporating 5°C, Condensing 50°C, Superheat 10K, Subcooling 0K
Tandem Assemblies by System Manufacturers. Emerson can provide full technical support.
Preliminary data

ZR* KCE Tandem Model Overview

Model	Tandem Assembly	Cooling Capacity (kW)	
		R407C	R134a
Even Tandem			
ZRT 188 KCE	2 x ZR94KCE	41.2	26.9
ZRT 216 KCE	2 x ZR108KCE	46.0	31.3
ZRT 250 KCE	2 x ZR125KCE	54.0	36.5
ZRT 288 KCE	2 x ZR144KCE	61.8	42.0
ZRT 320 KCE	2 x ZR160KCE	66.8	45.4
ZRT 380 KCE	2 x ZR190KCE	78.6	54.4
ZRT 500 KCE	2 x ZR250KCE	104.0	71.0
ZRT 620 KCE	2 x ZR310KCE	130.0	84.4
ZRT 760 KCE	2 x ZR380KCE	163.0	110.8
Uneven Tandem			
ZRU 315 KCE	ZR125KCE + ZR190KCE	66.3	45.5
ZRU 350 KCE	ZR160KCE + ZR190KCE	72.7	49.9
ZRU 440 KCE	ZR190KCE + ZR250KCE	91.5	62.7
ZRU 500 KCE	ZR190KCE + ZR310KCE	99.8	69.4
ZRU 560 KCE	ZR250KCE + ZR310KCE	112.7	77.7
ZRU 690 KCE	ZR310KCE + ZR380KCE	140.6	97.6

Conditions EN 12900: Evaporating 5°C, Condensing 50°C, Superheat 10K, Subcooling 0K
Tandem Assemblies by System Manufacturers. Emerson can provide full technical support.

YP Copeland™ Scroll Compressor Range for R32

The new YP compressors are designed for R32. Thanks to advanced Emerson technologies, they reach the same field of application as equivalent Copeland scroll compressors with R410A. This is achieved without liquid injection or economizer. A dedicated scroll set minimizes the discharge temperature caused by the high heat of compression of the R32 refrigerant. R32 has a GWP of 675 and has been used for many years as main ingredient of R410A and is widely available.

YP compressors can be used for cooling only systems, as well as for reversible systems up to 700kW.



YP Copeland scroll compressor

YP Scroll Compressor Line-up R32

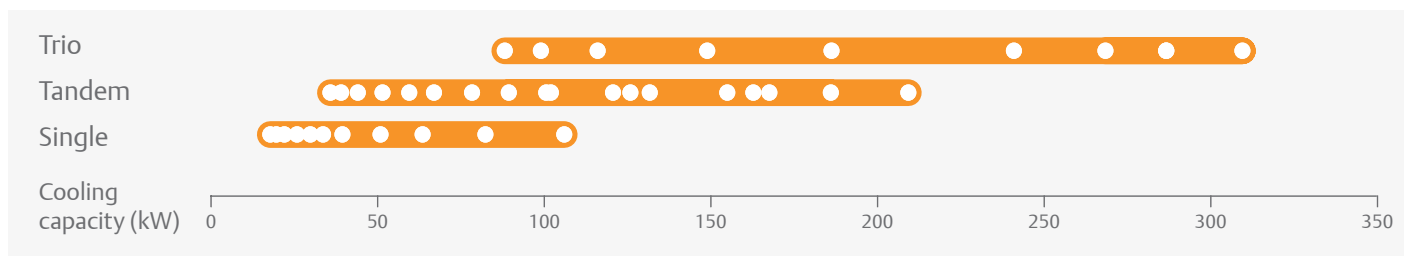

Features and Benefits

- Designed for R32
- Wide operating envelope
- Low leak discharge check valve
- High part load efficiency thanks to a variable compression ratio valve
- IP 54 terminal box
- Leak free hermetic design
- Tandem and trio capabilities
- Axial and radial compliance
- Emerson integrated solution ready

Maximum Allowable Pressure (PS)

- YP83 to YP91 and YP137
Low side PS 30.4 bar(g) / High Side PS 49 bar(g)
- YP104, YP122 and YP485
Low side PS 30.4 bar(g) / High Side PS 50 bar(g)

YP Operating Envelope

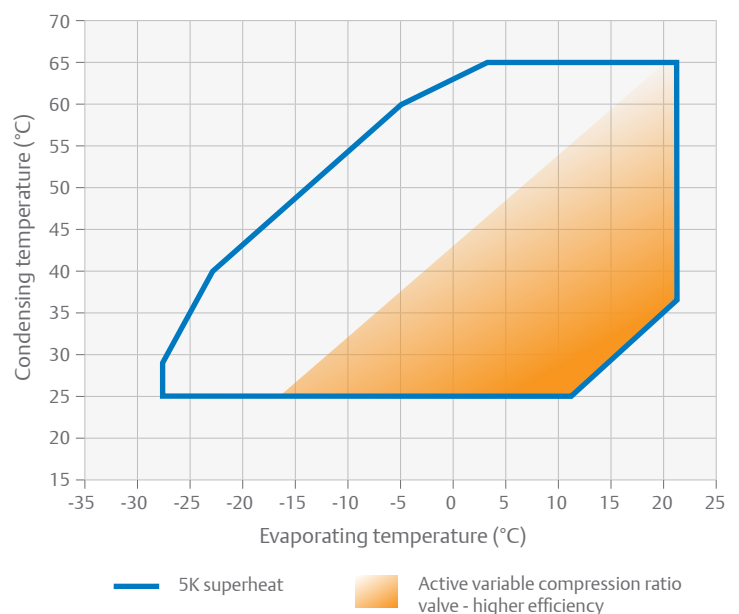

Technical Overview

Models	Nominal hp - TonR*	Cooling Capacity (kW)	EER	Stub Suction (inch)	Stub Discharge (inch)	Oil Quantity (l)	Length/Width/Height (mm)	PED Category	Net Weight (kg)	Motor Version/ Code	Maximum Operating Current (A)	Locked Rotor Current (A)
										3 Ph**	3 Ph**	3 Ph**
YP83K1T	7	18.8	3.2	7/8	1/2	1.8	246/246/443	2	40	TFD	15	101
YP91K1T	8	20.1	3.3	7/8	3/4	1.8	243/248/443	2	42	TFD	16	92
YP104K1T	9	23.4	3.3	1 1/8	7/8	2.5	297/262/559	2	49	TFD	18	128
YP122K1T	10	27.1	3.3	1 1/8	7/8	2.5	297/262/559	2	49	TFD	22	139
YP137K1T	11	30.9	3.3	1 3/8	7/8	3.3	271/285/551	3	63	TFD	24	118
YP154K1T	13	34.7	3.3	1 3/8	7/8	3.3	271/285/551	3	65	TFD	31	140
YP182K1T	15	40.6	3.3	1 3/8	7/8	3.3	271/285/551	3	66	TFD	34	174
YP232K1T	20	52.1	3.4	1 5/8	1 1/8	4.4	315/315/661	3	90	TND	38	241
YP292K1T	25	65.1	3.4	1 5/8	1 1/8	4.4	315/315/661	3	90	TND	49	288
YP385K1T	32	84.1	3.4	1 5/8	1 3/8	6.3	447/427/724	3	177	TND	65	310
YP485K1T	41	108.0	3.4	1 5/8	1 3/8	6.3	368/345/756	3	190	TND	83	408

Conditions EN12900 R32: Evaporating 5°C, Condensing 50°C, Superheat 10K, Subcooling 0K

TonR* : Ton of refrigeration at 60Hz

** 3 Ph: 380-420V/ 50Hz

Preliminary data

Capacity Data

Condensing Temperature +50°C															
R32	Cooling Capacity (kW)							R32	Power Input (kW)						
	Evaporating Temperature (°C)								Evaporating Temperature (°C)						
Model	-15	-10	-5	0	+5	+10	+15	Model	-15	-10	-5	0	+5	+10	+15
YP83K1T			13.1	15.8	18.8	22.2	26.0	YP83K1T			5.8	5.8	5.9	5.9	5.9
YP91K1T			13.9	16.8	20.1	23.9	28.2	YP91K1T			6.3	6.4	6.5	6.5	6.4
YP104K1T			16.2	19.5	23.4	27.8	32.8	YP104K1T			7.0	7.1	7.1	7.1	7.0
YP122K1T			18.9	22.7	27.1	32.1	37.8	YP122K1T			8.1	8.2	8.2	8.2	8.2
YP137K1T			21.5	25.9	30.9	36.5	42.8	YP137K1T			9.5	9.6	9.6	9.7	9.7
YP154K1T			24.2	29.2	34.7	41.0	48.1	YP154K1T			10.7	10.8	10.9	10.9	10.9
YP182K1T			28.2	34.1	40.6	48.0	56.3	YP182K1T			12.5	12.6	12.7	12.8	12.8
YP232K1T			36.8	43.9	52.1	61.4	72.0	YP232K1T			15.0	15.3	15.6	15.8	16.0
YP292K1T			45.9	54.9	65.1	76.8	90.0	YP292K1T			18.8	19.2	19.5	19.8	20.0
YP385K1T			59.6	71.0	84.1	99.7	118.5	YP385K1T			25.2	25.3	25.4	25.5	25.5
YP485K1T			75.7	90.8	108.0	128.0	150.0	YP485K1T			31.4	31.8	32.2	32.6	33.0

Conditions: Suction Superheat 10K / Subcooling 0K

Preliminary data

Tandem Model Overview

Model	Tandem Assembly	Cooling Capacity (kW)
Even Tandem YPT		
YPT 166 K	2 x YP 83 K1T	38
YPT 182 K	2 x YP 91 K1T	41
YPT 208 K	2 x YP 104 K1T	47
YPT 244x K	2 x YP 122 K1T	55
YPT 274 K	2 x YP 137 K1T	62
YPT 308 K	2 x YP 154 K1T	69
YPT 464 K	2 x YP 182 K1T	81
YPT 444 K	2 x YP 232 K1T	104
YPT 584 K	2 x YP 292 K1T	130
YPT 770 K	2 x YP 385 K1T	168
YPT 970 K	2 x YP 485 K1T	216

Model	Tandem Assembly	Cooling Capacity (kW)
Uneven Tandem YPU		
YPU 291 K	YP137 K1T + YP154 K1T	66
YPU 336 K	YP154 K1T + YP182 K1T	75
YPU 414 K	YP182 K1T + YP232 K1T	93
YPU 524 K	YP232 K1T + YP292 K1T	117
YPU 677 K	YP292 K1T + YP385 K1T	149
YPU 870 K	YP385 K1T + YP485 K1T	192

Conditions EN 12900: Evaporating 5°C, Condensing 50°C, Superheat 10K, Subcooling 0K

Tandem assemblies by system manufacturers. Emerson can provide full technical support.

ZP Copeland™ Scroll Compressor Range for R410A

ZP Copeland scroll compressors, for R410A, for comfort and process precision cooling applications. Emerson has been the pioneer in launching the first complete line-up of R410A commercial scroll compressors.

ZP Copeland scroll compressors are perfectly suitable for air-cooled chiller systems up to 900kW (1100 kW if water-cooled) featuring high comfort and superior seasonal efficiency (SEER / SEPR / SCOP). Whether used in stand-alone, tandem or trio configurations, the broad ZP Copeland scroll line-up meets today's market requirements with unmatched flexibility, efficiency and proven reliability.

ZP104, ZP122 and ZP143KCE compressors for light commercial systems have a reduced footprint and weight for more compact systems. Their high efficiency helps to reduce operating costs.



ZP scroll compressor

ZP Scroll Compressor Line-up

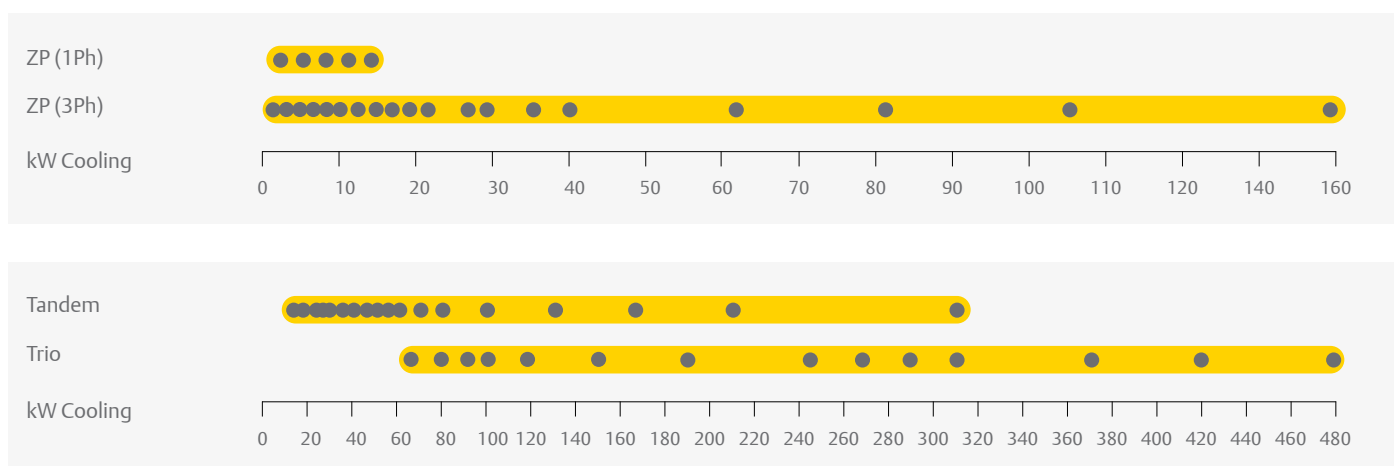

Conditions EN12900: Evaporating 5°C, Condensing 50°C, Superheat 10K, Subcooling 0K

Features and Benefits

- Copeland qualified tandem and trio (now also uneven configurations for superior seasonal efficiency (SEER / SEPR / SCOP)
- Copeland scroll axial and radial compliance for superior reliability and efficiency
- Extended 5K operating envelope suitable for heat pump applications
- Low TEWI (Total equivalent warming impact)
- Wide scroll line-up for R410A
- Low sound and vibration level
- Low oil circulation rate

Maximum Allowable Pressure (PS)

- ZP24 to ZP91:
Low side PS 28 bar(g) / High side PS 43 bar(g)
- ZP104 to ZP725:
Low side PS 29.5 bar(g) / High side PS 45 bar(g)

Operating Envelope R410A

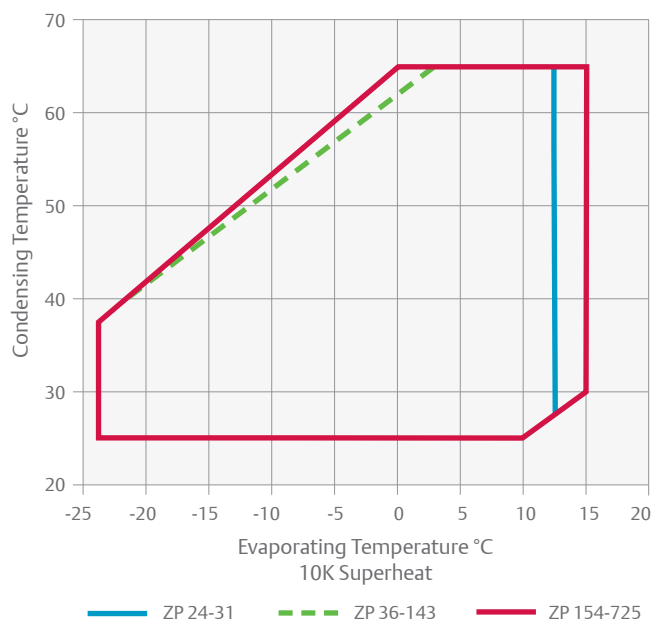

Technical Overview

Models	Nominal hp	Capacity (kW)	EER	Displacement (m ³ /h)	Stub Suction (inch)	Stub Discharge (inch)	Oil Quantity (l)	Length/Width/Height (mm)	Net Weight (kg)	Motor Version/ Code		Maximum Operating Current (A)		Locked Rotor Current (A)		Sound Pressure @1 m (dBA) ***
										1 Ph*	3 Ph**	1 Ph*	3 Ph**	1 Ph*	3 Ph**	
ZP24K5E	1.9	5.1	2.8	4.0	3/4	1/2	0.7	236/236/387	22	PFJ	TFD	13	5	60	28	55
ZP29K5E	2.2	6.0	2.8	4.8	3/4	1/2	0.7	246/246/387	23	PFJ	TFD	16	6	67	38	55
ZP31K5E	3.0	6.5	2.8	5.1	3/4	1/2	0.7	243/243/388	22	PFJ	TFD	17	7	67	38	55
ZP36K5E	2.6	7.6	2.9	6.0	7/8	1/2	1.2	243/243/506	32	PFJ	TFD	20	7	87	46	57
ZP42K5E	3.5	8.9	2.9	6.9	7/8	1/2	1.2	246/246/418	31	PFJ	TFD	21	8	98	43	57
ZP54K5E	4.6	11.5	3.0	8.9	7/8	1/2	1.2	246/246/418	34	PFJ	TFD	31	10	128	52	59
ZP61K5E	5.0	13.4	3.0	10.0	7/8	1/2	1.2	246/246/445	35		TFD		11		67	57
ZP72KCE	6.0	15.3	3.0	11.7	7/8	1/2	1.7	246/246/455	45		TFD		15		75	59
ZP83KCE	7.0	17.7	3.1	13.5	7/8	1/2	1.8	246/246/443	40		TFD		15		101	61
ZP91KCE	7.5	19.3	3.1	14.7	1 1/4	1 1/4	1.8	243/248/443	41		TFD		16		101	61
ZP104KCE	9.0	22.7	3.2	16.8	1 1/8	7/8	2.5	297/262/559	49		TFD		18		128	60
ZP122KCE	10.0	26.5	3.2	19.6	1 1/8	7/8	2.5	297/262/559	49		TFD		22		139	61
ZP143KCE	12.0	31.6	3.2	23.1	1 1/8	7/8	2.8	270/262/559	49		TFD		25		146	61
ZP154KCE	13.0	33.1	3.2	24.9	1 3/8	7/8	3.3	281/285/552	65		TFD		31		140	66
ZP182KCE	15.0	39.0	3.2	29.1	1 3/8	7/8	3.3	281/285/552	66		TFD		34		174	66
ZP385KCE	30.0	82.4	3.2	60.8	1 5/8	1 3/8	6.3	448/392/715	178		TWD		65		310	74
ZP485KCE	40.0	105.0	3.2	77.3	1 5/8	1 3/8	6.3	368/345/756	190		TWD		83		408	78
ZP725KCE	60.0	159.5	3.2	115.5	2 1/8	1 3/8	6.3	483/460/864	260		FED		123		666	82

Conditions EN12900 : Evaporating 5°C, Condensing 50°C, Superheat 10K, Subcooling 0K

* 1 Ph: 230V/ 50Hz

** 3 Ph: 380-420V/ 50Hz

*** @ 1m: sound pressure level at 1m distance from the compressor, free field condition

Capacity Data

Condensing Temperature +50°C															
R410A	Cooling Capacity (kW)							R410A	Power Input (kW)						
	Evaporating Temperature (°C)								Evaporating Temperature (°C)						
Model	-15	-10	-5	0	+5	+10	+15	Model	-15	-10	-5	0	+5	+10	+15
ZP24K5E		2.7	3.4	4.2	5.0	6.0		ZP24K5E		1.9	1.9	1.8	1.8	1.8	
ZP29K5E		3.1	4.0	4.9	6.0	7.3		ZP29K5E		2.3	2.2	2.2	2.2	2.1	
ZP31K5E		3.2	4.2	5.3	6.5	7.9		ZP31K5E		2.4	2.4	2.4	2.3	2.3	
ZP36K5E		4.1	5.1	6.3	7.6	9.1	10.8	ZP36K5E		2.8	2.7	2.7	2.6	2.6	2.5
ZP42K5E		4.5	5.8	7.3	8.9	10.7	12.8	ZP42K5E		3.3	3.2	3.1	3.0	3.0	2.9
ZP54K5E		5.8	7.5	9.3	11.5	13.9	16.6	ZP54K5E		4.0	3.9	3.9	3.8	3.8	3.8
ZP61K5E		7.2	9.0	11.1	13.4	16.0	18.9	ZP61K5E		4.6	4.5	4.5	4.4	4.4	4.4
ZP72KCE		8.6	10.5	12.7	15.3	18.2	21.5	ZP72KCE		5.1	5.1	5.1	5.1	5.1	5.1
ZP83KCE		9.8	12.1	14.7	17.7	21.1	25.1	ZP83KCE		5.7	5.8	5.8	5.8	5.8	5.9
ZP91KCE		10.6	13.2	16.1	19.3	22.9	27.0	ZP91KCE		6.1	6.1	6.1	6.2	6.2	6.2
ZP104KCE		12.6	15.6	18.9	22.7	27.0	31.9	ZP104KCE		7.1	7.1	7.1	7.1	7.1	7.1
ZP122KCE		14.8	18.3	22.1	26.5	31.5	37.2	ZP122KCE		8.3	8.3	8.3	8.3	8.3	8.4
ZP143KCE		17.1	21.4	26.3	31.6	37.6	44.1	ZP143KCE		9.8	9.8	9.8	9.8	9.8	9.8
ZP154KCE		18.7	23.0	27.7	33.1	39.3	46.3	ZP154KCE		10.3	10.3	10.4	10.5	10.6	10.7
ZP182KCE		22.2	27.1	32.7	39.0	46.2	54.6	ZP182KCE		12.0	12.1	12.2	12.3	12.4	12.5
ZP385KCE		46.3	56.6	68.6	82.3	98.1	116.0	ZP385KCE		25.4	25.3	25.4	25.6	25.9	26.3
ZP485KCE		60.2	73.1	88.0	105.0	125.0	147.0	ZP485KCE		31.1	31.5	32.0	32.5	33.2	34.0
ZP725KCE		91.7	111.0	135.5	159.0	188.0	222.0	ZP725KCE		49.7	50.0	50.3	50.5	50.9	51.3

Conditions: Suction Superheat 10K / Subcooling 0K

Tandem Model Overview

Model	Nominal hp	Cooling Capacity (kW)	Even Tandem	Uneven Tandem
Tandem ZPT - Tandem Uneven ZPU				
ZPT 72 K5E	2 x 3	16	•	
ZPT 84 K5E	2 x 3.5	18	•	
ZPT 108 K5E	2 x 4	23	•	
ZPT 122 K5E	2 x 5	26	•	
ZPT 144 KCE	2 x 6	31	•	
ZPT 166 KCE	2 x 6.5	35	•	
ZPT 182 KCE	2 x 8	39	•	
ZPT 208 KCE	2 x 9	45	•	
ZPT 244 KCE	2 x 10	53	•	
ZPT 286KCE	2 x 12	63	•	
ZPT 308KCE	2 x 13	67	•	
ZPU 336 KCE	13 + 15	73		•
ZPT 364 KCE	2 x 15	79	•	
ZPU 417 KCE	15 + 20	90		•
ZPT 470 KCE	2 x 20	101	•	
ZPU 477 KCE	15 + 25	103		•
ZPU 530 KCE	20 + 25	114		•
ZPT 590 KCE	2 x 25	127	•	
ZPU 680 KCE	25 + 30	146		•
ZPT 770 KCE	2 x 30	165	•	
ZPU 870 KCE	30 + 40	187		•
ZPT 970 KCE	2 x 40	209	•	
ZPU 111 MCE	30 + 60	240		•
ZPU 121 MCE	40 + 60	262		•
ZPT 145 MCE	60 + 60	317	•	

System using ZP235 or ZP295 (20 or 25 hp) shall use ZP232KZE and ZP292KZE (refer to next chapter)
 Conditions EN 12900: Evaporating 5°C, Condensing 50°C, Superheat 10K, Subcooling 0K
 Tandem assemblies by system manufacturers. Emerson can provide full technical support.

ZP Copeland™ Scroll Air Conditioning Compressor Range, Optimized for Seasonal Performance

The new ZP*KZE and ZP*KPE scroll compressors for large chillers feature advanced monitoring capabilities and improved part-load cooling efficiency, thanks to a variable compression ratio valve. This will help OEMs meet the minimum seasonal performance level required by the Ecodesign Directive.

The electronics module they are equipped with ensures enhanced reliability, by providing real time compressor data to the system controller to provide temperature protection.

They are designed for reversible chillers, rooftop or air handling units with a cooling capacity between 30 and 400 kW.



ZP*KZE scroll compressor

ZP*KZE & ZP*KPE Compressor Line-up

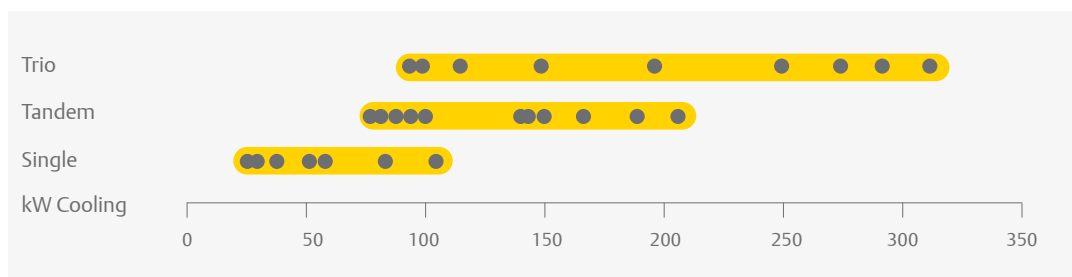

Multiple Copeland Scroll Nominal Cooling kW @ (5/50) EN12900 - 1 Circuit

Features and Benefits

- High seasonal performance (SEER)
 - 5% improved SEER versus previous generation
- Flexibility & reduced complexity
 - Wide range of even and uneven tandem and trio assemblies for a full system line-up with a reduced number of compressor models in stock.
- Enhanced reliability through electronics

The Copeland compressor electronics module provides realtime compressor data via RS485 Modbus that is used by the system controller to provide temperature protection. This ensures greater reliability for demanding applications.

Maximum Allowable Pressure (PS)

- ZP137- ZP485KPE and ZP232-ZP292KZE:
Low side PS 29.5 bar(g) / High side PS 45 bar(g)

Operating Envelope R410A

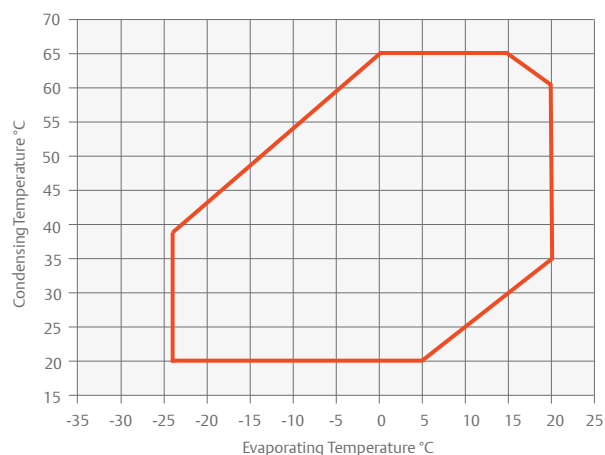

Technical Overview

Models	Nominal hp	Capacity (kW)	EER	Displacement (m ³ /h)	Stub Suction (inch)	Stub Discharge (inch)	Oil Quantity (l)	Length/Width/Height (mm)	Net Weight (kg)	Motor Version/Code	Maximum Operating Current (A)	Locked Rotor Current (A)	Sound Pressure @1 m (dBA) ***
										3 Ph **	3 Ph **	3 Ph **	
ZP137KPE	12.0	29.5	3.1	22.1	1 3/8	7/8	3.3	264/285/533	63	TFD	25	118	64
ZP154KPE	13.0	33.0	3.1	24.9	1 3/8	7/8	3.3	281/285/552	65	TFD	31	140	65
ZP182KPE	15.0	38.8	3.1	29.1	1 3/8	7/8	3.3	326/295/552	66	TFD	34	174	66
ZP232KZE	20.0	50.6	3.3	36.6	1 5/8	1 1/8	4.4	315/315/661	92	TND	38	241	72
ZP292KZE	25.0	63.3	3.3	45.7	1 5/8	1 1/8	4.4	315/315/661	92	TND	49	288	72
ZP385KPE	30.0	82.9	3.2	60.8	1 5/8	1 3/8	6.3	447/427/724	177	TWD	65	310	74
ZP485KPE	40.0	105.0	3.2	77.3	1 5/8	1 3/8	6.3	368/345/756	190	TWD	83	408	78

Conditions: EN12900 : Evaporating 5°C, Condensing 50°C, Superheat 10K, Subcooling 0K

** 3 Ph: 380-420V/ 50Hz

*** @ 1m: sound pressure level at 1m distance from the compressor, free field condition

Capacity Data

Condensing Temperature +50°C																
R410A	Cooling Capacity (kW)							R410A	Power Input (kW)							
	Evaporating Temperature (°C)								Evaporating Temperature (°C)							
	Model	-15	-10	-5	0	+5	+10		+15	Model	-15	-10	-5	0	+5	+10
ZP137KPE		16.0	20.0	24.5	29.5	35.2	41.5	ZP137KPE		9.8	9.7	9.6	9.5	9.5	9.4	
ZP154KPE		18.3	22.5	27.4	33.0	39.4	46.6	ZP154KPE		11.0	10.9	10.8	10.7	10.5	10.5	
ZP182KPE		21.6	26.7	32.4	38.8	46.0	54.2	ZP182KPE		12.8	12.8	12.7	12.6	12.5	12.4	
ZP232KZE		28.5	34.9	42.2	50.6	60.1	70.8	ZP232KZE		15.2	15.3	15.3	15.3	15.3	15.3	
ZP292KZE		36.1	44.0	53.1	63.3	74.8	87.6	ZP292KZE		19.4	19.5	19.4	19.4	19.3	19.3	
ZP385KPE		47.0	57.3	69.2	82.9	98.6	116.5	ZP385KPE		25.9	25.9	25.8	25.8	25.9	26.1	
ZP485KPE		60.7	73.5	88.2	105.0	124.5	146.0	ZP485KPE		32.9	32.9	32.9	33.0	33.1	33.4	

Conditions: Suction Superheat 10K / Subcooling 0K

Preliminary data

Tandem Model Overview

Model	Tandem Assembly	Cooling Capacity kW
Even Tandem ZPT		
ZPT 274 K	2 x ZP137 KZE	58
ZPT 308 K	2 x ZP154 KPE	67
ZPT 364 K	2 x ZP182 KPE	77
ZPT 464 K	2 x ZP232 KZE	101
ZPT 584 K	2 x ZP292 KZE	125
ZPT 770 K	2 x ZP385 KPE	165
ZPT 970 K	2 x ZP485 KPE	209
Uneven Tandem ZPU		
ZPU 336 K	ZP154 KPE + ZP182 KPE	72
ZPU 414 K	ZP182 KPE + ZP232 KZE	89
ZPU 474 K	ZP182 KPE + ZP292 KZE	102
ZPU 524 K	ZP232 KZE + ZP292 KZE	114
ZPU 677 K	ZP292 KZE + ZP385 KPE	146
ZPU 717 K	ZP232 KZE + ZP485 KPE	155
ZPU 870 K	ZP385 KPE + ZP485 KPE	187

Conditions EN 12900: Evaporating 5°C, Condensing 50°C, Superheat 10K, Subcooling 0K
Tandem assemblies by system manufacturers. Emerson can provide full technical support.

ZPD & ZRD Copeland™ Scroll Digital Compressor Ranges for R513A, R410A and R407C

Stepless capacity modulation in air conditioning applications: flexible solution for R513A, R407C and R410A.

In many cooling and heating systems, the load and the operating conditions vary over a wide range thus requiring the use of capacity modulation. Digital scroll assures stepless modulation down to 10% of the nominal capacity, enabling precise temperature control, superior comfort and energy saving.

Digital scroll compressors are the preferred choice for process cooling, refrigeration racks, refrigeration units, VRF, rooftop and air handling unit systems.

ZPD & ZRD Copeland scroll digital compressor



ZPD Digital Scroll Compressor Line-up R410A

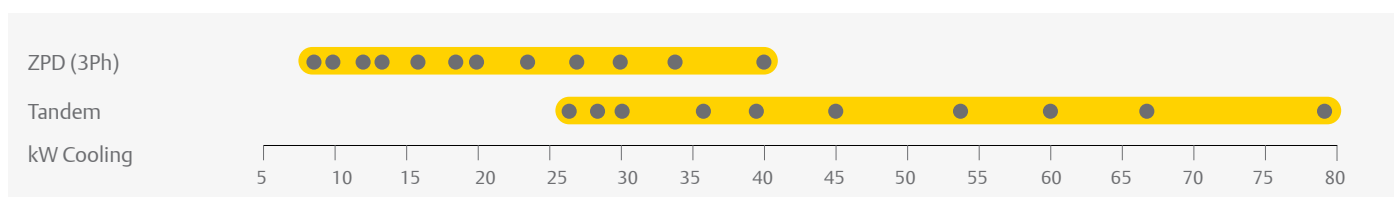

ZRD Digital Scroll Compressor Line-up R407C

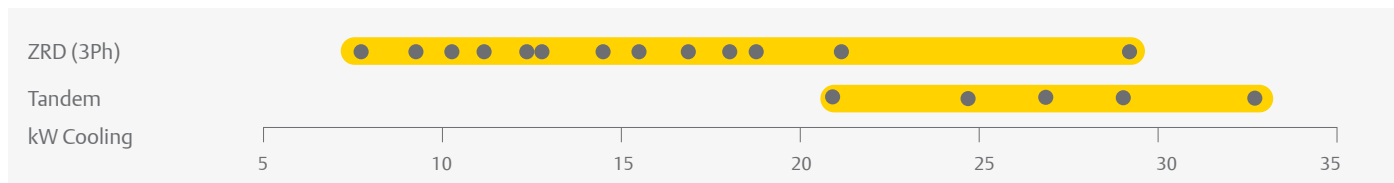

Conditions EN12900: Evaporating 5°C, Condensing 50°C, Superheat 10K, Subcooling 0K

ZRD* KRE Digital Scroll Compressor Line-up R513A

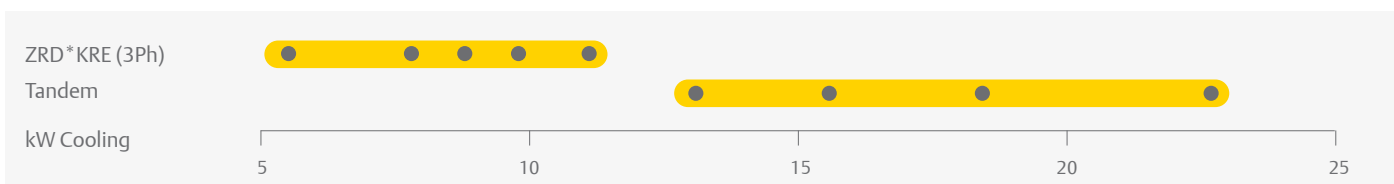

Conditions EN12900: Evaporating 5°C, Condensing 50°C, Superheat 10K, Subcooling 0K

Features and Benefits

- Wide modulation range from 10% to 100% for immediate load adjustment, close temperature comfort, optimal comfort
- No complex electronics, a quasi-drop-in solution for fast time to market, no EMI/EMC problems, easy installation and maintenance
- No impact on system mechanical balance: no vibration and resonance phenomenon, no frame / piping redesign necessary

Maximum Allowable Pressure (PS)

- Digital ZRD42 to ZRD81:
Low Side PS 20 bar(g) / High Side PS 29.5 bar(g)
- Digital ZRD94 to ZRD125:
Low Side PS 20 bar(g) / High Side PS 32 bar(g)
- Digital ZPD34 to ZPD91:
Low Side PS 28 bar(g) / High Side PS 43 bar(g)
- Digital ZPD103 to ZPD182:
Low Side PS 29.5 bar(g) / High Side PS 45 bar(g)

Operating Envelope R410A/R407C

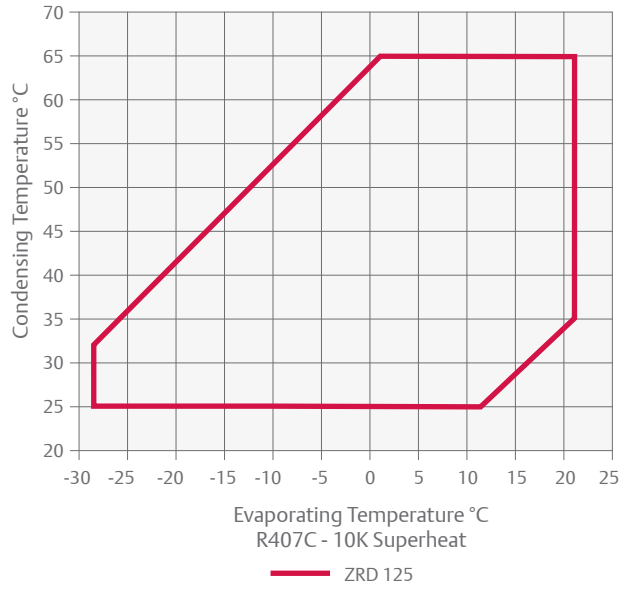
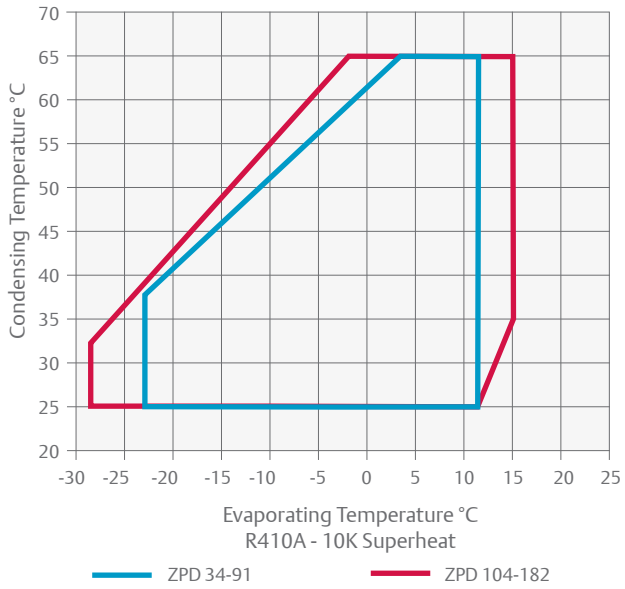

Operating Envelope R513A

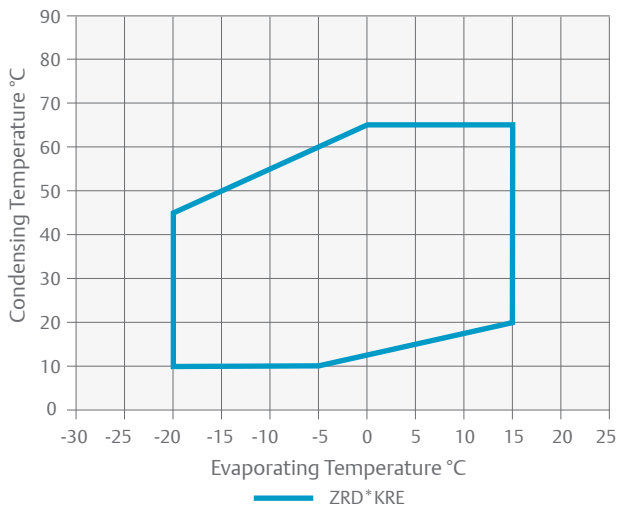

Technical Overview - ZPD R410A Models

Models	Nominal hp	Capacity (kW)	EER	Displacement (m ³ /h)	Stub Suction (inch)	Stub Discharge (inch)	Oil Quantity (l)	Length/Width/Height (mm)	Net Weight (kg)	Motor Version/ Code	Maximum Operating Current (A)	Locked Rotor Current (A)	Sound Pressure @1 m - dB(A) **
										3 Ph *	3 Ph *	3 Ph *	
ZPD34K5E	3.0	7.3	2.9	5.7	7/8	1/2	1.2	243/243/448	31	TFD	12	64	66
ZPD42K5E	3.5	9.1	3.0	6.9	7/8	1/2	1.2	243/243/464	31	TFD	8	52	66
ZPD54K5E	4.5	11.8	3.0	8.9	7/8	1/2	1.2	236/236/479	35	TFD	10	62	67
ZPD61KCE	5.0	13.2	3.0	10.1	7/8	1/2	1.9	241/246/484	41	TFD	12	64	63
ZPD72KCE	5.0	15.3	2.9	11.6	7/8	1/2	1.9	241/246/484	40	TFD	15	75	67
ZPD83KCE	6.5	17.7	3.0	13.5	7/8	1/2	1.8	246/253/481	40	TFD	16	101	64
ZPD91KCE	8.0	19.2	3.1	14.7	7/8	3/4	1.8	246/253/481	40	TFD	16	101	69
ZPD104KCE	9.0	22.7	3.1	16.7	1 1/8	7/8	2.5	270/262/605	61	TFD	18	128	63
ZPD122KCE	10.0	26.3	3.1	19.7	1 1/8	7/8	2.5	270/262/605	62	TFD	21	139	63
ZPD137KCE	12.0	29.4	3.1	22.1	1 3/8	7/8	3.3	293/285/533	62	TFD	25	118	63
ZPD154KCE	13.0	33.1	3.1	24.9	1 3/8	7/8	3.3	314/285/552	65	TFD	27	140	66
ZPD182KCE	15.0	39.0	3.1	29.1	1 3/8	7/8	3.3	314/285/552	67	TFD	34	173	68

Conditions EN12900: Evaporating 5°C, Condensing 50°C, Superheat 10K, Subcooling 0K

* 3 Ph: 380-420V/ 50Hz

** @ 1m: sound pressure level at 1m distance from the compressor, free field condition

Technical Overview - ZRD* KRE R407C, R134a and R513A Models

Models	Nominal hp	Capacity (kW)		EER	Displacement (m ³ /h)	Stub Suction (inch)	Stub Discharge (inch)	Oil Quantity (l)	Length/Width/Height (mm)	Net Weight (kg)	Motor Version/ Code		Maximum Operating Current (A)		Locked Rotor Current (A)		Sound Pressure @1 m *** (dBA)
		R513A/R134a	R407C								1 Ph *	3 Ph **	1 Ph *	3 Ph **	1 Ph *	3 Ph **	
ZRD36KRE	3.0	5.2	7.7	3.2	8.3	3/4	1/2	1.2	239/244/435	30	PFJ	TFD	17	7	97	40	57
ZRD48KRE	4.0	7.0	10.3	3.1	11.4	7/8	1/2	1.4	239/244/466	30		TFD		10		48	64
ZRD61KRE	5.0	8.9	12.4	3.2	14.4	7/8	1/2	1.9	246/257/481	38		TFD		11		64	65
ZRD72KRE	6.0	10.6	15.4	3.1	17.1	7/8	1/2	1.9	246/257/481	40		TFD		12		74	63
ZRD92KRE	8.0	13.4	18.8	3.1	21.4	7/8	3/4	1.9	246/257/481	43		TFD		16		102	64

Conditions EN12900: Evaporating 5°C, Condensing 50°C, Superheat 10K, Subcooling 0K

* 1 Ph: 230V/ 50Hz

** 3 Ph: 380-420V/ 50Hz

*** @ 1m: sound pressure level at 1m distance from the compressor, free field condition

Preliminary data

Technical Overview - ZRD* KCE R407C Models

Models	Nominal hp	Capacity (kW)	EER	Displacement (m ³ /h)	Stub Suction (inch)	Stub Discharge (inch)	Oil Quantity (l)	Length/Width/Height (mm)	Net weight (kg)	Motor Version/ Code	Maximum Operating Current (A)	Locked Rotor Current (A)	Sound Pressure @1 m - dB(A) **
										3 Ph *	3 Ph *	3 Ph *	
ZRD125KCE	11.0	27.6	3.3	28.8	1 3/8	7/8	3.3	293/285/533	62	TFD	20	118	64

Conditions EN12900: Evaporating 5°C, Condensing 50°C, Superheat 10K, Subcooling 0K

* 3 Ph: 380-420V/50Hz

** @1m: sound pressure level at 1m distance from the compressor, free field condition

Capacity Data

Condensing Temperature 50°C															
R410A	Cooling Capacity (kW)							R410A	Power Input (kW)						
	Evaporating Temperature (°C)								Evaporating Temperature (°C)						
Model	-15	-10	-5	0	+5	+10	+15	Model	-15	-10	-5	0	+5	+10	+15
ZPD34K5E		3.9	4.9	6.0	7.3	8.7		ZPD34K5E		2.7	2.6	2.6	2.6	2.5	
ZPD42K5E		5.0	6.2	7.6	9.1	10.9		ZPD42K5E		2.9	3.0	3.0	3.0	3.0	
ZPD54K5E		6.7	8.2	9.9	11.8	13.9		ZPD54K5E		4.0	3.9	3.9	3.8	3.8	
ZPD61KCE		7.3	9.0	10.9	13.2	15.7		ZPD61KCE		4.2	4.3	4.4	4.4	4.5	
ZPD72KCE		8.6	10.5	12.7	15.2	18.1		ZPD72KCE		4.9	5.0	5.1	5.2	5.2	
ZPD83KCE		9.8	12.1	14.7	17.7	21.1		ZPD83KCE		5.9	6.0	6.0	6.0	6.0	
ZPD91KCE		10.6	13.2	16.0	19.2	22.8		ZPD91KCE		6.2	6.2	6.2	6.3	6.3	
ZPD104KCE		13.0	15.8	19.0	22.7	26.9		ZPD104KCE		7.0	7.0	7.1	7.2	7.3	
ZPD122KCE		15.1	18.3	22.0	26.3	31.2		ZPD122KCE		8.0	8.1	8.2	8.3	8.4	
ZPD137KCE		16.0	20.0	24.4	29.4	35.1		ZPD137KCE		9.6	9.5	9.4	9.4	9.3	
ZPD154KCE		18.7	23.0	27.7	33.1	39.2	46.3	ZPD154KCE		10.3	10.3	10.4	10.5	10.6	10.7
ZPD182KCE		23.2	27.9	33.1	39.0	45.8	53.7	ZPD182KCE		12.2	12.3	12.4	12.5	12.6	12.7

Conditions: Suction Superheat 10K / Subcooling 0K

Condensing Temperature 50°C															
R513A / R134a	Cooling Capacity (kW)							R513A / R134a	Power Input (kW)						
	Evaporating Temperature (°C)								Evaporating Temperature (°C)						
Model	-15	-10	-5	0	+5	+10	+15	Model	-15	-10	-5	0	+5	+10	+15
ZRD36KRE	2.1	2.7	3.4	4.3	5.2	6.3	7.5	ZRD36KRE	1.5	1.5	1.6	1.6	1.6	1.6	1.6
ZRD48KRE	2.9	3.7	4.6	5.7	7.0	8.5	10.2	ZRD48KRE	2.3	2.3	2.3	2.3	2.2	2.2	2.3
ZRD61KRE	3.6	4.6	5.8	7.2	8.9	10.8	13.1	ZRD61KRE	2.5	2.6	2.6	2.7	2.8	2.9	2.9
ZRD72KRE	4.3	5.6	7.0	8.7	10.6	12.9	15.5	ZRD72KRE	2.9	3.0	3.1	3.3	3.4	3.5	3.7
ZRD92KRE	5.4	6.9	8.7	10.9	13.4	16.3	19.6	ZRD92KRE	3.7	3.9	4.0	4.2	4.3	4.4	4.4

Conditions: Suction Superheat 10K / Subcooling 0K

Preliminary data

For capacity data for R450A please refer to Emerson's Select Software

Condensing Temperature 50°C															
R407C	Cooling Capacity (kW)							R407C	Power Input (kW)						
	Evaporating Temperature (°C)								Evaporating Temperature (°C)						
Model	-15	-10	-5	0	+5	+10	+15	Model	-15	-10	-5	0	+5	+10	+15
ZRD36KRE		4.1	5.2	6.3	7.7	9.2		ZRD36KRE		2.3	2.4	2.4	2.4	2.4	
ZRD48KRE		5.4	6.8	8.4	10.3	12.5		ZRD48KRE		3.2	3.2	3.2	3.2	3.1	
ZRD61KRE		6.3	8.0	10.0	12.4	15.1		ZRD61KRE		3.9	4.0	4.0	4.0	4.0	
ZRD72KRE		8.0	10.1	12.5	15.4	18.6		ZRD72KRE		4.7	4.7	4.7	4.7	4.7	
ZRD92KRE		9.6	12.2	15.2	18.8	22.9		ZRD92KRE		6.0	6.1	6.2	6.2	6.2	
ZRD125KCE		14.3	18.1	22.5	27.6	33.3	39.4	ZRD125KCE		8.2	8.3	8.4	8.4	8.6	8.7

Conditions: Suction Superheat 10K / Subcooling 0K

YPV Copeland™ Scroll Variable Speed Compressor Range for R32 with Inverter Drive

The new YPV variable speed compressors are designed for R32, a widely available refrigerant with a GWP of 675. These scroll compressors deliver maximum efficiency and superior performances to comply or exceed the most stringent EcoDesign directive targets. Thanks to advanced Emerson technologies, YPV compressors reach the same field of application as equivalent Copeland scroll compressors with R410A.

The outstanding efficiency of YPV across different load- and operating conditions reflects in a lower total lifecycle cost of the system, in diverse applications such as commercial comfort - with hydronic cooling, reversible units or rooftops - industrial chillers or close control units.



YPV Copeland scroll variable speed compressor and drive

YPV Variable Speed Scroll Compressor Line-up R32

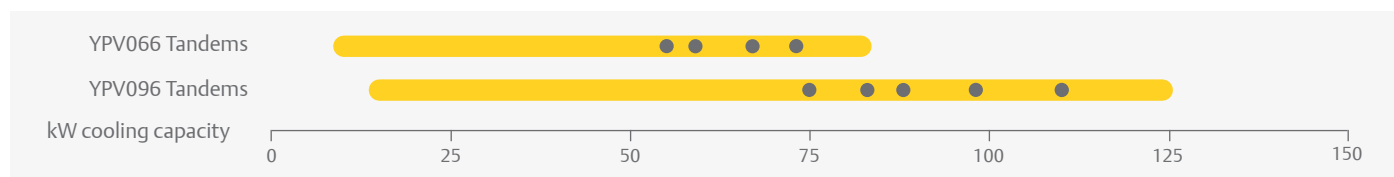
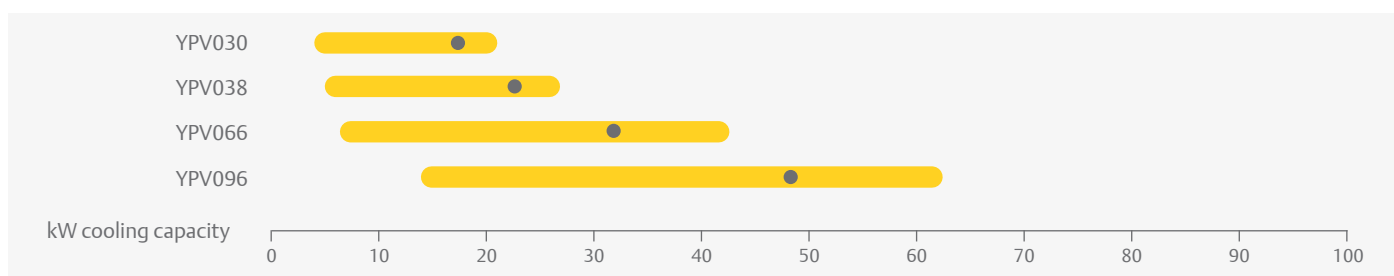

Features and Benefits

- Designed for R32
- Wide operating envelope for cooling and heating
- Outstanding efficiency, thanks to variable speed high performance motors and to Emerson variable compression ratio valve
- Capability to be tandemized with fixed speed compressors (YPV066-096) for maximum flexibility in system design - no need for an oil separator
- Low leak discharge check valve
- Axial and radial compliance
- Emerson integrated solution ready

Maximum Allowable Pressure (PS)

- YPV066 – 096:
Low side PS 30.4 bar(g) / High Side PS 50.0 bar(g)

Operating Envelope - YPV066/096

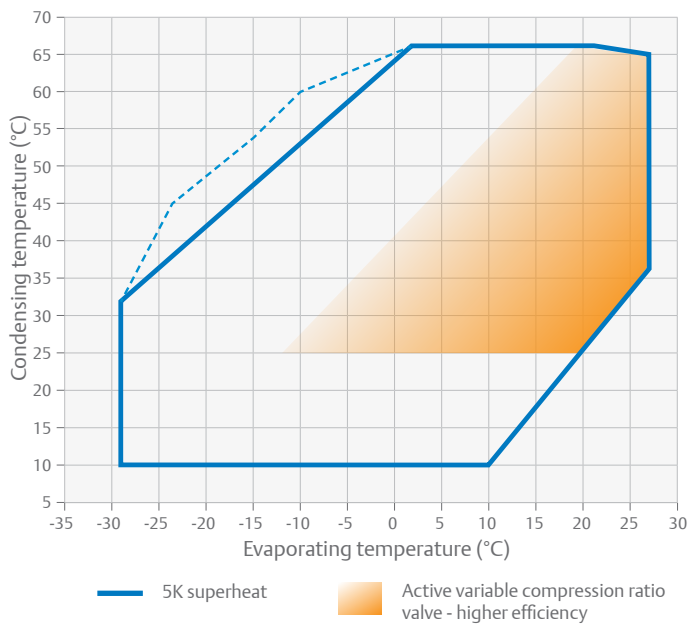

Operating Envelope - YPV030/038

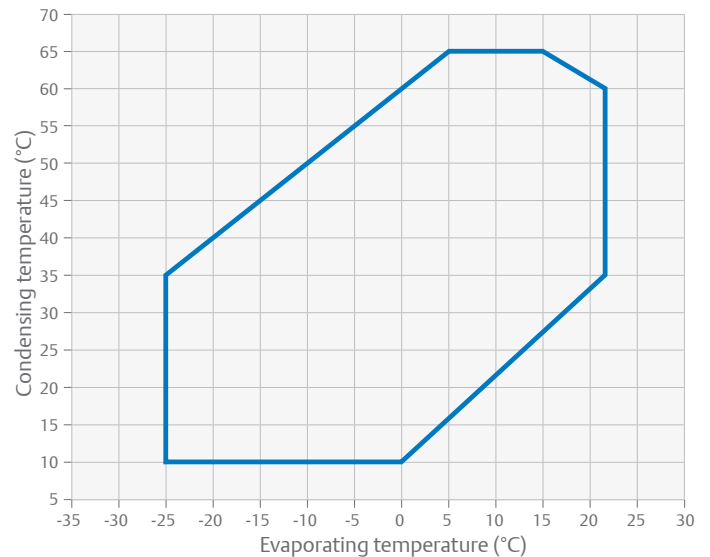

* The operating envelope may vary depending on the compressor speed. Please refer to the Select software

Technical Overview

Compressor										
Models	Cooling Capacity (kW)			EER	Stub Suction (inch)	Stub Discharge (inch)	Oil Quantity (l)	Length/ Width/ Height (mm)	PED Category	Net Weight (kg)
	Min	Max	Nominal							
YPV030-LT	4.2	20.8	17.3	3.4	3/4	1/2	1.2	216/196/376	2	18
YPV038-LT	5.5	26.9	22.2	3.4	3/4	1/2	1.2	216/196/376	2	20
YPV0661T	9.1	42.0	35.6	3.2	1 1/8	7/8	2.5	268/246/559	3	40
YPV0961T	13.7	62.7	53.1	3.2	1 1/8	7/8	2.5	268/246/559	3	43

*Conditions EN12900 for YPV066/096: Evaporating 5°C, Condensing 50°C, Superheat 10K, Subcooling 0K, 6000 rpm

**Conditions for YPV030/038: Evaporating 5°C, Condensing 50°C, Superheat 11K, Subcooling 8K, 6000rpm

Preliminary data

Inverter Drive**									
Models	Matched Compressor	Power Input (kW)	Amps (A)	Cooling	Net Weight (kg)	3Ph 400V	Comm.	Depth/Width/ Height (mm)*	
		Max	Max						
EV3150B	YPV066	15.0	27.0	Air	7.4	✓	Modbus	180/250/380	
EV3185B	YPV096	18.5	38.0		14.0	✓		180/250/380	

* Standard voltage air-cooled version including fins

** No matched inverter drive with models YPV030-LT - YPV038-LT

Capacity Data

Condensing Temperature +50°C																	
R32		Cooling Capacity (kW)						R32		Power Input (kW)							
		Evaporating Temperature (°C)								Evaporating Temperature (°C)							
Model		-15	-10	-5	0	+5	+10	+15	Model		-15	-10	-5	0	+5	+10	+15
YPV030-LT	Max		2.8	2.8	3.8	3.1	3.8	4.4	YPV030-LT	Max		2	1.6	1.6	1.2	1.2	1.1
	Min	9.5	12.0	14.5	17.5	21.0	24.5	29.0		Min	5.5	5.8	6	6.2	6.3	6.4	6.4
YPV038-LT	Max		4.5	4.0	5.0	3.8	4.6	5.6	YPV038-LT	Max		3	2.4	2.3	1.8	1.7	1.6
	Min	12.8	15.6	18.8	22.6	26.9	31.8	37.3		Min	7.5	7.7	7.9	8.1	8.2	8.4	8.5
YPV0661T	Max		24.1	29	35	42	50.2	59.5	YPV0661T	Max		13.4	13.7	14.0	14.2	14.5	14.7
	Min		5.9	7.0	8.4	10.1	12.1	14.3		Min		3.4	3.5	3.5	3.5	3.4	3.4
YPV0961T	Max		36	43.3	52.2	62.7	74.9	88.7	YPV0961T	Max		19.6	20.0	20.3	20.7	21.1	21.5
	Min		8.8	10.5	12.6	15.1	18.0	21.3		Min		4.8	4.9	4.9	4.8	4.7	4.5

Condition: Suction Superheat 5K, Subcooling 4K

Preliminary Data

XPV & ZPV Copeland™ Scroll Variable Speed Compressor Ranges for R410A with Inverter Drive

Copeland scroll XPV and ZPV variable speed compressors for R410A are designed to deliver maximum cooling and heating efficiency when you need it most. Equipped with the latest variable speed technology, they allow system manufacturers and building owners to achieve superior performance when designing reversible chillers, heat pumps, precision cooling systems or rooftops.

In addition to Copeland market-proven robustness, the new XPV and ZPV ranges with their qualified inverter drive meet and exceed the level of reliability expected for these applications.

Copeland scroll ZPV066 variable speed compressor and drive



XPV and ZPV Variable Speed Scroll Compressor Line-up

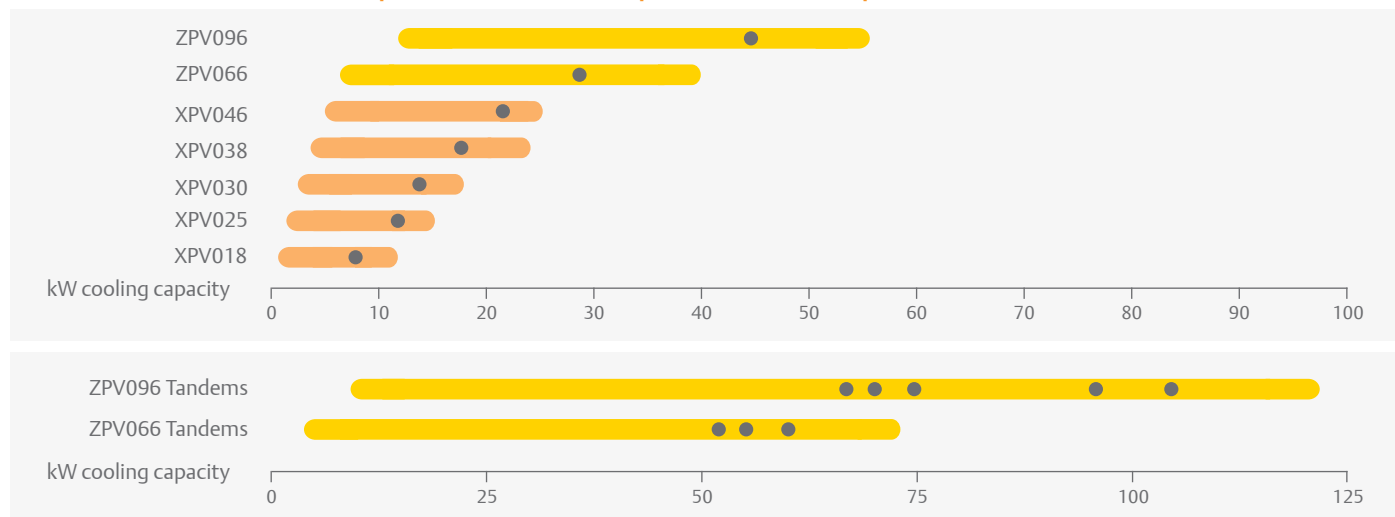

Features and Benefits

- Highest part load efficiency in its class enabling significant energy savings and standards compliance
- Wide speed range for enhanced part load efficiency and dehumidification: 900 - 7,200 RPM (15-120Hz)
- Capability to be tandemized with fixed speed compressors for maximum flexibility in system design
- Both compressor and drive are Copeland approved for reduced design time, cost and speed to market
- BPM motor technology for highest efficiency
- Sound reduction technology for reversible chiller transition and defrost

Maximum Allowable Pressure (PS)

- XPV018-025 and XPV046
Low Side PS 28 bar(g) / High Side PS 45 bar(g)
- XPV030-038
Low Side PS 29.5 bar(g) / High Side PS 43.3 bar(g)
- ZPV066 - 096
Low Side PS 29.5 bar(g) / High Side PS 45 bar(g)

ZPV Operating Envelope R410A*

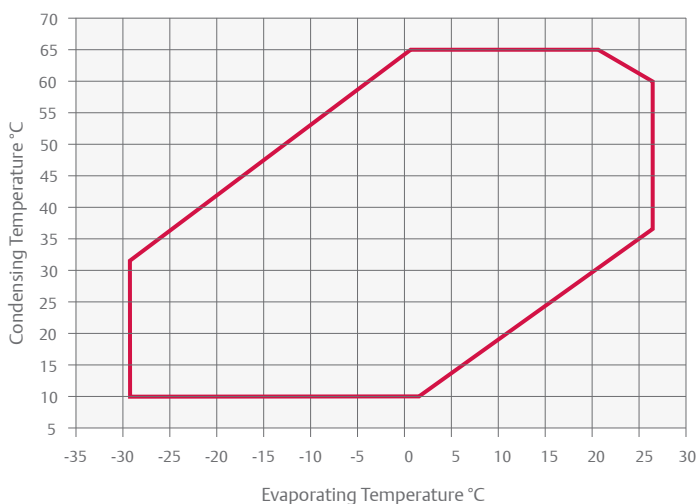

XPV Operating Envelope R410A*

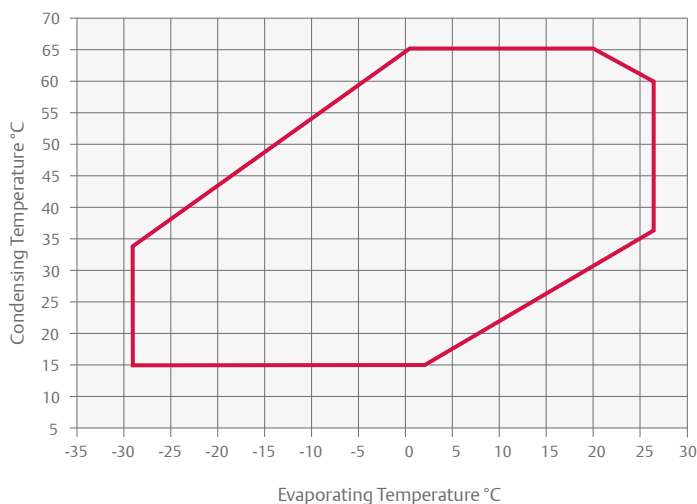

Note: * The operating envelope may vary depending on the compressor speed. Please refer to the Select software

Technical Overview

Compressor											
Models	Cooling Capacity (kW)			EER*	Displacement (cm ³)	Stub Suction (inch)	Stub Discharge (inch)	Oil Quantity (l)	Length/Width/Height (mm)	Net weight (kg)	Sound Pressure @1 m - dB(A)**
	Min	Max	Nominal								
XPV0182E	1.3	10.4	8.2	3.1	18.0	3/4	1/2	0.7	194/216/335	16	n.a.
XPV0252E	1.8	14.5	11.1	3.1	25.0	3/4	1/2	0.7	194/216/335	16	62
XPV0303E	2.2	17.4	13.0	3.1	30.0	3/4	1/2	1.2	218/198/379	19	62
XPV0383E	2.7	22.5	17.0	3.2	38.0	3/4	1/2	1.2	218/198/379	20	73
XPV0462E	6.2	24.0	20.5	3.2	46.0	3/4	1/2	1.2	229/198/388	22	n.a.
ZPV0662E	8.5	39.0	29.0	3.1	63.0	1 1/8	7/8	2.5	273/262/559	40	73
ZPV0962E	13.0	58.1	43.5	3.1	96.0	1 1/8	7/8	2.5	273/262/559	44	75

Conditions EN12900: Evaporating 5°C, Condensing 50°C, Superheat 10K, Subcooling 0K

*at Nominal Speed (5400 RPM)

** @ 1m: sound pressure level at 1m distance from the compressor, free field condition

Preliminary Data

Inverter Drive										
Models	Matched Compressor	Power Input (kW)	Amps (A)	Cooling	Net Weight (kg)	1ph 230V	3Ph 400V	Comm.	Depth/Width/Height (mm)*	
		Max	Max							
ED3015AU	XPV018	3.8	15	Air / Liquid	2.8	✓		Modbus RTU and analog board for 0-10V	205/240/144	
ED3020AU	XPV025	5.0	20		3.6	✓			205/250/180	
ED3018BU	XPV025 / XPV030	5.0	18		4.4		✓		205/250/183	
ED3022B	XPV038/ XPV046	8.0	22		5.2		✓		233/316/150	
EV3150B	ZPV066	15.0	27	Air	7.4		✓		180/250/380	
EV3185B	ZPV096	18.5	38		14.0		✓		180/250/380	

*Standard voltage air-cooled version including fins

Capacity Data

Condensing Temperature +50°C															
R410A		Cooling Capacity (kW)							R410A		Power Input (kW)				
		Evaporating Temperature (°C)									Evaporating Temperature (°C)				
Model		-15	-10	-5	0	+5	+10	+15	Model		-15	-10	+5	+10	+15
XPV0182E	Max	5.8	7.0	8.4	10.1	12.0	14.1	16.5	XPV0182E	Max	3.6	3.7	3.7	3.7	3.7
	Min	1.5	1.6	1.7	1.7	2.0	2.4	2.9		Min	1.0	1.0	0.8	0.8	0.8
XPV0252E	Max	7.2	8.8	10.8	13.2	15.8	18.8	22.2	XPV0252E	Max	4.8	4.9	5.2	5.2	5.2
	Min	2.2	2.4	2.4	2.4	2.9	3.4	4.1		Min	1.4	1.4	1.1	1.1	1.0
XPV0303E	Max	8.9	10.7	12.9	15.6	18.8	22.5	26.7	XPV0303E	Max	5.5	5.6	5.9	6.0	6.0
	Min	2.2	2.5	1.5	1.9	2.3	2.7	3.7		Min	1.8	1.6	1.0	1.0	1.0
XPV0383E	Max	11.3	13.6	16.4	19.8	23.8	28.5	33.8	XPV0383E	Max	7.0	7.1	7.5	7.5	7.6
	Min	2.8	3.2	1.9	2.4	2.9	3.4	4.6		Min	2.2	2.0	1.2	1.2	1.3
XPV0462E	Max	13.6	16.4	19.8	23.9	28.8	34.4	40.8	XPV0462E	Max	8.1	8.3	8.7	8.7	8.7
	Min	3.6	4.5	2.2	2.8	3.3	4.0	5.1		Min	2.7	2.6	1.4	1.4	1.4
ZPV0662E	Max	19.1	23.3	28.2	34.0	40.6	48.2	56.8	ZPV0662E	Max	13.2	13.5	14.3	14.5	14.7
	Min	6.2	4.9	6.0	7.1	8.3	9.8	11.5		Min	4.2	3.0	2.9	2.8	2.8
ZPV0962E	Max	28.0	34.3	41.7	50.4	60.4	71.8	84.6	ZPV0962E	Max	18.2	18.7	20.0	20.4	20.8
	Min	9.1	7.5	9.0	10.8	12.8	15.2	18.0		Min	5.7	4.1	4.1	4.1	4.0

Condition: Suction Superheat 5K, Subcooling 4K

Preliminary Data

YH Copeland™ Scroll Fixed Speed Compressor Range for A2L Refrigerants R454C and R452B

The new Copeland scroll YH compressors are designed for multiple applications such as air-to-water and brine-to-water heat pumps, process and close control cooling, as well as air conditioning. They have a dedicated design to support the market needs of customers for medium and low-pressure refrigerants with a low GWP. They are suitable for very aggressive refrigerants containing HFO molecule. YH compressors comply with the PED class requirements related to A2L refrigerants.



YH Copeland scroll compressor

YH Scroll Compressor Line-Up R454C and R452B

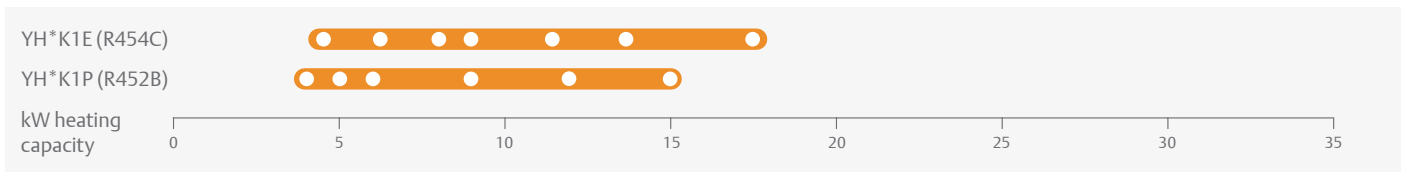

Conditions: Evaporating 5°C, Condensing 50°C, Superheat 10K, Subcooling 0K

Features and Benefits

- Multi-refrigerant compressor: optimized for operation with A2L refrigerants with a low GWP R454C (148) and R452B (698) compared to R407C (1774)
- PED class II certified
- Fully hermetic compressor design
- Wide operating envelope for heat pump applications
- Low super heat
- Tandem-ready version available for all sizes
- F-gas compliant

Maximum Allowable Pressure (PS)

- R454C models
Low side PS 28 bar(g) / High Side PS 49 bar(g)
- R452B models
Low side PS 28 bar(g) / High Side PS 46 bar(g)

YHK1P Operating Envelope R454C

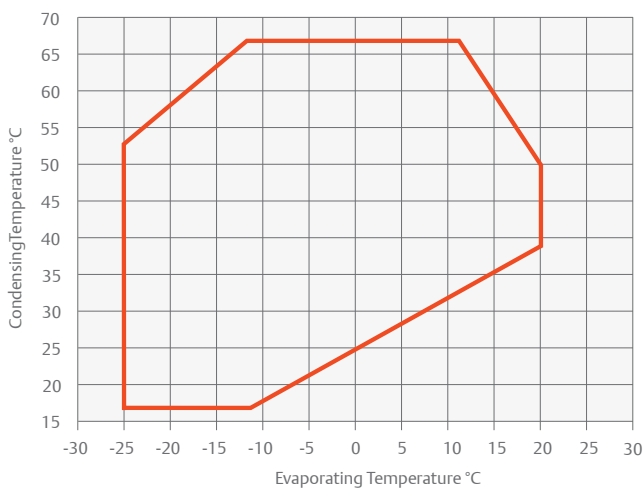

YHK1E Operating Envelope R452B

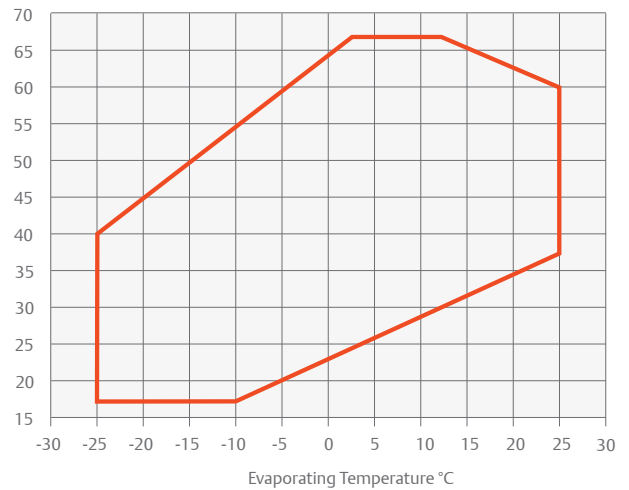

Technical Overview

R454C	Nominal hp	Heating Capacity (kW)	Displacement (m ³ /h)	Stub Suction (inch)	Stub Discharge (inch)	Oil Quantity (l)	Length/Width/Height (mm)	Net Weight (kg)	Motor Version/Code	Maximum Operating Current (A)	Locked Rotor Current (A)	Sound Pressure @1 m - dB(A) ***
									3 Ph **	3 Ph **	3 Ph **	
YH04K1E	2.0	4.4	5.8	3/4	1/2	1.3	253/248/365	23.0	TFMN	5	26	60
YH06K1E	2.5	6.1	8.0	3/4	1/2	1.5	253/248/387	27.2	TFMN	6	32	61
YH07K1E	3.5	7.7	10.0	3/4	1/2	1.5	253/248/401	28.1	TFMN	8	46	64
YH09K1E	4.0	8.7	11.4	7/8	1/2	1.5	253/248/417	28.6	TFMN	9	50	60
YH11K1E	5.0	10.9	14.3	7/8	1/2	1.9	255/261/442	37.3	TFMN	11	64	65
YH13K1E	6.0	12.9	16.7	7/8	1/2	1.9	255/261/442	39.5	TFMN	13	74	65
YH16K1E	8.0	16.4	21.4	7/8	3/4	1.9	255/261/442	39.5	TFMN	16	102	68

Conditions: Evaporating -7°C, Condensing 50°C, Superheat 5K, Subcooling 4K

** 3 Ph: 380-420V/ 50Hz

*** @ 1m: sound pressure level at 1m distance from the compressor, free field condition

R452B	Nominal hp	Heating Capacity (kW)	Displacement (m ³ /h)	Stub Suction (inch)	Stub Discharge (inch)	Oil Quantity (l)	Length/Width/Height (mm)	Net Weight (kg)	Motor Version/Code	Maximum Operating Current (A)	Locked Rotor Current (A)	Sound Pressure @1 m - dB(A) ***
									3 Ph **	3 Ph **	3 Ph **	
YH04K1P	1.8	4.0	3.4	3/4	1/2	1.3	227/194/388	21.3	TFMN	5	28	n/a
YH05K1P	2.0	4.7	4.0	3/4	1/2	1.5	227/194/388	21.3	TFMN	5	28	
YH06K1P	2.7	6.4	5.1	7/8	1/2	1.5	242/242/418		TFMN	6	43	
YH09K1P	3.5	8.6	6.9	7/8	1/2	1.5	242/242/418	33.0	TFMN	7	52	
YH12K1P	4.5	11.0	8.9	7/8	1/2	1.9	242/242/418	35.0	TFMN	10	62	
YH15K1P	5.0	14.4	11.7	7/8	1/2	1.9	245/249/442	39.5	TFMN	13	75	

Conditions: Evaporating -7°C, Condensing 50°C, Superheat 5K, Subcooling 4K

** 3 Ph: 380-420V/ 50Hz

*** @ 1m: sound pressure level at 1m distance from the compressor, free field condition

Capacity Data

Condensing Temperature +50°C															
R454C	Heating Capacity (kW)							R454C	Power Input (kW)						
	Evaporating Temperature (°C)								Evaporating Temperature (°C)						
	Model	-30	-15	-10	-5	0	+5		+15	Model	-30	-15	-10	-5	0
YH04K1E		3.4	4.0	4.7	5.5	6.4	8.6	YH04K1E	1.4	1.4	1.5	1.6	1.6	1.7	3.1
YH06K1E		4.8	5.6	6.5	7.6	8.9	12.1	YH06K1E	1.9	1.9	2.0	2.1	2.1	2.3	0.8
YH07K1E		6.0	7.0	8.2	9.5	11.1	15.1	YH07K1E	2.4	2.4	2.5	2.6	2.7	2.8	4.4
YH09K1E		6.9	8.0	9.3	10.8	12.6	17.1	YH09K1E	2.7	2.8	2.9	3.0	3.0	3.1	1.0
YH11K1E		8.5	9.9	11.6	13.6	15.8	21.3	YH11K1E	3.3	3.4	3.5	3.6	3.8	4.0	6.7
YH13K1E		10.0	11.7	13.7	16.0	18.7	25.2	YH13K1E	3.8	3.9	4.1	4.3	4.4	4.6	1.6
YH16K1E		12.8	14.9	17.4	20.3	23.6	31.9	YH16K1E	4.9	5.1	5.3	5.4	5.6	6.0	

Conditions: Suction Superheat 5K / Subcooling 4K

Condensing Temperature +50°C															
R452B	Heating Capacity (kW)							R452B	Power Input (kW)						
	Evaporating Temperature (°C)								Evaporating Temperature (°C)						
	Model	-30	-15	-10	-5	0	+5		+15	Model	-30	-15	-10	-5	0
YH04K1P		3.1	3.6	4.2	4.9	5.6	7.5	YH04K1P		1.4	1.4	1.4	1.4	1.4	1.4
YH05K1P		3.7	4.3	5.0	5.8	6.7	8.9	YH05K1P		1.6	1.6	1.6	1.7	1.7	1.7
YH06K1P		5.1	5.9	6.8	7.8	9.0	11.8	YH06K1P		2.1	2.2	2.2	2.2	2.2	2.1
YH09K1P		6.9	7.9	9.1	10.5	12.1	15.8	YH09K1P		2.7	2.8	2.8	2.8	2.9	2.8
YH12K1P		8.8	10.1	11.7	13.4	15.4	20.3	YH12K1P		3.5	3.6	3.6	3.6	3.6	3.6
YH15K1P		11.5	13.2	15.3	17.6	20.2	26.6	YH15K1P		4.4	4.5	4.7	4.8	4.8	5.0

Conditions: Suction Superheat 5K / Subcooling 4K

ZH Copeland™ Scroll Fixed Speed Compressor Range for R410A and R407C

ZH Copeland Scroll Compressor Range

The ZH compressor range is optimized for reversible and heat pump applications. In addition to the existing R407C range, a complete new range optimized for R410A has been developed. Both ranges are based on three platform sizes and cover a capacity of 4kW to 38kW.

ZH heating compressors have been optimized for reversible heating systems, they deliver higher capacity and efficiency at low evaporating (heat source) temperatures and are therefore better adapted to heating requirements than standard air conditioning compressors. Due to their larger operating map they also require less additional heating (electrical or gas) to cover the full heating demand on the coldest days and therefore further improve the system seasonal efficiency.

ZH Scroll Compressors With Enhanced Vapor Injection

ZH heating compressors with Enhanced Vapor Injection have been further optimized to ensure best-in-class performances in dedicated heating applications. This technology allows replacement of traditional boilers in new building and retrofit applications, without the need of substituting existing heating elements in the building.

ZH Copeland scroll heating compressors with Enhanced Vapor Injection have an additional port to inject vapor within the compression process. This improves system performances by increasing the heating capacity for a given compressor displacement. Additional benefits are the reduction of the gas



ZH Scroll Compressor

discharge temperature and the extension of the operating envelope which enable the production of high temperature water at all working conditions.

ZHI heating compressors reach the same high standards of durability and reliability as other Copeland scroll compressors. This includes the ability to handle relatively large amounts of liquid, which is known to damage or cause compressor failures. Fewer moving parts, robust running gear and low vibration due to balanced compression mechanism make the ZH range of Copeland scroll compressors the most reliable solution available in the heat pump market.

ZH Nomenclature Guidelines

ZH**K4E
Qualified for R407C/R134a
without enhanced vapor injection - ** capacity in Btu/h

ZH**KVE
Qualified for R407C only
enhanced vapor injection - ** capacity in kW

ZH**KRE
Qualified for R513A
without enhanced vapour injection ** capacity in kW

ZH**K1P
Qualified for R410A only
without enhanced vapor injection - ** capacity in kW

ZHI**K1P
Qualified for R410A only
enhanced vapor injection - ** capacity in kW

Enhanced Vapor Injection: System Design

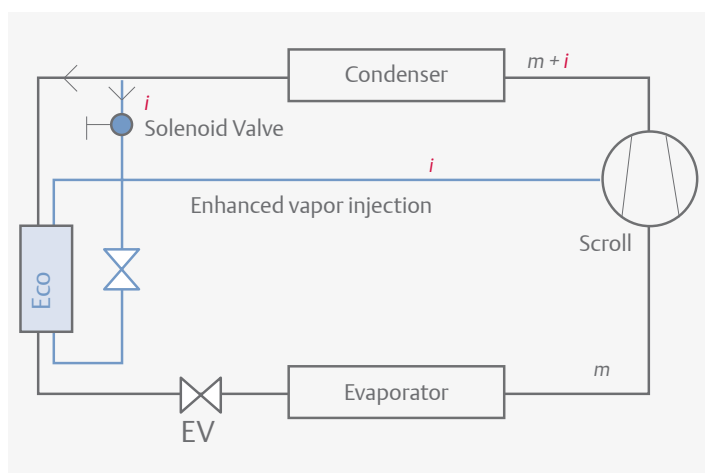

Enhanced Vapor Injection: Enthalpy Diagram

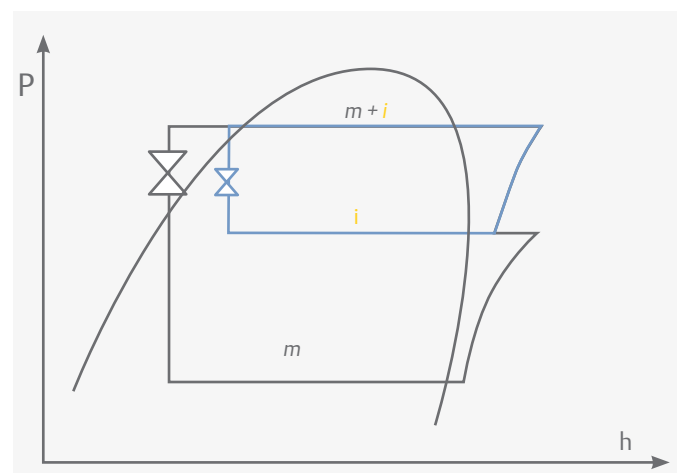

ZH*K4E / ZH*KVE Scroll Compressor Line-up R407C

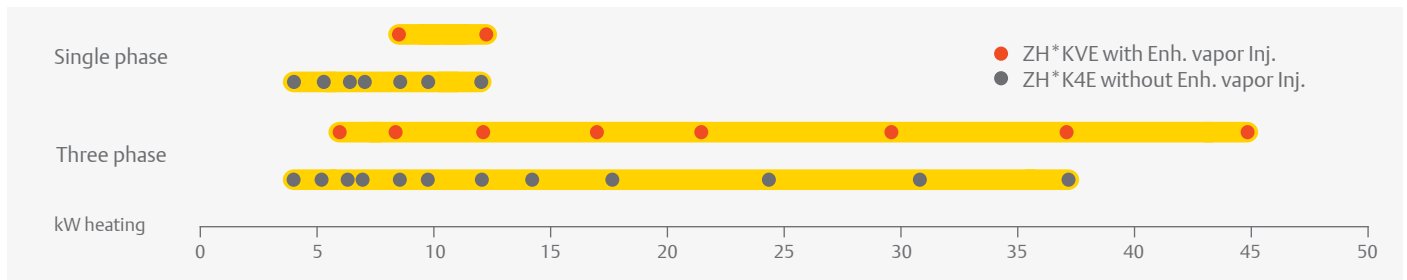

Conditions: Evaporating -7°C, Condensing 50°C, 4K Subcooling, 5K Superheat

ZH*P / ZHI*P Scroll Compressor Line-up R410A

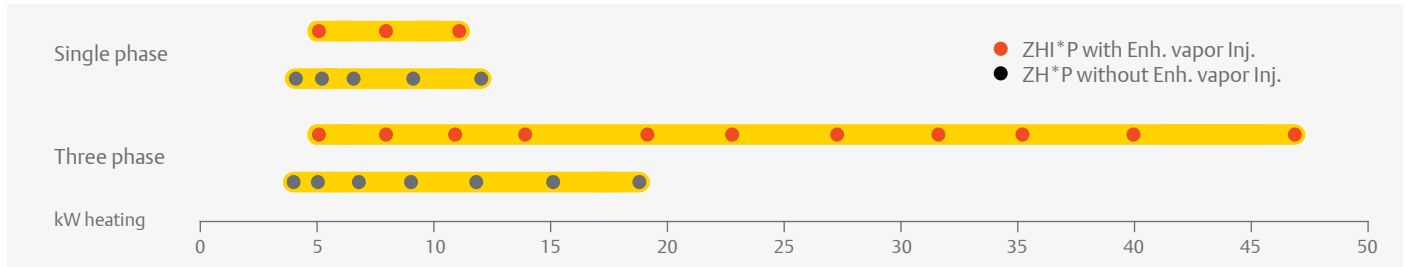

Conditions: Evaporating -7°C, Condensing 50°C, 4K Subcooling, 5K Superheat

ZH*KRE Scroll Compressor Line-up R513A



Features and Benefits

- Copeland™ scroll axial and radial compliance for high reliability
- High efficiency and increased heating capacity
- High water temperature for all applications
- Low sound and low vibration level
- Tandem combination for superior seasonal efficiency
- Enhanced Vapor Injection technology for best seasonal efficiency

Maximum Allowable Pressure (PS)

- ZH(I)04K1P to ZH(I)23K1P:
Low Side PS 28 bar(g) / High Side PS 45 bar(g)
- ZHI27K1P to ZHI46K1P:
Low Side PS 29.5 bar(g) / High Side PS 53 bar(g)
- ZH12K4E to ZH45K4E:
Low Side PS 20 bar(g) / High Side PS 32 bar(g)
- ZH56K4E to ZH11M4E:
Low Side PS 22.6 bar(g) / High Side PS 32 bar(g)
- ZH09KVE to ZH18KVE:
Low Side PS 20 bar(g) / High Side PS 32 bar(g)
- ZH24KVE to ZH48KVE:
Low Side PS 22.6 bar(g) / High Side PS 32 bar(g)

Operating Envelope R410A Heating

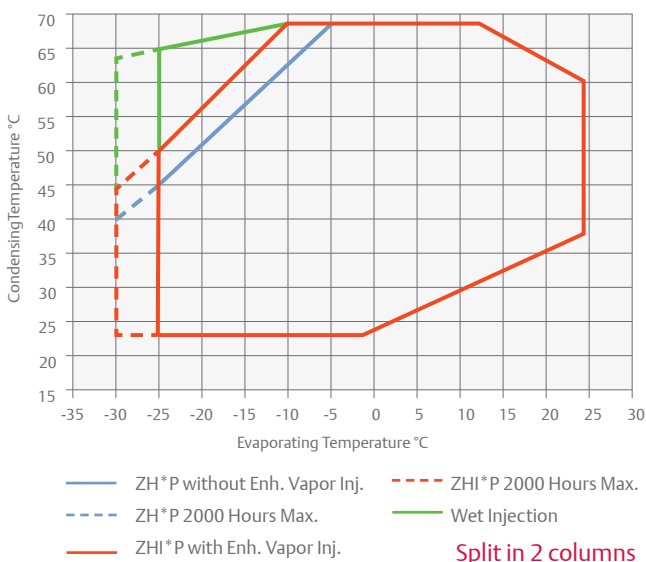

Operating Envelope R407C Heating

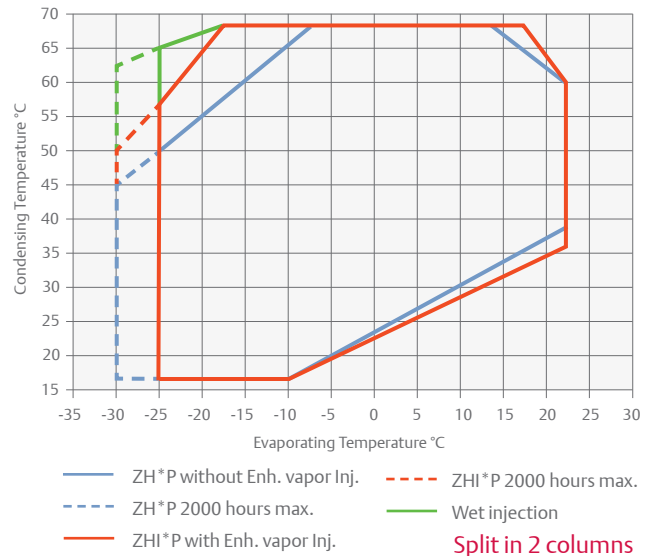

Refer to Emerson's Select Software for individual model operating envelopes and other refrigerants.

Technical Overview

R410A	Nominal hp	Capacity (kW)	COP	Displacement (m ³ /h)	Stub Suction (inch)	Stub Discharge (inch)	Oil Quantity (l)	Length/Width/Height (mm)	Net Weight (kg)	Motor Version/Code		Maximum Operating Current (A)		Locked Rotor Current (A)		Sound Pressure @1 m - dB(A) ***
										1 Ph*	3 Ph**	1 Ph*	3 Ph**	1 Ph*	3 Ph**	
ZH04 K1P	1.8	4.2	2.8	3.4	3/4	1/2	0.7	229/198/388	22	PFZ	TFM	9	5	50	28	62
ZH05 K1P	2.0	5.0	2.8	4.0	3/4	1/2	0.7	229/198/388	22	PFZ	TFM	13	5	60	28	62
ZH06 K1P	2.7	6.6	2.9	5.1	7/8	1/2	1.2	242/242/418	31	PFZ	TFM	17	6	83	44	62
ZH09 K1P	3.5	9.0	3.1	6.9	7/8	1/2	1.2	242/242/418	33	PFZ	TFM	23	7	108	52	62
ZH12 K1P	4.5	11.4	3.0	8.9	7/8	1/2	1.2	242/242/418	35	PFZ	TFM	28	10	130	62	65
ZH15 K1P	5.0	15.1	3.1	11.7	7/8	1/2	1.9	245/249/442	39		TFM		13		75	67
ZH19 K1P	6.5	18.7	3.2	14.8	7/8	3/4	1.9	239/244/443	39		TFM		17			67
ZHI05 K1P	1.9	5.2	3.0	3.4	3/4	1/2	0.7	229/198/388	22	PFZ	TFM	14	4	60	28	63
ZHI08 K1P	2.8	8.2	3.1	5.1	7/8	1/2	1.2	242/242/418	31	PFZ	TFM	19	6	108	43	63
ZHI11 K1P	3.6	10.8	3.2	6.9	7/8	1/2	1.2	242/242/418	31	PFZ	TFM	25	9	130	52	65
ZHI14 K1P	4.6	13.9	3.3	8.9	7/8	1/2	1.2	242/242/418	34		TFM		11		70	65
ZHI18 K1P	5.0	17.9	3.4	11.7	7/8	1/2	1.9	249/245/443	41		TFM		15			67
ZHI23 K1P	6.5	22.8	3.4	14.8	7/8	3/4	1.9	239/244/443	41		TFM		19			67
ZHI27 K1P	9.0	27.0	3.3	16.8	1 3/8	7/8	3.3	280/280/533	63		TFD		21.0		118	77
ZHI32 K1P	10.0	31.7	3.2	19.8	1 3/8	7/8	3.3	280/280/533	63		TFD		26.0		140	75
ZHI35 K1P	12.0	35.6	3.2	22.1	1 3/8	7/8	3.3	280/284/568	63		TFD		32.5		174	76
ZHI40 K1P	13.0	39.7	3.3	24.9	1 3/8	7/8	3.3	284/280/568	64		TFD		33.0		174	76
ZHI46 K1P	15.0	46.6	3.3	29.1	1 3/8	7/8	3.4	284/280/568	64		TWD		37.4		168	78

Conditions: Evaporating -7°C, Condensing 50°C, Superheat 5K, Subcooling 4K

* 1 Ph: 230V/ 50Hz

** 3 Ph: 380-420V/ 50Hz

*** @ 1m: sound pressure level at 1m distance from the compressor, free field condition

R407C	Nominal hp	Capacity (kW)	COP	Displacement (m ³ /h)	Stub Suction (inch)	Stub Discharge (inch)	Oil Quantity (l)	Length/Width/Height (mm)	Net Weight (kg)	Motor Version/Code		Maximum Operating Current (A)		Locked Rotor Current (A)		Sound Pressure @1 m - dB(A) ***
										1 Ph*	3 Ph**	1 Ph*	3 Ph**	1 Ph*	3 Ph**	
ZH12K4E	1.7	3.7	3.0	4.7	3/4	1/2	0.7	272/193/388	21	PFZ		10		44		53
ZH15K4E	2.0	4.6	3.0	5.8	3/4	1/2	1.3	243/243/364	23	PFJ	TFD	12	4	61	26	60
ZH06KVE	2.5	6.1	3.3	5.8	3/4	1/2	1.3	243/243/364	28		TFM		4		26	58
ZH19K4E	2.5	5.9	3.0	7.3	3/4	1/2	1.5	243/242/387	25	PFJ	TFD	17	6	74	32	60
ZH09KVE	3.0	8.3	3.3	8.0	3/4	1/2	1.5	243/243/386	30	PFZ	TFD	21	7	97	40	62
ZH21K4E	3.0	6.5	3.1	8.0	3/4	1/2	1.5	243/242/387	27	PFJ	TFD	19	5	76	32	61
ZH26K4E	3.5	8.2	3.1	10.0	3/4	1/2	1.5	243/242/400	28	PFJ	TFD	21	7	97	46	64
ZH13KVE	4.0	11.9	3.4	11.7	7/8	1/2	1.9	244/241/438	38	PFJ	TFD	30	10	160	74	68
ZH30K4E	4.0	9.5	3.1	11.7	7/8	1/2	1.9	247/241/438	38	PFJ	TFD	25	8	108	64	65
ZH38K4E	5.0	11.7	3.2	14.4	7/8	1/2	1.9	247/241/438	38	PFZ	TFD	31	10	150	64	66
ZH18KVE	6.0	16.8	3.4	17.1	7/8	1/2	1.9	244/241/438	40		TFD		14		101	65
ZH45K4E	6.0	14.0	3.2	17.1	7/8	1/2	1.9	250/246/438	40		TFD		12		74	67
ZH24KVE	7.5	21.5	3.3	20.9	1 3/8	7/8	4.0	368/321/525	93		TWD		18		99	75
ZH56K4E	7.5	17.4	3.1	20.9	1 3/8	7/8	4.0	357/321/497	93		TWD		17		99	75
ZH33KVE	10.0	29.7	3.4	29.0	1 3/8	7/8	4.0	368/321/525	93		TWD		24		127	73
ZH75K4E	10.0	24.2	3.2	28.8	1 3/8	7/8	4.0	357/321/497	93		TWD		21		127	75
ZH40KVE	13.0	37.3	3.4	35.5	1 3/8	7/8	4.1	368/321/532	95		TWD		30		167	75
ZH92K4E	13.0	30.7	3.3	35.6	1 3/8	7/8	4.1	356/320/505	95		TWD		25		167	75
ZH48KVE	15.0	45.0	3.5	42.8	1 5/8	1 1/8	4.1	368/323/579	112		TWD		36		198	77

Conditions: Evaporating -7°C, Condensing 50°C, Superheat 5K, Subcooling 4K

* 1 Ph: 230V/ 50Hz

** 3 Ph: 380-420V/ 50Hz

*** @ 1m: sound pressure level at 1m distance from the compressor, free field condition

R513A	Nominal hp	Capacity (kW)	COP	Displacement (m ³ /h)	Stub Suction (inch)	Stub Discharge (inch)	Oil Quantity (l)	Length/Width/Height (mm)	Net Weight (kg)	Motor Version/Code	Maximum Operating Current (A)	Locked Rotor Current (A)	Sound Pressure @1 m - dB(A) ***
										1 Ph*	1 Ph*	1 Ph*	
ZH21KRE	2.0	3.1	2.1	8.0	3/4	1/2	1.5	243/242/387	27	PFJ	19	76	61
ZH26KRE	3.0	3.1	2.1	10.0	3/4	1/2	1.5	243/242/400	28	PFJ	21	97	63

Conditions: Evaporating -7°C, Condensing 50°C, Superheat 5K, Subcooling 4K

* 1 Ph: 230V/ 50Hz

*** @ 1m: sound pressure level at 1m distance from the compressor, free field condition

Capacity Data

Condensing Temperature +50°C															
R410A	Heating Capacity (kW)							R410A	Power Input (kW)						
	Evaporating Temperature (°C)								Evaporating Temperature (°C)						
Model	-30	-15	-10	-5	0	+5	+15	Model	-30	-15	-10	-5	0	+5	+15
ZH04 K1P	n.a.	3.3	3.9	4.5	5.2	6.0	7.6	ZH04 K1P	n.a.	1.4	1.5	1.5	1.5	1.5	1.5
ZH09 K1P	n.a.	7.1	8.2	9.5	10.9	12.5	16.4	ZH09 K1P	n.a.	2.8	2.9	3.0	3.0	3.0	3.0
ZH12 K1P	n.a.	9.2	10.5	12.1	13.9	15.9	21.0	ZH12 K1P	n.a.	3.7	3.7	3.8	3.8	3.8	3.8
ZH15 K1P	n.a.	12.0	13.8	15.9	18.4	21.1	27.7	ZH15 K1P	n.a.	4.7	4.9	5.0	5.1	5.2	5.2
ZH19 K1P	n.a.	15.2	17.5	20.2	23.2	26.7	35.1	ZH19 K1P	n.a.	6.0	6.2	6.3	6.4	6.5	6.5
Models With Enhanced Vapor Injection															
ZHI05 K1P	2.6	4.2	4.8	5.4	6.1	6.9	8.6	ZHI05 K1P	1.7	1.7	1.7	1.8	1.8	1.8	1.7
ZHI08 K1P	5.0	6.7	7.6	8.4	9.4	10.5	13.1	ZHI08 K1P	2.5	2.6	2.6	2.6	2.6	2.6	2.4
ZHI11 K1P	6.4	9.0	10.1	11.3	12.6	14.0	17.2	ZHI11 K1P	3.2	3.3	3.3	3.3	3.3	3.3	3.1
ZHI14 K1P	8.5	11.6	13.0	14.5	16.2	18.1	22.3	ZHI14 K1P	3.9	4.1	4.2	4.2	4.2	4.2	4.0
ZHI18 K1P	10.8	14.9	16.7	18.7	20.9	23.2	28.7	ZHI18 K1P	5.1	5.3	5.4	5.4	5.4	5.3	5.2
ZHI23 K1P	13.8	19.0	21.3	23.9	26.6	29.7	36.7	ZHI23 K1P	6.6	6.8	6.9	6.9	6.9	6.8	6.6
ZHI27 K1P	14.2	22.1	25.1	28.4	31.8	35.5	43.8	ZHI27 K1P	7.9	8.2	8.2	8.1	8.1	7.9	7.5
ZHI32 K1P	16.4	26.1	29.5	33.2	37.1	41.4	51.1	ZHI32 K1P	8.7	9.7	9.8	9.8	9.7	9.6	9.4
ZHI35 K1P	19.5	29.2	33.1	37.3	41.9	46.7	57.4	ZHI35 K1P	11.0	10.8	10.9	11.0	11.1	11.2	11.1
ZHI40 K1P	21.7	32.5	36.9	41.7	47.0	52.7	65.6	ZHI40 K1P	12.0	12.0	12.1	12.1	12.2	12.2	12.3
ZHI46 K1P	26.1	38.7	43.5	48.7	54.3	60.4	74.0	ZHI46 K1P	13.2	14.0	14.1	14.1	14.1	14.1	14.0

Conditions: Suction Superheat 5K / Subcooling 4K

Condensing Temperature +50°C															
R407C	Heating Capacity (kW)							R407C	Power Input (kW)						
	Evaporating Temperature (°C)								Evaporating Temperature (°C)						
Model	-30	-15	-10	-5	0	+5	+15	Model	-30	-15	-10	-5	0	+5	+15
ZH12K4E	n.a.	2.8	3.3	3.9	4.6	5.4	7.5	ZH12K4E	n.a.	1.2	1.2	1.3	1.3	1.3	1.4
ZH15K4E	n.a.	3.6	4.3	5.0	5.8	6.8	9.2	ZH15K4E	n.a.	1.5	1.5	1.6	1.6	1.6	1.9
ZH21K4E	n.a.	5.1	5.9	6.9	8.1	9.6	13.2	ZH21K4E	n.a.	2.0	2.1	2.1	2.2	2.3	2.4
ZH26K4E	n.a.	6.3	7.4	8.7	10.3	12.1	16.5	ZH26K4E	n.a.	2.5	2.6	2.7	2.7	2.8	3.0
ZH30K4E	n.a.	7.3	8.6	10.1	11.9	14.0	19.2	ZH30K4E	n.a.	2.9	3.0	3.1	3.2	3.3	3.4
ZH38K4E	n.a.	9.0	10.6	12.5	14.6	17.2	23.4	ZH38K4E	n.a.	3.5	3.6	3.8	3.9	4.0	4.2
ZH45K4E	n.a.	10.8	12.7	14.9	17.4	20.3	27.2	ZH45K4E	n.a.	4.2	4.3	4.5	4.6	4.7	5.1
ZH56K4E	n.a.	13.4	15.8	18.6	21.8	25.5	34.1	ZH56K4E	n.a.	5.3	5.5	5.7	6.0	6.2	6.8
ZH75K4E	n.a.	18.5	21.9	25.8	30.3	35.5	47.6	ZH75K4E	n.a.	7.0	7.4	7.7	8.0	8.2	8.5
ZH92K4E	n.a.	23.4	27.8	32.8	38.5	45.1	60.3	ZH92K4E	n.a.	8.5	9.0	9.5	10.0	10.4	11.2
ZH11M4E	n.a.	28.4	33.6	39.5	46.3	54.3	72.7	ZH11M4E	n.a.	10.3	10.9	11.5	11.9	12.5	13.4
Models With Enhanced Vapor Injection															
ZH06KVE	3.3	4.9	5.7	6.5	7.4	8.4	10.8	ZH06KVE	1.7	1.8	1.9	1.9	2.0	2.0	2.1
ZH09KVE	4.1	6.6	7.6	8.7	9.9	11.2	14.3	ZH09KVE	2.1	2.4	2.4	2.5	2.6	2.6	2.6
ZH13KVE	5.7	9.5	10.9	12.5	14.3	16.2	20.7	ZH13KVE	3.0	3.4	3.5	3.5	3.6	3.6	3.7
ZH18KVE	8.0	13.5	15.4	17.6	20.0	22.6	28.7	ZH18KVE	4.2	4.8	4.9	5.0	5.1	5.1	5.2
ZH24KVE	9.7	17.0	19.6	22.5	25.5	28.9	36.7	ZH24KVE	5.2	6.2	6.4	6.6	6.7	6.8	7.0
ZH33KVE	14.3	23.7	27.2	31.1	35.3	40.0	50.7	ZH33KVE	7.0	8.2	8.5	8.8	9.1	9.3	9.6
ZH40KVE	18.1	29.6	34.1	39.1	44.7	50.9	65.5	ZH40KVE	8.9	10.2	10.6	11.0	11.3	11.7	12.4
ZH48KVE	21.1	35.6	41.1	47.2	54.1	61.8	80.4	ZH48KVE	10.0	12.2	12.7	13.2	13.5	14.0	15.1

Conditions: Suction Superheat 5K / Subcooling 4K

Condensing Temperature +50°C															
R513A	Heating Capacity (kW)							R513A	Power Input (kW)						
	Evaporating Temperature (°C)								Evaporating Temperature (°C)						
Model	-30	-15	-10	-5	0	+5	+15	Model	-30	-15	-10	-5	0	+5	+15
ZH21KRE		3.4	4.0	4.8	5.6	6.6	9.0	ZH21KRE		1.4	1.5	1.5	1.6	1.6	1.7
ZH26KRE		4.5	5.3	6.2	7.2	8.4	11.5	ZH26KRE		1.9	1.9	2.0	2.0	2.1	2.2

Conditions: Suction Superheat 5K / Subcooling 4K
Single phase only

YHV Copeland™ Scroll Variable Speed Compressor Range for A2L Refrigerants R452B/R454B with Inverter Drive

The new YHV compressor range is designed to support system manufacturers build brine-to-water or air-to-water heat pumps that meet the requirements of the F-gas phasedown. These scrolls are qualified to reach a wide operating envelope without the need of enhanced vapor injection (EVI).

The matched inverter drives are qualified per EN60335-1 and available for 1ph and 3ph power supply. YHV* 2P compressors and their matched drives belong to PED category II and therefore comply with stringent quality requirements: they are hermetically sealed and electrical connections are not source of ignition. This solution is offered to system manufacturers as a CE certified package for faster time to market and for the highest level of compressor protection.



YHV Copeland scroll variable speed compressor and drive

YHV Variable Speed Scroll Compressor Line-Up

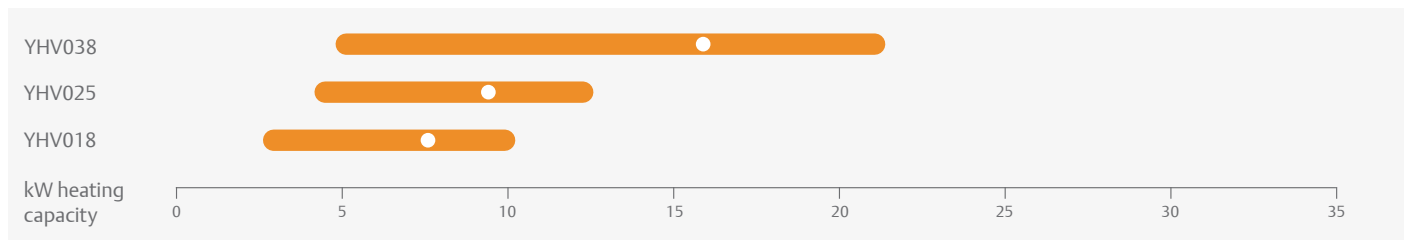

Conditions: Heating kW Evaporating -7°C, Condensing 50°C, 5K Superheat, 4K Subcooling

Features and Benefits

- Speed range from 15 to 120 Hz
- Drive available in air-cooled and flat plate version
- Axial and radial compliance for reliability
- Compressor model with 3-feet for compact units
- Pre-compliant solution to relevant application standards (EN378, EN60335), to facilitate system development
- F-gas compliant

Maximum Allowable Pressure (PS)

- Low side PS 28 bar(g) / High Side PS 49 bar(g)

Operating Envelope R454B

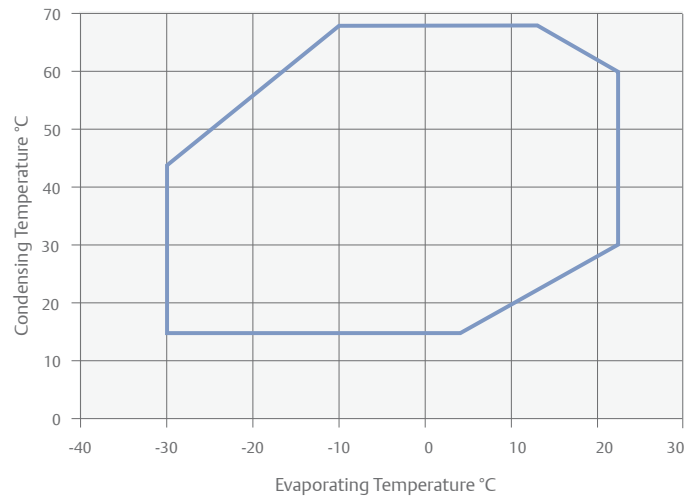

Technical Overview

Compressor											
Models	Heating Capacity (kW)			COP*	Displacement (cm ³)	Stub Suction (inch)	Stub Discharge (inch)	Oil Quantity (l)	Length/Width/Height (mm)	Net Weight (kg)	Sound Pressure @1 m - dB(A)**
	Min	Max	Nominal Capacity								
YHV0182P	2.6	10.1	6.2	2.0	18	3/4	1/2	0.7	194/216/335	15	61
YHV0252P	3.9	12.4	8.4	2.1	25	3/4	1/2	0.7	194/216/335	16	65
YHV0382P	5.4	21.4	12.6	2.2	38	3/4	1/2	1.2	216/194/385	20	64

Conditions: Evaporating -7°C, Condensing 50°C, Superheat 10K, Subcooling 0K

*at Nominal Speed (90Hz)

** @ 1m: sound pressure level at 1m distance from the compressor, free field condition

Inverter Drive										
Models	Matched Compressor	Power input (kW)	Amps (A)	Cooling	Net Weight (kg)	1Ph 230V	3Ph 400V	Comm.	Length/Width/Height (mm)*	
		Max	Max							
ED3011AU	YHV018	2.6	11	Air / Liquid	2.8	√	n.a.	Modbus	205/240/143	
ED3015AU	YHV025	3.8	15		2.8	√	n.a.		205/240/143	
ED3020AU	YHV025-38	5.5	20		3.6	√	n.a.		205/250/180	
ED3013BU	YHV018	4.4	13		3.4	n.a.	√		205/250/183	
ED3018BU	YHV025-38	6.0	18		4.4	n.a.	√		205/250/183	

*Air-cooled version including fins

Capacity Data

Condensing Temperature +50°C																	
R452B		Heating Capacity (kW)							R452B		Power Input (kW)						
		Evaporating Temperature (°C)									Evaporating Temperature (°C)						
Models		-15	-10	-5	0	5	+10	+15	Models		-15	-10	-5	0	5	+10	+15
YHV0182P	Max	7.8	9.0	10.3	11.9	13.4	14.2	14.9	YHV0182P	Max	3.2	3.3	3.3	3.4	3.3	3.1	2.8
	Min	3.2	3.7	4.3	4.9	5.6	6.4	7.2		Min	1.3	1.3	1.4	1.4	1.4	1.4	1.3
YHV0252P	Max	10.5	12.3	14.2	16.3	18.5	19.6	20.6	YHV0252P	Max	4.2	4.5	4.6	4.7	4.7	4.3	4.0
	Min	5.2	5.1	5.8	6.7	7.7	8.8	10.0		Min	2.6	1.8	1.8	1.8	1.8	1.8	1.8
YHV0382P	Max	12.9	16.1	18.6	21.4	24.6	27.7	28.3	YHV0382P	Max	4.7	5.6	5.8	5.9	6.1	6.1	5.4
	Min	6.6	7.7	8.8	10.2	11.7	13.3	15.2		Min	2.6	2.7	2.7	2.7	2.8	2.8	2.8

Conditions: Suction Superheat 10K / Subcooling 0K

Condensing Temperature +50°C																	
R454B		Heating Capacity (kW)							R454B		Power Input (kW)						
		Evaporating Temperature (°C)									Evaporating Temperature (°C)						
Models		-15	-10	-5	0	5	+10	+15	Models		-15	-10	-5	0	5	+10	+15
YHV0182P	Max	7.7	9.9	10.0	11.5	13.0	13.8	14.5	YHV0182P	Max	3.2	4.5	3.3	3.3	3.3	3.0	2.8
	Min	3.1	3.6	4.1	4.7	5.4	6.2	7.0		Min	1.3	1.3	1.3	1.3	1.4	1.3	1.3
YHV0252P	Max	10.4	11.9	13.8	15.8	17.9	19.0	20.0	YHV0252P	Max	4.3	4.4	4.5	4.6	4.6	4.3	3.9
	Min	4.3	4.9	5.7	6.5	7.5	8.6	9.7		Min	1.7	1.8	1.8	1.8	1.8	1.8	1.8
YHV0382P	Max	13.2	15.7	18.1	20.9	24.0	27.0	27.7	YHV0382P	Max	5.2	5.5	5.7	5.9	6.0	6.0	5.3
	Min	6.4	7.5	8.6	9.9	11.3	12.9	14.7		Min	2.6	2.7	2.7	2.7	2.7	2.7	2.7

Conditions: Suction Superheat 10K / Subcooling 0K

XHV & ZHW Copeland™ Scroll Variable Speed Compressor Ranges for R410A With Inverter Drive

XHV and ZHW variable speed scroll compressors for R410A, for outstanding performance for cooling and heating applications.

XHV and ZHW compressors deliver outstanding performances, both in new building and retrofit applications. Variable speed Copeland scroll compressors feature a state-of-the-art brushless permanent magnet motor matched with a highly efficient drive and vapor injection technology (ZHW only). In addition to Copeland market-proven robustness, XHV and ZHW compressors with the qualified inverter drive meet and exceed the level of reliability expected for these demanding applications.



ZHW Copeland scroll variable speed compressor and drive

XHV & ZHW Variable Speed Scroll Compressor Line-Up

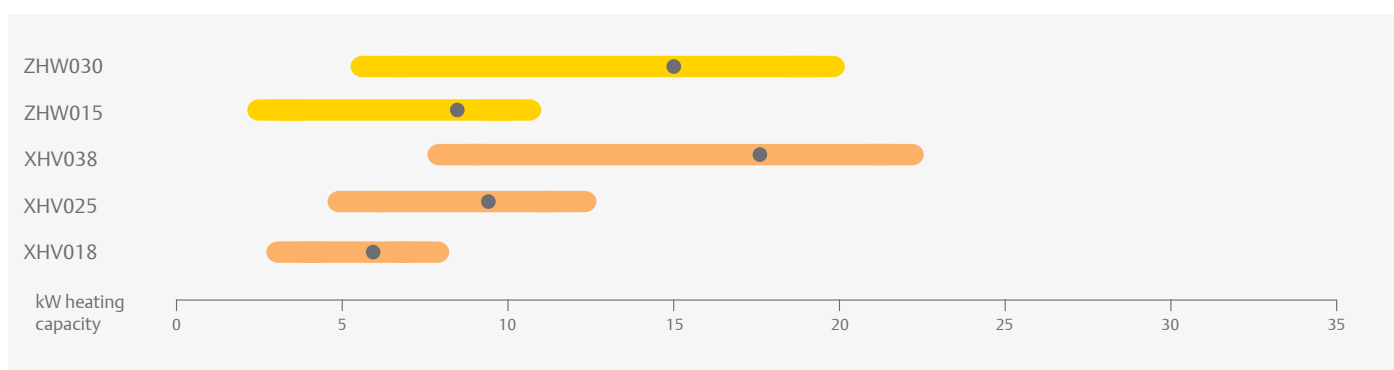

Conditions: Cooling kW Evaporating 5°C, Condensing 50°C, Superheat 10K, Subcooling 0K
Heating kW Evaporating -7°C, Condensing 50°C, 5K Superheat, 4K Subcooling

Features and Benefits

- Highest efficiency throughout the operating envelope and speed range
- Envelope and speed management information for the system controller (real-time communication via Modbus RS485)
- Enhanced Vapor Injection technology for best seasonal efficiency (ZHW)
- High water temperature for all applications
- Compliance with electromagnetic-compatibility (EMC) and electromagnetic-interference (EMI) requirements for residential applications
- VDE certification for ZHW compressor matched with Emerson inverter drive
- Wide speed range 15-120Hz
- Mutually optimized and qualified scroll and drive

Operating Envelope R410A

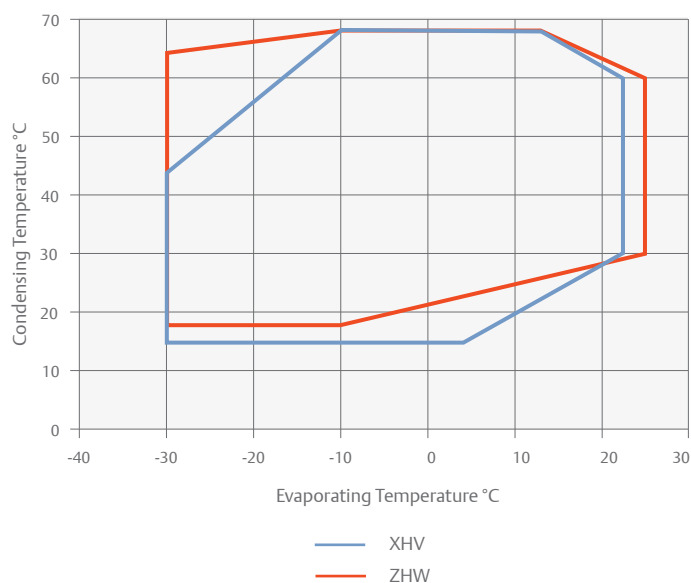

Maximum Allowable Pressure (PS)

- ZHW:
Low side PS 28 bar(g) / High side PS 45 bar(g)
- XHV:
Low side PS 28 bar(g) / High side PS 45 bar(g)

Technical Overview

Compressor											
R410A	Heating Capacity (kW)			COP*	Displacement (cm ³)	Stub Suction (inch)	Stub Discharge (inch)	Oil Quantity (l)	Length/Width/Height (mm)	Net Weight (kg)	Sound Pressure @1m - dB(A)**
	Min	Max	Nominal Capacity								
ZHW0152P	2.7	10.4	6.1	2.9	15.0	3/4	1/2	1.7	229/198/394	20	68
ZHW0302P	5.5	19.8	11.8	3.2	30.0	3/4	1/2	1.7	229/198/394	20	68
XHV0181P	2.6	10.7	6.4	3.0	18.0	3/4	1/2	0.7	218/198/334	15	61
XHV0251P	3.7	14.8	8.6	3.1	25.0	3/4	1/2	0.7	218/198/334	16	65
XHV0382P	5.5	22.8	13.0	3.1	38.0	3/4	1/2	1.2	218/198/384	20	64

Conditions: Evaporating -7°C, Condensing 50°C

*@ Nominal Speed (90Hz)

** @ 1m: sound pressure level at 1m distance from the compressor, free field condition

Inverter Drive										
Model	Matched Compressor	Power Input (kW)		Amps (A)	Cooling	Net Weight (kg)	1Ph 230V	3Ph 400V	Comm.	Length/Width/Height (mm)*
		Nominal	Nominal	Nominal						
EV2055M	ZHW015	5.5			Air / Liquid	3.6	√	√	Modbus	228/260/119
EV2080M	ZHW030	8.0				5.1	√	√		228/260/156
ED3015AU	XHV018-25	3.8		15	Air / Liquid	2.8	√	n.a.	Modbus	205/240/143
ED3020AU	XHV025-38	5.5		20		3.6	√	n.a.		205/250/180
ED3013BU	XHV018-25	4.4		13		3.4	n.a.	√		205/250/183
ED3018BU	XHV025-38	6.0		18		4.4	n.a.	√		205/250/183
ED3022B	XHV038	8.8		22	Air	5.2	n.a.	√		233/316/150

*Air-cooled version including fins

Capacity Data

Condensing Temperature +50°C																	
R410A		Heating Capacity (kW)							R410A		Power Input (kW)						
		Evaporating Temperature (°C)									Evaporating Temperature (°C)						
Model		-30	-15	-10	-5	0	+5	+15	Model		-30	-15	-10	-5	0	+5	+15
ZHW0152P	Max	6.0	8.6	9.7	11.0	12.0	12.0	12.4	ZHW0152P	Max	3.1	3.3	3.3	3.4	3.2	2.9	2.4
	Min	2.0	2.6	2.8	2.9	3.1	3.1	3.8		Min	1.3	1.1	1.1	1.0	0.9	0.9	0.9
ZHW0302P	Max	11.3	16.3	18.5	20.8	22.6	22.6	23.7	ZHW0302P	Max	5.7	6.0	6.1	6.1	5.7	5.4	4.4
	Min	4.2	5.2	5.8	5.9	6.6	6.6	8.1		Min	2.4	2.0	2.0	1.9	1.7	1.7	1.7

Condition: Suction Superheat 10K, Subcooling 4K

Condensing Temperature +50°C																	
R410A		Heating Capacity (kW)							R410A		Power Input (kW)						
		Evaporating Temperature (°C)									Evaporating Temperature (°C)						
Model		-20	-15	-10	-5	0	+5	+15	Model		-20	-15	-10	-5	0	+5	+15
XHV0181P	Max	7.7	8.7	9.9	11.3	12.9	14.4	16.2	XHV0181P	Max	3.4	3.5	3.6	3.7	3.7	3.6	3.1
	Min	2.2	2.4	2.5	2.6	2.5	2.8	3.7		Min	1.0	1.0	1.0	0.9	0.8	0.8	0.8
XHV0251P	Max	10.3	11.8	13.6	15.7	18.1	20.4	22.8	XHV0251P	Max	4.5	4.7	4.9	5.0	5.1	5.1	4.4
	Min	3.2	3.4	3.6	3.7	3.5	4.0	5.0		Min	1.4	1.4	1.3	1.2	1.1	1.1	1.0
XHV0382P	Max	15.8	18.1	20.9	24.1	27.8	31.4	35.0	XHV0382P	Max	6.9	7.1	7.4	7.6	7.8	7.8	6.7
	Min	4.7	5.1	5.5	5.6	5.4	6.1	7.7		Min	2.1	2.1	2.0	1.9	1.6	1.6	1.6

Condition: Suction Superheat 5K, Subcooling 4K

ZH Copeland™ Scroll for Heat Recovery and High Condensing Applications for R134a

ZH*KCE R134a Copeland scroll compressors were developed for the recovery and reuse of available heat. For example, the heat generated by processes or machining cooling equipment can be recovered and not wasted. This contributes to reducing the total energy cost of installations. On a water-cooled chiller, heat recovery on the condensing water loop can be used to produce high temperature water for sanitary or premise heating. With a typical evaporating temperature between 20°C and 40°C and condensing up to 85°C, ZH*KCE scrolls offer many opportunities of heat recovery.

The range of products goes from the ZH40KCE (7.5hp) to the ZH150 (30hp) which can be tandemized.



ZH*KCE scroll compressor for heat recovery

ZH*KCE Scroll Compressor Line-Up R134a

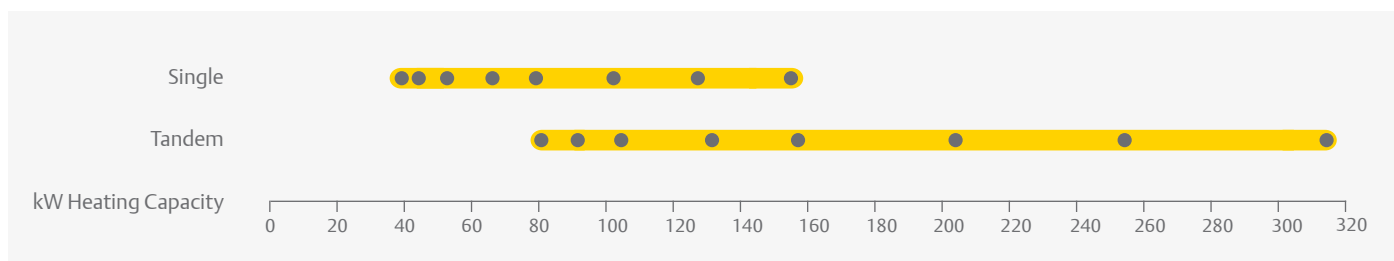

Conditions: Evaporating 40°C, Condensing 85°C, Superheat 10K, Subcooling 5K

Features and Benefits

- Copeland scroll axial and radial compliance for superior reliability and efficiency
- Wide scroll line-up R134a with 8 models and tandem
- Low sound and vibration level
- Low oil circulation rate
- Copeland qualified tandem

Typical Applications

- Heat recovery on the dry cooler water circuit of a water-cooled chiller to produce sanitary water or other heating
- Re-inject energy to district heating network and avoid wasting it
- Process industry where the water returning from the machinery comes back between 20 and 40°C
- Food industry where one areas needs cooling and another heating at the same time
- Air-to-water heat pump, even during the warm season
- Exhaust air heat recovery system
- Heat recovery on Fluegas

Operating Envelope R134a

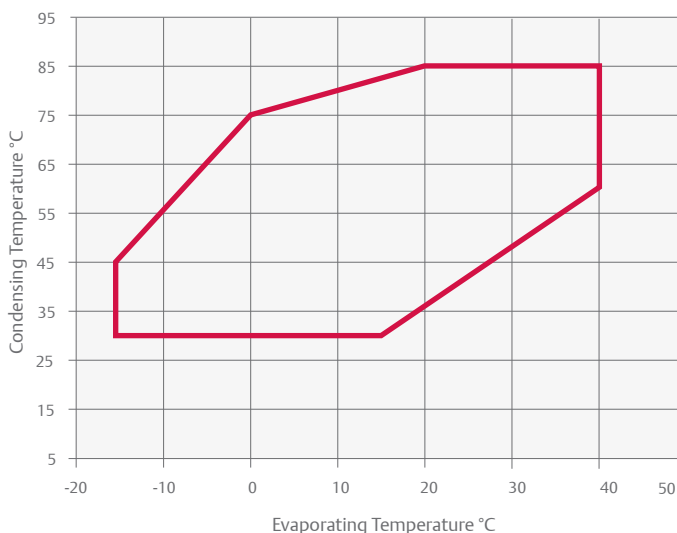

Maximum Allowable Pressure (PS)

- Low side PS 20 bar(g) / High side PS 32 bar(g)

Technical Overview

Models	Nominal hp	Heating Capacity (kW)	Heating COP	Displacement (m ³ /h)	Suction (inch)	Stub Discharge (inch)	Oil Quantity (l)	Length/Width/Height (mm)	Net Weight (kg)	Motor Version / Code	Maximum Operating Current (A)	Locked Rotor Current (A)	Sound Pressure @1 m - dB(A) **
										3 Ph*	3 Ph*	3 Ph*	
ZH40KCE	7.5	39.0	4.3	22.1	1 1/8	7/8	2.7	264 / 285 / 476	57	TFD	19	95	63
ZH45KCE	9.0	44.0	4.6	24.9	1 3/8	7/8	3.4	264 / 285 / 533	60	TFD	21	111	63
ZH50KCE	10.0	50.9	4.5	29.1	1 3/8	7/8	3.4	264 / 285 / 533	61	TFD	23	118	63
ZH64KCE	13.0	63.7	4.3	36.4	1 3/8	7/8	3.4	264 / 285 / 552	65	TFD	27	140	68
ZH75KCE	15.0	76.0	4.2	43.4	1 3/8	7/8	3.4	264 / 285 / 552	66	TFD	35	174	71
ZH100KCE	20.0	96.1	4.0	56.6	1 5/8	1 3/8	4.7	432 / 376 / 694	140	TWD	42	225	72
ZH125KCE	25.0	120.0	4.1	71.4	1 5/8	1 3/8	6.8	447 / 392 / 717	160	TWD	53	272	74
ZH150KCE	30.0	148.8	4.2	87.5	1 5/8	1 3/8	6.3	447 / 427 / 717	177	TWD	67	310	76

Conditions Evaporating 40°C - Condensing 85°C - Superheat 5K - Subcooling 4K

* 3 Ph: 380-420V/ 50Hz

** @ 1m: sound pressure level at 1m distance from the compressor, free field condition

For equivalent models to ZH45-75KCE with R513A, please refer to models ZR108-190KRE on pages 11.

Capacity Data

Condensing Temperature +80°C															
R134a	Heating Capacity (kW)							R134a	Power Input (kW)						
	Evaporating Temperature (°C)								Evaporating Temperature (°C)						
Models	+10	+15	+20	+25	+30	+35	+40	Models	+10	+15	+20	+25	+30	+35	+40
ZH40KCE	16.9	19.7	22.9	26.5	30.7	35.6	41.1	ZH40KCE	8.3	8.3	8.2	8.1	8.1	8.1	8.1
ZH45KCE	20.2	23.2	26.5	30.5	35.0	40.3	46.5	ZH45KCE	8.7	8.7	8.7	8.7	8.7	8.7	8.7
ZH50KCE	23.1	26.6	30.6	35.2	40.5	46.7	53.8	ZH50KCE	10.2	10.2	10.2	10.2	10.2	10.2	10.2
ZH64KCE	28.7	33.1	38.1	43.9	50.7	58.4	67.3	ZH64KCE	13.5	13.5	13.4	13.4	13.5	13.5	13.6
ZH75KCE	34.8	39.9	45.8	52.6	60.5	69.7	80.3	ZH75KCE	16.2	16.2	16.2	16.2	16.3	16.4	16.7
ZH100KCE	46.4	52.6	59.9	68.3	77.9	88.9	101.5	ZH100KCE	21.1	21.3	21.4	21.5	21.5	21.5	21.6
ZH125KCE	57.6	65.4	74.4	84.8	96.9	111.0	127.0	ZH125KCE	27.6	26.6	26.6	26.5	26.4	26.3	26.3
ZH150KCE	71.0	80.7	91.9	105.0	120.0	137.0	157.0	ZH150KCE	30.7	31.2	31.5	31.8	32.0	32.3	32.5

Conditions: Suction Superheat 5K / Subcooling 4K

ZRH(V) & YRH(V) Copeland™ Scroll Horizontal Compressor Ranges for R513A, R454C, R407C and R134a

Air conditioning for passenger comfort is a pre-requisite in today's public transport vehicles. At the same time, maximization of passenger space and streamlining of high speed trains increasingly impose limitations on height.

ZRH compressors are based on the unique Copeland scroll design and provide the same reliability as a standard Copeland scroll. An additional oil pump covers the specific needs of transport air conditioning and of horizontal compressor arrangement in general.

The low profile design and modulation capabilities of the ZRH compressor range are the ideal response to these market needs.



ZRH horizontal scroll compressor

ZRH & YRH Scroll Compressors Line-up R513A, R454C, R407C and R134a

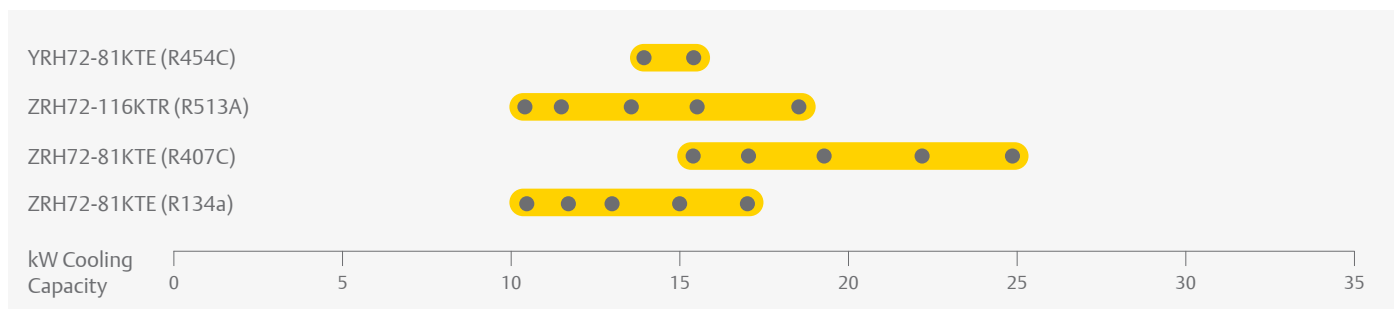

ZRHV & YRHV Variable Speed Scroll Compressors Line-up R513A, R454C, R407C and R134a

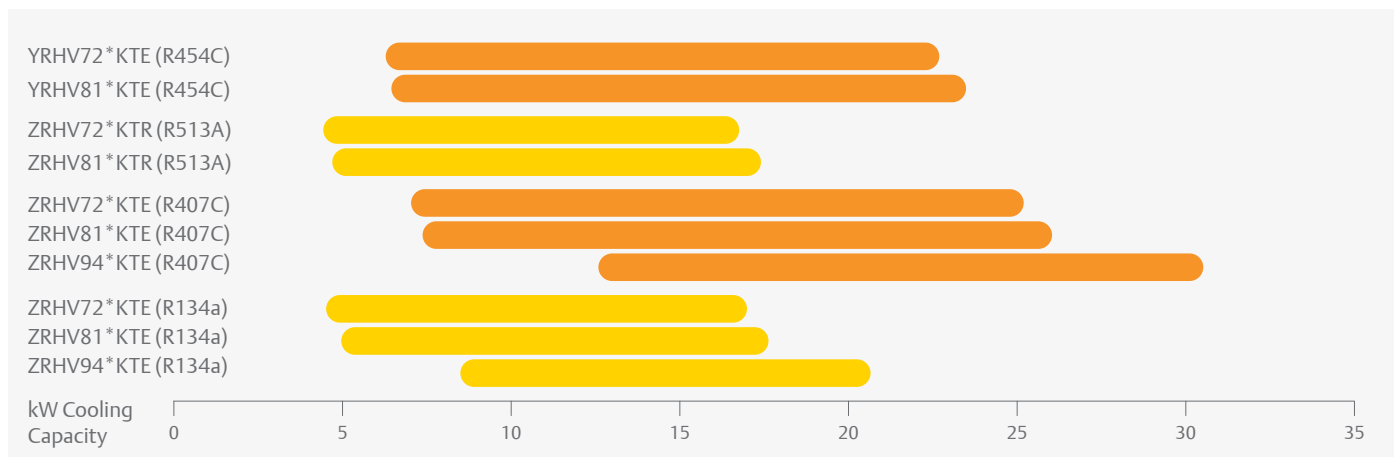

Conditions: EN12900: Evaporating 5°C, Condensing 50°C, Superheat 10K, Subcooling 0K

Features and Benefits

- Compact and low weight
- Horizontal design below 200mm height
- Copeland Scroll compliance for superior reliability and efficiency
- Two oil-pumps
- Hermetic design for leak-free operation
- Wide operating envelope for heat pump and cooling applications
- 25 - 100 Hz capacity modulation range for precise control and increase of the seasonal performance
- IP56 terminal box

Maximum Allowable Pressure (PS)

Low Side PS 21 bar(g) / High Side PS 28.8 bar(g)

Operating Envelope R407C

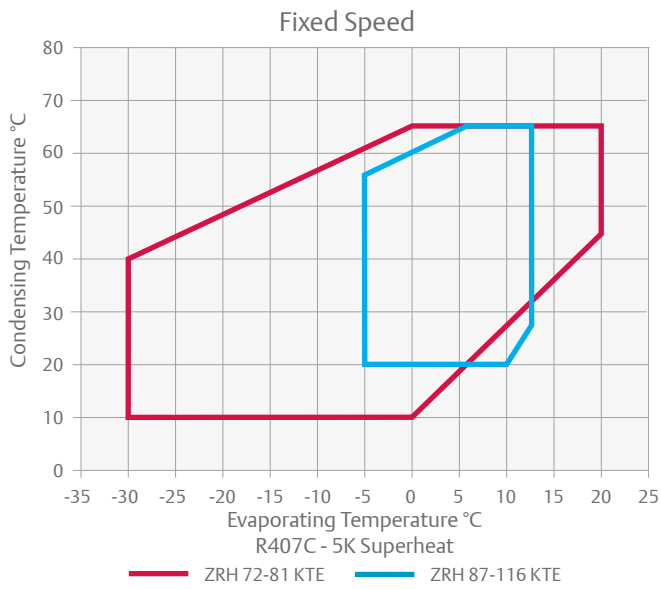

Operating Envelope R134a

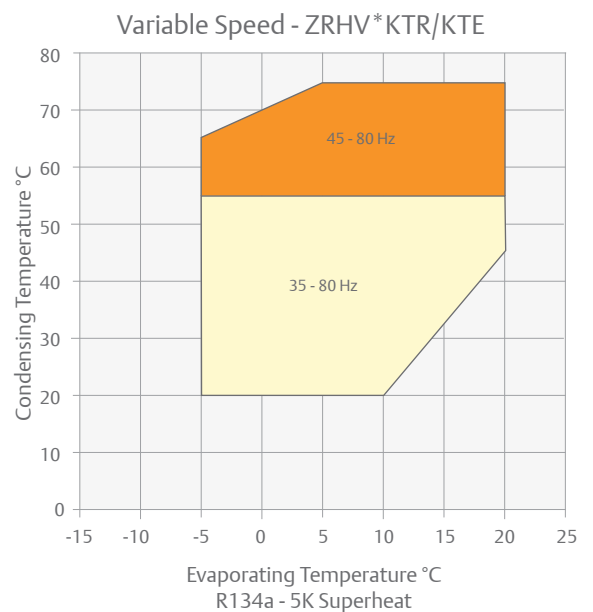
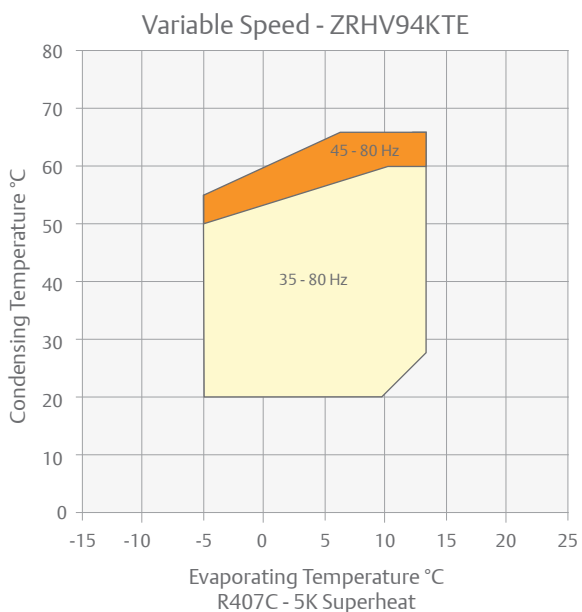
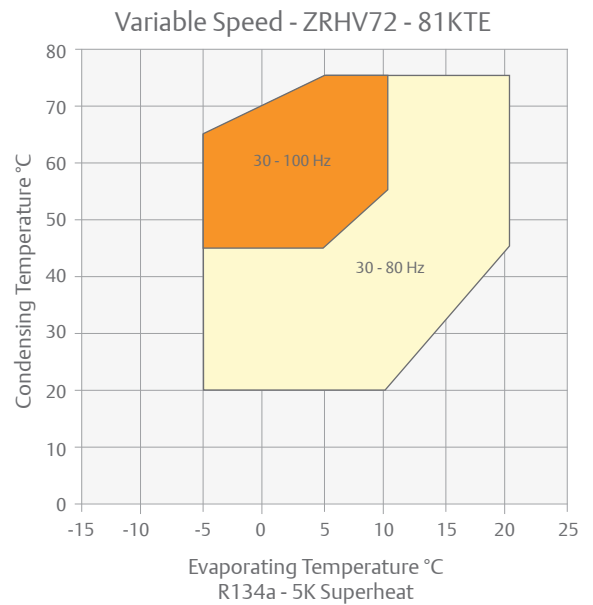
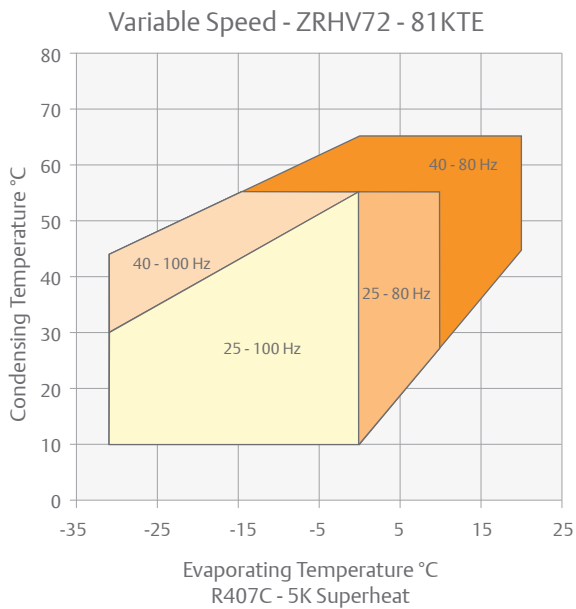
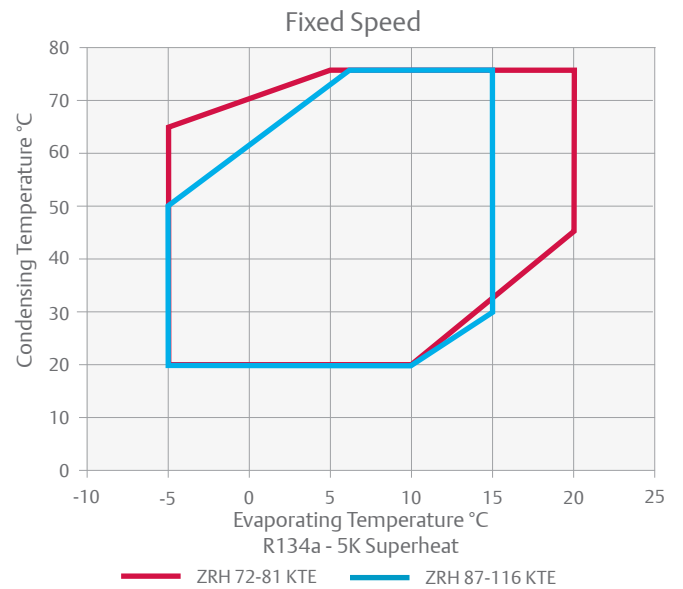

Technical Overview - Fixed Speed Models

Models	Nominal hp	Displacement (m ³ /h)	Stub Suction (inch)	Stub Discharge (inch)	Oil Quantity (l)	Length/Width/Height (mm)	Net Weight (kg)	Motor Version/Code	Maximum Operating Current (A)	Locked Rotor Current (A)	Sound Pressure @1 m - dB(A)**
								3 Ph*	3 Ph*	3 Ph*	
ZRH72KTE/KTR	6.0	17.1	7/8	3/4	2.6	567/290/191	49	TFD	12	92	61
ZRH81KTE/KTR	6.8	18.8	7/8	3/4	2.7	567/290/191	49	TFD	12	92	61
ZRH87KTE/KTR	7.5	22.1	1 3/8	7/8	1.6	586/314/245	60	TFD	16	95	63
ZRH100KTE/KTR	9.0	24.9	1 3/8	7/8	1.6	586/314/245	63	TFD	18	111	63
ZRH116KTE/KTR	10.0	29.1	1 3/8	7/8	1.6	586/314/245	64	TFD	20	118	63
YRH72KTE	6.0	17.1	7/8	3/4	2.6	567/291/191	49	TFD	12	92	61
YRH81KTE	6.8	18.8	7/8	3/4	2.7	567/291/191	49	TFD	12	92	61

Conditions: EN12900 R407C - HT: Evaporating +5°C, Condensing +50°C, suction Superheat 10K, Subcooling 0K

*TFD: 3Ph 380-420V/50Hz - 460/60Hz; TF5 200-220V/50Hz, 200-230V/60Hz

** @ 1m: sound pressure level at 1m distance from the compressor, free field condition

Preliminary Data

Capacity Data - Fixed Speed Models

Condensing Temperature +50°C													
R407C	Cooling Capacity (kW)						R407C	Power Input (kW)					
	Evaporating Temperature (°C)							Evaporating Temperature (°C)					
Model	-10	-5	0	+5	+10	+15	Model	-10	-5	0	+5	+10	+15
ZRH72KTE	8.1	10.1	12.5	15.3	18.6	22.4	ZRH72KTE	4.8	4.8	4.8	4.83	4.9	5.0
ZRH81KTE	9.0	11.2	13.9	17.0	20.5	24.7	ZRH81KTE	5.2	5.2	5.3	5.3	5.4	5.4
ZRH87KTE		11.8	15.2	19.2	23.9		ZRH87KTE		6.2	6.3	6.3	6.3	
ZRH100KTE		14.2	17.9	22.1	26.9		ZRH100KTE		6.8	6.9	7.0	7.0	
ZRH116KTE		16.0	20.0	24.9	30.6		ZRH116KTE		8.1	8.2	8.2	8.2	

Conditions: Suction Superheat 10K / Subcooling 0K

Condensing Temperature +50°C													
R134a	Cooling Capacity (kW)						R134a	Power Input (kW)					
	Evaporating Temperature (°C)							Evaporating Temperature (°C)					
Model	-10	-5	0	+5	+10	+15	Model	-10	-5	0	+5	+10	+15
ZRH72KTE		6.8	8.5	10.4	12.7	15.3	ZRH72KTE		3.2	3.3	3.3	3.4	3.4
ZRH81KTE		7.6	9.5	11.7	14.2	17.0	ZRH81KTE		3.5	3.6	3.6	3.7	3.7
ZRH87KTE		8.0	10.3	13.0	16.2	20.0	ZRH87KTE		4.3	4.3	4.3	4.3	4.5
ZRH100KTE		9.6	12.1	15.0	18.3	22.1	ZRH100KTE		4.7	4.8	4.8	4.8	4.9
ZRH116KTE		10.9	13.6	16.9	20.7	25.0	ZRH116KTE		5.6	5.6	5.6	5.7	5.7

Conditions: Suction Superheat 10K / Subcooling 0K

Preliminary Data

Condensing Temperature +50°C													
R513A	Cooling Capacity (kW)						R513A	Power Input (kW)					
	Evaporating Temperature (°C)							Evaporating Temperature (°C)					
Model	-10	-5	0	+5	+10	+15	Model	-10	-5	0	+5	+10	+15
ZRH72KTR		6.9	8.6	10.6	12.9	15.5	ZRH72KTR		3.4	3.5	3.5	3.5	3.6
ZRH81KTR		7.7	9.7	11.9	14.4	17.3	ZRH81KTR		3.8	3.9	3.9	3.9	3.9
ZRH87KTR		8.6	10.9	13.5	16.6		ZRH87KTR		4.3	4.4	4.4	4.4	
ZRH100KTR		10.0	12.5	15.4	18.8		ZRH100KTR		4.8	4.9	4.9	4.9	
ZRH116KTR		11.8	14.8	18.2	22.1		ZRH116KTR		5.6	5.7	5.7	5.8	

Conditions: Suction Superheat 10K / Subcooling 0K

Preliminary Data

Condensing Temperature +50°C													
R454C	Cooling Capacity (kW)						R454C	Power Input (kW)					
	Evaporating Temperature (°C)							Evaporating Temperature (°C)					
Model	-10	-5	0	+5	+10	+15	Model	-10	-5	0	+5	+10	+15
YRH72KTE	7.7	9.5	11.7	14.2	17.2	20.5	YRH72KTE	4.5	4.5	4.5	4.5	4.5	4.5
YRH81KTE	8.6	10.5	12.9	15.7	18.9	22.6	YRH81KTE	4.9	4.9	4.9	4.9	4.9	5.0

Conditions: Suction Superheat 10K / Subcooling 0K

Preliminary Data

Technical Overview - Variable Speed Models

Models	Capacity (kw)	EER	Displacement (m ³ /h) 50Hz	Stub Suction (inch)	Stub discharge (inch)	Oil Quantity (l)	Length/Width/Height (mm)	Net Weight (kg)	Motor Version/ Code	Maximum Operating Current (A)	Locked Rotor Current (A)	Sound pressure @1 m - dB(A)***
	Min								3 Ph *	3 Ph *	3 Ph *	
YRHV72KTE	6.5	3.1	20.6	7/8	3/4	2.7	567/291/191	49	TX7	22	92	70
YRHV81KTE	6.8	3.1	22.6	7/8	3/4	2.7	567/291/191	49	TX7	26	92	70
ZRHV72KTE/KTR	7.2	3.1	20.6	7/8	3/4	2.7	567/291/191	49	TX7	22	92	70
ZRHV81KTE/KTR	7.6	3.1	22.6	7/8	3/4	2.7	567/291/191	49	TX7	26	92	70
ZRHV94KTE	17.4	3.1	26.7	1 3/8	7/8	1.6	586/314/245	60	TF7	24	145	73

Conditions: EN12900 R407C - HT: Evaporating +5°C, Condensing +50°C, Suction Superheat 10K, Subcooling 0K

**TF7 For VFD Control 380/3/75Hz V/F curve

*** @ 1m: sound pressure level at 1m distance from the compressor, free field condition

Capacity Data - Variable Speed Models

Condensing Temperature +50°C															
R407C		Cooling Capacity (kW)						R407C		Power Input (kW)					
		Evaporating Temperature (°C)								Evaporating Temperature (°C)					
Model		-10	-5	0	+5	+10	+15	Model		-10	-5	0	+5	+10	+15
ZRHV72KTE/KTR	Max	15.8	19.8	24.7	25.0	30.3	36.2	ZRHV72KTE/KTR	Max	11.0	11.2	11.3	8.2	8.3	8.3
	Min	5.9	4.7	5.9	7.2	8.7	17.0		Min	4.1	2.6	2.6	2.5	2.5	4.2
ZRHV81KTE/KTR	Max	18.0	22.3	27.4	25.9	31.1	37.1	ZRHV81KTE/KTR	Max	8.5	8.6	8.7	8.8	9.0	9.2
	Min	6.3	4.6	6.0	7.6	9.4	18.4		Min	4.6	3.1	3.1	3.0	3.0	4.5
ZRHV94KTE	Max		18.9	24.6	31.4	38.9		ZRHV94KTE	Max		10.0	10.5	10.6	10.8	
	Min		7.8	10.1	12.9	15.9			Min		4.4	4.6	4.6	4.7	

Conditions: Suction Superheat 10K / Subcooling 0K

Condensing Temperature +50°C															
R134a		Cooling Capacity (kW)						R134a		Power Input (kW)					
		Evaporating Temperature (°C)								Evaporating Temperature (°C)					
Model		-10	-5	0	+5	+10	+15	Model		-10	-5	0	+5	+10	+15
ZRHV72KTE	Max	11.0	13.7	16.8	20.4	24.6	24.3	ZRHV72KTE	Max		5.5	5.6	5.6	5.7	5.7
	Min	3.1	3.9	4.8	5.8	11.4	11.4		Min		1.8	1.7	1.7	1.7	2.8
ZRHV81KTE	Max	12.4	15.5	19.0	23.1	27.8	24.9	ZRHV81KTE	Max		6.1	6.2	6.2	6.2	6.3
	Min	3.1	4.0	5.1	6.3	12.3	12.3		Min		2.1	2.1	2.0	2.0	3.0
ZRHV94KTE	Max	13.0	16.9	21.4	26.4	31.4	31.4	ZRHV94KTE	Max		6.9	7.2	7.3	7.5	8.0
	Min	8.0	6.7	8.8	10.9	12.9	12.9		Min		3.5	3.2	3.2	3.2	3.5

Conditions: Suction Superheat 10K / Subcooling 0K

Preliminary Data

Condensing Temperature +50°C															
R513A		Cooling Capacity (kW)						R513A		Power Input (kW)					
		Evaporating Temperature (°C)								Evaporating Temperature (°C)					
Model		-10	-5	0	+5	+10	+15	Model		-10	-5	0	+5	+10	+15
ZRHV72KTR	Max		13.8	16.5	19.3	23.0	26.4	ZRHV72KTR	Max		13.8	16.5	19.3	23.0	26.4
	Min		5.7	7.1	6.5	8.7	9.6		Min		5.7	7.1	6.5	8.7	9.6
ZRHV81KTR	Max		15.3	17.8	21.7	24.7	29.4	ZRHV81KTR	Max		15.3	17.8	21.7	24.7	29.4
	Min		6.2	7.8	7.2	8.8	10.6		Min		6.2	7.8	7.2	8.8	10.6

Conditions: Suction Superheat 10K / Subcooling 0K

Preliminary Data

Condensing Temperature +50°C															
R454C		Cooling Capacity (kW)						R454C		Power Input (kW)					
		Evaporating Temperature (°C)								Evaporating Temperature (°C)					
Model		-10	-5	0	+5	+10	+15	Model		-10	-5	0	+5	+10	+15
YRHV72KTE	Max	15.5	19.1	23.4	26.4	31.1	34.8	YRHV72KTE	Max	10.7	10.6	10.5	9.2	8.6	7.9
	Min	4.0	4.7	5.9	7.2	7.7	12.6		Min	3.0	2.6	2.5	2.4	2.3	2.9
YRHV81KTE	Max	16.5	20.3	24.6	27.7	32.4	36.3	YRHV81KTE	Max	10.3	10.2	10.1	9.8	9.4	8.7
	Min	4.0	4.7	6.1	7.6	9.3	14.5		Min	3.5	3.1	3.0	2.8	2.7	3.3

Conditions: Suction Superheat 10K / Subcooling 0K

Preliminary Data





Refrigeration Applications

Refrigeration Applications

Emerson offers a wide range of solutions for commercial refrigeration applications. With its long-lasting expertise in semi-hermetic reciprocating compressor technology as well as in scroll technology, we can meet the requirements for most applications - at the small end just like at the large end of commercial refrigeration.

Completed by the various offerings in the segment of refrigeration units, Emerson is able to offer the best solution and performance, whether you are looking for applications in foodservice or processing, supermarkets, hypermarkets, petrol stations or refrigerated warehousing.

Emerson prime focus for its semi-hermetic reciprocating technology is at the large end of commercial refrigeration. Here aspects such as reliability, serviceability and capacity modulation are of importance and they are perfectly provided by Emerson semi-hermetic reciprocating compressors. Innovations like Discus™ and Stream technologies, digital modulation and Copeland™ Compressor Electronics Technology for advanced protection and preventive maintenance keep semi-hermetic at the forefront of compressor technology.

Especially when compact equipment, energy efficiency and reliability are musts, scroll technology is the preferred choice for refrigeration applications. With developments such as vapor injection and digital modulation, scroll has become the leading technology and is widely recognized in the refrigeration market.

Whatever the chosen technology and product solution, Emerson's range meets the specific refrigeration needs covering the entire spectrum of medium and low temperature applications whether using standard HFCs, low GWP or natural refrigerants.

YB and YBD Copeland™ Scroll Compressor Ranges for Medium Temperature Refrigeration for Low GWP Refrigerants Classified as A2L

The standard and digital models from the new Copeland scroll YB*K1E series for medium temperature applications feature an optimized design for F-Gas compliant low GWP A2L refrigerants. The scroll compressor was optimized internally and externally to create the most reliable compressor with refrigerants with a high HFO content.

These compressors, available with displacements from 5.8 to 21.4 m³/h are designed to provide seasonal efficiencies 15% higher than traditional semi-hermetic compressors. These compressors are extremely quiet and can be fitted with an external sound shell for an additional 10 - 12 dBA sound reduction, which makes them best choice for refrigeration applications in urban and domestic areas.



YB scroll compressor

YB & YBD Scroll Compressors Line-up

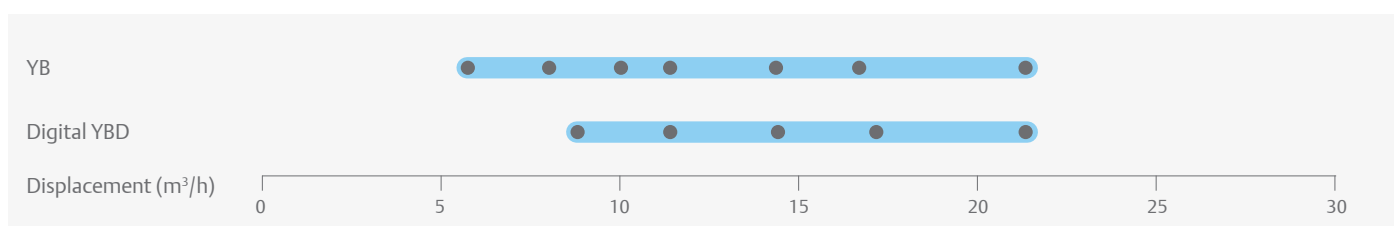

Features and Benefits

- One model for multiple refrigerants: R455A, R454A, R454C, as well as R1234yf for YB models
- Fully hermetic design to avoid risk of refrigerant leakage
- Flexibility in terms of required capacity: multiple design options
- Extremely quiet operation, specially adapted to applications in urban and domestic areas
- Copeland scroll digital technology for simple, stepless 10 to 100% capacity modulation
- Light weight and compact design
- Wide operating envelope with 10°C low condensing limit

Maximum Allowable Pressure (PS)

- Low Side PS 23.5 bar (g)
- High Side PS 38 bar (g)

Operating Envelopes

YB - R455A

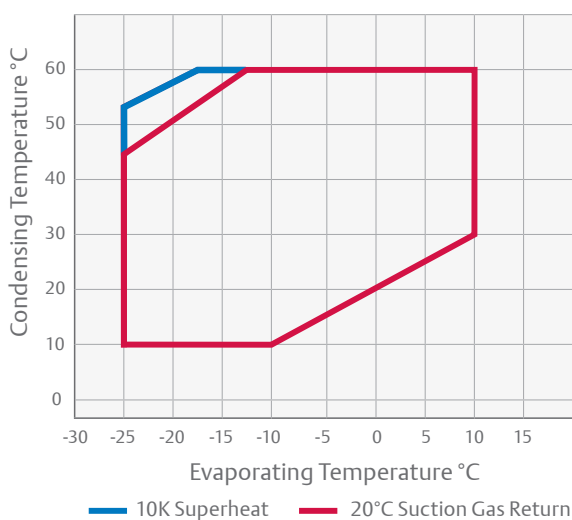

YBD - R455A

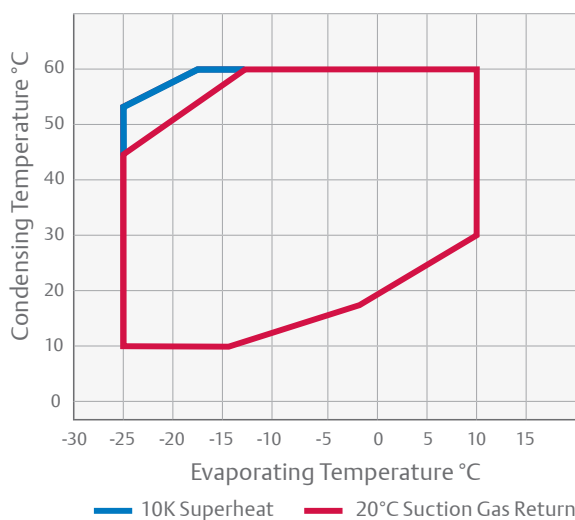

Operating Envelopes

YB - R454C

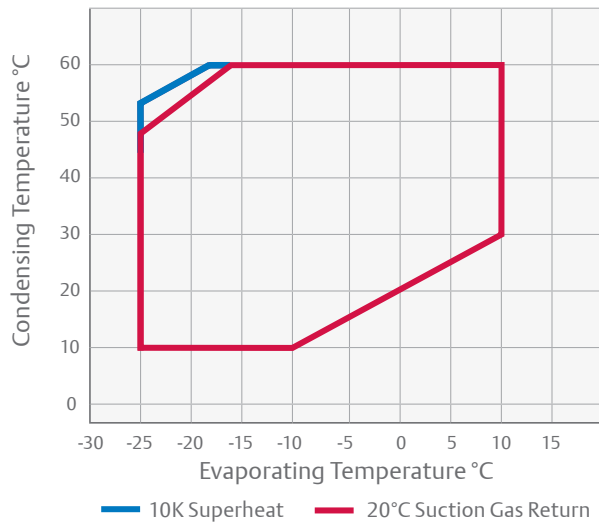

YBD - R454C

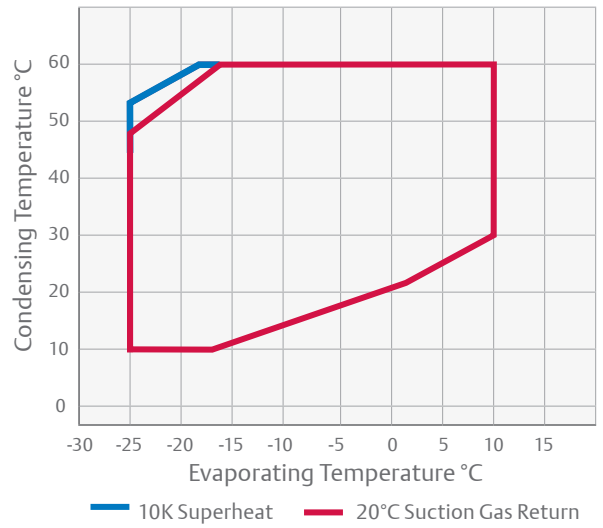

YB - R454A

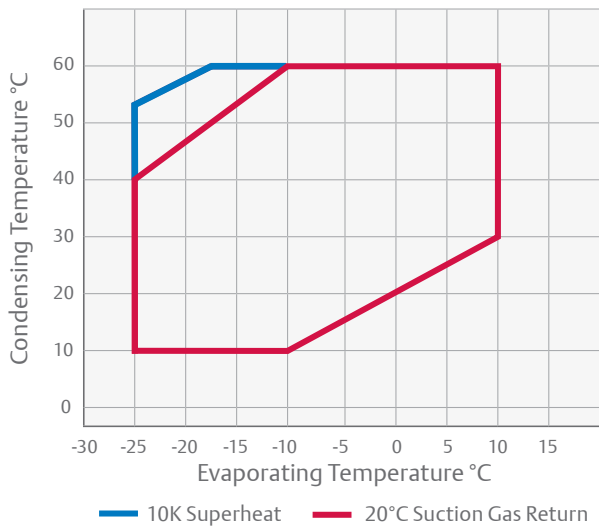

YBD - R454A

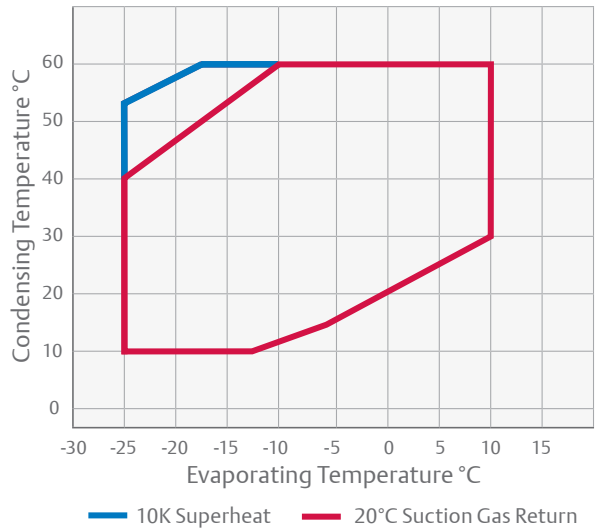

YB - R1234yf

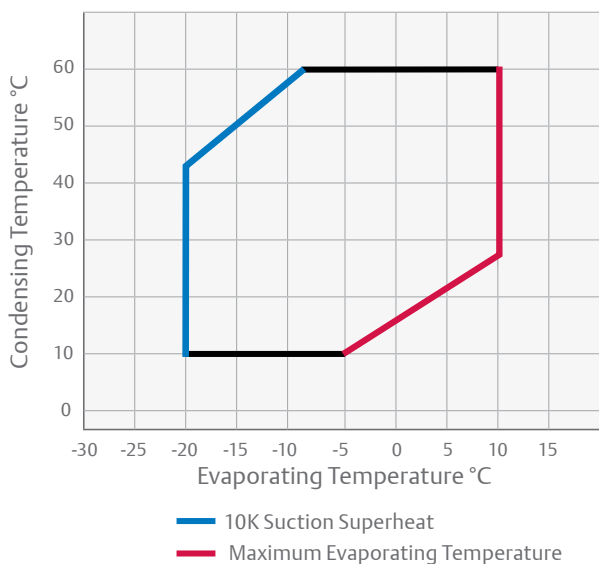

Technical Overview

Models	Nominal hp	Displacement (m ³ /h)	Braze Suction (inch)	Braze Discharge (inch)	Oil Quantity (l)	Length/Width/Height (mm)	Net Weight (kg)	Motor Version/Code	Maximum Operating Current (A)	Locked Rotor Current (A)
								1 Ph*	1 Ph*	1 Ph*
YB12K1E	2.0	5.8	3/4	1/2	1.3	253/248/365	23	TFMN	4	26
YB17K1E	2.5	8.0	3/4	1/2	1.5	253/248/387	27	TFMN	6	32
YB21K1E	3.5	10.0	3/4	1/2	1.5	253/248/401	28	TFMN	7	46
YB24K1E	4.0	11.4	3/4	1/2	1.5	253/248/417	29	TFMN	8	50
YB31K1E	5.0	14.3	7/8	1/2	1.9	255/261/442	37	TFMN	10	64
YB36K1E	6.0	16.7	7/8	1/2	1.9	255/261/442	40	TFMN	12	74
Digital Models										
YBD17K1E	3.0	8.8	3/4	1/2	1.2	253/248/435	30	TFMN	7	40
YBD24K1E	4.0	11.4	7/8	1/2	1.4	253/248/466	30	TFMN	10	48
YBD31K1E	5.0	14.4	7/8	1/2	1.9	255/261/481	38	TFMN	11	64
YBD36K1E	6.0	17.1	7/8	1/2	1.9	255/261/481	40	TFMN	12	74

** 3 Ph: 380-420V/ 50Hz

** @ 1m: sound pressure level at 1m distance from the compressor, free field condition

Capacity Data

Condensing Temperature 40°C															
R455A	Cooling Capacity (kW)							R455A	Power Input (kW)						
	Evaporating Temperature (°C)								Evaporating Temperature (°C)						
Model	-35	-30	-25	-20	-15	-10	-5	Model	-35	-30	-25	-20	-15	-10	-5
YB12K1E			1.7	2.2	2.7	3.3	4.0	YB12K1E			1.1	1.2	1.3	1.3	1.4
YB17K1E			2.5	3.1	3.8	4.6	5.6	YB17K1E			1.6	1.6	1.7	1.8	1.8
YB21K1E			3.1	3.9	4.8	5.8	7.0	YB21K1E			2.0	2.1	2.1	2.2	2.3
YB24K1E			3.6	4.4	5.4	6.5	7.9	YB24K1E			2.3	2.4	2.4	2.5	2.6
YB31K1E			4.4	5.5	6.8	8.2	10.0	YB31K1E			2.7	2.8	2.9	3.1	3.2
YB36K1E			5.2	6.5	8.0	9.7	11.8	YB36K1E			3.1	3.3	3.5	3.6	3.7
Digital Models															
YBD17K1E			2.7	3.4	4.1	5.0	6.1	YBD17K1E			1.8	1.8	1.9	5.0	2.0
YBD24K1E			3.5	4.4	5.3	6.5	7.9	YBD24K1E			2.3	2.4	2.4	6.5	2.6
YBD31K1E			4.4	5.5	6.7	8.2	9.9	YBD31K1E			2.7	2.8	3.0	8.2	3.2
YBD36K1E			5.3	6.6	8.1	9.9	12.0	YBD36K1E			3.2	3.4	3.5	9.9	3.8

Conditions: Suction Gas Return 20°C / Subcooling 0K

Capacity Data

Condensing Temperature 40°C															
R454C	Cooling Capacity (kW)							R454C	Power Input (kW)						
	Evaporating Temperature (°C)								Evaporating Temperature (°C)						
Model	-35	-30	-25	-20	-15	-10	-5	Model	-35	-30	-25	-20	-15	-10	-5
YB12K1E			1.7	2.1	2.0	3.1	3.8	YB12K1E			1.1	1.1	1.1	1.2	1.3
YB17K1E			2.4	2.9	2.9	4.3	5.3	YB17K1E			1.5	1.5	1.5	1.6	1.7
YB21K1E			3.0	3.7	3.7	5.5	6.7	YB21K1E			1.9	1.9	1.9	2.1	2.1
YB24K1E			3.4	4.2	4.1	6.2	7.6	YB24K1E			2.1	2.2	2.2	2.3	2.4
YB31K1E			4.2	5.2	5.2	7.7	9.5	YB31K1E			2.5	2.6	2.6	2.8	3.0
YB36K1E			5.0	6.2	6.1	9.2	11.3	YB36K1E			2.9	3.1	3.1	3.3	3.5
Digital Models															
YBD17K1E			2.6	3.2	3.9	1.8	5.8	YBD17K1E			1.7	1.7	1.7	1.8	1.8
YBD24K1E			3.3	4.1	5.1	2.3	7.5	YBD24K1E			2.1	2.2	2.3	2.3	2.4
YBD31K1E			4.2	5.2	6.4	2.9	9.4	YBD31K1E			2.5	2.7	2.8	2.9	3.0
YBD36K1E			5.0	6.2	7.7	3.4	11.4	YBD36K1E			3.0	3.1	3.3	3.4	3.5

Conditions: Suction Gas Return 20°C / Subcooling 0K

Condensing Temperature 40°C															
R454A	Cooling Capacity (kW)							R454A	Power Input (kW)						
	Evaporating Temperature (°C)								Evaporating Temperature (°C)						
Model	-35	-30	-25	-20	-15	-10	-5	Model	-35	-30	-25	-20	-15	-10	-5
YB12K1E			1.9	2.4	3.0	3.7	4.4	YB12K1E			1.3	1.3	1.4	1.5	1.5
YB17K1E			2.7	3.4	4.2	5.1	6.2	YB17K1E			1.8	1.8	1.9	1.9	2.0
YB21K1E			3.4	4.3	5.3	6.5	7.9	YB21K1E			2.2	2.3	2.4	2.4	2.5
YB24K1E			3.9	4.9	6.0	7.3	8.8	YB24K1E			2.5	2.6	2.7	2.8	2.9
YB31K1E			4.9	6.1	7.5	9.2	11.1	YB31K1E			3.0	3.1	3.3	3.4	3.5
YB36K1E			5.8	7.2	8.9	10.9	13.2	YB36K1E			3.5	3.7	3.8	4.0	4.1
Digital Models															
YBD17K1E			3.0	3.7	4.6	5.6	6.8	YBD17K1E			2.0	2.0	2.1	2.1	2.2
YBD24K1E			3.9	4.9	6.0	7.3	8.8	YBD24K1E			2.5	2.6	2.7	2.8	2.9
YBD31K1E			4.9	6.1	7.6	9.2	11.2	YBD31K1E			3.0	3.1	3.3	3.4	3.5
YBD36K1E			5.9	7.4	9.1	11.2	13.5	YBD36K1E			3.6	3.7	3.9	4.1	4.2

Conditions: Suction Gas Return 20°C / Subcooling 0K

Condensing Temperature 40°C															
R1234yf	Cooling Capacity (kW)							R1234yf	Power Input (kW)						
	Evaporating Temperature (°C)								Evaporating Temperature (°C)						
Model	-35	-30	-25	-20	-15	-10	-5	Model	-35	-30	-25	-20	-15	-10	-5
YB12K1E					1.6	2.0	2.5	YB12K1E					0.8	0.9	0.9
YB17K1E				1.8	2.2	2.8	3.5	YB17K1E				1.1	1.1	1.2	1.2
YB21K1E				2.2	2.8	3.6	4.4	YB21K1E				1.4	1.4	1.5	1.5
YB24K1E				2.5	3.2	4.0	5.0	YB24K1E				1.6	1.6	1.7	1.7
YB31K1E				3.2	4.0	5.0	6.2	YB31K1E				1.9	1.9	2.0	2.1
YB36K1E				3.7	4.7	5.9	7.3	YB36K1E				2.2	2.3	2.4	2.5

Conditions: Suction Superheat 10K, Subcooling 0K

ZB and ZBD Copeland™ Scroll Compressor Ranges for Medium Temperature Refrigeration Using R407A/F/C, R448A/R449A, R404A, R134a, R450A and R513A

Emerson offers ZB compressors with a wide displacement range from 5.9 m³/h to 87.5 m³/h. It includes digital ZBD compressor models that offer continuous capacity modulation technology.

Copeland scroll compressors have 3 times less moving parts than reciprocating compressors and feature a scroll compliance mechanism which makes them particularly robust and reliable under severe conditions including liquid slugging.

They have the advantage of light weight and compactness, making them ideal for the usage in refrigeration units, compact refrigeration systems or special process units.

The summit series from 7 to 15 hp is designed to provide seasonal efficiencies 15% higher than traditional semi-hermetic compressors. These compressors are extremely quiet and can be fitted with an external sound shell for an additional 10 dBA sound reduction.



ZB compressor for medium temperature refrigeration with and without sound shell

ZBD Digital Scroll Compressors

Based on the unique Copeland compliant scroll design, the digital modulation operates on a simple mechanism. Capacity control is achieved by separating the scroll sets axially over a small period of time. It is a simple mechanical solution allowing precise temperature control and system efficiency and it requires no other components.

Digital scroll technology provides continuous, stepless modulation from 10% to 100% with no operating envelope restriction. As a result, system pressures and temperatures are tightly controlled. These compressors provide optimum performance for refrigeration units, refrigeration packs, process and agricultural units.

ZB and ZBD Compressor Line-up

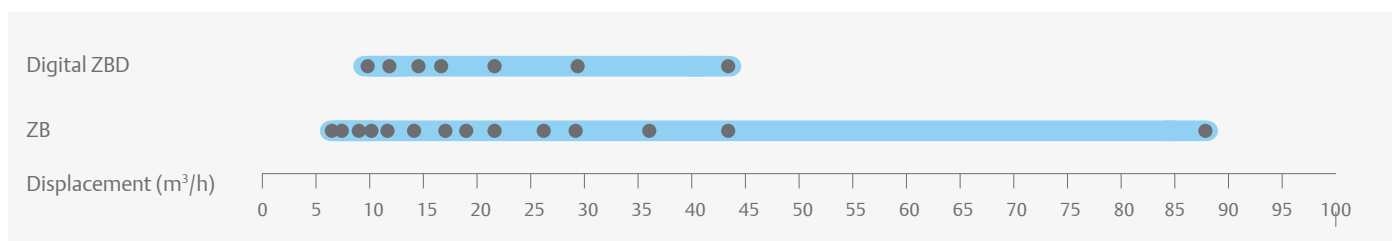

Features and Benefits

- Copeland scroll axial and radial compliance for superior reliability and efficiency
- Wide operating envelope with 10°C condensing limit and fast pull-down capabilities
- High seasonal efficiencies as scrolls are designed at the condition where equipment runs most of the time
- Light weight and compactness, up to half the weight of equivalent semi-hermetic compressors
- Availability of optional sound shell on all models providing an additional 10 dBA sound attenuation for silent operation
- Includes 12 digital scroll compressor models for simple, stepless 10 to 100% capacity modulation
- One model for multiple refrigerants R407A/F/C, R448A/R449A, R404A, R134a, R450A and R513A

Maximum Allowable Pressure (PS)

- ZB15 to ZB45:
Low Side PS 21 bar(g) / High Side PS 32 bar(g)
- ZB50 to ZB220:
Low Side PS 22.6 bar(g) / High Side PS 32 bar(g)
- Digital ZBD:
Low Side PS 21 bar(g) / High Side PS 28.8 bar(g)
- Summit ZBD:
Low Side PS 22.6 bar(g) / High Side PS 32 bar (g)

Operating Envelope R448A/R449A

For ZB Models

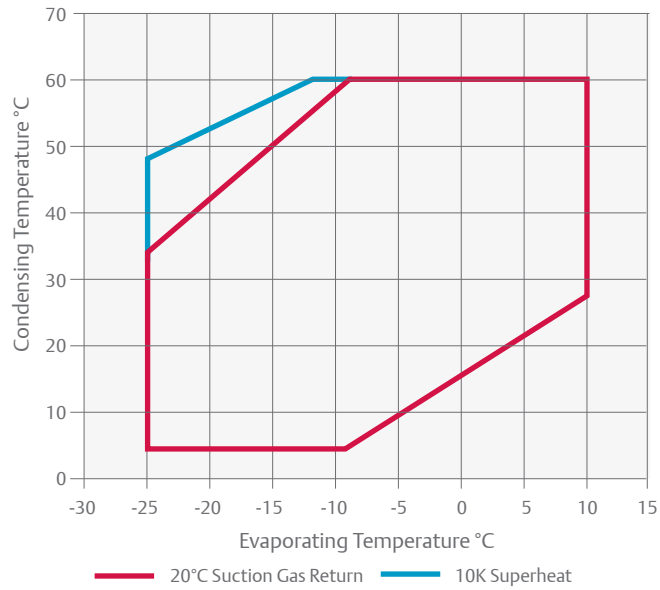

Operating Envelope R134a

For ZBD Digital Models

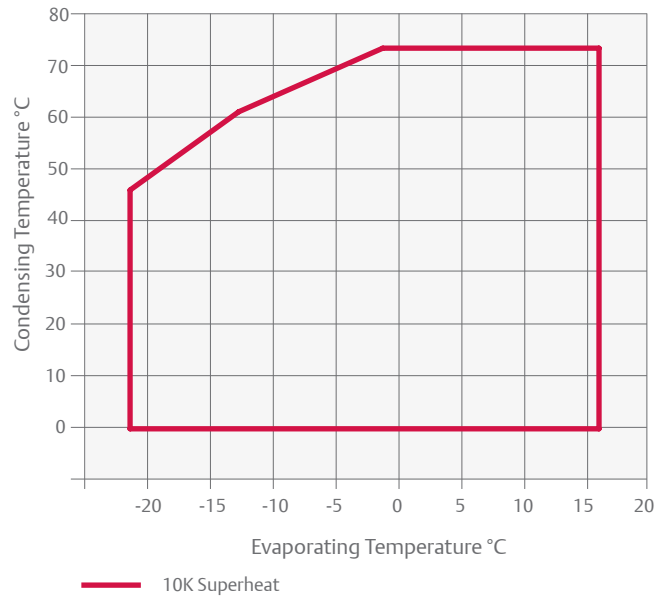

Operating Envelope R407A

For ZB Models

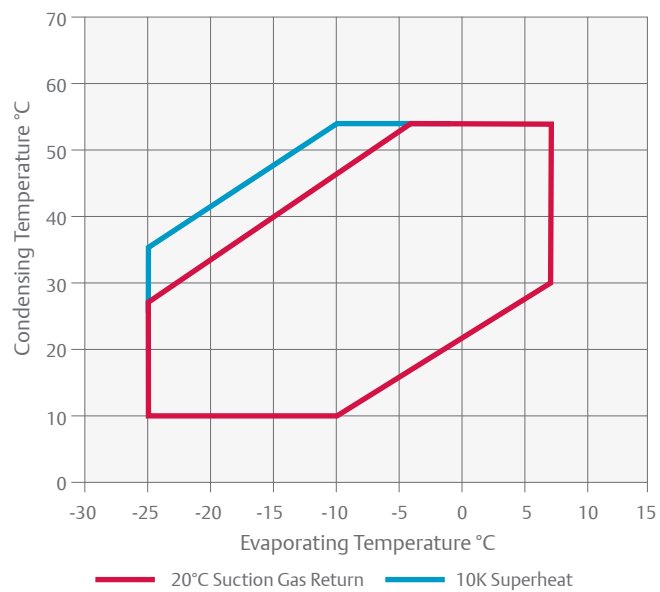

Operating Envelope R134a

For ZB Digital Models

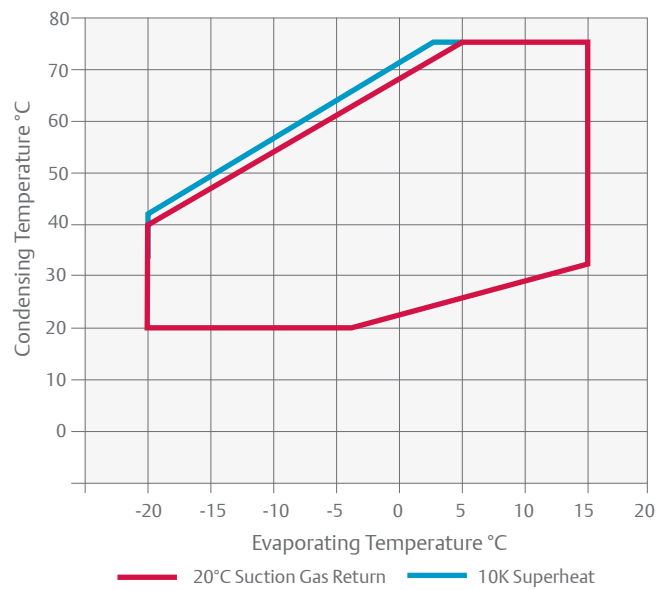

Technical Overview

Models	Nominal hp	Displacement (m ³ /h)	Rotolock suction (inch)	Rotolock Discharge (inch)	Oil Quantity (l)	Length/Width/Height (mm)	Net Weight (kg)	Motor Version/Code		Maximum Operating Current (A)		Locked Rotor Current (A)		Sound Pressure @1 m - dB(A)***
								1 Ph*	3 Ph**	1 Ph*	3 Ph**	1 Ph*	3 Ph**	
ZB15KCE	2.0	5.9	1 1/4	1	1.3	241/241/369	25	PFJ	TFD	12	4	58	26	55
ZB19KCE	2.5	6.8	1 1/4	1	1.5	242/242/369	27	PFJ	TFD	12	6	61	32	55
ZB21KCE	3.0	8.6	1 1/4	1	1.2	243/244/391	29	PFJ	TFD	16	7	82	40	58
ZB26KCE	3.5	10.0	1 1/4	1	1.5	243/244/405	28	PFJ	TFD	18	8	97	46	60
ZB29KCE	4.0	11.4	1 1/4	1	1.5	246/246/423	29		TFD		10		50	58
ZB38KCE	5.0	14.4	1 1/4	1	1.9	242/242/438	37	PFJ	TFD	32	12	142	65	61
ZB42KCE	5.5	16.2	1 1/4	1	1.9	251/246/438	43	PFJ		35		150		62
ZB45KCE	6.0	17.1	1 1/4	1	1.9	242/242/438	39		TFD		13		74	61
ZB48KCE	6.5	18.8	1 1/4	1 1/4	1.8	246/250/442	39		TFD		14		101	62
ZB57KCE		21.4	1 1/4	1 1/4	1.9	246/256/442	39		TFD		15		102	68
ZB Summit Models														
ZB66K5E	10.0	25.7	1 3/4	1 1/4	3.4	280/280/534	60		TFD		17		111	66
ZB76K5E	12.0	28.8	1 3/4	1 1/4	3.4	280/280/534	61		TFD		20		118	67
ZB95K5E	13.0	36.4	1 3/4	1 1/4	3.4	280/280/552	65		TFD		28		140	69
ZB114K5E	15.0	43.4	1 3/4	1 1/4	3.4	280/280/552	66		TFD		33		174	72
ZB220KCE	30.0	87.5	2 3/4	1 3/4	6.3	448/392/715	176		TWM		69		310	78
Digital Models														
ZBD21KCE	3.0	8.3	1 1/4	1	1.2	243/243/432	30	PFJ	TFD	16	6	97	40	62
ZBD29KCE	4.0	11.4	1 1/4	1	1.4	245/243/463	32		TFD		7		48	58
ZBD38KCE	5.0	14.4	1 1/4	1	1.9	246/250/481	38		TFD		11		64	67
ZBD45KCE	6.0	17.1	1 1/4	1	1.9	241/246/481	39		TFD		12		74	61
ZBD57KCE	7.5	21.4	1 1/4	1 1/4	1.9	246/257/481	43		TFD		15		102	68
ZBD76K5E	10.0	28.8	1 3/4	1 1/4	3.4	299/280/534	61		TFD		24		118	66
ZBD114K5E	15.0	43.3	1 3/4	1 1/4	3.4	299/280/552	68		TFD		33		174	71

* 1Ph: 230V/ 50Hz

** 3 Ph: 380-420V/ 50Hz

*** @ 1m: sound pressure level at 1m distance from the compressor, free field condition

Capacity Data

Condensing Temperature 40°C															
R407A	Cooling Capacity (kW)							R407A	Power Input (kW)						
	Evaporating Temperature (°C)								Evaporating Temperature (°C)						
Model	-35	-30	-25	-20	-15	-10	-5	Model	-35	-30	-25	-20	-15	-10	-5
ZB15KCE				2.1*	2.8	3.5	4.2	ZB15KCE				1.5*	1.5	1.5	1.5
ZB19KCE				2.4*	3.2	4.0	5.0	ZB19KCE				1.5*	1.6	1.6	1.6
ZB21KCE				3.0*	4.0	5.1	6.3	ZB21KCE				2.0*	2.0	2.0	2.1
ZB26KCE				3.6*	4.7	5.8	7.1	ZB26KCE				2.3*	2.3	2.3	2.4
ZB29KCE					5.3	6.5	8.0	ZB29KCE					2.6	2.6	2.6
ZB38KCE				5.4*	7.2	8.9	11.0	ZB38KCE				3.2*	3.3	3.3	3.4
ZB42KCE**				6.1*	7.9	9.8	12.0	ZB42KCE**				3.9*	3.9	3.9	3.9
ZB45KCE				6.3*	8.2	10.2	12.4	ZB45KCE				3.9*	4.0	4.0	4.0
ZB48KCE					9.5	11.7	14.3	ZB48KCE					4.5	4.6	4.5
ZB57KCE				8.2*	10.6	13.1	15.8	ZB57KCE				4.4*	4.6	4.8	4.9
ZB Summit Models															
ZB66K5E				9.2*	12.4	15.6	19.3	ZB66K5E				5.5*	5.5	5.7	5.8
ZB76K5E				10.6*	14.2	18.1	22.4	ZB76K5E				6.5*	6.5	6.7	6.9
ZB95K5E				12.9*	17.7	22.5	27.8	ZB95K5E				8.3*	8.3	8.5	8.7
ZB114K5E				14.8*	20.5	26.3	32.8	ZB114K5E				10.2*	10.2	10.3	10.5
Digital Models															
ZBD21KCE				3.4*	4.3	5.2	6.3	ZBD21KCE				1.8*	1.9	1.9	2.0
ZBD29KCE				4.2*	5.5	6.8	8.4	ZBD29KCE				2.6*	2.6	2.6	2.6
ZBD38KCE				5.5*	7.3	9.1	11.2	ZBD38KCE				3.4*	3.4	3.4	3.5
ZBD45KCE				6.1*	8.1	10.1	12.5	ZBD45KCE				3.8*	3.8	3.8	3.9
ZBD57KCE				8.4*	11.1	13.8	17.0	ZBD57KCE				5.2*	5.2	5.3	5.3
ZBD76K5E			8.2*	11.3	14.5	18.4	22.8	ZBD76K5E			7.5*	7.1	7.1	7.3	7.5
ZBD114K5E			10.8*	15.6	20.5	26.3	32.8	ZBD114K5E			10.3*	10.2	10.2	10.3	10.5

Conditions: Suction Gas Return 20°C / Subcooling 0K

*Conditions: Suction Superheat 10K, Subcooling 0K

** Single Phase Only

Preliminary Data

Condensing Temperature 40°C															
R407F	Cooling Capacity (kW)							R407F	Power Input (kW)						
	Evaporating Temperature (°C)								Evaporating Temperature (°C)						
Model	-35	-30	-25	-20	-15	-10	-5	Model	-35	-30	-25	-20	-15	-10	-5
ZB15KCE					2.6*	3.4	4.2	ZB15KCE					1.6*	1.6	1.6
ZB19KCE					3.2*	4.2	5.1	ZB19KCE					1.9*	1.9	1.9
ZB21KCE					3.9*	5.0	6.2	ZB21KCE					2.2*	2.2	2.3
ZB26KCE					4.5*	5.8	7.2	ZB26KCE					2.6*	2.6	2.6
ZB29KCE					5.4*	7.0	8.7	ZB29KCE					2.8*	2.9	2.8
ZB38KCE				5.2*	6.9*	8.9	11.0	ZB38KCE				3.7*	3.7*	3.7	3.7
ZB42KCE**				5.9*	7.8*	10.1	12.5	ZB42KCE**				4.0*	4.0*	4.0	4.1
ZB45KCE				6.0*	8.1*	10.5	13.0	ZB45KCE				4.1*	4.2*	4.3	4.2
ZB48KCE				7.0*	9.3*	12.1	15.0	ZB48KCE				4.7*	4.8*	4.9	4.9
ZB57KCE				8.5*	10.9*	13.8	16.9	ZB57KCE				5.0*	5.1*	5.1	5.2
ZB Summit Models															
ZB66K5E				9.5*	13.0*	16.9	20.9	ZB66K5E				5.8*	5.8*	5.9	6.1
ZB76K5E				10.9*	14.9*	19.6	24.2	ZB76K5E				6.9*	6.8*	7.0	7.2
ZB95K5E				13.2*	18.6*	24.4	30.1	ZB95K5E				8.7*	8.8*	8.9	9.1
ZB114K5E				15.2*	21.5*	28.5	35.4	ZB114K5E				10.6*	10.7*	10.8	11.0
Digital Models															
ZBD21KCE						5.1	6.3	ZBD21KCE						2.0	2.0
ZBD29KCE					5.8*	7.3	8.9	ZBD29KCE					2.9*	2.9	2.9
ZBD38KCE				5.7*	7.1*	8.9	10.8	ZBD38KCE				3.0*	3.3*	3.5	3.6
ZBD45KCE				6.4*	8.4*	10.8	13.2	ZBD45KCE				3.7*	3.9*	4.1	4.3
ZBD57KCE				8.5*	10.8*	13.8	17.0	ZBD57KCE				5.2*	5.2*	5.3	5.3
ZBD76K5E				11.5*	15.2	19.3	23.9	ZBD76K5E				7.5*	7.4	7.6	7.9
ZBD114K5E				15.8*	21.5	27.6	34.4	ZBD114K5E				10.7*	10.7	10.8	11.0

Conditions: Suction Gas Return 20°C / Subcooling 0K

*Conditions: Suction Superheat 10K, Subcooling 0K

** Single Phase Only

Preliminary Data

Capacity Data

Condensing Temperature 40°C															
R448A/ R449A	Cooling Capacity (kW)							R448A/ R449A	Power Input (kW)						
	Evaporating Temperature (°C)								Evaporating Temperature (°C)						
Model	-35	-30	-25	-20	-15	-10	-5	Model	-35	-30	-25	-20	-15	-10	-5
ZB15KCE			1.6*	2.2	2.9	3.6	4.4	ZB15KCE			1.6*	1.5	1.5	1.5	1.4
ZB19KCE			2.0*	2.6	3.3	4.1	5.1	ZB19KCE			1.6*	1.6	1.6	1.6	1.6
ZB21KCE			2.4*	3.3	4.2	5.2	6.4	ZB21KCE			2.1*	2.1	2.1	2.1	2.1
ZB26KCE			2.6*	3.8	4.8	5.9	7.2	ZB26KCE			2.4*	2.4	2.4	2.4	2.4
ZB29KCE			3.3*	4.5	5.5	6.8	8.3	ZB29KCE			2.6*	2.6	2.6	2.7	2.7
ZB38KCE			3.9*	5.7	7.2	8.9	10.9	ZB38KCE			3.4*	3.4	3.4	3.4	3.4
ZB42KCE**			4.4*	6.4	8.1	10.1	12.3	ZB42KCE**			3.9*	3.9	3.9	3.9	3.9
ZB45KCE			4.5*	6.6	8.5	10.5	12.8	ZB45KCE			3.9*	3.9	3.9	3.9	3.9
ZB48KCE			5.3*	7.6	9.7	12.1	14.7	ZB48KCE			4.5*	4.5	4.5	4.5	4.5
ZB57KCE			6.4*	8.6	10.8	13.4	16.4	ZB57KCE			4.4*	4.5	4.7	4.9	5.1
ZB Summit Models															
ZB66K5E			6.8*	9.4*	12.6	15.8	19.3	ZB66K5E			5.8*	5.8*	5.8	5.8	5.8
ZB76K5E			8.0*	11.1*	14.9	18.6	22.7	ZB76K5E			6.5*	6.6*	6.6	6.6	6.7
ZB95K5E			8.8*	13.2*	18.2	22.8	27.8	ZB95K5E			8.6*	8.6*	8.6	8.6	8.7
ZB114K5E			10.5*	15.5*	21.5	27.3	33.7	ZB114K5E			10.4*	10.3*	10.3	10.3	10.4
ZB220KCE				32.4*	43.1	53.7	65.7	ZB220KCE				20.3*	20.3	20.4	20.6
Digital Models															
ZFD13KVE EVI	3.3	4.2	5.2	6.3	7.6	9.0	10.6	ZFD13KVE EVI	2.3	2.3	2.4	2.5	2.7	2.8	2.8
ZFD18KVE EVI	4.8	6.0	7.4	9.0	10.8	12.9	15.2	ZFD18KVE EVI	3.4	3.6	3.8	4.0	4.3	4.5	4.7
ZFD25KVE EVI	6.2	7.7	9.5	11.4	13.5	15.7	18.1	ZFD25KVE EVI	3.9	4.2	4.5	4.8	5.1	5.3	5.5
ZFD41K5E	7.4	9.4	11.8	14.6	17.9	21.7	26.2	ZFD41K5E	5.4	5.8	6.2	6.8	7.4	8.1	8.9
ZFD41K5E EVI	9.9	12.5	15.6	19.0	22.8	27.9	31.9	ZFD41K5E EVI	6.8	7.3	7.8	8.4	9.0	9.7	10.4

Conditions: Suction Gas Return 20°C / Subcooling 0K

*Conditions: Suction Superheat 10K, Subcooling 0K

** Single Phase Only

Preliminary Data

Condensing Temperature 40°C															
R404A	Cooling Capacity (kW)							R404A	Power Input (kW)						
	Evaporating Temperature (°C)								Evaporating Temperature (°C)						
Model	-35	-30	-25	-20	-15	-10	-5	Model	-35	-30	-25	-20	-15	-10	-5
ZB15KCE			1.9	2.4	3.0	3.7	4.5	ZB15KCE			1.7	1.7	1.6	1.6	1.5
ZB19KCE			2.3	2.9	3.5	4.2	5.1	ZB19KCE			1.9	1.9	1.9	1.9	1.9
ZB21KCE			3.0	3.7	4.5	5.5	6.6	ZB21KCE			2.2	2.2	2.2	2.2	2.2
ZB26KCE			3.5	4.3	5.3	6.4	7.6	ZB26KCE			2.6	2.6	2.6	2.6	2.6
ZB29KCE			4.0	4.9	6.0	7.2	8.6	ZB29KCE			2.9	2.9	2.9	2.9	2.9
ZB38KCE			5.1	6.3	7.7	9.3	11.2	ZB38KCE			3.8	3.8	3.8	3.8	3.8
ZB42KCE**			5.7	7.1	8.7	10.6	12.7	ZB42KCE**			4.2	4.2	4.2	4.2	4.2
ZB45KCE			6.0	7.4	9.1	11.0	13.2	ZB45KCE			4.3	4.3	4.3	4.3	4.3
ZB48KCE			6.9	8.6	10.5	12.7	15.2	ZB48KCE			4.9	4.9	4.9	4.9	4.9
ZB57KCE			7.9	9.7	11.9	14.3	17.1	ZB57KCE			4.7	4.9	5.2	5.4	5.5
ZB Summit Models															
ZB66K5E			9.1	11.4	13.9	16.8	20.1	ZB66K5E			6.2	6.2	6.2	6.3	6.4
ZB76K5E			10.5	13.1	16.2	19.7	23.6	ZB76K5E			7.2	7.2	7.3	7.4	7.5
ZB95K5E			10.7*	16.0	20.1	24.5	29.3	ZB95K5E			9.3*	9.2	9.3	9.3	9.4
ZB114K5E			12.5*	18.7	23.4	28.7	34.7	ZB114K5E			11.3*	11.3	11.3	11.4	11.4
ZB220KCE			28.5*	39.2	47.7	57.5	68.9	ZB220KCE			21.4*	21.8	22.0	22.2	22.4
Digital Models															
ZFD13KVE EVI	4.0	4.9	6.0	7.2	8.5	10.0	11.7	ZFD13KVE EVI	2.9	3.0	3.1	3.2	3.3	3.4	3.5
ZFD18KVE EVI	6.1	7.3	8.7	10.4	12.3	14.4	16.9	ZFD18KVE EVI	4.0	4.3	4.5	4.6	4.8	5.0	5.1
ZFD25KVE EVI	7.7	9.3	11.2	13.2	15.3	17.5	19.7	ZFD25KVE EVI	4.8	5.1	5.4	5.7	6.0	6.3	6.6
ZFD41K5E EVI	12.5	15.0	18.1	21.5	25.4	29.5	33.9	ZFD41K5E EVI	7.9	8.4	8.8	9.3	9.7	10.1	10.6
ZFD41K5E	8.6	10.6	13.0	15.7	18.9	22.6	27.0	ZFD41K5E	6.3	6.7	7.1	7.5	7.9	8.4	8.8

Conditions: Suction Gas Return 20°C / Subcooling 0K

*Conditions: Suction Superheat 10K, Subcooling 0K

** Single Phase Only

Capacity Data

Condensing Temperature 40°C															
R134a	Cooling Capacity (kW)							R134a	Power Input (kW)						
	Evaporating Temperature (°C)								Evaporating Temperature (°C)						
Model	-35	-30	-25	-20	-15	-10	-5	Model	-35	-30	-25	-20	-15	-10	-5
ZB15KCE				1.4	1.7	2.2	2.7	ZB15KCE				0.9	0.9	0.9	0.9
ZB19KCE				1.6	2.0	2.5	3.1	ZB19KCE				1.1	1.1	1.1	1.1
ZB21KCE				2.0	2.5	3.2	4.0	ZB21KCE				1.3	1.3	1.3	1.3
ZB26KCE				2.3	2.9	3.7	4.6	ZB26KCE				1.5	1.5	1.5	1.5
ZB29KCE				2.5	3.2	4.0	5.0	ZB29KCE				1.7	1.7	1.7	1.7
ZB38KCE				3.2	4.2	5.4	6.7	ZB38KCE				2.1	2.1	2.1	2.2
ZB42KCE**				3.8	4.8	6.0	7.5	ZB42KCE**				2.5	2.5	2.5	2.4
ZB45KCE				4.0	5.1	6.4	8.0	ZB45KCE				2.4	2.4	2.5	2.5
ZB48KCE				4.8	6.0	7.5	9.1	ZB48KCE				2.8	2.8	2.9	2.9
ZB57KCE				5.0	6.4	8.1	10.1	ZB57KCE				3.4	3.4	3.4	3.5
ZB Summit Models															
ZB66K5E				6.0	7.5	9.5	11.8	ZB66K5E				3.8	3.7	3.8	3.8
ZB76K5E				6.9	8.6	10.8	13.5	ZB76K5E				4.4	4.4	4.4	4.5
ZB95K5E				8.2	10.8	13.8	17.1	ZB95K5E				5.4	5.5	5.5	5.6
ZB114K5E				9.6	12.7	16.3	20.4	ZB114K5E				6.6	6.6	6.7	6.7
ZB220KCE					27.3	34.1	42.1	ZB220KCE					13.0	13.2	13.5
Digital Models															
ZBD21KCE				2.0*	2.7	3.3	4.0	ZBD21KCE				1.2*	1.3	1.4	1.4
ZBD29KCE				2.5*	3.3	4.2	5.2	ZBD29KCE				1.7*	1.7	1.7	1.7
ZBD38KCE				3.2*	4.4	5.5	6.8	ZBD38KCE				1.9*	2.1	2.2	2.3
ZBD45KCE				3.8*	5.1	6.4	7.9	ZBD45KCE				2.3*	2.4	2.5	2.6
ZBD57KCE				4.7*	6.4	8.1	10.1	ZBD57KCE				3.4*	3.4	3.4	3.5
ZBD76K5E*				6.2	7.9	10.0	12.6	ZBD76K5E				5.3	5.3	5.4	5.4
ZBD114K5E*				8.1	11.1	14.6	18.7	ZBD114K5E				7.4	7.4	7.4	7.5

*Conditions: Suction Superheat 10K, Subcooling 0K

** Single Phase Only

ZF and ZFD Copeland™ Scroll Compressor Ranges for Low Temperature Refrigeration Using R407A/F, R448A/R449A and R404A

Emerson developed the ZF range to provide the best performance in low temperature. The range has a wide application envelope as it can operate from -40°C evaporating temperature to +7°C. They have been optimized in their design to perfectly fit frozen food application requirements. Thanks to their scroll compliance mechanism, these scroll compressors feature particularly high tolerance to liquid slugging.

The range consists of:

- The ZF*K4E models that operate with liquid injection in order to control discharge temperature and increase the operating envelope.
- The ZF*KVE models that are optimized for vapor injection with use of a sub-cooler. This boosts refrigeration system's cooling capacity and efficiency.
- The Summit ZF*K5E models that operate both with liquid injection or vapor injection.

These compressors are qualified for R407A/F, R448A/R449A, R404A and R134a for certain models.



ZF compressor for low temperature refrigeration with and without sound shell

ZFD Digital Scroll Compressors

Based on the unique Copeland compliant scroll design, the digital modulation operates on a simple mechanism. Capacity control is achieved by separating the scroll sets axially over a small period of time. It is a simple mechanical solution allowing precise temperature control and system efficiency and it requires no other components.

Digital scroll technology provides continuous, stepless modulation from 10% to 100% with no operating envelope restriction. As a result, system pressures and temperatures are tightly controlled. These compressors provide optimum performance for refrigeration units, refrigeration packs, process and agricultural units.

ZF and ZFD Compressor Line-Up

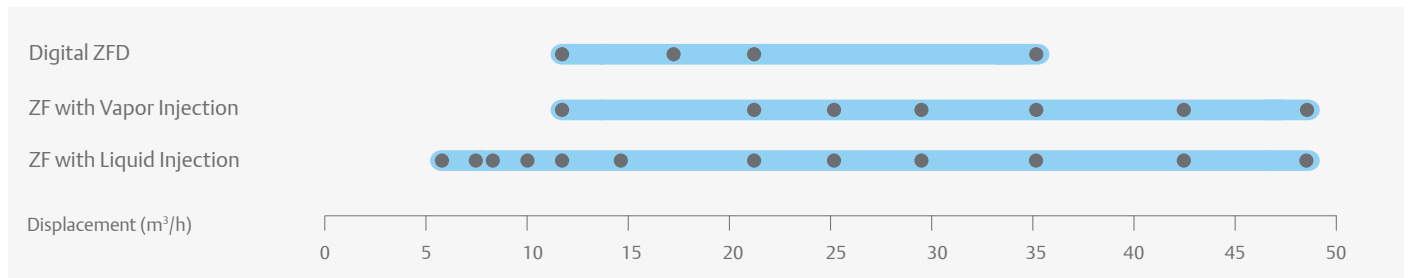

Features and Benefits

- Wide operating envelope with 10°C low condensing temperature to minimize energy consumption
- One model for multiple refrigerants
- Light weight and compactness, up to half the weight of equivalent semi-hermetic compressor
- Optional sound shell allowing up to 10 dBA sound attenuation
- ZF models with liquid injection
 - Easy, efficient and reliable injection via Discharge Temperature Control valve (DTC)
- ZF models with enhanced vapor injection
 - Seasonal efficiencies compared to Emerson's best semi-hermetic compressors
 - Improved system capacity and efficiency by 40% and 25% respectively, making them the most efficient compressors on the market.
 - Possibility to reduce the equipment and component sizes by using smaller compressors

Maximum Allowable Pressure (PS)

- ZF06 to ZF18 (K4E/KVE):
Low Side PS 21 bar(g) / High Side PS 32 bar(g)
- ZF25 to ZF54 (K5E):
Low Side PS 22.6 bar(g) / High Side PS 32 bar(g)
- Digital ZFD:
Low Side PS 22.6 bar(g) / High Side PS 32 bar(g)

Operating Envelope R407A

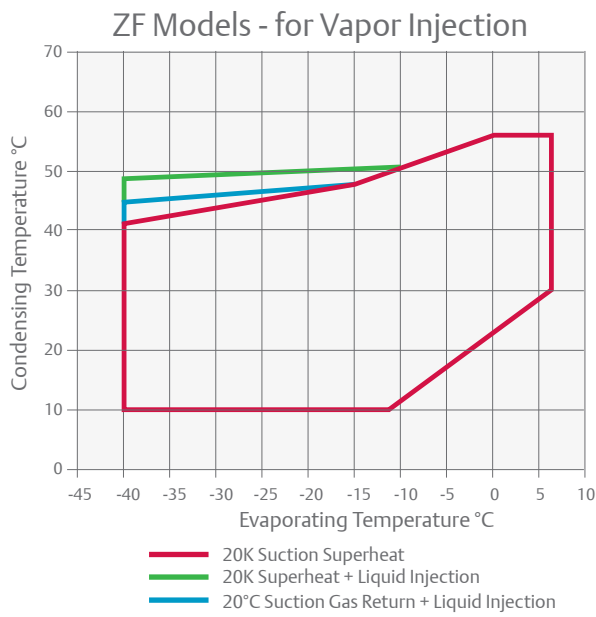

Operating Envelope R407F

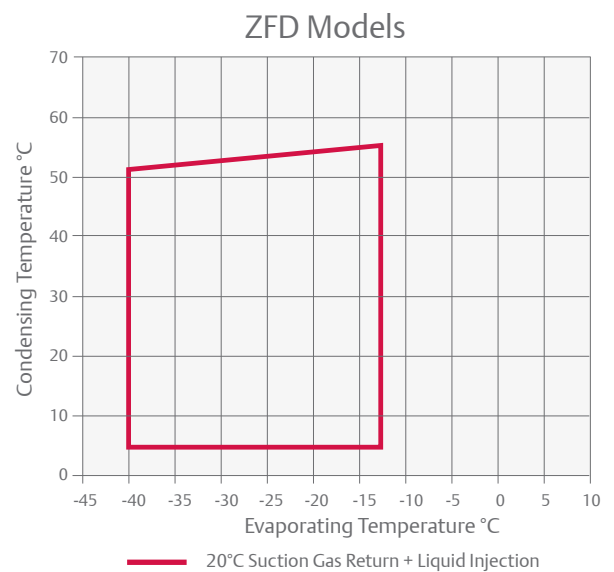
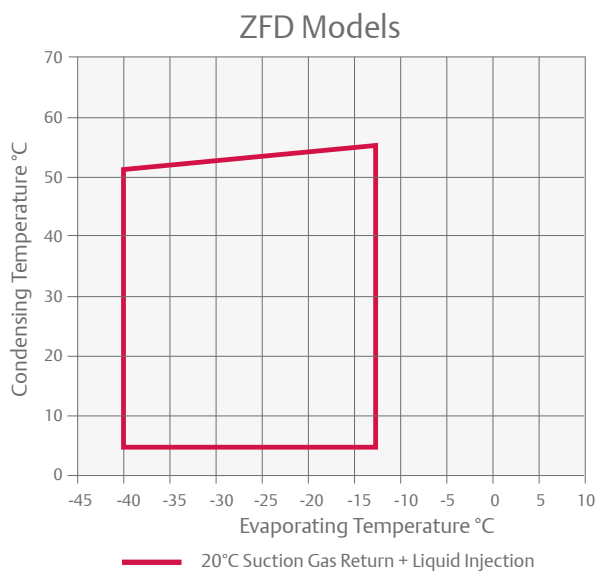
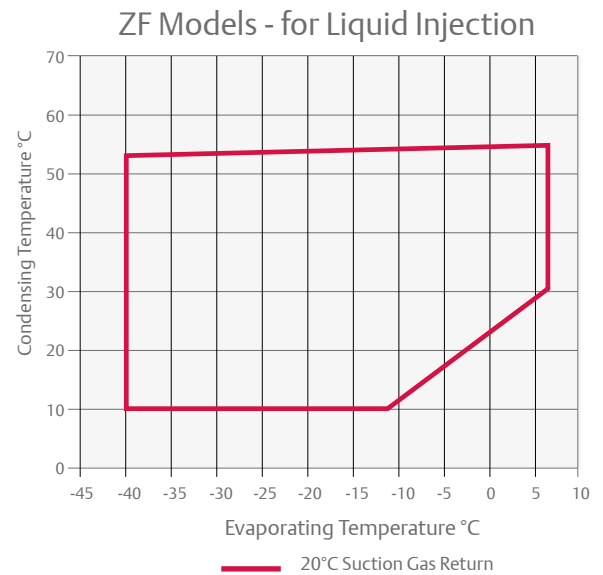
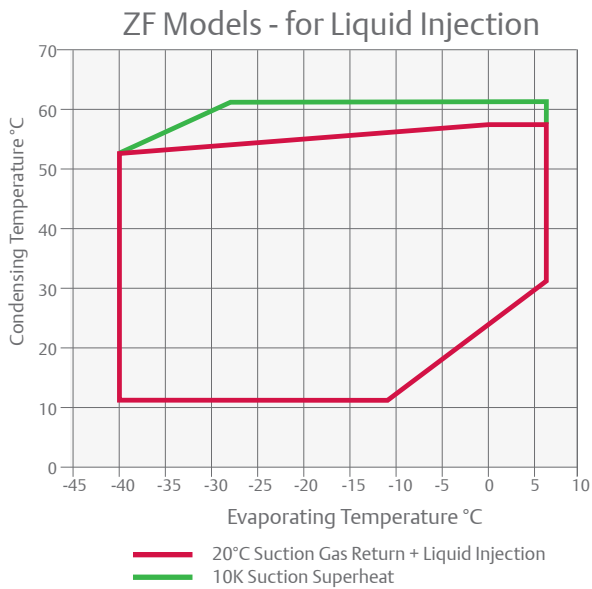
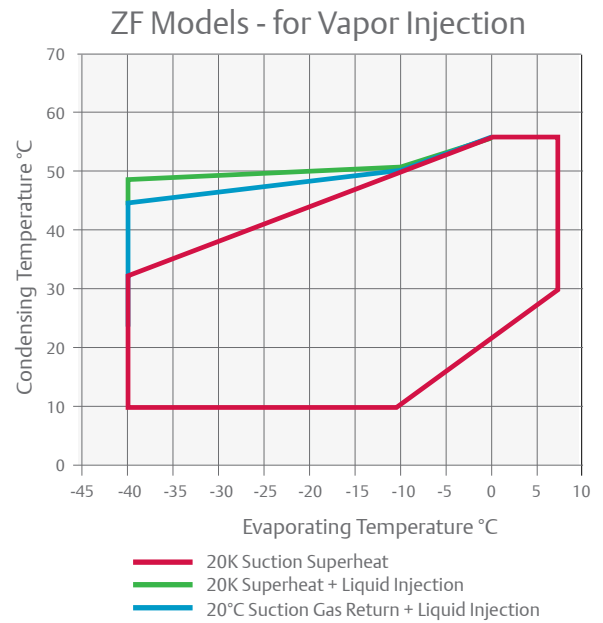

Operating Envelope R448A/R449A

ZF Models - for Liquid Injection

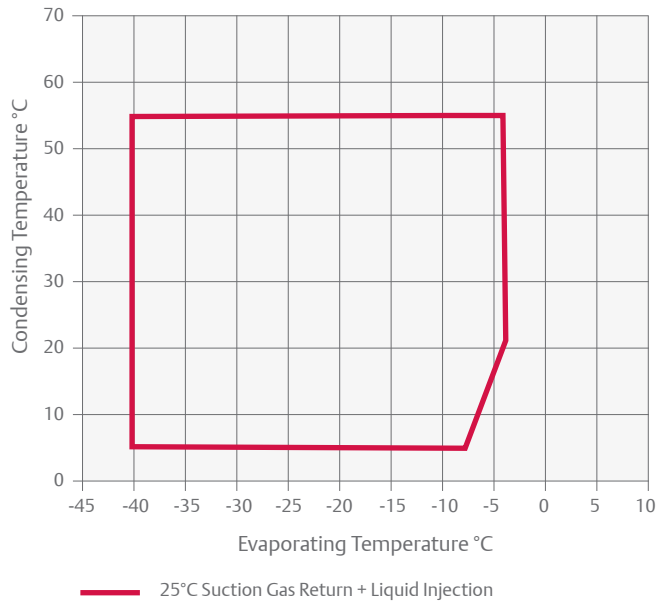

For individual model details please refer to Select Software.

For ZFD Digital Models

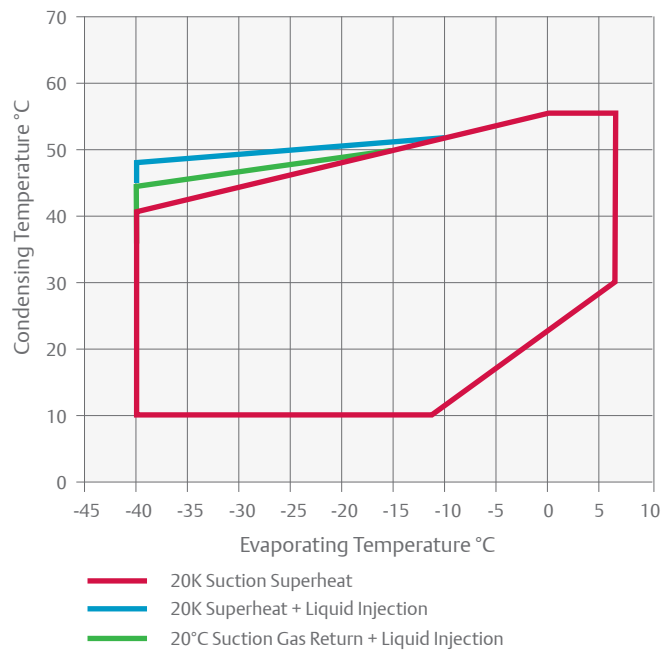

Technical Overview

Models	Nominal hp	Displacement (m ³ /h)	Rotolock Suction (inch)	Rotolock Discharge (inch)	Oil Quantity (l)	Length/Width/Height (mm)	Net Weight (kg)	Motor Version/Code	Maximum Operating Current (A)	Locked Rotor Current (A)	Sound Pressure @1 m - db(A)***
								3 Ph**	3 Ph**	3 Ph**	
Models with Liquid Injection only											
ZF06K4E	2.0	5.9	1 1/4	1	1.3	243/245/369	25.4	TFD	5	26	57
ZF08K4E	2.5	7.3	1 1/4	1	1.5	243/245/391	27.2	TFD	6	32	59
ZF09K4E	2.8	8.0	1 1/4	1	1.5	243/244/391	27.0	TFD	6	40	62
ZF11K4E	3.5	9.9	1 1/4	1	1.5	243/244/405	28.0	TFD	7	46	63
ZF13K4E	4.0	11.8	1 1/4	1	1.9	246/251/442	38.0	TFD	8	51	65
ZF15K4E	5.0	14.5	1 1/4	1	1.9	246/251/442	39.0	TFD	10	64	65
ZF18K4E	6.0	17.1	1 1/4	1	1.9	246/251/442	41.0	TFD	12	74	67
Models with Vapor Injection only											
ZF13KVE	4.0	11.7	1 1/4	1	1.9	246/251/442	38.0	TFD	9	64	63
ZF18KVE	6.0	17.1	1 1/4	1	1.9	246/251/442	39.5	TFD	13	74	67
Models which can have Liquid or Vapor Injection											
ZF25K5E	7.5	21.4	1 1/4	1 1/4	1.9	246/257/452	39.5	TFD	16	102	70
ZF34K5E	10.0	29.1	1 3/4	1 1/4	3.4	280/280/534	63.1	TFD	25	100	68
ZF41K5E	13.0	35.3	1 3/4	1 1/4	3.4	280/280/534	63.1	TFD	29	118	69
ZF49K5E	15.0	42.4	1 3/4	1 1/4	3.4	280/280/552	66.2	TFD	30	139	72
ZF54K5E	17.0	48.3	1 3/4	1 1/4	3.4	363/312/552	66.2	TFD	31	168	78
Digital Models											
ZFD13KVE EVI	4.0	11.7	1 1/4	1	1.9	246/250/481	38	TFD	9	64	65
ZFD18KVE EVI	6.0	17.1	1 1/4	1	1.9	300/299/481	43	TFD	13	74	67
ZFD25KVE EVI	7.5	21.4	1 1/4	1 1/4	1.9	246/250/481	43	TFD	16	102	70
ZFD41K5E	10.0	35.3	1 3/4	1 1/4	3.4	310/280/534	66	TFD	20	118	73
ZFD41K5E EVI	13.0	35.3	1 3/4	1 1/4	3.4	310/280/534	66	TFD	20	118	72

** 3 Ph: 380-420V/ 50Hz

*** @ 1m: sound pressure level at 1m distance from the compressor, free field condition

Capacity Data

Condensing Temperature 40°C															
R407A	Cooling Capacity (kW)							R407A	Power Input (kW)						
	Evaporating Temperature (°C)								Evaporating Temperature (°C)						
Model	-35	-30	-25	-20	-15	-10	-5	Model	-35	-30	-25	-20	-15	-10	-5
Models with Liquid Injection Only															
ZF06K4E	1.2	1.5	1.9	2.3	2.8	3.5	4.2	ZF06K4E	1.2	1.2	1.2	1.3	1.4	1.4	1.5
ZF08K4E	1.4	1.9	2.4	3.0	3.6	4.4	5.3	ZF08K4E	1.4	1.4	1.5	1.6	1.6	1.7	1.8
ZF09K4E	1.6	2.0	2.6	3.2	3.9	4.8	5.9	ZF09K4E	1.5	1.5	1.6	1.6	1.7	1.8	1.9
ZF11K4E	2.0	2.6	3.2	4.0	4.9	6.0	7.3	ZF11K4E	1.9	1.9	1.9	2.0	2.0	2.2	2.3
ZF13K4E	2.2	2.9	3.6	4.5	5.6	6.8	8.3	ZF13K4E	2.3	2.3	2.4	2.5	2.5	2.6	2.8
ZF15K4E	2.7	3.5	4.4	5.5	6.8	8.4	10.2	ZF15K4E	2.7	2.8	2.9	3.1	3.2	3.4	3.6
ZF18K4E	3.3	4.3	5.4	6.7	8.3	10.2	12.4	ZF18K4E	3.3	3.4	3.5	3.6	3.8	3.9	4.1
Models with Vapor Injection Only															
ZF13KVE	3.1	3.9	4.9	5.9	7.2	8.7	10.4	ZF13KVE	2.4	2.4	2.5	2.6	2.7	2.7	2.7
ZF18KVE	4.9	6.0	7.3	8.8	10.8	13.3	16.4	ZF18KVE	3.4	3.5	3.6	3.7	3.9	4.1	4.4
Models which can have Liquid or Vapor Injection															
ZF25K5E	4.3	5.5	6.9	8.6	10.7	13.2	16.0	ZF25K5E	4.0	4.2	4.5	4.7	4.9	5.2	5.4
ZF25K5E (EVI)	6.1	7.7	9.4	11.4	13.5	15.8	18.2	ZF25K5E (EVI)	4.3	4.4	4.6	4.8	5.0	5.3	5.5
ZF34K5E	5.9	7.6	9.6	12.1	15.0	18.3	22.3	ZF34K5E	5.1	5.5	5.9	6.2	6.6	6.9	7.3
ZF34K5E (EVI)	8.0	9.9	12.1	14.6	17.4	20.7	24.2	ZF34K5E (EVI)	5.3	5.5	5.7	5.9	6.1	6.3	6.4
ZF41K5E	7.3	9.3	11.7	14.5	17.9	21.8	26.4	ZF41K5E	6.2	6.7	7.1	7.6	8.0	8.4	8.9
ZF41K5E (EVI)	10.1	12.6	15.5	18.7	22.1	25.8	29.7	ZF41K5E (EVI)	6.7	6.9	7.2	7.4	7.6	7.8	8.0
ZF49K5E	8.6	11.2	14.1	17.7	21.9	26.8	32.5	ZF49K5E	7.6	8.2	8.7	9.2	9.7	10.2	10.7
ZF49K5E (EVI)	12.1	15.1	18.4	22.3	26.8			ZF49K5E (EVI)	8.0	8.3	8.5	8.8	9.1		
ZF54K5E	9.5	12.2	15.4	19.3	23.8			ZF54K5E	8.1	8.6	9.3	10.0	10.8		
ZF54K5E (EVI)	14.5	17.8	21.6	26.1	31.4			ZF54K5E (EVI)	9.7	10.1	10.4	10.7	11.1		
Digital Models															
ZFD13KVE EVI	3.1	4.1	5.2	6.4	7.7	9.2	10.9	ZFD13KVE EVI	2.7	2.8	2.8	2.9	2.9	3.0	3.1
ZFD18KVE EVI	4.9	6.0	7.3	8.8	10.8	13.3	16.4	ZFD18KVE EVI	3.4	3.5	3.6	3.7	3.9	4.1	4.4
ZFD25KVE EVI	6.1	7.7	9.4	11.4	13.5	15.8	18.2	ZFD25KVE EVI	4.3	4.4	4.6	4.8	5.0	5.3	5.5
ZFD41K5E	7.3	9.3	11.8	14.6				ZFD41K5E	6.2	6.7	7.2	7.5			
ZFD41K5E EVI	10.1	12.6	15.5	18.7	22.1	25.8	23.7	ZFD41K5E EVI	6.7	6.9	7.2	7.4	7.6	7.8	8.0

Conditions: Suction Gas Return 20°C / Subcooling 0K

Preliminary Data

Capacity Data

Condensing Temperature 40°C															
R407F	Cooling Capacity (kW)							R407F	Power Input (kW)						
	Evaporating Temperature (°C)								Evaporating Temperature (°C)						
Model	-35	-30	-25	-20	-15	-10	-5	Model	-35	-30	-25	-20	-15	-10	-5
Models with Liquid Injection Only															
ZF06K4E	1.2	1.5	1.9	2.3	2.8	3.5	4.2	ZF06K4E	1.3	1.3	1.3	1.4	1.4	1.5	1.6
ZF08K4E	1.4	1.9	2.4	3.0	3.6	4.4	5.3	ZF08K4E	1.5	1.5	1.6	1.6	1.7	1.8	1.9
ZF09K4E	1.6	2.0	2.6	3.2	3.9	4.8	5.9	ZF09K4E	1.6	1.6	1.6	1.7	1.8	1.9	2.0
ZF11K4E	2.0	2.6	3.2	4.0	4.9	6.0	7.3	ZF11K4E	1.9	2.0	2.0	2.1	2.2	2.3	2.4
ZF13K4E	2.2	2.9	3.6	4.5	5.6	6.8	8.3	ZF13K4E	2.4	2.4	2.5	2.6	2.7	2.8	2.9
ZF15K4E	2.7	3.5	4.4	5.5	6.8	8.4	10.2	ZF15K4E	2.8	3.0	3.1	3.2	3.4	3.5	3.8
ZF18K4E	3.3	4.3	5.4	6.7	8.3	10.2	12.4	ZF18K4E	3.5	3.6	3.7	3.8	4.0	4.1	4.3
Models with Vapor Injection Only															
ZF13KVE	3.3	4.3	5.4	6.7	8.1	9.7	11.5	ZF13KVE	2.8	2.9	3.0	3.0	3.1	3.2	3.3
ZF18KVE	4.9	6.1	7.6	9.3	11.3	13.5	16.0	ZF18KVE	3.8	4.0	4.1	4.2	4.4	4.5	4.7
Models which can have Liquid or Vapor Injection															
ZF25K5E	4.5	5.8	7.3	9.1	11.3	13.8	16.8	ZF25K5E	4.2	4.4	4.7	4.9	5.2	5.4	5.7
ZF25K5E (EVI)	6.4	8.0	9.9	11.9	14.2	16.6	19.1	ZF25K5E (EVI)	4.5	4.7	4.9	5.1	5.3	5.5	5.8
ZF34K5E	6.2	8.0	10.1	12.7	15.7	19.3	23.4	ZF34K5E	5.6	5.8	6.0	6.2	6.4	6.6	6.8
ZF34K5E (EVI)	8.3	10.4	12.7	15.4	18.4	21.7	25.4	ZF34K5E (EVI)	5.3	5.5	5.7	5.9	6.1	6.3	6.4
ZF41K5E	7.6	9.7	12.3	15.2	18.8	22.9	27.7	ZF41K5E	6.5	7.0	7.5	8.0	8.4	8.9	9.3
ZF41K5E (EVI)	10.6	13.3	16.3	19.6	23.2	27.1	31.2	ZF41K5E (EVI)	7.0	7.3	7.5	7.7	8.0	8.2	8.4
ZF49K5E	9.1	11.7	14.8	18.6	23.0	28.1	34.2	ZF49K5E	8.0	8.6	9.1	9.6	10.2	10.7	11.2
ZF49K5E (EVI)	14.1	17.1	20.5	24.5	28.9			ZF49K5E (EVI)	9.1	9.7	10.3	10.8	11.3		
ZF54K5E	9.9	12.6	15.8	19.5	23.9			ZF54K5E	8.5	9.1	9.8	10.5	11.3		
ZF54K5E (EVI)	15.2	18.7	22.7	27.4	33.0			ZF54K5E (EVI)	10.2	10.6	10.9	11.3	11.6		
Digital Models															
ZFD13KVE EVI	3.3	4.3	5.4	6.7	8.1	9.7	11.4	ZFD13KVE EVI	2.8	2.9	3.0	3.0	3.1	3.1	3.2
ZFD18KVE EVI	4.9	6.1	7.6	9.3	11.3	13.5	16.0	ZFD18KVE EVI	3.8	4.0	4.1	4.2	4.4	4.5	4.7
ZFD25KVE EVI	6.4	8.0	9.9	11.9	14.2	16.6	19.1	ZFD25KVE EVI	4.5	4.7	4.9	5.1	5.3	5.5	5.8
ZFD41K5E	7.3	9.3	11.8	14.6				ZFD41K5E	6.2	6.7	7.2	7.5			
ZFD41K5E EVI	23.5	29.8	37.2	45.9				ZFD41K5E KVE	6.4	6.6	6.8	7.1			

Conditions: Suction Gas Return 20°C / Subcooling 0K
Preliminary Data

Capacity Data

Condensing Temperature 40°C															
R448A/ R449A	Cooling Capacity (kW)							R448A/ R449A	Power Input (kW)						
	Evaporating Temperature (°C)								Evaporating Temperature (°C)						
Model	-35	-30	-25	-20	-15	-10	-5	Model	-35	-30	-25	-20	-15	-10	-5
Models with Liquid Injection Only															
ZF06K4E	1.2	1.5	1.9	2.4	2.9	3.6	4.3	ZF06K4E	1.3	1.4	1.4	1.4	1.5	1.5	1.6
ZF08K4E	1.4	1.8	2.3	2.9	3.5	4.4	5.3	ZF08K4E	1.4	1.5	1.6	1.6	1.7	1.8	1.9
ZF09K4E	1.7	2.1	2.6	3.3	4.0	4.9	5.9	ZF09K4E	1.5	1.5	1.6	1.7	1.8	1.9	2.0
ZF11K4E	2.1	2.6	3.3	4.0	4.9	6.0	7.2	ZF11K4E	2.0	2.0	2.1	2.2	2.3	2.4	2.6
ZF13K4E	2.4	3.1	3.9	4.8	5.9	7.2	8.6	ZF13K4E	2.1	2.2	2.3	2.4	2.5	2.6	2.8
ZF15K4E	3.0	3.8	4.8	5.9	7.2	8.6	10.3	ZF15K4E	2.8	2.8	3.0	3.1	3.3	3.4	3.6
ZF18K4E	3.6	4.7	5.9	7.2	8.8	10.7	12.9	ZF18K4E	3.6	3.6	3.6	3.6	3.7	3.9	4.0
Models with Vapor Injection Only															
ZF13KVE	3.2	4.1	5.1	6.2	7.5	9.0	10.6	ZF13KVE	2.5	2.6	2.7	2.8	2.8	2.9	2.9
ZF18KVE	4.9	6.0	7.4	9.0	10.9	13.0	15.5	ZF18KVE	3.4	3.7	3.9	4.0	4.1	4.2	4.3
Models which can have Liquid or Vapor Injection															
ZF25K5E	4.9	6.1	7.6	9.4	11.4	13.8	16.6	ZF25K5E	3.8	3.9	4.1	4.3	4.5	4.8	5.0
ZF25K5E (EVI)	6.1	7.7	9.4	11.3	13.4	15.6	17.9	ZF25K5E (EVI)	4.0	4.3	4.6	4.9	5.2	5.4	5.6
ZF34K5E	6.1	7.8	9.8	12.1	14.9	18.1	21.7	ZF34K5E	5.1	5.3	5.4	5.7	6.0	6.3	6.7
ZF34K5E (EVI)	8.1	10.3	12.7	15.5	18.6	22.1	26.0	ZF34K5E (EVI)	5.7	6.1	6.5	7.0	7.5	8.1	8.7
ZF41K5E	7.4	9.4	11.8	14.6	17.8	21.5	25.8	ZF41K5E	5.8	6.1	6.5	7.0	7.7	8.4	9.4
ZF41K5E (EVI)	9.8	12.5	15.5	18.9	22.6	26.9	31.6	ZF41K5E (EVI)	7.0	7.5	8.0	8.6	9.2	9.9	10.7
ZF49K5E	9.1	11.6	14.6	18.1	22.2	27.0	32.5	ZF49K5E	7.7	7.8	8.0	8.4	8.9	9.4	10.0
ZF49K5E (EVI)	11.8	14.8	18.2	22.1	26.6			ZF49K5E (EVI)	8.6	9.1	9.6	10.2	10.9		
ZF54K5E	10.0	12.7	15.9	19.8	24.3			ZF54K5E	8.0	8.6	9.3	10.1	10.9		
ZF54K5E (EVI)	14.1	17.4	21.4	25.9	31.2			ZF54K5E (EVI)	10.5	11.1	11.7	12.4	13.3		
Digital Models															
ZFD13KVE EVI	4.0	4.9	6.0	7.2	8.5	10.0	11.7	ZFD13KVE EVI	2.9	3.0	3.1	3.2	3.3	3.4	3.5
ZFD18KVE EVI	6.1	7.3	8.7	10.4	12.3	14.4	16.9	ZFD18KVE EVI	4.0	4.3	4.5	4.6	4.8	5.0	5.1
ZFD25KVE EVI	7.7	9.3	11.2	13.2	15.3	17.5	19.7	ZFD25KVE EVI	4.8	5.1	5.4	5.7	6.0	6.3	6.6
ZFD41K5E EVI	12.5	15.0	18.1	21.5	25.4	29.5	33.9	ZFD41K5E EVI	7.9	8.4	8.8	9.3	9.7	10.1	10.6
ZFD41K5E	8.6	10.6	13.0	15.7	18.9	22.6	27.0	ZFD41K5E	6.3	6.7	7.1	7.5	7.9	8.4	8.8

Conditions: Suction Gas Return 20°C / Subcooling 0K
Preliminary Data



ZS, ZB & ZF*KA Copeland™ Scroll Small Compressor Range for Medium and Low Temperature Applications

As an extension to the existing ZB*KCE and ZF*K4E scroll range, the new Copeland scroll ZS*KA, ZB*KA and ZF*KA compressors represent the latest innovation in scroll technology for refrigeration equipment covering a small size displacement range of 2.4 m³/h to 6.7 m³/h.

ZS*KA and ZB*KA models are intended for medium temperature refrigeration type systems, and are ideally suited for applications such as walk-in coolers, reach-in coolers, cold rooms, display cases and milk tank units. The ZB*KA scrolls cover a range from 0.7hp to 1.3hp, while ZS*KA cover 1.3hp to 1.8hp.

ZF*KA models are suitable for low temperature type systems such as walk-in freezers and reach-in freezers. They cover a range from 1hp to 2.5hp.

ZS, ZB and ZF*KA are multi-refrigerant capable and feature low sound and low vibration, which is particularly important in the retail and food service sector and recommended for supermarkets, restaurants, convenience stores and milk cooling operations. Their compact design provides seasonal efficiencies up to 28% higher than the equivalent hermetic reciprocating compressors. They are qualified for today's HFC as well as new low GWP refrigerants and HFO blends.



ZS*KA Copeland scroll compressor range for medium temperature refrigeration applications

Compressor Line-up

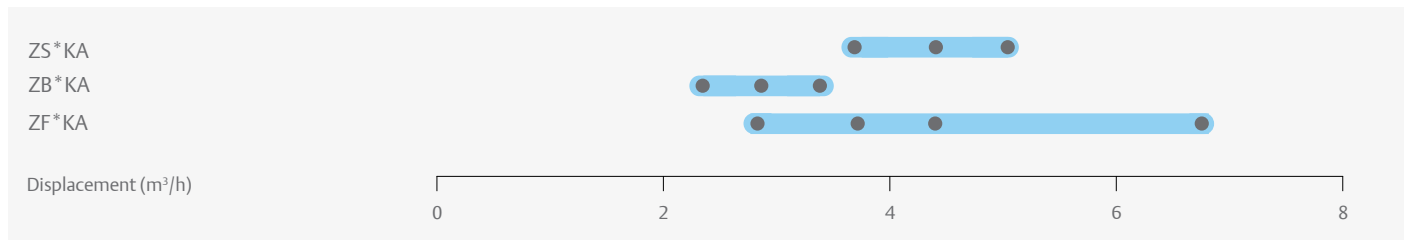

Features and Benefits

- Copeland scroll axial and radial compliance for superior reliability and efficiency
- High seasonal efficiencies as scrolls are designed at the condition where equipment runs most of the time
- Up to 15% efficiency advantage over hermetic reciprocating compressors at rating conditions, and up to 28% improvement at lower condensing temperatures
- Availability of optional sound shell on all models providing up to 10 dBA additional sound attenuation for silent operation
- Wide operating ranges: from -25°C to 10°C covering a minimum condensing limit of 10°C for ZS*KA and ZB*KA and -40°C to -12°C for ZF*KA
- Qualified for R407A/F/C, R448A, R449A, R404A and R134a refrigerants

Maximum Allowable Pressure (PS)

- ZS09 to ZS13KA:
Low Side PS 21.6 bar(g) / High Side PS 31.9 bar(g)
- ZB06 to ZB08KA:
Low Side PS 21.0 bar(g) / High Side PS 28.8 bar(g)
- ZF03 to ZF07KA:
Low Side PS 21.0 bar(g) / High Side PS 28.8 bar(g)

Operating Envelope ZS* KA R134a

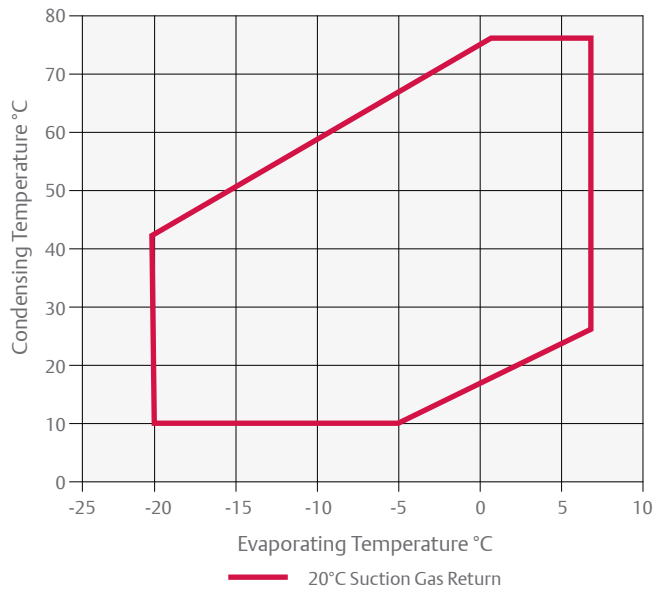

Operating Envelope ZB* KA R134a

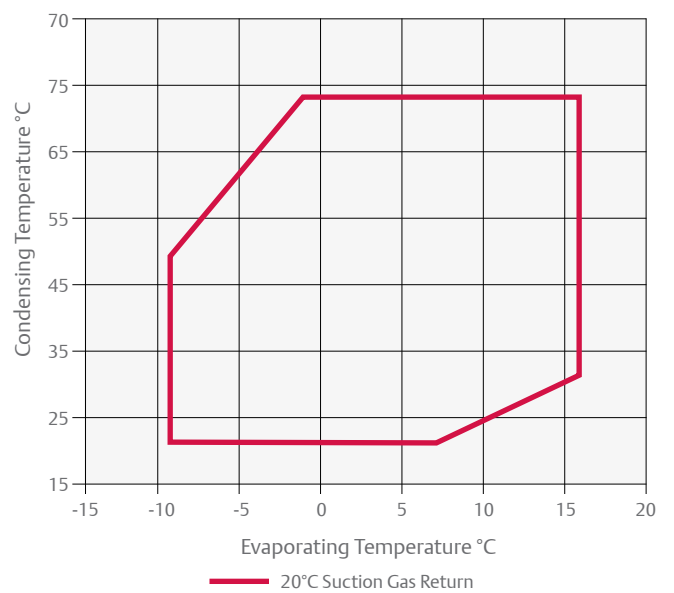

Operating Envelope ZS* KA R448A/R449A

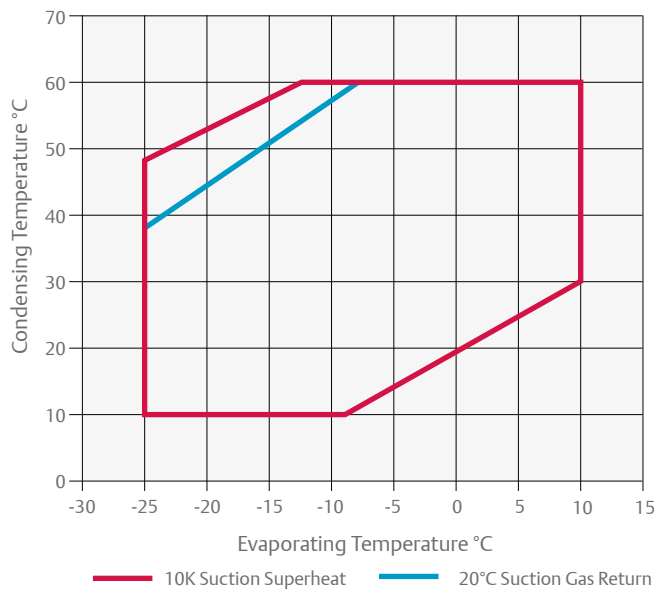

Operating Envelope ZB* KA R448A/R449A

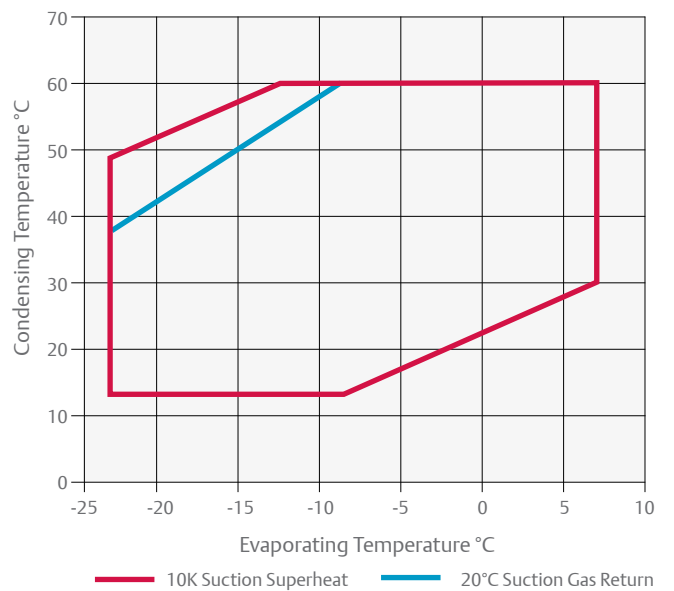

Operating Envelope ZF* KA R448A/R449A

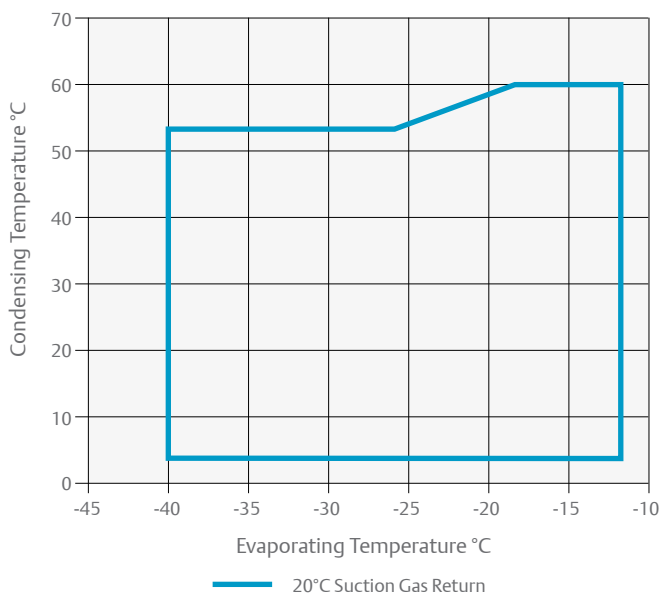

Technical Overview

Models	Nominal hp	Displacement (m ³ /h)	Rotolock Suction (inch)	Rotolock Discharge (inch)	Oil Quantity (l)	Length/Width/Height (mm)	Net Weight (kg)	Motor Version/ Code		Maximum Operating Current (A)		Locked Rotor Current (A)		Sound Pressure @1 m - dB(A)***
								1 Ph*	3 Ph**	1 Ph*	3 Ph**	1 Ph*	3 Ph**	
Medium Temperature														
ZB06KAE	0.8	2.4	3/4	1/2	0.7	246/246/380	21	PFJ	TFD	5	2	32	15	59
ZB07KAE	1.0	2.9	3/4	1/2	0.7	246/246/380	23	PFJ	TFD	6	2	45	20	59
ZB08KAE	1.2	3.4	3/4	1/2	0.7	246/246/380	23	PFJ	TFD	7	2	45	20	59
ZS09KAE	1.3	3.7	3/4	1/2	0.7	246/246/399	22	PFJ	TFD	7	3	45	27	58
ZS11KAE	1.5	4.4	3/4	1/2	0.7	246/246/399	22	PFJ	TFD	9	3	45	27	58
ZS13KAE	1.8	5.0	3/4	1/2	0.7	246/246/399	22	PFJ	TFD	10	4	54	29	59
Low Temperature														
ZF03KAE	1.0	2.8	3/4	1/2	0.7	246/246/387	22	PFJ	TFD	5	2	40	20	40
ZF04KAE	1.3	3.7	3/4	1/2	0.7	246/246/387	22	PFJ	TFD	6	3	45	27	45
ZF05KAE	1.5	4.4	3/4	1/2	0.7	246/246/387	22	PFJ	TFD	7	5	45	27	45
ZF07KAE	2.5	6.7	3/4	1/2	0.7	246/246/387	23	PFJ	TFD	11	4	79	27	79

* 1Ph: 230V/ 50Hz

** 3 Ph: 380-420V/ 50Hz

*** @ 1m: sound pressure level at 1m distance from the compressor, free field condition

Capacity Data

Condensing Temperature 40°C															
R407A	Cooling Capacity (kW)							R407A	Power Input (kW)						
	Evaporating Temperature (°C)								Evaporating Temperature (°C)						
Model	-35	-30	-25	-20	-15	-10	-5	Model	-35	-30	-25	-20	-15	-10	-5
Medium Temperature															
ZB06KAE				0.9	1.1	1.4	1.7	ZB06KAE				0.6	0.6	0.6	0.6
ZB07KAE				1.0	1.3	1.7	2.1	ZB07KAE				0.7	0.7	0.7	0.8
ZB08KAE				1.2	1.5	1.9	2.3	ZB08KAE				0.8	0.8	0.9	0.9
ZS09KAE		0.9	1.2	1.5	1.8	2.2	2.6	ZS09KAE		0.7	0.8	0.8	0.8	0.8	0.9
ZS11KAE		1.1	1.4	1.7	2.1	2.6	3.1	ZS11KAE		0.9	0.9	1.0	1.0	1.0	1.1
ZS13KAE		1.2	1.6	2.0	2.4	2.9	3.6	ZS13KAE		1.0	1.1	1.1	1.2	1.2	1.2
Low Temperature															
ZF03KAE	0.5*	0.6*	0.8*	0.9*	1.2*			ZF03KAE	0.6*	0.6*	0.7*	0.7*	0.7*		
ZF04KAE	0.6*	0.8*	1.1*	1.4*	1.7*			ZF04KAE	0.7*	0.8*	0.8*	0.9*	0.9*		
ZF05KAE	0.8*	1.0*	1.3*	1.6*	2.0*			ZF05KAE	0.9*	1.0*	1.0*	1.0*	1.0*		
ZF07KAE	1.3*	1.6*	2.0*	2.5*	3.1*			ZF07KAE	1.3*	1.4*	1.4*	1.5*	1.6*		

Conditions: Suction Gas Return 20°C / Subcooling 0K

*Conditions: Suction Superheat 10K, Subcooling 0K

Condensing Temperature 40°C															
R407F	Cooling Capacity (kW)							R407F	Power Input (kW)						
	Evaporating Temperature (°C)								Evaporating Temperature (°C)						
Model	-35	-30	-25	-20	-15	-10	-5	Model	-35	-30	-25	-20	-15	-10	-5
Medium Temperature															
ZB06KAE				0.9	1.1	1.4	1.7	ZB06KAE				0.6	0.6	0.6	0.6
ZB07KAE				1.0	1.3	1.7	2.1	ZB07KAE				0.7	0.7	0.7	0.8
ZB08KAE				1.2	1.5	1.9	2.3	ZB08KAE				0.8	0.8	0.9	0.9
ZS09KAE			1.2*	1.5	1.9	2.3	2.7	ZS09KAE			0.8*	0.8	0.9	0.9	0.9
ZS11KAE			1.4*	1.8	2.2	2.7	3.3	ZS11KAE			1.0*	1.0	1.1	1.1	1.1
ZS13KAE			1.6*	2.1	2.6	3.1	3.7	ZS13KAE			1.1*	1.2	1.2	1.2	1.3
Low Temperature															
ZF03KAE	0.5*	0.6*	0.8*	1.0*	1.2*			ZF03KAE	0.6*	0.6*	0.7*	0.7*	0.8*		
ZF04KAE	0.6*	0.8*	1.1*	1.4*	1.7*			ZF04KAE	0.7*	0.8*	0.8*	0.9*	1.0*		
ZF05KAE	0.8*	1.0*	1.3*	1.6*	2.0*			ZF05KAE	0.9*	1.0*	1.0*	1.0*	1.0*		
ZF07KAE	1.3*	1.6*	2.0*	2.5*	3.1*			ZF07KAE	1.3*	1.4*	1.4*	1.5*	1.6*		

Conditions: Suction Gas Return 20°C / Subcooling 0K

*Conditions: Suction Superheat 10K, Subcooling 0K

Capacity Data

Condensing Temperature 40°C															
R448A/ R449A	Cooling Capacity (kW)							R448A/ R449A	Power Input (kW)						
	Evaporating Temperature (°C)								Evaporating Temperature (°C)						
Model	-35	-30	-25	-20	-15	-10	-5	Model	-35	-30	-25	-20	-15	-10	-5
Medium Temperature															
ZB06KAE				0.9	1.2	1.4	1.7	ZB06KAE				0.6	0.6	0.6	0.6
ZB07KAE				1.1	1.4	1.7	2.1	ZB07KAE				0.7	0.7	0.8	0.8
ZB08KAE				1.2	1.5	1.9	2.3	ZB08KAE				0.8	0.9	0.9	0.9
ZS09KAE		0.9	1.1	1.4	1.7	2.1	2.5	ZS09KAE		0.7	0.8	0.8	0.9	0.9	0.9
ZS11KAE		1.0	1.3	1.6	2.0	2.5	3.1	ZS11KAE		0.8	0.9	1.0	1.0	1.0	1.0
ZS13KAE		1.4	1.8	2.3	2.8	3.4	4.1	ZS13KAE		1.1	1.3	1.4	1.4	1.5	1.5
Low Temperature															
ZF03KAE	0.5*	0.7*	0.8*	1.0*	1.3*			ZF03KAE	0.7*	0.7*	0.7*	0.7*	0.7*		
ZF04KAE	0.7*	0.9*	1.1*	1.4*	1.8*			ZF04KAE	0.7*	0.8*	0.8*	0.9*	1.0*		
ZF05KAE	0.8*	1.1*	1.3*	1.7*	2.1*			ZF05KAE	1.0*	1.0*	1.0*	1.0*	1.0*		
ZF07KAE	1.3*	1.7*	2.1*	2.6*	3.2*			ZF07KAE	1.3*	1.4*	1.4*	1.5*	1.6*		

Conditions: Suction Gas Return 20°C / Subcooling 0K
 *Conditions: Suction Superheat 10K, Subcooling 0K

Condensing Temperature 40°C															
R134a	Cooling Capacity (kW)							R134a	Power Input (kW)						
	Evaporating Temperature (°C)								Evaporating Temperature (°C)						
Model	-35	-30	-25	-20	-15	-10	-5	Model	-35	-30	-25	-20	-15	-10	-5
Medium Temperature															
ZB06KAE					0.7	0.9	1.1	ZB06KAE					0.4	0.4	0.4
ZB07KAE					0.8	1.0	1.3	ZB07KAE					0.5	0.5	0.5
ZB08KAE					0.9	1.2	1.5	ZB08KAE					0.5	0.6	0.6
ZS09KAE				0.9	1.1	1.4	1.7	ZS09KAE				0.5	0.6	0.6	0.6
ZS11KAE				1.1	1.3	1.7	2.0	ZS11KAE				0.6	0.7	0.7	0.7
ZS13KAE				1.2	1.5	1.9	2.3	ZS13KAE				0.7	0.8	0.8	0.8

Conditions: Suction Gas Return 20°C / Subcooling 0K

ZO & ZOD Copeland™ Scroll Compressor Ranges for R744-Subcritical Refrigeration

ZO Copeland scroll compressors have been designed for use in R744 (CO₂) low temperature refrigeration systems. These compressors are suitable for usage in CO₂-subcritical cascade and booster systems.

Increasing environmental concerns about potential direct emissions from HFC-based refrigeration systems into the atmosphere have led to the revival of R744 in the European refrigeration market. Regionally, this trend is reinforced by legislation and taxation schemes which favor the usage of refrigerant R744.

In comparison with HFC refrigerants, the specific properties of R744 require changes in the design of the refrigeration system. The ZO range of Copeland scroll compressors has been particularly designed to exploit the characteristics of the R744 refrigeration system. Efficiency, reliability and liquid handling advantages of the Copeland scroll technology equally apply.

The optimized design of ZO compressors effectively address the challenges of R744 systems i.e., high pressure levels, higher mass flow for a given displacement while securing proper lubrication.

The range consists of 6 models including 2 digital models for 10 to 100% continuous cooling capacity modulation.



ZO compressor for low temperature refrigeration

ZO and ZOD Compressor Line-up

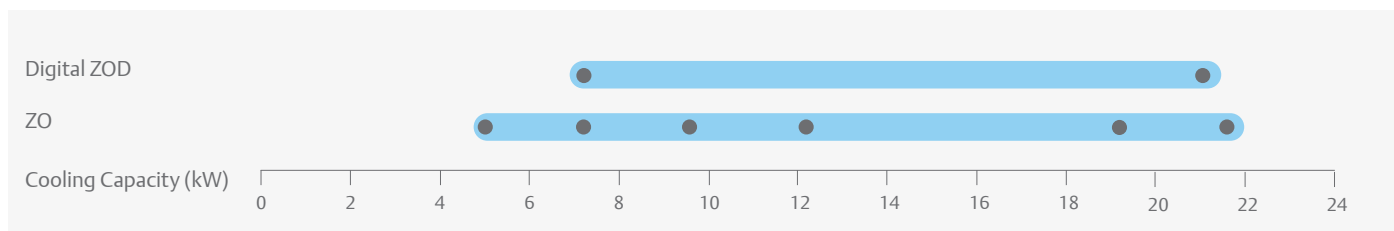

Conditions EN12900 R744: Evaporating -35°C, Refrigeration -5°C, Suction Superheat 10K, Subcooling 0K

Features and Benefits

- Optimized for high efficiency in CO₂-subcritical cascade and booster systems
- High condensing temperature limit allowing for optimized overall system design
- Compact design minimizing required machine room space
- Half the weight of equivalent semi-hermetic compressors
- Optional sound shell allowing 10 dBA sound attenuation
- High bearing reliability and lubrication of all critical parts under all conditions including liquid slugging
- Availability of a digital model offering simple, stepless 10 to 100% capacity modulation

Maximum Allowable Pressure (PS)

- ZO: Low Side PS 30 bar(g) / High Side PS 52 bar(g)
- Digital ZOD: Low Side PS 30 bar(g) / High Side PS 45 bar(g)

Operating Envelope R744

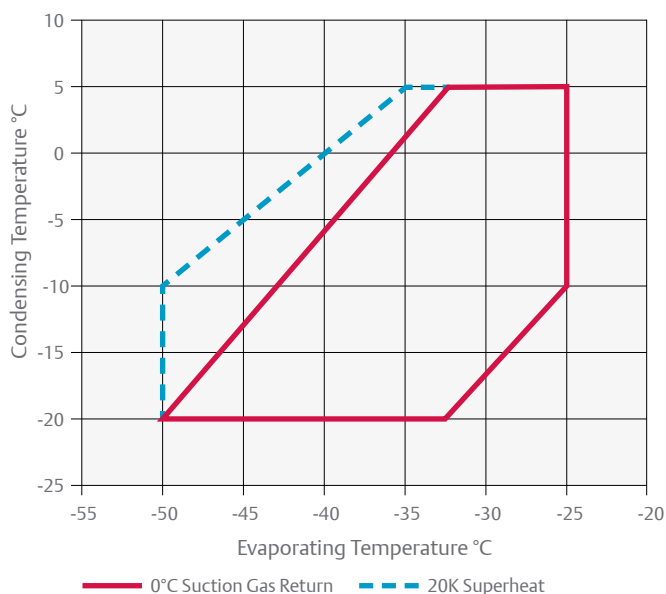

For individual model details please refer to Select Software.

Technical Overview

Models	Nominal hp	Displacement (m ³ /h)	Stub Suction (inch)	Stub Discharge (inch)	Oil Quantity (l)	Length/Width/height (mm)	Net Weight (kg)	Motor Version/ Code	Maximum Operating Current (A)	Locked Rotor Current (A)	Sound Pressure @1 m - dB(A) ***
								3 Ph **	3 Ph **	3 Ph **	
ZO21K5E	1.5	2.6	1 1/4	1	1.0	228/228/388	22	TFD	3.6	27	52
ZO34K3E	2.0	4.1	1 1/4	1	1.4	242/242/381	30	TFD	5.5	26	54
ZO45K3E	2.5	5.4	1 1/4	1	1.4	242/242/403	31	TFD	6.2	35	56
ZO58K3E	3.5	6.9	1 1/4	1	1.4	242/242/417	32	TFD	8.0	48	56
ZO88KCE	5.0	10.1	1 1/4	1	1.9	245/249/440	40	TFD	11.8	64	60
ZO104KCE	6.0	11.7	1 1/4	1	1.9	242/242/461	40	TFD	15.0	74	61
Digital Models											
ZOD34K3E	2.0	4.07	1 1/4	1	1.4	242/242/377	30	TFD	5.5	26	55
ZOD104KCE	6.0	11.7	1 1/4	1	1.9	241/246/484	41	TFD	15.0	75	67

** 3 Ph: 380-420V/ 50Hz

*** @ 1m: sound pressure level at 1m distance from the compressor, free field condition

Capacity Data

Condensing Temperature: -10°C									
R744	Cooling Capacity (kW)				R744	Power Input (kW)			
	Evaporating Temperature (°C)					Evaporating Temperature (°C)			
Model	-45	-40	-35	-30	Model	-45	-40	-35	-30
ZO21K5E	3.2	4.1	5.1	6.2	ZO21K5E	1.2	1.2	1.2	1.1
ZO34K3E	4.8	6.2	7.8	9.7	ZO34K3E	1.8	1.8	1.8	1.7
ZO45K3E	7.0	8.8	10.9	13.3	ZO45K3E	2.3	2.3	2.3	2.2
ZO58K3E	8.9	11.2	13.9	17.0	ZO58K3E	3.0	3.0	2.9	2.8
ZO88KCE	13.3	17.0	21.0	25.4	ZO88KCE	4.5	4.5	4.4	4.2
ZO104KCE	15.9	19.7	24.1	29.2	ZO104KCE	4.9	5.0	5.1	5.2
Digital Models									
ZOD34K3E	5.1	6.4	7.9	9.7	ZOD34K3E	1.8	1.8	1.8	1.7
ZOD104KCE	15.6	19.1	23.2	27.9	ZOD104KCE	5.0	5.0	5.1	5.3

Conditions: 10 K Superheat

Sound Shell for Copeland™ Scroll Compressors Quiet Operation in Sound Critical Environment

Environmental noise has become a serious problem that can lead to potential contentious situations. It is particularly true for refrigeration applications where kitchen equipment or compressor packs are often source of disturbing noise in domestic areas. Emerson put sound minimisation at the centre of any of its new compressor development along reliability, seasonal efficiency, size and weight reduction.

A large portion of equipment acoustic emissions come from condensers and compressors and in some critical sound sensitive applications the refrigeration installations need to be acoustically insulated. Simple solutions are now available to contain sound emissions. Emerson has developed a dedicated sound shell for all Copeland scroll compressors from 2–15 hp. It completely

encapsulates the compressor, minimizing sound leaks while cooling performance remains uncompromised.

Groundbreaking design techniques and materials, derived from the automotive industry, were utilized to design the sound shell. The use of low pressure reaction injection moulded parts (top cap cover, terminal box cover and compressor base plate) allows a 10–12 dBA sound attenuation.

It is a significant improvement over conventional sound jackets available from other suppliers that reduce sound by 3–6 dBA depending on the application. Particular attention was also paid in the design stage to ensure ease of mounting in retrofit, service and new installation situations.

Sound Shell for Copeland Scroll



Technical Overview

	Small Scroll		Summit Scroll			Summit Digital Scroll	
	All Sizes		Small Size	Medium Size	Large Size	Small Size	Medium Size
Technical Data							
Sound Attenuation	10 - 12 dBA						
Total weight (kg)	3.4	4.8	4.9	5.1	5.3	5.6	
Mantle thickness	25mm						
Flammability	Conforms to IEC 60335-1 §30						
Material							
Mantle	Green felt layer (cotton + binder 1.2 kg/m ²)						
	Heavy layer (PVC 4.5 kg/m ²)						
	Closure by use of Velcro fastening - High frequency welded on PVC layer						
Base Plate	PU SRIM - Low pressure reaction injection moulding technology						
Top cap cover	PU SRIM - Low pressure reaction injection moulding technology						
	Inside insulation green felt and aluminium film						
	High temperature insulation ring						
Terminal box cover	PU SRIM - Low pressure reaction injection moulding technology						





Semi-Hermetic Reciprocating Compressors

Emerson offers different ranges of semi-hermetic reciprocating compressors with distinct levels of performance and technical characteristics depending on the application requirements.

The Stream Series

Emerson has introduced Stream, a line of semi-hermetic 4 and 6 cylinder compressors. The series provides best in class performance for today's HFC-based and uprising natural and low GWP refrigerants, significantly reducing cost of operation and environmental impact compared to competing products.

The range consists of 4 and 6 cylinder models, available with both inverter and continuous capacity modulation options.

The new Emerson line-up of 4 cylinder compressors for CO₂-transcritical applications is the ideal solution for R744 medium temperature cascade and booster systems. It is characterised by a design pressure of 135 bar. Refrigerant flow and heat transfer have been optimized for best performance. In combination with the CO₂-subcritical scroll for the low temperature refrigeration side, Emerson offers the most energy efficient package available on the market today.

With advanced protection and diagnostics features for system reliability, reduced service costs and increased equipment uptime, the Stream series is built to last in today's modern and changing world.



Stream 4 Cylinder



Stream 6 Cylinder



Stream 4 Cylinder for R744



Stream Digital 4 Cylinder



Stream Digital 6 Cylinder



The S-Series

Its design is based on traditional “reed” valve plates similar to what is used in reciprocating compressors offered by other manufacturers. The performance of such compressors meets basic market requirements but cannot compete with Discus compressors in terms of efficiency. The S-Series ranges from 1.5 to 70 hp and is composed of K and L presented in this catalogue.



S-Series

The Discus Range

It is broadly recognized as the most efficient compressor whatever the running condition. This range is mainly used in medium and low temperature refrigeration applications where system efficiency is a priority for the end-user. The key difference between Discus and other reciprocating compressors lies in its valve plate design. Traditional “reed” valves are replaced by ‘puck” type valves that are integrated in the valve plate. This special design eliminates the dead volume at the end of the compression and allows for the highest compressor efficiency. To date, no other reciprocating compressor is able to match Discus in terms of performance. Available from 4 to 60 hp, they are referred to as 2D, 3D and 8D in this catalogue.



Discus 2 Cylinder

K and L Reciprocating Compressor Range

Small 2-cylinder semi-hermetic reciprocating compressors for medium and low temperature refrigeration applications and transport refrigeration.

Designed on the principle of standard reed valve type technology, these compressors feature an internal oil pump that guarantees optimum reliability in all operating conditions.

The K-series ranges from 0.5 to 2 hp and the L-series from 2 to 5 hp with a displacement of 4 to 22.5 m³/h.

These compressors are qualified for R407A/F/C, R448A/R449A, R404A and R134a.



K-Series compressor

K & L Compressor Line-Up

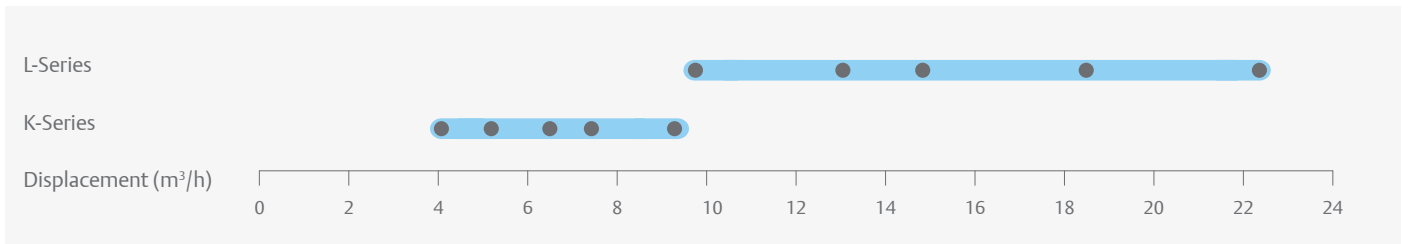

Features and Benefits

- Large operating envelope from 5°C to -45°C evaporating and up to 55°C condensing
- Two motor sizes per displacement, optimized for different applications
- Compact and light compressors
- Ideal for refrigeration unit or transport applications
- Integrated oil pump for maximum reliability

Maximum Allowable Pressure (PS)

- Low Side PS 22.5 bar (g)/ High Side PS 28 bar (g)

Operating Envelope R404A

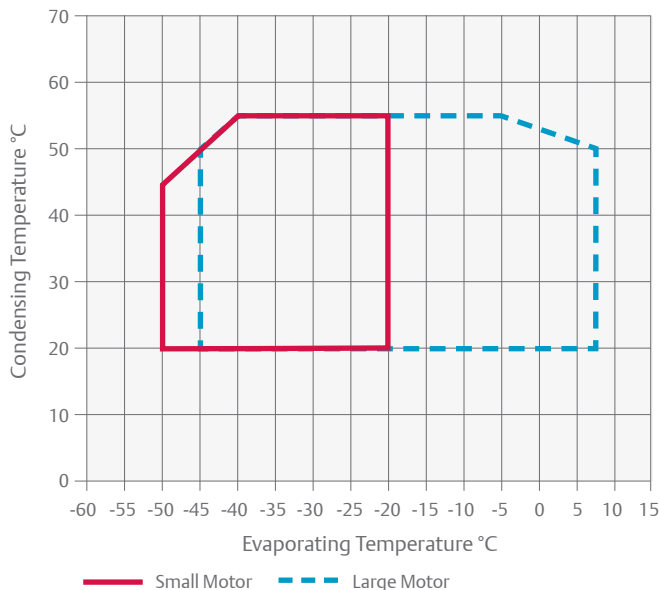

Operating Envelope R134a

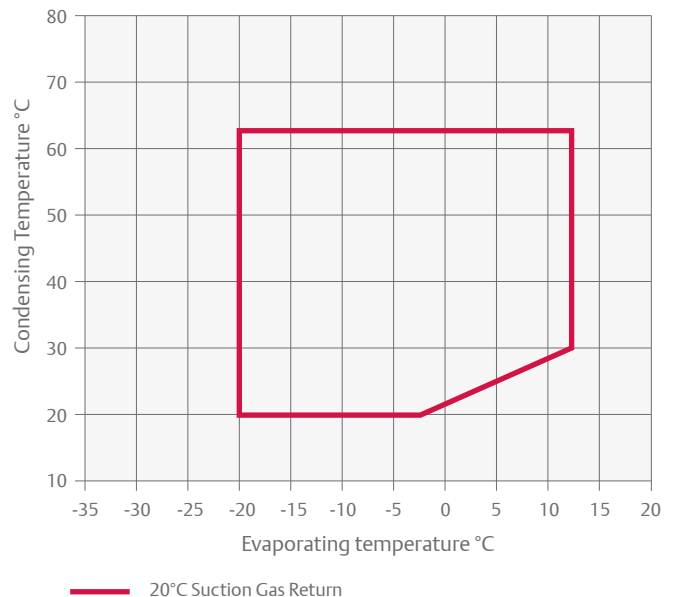

For individual model details please refer to select software.

Operating Envelope R448A/R449A

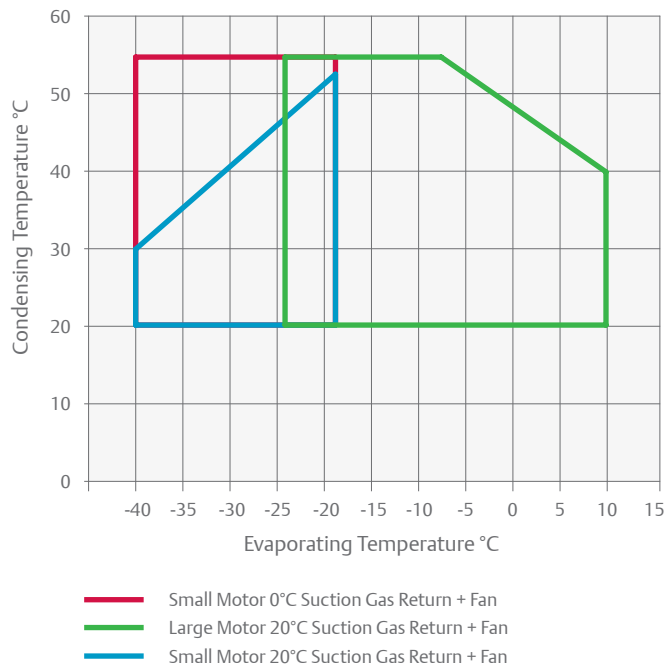

Technical Overview

Models	Nominal hp	Displacement (m ³ /h)	Oil quantity (l)	Length/Width/Height (mm)	Net Weight (kg)	Motor Version/ Code		Maximum Operating Current (A)		Locked Rotor Current (A)		Sound Pressure @1 m - dB(A) ***
						1 Ph*	3 Ph**	1 Ph*	3 Ph**	1 Ph*	3 Ph**	
KM-5X	0.5	4.0	0.7	365/235/280	39	CAG	EWL	4.8	1.8	24.0	12.2	45
KM-7X	0.8	4.0	0.7	365/235/280	39	CAG	EWL	6.0	2.4	34.5	12.2	45
KJ-7X	0.8	5.1	0.7	365/235/280	39	CAG	EWL	5.8	2.3	34.5	12.2	45
KJ-10X	1.0	5.1	0.7	365/235/280	39	CAG	EWL	7.1	3.2	32.4	15.5	45
KSJ-10X	1.0	6.3	0.7	365/235/280	40	CAG	EWL	6.7	2.7	32.4	15.5	50
KSJ-15X	1.5	6.3	0.7	365/235/280	40	CAG	EWL	9.0	3.4	43.0	19.1	53
KL-15X	1.5	7.4	0.7	365/235/280	39	CAG	EWL	8.4	3.4	43.0	19.1	47
KL-20X	2.0	7.4	0.7	365/235/280	39		EWL		3.8		20.4	
KSL-20X	2.0	9.1	0.7	365/235/280	40		EWL		4.7		20.4	
LE-20X	2.0	9.9	2.0	470/330/385	78		EWL		5.7		37.6	51
LF-20X	2.0	12.9	2.0	470/330/385	80		EWL		5.5		37.6	51
LF-30X	3.0	12.9	2.0	470/330/385	80		EWL		7.2		53.0	51
LJ-20X	2.0	14.5	2.0	470/330/385	78		EWL		5.6		37.6	52
LJ-30X	3.0	14.5	2.0	470/330/385	83		EWL		8.1		53.0	52
LL-30X	3.0	18.2	2.0	470/330/385	85		EWL		7.3		50.6	52
LL-40X	4.0	18.2	2.0	470/330/385	87		EWL		9.5		58.9	63
LSG-40X	4.0	22.5	2.0	470/330/385	77		EWL		8.9		58.9	63

* 1 Ph: 230V/ 50Hz

** 3 Ph: 380-420V/ 50Hz

*** @ 1m: sound pressure level at 1m distance from the compressor, free field condition

Capacity Data

Condensing Temperature: 40°C															
R404A	Cooling Capacity (kW)							R404A	Power Input (kW)						
	Evaporating Temperature (°C)								Evaporating Temperature (°C)						
Model	-45	-35	-30	-20	-10	-5	+5	Model	-45	-35	-30	-20	-10	-5	+5
KM-5X	0.2°	0.6°	0.8°	1.3°				KM-5X	0.3°	0.5°	0.6°	0.7°			
KM-7X	0.2°	0.5°	0.8°	1.3°	2.0°	2.5°	3.6°	KM-7X	0.3°	0.5°	0.6°	0.8°	0.9°	1.0°	1.0°
KJ-7X	0.4°	0.8°	1.1°	1.8°				KJ-7X	0.5°	0.7°	0.8°	1.0°			
KJ-10X	0.3°	0.8°	1.0°	1.8°	2.8°	3.4°	4.9°	KJ-10X	0.4°	0.7°	0.8°	1.0°	1.2°	1.3°	1.4°
KSJ-10X	0.5°	1.0°	1.4°	2.3°				KSJ-10X	0.7°	0.9°	1.1°	1.3°			
KSJ-15X	0.5°	1.0°	1.4°	2.3°	3.5°	4.2°	6.1°	KSJ-15X	0.6°	0.9°	1.0°	1.3°	1.6°	1.7°	1.8°
KL-15X	0.6°	1.2°	1.6°	2.6°				KL-15X	0.8°	1.0°	1.2°	1.5°			
KL-20X	0.5°	1.1°	1.5°	2.6°	4.1°	5.0°		KL-20X	0.6°	0.9°	1.1°	1.4°	1.7°	1.8°	
KSL-20X	0.8°	1.5°	2.0°	3.3°	5.1°	6.1°		KSL-20X	0.8°	1.2°	1.4°	1.9°	2.3°	2.5°	
LE-20X		1.1°	1.7°	3.2°	5.1°	6.4°	9.4°	LE-20X		1.0°	1.2°	1.6°	2.0°	2.2°	2.5°
LF-20X		1.8°	2.3°	4.0°				LF-20X		1.4°	1.7°	2.2°			
LF-30X	0.7°	1.9°	2.6°	4.6°	7.2°	8.8°	12.8°	LF-30X	1.0°	1.6°	1.9°	2.4°	2.9°	3.1°	3.4°
LJ-20X		1.9°	2.8°	5.0°				LJ-20X		1.6°	1.9°	2.6°			
LJ-30X	0.8°	2.1°	2.9°	5.1°	8.0°	9.8°	14.2°	LJ-30X	1.1°	1.8°	2.1°	2.8°	3.3°	3.6°	3.9°
LL-30X	0.9°	2.6°	3.7°	6.5°				LL-30X	1.1°	2.0°	2.4°	3.3°			
LL-40X	1.1°	2.7°	3.7°	6.4°	10.2°	12.6°	18.4°	LL-40X	1.4°	2.2°	2.6°	3.3°	4.0°	4.3°	4.9°
LSG-40X	1.4°	3.5°	4.8°	8.2°				LSG-40X	1.6°	2.6°	3.1°	4.1°			

Conditions: Suction Gas Return 20°C / Subcooling 0K
 ° High Discharge Temperature - Additional Cooling Required

Condensing Temperature: 40°C															
R134a	Cooling Capacity (kW)							R134a	Power Input (kW)						
	Evaporating Temperature (°C)								Evaporating Temperature (°C)						
Model	-45	-35	-30	-20	-10	-5	+5	Model	-45	-35	-30	-20	-10	-5	+5
KM-5X				0.7°	1.2°	1.5°	2.3°	KM-5X				0.5°	0.6°	0.6°	0.7°
KJ-7X				0.9°	1.6°	2.0°	3.0°	KJ-7X				0.6°	0.7°	0.8°	0.8°
KSJ-10X				1.2°	2.0°	2.5°	3.8°	KSJ-10X				0.7°	0.8°	0.9°	1.0°
KL-15X				1.4°	2.2°	2.8°	4.3°	KL-15X				0.8°	1.0°	1.1°	1.3°
KSL-15X				1.7°	2.8°	3.5°	5.3°	KSL-15X				1.0°	1.3°	1.4°	1.6°
KSL-20X				1.7°	2.9°	3.7°	5.6°	KSL-20X				1.0°	1.2°	1.4°	1.6°
LE-20X				1.5°	2.8°	3.6°	5.6°	LE-20X				1.0°	1.3°	1.4°	1.5°
LF-20X				2.2°	3.8°	4.9°	7.5°	LF-20X				1.2°	1.6°	1.7°	1.9°
LJ-20X				2.6°	4.3°	5.4°	8.3°	LJ-20X				1.6°	1.9°	2.1°	2.4°
LL-30X				3.2°	5.5°	7.0°	10.9°	LL-30X				1.9°	2.4°	2.6°	3.0°
LSG-40X				4.3°	7.2°	9.0°	13.7°	LSG-40X				2.3°	2.9°	3.2°	3.7°

Conditions: Suction Gas Return 20°C / Subcooling 0K
 ° High Discharge Temperature - Additional Cooling Required

For more details about other refrigerants please refer to Select software.

Capacity Data

Condensing Temperature 40°C															
R407A	Cooling Capacity (kW)							R407A	Power Input (kW)						
	Evaporating Temperature (°C)								Evaporating Temperature (°C)						
Model	-30	-20	-10	-5	+5	+10	+15	Model	-30	-20	-10	-5	+5	+10	+15
KM-5X	0.5°	1.1°	1.8°	2.3°				KM-5X	0.5°	0.7°	0.8°	0.9°			
KM-7X		1.0°	1.7°	2.2°	3.5°	4.2°		KM-7X		0.7°	0.8°	0.9°	1.0°	1.0°	
KJ-7X	0.8°	1.5°	2.4°	3.0°				KJ-7X	0.7°	0.9°	1.1°	1.2°			
KJ-10X		1.5°	2.5°	3.2°	4.8°	5.8°		KJ-10X		0.9°	1.1°	1.2°	1.4°	1.4°	
KSJ-10X	1.1°	1.9°	3.1°	3.8°				KSJ-10X	0.9°	1.1°	1.4°	1.5°			
KSJ-15X		1.9°	3.2°	4.0°	6.0°	7.2°		KSJ-15X		1.2°	1.5°	1.6°	1.8°	1.8°	
KL-15X	1.2°	2.2°	3.6°	4.5°				KL-15X	0.9°	1.2°	1.6°	1.7°			
KL-20X		2.5°	3.9°	4.8°	7.0°	8.4°		KL-20X		1.3°	1.6°	1.7°	1.9°	2.0°	
KSL-20X		2.9°	4.5°	5.6°	8.3°	10.1°		KSL-20X		1.6°	1.9°	2.1°	2.4°	2.4°	
LE-20X	1.5°	2.8°	4.8°	6.0°	9.0°	10.9°		LE-20X	1.2°	1.6°	2.1°	2.3°	2.6°	2.7°	
LF-20X	2.1°	3.9°	6.4°	8.0°				LF-20X	1.6°	2.2°	2.7°	2.9°			
LF-30X		4.2°	6.7°	8.2°	12.2°	14.7°		LF-30X		2.3°	2.8°	3.0°	3.5°	3.6°	
LJ-20X	2.5°	4.7°	7.7°	9.6°				LJ-20X	1.9°	2.5°	3.1°	3.4°			
LJ-30X		5.0°	7.8°	9.5°	13.9°	16.6°		LJ-30X		2.6°	3.1°	3.4°	3.8°	4.0°	
LL-30X	2.9°	5.5°	9.1°	11.4°				LL-30X	2.1°	2.9°	3.6°	4.0°			
LL-40X		5.5°	9.1°	11.4°	16.9°	20.4°		LL-40X		2.8°	3.5°	3.8°	4.4°	4.6°	
LSG-40X	3.9°	7.0°	11.3°	14.0°				LSG-40X	2.7°	3.7°	4.7°	5.2°			

Conditions: Suction Gas Return 20°C / Subcooling 0K

Preliminary Data

° High Discharge Temperature - Additional Cooling Required

Condensing Temperature 40°C															
R407F	Cooling Capacity (kW)							R407F	Power Input (kW)						
	Evaporating Temperature (°C)								Evaporating Temperature (°C)						
Model	-30	-20	-10	-5	+5	+10	+15	Model	-30	-20	-10	-5	+5	+10	+15
KM-5X	0.6°	1.1°	1.9°					KM-5X	0.5°	0.7°	0.9°				
KM-7X		1.1°	1.9°	2.4°	3.8°	4.6°		KM-7X		0.7°	0.9°	0.9°	1.1°	1.1°	
KJ-7X	0.9°	1.6°	2.6°	3.2°				KJ-7X	0.7°	0.9°	1.2°	1.3°			
KJ-10X		1.6°	2.7°	3.4°	5.1°	6.2°		KJ-10X		1.0°	1.2°	1.3°	1.5°	1.5°	
KSJ-10X	1.2°	2.1°	3.3°	4.1°				KSJ-10X	0.9°	1.2°	1.5°	1.6°			
KSJ-15X		2.0°	3.4°	4.2°	6.3°	7.5°		KSJ-15X		1.2°	1.5°	1.7°	1.9°	1.9°	
KL-15X	1.3°	2.4°	3.9°	4.9°				KL-15X	1.0°	1.3°	1.7°	1.8°			
KL-20X		2.6°	4.1°	5.1°	7.5°	8.9°		KL-20X		1.4°	1.7°	1.8°	2.0°	2.1°	
KSL-20X		3.1°	4.9°	6.0°	8.9°	10.7°		KSL-20X		1.7°	2.1°	2.2°	2.5°	2.6°	
LE-20X	1.6°	3.1°	5.2°	6.4°	9.6°	11.6°		LE-20X	1.3°	1.8°	2.2°	2.4°	2.7°	2.9°	
LF-20X	2.3°	4.2°	6.9°	8.6°				LF-20X	1.7°	2.3°	2.8°	3.1°			
LF-30X		4.6°	7.2°	8.9°	13.0°	15.6°		LF-30X		2.4°	2.9°	3.1°	3.5°	3.7°	
LJ-20X	2.7°	5.1°	8.3°	10.4°				LJ-20X	2.0°	2.7°	3.3°	3.6°			
LJ-30X		5.3°	8.3°	10.2°	14.8°	17.7°		LJ-30X		2.8°	3.4°	3.6°	4.1°	4.3°	
LL-30X	3.2°	5.8°	9.5°	11.9°				LL-30X	2.3°	3.1°	4.0°	4.4°			
LL-40X		5.9°	9.7°	12.1°	18.0°	21.7°		LL-40X		3.0°	3.7°	4.1°	4.7°	4.9°	
LSG-40X	4.3°	7.6°	12.2°					LSG-40X	2.9°	4.0°	5.0°				

Conditions: Suction Gas Return 20°C / Subcooling 0K

Preliminary Data

° High Discharge Temperature - Additional Cooling Required

Capacity Data

Condensing Temperature 40°C															
R448A/ R449A	Cooling Capacity (kW)							R448A/ R449A	Power Input (kW)						
	Evaporating Temperature (°C)								Evaporating Temperature (°C)						
Model	-30	-20	-10	-5	+5	+10	+15	Model	-30	-20	-10	-5	+5	+10	+15
KM-5X	0.7°	1.2°						KM-5X	0.5°	0.6°					
KM-7X		1.2°	1.9°	2.4°	3.5°	4.3°		KM-7X		0.7°	0.8°	0.9°	1.0°	1.0°	
KJ-7X	0.9°	1.6°						KJ-7X	0.7°	0.9°					
KJ-10X		1.6°	2.6°	3.2°	4.8°	5.7°		KJ-10X		1.0°	1.1°	1.2°	1.3°	1.4°	
KSJ-10X	1.3°	2.1°						KSJ-10X	1.0°	1.2°					
KSJ-15X		2.1°	3.3°	4.1°	6.0°	7.1°		KSJ-15X		1.2°	1.5°	1.6°	1.7°	1.7°	
KL-15X	1.5°	2.4°						KL-15X	1.0°	1.3°					
LE-20X		3.0°	5.0°	6.2°	5.3°	11.3°		LE-20X		1.5°	1.9°	2.0°	2.3°	2.4°	
LF-30X		4.4°	6.9°	8.4°	12.4°	14.8°		LF-30X		2.4°	2.9°	3.1°	3.5°	3.6°	
LF-20X	2.1°	3.8°						LF-20X	1.5°	2.0°					
LJ-20X	2.6°	4.7°						LJ-20X	1.7°	2.3°					
LJ-30X		4.7°	7.6°	9.4°	13.9°	16.6°		LJ-30X		2.5°	3.1°	3.3°	3.6°	3.7°	
LL-30X		6.1°						LL-30X	2.1°	3.0°					
LL-40X		5.9°	9.7°	12.0°	18.0°	21.7°		LL-40X		3.0°	3.6°	4.0°	4.5°	4.8°	
LSG-40X	4.4°	7.6°						LSG-40X	2.7°	3.7°					

Conditions: Suction Gas Return 20°C / Subcooling 0K

Preliminary Data

° High Discharge Temperature - Additional Cooling Required



Discus™ Reciprocating Compressor Range

From 2, 3 and 8 cylinder semi-hermetic reciprocating compressors for medium/low temperature refrigeration and high temperature applications like process cooling or air-conditioning.

The key difference between Discus and traditional reciprocating technologies lies in the valve plate design. The Discus valve plate allows gas to flow into the cylinders with a minimum heat gain, while suction cavities are designed to smoothly route the gas to minimize losses. These effects lead to:

- Superior cooling capacity due to no re-expansion volume
- Up to 10% higher efficiency compared to conventional “cost-effective” reed type compressors
- Lower operating costs for the end-user

The Discus ranges from 5 to 60 hp with a displacement of 16.8 to 181. These compressors are qualified for R407A/F/C, R448A/R449A, R404A, R134a, R450A and R513A. All Discus compressors are designed to deliver maximum performance and reliability:

- Discus “puck” valve integrated into the valve plate for highest performance whatever the operating condition
- Positive displacement high flow oil pump guarantees high oil feeding pressure for good lubrication and bearings’ cooling



Discus compressor

- PTFE-coated bearings for especially low friction and good protection at start-up
- Electronic motor protection module
- Availability of two motor sizes per displacement. The small motor covers all refrigeration applications while the large motor can be used in comfort, process cooling or inverter applications

Discus Compressor Line-Up

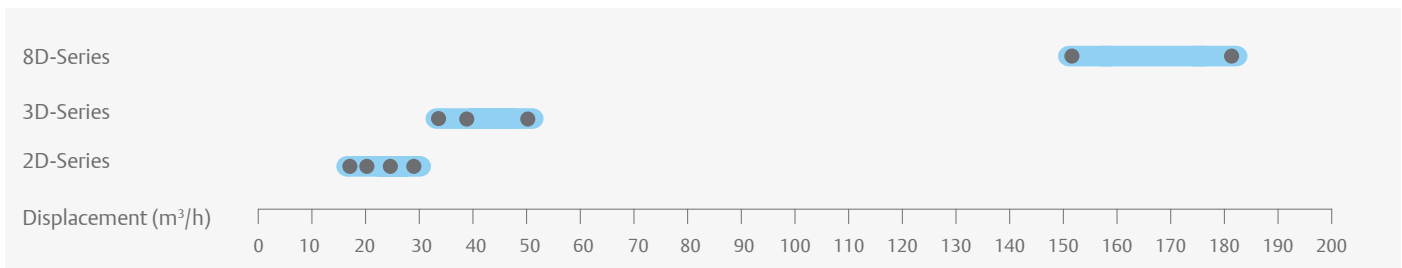

Features and Benefits

- Highest level of efficiency available on the market, whatever the refrigerant and operating condition
- Integrated oil pump and Electronic Oil Pressure Switch OPS2 for maximum reliability
- Two motor sizes per displacement, optimized for different applications
- Large operating envelope that allows medium and low temperature applications to be covered by one single model with condensing limit as low as 5°C
- Provide cooling capacity modulation either by cylinder head blocked suction or with use of frequency inverters from 25 to 60Hz
- Multi-refrigerant compressor range – one model to cover all standard refrigerants
- Option to use 2 and 3 cylinder models with additional Demand Cooling function in order to achieve extended low temperature operating envelope without any superheat restriction for new refrigerants R407A/F, R448A and R449A

Operating Envelope R404A

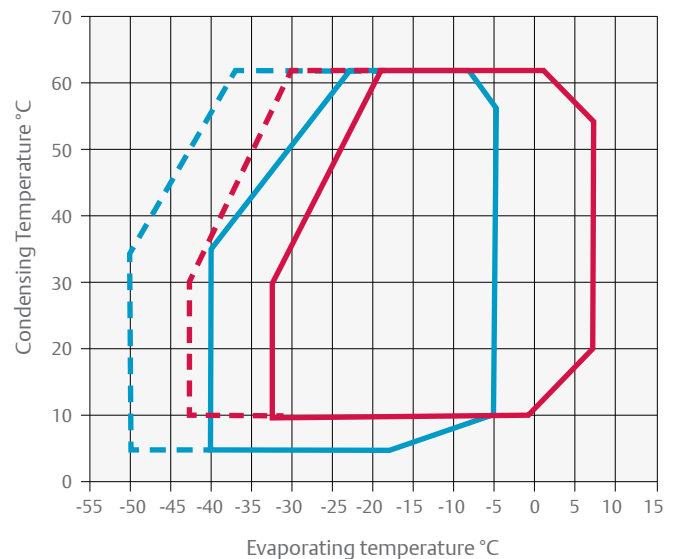

- Large Motor 20°C SGRT
- - - Large Motor 20°C SGRT + Fan
- Small Motor 20°C SGRT
- - - Small Motor 0°C SGRT + Fan

For individual model details please refer to select software.

Maximum Allowable Pressure (PS)

- Low Side PS 22.5 bar (g)/ High Side PS 28 bar (g)

Operating Envelope R407A

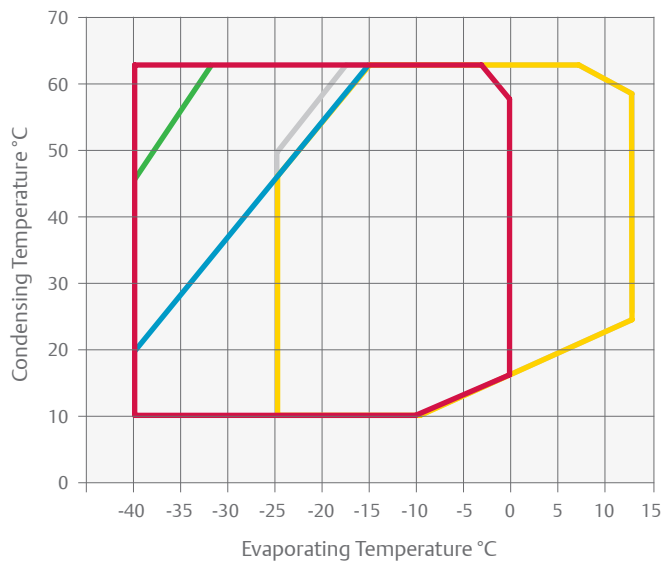

- Large Motor 0°C SGRT
- Large Motor 20°C SGRT
- Small Motor 20K Suction Superheat
- Small Motor 20°C SGRT
- Small Motor 20°C SGRT Demand cooling

Operating Envelope R407F

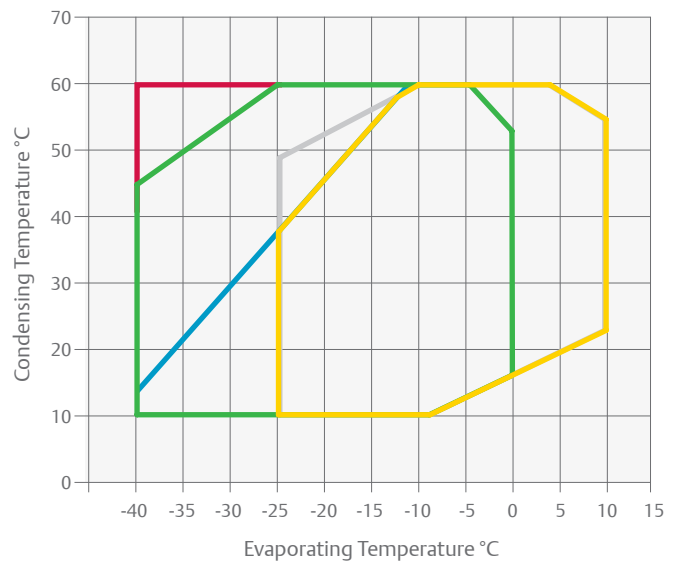

- Large Motor 0°C SGRT
- Large Motor 20°C SGRT
- Small Motor 20K Suction Superheat
- Small Motor 20°C SGRT
- Small Motor 20°C SGRT Demand cooling

Operating Envelope R448A/R449A

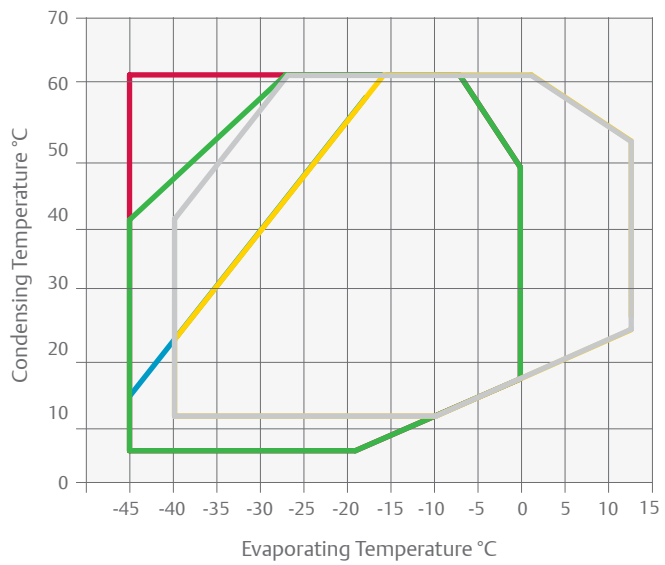

- Large Motor 20K Superheat
- Large Motor 20°C SGRT
- Small Motor 20K Suction Superheat
- Small Motor 20°C SGRT
- Small Motor 20°C SGRT Demand cooling

Operating Envelope R134a

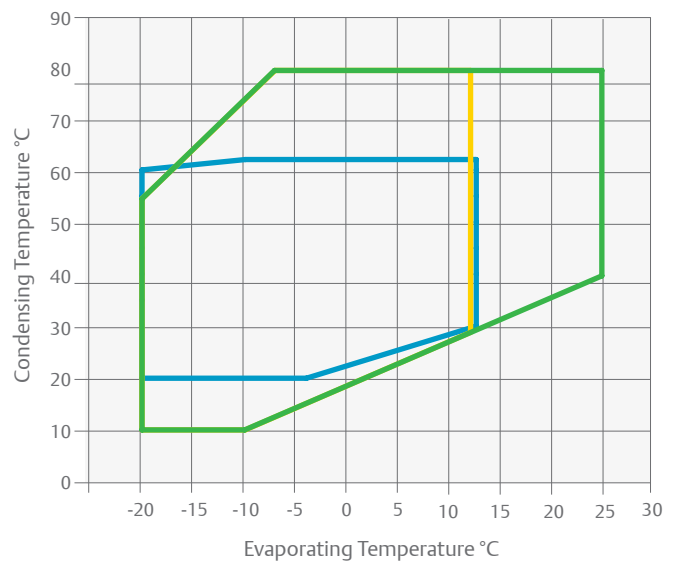

- Large Motor 20°C SGRT
- Small Motor 25°C SGRT
- Large Motor 20K Superheat

Technical Overview

Models	Nominal hp	Displacement (m ³ /h)	Oil Quantity (l)	Length/Width/Height (mm)	Net Weight (kg)	Motor Version/Code	Maximum Operating Current (A)	Locked Rotor Current (A)	Sound Pressure @1 m - dB(A)***
						3 Ph**	3 Ph**	3 Ph**	
2DC-50X	5.0	16.8	2.3	590/330/470	132	AWM	9	55	65
2DD-50X	5.0	19.3	2.3	590/330/470	132	AWM	10	55	65
2DL-40X	4.0	23.7	2.3	590/330/470	131	AWM	11	55	64
2DL-75X	7.5	23.7	2.3	590/330/470	136	AWM	13	70	66
2DB-50X	5.0	28.0	2.3	590/330/470	131	AWM	13	55	64
2DB-75X	7.5	28.0	2.3	590/330/470	136	AWM	16	70	66
3DA-50X	5.0	32.2	3.7	655/370/480	146	AWM	15	55	69
3DA-75X	7.5	32.2	3.7	680/370/480	152	AWM	17	106	69
3DC-75X	7.5	38.0	3.7	655/370/480	150	AWM	18	70	71
3DC-100X	10.0	38.0	3.7	680/370/480	164	AWM	20	121	70
3DS-100X	10.0	49.9	3.7	680/370/480	162	AWM	24	121	70
3DS-150X	15.0	49.9	3.7	710/370/490	166	AWM	29	125	70
8DH-500X	50.0	151.0	7.6	835/475/610	330	AWM	88	458	79
8DL-370X	37.0	151.0	7.6	835/475/610	323	AWM	74	349	76
8DJ-600X	60.0	181.0	7.6	835/475/610	331	AWM	108	476	79
8DT-450X	45.0	181.0	7.6	835/475/610	335	AWM	90	441	78

** 3 Ph: 380-420V/ 50Hz

*** @ 1m: sound pressure level at 1m distance from the compressor, free field condition

Capacity Data

Condensing Temperature: 40°C															
R407A	Cooling Capacity (kW)							R407A	Power Input (kW)						
	Evaporating Temperature (°C)								Evaporating Temperature (°C)						
Model	-45	-35	-30	-20	-10	-5	+5	Model	-45	-35	-30	-20	-10	-5	+5
2DC-50X		1.7	2.4	4.5	7.8	10.0	15.5	2DC-50X		1.4	1.7	2.3	2.9	3.2	3.6
2DD-50X		2.1	3.1	5.8	9.5	12.0	18.1	2DD-50X		1.7	2.1	2.7	3.4	3.7	4.1
2DL-40X		2.5*	3.7*	7.4	11.9	14.8		2DL-40X		2.3*	2.7*	3.5	4.3	4.6	
2DL-75X				7.2	11.9	14.8	22.1	2DL-75X				3.5	4.2	4.5	4.8
2DB-50X		3.3*	4.6*	9.0	14.4	17.8		2DB-50X		2.8*	3.3*	4.3	5.2	5.6	
2DB-75X				9.0	14.3	17.7	26.1	2DB-75X				4.4	5.3	5.7	6.1
3DA-50X		3.8*	5.4*	10.4	16.4	20.2		3DA-50X		3.2*	3.8*	5.0	6.1	6.5	
3DA-75X				10.3	16.7	20.7	30.8	3DA-75X				5.0	6.0	6.4	6.9
3DC-75X		4.7*	6.5*	12.4	19.6	24.2		3DC-75X		3.9*	4.6*	6.0	7.2	7.8	
3DC-100X				12.6	20.3	25.1	37.0	3DC-100X				5.8	7.1	7.6	8.1
3DS-100X		6.4*	9.1*	16.9	26.3	32.1		3DS-100X		5.2*	6.1*	7.9	9.6	10.3	
3DS-150X				16.8	26.6	32.7	48.0	3DS-150X				7.9	9.6	10.2	11.1
8DH-500X				49.1	78.8	97.7	146.0	8DH-500X				24.1	28.8	31.0	33.9
8DL-370X		20.7*	28.8*	53.6	85.3	105.5		8DL-370X		17.4*	19.8*	25.2	30.5	33.0	
8DJ-600X				60.3	95.5	118.0	174.5	8DJ-600X				28.9	35.1	37.9	42.2
8DT-450X		24.0*	32.6*	59.6	93.3	114.5		8DT-450X		20.1*	23.2*	29.5	35.8	38.6	

Conditions: Suction Gas Return 20°C / Subcooling 0K

* 10K Border

Capacity Data

R407F	Cooling Capacity (kW)							R407F	Power Input (kW)						
	Evaporating Temperature (°C)								Evaporating Temperature (°C)						
Model	-45	-35	-30	-20	-10	-5	+5	Model	-45	-35	-30	-20	-10	-5	+5
2DC-50X		1.1*	1.9*	4.7	8.0	10.1	15.4	2DC-50X		1.4*	1.7*	2.4	3.1	3.3	3.6
2DD-50X		1.6*	2.6*	5.9	9.7	12.1	18.1	2DD-50X		1.7*	2.1*	2.9	3.6	3.8	4.1
2DL-40X		2.6*	3.9*	7.7	12.4	15.3		2DL-40X		2.4*	2.8*	3.7	4.5	4.9	
2DL-75X				7.6	12.5	15.6	23.4	2DL-75X				3.7	4.4	4.6	5.0
2DB-50X		3.9*	5.4*	9.8	15.3	18.8		2DB-50X		2.9*	3.4*	4.5	5.4	5.8	
2DB-75X				9.6	15.3	18.9	27.9	2DB-75X				4.6	5.6	6.0	6.3
3DA-50X		4.3*	6.1*	11.3	17.9	22.1		3DA-50X		3.4*	4.0*	5.2	6.4	6.8	
3DA-75X				11.4	18.4	22.8	33.8	3DA-75X				5.2	6.3	6.8	7.2
3DC-75X		5.4*	7.5*	13.8	21.6	26.6		3DC-75X		4.2*	4.8*	6.2	7.5	8.1	
3DC-100X				14.0	22.1	27.3	40.2	3DC-100X				6.1	7.4	7.9	8.5
3DS-100X		7.3*	10.2*	18.4	28.8	35.3		3DS-100X		5.5*	6.4*	8.3	10.0	10.8	
3DS-150X				18.8	29.7	36.4	53.2	3DS-150X				8.2	10.1	10.8	11.8
8DL-370X		20.8*	28.9*	53.6	85.3	105.5		8DL-370X		17.4*	19.8*	25.2	30.5	33.0	
8DH-500X				53.0	84.6	105.0	156.5	8DH-500X				25.8	30.5	32.2	34.9
8DJ-600X				63.7	101.0	125.0	187.5	8DJ-600X				30.6	36.9	39.8	43.9
8DT-450X		26.8*	35.9*	64.1	100.5	123.5		8DT-450X		21.8*	24.7*	31.2	37.7	40.7	

Conditions: Suction Gas Return 20°C / Subcooling 0K

* 10K Border

Condensing Temperature 40°C															
R448A/ R449A	Cooling Capacity (kW)							R448A/ R449A	Power Input (kW)						
	Evaporating Temperature (°C)								Evaporating Temperature (°C)						
Model	-45	-35	-30	-20	-10	-5	+5	Model	-45	-35	-30	-20	-10	-5	+5
2DC-50X		1.4*	2.4*	5.1	8.4	10.6	15.9	2DC-50X		1.4*	1.7*	2.4	3.0	3.3	3.5
2DD-50X		1.7*	2.7*	5.8	9.7	12.2	18.3	2DD-50X		1.7*	2.0*	2.7	3.4	3.7	4.1
2DL-40X	1.0*	2.7*	3.9*	7.5	12.2	15.2		2DL-40X	1.5*	2.3*	2.7*	3.5	4.4	4.9	
2DL-75X		2.5*	3.7*	7.3	12.1	15.2	23.2	2DL-75X		2.3*	2.7*	3.5	4.3	4.6	5.1
2DB-50X	1.5*	3.6*	5.0*	9.2	14.7	18.2		2DB-50X	2.0*	2.8*	3.3*	4.4	5.4	5.8	
2DB-75X		3.8*	5.2*	9.4	15.0	18.5	27.6	2DB-75X		3.0*	3.5*	4.4	5.3	5.7	6.2
3DA-50X	1.9*	4.1*	5.6*	10.2	16.1	19.8		3DA-50X	2.3*	3.3*	3.9*	5.0	6.2	6.6	
3DA-75X		3.9*	5.8*	11.0	17.6	21.8	32.3	3DA-75X		3.3*	4.0*	5.2	6.1	6.5	6.8
3DC-75X	2.7*	5.1*	6.9*	12.4	19.4	23.8		3DC-75X	2.9*	4.0*	4.6*	6.0	7.3	7.8	
3DC-100X		4.4*	6.9*	13.3	21.1	25.9	37.7	3DC-100X		3.6*	4.4*	6.0	7.2	7.6	8.1
3DC-75X DC	2.6	5.4	7.3	12.4	19.5	23.9		3DC-75X DC	2.9	4.0	4.6	6.0	7.3	7.8	
3DS-100X	3.8*	7.1*	9.5*	16.9	26.5	32.5		3DS-100X	4.0*	5.4*	6.2*	8.1	9.8	10.6	
3DS-150X		7.5*	10.2*	17.8	27.6	33.7	49.1	3DS-150X		5.6*	6.4*	8.2	9.8	10.5	11.5
8DH-500X		18.7*	27.4*	51.0	80.6	99.2	145.0	8DH-500X		15.9*	18.8*	24.4	29.3	31.3	34.0
8DL-370X	7.4*	18.4*	26.2*	49.3	79.0	97.6		8DL-370X	11.5*	16.6*	19.3*	24.6	29.3	31.4	
8DJ-600X		24.2*	34.0*	61.7	96.9	119.0	174.5	8DJ-600X		19.3*	22.5*	29.2	35.6	38.4	42.9
8DT-450X	12.2*	25.4*	34.7*	62.0	97.7	120.0		8DT-450X	14.9*	20.1*	23.2*	29.6	36.0	38.8	

Conditions: Suction Gas Return 20°C / Subcooling 0K

*Conditions: Suction Superheat 10K, Subcooling 0K

Preliminary Data

Capacity Data

Condensing Temperature: 40°C															
R404A	Cooling Capacity (kW)							R404A	Power Input (kW)						
	Evaporating Temperature (°C)								Evaporating Temperature (°C)						
Model	-45	-35	-30	-20	-10	-5	+5	Model	-45	-35	-30	-20	-10	-5	+5
2DC-50X		2.1°	3.0°	5.4	8.8	11.0	16.5	2DC-50X		1.7°	2.1°	2.7	3.3	3.6	3.8
2DD-50X		2.8°	3.9°	6.8	10.8	13.2	19.3	2DD-50X		2.2°	2.5°	3.3	3.9	4.1	4.3
2DL-40X	1.2*	3.8	5.1	8.5	13.2	16.2		2DL-40X	1.8*	2.7	3.2	4.1	4.9	5.3	
2DL-75X		3.6°	4.9°	8.4	13.4	16.5	24.1	2DL-75X		2.7°	3.1°	4.0	4.8	5.1	5.5
2DB-50X	1.7*	4.6	6.2	10.4	16.0	19.4		2DB-50X	2.2*	3.2	3.8	4.9	5.9	6.3	
2DB-75X		4.9°	6.4°	10.5	16.2	19.8	28.6	2DB-75X		3.5°	4.0°	5.1	6.1	6.5	7.0
3DA-50X	2.0*	5.7	7.4	11.9	17.9	21.7		3DA-50X	2.7*	4.0	4.7	5.9	6.9	7.3	
3DA-75X		5.2°	7.2°	12.2	18.9	23.1	33.4	3DA-75X		3.9°	4.6°	5.9	6.9	7.3	7.6
3DC-75X	2.8*	7.0	9.1	14.4	21.6	26.1		3DC-75X	3.4*	4.9	5.6	7.0	8.2	8.7	
3DC-100X		6.6°	8.9°	14.9	22.7	27.5	39.3	3DC-100X		4.6°	5.4°	6.9	8.1	8.5	8.9
3DS-100X	4.0*	9.6	12.5	19.8	29.5	35.5		3DS-100X	4.7*	6.5	7.5	9.4	11.1	11.7	
3DS-150X		9.1°	12.2°	19.9	30.2	36.5	51.9	3DS-150X		6.3°	7.4°	9.4	11.1	11.6	12.0
8DH-500X		26.3°	35.7°	58.8	89.3	108.0	153.5	8DH-500X		19.1°	22.1°	27.9	32.8	34.7	37.3
8DL-370X	10.8*	28.0	36.9	59.3	88.8	106.5		8DL-370X	13.2*	19.5	22.4	27.9	32.7	34.7	
8DJ-600X		32.7°	44.0°	71.3	107.0	128.5	181.0	8DJ-600X		23.0°	26.8°	33.7	39.5	41.9	45.5
8DT-450X	14.2*	34.7	44.9	70.6	105.0	125.5		8DT-450X	16.9*	23.7	27.2	34.0	40.2	42.8	

Conditions: Suction Gas Return 20°C / Subcooling 0K

° High Discharge Temperature - Additional Cooling Required

* 10K Border

Condensing Temperature: 40°C															
R134a	Cooling Capacity (kW)							R134a	Power Input (kW)						
	Evaporating Temperature (°C)								Evaporating Temperature (°C)						
Model	-45	-35	-30	-20	-10	-5	+5	Model	-45	-35	-30	-20	-10	-5	+5
2DC-50X				2.4*	4.7*	6.3*	10.3	2DC-50X				1.5*	2.0*	2.1*	2.3
2DD-50X				3.1*	5.8*	7.6*	12.2	2DD-50X				1.9*	2.3*	2.5*	2.7
2DL-40X				4.0	7.2	9.2	14.4	2DL-40X				2.3	2.8	3.1	3.4
2DL-75X				3.6*	6.8*	8.9*	14.3	2DL-75X				2.1*	2.7*	3.0*	3.3
2DB-50X				5.2	9.1	11.6	17.9	2DB-50X				2.6	3.3	3.6	4.0
2DB-75X				4.5*	8.2*	10.6*	17.0	2DB-75X				2.6*	3.3*	3.5*	3.9
3DA-50X				6.0	10.2	12.9	19.8	3DA-50X				3.0	3.7	4.0	4.4
3DA-75X				5.1*	9.6*	12.5*	20.1	3DA-75X				3.1*	3.8*	4.1*	4.5
3DC-75X				7.4	12.5	15.7	23.9	3DC-75X				3.6	4.5	4.8	5.3
3DC-100X				6.8*	12.0*	15.3*	24.2	3DC-100X				3.7*	4.5*	4.8*	5.2
3DS-100X				9.7	16.2	20.4	31.0	3DS-100X				4.7	5.9	6.4	7.2
3DS-150X				9.7*	16.3*	20.6*	31.7	3DS-150X				5.0	6.2*	6.6*	7.3
8DH-500X				28.6*	47.9*	60.9*	95.6	8DH-500X				15.5*	18.8*	20.2*	22.2
8DJ-600X				34.4*	57.5*	72.9*	114.0	8DJ-600X				18.1*	22.2*	24.0*	26.8
8DL-370X				31.4	51.6	64.5	97.3	8DL-370X				15.1	18.5	19.9	22.2
8DT-450X				38.7	62.1	77.1	115.0	8DT-450X				18.4	22.5	24.4	27.5

Conditions: Suction Gas Return 20°C / Subcooling 0K

* 10K Border

Discus™ Digital (3Cylinder) Reciprocating Compressor With Continuous Capacity Modulation

Discus digital series with 3 cylinder compressors provide an alternative means of continuous modulation to inverter. Digital modulation is the most simple and precise method of capacity control and helps to contain applied costs associated with modulation.

Digital technology is based on controlling a high-cycle solenoid valve fitted on one of the cylinder heads based on cycle time. The valve actuates a piston that controls the flow of gas into the suction area of the Discus valve plate.

The compressor always runs at constant speed which resolves the challenges related to oil return, mechanical and electrical stress on the system.



Discus digital 3 cylinder compressor

Discus Digital Compressor Line-up

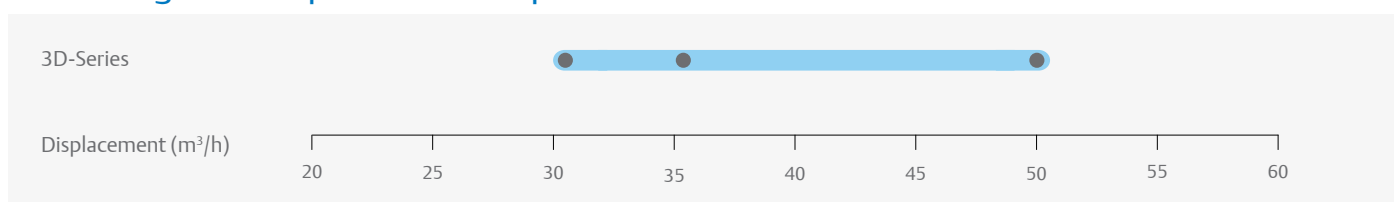

Features and Benefits

- Range of 6 models from 32 to 50 m³/h
- Compatible with R407A/F/C, R448A/ R449A, R404A, R134a, R450A and R513A.
- Continuous modulation from 10–100% ensuring a perfect match of capacity and power to refrigeration load
- Economical and reliable alternative to frequency inverters
- Precise suction pressure control with associated energy savings and stable evaporating temperatures
- Quick and easy integration into refrigeration equipment, similar to any other standard compressor
- Possibility to easily retrofit existing installations with digital cylinder head kit
- No vibrations or mechanical stress on system piping and compressor parts
- Reduced compressor cycling for longer contactor and compressor life

Operating Envelope R404A

With Small Motor

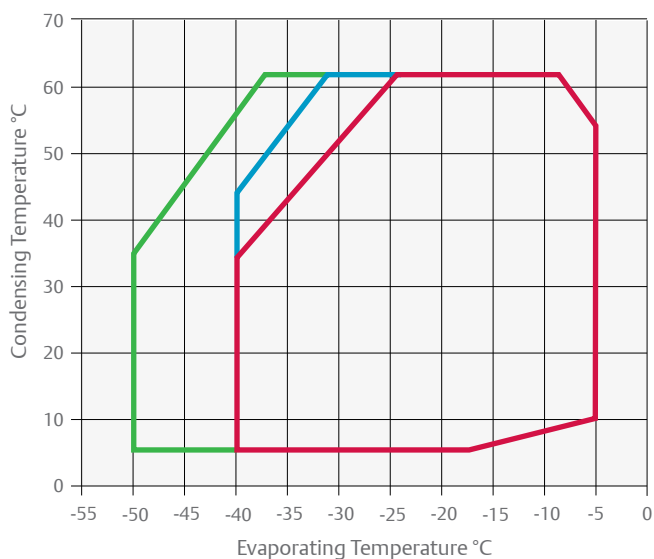

- 20°C Suction Gas Return
- 0°C Suction Gas Return
- 0°C Suction Gas Return + Fan

With Large Motor

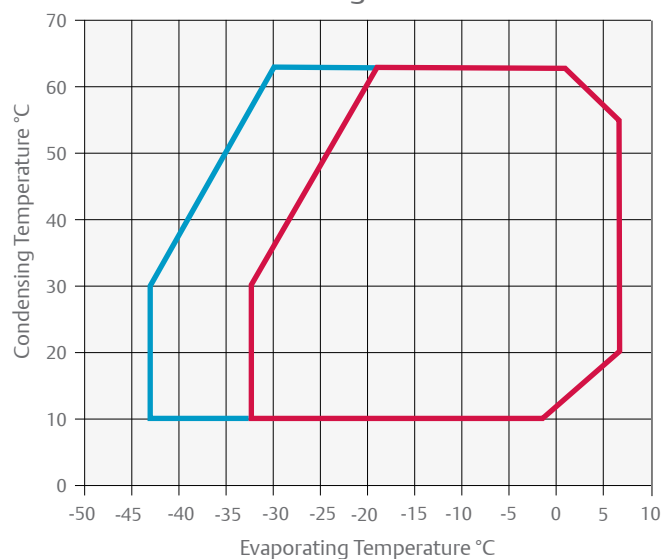

- 25°C Suction Gas Return
- 20°C Suction Gas Return + Fan

Operating Envelope R407A

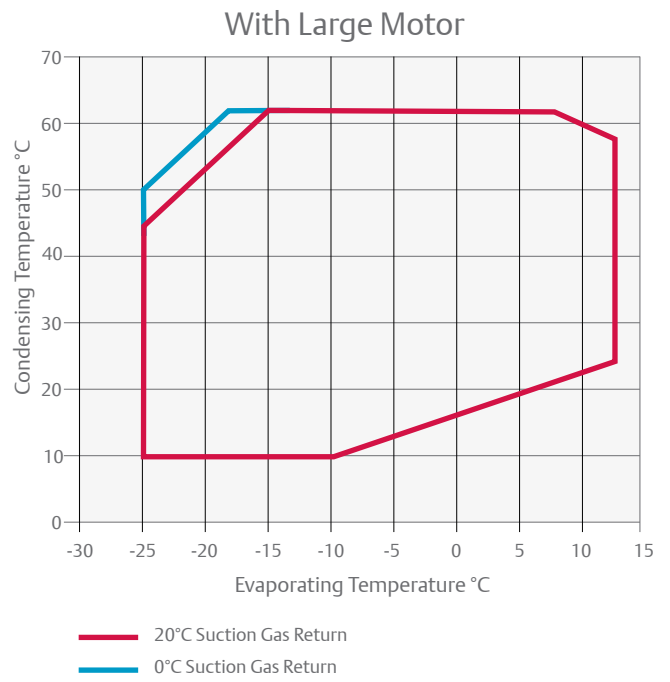
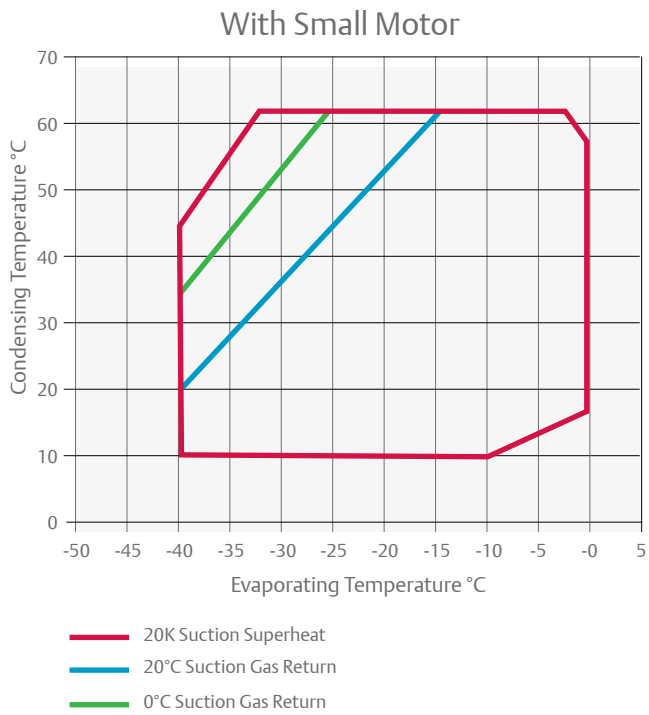

Operating Envelope R407F

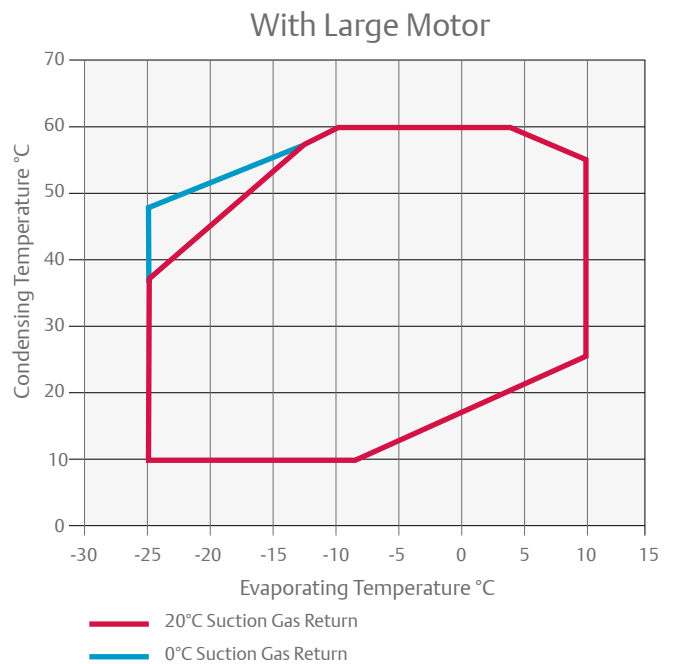
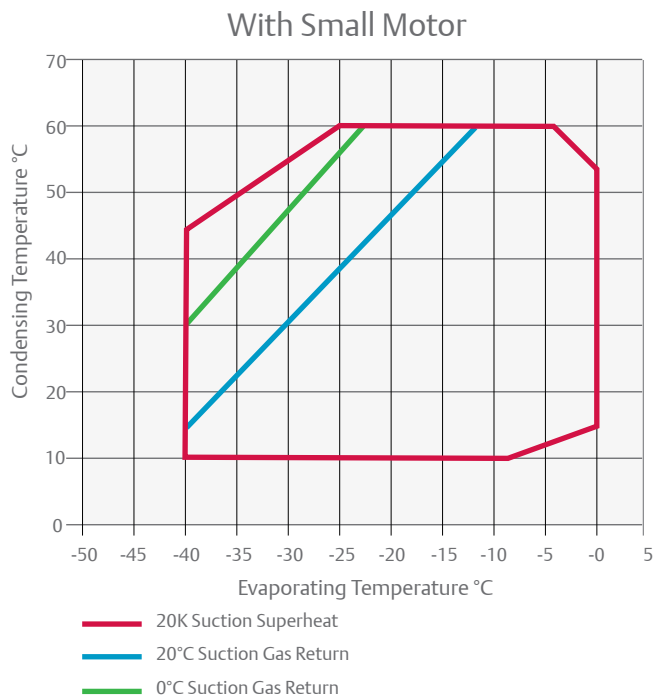

Operating Envelope R448A/R449A

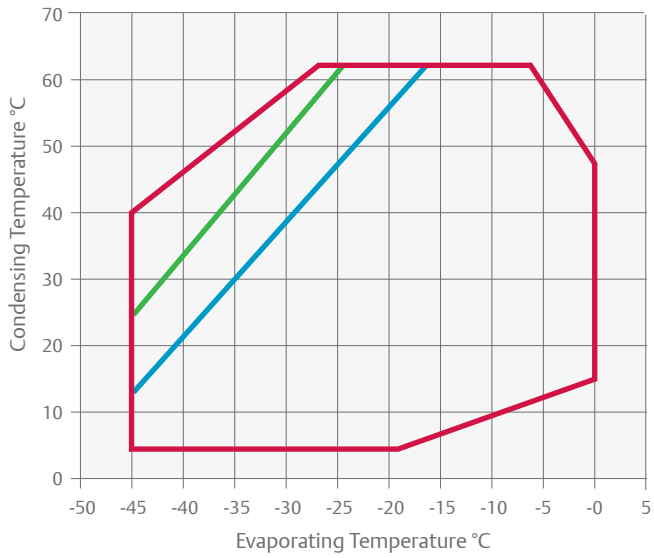

- 20K Suction Superheat
- 20°C Suction Gas Return
- 0°C Suction Gas Return

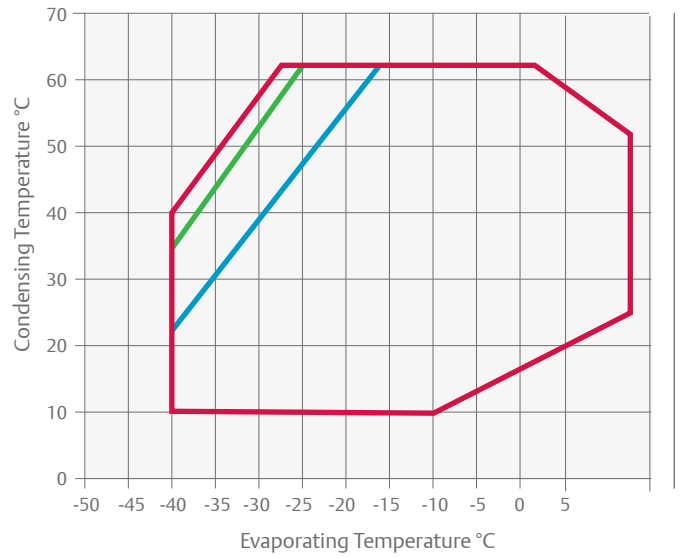

- 20K Suction Superheat
- 20°C Suction Gas Return
- 0°C Suction Gas Return

Technical Overview

Models	Nominal hp	Displacement (m ³ /h)	Oil Quantity (l)	Length/Width/Height (mm)	Net Weight (kg)	Motor Version/Code	Maximum Operating Current (A)	Locked Rotor Current (A)	Sound Pressure @ 1 m - dB(A)***
						3 Ph**	3 Ph**	3 Ph**	
3DAD-50X	5.0	32.2	3.7	655/370/480	146	AWM	15.7	55.0	65
3DAD-75X	7.5	32.2	3.7	680/370/480	152	AWM	18.6	106.0	67
3DCD-75X	7.5	38.0	3.7	655/370/480	150	AWM	18.5	70.0	67
3DCD-100X	10.0	38.0	3.7	680/370/480	164	AWM	21.6	121.0	68
3DSD-100X	10.0	49.9	3.7	680/370/480	162	AWM	24.4	121.0	69
3DSD-150X	15.0	49.9	3.7	710/370/490	166	AWM	29.7	129.0	69

** 3 Ph: 380-420V/ 50Hz

*** @ 1m: sound pressure level at 1m distance from the compressor, free field condition

Capacity Data

Condensing Temperature 40°C															
R407A	Cooling Capacity (kW)							R407A	Power Input (kW)						
	Evaporating Temperature (°C)								Evaporating Temperature (°C)						
Model	-30	-20	-10	-5	5	10	15	Model	-30	-20	-10	-5	5	10	15
3DAD-50X	5.3*	10.3	16.2	19.9				3DAD-50X	3.8*	5.0	6.1	6.5			
3DAD-75X		10.2	16.4	20.4	30.4	36.5		3DAD-75X		5.0	6.0	6.4	6.9	6.9	
3DCD-100X		12.4	20.0	24.7	36.6	43.9		3DCD-100X		5.8	7.1	7.6	8.3	8.3	
3DCD-75X	6.4*	12.3	19.4	23.8				3DCD-75X	4.6*	6.0	7.2	7.8			
3DSD-100X	8.9*	16.7	25.9	31.6				3DSD-100X	6.1*	7.9	9.6	10.3			
3DSD-150X		16.5	26.2	32.2	47.6	57.0		3DSD-150X		7.8	9.6	10.3	11.2	11.3	

Conditions: Suction Gas Return 20°C / Subcooling 0K, 100% Loaded

* Conditions: Suction Superheat 10K, Subcooling 0K

Condensing Temperature 40°C															
R407F	Cooling Capacity (kW)							R407F	Power Input (kW)						
	Evaporating Temperature (°C)								Evaporating Temperature (°C)						
Model	-30	-20	-10	-5	5	10	15	Model	-30	-20	-10	-5	5	10	15
3DAD-50X	6.0*	11.2	17.8	21.9				3DAD-50X	4.0*	5.2	6.4	6.8			
3DAD-75X		11.3	18.2	22.6	33.6	40.4		3DAD-75X		5.2	6.3	6.8	7.2	7.2	
3DCD-75X	7.4*	13.7	21.5	26.4				3DCD-75X	4.8*	6.2	7.5	8.1			
3DCD-100X		13.9	21.9	27.0	39.8	47.8		3DCD-100X		6.0	7.3	7.9	8.6	8.6	
3DSD-100X	10.0*	18.2	28.5	35.0				3DSD-100X	6.3*	8.3	10.1	10.8			
3DSD-150X		18.4	29.2	36.0	53.0	63.4		3DSD-150X		8.2	10.1	10.9	11.9	12.0	

Conditions: Suction Gas Return 20°C / Subcooling 0K, 100% Loaded

* Conditions: Suction Superheat 10K, Subcooling 0K

Capacity Data

Condensing Temperature 40°C															
R448A/ R449A	Cooling Capacity (kW)							R448A/ R449A	Power Input (kW)						
	Evaporating Temperature (°C)								Evaporating Temperature (°C)						
Model	-30	-20	-10	-5	5	10	15	Model	-30	-20	-10	-5	5	10	15
3DAD-50X	5.6*	10.2	16.1	19.8				3DAD-50X	3.9*	5.0	6.2	6.6			
3DAD-75X	6.7*	11.9	18.3	22.2	31.8	37.6		3DAD-75X	4.4*	5.7	6.8	7.2	7.5	7.4	
3DCD-75X	6.9*	12.4	19.4	23.8				3DCD-75X	4.6*	6.0	7.3	7.8			
3DCD-100X	7.3*	13.4	21.1	26.0	38.0	45.4		3DCD-100X	4.7*	6.1	7.2	7.6	8.0	7.9	
3DSD-150X	10.2*	17.8	27.6	33.7	49.1	58.4		3DSD-150X	6.4*	8.2	9.8	10.5	11.5	11.8	
3DSD-100X	9.5*	16.9	26.5	32.5				3DSD-100X	6.2*	8.1	9.8	10.6			

Conditions: Suction Gas Return 20°C / Subcooling 0K, 100% Loaded

* Conditions: Suction Superheat 10K, Subcooling 0K

Preliminary Data

Condensing Temperature 40°C															
R404A	Cooling Capacity (kW)							R404A	Power Input (kW)						
	Evaporating Temperature (°C)								Evaporating Temperature (°C)						
Model	-30	-20	-10	-5	5	10	15	Model	-30	-20	-10	-5	5	10	15
3DAD-75X	7.1	11.9	18.3	22.2	31.8			3DAD-75X	4.4	5.7	6.8	7.2	7.5		
3DAD-50X	7.3	11.8	17.8	21.5				3DAD-50X	4.6	5.9	6.9	7.3			
3DCD-75X	8.8	14.1	21.2	25.6				3DCD-75X	5.5	7.0	8.2	8.6			
3DCD-100X	8.6	14.3	21.8	26.5	37.9			3DCD-100X	5.3	6.8	8.0	8.4	8.9		
3DSD-150X	12.1	19.1	28.6	34.6	49.3			3DSD-150X	7.3	9.2	11.0	11.6	12.3		
3DSD-100X	11.9	18.9	28.3	34.1				3DSD-100X	7.4	9.3	10.9	11.6			

Conditions: Suction Gas Return 20°C / Subcooling 0K, 100% Loaded

High Discharge Temperature - Additional Cooling Required

Condensing Temperature 40°C															
R134a	Cooling Capacity (kW)							R134a	Power Input (kW)						
	Evaporating Temperature (°C)								Evaporating Temperature (°C)						
Model	-30	-20	-10	-5	5	10	15	Model	-30	-20	-10	-5	5	10	15
3DAD-50X		6.3	10.4	13.0	19.8	24.1		3DAD-50X		3.0	3.8	4.1	4.5	4.6	
3DAD-75X		5.5*	9.8*	12.6*	20.0	24.5	29.6	3DAD-75X		3.1*	3.8*	4.1*	4.5	4.5	4.5
3DCD-75X		7.5	12.4	15.6	23.5	28.5		3DCD-75X		3.6	4.5	4.9	5.4	5.5	
3DCD-100X		6.8*	11.9*	15.2*	23.8	29.0	34.9	3DCD-100X		3.7*	4.5*	4.8*	5.2	5.3	5.3
3DSD-100X		10.2	16.6	20.6	31.0	37.5		3DSD-100X		4.8	6.0	6.4	7.1	7.3	
3DSD-150X		9.1*	15.7*	19.9*	31.0	37.5	44.9	3DSD-150X		4.8*	6.0*	6.6*	7.3	7.4	7.3

Conditions: Suction Gas Return 20°C / Subcooling 0K, 100% Loaded

* Conditions: Suction Superheat 10K, Subcooling 0K



Copeland™ Compressor Electronics for Copeland Stream Semi-hermetic Compressors

Copeland compressor electronics monitor and interpret data inside the compressor in order to enhance the reliability and operational performance of HVACR systems. Built upon the success of CoreSense Diagnostics introduced a few years ago, Emerson is now introducing the next generation electronics module for Stream compressors featuring a modular design using state-of-the-art electronics. This modular design with plug-in modules gives the customers the flexibility to choose the advanced features as per their system requirements. These features include advanced protection and diagnostics, Bluetooth and Modbus communication for remote monitoring, liquid injection control, dynamic envelope monitoring, digital and capacity control etc.

The benefits of Copeland compressor electronics go beyond compressor protection by assisting in system diagnosis and optimization. Providing service engineers with detailed information at the right time, system-related problems can be diagnosed faster or even before they occur. Optional plug-in modules with advanced control features and factory mounted sensors reduce the system complexity and applied costs for system manufacturers. Supermarket operators benefit from increased system uptime, reduction in food loss and reduced maintenance costs.

Technical Specification

- Power supply 120/240V AC
- Communication protocol (Modbus®RTU)
- Bus to system controller: RS 485
- Discharge temperature sensor
- Current sensor and sensor module
- Flash memory
- Alarm reset button
- IP 54

Functions of modules

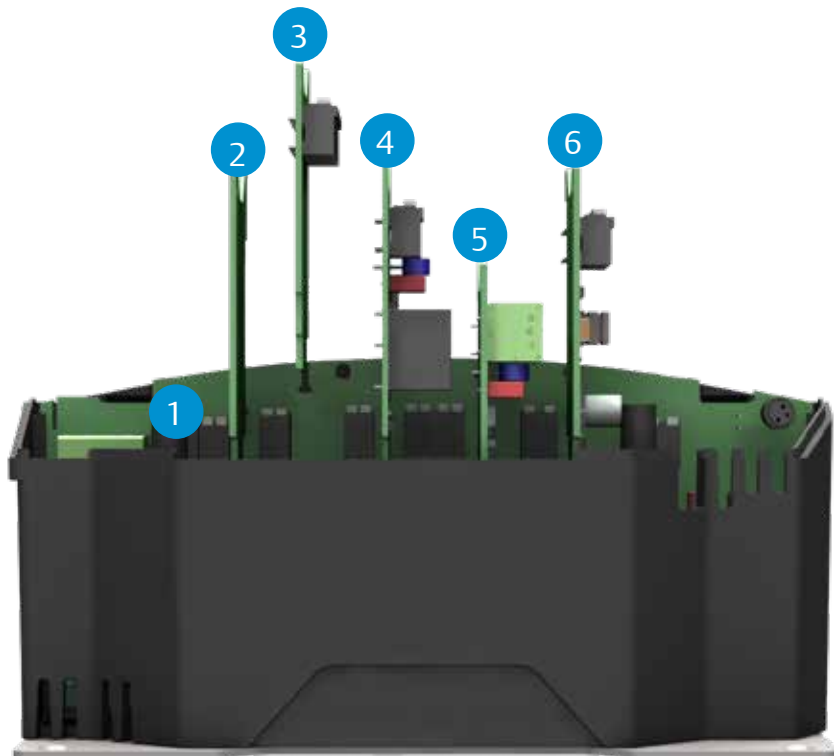

- 1 Base Board
- 2 Modbus
- 3 Bluetooth
- 4 Liquid Injection Control
- 5 Dynamic Envelope Monitoring
- 6 Digital Modulation Control



Copeland compressor electronic module

Benefits

- Modularity for customer flexibility
- Optional plug-in modules with different functionalities
- Advanced protection for reliable system operation
- Diagnostics for quicker troubleshooting
- Power monitoring for operational costs monitoring
- Communication options - Bluetooth and Modbus for remote monitoring
- Compressor control for reduced system applied costs



Scope of Supply

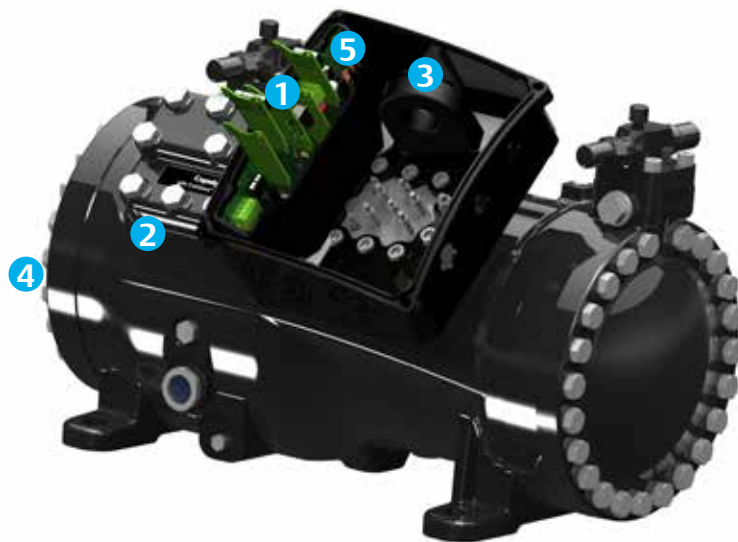

- ① Optional Plug-in Modules
- ② Discharge Temperature Sensor
- ③ Current Sensor
- ④ Oil Pressure Switch
- ⑤ Communication Port

Copeland™ Stream with Compressor Electronics, Semi-Hermetic Reciprocating Compressors for HFC / HFO Blends

Stream series 4 and 6 cylinder compressors provide best-in-class performance, thereby significantly reducing the cost of operation and environmental impact compared to competing products. With advanced protection and diagnostics features for system reliability, reduced service costs and increased equipment uptime, Stream series is built to last in today's modern changing world.



Copeland stream compressor

Stream Compressor Line-Up

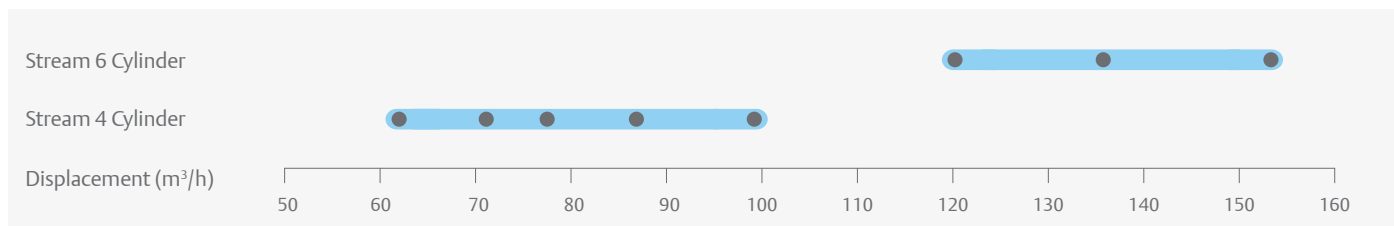

Features and Benefits

- Range of 16 models from 62 to 153m³/h
- Best-in-class seasonal efficiencies, up to 15% higher than market standard
- Multi-refrigerant compressor as it is compatible with R407A/F/C, R448A/ R449A, R404A, R134a, R450A and R513A
- Stepless capacity modulation by means of inverter or digital modulation
- Wide operating envelope covering low- and medium-temperature refrigeration without cooling fan
- Reduced sound level, dimensions and weight by up to 45 kg
- Option to use compressors with additional Demand Cooling function in order to achieve extended low temperature operating envelope without any superheat restriction for new refrigerants R407A/F, R448A and R449A

CoreSense Technology Features

- Motor and oil protection
- Storage of compressor asset and advanced runtime information
- Runtime/alarm signalling using multi-colour LED flash-codes
- Communication to system controller via Bluetooth or Modbus®
- Individual compressor power monitoring

Operating Envelope R404A

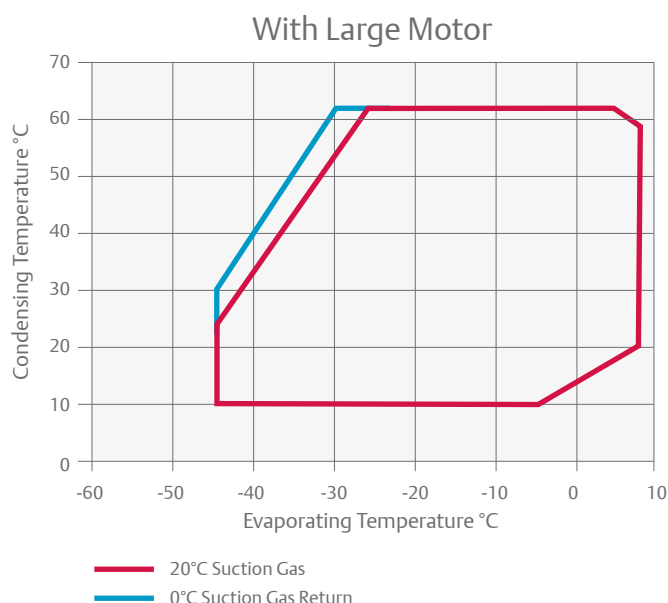
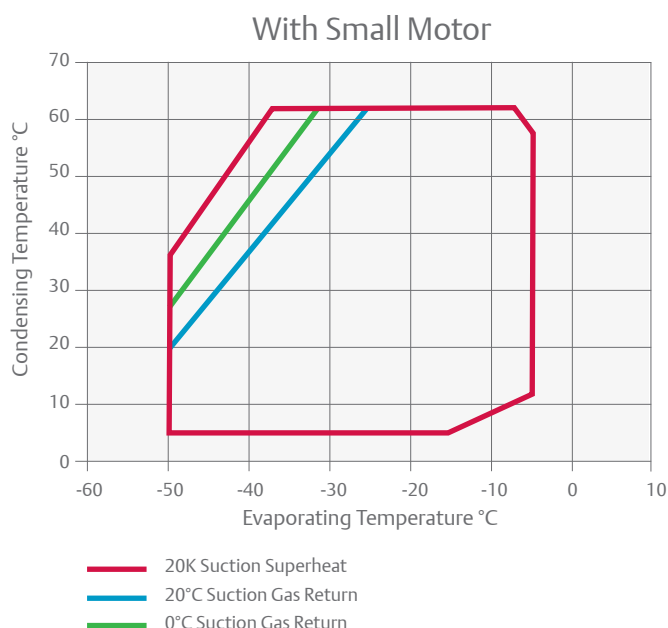

Operating Envelope R407A

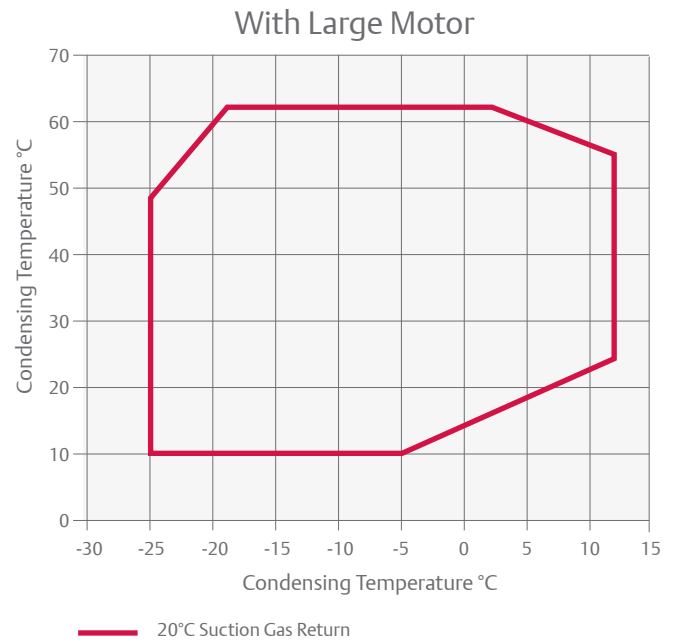
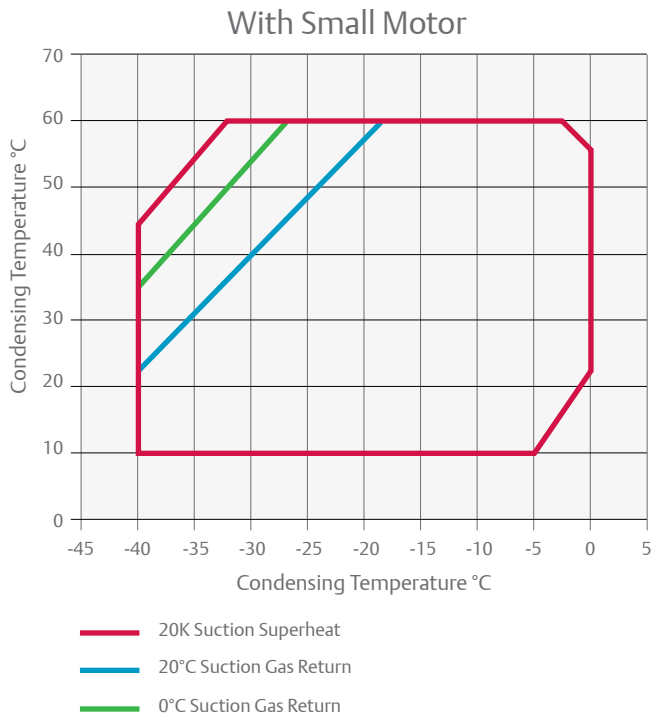

Operating Envelope R407F

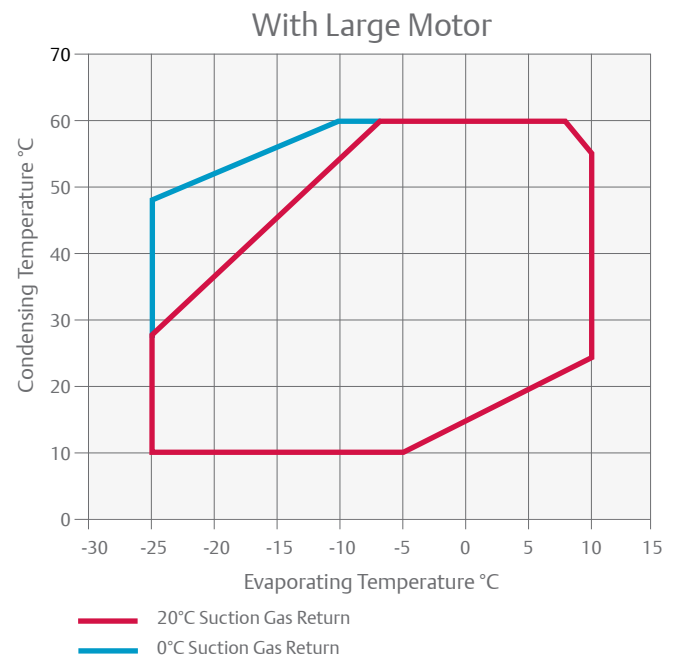
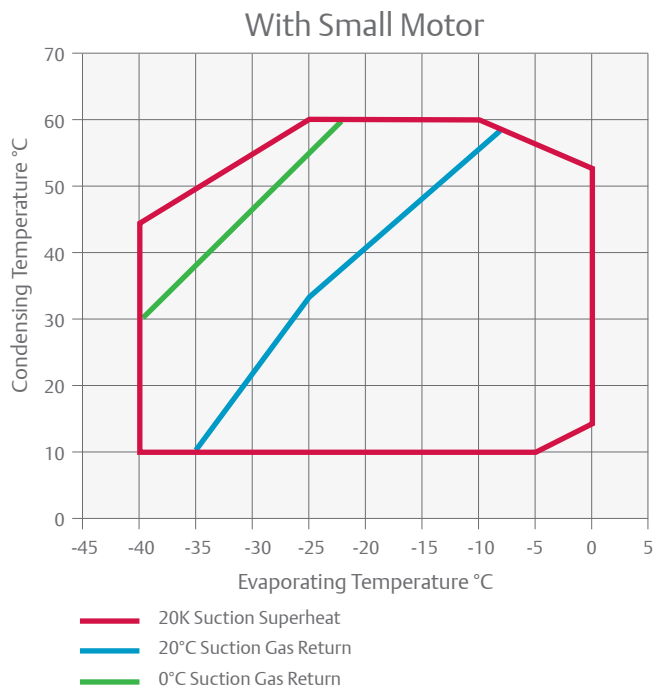

Operating Envelope R448A/R449A

With Small Motor

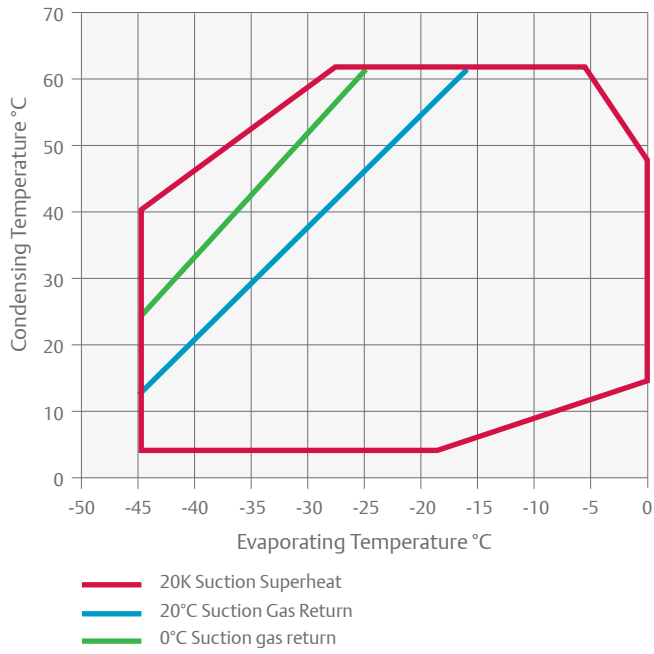

With Large Motor

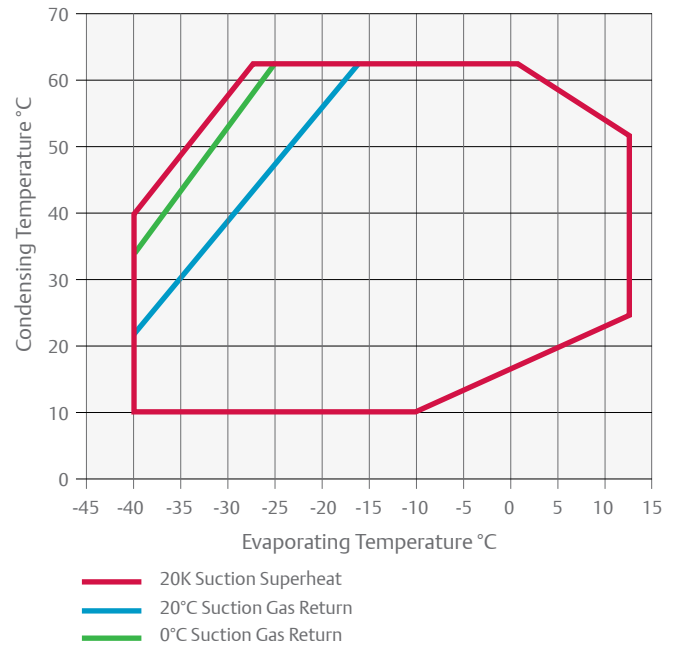

Operating Envelope R134a

With Small Motor

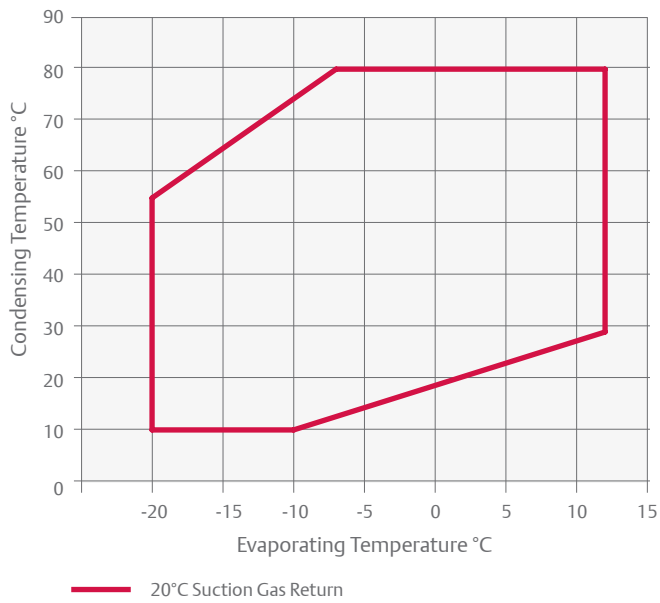

With Large Motor

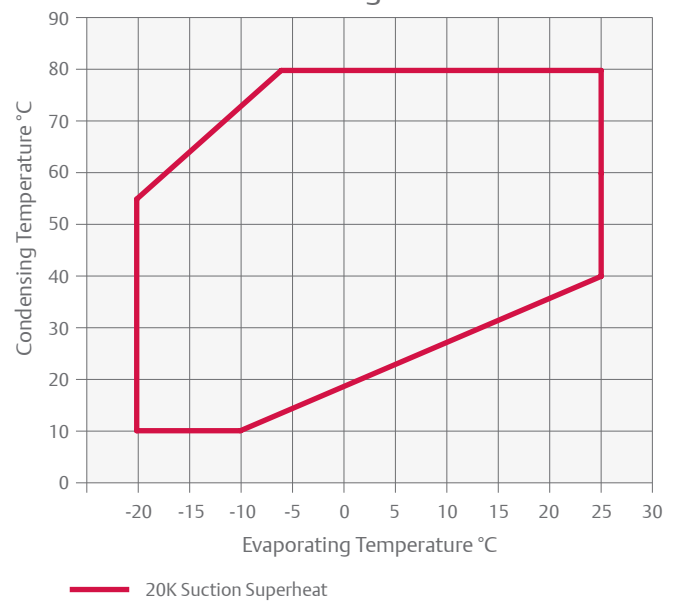

For individual model details please refer to select software.

Technical Overview

Models	Nominal hp	Displacement (m ³ /h)	Oil Quantity (l)	Length/width/height (mm)	Net Weight (kg)	Motor Version/ Code	Maximum Operating Current (A)	Locked Rotor Current (A)	Sound Pressure @ 1 m - dB(A) ***
						3 Ph **	3 Ph **	3 Ph **	
4MF-13X	13	61.7	3.3	638/501/452	177	AWM	30.8	105	70
4MA-22X	22	61.7	3.3	638/501/452	177	AWM	36.3	175	75
4ML-15X	15	71.4	3.3	638/501/452	180	AWM	35.4	156	71
4MH-25X	25	71.4	3.3	657/501/452	187	AWM	41.6	199	75
4MM-20X	17	78.2	3.3	657/501/452	182	AWM	39.0	175	71
4MI-30X	27	78.2	3.3	657/501/452	188	AWM	46.6	221	75
4MT-22X	22	87.7	3.3	657/501/452	183	AWM	44.5	175	73
4MJ-33X	33	87.7	3.3	657/501/452	190	AWM	52.9	221	74
4MU-25X	25	99.4	3.3	657/501/452	186	AWM	51.9	199	72
4MK-35X	32	99.4	3.3	688/501/452	202	AWM	61.1	255	74
6MM-30X	27	120.5	3.3	695/547/450	215	AWM	59.7	255	78
6MI-40X	35	120.5	3.3	695/547/450	219	AWM	71.4	304	78
6MT-35X	32	135.0	3.3	725/547/450	221	AWM	67.3	255	77
6MJ-45X	40	135.0	3.3	725/547/450	223	AWM	81.5	304	79
6MU-40X	40	153.0	3.3	757/547/450	225	AWM	75.8	306	78
6MK-50X	50	153.0	3.3	773/547/450	230	AWM	92.9	393	80

** 3 Ph: 380-420V/ 50Hz

*** @ 1m: sound pressure level at 1m distance from the compressor, free field condition

Capacity Data

Condensing Temperature: 40°C															
R407A	Cooling Capacity (kW)							R407A	Power Input (kW)						
	Evaporating Temperature (°C)								Evaporating Temperature (°C)						
Model	-45	-35	-30	-20	-10	-5	+5	Model	-45	-35	-30	-20	-10	-5	+5
4MF-13X		7.1*	10.3*	19.9	31.2	38.3		4MF-13X		6.1*	7.3*	9.7	11.8	12.7	
4MA-22X				20.3	32.6	40.3	59.9	4MA-22X				9.5	11.7	12.6	14.0
4ML-15X		9.2*	13.0*	24.3	38.0	46.6		4ML-15X		7.4*	8.8*	11.4	13.8	14.9	
4MH-25X				23.8	37.8	46.7	69.2	4MH-25X				11.4	13.7	14.6	15.9
4MM-20X		10.4*	14.5*	26.7	41.6	51.0		4MM-20X		8.3*	9.7*	12.7	15.3	16.5	
4MI-30X				26.7	42.1	51.9	76.5	4MI-30X				12.6	15.0	16.1	17.8
4MT-22X		11.2*	15.5*	28.7	44.7	54.8		4MT-22X		9.4*	11.1*	14.5	17.5	18.9	
4MJ-33X				29.7	46.8	57.7	85.1	4MJ-33X				14.2	17	18.2	20.1
4MU-25X		12.3*	17.3*	32.6	50.9	62.4		4MU-25X		10.6*	12.4*	16.2	19.9	21.6	
4MK-35X				33.5	52.6	64.7	95.1	4MK-35X				16.2	19.5	20.9	23.4
6MM-30X		15.1*	21.2*	39.7	61.9	75.8		6MM-30X		12.6*	14.9*	19.4	23.6	25.5	
6MI-40X				40.8	64.2	79.0	116.5	6MI-40X				19.3	23.3	25	27.6
6MT-35X		18.4*	25.1*	45.7	71.0	86.9		6MT-35X		14.5*	16.8*	21.9	26.9	29.1	
6MJ-45X				45.4	71.4	87.9	129.5	6MJ-45X				21.5	26.1	28.0	31.0
6MU-40X		20.9*	27.8*	50.3	78.7	96.7		6MU-40X		16.6*	19.0*	24.4	30.1	32.8	
6MK-50X				50.6	79.4	97.6	143.5	6MK-50X				24.4	29.8	32.3	36.4

Conditions: Suction Gas Return 20°C, Subcooling 0K

* Conditions: Suction Superheat 10K, Subcooling 0K

Capacity Data

Condensing Temperature: 40°C															
R407F	Cooling Capacity (kW)							R407F	Power Input (kW)						
	Evaporating Temperature (°C)								Evaporating Temperature (°C)						
Model	-45	-35	-30	-20	-10	-5	+5	Model	-45	-35	-30	-20	-10	-5	+5
4MF-13X		7.8*	11.1*	19.7*	32.5	39.9		4MF-13X		6.5*	7.7*	10.2*	12.4	13.3	
4MA-22X				20.7*	34.8	43	63.8	4MA-22X				10.2*	12.4	13.2	14.4
4MH-25X				24.2*	40.4	49.9	73.8	4MH-25X				11.9*	14.4	15.4	16.8
4ML-15X		9.9*	13.8*	24.2*	39.8	48.9		4ML-15X		7.8*	9.2*	12.0*	14.6	15.7	
4MM-20X		11.0*	15.3*	26.6*	43.5	53.4		4MM-20X		8.7*	10.3*	13.3*	16.0	17.2	
4MI-30X				26.9*	44.4	54.8	80.7	4MI-30X				13.1*	15.8	17.0	18.6
4MT-22X		12.7*	17.4*	29.9*	48.5	59.5		4MT-22X		10.0*	11.7*	15.1*	18.3	19.7	
4MJ-33X				30.2*	49.5	60.9	89.8	4MJ-33X				14.8*	17.8	19.2	21.1
4MU-25X		14.0*	19.3*	33.3*	54.6	66.9		4MU-25X		11.2*	13.2*	17.2*	21.0	22.8	
4MK-35X				33.7*	55.3	68.3	101.0	4MK-35X				16.8*	20.4	22.1	24.4
6MM-30X		17.2*	23.7*	40.7*	66	80.7		6MM-30X		13.6*	15.8*	20.4*	24.8	26.7	
6MI-40X				41.2*	67.9	83.5	122.5	6MI-40X				20.2*	24.4	26.2	28.9
6MT-35X		19.8*	27.0*	45.8*	74.1	90.4		6MT-35X		15.3*	18.0*	23.1*	28.0	30.3	
6MJ-45X				45.8*	75.2	92.6	136.0	6MJ-45X				22.9*	27.6	29.7	32.8
6MU-40X		20.1*	27.7*	48.5*	82.7	101.5		6MU-40X		16.9*	19.8*	25.9*	31.7	34.4	
6MK-50X				51.3*	84.5	104	153.5	6MK-50X				25.8*	31.3	33.7	37.5

Conditions: Suction Gas Return 20°C, Subcooling 0K
 * Conditions: Suction Superheat 10K, Subcooling 0K

Condensing Temperature 40°C															
R448A/ R449A	Cooling Capacity (kW)							R448A/ R449A	Power Input (kW)						
	Evaporating Temperature (°C)								Evaporating Temperature (°C)						
Model	-45	-35	-30	-20	-10	-5	5	Model	-45	-35	-30	-20	-10	-5	5
4MA-22X		7.8*	11.3*	21.2	34.3	42.7	63.5	4MA-22X		6.2*	7.4*	9.8	11.8	12.6	13.7
4MF-13X	3.8*	8.2*	11.1*	19.6	30.4	37.3		4MF-13X	4.5*	6.3*	7.4*	9.8	12.2	13.1	
4MH-25X		9.4*	13.5*	24.7	39.1	48.0	70.3	4MH-25X		7.6*	8.9*	11.6	14.1	15.1	16.7
4ML-15X	4.3*	10.5*	14.3*	25.2	38.7	47.1		4ML-15X	5.2*	7.6*	8.9*	11.6	14.2	15.4	
4MI-30X		10.8*	15.4*	28.1	44.1	54.0	78.6	4MI-30X		8.2*	9.8*	13.0	15.6	16.7	18.2
4MM-20X	4.9*	11.8*	16.0*	27.8	42.5	51.5		4MM-20X	5.8*	8.5*	9.9*	12.9	15.6	16.9	
4MJ-33X		12.1*	17.0*	30.9	48.7	59.8	87.6	4MJ-33X		9.2*	11.0*	14.5	17.6	18.9	20.6
4MT-22X	5.9*	13.5*	18.2*	31.3	47.7	57.8		4MT-22X	6.6*	9.7*	11.3*	14.6	17.8	19.2	
4MK-35X		13.7*	19.2*	34.7	54.8	67.5	98.9	4MK-35X		10.7*	12.7*	16.7	20.4	22.0	24.4
4MU-25X	6.5*	14.3*	19.5*	34.2	53.2	65.1		4MU-25X	7.4*	10.8*	12.7*	16.6	20.5	22.4	
6MI-40X		17.1*	23.9*	42.8	66.6	81.4	118.0	6MI-40X		13.0*	15.3*	19.6	23.5	25.2	28.0
6MM-30X	6.6*	17.6*	24.1*	41.8	63.2	76.3		6MM-30X	8.8*	13.1*	15.4*	19.9	23.9	25.6	
6MT-35X	7.5*	19.8*	26.9*	46.5	70.0	84.3		6MT-35X	9.7*	14.6*	17.2*	22.2	26.9	29.0	
6MJ-45X		19.5*	27.2*	48.1	74.5	91.0	132.0	6MJ-45X		14.3*	17.0*	22.2	26.9	28.8	31.7
6MK-50X		21.1*	29.4*	52.7	82.2	101.0	147.0	6MK-50X		16.4*	19.2*	25.0	30.3	32.7	36.7
6MU-40X	8.3*	22.2*	30.5*	53.4	81.8	99.4		6MU-40X	10.9*	16.3*	19.1*	24.6	29.8	32.1	

Conditions: Suction Gas Return 20°C / Subcooling 0K
 * Conditions: Suction Superheat 10K, Subcooling 0K
Preliminary Data

Capacity Data

Condensing Temperature: 40°C															
R404A	Cooling Capacity (kW)							R404A	Power Input (kW)						
	Evaporating Temperature (°C)								Evaporating Temperature (°C)						
Model	-45	-35	-30	-20	-10	-5	+5	Model	-45	-35	-30	-20	-10	-5	+5
4MA-22X		10.5	14.3	23.6	36.0	43.5	62.0	4MA-22X		7.3	8.6	11.0	13.0	13.7	14.7
4MF-13X	3.6*	10.7	14.0	22.8	34.8	42.2		4MF-13X	5.0*	7.4	8.7	11.0	13.0	13.9	
4MH-25X		12.4	16.7	27.5	42.2	51.3	73.6	4MH-25X		8.6	10.1	13.0	15.4	16.3	17.5
4ML-15X	4.8*	13.3	17.4	27.9	42.0	50.8		4ML-15X	6.3*	9.0	10.5	13.3	15.8	16.7	
4MI-30X		14.4	19.4	31.2	46.8	56.3	79.5	4MI-30X		9.8	11.5	14.5	17.0	18	19.5
4MM-20X	5.7*	15.1	19.6	30.9	46.1	55.4		4MM-20X	7.1*	10.1	11.6	14.6	17.0	18.2	
4MJ-33X		16.2	21.4	34.6	52.4	63.4	90.4	4MJ-33X		10.9	12.6	16.0	19.0	20.2	21.8
4MT-22X	6.7*	17.0	21.9	34.7	52.0	62.7		4MT-22X	8.0*	11.5	13.2	16.6	19.5	20.7	
4MK-35X		18.3	24.0	38.8	58.9	71.3	102.0	4MK-35X		12.6	14.6	18.5	22.0	23.5	25.7
4MU-25X	7.2*	18.6	24.1	38.5	58.1	70.2		4MU-25X	9.0*	12.9	14.9	18.8	22.3	23.7	
6MI-40X		21.9	28.9	46.7	70.8	85.8	122.5	6MI-40X		15.2	17.6	22.2	26.1	27.7	30.1
6MM-30X	8.9*	22.7	29.3	46.5	70.2	85.1		6MM-30X	11.0*	15.7	18.0	22.5	26.3	27.8	
6MJ-45X		24.3	32.3	52.5	79.5	96.1	136.5	6MJ-45X		16.8	19.6	24.9	29.5	31.4	33.9
6MT-35X	10.3*	25.6	33	52.5	79.3	95.9		6MT-35X	12.3*	17.5	20.1	25.3	29.7	31.5	
6MK-50X		27.3	36.3	58.7	88.6	107.0	152.0	6MK-50X		19.4	22.5	28.3	33.5	35.9	39.9
6MU-40X	11.0*	28.4	36.8	58.7	89.0	108.0		6MU-40X	13.8*	19.7	22.7	28.5	33.6	35.8	

Conditions Suction Gas Return 20°C, Subcooling 0K
 * Conditions Suction superheat 10K, Subcooling 0K

Condensing Temperature: 40°C															
R134a	Cooling Capacity (kW)							R134a	Power Input (kW)						
	Evaporating Temperature (°C)								Evaporating Temperature (°C)						
Models	-45	-35	-30	-20	-10	-5	+5	Models	-45	-35	-30	-20	-10	-5	+5
4MA-22X				13.1	21.3	26.6	40.1	4MA-22X				5.9	7.3	7.9	8.7
4MF-13X				12.2	20.4	25.6	38.9	4MF-13X				5.8	7.2	7.8	8.7
4MH-25X				15.0	24.6	30.7	46.4	4MH-25X				7.0	8.7	9.4	10.4
4ML-15X				15.0	24.5	30.5	46.0	4ML-15X				6.9	8.5	9.3	10.4
4MI-30X				16.8	27.1	33.7	50.7	4MI-30X				7.6	9.4	10.3	11.4
4MM-20X				16.6	27.0	33.6	50.3	4MM-20X				7.7	9.4	10.2	11.4
4MJ-33X				18.9	30.3	37.6	56.4	4MJ-33X				8.7	10.7	11.5	12.8
4MT-22X				19.0	30.6	38.1	57.2	4MT-22X				8.7	10.8	11.7	13.0
4MK-35X				21.0	34.0	42.2	63.3	4MK-35X				9.7	12.2	13.3	14.9
4MU-25X				20.7	33.9	42.3	63.8	4MU-25X				9.8	12.2	13.3	15.0
6MI-40X				24.8	40.2	50.2	76.0	6MI-40X				12.0	14.6	15.8	17.8
6MM-30X				25.2	40.7	50.7	76.1	6MM-30X				11.7	14.6	15.8	17.7
6MJ-45X				28.5	45.6	56.7	85.3	6MJ-45X				13.0	16.2	17.8	20.3
6MT-35X				28.5	46.0	57.1	85.2	6MT-35X				13.3	16.5	17.9	20.0
6MK-50X				29.8	49.1	61.7	94.3	6MK-50X				15.2	18.8	20.5	23.3
6MU-40X				31.5	50.6	62.9	94.5	6MU-40X				14.6	18.4	20.1	23.0

Conditions Suction Gas Return 20°C, Subcooling 0K
 * Conditions Suction Superheat 10K, Subcooling 0K

Copeland™ Stream Digital with Compressor Electronics for Continuous Capacity Modulation

Stream Digital series 4 and 6 cylinder compressors provide an alternative means of continuous modulation to inverter. Digital modulation is the most simple and precise method of capacity control and helps to contain applied costs associated with modulation.

Digital technology is based on controlling a high-cycle solenoid valve fitted on one of the cylinder heads based on cycle time. The valve actuates a piston that controls the flow of gas into the suction area of the Stream valve plate.

The compressor always runs at constant speed which resolves the challenges related to oil return, mechanical and electrical stress on the system.

All compressors are equipped with an Electronics Module and offer the possibility to diagnose system-related problems faster or even before they occur.



Copeland Stream Digital compressor

Stream Digital Line-Up

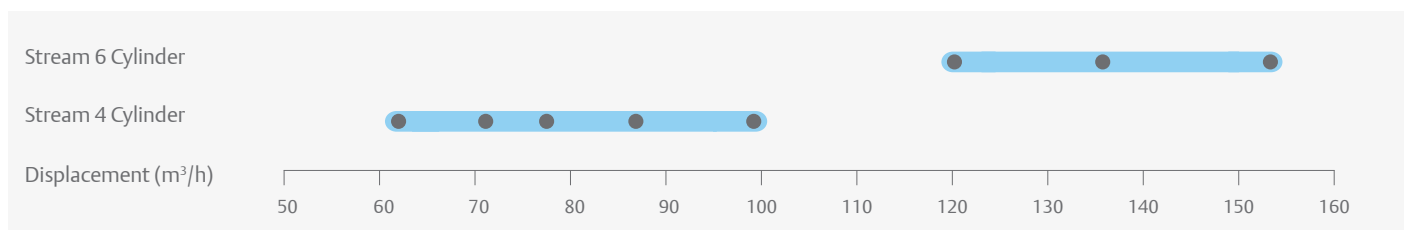

Features and Benefits

- Range of 16 models from 62 to 153 m³/h
- Multi-refrigerant compressor, compatible with R407A/F/C, R448A/ R449A, R404A, R134a, R450A and R513A
- Continuous modulation from 50–100% (4-cylinder) and 33–100% (6-cylinder) ensuring a perfect match of capacity and power to refrigeration load
- Economical and reliable alternative to frequency inverters
- Precise suction pressure control with associated energy savings and stable evaporating temperatures
- Quick and easy integration into refrigeration equipment, similar to any other standard compressor
- Possibility to easily retrofit existing installations with digital cylinder head kit
- No vibrations or mechanical stress on system piping and compressor parts
- Reduced compressor cycling for longer contactor and compressor life
- Copeland compressor electronics module providing advanced protection, diagnostics and preventive maintenance

Operating Envelope R448A/R449A

With 4 Cylinder Small Motor - 100% Modulation

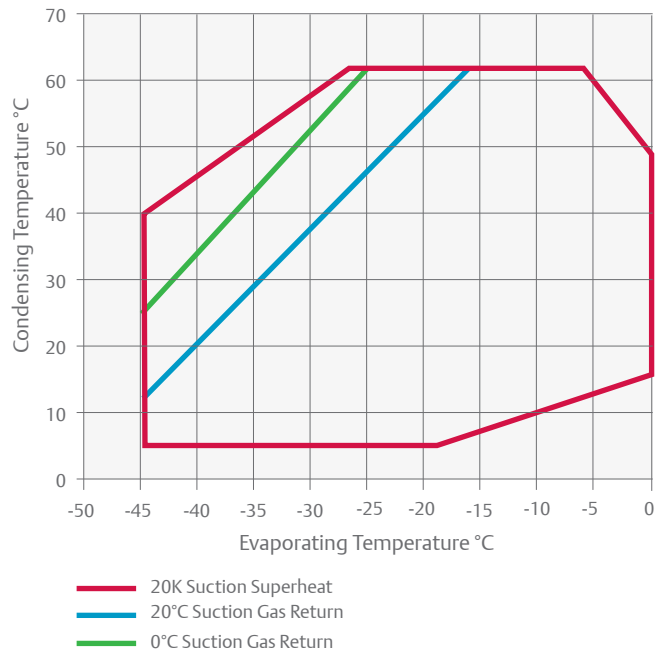

With 6 Cylinder Large Motor - 100% Modulation

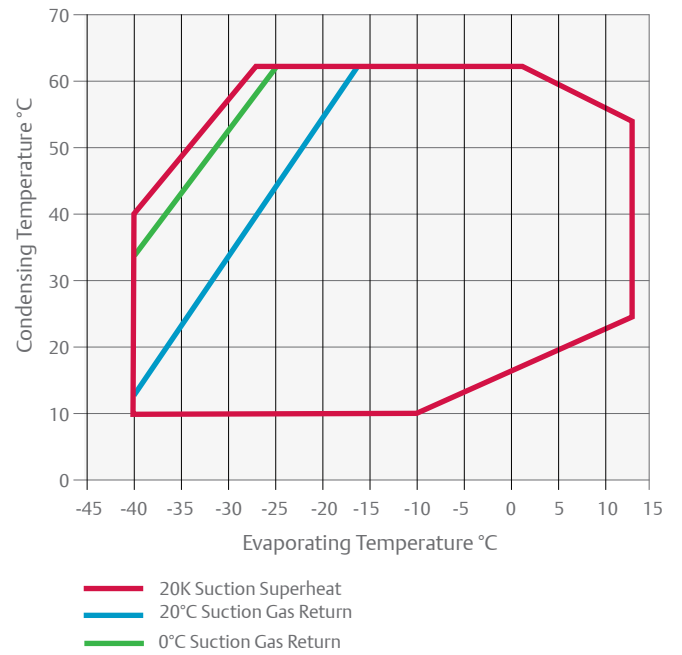

With 4 Cylinder Small Motor - 50% Modulation

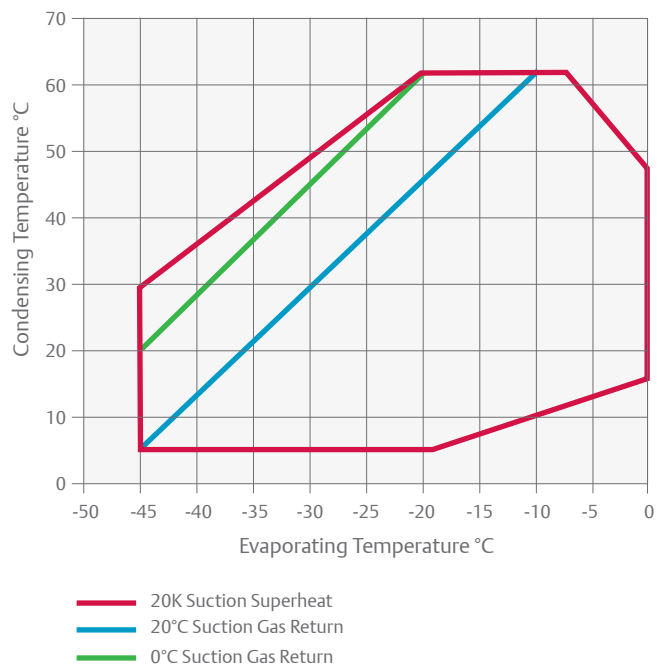

With 6 Cylinder Large Motor - 33% Modulation

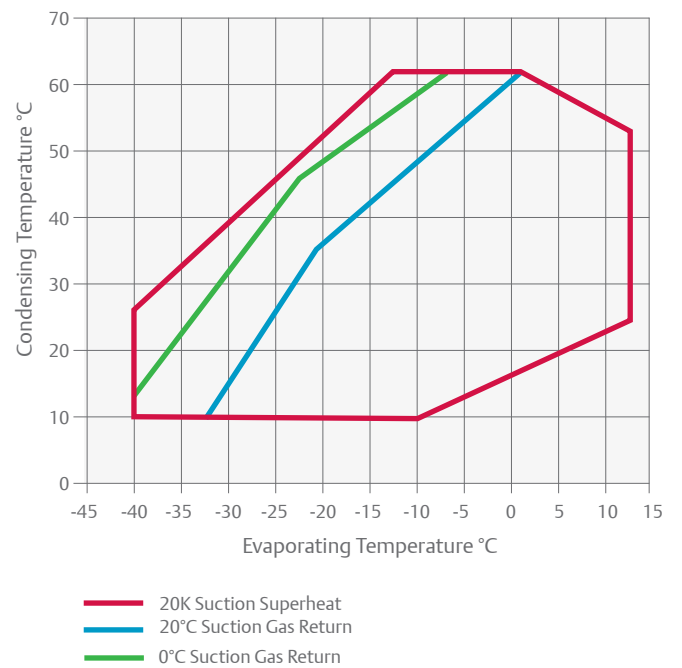

All other refrigerant envelopes are available as 'Dynamic Envelopes' and can be accessed through select software.

Technical Overview

Models	Nominal hp	Displacement (m ³ /h)	Oil Quantity (l)	Length/Width/Height (mm)	Net Weight (kg)	Motor Version/Code	Maximum Operating Current (A)	Locked Rotor Current (A)	Sound Pressure @1 m - dB(A) ***
						3 Ph **	3 Ph **	3 Ph **	
4MFD-13X	13	61.7	3.3	638/501/452	183	AWM	30.8	105	70
4MAD-22X	22	61.7	3.3	638/501/452	183	AWM	36.3	175	75
4MLD-15X	15	71.4	3.3	638/501/452	186	AWM	35.4	156	71
4MHD-25X	25	71.4	3.3	657/501/452	193	AWM	41.6	199	75
4MMD-20X	17	78.2	3.3	657/501/452	188	AWM	39.0	175	71
4MID-30X	27	78.2	3.3	657/501/452	194	AWM	46.6	221	75
4MTD-22X	22	87.7	3.3	657/501/452	189	AWM	44.5	175	73
4MJD-33X	33	87.7	3.3	657/501/452	196	AWM	52.9	221	74
4MUD-25X	25	99.4	3.3	657/501/452	192	AWM	51.9	199	72
4MKD-35X	32	99.4	3.3	688/501/452	202	AWM	61.1	255	74
6MMD-30X	27	120.5	3.3	695/547/450	221	AWM	59.7	255	78
6MID-40X	35	120.5	3.3	695/547/450	225	AWM	71.4	304	78
6MTD-35X	32	135.0	3.3	725/547/450	227	AWM	67.3	255	77
6MJD-45X	40	135.0	3.3	725/547/450	229	AWM	81.5	304	79
6MUD-40X	40	153.0	3.3	757/547/450	231	AWM	75.8	304	78
6MKD-50X	50	153.0	3.3	773/547/450	236	AWM	92.9	393	80

** 3 Ph: 380-420V/ 50Hz

*** @ 1m: sound pressure level at 1m distance from the compressor, free field condition

Capacity Data

Condensing Temperature: 40°C															
R407A	Cooling Capacity (kW)							R407A	Power Input (kW)						
	Evaporating Temperature (°C)								Evaporating Temperature (°C)						
Model	-45	-35	-30	-20	-10	-5	+5	Model	-45	-35	-30	-20	-10	-5	+5
4MFD-13X				18.3*	30.9	37.9		4MFD-13X				9.7*	11.8	12.7	
4MAD-22X					32.2	39.9	59.3	4MAD-22X					11.7	12.6	14.0
4MLD-15X				22.7*	37.7	46.1		4MLD-15X				11.4*	13.8	14.9	
4MHD-25X					37.4	46.2	68.5	4MHD-25X					13.7	14.6	15.9
4MMD-20X				24.9*	41.2	50.5		4MMD-20X				12.7*	15.3	16.5	
4MID-30X				21.6*	37.4	46.2	68.5	4MID-30X				11.4*	13.7	14.6	15.9
4MTD-22X				26.5*	44.2	54.2		4MTD-22X				14.5*	17.5	18.9	
4MJD-33X					41.7	51.4	75.7	4MJD-33X					15.1	16.1	17.8
4MUD-25X				30.1*	50.4	61.8		4MUD-25X				16.2*	19.9	21.6	
4MKD-35X					52.1	64.1	94.2	4MKD-35X					19.5	20.9	23.4
6MMD-30X			20.9*	39.3	61.3	75.0		6MMD-30X			14.9*	19.4	23.6	25.5	
6MID-40X				40.4	63.6	78.3	115.5	6MID-40X				19.3	23.3	25.0	27.6
6MTD-35X			24.8*	45.3	70.3	86.0		6MTD-35X			16.8*	21.9	26.9	29.1	
6MJD-45X				45.0	70.7	87.0	128.0	6MJD-45X				21.5	26.1	28.0	31.0
6MUD-40X				50.4	78.7	96.7		6MUD-40X				24.4	30.1	32.8	
6MKD-50X				50.1	78.6	96.6	142.0	6MKD-50X				24.4	29.8	32.3	36.4

Conditions: Suction Gas Return 20°C, Subcooling 0K, 100% Loaded

* Conditions: Suction Superheat 10K, Subcooling 0K

Condensing Temperature: 40°C															
R407F	Cooling Capacity (kW)							R407F	Power Input (kW)						
	Evaporating Temperature (°C)								Evaporating Temperature (°C)						
Model	-45	-35	-30	-20	-10	-5	+5	Models	-45	-35	-30	-20	-10	-5	+5
4MAD-22X				20.5*	34.4	42.6	63.1	4MAD-22X				10.2*	12.4	13.2	14.4
4MFD-13X				19.5*	32.2	39.5		4MFD-13X				10.2*	12.4	13.3	
4MHD-25X				23.9*	40.0	49.4	73.1	4MHD-25X				11.9*	14.4	15.4	16.8
4MLD-15X				23.9*	39.4	48.4		4MLD-15X				12.0*	14.6	15.7	
4MID-30X				26.6*	44.0	54.2	79.9	4MID-30X				13.1*	15.8	17.0	18.6
4MMD-20X				26.3*	43.0	52.9		4MMD-20X				13.3*	16.0	17.2	
4MJD-33X				29.8*	49.0	60.3	88.9	4MJD-33X				14.8*	17.8	19.2	21.1
4MTD-22X				29.5*	48.0	58.9		4MTD-22X				15.1*	18.3	19.7	
4MKD-35X				33.3*	54.8	67.6	100.0	4MKD-35X				16.8*	20.4	22.0	24.4
4MUD-25X				32.9*	54.0	66.3		4MUD-25X				17.1*	21.0	22.8	
6MID-40X				40.7*	67.2	82.6	121.5	6MID-40X				20.2*	24.4	26.2	28.9
6MMD-30X				40.2*	65.4	79.9		6MMD-30X				20.4*	24.8	26.7	
6MJD-45X				45.3*	74.5	91.6	135.0	6MJD-45X				22.9*	27.6	29.7	32.8
6MTD-35X				45.3*	73.3	89.5		6MTD-35X				23.1*	28.0	30.3	
6MKD-50X				50.7*	83.7	103.0	151.5	6MKD-50X				25.8*	31.3	33.7	37.5
6MUD-40X				47.9*	81.9	100.5		6MUD-40X				25.9*	31.7	34.4	

Conditions: Suction Gas Return 20°C, Subcooling 0K, 100% Loaded

* Conditions: Suction Superheat 10K, Subcooling 0K

Preliminary Data

Capacity Data

Condensing Temperature: 40°C																	
R404A		Cooling Capacity (kW)						R404A		Power Input (kW)							
		Evaporating Temperature (°C)								Evaporating Temperature (°C)							
Model		-45	-35	-30	-20	-10	-5	+5	Model		-45	-35	-30	-20	-10	-5	+5
4MAD-22X			8.1*	11.7*	23.4	35.6	43.1	61.3	4MAD-22X			7.3*	8.6*	11.0	13.0	13.7	14.7
4MFD-13X			8.3*	11.5*	22.6	34.5	41.8		4MFD-13X			7.4*	8.7*	11.0	13.1	13.9	
4MHD-25X			9.6*	13.7*	27.2	41.7	50.7	72.9	4MHD-25X			8.6*	10.1*	13.0	15.4	16.3	17.5
4MLD-15X			10.6*	14.5*	27.6	41.6	50.2		4MLD-15X			9.0*	10.5*	13.3	15.8	16.7	
4MID-30X			11.4*	16.2*	30.9	46.3	55.7	78.7	4MID-30X			9.8*	11.5*	14.5	17.0	18.0	19.5
4MMD-20X			12.2*	16.4*	30.6	45.6	54.8		4MMD-20X			10.1*	11.6*	14.6	17.1	18.2	
4MJJD-33X			12.9*	17.8*	34.2	51.9	62.7	89.5	4MJJD-33X			10.9*	12.6*	16.1	19.0	20.2	21.8
4MTD-22X			13.7*	18.4*	34.3	51.5	62.1		4MTD-22X			11.5*	13.2*	16.6	19.5	20.7	
4MKD-35X			14.5*	20.0*	38.4	58.3	70.6	101.0	4MKD-35X			12.6*	14.6*	18.5	22.0	23.5	25.7
4MUD-25X			14.9*	20.1*	38.1	57.5	69.5		4MUD-25X			12.9*	14.9*	18.8	22.3	23.7	
6MID-40X			17.3*	28.6°	46.2	70.1	84.9	121.5	6MID-40X			15.2*	17.6°	22.2	26.1	27.7	30.1
6MMD-30X			18.2*	29.0°	46.0	69.5	84.3		6MMD-30X			15.7*	18.1°	22.5	26.3	27.8	
6MJJD-45X			19.2*	32.0°	51.9	78.7	95.1	135.0	6MJJD-45X			16.8*	19.6°	24.9	29.5	31.4	33.9
6MTD-35X			20.5*	32.7°	52.0	78.5	94.9		6MTD-35X			17.5*	20.1°	25.3	29.7	31.5	
6MKD-50X			21.4*	36.0°	58.1	87.7	106.0	150.5	6MKD-50X			19.4*	22.5°	28.3	33.5	35.9	39.9
6MUD-40X			22.6*	36.5°	58.1	88.1	107.0		6MUD-40X			19.7*	22.7°	28.5	33.6	35.8	

Conditions: Suction Gas Return 20°C, Subcooling 0K, 100% Loaded

* Conditions: Suction Superheat 10K, Subcooling 0K

° Additional Cooling Required

Condensing Temperature: 40°C																	
R134a		Cooling Capacity (kW)						R134a		Power Input (kW)							
		Evaporating Temperature (°C)								Evaporating Temperature (°C)							
Model		-45	-35	-30	-20	-10	-5	+5	Model		-45	-35	-30	-20	-10	-5	+5
4MAD-22X			4.0*	6.2*	11.8*	20.0*	25.4*	39.7	4MAD-22X			3.7*	4.4*	5.9*	7.3*	7.9*	8.7
4MFD-13X					12.1	20.2	25.4	38.5	4MFD-13X					5.8	7.2	7.8	8.7
4MHD-25X			4.4*	6.9*	13.5*	23.1*	29.3*	45.9	4MHD-25X			4.7*	5.4*	7.1*	8.7*	9.4*	10.4
4MLD-15X					14.8	24.2	30.2	45.5	4MLD-15X					6.9	8.5	9.3	10.4
4MID-30X			5.2*	8.0*	15.1*	25.4*	32.2*	50.2	4MID-30X			4.9*	5.8*	7.6*	9.4*	10.3*	11.4
4MMD-20X					16.5	26.7	33.3	49.8	4MMD-20X					7.7	9.4	10.2	11.4
4MJJD-33X			6.0*	9.1*	17.0*	28.5*	35.9*	55.9	4MJJD-33X			5.6*	6.6*	8.7*	10.7*	11.5*	12.8
4MTD-22X					18.9	30.3	37.7	56.7	4MTD-22X					8.7	10.8	11.7	13.1
4MKD-35X			7.0*	10.4*	19.1*	31.9*	40.3*	62.7	4MKD-35X			7.1*	7.7*	9.7*	12.2*	13.3*	14.9
4MUD-25X					20.5	33.5	41.9	63.2	4MUD-25X					9.8	12.2	13.3	15.1
6MID-40X					22.2*	37.6*	47.8*	75.3	6MID-40X					12.0*	14.6*	15.8*	17.8
6MMD-30X					24.9	40.3	50.2	75.3	6MMD-30X					11.7	14.6	15.8	17.7
6MJJD-45X					25.6*	42.7*	54.0*	84.5	6MJJD-45X					13.0*	16.2*	17.8*	20.3
6MTD-35X					28.2	45.5	56.5	84.4	6MTD-35X					13.3	16.5	17.9	20.0
6MKD-50X					26.2*	45.7*	58.6*	93.4	6MKD-50X					15.2*	18.8*	20.5*	23.3
6MUD-40X					31.2	50.1	62.3	93.6	6MUD-40X					14.6	18.4	20.1	23.0

Conditions: Suction Gas Return 20°C, Subcooling 0K, 100% Loaded

* Conditions: Suction Superheat 10K, Subcooling 0K

Capacity Data

Condensing Temperature: 40°C															
R448A / R449A	Cooling Capacity (kW)							R448A / R449A	Power Input (kW)						
	Evaporating Temperature (°C)								Evaporating Temperature (°C)						
Model	-45	-35	-30	-20	-10	-5	+5	Model	-45	-35	-30	-20	-10	-5	+5
4MAD-22X		7.7*	11.1*	21.0	34.0	42.2	62.9	4MAD-22X		6.2*	7.4*	9.8	11.8	12.6	13.7
4MFD-13X	3.7*	8.1*	10.9*	19.4	30.1	36.9		4MFD-13X	4.5*	6.3*	7.4*	9.8	12.2	13.1	
4MLD-15X	4.2*	10.3*	14.2*	24.9	38.3	46.6		4MLD-15X	5.2*	7.6*	8.9*	11.6	14.2	15.4	
4MHD-25X		9.3*	13.3*	24.5	38.7	47.6	69.6	4MHD-25X		7.6*	8.9*	11.6	14.1	15.1	16.7
4MMD-20X	4.9*	11.6*	15.8*	27.5	42.0	51.0		4MMD-20X	5.8*	8.5*	9.9*	12.9	15.6	16.9	
4MID-30X		10.6*	15.3*	27.8	43.6	53.5	77.8	4MID-30X		8.2*	9.8*	13.0	15.6	16.7	18.2
4MJD-33X		11.9*	16.8*	30.6	48.2	59.2	86.7	4MJD-33X		9.2*	11.0*	14.5	17.6	18.9	20.6
4MTD-22X	5.8*	13.3*	17.9*	31.0	47.2	57.2		4MTD-22X	6.6*	9.7*	11.3*	14.6	17.8	19.2	
4MKD-35X		13.6*	19.0*	34.4	54.3	66.8	97.9	4MKD-35X		10.7*	12.7*	16.7	20.4	22.0	24.4
4MUD-25X	6.4*	14.2*	19.2*	33.9	52.7	64.4		4MUD-25X	7.4*	10.8*	12.7*	16.6	20.5	22.4	
6MID-40X		16.9*	23.7*	42.4	65.9	80.6	116.5	6MID-40X		13.0*	15.3*	19.6	23.5	25.2	28.0
6MMD-30X	6.5*	17.4*	23.8*	41.4	62.6	75.5		6MMD-30X	8.8*	13.1*	15.4*	19.9	23.9	25.6	
6MTD-35X	7.4*	19.5*	26.6*	46.0	69.3	83.5		6MTD-35X	9.7*	14.6*	17.2*	22.2	26.9	29.0	
6MJD-45X		19.3*	26.9*	47.6	73.7	90.1	131.0	6MJD-45X		14.3*	17.0*	22.2	26.9	28.8	31.7
6MKD-50X		20.8*	29.1*	52.2	81.4	99.8	145.5	6MKD-50X		16.4*	19.2*	25.0	30.3	32.7	36.7
6MUD-40X	8.2*	21.9*	30.2*	52.9	81.0	98.4		6MUD-40X	10.9*	16.3*	19.1*	24.6	29.8	32.1	

Conditions: Suction Gas Return 20°C / Subcooling 0K, 100% Loaded

*Conditions: Suction Superheat 10K, Subcooling 0K

Preliminary Data

Copeland™ Stream Compressors with Compressor Electronics for R744-Transcritical Applications

Stream series of 4 cylinder CO₂ compressors is the ideal solution for R744 booster systems. It is characterized by a design pressure of 135 bar. Refrigerant flow and heat transfer have been optimized for best performance. All compressors are equipped with Copeland Compressor Electronics Module and offer the possibility to diagnose system-related problems faster or even before they occur.



Copeland Stream compressor for R744

Stream Compressor Line-up

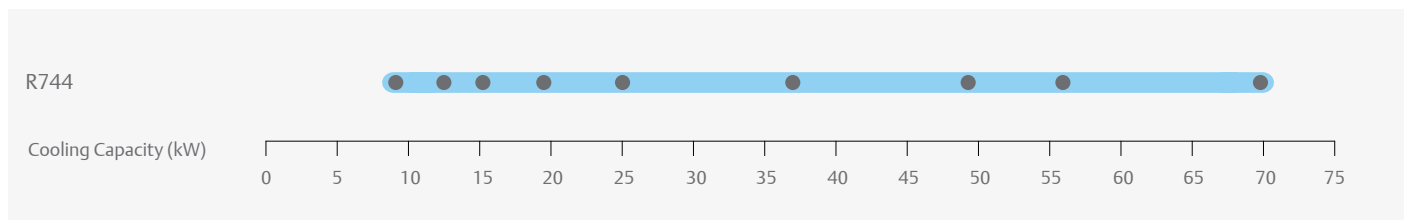

Conditions: EN12900 R744: Evaporating -10°C, gas cooler exit: 35°C/ 90 bar, superheat: 10K

Features and Benefits

Stream provides for flexibility in pack design and operation:

- Compact dimensions
- Integrated low pressure relief valve
- Discharge temperature protection
- Service valve 360° rotation for ease of piping design
- 2 sight glasses for mounting of oil management control and visual inspection
- One oil port for oil equalization in parallel system
- Oil splasher system ensuring lubrication at constant and variable speed

Designed for durability and performance in R744 applications:

- Low sound, low vibration and large discharge chamber to eliminate pulsation
- High design pressures of 135 bar (high side) and 90 bar (low side)
- Burst pressures in excess of safety factor 3
- Cylinder head and discharge plenum design minimizing heat transfer to suction side
- Stepless capacity modulation via inverter from 25 to 70Hz
- Copeland Compressor Electronics Technology
- Individual compressor power consumption monitoring

Operating Envelope R744

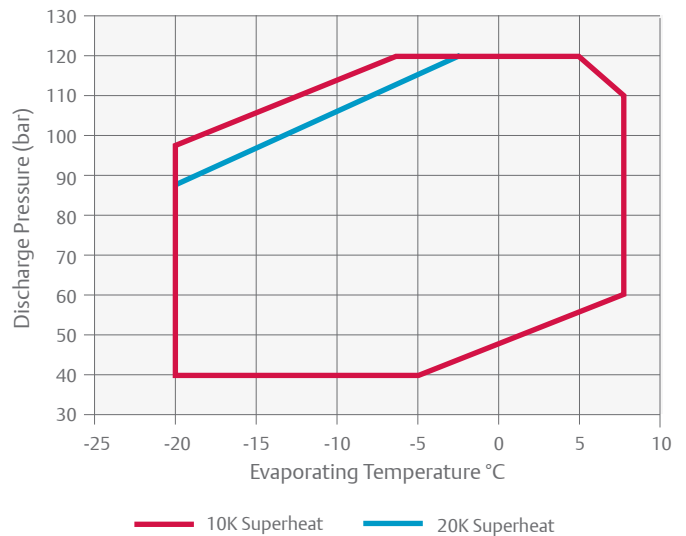

Technical Overview

Model	Nominal hp	Displacement (m ³ /h)	Capacity (kw)	COP	Oil Quantity (l)	Length/Width/Height (mm)	Net Weight (kg)	Motor Version/ Code	Maximum Operating Current (A)	Locked Rotor Current (A)	Sound Pressure @1 m - dB(A)***
								3 Ph**	3 Ph**	3 Ph**	
4MTL-05_	5.0	4.6	8.8	1.6	1.5	630/425/410	123	EWL	13	80	59
4MTL-07_	7.0	6.2	11.9	1.6	1.5	630/425/410	124	EWL	18	81	62
4MTL-09_	9.0	7.4	14.6	1.6	1.5	630/425/410	123	EWL	21	93	63
4MTL-12_	12.0	9.5	19.3	1.7	1.8	697/444/423	170	AWM	27	145	67
4MTL-15_	15.0	12.5	25.2	1.8	1.8	697/445/422	170	AWM	35	156	71
4MTL-30_	30.0	18.0	37.0	1.8	1.8	697/445/422	175	AWM	50	221	75
4MTL-35_	35.0	22.7	45.3	1.7	2.8	842/486/467	264	AWM	60	304	74
4MTL-40_	50.0	26.6	55.9	1.8	2.8	842/486/467	270	AWM	67	306	74
4MTL-50_	50.0	32.0	67.8	1.8	2.8	842/486/467	276	AWM	83	393	75

Conditions EN12900 - MT: Evaporating -10°C, Suction Superheat 10K, Pressure 90 bar, Temperature 35°C

** 3 Ph: 380-420V/ 50Hz

*** @ 1m: sound pressure level at 1m distance from the compressor, free field condition

Preliminary Data

Capacity Data

			Cooling Capacity (kW)					Power Input (kW)					
Model	Temperature (°C)	Pressure (bar)	Evaporating Temperature (°C)					Evaporating Temperature (°C)					
			-20	-15	-10	-5	0	-20	-15	-10	-5	0	
			Equivalent Evaporation Pressure (bar)					Equivalent Evaporation Pressure (bar)					
			19.7	22.9	26.5	30.5	34.9	19.7	22.9	26.5	30.5	34.9	
4MTL-05_	Condensing	10	45	11.0	13.5	16.4	19.8		3.1	3.0	2.7	2.4	
		15	50	9.9	12.3	14.9	18.0	21.5	3.4	3.4	3.2	3.0	2.6
		20	57	8.8	10.9	13.3	16.1	19.3	3.8	3.8	3.7	3.5	3.2
		25	64	7.6	9.5	11.6	14.1	16.9	4.1	4.2	4.1	4.0	3.8
		30	75	6.1	7.5	9.3	11.2	13.5	4.4	4.5	4.6	4.6	4.4
	Cool gas	35	90		7.14	8.8	10.8	13.0		5.3	5.5	5.6	5.6
		40	100			7.6	9.4	11.3			5.9	6.1	6.2
		40	110				9.7	11.75				6.5	6.7
4MTL-07_	Condensing	10	45	15.1	18.4	22.2	26.5		3.9	3.7	3.4	3.0	
		15	50	13.7	16.7	20.2	24.1	28.6	4.4	4.3	4.1	3.7	3.3
		20	57	12.2	14.9	18.1	21.6	25.7	4.8	4.8	4.7	4.5	4.1
		25	64	10.5	13.0	15.7	18.8	22.4	5.3	5.4	5.3	5.2	4.9
		30	75	8.3	10.3	12.5	15.0	17.9	5.7	5.9	6.0	5.9	5.7
	Cool gas	35	90		9.7	11.9	14.3	17.2		6.9	7.2	7.3	7.4
		40	100			10.2	12.4	14.9			7.7	8.0	8.2
		40	110				12.80	15.4				8.6	8.9
4MTL-09_	Condensing	10	45	18.4	22.4	27.0	32.2		4.7	4.5	4.2	3.7	
		15	50	16.6	20.3	24.5	29.4	34.9	5.3	5.2	4.9	4.6	4.0
		20	57	14.8	18.2	22.0	26.3	31.3	5.8	5.8	5.7	5.4	5.0
		25	64	12.8	15.8	19.2	23.0	27.4	6.4	6.5	6.5	6.3	6.0
		30	75	10.1	12.6	15.3	18.4	21.9	6.9	7.1	7.2	7.2	7.0
	Cool gas	35	90		11.9	14.6	17.7	21.1		8.4	8.7	8.9	9.0
		40	100			12.7	15.3	18.4			9.4	9.8	10.0
		40	110				15.9	19.0				10.6	10.9
4MTL-12_	Condensing	10	45	24.1	29.1	35.0	41.7		6.1	5.9	5.5	4.9	
		15	50	21.8	26.4	31.9	38.1	45.0	6.8	6.8	6.5	6.0	5.3
		20	57	19.5	23.7	28.6	34.3	40.6	7.6	7.6	7.4	7.0	6.5
		25	64	16.9	20.6	25.0	30.0	35.6	8.3	8.4	8.4	8.2	7.7
		30	75	13.5	16.4	20.0	24.1	28.6	9.0	9.3	9.4	9.3	9.0
	Cool gas	35	90	12.8	15.7	19.3	23.3	27.9	10.2	10.9	11.3	11.6	11.6
		40	100		13.6	16.8	20.4	24.4		11.5	12.2	12.6	12.8
		40	110			17.4	21.2	25.5			12.8	13.5	13.9
4MTL-15_	Condensing	10	45	31.2	37.9	45.6	54.4		7.9	7.6	7.1	6.3	
		15	50	28.3	34.5	41.6	49.7	58.7	8.8	8.7	8.4	7.8	6.9
		20	57	25.3	30.9	37.4	44.8	53.0	9.7	9.7	9.6	9.2	8.6
		25	64	22.0	26.9	32.7	39.3	46.6	10.5	10.8	10.8	10.7	10.2
		30	75	17.5	21.5	26.2	31.6	37.5	11.4	11.8	12.0	12.1	11.8
	Cool gas	35	90	16.5	20.5	25.2	30.5	36.5	13.1	13.8	14.4	14.8	15.0
		40	100		17.7	21.8	26.6	31.8		14.8	15.5	16.1	16.4
		40	110			22.5	27.5	33.1			16.6	17.3	17.9
4MTL-30_	Condensing	10	45	45.6	54.9	65.9	78.3		11.4	11.0	10.4	9.3	
		15	50	41.5	50.2	60.3	71.7	84.4	12.6	12.5	12.1	11.4	10.2
		20	57	37.2	45.1	54.3	64.7	76.3	13.9	14.0	13.9	13.4	12.5
		25	64	32.4	39.4	47.6	56.9	67.2	15.2	15.5	15.6	15.4	14.8
		30	75	25.9	31.6	38.3	45.8	54.2	16.4	16.9	17.3	17.4	17.1
	Cool gas	35	90	24.7	30.3	37.0	44.6	53.1	18.8	19.8	20.6	21.2	21.5
		40	100		26.3	32.2	39.0	46.5		21.2	22.2	23.0	23.6
		40	110			33.4	40.5	48.5			23.8	24.8	25.6

Conditions: Suction Superheat 10K / Subcooling 0K

Capacity Data (continued)

			Cooling Capacity (kW)					Power Input (kW)					
Model	Temperature (°C)	Pressure (bar)	Evaporating Temperature (°C)					Evaporating Temperature (°C)					
			-20	-15	-10	-5	0	-20	-15	-10	-5	0	
			Equivalent Evaporation Pressure (bar)					Equivalent Evaporation Pressure (bar)					
			19.7	22.9	26.5	30.5	34.9	19.7	22.9	26.5	30.5	34.9	
4MTL-35_	Condensing	10	45	55.8	68.0	82.0	97.9		14.1	13.4	12.5	11.0	
		15	50	50.5	61.7	74.6	89.3	106.0	15.8	15.4	14.8	13.6	12.0
		20	57	45.1	55.2	66.9	80.2	95.3	17.4	17.4	17.0	16.2	15.0
		25	64	39.2	48.2	58.5	70.3	83.6	18.9	19.2	19.2	18.8	17.9
		30	75	31.2	38.6	46.9	56.5	67.2	20.3	21.0	21.3	21.2	20.7
	Cool gas	35	90	29.7	37.0	45.3	54.8	65.5	22.7	24.2	25.3	26.0	26.3
		40	100		32.0	39.4	47.8	57.2		25.6	27.1	28.3	28.9
	40	110			40.6	49.5	59.5			28.9	30.4	31.5	
4MTL-40_	Condensing	10	45	69.0	83.1	99.7	118.5		16.5	15.9	14.7	13.0	
		15	50	62.8	75.8	91.1	108.5	128.0	18.5	18.2	17.4	16.1	14.1
		20	57	56.4	68.1	81.9	97.9	115.5	20.4	20.4	20.0	19.1	17.6
		25	64	49.3	59.6	71.8	85.9	101.5	22.4	22.7	22.6	22.1	21.1
		30	75	39.5	47.8	57.7	69.1	81.9	24.3	25.0	25.3	25.2	24.6
	Cool gas	35	90	38.1	46.2	55.9	67.2	79.9	28.2	29.4	30.4	31.1	31.4
		40	100		40.3	48.8	58.8	70.0		31.8	33.0	34.1	34.8
	40	110			50.8	61.2	73.1			35.6	36.9	37.9	
4MTL-50_	Condensing	10	45	82.8	99.7	119.5	142.0		20.2	19.6	18.4	16.7	
		15	50	75.6	91.1	109.5	130.5	153.5	22.6	22.3	21.5	20.0	18.0
		20	57	67.9	82.0	98.6	117.5	139.0	24.9	25.1	24.6	23.5	21.9
		25	64	59.5	71.9	86.5	103.5	122.0	27.3	27.8	27.8	27.2	25.9
		30	75	47.7	57.8	69.7	83.4	98.6	29.6	30.6	31.1	30.9	30.1
	Cool gas	35	90	46.2	56.0	67.8	81.4	96.7	33.9	35.9	37.4	38.3	38.6
		40	100		49.0	59.3	71.3	84.8		38.2	40.3	41.8	42.6
	40	110			61.9	74.5	88.8			42.6	44.7	46.2	

Conditions: Suction Superheat 10K / Subcooling 0K

Preliminary Data

Copeland™ Stream Compressors with Compressor Electronics for R744-Subcritical Applications Requiring High Standstill Pressures (90bar)

Stream series of 4 cylinder CO₂ compressors is the ideal solution for R744 low temperature cascade and booster systems requiring high standstill pressure of up to 90 bar suction. The use of transcritical compressors in medium / transcritical side as well as on the low temperature / subcritical side ensures that in case of power outage, the refrigeration system features full resilience and no operation disruption.

Stream is characterized by a design pressure of 135 bar. Refrigerant flow and heat transfer have been optimized for best performance. All compressors are equipped with a Copeland Compressor Electronics Technology and offer the possibility to diagnose system-related problems faster or even before they occur.



Copeland Stream compressor for low temperature applications with R744

Stream Compressor Line-up

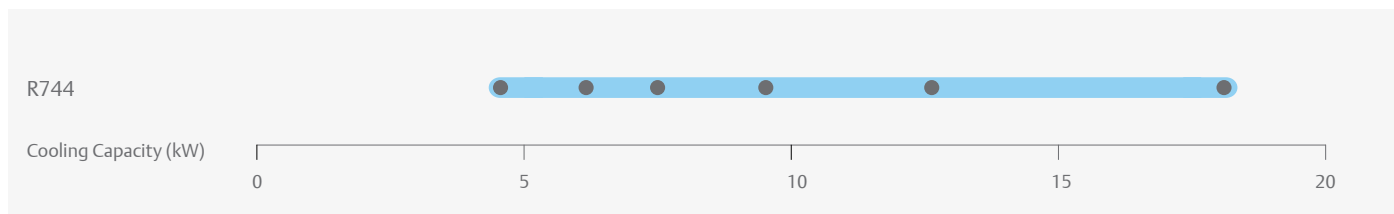

Conditions: EN12900 R744: Evaporating -35°C, condensing -5°C, superheat 10K, subcooling 0K

Features and Benefits

Stream provides for flexibility in pack design and operation:

- Compressor max. pressures (suction/discharge): 90 bar / 135 bar
- Compact dimensions
- Integrated low pressure relief valve
- Discharge temperature protection
- Service valve 360° rotation for ease of piping design
- 2 sight glasses for mounting of oil management control and visual inspection
- One oil port for oil equalization in parallel system
- Oil splasher system ensuring lubrication at constant and variable speed

Designed for durability and performance in R744 applications:

- Low sound, low vibration and large discharge chamber to eliminate pulsation
- Optimized motor selection for low temperature running conditions
- Burst pressures in excess of safety factor 3
- Cylinder head and discharge plenum design minimizing heat transfer to suction side
- Stepless capacity modulation via inverter from 25 to 70Hz
- Copeland compressor electronics technology for advanced protection, diagnostics, communication
- Individual compressor power consumption monitoring

Operating Envelope R744

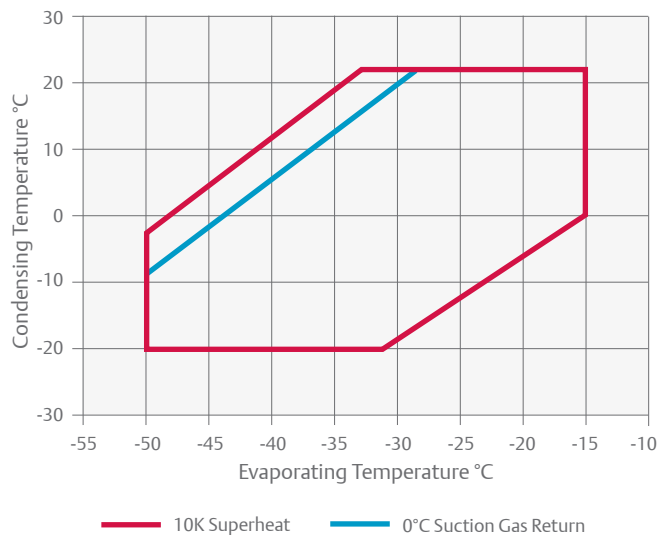

Technical Overview

Models	Nominal hp	Displacement (m ³ /h)	Capacity (kw)	COP	Oil Quantity (l)	Length/Width/Height (mm)	Net Weight (kg)	Motor Version/Code	Maximum Operating Current (A)	Locked Rotor Current (A)	Sound Pressure @1 m - dB(A)***
								3 Ph**	3 Ph**	3 Ph**	
4MSL-03_	3.0	4.6	7.1	3.3	1.3	630/425/410	120	EWL	7.0	50	76
4MSL-04_	4.0	6.2	9.7	3.5	1.3	630/425/410	120	EWL	8.8	50	76
4MSL-06_	6.0	7.4	12.2	3.7	1.3	630/425/410	120	EWL	10.5	62	76
4MSL-08_	8.0	9.5	15.9	3.6	1.8	697/444/423	170	AWM	13.9	87	76
4MSL-12_	12.0	12.5	21.0	3.7	1.8	697/445/422	170	AWM	18.7	145	76
4MSL-15_	15.0	18.0	31.0	3.8	1.8	697/445/422	170	AWM	25.7	156	76

Conditions EN12900 - LT: Evaporating -35°C, Condensing -5°C, Suction Superheat 10K, 0K Subcooling

** 3 Ph: 380-420V/ 50Hz

*** @ 1m: sound pressure level at 1m distance from the compressor, free field condition

Capacity Data

Condensing Temperature -10°C									
R744	Cooling Capacity (kW)				R744	Power Input (kW)			
	Evaporating Temperature (°C)					Evaporating Temperature (°C)			
Model	-45	-40	-35	-30	Model	-45	-40	-35	-30
4MSL-03_	4.6*	6.1*	7.8*	9.9*	4MSL-03X	1.9*	1.9*	1.9*	1.8*
4MSL-04_	6.2*	8.2*	10.6*	13.4*	4MSL-04X	2.4*	2.5*	2.5*	2.3*
4MSL-06_	7.6*	10.1*	13.0*	16.5*	4MSL-06X	2.8*	2.9*	2.9*	2.8*
4MSL-08_	10.3*	13.4*	17.1*	21.5*	4MSL-08X	3.8*	4.0*	3.9*	3.7*
4MSL-12_	13.8*	17.8*	22.7*	28.4*	4MSL-12X	4.9*	5.0*	5.0*	4.8*
4MSL-15_	20.3*	26.3*	33.4*	41.5*	4MSL-15X	7.0*	7.2*	7.2*	7.0*

Conditions: Suction Gas Return 20°C / Subcooling 0K

*Conditions: Suction Superheat 10K, Subcooling 0K

Service Compressors for 4 and 6 Cylinder S-Series and Discus Reciprocating Compressors

With the successful launch of Stream with Copeland compressor electronics technology 4M and 6M compressors, Emerson has decided to consolidate product families to allow our customers to reduce product proliferation and cost of operation. As a result, Emerson will in the future only produce the most efficient semi-hermetic reciprocating compressor platforms out of its current portfolio.

With a large number of 4 and 6 cylinder S-Series and Discus compressors operating in applications around the world, Emerson recognizes the importance of providing worry-free drop-in replacement models. The range of service compressors offers easy replacement (“like for like”) without the need of system adaptations.

More detailed information is available with our “Guidelines for replacement of S-Series and Discus compressors” available from your Emerson sales office or as download under climate.emerson.com/en-gb

For your product selection in case of replacement needs, please refer to the cross-reference table below. In addition, our local Application Engineering and Sales team is ready to support you.



Service Compressor

Discus Replacements

D4DF-100X	→	4MFS1-13_
D4DA-100X	→	4MFS1-13_
D4DA-200X	→	4MAS1-22_
D4DL-150X	→	4MLS1-15_
D4DH-150X	→	4MLS1-15_
D4DH-250X	→	4MHS1-25_
D4DT-220X	→	4MMS1-20_
D4DJ-200X	→	4MMS1-20_
D4DJ-300X	→	4MIS1-30_
D6DL-270X	→	6MLS1-27_
D6DH-200X	→	6MLS1-27_
D6DH-350X	→	6MHS1-35_
D6DT-320X	→	6MMS1-30_
D6DJ-300X	→	6MMS1-30_
D6DJ-400X	→	6MIS1-40_

*Valves are available as optional accessories.



Refrigeration Units

Refrigeration Units

Emerson offers the broadest and most reliable refrigeration unit product line-up. Leveraging the latest compressor technology, each platform provides you the option to select the refrigerant, capacity and application temperature combinations that meet your requirements. A huge variety of Copeland™ indoor and outdoor refrigeration units offer the right solution for applications in food retail and food service, commercial and industrial refrigeration.

Copeland scroll outdoor refrigeration units are designed and fully equipped for a quick and easy installation and ideal to integrate into urban environments. The latest scroll technology is combined with high-quality components and covered by a weatherproof housing in a unique design.

The Copeland ZX refrigeration unit series offers the highest energy efficiency available in a standard unit to lower operators' utility bills. Ranging in size from 1.2 to 7.5 hp, the ZX units are perfectly suited for typical food service and retail applications. The key benefits of compactness, silence and efficiency in the standard models will be enhanced by the capability of continuous capacity modulation of the ZX digital models. This makes ZX digital refrigeration units the perfect fit for applications with wide load variations.



Copeland scroll indoor refrigeration units are equipped with the latest refrigeration scroll compressors and constitute the widest range of their kind. The modular line concept offers base units which can be adapted to the target application by various options including weather housings and fan speed controls.

Copeland scroll digital receiver units HLR are an innovative offering for food service and retail businesses. Their compact design and the power of digital scroll continuous capacity modulation enable optimized environmental integration with highest system efficiency.

Semi-hermetic refrigeration units: robust, reliable and efficient air-cooled refrigeration unit platforms featuring semi-hermetic reciprocating compressor technology are for use in high-medium- and low-temperature applications. Emerson has expanded its semi-hermetic product range by the innovative Stream indoor refrigeration units which complete a product range from 0.8 - 40 hp with dedicated refrigerant approvals for R407A/F, R448A/ R449A, R404A, R134a, R450A and R513A.

Copeland™ Large Outdoor Refrigeration Units

Copeland air-cooled outdoor refrigeration units for medium-temperature and low-temperature applications.

Emerson has developed this series of refrigeration units especially for outdoor use. They feature the latest technology in an assembly of high quality components which are adjusted for efficient and reliable operation.

The line-up offers state-of-the-art technology and models featuring stepless capacity control, vapor injection and fan speed control. This makes it the first choice for target applications in food retail and food service:

- Proximity and convenience stores
- Mini markets and supermarkets
- Bars, restaurants and kitchens
- Beer cellars and beverage coolers



Copeland outdoor refrigeration unit with scroll compressors

OL/OM Line-up

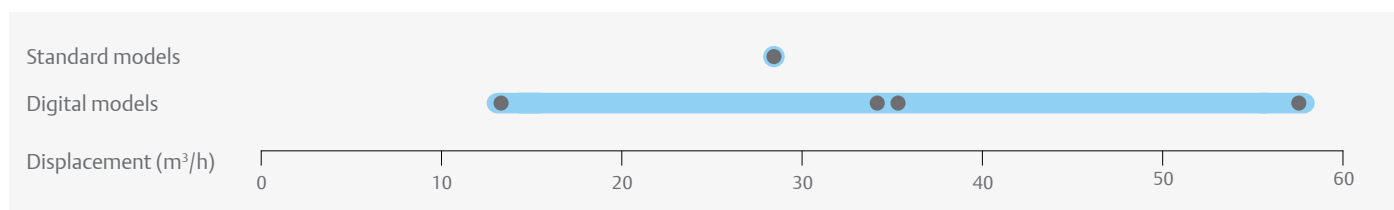

Features and Benefits

- Standard equipment: scroll compressor(s), crankcase heater(s), condenser with thermally protected fan(s), fan speed control, HP and LP switch, and EC fan(s)
- Suitable for multiple refrigerants: R407A/F, R448A/ R449A, R404A, R134a, R450A and R513A
- Wide range of quality accessories
- Excellent efficiency
- Filter drier, liquid sight glass and solenoid valve in liquid line
- Minimize capital investment
- Designed to the quality requirements of the retail sector
- Ready for heat recovery
- Liquid level control
- Remote monitoring capability (Modbus)

Maximum Allowable Pressure (PS)

- Low Side PS 22.5 bar (g)
- High Side PS 28 bar (g)

Technical Overview

Models	Displacement (m ³ /h)	Receiver Capacity (l)	Number of fans	Total Fan Motor Power (W)	Suction Line Diameter (inch)	Liquid Line Diameter (inch)	Width/Depth/Height (mm)	Net Weight (kg)	Motor Version/Code	Maximum Operating Current (A)	Locked Rotor Current (A)	Sound Pressure
									3 Ph**	3 Ph**	3 Ph**	@10m - d(BA)***
Digital Medium Temperature Models												
OMTE-76D	28.7	20.0	1	480	1 3/8	5/8	1574/920/1135	345	TFD	11+13	64+66	45
OMTE-90D	34.1	20.0	1	480	1 3/8	5/8	1574/920/1135	348	TFD	12+13	2x74	45
OMTE-152D	57.6	30.0	2	826	1 5/8	7/8	2300/920/1135	508	TFD	24+20	2x118	47
Low Temperature Models												
OLE-49	42.4	20.0	1	410	1 3/8	1/2	1574/920/1135	318	TFD	30.0	139	46
Low Temperature Digital Models												
OLTE-82D	70.7	30.6	2	684	1 5/8	7/8	2300/920/1135	511	TFD	2x29	2x118	47

Conditions EN13215: R448A/R449A, Evaporating Temperature MT -10°C/ LT -35°C, Ambient Temperature 32°C, Suction Gas Return 20°C

** 3 Ph: 380-420V/50Hz

*** @ 10m: sound pressure level at 10m distance from the compressor, free field condition

Capacity Data

Ambient Temperature: 32°C															
R407A	Cooling Capacity (kW)							R407A	Power Input (kW)						
	Evaporating Temperature (°C)								Evaporating Temperature (°C)						
	-45	-35	-30	-20	-10	-5	+5		-45	-35	-30	-20	-10	-5	+5
Digital Medium Temperature Models															
OMTE-76D				11.35	17.37	20.95	29.06	OMTE-76D				7.04	7.57	7.92	8.75
OMTE-90D				13.12	19.52	23.29	32.00	OMTE-90D				8.54	9.23	9.58	10.38
OMTE-152D				22.19	34.86	42.35	58.67	OMTE-152D				14.26	15.30	16.27	18.23

Conditions: EN13215: Suction Gas Return 20°C, Subcooling 0K

Preliminary Data

For detailed capacity data please refer to Emerson's Select software

Ambient Temperature: 32°C															
R407F	Cooling Capacity (kW)							R407F	Power Input (kW)						
	Evaporating Temperature (°C)								Evaporating Temperature (°C)						
	-45	-35	-30	-20	-10	-5	+5		-45	-35	-30	-20	-10	-5	+5
Digital Medium Temperature Models															
OMTE-76D				11.00	17.30	20.90	29.40	OMTE-76D				7.90	8.30	8.60	9.30
OMTE-90D				13.00	19.90	24.00	33.60	OMTE-90D				9.00	9.70	10.10	11.10
OMTE-152D				22.70	37.50	45.50	62.80	OMTE-152D				14.90	16.20	17.20	19.40

Conditions: EN13215: Suction Gas Return 20°C, Subcooling 0K

Preliminary Data

For detailed capacity data please refer to Emerson's Select software

Capacity Data

Ambient Temperature: 32°C															
R448A / R449A	Cooling Capacity (kW)							R448A / R449A	Power Input (kW)						
	Evaporating Temperature (°C)								Evaporating Temperature (°C)						
	-45	-35	-30	-20	-10	-5	+5		-45	-35	-30	-20	-10	-5	+5
Digital Medium Temperature Models															
OMTE-76D				11.05	16.60	19.70	26.80	OMTE-76D				7.27	8.25	8.80	10.10
OMTQ-90D				12.95	19.50	23.20	31.50	OMTQ-90D				8.20	9.32	9.94	11.40
OMTE-152D					34.70	41.50	56.80	OMTE-152D					16.20	17.10	19.40
Low Temperature Models															
OLE-49		9.35	11.96	18.87	27.21			OLE-49		7.70	7.78	8.42	9.41		
Digital Low Temperature Models															
OLTE-82D		13.50	17.00	25.60	35.90			OLTE-82D		13.90	15.05	18.00	21.90		

Conditions: EN13215: Suction Gas Return 20°C, Subcooling 0K

For detailed capacity data please refer to Emerson's Select software

* Conditions: EN13215: Suction Superheat 10K

Preliminary Data

Ambient Temperature: 32°C															
R513A	Cooling Capacity (kW)							R513A	Power Input (kW)						
	Evaporating Temperature (°C)								Evaporating Temperature (°C)						
	-45	-35	-30	-20	-10	-5	+5		-45	-35	-30	-20	-10	-5	+5
Digital Medium Temperature Models															
OMTE-76D				7.68	12	14.75	21.5	OMTE-76D				4.4	4.63	4.75	5.03
OMTE-90D				9.04	14.15	17.35	25.2	OMTE-90D				5.09	5.39	5.56	6.01
OMTE-152D				14.9	23.1	28.1	39.9	OMTE-152D				9.65	10.5	10.9	11.75

Conditions: EN13215: Suction Gas Return 20°C, Subcooling 0K

For detailed capacity data please refer to Emerson's Select software

Preliminary Data

Capacity Data

Ambient Temperature: 32°C															
R404A	Cooling Capacity (kW)							R404A	Power Input (kW)						
	Evaporating Temperature (°C)								Evaporating Temperature (°C)						
	-45	-35	-30	-20	-10	-5	+5		-45	-35	-30	-20	-10	-5	+5
Digital Medium Temperature Models															
OMTE-76D				11.97	16.69	19.35	25.24	OMTE-76D				7.94	8.77	9.21	10.13
OMTE-90D				13.38	19.08	22.34	29.58	OMTE-90D				9.93	10.93	11.51	12.92
OMTE-152D				25.17	35.78	41.66	54.36	OMTE-152D				16.58	18.01	18.81	20.51
Low Temperature Models															
OLE-49		10.25	12.85	19.55	27.95			OLE-49		7.63	8.05	9.13	10.26		
Digital Low Temperature Models															
OLTE-82D		16.60	20.16	28.28	37.81	43.07		OLTE-82D		13.86	15.07	17.71	20.72	22.38	

Conditions: EN13215: Suction Gas Return 20°C, Subcooling 0K
Preliminary Data

For detailed capacity data please refer to Emerson's Select software

Ambient Temperature: 32°C															
R134a	Cooling Capacity (kW)							R134a	Power Input (kW)						
	Evaporating Temperature (°C)								Evaporating Temperature (°C)						
	-45	-35	-30	-20	-10	-5	+5		-45	-35	-30	-20	-10	-5	+5
Digital Medium Temperature Models															
OMTE-76D					10.75	13.05	18.55	OMTE-76D					4.96	5.20	5.77
OMTE-90D					12.50	15.15	21.60	OMTE-90D					5.79	6.11	6.85
OMTE-152D					21.80	26.60	22.30	OMTE-152D					10.10	10.50	11.45

Conditions: EN13215: Suction Gas Return 20°C, Subcooling 0K
Preliminary Data

For detailed capacity data please refer to Emerson's Select software

Copeland™ Outdoor Refrigeration Units for R744-Transcritical Applications

With this range of outdoor refrigeration units, Emerson offers a solution which responds to the increasing demand for future proof refrigeration technology.

These models are designed for operation with the natural refrigerant CO₂ which has a very low global warming potential (GWP) of only 1.

The range features the latest technology like Stream series compressors which are characterized by their silent and reliable operation. The integrated frequency inverter controls the compressor speed exactly to the capacity demand of the application. EC-fans remove the heat from the gas cooler in the most efficient and silent way.

The state of the art electronic controller allows for precise adjustment and control of all relevant parameters and comprises numerous electronic protection functions for highly reliable operation.

The refrigeration units are future-proof choice for various target applications:

- Convenience stores
- Forecourt sites
- Cold rooms
- Fast food stores, bars and restaurants



Copeland outdoor refrigeration unit for R744-transcritical applications

R744 Refrigeration Unit Line-up

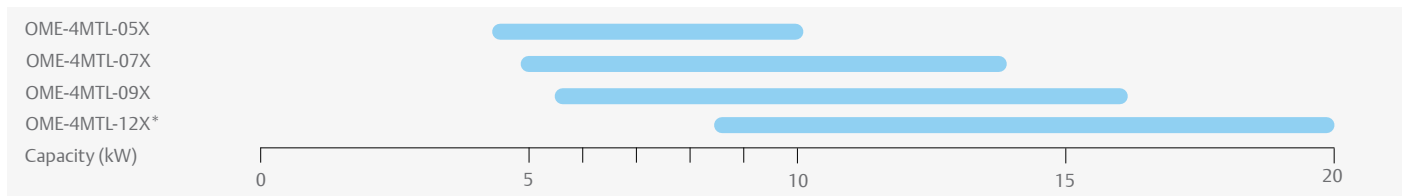

* Preliminary Data

Technical Overview

Model	Displacement @ 50 Hz (m ³ /h)	Cooling Capacity @ 50 Hz (kW)	Receiver Capacity (l)	Suction Line Diameter (inch)	Liquid Line Diameter (inch)	Width/Depth/Height (mm)	Net Weight (kg)	Power Supply	Nominal Current (A)	Sound Pressure @10m - d(BA)*
OME-4MTL-05X (HP**)	4.6	8.69	24.9	3/4	5/8	1574/920/1135	450	3/N/PE ~ 50Hz 400/230V TN-S	19	42 - 44
OME-4MTL-07X (HP**)	6.2	11.80		3/4	5/8	1574/920/1135	450		22	42 - 44
OME-4MTL-09X (HP**)	7.4	14.25		7/8	5/8	1574/920/1135	462		27	42 - 44
OME-4MTL-12X	9.5	17.00		7/8	5/8	1574/920/1135	473		33	45 - 47

Conditions EN13215: R744, evaporating temperature -10°C, ambient temperature 32°C, suction superheat 10 K

* @ 10m: sound pressure level at 10m distance from the compressor, free field condition

** 90 bar liquid line.

Preliminary Data

For detailed capacity data please refer to Emerson's Select software

Features and Benefits

- Future-proof solution with natural GWP 1 refrigerant, not impacted by F-Gas legislation
- Low carbon footprint
- Silent operation due to special attenuation on panels and sound optimized EC fans
- High energy efficiency through inverter controlled compressor and EC fans
- Space saving design
- Time saving commissioning by pre-set parameters
- High reliability with electronic protection against incorrect voltage, phase, current and discharge temperature
- State of the art controller for precise system control
- Modbus communication and monitoring functionality
- LCD Display to show the operation status
- OilWatch maintains correct system oil level
- Controller prepared for heat recovery
- Easy access for time saving service
- Built and tested in advanced industrial processes
- Individual compressor power consumption monitoring

Design Pressure:

- 90 bar in receiver and liquid line
- 120 bar on high-pressure side

Copeland™ ZX Outdoor Refrigeration Units for A2L Refrigerants

Copeland ZX outdoor refrigeration units combine efficient Copeland scroll technology with compact cabinet design and noise attenuation features, that enable legal compliance for applications with A2L refrigerants. The new range is specifically designed to cater for a wide range of refrigeration applications which request a low GWP and future-proof solution.

Copeland ZX units feature the most complete and unique equipment. The modified design, the innovative control logic and a selection of dedicated components enable legal compliance for applications with A2L refrigerants. The advanced electronic controller enables precise parameter control and displays the system status. Electronic protection functions, oil separator and suction accumulator guarantee optimum system safety. The range is completed by models with stepless digital capacity modulation which are well established in applications with multiple evaporators and precise temperature control.

The new Copeland series of outdoor refrigeration units are specifically designed to cater for a wide range of refrigeration applications which request a low GWP and future-proof solution:

- Convenience stores
- Cold rooms
- Fast food chains and restaurants
- Beverage coolers



Copeland ZX outdoor refrigeration units for A2L refrigerants

Capacity Line-up

ZX

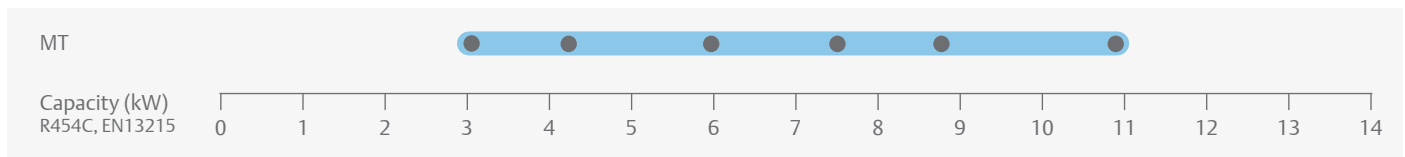

ZX Digital

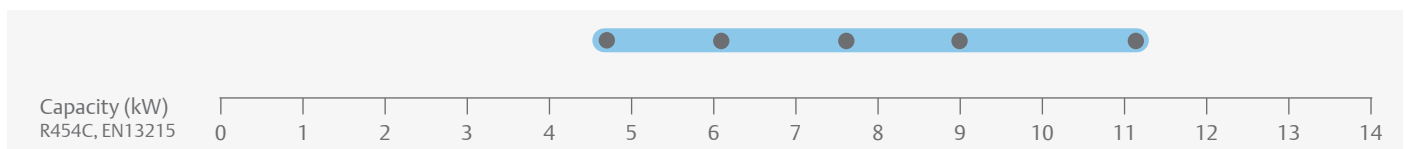

Features and Benefits

- Standard equipment: Copeland scroll compressor, crankcase heater, electronic controller, liquid receiver, service valves, filter drier & sight glass, external main power switch, fan speed control
- Oil separator (ZX Digital) and suction accumulator (ZX Digital & Low Temperature models)
- Multiple refrigerant approvals incl. R404A, R407A, R407F, R448A, R449A, R134a, R450A, R513A, R454A, R454C, R455A, R1234yf
- ZX Digital models allow for 10% to 100% continuous capacity modulation
- Electronic unit controller with intelligent protection and diagnostics capabilities
- Energy and operation cost saving due to excellent energy efficiency
- Quiet operation due to new fans with improved sound level, Copeland scroll compressor, and fan speed control
- Space saving due to compact dimensions
- Easy and quick installation

Technical Overview

Models	Displacement (m ³ /h)	Receiver Capacity (l)	Number of fans	Total Fan Motor Power (W)	Suction Line Diameter (inch)	Liquid Line Diameter (inch)	Width/Depth/Height (mm)	Net Weight (kg)	Motor Version/Code	Maximum Operating Current (A)	Locked Rotor Current (A)	Sound Pressure
									3 Ph **	3 Ph **	3 Ph **	@10m - d(BA) **
Medium Temperature Models												
ZXMY-020E	5.8	4.1	1	115	3/4	1/2	446/1035/840	76	TFM	4.2	26	38
ZXMY-030E	8.0	4.1	1	115	3/4	1/2	446/1035/840	79	TFM	5.5	32	39
ZXMY-040E	11.4	4.1	1	115	3/4	1/2	446/1035/840	91	TFM	7.8	50	39
ZXMY-050E	14.4	5.9	2	230	7/8	1/2	446/1035/1244	108	TFM	10.1	64	40
ZXMY-060E	17.1	5.9	2	230	7/8	1/2	446/1035/1244	112	TFM	11.8	74	40
ZXMY-075E	21.4	5.9	2	230	7/8	1/2	446/1035/1244	118	TFM	15.9	102	41
Digital Medium Temperature Models												
ZXDY-030E	8.0	4.1	1	115	3/4	1/2	446/1035/840	79	TFM	6.7	40	39
ZXDY-040E	11.4	5.9	2	230	7/8	1/2	446/1035/1244	104	TFM	10.0	48	39
ZXDY-050E	14.4	5.9	2	230	7/8	1/2	446/1035/1244	108	TFM	11.3	64	40
ZXDY-060E	17.1	5.9	2	230	7/8	1/2	446/1035/1244	112	TFM	12.3	74	40
ZXDY-075E	21.4	5.9	2	230	7/8	1/2	446/1035/1244	118	TFM	15.9	102	41

* 3ph: 380-420V/ 50Hz

** @ 10m: sound pressure level at 10m distance from the compressor, free field condition

Capacity Data

Ambient Temperature: 32°C															
R454A	Cooling Capacity (kW)							R454A	Power Input (kW)						
	Evaporating Temperature (°C)								Evaporating Temperature (°C)						
Model	-45	-35	-30	-20	-10	-5	+5	Model	-45	-35	-30	-20	-10	-5	+5
Medium Temperature Models															
ZXMY-020E				2.47	3.60	4.28	5.83	ZXMY-020E				1.44	1.62	1.72	1.96
ZXMY-030E				3.42	4.96	5.87	7.99	ZXMY-030E				1.96	2.17	2.30	2.63
ZXMY-040E				4.82	6.94	8.19	11.05	ZXMY-040E				2.81	3.16	3.35	3.80
ZXMY-050E				6.11	8.86	10.50	14.20	ZXMY-050E				3.39	3.85	4.11	4.69
ZXMY-060E				7.16	10.35	12.20	16.40	ZXMY-060E				4.00	4.58	4.90	5.65
ZXMY-075E				8.92	12.80	15.00	20.00	ZXMY-075E				5.16	5.96	6.41	7.43
Digital Medium Temperature Models															
ZXDY-030E				3.71	5.35	6.31	8.54	ZXDY-030E				2.19	2.44	2.60	2.98
ZXDY-040E				4.93	7.21	8.58	11.86	ZXDY-040E				2.82	3.10	3.25	3.58
ZXDY-050E				6.15	8.69	10.62	14.46	ZXDY-050E				3.41	3.85	4.09	4.65
ZXDY-060E				7.31	10.61	12.52	16.86	ZXDY-060E				4.07	4.65	4.96	5.71
ZXDY-075E				9.04	13.06	15.39	20.64	ZXDY-075E				5.06	5.79	6.20	7.17

Conditions: EN13215: Suction Gas Return 20°C, Subcooling 0K

Preliminary Data

For detailed capacity data please refer to Emerson's Select software

Capacity Data

Ambient Temperature: 32°C															
R454C	Cooling Capacity (kW)							R454C	Power Input (kW)						
	Evaporating Temperature (°C)								Evaporating Temperature (°C)						
Model	-45	-35	-30	-20	-10	-5	+5	Model	-45	-35	-30	-20	-10	-5	+5
Medium Temperature Models															
ZXMY-020E				2.09	3.05	3.62	4.95	ZXMY-020E				1.24	1.39	1.47	1.66
ZXMY-030E				2.91	4.23	5.01	6.83	ZXMY-030E				1.68	1.84	1.94	2.20
ZXMY-040E				4.12	5.94	7.03	9.53	ZXMY-040E				2.38	2.64	2.80	3.15
ZXMY-050E				5.20	7.53	8.90	12.10	ZXMY-050E				2.90	3.26	3.46	3.93
ZXMY-060E				6.08	8.77	10.35	13.95	ZXMY-060E				3.39	3.85	4.10	4.70
ZXMY-075E				7.60	10.90	12.80	17.10	ZXMY-075E				4.38	4.99	5.34	6.17
Digital Medium Temperature Models															
ZXDY-030E				3.15	4.7	5.42	7.39	ZXDY-030E				1.88	2.06	2.17	2.49
ZXDY-040E				4.16	6.12	7.32	10.18	ZXDY-040E				2.54	2.65	2.76	3.00
ZXDY-050E				5.20	7.59	9.03	12.40	ZXDY-050E				2.94	3.26	3.45	3.86
ZXDY-060E				6.00	8.97	10.64	14.84	ZXDY-060E				3.48	3.91	4.15	4.70
ZXDY-075E				7.66	11.11	13.14	17.79	ZXDY-075E				4.32	4.86	5.16	5.89

Conditions: EN13215: Suction Gas Return 20°C, Subcooling 0K
Preliminary Data

For detailed capacity data please refer to Emerson's Select software

Ambient Temperature: 32°C															
R455A	Cooling Capacity (kW)							R455A	Power Input (kW)						
	Evaporating Temperature (°C)								Evaporating Temperature (°C)						
Model	-45	-35	-30	-20	-10	-5	+5	Model	-45	-35	-30	-20	-10	-5	+5
Medium Temperature Models															
ZXMY-020E				2.14	3.10	3.67	4.98	ZXMY-020E				1.35	1.54	1.65	1.87
ZXMY-030E				3.01	4.33	5.11	6.89	ZXMY-030E				1.83	2.05	2.19	2.52
ZXMY-040E				4.26	6.06	7.12	9.58	ZXMY-040E				2.60	2.96	3.15	3.60
ZXMY-050E				5.37	7.69	9.06	12.20	ZXMY-050E				3.16	3.63	3.90	4.48
ZXMY-060E				6.29	8.99	10.55	14.20	ZXMY-060E				3.69	4.29	4.61	5.36
ZXMY-075E				7.87	11.15	13.10	17.40	ZXMY-075E				4.77	5.57	6.01	7.00
Digital Medium Temperature Models															
ZXDY-030E				3.24	4.70	5.58	7.63	ZXDY-030E				2.07	2.28	2.41	2.74
ZXDY-040E				4.27	6.24	7.45	10.43	ZXDY-040E				2.70	2.94	3.17	3.53
ZXDY-050E				5.34	7.79	9.27	12.81	ZXDY-050E				3.23	3.62	3.83	4.29
ZXDY-060E				6.34	9.23	10.96	14.99	ZXDY-060E				3.81	4.33	4.61	5.23
ZXDY-075E				7.88	11.42	13.53	18.41	ZXDY-075E				4.76	5.39	5.75	6.55

Conditions: EN13215: Suction Gas Return 20°C, Subcooling 0K
Preliminary Data

For detailed capacity data please refer to Emerson's Select software

Ambient Temperature: 32°C															
R1234yf	Cooling Capacity (kW)							R1234yf	Power Input (kW)						
	Evaporating Temperature (°C)								Evaporating Temperature (°C)						
Model	-45	-35	-30	-20	-10	-5	+5	Model	-45	-35	-30	-20	-10	-5	+5
Medium Temperature Models															
ZXMY-020E					2.07	2.54	3.71	ZXMY-020E					0.96	1.01	1.11
ZXMY-030E				1.86	2.88	3.53	5.14	ZXMY-030E				1.14	1.25	1.32	1.48
ZXMY-040E				2.62	4.03	4.92	7.11	ZXMY-040E				1.61	1.78	1.87	2.07
ZXMY-050E				3.34	5.15	6.28	9.06	ZXMY-050E				2.00	2.20	2.32	2.60
ZXMY-060E				3.86	5.96	7.26	10.45	ZXMY-060E				2.34	2.58	2.73	3.06
ZXMY-075E				4.89	7.46	9.06	12.90	ZXMY-075E				2.95	3.29	3.49	3.98
Digital Medium Temperature Models															
ZXDY-030E				2.22	3.31	3.97	5.56	ZXDY-030E				1.25	1.39	1.47	1.66
ZXDY-040E				2.94	4.41	5.32	7.55	ZXDY-040E				1.68	1.83	1.91	2.09
ZXDY-050E				3.70	5.51	6.61	9.26	ZXDY-050E				1.99	2.21	2.33	2.62
ZXDY-060E				4.34	6.48	7.77	10.80	ZXDY-060E				2.37	2.62	2.77	3.13
ZXDY-075E				5.45	8.06	9.64	13.32	ZXDY-075E				2.90	3.24	3.44	3.93

Conditions: EN13215: Suction Superheat 10K
Preliminary Data

For detailed capacity data please refer to Emerson's Select software

Copeland™ ZX Outdoor Refrigeration Units with Scroll Compressors

Copeland compact outdoor refrigeration units are for medium-temperature and low-temperature applications.

With this new range of outdoor refrigeration units, Emerson offers a solution for refrigeration applications with space and noise constraints which responds to the increasing demand for energy-efficient refrigeration solutions units.

Copeland ZX outdoor refrigeration units feature the most complete and unique equipment. Their advanced electronic controller enables precise parameter control and displays the system status. Vapor injection and liquid injection technology significantly increase system efficiency and operation map. Electronic protection functions, oil separator and suction accumulator guarantee optimum system safety.

Lowest life cycle costs and comprehensive safety features make Copeland ZX a cost efficient and reliable choice for:

- Convenience stores
- Cold rooms
- Fast food stores, bars and restaurants
- Beverage coolers



Copeland ZX outdoor refrigeration units with scroll compressors

Copeland ZX Line-up

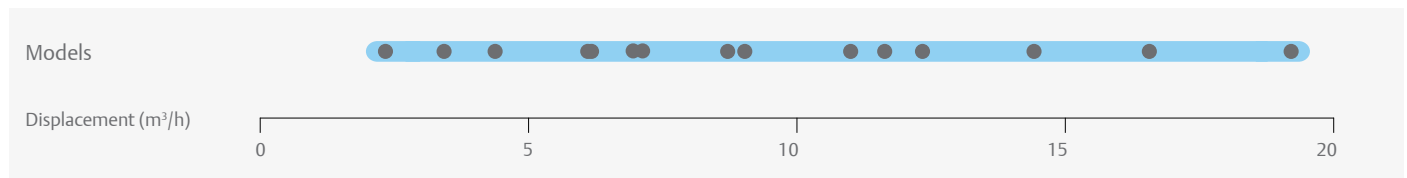

Copeland ZX Digital Line-up

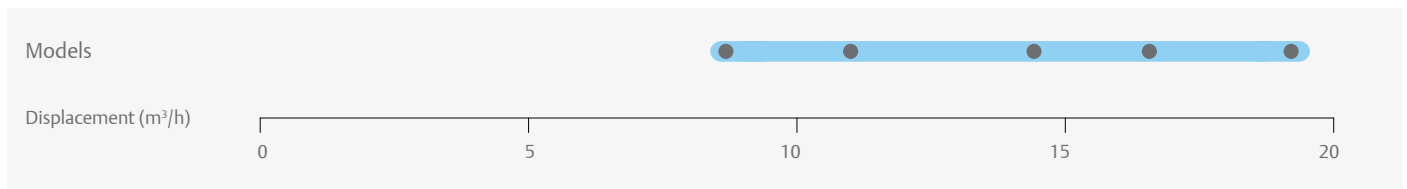

Features and Benefits

- Standard equipment: Copeland scroll compressor, crankcase heater, electronic controller, fan(s) with speed control, liquid receiver, safety switches, filter drier and sight glass, oil separator and suction accumulator (LT models only)
- Copeland ZX digital models allow for 10% to 100% continuous capacity modulation
- Diagnostic capabilities protect the unit from over-current, phase loss and phase imbalance
- LED display shows real time system status
- Precise electronic suction pressure control
- Energy and operation cost saving due to excellent energy efficiency
- Noise attenuation due to low speed fan motors with sickle blades, fan speed control and sound jacket
- High capacity vapor injection technology for LT models
- Space saving due to compact dimensions
- Easy and quick installation
- Multiple refrigerant approvals incl. R407A/F, R448A/R449A, R404A, R134a, R450A and R513A

Maximum Allowable Pressures (PS)

- Low Side PS 22.5 bar (g)
- High Side PS 28.8 bar (g)

Technical Overview

Model	Displacement (m ³ /h)	Receiver Capacity (l)	Number of fans	Total Fan Motor Power (W)	Suction Line Diameter (inch)	Liquid Line Diameter (inch)	Width/Depth/Height (mm)	Net Weight (kg)	Motor Version/Code		Maximum Operating Current (A)		Locked Rotor Current (A)		Sound Pressure @10m - d(BA)***	
									1 Ph*	3 Ph**	1 Ph*	3 Ph**	1 Ph*	3 Ph**		
Medium Temperature Models																
ZXME020E	5.9	4.1	1	116	3/4	1/2	446/1035/840	76	PFJ	TFD	13	5	58	26	39	
ZXME025E	6.8	4.1	1	116	3/4	1/2	446/1035/840	79	PFJ	TFD	12	5	61	38	40	
ZXME030E	8.6	4.1	1	116	3/4	1/2	446/1035/840	79	PFJ	TFD	16	7	82	40	40	
ZXME040E	11.4	4.1	1	116	3/4	1/2	446/1035/840	91	PFJ	TFD	24	10	114	49	40	
ZXME050E	17.1	5.9	2	246	7/8	1/2	447/1035/1244	108		TFD		13		66	41	
ZXME060E	18.8	5.9	2	246	7/8	1/2	447/1035/1244	112		TFD		13		74	41	
ZXME075E	11.9	5.9	2	246	7/8	1/2	447/1035/1244	118		TFD		14		101	42	
Digital Medium Temperature Models																
ZXDE-030E	8.3	4.1	1	116	3/4	1/2	446/1035/840	79		TFD		7		40	40	
ZXDE-040E	11.4	5.9	2	246	7/8	1/2	447/1035/1244	104		TFD		8		48	40	
ZXDE-050E	14.4	5.9	2	246	7/8	1/2	447/1035/1244	108		TFD		11		64	41	
ZXDE-060E	17.1	5.9	2	246	7/8	1/2	447/1035/1244	112		TFD		11		74	41	
ZXDE-075E	18.8	5.9	2	246	7/8	1/2	447/1035/1244	118		TFD		14		100	42	
Low Temperature Models																
ZXLE020E	6.1	4.1	1	116	3/4	1/2	446/1035/840	79	PFJ	TFD	14	6	57	39	39	
ZXLE025E	7.1	4.1	1	116	3/4	1/2	446/1035/840	79	PFJ		16		74		39	
ZXLE030E	8.0	4.1	1	116	3/4	1/2	446/1035/840	81	PFJ	TFD	18	7	82	36	40	
ZXLE040E	12.7	4.1	1	116	7/8	1/2	446/1035/840	93		TFD		9		52	40	
ZXLE050E	14.4	5.9	2	246	7/8	1/2	447/1035/1244	106		TFD		12		52	41	
ZXLE060E	17.1	5.9	2	246	7/8	1/2	447/1035/1244	116		TFD		14		74	41	
ZXLE075E	18.8	5.9	2	246	7/8	1/2	447/1035/1244	121		TFD		15		101	41	

* 1ph: 230V/ 50Hz

** 3 Ph: 380-420V/ 50Hz

*** @ 10m: sound pressure level at 10m distance from the compressor, free field condition

Capacity Data

Ambient Temperature: 32°C															
R407A	Cooling Capacity (kW)							R407A	Power Input (kW)						
	Evaporating Temperature (°C)								Evaporating Temperature (°C)						
	-45	-35	-30	-20	-10	-5	+5		-45	-35	-30	-20	-10	-5	+5
Medium Temperature Models															
ZXME020E					3.48	4.13	5.60	ZXME020E					1.67	1.68	1.73
ZXME025E				2.78	4.02	4.78	6.67	ZXME025E				1.52	1.66	1.74	1.93
ZXME030E					4.92	5.93	8.30	ZXME030E					2.27	2.38	2.57
ZXME040E					6.26	7.51	10.30	ZXME040E					3.24	3.39	3.77
ZXME050E					8.65	10.35	14.40	ZXME050E					3.73	3.90	4.26
ZXME060E					9.75	11.75	16.35	ZXME060E					4.33	4.53	4.99
ZXME075E					11.25	13.55	18.85	ZXME075E					4.85	5.07	5.59
Low Temperature Models															
ZXLE020E		1.39	1.82	2.87	4.16	4.90	6.53	ZXLE020E		1.41	1.48	1.62	1.76	1.84	1.99
ZXLE025E**		1.63	2.13	3.36	4.91	5.79	7.77	ZXLE025E**		1.63	1.73	1.89	2.03	2.10	2.24
ZXLE030E		1.98	2.51	3.81	5.51	6.52	8.88	ZXLE030E		1.82	1.93	2.11	2.28	2.36	2.55
ZXLE040E		3.04	3.83	5.67	7.87	9.08		ZXLE040E		2.76	2.97	3.43	3.95	4.25	
ZXLE050E		3.50	4.42	6.63	9.37	10.90	14.35	ZXLE050E		3.08	3.27	3.69	4.15	4.41	5.01
ZXLE060E		4.16	5.18	7.64	10.70	12.45	16.40	ZXLE060E		4.01	4.29	4.87	5.54	5.93	6.88
ZXLE075E		4.68	5.86	8.75	12.45	14.65	19.75	ZXLE075E		4.18	4.43	4.92	5.46	5.77	6.52
Digital Medium Temperature Models															
ZXDE-030E					5.08	5.98	7.95	ZXDE-030E					2.13	2.23	2.41
ZXDE-040E				4.72	7.28	8.84	12.50	ZXDE-040E				2.70	2.84	2.93	3.13
ZXDE-050E				5.83	8.65	10.35	14.40	ZXDE-050E				3.47	3.73	3.90	4.26
ZXDE-060E				6.38	9.75	11.75	16.35	ZXDE-060E				4.03	4.33	4.53	4.99
ZXDE-075E				7.35	11.25	13.55	18.85	ZXDE-075E				4.51	4.85	5.07	5.59

Conditions: EN13215: Suction Gas Return 20°C, Subcooling 0K
 ** Single Phase Only
 Preliminary Data

For detailed capacity data please refer to Emerson's Select software

Capacity Data

Ambient Temperature: 32°C															
R407F	Cooling Capacity (kW)							R407F	Power Input (kW)						
	Evaporating Temperature (°C)								Evaporating Temperature (°C)						
	-45	-35	-30	-20	-10	-5	+5		-45	-35	-30	-20	-10	-5	+5
Medium Temperature Models															
ZXME020E					3.37	4.05	5.68	ZXME020E					1.62	1.65	1.74
ZXME025E				2.91	4.20	4.99	6.95	ZXME025E				1.60	1.75	1.84	2.05
ZXME030E					4.92	5.93	8.29	ZXME030E					2.27	2.38	2.57
ZXME040E					6.52*	7.95	10.85	ZXME040E					3.33*	3.54	3.99
ZXME050E				5.68*	8.64	10.35	14.40	ZXME050E				3.46*	3.73	3.90	4.26
ZXME060E				6.17*	9.74	11.75	16.35	ZXME060E				4.01*	4.33	4.53	4.99
ZXME075E				7.14*	11.20	13.55	18.85	ZXME075E				4.49*	4.85	5.07	5.59
Low Temperature Models															
ZXLE020E		1.46	1.91	3.01	4.36	5.12	6.81	ZXLE020E		1.48	1.56	1.71	1.88	1.96	2.14
ZXLE025E**		1.71	2.23	3.52	5.14	6.06	8.11	ZXLE025E**		1.72	1.83	2.01	2.16	2.24	2.40
ZXLE030E		2.08	2.64	4.00	5.76	6.81	9.26	ZXLE030E		1.93	2.04	2.24	2.43	2.53	2.74
ZXLE040E		3.19	4.00	5.92	8.17	9.40		ZXLE040E		2.93	3.16	3.67	4.26	4.59	
ZXLE050E		3.67	4.63	6.94	9.77	11.35	14.90	ZXLE050E		3.25	3.47	3.92	4.43	4.72	5.39
ZXLE060E		4.35	5.42	7.97	11.15	12.95		ZXLE060E		4.24	4.55	5.19	5.94	6.38	
ZXLE075E		4.91	6.14	9.16	13.00	15.30	20.50	ZXLE075E		4.41	4.68	5.22	5.82	6.17	7.00
Digital Medium Temperature Models															
ZXDE-030E					4.94	5.97	8.29	ZXDE-030E					2.27	2.37	2.58
ZXDE-040E				4.67	7.20	8.75	12.40	ZXDE-040E				2.77	2.92	3.01	3.22
ZXDE-050E				5.65	8.64	10.45	14.55	ZXDE-050E				3.65	3.93	4.11	4.51
ZXDE-060E				5.85	8.96	10.85	15.10	ZXDE-060E				3.94	4.22	4.40	4.82
ZXDE-075E				6.65	10.20	12.30	17.20	ZXDE-075E				4.29	4.59	4.78	5.24

Conditions: EN13215: Suction Gas Return 20°C, Subcooling 0K

* Conditions: EN13215: Suction Superheat 10K

** Single Phase Only

Preliminary Data

For detailed capacity data please refer to Emerson's Select software

Capacity Data

Ambient Temperature: 32°C															
R448A/ R449A	Cooling Capacity (kW)							R448A/ R449A	Power Input (kW)						
	Evaporating Temperature (°C)								Evaporating Temperature (°C)						
	-45	-35	-30	-20	-10	-5	+5		-45	-35	-30	-20	-10	-5	+5
Medium Temperature Models															
ZXME020E				2.22	3.42	4.14	5.82	ZXME020E				1.56	1.58	1.62	1.75
ZXME025E				2.61	3.83	4.61	6.66	ZXME025E				1.50	1.64	1.71	1.92
ZXME030E				3.36	5.05	6.06	8.42	ZXME030E				2.12	2.28	2.37	2.58
ZXME040E				4.34	6.58	7.82	10.70	ZXME040E				3.02	3.29	3.45	3.86
ZXME050E				5.75	8.77	10.50	14.60	ZXME050E				3.58	3.79	3.92	4.27
ZXME060E				6.62	10.05	12.00	16.65	ZXME060E				4.12	4.41	4.58	5.03
ZXME075E				7.60	11.55	13.85	19.15	ZXME075E				4.74	5.07	5.27	5.79
Low Temperature Models															
ZXLE020E		1.45	1.91	3.05	4.46	5.27	7.08	ZXLE020E		1.38	1.48	1.64	1.77	1.82	1.91
ZXLE025E**		1.71	2.25	3.59	5.26	6.23	8.38	ZXLE025E**		1.60	1.72	1.90	2.02	2.07	2.16
ZXLE030E		2.06	2.59	3.93	5.71	6.80	9.37	ZXLE030E		1.74	1.85	2.02	2.17	2.23	2.37
ZXLE040E		3.16	3.97	5.92	8.31	9.66		ZXLE040E		2.61	2.85	3.30	3.72	3.93	
ZXLE050E		3.62	4.57	6.89	9.81	11.50	15.20	ZXLE050E		2.94	3.18	3.61	4.00	4.18	4.56
ZXLE060E		4.56	5.69	8.43	11.90	13.85		ZXLE060E		3.70	4.04	4.70	5.33	5.64	
ZXLE075E		5.11	6.40	9.61	13.75	16.20	21.90	ZXLE075E		3.85	4.18	4.77	5.31	5.59	6.16
Digital Medium Temperature Models															
ZXDE-030E				3.43	5.13	6.14	8.47	ZXDE-030E				1.90	2.21	2.38	2.79
ZXDE-040E				4.75	7.21	8.69	12.25	ZXDE-040E				2.48	2.72	2.82	3.07
ZXDE-050E				5.83	8.65	10.35	14.40	ZXDE-050E				3.22	3.67	3.91	4.43
ZXDE-060E				6.82	10.10	12.00	16.60	ZXDE-060E				3.88	4.46	4.78	5.47
ZXDE-075E				7.70	11.40	13.60	18.80	ZXDE-075E				4.22	4.83	5.14	5.83

Conditions: EN13215: Suction Gas Return 20°C, Subcooling 0K

** Single Phase Only

Preliminary Data

For detailed capacity data please refer to Emerson's Select software

Capacity Data

Ambient Temperature: 32°C															
R404A	Cooling Capacity (kW)							R404A	Power Input (kW)						
	Evaporating Temperature (°C)								Evaporating Temperature (°C)						
	-45	-35	-30	-20	-10	-5	+5		-45	-35	-30	-20	-10	-5	+5
Medium Temperature Models															
ZXME020E				2.44	3.58	4.24	5.70	ZXME020E				1.75	1.77	1.77	1.82
ZXME025E				2.94	4.24	5.01	6.80	ZXME025E				1.72	1.88	1.95	2.04
ZXME030E				3.69	5.24	6.15	8.19	ZXME030E				2.38	2.50	2.57	2.72
ZXME040E				4.94	6.99	8.16	10.80	ZXME040E				3.21	3.41	3.52	3.75
ZXME050E				6.39	9.12	10.70	14.35	ZXME050E				3.96	4.15	4.26	4.49
ZXME060E				7.34	10.40	12.20	16.20	ZXME060E				4.57	4.83	4.97	5.28
ZXME075E				8.37	11.90	13.90	18.50	ZXME075E				5.11	5.40	5.55	5.89
Low Temperature Models															
ZXLE020E		1.79	2.30	3.51	4.93	5.71	7.33	ZXLE020E		1.68	1.78	1.97	2.14	2.21	2.35
ZXLE025E**		2.11	2.70	4.13	5.83	6.76	8.71	ZXLE025E**		1.93	2.05	2.25	2.43	2.51	2.66
ZXLE030E		2.55	3.13	4.53	6.30	7.34	9.73	ZXLE030E		2.12	2.21	2.41	2.61	2.71	2.94
ZXLE040E		3.96	4.86	6.95	9.40	10.75	13.50	ZXLE040E		3.09	3.30	3.75	4.25	4.52	5.07
ZXLE050E		4.50	5.51	7.92	10.75	12.30	15.60	ZXLE050E		3.57	3.79	4.27	4.80	5.08	5.67
ZXLE060E		5.65	6.85	9.60	12.85	14.60	18.45	ZXLE060E		4.55	4.88	5.56	6.35	6.81	7.96
ZXLE075E		6.35	7.75	11.05	15.05	17.35	22.50	ZXLE075E		4.74	5.05	5.68	6.36	6.74	7.68
Digital Medium Temperature Models															
ZXDE-030E				3.67	5.27	6.19	8.21	ZXDE-030E				2.07	2.29	2.40	2.61
ZXDE-040E				5.29	7.58	8.94	12.15	ZXDE-040E				2.73	2.96	3.06	3.28
ZXDE-050E				6.36	9.03	10.60	14.10	ZXDE-050E				3.58	4.02	4.25	4.70
ZXDE-060E				7.42	10.45	12.20	16.05	ZXDE-060E				4.31	4.88	5.18	5.77
ZXDE-075E				8.39	11.80	13.80	18.25	ZXDE-075E				4.69	5.31	5.62	6.26

Conditions: EN13215: Suction Gas Return 20°C, Subcooling 0K

** Single Phase Only

Preliminary Data

For detailed capacity data please refer to Emerson's Select software

Ambient Temperature: 32°C															
R134a	Cooling Capacity (kW)							R134a	Power Input (kW)						
	Evaporating Temperature (°C)								Evaporating Temperature (°C)						
	-45	-35	-30	-20	-10	-5	+5		-45	-35	-30	-20	-10	-5	+5
Medium Temperature Models															
ZXME020E				1.42	2.25	2.77	4.04	ZXME020E				0.97	1.01	1.03	1.10
ZXME025E				1.71	2.65	3.23	4.65	ZXME025E				1.01	1.12	1.17	1.27
ZXME030E				2.06	3.24	3.99	5.81	ZXME030E				1.33	1.39	1.43	1.53
ZXME040E				2.78	4.36	5.35	7.76	ZXME040E				1.74	1.83	1.89	2.04
ZXME050E				3.38	5.49	6.77	9.87	ZXME050E				2.15	2.29	2.36	2.51
ZXME060E				4.20	6.51	8.03	11.70	ZXME060E				2.51	2.65	2.74	2.95
ZXME075E				4.76	7.46	9.13	13.15	ZXME075E				3.06	3.19	3.31	3.57
Digital Medium Temperature Models															
ZXDE-030E				2.16	3.33	4.02	5.70	ZXDE-030E				1.27	1.43	1.51	1.70
ZXDE-040E					4.29	5.34	7.97	ZXDE-040E					1.82	1.86	1.95
ZXDE-050E					5.26	6.53	9.68	ZXDE-050E					2.31	2.38	2.53
ZXDE-060E					6.34	7.88	11.65	ZXDE-060E					2.72	2.81	3.03
ZXDE-075E					7.21	8.82	12.70	ZXDE-075E					2.96	3.04	3.26

Conditions: EN13215: Suction Gas Return 20°C, Subcooling 0K

** Single Phase Only

Preliminary Data

For detailed capacity data please refer to Emerson's Select software

Capacity Data

Ambient Temperature: 32°C															
R450A	Cooling Capacity (kW)							R450A	Power Input (kW)						
	Evaporating Temperature (°C)								Evaporating Temperature (°C)						
	-45	-35	-30	-20	-10	-5	+5		-45	-35	-30	-20	-10	-5	+5
Medium Temperature Models															
ZXME020E				1.20	1.97	2.46	3.65	ZXME020E				0.89	0.88	0.87	0.90
ZXME025E				1.41	2.28	2.83	4.22	ZXME025E				1.00	1.01	1.02	1.07
ZXME030E				1.81	2.91	3.61	5.31	ZXME030E				1.19	1.21	1.23	1.30
ZXME040E				2.45	3.94	4.87	7.14	ZXME040E				1.58	1.61	1.63	1.72
ZXME050E				3.09	4.96	6.14	9.08	ZXME050E				2.05	2.08	2.11	2.21
ZXME060E				3.61	5.78	7.14	10.50	ZXME060E				2.34	2.38	2.41	2.54
ZXME075E				4.04	6.48	8.01	11.80	ZXME075E				2.62	2.67	2.71	2.86
Digital Medium Temperature Models															
ZXDE-030E				1.83	2.93	3.60	5.22	ZXDE-030E				1.07	1.15	1.18	1.25
ZXDE-040E					3.99	4.86	7.04	ZXDE-040E					1.42	1.48	1.62
ZXDE-050E					4.88	5.91	8.47	ZXDE-050E					1.86	1.98	2.22
ZXDE-060E					5.74	6.95	9.91	ZXDE-060E					2.20	2.35	2.66
ZXDE-075E					6.47	7.84	11.20	ZXDE-075E					2.39	2.55	2.89

Conditions: EN13215: Suction Gas Return 20°C, Subcooling 0K

** Single Phase Only

Preliminary Data

For detailed capacity data please refer to Emerson's Select software

Ambient Temperature: 32°C															
R513A	Cooling Capacity (kW)							R513A	Power Input (kW)						
	Evaporating Temperature (°C)								Evaporating Temperature (°C)						
	-45	-35	-30	-20	-10	-5	+5		-45	-35	-30	-20	-10	-5	+5
Medium Temperature Models															
ZXME020E				1.47	2.34	2.87	4.17	ZXME020E				1.04	1.03	1.03	1.06
ZXME025E				1.72	2.71	3.33	4.86	ZXME025E				1.17	1.19	1.21	1.26
ZXME030E				2.20	3.44	4.20	6.04	ZXME030E				1.40	1.44	1.47	1.55
ZXME040E				2.97	4.63	5.68	8.19	ZXME040E				1.87	1.93	1.96	2.08
ZXME050E				3.77	5.89	7.23	10.45	ZXME050E				2.39	2.46	2.50	2.63
ZXME060E				4.39	6.84	8.37	12.05	ZXME060E				2.75	2.83	2.88	3.03
ZXME075E				4.91	7.65	9.36	13.50	ZXME075E				3.08	3.18	3.24	3.42
Digital Medium Temperature Models															
ZXDE-030E				2.22	3.47	4.21	5.99	ZXDE-030E				1.25	1.35	1.39	1.49
ZXDE-040E					4.78	5.77	8.22	ZXDE-040E					1.70	1.77	1.93
ZXDE-050E					5.81	6.98	9.81	ZXDE-050E					2.26	2.40	2.68
ZXDE-060E					6.83	8.19	11.40	ZXDE-060E					2.69	2.87	3.24
ZXDE-075E					7.70	9.23	12.90	ZXDE-075E					2.92	3.12	3.51

Conditions: EN13215: Suction Gas Return 20°C, Subcooling 0K

** Single Phase Only

Preliminary Data

For detailed capacity data please refer to Emerson's Select software

Copeland™ Small ZX Outdoor Refrigeration Units with Scroll Compressors

Copeland small outdoor refrigeration units are for medium temperature and low temperature applications.

These new small ZX units help save space and time thanks to their small footprint and plug & play installation. Thanks to their small size and light weight, they can easily be installed on walls or roofs.

Copeland small ZX outdoor refrigeration units feature a low-sound Copeland scroll compressor and a sickle blade fan for quiet operation, which is important in urban environments and residential areas.



Copeland small ZX outdoor refrigeration unit

Copeland Small ZX Line-up

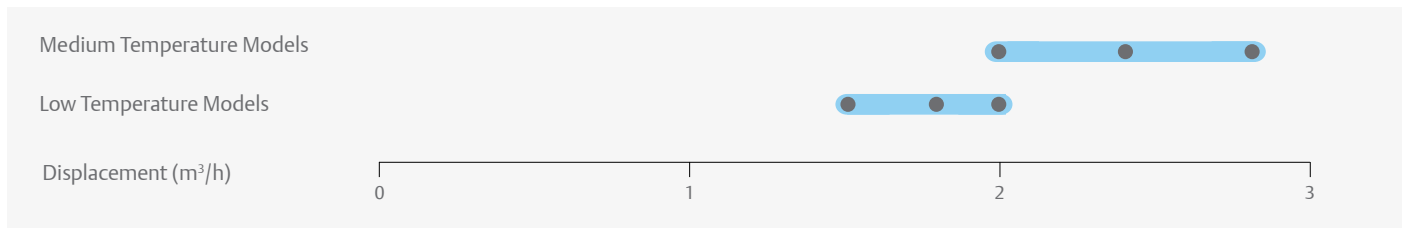

Features and Benefits

- Standard equipment: Copeland scroll compressor, crankcase heater, liquid receiver, service valves, double pressure switch, filter drier, sight glass, fan speed control, external main power switch
- Energy and operation cost saving due to excellent energy efficiency
- Noise attenuation thanks to fan motor with sickle blades and fan speed control
- Increased reliability ensured by advanced factory tests
- Space saving thanks to small smallest footprint in its class
- Easy and quick "plug & play" installation
- Multiple refrigerant approvals incl. R407A/F, R448A/R449A, R404A, R134a, R450A and R513A

Maximum Allowable Pressures (PS)

- Low Side PS 21 bar (g)
- High Side PS 28.8 bar (g)

Technical Overview

Model	Displacement (m³/h)	Receiver Capacity (l)	Number of fans	Total Fan Motor Power (W)	Suction Line Diameter (inch)	Liquid Line Diameter (inch)	Width/Depth/Height (mm)	Net Weight (kg)	Motor Version/Code	Maximum Operating Current (A)	Locked Rotor Current (A)	Sound Pressure
									1 Ph*	1 Ph*	1 Ph*	@10m - d(BA)**
Medium Temperature Models												
ZXME-013E	3.7	1.8	1	54	1/2	3/8	900/350/600	51	PFJ	7.2	45	37
ZXME-015E	4.4	1.8	1	54	1/2	3/8	900/350/600	51	PFJ	8.7	45	37
ZXME-018E	5.0	1.8	1	54	1/2	3/8	900/350/600	51	PFJ	9.9	54	38
Low Temperature Models												
ZXLE-018E	6.1	1.8	1	54	1/2	3/8	900/350/600	54	PFJ	13.6	57	37
ZXLE-023E	7.1	1.8	1	54	1/2	3/8	900/350/600	54	PFJ	15.6	74	37
ZXLE-028E	8.0	1.8	1	54	1/2	3/8	900/350/600	55	PFJ	17.8	82	38

* 1ph: 230V/ 50Hz

** @ 10m: sound pressure level at 10m distance from the compressor, free field condition

Capacity Data

Ambient Temperature: 32°C															
R448A/ R449A	Cooling Capacity (kW)							R448A/ R449A	Power Input (kW)						
	Evaporating Temperature (°C)								Evaporating Temperature (°C)						
	-45	-35	-30	-20	-10	-5	+5		-45	-35	-30	-20	-10	-5	+5
Medium Temperature Models															
ZXME-013E				1.39	2.00	2.36	3.32	ZXME-013E				0.96	1.06	1.12	1.27
ZXME-015E				1.66	2.35	2.76	3.85	ZXME-015E				1.10	1.23	1.30	1.49
ZXME-018E				1.87	2.62	3.07	4.25	ZXME-018E				1.29	1.46	1.55	1.78
Low Temperature Models															
ZXLE-018E		1.59	2.07	2.97				ZXLE-018E		1.65	1.75	1.98			
ZXLE-023E		1.75	2.08	2.98				ZXLE-023E		1.77	1.79	1.89			
ZXLE-028E		2.00	2.51	3.84				ZXLE-028E		2.06	2.18	2.43			

Suction Gas Return 20°C / Subcooling 0K
Preliminary data

For detailed capacity data please refer to Emerson's Select software

Ambient Temperature: 32°C															
R404A	Cooling Capacity (kW)							R404A	Power Input (kW)						
	Evaporating Temperature (°C)								Evaporating Temperature (°C)						
	-45	-35	-30	-20	-10	-5	+5		-45	-35	-30	-20	-10	-5	+5
Medium Temperature Models															
ZXME-013E				1.54	2.22	2.62	3.52	ZXME-013E				1.03	1.14	1.18	1.26
ZXME-015E				1.80	2.56	3.00	4.00	ZXME-015E				1.23	1.37	1.43	1.52
ZXME-018E				2.00	2.83	3.31	4.43	ZXME-018E				1.44	1.62	1.70	1.83

Suction Gas Return 20°C / Subcooling 0K

For detailed capacity data please refer to Emerson's Select software

Ambient Temperature: 32°C															
R134a	Cooling Capacity (kW)							R134a	Power Input (kW)						
	Evaporating Temperature (°C)								Evaporating Temperature (°C)						
	-45	-35	-30	-20	-10	-5	+5		-45	-35	-30	-20	-10	-5	+5
Medium Temperature Models															
ZXME-013E				0.91	1.40	1.70	2.43	ZXME-013E				0.62	0.69	0.72	0.79
ZXME-015E				1.08	1.64	1.99	2.82	ZXME-015E				0.73	0.82	0.87	0.97
ZXME-018E				1.82	2.19	3.07		ZXME-018E				0.97	1.03	1.17	

Suction Gas Return 20°C / Subcooling 0K

For detailed capacity data please refer to Emerson's Select software

Ambient Temperature: 32°C															
R450A	Cooling Capacity (kW)							R450A	Power Input (kW)						
	Evaporating Temperature (°C)								Evaporating Temperature (°C)						
	-45	-35	-30	-20	-10	-5	+5		-45	-35	-30	-20	-10	-5	+5
Medium Temperature Models															
ZXME-013E				0.76	1.26	1.51	2.10	ZXME-013E				0.56	0.62	0.65	0.71
ZXME-015E				0.84	1.43	1.68	2.44	ZXME-015E				0.65	0.73	0.78	0.87
ZXME-018E				0.92	1.60	1.85	2.60	ZXME-018E				0.73	0.87	0.92	1.05

Suction Gas Return 20°C / Subcooling 0K
Preliminary data

For detailed capacity data please refer to Emerson's Select software

Ambient Temperature: 32°C															
R513A	Cooling Capacity (kW)							R513A	Power Input (kW)						
	Evaporating Temperature (°C)								Evaporating Temperature (°C)						
	-45	-35	-30	-20	-10	-5	+5		-45	-35	-30	-20	-10	-5	+5
Medium Temperature Models															
ZXME-013E				0.90	1.50	1.80	2.50	ZXME-013E				0.69	0.77	0.81	0.88
ZXME-015E				1.00	1.70	2.00	2.90	ZXME-015E				0.82	0.92	0.97	1.09
ZXME-018E				1.10	1.90	2.20	3.10	ZXME-018E				0.90	1.09	1.15	1.31

Suction Gas Return 20°C / Subcooling 0K
Preliminary data

For detailed capacity data please refer to Emerson's Select software

Copeland™ ZX Indoor Refrigeration Units With Scroll Compressors

The Copeland ZX indoor range is the ideal solution for urban installations with space and noise constraints and also suits applications in areas with extreme weather conditions.

Copeland refrigeration units have brought innovation to refrigeration by providing solutions for quick and easy installation. Regular communication between Emerson and its customers has resulted in the latest indoor refrigeration unit design, taking this concept one step further. The adoption of the popular ZX condensing unit design to the needs of urban applications exactly meets customer needs.

Copeland ZX indoor refrigeration units feature the most complete and unique equipment. Their advanced electronic controller enables precise parameter control and displays the system status. Vapor injection and liquid injection technology significantly increase system efficiency and operation map. Electronic protection functions, oil separator and suction accumulator guarantee optimum system safety.

The units are prepared for standard air ducts, resulting in easy installation and lower installation costs because they do not require:

- remote condenser
- additional E-box
- additional wiring and tubing

Lowest life cycle costs and comprehensive safety features make Copeland ZX a cost efficient and reliable choice for:

- convenience stores
- cold rooms
- fast food stores, bars and restaurants
- service stations



Copeland ZX indoor refrigeration units

Copeland ZX Indoor Line-up

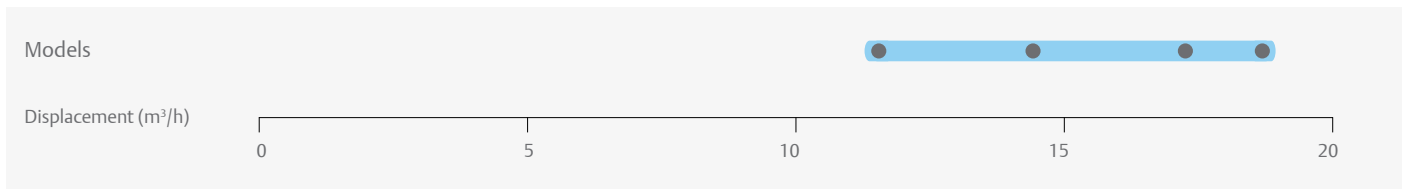

Features and Benefits

- Standard equipment: Copeland scroll compressor, crankcase heater, electronic controller, fan(s) with speed control, liquid receiver, safety switches, filter drier, sight glass, and oil separator
- Copeland ZX digital models allow for 10% to 100% continuous capacity modulation
- Diagnostic capabilities protect the unit from over-current, phase loss and phase imbalance
- LED display shows real time system status
- Precise electronic suction pressure control
- Energy and operation cost saving due to excellent energy efficiency
- Prepared for standard air ducts
- Operation in urban environments or extreme weather conditions
- Noise attenuation due to low speed fan motors with sickle blades, fan speed control and sound jacket
- Space saving due to compact dimensions
- Easy and quick installation
- Multiple refrigerant approvals incl. R407A/F, R448A/R449A, R404A, R134a, R450A and R513A

Maximum Allowable Pressures (PS)

- Low Side PS 22.5 bar (g)
- High Side PS 28.8 bar (g)

Technical Overview

Model	Displacement (m ³ /h)*	Max. Operating Current (A)	Number of Fans	Total Fan Motor Power (W)	Connection Lines Diameter (inch)		Width/Depth/Height (mm)	Weight (kg)	Max Sound Power dB(A)**
					Suction	Liquid			
Medium Temperature 380-420V 50Hz 3~									
ZXDI-040E-TFD-554	11.4	7.7	2	750	7/8	1/2	1029/ 424/ 1242	138	86
ZXDI-050E-TFD-554	14.4	10.4	2	750	7/8	1/2	1029/ 424/ 1242	142	86
ZXDI-060E-TFD-554	17.1	11.6	2	750	7/8	1/2	1029/ 424/ 1242	146	86
ZXDI-075E-TFD-554	18.8	12.4	2	750	7/8	1/2	1029/ 424/ 1242	152	86

Conditions: EN13215: Evaporating -10°C, Ambient = 32°C, Suction Gas Return 20°C, Subcooling 0K
 ** Sound pressure depends on individual installation type

Capacity Data

Models	Capacity (kW)							
	R134a	R404A	R407A	R407F	R448A	R449A	R450A	R513A
ZXDI-040E-TFD-554	4.31	7.72	7.22	7.15	7.14	7.14	3.99	4.80
ZXDI-050E-TFD-554	5.35	9.42	8.69	8.70	8.68	8.68	4.92	5.90
ZXDI-060E-TFD-554	6.48	11.00	9.81	9.03	10.10	10.10	5.70	6.96
ZXDI-075E-TFD-554	7.35	12.50	11.40	10.35	11.55	11.55	6.55	7.86

* Conditions: EN13215: Evaporating -10°C, Ambient = 32°C, Suction Gas Return 20°C, Subcooling 0K
 For detailed capacity data please refer to Emerson's Select software

Copeland™ Scroll Indoor Refrigeration Units for Refrigeration

Copeland air-cooled refrigeration units for medium temperature and low temperature applications.

Copeland scroll refrigeration units are equipped with the latest refrigeration scroll compressors and build the widest range of its kind. The modular line concept offers base units which can be adapted to the target application by various options including weather housings and fan speed controls.

Copeland scroll refrigeration units are available with normal or high capacity condensers to ensure optimum performance even under extreme conditions. They are equipped with dedicated medium or low temperature compressors which makes them suitable for all general refrigeration applications, such as:

- Mini markets and supermarkets
- Bars, restaurants and kitchens
- Beer cellars and beverage coolers
- Cold rooms
- Milk cooling tank



Copeland scroll indoor refrigeration unit

Copeland Scroll Refrigeration Units Line-up

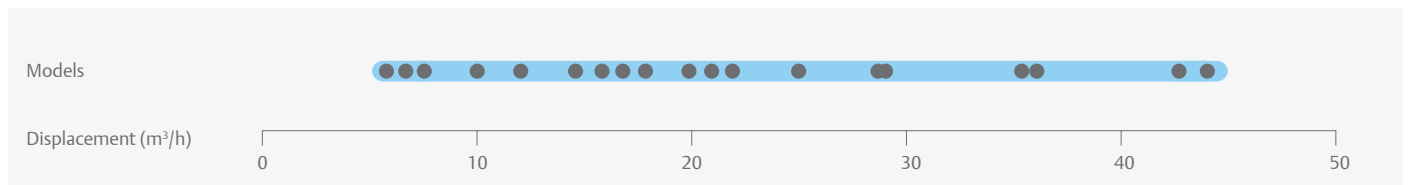

Copeland Scroll Digital Refrigeration Units Line-up

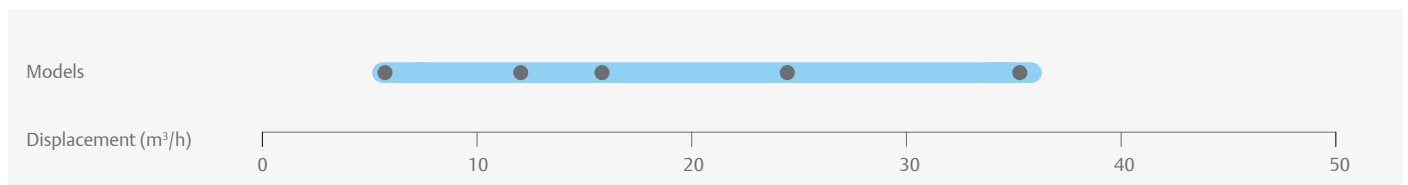

Features and Benefits

- Standard equipment: base plate, scroll compressor, crank case heater, condenser with 1 ph fan(s), HP and LP switch, liquid receiver with rotalock-valve, suction- and discharge shut-off valves
- Suitable for multiple refrigerants: R407A/F, R448A/R449A, R404A, R134a, R450A and R513A
- Wide range of quality accessories
- Excellent efficiency and reliability

Maximum Allowable Pressures (PS)

- Low Side PS 22.5 bar (g)
- High Side PS = 28 bar (g)

Technical Overview

Model	Displacement (m ³ /h)	Receiver Capacity (l)	Number of fans	Total Fan Motor Power (W)	Suction Line Diameter (inch)	Liquid Line Diameter (inch)	Width/Depth/Height (mm)	Net Weight (kg)	Motor Version/Code		Maximum Operating Current (A)		Locked Rotor Current (A)		Sound Pressure @10m - dB(A)***
									1 Ph*	3 Ph**	1 Ph*	3 Ph**	1 Ph*	3 Ph**	
Medium Temperature Models															
MC-D8-ZB15KE	5.9	3.9	1	110	3/4	1/2	560/570/446	48	PFJ	TFD	13	5	58	26	45
MC-H8-ZB15KE	5.9	7.9	1	235	3/4	1/2	735/680/533	57	PFJ	TFD	13	5	58	26	48
MC-D8-ZB19KE	6.8	3.9	1	110	3/4	1/2	560/570/446	49	PFJ	TFD	13	7	61	32	45
MC-K9-ZB19KE	6.8	7.9	2	220	3/4	1/2	950/640/454	66	PFJ	TFD	13	7	61	32	47
MC-H8-ZB19KE	6.8	7.9	1	235	3/4	1/2	735/680/533	61	PFJ	TFD	13	7	61	32	48
MC-D8-ZB21KE	8.6	3.9	1	110	7/8	1/2	560/570/446	50	PFJ	TFD	16	7	82	40	46
MC-H8-ZB21KE	8.6	7.9	1	235	7/8	1/2	735/680/533	61	PFJ	TFD	16	7	82	40	48
MC-K9-ZB21KE	8.6	7.9	2	220	7/8	1/2	950/640/454	67	PFJ	TFD	16	7	82	40	47
MC-K9-ZB26KE	10.0	7.9	2	220	7/8	1/2	950/640/454	68	PFJ	TFD	18	9	97	46	47
MC-H8-ZB26KE	10.0	7.9	1	235	7/8	1/2	735/680/533	62	PFJ	TFD	18	9	97	46	48
MC-H8-ZB30KE	11.7	7.9	1	235	7/8	1/2	735/680/533	74	PFJ	TFD	26	10	142	49	49
MC-M8-ZB30KE	11.7	7.9	1	235	7/8	1/2	735/730/708	86	PFJ	TFD	26	10	142	49	48
MC-P8-ZB30KE	11.7	7.9	2	220	7/8	1/2	950/640/633	86		TFD		10		49	48
MC-H8-ZB38KE	14.4	7.9	1	235	7/8	1/2	735/680/533	77	PFJ	TFD	32	13	142	66	49
MC-M8-ZB38KE	14.4	7.9	1	235	7/8	1/2	735/730/708	89	PFJ	TFD	32	13	142	66	48
MC-P8-ZB38KE	14.4	7.9	2	220	7/8	1/2	950/640/633	89	PFJ	TFD	32	13	142	66	48
MC-M8-ZB42KE	16.2	7.9	1	235	7/8	1/2	735/730/708	91	PFJ		36		150		49
MC-R7-ZB42KE	16.2	7.9	2	470	7/8	1/2	1130/680/633	101	PFJ		36		150		52
MC-M8-ZB45KE	17.1	7.9	1	235	7/8	1/2	735/730/708	91		TFD		13		74	49
MC-M9-ZB45KE	17.1	7.9	1	400	7/8	1/2	735/730/708	95		TFD		13		74	49
MC-R7-ZB45KE	17.1	7.9	2	470	7/8	1/2	1130/680/633	101		TFD		13		74	49
MC-R7-ZB50KE	19.8	7.9	2	470	1 3/8	1/2	1130/820/621	110		TFD		15		100	49
MC-S9-ZB50KE	22.1	11.7	2	470	1 3/8	5/8	1130/820/703	113		TFD		15		100	49
MC-R7-ZB58KE	22.1	7.9	2	470	1 3/8	1/2	1130/820/621	110		TFD		16		95	
MC-S9-ZB58KE	22.1	11.7	2	470	1 3/8	5/8	1130/820/703	113		TFD		16		95	
MC-S9-ZB66KE	24.9	11.7	2	470	1 3/8	5/8	1130/820/707	116		TFD		18		111	50
MC-V9-ZB66KE	24.9	15.8	2	470	1 3/8	3/4	1330/820/821	150		TFD		18		111	50
MC-V9-ZB76KE	29.1	15.8	2	470	1 3/8	3/4	1330/820/835	151		TFD		20		118	50
MC-V6-ZB76KE	29.1	15.8	2	800	1 3/8	3/4	1330/820/835	168		TFD		20		118	54
MC-V9-ZB95KE	36.4	15.8	2	470	1 3/8	3/4	1330/820/835	155		TFD		28		140	50
MC-V6-ZB95KE	36.4	15.8	2	800	1 3/8	3/4	1330/820/835	172		TFD		28		140	54
MC-V6-ZB114KE	43.3	15.8	2	800	1 3/8	3/4	1330/820/835	174		TFD		33		174	54
MC-W9-ZB114KE	43.3	15.8	2	800	1 3/8	3/4	1640/820/864	174		TFD		33		174	54
Digital Medium Temperature Models															
MC-M8-ZBD30	11.7	11.7	1	235	7/8	5/8	735/730/708	86		TFD		8		52	48
MC-M9-ZBD45	17.1	11.7	1	400	7/8	5/8	735/730/708	95		TFD		12		74	49
MC-V6-ZBDT60	23.4	18.9	2	800	1 3/8	3/4	1330/820/835	207		TFD		8+10			57
MC-V6-ZBDT90	34.1	18.9	2	800	1 3/8	3/4	1330/820/835	218		TFD		12+13			57

* 1ph: 230V/ 50Hz

** 3 Ph: 380-420V/ 50Hz

*** @ 10m: sound pressure level at 10m distance from the compressor, free field condition

Technical Overview

Models	Displacement (m ³ /h)	Receiver Capacity (l)	Number of Fans	Total Fan Motor Power (W)	Suction Line Diameter (inch)	Liquid Line Diameter (inch)	Width/Depth/Height (mm)	Net Weight (kg)	Motor Version/Code		Maximum Operating Current (A)		Locked Rotor Current (A)		Sound Pressure @10m - dB(A)***	
									1 Ph*	3 Ph**	1 Ph*	3 Ph**	1 Ph*	3 Ph**		
Low Temperature Models																
MC-B8-ZF06KE	3.3	3.3	1	85	7/8	1/2	560/570/396	64		TFD		5		26	46	
MC-D8-ZF09KE	3.9	3.9	1	110	7/8	1/2	560/570/446	64		TFD		6		40	46	
MC-H8-ZF09KE	7.9	7.9	1	235	7/8	1/2	735/680/533	66		TFD		6		40	49	
MC-H8-ZF13KE	7.9	7.9	1	235	7/8	1/2	735/680/533	77		TFD		8		52	49	
MC-M8E-ZF11	9.9	7.9	1	180	7/8	1/2	736/730/705	96		TFD		7		46	48	
MC-M8-ZF13KE	7.9	7.9	1	235	7/8	1/2	735/730/708	85		TFD		8		52	49	
MC-M8-ZF15KE	7.9	7.9	1	235	7/8	1/2	735/730/708	86		TFD		10		64	49	
MC-M8-ZF18KE	7.9	7.9	1	235	7/8	1/2	735/730/708	88		TFD		13		74	49	
MC-S9-ZF18KE	7.9	7.9	2	470	1 3/8	1/2	1130/680/708	168		TFD		13		74		
MC-S9-ZF25K5	11.7	11.7	2	470	1 1/8	5/8	1130/680/703	117		TFD		16		102	54	
MC-S9-ZF34K5	11.7	11.7	2	470	1 1/8	5/8	1130/680/703	141		TFD		25		100	54	
MC-V6-ZF41K5	11.7	11.7	2	800	1 3/8	5/8	1330/820/830	168		TFD		29		118	57	
MC-V6-ZF49K5	11.7	11.7	2	800	1 3/8	3/4	1330/820/830	185		TFD		30		139	57	

* 1ph: 230V/ 50Hz

** 3 Ph: 380-420V/ 50Hz

*** @ 10m: sound pressure level at 10m distance from the compressor, free field condition

Capacity Data

Ambient Temperature: 32°C															
R407A	Cooling Capacity (kW)							R407A	Power Input (kW)						
	Evaporating Temperature (°C)								Evaporating Temperature (°C)						
	-45	-35	-30	-20	-10	-5	+5		-45	-35	-30	-20	-10	-5	+5
Medium Temperature Models															
MC-H8-ZB15KE					3.45	4.15	5.86	MC-H8-ZB15KE					1.73	1.78	1.89
MC-D8-ZB15KE					3.22	3.83	5.32	MC-D8-ZB15KE					1.79	1.87	2.06
MC-D8-ZB19KE					3.64	4.34	5.94	MC-D8-ZB19KE					1.96	2.08	2.30
MC-K9-ZB19KE					3.94	4.76	6.67	MC-K9-ZB19KE					1.85	1.93	2.07
MC-H8-ZB19KE					3.95	4.77	6.69	MC-H8-ZB19KE					1.85	1.94	2.07
MC-K9-ZB21KE					4.78	5.75	7.97	MC-K9-ZB21KE					2.47	2.61	2.83
MC-H8-ZB21KE					4.80	5.77	8.01	MC-H8-ZB21KE					2.48	2.61	2.83
MC-D8-ZB21KE					4.15*	5.08		MC-D8-ZB21KE					2.72*	2.95	
MC-H8-ZB26KE					5.39	6.42	8.87	MC-H8-ZB26KE					2.89	3.04	3.36
MC-K9-ZB26KE					5.37	6.39	8.83	MC-K9-ZB26KE					2.89	3.04	3.37
MC-H8-ZB30KE					5.93*	7.33		MC-H8-ZB30KE					3.51*	3.71	
MC-M8-ZB30KE					6.44	7.76	10.80	MC-M8-ZB30KE					3.28	3.41	3.74
MC-P8-ZB30KE					6.49	7.82	10.90	MC-P8-ZB30KE					3.23	3.36	3.67
MC-H8-ZB38KE					7.23*	8.59*		MC-H8-ZB38KE					4.53*	4.85*	
MC-M8-ZB38KE					7.73*	9.48		MC-M8-ZB38KE					4.17*	4.47	
MC-P8-ZB38KE					7.81*	9.58	12.95	MC-P8-ZB38KE					4.10*	4.39	4.99
MC-M8-ZB42KE**				5.58*	8.23*	10.00	13.35	MC-M8-ZB42KE**				4.59*	5.13*	5.49	6.02
MC-R7-ZB42KE**				6.01*	9.28	11.05	15.25	MC-R7-ZB42KE**				4.39*	4.81	4.99	5.34
MC-M8-ZB45KE					8.48*	10.30		MC-M8-ZB45KE					5.17*	5.57	
MC-M9-ZB45KE					9.26	11.00	14.90	MC-M9-ZB45KE					5.06	5.30	5.81
MC-R7-ZB45KE					9.58	11.45	15.70	MC-R7-ZB45KE					4.89	5.08	5.49
MC-R7-ZB50KE					10.95	13.15	18.00	MC-R7-ZB50KE					6.00	6.29	6.89
MC-S9-ZB50KE					11.40	13.70	18.95	MC-S9-ZB50KE					5.70	5.93	6.41
MC-R7-ZB58KE					11.05*	13.80		MC-R7-ZB58KE					6.61*	7.06	
MC-S9-ZB58KE					11.90	14.50	20.40	MC-S9-ZB58KE					6.33	6.66	7.41
MC-S9-ZB66KE					13.15	15.85	21.90	MC-S9-ZB66KE					7.25	7.68	8.65
MC-V9-ZB66KE					13.75	16.65	23.20	MC-V9-ZB66KE					6.92	7.26	8.08
MC-V9-ZB76KE					15.75	19.00	26.30	MC-V9-ZB76KE					8.21	8.71	9.81
MC-V6-ZB76KE					16.65	20.20	28.40	MC-V6-ZB76KE					8.01	8.39	9.22
MC-V9-ZB95KE					17.35*	21.50		MC-V9-ZB95KE					11.25*	12.10	
MC-V6-ZB95KE					19.45	23.50	32.60	MC-V6-ZB95KE					10.70	11.30	12.60
MC-V6-ZB114KE					21.40*	26.80		MC-V6-ZB114KE					13.00*	13.90	
MC-W9-ZB114KE					22.50	27.40	38.40	MC-W9-ZB114KE					12.85	13.60	15.40
Low Temperature Models															
MC-D8-ZF09KE		1.58	1.99	2.99	4.27	5.01	6.62*	MC-D8-ZF09KE		1.65	1.70	1.87	2.14	2.33	2.79*
MC-H8-ZF09KE		1.66	2.09	3.19	4.65	5.52	7.57	MC-H8-ZF09KE		1.67	1.70	1.84	2.08	2.25	2.68
MC-H8-ZF13KE		2.25	2.83	4.31	6.25	7.39	10.00	MC-H8-ZF13KE		2.45	2.59	2.92	3.39	3.71	4.55
MC-M8-ZF13KE		2.29	2.89	4.43	6.48	7.72	10.60	MC-M8-ZF13KE		2.37	2.49	2.77	3.16	3.43	4.16
MC-M8-ZF15KE		2.77	3.49	5.29	7.64	9.02	12.15	MC-M8-ZF15KE		2.88	3.09	3.57	4.22	4.66	5.80
MC-M8-ZF18KE		3.31	4.15	6.23	8.88	10.40	13.65*	MC-M8-ZF18KE		3.60	3.83	4.39	5.13	5.61	6.78*
MC-S9-ZF18KE		3.46	4.38	6.73	9.88	11.80	16.25	MC-S9-ZF18KE		3.53	3.70	4.07	4.58	4.91	5.77
MC-S9-ZF25K5		4.38	5.53	8.48	12.40	14.75		MC-S9-ZF25K5		4.29	4.61	5.33	6.18	6.66	
MC-S9-ZF34K5		5.91	7.47	11.35	16.40	19.35		MC-S9-ZF34K5		5.61	6.15	7.41	8.99	9.92	
MC-V6-ZF41K5		7.44	9.37	14.20	20.60	24.40		MC-V6-ZF41K5		6.76	7.35	8.65	10.20	11.05	
MC-V6-ZF49K5		8.73	11.05	16.90	24.50	29.10		MC-V6-ZF49K5		8.30	9.05	10.75	12.75	13.85	
Digital Medium Temperature Models															
MC-M8-ZBD30KE					6.76	8.10	11.10	MC-M8-ZBD30KE					3.39	3.56	3.98
MC-M9-ZBD45KE					9.18	11.00	14.95	MC-M9-ZBD45KE					4.90	5.17	5.80
MC-V6-ZBDT60KE				9.39	14.40	17.40	24.30	MC-V6-ZBDT60KE				6.02	6.42	6.67	7.25
MC-V6-ZBDT90KE				12.70	19.05	22.80	31.40	MC-V6-ZBDT90KE				8.78	9.48	9.90	10.85

Conditions: EN13215: Suction Gas Return 20°C, Subcooling 0K

* Conditions: EN13215: Suction Superheat 10K

** Single Phase only

Preliminary Data

For detailed capacity data please refer to Emerson's Select software

Capacity Data

Ambient Temperature: 32°C															
R407F	Cooling Capacity (kW)							R407F	Power Input (kW)						
	Evaporating Temperature (°C)								Evaporating Temperature (°C)						
	-45	-35	-30	-20	-10	-5	+5		-45	-35	-30	-20	-10	-5	+5
Medium Temperature Models															
MC-D8-ZB15KE					3.04	3.66	5.04	MC-D8-ZB15KE					1.96	2.02	2.17
MC-H8-ZB15KE					3.36	4.07	5.70	MC-H8-ZB15KE					1.84	1.87	1.93
MC-D8-ZB19KE					3.51*	4.30	5.87	MC-D8-ZB19KE					2.37*	2.52	2.84
MC-H8-ZB19KE					4.02	4.84	6.74	MC-H8-ZB19KE					2.21	2.29	2.46
MC-K9-ZB19KE					4.01	4.82	6.72	MC-K9-ZB19KE					2.20	2.29	2.46
MC-K9-ZB21KE					4.69	5.62	7.72	MC-K9-ZB21KE					2.72	2.85	3.11
MC-H8-ZB21KE					4.71	5.65	7.76	MC-H8-ZB21KE					2.72	2.85	3.11
MC-H8-ZB26KE					5.12*	6.28	8.64	MC-H8-ZB26KE					3.26*	3.46	3.85
MC-K9-ZB26KE					5.10*	6.25	8.59	MC-K9-ZB26KE					3.27*	3.47	3.86
MC-H8-ZB30KE					6.06*	7.47		MC-H8-ZB30KE					3.80*	4.05	
MC-P8-ZB30KE				4.10*	6.64	8.03	11.25	MC-P8-ZB30KE				3.22*	3.49	3.64	4.01
MC-M8-ZB30KE				4.06*	6.58	7.96	11.15	MC-M8-ZB30KE	4.06*			3.26*	3.55	3.70	4.10
MC-H8-ZB38KE					6.97*	8.40*		MC-H8-ZB38KE					5.11*	5.47*	
MC-P8-ZB38KE					7.67*	9.44		MC-P8-ZB38KE					4.61*	4.88	
MC-M8-ZB38KE					7.58*	9.32		MC-M8-ZB38KE					4.69*	4.98	
MC-M8-ZB45KE					8.59*	10.30*		MC-M8-ZB45KE					5.71*	6.10*	
MC-R7-ZB45KE				6.15*	9.71	11.70	16.35	MC-R7-ZB45KE				4.77*	5.19	5.41	5.96
MC-M9-ZB45KE					9.15*	11.20	15.50	MC-M9-ZB45KE					5.40*	5.71	6.40
MC-R7-ZB58KE					11.70*	14.55		MC-R7-ZB58KE					7.09*	7.62	
MC-S9-ZB58KE				7.13*	12.40*	15.40	21.50	MC-S9-ZB58KE				5.97*	6.73*	7.16	8.06
MC-S9-ZB66KE					13.60*	16.75		MC-S9-ZB66KE					7.74*	8.26	
MC-V9-ZB66KE				8.66*	14.60	17.70	24.60	MC-V9-ZB66KE				6.58*	7.37	7.76	8.70
MC-V9-ZB76KE				9.76*	16.30*	20.10	27.80	MC-V9-ZB76KE				7.61*	8.73*	9.36	10.70
MC-V6-ZB76KE				10.55*	17.75	21.60	30.20	MC-V6-ZB76KE				7.61*	8.49	8.93	9.92
MC-V6-ZB114KE					22.60*	28.20		MC-V6-ZB114KE					14.00*	15.05	
MC-W9-ZB114KE				13.25*	23.20*	29.00		MC-W9-ZB114KE				12.10*	13.70*	14.65	
Low Temperature Models															
MC-B8-ZF06KE		1.15	1.43	2.11				MC-B8-ZF06KE		1.46	1.55	1.78			
MC-H8-ZF09KE		1.74	2.19	3.34	4.86	5.77	7.88	MC-H8-ZF09KE		1.75	1.79	1.94	2.20	2.37	2.83
MC-D8-ZF09KE		1.65	2.08	3.12	4.44	5.20		MC-D8-ZF09KE		1.75	1.80	1.98	2.28	2.47	
MC-H8-ZF13KE		2.36	2.96	4.50	6.51	7.69		MC-H8-ZF13KE		2.59	2.75	3.11	3.63	3.97	
MC-M8-ZF13KE		2.40	3.03	4.64	6.77	8.05	11.00	MC-M8-ZF13KE		2.50	2.63	2.93	3.37	3.66	4.45
MC-M8-ZF15KE		2.90	3.65	5.53	7.95	9.37		MC-M8-ZF15KE		3.04	3.27	3.80	4.51	4.99	
MC-M8-ZF18KE		3.47	4.34	6.50	9.22	10.80		MC-M8-ZF18KE		3.81	4.07	4.68	5.49	6.01	
MC-S9-ZF18KE		3.64	4.60	7.05	10.35	12.30	16.95	MC-S9-ZF18KE		3.71	3.89	4.30	4.85	5.20	6.13
Digital Medium Temperature Models															
MC-M8-ZBD30KE				4.57*	6.82	8.06	10.90	MC-M8-ZBD30KE				2.78*	3.32	3.58	4.14
MC-M9-ZBD45KE					9.44*	11.55	15.50	MC-M9-ZBD45KE					5.05*	5.54	6.58
MC-V6-ZBDT60KE				9.12*	14.25	17.15	24.00	MC-V6-ZBDT60KE				6.05*	6.65	6.94	7.59
MC-V6-ZBDT90KE				12.10*	19.70	23.70	32.60	MC-V6-ZBDT90KE				8.73*	10.05	10.70	12.15

Conditions: EN13215: Suction Gas Return 20°C, Subcooling 0K

* Conditions: EN13215: Suction Superheat 10K

Preliminary Data

For detailed capacity data please refer to Emerson's Select software

Capacity Data

Ambient Temperature: 32°C															
R448A	Cooling Capacity (kW)							R448A	Power Input (kW)						
	Evaporating Temperature (°C)								Evaporating Temperature (°C)						
	-45	-35	-30	-20	-10	-5	+5		-45	-35	-30	-20	-10	-5	+5
Medium Temperature Models															
MC-D8-ZB15KE				2.16	3.29	3.94	5.40	MC-D8-ZB15KE				1.72	1.80	1.86	2.03
MC-H8-ZB15KE				2.29	3.54	4.29	6.03	MC-H8-ZB15KE				1.67	1.70	1.74	1.84
MC-D8-ZB19KE				2.39*	3.71	4.41	5.95	MC-D8-ZB19KE				1.88*	2.04	2.14	2.41
MC-H8-ZB19KE				2.66	4.04	4.87	6.77	MC-H8-ZB19KE				1.82	1.91	1.98	2.16
MC-K9-ZB19KE				2.66	4.03	4.85	6.75	MC-K9-ZB19KE				1.81	1.90	1.97	2.16
MC-D8-ZB21KE				2.89*	4.44	5.22	6.86	MC-D8-ZB21KE				2.51*	2.83	3.02	3.46
MC-H8-ZB21KE				3.30	4.94	5.89	8.06	MC-H8-ZB21KE				2.34	2.52	2.64	2.92
MC-K9-ZB21KE				3.29	4.92	5.87	8.02	MC-K9-ZB21KE				2.34	2.52	2.64	2.92
MC-H8-ZB26KE				3.65	5.46	6.52	8.94	MC-H8-ZB26KE				2.74	2.96	3.09	3.39
MC-K9-ZB26KE				3.64	5.44	6.49	8.90	MC-K9-ZB26KE				2.74	2.96	3.10	3.40
MC-H8-ZB30KE				4.02*	6.37	7.55	10.25	MC-H8-ZB30KE				3.24*	3.58	3.76	4.24
MC-P8-ZB30KE				4.43	6.72	8.01	11.00	MC-P8-ZB30KE				3.05	3.28	3.42	3.79
MC-M8-ZB30KE				4.40	6.67	7.95	10.90	MC-M8-ZB30KE				3.09	3.33	3.48	3.86
MC-P8-ZB38KE				5.08*	8.03	9.53	12.95	MC-P8-ZB38KE				3.93*	4.33	4.55	5.12
MC-M8-ZB38KE				5.03*	7.96	9.43	12.80	MC-M8-ZB38KE				3.98*	4.41	4.64	5.23
MC-H8-ZB38KE				4.74*	7.49	8.82		MC-H8-ZB38KE				4.25*	4.81	5.11	
MC-M8-ZB42KE**				5.51*	8.70	10.30	13.85	MC-M8-ZB42KE**				4.61*	5.16	5.46	6.22
MC-R7-ZB42KE**				6.26	9.52	11.35	15.60	MC-R7-ZB42KE**				4.42	4.74	4.93	5.43
MC-M8-ZB45KE				5.68*	8.98	10.60	14.25	MC-M8-ZB45KE				4.66*	5.24	5.55	6.33
MC-R7-ZB45KE				6.48	9.84	11.75	16.10	MC-R7-ZB45KE				4.46	4.80	4.99	5.51
MC-M9-ZB45KE				6.28	9.49	11.25	15.35	MC-M9-ZB45KE				4.58	4.99	5.23	5.85
MC-R7-ZB58KE				7.12*	11.95	14.40	19.65	MC-R7-ZB58KE				6.09*	6.76	7.15	8.10
MC-S9-ZB58KE				7.49*	12.50	15.10	20.80	MC-S9-ZB58KE				5.86*	6.40	6.71	7.51
MC-S9-ZB66KE				8.64*	13.85	16.50	22.40	MC-S9-ZB66KE				6.71*	7.37	7.75	8.74
MC-V9-ZB66KE				8.99*	14.45	17.30	23.70	MC-V9-ZB66KE				6.45*	6.97	7.28	8.12
MC-V6-ZB76KE				10.85*	17.45	21.00	29.00	MC-V6-ZB76KE				7.44*	8.03	8.38	9.29
MC-V9-ZB76KE				10.30*	16.55	19.80	26.90	MC-V9-ZB76KE				7.49*	8.31	8.78	9.95
MC-V9-ZB95KE				11.20*	18.80	22.50	30.20	MC-V9-ZB95KE				10.20*	11.50	12.25	14.15
MC-W9-ZB114KE				14.05*	23.60	28.50	39.30	MC-W9-ZB114KE				11.90*	13.05	13.75	15.60
MC-V6-ZB114KE				13.75*	23.10	27.90	38.30	MC-V6-ZB114KE				12.15*	13.35	14.10	16.05
Low Temperature Models															
MC-D8-ZF09KE		1.66	2.07	3.09	4.38	5.14		MC-D8-ZF09KE		1.58	1.68	1.93	2.28	2.49	
MC-H8-ZF09KE		1.71	2.15	3.26	4.72	5.61		MC-H8-ZF09KE		1.61	1.69	1.91	2.20	2.37	
MC-H8-ZF13KE		2.44	3.06	4.58	6.53	7.66		MC-H8-ZF13KE		2.30	2.45	2.80	3.26	3.55	
MC-M8-ZF13KE		2.48	3.12	4.71	6.78	8.00		MC-M8-ZF13KE		2.23	2.37	2.68	3.10	3.36	
MC-M8-ZF15KE		3.02	3.76	5.58	7.86	9.17		MC-M8-ZF15KE		2.96	3.14	3.64	4.33	4.77	
MC-M8-ZF18KE		3.56	4.48	6.65	9.26	10.75		MC-M8-ZF18KE		4.06	4.16	4.60	5.37	5.89	
MC-S9-ZF18KE		3.79	4.79	7.23	10.40	12.25		MC-S9-ZF18KE		3.75	3.80	4.06	4.56	4.88	
Digital Medium Temperature Models															
MC-M8-ZBD30KE				4.55	6.79	8.09	11.05	MC-M8-ZBD30KE				2.72	3.20	3.47	4.09
MC-M9-ZBD45KE				6.52	9.72	11.55	15.55	MC-M9-ZBD45KE				4.00	4.78	5.20	6.14
MC-V6-ZBDT60KE				9.37	14.25	17.05	23.80	MC-V6-ZBDT60KE				5.77	6.33	6.64	7.40
MC-V6-ZBDT90KE				13.15	19.85	23.60	32.40	MC-V6-ZBDT90KE				8.29	9.32	9.90	11.25

Conditions: EN13215: Suction Gas Return 20°C, Subcooling 0K

* Conditions: EN13215: Suction Superheat 10K

** Single Phase only

Preliminary Data

For detailed capacity data please refer to Emerson's Select software

Capacity Data

Ambient Temperature: 32°C															
R449A	Cooling Capacity (kW)							R449A	Power Input (kW)						
	Evaporating Temperature (°C)								Evaporating Temperature (°C)						
	-45	-35	-30	-20	-10	-5	+5		-45	-35	-30	-20	-10	-5	+5
Medium Temperature Models															
MC-D8-ZB15KE				2.16	3.29	3.94	5.40	MC-D8-ZB15KE				1.72	1.80	1.86	2.03
MC-H8-ZB15KE				2.29	3.54	4.29	6.03	MC-H8-ZB15KE				1.67	1.70	1.74	1.84
MC-D8-ZB19KE				2.39*	3.71	4.41	5.95	MC-D8-ZB19KE				1.88*	2.04	2.14	2.41
MC-H8-ZB19KE				2.66	4.04	4.87	6.77	MC-H8-ZB19KE				1.82	1.91	1.98	2.16
MC-K9-ZB19KE				2.66	4.03	4.85	6.75	MC-K9-ZB19KE				1.81	1.90	1.97	2.16
MC-D8-ZB21KE				2.89*	4.44	5.22	6.86	MC-D8-ZB21KE				2.51*	2.83	3.02	3.46
MC-H8-ZB21KE				3.30	4.94	5.89	8.06	MC-H8-ZB21KE				2.34	2.52	2.64	2.92
MC-K9-ZB21KE				3.29	4.92	5.87	8.02	MC-K9-ZB21KE				2.34	2.52	2.64	2.92
MC-H8-ZB26KE				3.65	5.46	6.52	8.94	MC-H8-ZB26KE				2.74	2.96	3.09	3.39
MC-K9-ZB26KE				3.64	5.44	6.49	8.90	MC-K9-ZB26KE				2.74	2.96	3.10	3.40
MC-H8-ZB30KE				4.01*	6.37	7.55	10.25	MC-H8-ZB30KE				3.23*	3.58	3.76	4.24
MC-P8-ZB30KE				4.43	6.72	8.01	11.00	MC-P8-ZB30KE				3.05	3.28	3.42	3.79
MC-M8-ZB30KE				4.40	6.68	7.95	10.90	MC-M8-ZB30KE				3.09	3.33	3.48	3.86
MC-P8-ZB38KE				5.07*	8.03	9.53	12.95	MC-P8-ZB38KE				3.92*	4.33	4.55	5.12
MC-M8-ZB38KE				5.03*	7.96	9.44	12.80	MC-M8-ZB38KE				3.98*	4.41	4.64	5.23
MC-H8-ZB38KE				4.73*	7.49	8.82		MC-H8-ZB38KE				4.25*	4.81	5.11	
MC-M8-ZB42KE**				5.50*	8.70	10.30	13.85	MC-M8-ZB42KE**				4.61*	5.16	5.46	6.22
MC-R7-ZB42KE**				6.26	9.52	11.35	15.65	MC-R7-ZB42KE**				4.42	4.74	4.93	5.43
MC-M8-ZB45KE				5.67*	8.98	10.60	14.25	MC-M8-ZB45KE				4.66*	5.24	5.55	6.33
MC-R7-ZB45KE				6.48	9.84	11.75	16.10	MC-R7-ZB45KE				4.46	4.80	4.99	5.51
MC-M9-ZB45KE				6.28	9.50	11.25	15.35	MC-M9-ZB45KE				4.58	4.99	5.23	5.85
MC-R7-ZB50KE				6.88*	11.15	13.35	18.05	MC-R7-ZB50KE				5.32*	5.92	6.22	6.91
MC-S9-ZB50KE				7.17*	11.60	13.90	19.05	MC-S9-ZB50KE				5.12*	5.61	5.87	6.43
MC-R7-ZB56KE				7.36*	11.05	13.00	17.30	MC-R7-ZB56KE				5.69*	6.40	6.77	7.61
MC-S9-ZB56KE				7.57*	11.45	13.50	18.25	MC-S9-ZB56KE				5.49*	6.10	6.41	7.13
MC-R7-ZB58KE				7.11*	11.95	14.40	19.65	MC-R7-ZB58KE				6.09*	6.76	7.15	8.10
MC-S9-ZB58KE				7.48*	12.50	15.10	20.80	MC-S9-ZB58KE				5.86*	6.40	6.71	7.51
MC-S9-ZB66KE				8.62*	13.85	16.50	22.40	MC-S9-ZB66KE				6.70*	7.37	7.75	8.74
MC-V9-ZB66KE				8.98*	14.45	17.30	23.70	MC-V9-ZB66KE				6.44*	6.97	7.28	8.12
MC-V6-ZB76KE				10.85*	17.45	21.00	29.00	MC-V6-ZB76KE				7.43*	8.03	8.38	9.29
MC-V9-ZB76KE				10.25*	16.55	19.80	26.90	MC-V9-ZB76KE				7.49*	8.31	8.78	9.95
MC-V6-ZB95KE				12.30*	20.50	24.50	33.40	MC-V6-ZB95KE				9.87*	10.80	11.40	12.80
MC-V9-ZB95KE				11.15*	18.80	22.50	30.20	MC-V9-ZB95KE				10.20*	11.50	12.25	14.15
MC-V6-ZB114KE				13.70*	23.10	27.90	38.30	MC-V6-ZB114KE				12.15*	13.35	14.10	16.05
MC-W9-ZB114KE				14.05*	23.60	28.50	39.30	MC-W9-ZB114KE				11.90*	13.05	13.75	15.60
Low Temperature Models															
MC-D8-ZF09KE		1.66	2.07	3.09	4.38	5.14		MC-D8-ZF09KE		1.58	1.68	1.93	2.28	2.49	
MC-H8-ZF09KE		1.71	2.15	3.26	4.72	5.61		MC-H8-ZF09KE		1.61	1.69	1.91	2.20	2.37	
MC-H8-ZF13KE		2.44	3.06	4.58	6.53	7.66		MC-H8-ZF13KE		2.30	2.45	2.80	3.26	3.55	
MC-M8-ZF13KE		2.48	3.12	4.71	6.78	8.00		MC-M8-ZF13KE		2.23	2.37	2.68	3.10	3.36	
MC-M8-ZF15KE		3.02	3.76	5.58	7.86	9.17		MC-M8-ZF15KE		2.96	3.14	3.64	4.33	4.77	
MC-M8-ZF18KE		3.56	4.48	6.65	9.26	10.75		MC-M8-ZF18KE		4.06	4.16	4.60	5.37	5.89	
MC-S9-ZF18KE		3.79	4.79	7.23	10.40	12.25		MC-S9-ZF18KE		3.75	3.80	4.06	4.56	4.88	
Digital Medium Temperature Models															
MC-M8-ZBD30KE				4.55	6.79	8.09	11.05	MC-M8-ZBD30KE				2.72	3.20	3.47	4.09
MC-M9-ZBD45KE				6.52	9.72	11.55	15.55	MC-M9-ZBD45KE				4.00	4.78	5.20	6.14
MC-V6-ZBDT60KE				9.37	14.25	17.05	23.80	MC-V6-ZBDT60KE				5.77	6.33	6.64	7.40
MC-V6-ZBDT90KE				13.15	19.85	23.60	32.40	MC-V6-ZBDT90KE				8.29	9.32	9.90	11.25

Conditions: EN13215: Suction Gas Return 20°C, Subcooling 0K

* Conditions: EN13215: Suction Superheat 10K

** Single Phase only

Preliminary Data

For detailed capacity data please refer to Emerson's Select software

Capacity Data

Ambient Temperature: 32°C																
R404A	Cooling Capacity (kW)							R404A	Power Input (kW)							
	Evaporating Temperature (°C)								Evaporating Temperature (°C)							
	-45	-35	-30	-20	-10	-5	+5		-45	-35	-30	-20	-10	-5	+5	
Medium Temperature Models																
MC-D8-ZB15KE				2.24	3.25	3.81	5.02	MC-D8-ZB15KE					1.93	1.98	2.01	2.09
MC-H8-ZB15KE				2.46	3.62	4.29	5.80	MC-H8-ZB15KE					1.85	1.86	1.86	1.91
MC-D8-ZB19KE				2.63	3.68	4.27	5.57	MC-D8-ZB19KE					2.22	2.37	2.45	2.64
MC-H8-ZB19KE				2.86	4.09	4.81	6.47	MC-H8-ZB19KE					2.11	2.20	2.25	2.37
MC-K9-ZB19KE				2.86	4.10	4.83	6.50	MC-K9-ZB19KE					2.09	2.18	2.23	2.35
MC-K9-ZB21KE				3.60	5.09	5.94	7.83	MC-K9-ZB21KE					2.56	2.71	2.79	2.97
MC-D8-ZB21KE				3.20	4.38	5.02	6.37	MC-D8-ZB21KE					2.82	3.07	3.20	3.49
MC-H8-ZB21KE				3.59	5.07	5.91	7.79	MC-H8-ZB21KE					2.59	2.74	2.82	3.00
MC-H8-ZB26KE				4.05	5.65	6.57	8.64	MC-H8-ZB26KE					3.11	3.30	3.41	3.67
MC-K9-ZB26KE				4.06	5.68	6.60	8.69	MC-K9-ZB26KE					3.08	3.27	3.38	3.63
MC-H8-ZB30KE				4.55	6.35	7.36	9.60	MC-H8-ZB30KE					3.66	3.91	4.06	4.41
MC-P8-ZB30KE				4.96	7.06	8.28	11.05	MC-P8-ZB30KE					3.30	3.45	3.54	3.76
MC-M8-ZB30KE				4.81	6.80	7.94	10.50	MC-M8-ZB30KE					3.44	3.63	3.74	4.00
MC-H8-ZB38KE				5.34	7.30	8.38	10.70	MC-H8-ZB38KE					4.77	5.19	5.43	5.97
MC-P8-ZB38KE				5.95	8.35	9.73	12.85	MC-P8-ZB38KE					4.24	4.53	4.69	5.06
MC-M8-ZB38KE				5.72	7.96	9.23	12.00	MC-M8-ZB38KE					4.44	4.78	4.97	5.40
MC-M8-ZB42KE**				6.30	8.66	9.96	12.75	MC-M8-ZB42KE**					5.13	5.57	5.81	6.32
MC-R7-ZB42KE**				6.92	9.77	11.40	15.10	MC-R7-ZB42KE**					4.81	5.09	5.24	5.57
MC-M8-ZB45KE				6.49	8.92	10.25	13.15	MC-M8-ZB45KE					5.28	5.72	5.96	6.47
MC-R7-ZB45KE				7.14	10.10	11.75	15.55	MC-R7-ZB45KE					4.98	5.26	5.41	5.75
MC-M9-ZB45KE				6.87	9.59	11.10	14.50	MC-M9-ZB45KE					5.13	5.48	5.66	6.08
MC-S9-ZB45KE				7.37	10.50	12.30	16.45	MC-S9-ZB45KE					4.80	5.03	5.15	5.42
MC-R7-ZB50KE				7.53	11.40	13.40	17.65	MC-R7-ZB50KE					6.02	6.47	6.69	7.16
MC-S9-ZB50KE				7.94	12.00	14.20	18.90	MC-S9-ZB50KE					5.76	6.11	6.29	6.68
MC-R7-ZB58KE				8.48	12.35	14.45	18.75	MC-R7-ZB58KE					6.73	7.31	7.62	8.28
MC-S9-ZB58KE				8.94	13.10	15.35	20.30	MC-S9-ZB58KE					6.41	6.89	7.14	7.71
MC-S9-ZB66KE				10.30	14.45	16.75	21.70	MC-S9-ZB66KE					7.35	7.92	8.23	8.93
MC-V9-ZB66KE				10.65	15.05	17.55	23.00	MC-V9-ZB66KE					7.07	7.57	7.83	8.46
MC-V9-ZB76KE				12.15	17.15	19.90	25.80	MC-V9-ZB76KE					8.27	9.02	9.42	10.30
MC-V6-ZB76KE				12.90	18.45	21.60	28.70	MC-V6-ZB76KE					8.04	8.61	8.91	9.58
MC-V9-ZB95KE				12.15*	19.30	22.40	28.70	MC-V9-ZB95KE					11.15*	12.40	12.95	14.30
MC-V6-ZB95KE				14.85	21.50	25.20	33.10	MC-V6-ZB95KE					10.70	11.40	11.85	12.95
MC-V6-ZB114KE				15.05*	24.30	28.40	37.30	MC-V6-ZB114KE					13.05*	14.25	14.80	16.20
MC-W9-ZB114KE				16.80	24.60	28.80	38.00	MC-W9-ZB114KE					13.15	14.05	14.60	15.95
Low Temperature Models																
MC-B8-ZF06KE		1.31	1.59	2.19	2.85	3.20		MC-B8-ZF06KE		1.71	1.83	2.10	2.43	2.62		
MC-D8-ZF09KE		1.89	2.30	3.25	4.37	4.98	6.31	MC-D8-ZF09KE		1.97	2.05	2.26	2.57	2.76	3.20	
MC-H8-ZF09KE		1.99	2.45	3.55	4.91	5.70	7.47	MC-H8-ZF09KE		1.96	2.02	2.21	2.47	2.63	3.01	
MC-H8-ZF13KE		2.76	3.38	4.85	6.60	7.57	9.68	MC-H8-ZF13KE		2.60	2.73	3.07	3.51	3.76	4.34	
MC-M8-ZF13KE		2.83	3.49	5.08	7.01	8.11	10.55	MC-M8-ZF13KE		2.51	2.63	2.94	3.33	3.56	4.09	
MC-M8-ZF15KE		3.40	4.16	5.94	8.06	9.23	11.70	MC-M8-ZF15KE		3.29	3.52	4.04	4.69	5.08	6.01	
MC-M8-ZF18KE		3.90	4.79	6.80	9.15	10.45	13.30	MC-M8-ZF18KE		4.04	4.25	4.77	5.45	5.86	6.82	
MC-S9-ZF18KE		4.22	5.22	7.61	10.60	12.35	16.45	MC-S9-ZF18KE		3.84	3.98	4.36	4.86	5.15	5.85	
MC-S9-ZF25K5		5.27	6.46	9.34	12.95	15.05	19.80	MC-S9-ZF25K5		4.16	4.50	5.23	6.06	6.51	7.52	
MC-R7-ZF33KE		6.76	8.21	11.50	15.25	17.30		MC-R7-ZF33KE		6.59	7.14	8.32	9.64	10.35		
MC-V9-ZF33KE		7.13	8.74	12.55	17.15	19.75	25.50	MC-V9-ZF33KE		6.27	6.74	7.73	8.83	9.43	10.70	
MC-S9-ZF34K5		6.72	8.26	11.85	16.10	18.50		MC-S9-ZF34K5		5.63	6.05	7.07	8.35	9.09		
MC-V6-ZF41K5		8.64	10.60	15.40	21.40	24.80	32.60	MC-V6-ZF41K5		6.99	7.54	8.74	10.05	10.80	12.40	
MC-V6-ZF49K5		10.20	12.50	18.05	24.80	28.70		MC-V6-ZF49K5		8.39	8.93	10.30	12.10	13.10		
Digital Medium Temperature Models																
MC-M8-ZBD30KE				4.97	6.93	8.04	10.50	MC-M8-ZBD30KE					2.99	3.40	3.60	4.04
MC-M9-ZBD45KE				7.11	9.83	11.35	14.60	MC-M9-ZBD45KE					4.53	5.20	5.57	6.36
MC-V6-ZBDT60KE				10.40	14.90	17.55	23.60	MC-V6-ZBDT60KE					6.30	6.74	6.96	7.49
MC-V6-ZBDT90KE				14.10	20.40	24.10	32.50	MC-V6-ZBDT90KE					9.56	10.35	10.75	11.85

Conditions: EN13215: Suction Gas Return 20°C, Subcooling 0K

* Conditions: EN13215: Suction Superheat 10K

** Single Phase only

Preliminary Data

Capacity Data

Ambient Temperature: 32°C															
R407C	Cooling Capacity (kW)							R407C	Power Input (kW)						
	Evaporating Temperature (°C)								Evaporating Temperature (°C)						
	-45	-35	-30	-20	-10	-5	+5		-45	-35	-30	-20	-10	-5	+5
Medium Temperature Models															
MC-D8-ZB15KE				1.80*	2.98	3.61	5.05	MC-D8-ZB15KE				1.55*	1.63	1.67	1.78
MC-H8-ZB15KE				1.93*	3.20	3.91	5.56	MC-H8-ZB15KE				1.55*	1.58	1.59	1.65
MC-D8-ZB19KE				2.02*	3.20*	4.01	5.68	MC-D8-ZB19KE				1.72*	1.88*	1.99	2.22
MC-H8-ZB19KE				2.15*	3.52	4.34	6.30	MC-H8-ZB19KE				1.71*	1.81	1.87	1.99
MC-K9-ZB19KE				2.15*	3.51	4.33	6.28	MC-K9-ZB19KE				1.70*	1.80	1.86	1.98
MC-H8-ZB21KE				2.85*	4.56	5.51	7.75	MC-H8-ZB21KE				2.13*	2.29	2.38	2.58
MC-K9-ZB21KE				2.84*	4.55	5.50	7.72	MC-K9-ZB21KE				2.12*	2.29	2.38	2.58
MC-D8-ZB21KE				2.63*	4.04*	4.86*	6.79	MC-D8-ZB21KE				2.24*	2.49*	2.64*	3.03
MC-H8-ZB26KE				3.26*	5.08*	6.26	8.74	MC-H8-ZB26KE				2.53*	2.74*	2.87	3.16
MC-K9-ZB26KE				3.25*	5.06*	6.24	8.71	MC-K9-ZB26KE				2.52*	2.74*	2.87	3.17
MC-H8-ZB30KE				4.02*	5.89*	7.14	9.74	MC-H8-ZB30KE				2.96*	3.37*	3.59	4.04
MC-P8-ZB30KE				4.19*	6.31	7.53	10.45	MC-P8-ZB30KE				2.79*	3.13	3.27	3.61
MC-M8-ZB30KE				4.17*	6.15*	7.48	10.35	MC-M8-ZB30KE				2.83*	3.16*	3.33	3.68
MC-H8-ZB38KE					7.03*	8.36*	11.40	MC-H8-ZB38KE					4.27*	4.54*	5.26
MC-P8-ZB38KE				4.93*	7.52*	9.14	12.45	MC-P8-ZB38KE				3.55*	3.85*	4.09	4.61
MC-M8-ZB38KE				4.89*	7.45*	9.06	12.30	MC-M8-ZB38KE				3.60*	3.92*	4.16	4.71
MC-M8-ZB42KE**				5.29*	7.90*	9.44*	13.00	MC-M8-ZB42KE**				4.52*	4.93*	5.14*	5.64
MC-R7-ZB42KE**				5.65*	8.75	10.50	14.65	MC-R7-ZB42KE**				4.33*	4.57	4.66	4.83
MC-M8-ZB45KE				5.38*	8.17*	9.83*	13.75	MC-M8-ZB45KE				4.31*	4.78*	5.09*	5.89
MC-R7-ZB45KE				5.80*	9.14	11.05	15.50	MC-R7-ZB45KE				4.12*	4.45	4.65	5.14
MC-M9-ZB45KE				5.63*	8.65*	10.65	14.80	MC-M9-ZB45KE				4.21*	4.58*	4.85	5.45
MC-R7-ZB50KE				5.90*	10.00	12.25	17.10	MC-R7-ZB50KE				5.05*	5.48	5.69	6.31
MC-S9-ZB50KE				6.32*	10.45	12.75	17.75	MC-S9-ZB50KE				4.86*	5.21	5.40	5.96
MC-S9-ZB66KE					13.30	15.90	22.00	MC-S9-ZB66KE					6.72	7.07	7.90
MC-V9-ZB66KE				8.98*	13.75	16.50	23.00	MC-V9-ZB66KE				5.83*	6.37	6.65	7.32
MC-V9-ZB76KE				9.95*	15.55	18.70	26.00	MC-V9-ZB76KE				6.92*	7.65	8.05	9.05
MC-V6-ZB76KE				10.40*	16.25	19.65	27.60	MC-V6-ZB76KE				6.91*	7.45	7.74	8.45
MC-W9-ZB114KE				13.55*	22.20	26.90	37.70	MC-W9-ZB114KE				10.70*	11.85	12.50	14.00

Conditions: EN13215: Suction Gas Return 20°C, Subcooling 0K

* Conditions: EN13215: Suction Superheat 10K

** Single Phase only

Preliminary Data

For detailed capacity data please refer to Emerson's Select software

Capacity Data

Ambient Temperature: 32°C															
R134a	Cooling Capacity (kW)							R134a	Power Input (kW)						
	Evaporating Temperature (°C)								Evaporating Temperature (°C)						
	-45	-35	-30	-20	-10	-5	+5		-45	-35	-30	-20	-10	-5	+5
Medium Temperature Models															
MC-D8-ZB15KE				1.40	2.19	2.69	3.89	MC-D8-ZB15KE				0.99	1.04	1.08	1.16
MC-H8-ZB15KE				1.43	2.26	2.79	4.09	MC-H8-ZB15KE				1.08	1.11	1.14	1.20
MC-D8-ZB19KE				1.60	2.50	3.06	4.40	MC-D8-ZB19KE				1.13	1.20	1.25	1.36
MC-H8-ZB19KE				1.64	2.59	3.19	4.65	MC-H8-ZB19KE				1.21	1.26	1.29	1.36
MC-K9-ZB19KE				1.64	2.59	3.20	4.67	MC-K9-ZB19KE				1.19	1.24	1.27	1.34
MC-H8-ZB21KE				2.05	3.21	3.95	5.72	MC-H8-ZB21KE				1.46	1.53	1.58	1.69
MC-K9-ZB21KE				2.05	3.22	3.96	5.75	MC-K9-ZB21KE				1.44	1.51	1.55	1.66
MC-D8-ZB21KE				1.87*	3.07	3.74	5.33	MC-D8-ZB21KE				1.41*	1.52	1.59	1.76
MC-H8-ZB26KE				2.34	3.67	4.50	6.49	MC-H8-ZB26KE				1.66	1.75	1.81	1.95
MC-K9-ZB26KE				2.35	3.68	4.51	6.52	MC-K9-ZB26KE				1.64	1.72	1.78	1.92
MC-H8-ZB30KE				2.72	4.24	5.18	7.43	MC-H8-ZB30KE				1.92	2.04	2.12	2.32
MC-M8-ZB30KE				2.77	4.35	5.34	7.74	MC-M8-ZB30KE				1.86	1.95	2.02	2.17
MC-P8-ZB30KE				2.79	4.38	5.39	7.84	MC-P8-ZB30KE				1.83	1.91	1.97	2.11
MC-H8-ZB38KE				3.10*	5.08	6.18	8.77	MC-H8-ZB38KE				2.45*	2.66	2.78	3.09
MC-M8-ZB38KE				3.36	5.25	6.42	9.23	MC-M8-ZB38KE				2.37	2.52	2.61	2.85
MC-P8-ZB38KE				3.39	5.30	6.50	9.38	MC-P8-ZB38KE				2.32	2.46	2.54	2.76
MC-M8-ZB42KE**				3.81	5.87	7.12	10.10	MC-M8-ZB42KE**				2.76	2.91	2.97	3.09
MC-R7-ZB42KE**				3.93	6.11	7.46	10.75	MC-R7-ZB42KE**				2.83	2.89	2.90	2.90
MC-M8-ZB45KE				4.04	6.21	7.55	10.70	MC-M8-ZB45KE				2.74	2.96	3.09	3.42
MC-M9-ZB45KE				4.13	6.39	7.79	11.15	MC-M9-ZB45KE				2.81	2.99	3.10	3.36
MC-R7-ZB45KE				4.18	6.49	7.93	11.45	MC-R7-ZB45KE				2.83	2.99	3.08	3.30
MC-R7-ZB50KE				4.72	7.33	8.94	12.75	MC-R7-ZB50KE				3.36	3.52	3.66	3.97
MC-S9-ZB50KE				4.77	7.45	9.12	13.10	MC-S9-ZB50KE				3.29	3.42	3.54	3.81
MC-S9-ZB66KE				6.09	9.35	11.40	16.35	MC-S9-ZB66KE				4.11	4.31	4.49	4.90
MC-V9-ZB66KE				6.16	9.50	11.60	16.70	MC-V9-ZB66KE				4.03	4.20	4.36	4.72
MC-V9-ZB76KE				6.98	10.75	13.10	18.80	MC-V9-ZB76KE				4.74	4.94	5.15	5.61
MC-V6-ZB76KE				7.12	11.05	13.55	19.60	MC-V6-ZB76KE				4.91	5.04	5.20	5.56
MC-V9-ZB95KE				8.25	13.25	16.15	22.90	MC-V9-ZB95KE				5.87	6.37	6.67	7.43
MC-V6-ZB95KE				8.58	13.80	16.90	24.20	MC-V6-ZB95KE				5.94	6.32	6.54	7.12
MC-V6-ZB114KE				9.85	16.05	19.75	28.40	MC-V6-ZB114KE				7.16	7.64	7.94	8.72
MC-W9-ZB114KE				9.91	16.15	19.90	28.70	MC-W9-ZB114KE				7.11	7.56	7.85	8.59
Digital Medium Temperature Models															
MC-M8-ZBD30KE				2.91	4.47	5.39	7.60	MC-M8-ZBD30KE				1.78	2.01	2.12	2.37
MC-M9-ZBD45KE				3.93*	6.35	7.72	11.00	MC-M9-ZBD45KE				2.58*	2.95	3.13	3.53
MC-V6-ZBDT60KE				5.79	9.05	11.05	16.00	MC-V6-ZBDT60KE				3.87	4.13	4.26	4.59
MC-V6-ZBDT90KE				8.36	12.95	15.85	22.90	MC-V6-ZBDT90KE				5.23	5.71	5.96	6.55

Conditions: EN13215: Suction Gas Return 20°C, Subcooling 0K

* Conditions: EN13215: Suction Superheat 10K

** Single Phase only

Preliminary Data

For detailed capacity data please refer to Emerson's Select software

Capacity Data

Ambient Temperature: 32°C															
R450A	Cooling Capacity (kW)							R450A	Power Input (kW)						
	Evaporating Temperature (°C)								Evaporating Temperature (°C)						
	-45	-35	-30	-20	-10	-5	+5		-45	-35	-30	-20	-10	-5	+5
Medium Temperature Models															
MC-D8-ZB15KE				1.17	1.91	2.38	3.50	MC-D8-ZB15KE				0.92	0.91	0.91	0.95
MC-H8-ZB15KE				1.21	1.99	2.48	3.70	MC-H8-ZB15KE				1.00	0.98	0.98	1.00
MC-D8-ZB19KE				1.36	2.18	2.70	3.96	MC-D8-ZB19KE				1.05	1.07	1.10	1.17
MC-H8-ZB19KE				1.40	2.26	2.81	4.18	MC-H8-ZB19KE				1.13	1.14	1.15	1.20
MC-K9-ZB19KE				1.40	2.27	2.82	4.20	MC-K9-ZB19KE				1.11	1.12	1.13	1.18
MC-D8-ZB21KE				1.62*	2.76	3.39	4.88	MC-D8-ZB21KE				1.26*	1.32	1.35	1.47
MC-H8-ZB21KE				1.80	2.89	3.58	5.25	MC-H8-ZB21KE				1.32	1.35	1.37	1.44
MC-K9-ZB21KE				1.80	2.90	3.59	5.28	MC-K9-ZB21KE				1.30	1.32	1.34	1.41
MC-H8-ZB26KE				2.07	3.30	4.06	5.96	MC-H8-ZB26KE				1.54	1.57	1.60	1.70
MC-K9-ZB26KE				2.08	3.31	4.08	6.00	MC-K9-ZB26KE				1.52	1.54	1.57	1.67
MC-H8-ZB30KE				2.39	3.84	4.73	6.87	MC-H8-ZB30KE				1.75	1.80	1.83	1.95
MC-M8-ZB30KE				2.44	3.94	4.86	7.13	MC-M8-ZB30KE				1.70	1.73	1.75	1.84
MC-P8-ZB30KE				2.47	3.98	4.92	7.23	MC-P8-ZB30KE				1.66	1.69	1.71	1.79
MC-H8-ZB38KE				2.73*	4.62	5.66	8.18	MC-H8-ZB38KE				2.19*	2.29	2.36	2.57
MC-M8-ZB38KE				2.99	4.77	5.88	8.58	MC-M8-ZB38KE				2.13	2.19	2.24	2.40
MC-P8-ZB38KE				3.02	4.83	5.96	8.74	MC-P8-ZB38KE				2.08	2.13	2.18	2.32
MC-H8-ZB38KE				2.73*	4.62	5.66	8.18	MC-H8-ZB38KE				2.19*	2.29	2.36	2.57
MC-M8-ZB42KE**				3.33	5.33	6.53	9.43	MC-M8-ZB42KE**				2.35	2.45	2.51	2.69
MC-R7-ZB42KE**				3.44	5.54	6.83	10.00	MC-R7-ZB42KE**				2.48	2.54	2.58	2.70
MC-M8-ZB45KE				3.48	5.52	6.77	9.80	MC-M8-ZB45KE				2.45	2.53	2.60	2.79
MC-M9-ZB45KE				3.54	5.66	6.97	10.15	MC-M9-ZB45KE				2.55	2.61	2.66	2.81
MC-R7-ZB45KE				3.59	5.75	7.11	10.45	MC-R7-ZB45KE				2.58	2.62	2.66	2.78
MC-R7-ZB58KE				4.53	7.15	8.77	12.65	MC-R7-ZB58KE				3.32	3.61	3.77	4.13
MC-S9-ZB58KE				4.59	7.27	8.94	13.00	MC-S9-ZB58KE				3.26	3.53	3.67	3.99
MC-S9-ZB66KE				5.11	8.08	9.91	14.35	MC-S9-ZB66KE				3.64	3.94	4.10	4.50
MC-V9-ZB66KE				5.16	8.18	10.05	14.60	MC-V9-ZB66KE				3.59	3.87	4.02	4.38
MC-V6-ZB76KE				6.04	9.67	11.90	17.45	MC-V6-ZB76KE				4.37	4.70	4.87	5.23
MC-V9-ZB76KE				5.91	9.44	11.60	16.85	MC-V9-ZB76KE				4.14	4.53	4.74	5.18
MC-V6-ZB95KE				7.33	11.75	14.50	21.30	MC-V6-ZB95KE				5.39	5.73	6.00	6.68
MC-V9-ZB95KE				7.09	11.30	13.95	20.30	MC-V9-ZB95KE				5.26	5.66	5.97	6.79
MC-V6-ZB114KE				8.43	13.75	17.00	24.80	MC-V6-ZB114KE				6.52	7.02	7.34	8.12
MC-W9-ZB114KE				8.47	13.80	17.10	25.00	MC-W9-ZB114KE				6.49	6.97	7.29	8.04
Digital Medium Temperature Models															
MC-M8-ZBD30KE				2.48	3.96	4.86	7.07	MC-M8-ZBD30KE				1.54	1.69	1.76	1.96
MC-M9-ZBD45KE				3.60	5.76	7.06	10.20	MC-M9-ZBD45KE				2.32	2.56	2.70	3.04
MC-V6-ZBDT60KE				5.04	8.12	10.05	14.80	MC-V6-ZBDT60KE				3.49	3.63	3.70	3.95
MC-V6-ZBDT90KE				7.25	11.60	14.30	21.00	MC-V6-ZBDT90KE				4.79	5.06	5.22	5.67

Conditions: EN13215: Suction Gas Return 20°C, Subcooling 0K

* Conditions: EN13215: Suction Superheat 10K

** Single Phase only

Preliminary Data

For detailed capacity data please refer to Emerson's Select software

Capacity Data

Ambient Temperature: 32°C															
R513A	Cooling Capacity (kW)							R513A	Power Input (kW)						
	Evaporating Temperature (°C)								Evaporating Temperature (°C)						
	-45	-35	-30	-20	-10	-5	+5		-45	-35	-30	-20	-10	-5	+5
Medium Temperature Models															
MC-D8-ZB15KE				1.42	2.26	2.76	3.95	MC-D8-ZB15KE				1.08	1.08	1.09	1.13
MC-H8-ZB15KE				1.48	2.37	2.91	4.23	MC-H8-ZB15KE				1.15	1.14	1.13	1.15
MC-D8-ZB19KE				1.65	2.57	3.13	4.47	MC-D8-ZB19KE				1.24	1.29	1.32	1.41
MC-H8-ZB19KE				1.71	2.69	3.30	4.80	MC-H8-ZB19KE				1.30	1.33	1.34	1.40
MC-K9-ZB19KE				1.72	2.70	3.31	4.83	MC-K9-ZB19KE				1.28	1.30	1.32	1.38
MC-D8-ZB21KE				1.92*	3.20	3.86	5.41	MC-D8-ZB21KE				1.49*	1.60	1.66	1.79
MC-H8-ZB21KE				2.18	3.41	4.15	5.95	MC-H8-ZB21KE				1.54	1.59	1.62	1.70
MC-K9-ZB21KE				2.19	3.43	4.18	5.99	MC-K9-ZB21KE				1.51	1.56	1.59	1.67
MC-H8-ZB26KE				2.51	3.87	4.74	6.78	MC-H8-ZB26KE				1.80	1.86	1.91	2.03
MC-K9-ZB26KE				2.52	3.89	4.77	6.84	MC-K9-ZB26KE				1.77	1.83	1.88	1.99
MC-H8-ZB30KE				2.67*	4.47	5.45	7.77	MC-H8-ZB30KE				2.05*	2.15	2.21	2.37
MC-M8-ZB30KE				2.96	4.63	5.67	8.17	MC-M8-ZB30KE				1.99	2.05	2.09	2.21
MC-P8-ZB30KE				2.99	4.69	5.76	8.33	MC-P8-ZB30KE				1.95	2.00	2.03	2.13
MC-M8-ZB38KE				3.35*	5.60	6.84	9.74	MC-M8-ZB38KE				2.49*	2.63	2.70	2.90
MC-P8-ZB38KE				3.66	5.69	6.96	9.97	MC-P8-ZB38KE				2.45	2.56	2.62	2.79
MC-H8-ZB38KE				3.23*	5.37	6.52	9.15	MC-H8-ZB38KE				2.58*	2.78	2.88	3.15
MC-M8-ZB42KE**				3.74*	6.24	7.56	10.65	MC-M8-ZB42KE**				2.78*	2.96	3.05	3.29
MC-R7-ZB42KE**				4.21	6.56	8.01	11.50	MC-R7-ZB42KE**				2.88	2.98	3.04	3.19
MC-M8-ZB45KE				3.87*	6.45	7.83	11.05	MC-M8-ZB45KE				2.88*	3.07	3.16	3.41
MC-M9-ZB45KE				4.29	6.65	8.12	11.55	MC-M9-ZB45KE				2.98	3.10	3.17	3.36
MC-R7-ZB45KE				4.37	6.80	8.32	11.95	MC-R7-ZB45KE				2.99	3.08	3.14	3.29
MC-R7-ZB58KE				5.45	8.41	10.20	14.35	MC-R7-ZB58KE				3.93	4.13	4.27	4.65
MC-S9-ZB58KE				5.55	8.59	10.45	14.85	MC-S9-ZB58KE				3.85	4.01	4.13	4.45
MC-S9-ZB66KE				6.17	9.55	11.60	16.40	MC-S9-ZB66KE				4.32	4.53	4.67	5.07
MC-V9-ZB66KE				6.26	9.70	11.80	16.80	MC-V9-ZB66KE				4.26	4.43	4.55	4.90
MC-V6-ZB76KE				7.36	11.50	14.00	20.20	MC-V6-ZB76KE				5.11	5.33	5.46	5.79
MC-V9-ZB76KE				7.17	11.15	13.55	19.25	MC-V9-ZB76KE				4.93	5.23	5.41	5.87
MC-V6-ZB95KE				8.90	14.00	17.05	24.30	MC-V6-ZB95KE				6.35	6.71	6.91	7.41
MC-V9-ZB95KE				8.57	13.35	16.20	22.80	MC-V9-ZB95KE				6.28	6.77	7.06	7.76
MC-V6-ZB114KE				10.10	16.30	19.85	28.10	MC-V6-ZB114KE				7.76	8.23	8.49	9.12
MC-W9-ZB114KE				10.15	16.40	20.00	28.30	MC-W9-ZB114KE				7.72	8.16	8.40	9.00
Digital Medium Temperature Models															
MC-M8-ZBD30KE				3.02	4.67	5.67	8.07	MC-M8-ZBD30KE				1.79	1.99	2.08	2.32
MC-M9-ZBD45KE				4.38	6.75	8.19	11.60	MC-M9-ZBD45KE				2.70	3.02	3.20	3.61
MC-V6-ZBDT60KE				6.15	9.64	11.85	17.15	MC-V6-ZBDT60KE				3.99	4.18	4.28	4.58
MC-V6-ZBDT90KE				8.82	13.70	16.75	24.00	MC-V6-ZBDT90KE				5.56	5.95	6.16	6.70

Conditions: EN13215: Suction Gas Return 20°C, Subcooling 0K

* Conditions: EN13215: Suction Superheat 10K

** Single Phase only

Preliminary Data

For detailed capacity data please refer to Emerson's Select software

Copeland™ Scroll Digital Receiver Unit HLR

Copeland scroll digital receiver units are the perfect choice for remote condenser systems.

These scroll digital receiver units are an innovative offering by Emerson for food service and retail businesses. Their compact design and the power of digital scroll continuous capacity modulation allow for optimized environmental integration at highest system efficiency.

Eight models with single or tandem compressors cover the need of medium temperature refrigeration capacities in various applications. The continuous capacity modulation always provides the right performance, especially for systems with multiple evaporators and variable loads. The remote condenser concept allows for optimal building integration.



Digital receiver unit HLR



Digital Receiver Unit HLR Line-up

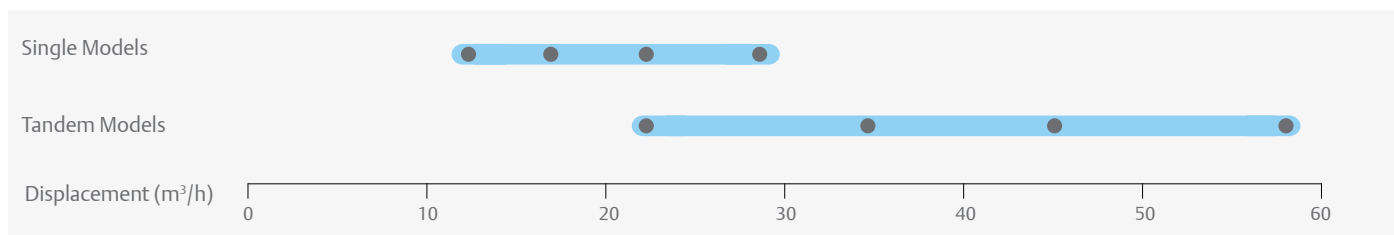

Features and Benefits

- Standard equipment: digital scroll compressor, liquid receiver, liquid line with filter drier and sight glass, HP/LP switch, complete electrical box including controller with overload protection and communication interface
- Continuous capacity modulation 10-100 % (Single) or 5-100 % (Tandem)
- Precise suction pressure control
- Maximum system flexibility by free choice of third party condensers
- Excellent energy efficiency
- High reliability
- Easy and quick installation
- Suitable for multiple refrigerants: R407A/F, R448A/R449A, R404A, R134a, R450A and R513A

Maximum Allowable Pressures (PS)

- Low Side PS 22.5 bar (g)
- High Side PS = 28/32 bar (g)

Technical Overview

Models	Displacement (m ³ /h)	Receiver Capacity (l)	Suction Line Diameter (inch)	Liquid Line Diameter (inch)	Width/Depth/Height (mm)	Net Weight (kg)	Motor Version/Code	Maximum Operating Current (A)	Locked Rotor Current (A)	Sound Pressure @1 m - dB(A) ^{***}	
							3 Ph ^{**}	3 Ph ^{**}	3 Ph ^{**}	Without Sound Shell	With Sound Shell
Single Compressor Unit Models											
HLR13-ZBD30KE	11.7	13	7/8	5/8	719/412/712	72	TFD	8	52	59	49
HLR13-ZBD45KE	17.1	13	7/8	5/8	719/412/712	75	TFD	12	74	61	51
HLR13-ZBD58KE	22.1	13	1 1/8	3/4	723/439/685	84	TFD	15	95	65	55
HLR13-ZBD76KE	28.8	13	1 3/8	3/4	723/439/742	90	TFD	20	118	66	56
Tandem Compressor Unit Models											
HLR31-ZBDT60KE	23.4	31	1 3/8	7/8	956/577/917	130	TFD	8+8	52 + 52	62	-
HLR31-ZBDT90KE	34.1	31	1 3/8	7/8	956/577/917	138	TFD	12 + 12	74 + 74	64	-
HLR31-ZBDT116KE	44.2	31	1 5/8	1 1/8	956/575/916	165	TFD	15 + 15	95 + 95	68	-
HLR31-ZBDT152KE	58.2	31	1 5/8	1 3/8	956/561/945	175	TFD	20 + 20	118+118	69	-

** 3 Ph: 380-420V/ 50Hz

*** @ 1m: sound pressure level at 1m distance from the compressor, free field condition

Capacity Data

Condensing Temperature: 40°C															
R407A	Cooling Capacity (kW)							R407A	Power Input (kW)						
	Evaporating Temperature (°C)								Evaporating Temperature (°C)						
Model	-45	-35	-30	-20	-10	-5	+5	Model	-45	-35	-30	-20	-10	-5	+5
Single Compressor Unit Models															
HLR13-ZBD30KCE				4.59	7.29	8.98	13.10	HLR13-ZBD30KCE				2.75	2.77	2.79	2.82
HLR13-ZBD45KCE				6.36	10.10	12.50	18.25	HLR13-ZBD45KCE				3.81	3.83	3.87	3.91
HLR13-ZBD58KCE				7.27*	13.05	16.30	24.10	HLR13-ZBD58KCE				5.13*	5.30	5.35	5.39
HLR13-ZBD76KCE				9.93*	17.25	21.50	31.70	HLR13-ZBD76KCE				6.57*	6.88	6.97	7.09
Tandem Compressor Unit Models															
HLR31-ZBDT60KCE				8.79*	14.55	17.90	26.10	HLR31-ZBDT60KCE				5.43*	5.49	5.55	5.63
HLR31-ZBDT90KCE				12.35*	20.30	24.90	36.30	HLR31-ZBDT90KCE				7.75*	7.82	7.84	7.81
HLR31-ZBDT116KE				14.50*	26.00	32.50	48.10	HLR31-ZBDT116KE				10.25*	10.55	10.60	10.70
HLR31-ZBDT152KE				19.95*	34.60	43.00	63.60	HLR31-ZBDT152KE				13.10*	13.70	13.85	14.10

Conditions: Suction Gas Return 20°C / Subcooling 0K

*Conditions: Suction Superheat 10K, Subcooling 0K

Preliminary Data

For detailed capacity data please refer to Emerson's Select software

Condensing Temperature: 40°C															
R407F	Cooling Capacity (kW)							R407F	Power Input (kW)						
	Evaporating Temperature (°C)								Evaporating Temperature (°C)						
Model	-45	-35	-30	-20	-10	-5	+5	Model	-45	-35	-30	-20	-10	-5	+5
Single Compressor Unit Models															
HLR13-ZBD30KCE				4.66*	7.27	8.82	12.75	HLR13-ZBD30KCE				2.49*	2.82	2.93	3.12
HLR13-ZBD45KCE				6.41*	10.75	13.15	18.85	HLR13-ZBD45KCE				3.68*	4.09	4.29	4.62
HLR13-ZBD58KCE				7.46*	14.05	17.55	25.80	HLR13-ZBD58KCE				5.37*	5.51	5.54	5.60
HLR13-ZBD76KCE				10.45*	18.80	23.30	34.20	HLR13-ZBD76KCE				6.85*	7.14	7.22	7.37
Tandem Compressor Unit Models															
HLR31-ZBDT60KCE				8.85*	14.45	17.70	25.70	HLR31-ZBDT60KCE				5.43*	5.73	5.83	5.96
HLR31-ZBDT90KCE				12.40*	21.20	26.10	37.90	HLR31-ZBDT90KCE				7.80*	8.35	8.53	8.82
HLR31-ZBDT116KE				14.90*	28.10	35.10	51.60	HLR31-ZBDT116KE				10.75*	11.00	11.10	11.20
HLR31-ZBDT152KE				20.90*	37.60	46.60	68.50	HLR31-ZBDT152KE				13.70*	14.30	14.45	14.75

Conditions: Suction Gas Return 20°C / Subcooling 0K

*Conditions: Suction Superheat 10K, Subcooling 0K

Preliminary Data

For detailed capacity data please refer to Emerson's Select software

Condensing Temperature: 40°C															
R448A	Cooling Capacity (kW)							R448A	Power Input (kW)						
	Evaporating Temperature (°C)								Evaporating Temperature (°C)						
Model	-45	-35	-30	-20	-10	-5	+5	Model	-45	-35	-30	-20	-10	-5	+5
Single Compressor Unit Models															
HLR13-ZBD30KCE				4.63	7.21	8.81	12.80	HLR13-ZBD30KCE				2.42	2.69	2.83	3.13
HLR13-ZBD45KCE				6.77	10.60	12.95	18.70	HLR13-ZBD45KCE				3.42	3.82	4.00	4.41
HLR13-ZBD58KCE				8.59*	13.70	16.85	24.4	HLR13-ZBD58KCE				5.26*	5.24	5.28	5.38
HLR13-ZBD76KCE				11.10*	18.70	22.90	33.00	HLR13-ZBD76KCE				7.02*	7.10	7.17	7.37
Tandem Compressor Unit Models															
HLR31-ZBDT60KCE				9.15	14.35	17.55	25.40	HLR31-ZBDT60KCE				5.16	5.43	5.57	5.91
HLR31-ZBDT90KCE				13.40	21.10	25.70	37.20	HLR31-ZBDT90KCE				7.30	7.69	7.89	8.34
HLR31-ZBDT116KE				15.65*	27.30	33.70	48.60	HLR31-ZBDT116KE				10.50*	10.45	10.50	10.70
HLR31-ZBDT152KE				21.90*	36.90	45.20	65.20	HLR31-ZBDT152KE				13.70*	13.85	13.95	14.35

Conditions: Suction Gas Return 20°C / Subcooling 0K

*Conditions: Suction Superheat 10K, Subcooling 0K

Preliminary Data

For detailed capacity data please refer to Emerson's Select software

Capacity Data

Condensing Temperature: 40°C															
R449A	Cooling Capacity (kW)						R449A	Power Input (kW)							
	Evaporating Temperature (°C)							Evaporating Temperature (°C)							
Model	-45	-35	-30	-20	-10	-5	+5	Model	-45	-35	-30	-20	-10	-5	+5
Single Compressor Unit Models															
HLR13-ZBD30KCE				4.63	7.21	8.81	12.80	HLR13-ZBD30KCE				2.42	2.69	2.83	3.13
HLR13-ZBD45KCE				6.77	10.60	12.95	18.70	HLR13-ZBD45KCE				3.42	3.82	4.00	4.41
HLR13-ZBD58KCE				7.86*	13.75	16.90	24.40	HLR13-ZBD58KCE				5.26*	5.24	5.28	5.38
HLR13-ZBD76KCE				11.05*	18.70	22.90	33.00	HLR13-ZBD76KCE				7.02*	7.10	7.17	7.37
Tandem Compressor Unit Models															
HLR31-ZBDT60KCE				9.15	14.35	17.55	25.40	HLR31-ZBDT60KCE				5.16	5.43	5.57	5.91
HLR31-ZBDT90KCE				13.40	21.10	25.70	37.20	HLR31-ZBDT90KCE				7.30	7.69	7.89	8.34
HLR31-ZBDT116KE				15.60*	27.30	33.70	48.60	HLR31-ZBDT116KE				10.50*	10.45	10.50	10.70
HLR31-ZBDT152KE				21.80*	36.90	45.20	65.20	HLR31-ZBDT152KE				13.70*	13.85	13.95	14.35

Conditions: Suction Gas Return 20°C / Subcooling 0K

*Conditions: Suction Superheat 10K, Subcooling 0K

Preliminary Data

For detailed capacity data please refer to Emerson's Select software

Condensing Temperature: 45°C															
R404A	Cooling Capacity (kW)						R404A	Power Input (kW)							
	Evaporating Temperature (°C)							Evaporating Temperature (°C)							
Model	-45	-35	-30	-20	-10	-5	+5	Model	-45	-35	-30	-20	-10	-5	+5
Single Compressor Unit Models															
HLR13-ZBD30KCE				5.14	7.57	9.07	12.70	HLR13-ZBD30KCE				2.65	2.87	2.96	3.20
HLR13-ZBD45KCE				7.55	11.15	13.35	18.80	HLR13-ZBD45KCE				3.84	4.19	4.37	4.75
HLR13-ZBD58KCE				9.53	14.65	17.65	24.80	HLR13-ZBD58KCE				5.66	5.70	5.76	5.81
HLR13-ZBD76KCE				12.90	19.35	23.20	32.70	HLR13-ZBD76KCE				7.26	7.42	7.50	7.64
Tandem Compressor Unit Models															
HLR31-ZBDT60KCE				10.35	15.20	18.20	25.50	HLR31-ZBDT60KCE				5.29	5.74	5.93	6.40
HLR31-ZBDT90KCE				14.95	22.10	26.50	37.40	HLR31-ZBDT90KCE				8.16	8.49	8.64	8.95
HLR31-ZBDT116KE				18.95	29.20	35.10	49.60	HLR31-ZBDT116KE				11.30	11.35	11.45	11.50
HLR31-ZBDT152KE				25.90	38.70	46.50	65.40	HLR31-ZBDT152KE				14.45	14.75	14.90	15.15

Conditions: Suction Gas Return 20°C / Subcooling 0K

For detailed capacity data please refer to Emerson's Select software

Condensing Temperature: 40°C															
R407C	Cooling Capacity (kW)						R407C	Power Input (kW)							
	Evaporating Temperature (°C)							Evaporating Temperature (°C)							
Model	-45	-35	-30	-20	-10	-5	+5	Model	-45	-35	-30	-20	-10	-5	+5
Single Compressor Unit Models															
HLR13-ZBD30KCE				4.24*	6.61	8.06	11.80	HLR13-ZBD30KCE				2.54*	2.66	2.67	2.70
HLR13-ZBD45KCE				5.83*	9.59	11.85	17.40	HLR13-ZBD45KCE				3.63*	3.65	3.67	3.72
Tandem Compressor Unit Models															
HLR31-ZBDT60KCE				8.47*	13.20	16.10	23.60	HLR31-ZBDT60KCE				5.08*	5.31	5.35	5.41
HLR31-ZBDT90KCE				11.65*	19.20	23.70	34.80	HLR31-ZBDT90KCE				7.25*	7.30	7.35	7.45

Conditions: Suction Gas Return 20°C / Subcooling 0K

*Conditions: Suction Superheat 10K, Subcooling 0K

For detailed capacity data please refer to Emerson's Select software

Capacity Data

Condensing Temperature: 40°C															
R134a	Cooling Capacity (kW)							R134a	Power Input (kW)						
	Evaporating Temperature (°C)								Evaporating Temperature (°C)						
Model	-45	-35	-30	-20	-10	-5	+5	Model	-45	-35	-30	-20	-10	-5	+5
Single Compressor Unit Models															
HLR13-ZBD30KCE				2.69*	4.46	5.44	7.94	HLR13-ZBD30KCE				1.59*	1.78	1.85	2.02
HLR13-ZBD45KCE				3.82*	6.40	7.91	11.80	HLR13-ZBD45KCE				2.25*	2.53	2.63	2.86
HLR13-ZBD58KCE				5.16	8.27	10.25	15.25	HLR13-ZBD58KCE				3.38	3.37	3.42	3.51
HLR13-ZBD76KCE				6.86	10.80	13.45	20.00	HLR13-ZBD76KCE				4.42	4.42	4.48	4.59
Tandem Compressor Unit Models															
HLR31-ZBDT60KCE				5.22*	8.78	10.80	16.00	HLR31-ZBDT60KCE				3.31*	3.52	3.61	3.80
HLR31-ZBDT90KCE				7.62*	12.80	15.95	23.90	HLR31-ZBDT90KCE				4.67*	4.99	5.12	5.39
HLR31-ZBDT116KE				10.30	16.55	20.50	30.50	HLR31-ZBDT116KE				6.77	6.75	6.84	7.03
HLR31-ZBDT152KE				13.70	21.70	26.90	40.00	HLR31-ZBDT152KE				8.85	8.83	8.95	9.18

Conditions: Suction Gas Return 20°C / Subcooling 0K

*Conditions: Suction Superheat 10K, Subcooling 0K

Preliminary Data

For detailed capacity data please refer to Emerson's Select software

Condensing Temperature: 40°C															
R450A	Cooling Capacity (kW)							R450A	Power Input (kW)						
	Evaporating Temperature (°C)								Evaporating Temperature (°C)						
Model	-45	-35	-30	-20	-10	-5	+5	Model	-45	-35	-30	-20	-10	-5	+5
Single Compressor Unit Models															
HLR13-ZBD30KCE				2.20*	3.89	4.85	7.29	HLR13-ZBD30KCE				1.38*	1.49	1.53	1.67
HLR13-ZBD45KCE				3.24*	5.74	7.16	10.80	HLR13-ZBD45KCE				2.01*	2.17	2.26	2.48
HLR13-ZBD58KCE				4.57	7.41	9.17	13.55	HLR13-ZBD58KCE				2.47	2.65	2.74	2.87
HLR13-ZBD76KCE				6.20	9.80	12.05	17.80	HLR13-ZBD76KCE				3.18	3.44	3.56	3.79
Tandem Compressor Unit Models															
HLR31-ZBDT60KCE				4.36*	7.76	9.70	14.65	HLR31-ZBDT60KCE				2.96*	3.03	3.06	3.20
HLR31-ZBDT90KCE				6.42*	11.35	14.20	21.50	HLR31-ZBDT90KCE				4.28*	4.40	4.47	4.69
HLR31-ZBDT116KE				8.97	14.60	18.10	26.90	HLR31-ZBDT116KE				5.42	5.78	5.94	6.22
HLR31-ZBDT152KE				11.90	19.20	23.80	35.30	HLR31-ZBDT152KE				7.03	7.53	7.75	8.17

Conditions: Suction Gas Return 20°C / Subcooling 0K

*Conditions: Suction Superheat 10K, Subcooling 0K

Preliminary Data

For detailed capacity data please refer to Emerson's Select software

Condensing Temperature: 40°C															
R513A	Cooling Capacity (kW)							R513A	Power Input (kW)						
	Evaporating Temperature (°C)								Evaporating Temperature (°C)						
Model	-45	-35	-30	-20	-10	-5	+5	Model	-45	-35	-30	-20	-10	-5	+5
Single Compressor Unit Models															
HLR13-ZBD30KCE				2.69*	4.66	5.76	8.55	HLR13-ZBD30KCE				1.62*	1.76	1.81	1.96
HLR13-ZBD45KCE				3.95*	6.85	8.50	12.70	HLR13-ZBD45KCE				2.36*	2.57	2.67	2.92
HLR13-ZBD58KCE				5.58	8.87	10.90	15.90	HLR13-ZBD58KCE				3.07	3.25	3.33	3.44
HLR13-ZBD76KCE				7.58	11.80	14.45	21.00	HLR13-ZBD76KCE				3.97	4.22	4.34	4.55
Tandem Compressor Unit Models															
HLR31-ZBDT60KCE				5.32*	9.27	11.55	17.20	HLR31-ZBDT60KCE				3.47*	3.58	3.61	3.76
HLR31-ZBDT90KCE				7.81*	13.60	16.90	25.30	HLR31-ZBDT90KCE				5.01*	5.20	5.28	5.51
HLR31-ZBDT116KE				10.95	17.45	21.50	31.60	HLR31-ZBDT116KE				6.58	6.80	6.90	7.09
HLR31-ZBDT152KE				14.60	23.10	28.40	41.60	HLR31-ZBDT152KE				8.54	8.89	9.05	9.35

Conditions: Suction Gas Return 20°C / Subcooling 0K

*Conditions: Suction Superheat 10K, Subcooling 0K

Preliminary Data

For detailed capacity data please refer to Emerson's Select software



Semi-Hermetic Refrigeration Units K/L Compressors

Copeland™ air-cooled indoor refrigeration units for medium temperature and low temperature applications.

Long-term engineering and manufacturing experience has led to these refrigeration units with reed valve technology compressors. Their excellent quality and reliability is traditionally well known in the refrigeration industry.

This series of refrigeration units is equipped with single fan or twin fans which allows for very compact dimensions. The wide range of models offers solutions for most applications including operation in extreme conditions like high evaporation temperatures and high ambient temperatures.



Semi-hermetic refrigeration unit K/L compressors

Semi-Hermetic K & L Refrigeration Units Line-up

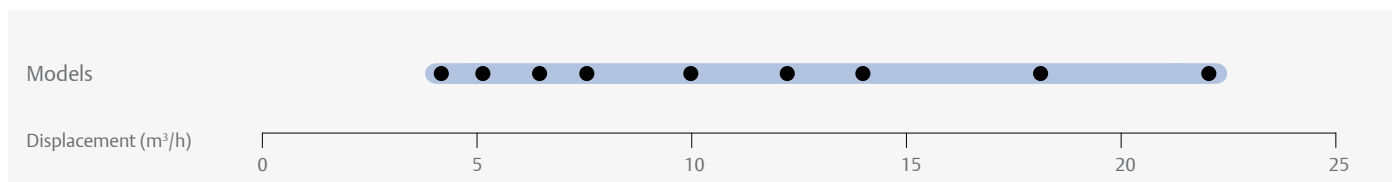

Features and Benefits

- Standard equipment: compressor, condenser with thermally protected fan(s), discharge line with flexible pipe loop or vibration absorber, liquid receiver with shut-off-valve, HP/LP switch with automatic reset
- Suitable for a broad range of refrigerants: R407A/F, R404A and R134a
- Wide range of quality accessories
- Proven reliability

Maximum Allowable Pressures (PS)

- Low Side PS 22.5 bar (g)
- High Side PS = 28 bar (g)

Technical Overview

Models	Displacement (m³/h)	Receiver Capacity (l)	Number of fans	Total Fan Motor Power (W)	Suction Line Diameter (inch)	Liquid Line Diameter (inch)	Width/Depth/Height (mm)	Net Weight (kg)	Motor Version/Code		Maximum Operating Current (A)		Locked Rotor Current (A)		Sound Pressure @10m - dB(A)***
									1 Ph*	3 Ph**	1 Ph*	3 Ph**	1 Ph*	3 Ph**	
B8-KJ-10X-B	3.3	3.3	1	85	5/8	1/2	560/570/396	57	CAG	EWL	7	3	32	16	39
B8-KJ-7X-B	3.3	3.3	1	85	5/8	1/2	560/570/396	57	CAG	EWL	6	2	35	12	
B8-KL-15X-B	3.3	3.3	1	85	5/8	1/2	560/570/396	57	CAG	EWL	8	3	43	19	39
B8-KM-5X-B	3.3	3.3	1	85	5/8	1/2	560/570/396	56	CAG	EWL	5	2	24	12	39
B8-KM-7X-B	3.3	3.3	1	85	1/2	1/2	560/570/396	57	CAG	EWL	6	2	35	12	
B8-KSJ-10X-B	3.3	3.3	1	85	5/8	1/2	560/570/396	58	CAG	EWL	7	3	32	16	
D8-KSJ-15X-B	3.9	3.9	1	110	7/8	1/2	560/570/446	62	CAG	EWL	9	3	43	19	45
D8-KSL-20X-B	3.9	3.9	1	110	5/8	1/2	560/570/446	60		EWL		5		23	
D8-LE-20X-B	3.9	3.9	1	110	5/8	1/2	560/715/446	96		EWL		6		38	
D8-LF-20X-B	3.9	3.9	1	110	5/8	1/2	560/715/446	98		EWL		6		38	
H8-KSL-20X-B	7.9	7.9	1	235	5/8	1/2	735/680/533	60		EWL		5		23	
H8-LE-20X-B	7.9	7.9	1	235	7/8	1/2	735/680/533	108		EWL		6		38	
H8-LF-30X-B	7.9	7.9	1	235	7/8	1/2	735/680/533	108		EWL		7		51	48
H8-LJ-20X-B	7.9	7.9	1	235	7/8	1/2	735/680/533	103		EWL		6		38	
H8-LJ-30X-B	7.9	7.9	1	235	7/8	1/2	735/680/533	108		EWL		7		51	48
H8-LL-30X-B	7.9	7.9	1	235	1 1/8	1/2	735/680/533	110		EWL		7		53	48
H8-LL-40X-B	7.9	7.9	1	235	1 1/8	1/2	735/680/533	112		EWL		10		59	48
K9-LL-30X-B	7.9	7.9	2	220	1 1/8	1/2	950/640/454	134		EWL		7		53	47
P8-LF-30X-B	7.9	7.9	2	220	1 1/8	1/2	950/640/633	127		EWL		7		51	47
P8-LJ-30X-B	7.9	7.9	2	220	7/8	1/2	950/640/633	127		EWL		7		51	47
P8-LL-40X-B	7.9	7.9	2	220	1 1/8	1/2	950/640/633	128		EWL		10		59	48

* 1ph: 230V/ 50Hz

** 3 Ph: 380-420V/ 50Hz

*** @ 10m: sound pressure level at 10m distance from the compressor, free field condition

Ambient Temperature: 32°C															
R407A	Cooling Capacity (kW)							R407A	Power Input (kW)						
	Evaporating Temperature (°C)								Evaporating Temperature (°C)						
Model	-45	-35	-30	-20	-10	-5	+5	Model	-45	-35	-30	-20	-10	-5	+5
B8-KM-5X-B		0.30*	0.60	1.09	1.72			B8-KM-5X-B		0.53*	0.60	0.76	0.93		
B8-KM-7X-B				1.03	1.67	2.05	2.93	B8-KM-7X-B				0.76	0.93	1.01	1.20
B8-KJ-7X-B		0.51*	0.85	1.43	2.17			B8-KJ-7X-B		0.65*	0.75	0.98	1.26		
B8-KJ-10X-B				1.43	2.26	2.73		B8-KJ-10X-B				0.99	1.26	1.42	
B8-KSJ-10X-B		0.69*	1.10	1.77	2.62			B8-KSJ-10X-B		0.83*	0.96	1.25	1.62		
D8-KSJ-15X-B				1.92	3.05	3.71	5.16	D8-KSJ-15X-B				1.30	1.61	1.77	2.11
B8-KL-15X-B		0.72*	1.20	2.01				B8-KL-15X-B		0.89*	1.02	1.37			
H8-LE-20X-B		0.90*	1.64	2.93	4.62	5.62	7.94	H8-LE-20X-B		1.31*	1.48	1.88	2.33	2.58	3.13
D8-LE-20X-B		0.86*	1.56	2.73	4.21	5.07		D8-LE-20X-B		1.17*	1.35	1.77	2.28	2.58	
H8-LF-30X-B				4.14	6.12	7.28		H8-LF-30X-B				2.55	3.15	3.50	
P8-LF-30X-B				4.28	6.41	7.68		P8-LF-30X-B				2.51	3.08	3.39	
D8-LF-20X-B		1.20*	2.08	3.51	5.25			D8-LF-20X-B		1.50*	1.74	2.31	3.03		
H8-LJ-30X-B				4.74	6.88	8.12		H8-LJ-30X-B				2.88	3.58	3.97	
P8-LJ-30X-B				4.93	7.26	8.63		P8-LJ-30X-B				2.83	3.48	3.84	
H8-LJ-20X-B		1.53*	2.60	4.47	6.84			H8-LJ-20X-B		1.79*	2.09	2.76	3.57		
P8-LL-40X-B				5.41	8.18	9.75		P8-LL-40X-B				3.02	3.88	4.36	
H8-LL-30X-B		1.69*	2.98	5.10	7.68			H8-LL-30X-B		1.96*	2.31	3.12	4.08		
H8-LL-40X-B				5.15	7.65	9.01		H8-LL-40X-B				3.06	3.97	4.49	

Conditions: EN13215: Suction Gas Return 20°C, Subcooling 0K

* Conditions: EN13215: Suction Superheat 10K

Preliminary data

For detailed capacity data please refer to Emerson's Select software

Capacity Data

Ambient Temperature: 32°C															
R404A	Cooling Capacity (kW)							R404A	Power Input (kW)						
	Evaporating Temperature (°C)								Evaporating Temperature (°C)						
Model	-45	-35	-30	-20	-10	-5	+5	Model	-45	-35	-30	-20	-10	-5	+5
B8-KM-7X-B	0.28	0.60	0.80	1.29	1.89	2.24	3.00	B8-KM-7X-B	0.44	0.60	0.68	0.85	1.01	1.10	1.26
B8-KM-5X-B	0.29	0.62	0.82	1.30				B8-KM-5X-B	0.45	0.58	0.65	0.79			
B8-KJ-7X-B	0.42	0.83	1.07	1.66				B8-KJ-7X-B	0.62	0.79	0.88	1.09			
B8-KJ-10X-B	0.38	0.80	1.05	1.66	2.38	2.77	3.62	B8-KJ-10X-B	0.55	0.77	0.88	1.12	1.38	1.52	1.81
D8-KSJ-15X-B	0.58	1.11	1.43	2.24	3.24	3.82		D8-KSJ-15X-B	0.71	0.97	1.12	1.43	1.75	1.91	
B8-KSJ-10X-B	0.58	1.05	1.34					B8-KSJ-10X-B	0.80	1.02	1.15				
B8-KL-15X-B	0.68	1.21	1.53	2.26				B8-KL-15X-B	0.87	1.12	1.27	1.64			
D8-KSL-20X-B	0.85	1.58	2.02	3.08	4.33			D8-KSL-20X-B	0.97	1.34	1.54	2.01	2.55		
H8-KSL-20X-B	0.89	1.66	2.15	3.33	4.82	5.67		H8-KSL-20X-B	1.10	1.46	1.66	2.09	2.56	2.81	
H8-LE-20X-B		1.33	1.88	3.20	4.83	5.77	7.84	H8-LE-20X-B		1.24	1.44	1.85	2.30	2.53	3.01
D8-LE-20X-B		1.24	1.74	2.91	4.26	5.00		D8-LE-20X-B		1.10	1.30	1.73	2.23	2.50	
H8-LF-30X-B	0.95	2.05	2.73	4.35	6.30	7.39		H8-LF-30X-B	1.33	1.85	2.13	2.68	3.28	3.59	
D8-LF-20X-B		1.65	2.21	3.50				D8-LF-20X-B		1.49	1.77	2.38			
P8-LF-30X-B	0.98	2.14	2.87	4.66	6.90	8.19	11.10	P8-LF-30X-B	1.33	1.85	2.11	2.64	3.16	3.43	3.99
H8-LJ-30X-B	1.07	2.26	2.99	4.71	6.76	7.89		H8-LJ-30X-B	1.40	2.02	2.35	3.04	3.77	4.15	
H8-LJ-20X-B		2.09	2.86					H8-LJ-20X-B		1.82	2.15				
P8-LJ-30X-B	1.11	2.38	3.17	5.09	7.49	8.86	11.90	P8-LJ-30X-B	1.40	2.02	2.34	3.00	3.64	3.96	4.59
H8-LL-30X-B	1.22	2.73	3.63	5.71				H8-LL-30X-B	1.49	2.23	2.65	3.61			
K9-LL-30X-B	1.23	2.73	3.64	5.73				K9-LL-30X-B	1.48	2.22	2.63	3.59			
P8-LL-40X-B	1.43	2.92	3.87	6.20	9.12	10.80		P8-LL-40X-B	1.72	2.39	2.75	3.56	4.49	4.99	
H8-LL-40X-B	1.37	2.75	3.61	5.65	8.07	9.39		H8-LL-40X-B	1.72	2.40	2.78	3.67	4.72	5.32	

Conditions: EN13215: Suction Gas Return 20°C, Subcooling 0K

For detailed capacity data please refer to Emerson's Select software

Ambient Temperature: 32°C															
R134a	Cooling Capacity (kW)							R134a	Power Input (kW)						
	Evaporating Temperature (°C)								Evaporating Temperature (°C)						
Model	-45	-35	-30	-20	-10	-5	+5	Model	-45	-35	-30	-20	-10	-5	+5
B8-KJ-7X-B				0.98	1.58	1.93	2.78	B8-KJ-7X-B				0.65	0.78	0.85	1.01
B8-KSJ-10X-B				1.20	1.92	2.36	3.39	B8-KSJ-10X-B				0.77	0.94	1.03	1.22
B8-KL-15X-B				1.38	2.16	2.63	3.70	B8-KL-15X-B				0.92	1.16	1.28	1.54
D8-KSL-20X-B				1.80	2.78	3.50	5.01	D8-KSL-20X-B				1.10	1.38	1.50	1.81
H8-KSL-20X-B				1.86	2.99	3.69	5.39	H8-KSL-20X-B				1.22	1.46	1.59	1.84
D8-LF-20X-B				2.21	3.56	4.37	6.20	D8-LF-20X-B				1.34	1.72	1.92	2.32
H8-LJ-20X-B				2.68	4.26	5.21	7.45	H8-LJ-20X-B				1.80	2.17	2.37	2.82
H8-LL-30X-B				3.22	5.23	6.43	9.21	H8-LL-30X-B				2.08	2.64	2.96	3.69
H8-LSG-40X-B				4.18	6.53	7.90	11.00	H8-LSG-40X-B				2.52	3.24	3.65	4.56

Conditions: EN13215: Suction Gas Return 20°C, Subcooling 0K

For detailed capacity data please refer to Emerson's Select software

Refrigeration Units With Semi-Hermetic Discus™ Compressors

Copeland™ air-cooled indoor refrigeration units for medium temperature and low temperature applications.

In a further approach to improve compressor performance and reduce compression losses, Emerson engineers developed the Discus valve technology.

This series of refrigeration units is equipped with 2 or 3 cylinder semi-hermetic compressors with Discus valve technology. The models are specifically suitable for those applications where high efficiency and low energy consumption is required.

The wide range of compressor models combined with 2 or 4 fan high capacity condensers covers most application needs of low temperature and medium temperature applications.



Refrigeration units with semi-hermetic Discus compressors

Discus Refrigeration Units Line-up

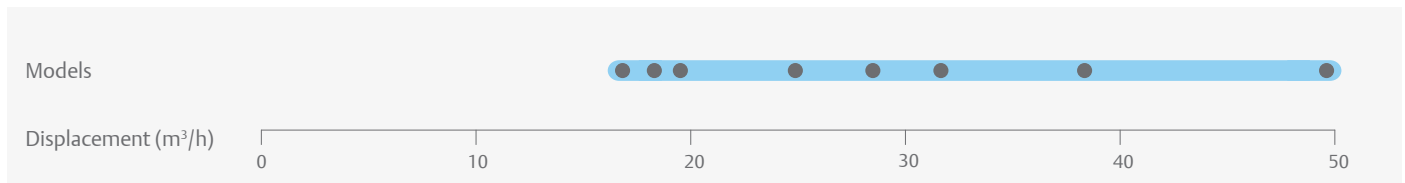

Features and Benefits

- Standard equipment: Discus compressor, condenser with thermally protected fan(s), discharge line with flexible pipe loop or vibration absorber, liquid receiver with shut-off-valve, HP/LP switch with automatic reset, oil pressure safety control OPS2
- Suitable for multiple refrigerants: R407A/F, R448A/R449A, R404A, R134a, R450A and R513A
- Wide range of quality accessories
- Excellent efficiency
- Proven reliability

Maximum Allowable Pressures (PS)

- Low Side PS 22.5 bar (g)
- High Side PS = 28 bar (g)

Technical Overview

Model	Displacement (m ³ /h)	Receiver Capacity (l)	Number of fans	Total Fan Motor Power (W)	Suction Line Diameter (inch)	Liquid Line Diameter (inch)	Width/Depth/Height (mm)	Net Weight (kg)	Motor Version/Code	Maximum Operating Current (A)	Locked Rotor Current (A)	Sound Pressure @10m - dB(A)***
									3 Ph**	3 Ph**	3 Ph**	
P8-2DC-50X-B	17	11.7	2	220	1 3/8	5/8	950/740/633	186	AWM	9	55	
R7-2DD-50X-B	19	15.8	2	470	1 3/8	3/4	1130/820/633	196	AWM	10	55	
P8-2DL-75X-B	24	11.7	2	220	1 3/8	5/8	950/740/633		AWM	14	82	50
R7-2DL-75X-B	24	15.8	2	470	1 3/8	3/4	1130/820/708	205	AWM	14	82	
P8-2DB-50X-B	28	11.7	2	220	1 3/8	5/8	950/740/633	186	AWM	13	55	49
P8-2DB-75X-B	28	11.7	2	220	1 3/8	5/8	950/740/633	191	AWM	16	82	52
S9-2DB-75X-B	28	15.8	2	470	1 3/8	3/4	1130/820/708	212	AWM	16	82	
P8-3DA-50X-B	32	11.7	2	220	1 3/8	5/8	950/740/633	205	AWM	16	55	51
P8-3DA-75X-B	32	11.7	2	220	1 3/8	5/8	950/740/633	211	AWM	18	106	52
S9-3DA-75X-B	32	18.9	2	470	1 3/8	7/8	1330/820/835	259	AWM	18	106	
R7-3DC-100X-B	38	15.8	2	470	1 3/8	3/4	1129/820/633	234	AWM	21	121	56
R7-3DC-75X-B	38	15.8	2	470	1 3/8	3/4	1130/820/633	278	AWM	18	82	54
S9-3DS-100X-B	50	15.8	2	470	1 3/8	3/4	1130/820/708	239	AWM	24	121	54
S9-3DS-150X-B	50	15.8	2	470	1 3/8	3/4	1129/820/708	243	AWM	29	123	57

** 3 Ph: 380-420V/ 50Hz

*** @ 10m: sound pressure level at 10m distance from the compressor, free field condition

Capacity Data

Ambient Temperature: 32°C															
R407A	Cooling Capacity (kW)							R407A	Power Input (kW)						
	Evaporating Temperature (°C)								Evaporating Temperature (°C)						
Model	-45	-35	-30	-20	-10	-5	+5	Model	-45	-35	-30	-20	-10	-5	+5
P8-2DC-50X-B		1.83	2.55	4.47	7.09	8.67	12.30	P8-2DC-50X-B		1.61	1.88	2.50	3.22	3.61	4.45
R7-2DD-50X-B		2.40	3.35	5.80	9.05	11.00	15.50	R7-2DD-50X-B		2.20	2.51	3.20	3.96	4.36	5.22
R7-2DL-75X-B				7.05	10.90	13.10	18.20	R7-2DL-75X-B				3.98	4.96	5.49	6.64
P8-2DB-75X-B				7.85	11.35	13.15		P8-2DB-75X-B				4.84	6.31	7.14	
S9-2DB-75X-B				8.73	13.15	15.65	21.40	S9-2DB-75X-B				4.90	6.11	6.76	8.11
P8-2DB-50X-B		3.29*	4.46*	7.89	11.30	13.15		P8-2DB-50X-B		2.97*	3.50*	4.74	6.22	7.06	
P8-3DA-50X-B		3.68*	5.00*	8.72	12.10	13.85		P8-3DA-50X-B		3.43*	4.07*	5.61	7.44	8.48	
S9-3DA-75X-B				9.78	14.70	17.50	23.70	S9-3DA-75X-B				5.58	7.01	7.76	9.41
P8-3DA-75X-B				8.50	12.20	14.15		P8-3DA-75X-B				5.48	7.20	8.15	
V6-3DC-100X-B				12.55	19.10	22.90	31.50	V6-3DC-100X-B				6.63	8.20	9.00	10.60
R7-3DC-75X-B		4.70*	6.32*	11.05	15.75	18.30		R7-3DC-75X-B		4.34*	5.07*	6.77	8.75	9.88	
R7-3DC-100X-B				11.05	16.15	18.85		R7-3DC-100X-B				6.53	8.52	9.62	
W9-3DS-150X-B				16.25	24.20	28.70	38.80	W9-3DS-150X-B				8.82	11.05	12.25	14.70
S9-3DS-100X-B		6.34*	8.54*	14.65	20.50	23.60		S9-3DS-100X-B		5.71*	6.67*	8.99	11.75	13.35	
V6-3DS-150X-B				16.05	23.80	28.20	37.80	V6-3DS-150X-B				8.85	11.15	12.40	15.00

Conditions: EN13215: Suction Gas Return 20°C, Subcooling 0K

* Conditions: EN13215: Suction Superheat 10K

For detailed capacity data please refer to Emerson's Select software

Ambient Temperature: 32°C															
R448A	Cooling Capacity (kW)							R448A	Power Input (kW)						
	Evaporating Temperature (°C)								Evaporating Temperature (°C)						
Model	-45	-35	-30	-20	-10	-5	+5	Model	-45	-35	-30	-20	-10	-5	+5
P8-2DC-50X-B		1.71*	2.83	4.92	7.59	9.13	12.60	P8-2DC-50X-B		1.65*	1.96	2.67	3.42	3.82	4.63
R7-2DD-50X-B		2.04*	3.34	5.84	9.15	11.10	15.65	R7-2DD-50X-B		2.16*	2.48	3.20	3.99	4.42	5.34
R7-2DL-75X-B		2.79*	4.24	7.12	11.00	13.35	18.75	R7-2DL-75X-B		2.78*	3.14	3.97	4.98	5.55	6.84
P8-2DL-75X-B		2.65*	3.68*	6.65	10.05	12.00		P8-2DL-75X-B		2.54*	2.90*	3.80	4.92	5.59	
P8-2DB-75X-B		3.74*	4.95*	8.20	11.65	13.55		P8-2DB-75X-B		3.24*	3.74*	4.95	6.42	7.26	
S9-2DB-75X-B		4.02*	5.38*	9.13	13.60	16.25	22.20	S9-2DB-75X-B		3.43*	3.90*	4.97	6.18	6.83	8.25
P8-2DB-50X-B		3.58*	4.76*	7.98	11.40	13.25		P8-2DB-50X-B		3.02*	3.55*	4.82	6.37	7.25	
P8-3DA-75X-B		3.80*	5.25*	9.03	12.95	15.10		P8-3DA-75X-B		3.56*	4.22*	5.71	7.39	8.31	
S9-3DA-75X-B		4.24*	5.91*	10.35	15.45	18.40	25.10	S9-3DA-75X-B		3.81*	4.44*	5.76	7.14	7.86	9.36
P8-3DA-50X-B		3.98*	5.19*	8.61	12.15			P8-3DA-50X-B		3.51*	4.12*	5.59	7.36		
R7-3DC-75X-B		5.12*	6.65*	11.00	15.80	18.45		R7-3DC-75X-B		4.46*	5.14*	6.77	8.70	9.79	
R7-3DC-100X-B		4.59*	6.58*	11.45	16.45	19.15		R7-3DC-100X-B		4.08*	4.90*	6.68	8.69	9.79	
V6-3DC-100X-B		5.18*	7.86	13.15	19.75	23.50	32.00	V6-3DC-100X-B		4.46*	5.23	6.79	8.34	9.12	10.70
W9-3DS-150X-B		7.77*	10.35*	17.20	25.00	29.40	39.30	W9-3DS-150X-B		6.29*	7.19*	9.16	11.30	12.50	14.95
V6-3DS-150X-B		7.70*	10.25*	17.00	24.60	28.80	38.30	V6-3DS-150X-B		6.30*	7.21*	9.21	11.40	12.60	15.20
S9-3DS-100X-B		6.96*	9.00*	14.80	21.20			S9-3DS-100X-B		5.84*	6.78*	9.09	11.90		
S9-3DS-150X-B		7.17*	9.47*	15.35	21.30	24.40		S9-3DS-150X-B		6.06*	7.03*	9.27	11.85	13.30	

Conditions: EN13215: Suction Gas Return 20°C, Subcooling 0K

* Conditions: EN13215: Suction Superheat 10K

Preliminary Data

For detailed capacity data please refer to Emerson's Select software

Ambient Temperature: 32°C															
R449A	Cooling Capacity (kW)							R449A	Power Input (kW)						
	Evaporating Temperature (°C)								Evaporating Temperature (°C)						
Model	-45	-35	-30	-20	-10	-5	+5	Model	-45	-35	-30	-20	-10	-5	+5
P8-2DC-50X-B		1.70*	2.83	4.92	7.59	9.13	12.60	P8-2DC-50X-B		1.65*	1.96	2.67	3.42	3.82	4.63
R7-2DD-50X-B		2.02*	3.34	5.86	9.15	11.10	15.55	R7-2DD-50X-B		2.11*	2.48	3.26	4.07	4.48	5.29
P8-2DL-75X-B		2.64*	3.67*	6.65	10.05	12.00		P8-2DL-75X-B		2.54*	2.90*	3.80	4.92	5.59	
R7-2DL-75X-B		2.78*	4.24	7.12	11.00	13.35	18.75	R7-2DL-75X-B		2.78*	3.14	3.97	4.98	5.55	6.84
P8-2DB-50X-B		3.55*	4.75*	8.00	11.40	13.25		P8-2DB-50X-B		3.05*	3.57*	4.82	6.35	7.23	
P8-2DB-75X-B		3.73*	4.94*	8.21	11.65	13.50		P8-2DB-75X-B		3.23*	3.74*	4.95	6.42	7.26	
S9-2DB-75X-B		4.01*	5.36*	9.15	13.60	16.25	22.10	S9-2DB-75X-B		3.44*	3.91*	4.98	6.18	6.83	8.26

Capacity Data

Ambient Temperature: 32°C															
R449A	Cooling Capacity (kW)							R449A	Power Input (kW)						
	Evaporating Temperature (°C)								Evaporating Temperature (°C)						
Model	-45	-35	-30	-20	-10	-5	+5	Model	-45	-35	-30	-20	-10	-5	+5
S9-3DA-75X-B		4.23*	5.90*	10.35	15.45	18.40	25.10	S9-3DA-75X-B		3.81*	4.44*	5.76	7.14	7.86	9.36
P8-3DA-50X-B		3.97*	5.18*	8.61	12.15			P8-3DA-50X-B		3.51*	4.12*	5.59	7.36		
P8-3DA-75X-B		3.79*	5.24*	9.03	12.95	15.10		P8-3DA-75X-B		3.56*	4.22*	5.71	7.39	8.31	
R7-3DC-100X-B		4.59*	6.56*	11.45	16.50	19.20		R7-3DC-100X-B		4.07*	4.84*	6.56	8.54	9.64	
V6-3DC-100X-B		5.16*	7.83	13.10	19.65	23.40	32.00	V6-3DC-100X-B		4.44*	5.17	6.67	8.24	9.06	10.75
R7-3DC-75X-B		5.11*	6.63*	11.00	15.80	18.45		R7-3DC-75X-B		4.46*	5.14*	6.77	8.70	9.79	
S9-3DS-150X-B		7.25*	9.47*	15.30	21.20	24.30		S9-3DS-150X-B		6.12*	7.05*	9.25	11.85	13.30	
S9-3DS-100X-B		6.94*	8.98*	14.80	21.20			S9-3DS-100X-B		5.84*	6.78*	9.09	11.90		
V6-3DS-150X-B		7.76*	10.25*	16.95	24.50	28.80	38.20	V6-3DS-150X-B		6.34*	7.21*	9.18	11.40	12.60	15.20
W9-3DS-150X-B		7.82*	10.35*	17.15	24.90	29.40	39.20	W9-3DS-150X-B		6.32*	7.19*	9.13	11.30	12.45	15.00

Conditions: EN13215: Suction Gas Return 20°C, Subcooling 0K

* Conditions: EN13215: Suction Superheat 10K

Preliminary Data

For detailed capacity data please refer to Emerson's Select software

Ambient Temperature: 32°C															
R404A	Cooling Capacity (kW)							R404A	Power Input (kW)						
	Evaporating Temperature (°C)								Evaporating Temperature (°C)						
Model	-45	-35	-30	-20	-10	-5	+5	Model	-45	-35	-30	-20	-10	-5	+5
P8-2DC-50X-B		2.36	3.17	5.24	7.92	9.48	12.95	P8-2DC-50X-B		1.96	2.27	2.96	3.67	4.03	4.74
R7-2DD-50X-B		3.06	4.12	6.69	9.89	11.70	15.85	R7-2DD-50X-B		2.63	3.00	3.76	4.53	4.91	5.64
R7-2DL-75X-B		3.84	5.02	8.00	11.75	13.85	18.55	R7-2DL-75X-B		3.15	3.58	4.54	5.59	6.14	7.27
P8-2DB-50X-B	1.95*	4.56	5.85	8.86	12.25			P8-2DB-50X-B	2.46*	3.44	4.04	5.43	6.99		
S9-2DB-75X-B		5.10	6.53	9.97	14.20	16.65	21.90	S9-2DB-75X-B		3.91	4.42	5.60	6.88	7.55	8.87
P8-2DB-75X-B		4.76	6.02	8.89	12.20	13.95		P8-2DB-75X-B		3.70	4.23	5.46	6.89	7.65	
S9-3DA-75X-B		5.42	7.14	11.15	16.00	18.65	24.50	S9-3DA-75X-B		4.36	5.06	6.50	7.97	8.72	10.25
P8-3DA-75X-B		4.96	6.46	9.79	13.45	15.35		P8-3DA-75X-B		4.09	4.82	6.40	8.12	9.03	
P8-3DA-50X-B	2.27*	5.36	6.70	9.64	12.85			P8-3DA-50X-B	2.91*	4.23	4.96	6.53	8.26		
R7-3DC-100X-B		6.32	8.19	12.25	16.60	18.90		R7-3DC-100X-B		5.09	5.93	7.76	9.75	10.80	
R7-3DC-75X-B	3.08*	6.71	8.36	12.05	16.15			R7-3DC-75X-B	3.87*	5.36	6.18	7.94	9.89		
V6-3DC-100X-B		7.08	9.30	14.55	20.90	24.50	32.50	V6-3DC-100X-B		5.41	6.18	7.75	9.31	10.05	11.45
S9-3DS-100X-B	4.24*	9.04	11.25	16.15	21.50			S9-3DS-100X-B	5.13*	7.07	8.20	10.70	13.50		
W9-3DS-150X-B		9.44	12.20	18.65	26.20	30.50	39.70	W9-3DS-150X-B		7.07	8.18	10.50	12.85	14.00	16.15
V6-3DS-150X-B		9.38	12.15	18.50	25.90	30.10	39.10	V6-3DS-150X-B		7.07	8.19	10.55	12.90	14.10	16.30

Conditions: EN13215: Suction Gas Return 20°C, Subcooling 0K

* Conditions: EN13215: Suction Superheat 10K

For detailed capacity data please refer to Emerson's Select software

Ambient Temperature: 32°C															
R134a	Cooling Capacity (kW)							R134a	Power Input (kW)						
	Evaporating Temperature (°C)								Evaporating Temperature (°C)						
Model	-45	-35	-30	-20	-10	-5	+5	Model	-45	-35	-30	-20	-10	-5	+5
P8-2DB-50X-B				5.14	8.36	10.25	14.45	P8-2DB-50X-B				2.81	3.67	4.13	5.08
P8-3DA-50X-B				5.77	9.21	11.20	15.70	P8-3DA-50X-B				3.23	4.16	4.66	5.75
R7-3DC-75X-B				7.27	11.50	13.95	19.60	R7-3DC-75X-B				4.10	5.19	5.78	7.01
S9-3DS-100X-B				9.50	14.90	18.10	25.30	S9-3DS-100X-B				5.16	6.73	7.57	9.35

Conditions: EN13215: Suction Gas Return 20°C, Subcooling 0K

For detailed capacity data please refer to Emerson's Select software

Refrigeration Units With Semi-Hermetic Stream Compressors

Copeland™ air-cooled indoor refrigeration units for low, medium and high temperature applications.

This series of refrigeration units is equipped with 4 or 6 cylinder high performance semi-hermetic Stream compressors. These models are specifically suitable for those applications where high efficiency and reliability is required to achieve low lifecycle costs.

Multiple refrigerant approvals and wide range of accessories improve flexibility in system design.



Refrigeration units with semi-hermetic Stream compressors

Refrigeration Units With Stream Compressor Line-up

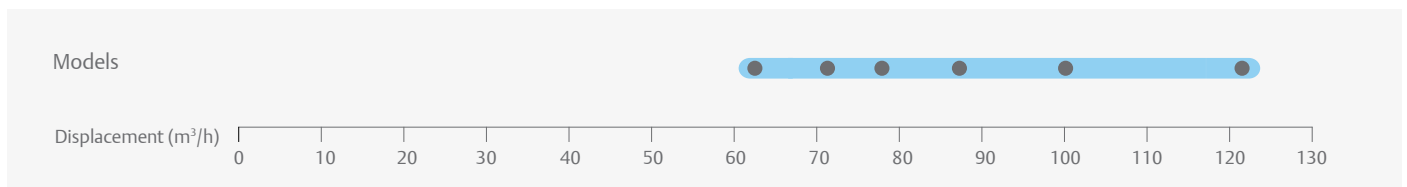

Features and Benefits

- Standard equipment: Stream compressor, condenser with thermally protected fan(s), discharge line with flexible pipe loop or vibration absorber, liquid receiver with shut-off-valve, HP/LP switch with automatic reset.
- Suitable for multiple refrigerants: R407A/F, R448A/R449A, R404A, R134a, R450A and R513A
- Wide range of quality accessories
- Excellent efficiency
- Proven reliability

Maximum Allowable Pressures (PS)

- Low pressure side = 22.5 bar
- High pressure side = 28 bar

Technical Overview

Model	Displacement (m ³ /h)	Receiver Capacity (l)	Number of Fans	Total Fan Motor Power (W)	Suction Line Diameter (inch)	Liquid Line Diameter (inch)	Net Weight (kg)	Motor Version/ Code	Maximum Operating Current (A)	Locked Rotor Current (A)	Sound Pressure @10m - dB(A)***
								3 Ph**	3 Ph**	3 Ph**	
W99-6MI-40X	121	47.9	4	1600	2 1/8	7/8	521	AWM	71	304	59
Z9-4MA-22X	62	18.9	4	1600	1 5/8	7/8	383	AWM	36	175	59
V6-4ML-15X	71	18.9	2	800	1 5/8	7/8	303	AWM	35	156	57
V6-4MF-13X	62	18.9	2	800	1 5/8	7/8	295	AWM	31	105	57
Z9-4MH-25X	71	18.9	4	1600	2 1/8	7/8	389	AWM	42	199	59
Z9-4MI-30X	78	18.9	4	1600	2 1/8	7/8	416	AWM	47	221	59
Z9-4MJ-33X	88	18.9	4	1600	2 1/8	7/8	416	AWM	53	221	59
W9-4MT-22X	88	18.9	2	800	2 1/8	7/8	358	AWM	45	175	59
W9-4MM-20X	78	18.9	2	800	2 1/8	7/8	358	AWM	39	175	57
Z9-4MU-25X	100	18.9	4	1600	2 1/8	7/8	392	AWM	52	199	59
Z9-6MM-30X	121	18.9	4	1600	2 1/8	7/8	410	AWM	60	255	59
W99-4MK-35X	121	47.9	4	1600	2 1/8	7/8	504	AWM	61	255	59

** 3 Ph: 380-420V/ 50Hz

*** @ 10m: sound pressure level at 10m distance from the compressor, free field condition

Capacity Data

R407A	Cooling Capacity (kW)							R407A	Power Input (kW)						
	Ambient Temperature: 32°C								Ambient Temperature: 32°C						
	Evaporating Temperature (°C)								Evaporating Temperature (°C)						
Model	-45	-35	-30	-20	-10	-5	+5	Model	-45	-35	-30	-20	-10	-5	+5
Z9-4MA-22X				20.90	32.00	38.70	54.50	Z9-4MA-22X				10.95	13.30	14.50	17.00
V6-4MF-13X		7.48*	10.30*	18.35	26.50	31.00		V6-4MF-13X		6.88*	8.08*	10.85	14.00	15.75	
V6-4ML-15X		9.29*	12.60*	21.70	30.90	35.90		V6-4ML-15X		8.22*	9.62*	12.85	16.70	18.90	
Z9-4MH-25X				24.40	36.60	43.90	60.90	Z9-4MH-25X				12.90	15.65	17.05	20.00
Z9-4MI-30X				26.60	40.00	47.90	66.10	Z9-4MI-30X				14.15	17.35	19.00	22.50
W9-4MM-20X		10.45*	13.95*	23.80	33.80	39.20		W9-4MM-20X		9.04*	10.60*	14.25	18.45	20.90	
W9-4MT-22X		11.10*	14.70*	25.10	35.20	40.60		W9-4MT-22X		10.25*	12.05*	16.35	21.40	24.30	
Z9-4MJ-33X				29.30	43.60	52.00	71.20	Z9-4MJ-33X				15.85	19.55	21.50	25.80
W99-4MK-35X				32.40	47.90	56.80	76.60	W99-4MK-35X				18.05	22.60	25.00	30.40
Z9-4MU-25X		13.15*	19.80	31.70	46.50	55.00		Z9-4MU-25X		12.05*	13.95	18.05	22.80	25.50	
Z9-6MM-30X		15.80*	23.70	37.50	54.50	64.00		Z9-6MM-30X		14.15*	16.50	21.70	27.60	30.90	
W99-6MI-40X				38.40	56.20	66.10	87.70	W99-6MI-40X				21.60	27.30	30.50	37.50

Conditions: EN13215: Suction Gas Return 20°C, Subcooling 0K
* Conditions: EN13215: Suction Superheat 10K

For detailed capacity data please refer to Emerson's Select software

R407F	Cooling Capacity (kW)							R407F	Power Input (kW)						
	Ambient Temperature: 32°C								Ambient Temperature: 32°C						
	Evaporating Temperature (°C)								Evaporating Temperature (°C)						
Model	-45	-35	-30	-20	-10	-5	+5	Model	-45	-35	-30	-20	-10	-5	+5
V6-4MF-13X		8.04*	11.00*	18.05*	27.50	32.10		V6-4MF-13X		7.23*	8.51*	11.40*	14.85	16.80	
Z9-4MA-22X				21.30*	34.10	41.10	57.50	Z9-4MA-22X				11.60*	14.15	15.45	17.90
Z9-4MH-25X				24.40*	38.70	46.50	64.50	Z9-4MH-25X				13.30*	16.50	18.10	21.30
V6-4ML-15X		9.88*	13.30*	21.40*	32.40			V6-4ML-15X		8.61*	10.10*	13.55*	17.90		
Z9-4MI-30X				26.90*	42.00	50.20	68.90	Z9-4MI-30X				14.70*	18.10	19.90	23.80
W9-4MM-20X		10.90*	14.60*	23.30*	35.10			W9-4MM-20X		9.55*	11.20*	15.00*	19.60		
Z9-4MJ-33X				29.60*	45.90	54.60	74.10	Z9-4MJ-33X				16.50*	20.60	22.90	27.70
Z9-4MU-25X		14.75*	19.75*	32.20*	49.50	58.50		Z9-4MU-25X		12.65*	14.65*	19.10*	24.40	27.30	
W99-4MK-35X				32.50*	50.30	59.50	79.80	W99-4MK-35X				18.85*	23.60	26.40	32.60
Z9-6MM-30X		17.70*	23.70*	38.10*	58.00	68.10		Z9-6MM-30X		15.05*	17.40*	22.80*	29.30	32.80	
W99-6MI-40X				38.30*	58.90	69.20	91.50	W99-6MI-40X				23.20*	29.10	32.40	40.00

Conditions: EN13215: Suction Gas Return 20°C, Subcooling 0K
* Conditions: EN13215: Suction Superheat 10K

For detailed capacity data please refer to Emerson's Select software

Capacity Data

R448A	Cooling Capacity (kW)							R448A	Power Input (kW)						
	Ambient Temperature: 32°C								Ambient Temperature: 32°C						
	Evaporating Temperature (°C)								Evaporating Temperature (°C)						
Model	-45	-35	-30	-20	-10	-5	+5	Model	-45	-35	-30	-20	-10	-5	+5
V6-4MF-13X		8.40*	11.00*	18.15	25.80	30.10		V6-4MF-13X		7.05*	8.23*	11.05	14.40	16.25	
Z9-4MA-22X		8.98*	13.05	21.80	33.60	40.80	57.80	Z9-4MA-22X		7.80*	8.95	11.25	13.60	14.80	17.20
Z9-4MH-25X		10.55*	15.20	24.90	37.50	45.00	62.20	Z9-4MH-25X		9.13*	10.40	13.15	16.10	17.65	20.90
V6-4ML-15X		10.45*	13.75*	22.40	31.60	36.60		V6-4ML-15X		8.40*	9.81*	13.15	17.25	19.70	
Z9-4ML-15X		11.45*	15.95	25.30	37.30	44.30		Z9-4ML-15X		9.09*	10.35	13.15	16.25	17.95	
W9-4MM-20X		11.70*	15.25*	24.50	34.10	39.20		W9-4MM-20X		9.33*	10.90*	14.60	19.25	22.00	
Z9-4MM-20X		12.70*	17.60	27.70	40.30	47.50		Z9-4MM-20X		9.98*	11.40	14.45	18.00	19.95	
Z9-4MI-30X		11.90*	17.15	27.90	41.70	49.70	68.20	Z9-4MI-30X		9.80*	11.35	14.55	17.95	19.65	23.20
Z9-4MT-22X		14.35*	18.80*	30.70	44.50	52.40		Z9-4MT-22X		11.15*	12.75*	16.40	20.50	22.80	
Z9-4MJ-33X		13.15*	18.75	30.30	45.00	53.60	73.30	Z9-4MJ-33X		10.80*	12.50	16.20	20.20	22.30	26.80
W99-4MK-35X		14.70*	19.75*	33.40	49.30	58.50	79.30	W99-4MK-35X		12.25*	14.20*	18.55	23.30	25.90	31.30
Z9-4MU-25X		15.15*	19.95*	33.10	48.30	57.10		Z9-4MU-25X		12.25*	14.15*	18.50	23.60	26.50	
Z9-6MM-30X		18.25*	24.00*	39.10	55.50	64.60		Z9-6MM-30X		14.60*	16.95*	22.20	28.10	31.40	
W99-6MI-40X		17.75*	23.90*	40.00	57.70	67.50	88.50	W99-6MI-40X		14.50*	16.85*	21.90	27.70	30.90	37.90

Conditions: EN13215: Suction Gas Return 20°C, Subcooling 0K

* Conditions: EN13215: Suction Superheat 10K

Preliminary Data

For detailed capacity data please refer to Emerson's Select software

R449A	Cooling Capacity (kW)							R449A	Power Input (kW)						
	Ambient Temperature: 32°C								Ambient Temperature: 32°C						
	Evaporating Temperature (°C)								Evaporating Temperature (°C)						
Model	-45	-35	-30	-20	-10	-5	+5	Model	-45	-35	-30	-20	-10	-5	+5
V6-4MF-13X		8.37*	11.00*	18.15	25.80	30.10		V6-4MF-13X		7.05*	8.23*	11.05	14.40	16.25	
Z9-4MA-22X		8.95*	13.05	21.80	33.60	40.80	57.80	Z9-4MA-22X		7.80*	8.95	11.25	13.60	14.80	17.20
Z9-4MH-25X		10.50*	15.20	24.90	37.50	45.00	62.20	Z9-4MH-25X		9.13*	10.40	13.15	16.10	17.65	20.90
V6-4ML-15X		10.40*	13.70*	22.40	31.60	36.60		V6-4ML-15X		8.40*	9.81*	13.15	17.25	19.70	
W9-4MM-20X		11.65*	15.20*	24.50	34.10	39.20		W9-4MM-20X		9.33*	10.90*	14.60	19.25	22.00	
Z9-4MJ-33X		13.15*	18.75	30.30	45.00	53.60	73.30	Z9-4MJ-33X		10.80*	12.50	16.20	20.20	22.30	26.80
W9-4MT-22X		13.05*	16.85*	27.00	37.20			W9-4MT-22X		10.50*	12.35*	16.70	22.10		
Z9-4MU-25X		15.10*	19.90*	33.10	48.30	57.10		Z9-4MU-25X		12.25*	14.15*	18.50	23.60	26.50	
W99-4MK-35X		14.65*	19.70*	33.40	49.30	58.50	79.30	W99-4MK-35X		12.25*	14.20*	18.55	23.30	25.90	31.30
W99-6MI-40X		17.70*	23.80*	40.00	57.70	67.50	88.50	W99-6MI-40X		14.50*	16.85*	21.90	27.70	30.90	37.90
Z9-6MM-30X		18.20*	24.00*	39.10	55.50	64.60		Z9-6MM-30X		14.60*	16.95*	22.20	28.10	31.40	

Conditions: EN13215: Suction Gas Return 20°C, Subcooling 0K

* Conditions: EN13215: Suction Superheat 10K

Preliminary Data

For detailed capacity data please refer to Emerson's Select software

Capacity Data

R404A	Cooling Capacity (kW)							R404A	Power Input (kW)						
	Ambient Temperature: 32°C								Ambient Temperature: 32°C						
	Evaporating Temperature (°C)								Evaporating Temperature (°C)						
Model	-45	-35	-30	-20	-10	-5	+5	Model	-45	-35	-30	-20	-10	-5	+5
V6-4MF-13X	4.26*	10.75	13.65	20.40	28.40	32.80		V6-4MF-13X	5.84*	8.22	9.50	12.25	15.25	16.90	
Z9-4MA-22X		11.65	15.30	24.00	34.80	41.00	55.00	Z9-4MA-22X		8.86	10.10	12.50	14.85	15.95	18.15
Z9-4MH-25X		13.40	17.50	27.30	39.60	46.70	62.80	Z9-4MH-25X		10.20	11.60	14.55	17.55	19.05	22.00
V6-4ML-15X	5.41*	13.00	16.35	23.90	32.60	37.20		V6-4ML-15X	7.08*	9.86	11.45	14.90	18.65	20.60	
W9-4MM-20X	6.27*	14.50	18.05	25.90	34.60	39.20		W9-4MM-20X	7.89*	10.95	12.70	16.45	20.70	23.00	
Z9-4MI-30X		15.40	19.95	30.50	43.10	50.30	66.10	Z9-4MI-30X		11.35	13.00	16.25	19.55	21.20	24.60
Z9-4MJ-33X		17.00	21.80	33.20	46.90	54.60	71.60	Z9-4MJ-33X		12.40	14.15	17.90	21.80	23.80	27.80
W9-4MT-22X	7.18*	15.90	19.70	28.10	37.60			W9-4MT-22X	8.83*	12.35	14.35	18.70	23.60		
Z9-4MU-25X	8.35*	19.15	24.20	36.10	50.70			Z9-4MU-25X	10.50*	14.40	16.45	20.90	25.50		
W99-4MK-35X		18.90	24.10	36.50	51.30	59.60	77.80	W99-4MK-35X		14.10	16.15	20.50	25.20	27.60	32.40
Z9-6MM-30X	10.10*	22.80	28.40	41.80	58.10	67.20		Z9-6MM-30X	12.75*	17.50	20.00	25.30	31.20	34.30	
W99-6MI-40X		22.10	28.20	42.30	58.80	67.90	87.30	W99-6MI-40X		16.75	19.30	24.80	30.60	33.60	40.00

Conditions: EN13215: Suction Gas Return 20°C, Subcooling 0K
 * Conditions: EN13215: Suction Superheat 10K

For detailed capacity data please refer to Emerson's Select software

R407C	Cooling Capacity (kW)							R407C	Power Input (kW)						
	Ambient Temperature: 32°C								Ambient Temperature: 32°C						
	Evaporating Temperature (°C)								Evaporating Temperature (°C)						
Model	-45	-35	-30	-20	-10	-5	+5	Model	-45	-35	-30	-20	-10	-5	+5
Z9-4MA-22X				19.95	30.40	36.70	51.50	Z9-4MA-22X				10.65	12.85	13.90	15.95
Z9-4MH-25X				22.70	34.80	42.00	58.80	Z9-4MH-25X				12.15	14.80	16.10	18.80
Z9-4MI-30X				25.30	38.30	46.00	64.00	Z9-4MI-30X				13.35	16.40	17.95	21.10
Z9-4MJ-33X				27.80	42.00	50.40	69.60	Z9-4MJ-33X				14.80	18.35	20.20	24.30
W99-4MK-35X				31.90	47.70	56.90	77.50	W99-4MK-35X				16.90	21.20	23.50	28.50
W99-6MI-40X				36.20	53.50	63.30	84.50	W99-6MI-40X				20.00	25.50	28.40	34.90

Conditions: EN13215: Suction Gas Return 20°C, Subcooling 0K
 Preliminary Data

For detailed capacity data please refer to Emerson's Select software

R134a	Cooling Capacity (kW)							R134a	Power Input (kW)						
	Ambient Temperature: 32°C								Ambient Temperature: 32°C						
	Evaporating Temperature (°C)								Evaporating Temperature (°C)						
Model	-45	-35	-30	-20	-10	-5	+5	Model	-45	-35	-30	-20	-10	-5	+5
Z9-4MA-22X				13.95	21.90	26.90	39.10	Z9-4MA-22X				7.41	8.79	9.44	10.60
V6-4MF-13X				12.45	19.55	23.90	33.80	V6-4MF-13X				6.57	8.24	9.09	10.90
V6-4ML-15X				14.80	22.90	27.70	38.60	V6-4ML-15X				7.72	9.77	10.85	13.20
Z9-4MH-25X				15.80	24.90	30.60	44.40	Z9-4MH-25X				8.53	10.20	11.05	12.60
Z9-4MI-30X				17.45	27.20	33.30	47.90	Z9-4MI-30X				9.11	11.00	11.95	13.80
W9-4MM-20X				16.40	25.20	30.30	42.10	W9-4MM-20X				8.52	10.75	11.95	14.55
W9-4MT-22X				18.55	28.10	33.60	45.90	W9-4MT-22X				9.70	12.30	13.75	16.95
Z9-4MJ-33X				19.45	30.10	36.70	52.40	Z9-4MJ-33X				10.20	12.25	13.35	15.50
Z9-4MU-25X				21.10	33.30	40.70	58.00	Z9-4MU-25X				11.25	13.95	15.30	18.25
W99-4MK-35X				21.80	33.70	41.00	58.50	W99-4MK-35X				11.20	13.80	15.15	17.95
W99-6MI-40X				25.20	39.00	47.40	67.30	W99-6MI-40X				13.50	16.50	18.15	21.70
Z9-6MM-30X				25.30	39.10	47.50	66.70	Z9-6MM-30X				13.30	16.65	18.45	22.10

Conditions: EN13215: Suction Gas Return 20°C, Subcooling 0K
 Refer to Emerson's Select software for R450A and R513A capacity data.

For detailed capacity data please refer to Emerson's Select software

Compressors Motor Codes Table

Semi-Hermetic						
Motor Codes	Voltage	Connection		Motor Codes	Voltage	Connection
Standard Motor Version						
CAG	220-230/1/50	-				
EWL (DK, DL, D2S)	220-240/3/50	Δ		EWN (DK, DL, D2S)	250-280/3/60	Δ
EWL (DK, DL, D2S)	380-420/3/50	Y		EWN (DK, DL, D2S)	440-480/3/60	Y
AWM	380-420/3/50	YY/Y		AWD	440-480/3/60	YY/Y
Special Motor Version						
EWM	380-420/3/50	Δ/Y-Start		EWD	440-480/3/60	Δ/Y-Start
AWR	220-240/3/50	YY/Y		EWK (not D8)	220-240/3/60	Δ
AWY	500-550/3/50	YY/Y		EWK (not D8)	380-420/3/60	Y
				AWC	208-230/3/60	YY/Y
				AWX	380/3/60	YY/Y
Hermetic & Scroll						
Motor Codes	Voltage	Connection		Motor Codes	Voltage	Connection
Standard Motor Version						
PFJ	220-240/1/50	-		PFJ	265/1/60	-
PFT	220-240/1/50	-				
PFZ	220-240/1/50	-				
TFD	380-420/3/50	Y		TFD	460/3/60	Y
TFM	380-420/3/50	Y				
TWD	380-420/3/50	Y		TWD	460/3/60	Y
FWD	380-420/3/50	Δ/Δ				
FWM	380-420/3/50	Δ/Δ				
TWM	380-420/3/50	Y				
Special Motor Version						
TF5	200-220/3/50	Y		TF5	200-230/3/60	Y
TWR	220-240/3/50	Y		TW7	380/3/60	Y
TWC	200/3/50	Y		TWC	208-230/3/60	Y
TFE	500/3/50	Y		TFE	575/3/60	Y
TWE	500/3/50	Y		TWE	575/3/60	Y
				TF7	380/3/60	Y
TW5	200-220/3/50	Y		TW5	220-230/3/60	Y
Variable Speed Motor Version						
*E9	BPM Motor	-				

YY/Y = Part-Winding-Start
 Δ/Δ = Part-Winding-Start





Controls Components

Controls Components

Alco Controls™ is the leading provider of precision mechanical controls for the refrigeration and air conditioning markets, and together with the range of electronic controls from Emerson we continue to pioneer the control of refrigerant flow with innovative design, keeping system performance optimization central to our product development.

The wide range of Emerson controllers covers all major applications in commercial air conditioning and refrigeration, as well as heat pump systems. There are stand-alone controllers and controllers with a communication interface.

The controllers with TCP/IP Ethernet communication feature a full web server function and provide full data exchange with any user in the World Wide Web. This allows quick and inexpensive monitoring from any PC with a standard web browser.

Emerson offers stepper motor drivers and superheat controllers for the electrically driven control valves, as well as capacity controllers for Copeland™ Scroll Digital compressors. See section “Electronic Controllers and Sensors” for more details.

Display case and cold room controllers provide all functions needed to run commercial refrigeration, like superheat control with electrical control valve, thermostat, fan and defrost control, integrated timer and alarm functions.

The compressor soft starter allows keeping the starting current below the limit imposed in residential heat pump applications.

Electronic fan speed controllers help to maintain a minimum condensing pressure by reducing fan speed at low ambient temperature.

Make use of Alco Controls pressure transmitters, temperature sensors and other assorted accessories compatible with all of the above-mentioned controllers.

Oil management components feature active oil level monitoring and balancing for optimal compressor protection. The patented TraxOil™ 3-zone level control technology is unique and offers comfortable monitoring and proactively protects the compressor against low oil levels.

Emerson’s controls portfolio is completed by offering a variety of mechanical controls such as:

- Pressostats & Thermostats
- System Protectors
- Solenoid Valves
- Ball Valves
- Moisture Indicators
- Thermo™-Expansion Valves
- Oil Separators
- and Suction Accumulators



Electrical Control Valves

Electrical Control Valves

Electrical Control Valve Technology

Thermostatic expansion valves and mechanical regulator valves have been used in the refrigeration and air conditioning industry to control superheat and refrigerant mass flow since its very beginning. As today's systems require improved energy efficiency, tighter temperature control, a wider range of operating conditions and incorporate new features like remote monitoring and diagnostics, the application of electronically operated valves becomes mandatory. Only these offer the controls performance necessary to meet these needs. Electrical control valves are actuators only. For operation in a system they need sensors, valve drivers and controllers, see next chapter.

The **EXM/EXL/EXN** biflow valves for OEM use are equipped with an unipolar stepper motor drive. They are mainly used for heat pumps, air conditioning and close control.

The EX2 is designed for pulse width modulation. It is applicable to common refrigerants and is used mainly for refrigeration applications such as display cases. The EX2 valve is a slide type solenoid valve with an orifice for expansion. It is either completely open or completely closed. One common valve body can be combined with 6 interchangeable orifices to cover 7 capacity ranges. The CX2 features the same technology and advantages as the EX2, however it is applicable to high-pressure CO₂ applications.

The **EX4-8** consist of two main internal assemblies, the valve and the stepper motor. The stepper motor is located next to the electrical plug and connected directly to the slide and cage assembly of the valve. Similar to the technology used in

compressors, the motor is exposed to refrigerant and lubricant and the materials used are identical to the ones in compressor motors. The housing of the motor and valve assembly is made from stainless steel and fully hermetic, utilising exclusively brazing and welding technologies and eliminating all gaskets. This design offers several technical advantages such as proportional linear mass flow and a wide capacity range. A common feature of all EX2, EX4-8 electrical control valves is the positive shut-off function, which eliminates the need for additional solenoid valves.

The **CV4-7** high pressure expansion valves are stepper motor driven valves for precise control of R744 (CO₂) refrigerant mass flow in air conditioning, refrigeration and heat pump applications. The Control Valves also can be used for liquid injection duty and hot gas bypass.

Valve Selection

For the EX2, the published table quotes capacities at 100% duty cycle, i.e. valve open continuously. However, it is recommended to operate the valve at partial load (50-80%) to allow for system load fluctuations. For **EX4-8** and **EXM/EXL/EXN** valves, all published capacities are maximum and there are no reserve capacities. Each valve should be selected for the highest possible capacity of the system. A wide range regulation (10 ... 100%) with one slide orifice for each valve is achievable. To facilitate valve dimensioning for other than the standard conditions, Emerson offers the program "Controls Navigator". This can be downloaded from climate.emerson.com/en-gb.



Selection Table for Electrical Control Valves and Applicable Controllers

Valve Type	Function	Capacity (kW) R407C	Feature	Main Application	Applicable Controller
EXM/ EXL	Expansion Valve	1.6 .. 20.7	Uni Polar Stepper Motor Driven	Heat pumps, Air Conditioning, Close Control	EXD-HP1/2 Superheat Controller (Modbus)
EXN	Expansion Valve	30 .. 38	Uni Polar Stepper Motor Driven	Heat Pumps, Air Conditioning, Close Control	EXD-HP1/2 Superheat Controller (Modbus)
EX2	Expansion Valve	1.0 .. 18.7	PWM	Refrigeration (Display cases)	
EX4-8	Expansion Valve, Hot Gas Bypass, Condensing Pressure And Liquid Regulator, Head Pressure Control, Suction/Crankcase Pressure Regulator, Heat Reclaim	17.4 ... 925 (Capacity Data as Expansion Valve)	Bi Polar Stepper Motor Driven	Refrigeration, Air Conditioning, Water Chillers, Heat Pumps	EXD-U02 Driver Module EXD-SH1/2 Superheat Controller (Modbus)

Selection Table for Electrical Control Valves and Applicable Controllers for CO₂ Applications

Valve Type	Function	Capacity (kW) R744	Feature	Main Application	Applicable Controller
CX2	Expansion Valve	1.5 ... 28.2	PWM	Refrigeration (Display cases)	
EX4-8	Expansion Valve	27 ... 1440	Bi Polar stepper Motor Driven	Refrigeration subcritical CO ₂	EXD-U02 Driver Module EXD-SH1/2 Superheat Controller (Modbus)
CV4-7	Expansion Valve HP Gas Valve Heat Reclaim Valve	Kv 0.21 ... 5.58 m ³ /h	Bi Polar stepper Motor Driven	Refrigeration subcritical and transcritical CO ₂	EXD-U02 Driver Module EXD-SH1/2 Superheat Controller (Modbus)

Electrical Control Valves Series EXM/EXL for OEM Use, Stepper Motor Driven

Features

- Unipolar stepper motor
- Bi-flow (same performance in both flow directions in term of capacity)
- High MOPD: 40 bar in normal flow direction
- Removable coils in two versions: 12VDC/24VDC
- Continuous modulation of mass flow, no stress (liquid hammering) in the refrigeration circuit
- Linear flow
- Resolution: 500 pulses (half steps) or 250 full steps
- Hermetic design
- Reliability: 225 millions pulses at continuous 40 bar differential pressure
- VDE tested according to IEC-60335-2-89 and IEC-60335-2-40



EXM/EXL

Note: The valve is not released for refrigeration applications such as cold rooms and refrigeration display cabinets.

Selection Table

Valve Series	Description	Type	Part No. (10 pcs)	Nominal Capacity (kW)						Connections Size / Style	
				R290	R32	R452B	R454B	R410A	R407C		R134a
EXM	Valve less coil	EXM-B0A	800 399M	1.6	2.7	2.1	2.1	1.8	1.6	1.2	¼" ODM
		EXM-B0B	800 400M	4.9	8.2	6.3	6.3	5.5	5.0	3.7	
		EXM-B0D	800 401M	10.3	17.3	13.3	13.3	11.6	10.5	7.7	
		EXM-B0E	800 402M	12.1	20.4	15.7	15.7	13.7	12.4	9.1	
	Coil 12VDC	EXM-125	800 403M	-	-	-	-	-	-	-	-
	Coil 24VDC	EXM-24U	800 415M	-	-	-	-	-	-	-	
EXL	Valve less coil	EXL-B1F	800 405M	15.0	25.3	19.4	19.4	17.0	15.4	11.3	¼" ODF 8 mm ODM
		EXL-B1G	800 406M	20.3	34.2	26.3	26.4	23.0	20.7	15.2	
	Coil 12VDC	EXL-125	800 407M	-	-	-	-	-	-	-	-
	Coil 24VDC	EXL-24U	800 416M	-	-	-	-	-	-	-	

Note 1: Nominal conditions: Evaporating Temperature +4°C (dew point), Condensing Temperature +38°C (bubble point), Subcooling 1 K

Note 2: For selection of other operation conditions, please use the „Controls Navigator“ selection tool.

Note 3: When selecting also observe the information in the operating instructions. Available for download on the Emerson website.

Technical Data

Max. Allowable Pressure PS	45 bar
MOPD	40 bar in Normal Flow Direction, 30 bar Reverse Flow Direction
Temperature Range TS	-30...+70°C (Liquid Refrigerant) -30...+60°C (Ambient)
Stepper Motor Type	Uni-polar, Constant Voltage

Full Travel Time	16.6 Seconds at 30 Pulse/Sec. 5.5 Seconds at 90 Pulse/Sec.
Reference Position	Mechanical Stop at Fully Close Position
Total Number of Pulses	500 Half Step (250 Full Step)
Insulation Class	EXM: A EXL: E
Cable Length	1m

Electrical Control Valves Series EXN for OEM Use, Stepper Motor Driven

Features

- Unipolar stepper motor
- Bi-flow with same capacity in normal and reverse flow direction
- MOPD: 36 bar in both flow directions
- Unipolar stepper motor with gear mechanism enabling Bi-flow performance at 36 bar differential pressure across the valve
- Removable coil: 12 VDC
- Continuous, linear modulation of mass flow
- High resolution: 2000 pulses (half steps) or 1000 full steps
- Hermetic design



EXN with Coil

Selection Table

Type	Description	Part No.	Nominal Capacity (kW)				Connections Size / Style
			R410A	R32	R134a	R407C	
EXN-B2K	Valve less coil	800421	34	50.6	22.2	30.7	1/2" ODF
EXN-B2L	Valve less coil	800422	42	62.5	28.8	37.9	1/2" ODF
EXN-125	Coil 12VDC	800420	-	-	-	-	-

Note 1: Nominal conditions: Evaporating Temperature +4°C (dew point), Condensing Temperature +38°C (bubble point), Subcooling 1 K

Note 2: For selection of other operation conditions, please use the „Controls Navigator“ selection tool.

Technical Data

MOPD (Maximum Operating Pressure Differential)	36 bar in Normal Flow 36 bar in Reverse Flow
Max. Allowable Pressure PS	45 bar
Temperature Range TS - liquid refrigerant - Ambient	-30...+70°C -30...+60°C
Stepper Motor Type	Uni-Polar, Constant Voltage, 5 Wires
Supply Voltage	12 VDC Coil: 12 V ± 10%

Total Number of Pulses	2000 Half Step (1000 Full Step)
Pulsing Rate Frequency (Pulse/Sec.)	100...200 Hz
Full Travel Time	20 Seconds at 100 Hz 10 Seconds at 200 Hz
Coil Insulation Class	A
Cable Length	1 m
Electrical Connection	JST XH connector, 5 pole Housing: XHP-5 Pin: SXH-001T-P0.6

Electronic Expansion Valves Series EX2 Pulse Width Modulated With Exchangeable Orifices Can Be Used With EC2 Display Case Controllers

Features

- Pulse width modulated
- Shut-off function eliminates the necessity of a separate solenoid valve
- Dampened plunger reduces noise effects of water hammer
- One valve body can be combined with 6 orifices to make 7 capacity ranges
- Long lifetime, high reliability
- Max. allowable pressure PS: 40 bar
- Medium temperature range TS: -40...+65°C

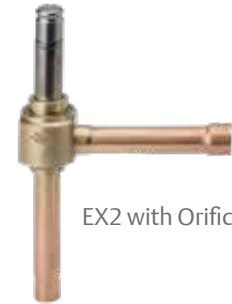

EX2 with Orifice

Selection Table

Type	Part No.	Description	Nominal Capacity at 100% Open Valve (kW) *								
			R134a	R22	R404A / R507	R407C	R448A	R449A	R450A	R513A	R452A
EX2-M00	801091	Valve less orifice 10 mm x 12 mm	13.3	17.2	12.1	18.7	17.2	16.8	11.7	12.0	13
EX2-I00	801090	Valve less orifice 3/8"x / 1/2"									
EXO-004	801089	Orifice 4	8.5	10.9	7.7	11.8	10.9	10.6	7.4	7.6	8.3
EXO-003	801088	Orifice 3	5.6	7.2	5.1	7.8	7.2	7.0	4.9	5.0	5.5
EXO-002	801087	Orifice 2	3.3	4.3	3.0	4.7	4.3	4.2	2.9	3.0	3.3
EXO-001	801086	Orifice 1	2.5	3.2	2.3	3.5	3.2	3.1	2.2	2.2	2.4
EXO-000	801085	Orifice 0	1.2	1.6	1.1	1.7	1.6	1.6	1.1	1.1	1.2
EXO-00X	801084	Orifice X	0.7	0.9	0.6	1.0	0.9	0.9	0.6	0.6	0.7

Note 1: Nominal conditions: Evaporating Temperature +4°C (dew point), Condensing Temperature +38°C (bubble point), Subcooling 1 K
For selection of other operation conditions, please use the „Controls Navigator“ selection tool.

Note 2: *) Orifice should be selected at maximum 80% of Q_n to allow covering the load fluctuation.

Accessories

Type	Part No.	Part No. (Multipack*)	Description	
ESC 24V	801033	-	Coil 24 VAC / 50 Hz	
ESC 230V	801031	-	Coil 230 VAC / 50 Hz	
ASC-N15	804570	804570M	Connector Cable Assembly	
ASC-N30	804571	804571M		1.5 m cable length
ASC-N60	804572	-		3.0 m cable length
Plug PG9	801012	-	Plug with cable guide	
Plug PG11	801013	-		
ESC-K01	801034	-	Screw cap (incl. 2x O-ring & fixing retainer)	

Note: *) Multipack = 20 pcs

Electronic Expansion Valves Series CX2 Pulse Width Modulated With Exchangeable Orifices for High-Pressure CO₂ Applications Can Be Used With EC2 Display Case Controllers

Features

- Pulse width modulated
- Shut-off function eliminates the necessity of a separate solenoid valve
- Dampened plunger reduces noise effects of water hammer
- One valve body can be combined with 6 orifices to make 7 capacity ranges up to 28.2 kW
- Long lifetime, high reliability
- Max. allowable pressure PS: 90 bar
- MOPD: 65 bar



Selection Table

Type	Part No.	Description	Nominal capacity (kW) at 100% continuous open R 744
CX2-100	801095	Valve: 3/8" x 1/2" ODF	28.2
EXO-004	801089	Orifice 4	17.9
EXO-003	801088	Orifice 3	11.8
EXO-002	801087	Orifice 2	7.0
EXO-001	801086	Orifice 1	5.2
EXO-000	801085	Orifice 0	2.6
EXO-00X	801084	Orifice X	1.5

Note 1: Nominal capacity at -10°C evaporating temperature, +10°C liquid temperature (45 bar) and 1K subcooling. For other operating conditions, please see quick selection table or Control Navigator selection software.

Note 2: The table quotes capacities at 100% duty cycle, i.e. valve is open continuously. However, it is recommended to operate the valve at partial loaded (50-80%) to allow for system load fluctuations. When used with an EC2 case controller, the valve operates with a 6 second pulse width cycle.

Note 3: CX2 is released as expansion valve and during operation of valve CO₂ must be feed in liquid phase to inlet of the valve.

Accessories

Type	Part No.	Part No. (Multipack*)	Description	
ESC 24V	801033	-	Coil 24 VAC / 50 Hz**	
ESC 230V	801031	-	Coil 230 VAC / 50 Hz**	
ASC-N15	804570	804570M	Connector Cable Assembly	
ASC-N30	804571	804571M		1.5 m cable length
ASC-N60	804572	-		3.0 m cable length
Plug PG9	801012	-	Plug according to EN 175301 with cable gland	
Plug PG11	801013	-		
ESC-K01	801034	-	Screw cap (incl. 2x O-ring & fixing retainer)	

Note: *) Multipack = 20 pcs **) 50Hz coils have lower MOPD with 60Hz frequency.

MOPD levels depending on supply voltage to coil

MOPD	Supply voltage to coil	Supply voltage to coil
65 bar	24 VAC nominal voltage	230 VAC nominal voltage
60 bar	24 at -5% = 22.8 VAC	230 at -5% = 218.5 VAC
50 bar	24 at -10% = 21.6 VAC	230 at -10% = 207 VAC
45 bar	24 at -15% = 20.4 VAC	230 at -15% = 195.5 VAC

Note: MOPD values are valid only for 50 Hz supply voltage operation.

Electrical Control Valves Series EX4-8

Features

- Multifunction as expansion valve, hot gas bypass, suction gas throttling, head pressure, liquid level actuator etc.
- Fully hermetic design (no thread joints between valve body and motor compartment)
- Applicable to all common refrigerants and for subcritical CO₂ applications
- Stepper motor driven
- Short opening and closing time
- Very fast full-stroke time
- High resolution and excellent repeatability
- Positive shut-off function to eliminate the need for additional solenoid valve
- Bi-flow versions for heat pump applications
- High linear flow capacity
- Extremely wide capacity range (10 ... 100%)
- Continuous modulation of mass flow, no stress (liquid hammering) in the refrigeration circuit
- Direct coupling of motor and valve for high reliability (no gear mechanism)
- Ceramic slide and port for highly accurate flow and minimal wear
- Europe patent No. 0743476, USA patent No. 5735501, Japan patent No. 28225789
- Balanced force design
- Corrosion resistant stainless steel body and stainless steel connections



Selection Table (Capacities See Following Page)

Type	Part No.	Flow Pattern	Capacity Range	Inlet Connection	Outlet Connection	Electrical Connection
EX4-I21	800 615	Uni-flow	10 ... 100%	3/8" ODF	5/8" ODF	M12 Plug
EX4-M21	800 616			10mm ODF	16mm ODF	
EX5-U21	800 618			5/8" (16mm) ODF	7/8" (22mm) ODF	
EX6-I21	800 620			7/8" ODF	1-1/8" ODF	
EX6-M21	800 621			22mm ODF	28 mm ODF	
EX7-I21	800 624			1 1/8" ODF	1-3/8" ODF	
EX7-M21	800 625			28mm ODF	35mm ODF	
EX8-M21	800 629			42mm ODF	42mm ODF	
EX8-U21	800 630			1 3/8" (35mm) ODF	1 3/8" (35mm) ODF	
EX8-I21	800 631			1-5/8" ODF	1-5/8" ODF	
EX4-U31	800 617	Bi-flow (Heat Pump)		5/8" (16mm) ODF	5/8" (16mm) ODF	
EX5-U31	800 619			7/8" (22mm) ODF	7/8" (22mm) ODF	
EX6-I31	800 622			1-1/8" ODF	1 1/8" ODF	
EX6-M31	800 623			28mm ODF	28mm ODF	
EX7-U31	800 626			1 3/8" (35mm) ODF	1 3/8" (35mm) ODF	

Cable Connector Assemblies

Type	Part No.	Temperature Range	Length	Connector Type to Valve	Connector Type to Driver or Controller	Illustration
EXV-M15	804 663	-50 ... +80°C	1.5 m	M12, 4 Pins	Loose Wires	
EXV-M30	804 664		3.0 m			
EXV-M60	804 665		6.0 m			

Capacity Data

Nominal capacities...

...as expansion valves and liquid injection valves, (kW) (10%...100%)

Type	R410A	R134a	R22	R404A / R507	R407C	R1234ze	R448A	R449A	R450A	R513A	R744	R124	R23	R452A
EX4	19.3	12.8	16.5	11.5	17.4	10.0	16.5	16.1	11.3	11.5	27.0	9.4	17.8	12.5
EX5	58.1	39.0	50.0	35.0	53.0	30.2	49.9	48.7	34.1	34.9	82.0	28.7	54.0	38
EX6	140	93	120	84	126	72	120	117	82	84	197	69	130	91
EX7	385	255	330	230	347	199	329	321	225	230	540	186	357	250
EX8	1028	680	880	613	925	531	877	857	600	614	1440	495	-	666

Note 1: Bi-flow versions are not released for use with R124, R452A and R23 refrigerants.

Note 2: Bi-flow versions have identical capacity in both flow directions.

...as hot gas bypass regulator, (kW)

Type	Kv (m ³ /h)	R410A	R134a	R22 / R407C	R404A / R507	R1234ze	R448A	R449A	R450A	R513A	R452A
EX4	0.21	5.9	2.7	4.4	3.8	2	4.5	4.4	2.4	2.7	3.9
EX5	0.68	19.1	8.8	14.3	12.2	6.5	14.6	14.4	7.7	8.6	12.8
EX6	1.57	44	20.4	33	28.3	15.1	33.7	33.1	17.7	19.9	30
EX7	5.58	156.4	72.5	117.4	100.5	53.6	119.8	117.8	63	70.7	105
EX8	16.95	475	220	357	305	163	364	358	191	215	320

Note: Bi-flow versions are not released for hot gas flow applications.

...as suction pressure regulator (evaporator or crankcase), (kW)

Type	Kv (m ³ /h)	R410A	R134a	R22	R404A	R507	R407C	R1234ze	R448A	R449A	R450A	R513A	R452A
EX6	1.57	5.0	3.1	4.1	3.5	3.5	3.9	2.5	3.9	3.8	2.8	3.0	3.4
EX7	5.58	17.9	11.1	14.7	12.5	12.5	13.7	9.0	13.8	13.6	9.9	10.6	12.1
EX8	16.95	54.5	33.6	44.5	38.1	37.9	41.8	27.4	42.0	41.4	30.1	32.2	36.8

Note: Bi-flow versions are not released for use below -40°C

...as condensing pressure regulator and liquid duty, (kW)

Type	Kv (m ³ /h)	R407C	R134a	R22	R404A	R507	R1234ze	R448A	R449A	R450A	R513A	R452A
EX4	0.21	5.7	5.6	6.0	4.0	3.8	5.1	5.3	5.2	5.3	5.0	4.1
EX5	0.68	18.5	18.3	19.6	12.9	12.5	16.5	17.1	16.8	17.0	16.3	13
EX6	1.57	43.0	42.4	45.5	29.9	29.0	38.3	39.9	39.1	39.6	37.8	31
EX7	5.58	153	151	162	106	103	136	142	139	141	134	109
EX8	16.95	464	458	491	323	313	413	430	422	428	408	331

...for hot gas flow such as heat reclaim application, (kW)

Type	Kv (m ³ /h)	R410A	R134a	R22 / R407C	R404A / R507	R1234ze	R448A	R449A	R450A	R513A	R452A
EX5	0.68	5.9	4	5.1	4.3	3.3	5.1	5	3.7	3.8	4.4
EX6	1.57	13.7	9.3	11.8	9.9	7.6	11.7	11.6	8.5	8.8	10.1
EX7	5.58	49	33	42	35	27	42	41	30	31	36
EX8	16.95	148	100	128	107	82	127	125	91	95	110

Note: Bi-flow versions are not released for hot gas flow applications.



The nominal capacity is based on the following conditions:

Refrigerant	Evaporating temperature	Condensing temperature	Pressure drop (For suction duty)	Pressure drop (For liquid duty)	Pressure drop (For hot gas flow duty)	Isentropic efficiency (For hot gas flow duty)
R134a, R404A, R410A, R513A, R1234ze	+4°C dew point	+38°C bubble & dew point	0.15 bar	0.35 bar	0.5 bar	80%
R407C	+4°C dew point	+38°C bubble/ +43°C dew point				
R124	+20°C	+80°C				
R23	-60°C	-25°C				
R744	-10°C	+10°C				
R450A	+4°C	+38°C bubble/ +38.6°C dew point				
R452A		+38°C bubble/ +41.6°C dew point				
R448A, R449A		+38°C bubble/ +42.6°C dew point				

Note: For selection of other operating condition, please use quick selection tables in the next pages or Navigator selection program 2019.

Technical Data

Compatibility <small>Note: UL only for use with A1 refrigerants.</small>	A1: R134a, R404A, R507, R407C, R450A, R513A, R452A, R448A, R449A, R410A, R744 (subcritical), R23, R124 A2L: R32, R452B, R454B, R454A, R454C, R1234ze, R123yf Mineral and POE lubricants
MOPD (maximum operating pressure differential)	EX4/EX5/EX6: 40 bar EX7: 35 bar EX8: 30 bar
Max. allowable pressure PS	EX4 (uni-flow): 90 bar EX4/5/6/7 (bi-flow): 60 bar EX8: 45 bar UL Approval: EX4/5/6/7: 60 bar UL Approval: EX8: 45 bar
Factory Test Pressure PT	EX4 (uni-flow): 99 bar EX4/5/6: 66 bar EX7: 86 bar EX8: 65 bar
Ambient Temperature Storage Temperature	-40...+55°C -40...+70°C
Medium Inlet Temperature Bi-flow version: Uni-flow version:	TS: -50...+80°C TS: -50...+100°C (UL-Approval based on ≥ -40°C)

Evaporating Temperature	-100...+55°C
Salt Spray Test	non-corrosion stainless steel body
Connections	ODF stainless steel fittings
Humidity	5 to 95% r.H.
Protection accordance to IEC 529, DIN 40050	IP67 with EMERSON supplied cable connector assembly
Vibration for non-connected and fastened valve	4g (0...1000 Hz, 1 octave /min.)
Shock	20g at 11 ms 80g at 1 ms
Net weight (kg)	0.5 kg (EX4), 0.52 kg (EX5), 0.60 kg (EX6), 1.1 kg (EX7), 1.5 kg (EX8)
External leakage	≤ 3 gram / year
Seat Leakage	Positive shut-off better than solenoid valves
Marking	EX4/5/6: None (Out of PED scope) EX7/8:  1017 (Module D1) EX4/5/6/7/8: 

Electrical Data

Stepper Motor Type	Bi-polar, phase current by chopper control (constant current)
Electrical Connection	4 pin terminal via plug
Recom. Driver Supply	24 VDC (nominal)
Driver Supply Voltage Range	18...36 VDC
Phase Current, Operating	EX4/EX5/EX6: 500 max, -10% EX7: 750 mA ±10% EX8: 800 mA ±10%
Holding Current	EX4/EX5/EX6: 100 mA EX7: 250 mA EX8: 500 mA
Nominal Input Power per Phase	EX4/EX5/EX6: 3.5 W EX7/EX8: 5 W
Stepping Rate	500 Hz

Phase Inductance	EX4/EX5/EX6: 30 mH ± 25% EX7: 20 mH ± 25% EX8: 22 mH ± 25%
Step Mode	2 phase full step
Step Angle	1.8° per step ± 8%
Reference Position	Mechanical stop at fully close position
Total Number of Steps	EX4/EX5/EX6: 750 full steps EX7: 1600 full steps EX8: 2600 full steps
Winding Resistance per Phase	EX4/EX5/EX6: 14 Ohm ±10% EX7: 10 Ohm ±10% EX8: 7.5 Ohm ±10%
Full Travel Time	EX4/EX5/EX6: 1.5 seconds EX7: 3.2 seconds EX8: 5.2 seconds

High Pressure Expansion Valves Series CV4-7

Emerson's CV4-7 valves are stepper motor driven valves for precise control of refrigerant mass flow in air conditioning and refrigeration systems with CO₂. The Control Valves can be used as high pressure gas valve for gas cooler control, expansion device, hot gas and cold gas bypass, liquid injection duty, evaporator pressure regulator, crankcase pressure regulator, head pressure regulator, or liquid level control.

Features and Benefits

- Maintenance free
- Multifunction
- Fully hermetic design with ODF connections
- Stepper motor driven
- Short opening and closing time
- Very fast full stroke time
- High resolution and excellent repeatability
- Positive shut-off function to eliminate the use of an additional solenoid valve
- Linear flow capacity
- Extremely wide capacity range (10...100%)
- Optimal solution applied to offer the highest reliability and lifespan, accordingly to the high differential pressures in the CO₂ systems
- Ceramic slide and port for precise flow and minimal wear
- Balanced force design
- Corrosion resistant stainless-steel body and connections



CV4/5/6/7
with ODF connection

Selection Table

Type	Part No.	Kv (m ³ /hr)	Control Range	Inlet Connection	Outlet Connection	Electric Connector
CV4-HPV	802056	0.2	Please refer to the selection tool "Controls Navigator"	3/8"	5/8"	M12 plug
CV5-HPV	802057	0.6		5/8"	7/8"	
CV6-HPV	802058	1.5		7/8"	1 1/8"	
CV7-HPV		5.5		1 1/8"	1 1/8"	

Note 1: Valves are delivered without cable/connector assembly (order separately)

Cable and Connector Assemblies

Type	Part No.	Temperature Range	Length	Connector type to valve	Connector type to driver board or controller	Illustration
EXV-M15	804 663	-50 ... +80°C	1.5 m	M12	Loose wires	
EXV-M30	804 664		3.0 m			
EXV-M60	804 665		6.0 m			

Technical Data CV Valves

Marking	CE	not required (Out of scope of PED)
	UL	CV4/5/6 (No.MP604)
Compatibility	CO ₂ and POE lubricants	
MOPD	70 bar (In conjunction with EXD-U02 driver)	
Max. Allowable Pressure PS	130 bar	
Factory Test Pressure PT	186 bar	
Temperatures	Ambient	-40...+65°C
	Storage	-40...+70°C
	Medium	-50...+100°C

Protection Accordance to IEC 529, DIN 40050	IP67 with EXV-Mxx plug and cable assembly
Vibration	4g (0...1000 Hz, 1 octave /min.)
Shock (CV4-6)	20g at 11 ms 80g at 1 ms
External Leakage	6.4 * 10 ⁻⁶ mbar*liter/sec.
Humidity	100% R.H.

Electrical data CV Valves

Stepper Motor Type	Bi-polar, phase current by chopper control (constant current)
Electrical Connection	4 pins terminal for M12 plug
Driver Supply Voltage to the Valve	18...36VDC
Operating (Moving) Current Peak	CV4: 625 mA CV5-7: 800 mA
Holding Current Peak	CV4: 100 mA CV5-7: 300 mA
Phase Inductance	CV4: 30 mH \pm 25% CV5/6/7: 20 mH \pm 25%

Step Mode	2 phase full step
Stepping Rate	500 Hz
Total Number of Steps	CV4-6: 750 full steps CV7: 6400 full steps
Winding Resistance per Phase	CV4: 14 Ohm \pm 10% CV5-7: 10 Ohm \pm 10%
Full Travel Time	CV4-6: 1.5 seconds CV7: 12.8 seconds
Reference Position	Mechanical stop at fully close position

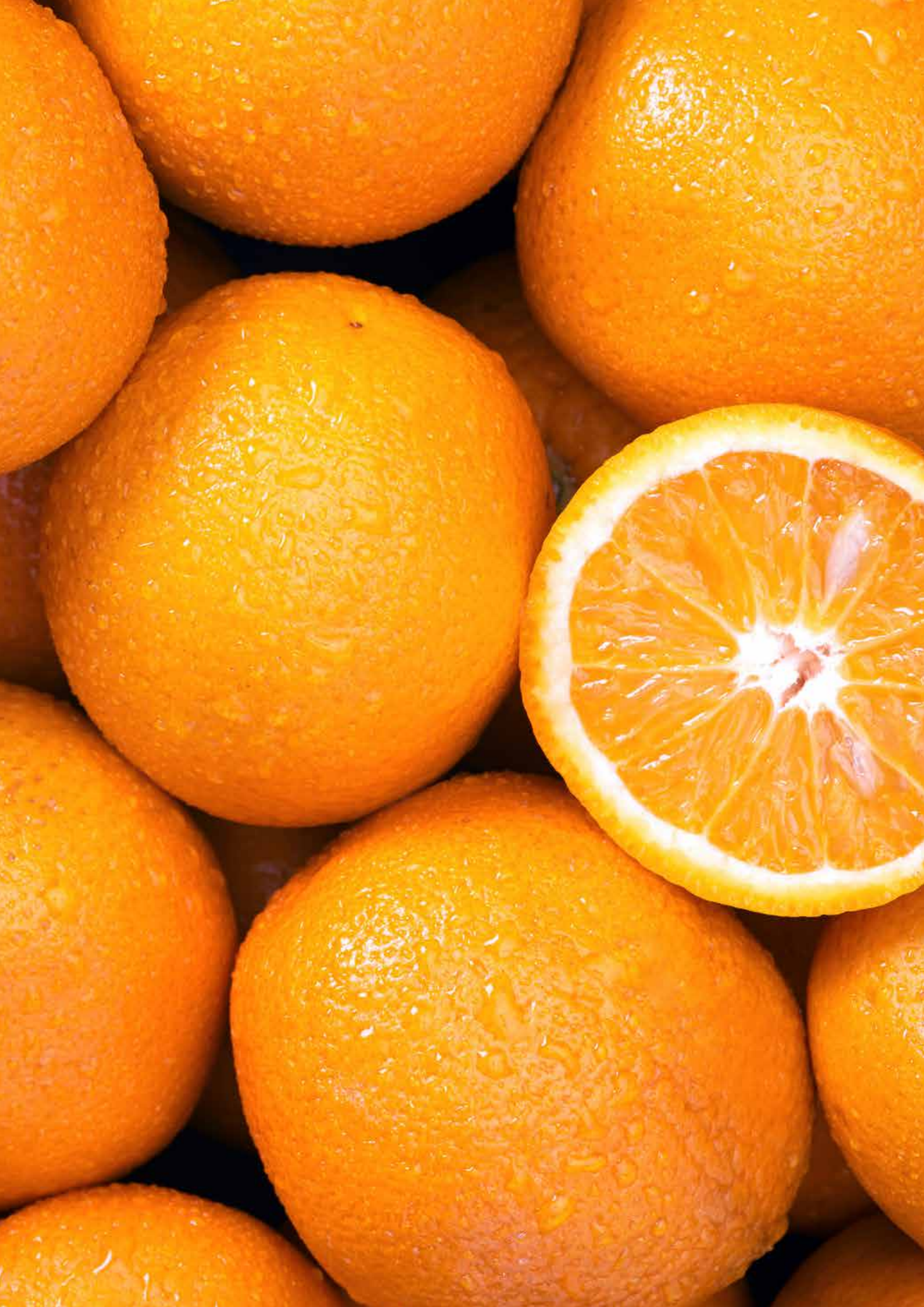

Electronic Controllers and Sensors



Selection Table Electronic Controllers

Description	Network Communication		
	Without	TCP/IP	Modbus
Superheat Controllers and Stepper Motor Drivers			
Universal Stepper Driver Module for Electrical Control Valves EX4-8	EXD-U02		
Superheat Controller for Electrical Control Valves EX4-8			EXD-SH1/2
Superheat Controller for Electrical Control Valves EXM/L			EXD HP1/2
Economizer Controller for Tandem Compressors			
Enhanced Wet Vapor Injection with EXM/L			EXD TEVI
Pressure Transmitter			
Output Signal 4 ... 20mA	PT5N		
Temperature Sensors			
NTC	TP1-NP..		
PT1000	ECN-Z.. / ECP-P..		
Compressor Soft Starter			
For Single Phase Compressor Motors with Up to 32A	CSS		
Electronic Fan Speed Controllers			
Pressure Actuated, Current Range 0.1 ... 4A	FSY/FSM		
Fan Speed Control Modules for EC-Type Motors	FSE		

Electronic Superheat Controllers and Stepper Motor Drivers

Emerson designs superheat controllers and valve drivers for stepper motor driven control valves for all commercial refrigeration and air conditioning applications.

The EXD-U02 universal driver can be connected to any controller which can provide a 4-20 mA or 0-10V analogue signal. The output is the opening/closing of EX4-8, CV4-7 and consequently the control of the refrigerant liquid or vapor mass flow in accordance with the analogue input.

EXD-SH1/2, EXD-HP1/2 and EXD-TEVI are superheat controllers and or economizer controllers with Modbus communication.

Sensors

PT5N series pressure transmitters are used to measure the suction and discharge pressures to modulate the compressor and fan capacities.

ECN, ECP, TP1 Temperature sensors (NTC/PT1000) are used to measure the suction and discharge temperatures.



EXD-SH1/2 Controller for EX/CV With ModBus Communication Capability

EXD-SH1/2 are stand-alone universal superheat and or temperature controllers for air conditioning units or refrigeration systems.

Features

- EXD-SH1: Control of one valve
- EXD-SH2: Control of two valves in two independent circuits
- Main function

	Circuit 1	Circuit 2
EXD-SH1	Superheat or Temperature Control	
EXD-SH2	Superheat or Temperature Control	Superheat Control

- Other functions: Limitation of evaporating pressure (MOP), Low pressure switch, freeze protection and manual positioning of valve(s)
- Self-adapting superheat control function in conjunction with Emerson EX4-8 & CV4-7
- For multiple refrigerants, including ultralow temperature refrigerant R23 (only with ECN-Z60)
- Released for applications using A2L and A3 refrigerants
- Modbus (RTU) communication
- EXD-SH2: capability the operation of two evaporator/ EXV / Pressure sensor with single pressure transmitter
- Integrated keyboard with two lines display
- Monitoring of sensors and detection of sensor (ECN-Z.../TP1-.../PT5N-...) stepper motor wiring failures
- Optional upload/download key (accessory) for transmission of parameter settings among controllers with the same setting
- Low/high superheat alarm as well as other function alarms
- Electrical connection via plug-in type screw terminals included with controller and Micro Molex EXD-M03 (must be ordered separately)
- DIN rail mounting housing



EXD-SH2



EXD-M03

Selection Table

Type	Description	Part No.	
Controllers		Multipack (25 pieces)	Single Pack
EXD-SH1	Controller for single refrigeration circuit	-	807 855
EXD-SH2	Controller for two independent refrigeration circuits	-	807 856
EXD-M03	Molex terminal with 3 meter wires	-	807 865
TP1-NP3	Temperature sensor with 3 meter cable	804489M (20pcs)	804 489
TP1-NP6	Temperature sensor with 6 meter cable	804490M (20pcs)	804 490
TP1-NP12	Temperature sensor with 12 m cable	804491M (20pcs)	804491
ECN-Z60	Ultralow temperature sensor with 6 meter cable	-	807 826
Pressure Transmitters: PT5N (7/16-20UNF Connection)			
PT5N-07M	Sensing pressure range -0.8...7 bar	805350M	805350
PT5N-18M	Sensing pressure range 0...18 bar	805351M	805351
PT5N-30M	Sensing pressure range 0...30 bar	805352M	805352
PT5N-50M	Sensing pressure range 0...50 bar	805353M	805353
PT5N-150D	Sensing pressure range 0...150 Bar (1/4 NPTF)	805379M	805379
Pressure Transmitters: PT5N (Brazing Connection)			
PT5N-07T	Sensing pressure range -0.8...7 bar	805380M	805380
PT5N-10P-FLR	Sensing pressure range -0.8... 10 bar	805391M	805391
PT5N-18T	Sensing pressure range 0...18 bar	805381M	805381
PT5N-30T	Sensing pressure range 0...30 bar	805382M	805382
PT5N-50T	Sensing pressure range 0...50 bar	805383M	805383

Note: Pressure Range 18 bar for System with R410A, 30 bar for R410A Economizer, 50/150 bar for CO₂

Accessories

Type	Description	Part No.	
M12 Plug And Cable For Pressure Transmitters PT5N		Multipack (20 Pieces)	Single Pack
PT4-M15	1.5 m	804 803M	804 803
PT4-M30	3.0 m	804 804M	804 804
PT4-M60	6.0 m	804 805M	804 805
PT4-M60-FLR	6.0 m cable length, 2-wire, ATEX certified		804 806
Uninterruptible Power Supply			
ECP-024	Backup Battery with Two Outputs for Two Controllers	-	804 558
K09-P00	Electrical Terminal Kit for ECP-024	-	804 560
EXD-PM	Super Cap for Only EXD-SH1 (Two Pieces of EXD-PM Required for One EXD-SH2)	-	807 854

Available Configuration Options

	Selectable Valves	
	EX4-8	CV4-7
Refrigerants	R22, R23, R32*, R124, R1234ze, R134a, R404A, R407A, R407C, R407F, R410A, R448A, R449A, R450A, R507, R513A, R744, R454C, R290*, R1270*	R744 (CO ₂)
Main Function	Superheat or and temperature control	Superheat control
Pressure Transmitters	PT5N or 3rd party ratio metric	PT5N-...

*) EXD-SH1/2 is not ATEX approved.

Technical Data: EXD-SH1/2

Supply Voltage	24VAC/DC \pm 10%, 50/60Hz
Power Consumption	EXD-SH1: Max. 25VA EXD-SH2: Max. 50VA
Terminals 1 to 12	Suitable for 12 Poles Molex Plug
Terminals 13 to 36	Suitable for Removable Screw Version: Wire Size 0.14 ... 1.5mm ² Included in Controller Delivery
Protection Class	IP 00
Marking	

Mounting	DIN Rail Mounted
Accessory (12 Poles Molex Plug with 3 Meter Cable)	Type: EXD-M03 (to be Ordered Separately)

Optional EXD-PM Supercap

Supply Voltage	24 VAC/DC \pm 10%, 50/60 Hz
Output Voltage	12 VDC
Max. Output Current	-1.2 A -350 mA during charging
Power Consumption	12 VA
Terminals	Suitable for removable screw version: wire size 0.14...1.5 mm ²
Output: to Driver/Controller	Suitable for one EXD-SH1 Two EXD-PM for one EXD-SH2
Charging Time	60 seconds
Max. Cable Length Between EXD-PM and EXD-SH1/2	50 cm AWG18 wire size

Protection Class	24 VAC/DC \pm 10%, 50/60 Hz
Mounting	12 VDC
Temperatures Storage Operating/Surrounding	-20°C...+70°C -10°C...+60°C
Housing	Self-extinguishing ABS
Relative Humidity	20...85% non-condensing
Marking	
Weight	125 g

Optional Uninterruptible Power Supply ECP-024

Backup Battery Type	Lead acid gel rechargeable battery
Number of Backup Batteries	2, each 12VDC, 0.8 Ah
Supply Voltage	24 VAC \pm 10%, 50-60 Hz
Output Voltage, UB	18VDC
Number of Outputs to Drivers	2
Battery Recharge Time	Approximately 2 hours
Marking	

Protection Class	IP 20
Mounting	DIN rail mounted
Temperatures Storage Operating/Surrounding	-20°C...+65°C -10°C...+60°C
Housing	Aluminum
Relative Humidity	< 90% non-condensing
Connection	Screw terminals for wire size 0.5...2.5 mm ²
Accessories: Terminals	K09-U00 Part No: 804559
Weight	1200 g

Input, Output EXD-SH1/2

Description	Specification
Analogue Input(s): NTC Temperature Sensor Analogue Input: PT1000 Temperature Sensor	TP1-N... (-45...+150°C operating range) ECN-Z60 (-80 ... -40°C sensing range)
Analogue Input(s): 4...20 mA Pressure Transmitters Analogue Input(s): 0.5...4.5 V Pressure Transmitters	PT5N Third Party Ratio Metric Pressure Transmitters (Total Error: \leq 1%)
Digital input(s)	Dry Contact, Potential Free
Digital output(s): Alarm Relay(s) Contact is closed: During Alarm Condition Contact is open: During Normal Operation and Supply Power OFF	Resistive Load 24 V AC/DC, Max. 1 A Inductive Load 24 V AC, Max. 0.5 A
Communication	RS485 RTU Modbus, Two Wires

EXD-HP1/2 Stand-alone Superheat/Economizer Controller

EXD-HP1/2 are stand-alone universal superheat and or economizer controllers for heat pumps, heating units, air conditioning and precision cooling such as telecom and shelter applications.

Features EXD-HP1/2

- Self adapting superheat/economizer control in conjunction with EMERSON stepper motor driven electronic expansion Valves EXM/EXL
- Discharge hot gas temperature control by liquid/vapor injection to compressor
- EXD-HP1: Controller with one EXV output
- EXD-HP2: Controller with two independent EXV outputs
- Controllers as slave with Modbus (RTU) communication capability. All data (read/write) accessible by any third party controller having modbus communication (RTU)
- Upload/download key (accessory) for transmission of parameter settings among controllers with the same setting
- Released for applications using A2L and A3 refrigerants
- Low pressure switch and freeze protection function
- Manual positioning of valve(s)
- Limitation of evaporating pressure (MOP)
- Low/high superheat alarm
- Monitoring of sensors and sensor wiring / detection of sensor and wiring failures
- Integrated display (3-digit LEDs) and keyboard
- Electrical connection via plug-in type screw terminals (included with controller)
- DIN rail mounting housing



EXD-HP2

Selection Table

Type	Description	Part No.	
		Multipack (20 pieces)	Single pack
Controllers			
EXD-HP1	with 1 EXV output	807836M	-
EXD-HP2	with 2 EXV outputs	807837M	-
Valves / Coils			
EXM-B0A	Electronic expansion valve	800399M	-
EXM-B0B		800400M	-
EXM-B0D		800401M	-
EXM-B0E		800402M	-
EXM-125	Coil 12 VDC	800403M	-
EXL-B1F	Electronic expansion valve	800405M	-
EXL-B1G		800406M	-
EXL-125	Coil 12 VDC	800407M	-
EXN-B2K	Electronic expansion valve (not selectable in conjunction with R290)	-	800421
EXN-B2L		-	800422
EXN-125	Coil 12 VDC	-	800420
Temperature Sensor			
ECP-P30	Temperature sensor with 3 m cable	-	804495
Pressure Sensors Suction Pressure (Refrigerant)			
PT5N-07M / PT5N-07T	-0.8...7 bar	805350M / 805380M	805350 / 805380
PT5N-10P-FLR	-0.8...10 bar	805391M	805391
PT5N-18M / PT5N-18T	0...18 bar	805351M / 805381M	805351 / 805381
PT5N-30M / PT5N-30T	0...30 bar	805352M / 805382M	805352 / 805382
Plug and Cable Assembly for Pressure Sensors			
PT4-M15	1.5 m cable length	804803M	804803
PT4-M30	3.0 m cable length	804804M	804804
PT4-M60	6.0 m cable length	804805M	804805
PT4-M60-FLR	6.0 m cable length, 2-wire, ATEX certified	-	804806

Application as Air to Water Heat Pumps: Heating and Cooling

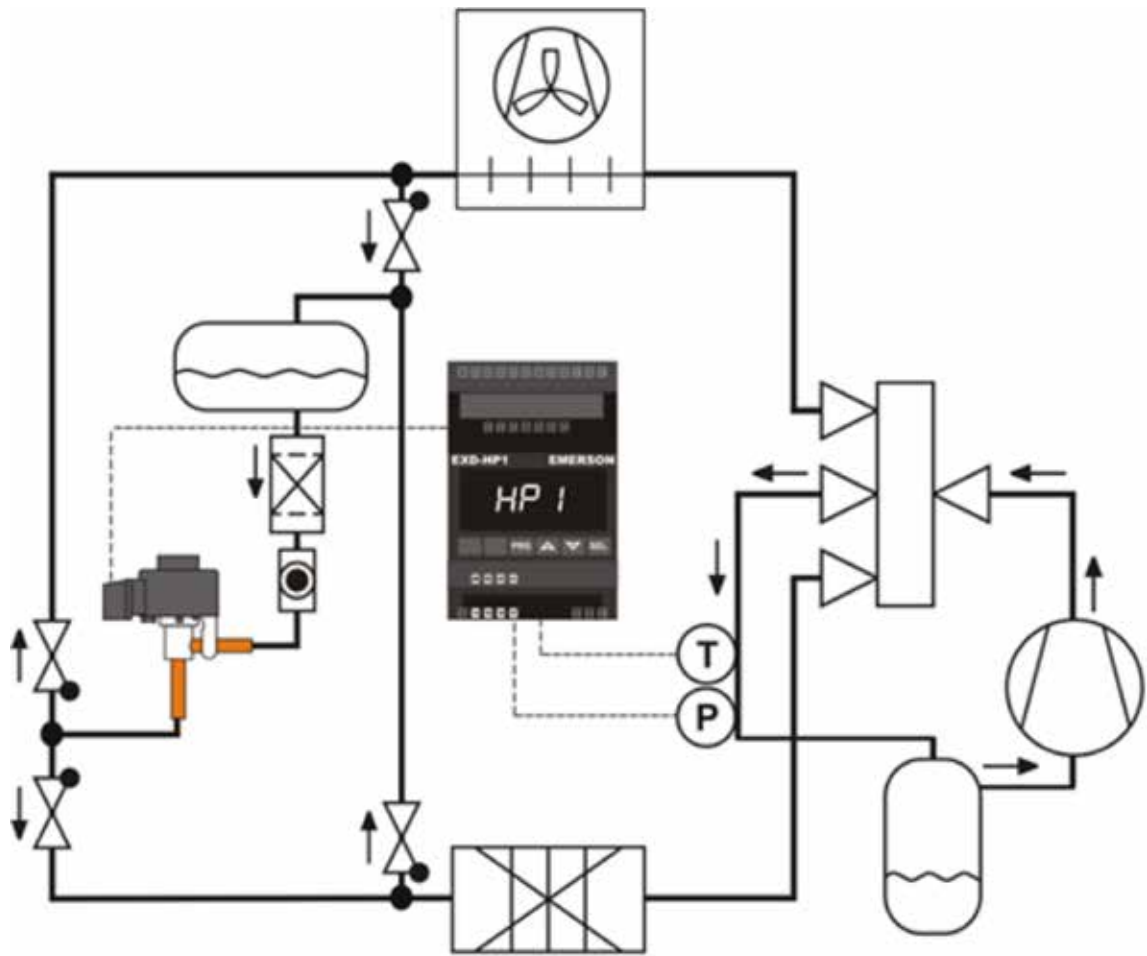

Technical Data

Supply Voltage	24 VAC/DC \pm 10%
Power Consumption	EXD-HP1: Max. 15 VA EXD-HP2: Max. 20 VA
Digital Inputs	EXD-HP1: Two, each potential free EXD-HP2: Three each potential free
Relay Output	SPDT contacts, AgSnO Inductive (AC15) 24 VAC : 1 A Resistive: 24 VAC/DC: 4 A
Plug-In Connector Size	Removable screw version wire size 0.14...1.5 mm ²
Protection Class	IP 20
Mounting	DIN Rail Mounted
Marking	

Input Sensors, Output Valves

Description	Specification
Temperature Input	ECP-P30 (3 meter cable length) Range: -30°C...+150°C
Pressure Sensor Input	PT5N Signal: 4 ... 20 mA

EXD-TEVI Economizer Controller for Tandem Compressors

EXD-TEVI is a stand-alone controller for enhanced wet vapor injection for Copeland™ Scroll tandem compressors in heating applications.

Features EXD-TEVI

- Emerson solution for specified operating map of tandem scroll
- Two EXL valves can be driven in parallel for required wide injection capacity
- Input signals: Injection (intermediate) pressure and temperature sensor as well as two compressor discharge temperature sensors
- Two independent digital inputs for recognition of tandem compressors operation
- High discharge temperature alarm
- Monitoring of sensors and sensor wiring and detection of sensor wiring failures
- Controllers as slave with Modbus (RTU) communication capability
- Upload/download key (accessory) allows to copy parameter settings from one controller to others
- Integrated 3¹/₂ digit 7-segment display with 6 indicator LEDs
- Electrical connection via plug-in type screw terminals (included with controller)



EXD-TEVI

Selection Table

Type	Description	Part No.	
		Multipack	Single pack
Controller			
EXD-TEVI	Controller with connectors	807838M	807838
Temperature Sensors: ECN			
ECN-N30	Temperature sensor with 3 m cable	-	804496
ECN-N60	Temperature sensor with 6 m cable	-	804497
Pressure transmitters: PT5N			
TP1-NP3	Temperature sensor with 3 m cable	804489M (20pcs)	804489
TP1-NP6	Temperature sensor with 6 m cable	804490M (20pcs)	804490
TP1-NP12	Temperature sensor with 12 m cable	804491M (20pcs)	804491
Plug and cable assembly for pressure transmitters			
PT4-M15	1.5 m cable	804803M	804803
PT4-M30	3 m cable	804804M	804804
Electronic expansion valve with coils			
EXL-B1F	Valve body	800405M	-
EXL-B1G		800406M	-
EXL-125	coil for EXL 12VDC	800407M	-

Technical Data

Supply Voltage	24VAC/DC ±10%
Power Consumption	EXD-TEVI: Max. 20 VA
Digital Inputs	2 (Potential Free)
Relay Output (Alarm)	SPDT, with AgSnO Contacts Inductive (AC15) 24V AC: 1 A Resistive: 24 V AC/DC: 4 A
Plug-In Connector Size	Removable Screw Version Wire Size 0.14 ... 1.5mm ²

Protection Class	IP 20
Mounting	DIN Rail Mounted
Marking	CE EAC

Technical Data: Sensors

Description	Specification
Temperature Sensors	1 x 10k NTC for Injection Line Temperature (TP1-N...) 2 x 86k NTC for Discharge Gas Temperature (Part of Compressor Delivery)
Pressure Transmitter EVI	PT5N-30M/T: 4...20 mA (Range: 0...30 bar)

Universal Driver Modules Series EXD-U02

Stepper motor valve driver specifically designed for the Emerson EX and CV Series of electrical control valves in applications such as:

- Capacity control by means of hot gas bypass
- Evaporating pressure regulator or crankcase pressure regulator
- Hot gas flow such as heat reclaim
- Condensing pressure regulation and liquid duty
- Refrigerant mass flow control in CO₂ transcritical systems

Features

- Plug and play, no parameter setting
- Valve opening proportional to 4...20mA or 0...10V analogue input signal
- Digital input can be used to force valve closing
- Easy configurable by Dip-switches
- Easy wiring
- Fully tested and ready for operation



EXD-U02

Options

- Uninterruptible Power Supply ECP-024 to automatically close valve after power down

Selection Table

Type	Part No.	Description
EXD-U01	804750	Universal Driver Module
EXD-U01 Contr. Kit	808052	Universal Driver Module with Terminal Kit
K09-U00	804559	Terminal Kit for EXD-U01

Accessories

Type	Part No.	Description
ECP-024	804558	Uninterruptible power supply for up to 2 drive modules
K09-P00	804560	Electrical terminal kit for ECP-024
ECT-323	804424	Transformer 25VA
ECT-623	804421	Transformer 60 VA 24V/230V AC – DIN-rail mounting



K09-U00



ECP-024



K09-P00



ECT-323



ECT-623

Function

The driver module EXD-U02 requires an analog input signal of 4...20 mA or 0...10 V. The output is the closing/opening of EX/CX valve series and consequently the control of liquid or vapor refrigerant mass flow in accordance with the analog input. The universal driver module can be connected to any controller which can provide a 4...20 mA or 0...10 V analog signal. This gives extreme flexibility to system manufacturers to use any desired controller and achieve different functionalities. The universal driver module keeps the valve at fully close position when the input signal is 4 mA or 0 V. The valve will be fully open at 20 mA or 10 V.

Optional uninterruptible power supply ECP-024

The optional uninterruptible power supply ECP-024 contains a rechargeable lead-acid battery, which provides enough energy to close the valve in case of power loss. ECP-024 can be connected to two EXD-U01 Driver Modules for closure of up to two valves.

Technical Data

Supply Voltage	24 VAC ±10%, 50-60 Hz Note: 24 VDC supply voltage can be used but it results to lower MOPD and it needs to be verified by system manufacture.
Supply Current	To be protected by a 1.0 A external fuse
Power Consumption	10 VA in conjunction with EXV
Protection Class	IP20
Weight	800 g
Marking	

Analog Input Signal Burden	4-20 mA 364 Ω
Analog Input Signal Impedance	0-10 V 27 kΩ
Digital Input	24 VAC ±10%, 50-60 Hz 24 VDC ±10%
Connector	Screw terminals for wire size 0.5-2.5 mm ²
Mounting	DIN rail mounted
Housing	Aluminum

Optional Uninterruptible Power Supply ECP-024

Backup Battery Type	Lead acid gel rechargeable battery
Number of Backup Batteries	2, each 12 VDC, 0.8 Ah
Supply Voltage	24 VAC ±10%, 50-60Hz
Output Voltage, UB	18 VDC
Number Of Outputs to Drivers	2
Marking	

Connection	Screw terminals for wire size 0.5-2.5 mm ²
Mounting	DIN rail mounted
Protection Class	IP20
Housing	Aluminum

Compressor Soft Starter CSS-25U / CSS-32U

The Compressor Soft Starter CSS-25U / CSS-32U is used for switching, protecting and starting current limitation of single phase compressors in residential heat pump applications.

Features

- For motors with maximum operating current up to 25A/32A
- Limitation of starting current to less than 45 A (Part No. 805209 less than 30 A)
- Self-adjusting for use in 50 Hz or 60 Hz supply
- Self-adjusting to motor current - no manual adjustment or calibration necessary
- Alarm relay output
- Start capacitor for improved motor acceleration is switched off after start
- Low voltage shutdown
- Locked rotor recognition and shutdown
- Delay function to limit number of motor starts per hour
- Thyristor protected contactor for long life
- No extra motor contactor needed
- Self-diagnostics
- Mounting clip for easy installation allows DIN rail mounting in two directions
- Easy connection by cage type screw terminals wire \varnothing 4mm



CSS-32W

CE Standards:

- LVD 2014/35/EU Low Voltage Directive
- EN 60947-1 Low voltage switchgear and controlgear
- EN 60947-4-2 Contactors and motor-starters- AC semiconductor motor controllers and starters
- EN 60335-1, EN 60335-2-40: Safety of household and similar electrical appliances (PCN 805 204 and 805 205 only, confirmed and certified by independent test lab VDE.)
- EMC 2014/30/EU
- ROHS 2011/65/EU

Selection Table

Type	Part No.	Part No. (20 Pieces)	Description	I max
CSS-32U	805 204	805 204 M	Soft Starter Incl. Mounting Clip, VDE Released Version	32A
CSS-25U	805 205	805 205M	Soft Starter Incl. Mounting Clip, VDE Released Version	25A
CSS-25U	805 209	805 209M	Soft Starter Incl. Mounting Clip (Limitation of Starting Current to Less Than 30 A)	25A
K00-003	807 663	-	3-pol Screw Connector to Alarm Output for Wires Up to 2.5mm ² ; Bag with 50 Pieces	

Technical Data

Operating Voltage	230 V 50/60 Hz Nominal
Nominal Compressor Current	CSS-32U: 32A Max. CSS-25U: 25A Max.
Maximum Start Current	CSS-32U: 45A CSS-25U (805 205): 45A CSS-25U (805 209): 30A
Operating Temperature	-20 ... +55°C Non Condensing
Storage Temperature	-20 ... +65°C Non Condensing
Start Capacitor	200 ... 240 μ F
Time Delay After Stop	0.5 ... 5 Min

Alarm Relay, AgNi (SPDT)	250V~ / 3A 30V= / 3A
Resistive (AC1) Max.	
Flexible Cable Cross Section	
CSS-32U/-25U All Terminals	0.25 ... 4 mm ²
Flexible Cable Cross Section	
Alarm Output Connector K00-003	0.25 ... 2.5 mm ²
Max. Vibration (At 10 ... 1000 Hz)	4 g
Weight	430 g
Protection Acc. IEC 529	IP 20

Wiring Diagram

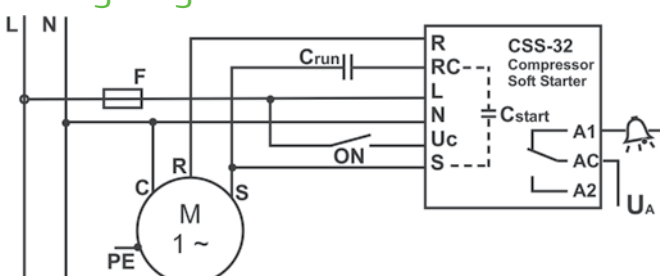

CSS Contacts

- R = Output Motor Run Winding
- RC = Output Run Capacitor
- L = 230V / AC Power Input
- N = Neutral Line
- Uc = Start Input (ON if Connected to 230V)
- S = Output Start Winding from Start Capacitor
- A1, AC, A2 = Alarm Relay Contact

Pressure Transmitter PT5N

PT5N Pressure Transmitters convert a pressure into a linear electrical 4 .. 20 mA output signal suitable for controlling simple compressor and fan switching to the more sophisticated application of superheat modulation of Electronic Control Valves.

With competitive performance to price characteristics and an easy to install pre-fabricated M12 cable assembly, PT5N transmitters are the designers choice for all heat pump, refrigeration and air conditioning applications.



PT5N-30M

PT5N-30T

Features

- Piezo-resistive sensor with output signal 4...20 mA and 2-wire connection for the precise operation of superheat, compressor or fan control systems
- Specially calibrated pressure ranges with $\pm 1\%$ accuracy performance to fulfill demands of today's refrigeration and HVAC applications
- Fully hermetic
- PT5N-xxM with 7/16"-20UNF pressure connection and Schrader valve opener
- PT5N-xxT with 40 mm stainless steel tube and integrated brazing neck for easy mounting in applications requiring a fully hermetic system solution
- PT5N-150D for subcritical and transcritical CO₂ systems
- Vibration, shock and pulsation resistant
- Protection class IP65 / IP67 (type-specific)
- UL (File No. E499688)

Selection Table

Type	Part No.		Pressure Range For Signal Output (bar)*	Output Signal	Medium Temp. Range at Pressure Connection (°C)	Max. Allowable Pressure PS (bar)	Test Pressure PT (bar)	Burst Pressure (bar)*	Pressure Connection
	Single Pack	Multi-Pack**							
PT5N-07M	805350	805350M	-0.8 .. 7	4 .. 20 mA	-40 .. +135	27	30	150	7/16" – 20 UNF (with Schrader Valve Opener)
PT5N-18M	805351	805351M	0 .. 18			48	63	250	
PT5N-30M	805352	805352M	0 .. 30			60	100	400	
PT5N-50M	805353	805353M	0 .. 50			75	150	400	
PT5N-07T	805380	805380M	-0.8 .. 7			6 mm ODM	27	30	150
PT5N-18T	805381	805381M	0 .. 18				48	63	250
PT5N-30T	805382	805382M	0 .. 30				60	100	400
PT5N-50T	805383	805383M	0 .. 50				75	150	400
PT5N-150D	805379	-	0 .. 150				150	320	1000

*) Sealed Gauge Pressure

**) 25 pcs

Selection Table Plug/Cable Assemblies: Assembly Fits All Models

Type	Part No.		Cable Length	Weight (g/Piece)	Temperature Range
	Single Pack	Multi Pack*			
PT4-M15	804 803	804 803M	1.5 m	50	-50 ... +80°C Static Application -25 ... +80°C Mobile Application
PT4-M30	804 804	804 804M	3.0 m	80	
PT4-M60	804 805	804 805M	6.0 m	140	

Note1: *) 20 pieces

Note2: PT4-M... are not in compliance with EN60335-1/2-40, clause 30 in term of glue wire test however, they comply to EN60079-15, clause 22.3 heat endurance test.

Technical Data Pressure Transmitter

Supply Voltage (Polarity Protected)	Nominal: 24VDC Range: 7.. 33VDC	Sensor Lifetime	30 Million Load Cycles with 1.3 Times of Nominal Pressure
Medium Compatibility	A1 Refrigerants A2L Refrigerants: R32, R452B, R454B	Electrical Connection PT4-Mxx Cable Assembly	M12 Connection according to EN61076-2-101 Part 2 Prefabricated, various cable lengths
Operating Current	Maximum ≤ 23 mA 4...20 mA Output	Approvals/Marking	CE acc. EMC Directive (EN 61326-2-3, EN 50121-3-2) UL, cRUus (UL File Nr. 499688) pending 
Load Resistance	$R_L \leq \frac{U_b - 7.0V}{0.02A}$	Protection Class (EN 60529)	IP67 with mounted plug and cable assembly
Response Time	≤ 2 ms	Vibration at 15...2000Hz	20 g according to IEC60068-2-6
Temperatures Transport and Storage Operating Ambient Housing Medium:	-50 .. +100 °C -30 .. +85°C -40 .. +135 °C (UL listed -40...+100°C)	Materials Housing	Stainless steel 1.4404 / AISI316L
		Pressure Connection PT5N-xxT	Stainless steel 1.4301 / AISI 304

Accuracy Performance

Type	Total Error *	Temperature Range
PT5N-07 / 18	±1% FS	-40 ... +20 °C
PT5N-30 / -50/	±1% FS ±2% FS	+10 ... +50 °C -10 ... +80 °C
PT5N-150D	±1% FS ±2% FS	+10 ... +50 °C -10 ... +90 °C

*) Total Error Includes Non-Linearity, Hysteresis, Repeatability As Well As Offset And Span Drift Due To The Temperature Changes.
Note: % FS is Related to Percentage of Full sensor Scale.

Electronic Fan Speed Controller Series FSY/FSM

Electronic Speed Controllers FSY / FSM control the speed of fan motors depending on pressure.

Features

- Adjustable pressure for cut-off
- High Voltage Triac (800 Volts)
- Integrated protection circuit against voltage peaks
- Compact design
- Easy mounting and adjustment
- Easy retrofit in existing systems
- No additional gasket required (completely molded into plug)
- Multi-position plug with EMC filter cable for flexible installation
- **CE** per 2014/30/EU (together with FSF cable)
- UL file E183816
- Other pressure connection upon request (minimum order volume 100 pieces)



FSY-43S

Selection Table

Type	Part No.	Pressure range * (bar)	Factory-setting * (bar)	Factory Setting * (bar)	Max. Allowable Pressure PS (bar)	Test Pressure PT (bar)	Pressure connection
Fan Speed Controllers With Cut-off Mode							
FSY-41S	0715533	4.0...12.5	8.0	27	27	30	7/16"-20 UNF female
FSY-42S	0715534	9.2...21.2	15.0	32	32	36	
FSY-43S	0715537	12.4...28.4	21.8	43	45	50	
Fan Speed Controllers With Min. Speed Mode							
FSM-41S	0715520	4.0...2.5	8.0	27	27	30	7/16"-20 UNF female
FSM-42S	0715521	9.2...21.2	15.0	32	32	36	
FSM-43S	0715522	12.4...28.4	21.8	43	45	50	



Note: *) Pressure at which fan is switched off (FSY) or at which fan is running with minimum speed (FSM)

Cable Assemblies With Plug and EMC Filter

Type	Part No.	Temperature Range	Cable Length
FSF-N15	804640	Temperature Range: -50...+80°C	Cable length 1.5 m
FSF-N30	804641		Cable length 3.0 m
FSF-N60	804642		Cable length 6.0 m
Seal Ring Pack	803780	Copper Gaskets 100 pcs	

Technical Data

Supply Voltage	230VAC, +15%, -20%, 50/60 Hz
Nominal Current (See Diagram Below)	FSY: 0.1 – 4.0A FSM: 0.5 – 4.0A
Starting Current	Max. 8 Amps/5 Sec.
Medium Compatibility	R410A, R134a, R404a, R507, R407C, R407A, R407F, R1234ze, R452A, R448a, R449a, R450A, R513A, R22
Protection Class According to IEC529 /EN 60529	IP 65 (with Fitted Connectors FSF-xxx)
Temperature Ranges Ambient	-20...+55°C (>40°C See Diagramm)
Storage & Transportation Medium	-30...+70°C -20...+70°C

Pressure Change Per Turn of Adjustment Screw	FSY-41: 4.0 .. 12.5 bar Clockwise ~ +1.2 bar Counterclockwise ~ -1.2 bar FSY-42: 9.2 .. 21.2 bar Clockwise ~ +2.5 bar Counterclockwise ~ -2.5 bar FSY-43: 12.4 .. 28.4 bar Clockwise ~ +3.3 bar Counterclockwise ~ -3.3 bar
Proportional Range	FSY-41: 2.5 bar FSY-42: 3.8 bar FSY-43: 4.6 bar
Housing Material	PC and PA
Marking	 (EMC 2014/30/EU, LVD 2014/35/EU, RoHS 2011/65/EU)  (FSY)

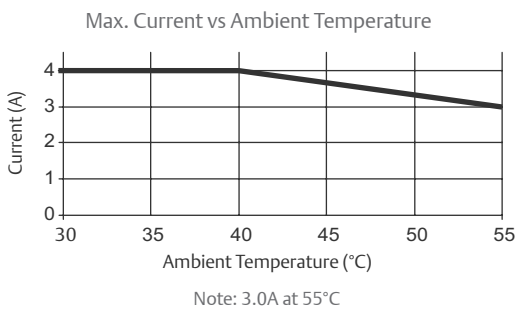

Function Diagram

The control behaviour can be easily described by looking at the function of output voltage versus input pressure: In the maximum range the FSY provides a constant output voltage of approximately 1% below the supply voltage. The fan is running at maximum speed. Along the proportional range, the output voltage varies between maximum and minimum voltage of approximately 50% of the supply voltage. This causes the fan to slow down from maximum to minimum speed.

Further decrease of pressure in the minimum range leads to cut-off of the fan motor. Reincrease of input pressure will start the motor with a hysteresis of approximately 0.7 bar to avoid cycling. The pressure from which motor cuts off is adjustable (see selection table - adjustment range).

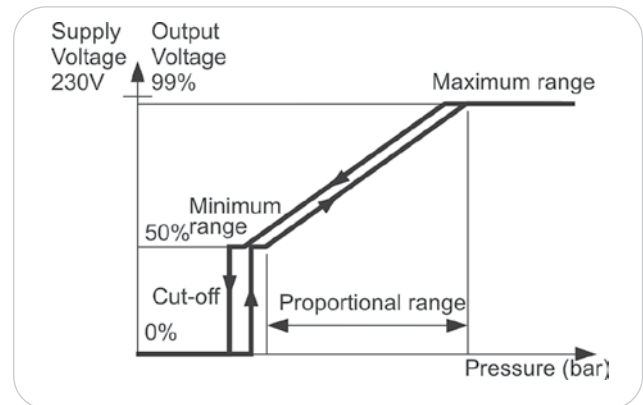

FSY

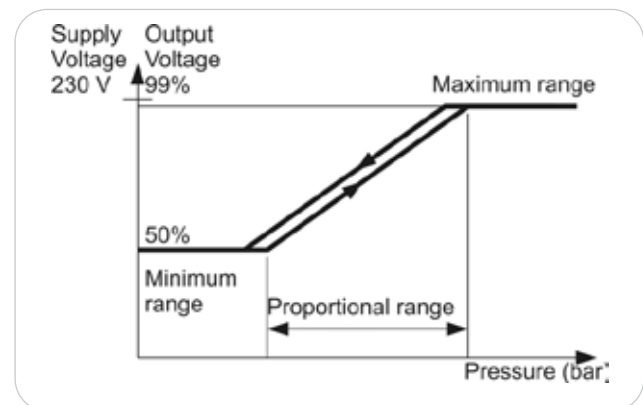

FSM

FSE Fan Speed Control Module

Electronic Fan Speed Control Modules FSE generate a 0...10 V signal, which is used to control the speed of condenser fan motors in commercial refrigeration and air-conditioning systems. Ideal for use with high efficient EC-motors, but can be also used with phase cut controllers for induction motors.

Features

- Energy saving due to improved cooling efficiency
- Pressure for minimum speed adjustable
- Small proportional band and large hysteresis to minimize cycling at small pressure changes
- Reduced fan noise level during low ambient temp. conditions
- Improved overall performance of cooling system
- Easy installation with cables for power supply and motor connection factory wired
- IP 65 protection for outdoor mounting suitable for any size of EC fan motors
- UL file nr.: E355325 (Released for 43 bar)



FSE Control Modules

Selection Chart Control Modules FSE

Type	Part No.	Adjustment Range PCut (bar)*	Factory settings (bar)	Max. Allowable Pressure PS (bar)	PT (bar)	Pressure Connection
FSE-01S	804 701	4 ... 12.5	7.8	27 bar	30 bar	7/16" -20 UNF female
FSE-02S	804 706	10 ... 21	15.5	32 bar	36 bar	7/16" -20 UNF female
FSE-03S	804 711	12 ... 28	20.4	45 bar	50 bar	7/16" -20 UNF female

Cable Assemblies for Connection of FSE Control Module to Controller

Type	Part No.	No of Leads	Diameter of Leads	Temperature Range	Cable Length
PS3-N15	804 580	3	0.75 mm ²	-25...+80°C	1.5m
PS3-N30	804 581				3.0m
PS3-N60	804 582				6.0m

Technical Data FSE

Supply Voltage	10 V; Supplied by Controller
Operating Current 0...10 VDC Output	Max. 1 mA
Medium Compatibility	R410A, R134a, R404a, R507, R407C, R1234ze, R452A, R448A, R449A, R450A, R513A, R22
Protection Class (IEC529/EN 60529)	IP 65 with Cable Connector Assemblies PS3-Nxx

Pressure Connection FSE-01S and FSE-02S FSE-03S	Brass Stainless Steel
Temperature Range Storage and Transportation Operation	-30° ... +70°C -20° ... +65°C
Materials Housing Cover	PA
Marking	UL (File No.E355325) ERC







Thermo™ - Expansion Valves

Basic Terms and Technical Information

Operating Principles

Alco Thermo-Expansion valves control the superheat of refrigerant vapor at the outlet of the evaporator. They act as a throttle device between the high pressure and the low pressure sides of refrigeration systems and ensure that the rate of refrigerant flow into the evaporator exactly matches the rate of evaporation of liquid refrigerant in the evaporator. Thus the evaporator is fully utilized and no liquid refrigerant may reach the compressor.

Description of Bulb Charges

The application ranges of Thermo-Expansion valves are heavily influenced by the charge selected.

Liquid Charges

The behaviour of Thermo-Expansion valves with liquid charges is exclusively determined by temperature changes at the bulb and not subject to any cross-ambient interference. They feature a fast response time and thus react quickly in the control circuit. Liquid charges cannot incorporate MOP functions. Maximum bulb temperatures shall not exceed 75°C.

Gas Charges

The behaviour of Thermo-Expansion valves with gas charges will be determined by the lowest temperature at any part of the expansion valve (power assembly, capillary tube or bulb). If any parts other than the bulb are subject to the lowest temperature, malfunction of the expansion valve may occur (i.e., erratic low pressure or excessive superheat). Alco Thermo-Expansion valves with gas charges always feature MOP functions and include ballasted bulbs. Ballast in the bulb leads to slow opening and fast closure of the valve. Maximum bulb temperature is 120°C.

Adsorption Charges

These charges feature control characteristics much like MOP charges but avoid the difficulties of cross-ambient interference. Response time is slow but perfectly suitable for common refrigeration systems. Maximum bulb temperature is 130°C.

MOP (Maximum Operating Pressure)

MOP functionality is somewhat similar to the application of a crankcase pressure regulator. Evaporator pressures are limited to a maximum value to protect compressor from overload conditions. MOP selection should be within maximum allowed low pressure rating of the compressor and should be at approximately 3K above evaporating temperatures.

Practical hint: Superheat adjustments influence the MOP:

Increase of superheat:	Decrease of MOP
Decrease of superheat:	Increase of MOP

Static Superheat

Alco Thermo-Expansion valves are factory preset for optimum superheat settings. This setting should be modified only if absolutely necessary. The readjustment should be at the lowest expected evaporating temperature.



Subcooling

Subcooling generally increases the capacity of the refrigeration system and may be accounted for when dimensioning an expansion valve by applying the correction factor K_c . The capacity corrections for evaporating temperature, condensing temperature and subcooling are all incorporated in K_c . These are, in particular the liquid density upstream from the expansion valve, the different enthalpies of liquid and vapor phase refrigerants, as well as certain parts of flash gas after expansion. The percentage of flash gas differs with various refrigerants and depends on system conditions.

Heavy subcooling results in very small flash gas amounts and therefore increases expansion valve capacities. These conditions are not covered by K_c . Likewise, small flash gas amounts lead to reduced evaporator capacities and may result in substantial discrepancies between the capacities of the Thermo-expansion valve and the evaporator. These effects have been integrated in selection program “Controls Navigator”.

Dimensioning

To facilitate valve dimensioning for other than standard conditions, Emerson offers the “Controls Navigator” selection tool which can be downloaded from climate.emerson.com/en-gb.

See climate.emerson.com/en-gb for contact addresses, email, phone numbers or downloads.

Dimensioning of Thermo™ - Expansion Valves for Systems With Refrigerant Having Temperature Glide

As opposed to single substances (e.g. R 134a) where the phase change takes place at a constant temperature/pressure the evaporation and condensation of zeotropic blends are in a "gliding" form (e.g. at a constant pressure the temperature varies within a certain range) through evaporators and condensers. HFO blends R448A and R449A are zeotropic blends.

The condensing /evaporating pressure must be determined at saturated temperatures (bubble for liquid / dew points for vapor) for dimensioning of the expansion valves, solenoid valves etc. The corresponding dew point for liquid pressures is provided in case of compressor selection based on dew point of liquid pressure.

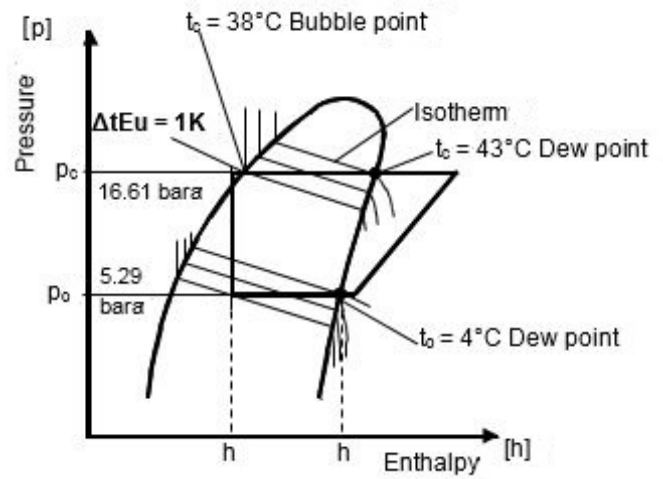

Selection Guide for Expansion Valves

Series	Selection Criteria			
	Capacity Range R448A (kW)	Evaporating Temp. Range (°C)	Main Application	Features
TI	0.5...19.4	+20...-45	Refrig./Air Cond. Heat Pumps	Exchangeable Orifices
TIH	3.1...28.4	+20...-45	Refrig./Air Cond. Heat Pumps	Hermetic, Superheat Adjustable, Optional with Check Valve
TX7	32...183 (R410A)	+20...-45	Air-Cond. Heat Pumps	Hermetic, Superheat Adjustable
T	1.9.. 301	+30...-45	Refrig./Air Cond. Heat Pumps	Exchangeable Orifices, Power-Assembly and Flange
ZZ	1.7...24.7	-45...-120	Low Temperature Application	Exchangeable Orifices, Power-Assembly and Flange
L	1.9...222	+30...-50	Liquid Injection Superheat Control	Exchangeable Orifices, Power-Assembly and Flange
935	5.2...59.8	+30...-45	Liquid Injection Temperature Control	Exchangeable Orifices, Power-Assembly and Flange

Thermo™- Expansion Valves Series TI Exchangeable Orifices

Features

- Laser-welded diaphragm / power element with large diameter for high reliability and maximum lifetime
- Constant superheat across wide application ranges
- Easy and precise superheat setting by internal fine threads
- Three styles of connections:
 - TILE: Stainless steel brazed fittings eliminate the need of wet rags during brazing
 - TIS(E): Copper brazed fittings (valve requires wet rag during brazing)
 - TI(E): Flare
- With capacities between 0.5kW and 19.4 kW (R448A) ideally suited for service work

- Internal or external equaliser
- Cleanable / exchangeable inlet strainer in orifice assembly
- Inlet brazing adapter
- Capillary tube length 1.5 m
- Max. allowable pressure PS: 45 bar
- Temperature range TS: -45...+75°C
- CE Marking acc. PED not required



Type Code

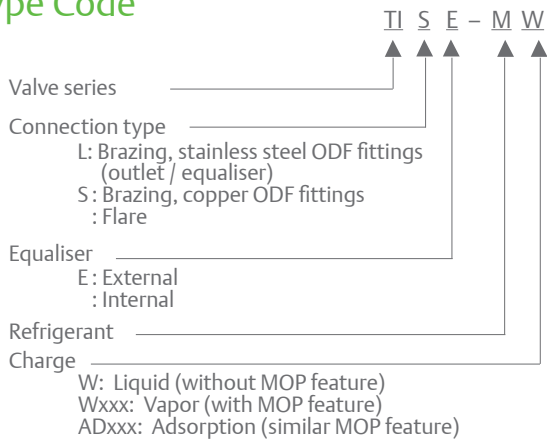

TIE



TILE

Selection Table for Orifice Assembly with Strainer for Inlet Connection

	Type	Nominal Capacity (kW)							
		TIO-00X	TIO-000	TIO-001	TIO-002	TIO-003	TIO-004	TIO-005	TIO-006
		Part No.	800 532	800 533	800 534	800 535	800 536	800 537	800 538
A1	R134a	0.3	0.8	1.9	3.1	5.0	8.3	10.1	11.7
	R22	0.5	1.3	3.2	5.3	8.5	13.9	16.9	19.5
	R404A/R507	0.4	1.0	2.3	3.9	6.2	10.1	12.3	14.2
	R407C	0.5	1.4	3.5	5.7	9.2	15	18.3	21.1
	R410A	0.6	1.5	3.7	6.2	9.9	16.2	19.7	22.8
	R448A	0.5	1.3	3.2	5.3	8.5	13.9	16.9	19.4
	R449A	0.5	1.3	3.1	5.2	8.3	13.5	16.5	19.0
	R513A/R450A	0.3	0.7	1.7	2.8	4.5	7.5	9.1	10.6
	R452A	0.4	1.0	2.4	4.0	6.4	10.5	12.8	14.8
AZL	R1234ze	0.2	0.6	1.5	2.4	3.9	6.5	7.9	9.1
	R455A	0.5	1.2	3.0	5.0	8.1	13.2	16.0	18.5
	R454C	0.4	1.1	2.6	4.3	7.0	11.4	13.8	16.0
	R1234yf	0.2	0.6	1.4	2.2	3.6	6.0	7.3	8.4
	R32	0.9	2.3	5.6	9.2	14.8	24.1	29.3	33.9

Note: Nominal conditions: Evaporating Temperature +4°C (dew point), Condensing Temperature +38°C (bubble point), Subcooling 1 K
For selection of other operation conditions, please use the "Controls Navigator" selection tool.

Brazing Adapter for TILE and TIS(E)

Type	Part No.	Connection, ODF	
		(mm)	(inch)
TIA-M06	802 500	6.0	-
TIA-M10	802 501	10.0	-
TIA-014	802 502	-	1/4"
TIA-038	802 503	-	3/8"
Gasket Set	803 780	100 pieces	



TI Valve Bodies without Orifice and Nut

Refrigerant		Outlet/ Equalizer Connection	Type	Part No.	Type	Part No.	MOP (°C)	Evaporating Temperature Range (°C)		
A1	A2L		External Equalizer		Internal Equalizer					
R404A/R507 R452A*		Brazing Stainless Steel Fittings *	TILE-SW (12mm)	802465			-	-45 ... +20		
			TILE-SW (1/2")	802466			-	-45 ... +20		
		Brazing Copper Fittings **	TISE-SW (12mm)	802462	TIS-SW (12mm)	802461	-	-45 ... +20		
			TISE-SW (1/2")	802464	TIS-SW (1/2")	802463	-	-45 ... +20		
			TISE-SAD10 (1/2")	802479	TIS-SAD10 (1/2")	802478	+10	-45 ... 0		
			TISE-SW75 (12mm)	802471			0	-45 ... -3		
			TISE-SW75 (1/2")	802472			0	-45 ... -3		
			TISE-SAD-20 (12mm)	802474			-20	-45 ... -27		
		Flare Fittings	TISE-SAD-20 (1/2")	802475			-20	-45 ... -27		
			TIE-SW	802460	TI-SW	802459	-	-45 ... +20		
			TIE-SAD10	802477			+10	-45 ... 0		
			TIE-SW75	802470	TI-SW75	802469	0	-45 ... -3		
		R134a R450A*	R1234ze*	Brazing Stainless Steel Fittings *	TILE-MW (12mm)	802451			-	-45 ... +20
					TILE-MW (1/2")	802452			-	-45 ... +20
Brazing Copper Fittings **	TISE-MW (12 mm)			802448	TIS-MW (12 mm)	802447	-	-45 ... +20		
	TISE-MW (1/2")			802450	TIS-MW (1/2")	802449	-	-45 ... +20		
	TISE-MW55 (12mm)			802457			+14	-45 ... +11		
	TISE-MW55 (1/2")			802458			+14	-45 ... +11		
Flare Fittings	TIE-MW			802446	TI-MW	802445	-	-45 ... +20		
	TIE-MW55			802456	TI-MW55	802455	+14	-45 ... +11		
R407C		Brazing Stainless Steel Fittings *	TILE-NW (12mm)	802486			-	-45 ... +20		
			TILE-NW (1/2")	802485			-	-45 ... +20		
		Brazing Copper Fittings **	TISE-NW (12mm)	802438	TIS-NW (12mm)	802437	-	-45 ... +20		
			TISE-NW (1/2")	802440	TIS-NW (1/2")	802439	-	-45 ... +20		
		Flare Fittings	TIE-NW	802436	TI-NW	802435	-	-45...+20		
R410A	R32*	Brazing Stainless Steel Fittings *	TILE-ZW (12mm)	802488			-	-35...+20		
			TILE-ZW (1/2")	802489			-	-35...+20		
			TILE-ZW175 (12mm)	802490			+16.4	-35...+15		
			TILE-ZW175 (1/2")	802491			+16.4	-35...+15		
R448A / R449A		Brazing Stainless Steel Fittings *	TILE-BW (12mm)	802418			-	-45...+20		
			TILE-BW (1/2")	802419			-	-45...+20		
		Brazing Copper Fittings **	TISE-BW (12mm)	802416	TIS-BW(12mm)	802414	-	-45...+20		
			TISE-BW (1/2")	802417	TIS-BW(1/2")	802415	-	-45...+20		
			TISE-BW30 (12mm)	802494			-15	-45...-18		
			TISE-BW30 (1/2")	802495			-15	-45...-18		
		Flare Fittings	TIE-BW	802413	TI-BW	802412	-	-45...+20		

Note: *) TILE Brazing without wet rag

**) TISE Brazing with wet rag

***) Superheat readjustment required - see Operating Instruction

TI Valve Bodies without Orifice and Nut

Refrigerant		Outlet/ Equalizer Connection	Type	Part No.	Type	Part No.	MOP (°C)	Evaporating Temperature Range (°C)
A1	A2L		External Equalizer		Internal Equalizer			
R513A		Brazing Stainless Steel Fittings**	TILE-CW (12mm)	802166			-	-30...+20°C
			TILE-CW (1/2")	802167			-	-30...+20°C
		Brazing Copper Fittings***	TISE-CW (12mm)	802168	TIS-CW (12mm)	802170	-	-30...+20°C
			TISE-CW (1/2")	802169	TIS-CW (1/2")	802171	-	-30...+20°C
		Flare Fittings	TIE-CW	802172	TI-CW	802173	-	-30...+20°C
	R454C	Brazing Stainless Steel Fittings**	TILE-LW (12mm)	802150			-	-35...+20°C
			TILE-LW (1/2")	802151			-	-35...+20°C
		Brazing Copper Fittings***	TISE-LW (12mm)	802152	TIS-LW (12mm)	802154	-	-35...+20°C
			TISE-LW (1/2")	802153	TIS-LW (1/2")	802155	-	-35...+20°C
		Flare Fittings	TIE-LW	802156	TI-LW	802157	-	-35...+20°C
	R455A	Brazing Stainless Steel Fittings**	TILE-KW (12mm)	802158			-	-35...+20°C
			TILE-KW (1/2")	802159			-	-35...+20°C
		Brazing Copper Fittings***	TISE-KW (12mm)	802160	TIS-KW (12mm)	802162	-	-35...+20°C
			TISE-KW (1/2")	802161	TIS-KW (1/2")	802163	-	-35...+20°C
		Flare Fittings	TIE-KW	802164	TI-KW	802165	-	-35...+20°C
	R1234yf	Brazing Stainless Steel Fittings**	TILE-FW (12mm)	802174			-	-35...+20°C
			TILE-FW (1/2")	802175			-	-35...+20°C
		Brazing Copper Fittings***	TISE-FW (12mm)	802176	TIS-FW (12mm)	802178	-	-35...+20°C
			TISE-FW (1/2")	802177	TIS-FW (1/2")	802179	-	-35...+20°C
		Flare Fittings	TIE-FW	802180	TI-FW	802181	-	-35...+20°C

Note: *) TILE Brazing without wet rag

**) TISE Brazing with wet rag

***) Superheat readjustment required - see Operating Instruction

Connections

Body	Inlet Connection		Outlet	External Equalizer*
	Brazing with Adapter	Flare		
TI(E) Flare connections	-	5/8"-18 UNF Flare suitable for 6 mm, 8 mm, 10 mm, 1/4", 5/16", 3/8" tubes	3/4" - 16 UNF Flare: for 12 mm, 1/2" tubes	7/16" - 20 UNF Flare: for 6 mm, 1/4" tubes
TIS(E) / TILE Braze connections	TIA - M06 (6 mm ODF) TIA - M10 (10 mm ODF)		12 mm ODF	6 mm ODF
	TIA - 014 (1/4" ODF) TIA - 038 (3/8" ODF)		1/2 ODF	1/4" ODF

Note: *) TIE, TISE and TILE

Thermo™- Expansion Valves Series TIH For OEM use, hermetic design

Features

- Compact size and hermetic design
- Up to 35kW for R410A, 49 kW for R32
- Brazing and metric connections with straight through configuration
- Stainless steel power element resists corrosion
- Large diaphragm provides smoother and consistent valve control
- Internal or external equalizer
- External superheat adjustment
- Standard with integrated 100 mesh size strainer at inlet of valve
- Packaging with 20 pieces necked including bulb fastening accessories and single operating instruction

TIH



Options

- Single engineering sample for test purpose
- Special setting or bleed hole function on request: Minimum order quantity 100 pieces per batch, type and order
- Valve without internal strainer on request: Minimum order quantity 100 pieces per batch, type and order

Selection table R32 / R410A / R452B / R454B

Nominal Capacity (kW)				with MOP		Connection		
R410A	R32 *	R452B *	R454B *	Type	Part No.	Inlet	Outlet	Equalizer
3.6	5.4	4.1	4.2	TIH-Z12m	802622M	6 mm	10 mm	internal
3.6	5.4	4.1	4.2	TIH-Z12	802636M	1/4"	3/8"	internal
6.0	9.0	6.9	6.9	TIH-Z13m	802623M	6 mm	10 mm	internal
6.0	9.0	6.9	6.9	TIH-Z13	802637M	1/4"	3/8"	internal
8.4	12.5	9.6	9.7	TIH-Z14m	802624M	10 mm	12 mm	internal
8.4	12.5	9.6	9.7	TIH-Z14	802638M	3/8"	1/2"	internal
3.6	5.4	4.1	4.2	TIH-Z32m	802625M	6 mm	10 mm	6 mm
3.6	5.4	4.1	4.2	TIH-Z32	802639M	1/4"	3/8"	1/4"
6.0	9.0	6.9	6.9	TIH-Z33m	802626M	6 mm	10 mm	6 mm
6.0	9.0	6.9	6.9	TIH-Z33	802640M	1/4"	3/8"	1/4"
8.4	12.5	9.6	9.7	TIH-Z34m	802627M	10 mm	12 mm	6 mm
8.4	12.5	9.6	9.7	TIH-Z34	802641M	3/8"	1/2"	1/4"
12.4	18.4	14.2	14.2	TIH-Z35m	802628M	10 mm	12 mm	6 mm
12.4	18.4	14.2	14.2	TIH-Z35	802642M	3/8"	1/2"	1/4"
14.6	21.8	16.7	16.8	TIH-Z36m	802629M	10 mm	12 mm	6 mm
14.6	21.8	16.7	16.8	TIH-Z36	802643M	3/8"	1/2"	1/4"
20.8	31.0	23.8	23.9	TIH-Z37m	802630M	12 mm	16 mm	6 mm
20.8	31.0	23.8	23.9	TIH-Z37	802644M	1/2"	5/8"	1/4"
23.2	34.6	26.6	26.7	TIH-Z38m	802631M	12 mm	16 mm	6 mm
23.2	34.6	26.6	26.7	TIH-Z38	802645M	1/2"	5/8"	1/4"
26.7	39.7	30.5	30.7	TIH-Z39m	802632M	12 mm	16 mm	6 mm
26.7	39.7	30.5	30.7	TIH-Z39	802646M	1/2"	5/8"	1/4"
33.2	49.4	38	38.2	TIH-Z3Am	802633M	12 mm	16 mm	6 mm
33.2	49.4	38	38.2	TIH-Z3A	802647M	1/2"	5/8"	1/4"

Note 1: Nominal conditions: Evaporating Temperature +4°C (dew point), Condensing Temperature +38°C (bubble point), Subcooling 1 K

Note 2: *) Superheat readjustment required - see Operating Instruction

Selection table R134a / R450A

Capacity (kW)		without MOP		with MOP		Connection		
R134a	R450A *	Type	Part No.	Type	Part No.	Inlet	Outlet	Equalizer
2.4	2.1	TIH-M02m	802510M	TIH-M12m	802538M	6 mm	10 mm	internal
2.4	2.1	TIH-M02	802524M	TIH-M12	802552M	1/4"	3/8"	internal
4.0	3.5	TIH-M03m	802511M	TIH-M13m	802539M	6 mm	10 mm	internal
4.0	3.5	TIH-M03	802525M	TIH-M13	802553M	1/4"	3/8"	internal
5.6	4.9	TIH-M04m	802512M	TIH-M14m	802540M	10 mm	12 mm	internal
5.6	4.9	TIH-M04	802526M	TIH-M14	802554M	3/8"	1/2"	internal
2.4	2.1	TIH-M22m	802513M	TIH-M32m	802541M	6 mm	10 mm	6 mm
2.4	2.1	TIH-M22	802527M	TIH-M32	802555M	1/4"	3/8"	1/4"
4.0	3.5	TIH-M23m	802514M	TIH-M33m	802542M	6 mm	10 mm	6 mm
4.0	3.5	TIH-M23	802528M	TIH-M33	802556M	1/4"	3/8"	1/4"
5.6	4.9	TIH-M24m	802515M	TIH-M34m	802543M	10 mm	12 mm	6 mm
5.6	4.9	TIH-M24	802529M	TIH-M34	802557M	3/8"	1/2"	1/4"
8.2	7.2	TIH-M25m	802516M	TIH-M35m	802544M	10 mm	12 mm	6 mm
8.2	7.2	TIH-M25	802530M	TIH-M35	802558M	3/8"	1/2"	1/4"
9.7	8.5	TIH-M26m	802517M	TIH-M36m	802545M	10 mm	12 mm	6 mm
9.7	8.5	TIH-M26	802531M	TIH-M36	802559M	3/8"	1/2"	1/4"
13.8	12.2	TIH-M27m	802518M	TIH-M37m	802546M	12 mm	16 mm	6 mm
13.8	12.2	TIH-M27	802532M	TIH-M37	802560M	1/2"	5/8"	1/4"
15.4	13.6	TIH-M28m	802519M	TIH-M38m	802547M	12 mm	16 mm	6 mm
15.4	13.6	TIH-M28	802533M	TIH-M38	802561M	1/2"	5/8"	1/4"
17.7	15.6	TIH-M39m	802520M	TIH-M39m	802548M	12 mm	16 mm	6 mm
17.7	15.6	TIH-M29	802534M	TIH-M39	802562M	1/2"	5/8"	1/4"
22.0	19.4	TIH-M3Am	802521M	TIH-M3Am	802549M	12 mm	16 mm	6 mm
22.0	19.4	TIH-M2A	802535M	TIH-M3A	802563M	1/2"	5/8"	1/4"

Note 1: Nominal conditions: Evaporating Temperature +4°C (dew point), Condensing Temperature +38°C (bubble point), Subcooling 1 K

Note 2: *) Superheat readjustment required - see Operating Instruction

Selection table R407C / R454C

Capacity (kW)		without MOP		with MOP		Connection		
R407C	R454C *	Type	Part No.	Type	Part No.	Inlet	Outlet	Equalizer
3.3	2.5	TIH-N02m	802566M	TIH-N12m	802594M	6 mm	10 mm	internal
3.3	2.5	TIH-N02	802580M	TIH-N12	802608M	1/4"	3/8"	internal
5.4	4.2	TIH-N03m	802567M	TIH-N13m	802595M	6 mm	10 mm	internal
5.4	4.2	TIH-N03	802581M	TIH-N13	802609M	1/4"	3/8"	internal
7.6	5.9	TIH-N04m	802568M	TIH-N14m	802596M	10 mm	12 mm	internal
7.6	5.9	TIH-N04	802582M	TIH-N14	802610M	3/8"	1/2"	internal
3.3	2.5	TIH-N22m	802569M	TIH-N32m	802597M	6 mm	10 mm	6 mm
3.3	2.5	TIH-N22	802583M	TIH-N32	802611M	1/4"	3/8"	1/4"
5.4	4.2	TIH-N23m	802570M	TIH-N33m	802598M	6 mm	10 mm	6 mm
5.4	4.2	TIH-N23	802584M	TIH-N33	802612M	1/4"	3/8"	1/4"
7.6	5.9	TIH-N24m	802571M	TIH-N34m	802599M	10 mm	12 mm	6 mm
7.6	5.9	TIH-N24	802585M	TIH-N34	802613M	3/8"	1/2"	1/4"
11.2	8.7	TIH-N25m	802572M	TIH-N35m	802600M	10 mm	12 mm	6 mm
11.2	8.7	TIH-N25	802586M	TIH-N35	802614M	3/8"	1/2"	1/4"
13.2	10.3	TIH-N26m	802573M	TIH-N36m	802601M	10 mm	12 mm	6 mm
13.2	10.3	TIH-N26	802587M	TIH-N36	802615M	3/8"	1/2"	1/4"
18.8	14.6	TIH-N27m	802574M	TIH-N37m	802602M	12 mm	16 mm	6 mm
18.8	14.6	TIH-N27	802588M	TIH-N37	802616M	1/2"	5/8"	1/4"
21	16.3	TIH-N28m	802575M	TIH-N38m	802603M	12 mm	16 mm	6 mm
21	16.3	TIH-N28	802589M	TIH-N38	802617M	1/2"	5/8"	1/4"
24.1	18.7	TIH-N29m	802576M	TIH-N39m	802604M	12 mm	16 mm	6 mm
24.1	18.7	TIH-N29	802590M	TIH-N39	802618M	1/2"	5/8"	1/4"
30	23.3	TIH-N2Am	802577M	TIH-N3Am	802605M	12 mm	16 mm	6 mm
30	23.3	TIH-N2A	802591M	TIH-N3A	802619M	1/2"	5/8"	1/4"

Note 1: Nominal conditions: Evaporating Temperature +4°C (dew point), Condensing Temperature +38°C (bubble point), Subcooling 1 K

Note 2: *) Superheat readjustment required - see Operating Instruction

Selection table R448A / R449A / R454A /R455A

Capacity (kW)				without MOP		Connection		
R448A	R449A	R454A*	R455A*	Type	Part No.	Inlet	Outlet	Equalizer
3.1	3	3.0	2.9	TIH-B02m	802706M	6 mm	10 mm	internal
3.1	3	3.0	2.9	TIH-B02	802720M	1/4"	3/8"	internal
5.1	5	5.1	4.9	TIH-B03m	802707M	6 mm	10 mm	internal
5.1	5	5.1	4.9	TIH-B03	802721M	1/4"	3/8"	internal
7.2	7	7.1	6.8	TIH-B04m	802708M	10 mm	12 mm	internal
7.2	7	7.1	6.8	TIH-B04	802722M	3/8"	1/2"	internal
3.1	3	3.0	2.9	TIH-B22m	802709M	6 mm	10 mm	6 mm
3.1	3	3.0	2.9	TIH-B22	802723M	1/4"	3/8"	1/4"
5.1	5	5.1	4.9	TIH-B23m	802710M	6 mm	10 mm	6 mm
5.1	5	5.1	4.9	TIH-B23	802724M	1/4"	3/8"	1/4"
7.2	7	7.1	6.8	TIH-B24m	802711M	10 mm	12 mm	6 mm
7.2	7	7.1	6.8	TIH-B24	802725M	3/8"	1/2"	1/4"
10.6	10.3	10.4	10.1	TIH-B25m	802712M	10 mm	12 mm	6 mm
10.6	10.3	10.4	10.1	TIH-B25	802726M	3/8"	1/2"	1/4"
12.5	12.2	12.3	11.9	TIH-B26 mm	802713M	10 mm	12 mm	6 mm
12.5	12.2	12.3	11.9	TIH-B26	802727M	3/8"	1/2"	1/4"
17.8	17.4	17.5	16.9	TIH-B27m	802714M	12 mm	16 mm	6 mm
17.8	17.4	17.5	16.9	TIH-B27	802728M	1/2"	5/8"	1/4"
19.9	19.4	19.6	18.9	TIH-B28m	802715M	12 mm	16 mm	6 mm
19.9	19.4	19.6	18.9	TIH-B28	802729M	1/2"	5/8"	1/4"
22.8	22.3	22.5	21.6	TIH-B29m	802716M	12 mm	16 mm	6 mm
22.8	22.3	22.5	21.6	TIH-B29	802730M	1/2"	5/8"	1/4"
28.4	27.7	28.0	27.0	TIH-B2Am	802717M	12 mm	16 mm	6 mm
28.4	27.7	28.0	27.0	TIH-B2A	802731M	1/2"	5/8"	1/4"

Note 1: Nominal conditions: Evaporating Temperature +4°C (dew point), Condensing Temperature +38°C (bubble point), Subcooling 1 K

Note 2: *) Superheat readjustment required - see Operating Instruction

Selection table R513A / R1234yf

Capacity (kW)		without MOP		with MOP		Connection		
R513A	R1234yf*	Type	Part No.	Type	Part No.	Inlet	Outlet	Equalizer
2.2	1.7	TIH-C02m	808400M	TIH-C12m	808428M	6 mm	10 mm	internal
2.2	1.7	TIH-C02	808414M	TIH-C12	808442M	1/4"	3/8"	internal
3.6	2.9	TIH-C03m	808401M	TIH-C13m	808429M	6 mm	10 mm	internal
3.6	2.9	TIH-C03	808415M	TIH-C13	808443M	1/4"	3/8"	internal
5.0	4.0	TIH-C04m	808402M	TIH-C14m	808430M	10 mm	12 mm	internal
5.0	4.0	TIH-C04	808416M	TIH-C14	808444M	3/8"	1/2"	internal
2.2	1.7	TIH-C22m	808403M	TIH-C32m	808431M	6 mm	10 mm	6 mm
2.2	1.7	TIH-C22	808417M	TIH-C32	808445M	1/4"	3/8"	1/4"
3.6	2.9	TIH-C23m	808404M	TIH-C33m	808432M	6 mm	10 mm	6 mm
3.6	2.9	TIH-C23	808418M	TIH-C33	808446M	1/4"	3/8"	1/4"
5.0	4.0	TIH-C24m	808405M	TIH-C34m	808433M	10 mm	12 mm	6 mm
5.0	4.0	TIH-C24	808419M	TIH-C34	808447M	3/8"	1/2"	1/4"
7.4	5.9	TIH-C25m	808406M	TIH-C35m	808434M	10 mm	12 mm	6 mm
7.4	5.9	TIH-C25	808420M	TIH-C35	808448M	3/8"	1/2"	1/4"
8.8	7.0	TIH-C26m	808407M	TIH-C36m	808435M	10 mm	12 mm	6 mm
8.8	7.0	TIH-C26	808421M	TIH-C36	808449M	3/8"	1/2"	1/4"
12.5	10.0	TIH-C27m	808408M	TIH-C37m	808436M	12 mm	16 mm	6 mm
12.5	10.0	TIH-C27	808422M	TIH-C37	808450M	1/2"	5/8"	1/4"
13.9	11.1	TIH-C28m	808409M	TIH-C38m	808437M	12 mm	16 mm	6 mm
13.9	11.1	TIH-C28	808423M	TIH-C38	808451M	1/2"	5/8"	1/4"
16.0	12.7	TIH-C29m	808410M	TIH-C39m	808438M	12 mm	16 mm	6 mm
16.0	12.7	TIH-C29	808424M	TIH-C39	808452M	1/2"	5/8"	1/4"
19.9	15.9	TIH-C2Am	808411M	TIH-C3Am	808439M	12 mm	16 mm	6 mm
19.9	15.9	TIH-C2A	808425M	TIH-C3A	808453M	1/2"	5/8"	1/4"

Note 1: Nominal conditions: Evaporating Temperature +4°C (dew point), Condensing Temperature +38°C (bubble point), Subcooling 1 K

Note 2: *) Superheat readjustment required - see Operating Instruction

Standard MOPs

Refrigerant	Standard MOP	Corresponding Ttemperature	Recommended Max. Design Evaporating Temperature
R134a	3.8 bar	+16°C	+12°C
R513A	3.8 bar	+14°C	+10°C
R407C	6.9 bar	+14.5°C	+12.5°C
R410A	13.4 bar	+20°C	+18°C
R32	13.4 bar	+20°C	+18°C
R452B	13.4 bar	+22°C	+20°C
R454B	13.4 bar	+22°C	+20°C

Charge	MOP	Refrigerant	Maximum Bulb Temperature
TIH-M0../M2..	-	R134a	+100°C
TIH-N0../N2..	-	R407C	+80°C
TIH-B0../B2..	-	R448A, R449A	+80°C
TIH-C0../C2..	-	R513A	+100°C
TIH-M1../M3..	3.8 bar	R134a	+120°C
TIH-C1../C3..	3.8 bar	R513A	+120°C
TIH-N1../N3..	6.9 bar	R407C	+120°C
TIH-Z1../Z3..	12.1 bar	R410A	+120°C

Thermo™-Expansion Valves Series TX7

TX7 series of Thermo-Expansion Valves are designed predominantly for AC, heat pumps, close control and industrial process cooling applications. The TX7 is ideal for those applications requiring hermetic / compact size combined with stable and accurate control over wide load and evaporating temperature ranges.

Features

- Monoblock, hermetic valve with brazing connections
- 7 sizes up to 180 kW (R410A)
- Maximum allowable pressure: PS 46 bar
- Factory test pressure PT: 50.6 bar
- Bi-Flow application
 - Balanced port in normal and reverse flow directions eliminates disturbance forces resulting from condensing pressure
 - Optimum static superheat in normal and reverse flow
 - Capacities performance in normal and reverse flow correlates to capacity of heat pumps in cooling and heating mode
- Power Element with 65 mm diameter enables low partial load (20-25%) performance at stable superheat
- Applicable in systems with digital scroll, step less screw compressors and variable speed compressors
- Floating superheat in reverse flow (heating mode) supports evaporator efficiency during low ambient operating conditions in air cooled reversible chillers
- Laser welded stainless steel power element with a special diaphragm profile provides life expectancy against high pressure during reversed flow via external equalizer.
- Single diaphragm with negligible hysteresis withstands against higher pressure
- Fine tuning by external superheat adjusting mechanism
- Special factory setting upon request. Minimum order quantity 60 pieces



TX7-Z13

Selection Table R410A / R32 / R452B / R454B

Nominal Capacity (kW)								With MOP		Connection	
R410A		R32*		R452B*		R454B*		Type	Part No.	Inlet x Outlet	Equalizer
Normal Flow	Reverse Flow	Normal Flow	Reverse Flow	Normal Flow	Reverse Flow	Normal Flow	Reverse Flow				
32.1	31.7	47.7	46.9	36.7	36.3	36.9	36.5	TX7-Z13m	806811	12mm x 16mm	6mm
32.1	31.7	47.7	46.9	36.7	36.3	36.9	36.5	TX7-Z13	806810	1/2" x 5/8"	1/4"
39.9	39.1	59.3	57.8	45.6	44.7	45.8	44.9	TX7-Z14m	806813	16mm x 22mm	6mm
39.9	39.1	59.3	57.8	45.6	44.7	45.8	44.9	TX7-Z14	806812	5/8" x 7/8"	1/4"
48.9	47.4	72.7	70.1	55.9	54.2	56.1	54.4	TX7-Z15m	806815	16mm x 22mm	6mm
48.9	47.4	72.7	70.1	55.9	54.2	56.1	54.4	TX7-Z15	806814	5/8" x 7/8"	1/4"
80.7	67.7	120	100.2	92.2	77.4	92.7	77.9	TX7-Z16m	806817	22mm x 28mm	6mm
80.7	67.7	120	100.2	92.2	77.4	92.7	77.9	TX7-Z16	806816	7/8" x 1-1/8"	1/4"
99.4	81.5	147.9	120.5	113.7	93.2	114.3	93.7	TX7-Z17m	806819	22mm x 28mm	6mm
99.4	81.5	147.9	120.5	113.7	93.2	114.3	93.7	TX7-Z17	806818	7/8" x 1-1/8"	1/4"
130.9	113.9	194.7	168.4	149.7	130.2	150.4	130.8	TX7-Z18m	806821	22mm x 28mm	6mm
130.9	113.9	194.7	168.4	149.7	130.2	150.4	130.8	TX7-Z18	806820	7/8" x 1-1/8"	1/4"
183.4	165.1	272.9	244.1	209.8	188.8	210.8	189.7	TX7-Z19m	806823	22mm x 28mm	6mm
183.4	165.1	272.9	244.1	209.8	188.8	210.8	189.7	TX7-Z19	806822	7/8" x 1-1/8"	1/4"

Note 1: *) Superheat readjustment required - see Operating Instruction

Note 2: Nominal conditions: Evaporating Temperature +4°C (dew point), Condensing Temperature +38°C (bubble point), Subcooling 1 K

Selection Table R134a / R450A / R513A / R1234yf

Nominal Capacity (kW)								with MOP		without MOP		Connection	
R134a		R450A*		R513A*		R1234yf*		Type	Part No.	Type	Part No.	Inlet x Outlet	Equalizer
Normal Flow	Reverse Flow	Normal Flow	Reverse Flow	Normal Flow	Reverse Flow	Normal Flow	Reverse Flow						
18.1	17.9	15.9	15.8	16.3	16.1	13.0	12.9	TX7-M13m	806839	TX7-M03m	806825	12mm x 16mm	6mm
18.1	17.9	15.9	15.8	16.3	16.1	13.0	12.9	TX7-M13	806838	TX7-M03	806824	1/2" x 5/8"	1/4"
22.5	22	19.8	19.4	20.3	19.9	16.2	15.9	TX7-M14m	806841	TX7-M04m	806827	16mm x 22mm	6mm
22.5	22	19.8	19.4	20.3	19.9	16.2	15.9	TX7-M14	806840	TX7-M04	806826	5/8" x 7/8"	1/4"
27.5	26.7	24.3	23.5	24.8	24.1	19.8	19.2	TX7-M15m	806843	TX7-M05m	806829	16mm x 22mm	6mm
27.5	26.7	24.3	23.5	24.8	24.1	19.8	19.2	TX7-M15	806842	TX7-M05	806828	5/8" x 7/8"	1/4"
45.4	38.2	40.1	33.6	41.0	34.4	32.8	27.5	TX7-M16m	806845	TX7-M06m	806831	22mm x 28mm	6mm
45.4	38.2	40.1	33.6	41.0	34.4	32.8	27.5	TX7-M16	806844	TX7-M06	806830	7/8" x 1-1/8"	1/4"
56	45.9	49.4	40.5	50.6	41.5	40.4	33.1	TX7-M17m	806847	TX7-M07m	806833	22mm x 28mm	6mm
56	45.9	49.4	40.5	50.6	41.5	40.4	33.1	TX7-M17	806846	TX7-M07	806832	7/8" x 1-1/8"	1/4"
73.7	64.1	65.0	56.6	66.6	57.9	53.2	46.3	TX7-M18m	806849	TX7-M08m	806835	22mm x 28mm	6mm
73.7	64.1	65.0	56.6	66.6	57.9	53.2	46.3	TX7-M18	806848	TX7-M08	806834	7/8" x 1-1/8"	1/4"
103.3	93	91.1	82.0	93.3	83.9	74.5	67.0	TX7-M19m	806851	TX7-M09m	806837	22mm x 28mm	6mm
103.3	93	91.1	82.0	93.3	83.9	74.5	67.0	TX7-M19	806850	TX7-M09	806836	7/8" x 1-1/8"	1/4"

Selection Table R407C / R454C

Nominal Capacity (kW)				with MOP		without MOP		Connection	
R407C		R454C*		Type	Part No.	Type	Part No.	Inlet x Outlet	Equalizer
Normal Flow	Reverse Flow	Normal Flow	Reverse Flow						
28.9	28.6	22.5	22.3	TX7-N13m	806868	TX7-N03m	806853	12mm x 16mm	6mm
28.9	28.6	22.5	22.3	TX7-N13	806867	TX7-N03	806852	1/2" x 5/8"	1/4"
36	35.2	27.9	27.4	TX7-N14m	806870	TX7-N04m	806855	16mm x 22mm	6mm
36	35.2	27.9	27.4	TX7-N14	806869	TX7-N04	806854	5/8" x 7/8"	1/4"
44.1	42.7	34.2	33.2	TX7-N15m	806872	TX7-N05m	806857	16mm x 22mm	6mm
44.1	42.7	34.2	33.2	TX7-N15	806871	TX7-N05	806856	5/8" x 7/8"	1/4"
72.7	61.1	56.5	47.5	TX7-N16m	806874	TX7-N06m	806859	22mm x 28mm	6mm
72.7	61.1	56.5	47.5	TX7-N16	806873	TX7-N06	806858	7/8" x 1-1/8"	1/4"
89.7	73.5	69.7	57.1	TX7-N17m	806876	TX7-N07m	806861	22mm x 28mm	6mm
89.7	73.5	69.7	57.1	TX7-N17	806875	TX7-N07	806860	7/8" x 1-1/8"	1/4"
118.1	102.7	91.8	79.8	TX7-N18m	806878	TX7-N08m	806863	22mm x 28mm	6mm
118.1	102.7	91.8	79.8	TX7-N18	806877	TX7-N08	806862	7/8" x 1-1/8"	1/4"
165.4	148.9	128.6	115.7	TX7-N19m	806880	TX7-N09m	806865	22mm x 28mm	6mm
165.4	148.9	128.6	115.7	TX7-N19	806879	TX7-N09	806864	7/8" x 1-1/8"	1/4"

Note 1: *) Superheat readjustment required - see Operating Instruction

Note 2: Nominal conditions: Evaporating Temperature +4°C (dew point), Condensing Temperature +38°C (bubble point), Subcooling 1 K

Charge	Refrigerant	Recommended Evaporating Temperature Range	Maximum Bulb Temperature
M0	R134a, R450A, R513A, R1234yf	-25...+30°C	88°C
N0	R407C, R454C	-25...+20°C	71°C
M1 MOP 3.8 bar	R134a, R450A, R513A, R1234yf	-25...+10°C	120°C
N1 MOP 6.9 bar	R407C, R454C	-25...+14°C	120°C
Z1 MOP 12.1 bar	R410A/ R32, R452B, R454B	-25...+14°C	120°C

Thermo™-Expansion Valve Series T Exchangeable Power Assemblies and Orifices

Features

- Modular design for economical logistics and easy assembly and servicing
- Very good stability due to large diaphragm diameter
- Constant superheat across a wide application range
- Superior partial load performance due to double seat orifice design (TJRE, TERE, TIRE & THRE)
- Bi-flow capability for applications in heat pumps
- Capillary tube length 1.5 m (TCLE, TJRE) and 3m (TERE, TIRE & THRE)
- Max. allowable pressure PS:
 - 46 bar with XB power assembly
 - 31 bar with XC power assembly
- Medium Temperature range TS: -45...+75°C
- Flanges: brazing ODF/ODM connection



TCLE

Type Code Valve

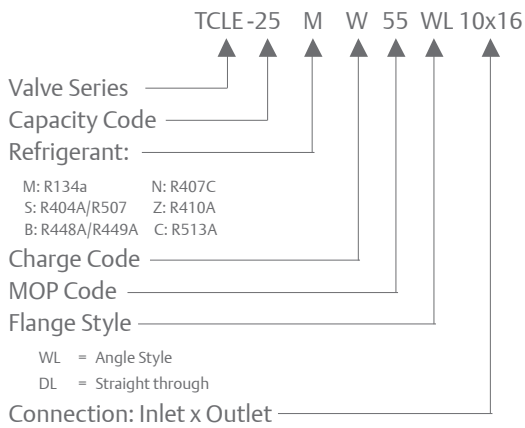

Type Code Power Element

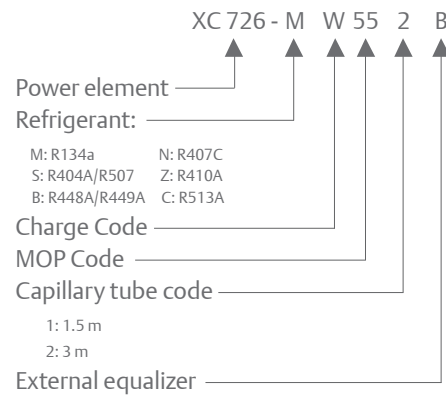

Nominal Capacities for Orifices

Valve Series	Type	Nominal Capacity (kW)					Type	Nominal Capacity (kW)		Orifice Type	Power Element Type
		R134a	R513A *	R450A *	R1234yf*	R1234ze *		R404A / R507	R452A *		
TCLE-	25MW	1.5	1.3	1.3	1.1	1.1	25SW	1.3	1.4	X22440-B1B	XB1019 ...1B
	75MW	2.9	2.6	2.5	2.1	2.2	75SW	2.6	2.8	X22440-B2B	
	150MW	6.1	5.5	5.4	4.4	4.8	150SW	5.6	6.0	X22440-B3B	
	200MW	9.3	8.3	8.1	6.6	7.2	200SW	8.4	9.0	X22440-B3,5B	
	250MW	13.5	12.1	11.8	9.6	10.5	250SW	12.2	13.1	X22440-B4B	
	350MW	17.3	15.5	15.1	12.4	13.4	400SW	15.7	16.8	X22440-B5B	
	550MW	23.6	21.2	20.7	17.0	18.4	600SW	21.5	23.0	X22440-B6B	
	750MW	32	28.7	28	22.9	24.8	850SW	29	31.1	X22440-B7B	
	900MW	37.2	33.4	32.6	26.7	28.9	1000SW	33.8	36.2	X22440-B8B	
TJRE-	11MW	45	40.5	39.6	32.3	35.1	12SW	40	43.9	X11873-B4B	XC726...2B
	13MW	57	51.7	50.5	41.3	44.7	14SW	51	56.0	X11873-B5B	
TERE-	16MW	71	63.5	62.1	50.7	55	18SW	63	68.9	X9117-B6B	
	19MW	81	72.6	70.9	58.0	62.9	20SW	72	78.7	X9117-B7B	
	25MW	112	99.8	97.5	79.7	86.4	27SW	99	108.3	X9117-B8B	
TIRE-	31MW	135	121.5	118.7	97.0	105.2	34SW	120	131.7	X9117-B9B	
	45MW	174	155.7	152.1	124.3	134.8	47SW	154	168.8	X9166-B10B	
THRE-	55MW	197	176.6	172.5	141.1	152.9	61SW	174	191.5	X9144-B11B	
	68MW	236	210.8	205.9	168.4	182.5	77SW	209	228.6	X9144-B13B	

Valve Series	Type	Nominal Capacity (kW)			Type	Nominal Capacity (kW)		Type	Nominal Capacity (kW)		Orifice Type	Power Element Type
		R134a	R513A *	R450A *		R404A / R507	R452A *		R404A / R507	R452A *		
TCLE-	55BW	1.9	1.9	1.8	50NW	2.1	1.6	50ZW	2.2	3.3	X22440-B1B	XB1019 ...1B
	100BW	3.7	3.6	3.5	100NW	4	3.0	100ZW	4.3	6.4	X22440-B2B	
	250BW	7.9	7.8	7.5	200NW	8.5	6.5	250ZW	9.2	13.7	X22440-B3B	
	350BW	11.9	11.7	11.3	300NW	12.9	9.7	400ZW	13.9	20.7	X22440-B3,5B	
	500BW	17.3	17.0	16.4	400NW	18.7	14.2	600ZW	20.2	30.0	X22440-B4B	
	650BW	22.1	21.8	21.0	550NW	24	18.2	750ZW	25.9	38.5	X22440-B5B	
	850BW	30.3	29.9	28.8	750NW	32.9	24.9	1000ZW	35.5	52.8	X22440-B6B	
	1150BW	41	40.4	38.9	1000NW	44.4	33.6	1400ZW	48	71.4	X22440-B7B	
	1350BW	47.7	47.0	45.3	1150NW	51.7	39.1	1600ZW	55.8	83.0	X22440-B8B	
TJRE-	17BW	57.8	57.0	54.9	14NW	62	47.4	19ZW	67.7	100.7	X11873-B4B	XC726...2B
	21BW	73.8	72.8	70.1	17NW	80	60.5	25ZW	86.4	128.5	X11873-B5B	
TERE-	26BW	90.7	89.5	86.2	21NW	99	74.4	-	-	-	X9117-B6B	
	30BW	103.7	102.3	98.5	25NW	112	85.1	-	-	-	X9117-B7B	
	41BW	142.6	140.6	135.4	33NW	155	117.0	-	-	-	X9117-B8B	
TIRE-	50BW	173.5	171.1	164.8	42NW	188	142.3	-	-	-	X9117-B9B	
	64BW	222.4	219.3	211.2	52NW	241	182.4	-	-	-	X9166-B10B	
THRE-	72BW	252.3	248.8	239.6	71NW	273	207.0	-	-	-	X9144-B11B	
	86BW	301.1	297.0	286.0	94NW	327	247.0	-	-	-	X9144-B13B	

Note 1: Nominal conditions: Evaporating Temperature +4°C (dew point), Condensing Temperature +38°C (bubble point), Subcooling 1 K

Note 2: *) Superheat readjustment required - see Operating Instruction

Note 3: For selection of other operation conditions, please use the "Controls Navigator" selection tool.

Selection Table Power Element and Recommended Flanges

Valve Series	Orifice Type	Angle Style Type	Straight Through Type	Connection (inlet x Outlet)		Power Element Type
				Metric	Imperial	
TCLC	X22440-B1B / B2B/ B3B / B3.5B / B4B	C501-5	9761-3	-	3/8"x5/8" ODF	XB1019...1B
		C501-5mm	9761-3mm	10x16 mm ODF	-	
	X22440-B5B / B6B	C501-7	9761-4	-	1/2"x5/8" ODF	
		C501-7mm	9761-4mm	12x16 mm ODF	-	
	X22440-B7B / B8B	-	6346-17	16x22 mm ODF	5/8"x7/8" ODF	
		A576	-	-	5/8"x7/8" ODF 7/8"x1-1/8" ODM	
A576-mm		-	16x22 mm ODF 22x28 mm ODM	-		
TJRE	X11873-B4B / B5B	10331	10332	22x22 mm ODF	7/8"x7/8" ODF 1-1/8"x1-1/8" ODM	
TERE	X9117-B6B / B7B / B8B / B9B	9153 9153-mm	9152 9152-mm	22x22 mm ODF 22x28 mm ODM	7/8"x7/8" ODF 1-1/8"x1-1/8" ODM	XC726...2B
TIRE						
THRE	X9144-B11B / B13B	9149	9148	22x22 mm ODF	7/8"x7/8" ODF 1-1/8"x1-1/8" ODM	

MOP Charges T-Series

MOP		Evaporating Temperature Range				
Code	bar	R134a MW	R404A/ R507 SW	R407C NW	R410A ZW	R448A/ R449A BW
15	1.0	-45...-16°C				
30	2.1					-45...-18°C
35	2.4	-45...0°C				
40	2.8		-45...-18°C			
55	3.8	-45...+11°C	-45...-10°C			
75	5.2		-45...-2°C			
80	5.5		-45...0°C			
100	6.9			-45...+14°C		
175	12.1				-45...+16°C	

Accessories and Spare Parts

Description	Type	Part No.
Service Tool for T, ZZ, L and 935 Series valves	X 99999	800005
Gasket sets for T, ZZ, L and 935 Series valves	X 13455-1	027579
Steel Screws for flange types: C501, 9761, 6346, A576	Screw ST 32	803573
Steel Screws for flange types: 9148, 9149, 9152, 9153, 10331, 10332	Screw ST 48	803574
Bulb clamp for XB1019	XA 1728-4	803260
Bulb clamp for XC726	XA 1728-5	803261

Thermo™ - Expansion Valve Series ZZ for Low Evaporating Temperatures Between -45 and -100°C

Features

- Modular design for economical logistics and easy assembly and servicing
- Very good stability due to large diaphragm diameter
- High-quality materials and processes for high reliability and long lifetime
- To withstand stress at extremely low temperatures, ZZ-Series valves feature bronze bolts.
- Max. allowable pressure PS:
- 31 bar with XC power assembly



Type Code Valve

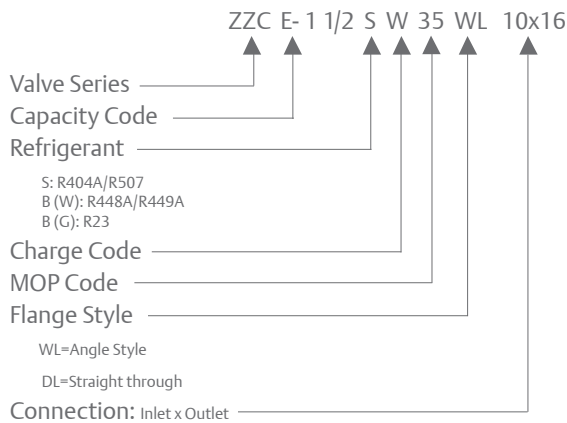

Type Code Power Element

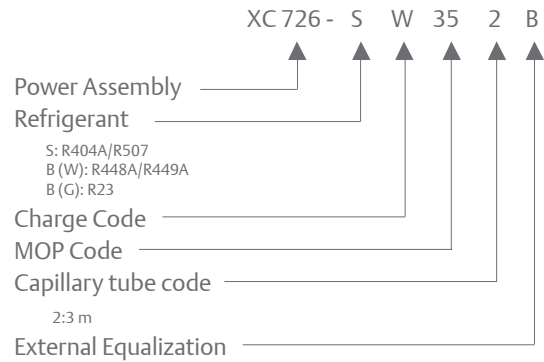

Selection Table

Valve Series	Type	Nominal Capacity (kW)	Type	Nominal Capacity (kW)		Type	Nominal Capacity (kW)			Orifice	Power Assembly
				R404A / R507	R452A		R448A / R449A	R454A	R455A		
ZZCE	2BG	1.9	2/4SW	1.2	1.3	1BW	1.7	1.7	1.6	X10-B01	XC726...2B
	6BG	4	1-1/2SW	2.6	2.8	2BW	3.7	3.7	3.4	X10-B02	
	8BG	6.8	2-1/2SW	4.4	4.6	3BW	6.2	6.2	5.7	X10-B03	
	12BG	10.8	3-1/2SW	7	7.4	5BW	9.8	9.8	9.1	X10-B04	
	17BG	16.3	5SW	10.6	11.1	6BW	14.8	14.8	13.7	X10-B05	
	25BG	21.7	8SW	14.1	14.8	10BW	19.8	19.8	18.2	X10-B06	
	31BG	27.1	9SW	17.6	18.5	12BW	24.7	24.7	22.8	X10-B07	

Note 1: Nominal conditions:

R23: Evaporating Temperature -60°C, Condensing Temperature -25°C, Subcooling 1 K

Other refrigerants: Evaporating Temperature -40°C (dew point), Condensing Temperature 25°C (bubble point), Subcooling 1 K "

Note 2: Attention - To withstand stress at extremely low temperatures, ZZ-Series valves feature bronze bolts. Please order separately Screw BZ 32 Part No. 803575

Selection table Power Element and Recommended Flanges

Valve Series	Orifice type	Connection Standard Flange, Angle Style		Connection (inlet x outlet)		Power Element Type
		Type	Type	Metric	Imperial	
ZZCE	X 10-B01/ B02/ B03	C501-5mm		10 X 16 mm ODF		XC726 ... 2B
			C501-5		3/8" X 5/8 ODF	
	X 10-B04/ B05	C501-7 mm		12x16 mm ODF		
			C501-7		1/2" x 5/8" ODF -	
	X 10-B04/ B05	A 576 mm		16x22 mm ODF		
			A 576	22x28 mm ODM	5/8" x 7/8" ODF	

MOP Charges ZZ-Series

MOP Code	MOP		Evaporating Temperature Range		
	bar	Tmax	R23	R404A/R507/R452A	R448A/ R449A/R545A/R455A
20	1.4	-66°C	-100 ... -71°C		
35	2.1	-14°C			-75 ... -18°C
40	2.8	-14°C		-75 ... -18°C	
55	3.8	-7°C		-75 ... -10°C	
60	4.1	-48°C	-100 ... -51°C		
125	8.6	-32°C	-100 ... -35°C		

Accessories and Spare Parts

Description	Type	Part No.
Service Tool for T, ZZ, L and 935 Series valves	X 99999	800005
Gasket sets for T, ZZ, L and 935 Series valves	X 13455-1	027579
Bronze screw for Flange types: C500, C501, 9761, X6346, X6669, A576	Screw BZ 32	803575
Bulb clamp for XC726	XA 1728-5	803261

Thermo™-Expansion Valves L-Series Exchangeable Power Assemblies and Orifices

Features

- Applications for Series L valves include superheat control (desuperheating of suction gas i.e., in hotgas bypass systems and interstage cooling in multiple stage compressors)
- Modular design for economical logistics and easy assembly and servicing
- Very good stability is attained because of the large forces generated by the large diaphragm diameter
- High-quality materials and processes for high reliability and long lifetime
- Superior partial load performance due to seat orifice design (LJRE, LERE & LIRE)
- Max. allowable pressure PS
 - 46 bar with XB power assembly
 - 31 bar with XC power assembly.
- Medium Temperature Range TS: -45...+65°C



Type Code Valve

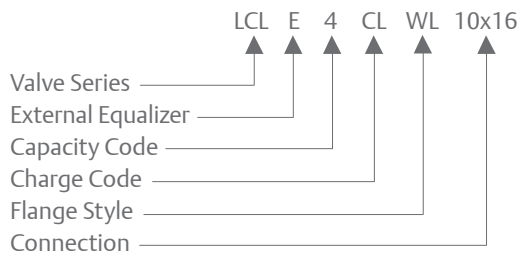

Type Code Power Assembly

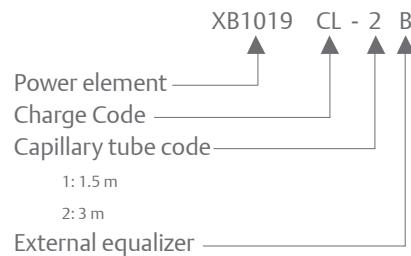

Nominal Capacities for Cages

Valve Series	Capacity Code *	Nominal Capacity Q _n (kW)														Orifice Type	Power Assembly Type	
		R134a	R404A / R507	R407C	R448A / R449A	R450A	R513A	R448A	R449A	R410A	R32	R454A	R454C	R1234yf	R1234ze			R455A
LCLE	1 *	1.5	1.3	2.1	1.9	1.3	1.3	1.9	1.9	2.2	3.3	1.9	1.6	1.1	1.1	1.8	X 22440-B1B	XB1019 ...1B
	2 *	2.9	2.6	4	3.7	2.5	2.6	3.7	3.6	4.3	6.4	3.6	3.0	2.1	2.2	3.5	X 22440-B2B	
	3 *	6.1	5.6	8.5	7.9	5.4	5.5	7.9	7.7	9.2	13.7	7.8	6.5	4.4	4.8	7.5	X 22440-B3B	
	3.5 *	9.3	8.4	12.9	11.9	8.1	8.3	11.9	11.6	13.9	20.7	11.7	9.7	6.6	7.2	11.3	X 22440-B3.5B	
	4 *	13.5	12.2	18.7	17.3	11.8	12.1	17.3	16.9	20.2	30.0	17.0	14.2	9.6	10.5	16.4	X 22440-B4B	
	6 *	17.3	15.7	24	22.1	15.1	15.5	22.1	21.6	25.9	38.5	21.8	18.2	12.4	13.4	21.0	X 22440-B5B	
	7 *	23.6	21.5	32.9	30.3	20.7	21.2	30.3	29.6	35.5	52.8	29.9	24.9	17.0	18.4	28.8	X 22440-B6B	
	9 *	32	29	44.4	41	28	28.7	41.0	40.0	48.0	71.4	40.4	33.6	22.9	24.8	38.9	X 22440-B7B	
LJRE-	10 *	37.2	33.8	51.7	47.7	32.6	33.4	47.7	46.6	55.8	83.0	47.0	39.1	26.7	28.9	45.3	X 22440-B8B	XB1019 ...1B
	11 *	45	40	62	58	40	40	57.8	56.5	67.7	100.7	57.0	47.4	32.3	35.1	54.9	X 11873-B4B	
LERE	12 *	57	51	80	74	50	52	73.8	72.1	86.4	128.5	72.8	60.5	41.3	44.7	70.1	X 11873-B5B	XC726...2B
	13 *	71	63	99	91	62	64	90.7	88.6	-	-	89.5	74.4	50.7	55.0	86.2	X 9117-B6B	
	14 *	81	72	112	104	71	73	103.7	101.3	-	-	102.3	85.1	58.0	62.9	98.5	X 9117-B7B	
	15 *	112	99	155	143	98	100	142.6	139.3	-	-	140.6	117.0	79.7	86.4	135.4	X 9117-B8B	
LIRE-	16 *	135	120	188	174	119	121	173.5	169.5	-	-	171.1	142.3	97.0	105.2	164.8	X 9117-B9B	XC726...2B
	17 *	174	154	241	222	152	156	222.4	217.2	-	-	219.3	182.4	124.3	134.8	211.2	X 9166-B10B	

Note 1: Nominal conditions: Evaporating Temperature +4°C (dew point), Condensing Temperature +38°C (bubble point), Subcooling 1 K

Note 2: For selection of other operating conditions, please use "Controls Navigator" selection program.

Note 3: *) Please indicate designation character for desired superheat.

Selection Table Power Assembly and Recommended Flanges

Valve Series	Orifice Type	Connection Standard Flange, Angle Style		Connection (Inlet x Outlet)		Power Element Type
		Type	Type	Metric	Imperial	
LCLE	X22440-B1B / B2B / B3B / B3.5B / B4B		C501-5	-	3/8" x 5/8" ODF	XB1019...1B
		C501-5mm		10x16 mm ODF		
	X22440-B5B / B6B		C501-7		1/2" x 5/8" ODF	
		C501-7mm		12x16 mm ODF		
			A576		5/8" x 7/8" ODF 7/8" x 1 1/8" ODF	
A576-mm		16x22 mm ODF 22x28 mm ODM	-			
LJRE	X11873-B4B / B5B	10331	10331	22x22 mm ODF	7/8" x 7/8" ODF 1 1/8" x 1 1/8" ODM	XC726...2B
LERE/ LIRE	X9117-B6B / B7B / B8B / B9B / B10B		9153	-	7/8" x 7/8" ODF 1 1/8" x 1 1/8" ODM	
		9153-mm		22x22 mm ODF 22x28 mm ODM		

Suction Gas Superheat Selection:

* Charge Code	Refrigerant												
	R134a	R404A / R507	R407C	R410A	R448A / R449A	R450A	R513A	R454A	R454C	R1234yf	R1234ze	R32	R455A
CL	-	22K	13K	30K	17K	-	-	19K	13K	-	-	31K	15K
GL	14K	-	25K	-	30K	10K	17K	32K	27K	16K	-	-	28K
UL	30K	-	-	-	-	26K	-	-	-	-	22K	-	-

Note: *) Please Indicate Designation Character for Desired Superheat.

Accessories and Spare Parts

Description	Type	Part No.
Service Tool for T, ZZ, L and 935 Series valves	X 99999	027 579
Gasket sets for T, ZZ, L and 935 Series valves	X 13455 -1	800 005
Gasket sets for T, ZZ, L and 935 Series valves Steel Screws for flange types: C500, C501, 9761, X6346, X6669, A576	Screw ST 32	803 573
Steel Screws for flange types: 9148, 9149, 9152, 9153, 10331, 10332	Screw ST 48	803 574
Bulb clamp for XB1019	XA 1728-4	803260
Bulb clamp for XC726	XA 1728-5	803261

Liquid Injection Valves Series 935

Exchangeable Power Assemblies and Orifices

Features

- Modular design for economical logistics and easy assembly and servicing
- Very good stability is attained because of the large forces generated by the large diaphragm diameter
- High-quality materials and processes for high reliability and long lifetime
- Combinations of different charges with various orifice springs cover a very large application range
- Max. allowable pressure PS:
 - 46 bar with XB power assembly
- Medium Temperature Range TS: -45...+65°C



Type Code Valve

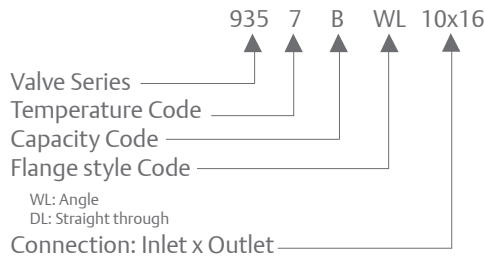

Type Code Power Assembly

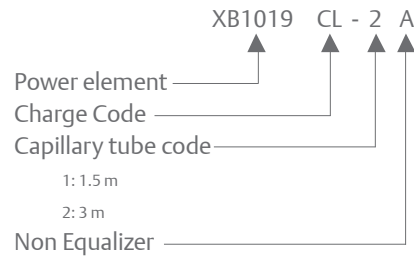

Nominal Capacities for Cages

Valve Series	Capacity code*	Nominal Capacity Q _n (kW)														Orifice Type	Power Element Type
		R134a	R32	R404A/R507	R407C	R410A	R448A/R449A	R450A	R454A	R454C	R455A	R513A	R452a	R1234yf	R1234ze		
935- *-	A	4.0	9.0	3.8	5.6	6.1	5.2	3.5	5.1	4.3	4.9	3.6	3.9	2.9	3.1	X10-**01	XB1019 - *** - 2A
	B	7.8	17.5	7.4	10.9	11.8	10.1	6.9	9.9	8.3	9.6	7.1	7.6	5.6	6.1	X10-**02	
	C	11.1	24.7	10.3	15.4	16.6	14.2	9.7	14.0	11.6	13.4	9.9	10.8	7.9	8.6	X10-**03	
	D	16.3	36.6	15.6	22.8	24.6	21.0	14.4	20.7	17.3	20	14.7	16.0	11.8	12.8	X10-**04	
	E	22.5	50.2	21.0	31.2	33.7	28.8	19.7	28.4	23.6	27.4	20.2	21.9	16.1	17.5	X10-**05	
	G	32.0	71.5	29.9	44.5	48.1	41.1	28.1	40.5	33.7	39.0	28.8	31.2	23.0	24.9	X10-**06	
	X	46.6	104.2	43.5	64.9	70.0	59.8	40.9	59.0	49.1	56.8	41.9	45.4	33.5	36.3	X10-**07	

*) Temperature Code	Temperature Range	**) Spring code	***) Charge code
3	-1 ... +17°C	B	UL
6	+14 ... +38°C	C	KL
105	+44 ... +70°C	C	YL
106	+66 ... +94°C	C	JL
100	+94 ... +121°C	C	LL

Note: Nominal conditions: Evaporating Temperature +4°C (dew point), Condensing Temperature +38°C (bubble point), Subcooling 1 K
For selection of other operating conditions, please use "Controls Navigator" selection program.

Selection Table Power Assembly and Recommended Flanges

Valve Series	Orifice Type	Connection Standard Flange, Angle Style		Connection (inlet x outlet)		Power Element Type
		Type	Type	Metric	Imperial	
935	X 10-*01/ *02/ *03	C501-5 mm		10 X 16 mm ODF		XB1019-***-2A
			C501-5		3/8" X 5/8 ODF	
	X 10-*04/ *05	C501-7 mm		12x16 mm ODF		
			C501-7		1/2"x5/8" ODF -	
	X 10-*06/ *07	A 576 mm		16x22 mm ODF 22x28 mm ODM		
			A 576		5/8"x7/8" ODF 7/8"x1-1/8" ODM	

Accessories and Spare Parts

Description	Type	Part No.
Service Tool for T, ZZ, L and 935 Series valves	X 99999	800005
Gasket sets for T, ZZ, L and 935 Series valves	X 13455-1	027579
Steel Screws for flange types: C500, C501, 9761, X6346, X6669, A576	Screw ST 32	803573
Bulb clamp for XB1019	XA 1728-4	803260



Overview Flange for Take Apart Valves

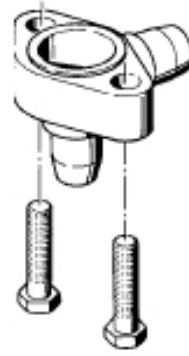

Angle Style Flange
(WL)

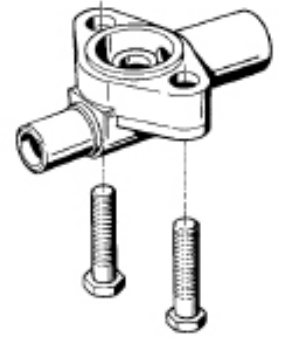

Straight Through Flange
(DL)

Flanges: T- / L-Series								
Valve Series	Orifice Type	Angle Style		Straight Through		Connection (Inlet x Outlet)		
		Type	Part No.	Type	Part No.	Metric	Imperial	
TCLE / LCLE	X22440-B1B / B2B / B3B / B3.5B / B4B	C501-5	803232	9761-3	803240	-	3/8"x5/8" ODF	
		C501-5mm	803233	9761-3mm	803241	10x16mm ODF		
	X22440-B5B / B6B	C501-7	803234	9761-4	803350		1/2"x5/8" ODF	
		C501-7mm	803235	9761-4mm	803243	12x16mm ODF	-	
	X22440-B7B / B8B	-	-	-	6346-17	803330	16x22mm ODF	5/8"x7/8" ODF
		A576	803238	-	-	-	-	5/8"x7/8" ODF 7/8"x1-1/8" ODM
A576-mm		803239	-	-	-	16x22mm ODF 22x28mm ODM	-	
TJRE / LJRE	X11873-B4B / B5B	10331	803338	10332	803324	22x22mm ODF	7/8"x7/8" ODF 1-1/8"x1-1/8" ODM	
TERE/ TIRE LERE/ LIRE	X9117-B6B / B7B / B8B / B9B / X9166-B10B	9153	803244	9152	803286	-	7/8"x7/8" ODF 1-1/8"x1-1/8" ODM	
		9153-mm	803245	9152-mm	803287	22x22mm ODF 28x28mm ODM		
THRE	X9144-B11B / B13B	9149	803284	9148	803283	22x22mm ODF	7/8"x7/8" ODF 1-1/8"x1-1/8" ODM	

Flanges: 935- / ZZ-Series								
Valve Series	Orifice Type	Angle Style		Straight Through		Connection (Inlet x Outlet)		
		Type	Part No.	Type	Part No.	Metric	Imperial	
935 / ZZ	X10-*01 / *02 / *03	C501-5	803232	9761-3	803240	-	3/8"x5/8" ODF	
		C501-5mm	803233	9761-3mm	803241	10x16mm ODF		
	X10-*04 / *05	C501-7	803234	9761-4	803350		1/2"x5/8" ODF	
		C501-7mm	803235	9761-4mm	803243	12x16mm ODF	-	
	X10-*06 / *07	-	-	-	6346-17	803330	16x22mm ODF	5/8"x7/8" ODF
		A576	803238	-	-	-	-	5/8"x7/8" ODF 7/8"x1-1/8" ODM
A576-mm		803239	-	-	-	16x22mm ODF 22x28mm ODM	-	





Solenoid Valves

Basic Terms and Technical Information Operating Principles

Directly actuated: The magnetic field of the solenoid coil forces a movement of the plunger and thus causes the opening of the valve seat.

Servo actuated: The magnetic field of the solenoid coil is only utilized for the opening of the pilot valve seat. The necessary energy to actuate the piston or diaphragm of the main valve seat is provided by the refrigerant flow and results in a certain pressure drop.

Minimum Pressure Drop

Directly actuated solenoid valves do not require a minimum pressure drop for proper operation.

Servo operated solenoid valves require a minimum pressure drop of approximately 0.05 bar to remain fully open. In case of insufficient refrigerant flow, this value will not be reached and the solenoid valve may close unintentionally. These closures may lead to malfunctions and oscillations in the refrigeration circuit. Improper sizing of solenoid valves (i.e., use of excessively large solenoid valves) is the main cause of this effect. This is particularly important in capacity controlled refrigeration circuits.

Therefore the decisive factor for proper solenoid valve sizing is the respective capacity of the valve and not its connection size.

Formula for calculating the actual pressure drop of a solenoid valve:

$$\Delta_{p1} = \Delta_{p2} \times (Q_{n1}/Q_{n2})^2$$

- Δ_{p1} : Actual pressure drop
- Δ_{p2} : Nominal pressure drop at Q_{n1}
- Q_{n1} : Calculated nominal capacity
- Q_{n2} : Nominal capacity of selected valve

Maximum Operating Pressure Differential (MOPD)

MOPD is the maximum pressure differential between inlet and outlet of the solenoid valve which permits proper opening of the valve. When used with Alco AC solenoid coils all Alco solenoid valves employ 25 bar MOPD.

Operation in conjunction with DC solenoid coils lead to reduced MOPD values depending on valve type and size. The DS2 Chopper Plugs allow the use of 24VAC coils with 24VDC by converting the DC in an AC voltage. Please contact Emerson application engineering for additional details.

Type Code

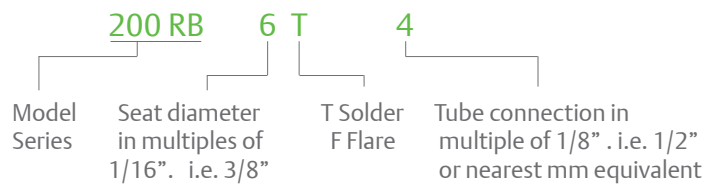

Selection Guide for Solenoid Valves

Selection Criteria	Series						
	110 RB	200 RB / 200 RH	240 RA		540 RA		M36
			8/9/12/16T9	16T11/20	8/9/12/16	20	
2-Way	+	+	+	+	+	+	
3-Way							+
Normally Closed (NC)	+	+	+	+			
Normally Open (NO)					+	+	
Min. Pressure Differential (bar)	0.00	0.05	0.05	0.05	0.05	0.05	
MWP (bar)	31	31 / 60	31	31	31	28	35
Media Temp. Range (°C)	-40 / +120	-40 / +120	-40 / +120	-40 / +120	-40 / +120	-40 / +120	-40 / +120
Coil Type	ESC	ESC	ESC	ESC	ESC	ESC	ESC



Coils ESC and Cable Assemblies

Standards

- ESC Coils and cable assemblies conform to Low Voltage Directive

Type	Part No.	Voltage	Power Input	Electr. Connection	Protection
ESC 230V / 50 (60) Hz	801031	AC	8 W	without plug see cable assemblies	IP65 with plug / cable assembly
ESC 120V / 50 (60) Hz	801032				
ESC 24V / 50 (60) Hz	801033				
ESC 24V DC	801030	DC	15 W		
DS2-N15 + ESC 24VAC	804620 + 801033	DC	3 W	with plug and cable assembly	IP65

Note: Coils are delivered with retainer kit. Please order cable assemblies separately.



ESC

Cable Assemblies for ESC Coils

Type	Part No.	Temperature Range	Cable Length	Wire Diameter	Connector Type
ASC-N15	804 570	-50 .. +80°C for stationary use only	1.5m	3 x 0.75 mm ²	loose wires
ASC-N30	804 571		3.0m		
ASC-N60	804 572		6.0m		

Note: Special cables for A2L applications. Check Technical Bulletin for details.



ASC-N15

Cable Assembly With 24V DC Chopper Plug

- Enables standard 24V AC Coil to be used for DC applications
- Low power assumption (3W only)
- No MOPD degradation

Type	Part No.	Temperature Range	Cable Length	Wire Diameter	Connector Type
DS2-N15	804 620	-25 .. +80°C	1.5 m	2 x 0.75 mm ²	loose wires



D2-N15

Other Accessories

Type	Part No.	Description
ESC-K01	801 034	Screw cap (incl. 2x O-ring & fixing retainer)
PG9 Plug	801 012	Plug according to EN 175301 with cable gland PG 9
PG11 Plug	801 013	Plug according to EN 175301 with cable gland PG 11

2-Way Solenoid Valves Series 110, 200, 240

Normally Closed

Features

- Compact size
- No disassembly necessary for soldering

Standards

- 240 RA 16T11 and 20 are CE marked per PED

Accessories

- Actuation coil and cable assemblies available for various voltages, see 'Coils ESC and Cable Assemblies'



Capacity Data

Type	Nominal Capacity (kW)														Kv-Value m ³ /h	Δp Min bar
	Liquid															
	R134a	R22	R404A R507	R407C	R450A	R452A	R454A	R454C	R455A	R513A	R1234yf	R1234ze	R448A	R449A		
110 RB 2	3.5	3.8	2.5	3.6	3.3	2.5	3.2	2.8	3	3.1	2.6	3.2	3.3	3.2	0.2	0.05
200 RB 3	6.6	7.1	4.6	6.8	6.1	4.7	5.9	5.2	5.6	5.8	4.8	5.9	6.1	6.0	0.4	
200 RB 4	15.5	16.8	10.9	16.1	14.5	11.0	14.0	12.4	13.1	13.8	11.4	13.9	14.5	14.2	0.9	
200 RB 6	27.3	29.5	18.9	28.0	25.4	19.4	24.6	21.8	23.1	24.2	20	24.5	25.5	25.0	1.6	
240 RA 8	36.3	39.3	25.2	37.3	33.8	25.8	32.7	29	30.7	32.2	26.6	32.6	34.0	33.3	2.3	
240 RA 9	76.2	82.5	52.9	78.4	71.0	54.2	68.7	60.9	64.5	67.7	55.9	68.5	71.3	69.8	4.8	
240 RA 12	85.7	92.8	59.5	88.1	79.9	61.0	77.3	68.6	72.5	76.1	62.9	77	80.2	78.6	5.4	
240 RA 16	139.1	150.5	96.5	142.9	129.5	98.9	-	-	-	123.5	-	124.9	130.1	127.4	8.8	
240 RA 20	202.6	219.3	140.7	208.3	188.7	144.1	-	-	-	179.9	-	182	189.6	185.7	12.8	

Type	Nominal Capacity (kW)														Kv-Value m ³ /h	Δp Min bar
	Hot Gas															
	R134a	R22	R404A R507	R407C	R450A	R452A	R454A	R454C	R455A	R513A	R1234yf	R1234ze	R448A	R449A		
110 RB 2	1.6	2.0	1.7	2.1	1.4	111.8	2.0	1.8	2.0	1.5	1.3	1.3	2.0	2.0	0.2	0.05
200 RB 3	3.0	3.7	3.2	3.9	2.9	76.9	4.1	3.6	3.9	3.0	2.6	2.6	4.0	4.0	0.4	
200 RB 4	7.1	8.8	7.5	9.2	6.5	47.2	9.2	8.1	8.8	6.8	5.9	5.8	9.1	9.0	0.9	
200 RB 6	12.5	15.4	13.1	16.1	11.6	41.9	16.4	14.3	15.7	12.1	10.5	10.4	16.2	15.9	1.6	
240 RA 8	16.7	20.5	17.4	21.4	16.6	20.1	23.5	20.6	22.5	17.3	15.1	14.9	23.2	22.9	2.3	
240 RA 9	35.1	43.1	36.5	44.9	34.7	14.0	49.1	43.0	47.0	36.2	31.4	31.1	48.5	47.8	4.8	
240 RA 12	39.4	48.4	41.1	50.5	39.0	7.9	55.2	48.4	52.8	40.7	35.4	35.0	54.5	53.8	5.4	
240 RA 16	64.0	78.5	66.6	81.9	63.5	3.5	-	-	-	66.3	-	57.0	88.9	87.6	8.8	
240 RA 20	93.2	114.4	97.1	119.3	92.4	1.7	-	-	-	96.4	-	82.9	129.3	127.5	12.8	

Type	Nominal Capacity Q _n (kW)														Kv-Value m ³ /h	Δp Min bar
	Suction Gas															
	R134a	R22	R404A R507	R407C	R450A	R452A	R454A	R454C	R455A	R513A	R1234yf	R1234ze	R448A	R449A		
240 RA 8	4.2	5.6	4.6	5.2	3.7	22.1	5.3	4.5	4.8	4.0	3.6	3.4	5.1	5.0	2.3	0.05
240 RA 9	8.8	11.7	9.7	10.9	7.8	15.2	11.2	9.4	9.9	8.4	7.6	7.1	10.6	10.5	4.8	
240 RA 12	9.9	13.1	10.9	12.3	8.8	9.3	12.5	10.6	11.2	9.4	8.5	8.0	11.9	11.8	5.4	
240 RA 16	16.0	21.3	17.7	19.9	14.3	8.3	-	-	-	15.3	-	13.1	19.4	19.2	8.8	
240 RA 20	33.0	31.0	25.7	29.0	20.8	4.0	-	-	-	22.3	-	19.0	28.3	27.9	12.8	

Note1: Nominal capacities at +38°C Condensing Temperature, +4°C Evaporating Temperature, Subcooling 1 K, Superheat 0K. 0.15 bar pressure drop between valve inlet and outlet in liquid applications. 1 bar pressure drop for hot gas applications. +18 °C Suction Gas temperature.

Note2: For selection of other operating conditions, please use "Controls Navigator" selection program.

Selection Guide

Type		Part No.	Connection Solder / ODF	
			mm	Inch
110 RB 2	T2	801 217	6	
	T2	801 210		1/4
	T3	801 209	10	
200 RB 3	T3	801 239	10	
200 RB 4	T3	801 176	10	
	T3	801 190		3/8
	T4	801 178	12	
	T4	801 179		1/2
200 RB 6	T4	801 182	12	
	T4	801 183		1/2
	T5	801 186	16	5/8
240 RA 8	T5	801 160		5/8
	T7	801 143	22	7/8
240 RA 9	T5	801 161	16	5/8
	T7	801 162	22	7/8
	T9	801 142		1-1/8
240 RA 12	T7	801 163	22	7/8
	T9	801 144		1 1/8
240 RA 16	T9	801 164		1 1/8
	T11	801 166	35	1 3/8
240 RA 20	T11-M	801 172	35	1 3/8
	T13-M	801 224	42	
	T13-M	801 173		1 5/8
	T17-M	801 174	54	2 1/8

Special Versions:

- Manual stems standard on Series 240 RA 20.

Options:

- Actuation coils available for various voltages, see 'Coils ESC and Cable Assemblies'

2-Way Solenoid Valves Series 540

Normally Open

Features

- Compact size
- No disassembly necessary for soldering



540 RA

Accessories

- Actuation coil and cable assemblies available for various voltages, see 'Coils ESC and Cable Assemblies'

Capacity Data

Type	Nominal Capacity Q_n (kW)									Kv-Value m ³ /h	Δp Min bar
	Liquid										
	R134a	R22	R404A R507	R407C	R450A	R513A	R448A	R449A	R452A		
540 RA 8	36.3	39.3	25.2	37.3	33.8	32.2	34	33.3	25.8	2.3	0.05
540 RA 9	76.2	82.5	52.9	78.4	71	67.7	w71.3	69.8	54.2	4.8	
540 RA 12	85.7	92.8	59.5	88.1	79.9	76.1	80.2	78.6	61.0	5.4	
540 RA 16	139.1	150.5	96.5	142.9	129.5	123.5	130.1	127.4	98.9	8.8	
540 RA 20	202.6	219.3	140.7	208.3	188.7	179.9	189.6	185.7	144.1	12.8	

Type	Nominal Capacity Q_n (kW)									Kv-Value m ³ /h	Δp Min bar
	Hot Gas										
	R134a	R22	R404A R507	R407C	R450A	R513A	R448A	R449A	R452A		
540 RA 8	16.7	20.5	17.4	21.4	16.6	17.3	23.2	22.9	20.1	2.3	0.05
540 RA 9	35.1	43.1	36.5	44.9	34.7	36.2	48.5	47.8	41.9	4.8	
540 RA 12	39.4	48.4	41.1	50.5	39.0	40.7	54.5	53.8	47.2	5.4	
540 RA 16	64.0	78.5	66.6	81.9	63.5	66.3	88.9	87.6	76.9	8.8	
540 RA 20	93.2	114.4	97.1	119.3	92.4	96.4	129.3	127.5	111.8	12.8	

Type	Nominal Capacity Q_n (kW)									Kv-Value m ³ /h	Δp Min bar
	Suction Gas										
	R134a	R22	R404A R507	R407C	R450A	R513A	R448A	R449A	R452A		
540 RA 8	4.2	5.6	4.6	5.2	3.7	4.0	5.1	5.0	4.0	2.3	0.05
540 RA 9	8.8	11.7	9.7	10.9	7.8	8.4	10.6	10.5	8.3	4.8	
540 RA 12	9.9	13.1	10.9	12.3	8.8	9.4	11.9	11.8	9.3	5.4	
540 RA 16	16.0	21.3	17.7	19.9	14.3	15.3	19.4	19.2	15.2	8.8	
540 RA 20	23.3	31.0	25.7	29.0	20.8	22.3	28.3	27.9	22.1	12.8	

Type	Nominal Capacity Q_n (kW)															Kv-Value m ³ /h	Δp Min bar
	Liquid					Hot Gas					Suction Gas						
	R454A	R454C	R1234yf	R1234ze	R455A	R454A	R454C	R1234yf	R1234ze	R455A	R454A	R454C	R1234yf	R1234ze	R455A		
540 RA 8	32.7	29	26.6	32.6	30.7	23.5	20.6	15.1	14.9	22.5	5.3	4.5	3.6	3.4	4.8	2.3	0.05
540 RA 9	68.7	60.9	55.9	68.5	64.5	49.1	43.0	31.4	31.1	47.0	11.2	9.4	7.6	7.1	9.9	4.8	0.05
540 RA 12	77.3	68.6	62.9	77	72.5	55.2	48.4	35.4	35.0	52.8	12.5	10.6	8.5	8.0	11.2	5.4	0.05
540 RA 16	-	-	-	124.9	-	-	-	-	57.0	-	-	-	-	13.1	-	8.8	0.05
540 RA 20	-	-	-	182	-	-	-	-	82.9	-	-	-	-	19.0	-	12.8	0.05

Note 1: Nominal Capacities at +38°C Condensing Temperature. +4°C Evaporating Temperature. 0.15 Bar Pressure Drop Between Valve inlet and Outlet in Liquid Applications (For Hot Gas Applications 1 Bar Pressure Drop and +18 °C Suction Gas Temperature); Subcooling 1 K.

Note 2: For selection of other operating condition, please use Controls Navigator selection program.

Selection Guide

Type		Part No.	Connection Solder / ODF	
			mm	Inch
540 RA 8	T5	046 265		5/8
540 RA 9	T5	046 266		5/8
	T7	046 268	22	7/8
540 RA 12	T7	046 269	22	7/8
540 RA 16	T9	046 270		1 1/8
540 RA 20	T11	047 953	35	1 3/8

Options:

- Actuation coils available for various voltages, see 'Coils ESC and Cable Assemblies'

Accessories and Spare Parts for Solenoid Valves

Gasket Kits

Description	Type	Part No.
110RB	KS 30040-2	801 232
200RB/200RH	KS 30039-1	801 233
240RA8	KS 30061-1	801 234
240RA9/12	KS 30062-1	801 235
240RA16	KS 30065-1	801 236
240RA20	KS 30097-1	801 237

Description	Type	Part No.
Service tool for 110 RB, 240 RA, 540 RA	X 11981 - 1	027 451

Repair Kits

Description	Type	Part No.
110RB	KS 30040-1	801 206
200RB	KS 30039/ KS 30109	801 205
240RA8	KS 30061	801 262
240RA9	KS 30062	801 263
240RA12	KS 30063	801 264
240RA16	KS 30065	801 200
240RA20	KS 30097	801 216

2-Way Solenoid Valves Series 200 RH for High Pressure Applications

Normally Closed

Features

- Compact size
- Media Temperature Range -40 ... +120 °C
- No disassembly necessary for soldering
- Extended copper tubes for easy installation
- No disassembly necessary for brazing
- IP 65 Solenoid coil and cable assembly
- One coil fits to all sizes and valve series
- Max. allowable pressure PS: 60 bar



Accessories

- Actuation coil and cable assemblies available for various voltages, see 'Coils ESC and Cable Assemblies'

Capacity Data

Type	Nominal Capacity Q _n (kW)										Kv-Value m ³ /h	Δp Min bar
	Liquid					Hot Gas						
	R410A	R744	R452B	R32	R454B	R410A	R744	R452B	R32	R454B		
200 RH 3	6.6	8.1	7.6	9.7	7.7	4.9	7.2	5.1	5.9	5.1	0.4	0.05
200 RH 4	15.7	19.1	18	23	18.2	11.0	16.1	11.4	13.4	11.4	0.9	
200 RH 6	27.5	33.6	31.7	40.3	31.9	19.5	28.7	20.3	23.8	20.3	1.6	

Note 1: R410A/R452B/R32/R454B: Nominal capacities at +38°C condensing temperature, +4°C evaporating temperature, subcooling 1 K
0.15 bar pressure drop between valve inlet and outlet in liquid applications.
1 bar pressure drop for hot gas applications

Note 2: R744: Nominal capacities at +10°C condensing temperature, -10°C evaporating temperature, subcooling 1 K
0.15 bar pressure drop between valve inlet and outlet in liquid applications.
1 bar pressure drop for hot gas applications

Note 3: For selection of other operating condition, please use Controls Navigator selection program.

Selection Guide

Type	Part No.	Connection Solder / ODF	
		mm	Inch
200 RH 3	T3	802 070	10 mm / 3/8"
200 RH 4	T3	802 071	10 mm / 3/8"
	T3	802 072	10 mm / 3/8"
	T4	802 073	12 mm / 1/2"
	T4	802 074	12 mm / 1/2"
200 RH 6	T4	802 075	12 mm / 1/2"
	T4	802 076	12 mm / 1/2"
	T5	802 077	16 mm / 5/8"

Options:

- Actuation coils available for various voltages, see 'Coils ESC and Cable Assemblies'

3-Way Solenoid Valves Series M36

Features

- For heat reclaim application
- Pilot connection to suction line required.
No minimum pressure drop
- Compact size
- No disassembly necessary for brazing
- Max. allowable pressure PS: 35 bar

Accessories

- Actuation coil and cable assemblies available for various voltages, see 'Coils ESC and Cable Assemblies'



M36-118



M36-078

Capacity Data

Type	Nominal Capacity Q_n (kW)															Kv-Value m ³ /h	Δp Min bar
	Hot Gas																
	R134a	R22	R404A	R507	R407C	R450A	R454A	R454A	R454C	R448A	R449A	R452A	R455A	R1234yf	R1234ze		
M36	28.9	35.1	31.3	30.4	38.5	26.4	36.7	36.7	32.3	36.2	35.7	31.4	35.1	24	23.9	6.7	0

Note 1: Nominal Capacities at +38°C Condensing Temperature, +4°C Evaporating Temperature (saturated pressures / dew point).
0.15 bar Pressure drop between valve inlet and outlet.

Note 2: For other operating conditions, please use Controls Navigator selection program.

Selection Guide

Type	Part No.	Connection Solder / ODF		Coil Type
		mm	inch	
M36-078	801420	22	7/8	ESC
M36-116	801421		1 1/8	

Accessories and Spare Parts

Gasket Kit

Description	Type	Part No.
M36	KS30177-1	801268

Repair Kit

Description	Type	Part No.
M36 (upper assembly inc. gasket)	M36-UNF	801440





Mechanical Pressure Regulators

Basic Terms and Technical Information

Capacity Regulators

Regulator series ACP and CPHE are hot gas bypass regulators and serve the purpose of compensating excess compressor capacity. Thus they prevent the generation of evaporator pressures below predetermined levels.

In case of hot gas injection into the suction line, a liquid injection valve in conjunction with a solenoid valve is required to desuperheat the excessively hot suction gas. The capacity should not be reduced below 60% of maximum in this application to avoid oil return problems.

With hot gas injection at the evaporator inlet, no liquid injection valve is necessary. The injection must be such that the incremental gas volume is taken into account. No problems with oil return should be expected even when regulating 100% of capacity.

Evaporator Pressure Regulators

Series PRE regulators serve the purpose of maintaining evaporator pressure above certain predetermined levels. The most important application is the use of several evaporators with different evaporating temperatures in conjunction with a common suction line.

The freezing of water in water chillers and air conditioning systems can be safely prevented if evaporating temperatures are kept above 0°C, even when loads are greatly reduced.

Crankcase Pressure Regulators

Series PRC regulators serve the purpose of preventing excessively high suction pressures to protect compressor motors from overloading.

Excessively high suction pressures can occur at start-up of a refrigeration circuit in case of high loads and after defrost. Crankcase regulators are adjusted to the maximum allowed suction pressure rating of the compressors as given by the compressor manufacturers.

Selection Guide for Pressure Regulators

Selection Criteria	Series			
	ACP	CPHE	PRE	PRC
Capacity Regulator	+	+		
Evaporator Pressure Regulator			+	
Crankcase Pressure Regulator				+



Hot Gas Bypass Regulators Series ACP

Features

- High-quality materials and processes for high reliability and long lifetime
- Internal equalization
- Compact size

Technical Data

Adjustment Range	0 ... 5 bar
Factory Setting	2.7 bar
Max. Allowable Pressure PS	31 bar
Medium Temperature Range TS	-40 ... 120°C
Ambient Temperature Range	-40 ... 50°C
Transport Temperature Range	-40 ... 70°C



ACP

Capacity Data

Type	Part No.	Connection. Angle Solder/ODF inch	Nominal Bypass Capacity (kW)			
			R134a	R22	R407C	R404A / R507
ACP 1	047 680	1/4 x 3/8"	0.21	0.35	0.41	0.30
ACP 3	047 283	1/4 x 3/8"	0.50	0.77	0.89	0.68
ACP 5	053 374	3/8 x 3/8"	1.18	1.83	2.12	1.59

Note 1: Nominal capacities at +38°C condensing temperature, +4°C evaporating temperature (saturated temperatures / dew point) and 1 K liquid subcooling at the inlet of the expansion valve.

Note 2: For other operating conditions, please use Controls Navigator selection program.

Hot Gas Bypass Regulators Series CPHE

Features

- High-quality materials and processes for high reliability and long lifetime
- Superior partial load performance due to double seat orifice design (CPHE3 to CPHE6)
- Modular design for economical logistics and easy assembly and servicing
- External equalization

Specific connection sizes and flanges available on request.

For selection see last page of “Thermo-Expansion Valves” chapter.



Technical Data

Adjustment Range	-0.4 ... 5 bar
Factory Setting	1.4 bar
Max. Allowable Pressure PS	35 bar
Medium Temperature Range TS	-40 ... 120°C
Ambient Temperature Range	-40 ... 50°C
Transport Temperature Range	-40 ... 70°C

Capacity Data CPHE

Type	Nominal Bypass Capacity (kW)									Orifice	Standard Flange Solder/ODF		Power Assembly
	R134a	R22	R407C	R404A / R507	R450A	R513A	R448A	R449A	R1234ze		mm	Inch	
CPHE - 1X	3.5	5	5.8	4.5	3.4	2.6	5.9	5.8	3.1	X 22440-B5B	C 501 - 7 mm 12 x 16	C 501 - 7 1/2 x 5/8	X7818 - 1
CPHE - 2X	6.4	9	10.4	8.1	6.2	4.8	10.6	10.5	5.6	X 22440-B8B	A 576 mm 16 x 22 (22 x 28 ODM)	A 576 5/8 x 7/8 (7/8 x 1 1/8 ODM)	
CPHE - 3X	12	17	20	15	12	9	20	20	10	X 11873-B5B	10331 22 x 22	10331 7/8 x 7/8 (1 1/8 x 1 1/8 ODM)	
CPHE - 3.5X	13	19	22	17	13	10	22	22	12	X 9117-B7B	9153 mm 22 x 22	9153 7/8 x 7/8	
CPHE - 4X	16	23	27	21	16	12	27	26	14	X 9117-B9B			
CPHE - 5X	21	29	34	26	20	15	35	34	18	X 9166-B10B	9149 22 x 22	9149 7/8 x 7/8	
CPHE - 6X	35	50	58	45	34	26	59	58	31	X 9144-B13B			

Note1: Nominal capacities at +38°C Condensing temperature, +4°C Evaporating temperature (saturated temperatures / dew point) and 1 K Liquid Subcooling at the inlet of the expansion valve.

Note2: Specific connection sizes and flanges available on request. For Selection, see last page of “Thermo-Expansion Valves” chapter.

Note3: For other operating conditions, please use Controls Navigator selection program.

Evaporator and Crankcase Pressure Regulator Series PRE and PRC

Features

- Compact design permits minimal space requirements
- Schrader valve on inlet for ease of setting
- Direct operated regulator
- Balanced port design provides accurate pressure control
- Copper tubes for easy soldering



Technical Data

Refrigerants	HFC, HCFC
Oil Compatibility	Mineral, Alkyl Benzene and Polyol-Ester (POE) Lubricants
Max. Allowable Pressure PS Max. Test Pressure PT	25 bar 30 bar
Material Housing	CW509L (EN12420)
Temperature Range	Storage -30 ... 80°C Medium TS -30 ... 80°C Ambient -30 ... 80°C

Pressure Change Per Turn: Valve Size 1 Valve Size 2	0.6 bar 0.4 bar
Pressure Range Factory Setting	0.5 to 6.9 bar 2 bar
Weight: PRC/PRE-1.. PRC/PRE-2..	0.6 kg 1.3 kg

Evaporator Pressure Regulator Series PRE

Selection

Type	Part No.	Tube Connection ODF	Nominal Capacity (kW)			
			R134a	R404A / R507	R407C	R22
PRE - 11A	800 380	16 mm - 5/8"	3.0	4.5	4.5	4.8
PRE - 11B	800 381	22 mm - 7/8"				
PRE - 21C	800 382	28 mm	7.4	11.1	11.1	11.9
PRE - 21D	800 383	1 1/8"				

Note 1: Nominal Capacities are Based on Evaporating Temperature +4°C, Condensing Temperature +38°C and a Pressure Drop of 1K.

Note 2: For other operating conditions, please use Controls Navigator selection program.

Crankcase Pressure Regulator Series PRC

Selection

Type	Part No.	Tube Connection ODF	Nominal Capacity (kW)			
			R134a	R404A / R507	R407C	R22
PRC - 11A	800 384	16 mm - 5/8"	3.0	4.5	4.5	4.8
PRC - 11B	800 385	22 mm - 7/8"				
PRC - 21C	800 386	28 mm	7.4	11.1	11.1	11.9
PRC - 21D	800 387	1 1/8"				
PRC - 21E	800 388	35 mm - 1 3/8"				

Note 1: *Nominal Capacities are Based on Evaporating Temperature +4°C and Condensing Temperature +38°C and a Pressure Drop of 1 K.

Note 2: For other operating conditions, please use Controls Navigator selection program.

Capacity Table

Refrigerant	Evaporating Temperature °C	Capacity (kW) Valve Setting °C													
		Valve Size 1: PRC-11x							Valve Size 2: PRC-21x						
		-20	-15	-10	-5	0	+5	+10	-20	-15	-10	-5	0	+5	+10
R22	-29	2.3	3.4	4.4	4.8	4.9			5.8	8.8	10.0	10.0	10.0		
	-21		2.4	4.1	5.4	5.8				6.5	12.1	12.1	12.1		
	-14			2.7	4.9	6.2					8.1	13.8	13.8		
	-8				3.5	5.3						9.0	15.4		
	-3					3.1							9.9		
R407C	-6				3.1	4.8						7.9	13.9		
	-1					2.9							9.2		
R134 a	-6					2.1	3.9	5.3					5.2	10.3	12.9
	1						2.4	4.7						6.1	12.2
	7							3.3							8.1
R404A / R507	-27	1.6	2.9	3.7	3.9				4.8	8.2	8.2	8.2			
	-20		1.9	3.5	4.5					5.7	9.8	9.8			
	-14			2.2	4.5						6.8	11.6			
	-10				3.1							8.1			

Note: Selection for Operating Conditions other than +38°C / +4°C and 1 K Liquid Subcooling at the inlet of the valve: (Capacities are based on a Pressure Drop of 0.07 bar).



Pressure Controls and Thermostats

Pressure Controls

Basic Terms and Technical Information

Characteristics

Pressure controls serve various functions, which may be divided into control and protection functions. Examples for control functions are compressor cycling, pump-down or defrost control. Protection functions include pressure limiting and cut-out against excessive pressures, against loss of charge or for freeze protection.

These functions are performed by operating a set of electrical contacts when exceeding a preset lower or upper pressure limit. Depending on whether they are type tested (TÜV approved) or not, they may be referred to by the following terms:

without TÜV approval:	Pressure Control
with TÜV approval:	Pressure Limiter, Pressure Cut-Out or Safety Pressure Cut-Out

Pressure controls with TÜV approval are tested according to EN 12263 as required by DIN 8901 and EN 378.

- 1. Pressure Controls (Without TÜV Approval)**
Pressure controls without type approval may either be of the automatic or manual reset type. Manual reset versions are available for decreasing (manual reset min.) or increasing pressure (manual reset max.).
- 2. Pressure Limiters PSL/PSH**
Pressure limiters are of the automatic reset type. Limiters for high pressure applications have a double bellows design to act as fail-safe controls.
- 3. Pressure Cut-outs PZH/PZL**
Pressure cut-outs are of the manual reset type where reset is possible from the outside of the control without the need for a tool (external reset). Cut-outs for high pressure applications have a double bellows design to act as fail-safe controls.
- 4. Safety Pressure Cut-outs PZHH/PZLL**
Pressure cut-outs are of the manual reset type where the reset requires the use of a tool. Typically, the removal of a cover is required in order to press the reset button (internal reset). Cut-outs for high pressure applications have a double bellows design to act as fail-safe controls.

Adjustment of Switching Points

A pressure gauge should always be used for comparison when adjusting the switching points on pressure controls. The setting scale on the

device is intended to serve for orientation, showing the setting range of the upper switching point p_{max} in bar/psig and the value of the pressure differential Δp as difference between upper switching point p_{max} and the lower switching point p_{min} . The upper switching point p_{max} has to be adjusted on the scale, whereas the lower switching point p_{min} is given by adjustment of the desired switching differential Δp .

The formula is:

$$\text{Upper switching point} - \text{Differential} = \text{Lower switching point}$$

$$P_{max} - \Delta p = P_{min}$$

Function of Contacts SPDT

On pressure rise above setting 1-2 opens and 1-4 closes. On pressure drop below setting 1-2 closes and 1-4 opens.

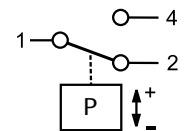

SPDT With Manual Reset Max.

On pressure rise above setting 1-2 opens and 1-4 closes and latches. The device can be manually reset when the pressure has dropped below setting.

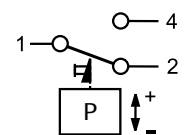

SPDT With Manual Reset Min.

On pressure drop below setting 1-2 closes, 1-4 opens and latches. The device can be manually reset when the pressure has risen above setting.

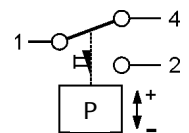

Unit of Pressure

All pressures are given in gauge pressure

$$P_{absolute} = P_{gauge} + 1 \text{ bar}$$

$$1 \text{ bar} = 100 \text{ kPa}$$

$$1 \text{ bar} = 14.5 \text{ psi}$$

Pulsation Damping

All high pressure controls with connection (7/16-20UNF. 1/4" SAE male) are equipped with a snubber to protect the pressure element from pulsations.



Standards and Regulations

BGV D4 (VBG20)	Accident Prevention Regulations for Refrigeration Plant.
DIN 8901	Heat Pumps with Fluorocarbon Refrigerants. Protection of Soil, Underground and Surface Water.
EN 60947-1/ EN 60947-5-1	Specifications for Low-Voltage Switch Gear.
EN 378	Refrigerating Systems and Heat Pumps - Safety and Environmental Requirements.
EN 12263	Refrigerating Systems and Heat Pumps - Safety Switching Devices for Limiting the Pressure Requirements and Tests.

Selection Guide for Pressure Controls

Series	Selection Criteria					
	Design	Number of Contacts (SPDT)	Adjustable	Protection DIN 40050 IEC 529	Rated Operational Current at 230 V AC	
					Inductive Amp. AC 15	Motor Rating UL
PS1	Pressure Control (single packaging) Model	1	yes	IP 44	10 A	24 A
PS2	Dual Pressure Control (single packaging)	1+1	yes	IP 44	10 A	24 A
PS3	Pressure Controls Standard types (single packaging)	1	Factory set to fixed values	IP 30 / IP 65	3 A	6 A
	Pressure Control Special types (100 pieces packaging)	1	Other fixed values acc. to agreed specification	IP 30 / IP 65	3 A	6 A
CS3 (for CO ₂ Applications)	Pressure Controls Standard types (60 pieces packaging)	1	Factory set to fixed values	IP 30 / IP 65	3 A	6 A
	Pressure Control Special types (60 pieces packaging)	1	Other fixed values acc. to agreed specification	IP 30 / IP 65	3 A	6 A
PS4	Pressure Controls standard types (100 pieces packaging)	(SPST)	Factory set to fixed values	IP67 (cable) IP20 (terminals)	6 A	6 A
FD 113	Differential Pressure Control	1	yes pressure diff. + time delay	IP 30	3 A / 6 A	-

Pressure Controls Series PS1 / PS2

Features

- Adjustable pressure setpoint
- Automatic and manual reset versions
- Flare and solder pressure connections
- Chatter-resistant (bounce-free) contacts
- High operational current, locked rotor max. 144 A (LRA)
- Standard SPDT with same operational current rating for both contacts
- Dual pressure control with independent SPDT switches (single pole double throw) for high and low pressure side
- Locking plate and mounting screws included

Options (minimum order quantity 100 pieces)

- Convertible reset to reduce stock
- Other types of pressure connections upon agreement
- Factory set to customer specification



Standards

- per Low Voltage Directive
- per PED Directive. TÜV appr. versions only
- Underwriter Laboratories (File Nr. E85974) (PS1 / PS2 only)
- German Lloyd for use on ships, only when used with marine cable glands (accessory)

Selection Table Single Pressure Controls PS1

Type	Part No.	Adjustment Range		Lowest Setpoint (bar)	Factory Setting (bar)	Leakage Test Pressure (bar)	Pressure Connection
		Upper Setpoint	Differential (bar)				
Low Pressure Controls							
PS1-A3A	4 370 700	-0.5 ... 7	0.5 ... 5	-0.9	3.5 / 4.5	24	7/16"-20 UNF
PS1-A3U	4 712 201						solder tube 6 mm
PS1-A3X	4 713 430						solder tube 1/4"
PS1-R3A	4 350 100	-0.5 ... 7	External Reset Approx. 1 bar Above Setpoint	-0.9	3.5	24	7/16"-20 UNF
High Pressure Controls							
PS1-A5A	4 350 500	6 ... 31	2 ... 15	3	16 / 20	35	7/16"-20 UNF
PS1-A5L	4 715 136						cap./solder tube 1/4"
PS1-A5U	4 713 325						solder tube 6 mm
PS1-A5X	4 713 434						solder tube 1/4"
PS1-R5A	4 350 700	6 ... 31	Ext. Manual Reset Approx. 3 bar Below Setpoint	-	20	35	7/16"-20 UNF

Selection Table Single Pressure Controls PS1 TÜV (EN 12263)

Type	Part No.	Adjustment Range		Lowest Setpoint (bar)	Factory Setting (bar)	Leakage Test Pressure (bar)	Pressure Connection
		Upper Setpoint (bar)	Differential (bar)				
Pressure Limiter for Low Pressure Protection PSL - Automatic Reset							
PS1-W3A	4 368 300	-0.5 ... 7	0.5 ... 5	-0.9	3.5 / 4.5	24	7/16"-20 UNF
PS1-W3U	4 713 437						solder tube 6 mm
Pressure Cut Out for Low Pressure Protection PZL - External Manual Reset							
PS1-B3A	4 470 400	-0.5 ... 7	Reset Approx. 1 bar Above Setpoint	-0.9	3.5	24	7/16"-20 UNF
PS1-B3U	4 715 141						solder tube 6 mm
Pressure Limiter for High Pressure Protection PSH - Automatic Reset							
PS1-W5A	4 353 200	6 ... 31	2 ... 15	3	16 / 20	35	7/16"-20 UNF
PS1-W5U	4 713 439						solder tube 6 mm
Pressure Cut Out for High Pressure Protection PZH - External Manual Reset							
PS1-B5A	4 353 300	6 ... 31	Reset Approx. 3 bar Below Setpoint	-	20	35	7/16"-20 UNF
PS1-B5U	4 712 332						solder tube 6 mm
Safety Pressure Cut Out for High Pressure Protection PZHH - Internal Manual Reset (with tool)							
PS1-S5A	4 368 400	6 ... 31	Reset Approx. 3 bar Below Setpoint	-	21	35	7/16"-20 UNF
PS1-S5U	4 711 591						solder tube 6 mm

Technical Data PS1/PS2/CS1

Type of Contacts	- PS1/CS1: 1 x SPDT contact - PS2: 2 x SPDT contacts
Resistive load (AC1) Inductive load (AC15) Inductive load (DC 13)	24A / 230V AC 10A / 230V AC 0.1A / 230V DC 3A / 24V DC 6A / 12V DC
Motor rating UL (FLA) Startup / Locked Rotor UL	24A / 120 / 240V AC 144A / 120 / 240V AC

Medium Compatibility	HFC, HCFC, HFO/HFO Blends, A2L*, CO ₂ (CS1 only)
Protection Acc. EN 60529 / IEC 529	IP 44
Ambient Temperature Range Max. Temperature at Pressure Connection	-50 ... +70°C +70°C
Cable Entry	Grommet PG 16
Locking Device	Blocking Plate
Mounting Screws	M4 / UNC 8-32

Note: For A2L applications please check the Operating Instructions.

Dual Pressure Controls Series PS2



PS2

Selection Table Dual Pressure Controls PS2

Type	Part No.	Adjustment Range				Factory Setting (bar)		Leakage Test Pressure (bar)		Pressure Connection
		Upper Setpoint (bar)		Differential (bar)		Left	Right	Left	Right	
		Left	Right	Left	Right					
Combined Low and High Pressure Controls (automatic and manual reset)										
PS2-A7A	4 353 400									7/16"-20 UNF
PS2-A7U	4 713 415	-0.5 ... 7	6 ... 31	0.5* ... 5	ca. 4 fix	3.5 / 4.5	20	24	35	solder tube 6 mm
PS2-A7X	4 713 416									solder tube 1/4"
PS2-L7A	4 351 100									7/16"-20 UNF
PS2-L7U	4 713 417	-0.5 ... 7	6 ... 31	0.5* ... 5	external manual reset approx. 4 bar under setpoint	3.5 / 4.5	20	24	35	solder tube 6 mm
PS2-R7A	4 351 300									7/16"-20 UNF
PS2-R7U	4 713 419	-0.5 ... 7	6 ... 31	0.5* ... 5	external manual reset approx. 1 bar above setpoint external manual reset approx. 4 bar below setpoint	3.5	20	24	35	solder tube 6 mm
Combined Low and High Pressure Controls, High Side Convertible from Automatic to Manual Reset										
PS2-M7A	4 361 300	-0.5 .. 7	6 ... 31	0.5* ... 5	-	3.5 / 4.5	21	24	35	7/16"-20 UNF

Selection Table - Dual Pressure Controls PS2 TÜV (EN12263)

Type	Part No.	Adjustment Range				Factory Setting (bar)		Leakage Test Pressure (bar)		Pressure Connection
		Upper Setpoint (bar)		Differential (bar)		Left	Right	Left	Right	
		Left	Right	Left	Right					
Combined Pressure Limiter for Low Pressure / High Pressure protection EN 12263 PSL / PSH (Automatic / Automatic)										
PS2-W7A	4 360 100									7/16"-20 UNF
PS2-W7L	4 450 300	-0.5 ... 7	6 ... 31	0.5* ... 5	ca. 4 fix	3.5 / 4.5	20	24	35	cap./solder 1/4"
PS2-W7U	4 712 436									Solder 6 mm
Combined Pressure Limiter / Pressure Cut-Out for Low Pressure / High Pressure Protection PSL / PZH (Automatic / External Manual Reset)										
PS2-C7A	4 353 500	-0.5 ... 7	6 ... 31	0.5* ... 5	external manual reset approx. 4 bar below setpoint	3.5 / 4.5	20	24	35	7/16"-20 UNF
Combined Pressure Limiter Safety Pressure Cut Out for Low Pressure / High Pressure Protection EN 12263 PSL / PZH (Automatic / Automatic Convertible to External Manual Reset)										
PS2-N7A	4 715 756	-0.5 .. 7	6 ... 31	0.5* ... 5	-	3.5 / 4.5	21	24	35	7/16"-20 UNF

Note: *) Lowest Possible Setpoint: -0.9 bar

Selection Table - Dual Pressure Controls PS2 TÜV (EN12263)

Type	Part No.	Adjustment Range				Factory Setting (bar)		Leakage Test Pressure (bar)		Pressure Connection
		Upper Setpoint (bar)		Differential (bar)		Left	Right	Left	Right	
		Left	Right	Left	Right					
Combined Pressure Limiter / Safety Pressure Cut-Out for Low Pressure / High Pressure Protection PSL / PZHH - Automatic / Internal Manual Reset										
PS2-T7A	4 368 500	-0.5 ... 7	6 ... 31	0.5* ... 5	Internal reset approx. 4 bar below setpoint	3.5 / 4.5	21	24	35	7/16"-20 UNF
PS2-T7U	4 713 424									solder tube 6 mm
Combined Pressure Cut-Out for Low Pressure / High Pressure Protection PZL / PZH External Manual Reset / External Manual Reset										
PS2-B7A	4 360 200	-0.5 ... 7	6 ... 31	External reset approx. 1 bar above setpoint	Internal reset approx. 4 bar below setpoint	3.5	20	24	35	7/16"-20 UNF
PS2-B7U	4 449 400									solder tube 6 mm
Combined Pressure Cut-Out / Safety Pressure Cut-Out for High Pressure Protection PZH / PZHH External Manual Reset / External Manual Reset										
PS2-G8A	4 368 600	6 ... 31	6 ... 31	External manual reset approx. 4 bar below setpoint	Internal manual reset approx. 4 bar below setpoint	20	21	35	35	7/16"-20 UNF
PS2-G8U	4 713 427									solder tube 6 mm
PS2-G8X	4 713 428									Solder 1/4"

Note: *) Lowest Possible Setpoint: -0.9 bar

Pressure Controls Series CS1

CS1 is an adjustable safety pressure for application in refrigeration systems in compliance with standard EN 378.

Features

- Adjustable pressure range
- Narrow adjustable differential
- Range and differential pointer in units bar and psig
- High rated SPDT contacts for all versions
- Chatter resistant bounce free contacts
- Captive terminal and cover screws
- 2 million cycles reliability (TÜV approved according to EN 12263 to meet requirements of EN 378)
- Locking plate and mounting screws included



Features

- Customer specific types available, minimum order quantity 100 pieces

Standards

-  acc. PED 2014/68/EU & LVD 2014/35/EU

Selection table - Pressure Limiter for high pressure protection EN 12263 PSH

Type	Part No.	Adjustment Range		Lowest Setpoint (Cut-in) (bar)	Factory Setting (bar)	Max. Allowable Pressure PS (bar)	Test Pressure (bar)	Pressure Connection
		Upper Setpoint (Cut-out) (bar)	Differential Setpoint (bar)					
CS1-W6A	812004/ 812004M*	10...45	4 - 10	6	28 / 20	70	77	7/16"-20 UNF male
CS1-W7A	812005/ 812005M*	15...65	5 - 10	10	40 / 32	70	77	

Accessories

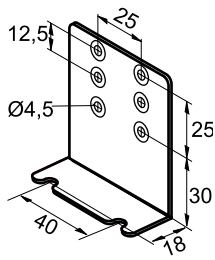

Mounting
Bracket Angle
Part No.: 803 799

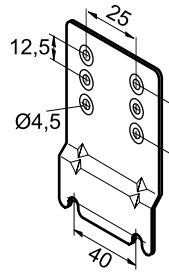

Mounting Plate for
Units with Hood
Part No.: 803 801

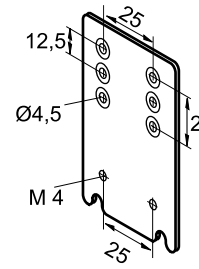

Extension Bracket
Part No.: 803 800

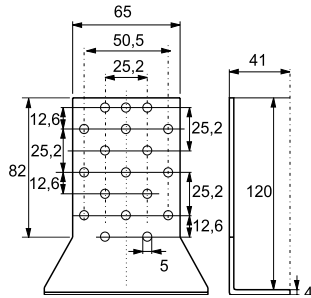

Universal
Mounting
Bracket
Part No.: 803 798

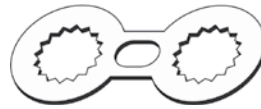

Locking Plate
Part No.: 803783 (20 pcs)

Copper Gasket Set for R 1/4"
(7/16"-20 UNF. Female)
100 pcs Package
Part No.: 803 780

Pressure Controls Series PS3 / Standard Types

Fixed Settings in Single Packaging

Features

- Maximum allowable pressure up to 45 bar / test pressure up to 50 bar
- High and low pressure switches
- High temperature version with snubber for direct compressor mounting (range 6)
- Direct mounting reduces the number of joints and thus avoiding potential leakage
- Precise setting and repeatability
- IP 65 protection if used with PS3-Nxx cables with plug (acc. EN 175301-803), no additional gasket required (molded into plug)
- Cables with plug to be ordered separately



PS3

Standards

- per Low Voltage Directive
- per PED Directive, TÜV appr. versions only
- Underwriter Laboratories (File No. E85974) (Released for 43 bar)

Selection Table PS3- Standard Types

Pressure Control Type	Part No.	Fixed setting		Reset	Max. Temperature		Leakage Test Pressure	Pressure Connection
		Cut-out	Cut-in		Ambient	Pressure Connection		
High Pressure Controls								
PS3-A6S	0 715 603	16.0 bar	11.0 bar	Auto	+70°C	+150°C	50 bar	7/16"-20UNF Female Thread with Schrader Opener
PS3-A6S	0 715 604	19.0 bar	15.0 bar					
PS3-A6S	0 715 600	26.5 bar	22.5 bar					
Low Pressure Controls / Pressure Limiter for Low Pressure Protection PSL TÜV / EN 12263								
PS3-W1S	0 714 760	-0.3 bar	1.2 bar	Auto	+70°C	+70°C	30 bar	7/16"-20UNF Female Thread with Schrader Opener
PS3-W1S	0 714 761	0.3 bar	1.8 bar					
PS3-W1S	0 714 762	2.0 bar	3.5 bar					
Pressure Limiter for High Pressure Protection PSH with snubber for direct compressor mounting TÜV / EN 12263								
PS3-W6S	0 715 831	14.0 bar	10.0 bar	Auto	+70°C	+150°C	50 bar	7/16"-20UNF Female Thread with Schrader Opener and Snubber
PS3-W6S	0 715 556	21.0 bar	16.0 bar					
PS3-W6S	0 715 555	25.0 bar	20.0 bar					
PS3-W6S	0 715 567	29.0 bar	23.0 bar					
PS3-W6S	0 715 550	33.5 bar	27.5 bar					
PS3-W6S	0 715 553	40.0 bar	33.0 bar					
Pressure Cut-Out for High Pressure Protection PZH with Snubber for Direct Compressor Mounting TÜV / EN 12263								
PS3-B6S	0 715 568	19.2 bar	Approx. 5 bar below cut-out	External manual reset	+70°C	+150°C	50 bar	7/16"-20UNF Female Thread with Schrader Opener and Snubber
PS3-B6S	0 715 564	22.7 bar						
PS3-B6S	0 715 563	27.3 bar						
PS3-B6S	0 715 569	29.5 bar						
PS3-B6S	0 715 560	36.0 bar						

Accessories Cable Assemblies

Type	Part No.	Length	Temperature Range	Leads
PS3-N15	804 580	1.5m	-50...80°C / No UL	3 x 0.75 mm ²
PS3-N30	804 581	3.0m		
PS3-N60	804 582	6.0m		

Note: PS3-M... are not in compliance with EN60335-1/2-40, clause 30 in term of glue wire test.



Plug According to EN 175301	Part No.
PG9	801 012
PG11	801 013

Technical Data

Protection According to EN 60529 / IEC 529	IP 00 IP 30 with Terminal Cover IP 65 with PS3-Nxx Cables with Plug or Plug DIN 43650
Inductive Load (AC15)	3A / 230V AC
Inductive Load (DC)	0.1A / 230V DC
Motor Rating Amps (FLA)	6A / 120/240V AC
Lock Rotor Amps (LRA)	36A / 120/240V AC

Temperature Range TS * Ambient, Storage and Transportation Medium	-40 ... 70 °C -40 ... 70 °C (150°C Range 6)
Pressure Range PS	- 0.6 .. 43 bar
Type of Contacts	1 SPDT
Medium Compatibility	HFC, HCFC, HFO/HFO Blends (refrigerant safety group A1)

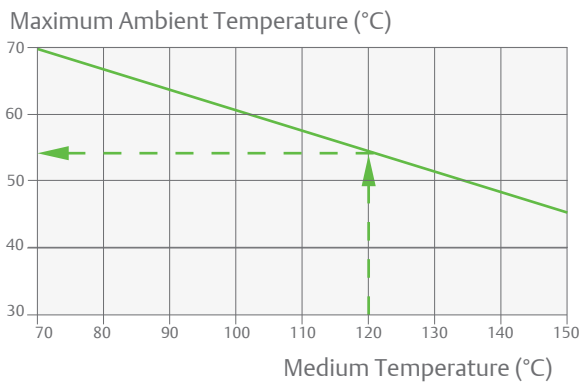

Note: *) For high temperature applications, i. e., medium temperatures between 70 °C and 150 °C, the maximum ambient temperature must be derated as per drawing. E.g.: on medium temperature 120 °C the ambient temperature of 55 °C around the switch housing should not be exceeded.

Pressure Controls Series PS3/PSC Special Types

According to Agreed Specification, 100 Pieces Packaging

Features

- Maximum allowable pressure up to 45 bar / test pressure up to 50 bar
- For direct mounting on a pressure connection (free standing) or with a capillary tube
- Direct mounting reduces the number of joints and thus avoids potential leakage
- Direct mounting saves cost for flexible hose and additional fittings
- Precise setting and repeatability
- High temperature version with snubber, for direct compressor mounting (range 6)
- Micro switch for narrow pressure differentials
- Gold plated contacts for low voltage / current applications
- Worldwide approvals
- Easy mounting
- Housing with integrated console for free-standing installation
- Low pressure switch with automatic or manual reset
- High pressure switch with automatic or manual reset, standard or high temperature version
- Pressure limiter PSH - standard or high temperature version
- Pressure cut-out PZH - external reset, standard or high temperature version
- Safety pressure cut-out PZHH - internal reset, standard or high temperature version
- Cables with plug in lengths of 1.5m, 3.0m and 6.0m available. No additional gasket required.
- Appliance socket DIN 43650
- Electrical contact single pole double throw
- Electrical micro switch single pole double throw (SPDT)
- Gold plated contacts upon request



PS3

Standards

- per Low Voltage Directive
- per PED Directive TÜV appr. versions only
- **UL LISTED** Underwriter Laboratories (File No. E85974) (Released for 43 bar)

Pressure Connections

- S: 7/16"-20UNF, female with Schrader opener and snubber (snubber only with high temperature diaphragm)
- A: 7/16"- 20UNF, 1/4" SAE male
- U: 6 mm solder. 80 mm length. ODF
- X: 1/4" solder. 80 mm length. ODF
- K: 1 m capillary tube with 1/4" SAE flare nut and Schrader opener
- L: 1 m capillary tube and 1/4" ODM solder connector

Technical Data

Protection According to EN 60529 / IEC 529	IP 00 IP 30 with Terminal Cover IP 65 with PS3-Nxx Cables with Plug or Plug DIN 43650
Inductive Load (AC15)	3 A / 230V AC 1.5 A with Microswitch Standard 0.1 A with Gold Plated Contacts
Inductive Load (DC)	0.1 A / 230V DC
Motor Rating Amps (FLA)	6 A / 120/240V AC 2.5 A with Microswitch
Lock Rotor Amps (LRA)	36 A / 120/240V AC 15 A with Microswitch

Note: For more information see the technical bulletin of PS3

Temperature Range TS Ambient. Storage and Transportation Medium	-40 ... 70°C -40 ... 70°C (150°C Range 6)
Pressure Range PS	- 0.6 .. 43 bar
Type of Contacts	1 SPDT
Medium Compatibility	HFC, HCFC, HFO/HFO Blends (refrigerant safety group A1)

Pressure Controls Series CS3 for R744/ CO₂ Standard Types With Fixed Settings and Special Types, 60 Pieces Packaging

Features

- Pressure range 8/Q
 - Versions with fixed factory cut-out setting available between 60 bar to 140 bar
 - Maximum allowable pressure of 140 bar
 - Factory test pressure of 154 bar
 - Narrow differential (approx. 6 bar) between cut-out and cut-in (in Microswitch version)
- Pressure range 7/P
 - Versions with fixed factory cut-out setting available between 40 bar to 70 bar
 - Maximum allowable pressure of 90 bar
 - Factory test pressure of 100 bar
 - Narrow differential (approx. 4 bar) between cut-out and cut-in (in Microswitch version)
- Manual reset versions available
- Precise switching and repeatability; Snap Action Contacts => Chatter Free (Bounce free) and Accurate Operation
- Contacts are designed as SPDT (Single pole double throw) for control function and alarm/status reporting
- Direct compressor mounting with adapter option
- 2 million cycles reliability (TÜV EN 12263 approved)
- IP65 protection if used with PS3-Nxx with plug (acc. EN 175301-803), no additional gasket required (molded into plug)



CS3

Applied Standards

- per Low Voltage Directive
- per PED Directive
- US LISTED Underwriter Laboratories (File No. E85974)

Selection Table

1. Standard Types

Pressure Range 8/Q

Type	Part No. (Multi-Pack 60 Pcs)	Fixed Setting		Reset	Electrical Switch	Pressure Connection
		Cut-out	Cut-in			
Pressure Limiter CS3-WQS	0718008M	106 bar	100 bar	Automatic	Micro Switch	7/16"-20 UNF Female Thread with Schrader Opener
Pressure Limiter CS3-W8S	0718009M	106 bar	80 bar		Standard Switch	
Pressure Cut-out CS3-B8S	0718001M	108 bar	Approx. 25 bar below cut-out	External Manual	Standard Switch	
Safety Pressure Cut-out CS3-S8S	0718002M	108 bar	Approx. 25 bar below cut-out	Internal Manual	Standard Switch	

Pressure Range 7/P

Type	Part No. (Multi-Pack 60 Pcs)	Fixed Setting		Reset	Electrical Switch	Pressure Connection
		Cut-out	Cut-in			
Pressure Limiter CS3-WPS	0718007M	54 bar	50 bar	Automatic	Micro Switch	7/16"-20 UNF Female Thread with Schrader Opener
Pressure Limiter CS3-W7S	0718006M	54 bar	41 bar		Standard Switch	
Pressure Cut-out CS3-B7S	0718004M	54 bar	Approx. 13 bar Below Cut-out	External Manual	Standard Switch	
Safety Pressure Cut-out CS3-S7S	0718005M	54 bar	Approx. 13 bar Below Cut-out	Internal Manual	Standard Switch	

Note: Cables with plug must be ordered separately (see next page).

2. Pressure Controls CS3 Special Type

According to Agreed Specification, 60 Pieces Packaging

Pressure Range 8/Q: Versions with fixed factory cut-out settings available between 60 bar to 140 bar
 Pressure Range 7/P: Versions with fixed factory cut-out settings available between 40 bar to 70 bar

Accessories Cable Assemblies

Type	Part No.	No. of Leads	Diameter of Lead	Temperature Range	Cable Length
PS3-N15	804 580	3	0.75 mm ²	-50...+80 °C	1.5 m
PS3-N30	804 581				3.0 m
PS3-N60	804 582				6.0 m

Note: PS3-M... are not in compliance with EN60335-1/2-40, clause 30 in term of glue wire test

Plug According to EN75301	Part No.
PG9	801 012
PG11	801 013

Technical Data

Protection Class Acc. to EN 60529	IP 65 with PS3-Nxx IP00 without Appliance Socket
Max. Allowable Pressure PS	Pressure Range 8/Q: 140 bar Pressure Range 7/P: 90 bar
Factory Test Pressure PT	Pressure Range 8/Q: 154 bar Pressure Range 7/P: 100 bar
Tolerances (As Per EN 12263) - Only for Standard Types (See page 1)	Pressure Range 8/Q Cut-out Tolerance: 0 to -6 bar Cut-in Tolerance: +/-3 bar
Note: Tolerances are Valid Between -20...+55°C.	Pressure Range 7/P Cut-out Tolerance: 0 to -3 bar Cut-in Tolerance: +/-1.5 bar

Storage and Transportation Temperature	-40 ...+70°C
Ambient Temperature (Housing)*	-40 ...+70°C
Medium Temperature*	-40 ...+150°C

*) Note: For high temperature applications, i.e. medium temperatures between 70°C and 150°C, the maximum ambient temperature must be derated as per drawing.

E.g.: On medium temperature 120°C the ambient temperature of 55°C around the switch housing should not be exceeded.

Maximum Ambient Temperature (°C)

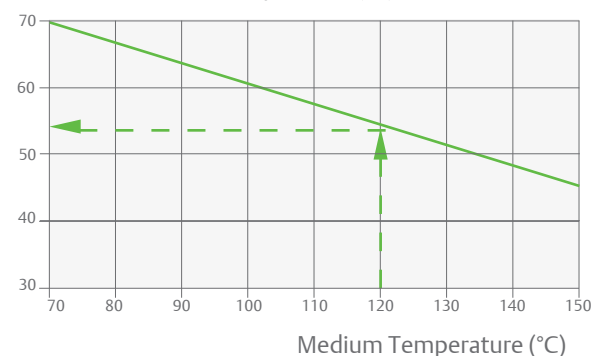

Electrical Data





	Standard (SPDT)	Micro Switch (SPDT)
Inductive Load (AC15)	3A / 230VAC	1.5A / 230VAC
Inductive Load (DC)	0.1A / 230VDC	0.1A / 230VDC
Motor Rating Amps (FLA)	6A / 120 / 240VAC	2.5A / 120 / 240VAC
Lock Rotor Amps (LRA)	36A / 120 / 240VAC	15A / 120 / 240VAC

Pressure Controls Series PS4 with Fixed Settings for OEM Applications; Minimum Order Quantity 100 Pieces

Features

- High- and low pressure switches
- Precise settings and repeatability
- Cable version with IP67 (IP20 for terminal version)
- Normally open/closed electrical contacts (under standard operating conditions)
- TUV approved versions (W & B)
- UL approved
- Released for A2L applications, please check the Operating Instructions

Standards

-  According to low Voltage Directive and European scheme EN60950
-  According to Electrical Equipment Directive 14/35/EU
-  0035 According to Pressure Equipment Directive 14/68/EU
-  Underwriter Laboratories file Nr. E258370



PS4

Selection Table - Low Pressure Switches With Automatic Reset; Open On Falling Pressure

Type	Part No.	Setting		Connector (QC) Cable	Test Pressure	EN 12263	Contact Function	Application	Pressure Connection
		Cut-out	Cut-in						
PS4-W1	808269	0.3 bar	1.5 bar	3.0m	25 bar	PSL	Open on falling pressure	Low pressure	6mm
PS4-A1	808266	0.4 bar	1.4 bar	1.5m		none			7/16"-20UNF*
PS4-W1	808208	0.6 bar	1.8 bar	1.5m		PSL			6mm
PS4-W3	808235	0.6 bar	1.8 bar	QC					7/16"-20UNF*
PS4-W1	808251	0.6 bar	1.8 bar	3.0m		PSL			6mm
PS4-W1	808209	0.7 bar	2.1 bar	1.5m					7/16"-20UNF*
PS4-W1	808241	0.7 bar	2.4 bar	3.0m		none			6mm
PS4-W3	808284	1.2 bar	1.9 bar	QC					7/16"-20UNF*
PS4-A1	808247	1.5 bar	2.5 bar	2.5m		PSL			6mm
PS4-A1	808229	1.5 bar	3.0 bar	1.5m					7/16"-20UNF*
PS4-W1	808210	1.7 bar	3.4 bar	1.5m		None			6mm
PS4-W1	808249	1.7 bar	3.4 bar	1.5m					7/16"-20UNF*
PS4-W1	808271	1.8 bar	3.2 bar	1.5m					
PS4-A1	808276	3.3 bar	4.8 bar	1.5m					

Note: *) 7/16-20UNF female with Schrader valve opener

Selection Table - High Pressure Switches With Automatic Reset; Open On Rising Pressure

Type	Part No.	Setting		Connector (QC) Cable	Test Pressure	EN 12263	Contact Function	Application	Pressure Connection
		Cut-out	Cut-in						
PS4-W1	808200	18 bar	13 bar	1.5m	41 bar	PSH	Open on rising pressure	High pressure	7/16-20UNF*
PS4-W1	808265	18 bar	13 bar	3.0m					6mm
PS4-W1	808201	26 bar	20 bar	1.5m					7/16-20UNF*
PS4-W1	808224	26 bar	20 bar	3.0m					6mm
PS4-W1	808 282	24 bar	18 bar	5.0m					7/16-20UNF*
PS4-W3	808236	26 bar	20 bar	QC					1/4"
PS4-A1	808260	26 bar	20 bar	1.5m					None
PS4-W1	808203	28 bar	21 bar	1.5m	55 bar	PSH	Open on rising pressure	High pressure	7/16-20UNF*
PS4-A1	808233	28 bar	21 bar	1.5m					none
PS4-A1	808244	28 bar	21 bar	1.5m					1/4"
PS4-W3	808273	29 bar	22.8 bar	QC					7/16-20UNF Female with Schrader Opener
PS4-A1	808237	29.5 bar	22.5 bar	1.5m					None
PS4-A1	808238	31 bar	24 bar	1.5m					None
PS4-A1	808248	32 bar	24 bar	2.5m					None
PS4-W1	808205	42 bar	33 bar	1.5m	69 bar	PSH	Open on rising pressure	High pressure	7/16-20UNF Female with Schrader Opener
PS4-W3	808242	42 bar	33 bar	QC					6mm
PS4-W5	808287	45 bar	34 bar	1.5m					6mm
PS4-W1	808261	45 bar	35 bar	1.5m					6mm

Selection Table - High Pressure Switches with Automatic Reset; Close on Rising Pressure

Type	Part No.	Setting		Connector (QC) Cable	Test Pressure	EN 12263	Contact Function	Application	Pressure Connection	
		Cut-Out	Cut-in							
PS4-A2	808212	13 bar	18 bar	1.5m	41 bar	None	Close on Rising Pressure	Fan control	7/16-20UNF Female with Schrader Opener	
PS4-W2	808274	14.6 bar	20 bar	1.5m						PSH
PS4-A2	808264	17 bar	22.6 bar	1.5m						None
PS4-W2	808227	22 bar	28 bar	1.5m	55 bar	PSH				

Selection Table - High Pressure Switches With Manual Reset; Open on Rising Pressure

Type	Part No.	Setting		Connector (QC) Cable	Test Pressure	EN 12263	Contact Function	Application	Pressure Connection
		Cut-Out	Cut-in						
PS4-BL	808202	26 bar	-	1.5m	41 bar	PZH	Open on Rising Pressure	high pressure EN 378	7/16"-20UNF Female with Schrader Opener
PS4-BL	808204	28 bar	-	1.5m	55 bar				
PS4-BL	808206	42 bar	-	1.5m	55 bar				

Technical Data

Type	PS4-A	PS4-W	PS4-BL
Electrical Data: Silver contact: Inductive Load 230 VAC Inductive Load (DC <28V) Motor rating FLA 230 VAC Motor rating LRA 230 VAC Gold Contact:	0.1...6A 2A 6A 36A 25-100mA		0.1...6A 2A 3A 15A
Electrical Connection	Cable or Terminal (QC) Version		Cable Version
Life Time	> 100.000 cycles -B and -R versions 10.000 cycles (6.000 for UL approved)		
Protection Class IEC 529 / DIN 40050	IP67 (IP20 for Terminal Version)		

Differential Pressure Controls Series FD 113

Features

- Immediate reset (no cooling down period)
- Precise timing
- Adjustable time delay from 30 ... 150 sec (ZU types)
- Separate output signals for operation and alarm
- Suitable for supply voltage 24...240 V AC / DC
- Pressure connection: Flare 7/16"-20 UNF, 1/4" SAE male



FD 113

Standards

- per Low Voltage Directive
- File No. E85974

Type	Part No.	Time Delay		Cut out		Cut in Fixed Setting	Max. Differential Pressure	Max. Proof Pressure
		Adjustable	Factory Setting	Adjusting Range Δp	Factory Setting			
FD 113	0 710 173	-	-	0.3 ... 4.5 bar	0.7 bar	0.2 bar above cut-out		
FD 113 ZU	3 465 300	20 ... 150 s	120 s*					
FD 113 ZU (A22-057) Copeland™ brand products	0 711 195	-	115 s* Fix	-	0.63 bar Fix	Appr. 0.9 bar	-0.8 ... 12 bar	25 bar

Note: *) Time Delay tolerance +/- 20%.

Technical Data

Inductive Amp. (AC)	3.0 A / 230 V AC
Inductive Amp. (DC)	0.1 A / 230 V DC
Protection Acc. to EN 60 529	IP 30
Max. Temperature at Pressure Connection	+70°C

Accessories

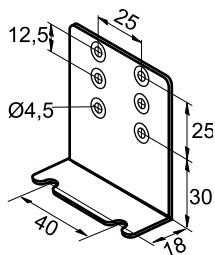

Mounting Bracket Angle
Part No.: 803 799

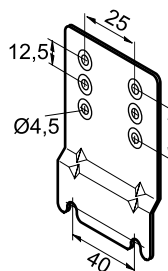

Mounting Plate for Units with Hood
Part No.: 803 801

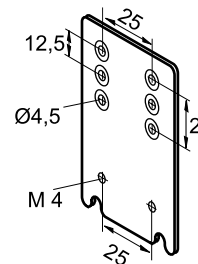

Extension Bracket
Part No.: 803 800



Thermostats

Basic Terms and Technical Information

Characteristics

Alco thermostats are electric circuit control devices which open or close an electric contact depending on temperature changes at the bulb.

Description of Bulb Charges

The application range of thermostats is mainly determined by the charge. Accordingly, various bulb shapes and sizes are necessary.

- **Vapor Charge, Bulb Type A, E, P**
The thermosystem is filled with a medium in vapor phase. A thermostat with vapor charge operates in accordance with temperature changes at the bulb as long as the bulb is the coldest part in the whole system (bellows, capillary tube, bulb). Alco thermostats are equipped with a bellows heater (82 k Ohm, 230 V) to avoid such conditions. On applications with low current the bellows heater has to be removed. Max. bulb temperature is 150°C (70°C for bulb type E). Response time is very fast.
- **Adsorption Charge, Bulb Type F**
This charge only reacts on temperature changes at the bulb. Max. bulb temperature is 100°C. Response time is slow but perfectly suitable for common refrigeration systems.

Adjustment of Switching Points

A thermometer should always be used for comparison when adjusting the switching points on temperature controls. The setting scale on the device is intended to serve for orientation, showing the setting range of the upper switching point t_{\max} in °C and °F and the value of the temperature differential Δt in K as difference between the upper switching point t_{\max} and the lower switching point t_{\min} . The upper switching point t_{\max} has to be adjusted on the scale, whereas the lower switching point t_{\min} is given by adjustment of the desired switching differential Δt . The formula is:

$$\text{Upper switching point} - \text{Differential} = \text{Lower switching point}$$

$$t_{\max} - \Delta t = t_{\min}$$

Important!

The differential Δt mentioned on the differential scale and in the technical data refers to the upper part of the setting range and the upper switching point.

In the lower part of the setting range an increase of the differential Δt can be expected. The lowest possible lower switching point t_{\min} is mentioned in the selection tables and is helpful to select switching points with large differentials Δt in the lower temperature range.

Bulb Sizes

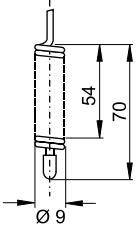
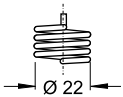
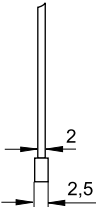
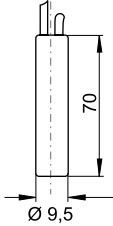
A	E	P	F
			
Vapor 2m, Capillary with Bulb	Vapor Coil, 0m	Vapor 2m, Capillary with Function C and D 6m	Adsorption 2m, Capillary with Bulb

Function of Contacts

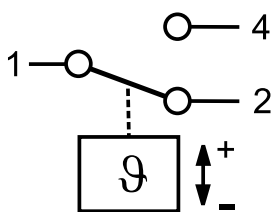

SPDT

- On temperature rise above setting 1-2 opens and 1-4 closes.
- On temperature drop below setting 1-2 closes and 1-4 opens.

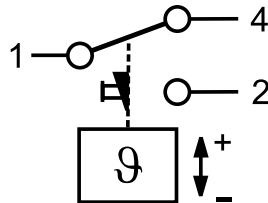

SPDT with manual reset min.

- On temperature drop below setting 1-2 closes. 1-4 opens and latches.
- The device can be manually reset when the temperature has risen at least 2K above setting.

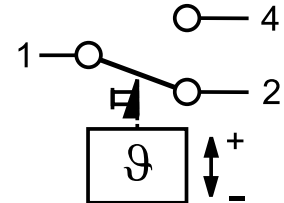

SPDT with manual reset max.

- On temperature rise above setting 1-2 opens and 1-4 closes and latches.
- The device can be manually reset when the temperature has dropped 2K below setting.

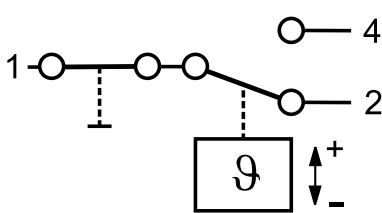

SPDT with off switch
AUTOmatic - STOP

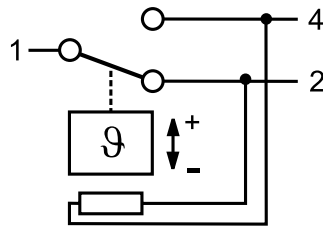

SPDT with bellows heater
includes a 82 k Ohm, 230 V AC/DC resistor

Standards and Regulations

Important for the installation of thermostats:

EN 60730-2-9 Specification for temperature controls and temperature cut-outs.

EN 60947-1/ Specifications for low-voltage switchgear.
EN 60947-5-1

Thermostats Series TS1

Features

- Adjustable temperatures and differentials
- Chatter resistant contacts (bounce-free)
- High operational current, locked rotor max. 144 A (LRA)
- Standard SPDT with same operational current rating for both contacts
- Captive terminal and cover screws
- Range and differential individually lockable by wire seal

Technical Data

Type of Contacts	1 SPDT
Heating Load (AC1)	24A / 230V AC
Inductive Load (AC15)	10A / 230V AC
Inductive Load (DC13)	0.1A / 230V DC, 3A / 24V DC
Motor Rating (FLA):	24 A / 120/240V AC
Locked Rotor (LRA):	144 A / 120/240V AC
Ambient Temperature Range	-50 ... +70°C
Cable Entry	Grommet PG 16
Protection Acc. to EN 60529 / IEC 529	IP 44 (IP 30 with Selector Switch)
Bellows Heater at Vapor Charge	82 K Ohm. 230 V AC / DC (12 and 24 V DC upon request) sensing range: -55...+180°C



TS1 Top Operated

TS1 Flush Mounted

TS1 Front Operated

Standards

- per Low Voltage Directive
- US LISTED Underwriter Laboratories File Nr: E85974

Type	Part No.	Adjustment Range		Lowest Setpoint	Factory Setting	Max. Bulb Temp.	Temperature Sensor	
		Upper Setpoint	Differential Setpoint ΔT				Charge	Cap. Tube Length
Thermostats Top Operated Thermostats without Off-Switch								
TS1-A2P	4 530 400	-30 ... +15°C	1.5 ... 16K	-36°C	-1°C / -6°C	+150°C	Vapor	2m Capillary
TS1-A3P	4 356 700	-10 ... +35°C	1.5 ... 16K	-23°C	+3°C / -2°C			
TS1-A1A	4 351 500	-45 ... -10°C	1.5 ... 16K	-55°C	-18°C / -20°C	+150°C	Vapor	2m Capillary and Bulb
TS1-A2A	4 351 600	-30 ... +15°C	1.5 ... 16K	-36°C	-1°C / -6°C			
TS1-A3A	4 352 500	-10 ... +35°C	1.5 ... 16K	-23°C	+3°C / -2°C			
TS1-A4F Defrost- and Universal Thermostat	4 351 800	-30 ... +35°C	2.8 ... 20°C	-35°C	+5°C / 0°C	+100°C	Adsorption	2m Capillary and Bulb
TS1-A5F	4 458 400	+20 ... +60°C	3 ... 10K	+10°C	+35°C / +30°C			
Thermostats with Off-Switch								
TS1-B2A	4 366 800	-30 ... +15°C	1.5 ... 16K	-36°C	-1v / -6°C	+100°C	Adsorption	
TS1-B3A	4 366 900	-10 ... +35°C	1.5 ... 16K	-23°C	+3°C / -2°C			
TS1-B4F	4 367 000	-30 ... +35°C	2.8 ... 20K	-35°C	+5°C / 0°C			
Frost Monitors Top Operated Frost Monitors without Off-Switch								
TS1-C0P	4 352 100	+4.5 ... +20°C	2.5K fix	+2°C	4,5°C / +2°C	+150°C	Vapor	6m Capillary
TS1-D0P Low Temp. Cut Out	4 352 200	+4.5 ... +20°C	Man. Reset ca. 2.5K fix	+2°C	+2°C			

Type	Part No.	Adjustment Range		Lowest Setpoint	Factory Setting	Max. Bulb Temp.	Temperature Sensor	
		Upper Setpoint	Differential Setpoint ΔT				Charge	Cap. Tube Length
Room Thermostats Top Operated								
Room Thermostats without Off-Switch, Including Insulation Console								
TS1-A3E	4 355 300	-10 ... +35°C	1.5 ... 16K	-23°C	+20 / +18°C	+70°C	Vapor	0m coil
Room Thermostats with Off-Switch, Including Insulation Console								
TS1-B3E	4 344 500	-10 ... +35°C	1.5 ... 16K	-23°C	+20 / +18°C	+70°C	Vapor	0m coil
Thermostats Front Operated								
Thermostats without Off-Switch								
TS1-E1A	4 361 000	-45 ... -10°C	2 ... 16K	-55°C	-18 / -20°C	+150°C	Vapor	2m capillary and bulb
TS1-E2A	4 356 200	-30 ... +10°C	1.5 ... 15K	-36°C	+4 / +2°C			
TS1-E3A	4 365 200	-10 ... +25°C	1.5 ... 15K	-23°C	+3 / -2°C			
TS1-E4F Defrost- and universal thermostat	4 367 500	-25 ... +30°C	2.8 ... 20K	-30°C	+5 / 0°C	+100°C	Adsorption	
TS1-E5F	4 338 100	+20 ... +60°C	3 ... 10K	+10°C	+35 / +30°C			
Thermostats with Off-Switch								
TS1-F1A	4 367 100	-45 ... -10°C	2 ... 16K	-55°C	-18 / -20°C	+150°C	Vapor	2m capillary and bulb
TS1-F2A	4 367 200	-30 ... +10°C	1.5 ... 15K	-36°C	-1 / -6°C			
TS1-F3A	4 367 400	-10 ... +25°C	1.5 ... 15K	-23°C	+3 / -2°C			
Room Thermostats Front Operated								
Room Thermostats without Off-Switch, Including Insulation Console								
TS1-E1E	4 365 300	-45 ... -10°C	2 ... 16K	-55°C	-18 / -20°C	+70°C	Vapor	0m coil
TS1-E2E	4 356 800	-30 ... +10°C	1.5 ... 15K	-36°C	+4 / +2°C			
Room Thermostats with Off-Switch, Including Insulation Console								
TS1-F1E	4 368 000	-45 ... -10°C	2 ... 16K	-55°C	-18 / -20°C	+70°C	Vapor	0m coil
TS1-F2E	4 368 100	-30 ... +10°C	1.5 ... 15K	-36°C	+4 / +2°C			
TS1-F3E	4 368 200	-10 ... +25°C	1.5 ... 15K	-23°C	+20 / +18°C			
Thermostats for Flush Mounting								
Thermostats for Flush Mounting without Off-Switch								
TS1-G2A	4 355 400	-30 ... +15°C	1.5 ... 15K	-36°C	+4 / +2°C	+150°C	Vapor	2m capillary and bulb
TS1-G4F Defrost- and universal thermostat	4 355 600	-30 ... +35°C	2.8 ... 20K	-35°C	+5 / 0°C	+100°C	Adsorption	
Thermostats for Flush Mounting with Off-Switch								
TS1-H2A	4 355 500	-30 ... +15°C	1.5 ... 15K	-36°C	-1 / -6°C	+150°C	Vapor	2m capillary and bulb
TS1-H3A	4 367 900	-10 ... +35°C	1.5 ... 15K	-23°C	+3 / +2°C			

Accessories

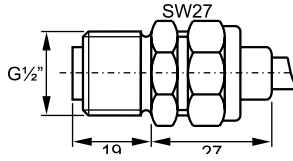

Capillary Tube Gland. Brass
for Bulb Style A / C
Part No.: 803 807

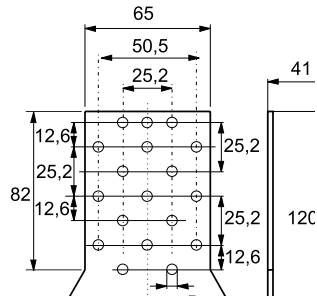

Universal Mounting Bracket
Part No.: 803 798

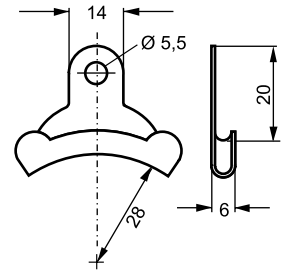

Capillary Tube Holder
for Frost Monitors Standard
Part No.: 803 778

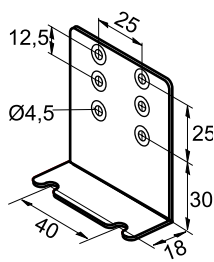

Mounting Bracket Angle
Part No.: 803 799

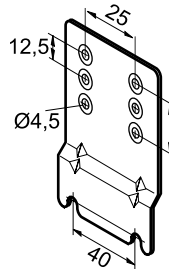

Mounting Plate
for Units with Hood
Part No.: 803 801

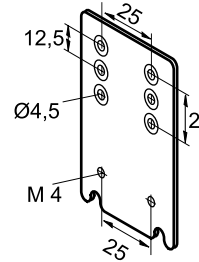

Extension Bracket
Part No.: 803 800

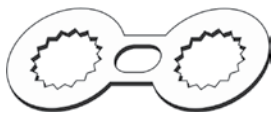

Locking Plate
Part No.: 803783 (20 pcs)





System Protectors and Moisture Indicators

Filter Driers

Basic Terminology and Technical Information

Function

The purpose of filter driers is to keep the refrigeration circuit clean of water, acid and solid contaminants. In case of contamination, corrosion and ice building can occur, as well as malfunction of the compressor.

Property of Desiccants

Molecular Sieves

This kind of desiccant has a very good drying effect independent of the oil content of the refrigerant. Molecular sieve is a fast acting desiccant and will remove moisture even when the water content of the refrigerant is low and when the temperature of the liquid refrigerant is high.

Activated Alumina

Activated alumina incorporate an excellent acid capacity. By selecting a specific mixture of both desiccants, an optimum effect can be achieved to cover the requirements of all kinds of applications. Liquid filter driers are specially designed for a high water capacity, whereas suction line filter driers feature a high acid and filtration capacity.

Flow Capacity

Flow capacity refers to ARI-Standard 710-86 and DIN 8949 and is based on a pressure drop of 0.07 bar, +30°C liquid temperature and -15°C evaporating temperature for common refrigerants.

The flow capacities are given at two levels of pressure drop: 0.07 and 0.14 bar.

For selection of other operating condition, please use Controls Navigator selection program.

Water Capacity

The water capacity for R22 refers to ARI 710-86 and DIN8948 is based on a liquid temperature of 24/52°C and an equilibrium point dryness (EPD) of 60 PPM water in refrigerant. The EPD for other refrigerants according to DIN 8949 is as follows:

Refrigerant	EPD (PPM)
R134a, R407C, R404A, R507C, R410A, R32, R1234ze, R1234yf, R744	50
R450A, R513A, R448A, R449A, R452B, R454B, R454C, R454A, R455A	60



Selection Guide for Filter and Filter Driers

Selection Criteria	Series										
	BFK	ADK	FDB	ADKS/FDH with Core		FDS-24 with Core		ASF	ASD	BTAS with Core	
				H/S/W48	F48	S24	F24			AF	AF-D
Hermetic Design	+	+	+					+	+		
For Exchangeable Cores				+	+	+	+			+	+
Quick Cap Fange						+	+				
Filter					+		+	+		+	
Filter Drier	+	+	+	+		+			+		+
For Liquid Service	+	+	+	+		+					
For Suction Service					+	+	+	+	+	+	+
For Heat Pumps (Bi-Flow)	+										
Shell Material	Steel	Steel	Steel	Steel		Steel		Steel	Steel	Brass	
Max. Allowable Pressure PS	45 bar	45 bar	45 Bbar	34.5*/46.0* bar		34.5* bar		27.5 bar		24 bar	

Note: *) Dependent on Medium Temperature

Bi-flow Filter Driers Series BFK

Hermetic Design for Liquid Refrigerants

Features

- Solid block style
- Integrated check valves ensure Bi-flow capability, eliminate the need for external check valves and reduce the external piping
- ODF Copper fittings for easy brazing
- Pattern flow for non-turbulent performance
- High water, acid adsorption capacity
- Filtration down to 40 microns
- Temperature range TS: -45°C...+65°C
- Max. allowable pressure PS: 45 bar
- CE marking not required acc. PED
-  US LISTED Underwriter Laboratories



BFK

Selection table - A1 Refrigerants

Type	Part No.	Connection ODF* /SAE*	Flow Capacity (kW) Pressure Drop 0.07 bar**					
			R134a	R407C	R404A R507	R410A	R450A	R513A
BFK 052	007343	1/4"(6mm) SAE	5.2	5.4	3.7	5.6	4.8	4.6
BFK 052S	007344	1/4" ODF	6.7	7.0	4.8	7.2	6.1	5.9
BFK 083	007345	3/8"(10mm) SAE	10.6	11.0	7.5	11.4	9.7	9.2
BFK 083S	007346	3/8" ODF	12.0	12.5	8.5	12.9	11.0	10.5
BFK 084	007347	1/2"(12mm) SAE	15.2	15.8	10.8	16.4	13.9	13.3
BFK 084S	007348	1/2" ODF	15.6	16.2	11.1	16.8	14.3	13.6
BFK 163	007349	3/8"(10mm) SAE	13.6	14.2	9.7	14.7	12.5	11.9
BFK 163S	007350	3/8" ODF	15.5	16.1	11.0	16.7	14.2	13.5
BFK 164	007351	1/2"(12mm) SAE	20.3	21.1	14.4	21.9	18.6	17.7
BFK 164S	007352	1/2" ODF	24.3	25.3	17.3	26.1	22.2	21.2
BFK 165	007353	5/8"(16mm) SAE	25.1	26.2	17.9	27.1	23.0	21.9
BFK 165S	007354	5/8" ODF	25.6	26.7	18.3	27.6	23.5	22.4
BFK 305S	007356	5/8" (16mm) ODF	34.1	35.6	24.3	36.8	31.3	29.8
BFK 307S	007357	7/8" (22mm) ODF	40.6	42.3	28.9	43.7	37.2	35.5
BFK 309S	007358	1 1/8" ODF	47.0	49.0	33.5	50.7	43.1	41.1

Selection table - A2L Refrigerants

Type	Part No.	Connection ODF* /SAE*	Flow capacity (kW) pressure drop 0.07 bar**					
			R32	R452B	R454B	R454C	R1234ze	R1234yf
BFK 052	007343	1/4"(6mm) SAE	8.1	6.3	6.4	4.2	4.6	3.8
BFK 052S	007344	1/4" ODF	10.4	8.1	8.2	5.4	5.9	4.8
BFK 083	007345	3/8"(10mm) SAE	16.3	12.8	12.8	8.5	9.2	7.6
BFK 083S	007346	3/8" ODF	18.5	14.5	14.6	9.7	10.5	8.6
BFK 084	007347	1/2"(12mm) SAE	23.5	18.4	18.5	12.3	13.3	10.9
BFK 084S	007348	1/2" ODF	24.1	18.8	18.9	12.6	13.6	11.2
BFK 163	007349	3/8"(10mm) SAE	21.1	16.5	16.6	11.0	11.9	9.8
BFK 163S	007350	3/8" ODF	23.9	18.7	18.8	12.5	13.6	11.1
BFK 164	007351	1/2"(12mm) SAE	31.3	24.5	24.7	16.4	17.8	14.6
BFK 164S	007352	1/2" ODF	37.5	29.3	29.5	19.6	21.3	17.5
BFK 165	007353	5/8"(16mm) SAE	38.8	30.4	30.6	20.3	22.0	18.1
BFK 165S	007354	5/8" ODF	39.7	31.0	31.2	20.7	22.5	18.5
BFK 305S	007356	5/8" (16mm) ODF	52.8	41.3	41.5	27.6	29.9	24.6
BFK 307S	007357	7/8" (22mm) ODF	62.8	49.1	49.4	32.8	35.6	29.2
BFK 309S	007358	1 1/8" ODF	72.7	56.9	57.2	38.0	41.2	33.8

Note 1: Flow capacities are in accordance with ARI710-86 and DIN8949

Note 2: **) for 0.14 bar pressure drop, multiple values by 1.4

Note 3: *) SAE = Flare. ODF = Brazing female

Note 4: Product label update is pending!

Nominal Operating Capacities Based on Following Conditions:

Refrigerant	Evaporating Temperature	Liquid Temperature	Flow Rate kg/kW/sec.	Refrigerant	Evaporating Temperature	Liquid Temperature	Flow rate kg/kW/sec.
R134a	-15°C	+30°C	0.0068	R32	-15°C	+30°C	0.0039
R407C			0.0063	R452B			0.0043
R404A/R507			0.0088	R454B			0.0047
R410A			0.0059	R454C			0.0058
R450A			0.0074	R1234ze			0.0076
R513A			0.0079	R1234yf			0.0089

Note: For selection of other operating conditions please use Control Navigator Software. Product label update is pending!

Water and Acid Adsorption Capacity



A1 Refrigerants

Type / Size	Water Adsorption Capacity (gram)												Acid Adsorption Capacity (gram)
	Liquid Temperature 24°C						Liquid Temperature 52°C						
	R134a	R404A/R507	R407C	R410A	R450A	R513A	R134a	R404A/R507	R407C	R410A	R450A	R513A	
BFK-05...	4.4	4.5	3.4	2.8	6.0	6.0	4.1	4.3	2.8	2.2	5.4	5.4	0.3
BFK-08...	9.6	9.9	7.5	6.2	10.2	10.1	8.9	9.4	6.0	4.7	9.2	9.2	0.6
BFK-16...	18.9	19.5	14.8	12.2	14.1	14.1	17.5	18.5	11.9	9.3	15.5	15.5	1.2
BFK-30...	34.5	35.6	27.1	22.4	28.8	28.8	31.9	33.7	21.7	17.0	31.7	31.7	2.0

A2L Refrigerants

Type / Size	Water Adsorption Capacity (gram)										Acid Adsorption Capacity (gram)
	Liquid Temperature 24°C					Liquid Temperature 52°C					
	R32	R452B	R454B/R454C	R1234ze	R1234yf	R32	R452B/R454C	R454B	R1234ze	R1234yf	
BFK-05...	3.4	3.4	3.4	6.0	6.0	2.7	2.6	2.6	5.4	5.4	0.3
BFK-08...	5.7	5.7	5.7	10.2	10.2	4.5	4.4	4.4	9.2	9.2	0.6
BFK-16...	11.5	10.8	10.8	19.1	14.1	9.1	8.3	8.3	17.4	17.4	1.2
BFK-30...	23.2	21.9	21.9	39.1	28.8	18.4	17.0	17.0	35.5	35.5	2.0

A2L Refrigerants

Max. Allowable Pressure PS	45 bar	Material Shell	Steel
Test Pressure PT	47.3 bar	Paint	Epoxy Powder paint
Liquid Temperature Refrigerant	-45...+65 °C	Connections	Solder Flare Copper, ODF Burnished, SAE
Fluid Group	I + II	Protection	
List of Released Refrigerants	Fluid Group II (A1): R134a, R404A, R407C, R410A, R450A, R507, R513A Fluid Group I (A2L): R32, R452B, R454B, R454C, R1234ze, R1234yf	Package	Individual packaged
Note: Fluid group classification according to PED 2014/68/EU.		Marking	 (A2L pending)  (acc. PED, V > 1 liter), 

Filter Driers Series ADK

Hermetic Design for Liquid Refrigerants

Features

- Robust block with optimum blend of molecular sieve and activated alumina
- ODF Copper fittings for easy brazing
- High water and acid adsorption capacity
- Filtration down to 20 microns
- Temperature range TS: -45°C...+65°C
- Max. allowable pressure PS: 45 bar
- CE marking not required acc. PED
-  Underwriter Laboratories



ADK

Selection Table - A1 Refrigerants

Type	Part No.	Connection ODF*/SAE*	Flow capacity (kW) pressure drop 0.07 bar **									
			R134a	R407C	R404A R507	R410A	R448A	R449A	R450A	R513A	R452A	R744
ADK-032	003 595	1/4"(6 mm) SAE	6.7	7	4.8	7.2	6.4	6.2	6.1	5.9	4.8	8.1
ADK-032S	003 596	1/4" ODF	8.1	8.4	5.7	8.7	7.7	7.5	7.4	7.0	5.8	9.7
ADK-036MMS	003 597	6 mm ODF	7.3	7.6	5.2	7.9	7.0	6.8	6.7	6.4	5.3	8.8
ADK-052	003 598	1/4"(6 mm) SAE	6.9	7.2	4.9	7.5	6.6	6.5	6.4	6.1	5.0	8.3
ADK-052S	003 599	1/4" ODF	9.9	10.3	7	10.7	9.4	9.2	9.1	8.6	7.1	11.9
ADK-056MMS	003 600	6 mm ODF	9.2	9.5	6.5	9.9	8.7	8.5	8.4	8.0	6.6	11.0
ADK-053	003 601	3/8"(10 mm) SAE	13	13.5	9.2	14	12.3	12.1	11.9	11.3	9.4	15.6
ADK-053S	003 602	3/8" ODF	15	15.6	10.7	16.1	14.3	14.0	13.7	13.1	10.8	18.0
ADK-0510MMS	003 603	10 mm ODF	15	15.6	10.7	16.1	14.3	14.0	13.7	13.1	10.8	18.0
ADK-082	003 604	1/4"(6 mm) SAE	7.1	7.4	5.1	7.7	6.8	6.7	6.5	6.2	5.2	8.6
ADK-082S	003 605	1/4" ODF	10.9	11.4	7.8	11.8	10.4	10.2	10.0	9.6	7.9	13.2
ADK-086MMS	003 606	6 mm ODF	9.8	10.2	7	10.5	9.3	9.1	9.0	8.5	7.1	11.7
ADK-083	003 607	3/8"(10 mm) SAE	15	15.6	10.7	16.2	14.3	14.0	13.8	13.1	10.8	18.1
ADK-083S	003 608	3/8" ODF	15	15.7	10.7	16.2	14.3	14.0	13.8	13.1	10.9	18.1
ADK-0810MMS	003 609	10 mm ODF	15	15.6	10.7	16.2	14.3	14.0	13.8	13.1	10.8	18.1
ADK-084	003 610	1/2"(12 mm) SAE	23.5	24.5	16.7	25.3	22.4	21.9	21.5	20.5	17.0	28.3
ADK-084S	003 611	1/2" ODF	24.5	25.6	17.5	26.4	23.3	22.9	22.5	21.4	17.7	29.5
ADK-0812MMS	003 612	12 mm ODF	24.1	25.1	17.2	26	22.9	22.5	22.1	21.1	17.4	29.0
ADK-162	003 613	1/4"(6 mm) SAE	7.3	7.6	5.2	7.8	6.9	6.8	6.7	6.4	5.3	8.8
ADK-163	003 614	3/8"(10 mm) SAE	15.4	16	10.9	16.5	14.6	14.3	14.1	13.4	11.1	18.5
ADK-163S	003 615	3/8" ODF	17.2	17.9	12.2	18.5	16.3	16.0	15.7	15.0	12.4	20.6
ADK-1610MMS	003 616	10 mm ODF	17.1	17.8	12.2	18.5	16.3	16.0	15.7	15.0	12.4	20.6
ADK-164	003 617	1/2"(12 mm) SAE	28.7	29.9	20.4	30.9	27.3	26.7	26.3	25.1	20.7	34.5
ADK-164S	003 618	1/2" ODF	33	34.3	23.5	35.5	31.4	30.7	30.2	28.8	23.8	39.6
ADK-1612MMS	003 619	12 mm ODF	29.6	30.8	21.1	31.9	28.2	27.6	27.1	25.9	21.4	35.6
ADK-165	003 620	5/8"(16 mm) SAE	41.1	42.8	29.2	44.3	39.1	38.3	37.7	35.9	29.7	49.4
ADK-165S	003 621	5/8"(16 mm) ODF	45.6	47.4	32.4	49.1	43.3	42.5	41.8	39.8	32.9	54.8
ADK-303	003 622	3/8"(10 mm) SAE	16.2	16.9	11.5	17.5	15.4	15.1	14.9	14.2	11.7	19.5
ADK-304	003 623	1/2"(12 mm) SAE	28.7	29.9	20.4	30.9	27.3	26.7	26.3	25.1	20.7	34.5
ADK-304S	003 624	1/2" ODF	33	34.4	23.5	35.6	31.4	30.8	30.3	28.8	23.8	39.7
ADK-305	003 626	5/8"(16 mm) SAE	48.2	50.2	34.3	52	45.9	45.0	44.2	42.1	34.8	58.0
ADK-305S	003 627	5/8"(16 mm) ODF	48.4	50.4	34.4	52.1	46.0	45.1	44.3	42.2	34.9	58.1
ADK-307S	003 628	7/8"(22 mm) ODF	60.7	63.2	43.2	65.4	57.8	56.6	55.7	53.0	43.9	73.0
ADK-414	003 629	1/2"(12 mm) SAE	33.7	35.1	24	36.3	32.1	31.4	30.9	29.4	24.3	40.5
ADK-415	003 632	5/8"(16 mm) SAE	53.7	55.9	38.2	57.8	51.1	50.0	49.2	46.9	38.8	64.5
ADK-415S	003 633	5/8"(16 mm) ODF	57.7	60.1	41.1	62.2	54.9	53.8	52.9	50.4	41.7	69.4
ADK-417S	003 634	7/8"(22 mm) ODF	71.4	74.3	50.8	76.9	67.9	66.6	65.4	62.4	51.5	85.8
ADK-757S	003 635	7/8"(22 mm) ODF	96.7	100.7	68.8	104.2	92.0	90.1	88.6	84.4	69.8	116.2
ADK-759S	003 636	1-1/8" ODF	107.4	111.8	76.4	115.7	102.1	100.1	98.4	93.8	77.5	129.0

Note 1: Flow capacities are in accordance with ARI710-86 and DIN8949. R744 is not specified by standard.

Note 2: **) for 0.14 bar pressure drop, multiple values by 1.4

Note 3: *) SAE = Flare. ODF = Brazing female

Note 4: Product label update is pending!

Nominal Flow Capacities bases on following operating conditions:

Refrigerant	Evaporating Temperature	Liquid Temperature	Flow rate kg/kW/sec.	Refrigerant	Evaporating Temperature	Liquid Temperature	Flow rate kg/kW/sec.
R134a	-15°C	+30°C	0.0068	R448A	-15°C	+30°C	0.0061
R407C			0.0063	R449A			0.0061
R404A/R50			0.0088	R450A			0.0074
R410A			0.0059	R452A			0.0086
R744	-40°C	-10°C	0.0039	R513A			0.0079

Note: For selection of other operating conditions please use Control Navigator Software.

Selection Table - A2L Refrigerants

Type	Part No.	Connection ODF*/SAE*	Flow capacity (kW) pressure drop 0.07 bar **							
			R32	R452B	R454B	R454A	R454C	R455A	R1234ze	R1234yf
ADK-032	003 595	1/4"(6 mm) SAE	10.4	8.1	8.1	6.2	5.4	5.7	5.9	4.8
ADK-032S	003 596	1/4" ODF	12.4	9.7	9.8	7.4	6.5	6.9	7.1	5.8
ADK-036MMS	003 597	6 mm ODF	11.3	8.9	8.9	6.8	5.9	6.3	6.4	5.3
ADK-052	003 598	1/4"(6 mm) SAE	10.7	8.4	8.4	6.4	5.6	5.9	6.1	5.0
ADK-052S	003 599	1/4" ODF	15.3	12.0	12.0	9.1	8.0	8.5	8.7	7.1
ADK-056MMS	003 600	6 mm ODF	14.2	11.1	11.1	8.5	7.4	7.8	8.0	6.6
ADK-053	003 601	3/8"(10 mm) SAE	20.1	15.7	15.8	12.0	10.5	11.1	11.4	9.3
ADK-053S	003 602	3/8" ODF	23.2	18.1	18.2	13.8	12.1	12.8	13.1	10.8
ADK-0510MMS	003 603	10 mm ODF	23.2	18.1	18.2	13.8	12.1	12.8	13.1	10.8
ADK-082	003 604	1/4"(6 mm) SAE	11.0	8.6	8.7	6.6	5.8	6.1	6.2	5.1
ADK-082S	003 605	1/4" ODF	16.9	13.2	13.3	10.1	8.8	9.4	9.6	7.9
ADK-086MMS	003 606	6 mm ODF	15.1	11.8	11.9	9.0	7.9	8.4	8.6	7.0
ADK-083	003 607	3/8"(10 mm) SAE	23.2	18.2	18.3	13.9	12.1	12.8	13.2	10.8
ADK-083S	003 608	3/8" ODF	23.2	18.2	18.3	13.9	12.1	12.9	13.2	10.8
ADK-0810MMS	003 609	10 mm ODF	23.2	18.2	18.3	13.9	12.1	12.8	13.2	10.8
ADK-084	003 610	1/2"(12 mm) SAE	36.3	28.4	28.6	21.7	19.0	20.1	20.6	16.9
ADK-084S	003 611	1/2" ODF	37.9	29.7	29.9	22.6	19.8	21.0	21.5	17.7
ADK-0812MMS	003 612	12 mm ODF	37.3	29.2	29.3	22.3	19.5	20.6	21.1	17.4
ADK-162	003 613	1/4"(6 mm) SAE	11.3	8.8	8.9	6.7	5.9	6.2	6.4	5.2
ADK-163	003 614	3/8"(10 mm) SAE	23.7	18.6	18.7	14.2	12.4	13.1	13.4	11.0
ADK-163S	003 615	3/8" ODF	26.5	20.7	20.9	15.8	13.8	14.7	15.0	12.3
ADK-1610MMS	003 616	10 mm ODF	26.5	20.7	20.8	15.8	13.8	14.7	15.0	12.3
ADK-164	003 617	1/2"(12 mm) SAE	44.4	34.7	34.9	26.5	23.2	24.5	25.1	20.6
ADK-164S	003 618	1/2" ODF	51.0	39.9	40.1	30.4	26.6	28.2	28.9	23.7
ADK-1612MMS	003 619	12 mm ODF	45.8	35.8	36.0	27.3	23.9	25.3	25.9	21.3
ADK-165	003 620	5/8"(16 mm) SAE	63.5	49.7	50.0	37.9	33.2	35.1	36.0	29.6
ADK-165S	003 621	5/8"(16 mm) ODF	70.4	55.1	55.4	42.0	36.8	39.0	39.9	32.8
ADK-303	003 622	3/8"(10 mm) SAE	25.0	19.6	19.7	15.0	13.1	13.9	14.2	11.7
ADK-304	003 623	1/2"(12 mm) SAE	44.4	34.7	34.9	26.5	23.2	24.5	25.1	20.6
ADK-304S	003 624	1/2" ODF	51.0	39.9	40.1	30.5	26.7	28.2	28.9	23.7
ADK-305	003 626	5/8"(16 mm) SAE	74.5	58.3	58.7	44.5	38.9	41.2	42.2	34.7
ADK-305S	003 627	5/8"(16 mm) ODF	74.8	58.5	58.8	44.6	39.0	41.4	42.4	34.8
ADK-307S	003 628	7/8"(22 mm) ODF	93.9	73.4	73.9	56.0	49.0	51.9	53.2	43.7
ADK-414	003 629	1/2"(12 mm) SAE	52.1	40.8	41.0	31.1	27.2	28.8	29.5	24.3
ADK-415	003 632	5/8"(16 mm) SAE	83.0	64.9	65.3	49.5	43.3	45.9	47.0	38.6
ADK-415S	003 633	5/8"(16 mm) ODF	89.2	69.8	70.2	53.3	46.6	49.4	50.5	41.5
ADK-417S	003 634	7/8"(22 mm) ODF	110.4	86.3	86.8	65.9	57.6	61.1	62.5	51.4
ADK-757S	003 635	7/8"(22 mm) ODF	149.4	116.9	117.6	89.2	78.1	82.7	84.7	69.5
ADK-759S	003 636	1-1/8" ODF	166.0	129.8	130.6	99.1	86.7	91.8	94.0	77.2

Note 1: Flow capacities are in accordance with ARI710-86 and DIN8949.

Note 2: *) SAE = Flare, ODF = Brazing female

Note 3: **) for 0.14 bar pressure drop, multiple values by 1.4

Note 4: Product label update is pending!

Nominal Flow Capacities bases on following operating conditions:

Refrigerant	Evaporating Temperature	Liquid Temperature	Flow rate kg/kW/sec.	Refrigerant	Evaporating Temperature	Liquid Temperature	Flow rate kg/kW/sec.
R32	-15°C	+30°C	0.0039	R454C	-15°C	+30°C	0.0058
R452B			0.0043	R455A			0.0072
R454B			0.0047	R1234ze			0.0076
R454A			0.0061	R1234yf			0.0089

Note: For selection of other operating conditions please use Control Navigator Software.

Water and Acid Adsorption Capacity

A1 Refrigerants / CO₂

Type / Size	Water Adsorption Capacity (gram)										Acid Adsorption Capacity
	Liquid Temperature 24°C					Liquid Temperature 52°C					
	R134a	R404A/R507	R407C	R410A	R744	R134a	R404A/R507	R407C	R410A	R744	
ADK-03	4.9	4.9	3.4	2.8		4.4	4.6	2.9	2.4		0.8 g
ADK-05	11.8	11.8	8.2	6.8		10.6	10.9	7	5.8		2.3 g
ADK-08	17.9	18	12.4	10.3		16.2	16.6	10.7	8.8		3.3 g
ADK-16	23	23.1	16	13.2		20.8	21.3	13.8	11.4		4.5 g
ADK-30	51.8	53.5	36.9	30.6		47.4	49.3	31.8	26.3		11.3 g
ADK-41	81.7	84.3	58.2	48.3		74.8	77.8	50.2	41.4		16.8 g
ADK-75	143.5	148.1	102.1	84.8		131.4	136.6	88.1	72.8		29.9 g



Type / Size	Water Adsorption Capacity (gram)										Acid Adsorption Capacity
	Liquid Temperature 25°C					Liquid Temperature 52°C					
	R448A	R449A	R450A	R513A	R452A	R448A	R449A	R450A	R513A	R452A	
ADK-03	4.7	4.7	6.0	6.0	3.4	4.3	4.3	5.5	5.4	2.7	0.8 g
ADK-05	9.0	9.0	11.4	11.3	6.5	8.2	8.2	10.3	10.3	5.0	2.3 g
ADK-08	13.7	13.7	17.3	17.2	9.8	12.4	12.4	15.7	15.7	7.7	3.3 g
ADK-16	17.5	17.5	22.2	22.1	12.6	16.0	16.0	20.2	20.1	9.9	4.5 g
ADK-30	39.9	39.9	52.0	51.7	32.8	37.5	36.3	46.1	45.9	25.6	11.3 g
ADK-41	52.8	52.8	68.8	68.4	43.4	49.7	48.1	61.0	60.7	33.9	16.8 g
ADK-75	93.8	93.8	122.1	121.4	77.1	88.2	85.3	108.4	107.8	60.1	29.9 g

A2L Refrigerants

Type / Size	Water Adsorption Capacity (gram)										Acid Adsorption Capacity
	Liquid Temperature 24°C					Liquid Temperature 52°C					
	R32	R452B	R454A R454B R454C	R455A	R1234ze R1234yf	R32	R452B	R454A R454B R454C	R455A	R1234ze R1234yf	
ADK-03	3.4	3.4	3.4	3.4	6.0	2.7	2.7	2.7	2.7	5.5	0.8 g
ADK-05	6.5	6.5	6.5	6.5	11.4	5.2	5.0	5.0	5.0	10.3	2.3 g
ADK-08	9.8	9.8	9.8	9.8	17.3	7.8	7.7	7.7	7.7	15.7	3.3 g
ADK-16	12.6	12.6	12.6	12.6	22.2	10.1	9.9	9.9	9.9	20.2	4.5 g
ADK-30	32.8	32.8	32.8	32.8	57.6	26.2	25.6	25.6	25.6	52.5	11.3 g
ADK-41	43.4	43.4	43.4	43.4	76.2	34.6	33.9	33.9	33.9	69.4	16.8 g
ADK-75	77.1	77.1	77.1	77.1	135.4	61.5	60.1	60.1	60.1	123.3	29.9 g

Technical Data

Max. Allowable Pressure PS	47.3 bar
Test Pressure PT	47.3 bar
Liquid Temperature Refrigerant	-45...+65°C
Fluid Group	I + II
List of Released Refrigerants Fluid Group II (A1):	R134a, R404A, R407C, R410A, R448A, R449A, R450A, R452A, R507, R513A, R774
Fluid Group I (A2L):	R32, R452B, R454B, R454A, R454C, R455A, R1234ze, R1234yf
<small>Note: Fluid group classification according to PED 2014/68/EU.</small>	

Material Shell	Steel
Paint	Epoxy Powder paint
Connections	Solder Flare Copper, ODF Burnished, SAE
Protection	500+ Hours salt spray test
Package	Individual packaged
Marking	 (A2L pending)  (acc. PED, V > 1 liter) 

Filter Driers Series FDB Hermetic Design, Bead Style for Liquid Refrigerants

Features

- Compacted bead style (spring loaded)
- Optimum blend of molecular sieve and activated alumina combined with high filtration capacity
- Filtration first for more effective use of surface area of desiccant
- High water and acid capacity
- Cushioned flow for non-turbulent performance
- ODF Copper fittings for easy brazing
- Rugged steel shells
- Corrosion-resistant epoxy paint
- Temperature range TS: -40°C...+65°C
- Max. allowable pressure PS: 45 bar
- CE marking not required acc. PED
-  Underwriter Laboratories



FDB

Selection Table - A1 Refrigerants

Type	Part No.	Connection ODF* /SAE*	Flow capacity (kW) pressure drop 0.07 bar **								
			R134a	R407C	R404A R507	R410A	R448A	R449A	R450A	R452A	R513A
FDB-032	059305	1/4"(6mm) SAE	6.3	6.6	4.5	6.8	6.0	5.9	5.8	4.6	5.5
FDB-032S	059306	1/4" ODF	9.7	10.1	6.9	10.5	9.2	9.1	8.9	7.0	8.5
FDB-052	059307	1/4"(6mm) SAE	6.5	6.8	4.6	7.0	6.2	6.1	6.0	4.7	5.7
FDB-052S	059309	1/4" ODF	9.7	10.1	6.9	10.5	9.2	9.1	8.9	7.0	8.5
FDB-053	059308	3/8"(10mm) SAE	15.5	16.1	11.0	16.7	6.4	6.3	6.2	4.9	5.9
FDB-053S	059310	3/8" ODF	19.3	20.1	13.8	20.8	9.4	9.2	9.1	7.1	8.6
FDB-082	059311	1/4"(6mm) SAE	6.8	7.1	4.8	7.3	6.4	6.3	6.2	4.9	5.9
FDB-082S	059314	1/4" ODF	9.9	10.3	7.0	10.7	14.7	14.4	14.2	11.2	13.5
FDB-083	059312	3/8"(10mm) SAE	15.8	16.4	11.2	17.0	18.4	18.0	17.7	14.0	16.9
FDB-083S	059315	3/8" ODF	19.8	20.6	14.1	21.3	15.0	14.7	14.4	11.4	13.8
FDB-084	059313	1/2"(12mm) SAE	26.4	27.5	18.8	28.4	18.8	18.4	18.1	14.3	17.3
FDB-084S	059316	1/2" ODF	28.3	29.5	20.1	30.5	15.4	15.1	14.9	11.7	14.2
FDB-162	059317	1/4"(6mm) SAE	6.8	7.1	4.8	7.3	21.9	21.4	21.1	16.6	20.1
FDB-163	059318	3/8"(10mm) SAE	16.2	16.9	11.5	17.5	17.2	16.8	16.5	13.0	15.8
FDB-163S	059321	3/8" ODF	23.0	23.9	16.4	24.8	25.1	24.6	24.2	19.0	23.0
FDB-164	059319	1/2"(12mm) SAE	27.9	29.1	19.9	30.1	26.9	26.4	25.9	20.4	24.7
FDB-164S	059322	1/2" ODF	36.0	37.5	25.6	38.8	26.6	26.0	25.6	20.2	24.4
FDB-165	059320	5/8"(16mm) SAE	36.6	38.2	26.1	39.5	34.2	33.6	33.0	26.0	31.4
FDB-165S	059323	5/8" ODF	48.8	50.8	34.8	52.6	30.2	29.6	29.1	23.0	27.8
FDB-303	059324	3/8"(10mm) SAE	18.0	18.8	12.8	19.4	36.2	35.4	34.8	27.4	33.2
FDB-304	059325	1/2"(12mm) SAE	31.8	33.1	22.6	34.2	34.9	34.2	33.6	26.5	32.0
FDB-304S	003667	1/2" ODF	38.0	39.6	27.1	41.0	46.4	45.5	44.7	35.3	42.6
FDB-305	059326	5/8"(16mm) SAE	40.3	42.0	28.7	43.4	38.3	37.6	36.9	29.1	35.2
FDB-305S	059327	5/8" ODF	53.8	56.0	38.3	57.9	51.2	50.1	49.3	38.8	47.0
FDB-307S	059328	7/8" ODF	60.5	63.1	43.1	65.2	47.3	46.4	45.6	35.9	43.4
FDB-415	059329	5/8"(16mm) SAE	49.7	51.8	35.4	53.6	57.6	56.5	55.5	43.7	52.9
FDB-417S	059330	7/8" ODF	77.2	80.4	55.0	83.2	73.5	72.0	70.8	55.8	67.5

Note 1: Flow capacities are in accordance with ARI710-86 and DIN8949.

Note 2: **) for 0.14 bar pressure drop, multiple values by 1.4

Note 3: *) SAE = Flare, ODF = Brazing female

Note 4: Product label update is pending!

Nominal Flow Capacities bases on following operating conditions:

Refrigerant	Evaporating Temperature	Liquid Temperature	Flow rate kg/kW/sec.	Refrigerant	Evaporating Temperature	Liquid Temperature	Flow rate kg/kW/sec.
R134a	-15°C	+30°C	0.0068	R448A	-15°C	+30°C	0.0061
R407C			0.0063	R449A			0.0061
R404A/R50			0.0088	R450A			0.0074
R410A			0.0059	R452A			0.0086
				R513A			0.0079

Note: For selection of other operating conditions please use Control Navigator Software.

Selection Table - A2L Refrigerants

Type	Part No.	Connection ODF*/SAE*	Flow capacity (kW) pressure drop 0.07 bar **							
			R32	R452B	R454B	R454A	R454C	R455A	R1234ze	R1234yf
FDB-032	059305	1/4"(6mm) SAE	9.8	7.6	7.7	5.8	5.1	5.4	4.5	5.5
FDB-032S	059306	1/4" ODF	15.0	11.7	11.8	9.0	7.8	8.3	7.0	8.5
FDB-052	059307	1/4"(6mm) SAE	10.1	7.9	7.9	6.0	5.3	5.6	4.7	5.7
FDB-052S	059309	1/4" ODF	15.0	11.7	11.8	9.0	7.8	8.3	7.0	8.5
FDB-053	059308	3/8"(10mm) SAE	23.9	18.7	18.8	14.3	12.5	13.2	11.1	13.6
FDB-053S	059310	3/8" ODF	29.9	23.4	23.5	17.8	15.6	16.5	13.9	16.9
FDB-082	059311	1/4"(6mm) SAE	10.5	8.2	8.2	6.3	5.5	5.8	4.9	5.9
FDB-082S	059314	1/4" ODF	15.3	12.0	12.0	9.1	8.0	8.3	7.1	8.7
FDB-083	059312	3/8"(10mm) SAE	24.4	19.1	19.2	14.5	12.7	13.5	11.3	13.8
FDB-083S	059315	3/8" ODF	30.6	23.9	24.1	18.3	16.0	16.9	14.2	17.3
FDB-084	059313	1/2"(12mm) SAE	40.8	31.9	32.1	24.3	21.3	22.6	19.0	23.1
FDB-084S	059316	1/2" ODF	43.8	34.2	34.4	26.1	22.9	24.2	20.4	24.8
FDB-162	059317	1/4"(6mm) SAE	10.5	8.2	8.2	6.3	5.5	5.8	4.9	5.9
FDB-163	059318	3/8"(10mm) SAE	25.1	19.6	19.7	15.0	13.1	13.9	11.7	14.2
FDB-163S	059321	3/8" ODF	35.5	27.8	28.0	21.2	18.6	19.7	16.5	20.1
FDB-164	059319	1/2"(12mm) SAE	43.2	33.8	34.0	25.8	22.6	23.9	20.1	24.5
FDB-164S	059322	1/2" ODF	55.7	43.5	43.8	33.2	29.1	30.8	25.9	31.5
FDB-165	059320	5/8"(16mm) SAE	56.6	44.3	44.6	33.8	29.6	31.3	26.4	32.1
FDB-165S	059323	5/8" ODF	75.5	59.0	59.4	45.1	39.4	41.8	35.1	42.8
FDB-303	059324	3/8"(10mm) SAE	27.9	21.8	21.9	16.7	14.6	15.4	13.0	15.8
FDB-304	059325	1/2"(12mm) SAE	49.1	38.4	38.7	29.3	25.7	27.2	22.9	27.8
FDB-304S	003667	1/2" ODF	58.8	46.0	46.2	35.1	30.7	32.5	27.3	33.3
FDB-305	059326	5/8"(16mm) SAE	62.3	48.7	49.0	37.2	32.5	34.5	29.0	35.3
FDB-305S	059327	5/8" ODF	83.1	65.0	65.4	49.6	43.4	46.0	38.7	47.1
FDB-307S	059328	7/8" ODF	93.6	73.2	73.6	55.9	48.9	51.8	43.6	53.0
FDB-415	059329	5/8"(16mm) SAE	76.9	60.1	60.5	45.9	40.2	51.8	35.8	43.6
FDB-417S	059330	7/8" ODF	119.4	93.4	93.9	71.3	62.3	66.0	55.6	67.6

Note 1: Flow capacities are in accordance with ARI710-86 and DIN8949.

Note 2: *) SAE = Flare. ODF = Brazing female

Note 3: **) for 0.14 bar pressure drop, multiple values by 1.4

Note 4: Product label update is pending!

Nominal Flow Capacities bases on following operating conditions:

Refrigerant	Evaporating Temperature	Liquid Temperature	Flow rate kg/kW/sec.	Refrigerant	Evaporating Temperature	Liquid Temperature	Flow rate kg/kW/sec.
R32	-15°C	+30°C	0.0039	R454C	-15°C	+30°C	0.0058
R452B			0.0043	R455A			0.0072
R454B			0.0047	R1234ze			0.0076
R454A			0.0061	R1234yf			0.0089

Note: For selection of other operating conditions please use Control Navigator Software.

Water and Acid Adsorption Capacity

A1 Refrigerants

Type / Size	Water Adsorption Capacity (gram)									
	Liquid Temperature 24°C					Liquid Temperature 52°C				
	R134a	R404A/ R507	R407C	R410A	R452A	R134a	R404A/ R507	R407C	R410A	R452A
FDB-03...	1.9	1.9	1.7	1.6		1.8	1.9	1.6	1.3	
FDB-05...	5.5	5.5	5.0	4.4		5.2	5.3	4.5	3.3	
FDB-08...	8.8	8.8	8.0	7.1		8.4	8.5	7.2	5.4	
FDB-16...	17.7	17.6	15.9	14.2		16.8	17.1	14.5	10.8	
FDB-30...	31.7	31.6	28.5	25.0		30.1	30.5	26.0	19.0	
FDB-41...	44.2	44.1	39.9	35.0		42.1	42.7	36.3	26.6	

Type / Size	Water Adsorption Capacity (gram)							
	Liquid Temperature 25°C				Liquid Temperature 52°C			
	R448A	R449A	R450A	R513A	R448A	R449A	R450A	R513A
FDB-03...	2.5	2.5	2.5	2.5	2.3	2.3	2.3	2.3
FDB-05...	6.8	6.8	6.9	6.9	6.2	6.2	6.3	6.3
FDB-08...	10.9	10.9	11.1	11.1	9.9	9.9	10.1	10.1
FDB-16...	21.6	21.6	22.0	22.0	19.7	19.7	20.0	20.0
FDB-30...	37.9	37.9	38.6	38.6	34.6	34.6	35.2	35.2
FDB-41...	53.2	53.2	54.2	54.2	48.5	48.5	49.4	49.4

A2L Refrigerants

Type / Size	Water Adsorption Capacity (gram)									
	Liquid Temperature 24°C					Liquid Temperature 52°C				
	R32	R452B	R454A R454B R454C	R455A	R1234ze R1234yf	R32	R452B	R454A R454B R454C	R455A	R1234ze R1234yf
FDB-03...	2.3	2.4	2.4	2.4	2.5	2.2	2.0	2.0	2.0	2.3
FDB-05...	6.3	6.5	6.5	6.5	6.9	5.9	5.5	5.5	5.5	6.3
FDB-08...	10.1	10.4	10.4	10.4	11.1	9.5	8.8	8.8	8.8	10.1
FDB-16...	20.1	20.7	20.7	20.7	22.0	18.8	17.5	17.5	17.5	20.0
FDB-30...	35.3	36.3	36.3	36.3	38.6	33.1	30.8	30.8	30.8	35.2
FDB-41...	49.5	50.9	50.9	50.9	54.2	46.4	43.2	43.2	43.2	49.4

Technical Data

Max. allowable pressure PS	45 bar
Test pressure PT	47.3 bar
Liquid Temperature Refrigerant	-45...+65°C
Fluid Group	I + II
List of released refrigerants	
Fluid group II (A1):	R134a, R404A, R407C, R410A, R448A, R449A, R450A, R452A, R507, R513A
Fluid group I (A2L):	R32, R452B, R454B, R454A, R454C, R455A, R1234ze, R1234yf
<small>Note: Fluid group classification according to PED 2014/68/EU.</small>	

Material shell	Steel
Paint	Epoxy Powder paint
Connections	Solder Flare Copper, ODF Burnished, SAE
Protection	
Package	Individual packaged
Marking	 (A2L pending)  (acc. PED, V > 1 liter) 

Filter Drier Shells Series ADKS-Plus for Liquid - and Suction Applications With Replaceable Cores

Features

- Rustproof Aluminum flange cover with notch hole for ease of mounting
- ODF Copper fittings for easy brazing
- Rigid core holder from steel (no plastic)
- Service-friendly core holder and flange cover
- Optimum flow capacity at low pressure drop
- Temperature range TS: -45°C...+65°C
- Max. allowable pressure PS:
34.5 bar (-10°C...+65°C)
25.9 bar (-45°C...-10°C)
- CE marking according to PED
-  Underwriter Laboratories



ADKS-Plus

Selection Table

Type	Part No.	Connection Solder/ODF		Nominal Flow Capacity (kW)										Number of Blocks S48, H48 W48, F48
				Pressure Drop 0.07 bar										
		(mm)	(inch)	R22	R134a	R404A/ R507	R407C	R410A	R448A	R449A	R450A	R513A	R1234ze	
Conformity Assessment Cat. I, Procedure Module A														
485T	883 551	16	5/8	78	72	51	75	77	68	67	66	63	63	1
487T	883 552	22	7/8	145	133	95	138	143	126	124	122	116	116	
489T	883 553		1 1/8	204	187	133	195	202	178	174	172	163	164	
4811T	883 554	35	1 3/8	285	261	186	272	281	248	243	239	228	228	
4813T MM	883 836	42		310	284	202	196	306	270	265	260	248	249	
4817	882 603	54	2 1/8	Primary for Suction Line Applications										
967T	883 555	22	7/8	159	146	104	152	157	139	136	134	127	128	2
969T	883 556		1 1/8	250	229	163	239	247	218	214	210	200	201	
9611T	883 557	35	1 3/8	305	279	199	291	301	266	260	256	244	245	
9613T	883 558		1 5/8	350	321	228	334	345	305	299	294	280	281	
9613T MM	883 559	42		355	325	231	339	350	309	303	298	284	285	
9617	887 215	54		350	321	228	334	345	305	299	294	280	281	
1449T	883 560		1 1/8	252	231	165	241	249	220	216	212	202	202	3
14411T	883 561	35	1 3/8	351	322	229	335	347	306	300	295	281	282	
14413T	883 562		1 5/8	354	325	231	338	350	309	303	298	284	284	
14413T MM	883 563	42		360	330	235	343	355	314	307	302	288	289	
14417T	883 564	54	2 1/8	420	385	274	401	415	366	359	353	336	337	
Conformity Assessment Cat. II, Procedure Module D1														
19211T	883 565	35	1 3/8	358	328	233	342	353	312	306	301	287	287	4
19213T	883 566		1 5/8	395	362	258	377	390	344	337	332	316	317	
19213T MM	883 567	42		400	366	261	382	395	349	342	336	320	321	
19217T	883 568	54	2 1/8	430	394	281	411	425	375	368	361	344	345	

Nominal Capacity (Q_n) is based on the following conditions:

Refrigerant	Evaporating Temperature	Liquid Temperature
R744	-40°C	-10°C
R22, R134a, R404A, R407C, R410A, R450A, R507, R513A, R1234ze, R448A, R449A	-15°C	+30°C

Filter Drier Shells Series FDH for Liquid- and Suction Applications With Replaceable Cores

Features

- Steel flange cover with notch hole for ease of mounting
- Plated steel ODF connections
- Rigid core holder from steel (no plastic)
- Service-friendly core holder and flange cover
- Optimum flow capacity at low pressure drop
- Temperature range TS: -45°C...+65°C
- Max. allowable pressure PS:
46 bar (-10°C...+65°C)
25.9 bar (-45°C...-10°C)
- CE marking according PED



Selection Table

Type	Part No.	Connection Solder/ODF (mm) (inch)		Nominal Flow Capacity (kW)												Number of Blocks
				Pressure Drop 0.07 bar						Pressure Drop 0.14bar						
				R22	R134a	R404A R507	R407C	R410A	R744	R22	R134a	R404 R507	R407C	R410A	R744	
Conformity Assessment Cat. I, Procedure Module A																
FDH-485	880 300	16	5/8"	78	72	51	75	77	114	100	92	65	95	99	146	1
FDH-487	880 301	22	7/8"	145	133	95	138	143	211	182	167	119	174	180	265	
FDH-489	880 302		1 1/8"	204	187	133	195	202	297	262	240	171	250	258	380	
FDH-969	880 306		1 1/8"	250	229	163	239	247	364	300	275	196	286	296	436	2
FDH-9611	880 307	35	1 3/8"	305	279	199	291	301	443	402	369	262	384	397	585	

Note: Conditions for nominal capacities see previous page. For selection of other operating condition, please use Controls Navigator selection program.

Features Core

- Water capacities to suit specific system conditions
- Exceptional acid capacities for normal system protection, or to effectively clean-up following a compressor burnout (W48)



Core H48

Selection Table - Core for ADKS-Plus & FDH (to be ordered separately)

Size	Part No.	Water Adsorption Capacity (g)								Acid Adsorption Capacity (g)
		Liquid Temperature 24°C				Liquid Temperature 52°C				
		R134a	R22	R404A R507	R407C	R134a	R22	R404A R507	R407C	
S48	003 508	79.7	74.7	82.3	56.7	73.0	66.7	75.9	48.9	16.3
H48	006 969	35.0	31.7	37.0	24.4	29.0	24.5	28.9	18.1	44.6
W48	006 970	24.7	22.1	26.2	17.1	19.9	16.4	19.5	12.1	39.7
F48	006 973	Filter For Suction Line								
H100 / W100 are for Use with Phased-out ADKS-300/-400 Only										
H100	006 971	59.9	53.3	63.8	41.2	47.4	38.3	46.0	28.5	105.1
W100	006 972	52.7	47.1	56.0	36.4	42.4	34.7	41.4	25.7	85.5

Accessories and Spare Parts for ADKS & FDH

Description	Type	Part No.
ADKS, FDH		
Gasket Set	X 99961	003 710
Schrader Nipple 1/4" NPT	X 11562-2	803 251
Core Holder	X 99963	003 712

Filter-Drier Shells With Quick-Cap Series FDS-24 For Liquid- and Suction Applications With Replaceable Cores

Features

- Quick-cap flange (one bolt) design makes replacing of cores in a matter of seconds
- Ideal for retrofit, reducing installation / material cost
- Ideal for refrigerant recovery / reclaim units with regular change of filter-drier
- Free volume as a receiver in FDS-24... (580 cm³)
- ODF Copper fittings for easy brazing
- Corrosion-resistant powder painting of shell body
- Temperature range TS: -45°C...+65°C
- Max. allowable pressure PS:
34.5 bar (-10°C...+65°C)
25.9 bar (-45°C...-10°C)



FDS-24

Selection Table Suction Application

Type	Part No.	Connection		Nominal Flow Capacity (kW)												
		(mm)	(inch)	Block Core S24									Filter F24			
				R134a	R22	R407C	R507/R404A	R448A	R449A	R450A	R513A	R1234ze	R134a	R22	R407C	R507/R404A
FDS-245	003 573	16	5/8	22.3	30.6	28.5	26.0	65.1	63.8	62.7	59.8	59.9	24.7	33.9	31.5	28.8
FDS-247	003 574	22	7/8	32.2	44.1	44.1	37.5	97.4	95.4	93.8	89.4	89.7	37.8	51.8	48.2	44.0
FDS-249	003 575		1 1/8	46.0	63.0	58.6	53.6	98.5	96.5	94.9	90.4	90.7	50.7	69.4	64.5	59.0
FDS-249	003 576	28		44.2	60.5	56.3	51.4	99.0	97.0	95.3	90.9	91.1	48.6	66.9	61.9	56.6

Selection Table Liquid Application

Type	Part No.	Connection Solder/ODF		Nominal Flow Capacity (kW)									
		(mm)	(inch)	Pressure Drop 0.07 bar					Pressure Drop 0.14 bar				
				R22	R134a	R507/R404A	R407C	R410A	R22	R134a	R507/R404A	R407C	R410A
FDS-245	003 573	16	5/8	75	68	49	71	74	98	90	64	93	97
FDS-247	003 574	22	7/8	112	102	73	107	110	151	139	99	144	149
FDS-249	003 575		1-1/8	113	104	74	108	112	160	147	104	153	158
FDS-249	003 576	28		114	104	74	108	112	163	150	106	156	161

Note: For selection of other operating condition, please use Controls Navigator selection program.

Selection Table Cores

Type	Part No.	Water Capacity in Grams at a Liquid Temperature of 24°C (52°C)			Application	Acid Adsorption Capacity (g)
		R134a	R22	R404A/R507		
S24	003 504	35.2 (32.3)	34.8 (29.5)	35.4 (32.1)	Liquid and Suction Line	8.9
W24	003 505	12.5 (9.2)	12.3 (8.9)	13.5 (10.4)	For Motor Burn-Out (Suction)	25.6
F24	003 506	- (-)	- (-)	- (-)	Filter for Suction Line	-

Note: Cores have to be ordered separately. 1 piece needed for FDS24 shell.

Accessories and Spare Parts for FDS

Description	Type	Part No.
Gasket Set	X 99967	003 716
O-Ring Set	X 99968	003 717
Core Holder	X 99969	003 718

Suction Line Filters and Filter Driers Series ASF and ASD Hermetic Design

Features

- Minimum pressure drop due to internal construction and compacted bead style
- Service-friendly with 2 Schrader valves for pressure drop measurement
- ODF Copper fittings for easy brazing
- Filtration down to 40 microns
- Temperature range TS: -45°C...+50°C
- Max. allowable pressure PS: 27.5 bar
- CE marking not required acc. PED



ASF, ASD

Suction Line Filters

Type	Part No.	Connection Solder/ODF		Nominal Flow Capacity (kW)								
		(mm)	(inch)	R134a	R22	R404A	R407C	R507	R448A R449A	R450A	R513A	R507
ASF-28 S3	008 965		3/8	6	8.4	7.7	7.8	7.7	8.3	3.7	3.4	3.2
ASF-28 S4	008 941		1/2	9.9	14.4	13.4	13.4	13.4	13.7	6.5	5.9	5.6
ASF-35 S5	008 915	16	5/8	15.9	23.2	21.4	21.6	21.4	20.9	9.9	8.9	8.5
ASF-45 S6	008 946		3/4	23.3	34.5	32	32.1	32	25.2	13.3	12	11.4
ASF-45 S7	008 904	22	7/8	32.5	42.5	34.5	39.5	34.5	33.1	17.3	15.7	14.9
ASF-50 S9	008 908		1-1/8	46	67.1	55.5	62.4	55.5	47.5	24.8	22.5	21.3
ASF-75 S11	008 919	35	1-3/8	60.2	85.4	70.7	79.4	70.7	58.3	29.9	27.1	25.7
ASF-75 S13	008 940		1-5/8	65.4	87.5	73.1	81.4	73.1	62.2	31.6	28.7	27.2

Suction Line Filter Driers

Type	Part No.	Connection Solder/ODF		Nominal Flow Capacity (kW)								
		(mm)	(inch)	R134a	R22	R404A	R407C	R507	R448A R449A	R450A	R513A	R507
ASD-28 S3	008 909		3/8	5.5	8.1	7.4	7.5	7.4	8.6	4.1	3.7	3.5
ASD-28 S4	008 910		1/2	9.1	13.4	12.7	12.5	12.7	14.8	6.8	6.2	5.8
ASD-35 S5	008 899	16	5/8	14.3	20.4	19	19	19	23.7	11.2	10.2	9.6
ASD-45 S6	008 925		3/4	19.1	24.6	22.5	22.9	22.5	35.3	16.3	14.8	14
ASD-45 S7	008 896	22	7/8	25	32.3	26.4	30	26.4	43.2	22.8	20.7	19.6
ASD-50 S9	008 881		1-1/8	35.3	46.4	38.3	43.2	38.3	68.4	32.3	29.3	27.8
ASD-75 S11	008 891	35	1-3/8	42.9	56.9	47.8	52.9	47.8	57.6	40.8	37	35.1
ASD-75 S13	008 953		1-5/8	45.2	60.8	51	56.5	51	86.4	47.6	43.2	40.9

Nominal flow capacity at +4°C evaporating temperature (saturated condition/dew point) and a pressure drop of 0.21 bar between inlet and outlet of ASF/ASD. Correction factor for other evaporating temperatures than +4°C:

$$Q_n = Q_o \times K_s$$

- Q_n: Nominal Capacity
- K_s: Correction Factor for a Pressure Drop Corresponding 1 K Saturation Temperature
- Q_o: Required Cooling Capacity

For selection of other operating condition, please use Controls Navigator selection program.

Evaporating Temperature (°C)	+4	0	-5	-10	-15	-20	-25	-30	-35	-40
Correction Factor k _s	1.00	1.12	1.35	1.75	2.00	2.50	3.00	3.75	5.00	6.60

Water and Acid Adsorption Capacity

Type	Water Adsorption Capacity (g)										Acid Adsorption Capacity (g)
	Liquid Temperature 24°C					Liquid Temperature 52°C					
	R134a	R22	R404A R507	R407C	R410A	R134a	R22	R404A R507	R407C	R410A	
ASD-28	11.8	5.7	12.2	9.1	8.0	10.0	3.6	9.7	6.7	5.6	3.0
ASD-35	14.5	7.0	15.0	11.2	9.9	12.3	4.4	12.0	8.2	6.9	3.6
ASD-45	18.0	8.8	18.6	13.9	12.3	15.3	5.5	14.9	10.2	8.6	4.5
ASD-50	21.4	10.4	22.2	16.5	14.6	18.2	6.5	17.7	12.1	10.2	5.4
ASD-75	31.5	15.4	32.6	24.3	21.5	26.7	9.6	26.0	17.8	15.0	7.9

Suction Line Filter and Filter Drier Shells Series BTAS for Replaceable Filters and Filter Drier Cores

Features

- Corrosion-free brass body ideal for suction line applications
- Extremely large filtration area for optimum flow capacity
- Low pressure drop
- Filtration down to 40 micron
- Temperature range TS: -45°C ... +50°C
- Max. allowable pressure PS: 24 bar
- UL/CUL: File Nr. SA3124



BTAS

Selection Table - Suction Line Shells with Filter Core

Type	Part No.	Connection Solder/ODF		Nominal Capacity Q _n (kW)									Filter Core		
		(mm)	(inch)	R134a	R22	R404A	R407C	R507	R448A R449A	R450A	R513A	R507	Type	Part No.	
CE marking not required acc. PED															
BTAS 25	015 353		5/8	12.5	17.1	13.9	15.9	13.9						A2F	009 907
BTAS 27	015 354	22	7/8	22.3	29.6	24.3	27.5	24.3	31.7	16.3	14.8	14.6			
BTAS 39	015 355		1 1/8	37.7	50.4	40.6	46.9	40.6	50.4	24.8	22.5	22.2	A3F	009 909	
BTAS 311	015 356	35	1 3/8	60.3	80.7	65.2	75.1	65.2	54.0	27.5	25.0	24.7			
BTAS 313	015 357		1 5/8	73.4	97.5	81.1	90.7	81.1	86.4	44.2	40.1	39.6			
BTAS 342	015 358	42		73.4	97.5	81.1	90.7	81.1	86.4	44.2	40.1	39.6			
BTAS 317	015 359	54	2 1/8	97.6	127.7	104.8	118.8	104.8	104.3	54.4	49.3	48.7	A4F	009 911	
BTAS 417	015 360	54	2 1/8	134.7	178.2	145.3	165.7	145.3	190.7	98.6	89.4	88.3			
CE Marked, Conformity Assessment Cat. I, Procedure Module A															
BTAS 521	015 361		2 5/8	209.0	282.4	229.8	262.6	229.8	302.2	153.0	138.7	137.0	A5F	009 913	
BTAS 525	015 362		3 1/8	260.1	346.1	283.9	321.9	283.9	370.6	190.4	172.6	170.4			
BTAS 580	015 363	80		260.1	346.1	283.9	321.9	283.9	370.6	190.4	172.6	170.4			

Note: Filter Core has to be Ordered Separately.

Selection Table - Suction Line Shells with Filter Drier Core

Type	Part No.	Connection Solder/ODF		Nominal Capacity Q _n (kW)									Filter Drier Core	
		(mm)	(inch)	R134a	R22	R404A	R407C	R507	R448A R449A	R450A	R513A	R507	Type	Part No.
CE marking not required acc. PED														
BTAS 25	015 353		5/8	11.6	15.5	12.8	14.3	12.8	16.6	8.5	7.7	7.6	A2F-D	009 908
BTAS 27	015 354	22	7/8	19.1	25.2	20.6	23.4	20.6	27.0	13.9	12.6	12.5		
BTAS 39	015 355		1 1/8	34.4	45.7	37.5	42.5	37.5	36.0	18.0	16.3	16.1	A3F-D	009 910
BTAS 311	015 356	35	1 3/8	49.2	65.5	53.7	60.9	53.7	50.4	25.2	22.8	22.5		
BTAS 313	015 357		1 5/8	57.1	77.3	62.5	71.9	62.5	72.0	37.4	33.9	33.5		
BTAS 342	015 358	42		57.1	77.3	62.5	71.9	62.5	72.0	37.4	33.9	33.5		
BTAS 317	015 359	54	2 1/8	77.1	94.1	77.7	87.5	77.7	82.8	40.8	37.0	36.5	A4F-D	009 912
BTAS 417	015 360	54	2 1/8	106.8	144.5	118.3	134.4	118.3	154.7	78.2	70.9	70.0		
CE marked, Conformity Assessment Cat. I, Procedure Module A														
BTAS 521	015 361		2 5/8	153.3	205.1	169.0	190.7	169.0	219.5	112.2	101.7	100.4	A5F-D	009 914
BTAS 525	015 362		3 1/8	181.2	242.0	199.4	225.1	199.4	259.1	132.6	120.2	118.7		
BTAS 580	015 363	80		181.2	242.0	199.4	225.1	199.4	259.1	132.6	120.2	118.7		

Note: Filter Drier Core has to be Ordered Separately.

Nominal capacity at +4°C evaporating temperature (saturated condition/ dew point) and a pressure drop of 0.21 bar between inlet and outlet of BTAS. Correction factor for other evaporating temperatures than +4°C:

$$Q_n = Q_o \times K_s$$

Q_n : Nominal capacity

K_s : Correction factor for a pressure drop corresponding 1K saturation temperature

Q_o : Required cooling capacity

Evaporating Temperature (°C)	+4	0	-5	-10	-15	-20	-25	-30	-35	-40
Correction Factor k_s	1.00	1.12	1.35	1.75	2.00	2.50	3.00	3.75	5.00	6.60

BTAS - Water and Acid Adsorption Capacity

Core	Water Adsorption Capacity (g)								Acid Adsorption Capacity (g)
	Liquid Temperature 24°C				Liquid Temperature 52°C				
	R134a	R22	R404A R507	R407C	R134a	R22	R404A R507	R407C	
A2F-D	2.8	2.5	2.9	4.8	2.3	1.9	2.3	5.0	3.7
A3F-D	7.6	6.8	8.0	13.3	6.3	5.3	6.2	13.8	10.3
A4F-D	14.8	13.3	15.7	25.9	12.2	10.3	12.2	26.9	20.1
A5F-D	21.8	19.6	23.1	38.2	18.0	15.1	17.9	39.7	29.6

Accessories and Spare Parts

Repair Kits with Cover, Screws and Gaskets	Type	Part No.
Repair Kit BTAS 2	KD 30519-2	065 970
Repair Kit BTAS 3	KD 30519-3	065 971
Repair Kit BTAS 4	KD 30519-4	065 972
Repair Kit BTAS 5	KD 30519-5	065 973

Moisture / Liquid Indicators AMI, MIA & CIA

The AMI / MIA / CIA series of Moisture Indicators are designed to monitor the moisture content within the liquid line of a refrigeration system.

MIA and CIA series with stainless steel body and extended copper tube connections are fully hermetic products without the use of any gasket.

AMI is a highly serviceable product with exchangeable lens assembly and indicator element. available in various configurations including saddle type.



AMI



MIA / CIA







Features

- Maximum allowable pressure PS:
 - AMI: 35 bar
 - MIA: 45 bar
 - CIA: 60 bar for subcritical CO₂ & R32
- MIA/CIA released for A2L refrigerants: R32, R452B, R454C, R454B, R454A, R1234yf
- Crystal indicator element for long lifetime and reliability
- Highest sensitivity moisture indicator available
- Indication of dryness according to ASERCOM recommendation
- Easy determination of moisture content with calibrated four colors
- Large clear viewing area
- AMI sight glass with grooves to distinguish between pure liquid and pure vapor

Selection table MIA & CIA

For Tube Outside Diameter		Type	Part No.	Configuration	Medium Compatibility		Markings				Picture	
(mm)	(inch)				A1	A2L	UL SA4876	CSA Canada	CE Cat. I PED	EAC		
6		MIA M06	805880	Female solder x female solder ODF x ODF	R134a	R22	R452B	R454A	R454B	R123yf		
	1/4"	MIA 014	805883									
10		MIA M10	805881									
	3/8"	MIA 038	805884									
12		MIA M12	805882									
	1/2"	MIA 012	805885									
16	5/8"	MIA M16 / 058	805886									
22	7/8"	MIA 078	805887									
28		MIA M28	805891									
	1 1/8"	MIA 118	805892									
10		MIA M10S female/male	805888	Female solder x male solder ODF x ODF								
12		MIA M10S female/male	805888									
6		CIA M06	805914	Female solder x female solder ODF x ODF	CO ₂	R32						
	1/4"	CIA 014	805910									
10		CIA M10	805915									
	3/8"	CIA 038	805911									
12		CIA M12	805916									
	1/2"	CIA 012	805912									
16	5/8"	CIA M16 / 058	805913									

Selection Table - AMI

For Tube Outside Diameter		Type	Part No.	Configuration	Medium Compatibility	Markings				Picture
(mm)	(inch)					A1	UL SA4876	CSA Canada	CE Cat. I PED	
6		AMI-1 TT2 MM	805697	Female solder x female solder ODF x ODF						
	1/4"	AMI-1 TT2	805655							
10		AMI-1 TT3 MM	805698							
	3/8"	AMI-1 TT3	805654							
12		AMI-1 TT4 MM	805699							
	1/2"	AMI-1 TT4	805653							
16	5/8"	AMI-1 TT5	805652							
22	7/8"	AMI-1 TT7	805656							
28		AMI-1 TT9 MM	805700							
	1 1/8"	AMI-1 TT9	805651							
6		AMI-1 SS2 MM	805732	Female solder x female solder ODF x ODF	R134a R22 R404A R407C R507 R513A					
	1/4"	AMI-1 SS2	805713							
10		AMI-1 SS3 MM	805733							
	3/8"	AMI-1 SS3	805714							
12		AMI-1 SS4 MM	805734							
	1/2"	AMI-1 SS4	805715							
16	5/8"	AMI-1 SS5	805716							
22	7/8"	AMI-1 SS7	805717							
28		AMI-1 SS9 MM	805703							
	1 1/8"	AMI-1 SS9	805705							
6	1/4"	AMI-1 MM2	805706	Male flare x male flare						
10	3/8"	AMI-1 MM3	805707							
12	1/2"	AMI-1 MM4	805708							
16	5/8"	AMI-1 MM5	805709							
6	1/4"	AMI-1 FM2	805710	Female flare x male flare						
10	3/8"	AMI-1 FM3	805711							
12	1/2"	AMI-1 FM4	805712							
35	1 3/8"	AMI-2 S11	805704	Male solder ODM (for soldering into fittings)						
42	1 5/8"	AMI-2 S13	805659							
54	2 1/8"	AMI-2 S17	805687							
22	7/8"	AMI-3 S7	805650	Saddle type (for soldering onto the pipe)						
28	1 1/8"	AMI-3 S9	805649							
35	1 3/8"	AMI-3 S11	805648							

Accessories for AMI

Type	Part No.	Description
X 12978-1	805742	Lens assembly kit
x 99995	805643	O-Ring

Technical Data

Maximum Allowable Pressure PS	AMI 35 bar MIA 45 bar CIA 60 bar
Test Pressure PT	AMI 39 bar MIA 49.5 bar CIA 66 bar
Operating Temperature TS	-40...+100 °C
Medium Compatibility	
A1 (Fluid Group II):	
AMI/MIA:	R134a, R22, R404A, R407C, R507, R513A
MIA only:	R410A
CIA only:	R744
A2L (Fluid Group I):	
MIA only:	R452B, R454A, R454B, R123yf
CIA only:	R32
<small>(Not released for use with caustic, poisonous or flammable substances)</small>	

Installation Location	In any position
Pressure Drop	Negligible
Standards	EN 12178
Marking	UL: see SA 4876 CSA for Canada: AMI series except AMI-3 MIA series except MIA-078 CE AMI>32mm & MIA > 25 mm belong to Cat. I of the PED 2014/68/EU

Crystal Indicator

Where many products in the market use insensitive and technically simple paper indicators. Emerson has retained the long established crystal moisture indicators in all existing product series because of its known advantages. This guarantees system performance by providing a sensitive and durable monitoring of the systems moisture content. enabling the indicator to react to a minimum moisture level of 50 ppm specified by leading compressor manufacturers (see Asercom statement: www.asercom.org).

Moisture Contents by Indicator Color

CIA	Refrigerants	A1 (CIA only)						A2L (CIA only)		
		R744						R32		
		Liquid Temperature (°C)						Liquid Temperature (°C)		
Color Code	-40	-20	-10	0	+5	+20	25	38	52	
ppm	Blue/ Dry	3	6	8	11	13	20	6	8	12
	Purple	5	10	14	19	22	34	9	13	19
	Fuchsia/ Caution	10	20	29	39	46	72	21	29	43
	Rose/ Caution WET!	16	32	46	63	75	116	34	46	69



AMI/MIA	Refrigerants	Liquid Temp. (°C)	A1 (AMI/MIA)					A2L (MIA only)				
			R22	R404A R507	R134a	R407C	R410A	R513A	R452B	R454B	R454A	R123yf
ppm	Blue/ Dry	25	25	15	20	26	30	15	22	24	22	12
		38	35	25	35	40	55	20	34	34	28	14
		52	50	45	50	64	75	24	46	46	35	16
	Purple	25	40	33	35	42	50	19	28	28	27	14
		38	65	50	55	68	85	25	42	42	35	17
		52	90	60	85	109	120	30	58	58	44	20
	Fuchsia/ Caution	25	80	60	90	94	110	44	66	68	64	34
		38	130	110	120	144	190	58	99	101	82	40
		52	185	140	150	230	270	71	136	138	105	46
Rose/ Caution WET!	25	145	120	130	151	165	75	112	119	108	58	
	38	205	150	160	232	290	98	168	170	138	68	
	52	290	180	190	371	420	121	230	232	177	78	

Note: In area "Caution" and "Caution wet" filter drier should be changed.





Oil Management and Liquid Level Monitoring Components

Technical Information

Refrigeration compressors are lubricated by refrigeration oil that circulates from the compressor crankcase or housing. As refrigerant gas is discharged by the compressor, it will leave a fine oil mist that will be circulated throughout the entire system. Small amounts of oil circulating through the system will not affect the system performance. Too much refrigeration oil circulating in the system will have adverse effects on the components in the system. Circulating oil reduces the ability of the system to effectively remove the heat. Condensers, evaporators and other heat exchangers lose efficiency when coated internally with an oil film.

Oil not returning to the compressor causes improper lubrication and eventual compressor failure. At low temperature application, oil thickness becomes difficult to move, causing oil to be trapped in the system.

Oil Separator Function

Refrigerant gas leaving the compressor through the discharge line contains refrigeration oil in a vaporous mist. As this mixture enters the oil separator, the velocity is reduced to allow oil separation to begin.

The refrigerant gas and oil mixture enters the oil separator and passes through an inlet screen, causing the fine particles to combine. Larger oil particles are formed and drop to the bottom of the oil separator.

The refrigerant gas then passes through an outlet screen to remove residual oil particles. The oil gathers in the bottom of the oil separator until a float operated needle valve opens to allow the return of oil to the compressor. Oil returns quickly to the compressor, because of the higher pressure in the oil separator than in the compressor crankcase. When the oil level has lowered, the needle valve retracts to prevent refrigerant gas from returning back to the compressor. The refrigerant gas leaves through the outlet of the oil separator and goes to the condenser.

Oil Level Management System Function

This system provides oil level balancing as well as oil level monitoring including alarm and compressor shut-down functions. The oil level is measured inside the compressor's crankcase. By operating an integrated solenoid valve, missing oil can be fed from the oil receiver or from the oil separator directly into the compressor sump. If the oil level drops to a dangerous level, the alarm contact changes into alarm state. The alarm contact may be used to shut down the compressor. The integrated electronics include delay times in order to avoid short-cycling and nuisance alarms.

This system applies to compressor pack applications with multiple parallel compressor arrangements, but also to stand-alone compressor applications for compressors without differential oil pressure monitoring.

Liquid Level Monitoring

LW4 and LW5 are self-contained units intended for liquid level monitoring at the sight glass or plugged connection of vessels, maintaining a permanent visibility of the liquid level versus other liquid level sensors. There are two versions for monitoring maximum or minimum liquid level. LW can be applied to a variety of media such as liquid refrigerants as well as oil.

The typical application are in liquid receivers, oil separators, oil reservoirs and flash tanks.



OM3, OM4 and OM5 TraxOil™ Oil Management

The Emerson TraxOil oil management is a self-contained and reliable electronically controlled system with an integrated solenoid valve, which feeds missing oil directly into the compressor sump. The sight glass function remains fully available, status and level information is indicated by LED's. The integrated alarm function with compressor shut down completes the overall proven solution for compressor protection.

OM3 and OM4 are released for A2L refrigerants:

- The power supply must be 24VAC only.
- The voltage of alarm contact is max. 24VAC.

While OM3 is the well-proven solution for HFC refrigerants, OM4 can also be used for subcritical CO₂ systems.

OM5 TraxOil has been specially developed for transcritical CO₂ applications, the new adapters are equipped with special types of O-rings to guarantee safe long-term and reliable operation.

Features

- OM3 for selected HFC and HFO/HFO blends refrigerants
 - max. allowable pressure PS: 46 bar
- OM4 for liquid R744 (CO₂) subcritical and selected HFC and HFO/HFO blends refrigerants
 - max. allowable pressure PS: 60 bar
- OM5 for liquid R744 (CO₂) transcritical
 - max. allowable pressure PS: 130 bar
 - max. operating pressure differential: 100 bar
 - CO₂ optimized gasket material
 - Adapters with CO₂ optimized gasket material
 - High wattage ESC-W coil to achieve high pressure differential MOPD of 100 bar
- Self-contained unit with oil level sensor and integral solenoid to manage oil level supply
- 3 Zone Level Control by using precise Hall-Sensor measurement, not prone to errors by foaming or light like optical sensors
- Alarm, status and level indication by LED's
- Supply 24 VAC or 230 VAC
- SPDT output contact for compressor shut down or alarming, rating 230 VAC / 3 A
- Easy installation by sight-glass replacement and front side mounting without nuts
- Adapters suitable for various types of compressors
- Recommended by leading compressor manufacturers
- **CE** marking under LVC and EMC Directive



OM5 + ESC-W Coil 24V



OM4 + ESC Coil 230V + OM-230V

Selection Table OM3 and OM4 (Select One Item of Each Group)

1. Base Units (Supplied Without Adapter and Coil)

Type	Part No.	Max. Allowable Pressure PS	Time Delay Alarm
OM3-020	805 133	46 bar	20 Sec
OM3-120	805 134		120 Sec
OM4-020	805135	60 bar	20 Sec
OM4-120	805136		120 Sec



2. Adapter

OM0-CUA	805 037	Flange Adapter 3- / 4-Hole
OM0-CBB	805 038	Screw Adapter 1 1/8"-18 UNEF
OM0-CCA	805 039	Screw Adapter 3/4"-14 NPTF
OM0-CCB	805 040	Screw Adapter 1 1/8"-12 UNF
OM0-CCC	805 041	Flange Adapter 3-Hole
OM0-CCD	805 042	Rotalock Adapter 1 3/4"-12UNF
OM0-CCE	805 043	Rotalock Adapter 1 1/4"-12UNF
OM0-CCL	805 261	Braze adapter Ø22.5 mm

Note: For use with A2L refrigerants, only the OM0-CCL can be used.

3. Cables Alarm Relay

OM3-N30	805 141	Connection to Relay 3 m
OM3-N60	805 142	Connection to Relay 6 m
OM3-N100	805 146	Connection to Relay 10 m

Supply Voltage 24V

4. Solenoid Coil

Type	Part No.	
ESC-24VAC	801033	50 Hz, 17VA

5. Cable Assembly Power Supply and Solenoid

OM3-P30	805 151	24V, 3 m
OM3-P60	805 152	24V, 6 m
OM3-P100	805 153	24V, 10 m

Note: For A2L, the power supply must be 24VAC only.

Supply Voltage 230V

4. Solenoid Coil

Type	Part No.	
ESC-230 VAC	801031	50 Hz, 17VA

5. Cable Assembly with 230V Module

OM-230V-3	805 163	230V, 3.0m
OM-230V-6	805 164	230V, 6.0m

Oil Management Kits Including Adapter and 24V Coil: Cross Reference

Kit Inc. Adapter	Part No.		Base Unit	Part No.	Adapter	Part No.	Coil	Part No.
OM3-CUA	805 301	➔	OM3-020	805133	OM0-CUA	805037	ESC 24 VAC	801 062
OM3-CBB	805 303				OM0-CBB	805038		
OM3-CCA	805 304				OM0-CCA	805039		
OM3-CCB	805 305				OM0-CCB	805040		
OM3-CCC	805 306				OM0-CCC	805041		
OM3-CCD	805 302				OM0-CCD	805042		
OM3-CCE	805 300				OM0-CCE	805043		
OM3-CCL (A2L)	805126				OM0-CCL	805261		
OM4-CUA	805 307					OM4-020		
OM4-CBB	805 309	OM0-CBB	805 338					
OM4-CCA	805 310	OM0-CCA	805 339					
OM4-CCB	805 311	OM0-CCB	805 340					
OM4-CCC	805 312	OM0-CCC	805 341					
OM4-CCD	805 308	OM0-CCD	805 342					
OM4-CCE	805 313	OM0-CCE	805 343					
OM4-CCL (A2L)	805129	OM0-CCL	805261					

Selection Table OM5 (Select One Item of Each Group)

1. Base Units (Supplied Without Adapter and Coil)

Type	Part No.	Max. Allowable Pressure PS	Time Delay Alarm
OM5-020	805230	130 bar	20 Sec
OM5-120	805231		120 Sec



2. Adapter

OM0-CUA CO2	805337	Flange Adapter 3- / 4-Hole
OM0-CCC CO2	805341	Flange Adapter 3-Hole
OM0-CUD CO2	805049	Flange Adapter 6- / 6-Hole
OM0-CBB CO2	805338	Screw Adapter 1 1/8"-18 UNEF
OM0-CCA CO2	805339	Screw Adapter 3/4"-14 NPTF
OM0-CCB CO2	805340	Screw Adapter 1 1/8"-12 UNF
OM0-CCD CO2	805342	Rotalock Adapter 1 3/4"-12UNF
OM0-CCE CO2	805343	Rotalock Adapter 1 1/4"-12UNF

3. Cables Alarm Relay

OM3-N30	805 141	Connection to Relay 3 m
OM3-N60	805 142	Connection to Relay 6 m
OM3-N100	805 146	Connection to Relay 10 m

Supply Voltage 24V

4. Solenoid Coil

Type	Part No.	Description
ESC-W24VAC	801028	50 Hz, 38 VA

5. Cable Assembly Power Supply and Solenoid

OM3-P30	805 151	24V, 3 m
OM3-P60	805 152	24V, 6 m
OM3-P100	805 153	24V, 10 m

Supply Voltage 230V

4. Solenoid Coil

Type	Part No.	Description
ESC-W230VAC	801029	50 Hz, 38 VA

5. Cable Assembly with 230V Module

OM-230V-3	805 163	230V, 3 m
OM-230V-6	805 164	230V, 6 m

Accessories and Spare Parts

Type	Part No.	Description
ECT-623	804 421	Transformer 230 VAC / 24VAC, 60 VA (Supply of 3 Pieces Base Unit)
ESC-K01	801 080	Retainer Kit ESC Including O-Rings
ODP-33A	800 366	Differential Oil Check Valve 3.5 bar, PS: 46 bar (Inlet 5/8"-UNF Female, Outlet 5/8"- UNF Male)
OM3-K01	805 036	Repair Kit OM3/OM4 (Consists of Sight Glass with O-Ring and Screws, Oil Adapter with Strainer, O-Ring Back Side)
OM5-K01	805 067	Repair Kit OM5 for CO ₂ (Consists of Sight Glass with O-Ring and Screws, Oil Adapter with Strainer, O-Ring Back Side)
OM-HFC-K01	805 081	Sealing Kit OM3/OM4 (Consists of all O-Rings for OM3/OM4 and for All Types of Adapters)
OM-HFC-K02	805 083	Enclosing Tube for OM3/OM4 (Including O-Ring), Only for Replacement of New Version with Hexagonal Nut!
OM-CO2-K01	805 079	Sealing Kit CO ₂ for OM5 (Consists of All O-Rings for OM5 and for All Types of Adapters)
OM-CO2-K02	805 082	Enclosing Tube for OM5 (Including O-Ring), Only for Replacement of New Version with Hexagonal Nut!

Technical Data

Markings	CE Under: - Low Voltage Directive - EMC Directive
Max. Allowable Pressure PS	OM3: 46 bar OM4: 60 bar OM5: HP Side (Inlet): 130 bar LP Side (Outlet): 100 bar
Max. Test Pressure PT	OM3: 51 bar OM4: 66 bar OM5: 143 bar
Supply Voltage / Total Power	OM3/OM4: Max. 24VAC for A2L 24 VAC±10%, 50Hz, 17 VA 230 VAC±10%, 50Hz, 17 VA
<ul style="list-style-type: none"> • With ESC-24VAC Coil • With ESC-230VAC Coil and OM-230V-x Module 	
<ul style="list-style-type: none"> • With ESC-W24VAC Coil • With ESC-W230VAC Coil and OM-230V-x Module 	only OM5: 24VAC, 50 Hz, ±10%, 38VA 230VAC, 50 Hz, ±10%, 38VA
Solenoid Valve MOPD	OM3/OM4: 30 bar OM5: 100 bar (50Hz) See Fig. 1
Medium Temperature Ambient/Storage Temperature	-20...+80°C -20...+50°C
Medium Compatibility	OM3/OM4: A1: R134a, R404A, R407C, R450A, R452A, R448A, R449A, R507, R513A, R410A A2L: R32, R452B, R454B, R454A, R454C, R455A, R1234ze, R1234yf, Note: A2L only with oil: Emkarate RL-3MAF, R32 only with SP32 oil type OM4/OM5: R744

Flow Rate	OM3/OM4 at $\Delta P = 3$ bar: 340g/min. (22°C Oil Temperature, Oil type HM46) OM5: See Fig. 1
Orientation of Base Unit	horizontal, +/- 1°
Level Control	40% to 60% of Sight Glass Height
Alarm Contact	Max. 3 A, 230 VAC, (max. 24VAC for A2L) SPDT dry contact
Time Delay Alarm	20 Sec.: OM3/4/5-020, All OM3/4 Kits 120 Sec.: OM3/4/5-120
Time Delay Filling	10 Sec.
Protection Class	IP 65 with plug/cable assembly acc. EN 60529 test conditions
Oil Connection	7/16"-20 UNF Male, with Strainer and O-Ring (Replaceable, See Acc.)
Enclosing Tube	Replaceable for Cleaning, Hexagon Wrench Size 18, See Spare Parts

Fig. 1: OM5: Performance Related to Supply Voltage: Flow Rate and Differential Pressure Between Inlet and Outlet (Oil Type Reniso C85E, Oil Temperature 54°C)

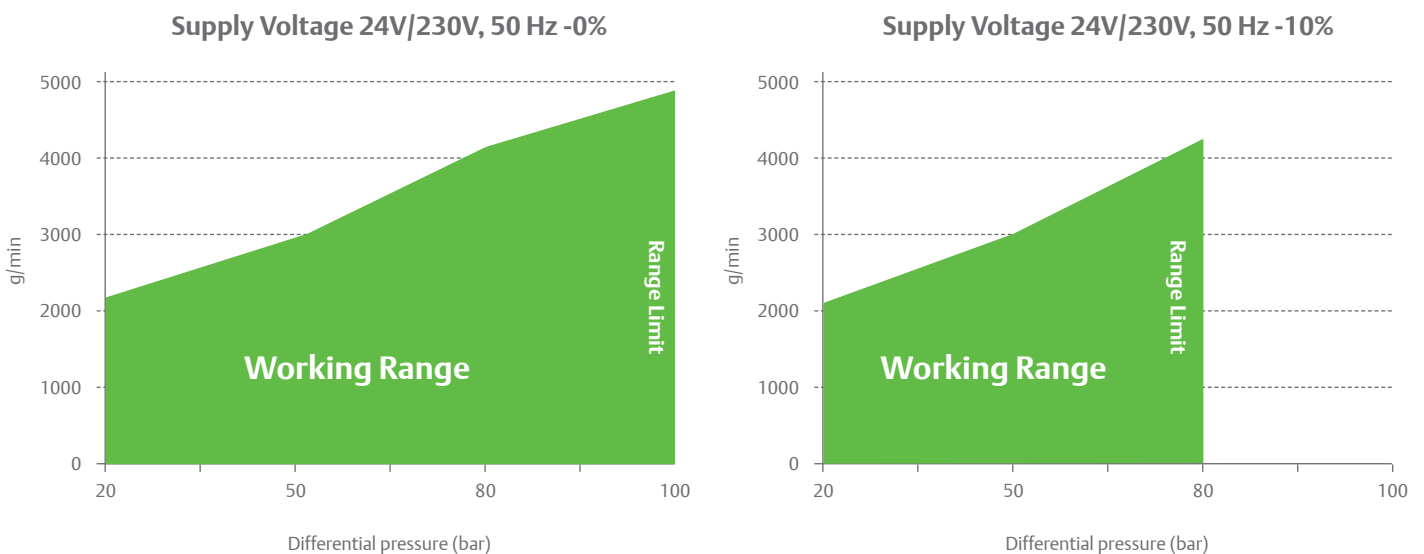



Electronic Oil Level Monitoring TraxOil™ OW4 and OW5

OW4 and OW5 TraxOil are intended for systems which require oil level monitoring and alarming instead of active oil level balancing.

Features

- OW4 for CO₂ subcritical and selected HFC and HFO/HFO blends refrigerants
 - Max. allowable pressure PS: 60 bar
- OW5 for CO₂ transcritical
 - Max. allowable pressure PS: 100 bar
 - CO₂ optimized gasket material, not released for HCFC and HFCs
 - Adapters with CO₂ optimized gasket material
- 3 Zone Level Control by using precise Hall-sensor measurement, not prone to errors by foaming or light like optical sensors
- Alarm, status and 3 zone indication by LED's
- SPDT output contact for compressor shut down or alarming, rating 230VAC / 3A
- Easy installation by sight-glass replacement and front side mounting without nuts
- Supply 24V AC, 50/60Hz
- Recommended by leading compressor manufacturers
- **CE** marking under Low Voltage and EMC Directive



OW4 TraxOil



OW5 TraxOil

Selection Table (Select One Item of Each Group)

1. Base Units (Supplied without Adapter)

Type	Part No.	Max. Allowable Pressure	Time Delay Alarm
OW4-020	805 116	60 bar	20 Sec

2. Adapter

OM0-CUA	805037	Flange Adapter 3-/4-Hole
OM0-CCC	805041	Flange Adapter 3-Hole
OM0-CBB	805038	Screw Adapter 1-1/8"-18 UNEF
OM0-CCA	805039	Screw Adapter 3/4"-14 NPTF
OM0-CCB	805040	Screw Adapter 1-1/8"-12 UNF
OM0-CCD	805042	Rotalock Adapter 1-3/4"-12UNF
OM0-CCE	805043	Rotalock Adapter 1-1/4"-12UNF
OM0-CCL	805 261	Braze adapter Ø22.5 mm

Note: For use with A2L refrigerants, only the OM0-CCL can be used.

3. Relay Cables

OM3-N30	805 141	Connection to Relay 3.0 m
OM3-N60	805 142	Connection to Relay 6.0 m
OM3-N100	805 146	Connection to Relay 10.0 m

4. Power Cables

Type	Part No.	Description	Cable Length
OW-24V-3	804 672	Connection to Power Supply 24VAC	3.0m

Product Selection (Select One Item of Each Group)

1. Base Units (Supplied without Adapter)

Type	Part No.	Max. Allowable Pressure PS (bar)	Time Delay Alarm
OW5-120	805 241	100 bar	120 Sec

2. Adapter

OM0-CUA CO ₂	805 337	Flange Adapter 3-/4-Hole
OM0-CCC CO ₂	805 341	Flange Adapter 3-Hole
OM0-CUD CO ₂	805 049	Flange Adapter 6-/6-Hole
OM0-CBB CO ₂	805 338	Screw Adapter 1-1/8"-18 UNEF
OM0-CCA CO ₂	805 339	Screw Adapter 3/4"-14 NPTF
OM0-CCB CO ₂	805 340	Screw Adapter 1-1/8"-12 UNF
OM0-CCD CO ₂	805 342	Rotalock Adapter 1-3/4"-12UNF
OM0-CCE CO ₂	805 343	Rotalock Adapter 1-1/4"-12UNF

3. Relay Cables

OM3-N30	805 141	Connection to Relay 3.0 m
OM3-N60	805 142	Connection to Relay 6.0 m
OM3-N100	805 146	Connection to Relay 10.0 m

4. Power Cables

Type	Part No.	Description	Cable Length
OW-24V-3	804 672	Connection to Power Supply 24VAC	3.0 m

Accessories and Spare Parts

Type	Part No.	Description
ECT-623	804 421	Transformer 230 VAC / 24 VAC, 60 VA (Supply of 3 Pieces Base Unit)
OM-HFC-K01	805 081	Sealing Kit OW4 (Consists of All O-Rings, Incl. Adapter Gaskets)
OM-CO2-K01	805 079	Sealing Kit OW5 (Consists of All O-Rings, Incl. Adapter Gaskets)

Technical Data

Markings	CE Under: -Low Voltage Directive -EMC Directive
Max. Allowable Pressure PS Max. Test Pressure PT	OW4: 60 bar OW5: 100 bar OW4: 66 bar OW5: 110 bar
Supply Voltage Current	24VAC, 50/60Hz, ±10%, 0.05A
Medium Temperature Ambient/Storage Temperature	-20...80°C -20...50°C
Medium Compatibility	OW4: A1: R134a, R404A, R407C, R450A, R452A, 448A, R449A, R507, R513A, R410A A2L: R32, R452B, R454B, R454A, R454C, R455A, R1234ze, R1234yf Note: A2L only with oil: Emkarate RL-3MAF, R32 only with SP32 oil type OW4/OW5: R744

Orientation of Base Unit Level Control	Horizontal, +/- 1° 40%...60% Sight Glass Height
Alarm Contact	Max. 3 A, 230 VAC SPDT Dry Contact
Time Delay Alarm	20 Sec or 120 Sec
Protection Class	IP 65 with plug/cable assembly acc. EN 60529 test conditions

Level Watch LW4 and LW5 Liquid Level Control

LW4 and LW5 are self-contained units intended for liquid level monitoring and control at the sight glass connection of vessels, maintaining a permanent visibility of the liquid level versus other liquid level sensors.

Features

- LW4 for liquid CO₂, selected HFC and HFO/HFO blends refrigerants and oil
 - Max. allowable pressure PS: 60 bar
- LW5 for liquid CO₂ and oil
 - Max. allowable pressure PS: 130 bar
 - CO₂ optimized gasket material, not released for HFCs
 - Adapters with CO₂ optimized gasket material
- Two Versions of each model:
 - LW4/5-H for high liquid level monitoring
 - LW4/5-L for low liquid level monitoring
- 3 Zone Level Control by using precise Hall-sensor measurement, not prone to errors by foaming or light like optical sensors
- Alarm, status and 3 zone indication by LED's
- Dual monitoring and protection:
- 24 V output signal for critical liquid levels
- SPDT output contact for alarming, rating 230 VAC / 3 A
- Easy installation by sight-glass replacement and front side mounting without nuts
- Supply 24 VAC, 50/60 Hz
- **CE** marking under LVD and EMC Directive



LW4



LW5

Selection Table (Select One Item of Each Group)

1. Base Units (Supplied without Adapter)

Type	Part No.	Max. Allowable Pressure	Liquid Vessel Connection ϕ	Medium
LW4-H120	805491	60 bar	Larger than 1/2"	HFC, HFO/HFO blends, CO ₂ , Oil
LW4-L120	805490			
LW4X-H120	805494		1/2"	
LW4X-L120	805493			

2. Adapter

OM0-CUA	805037	Flange Adapter 3-/4-Hole
OM0-CCC	805041	Flange Adapter 3-Hole
OM0-CBB	805038	Screw Adapter 1 1/8"-18 UNEF
OM0-CCA	805039	Screw Adapter 3/4"-14 NPTF
OM0-CCB	805040	Screw Adapter 1 1/8"-12 UNF
OM0-CCD	805042	Rotalock Adapter 1 3/4"-12UNF
OM0-CCE	805043	Rotalock Adapter 1 1/4"-12UNF
LW0-1/2	805256	Screw adapter 1/2"-14 NPTF

3. Cables Alarm Relay

OM3-N30	805141	Connection to Relay 3.0m
OM3-N60	805142	Connection to Relay 6.0m
OM3-N100	805146	Connection to Relay 10.0m

4. Cable Power Supply

LW-24V-3	805500	Connection to Power Supply 24V AC 3.0m
LW-24V-6	805501	Connection to Power Supply 24V AC 6.0m
LW-24V-10	805502	Connection to Power Supply 24V AC 10.0m

Selection Table (Select One Item of Each Group)

1. Base Units (Supplied Without Adapter)

Type	Part No.	Max. Allowable Pressure	Liquid Vessel Connection \varnothing	Medium
LW5-H120	805481	130 bar	Larger than 1/2"	CO ₂ , Oil
LW5-L120	805480	130 bar		
LW5X-H120	805484	130 bar	1/2"	
LW5X-L120	805483	130 bar		

2. Adapter

LW0-CCA CO ₂	805254	Screw Adapter 3/4"-14 NPTF Steel
LW0-1/2 CO ₂	805257	Screw adapter 1/2"-14 NPTF

3. Cables Alarm Relay

OM3-N30	805141	Connection to Relay 3.0m
OM3-N60	805142	Connection to Relay 6.0m
OM3-N100	805146	Connection to Relay 10.0m

4. Cable Power Supply

LW-24V-3	805500	Connection to Power Supply 24V AC 3.0m
LW-24V-6	805501	Connection to Power Supply 24V AC 6.0m
LW-24V-10	805502	Connection to Power Supply 24V AC 10.0m

Accessories and Spare Parts

Type	Part No.	Description
ECT-623	804 421	Transformer 230 VAC / 24VAC, 60 VA
OM-HFC-K01	805 081	Sealing-Kit LW4 (Contains All Gaskets Incl. Adapter Gaskets)
OM-CO2-K01	805 079	Sealing-Kit LW5 for CO ₂ (Contains All Gaskets Incl. Adapter Gaskets)

Function

LW Liquid Level Monitoring Systems use a Hall-Sensor to measure the liquid levels. Unaffected from foaming oil or light a magnetic float changes its position according to the oil level. The hall sensor

converts these magnetic field changes into an equivalent signal, which is used by the integrated electronic controller to monitor the actual liquid level by LEDs.

Technical Data

Marking	CE Under: - Low Voltage Directive - EMC Directive
Max. Allowable Pressure PS Max. Test Pressure PT	LW4: 60 bar LW5: 130 bar LW4: 66 bar LW5: 143 bar
Supply Voltage Current	24 VAC, 50/60Hz, $\pm 10\%$, 0.05A
Medium Temperature Ambient/Storage Temperature	-20...80°C -20...50°C
Medium Compatibility	LW4: R410A, R134a, R22, R404A, R507, R407C, R1234ze, R448A, R449A, R450A, R513A, R452A, R744 LW5: R744 Mineral, Synthetic and Ester Lubricants

Orientation of Base Unit Level Control	Horizontal, $\pm 1^\circ$ 30%...60% Sight Glass Height
Alarm Contact:	Max. 3 A, 230 VAC SPDT Dry Contact
Output Signal	24 VAC Inductive Load: 35 VA
Time Delay Alarm	120 Sec
Protection Class	IP 65 (IEC529/EN 60529)

Oil Separator Series OS

Features

- Three different construction styles:
 - Hermetic
 - Top flange
 - Bottom flange with support bracket
- Stainless steel needle valve and floater
- Permanent magnet to catch iron particles out of the system
- Corrosion-resistant epoxy powder coating
- ODF Copper fittings for easy brazing
- Temperature range TS: -10°C ... +150°C
- Max. allowable pressure PS: 31 bar
- **CE** marking according PED

Type Code

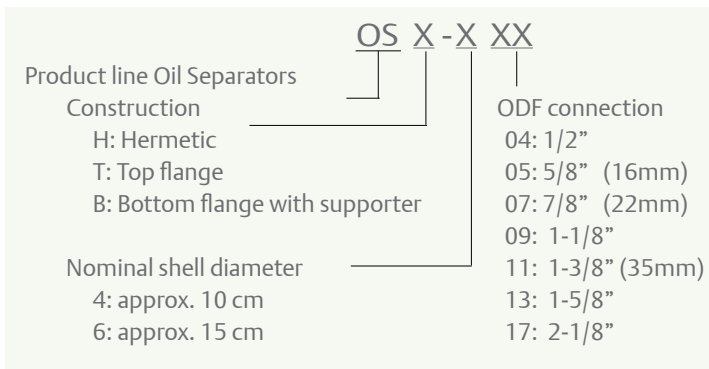

Selection Table

A1

Type	Part No.	Connection ODF		Nominal Capacity (kW)								Volume (l)
		(Inch)	(mm)	R22/ R407C	R134a	R404A/ R507	R448A	R449A	R450A	R513A	R452A	
OSH-404	881 598	1/2"		7	4.9	7.3	7.4	7.9	4.6	4.7		2.0
OSH-405	881 599	5/8"	16	18.7	13.1	19.4	18.8	20.1	11.7	12.1		2.4
OSH-407	881 600	7/8"	22	28.1	19.7	29	29.9	32.1	18.6	19.2		2.8
OSH-409	881 792	1 1/8"		37.4	26.2	38.7	40.9	43.9	25.4	26.3		3.0
OSH-411	881 794	1 3/8"	35	46.8	32.8	48.4	49.3	52.9	30.7	31.7		3.6
OSH-611	881 940	1 3/8"	35	65.5	45.9	67.8	68.7	73.6	42.7	44.1		3.6
OSH-413	881 856	1 5/8"		51.5	36.1	53.3	60.6	65	37.7	38.9		6.5
OSH-613	881 953	1 5/8"		65.5	45.9	67.8	71.7	76.8	44.5	46		7.9
OSH-642	889 022		42	65.5	45.9	67.8	71.7	76.8	44.5	46		7.9
OSH-617	881 970	2 1/8"	54	105.3	73.8	108.9	108.7	116.5	67.5	69.8		7.9
OST-404	881 860	1/2"		7	4.9	7.3	7.4	7.9	4.6	4.7		1.8
OST-405	881 861	5/8"	16	18.7	13.1	19.4	18.8	20.1	11.7	12.1		2.6
OST-407	881 862	7/8"	22	28.1	19.7	29	29.9	32.1	18.6	19.2		3.2
OST-409	881 863	1 1/8"		37.4	26.2	38.7	40.9	43.9	25.4	26.3		3.8
OST-411	881 938	1 3/8"	35	46.8	32.8	48.4	49.3	52.9	30.7	31.7		3.8
OST-413	881 939	1 5/8"		65.5	45.9	67.8	68.7	73.6	42.7	44.1		3.8
OSB-613	881 971	1 5/8"		65.5	45.9	67.8	71.7	76.8	44.5	46		7.8
OSB-617	881 972	2 1/8"	54	105.3	73.8	108.9	108.7	116.5	67.5	69.8		7.8

Note: *) Applied higher module as required

Selection Table

A2L

Type	Part No.	Connection ODF		Nominal Capacity (kW)							Volume (l)
		(Inch)	(mm)	R1234ze	R455A	R452B	R1234yf	R454A	R454B	R454C	
OSH-404	881601	1/2"		3.9	6.5	10.3	4.5	6.5	8.9	5.7	2.0
OSH-405	881602	5/8"	16	9.9	14.9	23.8	10.4	15	20.4	13.1	2.4
OSH-407	881603	7/8"	22	15.8	26.4	42.1	18.3	26.5	36	23.2	2.8
OSH-409	881604	1 1/8"		21.6	36.1	57.6	25.1	36.3	49.3	31.8	3.0
OSH-411	881605	1 3/8"	35	26	43.6	69.4	30.3	43.7	59.4	38.3	3.6
OSH-611	881606	1 3/8"	35	36.2	46.5	74.1	32.3	46.7	63.4	40.9	3.6
OSH-413	881607	1 5/8"		32	-	-	-	-	-	-	6.5
OSH-613	881608	1 5/8"		37.8	-	-	-	-	-	-	7.9
OSH-642	881609		42	37.8	-	-	-	-	-	-	7.9
OSH-617	881610	2 1/8"	54	57.4	-	-	-	-	-	-	7.9
OST-404	881611	1/2"		3.9	6.5	10.3	4.5	6.5	8.9	5.7	1.8
OST-405	881612	5/8"	16	9.9	14.9	23.8	10.4	15	20.4	13.1	2.6
OST-407	881613	7/8"	22	15.8	26.4	42.1	18.3	26.5	36	23.2	3.2
OST-409	881614	1 1/8"		21.6	36.1	57.6	25.1	36.3	49.3	31.8	3.8
OST-411	881615	1 3/8"	35	26	43.6	69.4	30.3	43.7	59.4	38.3	3.8
OST-413	881616	1 5/8"		36.2	46.5	74.1	32.3	46.7	63.4	40.9	3.8
OSB-613	881617	1 5/8"		37.8	-	-	-	-	-	-	7.8
OSB-617	881618	2 1/8"	54	57.4	-	-	-	-	-	-	7.8

Note: *) Applied higher module as required

Spare Part

Part No.	Description
808800	Gasket set for OSB/OST

Suction Accumulators and Ball Valves

Suction Accumulators

Features

- Hermetic design
- ODF Copper fittings for easy brazing
- Corrosion-resistant epoxy powder coating
- Internal orifice with strainer for optimum oil return
- Temperature range TS: -45°C...+65°C
- Max. allowable pressure PS:
 - 20.7 bar (-10°C...+65°C)
 - 15.5 bar (-45°C...-10°C)
- **CE** marking for certain types according PED
- UL/CUL file number: SA 10225



A08



Selection Table

Type	Part No.	Connection		Nominal Capacity (kW)																Conformity Assessment		Volume (l) *
				R407C		R134a		R404A / R507		R450A		R513A		R448A / R449A		R410A		R452A		Category	Procedure	
		Max.	Min.	Max.	Min.	Max.	Min.	Max.	Min.	Max.	Min.	Max.	Min.	Max.	Min.	Max.	Min.	Max.	Min.			
A08-304	001973		1/2	7	1.1	4.2	0.6	4.6	0.7	4.1	0.6	3.7	0.6	7.2	1.1	8.6	1.3			CE Marking Not Required		0.73
A10-305	001977	16	5/8	10.5	1.6	6	0.9	7	1.1	5.8	0.9	5.2	0.8	10.8	1.6	12.9	1.9					0.93
A12-305	001978	16	5/8	10.5	1.6	6	0.9	7	1.1	5.8	0.9	5.2	0.8	10.8	1.6	12.9	1.9					1.16
A12-306	001979		3/4	14	2.1	8.1	1.2	9.1	1.4	7.8	1.2	7.1	1.1	14.4	2.2	17.1	2.6					1.16
A14-305	001980	16	5/8	10.5	1.6	6	0.9	7	1.1	5.8	0.9	5.2	0.8	10.8	1.6	12.9	1.9					1.4
A14-306	001987		3/4	14	2.1	8.1	1.2	9.1	1.4	7.8	1.2	7.1	1.1	14.4	2.2	17.1	2.6			Cat. I	Mod. A	1.4
A06-405	001989	16	5/8	10.5	1.6	6	0.9	7	1.1	5.8	0.9	5.2	0.8	10.8	1.6	12.9	1.9					0.93
A10-405	001990	16	5/8	10.5	1.6	6	0.9	7	1.1	5.8	0.9	5.2	0.8	10.8	1.6	12.9	1.9					1.75
A10-406	001994		3/4	14	2.1	8.1	1.2	9.1	1.4	7.8	1.2	7.1	1.1	14.4	2.2	17.1	2.6					
A09-506	881995		3/4	14	2.1	8.1	1.2	9.1	1.4	7.8	1.2	7.1	1.1	14.4	2.2	17.1	2.6					2.33
A09-507	882455	22	7/8	25.6	3.8	14	2.1	16.1	2.4	13.6	2	12.3	1.8	26.3	3.9	31.3	4.7					2.73
A12-506	881996		3/4	14	2.1	8.1	1.2	9.1	1.4	7.8	1.2	7.1	1.1	14.4	2.2	17.1	2.6					3.29
A12-507	881998	22	7/8	25.6	3.8	14	2.1	16.1	2.4	13.6	2	12.3	1.8	26.3	3.9	31.3	4.7					3.29
A13-507	882007	22	7/8	25.6	3.8	14	2.1	16.1	2.4	13.6	2	12.3	1.8	26.3	3.9	31.3	4.7					3.8
A13-509	882011		1 1/8	41.4	6.2	25.3	3.8	26.7	4	24.5	3.7	22.2	3.3	42.5	6.4	50.6	7.6					3.8
A17-509	882012		1 1/8	41.4	6.2	25.3	3.8	26.7	4	24.5	3.7	22.2	3.3	42.5	6.4	50.6	7.6					4.87
A17-511	882013	35	1 3/8	66	9.9	37.6	5.6	42.8	6.4	36.4	5.5	33	5	67.6	10.1	80.6	12.1			Cat. I	Mod. D1	4.87
A11-607	882014	22	7/8	25.6	3.8	14	2.1	16.1	2.4	13.6	2	12.3	1.8	26.3	3.9	31.3	4.7					4.3
A13-607	882015	22	7/8	25.6	3.8	14	2.1	16.1	2.4	13.6	2	12.3	1.8	26.3	3.9	31.3	4.7					4.98
A13-609	882019		1 1/8	41.4	6.2	25.3	3.8	26.7	4	24.5	3.7	22.2	3.3	42.5	6.4	50.6	7.6					4.98
A14-611	882020	35	1 3/8	66	9.9	37.6	5.6	42.8	6.4	36.4	5.5	33	5	67.6	10.1	80.6	12.1					5.48
A17-613	882022		1 5/8	100	15	59.7	9	63.9	9.6	57.8	8.7	52.4	7.9	102.5	15.4	122.2	18.3					6.85
A17-642	889023	42		100	15	59.7	9	63.9	9.6	57.8	8.7	52.4	7.9	102.5	15.4	122.2	18.3					6.85
A20-613	882021		1 5/8	100	15	59.7	9	63.9	9.6	57.8	8.7	52.4	7.9	102.5	15.4	122.2	18.3					8.21
A25-613	882023		1 5/8	100	15	59.7	9	63.9	9.6	57.8	8.7	52.4	7.9	102.5	15.4	122.2	18.3			Cat II	Mod. D1	10.23

Note 1: For selection of other operating conditions, please use "Controls Navigator" selection program

Note 2: *) Functional volume

Type	Part No.	Connection		Nominal Capacity (kW)																Conformity Assessment		Volume (l)*
				R452B		R455A		R454A		R454B		R454C		R1234yf		R1234ze		R32				
		mm	Inch	Max.	Min.	Max.	Min.	Max.	Min.	Max.	Min.	Max.	Min.	Max.	Min.	Max.	Min.	Max.	Min.	Category	Procedure	
A08-304	882453		1/2	5.1	0.8	7.9	1.2	7.2	1.1	5.4	0.8	8.2	1.2	3.6	0.5	3.5	0.5	11	1.7	CE Marking Not Required	0.73	
A10-305	882457	16	5/8	7.7	1.2	11.8	1.8	10.8	1.6	8	1.2	12.4	1.9	5.1	0.8	5	0.8	16.5	2.5		0.93	
A12-305	882458	16	5/8	7.7	1.2	11.8	1.8	10.8	1.6	8	1.2	12.4	1.9	5.1	0.8	5	0.8	16.5	2.5		1.16	
A12-306	882459		3/4	10.3	1.5	15.8	2.4	14.4	2.2	10.7	1.6	16.5	2.5	6.9	1	6.7	1	22	3.3	Cat. I Mod. A	1.16	
A14-305	882460	16	5/8	7.7	1.2	11.8	1.8	10.8	1.6	8	1.2	12.4	1.9	5.1	0.8	5	0.8	16.5	2.5		1.4	
A14-306	882461		3/4	10.3	1.5	15.8	2.4	14.4	2.2	10.7	1.6	16.5	2.5	6.9	1	6.7	1	22	3.3		1.4	
A06-405	882462	16	5/8	7.7	1.2	11.8	1.8	10.8	1.6	8	1.2	12.4	1.9	5.1	0.8	5	0.8	16.5	2.5		0.93	
A10-405	882463	16	5/8	7.7	1.2	11.8	1.8	10.8	1.6	8	1.2	12.4	1.9	5.1	0.8	5	0.8	16.5	2.5		1.75	
A10-406	882464		3/4	10.3	1.5	15.8	2.4	14.4	2.2	10.7	1.6	16.5	2.5	6.9	1	6.7	1	22	3.3		1.75	
A09-506	881994		3/4	10.3	1.5	15.8	2.4	14.4	2.2	10.7	1.6	16.5	2.5	6.9	1	6.7	1	22	3.3		Cat. II Mod. D1	2.33
A09-507	882456	22	7/8	18.8	2.8	28.8	4.3	26.2	3.9	19.5	2.9	30.1	4.5	12.1	1.8	11.7	1.8	40.2	6	2.73		
A12-506	881997		3/4	10.3	1.5	15.8	2.4	14.4	2.2	10.7	1.6	16.5	2.5	6.9	1	6.7	1	22	3.3	3.29		
A12-507	881999	22	7/8	18.8	2.8	28.8	4.3	26.2	3.9	19.5	2.9	30.1	4.5	12.1	1.8	11.7	1.8	40.2	6	3.29		
A13-507	882000	22	7/8	18.8	2.8	28.8	4.3	26.2	3.9	19.5	2.9	30.1	4.5	12.1	1.8	11.7	1.8	40.2	6	3.8		
A13-509	882001		1 1/8	30.3	4.5	46.6	7	42.4	6.4	31.6	4.7	48.7	7.3	21.7	3.3	21	3.2	64.9	9.7	3.8		
A17-509	882002		1 1/8	30.3	4.5	46.6	7	42.4	6.4	31.6	4.7	48.7	7.3	21.7	3.3	21	3.2	64.9	9.7	4.87		
A17-511	882003	35	1 3/8	48.3	7.2	74.2	11.1	67.5	10.1	50.3	7.5	77.5	11.6	32.3	4.8	31.3	4.7	103.4	15.5	4.87		
A11-607	882004	22	7/8	18.8	2.8	28.8	4.3	26.2	3.9	19.5	2.9	30.1	4.5	12.1	1.8	11.7	1.8	40.2	6	4.3		
A13-607	882005	22	7/8	18.8	2.8	28.8	4.3	26.2	3.9	19.5	2.9	30.1	4.5	12.1	1.8	11.7	1.8	40.2	6	4.98		
A13-609	882006		1 1/8	30.3	4.5	46.6	7	42.4	6.4	31.6	4.7	48.7	7.3	21.7	3.3	21	3.2	64.9	9.7	4.98		
A14-611	882008	35	1 3/8	48.3	7.2	74.2	11.1	67.5	10.1	50.3	7.5	77.5	11.6	32.3	4.8	31.3	4.7	103.4	15.5	5.48		
A17-613	882009		1 5/8	73.2	11	112.5	16.9	102.4	15.4	76.3	11.4	117.5	17.6	51.3	7.7	49.7	7.5	156.8	23.5	6.85		
A17-642	882010	42		73.2	11	112.5	16.9	102.4	15.4	76.3	11.4	117.5	17.6	51.3	7.7	49.7	7.5	156.8	23.5	6.85		
A20-613	882016		1 5/8	73.2	11	112.5	16.9	102.4	15.4	76.3	11.4	117.5	17.6	51.3	7.7	49.7	7.5	156.8	23.5	8.21		
A25-613	882017		1 5/8	-	-	-	-	-	-	-	-	-	-	-	-	49.7	7.5	-	-	Cat II	Mod. D1	10.23

Ball Valves Series BVE/BVS and CVE/CVS

Features

- BVE/S, Max. allowable pressure PS: 45 bar
- CVE/S for CO₂, max. allowable pressure PS: 60 bar
- BVS/CVS version with Schrader valve
- Two threads at valve body for easy mounting
- Hermetic design with Laser welded valve body
- Bi-directional flow characteristics
- Valve cap retained by strap attached to main body
- Pressure relief port design
- CE Marking acc. PED (from BVE-138 up to BVE-318)
- To protect valve from unauthorized use a special seal cap is available as accessory



Selection table BVE/BVS (UL Approved)

Type BVE	Part No.	Type BVS	Part No.	Connection size ODF	
				(inch)	(mm)
BVE-014	806 730	BVS-014	806 750	1/4"	
BVE-M06	806 731	BVS-M06	806 751		6mm
BVE-038	806 732	BVS-038	806 752	3/8"	
BVE-M10	806 733	BVS-M10	806 753		10mm
BVE-012	806 734	BVS-012	806 754	1/2"	
BVE-M12	806 735	BVS-M12	806 755		12mm
BVE-058	806 736	BVS-058	806 756	5/8"	16mm
BVE-034	806 737	BVS-034	806 757	3/4"	
BVE-078	806 738	BVS-078	806 758	7/8"	22mm
BVE-118	806 739	BVS-118	806 759	1 1/8"	
BVE-M28	806 740	BVS-M28	806 760		28mm
BVE-138	806 741	BVS-138	806 761	1 3/8"	35mm
BVE-158	806 742	BVS-158	806 762	1 5/8"	
BVE-M42	806 743	BVS-M42	806 763		42mm
BVE-218	806 744	BVS-218	806 764	2 1/8"	54mm
BVE-258	806 745	BVS-258	806 765	2 5/8"	
BVE-318	806746	BVS-318	806766	3 1/8"	

Selection table CVE/CVS (Not UL Approved)

Type CVE	Part No.	Type CVS	Part No.	Connection size ODF	
				(inch)	(mm)
CVE-014	808 130	CVS-014	808 150	1/4"	
CVE-M06	808 131	CVS-M06	808 151		6mm
CVE-038	808 132	CVS-038	808 152	3/8"	
CVE-M10	808 133	CVS-M10	808 153		10mm
CVE-012	808 134	CVS-012	808 154	1/2"	
CVE-M12	808 135	CVS-M12	808 155		12mm
CVE-058	808 136	CVS-058	808 156	5/8"	16mm
CVE-034	808 137	CVS-034	808 157	3/4"	
CVE-078	808 138	CVS-078	808 158	7/8"	22mm

Technical Data

Max. Allowable Pressure PS	BVE/BVS 45 bar; CVE/CVS 60 bar
Test Pressure PT	BVE/BVS 49.5 bar; CVE/CVS 66 bar
Medium Temperature TS	-40 ... 120°C
Medium Compatibility	A1: R410A R134a R22 R404A R507 R407C R1234ze R448A R449A R450A R513A R744 R124 R452A, A2L*: R32, R452B, R455A, R454A, R454B, R454C, R1234yf, R1234ze

Accessories - Special Seal Caps

BVE / BVS , CVE / CVS Valve Size	Part No.	Thread (3)	Quantity Per Pack
1/4" ... 7/8" (6 ... 22mm)	806 770	M18x1	10 pcs
1 1/8" ... 1 3/8" (28 ... 35mm)	806 771	M27x1	10 pcs
1 5/8" (42 mm) ... 3 1/8"	806 772	M36x1	10 pcs





Appendix

Appendix Conversion Table

Power

$\text{kW} / \text{h} = \text{Kcal} / \text{h} : 860$	$\text{Kcal} / \text{h} = \text{kW} / \text{h} \times 860$
$\text{kW} = \text{US Ton of Refrigeration} : 0.284$	$\text{US Ton of Refrigeration} = \text{kW} \times 0.284$
$\text{kW} = \text{BTU} / \text{h} : 3413$	$\text{BTU} / \text{h} = \text{kW} \times 3413$

Temperature

$^{\circ}\text{C} = (^{\circ}\text{F} - 32) : 1.8$	$^{\circ}\text{F} = (^{\circ}\text{C} \times 1.8) + 32$
--	---

Pressure

$\text{Bar} = \text{PSI} : 14.5$	$\text{PSI} = \text{Bar} \times 14.5$
$1 \text{ Bar} = 100\,000 \text{ Pascal}$	$100 \text{ Pascal} = 1 \text{ m Bar}$



Connections

Specification		Connection Tube			Thread
		SAE	Inch	Metric	
SAE	Flare	SAE 1/4"	1/4"	6mm	7/16" - 20UNF
		SAE 5/16"	5/16"	8mm	5/8" - 18UNF
		SAE 3/8"	3/8"	10mm	5/8" - 18UNF
		SAE 1/2"	1/2"	12mm	3/4" - 16UNF
		SAE 5/8"	5/8"	16mm	7/8" - 14UNF
		SAE 3/4"	3/4"	18mm	1-1/16" - 14UNF
		SAE 7/8"	7/8"	22mm	1-1/4" - 12UNF
		SAE 1"	1	25mm	1-1/2" - 12UNF
			1-1/8"		
			1-3/8"	35mm	
			1-5/8"		
			2-1/8"	54mm	
			2-5/8"		
	3-1/8"				
R or G same as BSP	Pipe thread female cylindrical	Male Thread: R / NPT / BSP / G			Withworth-Pipe Thread DIN 2999 / ISO 228
R same as BSP	Pipe Thread Male Tapering	Female Thread: R / NPT / BSP / G			Withworth-Pipe Thread DIN 2999
G	Pipe Thread Male Cylinder	Female thread: R / BSP / G			Withworth-Pipe Thread ISO 228
NPT	Pipe Thread Female Tapering	Male thread: R / NPT / BSP			Standard Taper Pipe Thread ASA B 2.1
	Pipe Thread Male Tapering	Female thread: R / NPT / BSP / G			
ODF Outside Diameter Female	Solder Female	Given dimension is outside tube diameter. Tube has to be pushed into odf connection.			
ODM Outside Diameter Male	Solder Male	Given dimension is outside tube diameter. Expanded tube can be pushed onto odm connection or tube can be connected through a sleeve with the odm connection.			

CE Per Pressure Vessel Directive 14/68/EU

Product	Fluid Group	Volume (Liter)	TS (°C)	PS (bar)	Hazard Category	Conformity Assessment Module	Marking
Filter Driers							
ADK-03 / 05 / 08 / 16...	II	0.1 ... 0.38	-40 ... +65	45	SEP	-	HP & UL
ADK-30 / 41 / 75...	II	0.4 ... 0.65		45	SEP	-	HP & UL
FDB-03 / 05 / 08 / 16...	II	0.1 ... 0.38		45	SEP	-	HP & UL
FDB-30 / 41...	II	0.45 ... 0.5		45	SEP	-	HP & UL
BFK-05 / 08 / 16...	II	0.18 ... 0.32		45	SEP	-	HP & UL
BFK-30...	II	0.4		45	SEP	-	HP & UL
FDS-24...	II	1.0	-10 ... +65 (-45 ... -10)	34.5 (25.9)	SEP	-	HP & UL
ADKS-Plus-48...	II	2.1			I	A	CE & UL
ADKS-Plus-96...	II	3.8			I	A	CE & UL
ADKS-Plus-144...	II	5.4			I	A	CE & UL
ADKS-Plus-192...	II	7.0			II	D1	CE0036 & UL
FDH-48.../96...	II		-10...+65 (-45...-10)	46 (25,9)	I	A	CE & UL
ASD/ASF-28.../35.../45...	II	<1.0	-45 ... +50	27.5	SEP	-	HP & UL
ASD/ASF50.../75...	II	<1.4			SEP	-	HP & UL
BTAS-2...	II	0.42	-45 ... +50	24	SEP	-	HP & UL
BTAS-3...	II	1.1			SEP	-	HP & UL
BTAS-4...	II	1.97			SEP	-	HP & UL
BTAS-5...	II	3.19			I	A	CE & UL
Oil Management / Components							
OSH-404	II	2.0	-10 ... +150	31	I	A	HP & UL
OSH-405	II	2.4			I	A	HP & UL
OSH-407	II	2.8			I	A	HP & UL
OSH-409	II	3.0			I	A	HP & UL
OSH-411 / -413	II	3.6			I	A	HP & UL
OST-404	II	1.8			I	A	HP & UL
OST-405	II	2.6			I	A	HP & UL
OSH-407	II	3.2			I	A	CE & UL
OST-409 / -411 / -413	II	3.8			I	A	CE & UL
OSH-611	II	6.5			II	D1	CE0036 & UL
OSH-613 / -617	II	7.9			II	D1	CE0036 & UL
OSB-613 / -617	II	7.8			II	D1	CE0036 & UL
OM3	II	DN 6MM			-20 ... +80	46	SEP
OM4 & OW4 & LW4	II	DN 6MM	-20 ... +80	60	SEP	CE under Low Voltage and EMC Directive	
OM5 & OW5 & LW5	II	DN 6MM	-20 ... +80	130	SEP	CE under Low Voltage and EMC Directive	
Suction Accumulators							
A08-304	II	0.9	-10 ... +65 (-45 ... -10)	20.7 (15.5)	SEP	-	HP & UL
A10-305	II	1.1			SEP	-	HP & UL
A12-305 / -306	II	1.3			SEP	-	HP & UL
A14-305 / -306	II	1.6			SEP	-	HP & UL
A06-404 / -405	II	1.2			SEP	-	HP & UL
A10-405 / -406	II	2.1			SEP	-	HP & UL
A09-506 / -507	II	2.7			I	A	CE & UL
A12-506 / -507	II	3.8			I	A	CE & UL
A13-507 / -509	II	4.3			I	A	CE & UL
A17-509 / -511	II	5.4			I	A	CE & UL
A11-607	II	5.1			I	A	CE & UL
A13-607 / -609	II	5.8			I	A	CE & UL
A14-611	II	6.4			I	A	CE & UL
A17-613	II	7.9			I	A	CE & UL
A20-613	II	9.4			I	A	CE & UL
A25-613	II	11.6			II	D1	CE0036 & UL

CE Per Pressure Vessel Directive 14/68/EU

Product	Fluid Group	DN (mm)	TS (°C)	PS (bar)	Hazard Category	Conformity Assessment Module	Marking
Pressure Switches							
PS1-B3..., PSA-B3...		6	-50 ... +70	22	IV	B, D	CE0035 & UL
PS1-S3..., PSA-S3...		6			IV	B, D	CE0035 & UL
PS1-W3..., PSA-W3...		6			IV	B, D	CE0035 & UL
PS1-B5..., PSA-B5...		6		32	IV	B, D	CE0035 & UL
PS1-S5..., PSA-S5...		6			IV	B, D	CE0035 & UL
PS1-W5..., PSA-W5...		6			IV	B, D	CE0035 & UL
All Other PS1 Types		6	22/32	Under LVD, Excluded from PED		CE & UL	
PS2-B7..., PSB-B7...		6	-50 ... +70	22/32	IV	B, D	CE0035 & UL
PS2-C7..., PSB-C7...		6			IV	B, D	CE0035 & UL
PS2-T7..., PSB-T7...		6			IV	B, D	CE0035 & UL
PS2-W7..., PSB-W7...		6			IV	B, D	CE0035 & UL
PS2-N7..., PSB-N7...		6			IV	B, D	CE0035 & UL
PS2-C8..., PSB-C8...		6			32	IV	B, D
PS2-G8..., PSB-G8...		6		IV		B, D	CE0035 & UL
PS2-S8..., PSB-S8...		6		IV		B, D	CE0035 & UL
All Other PS2 Types		6		22/32		Under LVD, Excluded from PED	
PS3-W1...		6		-40 ... +70	27	IV	B, D
PS3-B6...		6	-40 ... +150	45	IV	B, D	CE0035 & UL
PS3-W6...		6			IV	B, D	CE0035 & UL
All Other PS3 Type	6	-40 ... +70	27/32	Under LVD, Excluded from PED		CE	
CS3-.8...,CS3-.Q...	6	-40 ... +70	140	IV	B, D	CE	
CS3-.7...,CS3-.P...	6	-40 ... +70	90	IV	B, D	CE	
PS4-W..., PS4-BL...	6	-30 ... +80	25/41/55/69	IV	B, D	CE	
All Other PS4 Type	6	-40...+135	24/41/55/69	Under LVD, Excluded from PED		CE	
FD113...	6	Under LVD, Excluded from PED				CE & UL	

LVD = Low Voltage Directive

CE Per Pressure Vessel Directive 14/68/EU

Product	Fluid Group	DN (mm)	TS (°C)	PS (bar)	Hazard Category	Conformity Assessment Module	Marking	
Fan Speed Controllers								
FSY-41...	II	6	-20 ... +70	27	Under LVD, Excluded from PED		CE	
FSY-42...	II	6		32			CE	
FSY-43...	II	6		43			CE	
Transmitters								
PT5N-07M/T	II	6	-40 ... +135	27	SEP	-	CE	
PT5N-18M/T	II	6		48	SEP	-	CE	
PT5N-30M/T	II	6		60	SEP	-	CE	
PT5N-50M/T	II	6		75	SEP	-	CE	
PT5N-150D	II	6	-40 ... +135	150	SEP	-	CE	
Thermo™ Expansion Valves and Electrical Control Valves								
TI	II	Max. 12	-45 ... +75	45	SEP	-	-	
TIH	II	Max. 16	-40 ... +70	46	SEP	-	-	
TX7	II	Max. 22	-25 ... +70	46	SEP	-	-	
T-Series with XB / XC Power Element	II	Max. 28	-45 ... +75	46 / 31	SEP	-	-	
L-Series with XB / XC Power Element	II	Max. 28		46 / 31	SEP	-	-	
935-Series with XB / XC Power Element	II	Max. 28		46 / 31	SEP	-	-	
ZZ-Series	II	Max. 28	-100 ... +75	31	SEP	-	-	
EXL/M	II	Max. 6	-30 ... +70	45	SEP	-	-	
EXN	II	Max. 12	-30 ... +70	45	SEP	-	-	
EX2	II	Max. 12	-40 ... +65	40	SEP	-	-	
CX2	II	Max. 12	-40 ... +65	90	SEP	-	-	
EX4/EX5/EX6	II	Max. 25	-50 ... +100	60	SEP	-	-	
EX7	II	35		60	I	A	CE	
EX8	II	42	Bi-flow: -50 ... +80	56	I	A	CE	
CV4/CV5/CV6	II	Max. 22	-50 ... +100	130	SEP	-	-	
Solenoid Valves								
110 RB 2...	II	6...10	-40 ... +120	31	SEP	-	-	
200 RB 3/4/6...	II	10 ... 16		31	SEP	-	-	
200 RH 3-6T4/6T5	II	10 ... 16		60	SEP	-	-	
240 RA 8/9/12...	II	16 ... 28		31	SEP	-	-	
240 RA 16T9	II	28		31	SEP	-	-	
240 RA 16T11	II	35		31	I	A	CE	
240 RA 20T11/13/17...	II	35		31	I	A	CE	
540 RA 8/9/12/16...	II	16 ... 28		31	SEP	-	-	
540 RA 20T11	II	35		28	I	A	CE	
M36-078	II	28		35	SEP	-	-	
M36-118	II	28		35	SEP	-	-	
Regulators								
ACP	II	6...10		-40 ... +120	31	SEP	-	-
CPHE...	II	12 ... 28	35		SEP	-	-	
PRE/PRC	II	16 ... 35	-30... +80	25	SEP	-	-	
Ball Valves								
BVE/BVS/CVE/CVS...	II	≤ 28	-40 ... +120	45 / 60	SEP	-	-	
BVE/BVS....	II	≥ 35		45	I	A	CE	
Moisture Indicators								
MIA	II	≤ 28	-40 ... +100	45	SEP	-	-	
CIA	II	≤ 16		60	SEP	-	-	
AMI-1..., AMI-3S7, AMI-S9	II	≤ 28		35	SEP	-	-	
AMI-2..., AMI-3S11	II	≤ 54		35	I	A	CE	



Alco Keyword Register

Alco Keyword Register

Series	Description	Page
110 RB	2-Way Solenoid Valve	234
200 RB	2-Way Solenoid Valve	234
200 RH	2-Way Solenoid Valve	238
240 RA	2-Way Solenoid Valve	234
540 RA	2-Way Solenoid Valve	236
935	Liquid Injection Valve	227
A		
A	Suction Accumulators	304
ACP	Hot Gas Bypass Regulator	243
ADK	Filter Drier	276
ADKS-Plus	Filter Drier Shell	282
AMI	Moisture/Liquid Indicator	288
ASF	Suction Line Filter	285
ASD	Suction Line Filter Drier	285
B		
BFK	Bi-Flow Filter Drier	274
BTAS	Suction Line Filter and Filter Drier Shell	286
BVE / BVS, CVE / CVS	Ball Valves	307

Series	Description	Page
C		
CPHE	Hot Gas Bypass Regulator	244
CSS	Compressor Soft Starter	200
CS1	Pressure controls	254
CS3	Pressure Controls (High Pressure)	259
CV	Electronic Control Valve	189
CX2	Electronic Expansion Valve	185
E		
ESC	Coils	233
EX2	Electronic Expansion Valve	184
EX4 .. EX8	Electrical Control Valves	186
EXD-HP1/2	Stand-alone Superheat/Economizer Controller	196
EXD-SH1/2	Superheat Controller for EX/CX Valves	193
EXD-TEV1	Economizer Controller for Tandem Compressors	198
EXD-U02	Universal Driver Modules	199
EXM/EXL	Electronic Expansion Valve	182



Alco Keyword Register

Series	Description	Page
F		
FD 113	Differential Pressure Controls	264
FDB	Filter Driers	279
FDH	Filter Drier Shell	283
FDS-24	Filter-Drier Shells With Quick-Cap	284
FSE	Fan Speed Control Module	205
FSY	Electronic Fan Speed Controller	203
L		
LW4/5	Level Watch LW4 and LW5	300
L-Series	Thermo Expansion Valve	225
M		
M36	3-Way Solenoid Valve	225
MIA / CIA	Moisture/Liquid Indicator	288
O		
OM3 / OM4 / OM5	Oil Level Management System	293
OW4 / OW5	Electronic Oil Level Monitoring	298
OS	Oil Separator	302

Series	Description	Page
P		
PRC	Crankcase Pressure Regulator	245
PRE	Evaporator Pressure Regulator	245
PS1	Pressure Controls	250
PS2	Dual Pressure Controls	252
PS3	Pressure Controls	256
PS4	Pressure Controls	261
PT5N	Pressure Transmitter	201
T		
TI	Thermo Expansion Valve	211
TIH	Thermo Expansion Valve	214
T-Series	Thermo Expansion Valve	220
TS1	Thermostat	267
TX7	Thermo Expansion Valve	218
Z		
ZZ	Thermo Expansion Valve	223

Notes

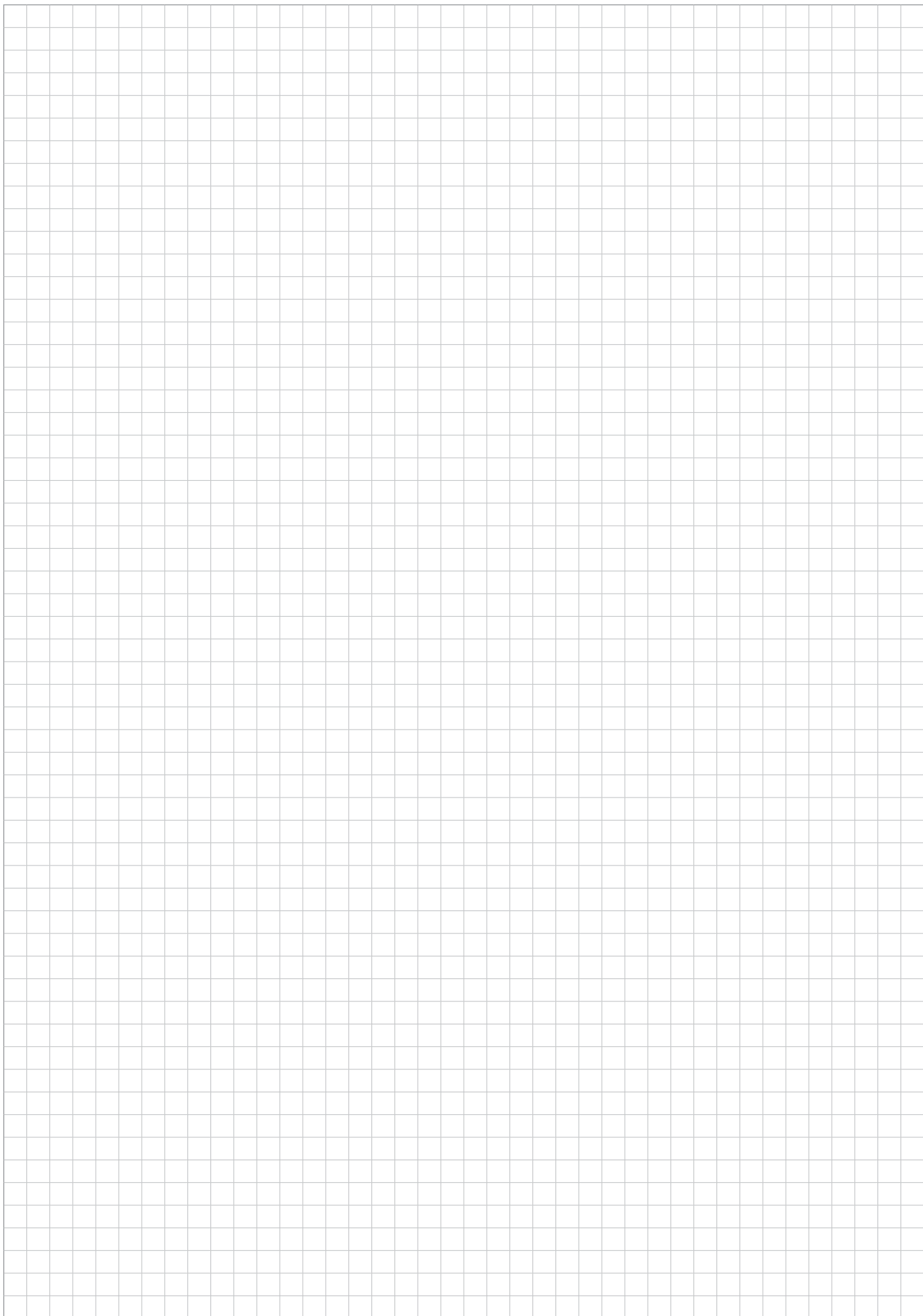

Notes

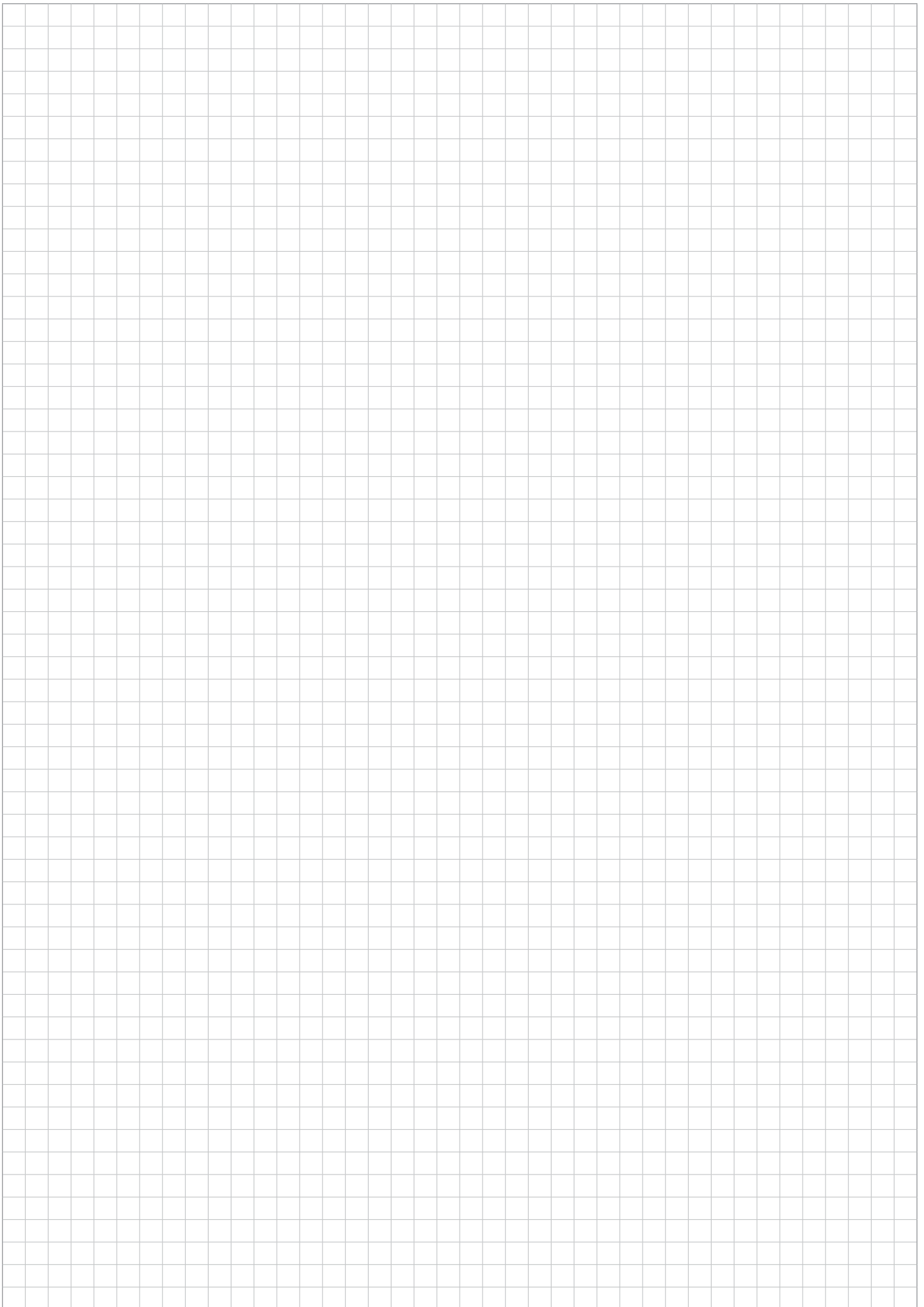

1. DEFINITIONS:

In these Terms and Conditions of Sale, "Seller" means one of the three Emerson companies mentioned in the title; "Buyer" means the person, firm, company or corporation by whom the order is given; "Goods" means the goods (including any Software and Documentation, as defined in Clause 9) described in Seller's Acknowledgement of Order form; "Services" means the services described in Seller's Acknowledgement of Order Form; "Contract" means the written agreement (including these Terms and Conditions) made between Buyer and Seller for the supply of the Goods and/or provision of Services; "Contract Price" means the price payable to Seller by Buyer for the Goods and/or Services and "Seller Affiliate" means an Emerson Group company which is an affiliate within the meaning of Section 15 AktG (German Stock Corporation Act).

2. THE CONTRACT:

2.1 All orders must be in writing and are accepted subject to these Terms and Conditions of Sale. No terms or conditions put forward by Buyer and no representations, warranties, guarantees or other statements not contained in Seller's quotation or Acknowledgement of Order nor otherwise expressly agreed in writing by Seller shall be binding on Seller.

2.2 The Contract shall become effective only upon the date of acceptance of Buyer's order on Seller's Acknowledgement of Order form. If the details of the Goods or Services described in Seller's quotation differ from those set out in the Acknowledgement of Order Form the latter shall apply.

2.3 No alteration or variation to the Contract shall apply unless agreed in writing by both parties. However, Seller reserves the right to effect minor modifications and/or improvements to the Goods before delivery provided that the performance of the Goods is not adversely affected and that neither the Contract Price nor the delivery date is affected.

3. VALIDITY OF QUOTATION AND PRICES:

3.1 Unless previously withdrawn, Seller's quotation is open for acceptance within the period stated therein or, when no period is so stated, within thirty days after its date.

3.2 Prices are firm for delivery within the period stated in Seller's quotation and are exclusive of (a) Value Added Tax and (b) any similar and other taxes, duties, levies or other like charges arising outside Germany in connection with the performance of the Contract.

3.3 Prices (a) are for Goods delivered EXW (Ex works) Seller's shipping point, exclusive of freight, insurance and handling and (b) unless otherwise stated in the Seller's quotation, are exclusive of packing. If the Goods are to be packed, packing materials are non-returnable.

4. PAYMENT:

4.1 Payment shall be made: (a) in full without set-off, counterclaim or withholding of any kind (save where and to the extent that this cannot by law be excluded); and (b) in the currency of Seller's quotation within thirty days of receipt of invoice unless otherwise specified by Seller's Finance Department. Goods will be invoiced at any time after their readiness for dispatch has been notified to Buyer. Services will be invoiced monthly in arrears or, if earlier, upon completion. Without prejudice to Seller's other rights, Seller reserves the right to: (i) charge interest on any overdue sums at 8% above the base lending rate of Section 247 BGB (German Civil Code) during the period of delay; (ii) suspend performance of the Contract (including withholding shipment) in the event that Buyer fails or in Seller's reasonable opinion it appears that Buyer is likely to fail to make payment when due under the Contract or any other contract; and (iii) under the same conditions require reasonable security for payment.

4.2 Customer may set off counterclaims only if recognized or non-appealable. A right of retention may be exercised by Customer only if as it concerns the same contractual relationship.

5. DELIVERY PERIOD:

5.1 Unless otherwise stated in Seller's quotation, all periods stated for delivery or completion run from the Effective Date and are to be treated as estimates only not involving any contractual obligations.

5.2 If Seller is delayed in or prevented from performing any of its obligations under the Contract due to the acts or omissions of Buyer or its agents (including but not limited to failure to provide specifications and/or fully dimensioned working drawings and/or such other information as Seller reasonably requires to proceed expeditiously with its obligations under the Contract), the delivery/completion period and the Contract Price shall both be adjusted accordingly.

5.3 If delivery is delayed due to any act or omission of Buyer, or if having been notified that the Goods are ready for dispatch, Buyer fails to take delivery or provide adequate shipping instructions, Seller shall be entitled to place the Goods into a suitable store at Buyer's expense. Upon placing the Goods into the store, delivery shall be deemed to be complete, risk in the Goods shall pass to Buyer and Buyer shall pay Seller accordingly.

6. FORCE MAJEURE:

6.1 The Contract (other than Buyer's obligation to pay all sums due to Seller in accordance with the Contract) shall be suspended, without liability, in the event and to the extent that its performance is prevented or delayed due to any circumstance beyond the reasonable control of the party affected, including but not limited to: Act of God, war, armed conflict or terrorist attack, riot, fire, explosion, accident, flood, sabotage; governmental decisions or actions (including but not limited to prohibition of exports or re-exports or the failure to grant or the revocation of applicable export licenses), or labor trouble, strike, lockout or injunction. Seller shall have no obligation to supply hardware, software or technology or to provide services in the absence of government permits or fulfillment of statutory conditions of exemption from such permits within the framework of import and export control (in particular, according to the regulations applicable in the United States, the European Union and the jurisdiction in which Seller has its registered office or from which components of the Goods are supplied) and the underlying circumstances could not be foreseen by Seller and are outside of Seller's sphere of influence. In the event of revocation of issued government permits or in the event of a change in the applicable statutory import and export control regulations such that Seller is prevented from fulfilling the contract, Seller is discharged from the contractual obligation without any liability of Seller.

6.2 If either party is delayed or prevented from performance of its obligations by reason of this Clause for more than 180 consecutive calendar days, either party may terminate the then unperformed portion of the Contract by notice in writing given to the other party, without liability provided that Buyer shall be obliged to pay the reasonable cost and expense of any work in progress and to pay for all Goods delivered and Services performed as at the date of termination.

7. INSPECTION, TESTING, AND CALIBRATION:

7.1 Goods will be inspected by Seller or manufacturer and, where practicable, submitted to Seller's or manufacturer's standard tests before dispatch. Any additional tests or inspection (including inspection by Buyer or its representative, or tests in the presence of Buyer or its representative and/or calibration) or the supply of test certificates and/or detailed test results shall be subject to Seller's prior written agreement and Seller reserves the right to charge therefor; if Buyer or its representative fails to attend such tests, inspection and/or calibration after seven days' notice that the Goods are ready therefor, the tests, inspection and/or calibration will proceed and shall be deemed to have been made in the presence of Buyer or its representative and the Seller's statement that the Goods have passed such testing and/or inspection and/or have been calibrated shall be conclusive.

7.2 Buyer's warranty rights are subject to Buyer's proper compliance with Buyer's inspection and complaint obligations set forth in Section 377 of the German Commercial Code (HGB).

8. DELIVERY, RISK & TITLE:

8.1 Unless otherwise expressly stated in the Contract, the Goods will be delivered Carriage Paid To (CPT) the destination named in the Contract; freight, packing and handling will be charged at Seller's standard rates. Risk of loss of or damage to the Goods shall pass to Buyer upon delivery as aforesaid and Buyer shall be responsible for insurance of the Goods after risk has so passed. Alternatively, if it is expressly stated in the Contract that Seller is responsible for the insurance of the Goods after their delivery to the carrier, such insurance will be charged at Seller's standard rates. "Ex-works", "FCA", "CPT" and any other delivery terms used in the Contract shall be defined in accordance with the latest version of Incoterms.

9. DOCUMENTATION AND SOFTWARE:

9.1 Title to and ownership of the copyrights in software and/or firmware incorporated into or provided for use with the Goods ("Software") and documentation supplied with the Goods ("Documentation") shall remain with the relevant Seller Affiliate (or such other party as may have supplied the Software and/or Documentation to Seller) and is not transferred hereby to Buyer.

9.2 Except as otherwise provided herein, Buyer is hereby granted a non-exclusive, royalty-free license to use the Software and Documentation in conjunction with the Goods, provided that and for so long as the Software and Documentation are not copied (unless expressly authorized by applicable law) and Buyer holds the Software and Documentation in strict confidence and does not disclose them to others, or permit others to have access to them (other than Seller's standard operating and maintenance manuals). Buyer may transfer the foregoing license to another party which purchases, rents or leases the Goods, provided the other party accepts and agrees in writing to be bound by the conditions of this Clause 9.

9.3 Notwithstanding Sub-clause 9.2, Buyer's use of certain Software, (as specified by Seller and including but not limited to control system and AMS Software) shall be governed exclusively by the applicable Seller Affiliate or third party license agreement.

9.4 Seller and Seller Affiliates shall retain ownership of all inventions, designs and processes made or evolved by them and save as set out in this Clause 9 no rights in intellectual property are hereby granted.

10. LIABILITY FOR DEFECTS OF QUALITY

10.1 Seller warrants that upon passing of the risk the Goods and Services will have the quality agreed upon. Unless otherwise agreed, the quality agreed upon shall meet Seller's specifications as valid and published at the time of the order confirmation.

10.2 If, upon passing of the risk, the Goods or Services do not have the quality agreed upon, Seller warrants to provide subsequent performance by either, at its option, repairing or replacing the concerned parts (subsequent rectification) or by replacing the Goods or Services by such Goods or Services which are free from defects (subsequent delivery).

10.3 Seller may rectify any defect several times and may decide at its discretion to change from rectification to subsequent delivery. Seller shall be responsible for all costs incurred in connection with its subsequent performance, especially the transport, shipping, labor and material cost, unless such costs are incurred as a result of the Goods being taken to a place other than the place of performance.

Emerson Climate Technologies GmbH
Registered Office:
Amtsgericht Berlin-Charlottenburg, HRB 8778

10.4 Buyer may set a reasonable period of at least four (4) weeks to Seller for him to provide subsequent performance and, if subsequent performance fails during such period, may demand reduction of the Contract Price after expiry of that period or, unless the defect is insignificant, may rescind the Contract. Damages may only be claimed in line with Clause 14.

10.5 Any claims and rights based on defects will become time-barred, except in the case of intent, after expiry of twelve (12) months since taking into operation of the Goods, however no later than eighteen (18) months since delivery. Claims to damages based on defects will become time-barred after expiry of the statutory period if they result from a violation of another's life, health or body, or from Seller's gross negligence.

10.6 Seller assumes no warranty for normal wear and tear, material provided by Buyer, processing of the Goods made by Buyer, damage due to improper storage, installation or operation or due to inadequate maintenance, or damage resulting from any modification or repair not approved beforehand by Seller in writing. Seller will not be liable where any non-authorized software or non-authorized spare or replacement parts are used. Any costs incurred by Seller for examining and removing such defects will be borne by Buyer upon demand. Buyer will always be responsible alone for the completeness and correctness of any information provided by it.

10.7 Regarding products or Services sourced by Seller from a third party (other than a Seller Affiliate) for resale to Buyer, Seller assigns to Buyer all warranty rights against such third party. In addition, Seller remains obliged to assume the guarantee set forth the preceding clauses towards Buyer, however, only under the restriction that Buyer has beforehand unsuccessfully tried to execute the assigned warranty rights against the third party.

11. LIABILITY FOR PROPRIETARY RIGHTS INFRINGEMENTS

11.1 Seller warrants that upon passing of the risk no patents or other proprietary rights of third parties exist which may be claimed with respect to the Goods or Services if these are used as intended. Clauses 10.2 to 10.5 and 10.7 shall apply correspondingly.

11.2 Seller's liability shall be excluded where a third party patent or proprietary right is infringed because Seller has adhered to a design provided by Buyer or has complied with an instruction given by Buyer, or because the Goods are used in a manner, for a purpose, in a country, or in connection with other goods or services, without this having been communicated to Seller before execution of the Contract.

11.3 During the period of Seller's warranty, Buyer has the obligation to inform Seller in writing as promptly as possible in the event that a third party claims any patent or other proprietary right or asserts any claims in or out of court with respect to the Goods or Services. Before recognizing any claim advanced by a third party in or out of court, Buyer shall give Seller the opportunity to comment. At its request, Seller shall be given the authority to handle the negotiations or legal dispute with such third party at its own cost and responsibility. Buyer shall be liable to Seller for any damage sustained by it as a result of a culpable violation of said obligations.

11.4 Buyer warrants that the use of a design provided by it or compliance with an instruction given by it will not lead to Seller infringing any patents or other proprietary rights when performing its contractual obligations. Buyer agrees to indemnify and hold Seller harmless against any reasonable cost and damages incurred by Seller as a result of Buyer's breach of this warranty.

12. DAMAGES

12.1 Seller shall be liable to Buyer only for damage caused with intent or gross negligence. In the event of breach of material contractual obligations, Seller shall, however, be liable for each full of its personnel (statutory representatives, executive employees and other persons employed in the performance of its obligations) causing damage.

12.2 Except in case of intentional causation of damage by personnel of Seller or causation of damage with gross negligence by statutory representatives or executive employees of Seller, Seller shall not be liable for compensation for indirect damage and, in particular, Seller shall not be liable for compensation for loss of profit, unless such damage is covered by the protective purpose of a warranty explicitly assumed.

12.3 Except in case of intentional causation of damage by personnel of Seller or causation of damage with gross negligence by statutory representatives or executive employees of Seller, the liability of Seller shall, in each case, be limited in terms of amount to the damage which is typically foreseeable in the time of conclusion of the contract.

12.4 Claims to damages which result from the violation of another's life, body or health, from the violation of a guaranty given by Seller expressly in writing as well as damage claims under the Product Liability Act shall remain unaffected.

13. STATUTORY AND OTHER REGULATIONS:

13.1 If Seller's obligations under the Contract shall be increased or reduced by reason of the making or amendment after the date of Seller's quotation of any law or any order, regulation or by-law having the force of law that shall affect the performance of Seller's obligations under the Contract, the Contract Price and delivery period shall be adjusted accordingly and/or performance of the Contract suspended or terminated, as appropriate. A price adjustment shall not be implemented if the delivery is to be carried out within 4 months after the closing of the Contract.

13.2 Except to the extent otherwise required by applicable law, Seller shall have no responsibility for the collection, treatment, recovery or disposal of (i) the Goods or any part thereof when they are deemed by law to be "waste" or (ii) any items for which the Goods or any part thereof are replacements. If Seller is required by applicable law, including waste electrical and electronic equipment legislation, European Directive 2002/96/EC (WEEE) and related legislation in EU Member States, to dispose of "waste" Goods or any part thereof, Buyer shall, unless prohibited by applicable law, pay Seller, in addition to the Contract Price, either (i) Seller's standard charge for disposing of such Goods or (ii) if Seller does not have such a standard charge, Seller's costs (including all handling, transportation and disposal costs and a reasonable mark-up for overhead) incurred in disposing of such Goods.

13.3 Buyer's personnel shall, whilst on Seller's premises, comply with Seller's applicable site regulations and Seller's reasonable instructions, including but not limited to those relating to safety, security and electrostatic discharge.

14. COMPLIANCE WITH LAWS

Buyer agrees that all applicable import, export control and sanctions laws, regulations, orders and requirements, as they may be amended from time to time, including without limitation those of the United States, the European Union and the jurisdictions in which Seller and Buyer are established or from which items may be supplied, and the requirements of any licenses, authorizations, general licenses or license exceptions relating thereto will apply to its receipt and use of hardware, software, services and technology. In no event shall Buyer use, transfer, release, export or re-export any such hardware, software or technology in violation of such applicable laws, regulations, orders or requirements or the requirements of any licenses, authorizations or license exceptions relating thereto. Buyer agrees furthermore that it shall not engage in any activity that would expose the Seller or any of its affiliates to a risk of penalties under laws and regulations of any relevant jurisdiction prohibiting improper payments, including but not limited to bribes, to officials of any government or of any agency, instrumentality or political subdivision thereof, to political parties or political party officials or candidates for public office, or to any employee of any customer or supplier. Buyer agrees to comply with all appropriate legal, ethical and compliance requirements.

15. DEFAULT, INSOLVENCY AND CANCELLATION:

Seller shall be entitled, without prejudice to any other rights it may have, to cancel the Contract forthwith, wholly or partly, by notice in writing to Buyer, if Buyer is in default of any of its obligations under the Contract and fails, within 30 (thirty) days of the date of Seller's notification in writing of the existence of the default, either to rectify such default if it is reasonably capable of being rectified within such period or, if the default is not reasonably capable of being rectified within such period, to take action to remedy the default.

16. SUPPLEMENTARY TERMS AND CONDITIONS:

If the Goods comprise or include a control system, Seller's Supplementary Terms and Conditions Applicable to the Supply of Control Systems and Related Services shall apply to the control system and related services only. Such Supplementary Terms and Conditions shall take precedence over these Standard Terms and Conditions of Sale; copies are available from Seller upon request.

17. MISCELLANEOUS:

17.1 No waiver by either party with respect to any breach or default or of any right or remedy and no course of dealing, shall be deemed to constitute a continuing waiver of any other breach or default or of any other right or remedy, unless such waiver be expressed in writing and signed by the party to be bound.

17.2 If any clause, sub-clause or other provision of the Contract is invalid or unenforceable, this shall not affect the validity of the remainder of the Contract. Should one of the clauses be invalid or unenforceable, the parties obligate themselves to replace the invalid or unenforceable clause by such a clause which comes closest to the intended economic purpose of the invalid clause.

17.3 Buyer shall not be entitled to assign its rights or obligations hereunder without the prior written consent of Seller.

17.4 Seller enters into the Contract as principal. Buyer agrees to look only to Seller for due performance of the Contract.

17.5 GOODS AND SERVICES PROVIDED HEREUNDER ARE NOT SOLD OR INTENDED FOR USE IN ANY NUCLEAR OR NUCLEAR RELATED APPLICATIONS. Buyer (i) accepts Goods and Services in accordance with the foregoing restriction, (ii) agrees to communicate such restriction in writing to any and all subsequent purchasers or users and (iii) agrees to defend, indemnify and hold harmless Seller and Seller's Affiliates from any and all claims, losses, liabilities, suits, judgements and damages, including incidental and consequential damages, arising from use of Goods and Services in any nuclear or nuclear related applications, whether the cause of action be based in tort, contract or otherwise, including allegations that the Seller's liability is based on negligence or strict liability.

17.6 The Contract shall in all respects be construed in accordance with the laws of the Federal Republic of Germany excluding, however, any effect on such laws of the 1980 Vienna Convention on Contracts for the International Sale of Goods, and to the fullest extent permitted by law, shall be without regard to any conflict of laws or rules which might apply the laws of any other jurisdiction. All disputes arising out of the Contract shall be subject to the exclusive jurisdiction of the Berlin courts. However, Seller is entitled to sue Buyer in the court of Buyer's residence as well.

17.7 The headings to the Clauses and paragraphs of the Contract are for guidance only and shall not affect the interpretation thereof.

17.8 All notices and claims in connection with the Contract must be in writing.

Emerson Retail Services Europe GmbH
Registered Office:
Amtsgericht Berlin-Charlottenburg, HRB 81171

BENELUX

Josephinastraat 19
NL-6462 EL Kerkrade
Tel: +31 45 535 06 73
Fax: +31 45 535 06 71
benelux.sales@emerson.com

GERMANY, AUSTRIA & SWITZERLAND

Theo-Mack-Str. 3
DE-63477 Maintal
Tel: +49 6109 605 90
Fax: +49 6109 60 59 40
ECTGermany.sales@emerson.com

FRANCE, GREECE & MAGHREB

8, Allée du Moulin Berger
FR-69134 Ecully Cédex, Technoparc - CS 90220
Tel: +33 4 78 66 85 70
Fax: +33 4 78 66 85 71
mediterranean.sales@emerson.com

ITALY

Via Ramazzotti, 26
IT-21047 Saronno (VA)
Tel: +39 02 96 17 81
Fax: +39 02 96 17 88 88
italy.sales@emerson.com

SPAIN & PORTUGAL

C/ Pujades, 51-55 Box 53
ES-08005 Barcelona
Tel: +34 93 412 37 52
iberica.sales@emerson.com

CZECH REPUBLIC

Hajkova 22
CZ - 133 00 Prague
Tel: +420 733 161 651
Fax: +420 271 035 655
Pavel.Sudek@emerson.com

ROMANIA & BULGARIA

Parcul Industrial Tetarom 2
Emerson Nr. 4 400641 Cluj-Napoca
Tel: +40 374 13 23 50
Fax: +40 374 13 28 11
ro-bg.sales@emerson.com

ASIA PACIFIC

Suite 2503-8, 25/F., Exchange Tower
33 Wang Chiu Road, Kowloon Bay
Kowloon, Hong Kong
Tel: +852 2866 3108
Fax: +852 2520 6227

UK & IRELAND

Unit 17, Theale Lakes Business Park
Reading, Berkshire RG7 4GB
Tel: +44 1189 83 80 00
Fax: +44 1189 83 80 01
uk.sales@emerson.com

SWEDEN, DENMARK, NORWAY & FINLAND

Pascalstr. 65
DE-52076 Aachen
Tel: +49 2408 929 0
Fax: +49 2408 929 525
nordic.sales@emerson.com

EASTERN EUROPE & TURKEY

Pascalstr. 65
DE-52076 Aachen
Tel: +49 2408 929 0
Fax: +49 2408 929 525
easterneurope.sales@emerson.com

POLAND

Szturmowa 2
PL-02678 Warsaw
Tel. +48 22 458 92 05
Fax +48 22 458 92 55
poland.sales@emerson.com

RUSSIA & CIS

Dubininskaya 53, bld. 5
RU-115054, Moscow
Tel: +7 - 495 - 995 95 59
Fax: +7 - 495 - 424 88 50
ECT.Holod@emerson.com

BALKAN

Selska cesta 93
HR-10 000 Zagreb
Tel: +385 1 560 38 75
Fax: +385 1 560 38 79
balkan.sales@emerson.com

MIDDLE EAST & AFRICA

PO Box 26382
Jebel Ali Free Zone - South, Dubai - UAE
Tel: +971 4 811 81 00
Fax: +971 4 886 54 65
mea.sales@emerson.com

For more details, see www.climate.emerson.com/en-gb
Connect with us: facebook.com/EmersonCommercialResidentialSolutions



Emerson Commercial & Residential Solutions

Emerson Climate Technologies GmbH - Pascalstrasse 65 - 52076 Aachen, Germany
Tel. +49 (0) 2408 929 0 - Fax: +49 (0) 2408 929 570 - Internet: www.climate.emerson.com/en-gb

The Emerson logo is a trademark and service mark of Emerson Electric Co. Emerson Climate Technologies Inc. is a subsidiary of Emerson Electric Co. Copeland is a registered trademark and Copeland Scroll is a trademark of Emerson Climate Technologies Inc.. All other trademarks are property of their respective owners. Emerson Climate Technologies GmbH shall not be liable for errors in the stated capacities, dimensions, etc., as well as typographic errors. Products, specifications, designs and technical data contained in this document are subject to modification by us without prior notice. Illustrations are not binding.

© 2021 Emerson Climate Technologies, Inc.