



> 2014 JOURNEY // USER GUIDE

DODGE 



> IMPORTANT

This User Guide is intended to familiarize you with the important features of your vehicle. **The DVD enclosed contains your Owner's Manual, Navigation/Uconnect® Manuals, Warranty Booklets, Tire Warranty and Roadside Assistance (new vehicles purchased in the U.S.) or Roadside Assistance (new vehicles purchased in Canada) in electronic format.** We hope you find it useful. Replacement DVD kits may be purchased by visiting www.techauthority.com. Copyright 2013 Chrysler Group LLC.

If you are the first registered retail owner of your vehicle, you may obtain a complimentary printed copy of the Owner's Manual, Navigation/Uconnect® Manuals or Warranty Booklet by calling 1-800-423-6343 (U.S.) or 1-800-387-1143 (Canada) or by contacting your dealer.

The driver's primary responsibility is the safe operation of the vehicle. Driving while distracted can result in loss of vehicle control, resulting in a collision and personal injury. Chrysler Group LLC strongly recommends that the driver use extreme caution when using any device or feature that may take their attention off the road. Use of any electrical devices such as cell phones, computers, portable radios, vehicle navigation or other devices by the driver while the vehicle is moving is dangerous and could lead to a serious collision. Texting while driving is also dangerous and should never be done while the vehicle is moving. If you find yourself unable to devote your full attention to vehicle operation, pull off the road to a safe location and stop your vehicle. Some States or Provinces prohibit the use of cellular telephones or texting while driving. It is always the driver's responsibility to comply with all local laws.

TABLE OF CONTENTS

INTRODUCTION/WELCOME

WELCOME FROM CHRYSLER GROUP LLC	2
---	---

CONTROLS AT A GLANCE

DRIVER COCKPIT	4
INSTRUMENT CLUSTER	6

GETTING STARTED

KEY FOB	8
REMOTE START	9
KEYLESS ENTER-N-GO™	9
SECURITY ALARM	12
SEAT BELT	13
SUPPLEMENTAL RESTRAINT SYSTEM (SRS) – AIR BAGS	14
CHILD RESTRAINTS	15
FRONT SEATS	20
REAR SEATS	22
HEATED SEATS	24
HEATED STEERING WHEEL	25
TILT/TELESCOPING STEERING COLUMN	26

OPERATING YOUR VEHICLE

ENGINE BREAK-IN RECOMMENDATIONS	27
TURN SIGNAL/WIPER/WASHER/HIGH BEAM LEVER	28
HEADLIGHT SWITCH	29
SPEED CONTROL	30
CLIMATE CONTROL	31
PARKVIEW® REAR BACK-UP CAMERA	33
POWER SUNROOF	33
WIND BUFFETING	35

ELECTRONICS

YOUR VEHICLE'S SOUND SYSTEM	36
IDENTIFYING YOUR RADIO	38
Uconnect® 4.3 & 4.3S AT A GLANCE	39
Uconnect® 8.4 & 8.4N AT A GLANCE	40
RADIO	42
SiriusXM SATELLITE RADIO	43
iPod®/CD/AUX CONTROLS	46
GARMIN® NAVIGATION (8.4N ONLY)	48
SiriusXM TRAVEL LINK (8.4N ONLY)	51
PLAYING iPod®/USB/MP3 DEVICES	52
Uconnect® Phone (Bluetooth® HANDS FREE CALLING)	53
Uconnect® Voice Command (8.4 & 8.4N ONLY)	59
VIDEO ENTERTAINMENT SYSTEM (VES™)	61
STEERING WHEEL AUDIO CONTROLS	62

ELECTRONIC VEHICLE INFORMATION CENTER (EVIC)	62
PROGRAMMABLE FEATURES	63
UNIVERSAL GARAGE DOOR OPENER (HomeLink®)	64
POWER INVERTER	67
POWER OUTLETS	68

UTILITY

TRAILER TOWING WEIGHTS (MAXIMUM TRAILER WEIGHT RATINGS)	69
RECREATIONAL TOWING (BEHIND MOTORHOME, ETC.)	70

WHAT TO DO IN EMERGENCIES

ROADSIDE ASSISTANCE	71
INSTRUMENT CLUSTER WARNING LIGHTS	71
IF YOUR ENGINE OVERHEATS	76
JACKING AND TIRE CHANGING	77
JUMP-STARTING	85
SHIFT LEVER OVERRIDE	87
TOWING A DISABLED VEHICLE	88
FREEDOM A STUCK VEHICLE	89
EVENT DATA RECORDER (EDR)	90

MAINTAINING YOUR VEHICLE

OPENING THE HOOD	91
ENGINE COMPARTMENT	92
FLUIDS AND CAPACITIES	94
MAINTENANCE SCHEDULE	96
MAINTENANCE RECORD	100
FUSES	101
TIRE PRESSURES	103
WHEEL AND WHEEL TRIM CARE	104
EXTERIOR BULBS	105

CONSUMER ASSISTANCE

CHRYSLER GROUP LLC CUSTOMER CENTER	106
CHRYSLER CANADA INC. CUSTOMER CENTER	106
ASSISTANCE FOR THE HEARING IMPAIRED	106
PUBLICATIONS ORDERING	106
REPORTING SAFETY DEFECTS IN THE UNITED STATES	107

MOPAR® ACCESSORIES

AUTHENTIC ACCESSORIES BY MOPAR®	108
---	-----

INDEX 109

FAQ (How To?)

FREQUENTLY ASKED QUESTIONS	112
--------------------------------------	-----

INTRODUCTION/WELCOME

WELCOME FROM CHRYSLER GROUP LLC

Congratulations on selecting your new Chrysler Group LLC vehicle. Be assured that it represents precision workmanship, distinctive styling, and high quality - all essentials that are traditional to our vehicles.

Your new Chrysler Group LLC vehicle has characteristics to enhance the driver's control under some driving conditions. These are to assist the driver and are never a substitute for attentive driving. They can never take the driver's place. Always drive carefully.

Your new vehicle has many features for the comfort and convenience of you and your passengers. Some of these should not be used when driving because they take your eyes from the road or your attention from driving. Never text while driving or take your eyes more than momentarily off the road.

This guide illustrates and describes the operation of features and equipment that are either standard or optional on this vehicle. This guide may also include a description of features and equipment that are no longer available or were not ordered on this vehicle. Please disregard any features and equipment described in this guide that are not available on this vehicle. Chrysler Group LLC reserves the right to make changes in design and specifications and/or make additions to or improvements to its products without imposing any obligation upon itself to install them on products previously manufactured.

This User Guide has been prepared to help you quickly become acquainted with the important features of your vehicle. It contains most things you will need to operate and maintain the vehicle, including emergency information.

The DVD includes a computer application containing detailed owner's information which can be viewed on a personal computer or MAC computer. The multimedia DVD also includes videos which can be played on any standard DVD player (including the Uconnect® Touch-screen Radios). Additional DVD operational information is located on the back of the DVD sleeve.

For complete owner information, refer to your Owner's Manual on the DVD in the owner's kit provided at the time of new vehicle purchase. For your convenience, the information contained on the DVD may also be printed and saved for future reference.

Chrysler Group LLC is committed to protecting our environment and natural resources. By converting from paper to electronic delivery for the majority of the user information for your vehicle, together we greatly reduce the demand for tree-based products and lessen the stress on our environment.

INTRODUCTION/WELCOME

VEHICLES SOLD IN CANADA

With respect to any vehicles sold in Canada, the name Chrysler Group LLC shall be deemed to be deleted and the name Chrysler Canada Inc. used in substitution.

WARNING!

- Pedals that cannot move freely can cause loss of vehicle control and increase the risk of serious personal injury.
- Always make sure that objects cannot fall into the driver foot well while the vehicle is moving. Objects can become trapped under the brake pedal and accelerator pedal causing a loss of vehicle control.
- Failure to properly follow floor mat installation or mounting can cause interference with the brake pedal and accelerator pedal operation causing loss of control of the vehicle.
- Never use the 'PARK' position as a substitute for the parking brake. Always apply the parking brake fully when parked to guard against vehicle movement and possible injury or damage.
- Refer to your Owner's Manual on the DVD for further details.

USE OF AFTERMARKET PRODUCTS (ELECTRONICS)

The use of aftermarket devices including cell phones, MP3 players, GPS systems, or chargers may affect the performance of on-board wireless features including Keyless Enter-N-Go™ and Remote Start range. If you are experiencing difficulties with any of your wireless features, try disconnecting your aftermarket devices to see if the situation improves. If your symptoms persist, please see an authorized dealer.

CHRYSLER, DODGE, JEEP, RAM TRUCK, SRT, ATF+4, MOPAR and Uconnect are registered trademarks of Chrysler Group LLC.

COPYRIGHT ©2013 CHRYSLER GROUP LLC



CONTROLS AT A GLANCE

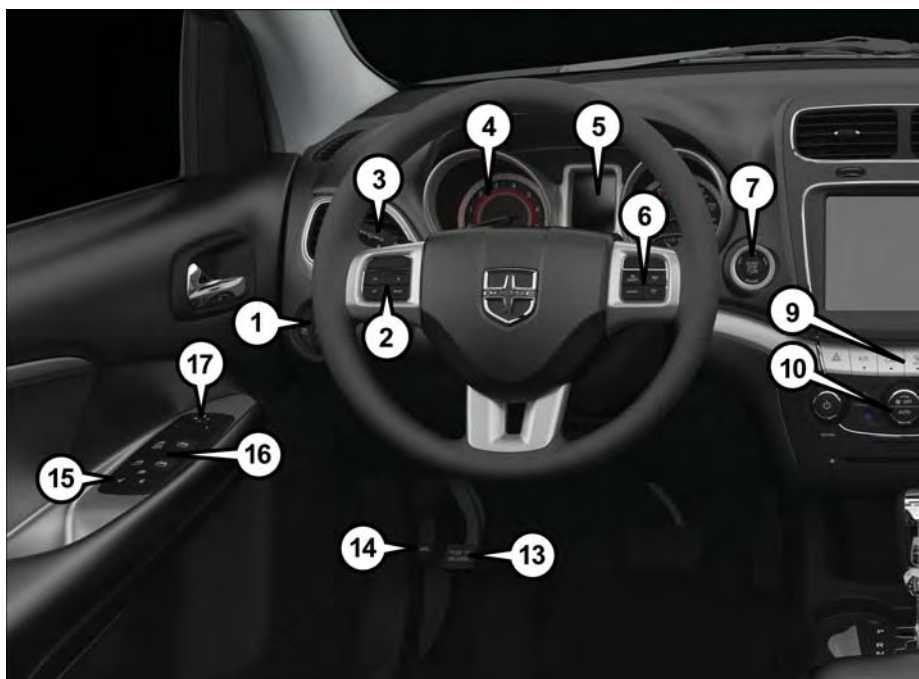

DRIVER COCKPIT

1. Headlight Switch pg. 29
2. Electronic Vehicle Information Center (EVIC) Controls pg. 62
3. Turn Signal/Light Lever pg. 28
4. Instrument Cluster pg. 6
5. Electronic Vehicle Information Center (EVIC) Display pg. 6
6. Speed Controls pg. 30
7. Engine Start/Stop Button pg. 11
8. Your Vehicle's Sound System pg. 36
9. Switch Panel
 - Hazard Switch
 - Rear Defroster pg. 32
 - Electronic Stability Control (ESC) OFF Indicator Light pg. 75
 - Air Recirculation pg. 32

CONTROLS AT A GLANCE



- 10. Climate Controls pg. 31
- 11. Power Outlet pg. 68
- 12. Shifter
- 13. Emergency Brake Pedal
- 14. Opening The Hood pg. 91
- 15. Power Door Locks
- 16. Power Windows
- 17. Power Mirror Switch













CONTROLS AT A GLANCE



INSTRUMENT CLUSTER

1. Temperature Gauge
2. Tachometer
3. Electronic Vehicle Information Center (EVIC) Display

Warning Lights

-  - Low Fuel Warning Light
-  - Charging System Light**
-  - Oil Pressure Warning Light
-  - Anti-Lock Brake (ABS) Light**
-  - Air Bag Warning Light**
-  - Electronic Throttle Control (ETC) Light
-  - Tire Pressure Monitoring System (TPMS) Light
-  - Engine Temperature Warning Light
-  - Seat Belt Reminder Light
- BRAKE**
-  - Brake Warning Light**
-  - Malfunction Indicator Light (MIL)**
-  - Electronic Stability Control (ESC) Activation/Malfunction Indicator Light**







(See page 71 for more information.)

CONTROLS AT A GLANCE



4. Fuel Gauge
5. Speedometer
6. Fuel Filler Door Location

Indicators

-  - Turn Signal Indicators
-  - High Beam Indicator
-  - Front Fog Light Indicator
-  - Vehicle Security Indicator*
-  - Electronic Stability Control (ESC) Off Indicator
-  - Electronic Speed Control ON Indicator
-  - Electronic Speed Control SET Indicator

* If equipped

** Bulb Check with Key On

GETTING STARTED

KEY FOB

Locking And Unlocking The Doors/Liftgate

- Press the LOCK button once to lock all the doors and the liftgate. Press the UNLOCK button once to unlock the driver's door only and twice within five seconds to unlock all the doors and liftgate.
- All doors can be programmed to unlock on the first press of the UNLOCK button. Refer to Programmable Features in the Electronics section of this guide.

Panic Alarm

- Press the PANIC button once to turn the panic alarm on.
- Wait approximately three seconds and press the button a second time to turn the panic alarm off.

Emergency Key

- Should the battery in the vehicle or the Key Fob transmitter go dead, there is an emergency key located in the Key Fob. To remove the emergency key, slide the button at the back of the Key Fob sideways with your thumb and then pull the key out with your other hand.



- | | |
|------------------|-------------------|
| 1 – Unlock | 4 – Panic Button |
| 2 – Lock | 5 – Emergency Key |
| 3 – Remote Start | |

WARNING!

- When leaving the vehicle, always remove the key fob from the ignition and lock your vehicle.
- Never leave children alone in a vehicle, or with access to an unlocked vehicle. Allowing children to be in a vehicle unattended is dangerous for a number of reasons. A child or others could be seriously or fatally injured. Children should be warned not to touch the parking brake, brake pedal or the shift lever.
- Do not leave the key fob in or near the vehicle (or in a location accessible to children), and do not leave the ignition of a vehicle equipped with Keyless EnterNGo™ in the ACC or ON/RUN mode. A child could operate power windows, other controls, or move the vehicle.

GETTING STARTED

REMOTE START

- Press the REMOTE START button  on the Key Fob twice within five seconds. Pressing the REMOTE START button a third time shuts the engine off.
- To drive the vehicle, press the UNLOCK button and cycle the ignition to the ON/RUN position.
- With remote start, the engine will only run for 15 minutes (timeout) unless the ignition is cycled to the ON/RUN position.
- The vehicle must be cycled to the ON/RUN position after two consecutive timeouts.

WARNING!

- Do not start or run an engine in a closed garage or confined area. Exhaust gas contains Carbon Monoxide (CO) which is odorless and colorless. Carbon Monoxide is poisonous and can cause you or others to be severely injured or killed when inhaled.
- Keep Key Fob transmitters away from children. Operation of the Remote Start System, windows, door locks or other controls could cause you and others to be severely injured or killed.

KEYLESS ENTER-N-GO™

- The Keyless Enter-N-Go™ system is an enhancement to the vehicle's Key Fob. This feature allows you to lock and unlock the vehicle's door(s) and liftgate without having to press the Key Fob lock or unlock buttons, as well as starting and stopping the vehicle with the press of a button.

To Unlock From The Driver Or Passenger Side:

- With a valid Keyless Enter-N-Go™ Key Fob located outside the vehicle and within 5 ft (1.5m) of the driver or passenger side door handle, grab either front door handle to unlock the door automatically.

To Lock The Vehicle:

- Both front door handles have LOCK buttons located on the outside of the handle. With one of the vehicle's Keyless Enter-N-Go™ Key Fobs located outside the vehicle and within 5 ft (1.5m) of the driver's or passenger front door handle, press the door handle LOCK button to lock all four doors and liftgate.



Grab the door handle to unlock

GETTING STARTED

- DO NOT grab the door handle, when pressing the door handle lock button. This could unlock the door(s).

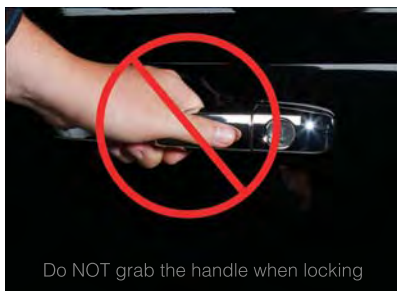
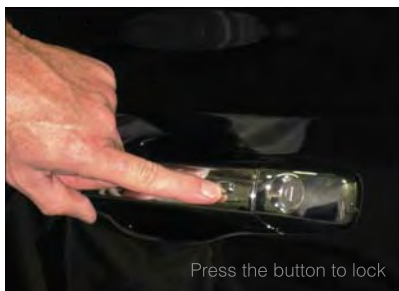

NOTE:

- If "Unlock All Doors 1st Press" is programmed all doors will unlock when you grab hold of the front driver's door handle. To select between "Unlock Driver Door 1st Press" and "Unlock All Doors 1st Press", refer to the Uconnect® Settings in your vehicle's Owner's Manual on the DVD or Programmable Features in this guide for further information.
- If "Unlock All Doors 1st Press" is programmed all doors and liftgate will unlock when you press the liftgate button. If "Unlock Driver Door 1st Press" is programmed only the liftgate will unlock when you press the liftgate button. To select between "Unlock Driver Door 1st Press" and "Unlock All Doors 1st Press", refer to the Uconnect® Settings in your vehicle's Owner's Manual on the DVD or Programmable Features in this guide for further information.
- If a Key Fob is detected in the vehicle when locking the vehicle using the power door lock switch, the doors and liftgate will unlock and the horn will chirp three times. On the third attempt, your Key Fob can be locked inside the vehicle.
- After pressing the Keyless Enter-N-Go™ LOCK button, you must wait two seconds before you can lock or unlock the vehicle using the door handle. This is done to allow you to check if the vehicle is locked by pulling the door handle, without the vehicle reacting and unlocking.

GETTING STARTED

Lock or Unlock the Liftgate:

- With a valid Keyless Enter-N-Go™ Key Fob within 3 feet (1 meter) of the liftgate, press the electronic liftgate lock/unlock pad located to the left of the liftgate handle to unlock the liftgate. Press the button a second time to lock the liftgate.

NOTE:

Refer to your Owner's Manual on the DVD for further information.



1 – Electronic Liftgate Lock/Unlock Pad

ENGINE STARTING/STOPPING

Starting

- With a valid Keyless Enter-N-Go™ Key Fob inside the vehicle.
- Place the shift lever in PARK or NEUTRAL.
- While pressing the brake pedal, press the ENGINE START/STOP button once. If the engine fails to start, the starter will disengage automatically after 10 seconds.
- To stop the cranking of the engine prior to the engine starting, press the button again.

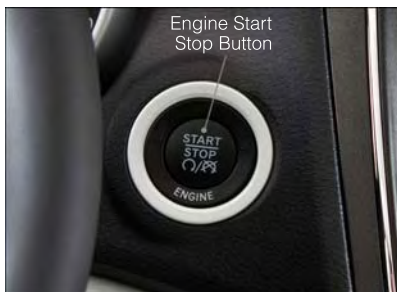

NOTE:

In case the ignition switch does not change with the push of a button, the RKE transmitter (Key Fob) may have a low or dead battery. In this situation a back up method can be used to operate the ignition switch. Put the nose side of the Key Fob against the ENGINE START/STOP button and push to operate the ignition switch.

Stopping

- Place the shift lever in PARK.
- Press the ENGINE START/STOP button once. The ignition switch will return to the OFF position.
- If the shift lever is not in PARK, the ENGINE START/STOP button must be held for two seconds and vehicle speed must be above 5 mph (8 km/h) before the engine will shut off.

GETTING STARTED

Accessory Positions With Engine Off

NOTE:

The following functions are with the driver's foot OFF the Brake Pedal (Transmission in PARK or NEUTRAL Position).

Starting With The Ignition Switch In The OFF Position:

- Press the ENGINE START/STOP button once to change the ignition switch to the ACC position.
- Press the ENGINE START/STOP button a second time to change the ignition switch to the ON/RUN position.
- Press the ENGINE START/STOP button a third time to return the ignition switch to the OFF position.

NOTE:

If the ignition switch is left in the ACC or ON/RUN (engine not running) position and the transmission is in PARK, the system will automatically time out after 30 minutes of inactivity and the ignition will switch to the OFF position.

- In case the ignition switch does not change with the push of a button, the RKE transmitter (Key Fob) may have a low or dead battery. In this situation a back up method can be used to operate the ignition switch. Put the nose side (side opposite of the emergency key) of the Key Fob against the ENGINE START/STOP button and push to operate the ignition switch.

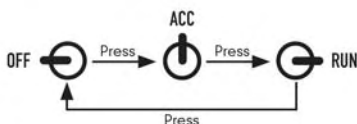

SECURITY ALARM

To Arm:

- Press the Keyless Enter-N-Go™ Start/Stop button until the Electronic Vehicle Information Center (EVIC) indicates that the vehicle ignition is "OFF". Press the power door lock switch while the door is open, press the Key Fob LOCK button, or with one of the Key Fobs located outside the vehicle and within 5 ft (1.5 m) of the driver's and passenger front door handles, press the Keyless Enter-N-Go™ LOCK button located on the door handle.

NOTE:

After pressing the Keyless Enter-N-Go™ LOCK button, you must wait two seconds before you can lock or unlock the vehicle via the door handle.

To Disarm:

- Press the Key Fob UNLOCK button or with one of the Key Fobs located outside the vehicle and within 5 ft (1.5 m) of the driver's and passenger front door handles, grab the Keyless Enter-N-Go™ door handle and enter the vehicle, then press the Keyless Enter-N-Go™ Start/Stop button (requires at least one valid Key Fob in the vehicle).

SEAT BELT

- Be sure everyone in your vehicle is in a seat and using a seat belt properly.
- Position the lap belt across your thighs, below your abdomen. To remove slack in the lap portion, pull up a bit on the shoulder belt. To loosen the lap belt if it is too tight, tilt the latch plate and pull on the lap belt. A snug belt reduces the risk of sliding under the belt in a collision.
- Position the shoulder belt on your chest so that it is comfortable and not resting on your neck. The retractor will withdraw any slack in the belt.
- A shoulder belt placed behind you will not protect you from injury during a collision. You are more likely to hit your head in a collision if you do not wear your shoulder belt. The lap and shoulder belt are meant to be used together.
- A belt that is too loose will not protect you properly. In a sudden stop you could move too far forward, increasing the possibility of injury. Wear your seat belt snugly.
- A frayed or torn belt could rip apart in a collision and leave you with no protection. Inspect the belt system periodically, checking for cuts, frays, or loose parts. Damaged parts must be replaced immediately. Do not disassemble or modify the system. Seat belt assemblies must be replaced after a collision if they have been damaged (bent retractor, torn webbing, etc.).
- The seat belts for both front seating positions are equipped with pretensioning devices that are designed to remove slack from the seat belt in the event of a collision.
- A deployed pretensioner or a deployed air bag must be replaced immediately.

NOTE:

When the ignition switch is first turned to the ON/RUN position, this light will turn on for four to eight seconds as a bulb check. During the bulb check, if the driver's seat belt is unbuckled, a chime will sound. After the bulb check or when driving, if the driver or front passenger seat belt remains unbuckled, the Seat Belt Indicator Light will flash or remain on continuously.

WARNING!

In a collision, you and your passengers can suffer much greater injuries if you are not buckled up properly. You can strike the interior of your vehicle or other passengers, or you can be thrown out of the vehicle. Always be sure you and others in your vehicle are buckled up properly.

GETTING STARTED

SUPPLEMENTAL RESTRAINT SYSTEM (SRS) – AIR BAGS

- This vehicle has Advanced Front Air Bags for both the driver and front passenger as a supplement to the seat belt restraint systems. The driver's Advanced Front Air Bag is mounted in the center of the steering wheel. The passenger's Advanced Front Air Bag is mounted in the instrument panel, above the glove compartment. The words SRS AIRBAG are embossed on the air bag covers. In addition, the vehicle is equipped with a Supplemental Driver Side Knee Air Bag mounted in the instrument panel below the steering column.
- The Advanced Front Air Bags have a multistage inflator design. This allows the air bag to have different rates of inflation based on several factors, including the severity and type of collision.
- This vehicle may be equipped with driver and/or front passenger seat track position sensors that may adjust the inflation rate of the Advanced Front Air Bags based upon seat position.
- This vehicle may be equipped with a driver and/or front passenger seat belt buckle switch that detects whether the driver or front passenger seat belt is fastened. The seat belt buckle switch may adjust the inflation rate of the Advanced Front Air Bags.
- This vehicle may be equipped with Supplemental Side Air Bag Inflatable Curtains (SABIC) to protect the driver, front, and rear passengers sitting next to a window. The SABIC air bags are located above the side windows and their covers are labeled: SRS AIRBAG.
- If the Air Bag Warning Light  is not on during starting, stays on, or turns on while driving, have the vehicle serviced by an authorized service center immediately.
- Refer to the Owner's Manual on the DVD for further details regarding the Supplemental Restraint System (SRS).

WARNING!

- Relying on the air bags alone could lead to more severe injuries in a collision. The air bags work with your seat belt to restrain you properly. In some collisions, the air bags won't deploy at all. Always wear your seat belts even though you have air bags.
- Being too close to the steering wheel or instrument panel during Advanced Front Air Bag deployment could cause serious injury, including death. Air bags need room to inflate. Sit back, comfortably extending your arms to reach the steering wheel or instrument panel.
- Supplemental Side Air Bag Inflatable Curtains and Supplemental Seat-Mounted Side Air Bags need room to inflate. Do not lean against the door or window. Sit upright in the center of the seat.
- Being too close to the Supplemental Side Air Bag Inflatable Curtain and/or Seat-Mounted Side Air Bag during deployment could cause you to be severely injured or killed.
- Do not drive your vehicle after the air bags have deployed. If you are involved in another collision, the air bags will not be in place to protect you.
- After any collision, the vehicle should be taken to an authorized dealer immediately.

CHILD RESTRAINTS

- Children 12 years or younger should ride properly buckled up in a rear seat, if available. According to crash statistics, children are safer when properly restrained in the rear seats rather than in the front.
- Every state in the United States and all Canadian provinces require that small children ride in proper restraint systems. This is the law, and you can be prosecuted for ignoring it.

NOTE:

- For additional information, refer to www.seatcheck.org or call 1-866-SEAT-CHECK (1-866-732-8243).
- Canadian residents, should refer to Transport Canada's website for additional information: <http://www.tc.gc.ca/eng/roadsafety/safedrivers-childsafety-index-53.htm>

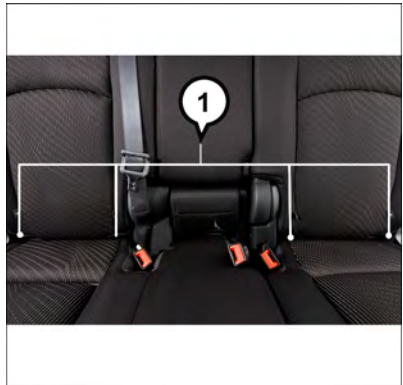

LATCH – Lower Anchors And Tethers For Children

- Your vehicle is equipped with the child restraint anchorage system called LATCH, which stands for Lower Anchors and Tethers for Children.
- All rear seating positions have lower anchors and top tether anchors.
- You may use the LATCH anchorage system until the combined weight of the child and the child restraint is 65 lbs (29.5 kg). Use the seat belt and tether anchor instead of the LATCH system once the combined weight is more than 65 lbs (29.5 kg).



1 – Lower Anchors

GETTING STARTED

-  The lower anchorages are round bars that are found at the rear of the seat cushion where it meets the seatback. They are just visible when you lean into the rear seat to install the child restraint. You will easily feel them if you run your finger along the gap between the seatback and seat cushion.
-  In addition, there are tether strap anchors located behind each rear seatback, near to the floor.
- The center seating position in this vehicle has a single dedicated anchorage. Use anchorages B and C to install a child seat in the center position. Do not use anchorages C and D to install a child seat. If you are installing three child restraints, you must use the seatbelt to install the center child restraint. You can use either the LATCH anchors or the vehicle's seat belt for installing the child seats in the outboard positions. See the vehicle owner's manual for more information about center LATCH.

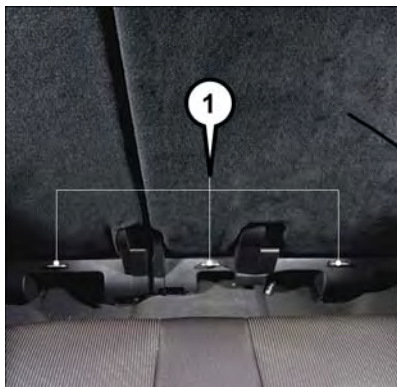

1 – Tether Anchors

Installing The Child Restraint Using The LATCH Lower Anchors

NOTE:

Never “share” a LATCH anchorage with two or more child restraints.

1. Loosen the adjusters on the lower straps and on the tether strap of the child seat so that you can more easily attach the hooks or connectors to the vehicle anchorages.
2. Attach the lower hooks or connectors of the child restraint to the lower anchorages in the selected seating position.
3. If the child restraint has a tether strap, connect it to the top tether anchorage. See below for directions to attach a tether anchor.
4. Tighten all of the straps as you push the child restraint rearward and downward into the seat. Remove slack in the straps according to the child restraint manufacturer's instructions.
5. Test that the child restraint is installed tightly by pulling back and forth on the child seat at the belt path. It should not move more than 1 inch (25.4 mm) in any direction.



022639797

Installing The Child Restraints Using The Vehicle Seat Belts

- The seat belts in the outboard passenger seating positions are equipped with a Switchable Automatic Locking Retractor (ALR). The center seating positions are equipped with a cinching latch plate. Both types of seat belts are designed to keep the lap portion of the seat belt tight around the child restraint. Any seat belt system will loosen with time, so check the belt occasionally, and pull it tight if necessary.
- Always use the tether anchor when using the seat belt to install a forward facing child restraint, up to the recommended weight limit of the child restraint.

To Install A Child Seat Using An ALR:

1. Pull enough of the seat belt webbing from the retractor to pass it through the belt path of the child restraint. Do not twist the belt webbing in the belt path.
2. Slide the latch plate into the buckle until you hear a “click.”
3. Pull on the webbing to make the lap portion tight against the child seat.
4. To lock the seat belt, pull down on the shoulder part of the belt until you have pulled all the seat belt webbing out of the retractor. Then, allow the webbing to retract back into the retractor. As the webbing retracts, you will hear a clicking sound. This means the seat belt is now in the Automatic Locking mode.
5. Try to pull the webbing out of the retractor. If it is locked, you should not be able to pull out any webbing. If the retractor is not locked, repeat the last step.
6. Finally, pull up on any extra webbing to tighten the lap portion around the child restraint while you push the child restraint rearward and downward into the vehicle seat.
7. If the child restraint has a top tether strap and the seating position has a top tether anchorage, connect the tether strap to the anchorage and tighten the tether strap. See below for directions to attach a tether anchor.
8. Test that the child restraint is installed tightly by pulling back and forth on the child seat at the belt path. It should not move more than 1 inch (25.4 mm) in any direction.

To Install A Child Seat Using A Cinching Latch Plate:

1. Place the child seat in the center of the seating position.
2. Next, pull enough of the seat belt webbing from the retractor to pass it through the belt path of the child restraint. Do not twist the belt webbing in the belt path.
3. Slide the latch plate into the buckle until you hear a “click.”
4. Finally, pull up on any excess webbing to tighten the lap portion around the child restraint while you push the child restraint rearward and downward into the vehicle seat.
5. If the child restraint has a top tether strap and the seating position has a top tether anchorage, connect the tether strap to the anchorage and tighten the tether strap. See below for directions to attach a tether anchor.
6. Test that the child restraint is installed tightly by pulling back and forth on the child seat at the belt path. It should not move more than 1 inch (25.4 mm) in any direction.

GETTING STARTED

Installing The Top Tether Strap (With Either Lower Anchors Or Vehicle Seat Belt):

- When installing a forward-facing child restraint, always secure the top tether strap, up to the tether anchor weight limit, whether the child restraint is installed with the lower anchors or the vehicle seat belt.
1. Route the tether strap to provide the most direct path for the strap between the anchor and the child seat.
 2. If your vehicle is equipped with adjustable rear head restraints, raise the head restraint, and where possible, route the tether strap under the head restraint and between the two posts. If not possible, lower the head restraint and pass the tether strap around the outboard side of the head restraint.
 3. Attach the tether strap hook of the child restraint to the top tether anchorage and remove slack in the tether strap according to the child restraint manufacturer's instructions.

Integrated Child Booster Seat – If Equipped

- The Integrated Child Booster Seat is located in each outboard second-row passenger seat.

NOTE:

Refer to the Integrated Child Booster Seat information label located on the front lower panel of the opened Booster Seat for child weight specifications.

- To position a child into the Integrated Child Booster Seat follow these steps:
1. Slide the second row seat to the full rear position to use the Integrated Child Booster Seat.

NOTE:

The second row bench with Integrated Child Booster Seat must remain in the full rear position during use.

2. Pull the release loop forward to release the latch and seat cushion.



Booster Seat
Release Loop

GETTING STARTED

3. Lift the seat cushion up and push back to lock it in the booster seat position.
4. Place the child upright in the seat with their back firmly against the seatback.
5. Grasp the latch plate and pull out the seat belt.
6. Slide the latch plate up the webbing as far as necessary to allow the seat belt to go around the child's lap.

NOTE:

The lap portion of the seat belt should be low on the hips and as snug as possible.

7. Once the seat belt is long enough to fit properly, insert the latch plate into the buckle until you hear a "click."
8. To remove the slack from the lap belt, pull upward on the shoulder portion of the seat belt.

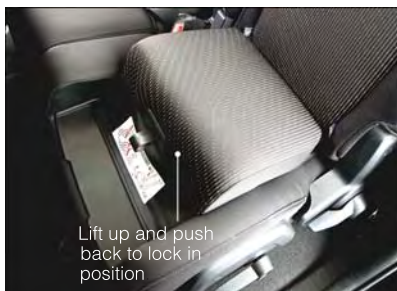

WARNING!

Securely lock the seat cushion into position before using the seat. Otherwise, the seat will not provide the proper stability for child seats and/or passengers. An improperly latched seat cushion could cause serious injury.

WARNING!

- In a collision, an unrestrained child, even a tiny baby, can become a projectile inside the vehicle. The force required to hold even an infant on your lap could become so great that you could not hold the child, no matter how strong you are. The child and others could be severely injured or killed. Any child riding in your vehicle should be in a proper restraint for the child's size.
- Rearward-facing child seats must never be used in the front seat of a vehicle with a front passenger air bag. An air bag deployment could cause severe injury or death to infants in this position.
- Only use a rearward-facing child restraint in a vehicle with a rear seat.
- Improper installation of a child restraint to the LATCH anchorages can lead to failure of an infant or child restraint. The child could be severely injured or killed. Follow the manufacturer's directions exactly when installing an infant or child restraint.
- An incorrectly anchored tether strap could lead to increased head motion and possible injury to the child. Use only the anchor positions directly behind the child seat to secure a child restraint top tether strap.
- If your vehicle is equipped with a split rear seat, make sure the tether strap does not slip into the opening between the seatbacks as you remove slack in the strap.

GETTING STARTED

FRONT SEATS

Power Seats

- The power seat switch, located on the outboard side of the seat near the floor, controls forward/back, up/down, and tilt adjustment.

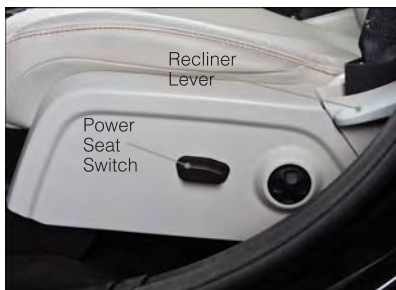

Power Lumbar

- Push the switch forward to increase the lumbar support. Push the switch rearward to decrease the lumbar support.
- Pushing upward or downward on the switch will raise and lower the position of the support.

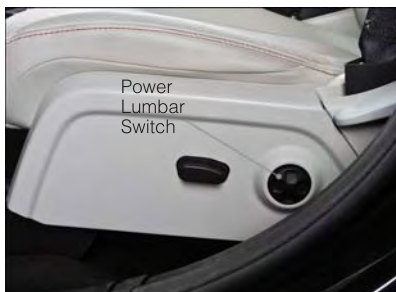

Manual Seat Adjustment

Forward/Rearward

- Lift up on the adjusting bar located at the front of the seat near the floor and release it when the seat is at the desired position. Then, using body pressure, move forward and backward on the seat to be sure that the seat adjusters have latched.



Recliner

- Lift the recliner lever located on the outboard side of the seat, lean back and release at the desired position.

GETTING STARTED

Fold-Flat Front Passenger Seat

- The front passenger seat can be folded flat to allow for extended cargo space. Pull up on the recliner lever to fold down the seatback.



Flip 'n Stow™ Front Passenger Seat Storage

- The seat latch release-loop is located in the center of the seat cushion between the seat cushion and the seatback. Pull the loop upward to release the latch and then forward to open the seat to the detent position.



NOTE:

Make sure that objects inside the bin do not interfere with the latch before closing the seat. Push the seat cushion downward after closing it to make sure it latches to the base.

CAUTION!

Do not place any article under a power seat or impede its ability to move as it may cause damage to the seat controls. Seat travel may become limited if movement is stopped by an obstruction in the seat's path.

WARNING!

- Adjusting a seat while the vehicle is moving is dangerous. The sudden movement of the seat could cause you to lose control. The seat belt might not be properly adjusted, and you could be severely injured or killed. Only adjust a seat while the vehicle is parked.
- Do not ride with the seatback reclined so that the seat belt is no longer resting against your chest. In a collision, you could slide under the seat belt and be severely injured or killed. Use the recliner only when the vehicle is parked.
- Be certain that the seat cushion is locked securely into position before using the seat. Otherwise, the seat will not provide the proper stability for passengers. An improperly latched seat cushion could cause serious injury.

GETTING STARTED

REAR SEATS

60/40 SPLIT SECOND-ROW PASSENGER SEATS

To Lower The Seatback

- Locate the seatback release lever on the lower outboard side of the seat.
- Place one hand on the seatback and apply a gentle pressure.
- Lift the seatback release lever with the other hand, allowing the seatback to move forward slightly, and then release the lever.
- Gently guide the seatback into the folded position.

To Raise The Seatback

- Raise the seatback and lock it in place.

Forward And Rearward Adjustment

- The control lever is on the outboard side of the seat. Lift the lever to move the seat forward or rearward. Release the lever once the seat is in the position desired.

Recliner Adjustment

- The seatback release lever is on the outboard side of the seat. To recline the seat, lean back, lift the lever, position the seatback as desired, and then release the lever. To return the seatback to its normal upright position, lean back, lift the lever, lean forward, and then release the lever once the seatback is in the upright position.

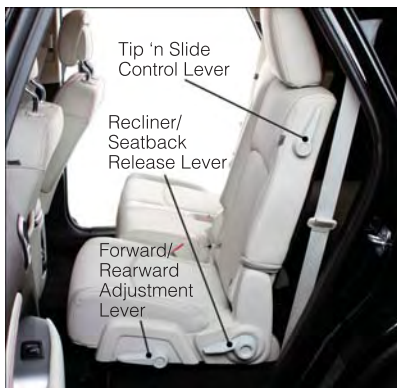

STADIUM Tip 'n Slide™ (EASY ENTRY/EXIT SEAT) – SEVEN PASSENGER MODELS

To Move The Second-Row Passenger Seat Forward

NOTE:

Raise the 20% seatback/armrest before moving the 60% seat to allow for full seat travel.

- To allow passengers to easily enter or exit the third-row passenger seats move the Tip 'n Slide™ control lever on the upper outboard side of the seatback forward, and in one fluid motion, the seat cushion flips upward and the seat moves forward on its tracks.

To Unfold And Move The Second-Row Passenger Seat Rearward

- Move the seatback rearward until it locks in place and then continue sliding the seat rearward on its tracks until it locks in place.
- Push the seat cushion downward to lock it in place.
- Adjust the seat track position as desired.

50/50 SPLIT THIRD-ROW PASSENGER SEATS WITH FOLD-FLAT FEATURE

To Fold The Seat

- With the second-row passenger seat fully upright, pull the latch release-loop located at the top of the seatback upward, push the seat forward slightly, and release the release-loop. Then, continue to push the seat forward. The head restraints will fold automatically as the seat moves forward.

To Unfold The Seat

- Grasp the assist strap loop on the seatback and pull it toward you to raise the seatback. Continue to raise the seatback until it locks in place. Then, raise the head restraint to lock it in place.
- To lock the seatback in a reclined position, pull the latch release-loop located at the top of the seatback upward, allow the seatback to recline, then release the release-loop.



GETTING STARTED

WARNING!

- Be certain that the seatback is locked securely into position. Otherwise, the seat will not provide the proper stability for child seats and/or passengers. An improperly latched seat could cause you and others to be severely injured or killed.
- Do not allow a passenger to sit in a third row seat without having the head restraint unfolded and locked in place or seatback(s) folded flat. Failure to follow this warning may result in the passengers being severely injured or killed in the event of a collision.
- Do not drive the vehicle with the seat in the Tip 'n Slide™ position, as it is only intended for entering and exiting the third row seats. Failure to follow this warning may result in you and others being severely injured or killed.
- Be certain that the seatback and seat are locked securely into position. Otherwise, the seat will not provide the proper stability for child seats and/or passengers. An improperly latched seat could cause you or others to be severely injured or killed.

HEATED SEATS

Front Heated Seats

- The heated seats are operated using the Uconnect® System.

Uconnect® 4.3

- Press the Climate hard-key (located on the left side of the Uconnect® screen) to enter the climate control screen.
- Press the Driver or Passenger seat soft-key once to select HI-level heating. Press the soft-key a second time to select LO-level heating. Press the soft-key a third time to shut the heating elements OFF.
- If the High-level setting is selected, the system will automatically switch to Low-level after approximately 60 minutes. The Low-level setting will turn Off automatically after approximately 45 minutes.



Uconnect® 8.4

- Press the Controls soft-key located on the Uconnect® screen.
- Press the Driver or Passenger seat soft-key once to select HI-level heating. Press the soft-key a second time to select LO-level heating. Press the soft-key a third time to shut the heating elements OFF.
- If the High-level setting is selected, the system will automatically switch to Low-level after approximately 60 minutes. The Low-level setting will turn Off automatically after approximately 45 minutes.



WARNING!

- Persons who are unable to feel pain to the skin because of advanced age, chronic illness, diabetes, spinal cord injury, medication, alcohol use, exhaustion or other physical conditions must exercise care when using the seat heater. It may cause burns even at low temperatures, especially if used for long periods of time.
- Do not place anything on the seat that insulates against heat, such as a blanket or cushion. This may cause the seat heater to overheat. Sitting in a seat that has been overheated could cause serious burns due to the increased surface temperature of the seat.

HEATED STEERING WHEEL

- The steering wheel contains a heating element that heats the steering wheel to one temperature setting.
- To access the Heated Steering Wheel soft-key, touch the Controls soft-key located on the Uconnect® display.
- Touch the soft-key once to turn the heating element On. Press the soft-key a second time to turn the heating element Off.
- Once the heated steering wheel has been turned on, it will operate for up to 80 minutes before automatically shutting off. The heated steering wheel can shut off early or may not turn on when the steering wheel is already warm.

GETTING STARTED

TILT/TELESCOPING STEERING COLUMN

- The tilt/telescoping control handle is located below the steering wheel at the end of the steering column.
- Push down on the handle to unlock the steering column.
- To tilt the steering column, move the steering wheel upward or downward as desired.
- To lengthen or shorten the steering column, pull the steering wheel outward or push it inward as desired.
- Pull upward on the handle to lock the column firmly in place.



WARNING!

Do not adjust the steering wheel while driving. The tilt/telescoping adjustment must be locked while driving. Adjusting the steering wheel while driving or driving without the tilt/telescoping adjustment locked could cause the driver to lose control of the vehicle. Failure to follow this warning may result in you and others being severely injured or killed.

ENGINE BREAK-IN RECOMMENDATIONS

- A long break-in period is not required for the engine and drivetrain (transmission and axle) in your vehicle.
- Drive moderately during the first 300 miles (500 km). After the initial 60 miles (100 km), speeds up to 50 or 55 mph (80 or 90 km/h) are desirable.
- While cruising, brief full-throttle acceleration within the limits of local traffic laws contributes to a good break-in. Wide-open throttle acceleration in low gear can be detrimental and should be avoided.
- The engine oil installed in the engine at the factory is a high-quality energy conserving type lubricant. Oil changes should be consistent with anticipated climate conditions under which vehicle operations will occur. For the recommended viscosity and quality grades, refer to "Maintaining Your Vehicle".

NOTE:

A new engine may consume some oil during its first few thousand miles (kilometers) of operation. This should be considered a normal part of the break-in and not interpreted as an indication to an engine problem or malfunction.

CAUTION!

Never use Non-Detergent Oil or Straight Mineral Oil in the engine or damage may result.

OPERATING YOUR VEHICLE

TURN SIGNAL/WIPER/WASHER/HIGH BEAM LEVER

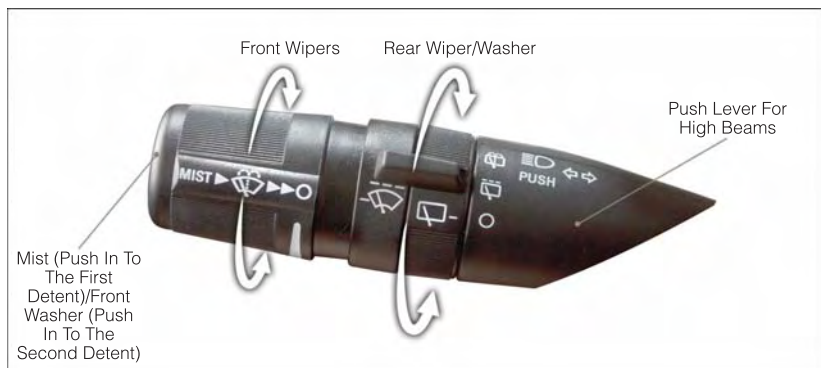

Turn Signal/Lane Change Assist

- Tap the lever up or down once and the turn signal (right or left) will flash three times and automatically turn off.

Front Wipers

Intermittent, Low And High Operation

- Rotate the end of the lever to the first detent position for one of five intermittent settings, the second detent for low wiper operation and the third detent for high wiper operation.

Washer Operation

- Push the end of the lever in to the second detent and release.

Mist

- Push the end of the lever in to the first detent and release.

NOTE:

The mist feature does not activate the washer pump; therefore, no washer fluid will be sprayed on the windshield. The wash function must be activated in order to spray the windshield with washer fluid.

Rear Wiper

Wiper Operation



- Rotate the center portion of the lever forward to the first detent for rear wiper operation.

Washer Operation

- Rotate the center portion of the lever past the first detent to activate the rear washer.

HEADLIGHT SWITCH

Automatic Headlights/Parking Lights/Headlights

- Rotate the headlight switch, located on the instrument panel to the left of the steering wheel, to the first detent  for parking lights and to the second detent for headlights .
- With the parking lights or low beam headlights on, push the headlight switch once for fog lights.
- Rotate the headlight switch to "AUTO" for AUTO headlights.
- When set to AUTO, the system automatically turns the headlights on or off based on ambient light levels.



Instrument Panel Dimmer

- Rotate the dimmer control to the extreme bottom position to fully dim the instrument panel lights and prevent the interior lights from illuminating when a door is opened.
- Rotate the dimmer control up to increase the brightness of the instrument panel when the parking lights or headlights are on.
- Rotate the dimmer control up to the next detent position to fully brighten the odometer and radio when the parking lights or headlights are on. Refer to the Uconnect® Settings in your vehicle's Owner's Manual on the DVD for display dimming.
- Rotate the dimmer control up to the last detent position to turn on the interior lighting.

Door/Map Pocket Lights

- Rotate the Door/Map Pocket control up or down to increase or decrease the brightness of the door handle and map pocket lighting when the parking lights or headlights are on.

OPERATING YOUR VEHICLE

SPEED CONTROL

- The Speed Control switches are located on the steering wheel.

Cruise ON/OFF

- Push the ON/OFF button to activate the Speed Control.
- CRUISE  will appear on the instrument cluster to indicate the Speed Control is on.
- Push the ON/OFF button a second time to turn the system off.

SET

- With the Speed Control on, push and release the SET - button to set a desired speed.



Accel/Decel

- Once a speed is set, pushing the RES + button once or the SET - button once will increase or decrease the set speed approximately 1 mph (2 km/h).
- Push and hold the RES + button to accelerate in 5 mph (8 km/h) increments or push and hold the SET - button to decelerate in 5 mph (8 km/h) increments; release the button to save the new set speed.

Resume

- To resume a previously selected set speed in memory, push the RES + button and release.

Cancel

- Push the CANCEL button, or apply the brakes to cancel the set speed and maintain the set speed memory.
- Push the ON/OFF button to turn the system off and erase the set speed memory.

WARNING!

- Leaving the Electronic Speed Control system on when not in use is dangerous. You could accidentally set the system or cause it to go faster than you want. You could lose control and have a collision. Always leave the Electronic Speed Control system off when you are not using it.
- Electronic Speed Control can be dangerous where the system cannot maintain a constant speed. Your vehicle could go too fast for the conditions, and you could lose control. A collision could be the result. Do not use Electronic Speed Control in heavy traffic or on roads that are winding, icy, snow-covered or slippery.

OPERATING YOUR VEHICLE

CLIMATE CONTROL



Uconnect® 8.4 Automatic Climate Controls



OPERATING YOUR VEHICLE

Climate Control Knobs

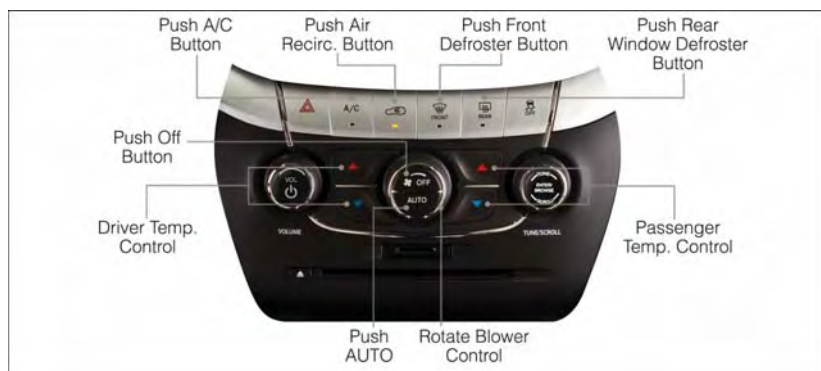

- For your convenience the climate controls can be operated by using the soft-keys located on the touch screen or the climate control knobs below the Uconnect® display.

Automatic Operation

- Press the AUTO button or AUTO soft-key.
- Select the desired temperature by pressing the Temperature Controls for the driver or passenger.
- The system will maintain the set temperature automatically.

SYNC Temperature Soft-Key

- Press the SYNC soft-key once to control driver and passenger temperatures simultaneously.
- Press the SYNC soft-key a second time to control the temperatures individually.

Air Recirculation

- Use recirculation for maximum A/C operation.
- For window defogging, turn the recirculation button off.
- If the hard-key Recirculation button is pushed while in the AUTO mode, the indicator light may flash three times to indicate the cabin air is being controlled automatically. The soft-key recirculation button will be greyed out in these conditions.

Heated Mirrors

- The mirrors are heated to melt frost or ice. This feature is activated whenever you turn on the rear window defroster.

OPERATING YOUR VEHICLE

PARKVIEW® REAR BACK-UP CAMERA

- You can see an on-screen image of the rear of your vehicle whenever the shift lever is put into REVERSE. The ParkView® Rear Back-Up Camera image will be displayed on the radio display screen, located on the center stack of the instrument panel.
- If the radio display screen appears foggy, clean the camera lens located on the liftgate.

WARNING!

Drivers must be careful when backing up; even when using the ParkView® Rear Back-Up Camera. Always check carefully behind your vehicle, and be sure to check for pedestrians, animals, other vehicles, obstructions, or blind spots before backing up. You must continue to pay attention while backing up. Failure to do so can result in serious injury or death.

POWER SUNROOF

• Express Open:

Press the switch rearward and release. The sunroof will fully open and stop automatically.

• Express Venting:

Press and release the "V" button, and the sunroof will open to the vent position.

• Express Close:

Press the switch forward and release. The sunroof will close automatically from any position.

Manual Open/Close

- Press and hold the switch rearward to open or forward to close the sunroof. Any release of the switch will stop the movement, and the sunroof will remain in a partially open or closed position until the switch is pressed again.

Pinch Protection Feature

- This feature will detect an obstruction in the opening of the sunroof during Express Close operation. If an obstruction in the path of the sunroof is detected, the sunroof will automatically retract. Remove the obstruction if this occurs. Next, press the switch forward and release to Express Close.

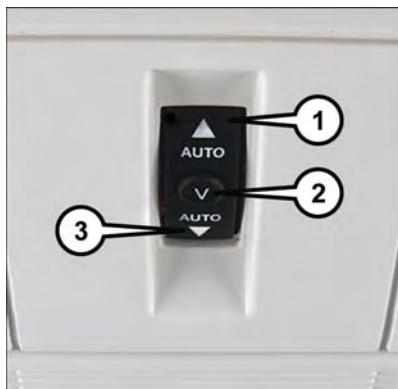

- 1 - Express Open
- 2 - Express Venting
- 3 - Express Close

OPERATING YOUR VEHICLE

NOTE:

If three consecutive sunroof close attempts result in Pinch Protect reversals, the fourth close attempt will be a Manual Close movement with Pinch Protect disabled.

WARNING!

- Do not let children play with the sunroof. Never leave children unattended in a vehicle, or with access to an unlocked vehicle. Do not leave the key fob in or near the vehicle, and do not leave the ignition of a vehicle equipped with Keyless Enter-N-Go in the ACC or ON/RUN mode. Occupants, particularly unattended children, can become entrapped by the power sunroof while operating the power sunroof switch. Such entrapment may result in serious injury or death.
- In a collision, there is a greater risk of being thrown from a vehicle with an open sunroof. You could also be severely injured or killed. Always fasten your seat belt properly and make sure all passengers are properly secured.
- Do not allow small children to operate the sunroof. Never allow your fingers, other body parts, or any object to project through the sunroof opening. Injury may result.

WIND BUFFETING

- Wind buffeting can be described as a helicopter-type percussion sound. If buffeting occurs with the rear windows open, adjust the front and rear windows together.
- If buffeting occurs with the sunroof open, adjust the sunroof opening, or adjust any window. This will minimize buffeting.

ELECTRONICS



YOUR VEHICLE'S SOUND SYSTEM

1. Uconnect[®] Voice Command Button pg. 59
2. Uconnect[®] Phone Button pg. 53
3. Steering Wheel Audio control (Left) pg. 62
4. Steering Wheel Audio control (Right) pg. 62
5. Volume Knob / Audio Mute Button
6. Uconnect[®] Radio pg. 38



- 7. Tune / Scroll Knob / Browse / Enter Button
- 8. SD Card Slot (push in to insert/eject) pg. 53
- 9. Front Power Outlet pg. 68
- 10. CD Slot
- 11. CD Eject Button
- 12. Audio Jack / USB Port pg. 52

ELECTRONICS

IDENTIFYING YOUR RADIO

Uconnect® 4.3 & 4.3S

- Models 4.3 and 4.3S have a 4.3 inch touch screen with hard-keys to each side of it.
- Model 4.3S has all Model 4.3 features, plus SiriusXM Satellite Radio (1 year trial subscription included).
- Model 4.3S is identified by the presence of SAT on the band button, indicating the presence of satellite radio.



Uconnect® 8.4 & 8.4N

- Models 8.4 and 8.4N have an 8.4 inch touch screen.
- Model 8.4N has all Model 8.4 features, plus Garmin® Navigation and SiriusXM Travel Link (1-year trial subscription included).
- Model 8.4N is identified by the unique Nav button on the main screen menu bar, located at the bottom of the screen, and the presence of SiriusXM Travel Link within the More menu.



Uconnect® 4.3 & 4.3S AT A GLANCE

**Displaying the Time**

- If the time is not currently displayed at the top of the screen when in Radio mode, press the Settings button, then touch clock. Select Show Time, then touch On.

Setting the Time

- Press the Settings hard-key, then touch the Clock soft-key.
- Touch the Time soft-key.
- Touch the up or down soft-keys to adjust the hours, minutes or AM/PM.

NOTE:

12hr format and 24hr format can also be set.

- Once the time is set press the "Done" soft-key to exit the time screen.

Audio Settings

- Press the SETTINGS hard-key on the right side of the unit.
- Then scroll down and press the Audio soft-key to get to the Audio menu.
- The Audio Menu shows the following options for you to customize your audio settings.
 - Equalizer
 - Balance/Fade
 - Speed Adjust Volume
- Touch the Exit soft-key to exit from the Audio Menu.

ELECTRONICS

Equalizer

- Touch the Equalizer soft-key to adjust the Bass, Mid and Treble. Use the + or - soft-key to adjust the equalizer to your desired settings. Press the Done soft-key when done.

Balance/Fade

- Touch the Balance/Fade soft-key to adjust the sound from the speakers. Use the arrow soft-key to adjust the sound level from the front and rear or right and left side speakers. Touch the center "C" soft-key to reset the balance and fade to the factory setting. Press the Done soft-key when done.

Speed Adjust Volume

- Touch the Speed Adjust Volume soft-key to select between OFF, 1, 2 or 3. This will decrease the radio volume relative to a decrease in vehicle speed. Press the Done soft-key when done.

Uconnect® 8.4 & 8.4N AT A GLANCE

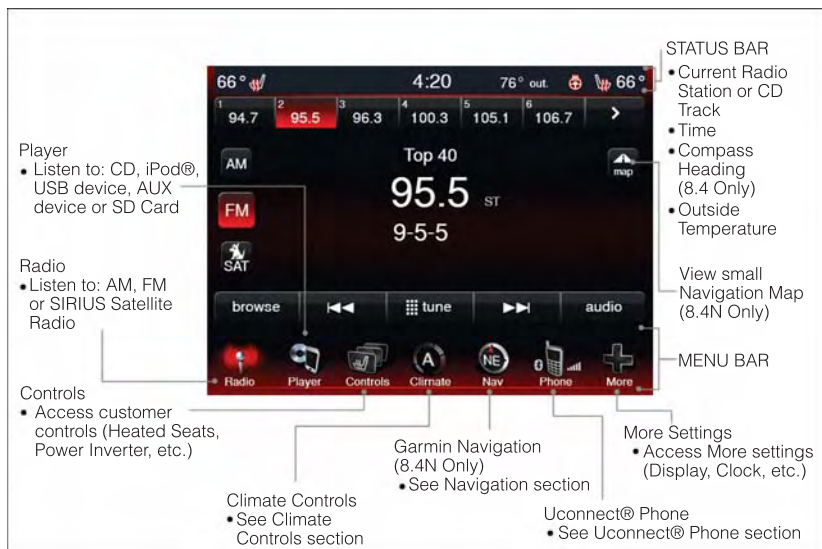

Displaying the Time

- If the time is not currently displayed on the radio or player main page, touch the More soft-key and then touch the Settings soft-key. In the Settings list, touch the Clock soft-key then touch the check box next to Show Time in Status Bar.

Setting the Time

- Model 8.4N synchronizes time automatically via GPS, so should not require any time adjustment. If you do need to set the time manually, follow the instructions below for Model 8.4.
- For Model 8.4, turn the unit on, then touch the time display at the top of the screen. Touch Yes.
- If the time is not displayed at the top of the screen, touch More soft-key and then Settings soft-key. In the Settings screen, touch the Clock soft-key, then check or uncheck this option.
- Touch + or - next to Set Time Hours and Set Time Minutes to adjust the time.
- If these features are not available, uncheck the Sync with GPS box.
- Touch X to save your settings and exit out of the Clock Setting screen.

Audio Settings

- Touch the Audio soft-key to activate the Audio settings screen to adjust Balance\Fade, Equalizer, and Speed Adjusted Volume.
- You can return to the Radio screen by touching the X located at the top right.

Balance/Fade

- Touch the Balance/Fade soft-key to Balance audio between the front speakers or fade the audio between the rear and front speakers.
- Touching the Front, Rear, Left, or Right soft-keys or touch and drag the red Speaker Icon to adjust the Balance/Fade.

Equalizer

- Touch the Equalizer soft-key to activate the Equalizer screen.
- Touch the + or - soft-keys, or by touching and dragging over the level bar for each of the equalizer bands. The level value, which spans between ± 9 , is displayed at the bottom of each of the Bands.

Speed Adjusted Volume

- Touch the Speed Adjusted Volume soft-key to activate the Speed Adjusted Volume screen. The Speed Adjusted Volume is adjusted by touching the + and - buttons or by touching and dragging over the level bar. This alters the automatic adjustment of the audio volume with variation to vehicle speed.

RADIO

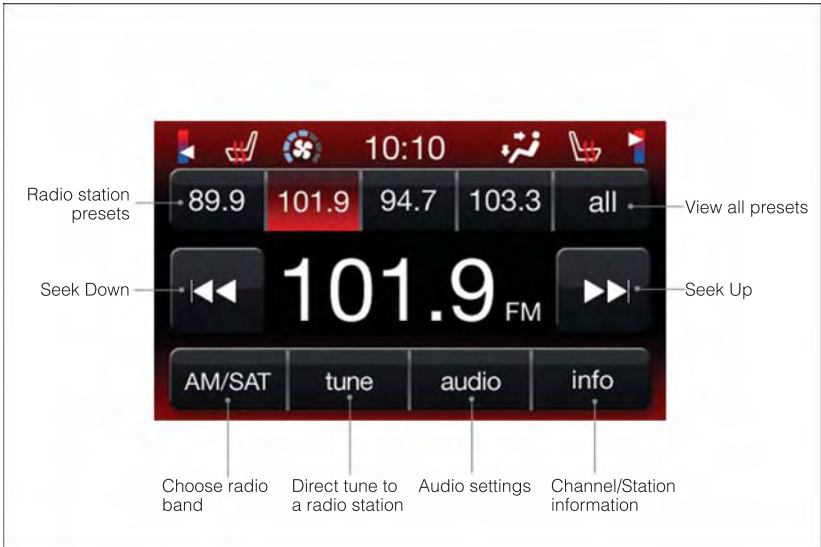

Models 4.3 & 4.3S

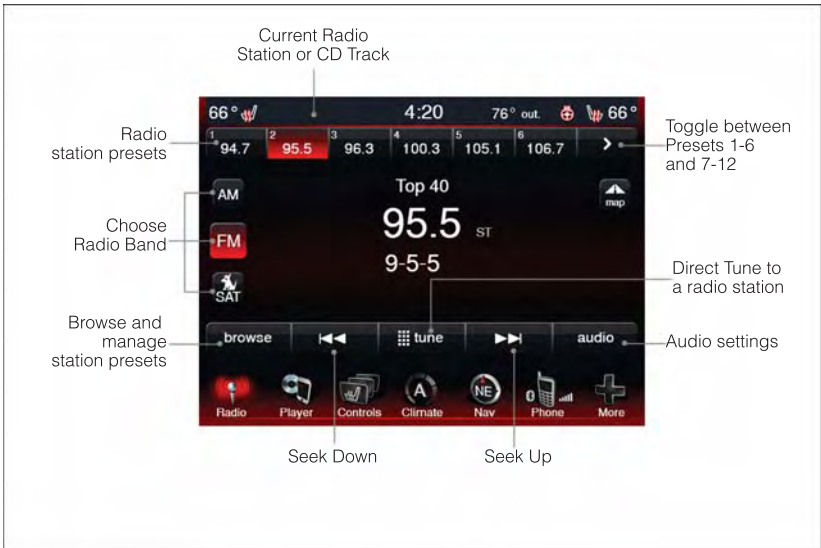

Models 8.4 & 8.4N

- To access the Radio mode, touch the Radio hard-key on the upper left side of the faceplate (4.3 & 4.3S) or the Radio soft-key at the lower left of the screen (8.4 & 8.4N).
- Unless otherwise noted, the information provided on the operation and functionality of the radios in this section is common to all Uconnect® radios.

Selecting Radio Stations

- Touch the Radio band soft-key to cycle through AM, FM or SAT (4.3 & 4.3S) or the desired radio band (AM, FM or SAT) soft-key (8.4 & 8.4N). SiriusXM Satellite Radio is not available on the 4.3.

Seek Up/Seek Down

- Touch the Seek arrow soft-keys for less than two seconds to seek through radio stations.
- Touch and hold either arrow soft-key for more than two seconds to bypass stations without stopping. The radio will stop at the next listenable station once the arrow soft-key is released.

Direct Tune

- Tune directly to a radio station by pressing the "Tune" button on the screen, and entering the desired station number.

Store Radio Presets

- Your radio can store 12 total preset stations. They are shown at the top of your screen. To see all 12 stations, Press the all soft-key (4.3 & 4.3S) or press the arrow soft-key at the top right of the screen to toggle between the six presets (8.4 & 8.4N).
- To set a station into memory press and hold the desired numbered soft-key for more than two seconds or until you hear a confirmation beep.

SiriusXM SATELLITE RADIO

- SiriusXM Satellite Radio gives you over 130 channels, including 100% commercial-free music from nearly every genre, plus all your favorite sports, news, talk and entertainment channels – all with crystal clear, coast-to-coast coverage, all in one place and all at your fingertips.
- To access SiriusXM Satellite Radio, touch the Radio band soft-key and select the SAT soft-key (4.3S) or touch the SAT soft-key on the main Radio screen (8.4 & 8.4N).
- The following describes features that are available when in SiriusXM Satellite Radio mode.
- Unless otherwise noted, the information provided on the operation and functionality of the radios in this section is common to all Uconnect® radios.

Selecting SiriusXM Satellite Channels

Seek Up/Seek Down

- Touch the Seek arrow soft-keys for less than two seconds to seek through channels in SAT mode.
- Touch and hold either arrow soft-key for more than two seconds to bypass channels without stopping. The radio will stop at the next listenable channel once the arrow soft-key is released.

Direct Tune

- Tune directly to a SAT channel by pressing the "Tune" button on the screen, and entering the desired station number.

Info (4.3S Only)

- Provides detailed information about the current SiriusXM Satellite Radio channel.

More... (4.3S Only)

- Access more menus: Audio, Favorites, Game Zone, and Replay.

Jump (8.4 & 8.4N Only)

- Automatically tells you when Traffic & Weather for a favorite city is available, and gives you the option to switch to that channel. Select Traffic then touch Jump to activate the feature. After listening to Traffic and Weather, touch Jump again to return to the previous channel.

Fav (8.4 & 8.4N Only)

- Activates the favorites menu. You can add up to 50 favorite artists or songs. Just touch Add Fav Artist or Add Fav Song while the song is playing. You will then be alerted any time one of these songs, or works by these artists, is playing on other SiriusXM Satellite Radio channels.

SiriusXM Parental Controls

- You can skip or hide certain channels from view if you do not want access to them. Press the Settings hard-key (4.3S) or touch the More soft-key, then the Settings soft-key (8.4 & 8.4N), next touch the SiriusXM Satellite Radio Setup soft-key, then select Channel Skip. Touch the channel(s) to be skipped (4.3S) or touch the box, check-mark, next to the channel you want skipped (8.4 & 8.4N). They will not show up in normal usage.
- SiriusXM Satellite Radio also offers the option to permanently block selected channels. Call 1-888-539-7474 and request the Family Package.

Browse

- Lets you browse the SiriusXM Satellite Radio channel listing, Favorites, Genres, Game Zone, and Weather channels. Jump setting, and also provides the SiriusXM Satellite Radio channel list. Browse contains many sub-menus.

Browse Sub-Menu	Sub-Menu Description
All	Shows the channel listing.
Genre	Provides a list of all genres, and lets you jump to a channel within the selected genre.
Presets (8.4 & 8.4N Only)	Lets you scroll the list of Preset satellite channels. Touch the channel, or press Enter on the Tune knob, to go to that channel. Touch the trash can icon to delete a preset. Your presets are also shown at the top of the main Satellite Radio screen.
Favorites	Lets you manage artists and songs in the Favorites list and configure Alert Settings to let you know when favorite songs or artists are playing on other channels). Also, view a list of channels airing any of your Favorites.
Game Zone	Provides alerts when your favorite sports teams are starting a game which is being aired on other SiriusXM Satellite Radio channels, or when their game score is announced. You can select and manage your Teams list here, and configure alerts.
Traffic/Weather (4.3S only)	Lets you browse Traffic & Weather information by city.
Jump (8.4 & 8.4N only)	Lets you select your favorite cities for Traffic & Weather information, by selecting Traffic, then Jump feature on the main satellite radio screen.

Replay

- Lets you replay up to 44 minutes of the content of the current SiriusXM Satellite Radio channel.

Replay Option	Option Description
Play/Pause	Touch to Pause content playback. Touch Pause/Play again to resume playback.
Rewind/RW	Rewinds the channel content in steps of 5 seconds. Touch and hold to rewind continuously, then release to begin playing content at that point.
Fast Forward/FW	Forwards the content, and works similarly to Rewind/RW. However, Fast Forward/FW can only be used when content has been previously rewound.
Replay Time	Displays the amount of time in the upper center of the screen by which your content lags the Live channel.
Live	Resumes playback of Live content at any time while replaying rewound content.

iPod®/CD/AUX CONTROLS

Models 4.3 & 4.3S

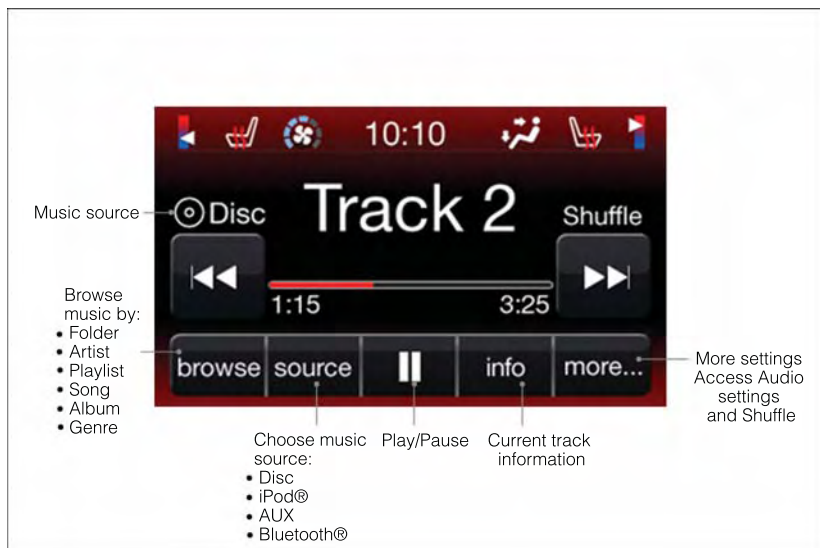

- The iPod®/CD/AUX controls are accessed by pressing the Player hard-key to enter the Player main screen, then touch the source soft-key and choose between Disc, AUX, iPod® or Bluetooth®.

NOTE:

Uconnect® will usually automatically switch to the appropriate mode when something is first connected or inserted into the system.

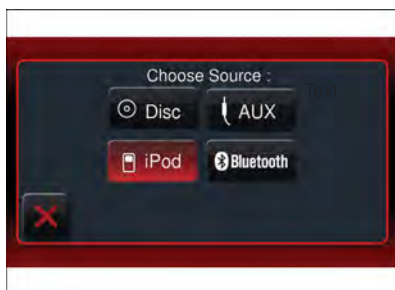

Models 8.4 & 8.4N



- The iPod®/USB, CD, Audio Jack, SD Card or Bluetooth® source is accessed by touching the Player soft-key to enter the Player main screen, then touch the source soft-key and choose between Disc, Aux, iPod®, Bluetooth® or SD Card.

NOTE:

Uconnect® will usually automatically switch to the appropriate mode when something is first connected or inserted into the system.



GARMIN® NAVIGATION (8.4N ONLY)

- Uconnect® 8.4N integrates Garmin's consumer-friendly navigation into your vehicle. Garmin Navigation includes Lane Assist and Junction View, Speed Limit information, and a database with over 6 million points of interest.
- Touch the NAV soft-key in the menu bar to access the Navigation system.

Changing the Navigation Voice Prompt Volume

1. Program a destination.
2. While traveling on your route, touch the upper left area of the map screen where your next turn is displayed.
3. The Navigation system will then repeat the distance to your next turn.
4. While the Navigation system is speaking, use the ON/OFF VOLUME rotary knob to adjust the volume to a comfortable level. Please note the volume setting for Navigation Voice Prompt is different than the audio system.

Main Navigation Menu



Acquiring Satellites

- The GPS Satellite strength bars indicate the strength of your satellite reception.
- Acquiring satellite signals can take a few minutes. When at least one of the bars is green, your device has acquired satellite signals. If no signal is found the Navigation system still can operate with internal gyro direction & location based on data provided by the vehicle.

- Dead Reckoning technology uses the speed sensors attached to your vehicle's drivetrain and a gyroscope to supplement the existing GPS data. The combined data provides accurate positioning for your vehicle in tunnels, indoor parking garages, urban canyons, and any other area where GPS signals can become obstructed.

Finding Points of Interest

- From the main Navigation menu, touch Where To?, then touch Points of Interest.
- Select a Category and then a subcategory, if necessary.
- Select your destination and touch Go.

Finding a Place by Spelling the Name

- From the Main Navigation Menu, touch Where to?, then touch Points of Interest and then touch Spell Name.
- Enter the name of your destination.
- Touch Done.
- Select your destination and touch Go.

Entering a Destination Address

- From the main Navigation menu, touch Where To?, then touch Address.
- Follow the on-screen prompts to enter the address and touch Go.

Searching Near Another Location

- From the main Navigation menu, touch Where To?, then touch a destination and then touch Near.
- Select an option from the available choices.

Setting or Changing Your Home Location

- Touch the NAV soft-key in the menu bar to access the Navigation system and the Main Navigation menu.
- Touch Where To?, then touch Go Home.
- You may enter your address directly, use your current location as your home address, or choose from recently found locations.
- To edit your Home location (or other saved locations), touch Where To? from the Main Navigation menu, then touch Favorites, and touch the location you want to edit. After selecting a location to edit, touch Press for More, then Edit.

Go Home

- A Home location must be saved in the system. From the Main Navigation menu, touch Where To?, then touch Go Home.

Following Your Route

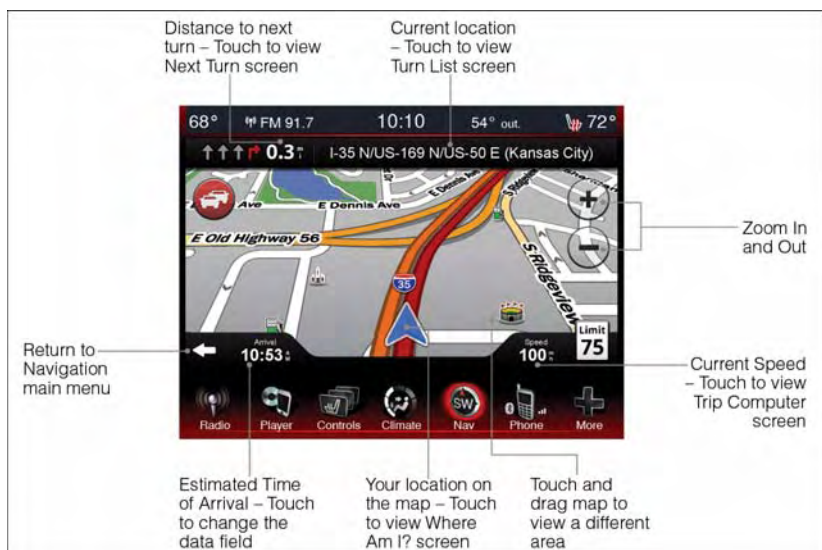

- Your route is marked with a magenta line on the map. If you depart from the original route, your route is recalculated. A speed limit icon could appear as you travel on major roadways.
- Lane Assist helps you decide which lane to be in at upcoming junctions.
- Junction View gives you an expanded view as junctions approach.

Adding a Via Point

- To add a stop between your current location and your end destination, you must be navigating a route.
- Touch the back arrow multiple times to return to the Main Navigation menu.
- Touch Where To?, then search for the via point. Select the via point to add from the search results.
- Touch Go, then touch Add as a Via Point.

Taking a Detour

- To take a detour you must be navigating a route.
- Touch Detour.

NOTE:

If the route you are currently taking is the only reasonable option, the device might not calculate a detour.

SiriusXM TRAVEL LINK (8.4N ONLY)

- SiriusXM Travel Link is only available in the United States.
- SiriusXM Travel Link brings a wealth of useful information into your vehicle and right to your fingertips.
- To access Travel Link, touch More soft-key, then the Travel Link soft-key.

NOTE:

SiriusXM Travel Link requires a subscription, sold separately after the 1 year trial subscription included with your vehicle purchase.

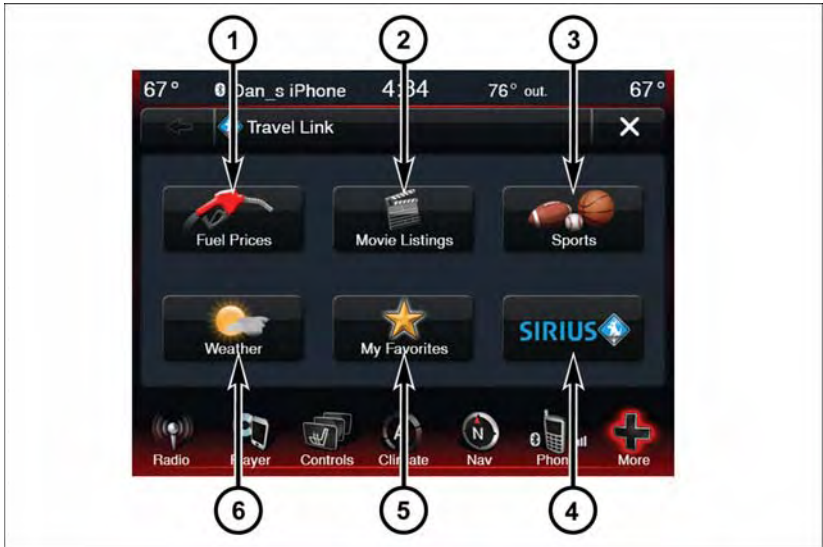

1 - Fuel Prices	View detailed price information for fuel stations near your current location.
2 - Movie Listings	View information on movies that are playing at theaters near your current location.
3 - Sports Scores	View scores and upcoming events for all major sports.
4 - SiriusXM	View subscription information.
5 - My Favorites	View and store your favorite location, theater and sport teams for quick access.
6 - Weather	View detailed weather conditions, forecasts and ski/snowboarding conditions at local resorts.

ELECTRONICS

PLAYING iPod®/USB/MP3 DEVICES

- There are many ways to play music from iPod®/MP3 players or USB devices through your vehicles sound system.

Audio Jack (AUX)

- The Audio Jack, located in the center console, allows a portable device, such as an MP3 player or an iPod, to be plugged into the radio and utilize the vehicles sound system, using a 3.5 mm audio cable, to amplify the source and play through the vehicle speakers.
- Touching the Player soft-key then choose AUX source will change the mode to auxiliary device if the Audio Jack is connected, allowing the music from your portable device to be heard through the vehicles speakers.
- The functions of the portable device are controlled using the device buttons. The volume may be controlled using the radio or portable device.
- To route the audio cable out of the center console, use the access cut out in the front of the console.

USB Port

- Connect your iPod® or compatible device using a USB cable into the USB Port. The USB Port is contained within the center console. USB Memory sticks with audio files can also be used. Then, audio from the device can be played on the vehicles sound system while providing metadata (artist, track title, album, etc.) information on the radio display.
- When connected, the iPod®/compatible USB device can be controlled using the radio or Steering Wheel Audio Controls to play, skip to the next or previous track, browse, and list the contents.
- The iPod® battery charges when plugged into the USB port (if supported by the specific device).
- To route the USB/iPod® cable out of the center console, use the access cut out in the front of the console.

NOTE:

- When connecting your iPod® device for the first time, the system may take several minutes to read your music, depending on the number of files. For example, the system will take approximately five minutes for every 1000 songs loaded on the device. Also during the reading process, the Shuffle and Browse functions will be disabled. This process is needed to ensure the full use of your iPod® features and only happens the first time it is connected. After the first time, the reading process of your iPod® will take considerably less time unless changes are made or new songs are added to the playlist.
- The USB port supports certain Mini, Classic, Nano, Touch, and iPhone® devices. The USB port also supports playing music from compatible external USB Mass Storage Class memory devices. Some iPod® software versions may not fully support the USB port features. Please visit Apple's website for iPod® software updates.

SD Card (8.4 & 8.4N Only)

- Play songs stored on an SD card inserted into the SD card slot, located on the radio faceplate.
- Song playback can be controlled using the radio or Steering Wheel Audio Controls to play, skip to the next or previous track, browse, and list the contents.

Bluetooth® Streaming Audio

- If equipped with Uconnect® Voice Command, your Bluetooth® - equipped iPod® devices, cell phones or other media players, may also be able to stream music to your vehicles sound system. Your connected device must be Bluetooth® - compatible, and paired with your Uconnect® system (see Uconnect® Phone for pairing instructions). You can access the music from your connected Bluetooth® device by touching the Source soft-key while in Player mode.

Uconnect® Phone (Bluetooth® HANDS FREE CALLING)

- If the Uconnect® Phone Button  exists on your steering wheel, then you have the Uconnect® Phone features.
- The Uconnect® Phone is a voice-activated, hands-free, in-vehicle communications system with Voice Command Capability (see Voice Command section).
- The Uconnect® Phone allows you to dial a phone number with your mobile phone using simple voice commands or using screen soft-keys.
- Refer to the Understand The Features Of Your Vehicle section of your vehicle's Owner's Manual on the DVD for further details.

NOTE:

The Uconnect® Phone requires a mobile phone equipped with the Bluetooth® Hands-Free Profile, Version 1.0 or higher. For Uconnect® customer support: U.S. residents - visit www.UconnectPhone.com or call 1-877-855-8400. Canadian Residents - call 1-800-465-2001 (English) or 1-800-387-9983 (French).

Pairing a Phone

- To use the Uconnect® Phone feature, you must first pair your Bluetooth® phone with the Uconnect® system.

Start pairing procedure on the radio

- **Models 8.4, 8.4N:** Touch the Phone soft-key and then the Settings soft-key. Next, touch Add Device.
- **Models 4.3, 4.3S:** Press the More hard-key, then touch the Phone soft-key. Next, touch the settings soft-key and then Add Device.
- Uconnect® Phone will display an "In progress" screen while the system is connecting.

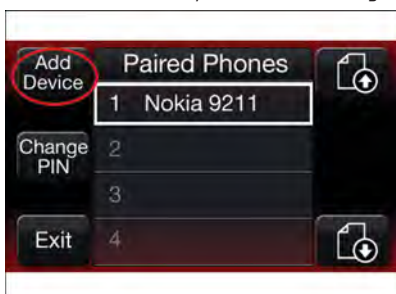

Models 4.3 & 4.3S



Models 8.4 & 8.4N

Start pairing procedure on mobile phone

- Search for available devices on your Bluetooth® enabled mobile phone. This is usually within Settings or Options under "Bluetooth®." See your mobile phone's manual for details.
- When your phone finds the system, select "Uconnect®" as the paired device.

Complete the pairing procedure

- When prompted on the phone, enter the 4-digit PIN number shown on the Uconnect® Screen.
- If your phone asks you to accept a connection request from Uconnect®, select "Yes." If available, check the box telling it not to ask again – that way your phone will automatically connect each time you start the vehicle.

NOTE:

Refer to www.UconnectPhone.com website for additional information on phone pairing and for a list of compatible phones.

Select the mobile phone's priority level

- When the pairing process has successfully completed, the system will prompt you to choose whether or not this is your favorite phone. Selecting Yes will make this phone the highest priority. This phone will take precedence over other paired phones within range. Only one phone can be connected at a time.
- You are now ready to make hands-free calls. Press the Uconnect® Phone button on your steering wheel to begin.



Models 4.3 & 4.3S

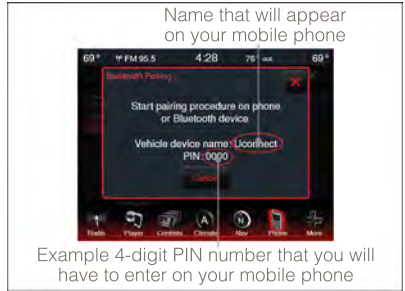

Models 8.4 & 8.4N

ELECTRONICS

Phone Menu Screen - Models 4.3 & 4.3S



Phone Menu Screen - Models 8.4 & 8.4N



Making A Phone Call

- Press the Uconnect® Phone button .
- After the BEEP, say “dial” then the number (or “call” then the name as listed in your phone; see Phonebook).

NOTE:

You can also initiate a call by using the touchscreen on the Phone main screen.

Receiving A Call – Accept (And End)

- When an incoming call rings/is announced on Uconnect®, press the Phone button .
- To end a call, press the Phone button .

Mute (Or Unmute) Microphone During Call

- During a call, touch the mute soft-key on the Phone main screen to mute and unmute the call.

Transfer Ongoing Call Between Handset And Vehicle

- During an on-going call, touch the Transfer soft-key on the Phone main screen to transfer an on-going call between handset and vehicle.

Common Phone Commands (Examples)

- “Call John Smith”
- “Call John Smith mobile”
- “Dial 1 248 555 1212”
- “Call Emergency”
- “Call Towing Assistance”
- “Redial”

Phonebook

- Uconnect® radios will automatically download your phonebook from your paired phone, if this feature is supported by your phone. Entries are updated each time that the phone is connected. If your phone book entries do not appear, check the settings on your phone. Some phones require you to enable this feature manually.
- Your phonebook can be browsed on your radio screen, but editing can only be done on your phone. To browse, touch the Phone soft-key, then the Phonebook soft-key.
- Favorite phonebook entries can be saved as Favorites for quicker access. Favorites are shown at the top of your main phone screen.

Voice Command Tips

- Using complete names (i.e; Call John Doe vs. Call John) will result in greater system accuracy.
- You can “chain” commands together for faster results. Say “Call John Doe, mobile”, for example.



ELECTRONICS

- If you are listening to available voice command options, you do not have to listen to the entire list. When you hear the command that you need, press the  VR button on the steering wheel, wait for the beep and say your command.

Changing The Volume

- Start a dialogue by pressing the Phone button , then say a command for example - "Help."
- Use the radio ON/OFF VOLUME rotary knob to adjust the volume to a comfortable level while the Uconnect[®] system is speaking. Please note the volume setting for Uconnect[®] is different than the audio system.

NOTE:

To access help, press the Uconnect[®] Phone  button on the steering wheel and say "help." Touch the display or push either  or  button and say "cancel" to cancel the help session.

Voice Text Reply

- Uconnect[®] Phone can read or send new text messages on your mobile phone.
- Your mobile phone must support Voice Text Reply over Bluetooth[®] in order to use this feature. If the Uconnect[®] Phone determines your phone is not compatible with Voice Text Reply messaging over Bluetooth[®] the "Messaging" button will be greyed out and the feature will not be available for use.

NOTE:

- For mobile phone compatibility and pairing instructions, please visit www.UconnectPhone.com
- Uconnect[®] Phone Voice Text Reply is only available when the vehicle is not moving.

WARNING!

- Any voice commanded system should be used only in safe driving conditions following applicable laws regarding phone use. Your attention should be focused on safely operating the vehicle. Failure to do so may result in a collision causing you and others to be severely injured or killed.
- In an emergency, to use Uconnect[®] Phone, your mobile phone must be:
 - turned on,
 - paired to Uconnect[®] Phone,
 - and have network coverage.

Uconnect® Voice Command (8.4 & 8.4N ONLY)

- If the Uconnect® Voice Command (Ⓜ VR button exists on your steering wheel, then you have the Voice Command feature.
- The Voice Command feature lets you keep your hands on the steering wheel, and your eyes on the road.
- When you press the Voice Command button (Ⓜ VR located on the radio faceplate or steering wheel, you will hear a beep. The beep is your signal to give a command. If you do not know what commands to say, you can say "help" and the system will provide options to you. If you ever wish to interrupt the system while it lists options, press the Voice Command button (Ⓜ VR, listen for the BEEP, and say your command.
- You can "chain" commands together for faster results. Say "Play the artist Scott Joplin", for example.

Changing The Volume

- Start a dialogue by pressing the Voice Command button (Ⓜ VR, then say a command (for example, "help").
- Use the radio ON/OFF VOLUME rotary knob to adjust the volume to a comfortable level while the Voice Command system is speaking. The volume setting for Voice Command is different than the audio system.
- Refer to the Understand The Features Of Your Vehicle section of your vehicle's Owner's Manual on the DVD for further details.

Common Voice Commands (Examples)

Switch Modes	"FM" "Satellite" "AM" "Change Source to iPod" "Change Source to SD Card"
Radio (FM, AM)	"95.5" "95.5 FM" "Go to preset 5"
Player	"Play Album 'Greatest Hits' "Play Artist 'Scott Joplin" "Play Genre 'Rock" "Play Song 'Maple Leaf Rag"
SiriusXM Satellite Radio	"39" "Foxxhole"
SiriusXM Travel Link	"Show fuel prices" "Show movie listings" "Show current weather" "Show extended weather" "Show Travel Link favorites" "Show NFL headlines" "Show NBA rankings" "Show NFL schedules" "Show NBA scores"
Navigation	"Navigate to {Address}" "Navigate to {Point of Interest}"

NOTE:

For the shortened SiriusXM Satellite Radio mode commands to be recognized you must be in that mode. For example, if you are in SiriusXM Satellite Radio mode you can say “39”, but if you are not in SiriusXM mode, you would need to say “Tune to Satellite Channel 39.”

Common Navigation Voice Commands

- To access the navigation voice commands, press the Uconnect® Voice Command (VR) button while in any mode and say “Navigation.”
- Once in the Navigation feature, you can simply **Say What You See** on the touchscreen to give a navigation voice command.
- Locating an address can be given as a **one shot entry**. For example, after saying “Find Address” and the system is ready, you can say the entire address in one command, “1234 1st Street, Any Town, Michigan.” If you are searching for a particular address or Point Of Interest, the available voice commands depend on what is displayed on the touchscreen.
- When the Voice Command system is ready to be given a command, the green indicator is visible in the right corner of the touchscreen.

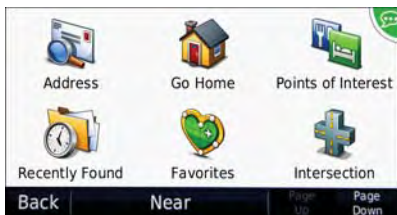

The following chart lists the navigation voice commands that may be available.

Navigation Commands:	Voice	Com-	
			“Where To?” (Main Menu command)
			“View Map” (Main Menu command)
			“Repeat guidance” “Cancel Route” “Detour” (During a Route Guidance)
			“Where Am I?”
			“Find Address”
			“Go Home”
			“Find Place by Category”
			“Find Place by Name”
			“Find Recently Found”
			“Find Favorite”
			“Find City”
			“Find Nearest Restaurant”
			“Find Nearest Fuel”
			“Find Nearest Transit”
			“Find Nearest Lodging”
			“Find Nearest Shopping”
			“Find Nearest Bank”
			“Find Nearest Parking”
			“Find Nearest Entertainment”
			“Find Nearest Recreation”
			“Find Nearest Attractions”
			“Find Nearest Hospitals”
			“Find Nearest Community”
			“Find Nearest Auto Services”
			“Find Nearest Airport”
			“Find Nearest Police Stations”
			“Find Nearest Fire Stations”
			“Find Nearest Auto Dealers”

WARNING!

Any voice commanded system should be used only in safe driving conditions following applicable laws regarding phone use. Your attention should be focused on safely operating the vehicle. Failure to do so may result in a collision causing you and others to be severely injured or killed.

VIDEO ENTERTAINMENT SYSTEM (VES™)

System Operation

- The screen is located on the headliner behind the front seat. To lower the screen, press the release button located in the rear of the overhead console.
- The system may be controlled by the front seat occupants using the touchscreen radio, or by the rear seat occupants using the remote control.
- The video screen displays information in a split-screen format. The left side of the screen is referred to as Channel 1 and the right side of the screen is referred to as Channel 2. All modes except video modes are displayed in a split-screen format.
- To use the headphones, press the power button located on the right ear cup. Select the channel on the headphones (1 or 2) that corresponds to the channel selected on the VES™ screen.

Operation Of The Remote

- The remote control operates similarly to any DVD remote you have used before and allows the rear seat passengers to change stations, tracks, discs and audio/video modes.
- The remote control is designed to control either channel by using the selector switch located on the right side of the remote.
- Pressing the power button will turn the VES™ system ON/OFF.
- Pressing the MODE button causes the Mode Selection menu to appear on the VES™ screen. Use the remote control arrow buttons to scroll through the available modes, then press ENTER to select the desired mode.

Auxiliary Audio/Video Input Jacks

- The Aux jacks are located on the rear of the center console.
- Connect the video game or other external media devices to the AUX jacks following the color coding for VES™ jacks.
- Using either the touchscreen radio or remote control, select AUX from the Rear VES™ Control or Mode Selection screen.
- Refer to your vehicle's Owners Manual on the DVD for further details.

ELECTRONICS

STEERING WHEEL AUDIO CONTROLS

- The steering wheel audio controls are located on the rear surface of the steering wheel.

Right Switch

- Press the switch up or down to increase or decrease the volume.
- Press the button in the center to change modes AM/FM/CD/SAT.

Left Switch

- Press the switch up or down to search for the next listenable station or select the next or previous CD track.
- Press the button in the center to select the next preset station (radio) or to change CDs if equipped with a CD Changer.

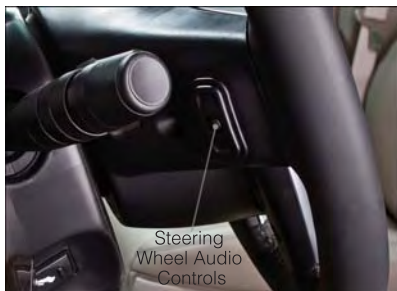

ELECTRONIC VEHICLE INFORMATION CENTER (EVIC)

- The EVIC features a driver interactive display that is located in the instrument cluster. Pressing the controls on the left side of the steering wheel allows the driver to select vehicle information and Personal Settings. For additional information, refer to "Programmable Features" located in this guide.
- Press and release the UP Δ button to scroll upward through the main menus (Fuel Economy, Vehicle Info, Tire PSI, Cruise, Messages, Units, System Setup) and sub menus.
- Press and release the DOWN ∇ button to scroll downward through the main menus and sub menus.
- Press and release the SELECT \triangleright button for access to main menus, sub menus or to select a personal setting in the setup menu.
- Press the BACK button to scroll back to a previous menu or sub menu.



Compass Calibration

- This compass is self-calibrating, which eliminates the need to set the compass manually. When the vehicle is new, the compass may appear erratic and the EVIC will display "CAL" until the compass is calibrated.
- You may also calibrate the compass by completing one or more 360 degree turns (in an area free from large metal or metallic objects) until the "CAL" message displayed in the EVIC turns off. The compass will now function normally.

PROGRAMMABLE FEATURES

Electronic Vehicle Information Center (EVIC) - If Equipped

- The EVIC can be used to view or change the following settings. Press the UP Δ or DOWN ∇ button until System Setup displays, then press the SELECT \triangleright button. Scroll through the settings using the UP or DOWN buttons. Press the SELECT \triangleright button to change the setting. Press the BACK button to scroll back to a previous menu or sub menu.
 - Fuel Economy
 - Average Fuel Economy
 - Distance To Empty (DTE)
 - Miles Per Gallon (MPG)
 - Vehicle Speed
 - To Reset The Display
 - Trip Info
 - Trip A
 - Trip B
 - Elapsed Time
 - Units
 - Vehicle Info (Customer Information Features)

Uconnect[®] 4.3 Customer Programmable Features

- The Uconnect[®] 4.3 system allows you to access Customer Programmable feature settings such as Display, Clock, Safety/Assistance, Lights, Doors & Locks, Heated Seats, Engine Off Operation, Compass Settings, Audio, Phone/ Bluetooth[®] and SIRIUS Setup through hard-keys and soft-keys.
- Press the Settings hard-key to on the right side of the unit to access the Settings screen, use the Page Up/Down soft-keys to scroll through the following settings. The following feature settings are available:
 - Display
 - Clock
 - Safety / Assistance
 - Lights
 - Doors & Locks
 - Heated Seats
 - Engine Off Options
 - Compass Settings
 - Audio
 - Phone / Bluetooth[®]
 - SIRIUS Setup

Uconnect® 8.4 Customer Programmable Features

- The Uconnect® 8.4 system allows you to access Customer Programmable feature settings such as Display, Clock, Safety/Assistance, Lights, Doors & Locks, Heated Seats, Engine Off Operation, Compass Settings, Audio, Phone/ Bluetooth® and SIRIUS Setup through soft-keys.
- Touch the More soft-key on the bottom of the screen, then touch the Settings soft-key to access the Settings screen. When making a selection, scroll up or down until the preferred setting is highlighted, then press and release the preferred setting until a check-mark appears next to the setting, showing that setting has been selected. The following feature settings are available:
 - Display
 - Clock
 - Safety / Assistance
 - Lights
 - Doors & Locks
 - Heated Seats
 - Engine Off Options
 - Compass Settings
 - Audio
 - Phone / Bluetooth®
 - SIRIUS Setup

UNIVERSAL GARAGE DOOR OPENER (HomeLink®)

- HomeLink® replaces up to three hand-held transmitters that operate devices such as garage door openers, motorized gates, lighting or home security systems. The HomeLink® unit is powered by your vehicle's 12 Volt battery.
- The HomeLink® buttons that are located in the overhead console or sunvisor designate the three different HomeLink® channels.
- The HomeLink® indicator is located above the center button.

Before You Begin Programming HomeLink®

- Ensure that your vehicle is parked outside of the garage before you begin programming.
- For efficient programming and accurate transmission of the radio-frequency signal, it is recommended that a new battery be placed in the hand-held transmitter of the device that is being programmed to the HomeLink® system.
- Erase all channels before you begin programming. To erase the channels, place the ignition switch into the ON/RUN position, then press and hold the two outside HomeLink® buttons (I and III) for up to 20 seconds or until the red indicator flashes.



NOTE:

Erasing all channels should only be performed when programming HomeLink® for the first time. Do not erase channels when programming additional buttons.

- If you have any problems, or require assistance, please call toll-free 1-800-355-3515 or, on the Internet at www.HomeLink.com for information or assistance.

Programming A Rolling Code

- For programming Garage Door Openers that were manufactured after 1995. These Garage Door Openers can be identified by the “LEARN” or “TRAIN” button located where the hanging antenna is attached to the Garage Door Opener. It is NOT the button that is normally used to open and close the door. The name and color of the button may vary by manufacturer.
1. Place the ignition switch into the ON/RUN position.
 2. Place the hand-held transmitter 1 to 3 in (3 to 8 cm) away from the HomeLink® button you wish to program while keeping the HomeLink® indicator light in view.
 3. Simultaneously press and hold both the HomeLink® button you want to program and the hand-held transmitter button.
 4. Continue to hold both buttons and observe the indicator light. The HomeLink® indicator will flash slowly and then rapidly after HomeLink® has received the frequency signal from the hand-held transmitter. Release both buttons after the indicator light changes from slow to rapid.
 5. At the garage door opener motor (in the garage), locate the “LEARN” or “TRAINING” button. This can usually be found where the hanging antenna wire is attached to the garage door opener motor. Firmly press and release the “LEARN” or “TRAINING” button.

NOTE:

You have 30 seconds in which to initiate the next step after the LEARN button has been pressed.

6. Return to the vehicle and press the programmed HomeLink® button twice (holding the button for two seconds each time). If the device is plugged in and activates, programming is complete.

NOTE:

If the device does not activate, press the button a third time (for two seconds) to complete the training.

7. To program the remaining two HomeLink® buttons, repeat each step for each remaining button. DO NOT erase the channels.

Programming A Non-Rolling Code

- For programming Garage Door Openers manufactured before 1995.
1. Turn the ignition switch to the ON/RUN position.
 2. Place the hand-held transmitter 1 to 3 in (3 to 8 cm) away from the HomeLink® button you wish to program while keeping the HomeLink® indicator light in view.
 3. Simultaneously press and hold both the HomeLink® button you want to program and the hand-held transmitter button.
 4. Continue to hold both buttons and observe the indicator light. The HomeLink® indicator will flash slowly and then rapidly after HomeLink® has received the frequency signal from the hand-held transmitter. Release both buttons after the indicator light changes from slow to rapid.
 5. Press and hold the programmed HomeLink® button and observe the indicator light.

NOTE:

- If the indicator light stays on constantly, programming is complete and the garage door (or device) should activate when the HomeLink® button is pressed.
- To program the two remaining HomeLink® buttons, repeat each step for each remaining button. DO NOT erase the channels.

Using HomeLink®

- To operate, press and release the programmed HomeLink® button. Activation will now occur for the programmed device (e.g., garage door opener, gate operator, security system, entry door lock, home/office lighting, etc.). The hand-held transmitter of the device may also be used at any time.

WARNING!

- Your motorized door or gate will open and close while you are programming the universal transceiver. Do not program the transceiver if people or pets are in the path of the door or gate.
- Do not run your vehicle in a closed garage or confined area while programming the transceiver. Exhaust gas from your vehicle contains Carbon Monoxide (CO) which is odorless and colorless. Carbon Monoxide is poisonous when inhaled and can cause you and others to be severely injured or killed.

POWER INVERTER

- There is a 115 Volt, 150 Watt power inverter outlet located on the back of the center console. This outlet can power cellular phones, electronics and other low power devices requiring power up to 150 Watts.

Uconnect® 4.3 System

- Press the More hard-key (located next to the Uconnect® screen).
- Press the Outlet soft-key to turn the power inverter On or Off.



Uconnect® 8.4 System

- Press the Controls soft-key (located at the bottom of the Uconnect® screen).
- Press the Outlet soft-key to turn the power inverter On or Off.

NOTE:

The power inverter is designed with built-in overload protection. If the power rating of 150 Watts is exceeded, the power inverter will automatically shut down. Once the electrical device has been removed from the outlet, the inverter should automatically reset. If the power rating exceeds approximately 170 Watts, the power inverter may have to be reset manually. To reset the inverter manually, unplug the device and plug it in again. To avoid overloading the circuit, check the power ratings on electrical devices prior to using the inverter.

WARNING!

- To Avoid Serious Injury or Death DO NOT:
 - use a three-prong adaptor
 - insert any objects into the receptacles
 - touch with wet hands

Close the lid when not in use. If this outlet is mishandled, it may cause an electric shock and failure.

ELECTRONICS

POWER OUTLETS

- There is a 12 Volt power outlet located in the front storage bin below the radio. This outlet has power available when the ignition switch is in the ON position.
- A second 12 Volt power outlet is located inside the center console. This outlet has power available when the ignition switch is in the LOCK, ON, or ACC position.
- A third 12 Volt power outlet is located on the back of the center console. This outlet has power available when the ignition switch is in the LOCK, ON or ACC position.
- A fourth fused 12 Volt power outlet is located on the left quarter trim panel in the cargo area. This outlet has power available when the ignition switch is in the ON or ACC position.



NOTE:

- Do not exceed the maximum power of 160 Watts (13 Amps) at 12 Volts. If the 160 Watt (13 Amp) power rating is exceeded, the fuse protecting the system will need to be replaced.
- Power outlets are designed for accessory plugs only. Do not insert any other object in the power outlet as this will damage the outlet and blow the fuse. Improper use of the power outlet can cause damage not covered by your new vehicle warranty.



F103 20 Amp Yellow – Power Outlet Console Bin & Power Outlet Console Rear

F102 20 Amp Yellow – Cigar Lighter Instrument Panel & Power Outlet Left Rear Cargo Area

TRAILER TOWING WEIGHTS (MAXIMUM TRAILER WEIGHT RATINGS)

Engine/Transmission	GCWR (Gross Combined Wt. Rating)	Frontal Area	Max. GTW (Gross Trailer Wt.) which includes up to 5 persons & Luggage	Max. Tongue Wt.
2.4L/Automatic	6,000 lbs (2,722 kg)	22 sq ft (2.0 sq m)	1,000 lbs (454 kg) which includes up to 5 persons & Luggage	100 lbs (45 kg)
	7,300 lbs (3,311 kg)	32 sq ft (3.0 sq m)	2,500 lbs (1,134 kg) which includes 1 to 2 persons & Luggage	200 lbs (91 kg)
3.6L/Automatic	7,300 lbs (3,311 kg)	32 sq ft (3.0 sq m)	2,000 lbs (907 kg) which includes 3 to 4 persons & Luggage	150 lbs (68 kg)
	7,300 lbs (3,311 kg)	32 sq ft (3.0 sq m)	1,500 lbs (680 kg) which includes 5 to 7 persons & Luggage	100 lbs (45 kg) * Except for AWD models

NOTE:

- The trailer tongue weight must be considered as part of the combined weight of occupants and cargo, and should never exceed the weight referenced on the Tire and Loading Information placard.
- * For All Wheel Drive (AWD) models carrying 5 to 7 persons and luggage will exceed the rear Gross Axle Weight Rating (GAWR) and therefore should not be attempted.

RECREATIONAL TOWING (BEHIND MOTORHOME, ETC.)

Towing This Vehicle Behind Another Vehicle

Towing Condition	Wheel OFF the Ground	FWD Models	AWD Models
Flat Tow	NONE	NOT ALLOWED	NOT ALLOWED
Dolly Tow	Front	OK	NOT ALLOWED
	Rear	NOT ALLOWED	NOT ALLOWED
On Trailer	ALL	OK	OK

• Recreational Towing – Front-Wheel Drive (FWD) Models – Automatic Transmission

- Recreational towing is allowed **ONLY** if the front wheels are **OFF** the ground. This may be accomplished using a tow dolly or vehicle trailer. If using a tow dolly, follow this procedure:

1. Properly secure the dolly to the tow vehicle, following the dolly manufacturer's instructions.
2. Drive the front wheels onto the tow dolly.
3. Firmly apply the parking brake. Place the transmission in PARK.
4. Properly secure the front wheels to the dolly, following the dolly manufacturer's instructions.
5. Release the parking brake.

CAUTION!

- DO NOT flat tow this vehicle. Damage to the drivetrain will result.
- Towing this vehicle in violation of the above requirements can cause severe transmission damage. Damage from improper towing is not covered under the New Vehicle Limited Warranty.

• Recreational Towing – All-Wheel Drive (AWD) Models

- Recreational towing (with all four wheels on the ground, or using a towing dolly) is **NOT ALLOWED**. The only acceptable method for towing this vehicle (behind another vehicle) is on a vehicle trailer with all four wheels **OFF** the ground.

CAUTION!

Towing this vehicle with **ANY** of its wheels on the ground can cause severe transmission and/or power transfer unit damage. Damage from improper towing is not covered under the New Vehicle Limited Warranty.

WHAT TO DO IN EMERGENCIES

ROADSIDE ASSISTANCE

- Dial toll-free 1-800-521-2779 for U.S. Residents or 1-800-363-4869 for Canadian Residents.
- Provide your name, vehicle identification number, license plate number, and your location, including the telephone number from which you are calling.
- Briefly describe the nature of the problem and answer a few simple questions.
- You will be given the name of the service provider and an estimated time of arrival. If you feel you are in an “unsafe situation”, please let us know. With your consent, we will contact local police or safety authorities.

INSTRUMENT CLUSTER WARNING LIGHTS



- Charging System Light

- This light shows the status of the electrical charging system. If the charging system light remains on, it means that the vehicle is experiencing a problem with the charging system.
- We recommend you do not continue driving if the charging system light is on. Have the vehicle serviced immediately.



- Oil Pressure Warning Light

- This light indicates low engine oil pressure. If the light turns on while driving, stop the vehicle and shut off the engine as soon as possible. A chime will sound for four minutes when this light turns on.
- We recommend you do not operate the vehicle or engine damage will occur. Have the vehicle serviced immediately.



- Anti-Lock Brake (ABS) Light

- This light monitors the Anti-Lock Brake System (ABS). The light will turn on when the ignition switch is turned to the ON/RUN position and may stay on for as long as four seconds.
- If the ABS light remains on or turns on while driving, it indicates that the Anti-Lock portion of the brake system is not functioning and that service is required. However, the conventional brake system will continue to operate normally if the BRAKE warning light is not on.
- If the ABS light is on, the brake system should be serviced as soon as possible to restore the benefits of Anti-Lock brakes. If the ABS light does not turn on when the ignition switch is turned to the ON/RUN position, have the light inspected by an authorized dealer.



- Air Bag Warning Light

- This light will turn on for four to eight seconds as a bulb check when the ignition switch is first turned to the ON/RUN position. If the light is either not on during starting, stays on, or turns on while driving, have the system inspected at an authorized dealer as soon as possible. Refer to “Occupant Restraints” in “Things To Know Before Starting Your Vehicle” of your owners manual for further information.

WHAT TO DO IN EMERGENCIES

- Electronic Throttle Control (ETC) Light

- This light informs you of a problem with the Electronic Throttle Control (ETC) system.
- If a problem is detected, the light will come on while the engine is running. Cycle the ignition when the vehicle has completely stopped and the shift lever is placed in the PARK position; the light should turn off.
- If the light remains lit with the engine running, your vehicle will usually be drivable; however, see an authorized service center immediately. If the light is flashing when the engine is running, immediate service is required and you may experience reduced performance, an elevated/rough idle or engine stall and your vehicle may require towing.

- Tire Pressure Monitoring System (TPMS) Light

- Each tire, including the spare (if provided), should be checked monthly, when cold and inflated to the inflation pressure recommended by the vehicle manufacturer on the vehicle placard or tire inflation pressure label. (If your vehicle has tires of a different size than the size indicated on the vehicle placard or tire inflation pressure label, you should determine the proper tire inflation pressure for those tires.)
- As an added safety feature, your vehicle has been equipped with a Tire Pressure Monitoring System (TPMS) which display in the Electronic Vehicle Information Center (EVIC) when one or more of your tires is significantly under-inflated. Accordingly, when the low tire pressure EVIC display illuminates, you should stop and check your tires as soon as possible, and inflate them to the proper pressure. Driving on a significantly under-inflated tire causes the tire to overheat and can lead to tire failure. Under-inflation also reduces fuel efficiency and tire tread life, and may affect the vehicle's handling and stopping ability.
- **IF THE LIGHT STARTS FLASHING INDICATING A LOW TIRE PRESSURE, ADJUST THE AIR PRESSURE IN THE LOW TIRE TO THE AIR PRESSURE SHOWN ON THE VEHICLE PLACARD OR TIRE INFLATION PRESSURE LABEL LOCATED ON THE DRIVER'S DOOR. NOTE: AFTER INFLATION, THE VEHICLE MAY NEED TO BE DRIVEN FOR 20 MINUTES BEFORE THE FLASHING LIGHT WILL TURN OFF.**
- Please note that the TPMS is not a substitute for proper tire maintenance, and it is the driver's responsibility to maintain correct tire pressure, even if under-inflation has not reached the level to trigger illumination of the TPMS low EVIC display.
- Your vehicle has also been equipped with a TPMS malfunction indicator to indicate when the system is not operating properly. The TPMS malfunction indicator is combined with the low tire pressure telltale. When the system detects a malfunction, the telltale will flash for approximately one minute and then remain continuously illuminated. This sequence will continue each time the vehicle is restarted as long as the malfunction exists.
- When the malfunction indicator is illuminated, the system may not be able to detect or signal low tire pressure as intended. TPMS malfunctions may occur for a variety of reasons, including the installation of replacement or alternate tires or wheels on the vehicle that prevent the TPMS from functioning properly. Always check the TPMS mal-

WHAT TO DO IN EMERGENCIES

function telltale after replacing one or more tires or wheels on your vehicle, to ensure that the replacement or alternate tires and wheels allow the TPMS to continue to function properly.

NOTE:

Tire pressures change by approximately 1 psi (7 kPa) per 12° F (7° C) of air temperature change. Keep this in mind when checking tire pressure inside a garage, especially in the Winter. Example: If garage temperature is 68°F (20°C) and the outside temperature is 32°F (0°C), then the cold tire inflation pressure should be increased by 3 psi (21 kPa), which equals 1 psi (7 kPa) for every 12°F (7°C) for this outside temperature condition.

CAUTION!

The TPMS has been optimized for the original equipment tires and wheels. TPMS pressures and warning have been established for the tire size equipped on your vehicle. Undesirable system operation or sensor damage may result when using replacement equipment that is not of the same size, type, and/or style. Aftermarket wheels can cause sensor damage. Do not use tire sealant from a can, or balance beads if your vehicle is equipped with a TPMS, as damage to the sensors may result.

- Engine Temperature Warning Light

- This light warns of an overheated engine condition.
- If the light turns on and a warning chime sounds while driving, safely pull over and stop the vehicle. If the A/C system is on, turn it off. Also, shift the transmission into NEUTRAL and idle the vehicle. If the temperature reading does not return to normal, turn the engine off immediately.
- We recommend that you do not operate the vehicle or engine damage will occur. Have the vehicle serviced immediately.

WARNING!

A hot engine cooling system is dangerous. You or others could be badly burned by steam or boiling coolant.

- Seat Belt Reminder Light

- When the ignition switch is first turned to the ON/RUN position, this light will turn on for four to eight seconds as a bulb check. During the bulb check, if the driver's seat belt is unbuckled, a chime will sound. After the bulb check or when driving, if the driver or front passenger seat belt remains unbuckled, the Seat Belt Indicator Light will flash or remain on continuously. Refer to "Seat Belts" in "Getting Started" of this user guide for further information.

WHAT TO DO IN EMERGENCIES

BRAKE - Brake Warning Light

- This light monitors various brake functions, including brake fluid level and parking brake application. If the brake light turns on it may indicate that the parking brake is applied, that the brake fluid level is low, or that there is a problem with the anti-lock brake system reservoir.
- If the light remains on when the parking brake has been disengaged, and the fluid level is at the full mark on the master cylinder reservoir, it indicates a possible brake hydraulic system malfunction or that a problem with the Brake Booster has been detected by the Anti-Lock Brake System (ABS) / Electronic Stability Control (ESC) system. In this case, the light will remain on until the condition has been corrected. If the problem is related to the brake booster, the ABS pump will run when applying the brake and a brake pedal pulsation may be felt during each stop.
- The dual brake system provides a reserve braking capacity in the event of a failure to a portion of the hydraulic system. A leak in either half of the dual brake system is indicated by the Brake Warning Light, which will turn on when the brake fluid level in the master cylinder has dropped below a specified level.
- The light will remain on until the cause is corrected.
- Vehicles equipped with the Anti-Lock Brake System (ABS), are also equipped with Electronic Brake Force Distribution (EBD). In the event of an EBD failure, the Brake Warning Light will turn on along with the ABS Light. Immediate repair to the ABS system is required.
- Operation of the Brake Warning Light can be checked by turning the ignition switch from the OFF position to the ON/RUN position. The light should illuminate for approximately two seconds. The light should then turn off unless the parking brake is applied or a brake fault is detected. If the light does not illuminate, have the light inspected by an authorized dealer.
- The light also will turn on when the parking brake is applied with the ignition switch in the ON/RUN position.

NOTE:

This light shows only that the parking brake is applied. It does not show the degree of brake application.

WARNING!

Driving a vehicle with the red brake light on is dangerous. Part of the brake system may have failed. It will take longer to stop the vehicle. You could have a collision. Have the vehicle checked immediately.

- **Malfunction Indicator Light (MIL)**

- The Malfunction Indicator Light (MIL) is part of an onboard diagnostic system called OBD II that monitors engine and automatic transmission control systems. The light will illuminate when the key is in the ON/RUN position before engine start. If the bulb does not come on when turning the key from OFF to ON/RUN, have the condition checked promptly.

WHAT TO DO IN EMERGENCIES

- Certain conditions, poor fuel quality, etc., may illuminate the light after engine start. The vehicle should be serviced if the light stays on through several of your typical driving cycles. In most situations, the vehicle will drive normally and will not require towing.

CAUTION!

Prolonged driving with the Malfunction Indicator Light (MIL) on could cause damage to the engine control system. It also could affect fuel economy and driveability. If the MIL is flashing, severe catalytic converter damage and power loss will soon occur. Immediate service is required.

WARNING!

A malfunctioning catalytic converter, as referenced above, can reach higher temperatures than in normal operating conditions. This can cause a fire if you drive slowly or park over flammable substances such as dry plants, wood, cardboard, etc. This could result in death or serious injury to the driver, occupants or others.



Electronic Stability Control (ESC) Activation/Malfunction Indicator Light

- If this indicator light flashes during acceleration, apply as little throttle as possible. While driving, ease up on the accelerator. Adapt your speed and driving to the prevailing road conditions. To improve the vehicle's traction when starting off in deep snow, sand or gravel, it may be desirable to switch the ESC system off.



Electronic Stability Control (ESC) OFF Indicator Light

- If the ESC OFF indicator light comes on when the Electronic Stability Control (ESC) is off.



Turn Signal Indicator

- The arrows will flash with the exterior turn signals when the turn signal lever is operated. A tone will chime, and an EVIC message will appear if either turn signal is left on for more than 1 mile (1.6 km).

NOTE:

If either indicator flashes at a rapid rate, check for a defective outside light bulb.



High Beam Indicator

- Indicates that headlights are on high beam.



Front Fog Light Indicator

- This indicator will illuminate when the front fog lights are on.



Vehicle Security Light

- This light will flash rapidly for approximately 15 seconds when the vehicle theft alarm is arming. The light will flash at a slower speed continuously after the alarm is set. The security light will also come on for about three seconds when the ignition is first turned on.

WHAT TO DO IN EMERGENCIES

- Electronic Speed Control ON Indicator

- This indicator will illuminate when the electronic speed control has been activated to the “ON” position.

- Electronic Speed Control SET Indicator

- This indicator will illuminate when the cruising speed has been set.

Oil Change Indicator

Message

- If an “oil change due” message (shown as Oil Change Due) appears and a single chime sounds, it is time for your next required oil change.

Resetting The Light After Servicing

- Without pressing the brake pedal, push the ENGINE START/STOP button and cycle the ignition to the ON/RUN position (Do not start the engine.)
- Fully depress the accelerator pedal, slowly, three times within 10 seconds.
- Without pressing the brake pedal, push the ENGINE START/STOP button once to return the ignition to the OFF/LOCK position.

IF YOUR ENGINE OVERHEATS

- In any of the following situations, you can reduce the potential for overheating by taking the appropriate action.
- On the highways – slow down.
- In city traffic – while stopped, shift the transmission to NEUTRAL, but do not increase engine idle speed.

NOTE:

There are steps that you can take to slow down an impending overheat condition:

- If your air conditioner (A/C) is on, turn it off. The A/C system adds heat to the engine cooling system and turning the A/C off can help remove this heat.
- You can also turn the temperature control to maximum heat, the mode control to floor and the blower control to high. This allows the heater core to act as a supplement to the radiator and aids in removing heat from the engine cooling system.

CAUTION!

Driving with a hot cooling system could damage your vehicle. If the temperature gauge reads HDT (H), pull over and stop the vehicle. Idle the vehicle with the air conditioner turned off until the pointer drops back into the normal range. If the pointer remains on HDT (H), and you hear continuous chimes, turn the engine off immediately, and call for service.

WHAT TO DO IN EMERGENCIES

WARNING!

You or others can be badly burned by hot engine coolant (antifreeze) or steam from your radiator. If you see or hear steam coming from under the hood, do not open the hood until the radiator has had time to cool. Never try to open a cooling system pressure cap when the radiator or coolant bottle is hot.

JACKING AND TIRE CHANGING

Jack Location

- The jack and jack-handle are stowed underneath a cover in the rear storage bin in the cargo area.

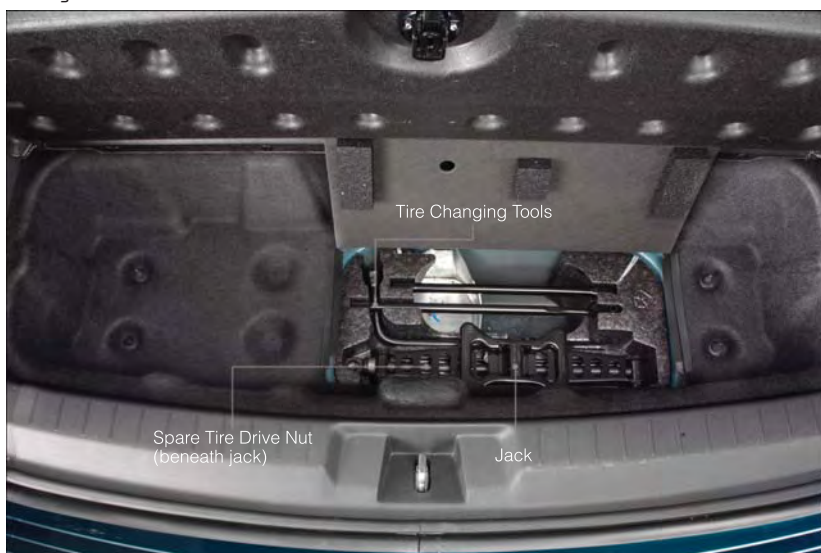

Spare Tire Location

- The spare tire is stowed underneath the rear of the vehicle and is held in place by means of a cable winch mechanism.

WHAT TO DO IN EMERGENCIES

Preparations For Jacking

1. Park the vehicle on a firm, level surface as far from the edge of the roadway as possible. Avoid icy or slippery areas.
2. Turn on the Hazard Warning flashers.
3. Set the parking brake.
4. Place the shift lever in PARK.
5. Turn OFF the ignition.
6. Block both the front and rear of the wheel diagonally opposite of the jacking position. For example, if changing the right front tire, block the left rear wheel.

NOTE:

Passengers should not remain in the vehicle when the vehicle is being jacked.

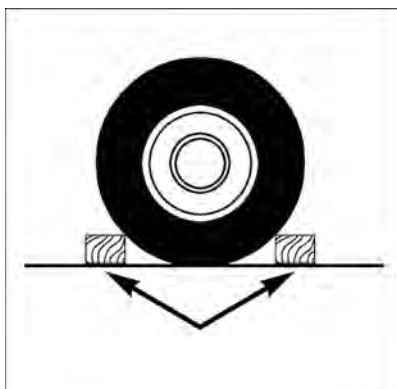

Spare Tire Removal

NOTE:

On seven-passenger models, fold the third-row passenger seats flat. This will provide more space when accessing the jacking tools and when operating the winch mechanism.

1. Remove the jack-handle components 1, 2 and 3 from storage and assemble them.

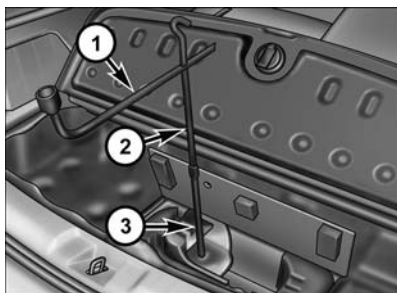

WHAT TO DO IN EMERGENCIES

NOTE:

Assemble components 2 and 3 by seating the small ball at the end of component 2 in the small hole at the end of component 3. This will lock these components together. Assemble components 1 and 2 so that the wheel nut socket at the end of component 1 faces upward when seated on component 2. This will make it easier to rotate the assembly when operating the winch mechanism.

2. Fit the assembled jack-handle over the winch drive nut located in the jack storage area. Rotate the jack-handle assembly counterclockwise until the spare tire is on the ground with enough cable slack to allow you to pull the spare tire out from underneath the vehicle.
3. Pull the spare tire out from underneath the vehicle and raise it upright so the tire's tread is on the ground.
4. Tilt the retainer at the end of the winch cable and remove it from the center of the wheel.

Spare Tire Stowage**NOTE:**

Refer to "Spare Tire Removal" for information on assembling the winch tools.

1. Place the spare tire near to the winch cable. Hold the spare upright so that the tire's tread is on the ground and the valve stem is at the top of the wheel facing away from the rear of the vehicle.
2. Tilt the retainer at the end of the winch cable and drop it through the center of the wheel. Then place the spare tire with the cable and retainer underneath the vehicle.
3. Fit the assembled jack-handle over the winch drive nut. Rotate the jack-handle assembly clockwise to raise the spare tire into the storage area. Continue to rotate the jack-handle assembly until you hear the winch mechanism click three times. It cannot be over tightened. Push against the tire several times to be sure it is held securely in place.

WHAT TO DO IN EMERGENCIES

Jacking Instructions

1. Remove the spare tire, jack, and jack-handle from stowage.
2. Loosen, but do not remove, the wheel nuts on the wheel with the flat tire. Turn the wheel nuts counterclockwise one turn while the wheel is still on the ground.

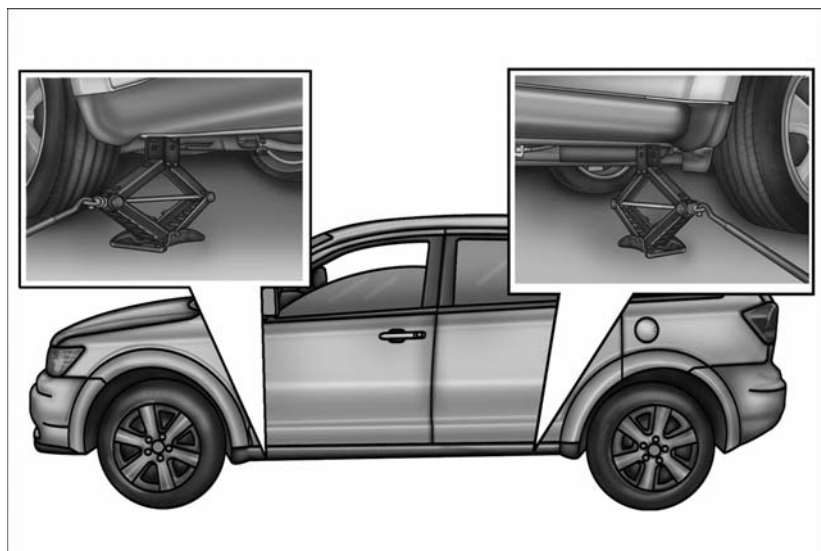

WHAT TO DO IN EMERGENCIES

- Place the jack underneath the lift area that is closest to the flat tire. Turn the jack screw clockwise to firmly engage the jack saddle with the lift area of the sill flange.
- Raise the vehicle by turning the jack screw clockwise with the jack handle. Raise the vehicle until the tire just clears the road surface and enough clearance is obtained to install the spare tire. Minimum tire lift provides maximum stability.
- Remove the wheel nuts. For vehicles so equipped, remove the wheel cover from the wheel by hand. Do not pry the wheel cover off. Then pull the wheel off the hub.
- Install the spare tire.

NOTE:

For vehicles so equipped, do not attempt to install a center cap or wheel cover on the compact spare.

- Install the wheel nuts with the cone-shaped end of the nut toward the wheel. Lightly tighten the wheel nuts.
- Lower the vehicle by turning the jack screw counterclockwise with the jack handle.
- Finish tightening the lug nuts. Push down on the wrench while at the end of the handle for increased leverage. Tighten the lug nuts in a star pattern until each nut has been tightened twice. The correct tightness of each lug nut is 95 ft.lbs. (130 N·m). If in doubt about the correct tightness, have them checked with a torque wrench by you authorized dealer or service station.
- Lower the jack to its fully closed position.
- Place the deflated (flat) tire in the cargo area. **Do not stow the deflated tire in the spare tire stowage location.** Have the deflated (flat) tire repaired or replaced as soon as possible.

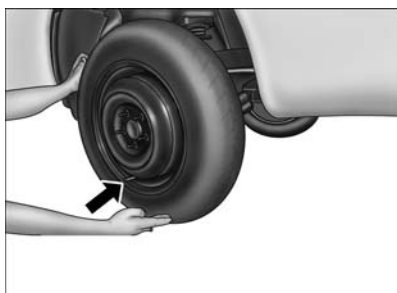
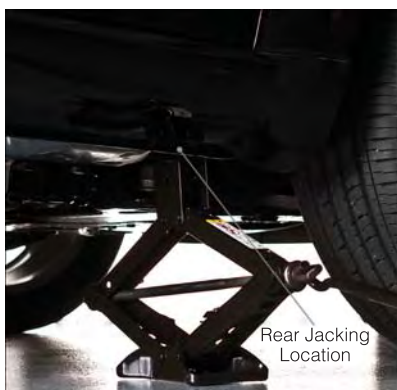

WHAT TO DO IN EMERGENCIES

12. To stow the winch cable and retainer, fit the assembled jack-handle over the winch drive nut. Rotate the jack-handle assembly clockwise until you hear the winch mechanism click three times. It cannot be over tightened.
13. Stow the jack-handle and jack.
14. Check the tire pressure as soon as possible. Adjust the tire pressure as required.

Road Tire Installation

Vehicles Equipped With Wheel Covers

1. Mount the road tire on the axle.
2. To ease the installation process for steel wheels with wheel covers, install two lug nuts on the mounting studs which are on each side of the valve stem. Install the lug nuts with the cone shaped end of the nut toward the wheel. Lightly tighten the lug nuts.
3. Align the valve notch in the wheel cover with the valve stem on the wheel. Install the cover by hand, snapping the cover over the two lug nuts. Do not use a hammer or excessive force to install the cover.
4. Install the remaining lug nuts with the cone shaped end of the nut toward the wheel. Lightly tighten the lug nuts.
5. Lower the vehicle to the ground by turning the jack handle counterclockwise.
6. Finish tightening the lug nuts. Push down on the wrench while at the end of the handle for increased leverage. Tighten the lug nuts in a star pattern until each nut has been tightened twice. The correct tightness of each lug nut is 95 ft.lbs. (130 N·m). If in doubt about the correct tightness, have them checked with a torque wrench by your authorized dealer or service station.
7. After 25 miles (40 km) check the lug nut torque with a torque wrench to ensure that all lug nuts are properly seated against the wheel.

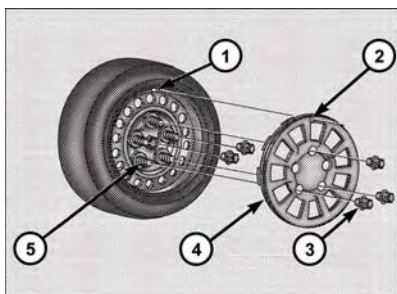

1 – Valve Stem 4 – Wheel Cover
2 – Valve Notch 5 – Mounting Stud
3 – Wheel Lug Nut

WHAT TO DO IN EMERGENCIES

Vehicles Without Wheel Covers

1. Mount the road tire on the axle.
2. Install the remaining lug nuts with the cone shaped end of the nut toward the wheel. Lightly tighten the lug nuts.
3. Lower the vehicle to the ground by turning the jack handle counterclockwise.
4. Finish tightening the lug nuts. Push down on the wrench while at the end of the handle for increased leverage. Tighten the lug nuts in a star pattern until each nut has been tightened twice. The correct tightness of each lug nut is 95 ft.lbs. (130 N·m). If in doubt about the correct tightness, have them checked with a torque wrench by your authorized dealer or service station.
5. After 25 miles (40 km) check the lug nut torque with a torque wrench to ensure that all lug nuts are properly seated against the wheel.

CAUTION!

- The winch mechanism is designed for use with the jack-handle only. Use of an air wrench or other power tools is not recommended and they can damage the winch.
- Do not attempt to raise the vehicle by jacking on locations other than those indicated in the Jacking Instructions for this vehicle.
- Be sure to mount the spare tire with the valve stem facing outward. The vehicle could be damaged if the spare tire is mounted incorrectly.

WHAT TO DO IN EMERGENCIES

WARNING!

- Do not attempt to change a tire on the side of the vehicle close to moving traffic. Pull far enough off the road to avoid the danger of being hit when operating the jack or changing the wheel.
- Being under a jacked-up vehicle is dangerous. The vehicle could slip off the jack and fall on you. You could be crushed. Never put any part of your body under a vehicle that is on a jack. If you need to get under a raised vehicle, take it to an authorized service center where it can be raised on a lift.
- Never start or run the engine while the vehicle is on a jack.
- The jack is designed to be used as a tool for changing tires only. The jack should not be used to lift the vehicle for service purposes. The vehicle should be jacked on a firm level surface only. Avoid ice or slippery areas.
- Carefully follow these tire changing warnings to help prevent personal injury or damage to your vehicle:
- Always park on a firm, level surface as far from the edge of the roadway as possible before raising the vehicle.
- Turn on the Hazard Warning flasher.
- Block the wheel diagonally opposite the wheel to be raised.
- Set the parking brake firmly and set an automatic transmission in PARK.
- Do not let anyone sit in the vehicle when it is on a jack.
- Do not get under the vehicle when it is on a jack.
- Only use the jack in the positions indicated and for lifting this vehicle during a tire change.
- If working on or near a roadway, be extremely careful of motor traffic.
- To assure that spare tires, flat or inflated, are securely stowed, spares must be stowed with the valve stem facing the ground.
- Raising the vehicle higher than necessary can make the vehicle less stable. It could slip off the jack and hurt someone near it. Raise the vehicle only enough to remove the tire.
- To avoid possible personal injury, handle the wheel covers with care to avoid contact with any sharp edges.
- To avoid the risk of forcing the vehicle off the jack, do not tighten the wheel nuts fully until the vehicle has been lowered. Failure to follow this warning may result in personal injury.
- A loose tire or jack, thrown forward in a collision or hard stop could endanger the occupants of the vehicle. Always stow the jack parts and the spare tire in the places provided. Have the deflated (flat) tire repaired or replaced immediately.

WHAT TO DO IN EMERGENCIES

JUMP-STARTING

- If your vehicle has a discharged battery it can be jump-started using a set of jumper cables and a battery in another vehicle or by using a portable battery booster pack.
- Jump-starting can be dangerous if done improperly so please follow the procedures in this section carefully.

NOTE:

When using a portable battery booster pack follow the manufacturer's operating instructions and precautions.

Preparations for Jump-Start

- The battery in your vehicle is located between the left front headlight assembly and the left front wheel splash shield. To allow jump-starting there are remote battery posts located on the left side of the engine compartment.
- Set the parking brake, shift the automatic transmission into PARK and turn the ignition to LOCK.
- Turn off the heater, radio, and all unnecessary electrical accessories.
- Remove the protective cover over the remote positive (+) battery post. To remove the cover, press the locking tab and pull upward on the cover.
- If using another vehicle to jump-start the battery, park the vehicle within the jumper cables reach, set the parking brake and make sure the ignition is OFF.

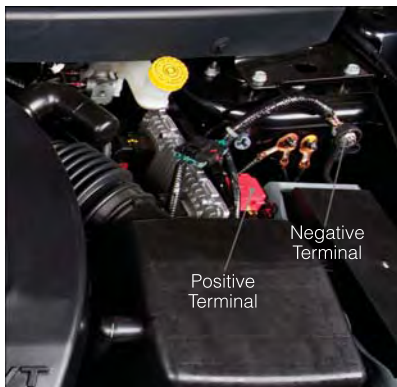

WHAT TO DO IN EMERGENCIES

Jump-Starting Procedure

1. Connect the positive **(+)** end of the jumper cable to the remote positive **(+)** post of the discharged vehicle.
2. Connect the opposite end of the positive **(+)** jumper cable to the positive **(+)** post of the booster battery.
3. Connect the negative end **(-)** of the jumper cable to the negative **(-)** post of the booster battery.
4. Connect the opposite end of the negative **(-)** jumper cable to the remote negative **(-)** post of the vehicle with the discharged battery.
5. Start the engine in the vehicle that has the booster battery, let the engine idle a few minutes, and then start the engine in the vehicle with the discharged battery.

Once the engine is started, remove the jumper cables in the reverse sequence:

1. Disconnect the negative **(-)** jumper cable from the remote negative **(-)** post of the vehicle with the discharged battery.
2. Disconnect the negative end **(-)** of the jumper cable from the negative **(-)** post of the booster battery.
3. Disconnect the opposite end of the positive **(+)** jumper cable from the positive **(+)** post of the booster battery.
4. Disconnect the positive **(+)** end of the jumper cable from the remote positive **(+)** post of the discharged vehicle.
5. Reinstall the protective cover over the remote positive **(+)** battery post of the discharged vehicle.

NOTE:

If frequent jump-starting is required to start your vehicle you should have the battery and charging system inspected at your authorized dealer.

CAUTION!

- Do not use a portable battery booster pack or any other booster source with a system voltage greater than 12 Volts or damage to the battery, starter motor, alternator or electrical system may occur.
- Failure to follow these procedures could result in damage to the charging system of the booster vehicle or the discharged vehicle.
- Accessories that can be plugged into the vehicle power outlets draw power from the vehicle's battery, even when not in use (i.e., cellular phones, etc.). Eventually, if plugged in long enough, the vehicle's battery discharges sufficiently to degrade battery life and/or prevent the engine from starting.

WHAT TO DO IN EMERGENCIES

WARNING!

- When temperatures are below the freezing point, electrolyte in a discharged battery may freeze. Do not attempt jump-starting because the battery could rupture or explode and cause personal injury. Battery temperature must be brought above the freezing point before attempting a jump-start.
- Take care to avoid the radiator cooling fan whenever the hood is raised. It can start anytime the ignition switch is on. You can be injured by moving fan blades.
- Remove any metal jewelry, such as watch bands or bracelets, that might make an inadvertent electrical contact. You could be severely injured.
- Batteries contain sulfuric acid that can burn your skin or eyes and generate hydrogen gas which is flammable and explosive. Keep open flames or sparks away from the battery.
- Do not allow vehicles to touch each other as this could establish a ground connection and personal injury could result.
- Failure to follow this procedure could result in personal injury or property damage due to battery explosion.
- Do not connect the cable to the negative post (-) of the discharged battery. The resulting electrical spark could cause the battery to explode and could result in personal injury.

SHIFT LEVER OVERRIDE

- If a malfunction occurs and the shift lever cannot be moved out of the PARK position, you can use the following procedure to temporarily move the shift lever:
 - To access the shift lever override, remove the cubby bin liner located in the center console behind the shift lever. The override access port is at the front of the cubby bin.
 - Firmly set the parking brake.
 - Turn the ignition switch to the ACC or ON position without starting the engine.
 - Press and maintain firm pressure on the brake pedal.
 - Using a screwdriver or similar tool, press and hold the override tab through the access port on the center console.
 - Move the shift lever into the NEUTRAL position.
 - The vehicle may then be started in NEUTRAL.
 - Reinstall the override cover.

WHAT TO DO IN EMERGENCIES

TOWING A DISABLED VEHICLE

Model	Flat Towing (all four wheels on the ground)	Flatbed Towing (all four wheels suspended OFF the ground)	Front Wheels Raised, Rear Wheels on the Ground	Rear Wheels Raised, Front Wheels on the Ground
FWD Without a Key	NOT Permitted	Recommended Method	May Be Used	NOT Permitted without a front end dolly
FWD With a Key	Shift lever must be in NEUTRAL. The distance to be traveled must not exceed 15 mi (25 km), and the towing speed must not exceed 25 mph (40 km/h).	Recommended Method	May Be Used	NOT Permitted without a front end dolly
AWD Without a Key	NOT Permitted	Recommended Method	NOT Permitted	NOT Permitted
AWD With a Key	Shift lever must be in NEUTRAL, the distance to be traveled must not exceed 15 mi (25 km), the towing speed must not exceed 25 mph (40 km/h), and both front and rear wheels must be on the ground.	Recommended Method	NOT Permitted	NOT Permitted

WHAT TO DO IN EMERGENCIES

FREEING A STUCK VEHICLE

- If your vehicle becomes stuck in mud, sand or snow, it can often be moved using a rocking motion. Turn your steering wheel right and left to clear the area around the front wheels. Then shift back and forth between DRIVE and REVERSE while gently pressing the accelerator. Use the least amount of accelerator pedal pressure that will maintain the rocking motion, without spinning the wheels or racing the engine.

NOTE:

Press the "ESC Off" switch, to place the Electronic Stability Control (ESC) system in "Partial Off" mode before rocking the vehicle. Once the vehicle has been freed, press the "ESC Off" switch again to restore "ESC On" mode.

CAUTION!

- When "rocking" a stuck vehicle by shifting between REVERSE and DRIVE, do not spin the wheels faster than 15 mph (24 km/h), or drivetrain damage may result.
- Revving the engine or spinning the wheels too fast may lead to transmission overheating and failure. It can also damage the tires. Do not spin the wheels above 30 mph (48 km/h) while in gear (no transmission shifting occurring).

WARNING!

Fast spinning tires can be dangerous. Forces generated by excessive wheel speeds may cause tire damage or failure. A tire could explode and injure someone. Do not spin your vehicle's wheels faster than 30 mph (48 km/h) when you are stuck. Do not let anyone near a spinning wheel, no matter what the speed.

WHAT TO DO IN EMERGENCIES

EVENT DATA RECORDER (EDR)

- This vehicle is equipped with an Event Data Recorder (EDR). The main purpose of an EDR is to record, in certain crash or near crash-like situations, such as an air bag deployment or hitting a road obstacle, data that will assist in understanding how a vehicle's systems performed. The EDR is designed to record data related to vehicle dynamics and safety systems for a short period of time, typically 30 seconds or less. The EDR in this vehicle is designed to record such data as:
 - How various systems in your vehicle were operating.
 - Whether or not the driver and passenger safety belts were buckled/fastened.
 - How far (if at all) the driver was depressing the accelerator and/or brake pedal.
 - How fast the vehicle was traveling.
- These data can help provide a better understanding of the circumstances in which crashes and injuries occur.

NOTE:

EDR data are recorded by your vehicle only if a non-trivial crash situation occurs; no data are recorded by the EDR under normal driving conditions and no personal data (e.g. name, gender, age, and crash location) are recorded. However, other parties, such as law enforcement, could combine the EDR data with the type of personally identifying data routinely acquired during a crash investigation.

- To read data recorded by an EDR, special equipment is required, and access to the vehicle or the EDR is needed. In addition to the vehicle manufacturer, other parties such as law enforcement, that have the special equipment, can read the information if they have access to the vehicle or the EDR.

MAINTAINING YOUR VEHICLE

OPENING THE HOOD

- Pull the hood release lever located under the left side of the instrument panel.
- Raise the hood and locate the safety latch, in the middle of the hood opening.
- Move the safety latch while lifting the hood at the same time.
- Insert the support rod into the slot on the hood.
- To close the hood, remove the support rod and place it in the retaining clip, then lower the hood slowly.



1 – Hood Release

WARNING!

Be sure the hood is fully latched before driving your vehicle. If the hood is not fully latched, it could open when the vehicle is in motion and block your vision. Failure to follow this warning could result in serious injury or death.

MAINTAINING YOUR VEHICLE

ENGINE COMPARTMENT

2.4L Engine

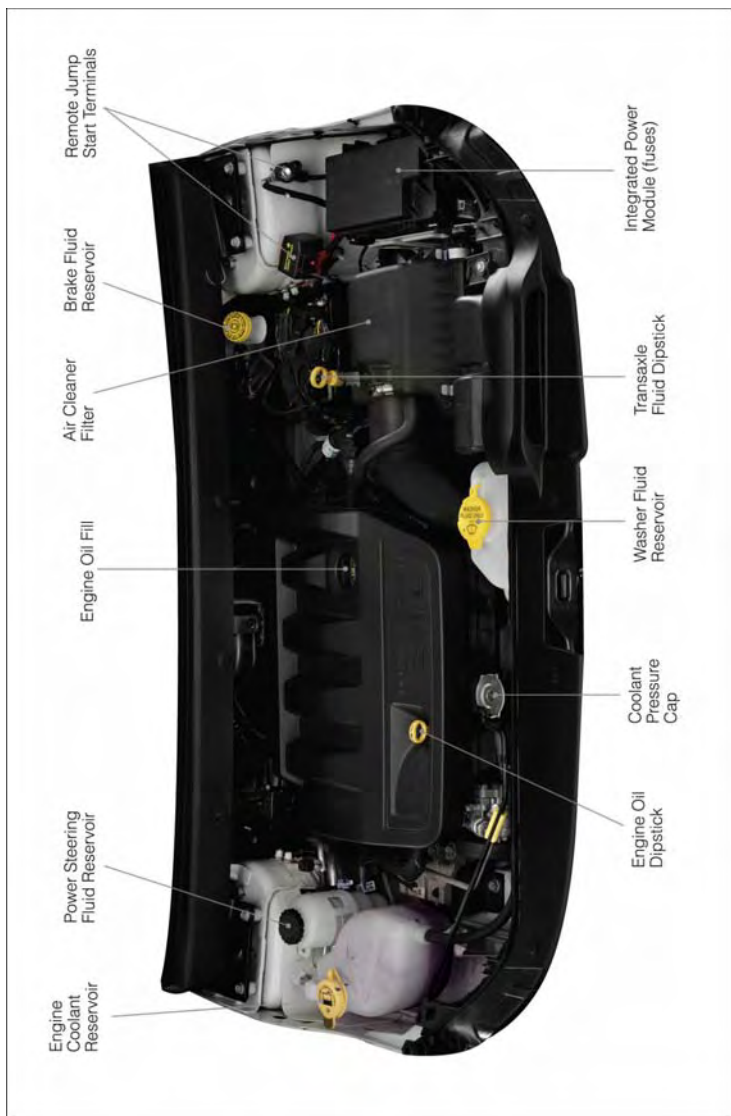

3.6L Engine



MAINTAINING YOUR VEHICLE

FLUIDS AND CAPACITIES

Component	Fluid, Lubricant, or Genuine Part	Capacities
Engine Coolant- 2.4L Engine Single or Dual-Zone Climate Control System.	We recommend you use MOPAR® Antifreeze/Coolant TenYear/150,000 Mile Formula OAT (Organic Additive Technology)	10.7 Quarts (10.1 Liters) Includes heater and coolant recovery bottle filled to MAX level.
Engine Coolant- 2.4L Engine Three-Zone Climate Control System.	We recommend you use MOPAR® Antifreeze/Coolant Ten Year/150,000 Mile Formula OAT (Organic Additive Technology)	11.6 Quarts (11.0 Liters) Includes heater and coolant recovery bottle filled to MAX level.
Engine Coolant- 3.6L Engine Single or Dual-Zone Climate Control System.	We recommend you use MOPAR® Antifreeze/Coolant Ten Year/150,000 Mile Formula OAT (Organic Additive Technology)	13.1 Quarts (12.4 Liters) Includes heater and coolant recovery bottle filled to MAX level.
Engine Coolant- 3.6L Engine Three-Zone Climate Control System.	We recommend you use MOPAR® Antifreeze/Coolant TenYear/150,000 Mile Formula OAT (Organic Additive Technology)	14.5 Quarts (13.7 Liters) Includes heater and coolant recovery bottle filled to MAX level.
Engine Oil with Filter- 2.4L Engine	We recommend you use API Certified SAE 5W-20 Engine Oil, meeting the requirements of Chrysler Material Standard MS-6395 such as MOPAR®, Pennzoil®, and Shell Helix®. Refer to your engine oil filler cap for correct SAE grade.	4.5 Quarts (4.26 Liters)
Engine Oil with Filter- 3.6L Engine	We recommend you use API Certified SAE 5W-20 Engine Oil, meeting the requirements of Chrysler Material Standard MS-6395 such as MOPAR®, Pennzoil®, and Shell Helix®. Refer to your engine oil filler cap for correct SAE grade.	6 Quarts (5.6 Liters)
Engine Oil Filter	We recommend you use MOPAR® Engine Oil Filter	—
Spark Plugs- 2.4L Engine	We recommend you use MOPAR® Spark Plugs (Gap 0.043 in [1.1 mm])	—
Spark Plugs- 3.6L Engine	We recommend you use MOPAR® Spark Plugs (Gap 0.043 in [1.1 mm])	—
Automatic Transmission	We recommend you use MOPAR® ATF+4® Automatic Transmission Fluid. Failure to use ATF+4® fluid may affect the function or performance of your transmission.	—

MAINTAINING YOUR VEHICLE

Component	Fluid, Lubricant, or Genuine Part	Capacities
Brake Master Cylinder	We recommend you use MOPAR® DOT 3 and SAE J1703. If DOT 3, SAE J1703 is not available, then DOT 4 is acceptable	–
Power Steering Reservoir	We recommend you use MOPAR® Power Steering Fluid + 4 or MOPAR® ATF+4® Automatic Transmission Fluid.	–
Power Transfer Unit (PTU)	We recommend you use MOPAR® Gear Lubricant 75W-90.	–
Rear Drive Assembly (RDA)	We recommend you use MOPAR® Gear Lubricant 75W-90.	–
Fuel Selection All-Wheel Drive	87 Octane	21 Gallons (79.8 Liters) [Approximate]
Fuel Selection Front Wheel Drive (FWD) Models	87 Octane	20.5 Gallons (77.6 Liters) [Approximate]

CAUTION!

- Mixing of engine coolant (antifreeze) other than specified Organic Additive Technology (OAT) engine coolant (antifreeze), may result in engine damage and may decrease corrosion protection. Organic Additive Technology (OAT) engine coolant is different and should not be mixed with Hybrid Organic Additive Technology (HOAT) engine coolant (antifreeze) or any “globally compatible” coolant (antifreeze). If a non-OAT engine coolant (antifreeze) is introduced into the cooling system in an emergency, the cooling system will need to be drained, flushed, and refilled with fresh OAT coolant (conforming to MS-12106), by an authorized dealer as soon as possible.
- Do not use water alone or alcohol-based engine coolant (antifreeze) products. Do not use additional rust inhibitors or antirust products, as they may not be compatible with the radiator engine coolant and may plug the radiator.
- This vehicle has not been designed for use with propylene glycol-based engine coolant (antifreeze). Use of propylene glycol-based engine coolant (antifreeze) is not recommended.

E-85 Flexible Fuel – 3.6L Engine Only

CAUTION!

Only vehicles with the E-85 fuel filler door label or a yellow gas cap can operate on E-85.

- Refer to your Owner's Manual on the DVD for further details.

MAINTAINING YOUR VEHICLE

MAINTENANCE SCHEDULE

Your vehicle is equipped with an automatic oil change indicator system. The oil change indicator system will remind you that it is time to take your vehicle in for scheduled maintenance.

Based on engine operation conditions, the oil change indicator message will illuminate. This means that service is required for your vehicle. Operating conditions such as frequent short-trips, trailer tow, extremely hot or cold ambient temperatures, and E85 fuel usage will influence when the "Change Oil" or "Oil Change Required" message is displayed. Severe Operating Conditions can cause the change oil message to illuminate as early as 3,500 miles (5,600 km) since last reset. Have your vehicle serviced as soon as possible, within the next 500 miles (805 km).

On Electronic Vehicle Information Center (EVIC) equipped vehicles, "Oil Change Required" will be displayed in the EVIC and a single chime will sound, indicating that an oil change is necessary.

On Non-EVIC equipped vehicles, "Change Oil" will flash in the instrument cluster odometer and a single chime will sound, indicating that an oil change is necessary.

Your authorized dealer will reset the oil change indicator message after completing the scheduled oil change. If a scheduled oil change is performed by someone other than your authorized dealer, the message can be reset by referring to the steps described under "Electronic Vehicle Information Center (EVIC)/Oil Change Required" in "Understanding Your Instrument Panel" or under "Instrument Cluster Description/Odometer/Trip Odometer" in "Understanding Your Instrument Panel" for further information.

NOTE:

Under no circumstances should oil change intervals exceed 10,000 miles (16,000 km) or twelve months, whichever comes first.

Severe Duty All Models

Change Engine Oil at 4000 miles (6,500 km) if the vehicle is operated in a dusty and off road environment. This type of vehicle use is considered Severe Duty.

MAINTAINING YOUR VEHICLE

Once A Month Or Before A Long Trip:

- Check engine oil level.
- Check windshield washer fluid level.
- Check tire pressure and look for unusual wear or damage. Rotate tires at the first sign of irregular wear, even if it occurs before the oil indicator system turns on.
- Check the fluid levels of the coolant reservoir, brake master cylinder, power steering and transmission (2.4L engine only) and fill as needed.
- Check function of all interior and exterior lights

Required Maintenance Intervals.

Refer to the maintenance schedules on the following page for the required maintenance intervals.

At Every Oil Change Interval As Indicated By Oil Change Indicator System:
• Change oil and filter.
• Rotate the tires. Rotate at the first sign of irregular wear, even if it occurs before the oil indicator system turns on.
• Inspect battery and clean and tighten terminals as required.
• Inspect automatic transmission fluid if equipped with dipstick.
• Inspect brake pads, shoes, rotors, drums, hoses and park brake.
• Inspect engine cooling system protection and hoses.
• Inspect exhaust system.
• Inspect engine air cleaner if using in dusty or off-road conditions.

MAINTAINING YOUR VEHICLE

Maintenance Chart

Refer to the Maintenance Schedules on the following pages for the required maintenance intervals.

Mileage or time passed (whichever comes first)	2	3	4	5	6	7	8	9	10	11	12	13	14	15
Or Years:	32,000	48,000	64,000	80,000	96,000	112,000	128,000	144,000	160,000	176,000	192,000	208,000	224,000	240,000
Or Kilometers:														
Additional Inspections														
Inspect the CV joints.		X			X			X			X			X
Inspect front suspension, tie rod ends, and replace if necessary.	X		X		X		X		X		X		X	
Inspect the brake linings, parking brake function.	X		X		X		X		X		X		X	
Additional Maintenance														
Replace engine air filter.		X			X			X			X			X
Replace air conditioning filter.	X		X		X		X		X		X		X	
Replace spark plugs (2.4L Engine). **		X			X			X			X			X
Replace spark plugs (3.6L Engine). **									X					
Flush and replace the engine coolant at 10 years or 150,000 miles (240,000 km) whichever comes first.									X					X
Change the automatic transmission fluid and filter.											X			
Change the automatic transmission fluid and filter if using your vehicle for any of the following: police, taxi, fleet, or frequent trailer towing.					X									
Replace rear drive assembly (RDA) fluid.					X									X

MAINTAINING YOUR VEHICLE

Mileage or time passed (whichever comes first)	20,000	30,000	40,000	50,000	60,000	70,000	80,000	90,000	100,000	110,000	120,000	130,000	140,000	150,000
Or Years:	2	3	4	5	6	7	8	9	10	11	12	13	14	15
Or Kilometers:	32,000	48,000	64,000	80,000	96,000	112,000	128,000	144,000	160,000	176,000	192,000	208,000	224,000	240,000
Replace power transfer unit (PTU) fluid.					X						X			
Inspect and replace PCV valve if necessary									X					

** The spark plug change interval is mileage based only, yearly intervals do not apply.

WARNING!

- You can be badly injured working on or around a motor vehicle. Do only service work for which you have the knowledge and the right equipment. If you have any doubt about your ability to perform a service job, take your vehicle to a competent mechanic.
- Failure to properly inspect and maintain your vehicle could result in a component malfunction and effect vehicle handling and performance. This could cause an accident.

MAINTAINING YOUR VEHICLE

MAINTENANCE RECORD

	Odometer	Date	Signature, Authorized Service Center
20,000 Miles (32,000 km) or 2 Years			
30,000 Miles (48,000 km) or 3 Years			
40,000 Miles (64,000 km) or 4 Years			
50,000 Miles (80,000 km) or 5 Years			
60,000 Miles (96,000 km) or 6 Years			
70,000 Miles (112,000 km) or 7 Years			
80,000 Miles (128,000 km) or 8 Years			

	Odometer	Date	Signature, Authorized Service Center
90,000 Miles (144,000 km) or 9 Years			
100,000 Miles (160,000 km) or 10 Years			
110,000 Miles (176,000 km) or 11 Years			
120,000 Miles (192,000 km) or 12 Years			
130,000 Miles (208,000 km) or 13 Years			
140,000 Miles (224,000 km) or 14 Years			
150,000 Miles (240,000 km) or 15 Years			

MAINTAINING YOUR VEHICLE

FUSES

Interior Fuses

- The interior fuse panel is located on the passenger side under the instrument panel.

Cavity	Cartridge Fuse	Mini-Fuse	Description
F100	30 Amp Pink		110V AC Inverter - If Equipped
F101		10 Amp Red	Interior Lights
F102		20 Amp Yellow	Cigar Lighter in Instrument Panel/ Left Rear Power Outlet
F103		20 Amp Yellow	Power Outlet in Console Bin/Power Outlet in Rear of Console
F105		20 Amp Yellow	Heated Seats - If Equipped
F106		20 Amp Yellow	Rear Power Outlet
F107		10 Amp Red	Rear Camera - If Equipped
F108		15 Amp Blue	Instrument Panel
F109		10 Amp Red	Climate Control/HVAC
F110		10 Amp Red	Occupant Restraint Controller
F112		10 Amp Red	Spare
F114		20 Amp Yellow	Rear HVAC Blower/Motor
F115		20 Amp Yellow	Rear Wiper Motor
F116	30 Amp Pink		Rear Defroster (EBL)
F117		10 Amp Red	Heated Mirrors
F118		10 Amp Red	Occupant Restraint Controller
F119		10 Amp Red	Steering Column Control Module
F120		10 Amp Red	All Wheel Drive - If Equipped
F121		15 Amp Blue	Wireless Ignition Node
F122		25 Amp Natural	Driver Door Module
F123		25 Amp Natural	Passenger Door Module
F124		10 Amp Red	Mirrors
F125		10 Amp Red	Steering Column Control Module
F126		10 Amp Red	Audio Amplifier
F127		20 Amp Yellow	Trailer Tow - If Equipped
F128		15 Amp Blue	Radio
F129		15 Amp Blue	Video/DVD - If Equipped
F130		15 Amp Blue	Climate Control/Instrument Panel
F131		10 Amp Red	Passenger Assistance/Hands Free System - If Equipped
F132		10 Amp Red	Tire Pressure Module
F133		10 Amp Red	Spare

MAINTAINING YOUR VEHICLE

Underhood Fuses

- The power distribution center is located in the engine compartment.

Cavity	Cartridge Fuse	Mini-Fuse	Description
F101	60 Amp Yellow		Interior Power Distribution Center Rail
F102	60 Amp Yellow		Interior Power Distribution Center Rail
F103	60 Amp Yellow		Interior Power Distribution Center Rail
F105	60 Amp Yellow		Interior Power Distribution Center Rail Ignition Run Relay
F106	60 Amp Yellow		Interior Power Distribution Center Rail Run/Accessory Relays
F139	40 Amp Green		Climate Control System Blower
F140	30 Amp Pink		Power Locks
F141	40 Amp Green		Anti-Lock Brake System
F142	40 Amp Green		Glow Plugs - If Equipped
F143	40 Amp Green		Exterior Lights 1
F144	40 Amp Green		Exterior Lights 2
F145	30 Amp Pink		To Body Computer - Lamp
F146	30 Amp Pink		Spare
F147	30 Amp Pink		Spare
F148	40 Amp Green		Radiator Fan Motor
F149	30 Amp Pink		Starter Solenoid
F150		25 Amp Natural	Powertrain Control Modules
F151	30 Amp Pink		Headlamp Washer Motor - If Equipped
F152		25 Amp Natural	Diesel Fuel Heater - If Equipped
F153		20 Amp Yellow	Fuel Pump
F156		10 Amp Red	Brake/Electronic Stability Control Module
F157		10 Amp Red	Transfer Case Module - If Equipped
F158		10 Amp Red	Active Hood Module - If Equipped
F159		10 Amp Red	Spare
F160		20 Amp Yellow	Interior Lights
F161		20 Amp Yellow	Horn
F162	50 Amp Red		Cabin Heater #1/Vacuum Pump - If Equipped
F163	50 Amp Red		Cabin Heater #2 - If Equipped
F164		25 Amp Natural	Powertrain Auto Shutdown
F165		20 Amp Yellow	Powertrain Shutdown
F166		20 Amp Yellow	Spare

MAINTAINING YOUR VEHICLE

Cavity	Cartridge Fuse	Mini-Fuse	Description
F167		30 Amp Green	Powertrain Shutdown
F168		10 Amp Red	Air Conditioner Clutch
F169	40 Amp Green		Emissions - Partial Zero Emissions Vehicle Motor
F170		15 Amp Blue	Emissions - Partial Zero Emissions Vehicle Actuators
F172		20 Amp Yellow	Spare
F173		25 Amp Natural	Anti Lock Brake Valves
F174		20 Amp Yellow	Siren - If Equipped
F175		30 Amp Green	Spare
F176		10 Amp Red	Powertrain Control Modules
F177		20 Amp Yellow	All Wheel Drive Module - If Equipped
F178		25 Amp Natural	Sunroof - If Equipped
F179		10 Amp Red	Battery Sensor
F181	100 Amp Blue		Electrohydraulic Steering (EHPS) - If Equipped
F182	50 Amp Red		Cabin Heater #3 - If Equipped
F184	30 Amp Pink		Front Wiper Motor

TIRE PRESSURES

- Check the inflation pressure of each tire, including the spare tire, at least monthly and inflate to the recommended pressure for your vehicle.
- The tire pressures recommended for your vehicle are found on the "Tire and Loading Information" label located on the driver's side door opening.

NOTE:

Refer to the Owner's Manual on the DVD for more information regarding tire warnings and instructions.

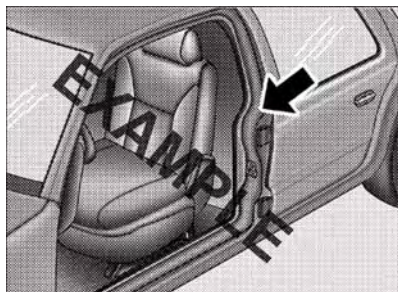

MAINTAINING YOUR VEHICLE

WARNING!

- Overloading of your tires is dangerous. Overloading can cause tire failure, affect vehicle handling, and increase your stopping distance. Use tires of the recommended load capacity for your vehicle. Never overload them.
- Improperly inflated tires are dangerous and can cause collisions. Under-inflation is the leading cause of tire failure and may result in severe cracking, component separation, or "blow out". Over-inflation reduces a tire's ability to cushion shock. Objects on the road and chuck holes can cause damage that results in tire failure. Unequal tire pressures can cause steering problems. You could lose control of your vehicle. Over-inflated or under-inflated tires can affect vehicle handling and can fail suddenly, resulting in loss of vehicle control.

WHEEL AND WHEEL TRIM CARE

- All wheels and wheel trim, especially aluminum and chrome plated wheels, should be cleaned regularly with a mild soap and water to prevent corrosion.
- To remove heavy soil and/or excessive brake dust, use MOPAR® Wheel Cleaner or equivalent or select a non-abrasive, non-acidic cleaner.

CAUTION!

Do not use scouring pads, steel wool, a bristle brush, or metal polishes. Do not use oven cleaner. These products may damage the wheel's protective finish. Avoid automatic car washes that use acidic solutions or harsh brushes that may damage the wheel's protective finish. Only MOPAR® Wheel Cleaner or equivalent is recommended.

MAINTAINING YOUR VEHICLE

EXTERIOR BULBS

LIGHT BULBS - Exterior	Bulb Number
Low Beam Headlamp	9006
High Beam Headlamp	9005
Front Park/Turn Signal	3757AK
Side Marker Lamp	168
Front Fog Lamp	PSX24W
Center High Mounted Stop Lamp (CHMSL)	LED (Serviced at Authorized Dealer)
License Lamp	168
LIGHTS BULBS - Rear (LED Version)	Bulb Number
Rear Tail/Stop Lamp	LED (Serviced at Authorized Dealer)
Rear Tail (Liftgate) Lamp	LED (Serviced at Authorized Dealer)
Rear Turn Signal Lamp	WY21W
Backup Lamp	W21W
LIGHTS BULBS - Rear (Bulb Version)	Bulb Number
Rear Tail/Stop/Turn Signal Lamp	P27/7W
Rear Tail (Liftgate) Lamp	P27/7W
Backup Lamp	P27/7W

CONSUMER ASSISTANCE

CHRYSLER GROUP LLC CUSTOMER CENTER

P.O. Box 21-8004 Auburn Hills, MI 48321-8004 Phone: 1-800-423-6343

CHRYSLER CANADA INC. CUSTOMER CENTER

P.O. Box 1621 Windsor, Ontario N9A 4H6 Phone: 1-800-465-2001 (English) Phone: 1-800-387-9983 (French)

ASSISTANCE FOR THE HEARING IMPAIRED

- To assist customers who have hearing difficulties, the manufacturer has installed special TDD (Telecommunication Devices for the Deaf) equipment at its customer center. Any hearing or speech impaired customer, who has access to a TDD or a conventional teletypewriter (TTY) in the United States, can communicate with the manufacturer by dialing 1-800-380-CHRY. Canadian residents with hearing difficulties that require assistance can use the special needs relay service offered by Bell Canada. For TTY teletypewriter users, dial 711 and for Voice callers, dial 1-800-855-0511 to connect with a Bell Relay Service operator.

WARNING!

Engine exhaust, some of its constituents, and certain vehicle components contain, or emit, chemicals known to the State of California to cause cancer and birth defects, or other reproductive harm. In addition, certain fluids contained in vehicles and certain products of component wear contain, or emit, chemicals known to the State of California to cause cancer and birth defects, or other reproductive harm.

PUBLICATIONS ORDERING

- **If you are the first registered retail owner of your vehicle**, you may obtain one free printed copy of the Owner's Manual, Warranty Booklet or Radio Manuals on your DVD by calling 1-800-423-6343 (U.S.) or 1-800-387-1143 (Canada) or by contacting your dealer.
- Replacement User Guide kits or DVDs or, if you prefer, additional printed copies of the Owner's Manual, Warranty Booklet or Radio Manuals may be purchased by visiting www.techauthority.com or by calling 1-800-890-4038 (U.S.) or 1-800-387-1143 (Canada). Visa, Master Card, American Express and Discover orders are accepted. If you prefer mailing your order, please call the above numbers for an order form.

NOTE:

- A street address is required when ordering manuals (no P.O. Boxes).
- The Owner's Manual and User Guide electronic files are also available on the Chrysler, Jeep, Ram Truck, Dodge and SRT websites.
- Click on the "For Owners" tab, select "Owner/Service Manuals", then select your desired model year and vehicle from the drop down lists.

REPORTING SAFETY DEFECTS IN THE UNITED STATES

- If you believe that your vehicle has a defect that could cause a collision or cause injury or death, you should immediately inform the National Highway Traffic Safety Administration (NHTSA) in addition to notifying the manufacturer.
- If NHTSA receives similar complaints, it may open an investigation, and if it finds that a safety defect exists in a group of vehicles, it may order a recall and remedy campaign. However, NHTSA cannot become involved in individual problems between you, your authorized dealer and the manufacturer.
- To contact NHTSA, you may either call the Auto Safety Hotline toll free at 1-888-327-4236 (TTY: 1-800-424-9153), or go to <http://www.safercar.gov>; or write to: Administrator, NHTSA, 1200 New Jersey Avenue, SE., West Building, Washington, D.C. 20590. You can also obtain other information about motor vehicle safety from <http://www.safercar.gov>.

In Canada

- If you believe that your vehicle has a safety defect, you should contact the Customer Service Department immediately. Canadian customers who wish to report a safety defect to the Canadian government should contact Transport Canada, Motor Vehicle Defect Investigations and Recalls at 1-800-333-0510 or go to <http://www.tc.gc.ca/eng/roadsafety/safedrivers-childsafety-index-53.htm>
- French Canadian customers who wish to report a safety defect to the Canadian government should contact Transport Canada, Motor Vehicle Defect Investigations and Recalls at 1-800-333-0510 or go to <http://www.tc.gc.ca/securiteroutiere/>

MOPAR[®] ACCESSORIES

AUTHENTIC ACCESSORIES BY MOPAR[®]

- The following highlights just some of the many Authentic Dodge Accessories by Mopar[®] featuring a fit, finish, and functionality specifically for your Dodge Journey.
- In choosing Authentic Accessories you gain far more than expressive style, premium protection, or extreme entertainment, you also benefit from enhancing your vehicle with accessories that have been thoroughly tested and factory-approved.
- For the full line of Authentic Dodge Accessories by Mopar[®], visit your local Dodge dealership or online at mopar.com for U.S. residents and mopar.ca for Canadian residents.

CHROME:

- Bodyside Moldings
- Fuel Filler Door
- Exhaust Tip
- Mirror Covers

EXTERIOR:

- Fog Lights
- Molded Splash Guards
- Front Air Deflector
- Hitch Receiver

INTERIOR:

- Premium Carpet Floor Mats
- Slush Mats
- Door Sill Guards
- Bright Pedal Kit
- Katzkin Leather Interiors
- Cargo Tray

ELECTRONICS:

- Ambient Lighting
- Mopar[®] Web (Wi-Fi)
- Park Assist
- Electronic Vehicle Tracking System
- Remote Start

CARRIERS:

- Hitch-Mount Bike Carrier
- Roof Mount Bike Carrier
- Roof Box Cargo Carrier
- Roof Mount Ski and Snowboard Carrier
- Roof Mount Water Sports Carrier
- Roof Mount Canoe Carrier

- Airbag15
- Air Conditioning31
- Alarm (Security Alarm)13, 76
- Anti-Lock Brake System (ABS)71
- Arming System (Security Alarm)13
- Automatic Headlights29
- Automatic Temperature Control (ATC)31
- Automatic Transmission
 - Fluid Type95
- Axle Fluid95

- Back-Up Camera33
- Battery
 - Charging System Light71
- Belts, Seat14
- Booster Seat19
- Brake Fluid95
- Brake System
 - Warning Light74
- Break-In Recommendations, New
 - Vehicle28
- Bulb Replacement107

- Calibration, Compass62
- Change Oil Indicator76
- Changing A Flat Tire77
- Charging System Light71
- Check Engine Light (Malfunction
 - Indicator Light)74
- Child Booster Seat19
- Child Restraint16
- Climate Control31
- Compass Calibration62
- Cooling System
 - Coolant Capacity95
- Cruise Control (Speed Control)30
- Cruise Light30
- Customer Assistance109
- Customer Programmable Features62, 63

- Defects, Reporting110
- Disarming, Security System14
- Driver Cockpit37

- Electronics
 - Your Vehicle's Sound System36
- Electronic Speed Control
 - (Cruise Control)30

- Electronic Throttle Control
 - Warning Light72
- Electronic Vehicle Information Center
 - (EVIC)61, 62
- Electronic Vehicle Information Center
 - (EVIC) Display6
- Emergency, In Case of
 - Freeing Vehicle When Stuck89
 - Jacking77
 - Overheating76
- Engine
 - Break-In Recommendations28
 - Compartment91
 - Malfunction Indicator
 - (Check Engine)74
 - Oil Selection95
 - Overheating76
- Event Data Recorder89
- EVIC Display6
- Exterior Lights107

- Flashers
 - Turn Signal75
- Fluid Capacities95
- Fluids95
- Fog Lights29, 76
- Folding Front Passenger Seat22
- Folding Rear Seat23
- Freeing A Stuck Vehicle89
- Front Heated Seats25
- Fuel
 - Specifications95
- Fuse104
- Fuses104

- Garage Door Opener (HomeLink®)63
- Gauges
 - Speedometer8
 - Tachometer6

- Headlights
 - Automatic29
- Heated Mirrors33
- Heated Seats25
- Heated Steering Wheel26
- High Beam Indicator76
- HomeLink® (Garage Door Opener)63

INDEX

- Hood Release91
- Instrument Cluster.6
 - Indicators8
- Instrument Cluster Warning Lights6
- Interior and Instrument Lights.5
- Interior Fuses104
- Intermittent Wipers (Delay Wipers).28
- Introduction2
- Inverter Outlet (115V)65
- Inverter, Power65
- iPod®/USB/MP3 Control52
 - Bluetooth Streaming Audio53
- Jacking Instructions80
- Jack Location77
- Jack Operation77, 80
- Jump Starting84
- Key Fob.9
- Keyless Enter-N-Go10
 - Lock/Unlock10, 11
- Lane Change Assist28
- Lap/Shoulder Belts14
- LATCH (Lower Anchors and Tether for Children).16, 17, 18, 19
- Lights
 - Engine Temperature Warning73
 - Fog76
 - High Beam Indicator76
 - Seat Belt Reminder73
 - Security Alarm76
 - Warning (Instrument Cluster Description)6
- Locks
 - Liftgate, Tailgate9
- Lower Anchors and Tether for Children (LATCH).16, 17
- Maintenance Record.101
- Malfunction Indicator Light (Check Engine).74
- Mirrors
 - Heated33
- MOPAR® Accessories.111
- Navigation Voice Commands.59
- Navigation Voice Prompt Volume58
- New Vehicle Break-In Period28
- Oil Change Indicator76
- Oil Change Indicator, Reset76
- Oil, Engine
 - Capacity95
- Outlet
 - Power66
- Overheating, Engine76
- Placard, Tire and Loading Information . .106
- Power
 - Distribution Center (Fuses)105
 - Inverter65
 - Outlet (Auxiliary Electrical Outlet) . .66
 - Seats21
 - Steering95
- Preparation for Jacking.78
- Programmable Electronic Features . . .62
- Rain Sensitive Wiper System.28
- Rear Camera33
- Rear ParkSense System33
- Rear Seat, Folding23
- Recreational Towing70
- Replacement Bulbs107
- Reporting Safety Defects110
- Rocking Vehicle When Stuck89
- Seat Belts14
 - Reminder73
- Seats21
 - Adjustment21
 - Folding Front Passenger22
 - Heated25
 - Power21
 - Rear Folding23
- Security Alarm76
- Shift Lever Override.87
- Signals, Turn28, 75
- SIRIUS Travel Link.51
- Spare Tire78
- Spark Plugs95
- Speed Control
 - Cancel30
 - Resume30
 - Set30

Steering	
Tilt Column26
Wheel, Heated26
Steering Wheel Audio Controls61
Stuck, Freeing89
Supplemental Restraint System -	
Airbag15
Temperature Control, Automatic (ATC)31
Tether Anchor, Child Restraint17
Tilt Steering Column26
Tires	
Air Pressure106
Changing77
Jacking77
Pressure Warning Light72
Spare Tire78
Towing69
Disabled Vehicle88
Recreational70
Towing Vehicle Behind a Motorhome70
Trailer Towing	
Trailer and Tongue Weight69
Trailer Weight69
Transmission	
Fluid95
Turn Signals.28, 75
Uconnect® Voice Command58
Underhood Fuses105
Universal Garage Door Opener	
(HomeLink®).63
USB Port52
Video Entertainment System™	
(Rear Seat Video System)60
Voice Command58
Washer	
Rear29
Washers, Windshield28
Wheel and Wheel Trim Care107
Wind Buffeting35
Windshield Washers28
Windshield Wipers28
Wiper, Rear29

FAQ (How To?)

FREQUENTLY ASKED QUESTIONS

GETTING STARTED

- How do I install my LATCH Equipped Child Seat? pg. 15
- How do I move my rear seats? pg. 22

ELECTRONICS

- How do I know which radio I have?
 - Uconnect® 4.3 & 4.3S pg. 39
 - Uconnect® 8.4 & 8.4N pg. 40
- How do I select the AUX music source? pg. 52
- How do I set the clock on my radio?
 - Uconnect® 4.3 & 4.3S pg. 39
 - Uconnect® 8.4 & 8.4N pg. 40
- How do I use the Navigation feature? pg. 48
- How do I pair my cell phone via Bluetooth® with the Uconnect® Hands-Free Voice Activation System? pg. 53
- How do I hear the audio from my iPod® through the USB port using the radio?
 - Uconnect® 4.3 & 4.3S pg. 52
 - Uconnect® 8.4, 8.4N pg. 52
- How do I configure my Universal Garage Door Opener (HomeLink®)? pg. 64

UTILITY

- How do I know how much I can tow with my Dodge Journey? pg. 69

WHAT TO DO IN EMERGENCIES

- What do I do if my TPMS warning light is blinking? pg. 72
- How do I change a flat tire? pg. 77
- How do I Jump-Start my vehicle? pg. 85

MAINTAINING YOUR VEHICLE

- Where is my Fuse Block located?
 - Interior Fuses pg. 101
 - Underhood Fuses pg. 102
- What type of oil do I use? pg. 94
- How often should I change my engine's oil? pg. 96
- What should my tire pressure be set at? pg. 103

This guide has been prepared to help you get quickly acquainted with your new Dodge and to provide a convenient reference source for common questions. However, it is not a substitute for your Owner's Manual.

For complete operational instructions, maintenance procedures and important safety messages, please consult your Owner's Manual, Navigation/Uconnect Manuals and other Warning Labels in your vehicle.

Not all features shown in this guide may apply to your vehicle. For additional information on accessories to help personalize your vehicle, visit www.mopar.com (U.S.), www.mopar.ca (Canada) or your local Dodge dealer.



DRIVING AND ALCOHOL

Drunken driving is one of the most frequent causes of accidents. Your driving ability can be seriously impaired with blood alcohol levels far below the legal minimum. If you are drinking, don't drive. Ride with a designated non-drinking driver, call a cab, a friend, or use public transportation.

WARNING!

Driving after drinking can lead to an accident. Your perceptions are less sharp, your reflexes are slower, and your judgment is impaired when you have been drinking. Never drink and then drive.



DOWNLOAD A FREE ELECTRONIC COPY OF THE OWNER'S MANUAL OR WARRANTY BOOKLET

by visiting the Owners tab at:

www.dodge.com (U.S.)

www.dodge.ca (Canada)



14JC49-926-AA
JOURNEY

Second Edition
User Guide