

polystat[®]

 Cole-Parmer[®]

Heated Immersion Circulators/Baths

Manual P/N U01081 Rev. 08/24/2011



**Installation
Operation**

Table of Contents

Quick Starts

Preface	i
Compliance	i
Warranty	i
Unpacking	i
Section 1 Safety	1-1
Safety Warnings	1-1
Section 2 General Information	2-1
Description	2-1
Specifications	2-1
Wetted Parts	2-4
Section 3 Installation	3-1
Ambient Conditions	3-1
Ventilation	3-1
Electrical Requirements	3-2
Remote Temperature Sensor	3-3
External Circulation	3-4
Fluid Considerations	3-4
Fluids	3-4
Additional Fluid Precautions	3-7
Filling Requirements	3-7
Draining	3-7
Section 4 Operation	4-1
Controller	4-1
Setup	4-2
Start Up	4-2
Status Display	4-3
Standby Mode	4-3
Changing the Setpoint	4-4
Menu Displays	4-5
Menu	4-5
Menu Tree	4-6
Settings	4-7
Stopping the Unit	4-16
Power Down	4-16
Shut Down	4-16
Restarting	4-16

Section 5	Preventive Maintenance.....	5-1
	Cleaning	5-1
	Condenser Fins	5-1
	Testing the Safety Features	5-2
Section 6	Troubleshooting.....	6-1
	Error Displays	6-1
	Check List	6-3
Appendix	Serial Communications.....	1
	Declaration of Conformity	
	RoHS Declaration of Conformity	

Safety Precautions:

The unit is designed for indoor use only.

Never place unit in a location where excessive heat, moisture, inadequate ventilation, or corrosive materials are present.

Never use flammable or corrosive fluids with this unit.

Ensure the tubing you select will meet your maximum temperature and pressure requirements.

Before using any fluid or performing maintenance where contact with the fluid is likely refer to the manufacturer's MSDS for handling precautions.

What you need to get started:

- An adjustable wrench
- Appropriate hose or plumbing
- Appropriate size clamps or connection type

Ensure all communication and electrical connections are made prior to starting the unit.

- 1 Ensure the line cord from the bath is securely connected to the rear of the controller.
- 2 Ensure the communications cable from the bath is connected to the RJ45 connectors (similar to Ethernet) on the rear of the controller.
- 3 Connect the supplied line cord to the controller and to a properly grounded outlet.

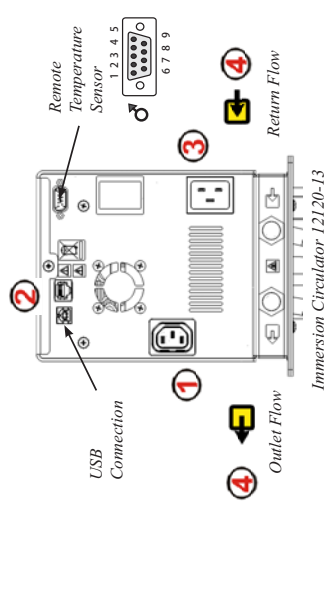
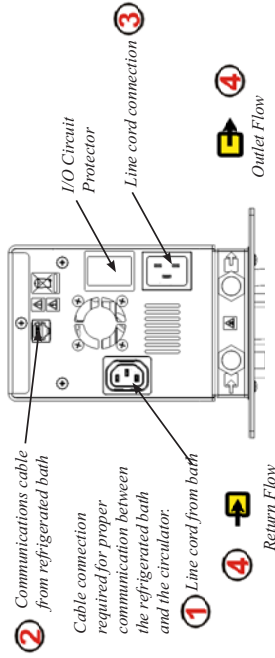

- 4 The plumbing connections for external circulation are located on the rear of the controller. is the return flow from the external application. is the outlet flow to the external application (supply side). The connections are 16 mm O.D. Remove the union nuts and plates to install the 8 mm or 12 mm hose barbs and clamps supplied with the unit.

Ensure the electrical cords do not come in contact with any of the plumbing connections or tubing.

Acceptable Fluids:

5°C to 95°C — Distilled Water or Deionized Water (up to 3 MΩ-cm)
-30°C to 80°C — Water with Glycol
-40°C to 200°C — SIL180
SYNTH 60, SYNTH 200, SYNTH 260
SIL 100, SIL 180, SIL 200, SIL 300

Ensure none of the tubing comes in contact with the power cord.

Tubing is normally used to connect the pump to an external application.

The maximum allowable length of tube depends largely on the size, form and material of the external vessel. The length of tube and its diameter, combined with the circulating capacity, have a large effect on the temperature stability. Whenever possible, use a wider tube diameter and place the application as close as possible to the circulator.

Extreme operating temperatures will lead to extreme temperatures on the tube surface, this is even more critical with metal nozzles.

- the required tube material depends on the heat transfer liquid used
- tubes must not be folded or bent
- secure all tube connections using clamps

When using the internal bath only, the plumbing connections can be closed with the supplied plate and union nuts.

Ensure the reservoir drain port on the front of the unit is *closed* and that all plumbing connections are secure. Also ensure any residue is thoroughly removed before filling the unit.

To avoid spillings, place your containers into the bath before filling.

With a low level WARNING the unit continues to run, with a FAULT the unit will shut the refrigeration, pump and heater will shut down, see manual. The low level warning is at approximately 4 cm (1 5/8") below the top, the low level fault is at approximately 5.5 cm (2 1/8").

Avoid overfilling, oil-based fluids expand when heated.

When pumping to an external system, keep extra fluid on hand to maintain the proper level in the circulating lines and the external system.

Monitor the fluid level whenever heating the fluid.

Start Up

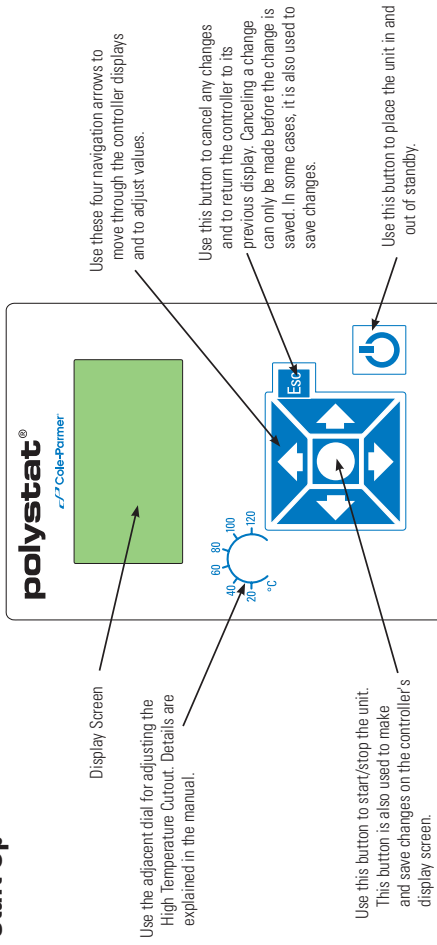

Refrigerated units should be left in an upright position at room temperature (~25°C) for 24 hours before starting. This will ensure the lubrication oil has drained back into the compressor.



Before starting the unit, double check all USB (optional), electrical and plumbing connections.

Do not run the unit until fluid is added to the unit. Have extra fluid on hand. If the unit will not start refer to the manual.

- Place the circuit protector located on the rear of the unit to the **I** position.



The controller will display **System Standby**.

- Press , the Start Display will appear.
- Ensure the start symbol has a highlight box around it, if not use the arrow keys to navigate to the symbol.
- Press : The unit will start and the start symbol will turn into a stop symbol ().

NOTE It will take 30 seconds for the compressor to start.

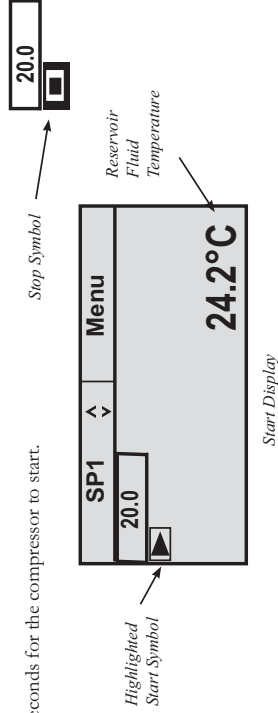

After start, check all external plumbing connections for leaks.

The **SP1** and **Menu** portions on the top of the display are used to view and/or change the controller's settings. They are explained in detail in the manual.

If desired, press **ESC** to bring up the Status Displays.

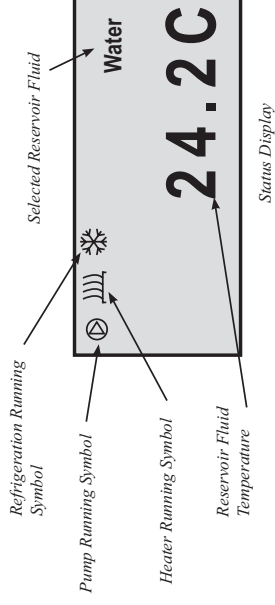

If desired, press **ESC** to toggle between the Start/Status Displays.

Shut Down

Ensure the stop symbol has a box around it, if not use the arrow keys to navigate to the symbol.

Press . The unit will stop and the stop symbol will turn into a start symbol ().

Press . The circulator's screen will go blank and the blue LED will illuminate.

Place the circuit protector on the rear of the thermostat to the **O** position. The blue LED will extinguish.

Sicherheitsvorkehrungen:

Das Gerät darf nur in geschlossenen Räumen betrieben werden.

Stellen Sie das Gerät niemals an Orten auf, wo es übermäßiger Hitze, Feuchtigkeit, unzureichender Belüftung oder korrosiven Stoffen ausgesetzt ist.

Verwenden Sie niemals brennbare oder korrosive Flüssigkeiten in diesem Gerät.

Stellen Sie sicher, dass die von Ihnen ausgewählten Schläuche die Höchstgrenzen für Temperatur und Druck nicht überschreiten.

Bevor Sie Flüssigkeiten einsetzen oder eine Wartung durchführen, bei denen Sie möglicherweise mit Flüssigkeiten in Berührung kommen, beachten Sie die im Sicherheitsdatenblatt des Herstellers beschriebenen Vorsichtsmaßnahmen.

Vor der Inbetriebnahme des Geräts müssen alle Kommunikations- und Stromverbindungen hergestellt worden sein.

① Das Netzkabel vom Bad muss sicher an der Reglerrückseite befestigt sein.

② Das Kommunikationskabel vom Bad muss am RJ45-Anschluss (ähnelt einem Ethernet-Anschluss) an der Reglerrückseite angeschlossen sein.

③ Schließen Sie das mitgelieferte Netzkabel an den Regler an und stecken Sie es in eine ordnungsgemäß geerdete Wandsteckdose.

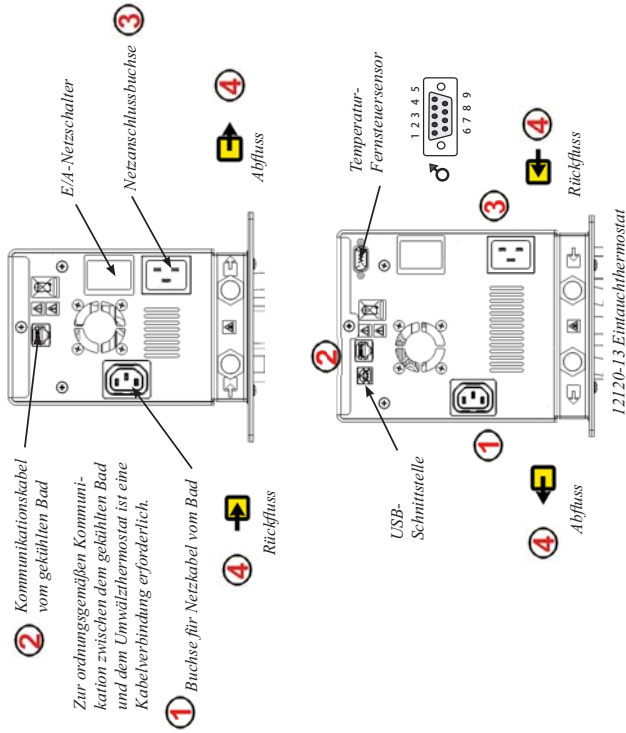

④ Die Schlauchanschlüsse für den externen Umlauf befinden sich auf der Reglerrückseite. ist der Rückfluss von der externen Anwendung. ist der Abfluss in Richtung der externen Anwendung (Zuluflusseite). Der Außendurchmesser der Anschlüsse beträgt 16 mm. Entfernen Sie die Überwurfmutter und Platten, um die mit dem Gerät mitgelieferten 8 mm bzw. 12 mm Schlauchhüllen und -klemmen zu montieren.

Achten Sie darauf, dass die Stromkabel nicht mit einem der Wasseranschlüsse oder Schläuche in Kontakt geraten.

Geeignete Flüssigkeiten:

5 °C bis 95 °C — destilliertes oder deionisiertes Wasser
(bis zu 3 MΩ·cm)

-30 °C bis 80 °C — Wasser mit Glykol

-40°C bis 200°C — SIL180
SYNTH 60, SYNTH 200, SYNTH 260

Achten Sie darauf, dass keiner der Schläuche mit dem Stromkabel in Kontakt gerät.

Schläuche dienen normalerweise dazu, die Pumpe an eine externe Anwendung anzuschließen.

Die maximal zulässige Schlauchlänge des Rohres hängt weitgehend von Größe, Form und Material des äußeren Gefäßes ab, Schlauchlänge und -durchmesser, sowie die Umwälzleistung haben einen starken Einfluss auf die Temperaturkonstanz. Verwenden Sie möglichst einen größeren Schlauchdurchmesser und stellen Sie die Anwendung so nahe wie möglich an den Umwälzthermostat.

Extreme Betriebstemperaturen führen zu extremen Temperaturen an der Schlauchoberfläche, insbesondere bei Metallschläuchen.

- das erforderliche Schlauchmaterial hängt von der verwendeten Wärmeträgerflüssigkeit ab
- die Schläuche dürfen nicht geknickt oder gebogen werden
- sichern Sie alle Schlauchanschlüsse mit Schlauchklemmen

Wenn nur das interne Bad verwendet wird, können die Wasseranschlüsse mithilfe der mitgelieferten Platte und den Überwurfmuttern geschlossen werden.

Achten Sie darauf, dass der Ablaufbahn des Behälters an der Vorderseite des Geräts *geschlossen* ist und alle Wasseranschlüsse fest sitzen. Achten Sie außerdem darauf, dass vor dem Befüllen des Geräts alle Rückstände gründlich entfernt wurden.

Stellen Sie die Behälter vor dem Befüllen in das Bad, um ein Überlaufen zu vermeiden.

Wenn eine Warnmeldung auf einen niedrigen Füllstand hinweist, läuft das Gerät trotzdem weiter, bei einem Fehler schaltet es Kühlung, Pumpe und Heizung ab (siehe Gebrauchsanweisung). Die Warnmeldung zum niedrigen Füllstand erscheint, wenn der Flüssigkeitsspiegel ca. 4 cm unterhalb des oberen Randes liegt; ein Fehler wird generiert, wenn er ca. 5,5 cm unterhalb des oberen Randes liegt.

Vermeiden Sie ein Überfüllen, da sich Flüssigkeiten auf Ölbasis unter Erwärmung ausdehnen.

Halten Sie zusätzliche Flüssigkeit griffbereit, wenn Sie Flüssigkeit in ein externes System pumpen, um den ordnungsgemäßen Füllstand in den Umwälzleitungen und im externen System aufrecht zu erhalten.

Überwachen Sie den Füllstand sorgfältig beim Erhitzen der Flüssigkeit.

Einschalten

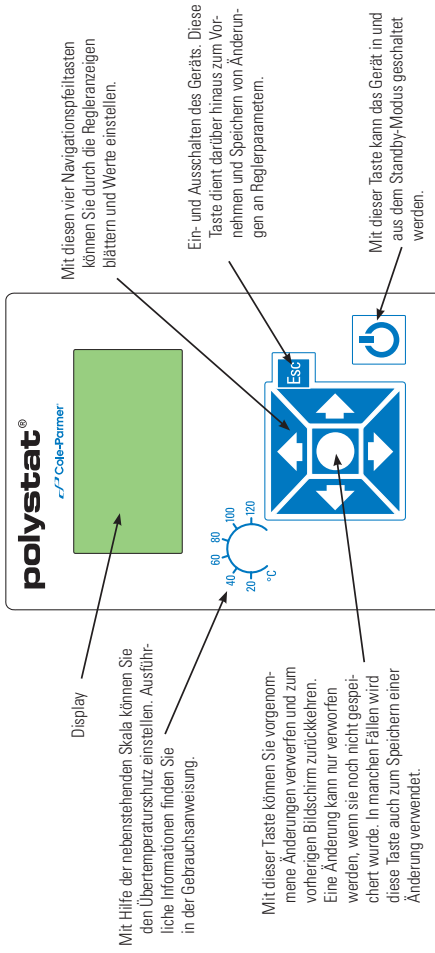



Gekühlte Geräte müssen vor dem Einschalten mindestens 24 Stunden lang bei ~25°C in aufrechter Position gestanden haben. Dadurch wird gewährleistet, dass das Schmieröl zurück in den Kompressor fließt.

Inspizieren Sie vor dem Einschalten alle elektrischen Anschlüsse, Schlauchverbindungen und (optional) USB-Kabelanschlüsse.

Das Gerät niemals mit leerem Behälter betreiben. Halten Sie zusätzliche Flüssigkeit griffbereit. Konsultieren Sie die Gebrauchsanweisung, wenn sich das Gerät nicht einschaltet.

- Schalten Sie den Netzschalter auf der Geräterückseite in die Stellung **I**.

Der Regler zeigt **System Standby** an.

- Drücken Sie auf . Die Startanzeige erscheint.
- Das Startsymbol muss hervorgehoben sein. Gehen Sie mit den Pfeiltasten zu diesem Symbol, wenn dies nicht der Fall ist.
- Drücken Sie . Das Gerät wird gestartet, und statt dem Startsymbol wird jetzt das Stoppsymbol () angezeigt.

HINWEIS Es dauert 30 Sekunden, bis der Kompressor anläuft.

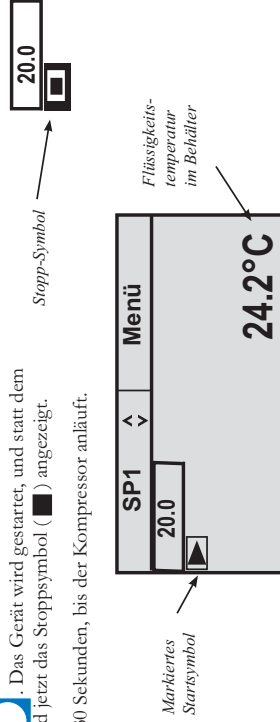

Überprüfen Sie nach dem Start alle externen Schlauchanschlüsse auf Dichtheit.

Über die Optionen **SP1** und **Menü** am oberen Bildschirmrand können die Reglereinstellungen angezeigt und/oder geändert werden. Sie werden ausführlich in der Gebrauchsanweisung erläutert.

Drücken Sie bei Bedarf auf **ESC**, um die Statusanzeigen einzublenden.

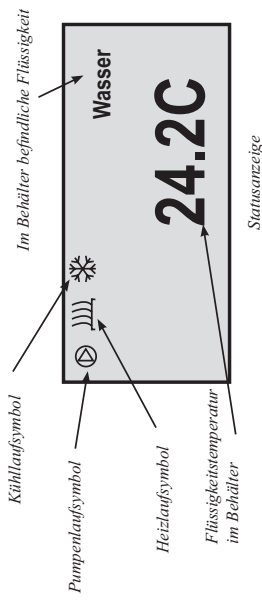

Drücken Sie bei Bedarf auf **ESC**, um zwischen der Startanzeige und den Statusanzeigen umzuschalten.

Ausschalten

Achten Sie darauf, dass das Stopp-Symbol in einem Kästchen erscheint. Navigieren Sie mit den Pfeiltasten auf das Symbol, wenn dies nicht der Fall ist.

Drücken Sie . Das Gerät wird gestoppt, und statt dem Stoppsymbol wird jetzt das Startsymbol () angezeigt.

Drücken Sie . Das Display des Thermostats schaltet sich aus und die blaue LED leuchtet.

Schalten Sie den Netzschalter auf der Thermostatrückseite in die Stellung **O**. Die blaue LED erlischt.

Consignes de sécurité :

Cet appareil est exclusivement destiné à une utilisation intérieure.

Ne jamais l'exposer à une chaleur ou une humidité excessive, à une ventilation inadéquate ou à des matières corrosives.

Ne jamais utiliser de liquides inflammables ou corrosifs avec cet appareil.

S'assurer que la tubulure que vous choisissez est conforme aux exigences de température et de pression (valeurs maximales).

Avant d'utiliser un quelconque liquide ou d'effectuer des travaux d'entretien susceptibles d'entraîner un contact avec le liquide, consulter la fiche technique santé-sécurité du fabricant.

Veiller à établir tous les branchements électriques et branchements de communication avant la mise sous tension de l'appareil.

- 1) S'assurer que le cordon d'alimentation est solidement branché entre le bain et l'arrière du contrôleur.
- 2) S'assurer que le câble de communication partant du bain est branché sur les connecteurs RJ45 (similaires à des connecteurs Ethernet) à l'arrière du contrôleur.
- 3) Brancher le cordon d'alimentation fourni entre le contrôleur et une prise de courant avec une prise de terre.

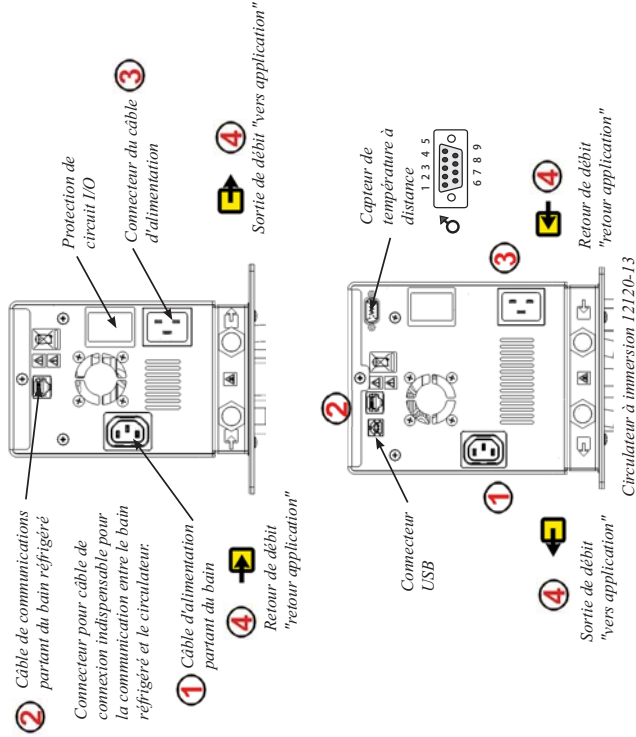

- 4) Les raccords de plomberie pour la circulation externe se situent à l'arrière du contrôleur. est la connexion de retour de l'application externe. est la connexion de sortie vers l'application externe (côté alimentation). Les connecteurs mesurent 16 mm de diamètre extérieur. Enlever les écrous-unions et les plaques pour installer les raccords cannelés de 8 ou 12 mm et les colliers fournis avec l'appareil.

Veiller à ce que les cordons électriques ne touchent pas les raccords de plomberie ou la tubulure.

Liquides autorisés :

5 à 95 °C — eau distillée ou désionisée (3 MΩ·cm max.)

-30 à 80 °C — mélange eau/glycol

-40 à 200 °C — SIL180

SYNTH 60, SYNTH 200, SYNTH 260

SIL 100, SIL 180, SIL 200, SIL 300

S'assurer qu'aucune partie de la tubulure n'entre en contact avec le cordon d'alimentation.

La tubulure sert normalement à connecter la pompe à une application externe.

La longueur de tubulure maximum autorisée dépend en grande partie de la taille, de la forme et du matériau du récipient extérieur. La longueur de tubulure et son diamètre, combinés à la capacité de circulation de l'appareil, jouent un rôle important sur la stabilité de la température. Si possible, utiliser une tubulure de diamètre supérieur et placer l'application le plus près possible du circulateur.

Des températures opératoires extrêmes se soldent par des températures extrêmes à la surface de la tubulure, ce qui est encore plus critique avec les buses métalliques.

- le matériau de tubulure requis dépend du liquide de transfert de chaleur utilisé (fluide caloporteur)
- les tubulures ne doivent pas être pliées ou courbées
- fixer tous les raccords de tubulure à l'aide de colliers

Lorsque seul le bain interne est utilisé, les raccords de plomberie peuvent être fermés avec la plaque et les écrous-unions fournis.

S'assurer que l'orifice de vidange du réservoir sur l'avant de l'appareil est *fermé* et que tous les raccords de plomberie sont solidement fixés. Veiller par ailleurs à enlever tous les résidus avant de remplir l'appareil.

Pour éviter les déversements de liquide, placer les récipients dans le bain avant de commencer à remplir.

En présence d'un AVERTISSEMENT pour niveau bas, l'appareil continue à fonctionner ; en présence d'une ERREUR, il arrête la réfrigération, la pompe et l'élément chauffant ; voir le manuel. L'avertissement pour niveau bas se déclenche à 4 cm environ du haut ; une erreur pour niveau bas à 5,5 cm environ.

Éviter de trop remplir les récipients - les liquides à base d'huile se dilatent quand ils chauffent.

Lors d'un pompage de liquide vers un système extérieur, avoir du liquide d'appoint à portée de la main pour maintenir un niveau correct dans les lignes de circulation et le système extérieur.

Surveiller le niveau de liquide pendant qu'il chauffe.

Mise en route

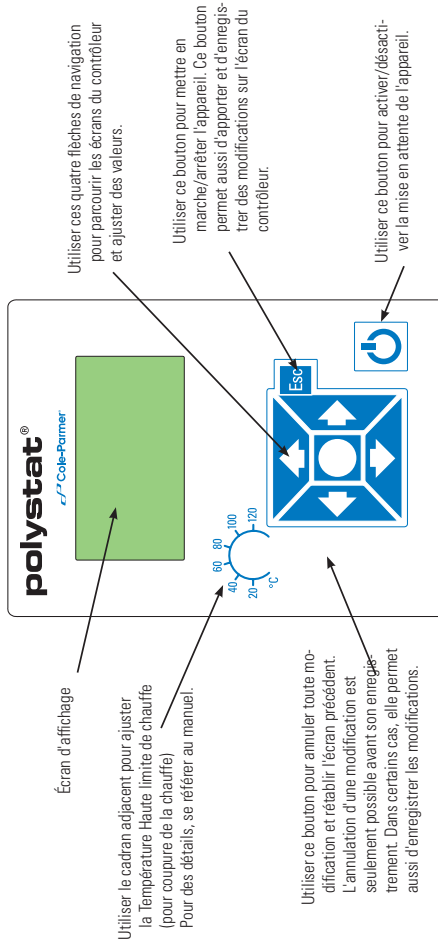

Les appareils réfrigérés doivent rester à la verticale à température ambiante (~25 °C) pendant 24 heures avant leur mise en marche. Ainsi, l'huile lubrifiante sera renvoyée au compresseur.



Avant de démarrer l'appareil, vérifiez tous les connecteurs USB (option), électriques, et les raccords de plomberie.

Ne pas mettre l'appareil en marche sans liquide à l'intérieur. Avoir du liquide d'appoint à portée de la main. Si l'appareil ne démarre pas, se reporter au manuel.



- Placer la protection de circuit située à l'arrière de l'appareil en position I.

Le contrôleur affiche **System Standby ("système en attente")**.

- Appuyer sur  : l'écran de démarrage s'affiche.
- S'assurer que le symbole Marche est encadré d'une surbrillance ; sinon, utiliser les touches fléchées pour naviguer jusqu'au symbole.
- Appuyer sur  . L'appareil démarre et le symbole Marche est remplacé par le symbole Arrêt ().

REMARQUE Le démarrage du compresseur prend 30 secondes environ.

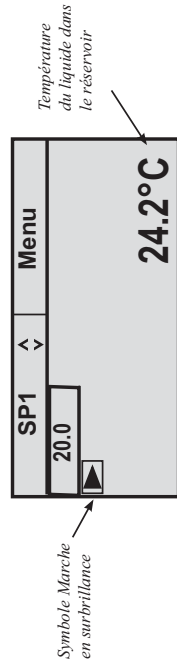

Écran de démarrage

Après démarrage, vérifiez l'étanchéité de tous les raccords de plomberie externes.

Les sections **SP1** et **Menu** en haut de l'écran permettent d'afficher et/ou de modifier les paramètres du contrôleur. Pour des détails, se référer au manuel.

Au besoin, appuyer sur **ESC** pour afficher les écrans d'état.

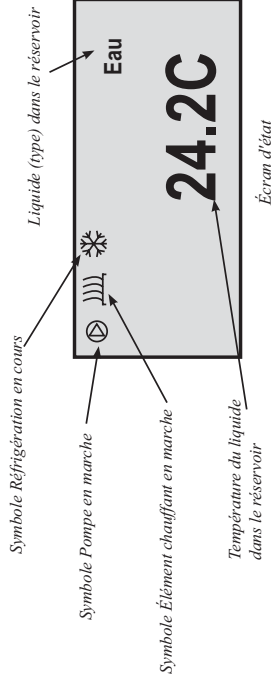

Au besoin, appuyer sur **ESC** pour basculer de l'écran de démarrage à l'écran d'état, ou vice-versa.

Arrêt

S'assurer que le symbole Arrêt est encadré d'une surbrillance ; sinon, utiliser les touches fléchées pour naviguer jusqu'au symbole.

Appuyer sur  . L'appareil démarre et le symbole Arrêt est remplacé par le symbole Marche ().

Appuyer sur  . L'écran du thermostat s'efface et le voyant bleu s'allume.

Placer la protection de circuit située à l'arrière de l'appareil en position **O**. Le voyant bleu s'éteint.

Veiligheidsmaatregelen:

De unit is alleen ontworpen voor gebruik binnenshuis.

Plaats een unit nooit op een plek met overmatige warmte, vocht, onvoldoende ventilatie of corrosieve materialen.

Gebruik nooit ontvlambare of corrosieve vloeistoffen met deze unit. Zorg ervoor dat de leidingen die u gebruikt voldoen aan uw maximale vereisten m.b.t. temperatuur en druk.

Readpleeg voordat u vloeistoffen gebruikt of onderhoud uitvoert op plekken waar mogelijk contact is met vloeistof, de veiligheidsbladen van de fabrikant voor voorzorgsmaatregelen.

Zorg ervoor dat alle communicatie- en elektrische aansluitingen tot stand zijn gebracht voordat u de unit start.

- 1 Zorg ervoor dat het netsnoer van het bad correct is aangesloten op de achterkant van de controller.
- 2 Zorg ervoor dat de communicatiekabel van het bad is aangesloten op de RJ45-aansluiting (vergelijkbaar met ethernet) op de achterkant van de controller.
- 3 Sluit het bijgeleverde netsnoer aan op de controller en op een deugdelijk geaard stopcontact.

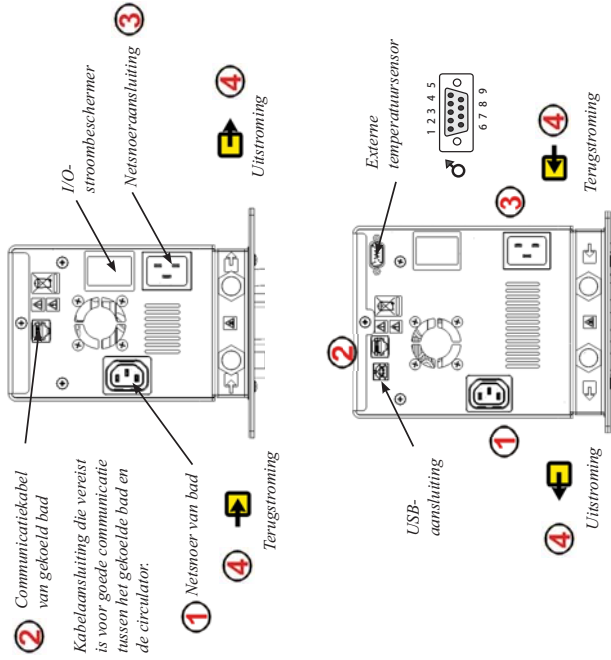

12120-13 Rondpomp thermostaat

- 4 De leidingaansluitingen voor externe circulatie bevinden zich op de achterkant van de controller. is de retour van de externe toepassing. is de aanvoer naar de externe toepassing (toevoorzijde). De aansluitingen hebben een buitendiameter van 16 mm. Verwijder de wartelmoeren en platen om de bij de unit geleverde aansluitingen en klemmen van 8 of 12 mm te installeren.

Zorg ervoor dat de elektrische kabels niet in contact komen met de vloeistofaansluitingen of -leidingen.

Toegestane vloeistoffen:
5°C tot 95°C — Gedestilleerd of gedefioniseerd water (tot maximaal 3 MΩ·cm)
-30°C tot 80°C — Water met glycol
-40°C tot 200°C — SIL180
SYNTH 60, SYNTH 200, SYNTH 260
SIL 100, SIL 180, SIL 200, SIL 300

Zorg ervoor dat de leidingen niet in contact komen met het netsnoer.

De leidingen worden normaal gesproken gebruikt om de pomp aan te sluiten op een externe toepassing.

De maximaal toegestane lengte van de leiding is grotendeels afhankelijk van de grootte, de vorm en het materiaal van het externe vat. De lengte van de leiding en de diameter, in combinatie met de circulatiecapaciteit zijn van grote invloed op de temperatuurstabiliteit. Gebruik waar mogelijk een leiding met een grotere diameter en plaats de toepassing zo dicht mogelijk bij de circulator.

Zeer hoge bedrijfstemperaturen leiden tot zeer hoge temperaturen op het leidingoppervlak, dit geldt nog meer bij metalen aansluitstukken.

- het vereiste leidingmateriaal is afhankelijk van de gebruikte vloeistof
- leidingen mogen niet worden gevouwen of gebogen
- zet alle leidingaansluitingen vast met klemmen

Wanneer u alleen het interne bad gebruikt, kunnen de leidingaansluitingen worden afgesloten met de bijgeleverde plaat en wartelmoeren.

Controleer of de afvoerpoort van het reservoir aan de voorkant van de unit gesloten is en dat alle leidingaansluitingen goed zijn aangesloten. Zorg er tevens voor dat eventuele resten grondig verwijderd worden voordat u de unit vult.

Plaats uw houders in het bad voordat u vult om morsen te voorkomen.

Bij een laag niveau WAARSCHUWING blijft de unit werken, bij een STORING schakelt de unit de koeling de pomp en verwarmert uit. Zie de handleiding. De laag niveau waarschuwing treedt op bij ongeveer 4 cm (1 5/8") onder de bovenkant, de laag niveau storing treedt op bij ongeveer 5,5 cm (2 1/8").

Vul het reservoir niet te vol; vloeistoffen op oliebasis zetten uit bij verwarming.

Houd bij pompen naar een extern systeem extra vloeistof bij de hand om het juiste niveau in de circulatie leidingen en het externe systeem te houden.

Bewaak het vloeistofniveau altijd wanneer u de vloeistof verwarmt.

Opstarten

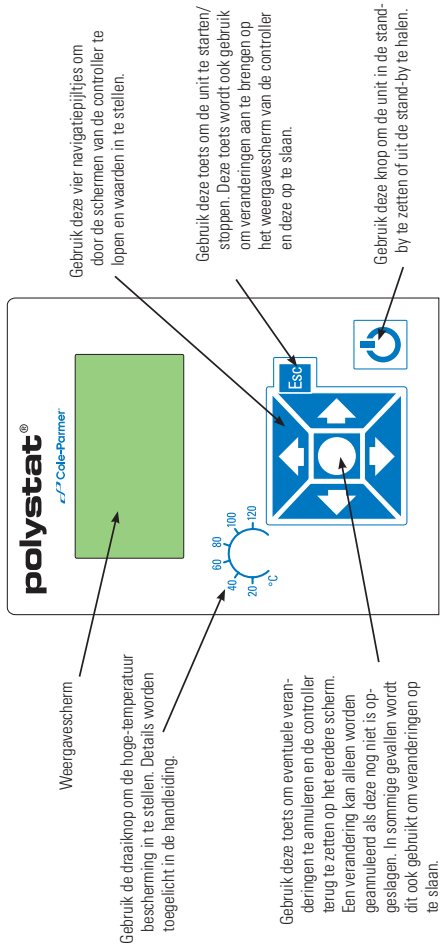



Gekoelde units moeten gedurende 24 uur voordat ze gestart worden rechtop staan bij kamertemperatuur (~25°C). Hierdoor wordt gegarandeerd dat de smeerolie teruggelopen is in de compressor.

Controleer voordat u de unit start alle USB- (optioneel) en elektrische aansluitingen en de aansluitingen van de vloeistofleidingen.

Schakel de unit niet in voordat u vloeistof heeft toegevoegd. Houd extra vloeistof bij de hand. Als de unit niet start, raadpleeg dan de handleiding.

- Zet de stroombeschermer op de achterkant van de unit in de **I**-stand.

De controller geeft **System Standby** weer.

- Druk op , het Startscherm verschijnt.
- Controleer of het startsymbool gemarkeerd is; als dit niet het geval is, gebruik dan de pijljestoetsen om naar het symbool te navigeren.
- Druk op . De unit start en het startsymbool verandert in een stopsymbool ().

OPMERKING Het duurt 30 seconden voordat de compressor start.

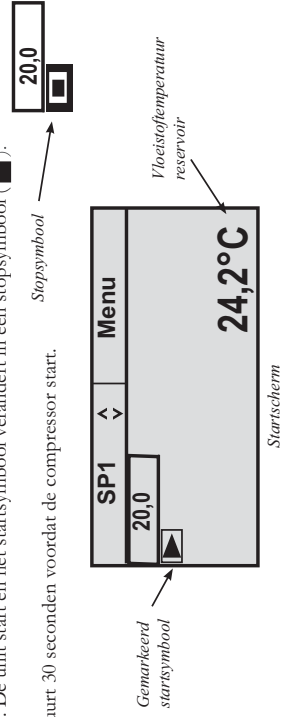

Controleer na het starten alle externe leidingverbindingen op lekken.

De gedeeltes **SP1** en **Menu** bovenaan het scherm worden gebruikt om de instellingen van de controller te bekijken en/of te veranderen. Deze worden uitgebreid beschreven in de handleiding.

Druk indien gewenst op **ESC** om de statusschermen te openen.

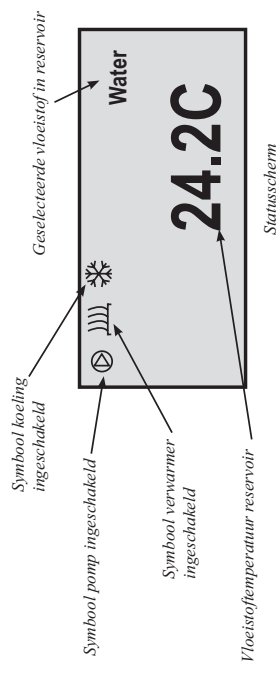

Druk indien gewenst op **ESC** om heen en weer te gaan tussen de start-/ statusschermen.

Uitschakelen

Controleer of het stopsymbool gemarkeerd is; als dit niet het geval is, gebruik dan de pijljestoetsen om naar het symbool te navigeren.

Druk op . De unit stopt en het stopsymbool verandert in een startsymbool ().

Druk op . Het thermostaat scherm wordt blanco en het blauwe ledlampje gaat branden.

Zet de stroombeschermer op de achterkant van de thermostaat in de **O**-stand. Het blauwe lampje gaat uit.

Precauciones de seguridad:

La unidad está diseñada sólo para uso interior.

No coloque nunca la unidad donde quede expuesta a exceso de calor, humedad, mala ventilación o materiales corrosivos.

No utilice nunca fluidos inflamables o corrosivos con esta unidad.

Asegúrese de que los tubos seleccionados cumplen los requisitos de temperatura y presión máximas.

Antes de utilizar cualquier fluido o realizar operaciones de mantenimiento que entrañen riesgo de contacto con el fluido, consulte las precauciones de manipulación en el documento MSDS del fabricante.

Todas las conexiones eléctricas y de comunicación deben realizarse antes de poner en marcha la unidad.

- 1 Compruebe que el cable de alimentación del baño esté conectado firmemente a la parte posterior del controlador.
- 2 Asegúrese de que el cable de comunicaciones del baño está conectado a los conectores RJ45 (similares a Ethernet) de la parte posterior del controlador.
- 3 Conecte el cable de alimentación suministrado al controlador y a una toma de alimentación con puesta a tierra.

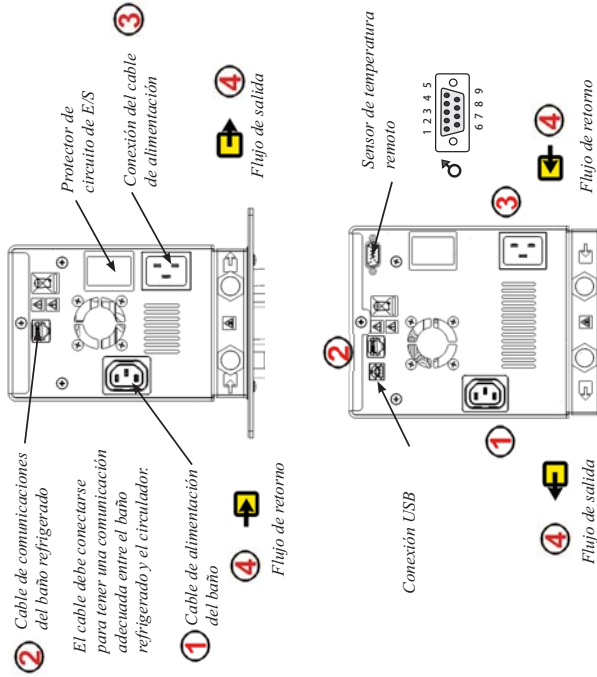

Circulador de inmersión 12120-13

- 4 Las conexiones de las conducciones para circulación externa están en la parte trasera del controlador. es el flujo de retorno desde la aplicación externa. es el flujo de salida hacia la aplicación externa (alimentación). Las conexiones tienen un diámetro exterior de 16 mm. Quite las tuercas y placas de unión para instalar las abrazaderas y las conexiones dentadas de 8 mm o 12 mm suministradas con la unidad.

Asegúrese de que los cables eléctricos no entran en contacto con las conexiones ni los tubos de fontanería.

Fluidos aceptables:

5°C a 95°C: agua destilada o desionizada (hasta 3 MΩ-cm)

-30°C a 80°C: agua con glicol

-40°C a 200°C: SIL180

SYNTH 60, SYNTH 200, SYNTH 260

SIL 100, SIL 180, SIL 200, SIL 300

Asegúrese de que ningún tubo entre en contacto con el cable de alimentación.

Los tubos suelen utilizarse para conectar la bomba a una aplicación externa.

La máxima longitud admitida del tubo depende sobre todo del tamaño, la forma y el material del recipiente externo. La longitud y el diámetro del tubo, combinados con la capacidad de circulación, tienen un efecto importante sobre la estabilidad de la temperatura. Siempre que pueda, utilice un diámetro de tubo mayor y sitúe la aplicación a la menor distancia posible del circulador.

Las temperaturas de funcionamiento extremas producen temperaturas extremas en la superficie del tubo, lo que se acentúa con las boquillas de metal.

- El material del tubo depende del líquido de transferencia térmica empleado.
- Los tubos no deben plegarse ni doblarse.
- Fije todas las conexiones de los tubos con abrazaderas.

Cuando se usa sólo el baño interno, las conexiones de tuberías pueden cerrarse con las placas y tuercas de unión suministradas.

Asegúrese de que el orificio frontal de desagüe del depósito de la unidad está cerrado y de que todas las conexiones de tubos están firmes. Asegúrese también de eliminar por completo cualquier residuo antes de llenar la unidad.

Para evitar derrames, coloque los contenedores dentro del baño antes del llenado.

Con una ADVERTENCIA de bajo nivel, la unidad sigue funcionando, pero con un FALLO, la unidad detiene la refrigeración y se apagan la bomba y el calentador; consulte el manual. La advertencia de bajo nivel aparece a unos 4 cm (1 5/8") de la parte superior, mientras que el fallo de bajo nivel queda a unos 5,5 cm (2 1/8").

Evite el llenado excesivo, porque los fluidos basados en aceite se expanden al calentarse.

Cuando bombee a un sistema externo, tenga a mano fluido adicional para mantener el nivel adecuado en los conductos de circulación y el sistema externo.

Supervise el nivel de fluido siempre que lo caliente.

Puesta en marcha

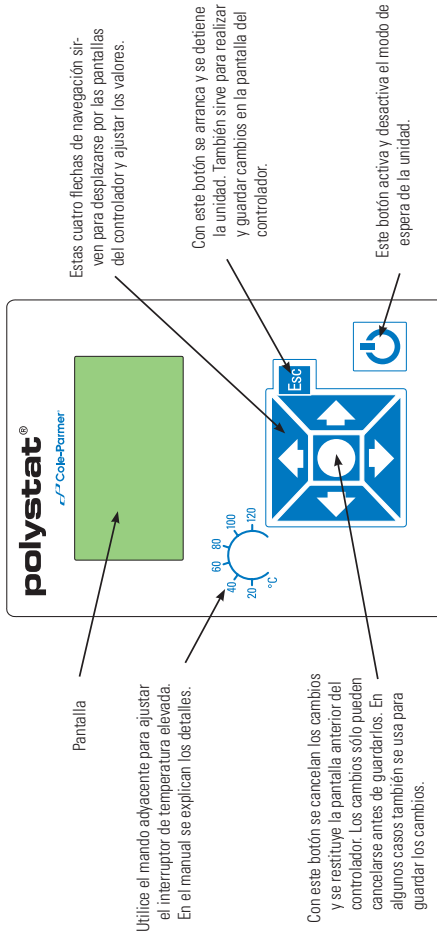

Las unidades refrigeradas deben mantenerse en posición vertical a temperatura ambiente (~25°C) durante 24 horas antes de ponerlas en marcha. Así se asegura que el aceite lubricante ha vuelto al compresor.

Antes de poner en marcha la unidad, verifique todas las conexiones USB (opcional), eléctricas y de conducciones.

No ponga en marcha la unidad sin haberte añadido el fluido. Tenga a mano fluido adicional. Si la unidad no arranca, consulte el manual.

- Coloque en la posición **I** el protector de circuito que hay en la parte posterior de la unidad.



El controlador indica que el sistema está en espera (**System Standby**).

- Pulse y aparecerá la pantalla de inicio.
- Compruebe si el símbolo de inicio está rodeado por un cuadro resaltado; de lo contrario, utilice los botones de flecha para ir a dicho símbolo.
- Pulse . La unidad arrancará y el símbolo de inicio cambiará al de parada ().

NOTA: El compresor tarda 30 segundos en arrancar.

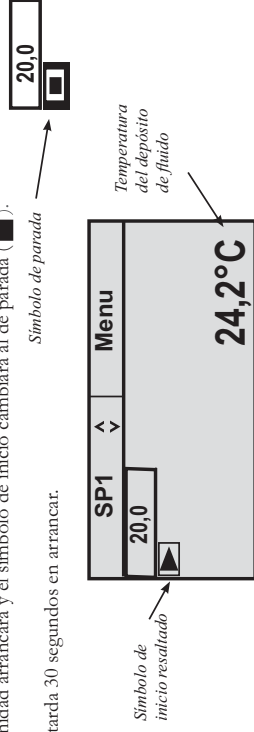

Después de arrancar, busque posibles fugas en todas las conexiones de conductos externas.

Las áreas **SP1** y **Menu** de la parte superior de la pantalla sirven para ver y/o cambiar los ajustes del controlador. Se explican en detalle en el manual.

Para ver las pantallas de estado, pulse **ESC**.

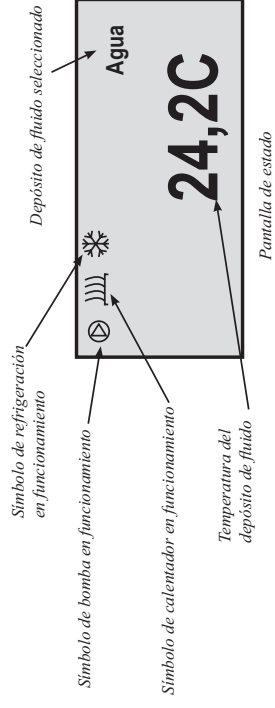

Para cambiar entre las pantallas de inicio/estado, pulse **ESC**.

Apagado

- Compruebe si el símbolo de parada está rodeado por un cuadro; de lo contrario, utilice los botones de flecha para ir a dicho símbolo.
- Pulse . La unidad se detiene y el símbolo de parada cambia al de inicio ().
- Pulse . La pantalla del termostato queda en blanco y el LED azul se ilumina.
- Coloque en la posición **O** el protector de circuito que hay en la parte posterior del termostato. El LED azul se apaga.

Preface

Compliance

Refer to the Declaration of Conformity in the back of this manual.

Warranty

Cole-Parmer warrants to the direct purchaser that the Cole-Parmer Polystat immersion circulators, distributed by Cole-Parmer, will be free from defects in material or workmanship for a period of two years from the date of delivery.

Cole-Parmer will repair or replace the product or provide credit, as its sole option, upon prompt notification and compliance with its instructions.

The Distributor warrants to Customer that upon prompt notification and compliance with Distributor's instructions, that the Distributor will repair or replace, at Distributor's sole option, any Product which is defective in material or workmanship.

Distributor expressly disclaims all other warranties, whether expressed, implied or statutory, including the warranties of merchantability, and fitness for a particular purpose. Distributor's sole responsibility and the Customer's exclusive remedy for any claim arising out of the purchase of any Product is repair or replacement, as described above. In no event shall Distributor's liability exceed the purchase price paid therefor; nor shall Distributor be liable for any claims, losses or damage of any third party or for lost profits or any special, indirect, incidental, consequential, or exemplary damages, howsoever arising, even if Distributor has been advised of the possibility of such damages.

Unpacking

Retain all cartons and packing material until the unit is operated and found to be in good condition. If the unit shows external or internal damage contact the transportation company and file a damage claim. Under ICC regulations, this is your responsibility.

Refrigerated units should be left in an upright position at room temperature for 24 hours before starting. This will ensure the lubrication oil has drained back into the compressor. ▲

Section 1 Safety

Safety Warnings

Make sure you read and understand all instructions and safety precautions listed in this manual before installing or operating your unit. If you have any questions concerning the operation of your unit or the information in this manual, please contact us. See inside cover for contact information.



DANGER indicates an imminently hazardous situation which, if not avoided, *will* result in death or serious injury.



WARNING indicates a potentially hazardous situation which, if not avoided, *could* result in death or serious injury.



CAUTION indicates a potentially hazardous situation which, if not avoided, may result in minor or moderate injury. It is also be used to alert against unsafe practices.



The lightning flash with arrow symbol, within an equilateral triangle, is intended to alert the user to the presence of non-insulated "dangerous voltage" within the unit's enclosure. The voltage magnitude is significant enough to constitute a risk of electrical shock.



This label indicates the presence of hot surfaces.



This label indicates read the manual.

Observe all warning labels. ▲

Never remove warning labels. ▲

Refrigerated units should be left in an upright position for 24 hours before starting. This will ensure the lubrication oil has drained back into the compressor. ▲

The unit construction provides protection against the risk of electrical shock by grounding appropriate metal parts. The protection will not function unless the power cord is connected to a properly grounded outlet. It is the user's responsibility to assure a proper ground connection is provided. ▲

The circuit protector located on the rear of the unit is not intended to act as a disconnecting means. ▲

Never operate the unit with the immersion circulator removed from the bath. ▲

Do not mount the immersion circulator backwards on the bath; the line cord could contact the reservoir fluid. Ensure the electrical cords do not come in contact with any of the plumbing connections or tubing. ▲

Operate the unit using only the supplied line cord. If the unit's power cord is used as the disconnecting device, it must be easily accessible at all times. ▲

Never place the unit in a location or atmosphere where excessive heat, moisture, or corrosive materials are present. ▲

Ensure the tubing you select will meet your maximum temperature and pressure requirements. ▲

Ensure all communication and electrical connections are made prior to starting the unit. ▲

Many refrigerants which may be undetectable by human senses are heavier than air and will replace the oxygen in an enclosed area causing loss of consciousness. Refer to the unit's nameplate and the manufacturer's most current MSDS for additional information. ▲

Never operate the unit without fluid in the reservoir. ▲

Other than water, before using any fluid, or when performing maintenance where contact with the fluid is likely, refer to the manufacturer's MSDS and EC Safety Data sheet for handling precautions. ▲

Ensure, that no toxic gases can be generated by the fluid. Flammable gases can build up over the fluid during usage. ▲

Never use corrosive or flammable fluids with this unit. Use of these fluids will void the manufacturer's warranty. ▲

When using ethylene glycol and water, check the fluid concentration and pH on a regular basis. Changes in concentration and pH can impact system performance. ▲

Ensure the fluid is at a safe temperature (20°C to 55°C) before handling or draining. ▲

Never operate damaged or leaking equipment, or with any damaged cords. ▲

Never operate the unit or add fluid to the reservoir with panels removed. ▲

Do not clean the unit with solvents, only use a soft cloth and water. ▲

Drain the unit before it is transported and/or stored in, near or below freezing temperatures.

Always turn the unit off and disconnect the supply voltage from its power source before moving the unit or before performing any service or maintenance procedures. ▲

Transport the unit with care. Sudden jolts or drops can damage the unit's components. ▲

Refer service and repairs to a qualified technician. ▲

Section 2 General Information

Specifications

The Cole Parmer Polystat® Heated Immersion Circulators are used with refrigerated and heated baths. All circulators can pump to an external system. All have a digital display and easy-to-use touch pad, five programmable setpoint temperatures, acoustic and optical alarms, and offer adjustable high temperature protection.

Part Number	12120-01 or 12120-08 12120-02 or 12120-09	12120-03 or 12120-11 12120-04 or 12120-12	12120-13 -
Process Fluid Temperature and Setpoint Range	Ambient to 100°C Ambient to 212°F	Ambient to 150°C Ambient to 302°F	Ambient to 200°C Ambient to 392°F
Temperature Stability	±0.05°C	±0.05°C	±0.025°C
Heater Capacity KWatts			
230V	1.2	1.2	2.0
115V	1.0	1.0	1.2
Dimensions (H x W x D)			
mm	321.2 x 112.5 x 189.6	321.2 x 112.5 x 189.6	339.2 x 144.3 x 189.6
Inches	12.6 x 4.4 x 7.5	12.6 x 4.4 x 7.5	13.4 x 5.7 x 7.5
Net Weight			
kg	3.9	3.9	4.7
lb	7.4	7.4	10.1
Pump Type	Force only	Force only	Force/Suction

Pumping Capacity

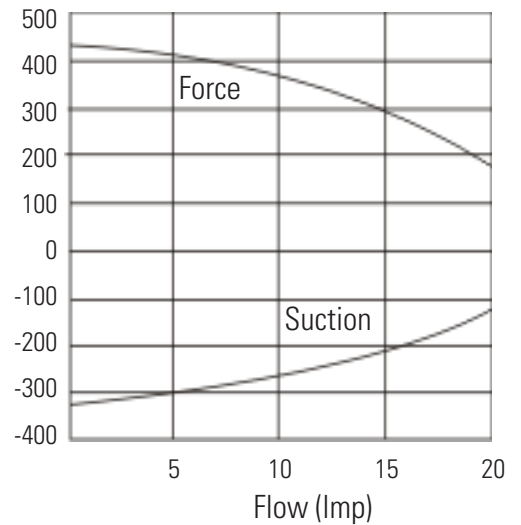
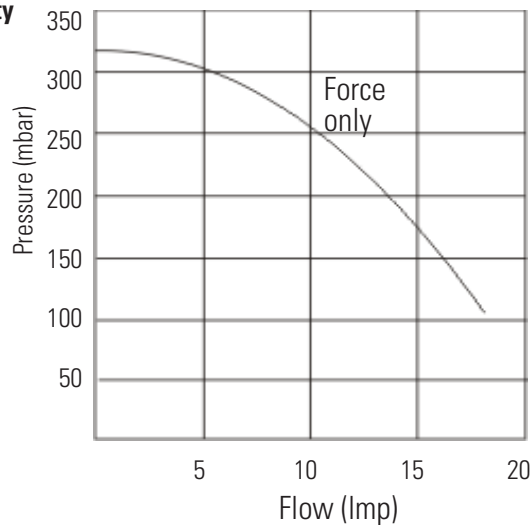

- Lower process fluid temperature ranges available with supplemental cooling.
- Pumping curves obtained using water at ambient temperature, nominal voltage operating in high speed mode. Other conditions will affect performance.
- Cole Parmer reserves the right to change specifications without notice.

Stainless Steel Refrigerated/Heated Bath Circulator Specifications

Part Number* 115V/60Hz 230V/50Hz	12122-02 12122-04	12122-16 12122-18	12122-32 21233-34	12122-46 12122-48
Temperature Range	-20 to 100°C -4 to 212°F	-20 to 100°C -4 to 212°F	-28 to 100°C -18 to 212°F	-35 to 100°C -31 to 212°F
Bath Volume liters gallons	3 - 6 0.8 - 1.6	3 - 6 0.8 - 1.6	8 - 15 2.1 - 4.0	8 - 15 2.1 - 4.0
Cooling Capacity watts @20°C	250	250	500	800
Refrigerant	R134a	R134a	R134a	R404a
Dimensions (H x W x D)** mm inches	617.2 x 205.0 x 414.0 24.3 x 8.1 x 16.3	425.5 x 467.4 x 416.6 16.8 x 18.4 x 16.4	647.9 x 258.0 x 483.0 25.5 x 10.2 x 19.0	686.9 x 370.0 x 520.7 27.0 x 14.6 x 20.5
Net Weight kg lb	23.9 52.7	26.7 58.9	33.3 73.4	52.6 115.9

Part Number* 115V/60Hz 230V/50Hz	12122-36 12122-38	12122-52 12122-54
Temperature Range	-28 to 150°C -18 to 302°F	-35 to 150°C -31 to 302°F
Bath Volume liters gallons	8 - 15 2.1 - 4.0	8 - 15 2.1 - 4.0
Cooling Capacity watts @20°C	500	800
Refrigerant	R134a	R404a
Dimensions (H x W x D)** mm inches	647.9 x 258.0 x 483.0 25.5 x 10.2 x 19.0	686.9 x 370.0 x 519.0 27.0 x 14.6 x 20.4
Net Weight kg lb	33.3 73.4	52.6 115.9

Part Number* 115V/60Hz 230V/50Hz	12122-12 12122-14	12122-26 12122-28	12122-42 12122-44	12122-56 12122-58
Temperature Range	-20 to 100°C -4 to 212°F	-20 to 100°C -4 to 212°F	-28 to 200°C -18 to 392°F	-35 to 200°C -31 to 392°F
Bath Volume liters gallons	3 - 6 0.8 - 1.6	3 - 6 0.8 - 1.6	8 - 15 2.1 - 4.0	8 - 15 2.1 - 4.0
Cooling Capacity watts @20°C	250	250	500	800
Refrigerant	R134a	R134a	R134a	R404a
Dimensions (H x W x D)** mm inches	635.0 x 205.0 x 414.0 25.0 x 8.1 x 16.3	443.0 x 467.4 x 416.6 17.4 x 18.4 x 16.4	665.4 x 258.0 x 483.0 26.2 x 10.2 x 19.0	706.1 x 370.0 x 520.7 27.8 x 14.6 x 20.5
Net Weight kg lb	24.7 53.5	27.1 59.7	33.7 74.2	52.9 116.7

*Refer to serial tag on the back of the bath for part number.

**Add ~15 mm to D for drain fitting

Stainless Steel Heated Bath Circulators Specifications

Part Number* 115V/60Hz 230V/50Hz	12134-60 12134-62	12134-64 12134-66	12134-68 12134-70
Temperature Range**	Ambient +10 to 100°C Ambient +50 to 212°F	Ambient +10 to 100°C Ambient +50 to 212°F	Ambient +10 to 100°C Ambient +50 to 212°F
Bath Volume liters gallons	4 - 7 1.1 - 1.8	7 - 11 1.8 - 2.9	14 - 24 3.7 - 6.3
Dimensions*** (H x W x D) mm inches	393.7 x 214.0 x 361.0 15.5 x 8.4 x 14.2	393.7 x 300.0 x 361.0 15.5 x 11.8 x 14.2	393.7 x 367.0 x 561.0 15.5 x 14.1 x 22.1
Net Weight kg lb	10.6 23.4	12.3 27.0	16.5 36.2

Part Number* 115V/60Hz 230V/50Hz	12121-02 12121-04	12121-22 12121-24	12121-42 12121-44
Temperature Range*	Ambient +10 to 150°C Ambient +50 to 302°F	Ambient +10 to 150°C Ambient +50 to 302°F	Ambient +10 to 150°C Ambient +50 to 302°F
Bath Volume liters gallons	4 - 7 1.1 - 1.8	7 - 11 1.8 - 2.9	14 - 24 3.7 - 6.3
Dimensions*** (H x W x D) mm inches	393.7 x 214.0 x 361.0 15.5 x 8.4 x 14.2	393.7 x 300.0 x 361.0 15.5 x 11.8 x 14.2	393.7 x 358.1 x 561.0 15.5 x 14.1 x 22.1
Net Weight kg lb	10.6 23.4	12.3 27.0	16.5 36.2

Part Number* 115V/60Hz 230V/50Hz	12121-06 12121-08	12121-26 12121-28	12121-46 12121-48
Temperature Range** (Low pump speed)	Ambient +10 to 200°C Ambient +50 to 392°F	Ambient +10 to 200°C Ambient +50 to 392°F	Ambient +10 to 200°C Ambient +50 to 392°F
Temperature Range** (High pump speed)	Ambient +25 to 200°C Ambient +77 to 392°F	Ambient +20 to 200°C Ambient +68 to 392°F	Ambient +10 to 200°C Ambient +50 to 392°F
Bath Volume liters gallons	4 - 7 1.1 - 1.8	7 - 11 1.8 - 2.9	14 - 24 3.7 - 6.3
Dimensions*** (H x W x D) mm inches	414.0 x 214.0 x 361.0 16.3 x 8.4 x 14.2	414.0 x 300.0 x 361.0 16.3 x 11.8 x 14.2	412.7 x 358.1 x 561.0 16.3 x 14.1 x 22.1
Net Weight kg lb	11.9 26.1	13.5 29.7	17.7 39.0

*Refer to serial tag on the back of the bath for part number.

**Lower temperature ranges available with supplemental cooling.

***Add ~15 mm to D for drain fitting.

- Cole Parmer reserves the right to change specifications without notice.

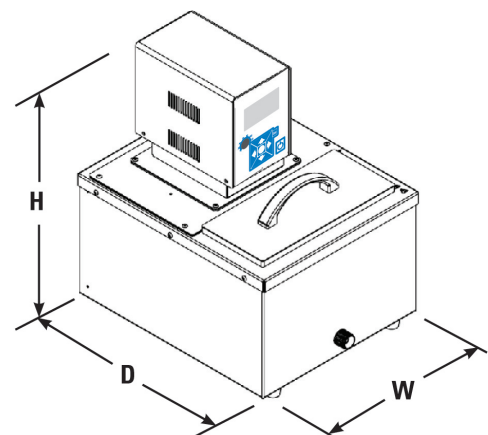

Polyphenylene oxide (PPO) Bath Circulators			
Part Number* 115V/60Hz 230V/50Hz	12134-30 12134-32	12134-34 13134-36	12134-38 12134-40
Temperature Range**	Ambient +10 to 100°C Ambient +50 to 212°F	Ambient +10 to 100°C Ambient +50 to 212°F	Ambient +10 to 100°C Ambient +50 to 212°F
Bath Volume liters gallons	3 - 5 0.8 - 1.3	8 - 14 2.1 - 3.7	13 - 21 3.4 - 5.5
Dimensions (H x W x D) mm inches	346.9 x 190.5 x 388.6 13.7 x 7.5 x 15.3	347.9 x 358.1 x 452.0 13.7 x 14.1 x 17.8	347.9 x 358.1 x 642.6 13.7 x 14.1 x 25.3
Net Weight kg lb	4.6 10.1	6.3 13.8	7.1 15.6

Transparent Acrylic Bath Circulators			
Part Number* 115V/60Hz 230V/50Hz	12134-00 12134-02	12134-04 12134-06	12134-08 12134-10
Temperature Range**	Ambient +10 to 80°C Ambient +50 to 176°F	Ambient +10 to 80°C Ambient +50 to 176°F	Ambient +10 to 80°C Ambient +50 to 176°F
Bath Volume liters gallons	4 - 6 1.1 - 1.6	8 - 12 2.1 - 3.2	12 - 19 3.2- 5.0
Dimensions (H x W x D) mm inches	336.9 x 188.8 x 407 13.3 x 7.4 x 16	338.9 x 356.1 x 348*** 13.3 x 14.0 x 13.7	338.9 x 356.1 x 526*** 13.3 x 14.0 x 20.7
Net Weight kg lb	5.2 11.4	7.1 15.6	8.2 18.1

*Refer to serial tag on the back of the bath for part number.

**Lower temperature ranges available with supplemental cooling.

***Add ~6 mm to D for drain fitting.

- Cole Parmer reserves the right to change specifications without notice.

Wetted Materials

Immersion Circulators

Viton
EPDM
Ryton
Ultem
Vectra
Stainless Steel

Stainless Steel Baths/Circulators

Stainless Steel 316
Stainless Steel 304
EPDM (drain fitting)
Ryton
Zotek-N (cover seal)

Transparent Acrylic Baths/Circulators

Poly-acryl

Polyphenylene oxide (PPO) Baths/ Circulators

Polyphenylenoxid

Section 3 Installation

Ambient Conditions

Ambient Temperature Range	10°C to 40°C (50°F to 104°F)
Maximum Relative Humidity	80% at 31°C (88°F)
Operating Altitude	Sea Level to 2000 meters (6560 feet)
Overvoltage Category	II
Pollution Degree	2
Degree of Protection	IP 20

The unit is designed for continuous operation and for indoor use.



Never place the unit in a location where excessive heat, moisture, inadequate ventilation, or corrosive materials are present. ▲



Refrigerated units should be left in an upright position for 24 hours at room temperature before starting. This will ensure the lubrication oil has drained back into the compressor. ▲

Ventilation

The unit can operate with 0 clearance on two exhaust sides as long as the third exhaust side has unrestricted air flow. Blocked ventilation will increase the unit's temperature, reduce its cooling capacity and, on refrigerated units, eventually lead to premature compressor failure.

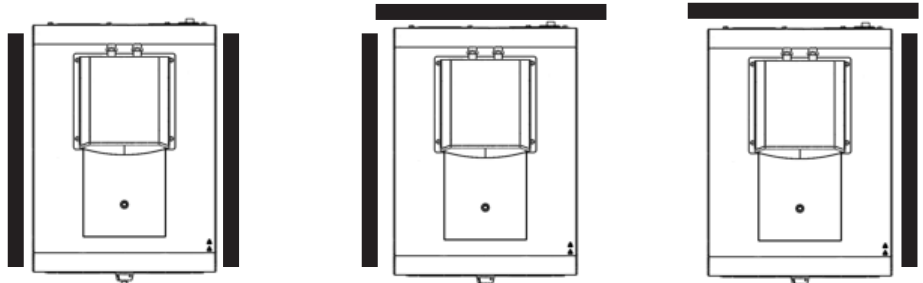

Ventilation Options

Electrical Requirements



The unit construction provides protection against the risk of electrical shock by grounding appropriate metal parts. The protection will not function unless the power cord is connected to a properly grounded outlet. It is the user's responsibility to assure a proper ground connection is provided. ▲

The unit is intended for use on a dedicated outlet.

NOTE If the circuit protector activates allow the unit to cool before resetting. Restart the unit. Contact us if it activates again. ▲

The circuit protection is designed to protect the controller, and is not intended as a substitute for branch circuit protection. Position the unit so it is not difficult to operate the disconnecting device.



If the unit's power cord is used as the disconnecting device, it must be easily accessible at all times. ▲

Refer to the unit nameplate on the rear, upper-left-hand corner of the unit for specific electrical requirements. Voltage deviations of $\pm 10\%$ are permissible. The outlet must be rated as suitable for the total power consumption of the unit, see below.

The following power options are available:

Unit	Volts ¹ /Hertz/Phase	Amps ²	Total Wattage	Plug Type
12122-02/16	115/60/1	11.5	1328	N5-15
12122-04/18	230/50/1	6.8	1573	Country Specific
12122-12/26	115/60/1	11.5	1328	N5-15
12122-14/28	230/50/1	10.3	2373	Country Specific
12122-32/36	115/60/1	11.7	1345	N5-15
12122-34/38	230/50/1	6.9	1596	Country Specific
12122-42	115/60/1	11.7	1345	N5-15
12122-44	230/50/1	10.4	2396	Country Specific
12122-46/52	115/60/1	14.4	1662	N5-20
12122-48/54	230/50/1	7.8	1798	Country Specific
12122-56	115/60/1	14.4	1662	N5-20
12122-58	230/50/1	11.3	2598	Country Specific
12122-02/60/64	115/60/1	9.6	1104	N5-15
12122-04/62/66	230/50/1	5.8	1338	Country Specific
12122-22/42/68	115/60/1	9.6	1104	N5-15
12122-24/44/70	230/50/1	5.8	1338	Country Specific
12122-06/26/46	115/60/1	11.3	1304	N5-150
12122-08/28/48	230/50/1	9.3	2138	Country Specific

1. Volts $\pm 10\%$

2. Maximum amp draw



Ensure all communication and electrical connections are made prior to starting the unit. ▲

- Ensure the line cord from the bath is securely connected to the rear of the controller.
- Ensure the communications cable from the bath is connected to the RJ45 connectors (similar to Ethernet) on the rear of the controller.
- Connect the supplied line cord to the controller and to a properly grounded outlet.

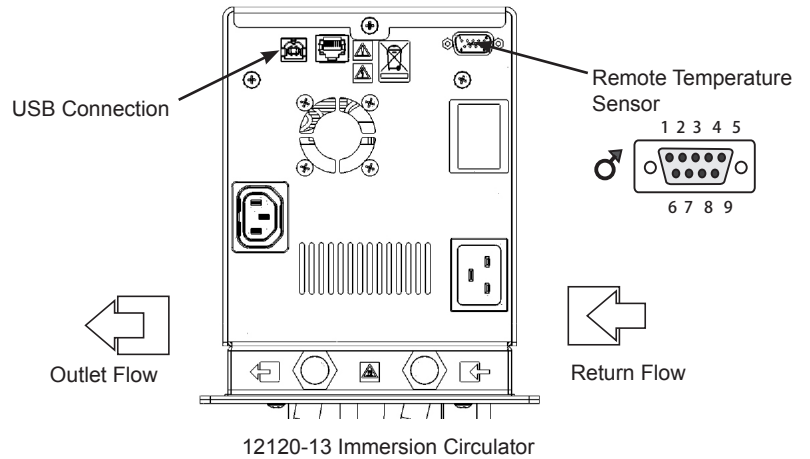
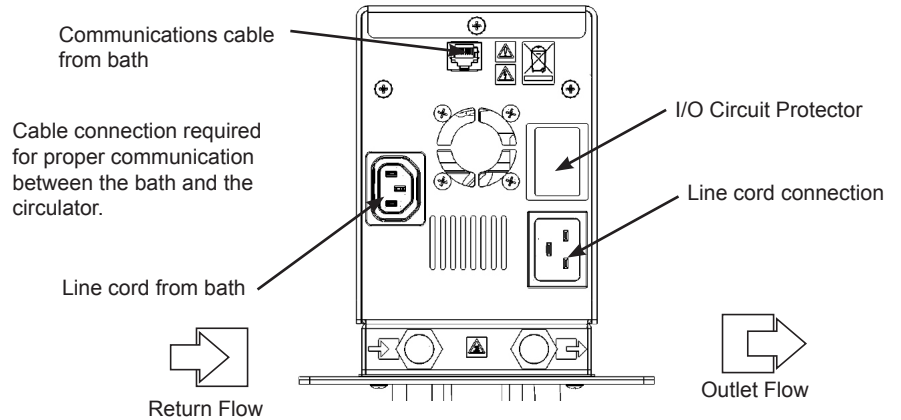

Remote Temperature Sensor





Never apply line voltage to the connection. ▲

The optional remote temperature sensor is enabled using the controller, see Section 4.

Pin		Pin	
1	White	7	Red
2, 3	NA	8	NA
4	White	9	Red (4th wire not connected to the control board)
5, 6	NA		

External Circulation

The plumbing connections for external circulation are located on the rear of the thermostat.  is the return flow from the external application.  is the outlet flow to the external application (supply side). The connections are 16 mm O.D. Remove the union nuts and plates to install the 8 mm or 12 mm hose barbs and clamps supplied with the unit.



Ensure the electrical cords do not come in contact with any of the plumbing connections or tubing. ▲

Fluids



The user is always responsible for the fluid used. Never use corrosive fluids with this unit. ▲



Never use 100% glycol. ▲



Handling and disposal of liquids other than water should be done in accordance with the fluid manufacturers specification and/or the MSDS for the fluid used. ▲



Always adjust the unit's software to the fluid used, see Section 4. ▲



When using water above 80°C closely monitor the fluid level, frequent top-offs will be required. It will also create steam. ▲



Water/glycol mixtures require top-offs with pure water, otherwise the percentage of glycol will increase resulting in high viscosity and poor performance. ▲

The fluid information is only a guide since specifications may change.

Cole Parmer takes no responsibility for damages caused by the selection of an unsuitable bath fluid.

Unsuitable bath fluids are fluids which:

- are very highly viscous (much higher than 30 mPas at the respective working temperature)
- have corrosive characteristics or
- tend to break down at high temperatures

For fluid selection consider application requirements, operating temperature range, material compatibility, safety concerns, and environmental issues.

5°C to 95°C — Distilled Water or Deionized Water (up to 3 MΩ-cm)
Normal tap water leads to calcareous deposits necessitating frequent unit decalcification, see table on next page.

Calcium tends to deposit itself on the heating element. The heating capacity is reduced and service life shortened.

-30°C to 80°C — Water with Glycol

Below 5°C water has to be mixed with a glycol. The amount of glycol added should cover a temperature range 5°C lower than the operating temperature of the particular application. This will prevent the water/glycol from gelling (freezing) near the evaporating coil.

Excess glycol deteriorates the temperature accuracy due to its high viscosity.

-40°C to 200°C — SIL180:

SIL180 is suitable for covering nearly the entire range with just one liquid, especially when used with the cooling units. See next page for additional information. Unfortunately SIL180 has a wetting tendency necessitating the occasional cleaning of the bath cover.

other temperatures:

Cole Parmer offers a range of heat transfer fluids for these temperature control applications.

SYNTH 60, SYNTH 200, SYNTH 260:

Synthetic thermal liquid with a medium life span (several months) and little smell annoyance.

SIL 100, SIL 180, SIL 200, SIL 300:

Silicone oil with a long life span (over 1 year) and negligible smell.

Heat transfer fluids are supplied with an EC Safety Data Sheet.



Ensure, when selecting the heat transfer fluid, that no toxic gases can be generated. Flammable gases can build up over the fluid during usage. ▲



Ensure the over temperature cut-off point is set lower than the fire point for the heat transfer fluid selected. ▲



The highest working temperature as defined by the EN 61010 (IEC 1010) must be limited to 25°C below the fire point of the bath fluid. ▲

Water Quality and Standards

Process Fluid	Permissible (PPM)	Desirable (PPM)
Microbiologicals		
(algae, bacteria, fungi)	0	0
Inorganic Chemicals		
Calcium	<25	<0.6
Chloride	<25	<10
Copper	<1.3	<1.0
0.020 ppm if fluid in contact with aluminum		
Iron	<0.3	<0.1
Lead	<0.015	0
Magnesium	<12	<0.1
Manganese	<0.05	<0.03
Nitrates/Nitrites	<10 as N	0
Potassium	<20	<0.3
Silicate	<25	<1.0
Sodium	<20	<0.3
Sulfate	<25	<1
Hardness	<17	<0.05
Total Dissolved Solids	<50	<10
Other Parameters		
pH	6.5-8.5	7-8
Resistivity	0.01*	0.05-0.1*

* MΩ-cm (compensated to 25°C)

Unfavorably high total ionized solids (TIS) can accelerate the rate of galvanic corrosion. These contaminants can function as electrolytes which increase the potential for galvanic cell corrosion and lead to localized corrosion such as pitting. Eventually, the pitting will become so extensive that refrigerant will leak into the water reservoir.

As an example, raw water in the United States averages 171 ppm (of NaCl). The recommended level for use in a water system is between 0.5 to 5.0 ppm (of NaCl).

Recommendation: Initially fill the tank with distilled or deionized water. Do not use untreated tap water as the total ionized solids level may be too high. This will reduce the electrolytic potential of the water and prevent or reduce the galvanic corrosion observed.

Additional Fluid Precautions

When working with fluids other than water:

- Do not use any fluid until you have read and understood the label and the Material Safety Data Sheet (MSDS).
- Do not blend any fluids.
- Ensure any fluid residue or any other material is thoroughly removed before filling the unit with a different fluid.
- Always wear protective clothing, especially a face shield and gloves.
- Avoid spattering on any of the unit's components, always *slowly* add fluid. When adding, point the opening of a container away from yourself.
- Use fume hoods.
- Do not allow any ignition sources in the vicinity.

Filling Requirements

Ensure the reservoir drain port on the front of the unit is *closed* and that all plumbing connections are secure. Also ensure any residue is thoroughly removed before filling the unit.



Before using any fluid refer to the manufacturer's MSDS and EC safety data sheets for handling precautions. ▲

To avoid spilling, place your containers into the bath before filling.

With a low level WARNING the unit continues to run, with a FAULT the unit will shut the refrigeration, pump and heater will shut down, see Section 7. The low level warning is at approximately 4 cm (1 5/8") below the top, the low level fault is at approximately 5.5 cm (2 1/8").



Avoid overfilling, oil-based fluids expand when heated. ▲

When pumping to an external system, keep extra fluid on hand to maintain the proper level in the circulating lines and the external system.

NOTE Monitor the fluid level whenever heating the fluid. ▲

Draining



Before draining any fluid refer to the manufacturer's MSDS and EC safety data sheets for handling precautions. ▲



Ensure the fluid is at a safe handling temperature, ~55°C. Wear protective clothing and gloves. ▲

- place a suitable vessel underneath the drain. If desired, attach an 8 mm id tube on the drain.
- *slowly* turn the drain plug until flow is observed.

Section 4 Operation

Heated Immersion Circulator

The Cole Parmer Heated Immersion Circulators have a digital display and easy-to-use touch pad, five programmable setpoint temperatures, acoustic and optical alarms and adjustable high temperature protection.

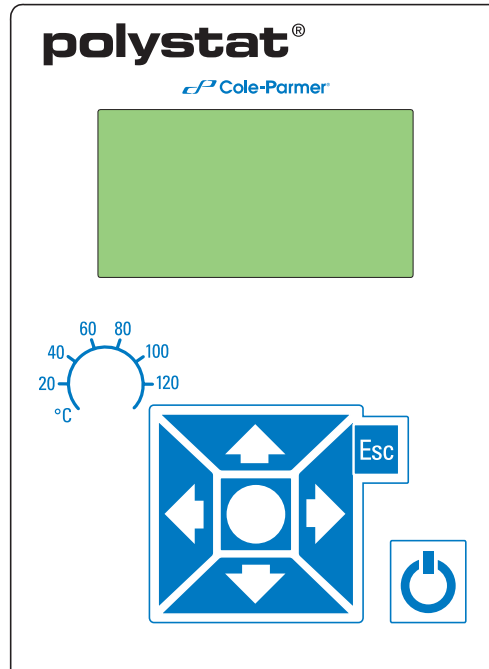

Use this button to place the unit in and out of standby mode.

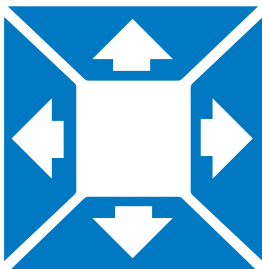

Use these navigation arrows to move through the controller displays and to adjust values.



Use this button to start/stop the unit. This button is also used to make and save changes on the controller's display screen.



Use this button to cancel any changes and to return the controller to its previous display. Canceling a change can only be made before the change is saved. In some cases, it is also used to save changes.

NOTE Holding this button for five seconds resets the display contrast to the default level and also brings up the language menu to change, if needed, the displayed language. See **Settings - Display Options** in this Section. ▲



Use the adjacent dial for adjusting the High Temperature Cutout. Details are explained in Section 6.

Setup



Refrigerated units should be left in an upright position at room temperature (~25°C) for 24 hours before starting. This will ensure the lubrication oil has drained back into the compressor. ▲



Before starting the unit, double check all USB (optional), electrical and plumbing connections. ▲

Start Up

Do not run the unit until fluid is added to the unit. Have extra fluid on hand. If the unit will not start refer to Section 5 Troubleshooting.

- Place the circuit protector located on the front of the unit to the **I** position.
- Press , the Start Display will appear.
- Ensure the start symbol has a highlight box around it, if not use the arrow keys to navigate to the symbol.

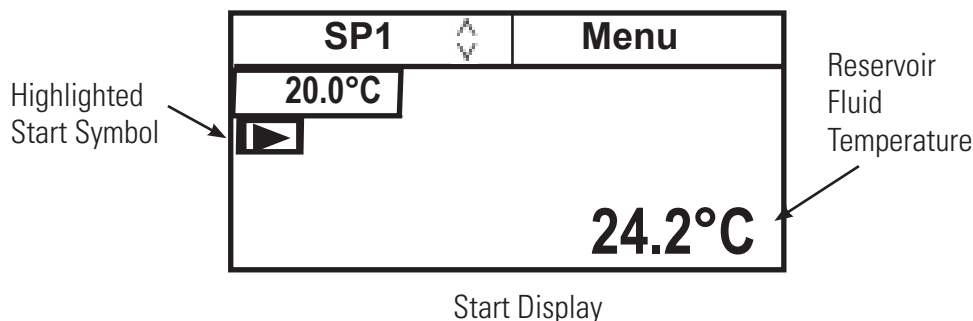

- Press . The unit will start and the start symbol will turn into a stop symbol (■).

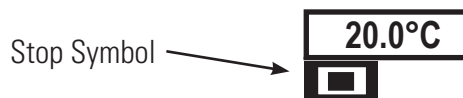

NOTE It will take 30 seconds for the compressor to start. ▲

NOTE After start, check external plumbing connections for leaks. ▲

The **SP1** and **Menu** portions on the top of the display are used to view and/or change the controller's settings. They are explained in detail later in this Section.

Status Display

If desired, press **Esc** to toggle between the Start/Status Displays.

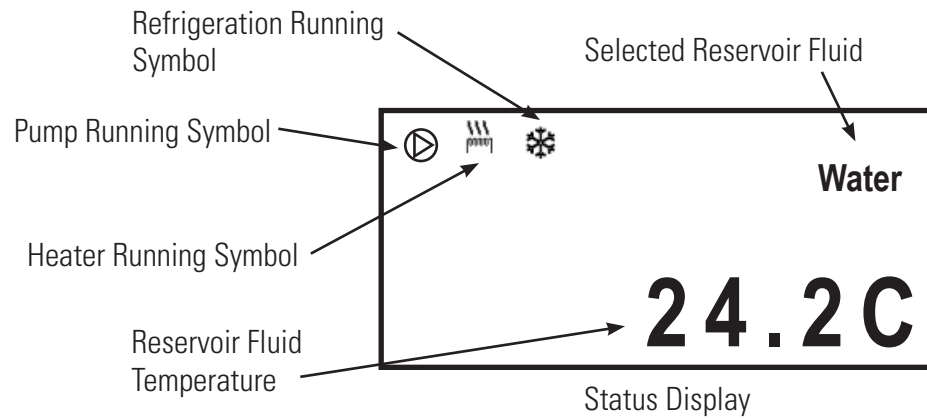

Standby Mode

Press , the display will go blank and the unit will be in the standby mode.

Changing the Setpoint

NOTE You cannot adjust the setpoint closer than 0.1°C to either of the fluid's system limits, see Fluids Type in this Section, or beyond the unit's temperature range. ▲

NOTE The setpoint can be changed with the unit running or not. ▲

The Setpoint is the desired fluid temperature. The controller can store up to five setpoints, **SP1** through **SP5**. The procedure for changing the stored setpoint values is discussed later in this Section.

Use the navigation arrows and move to the **SP1** window and then press  to highlight it as shown below.

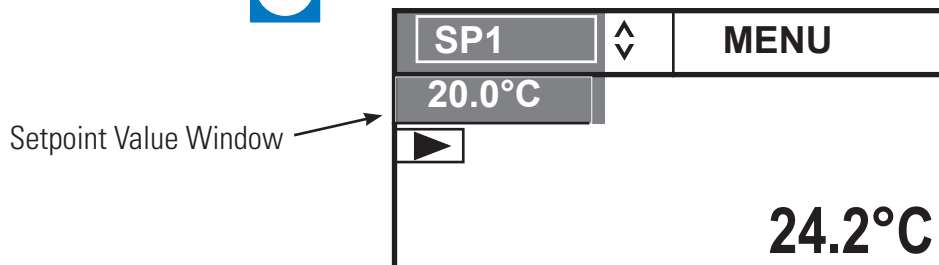

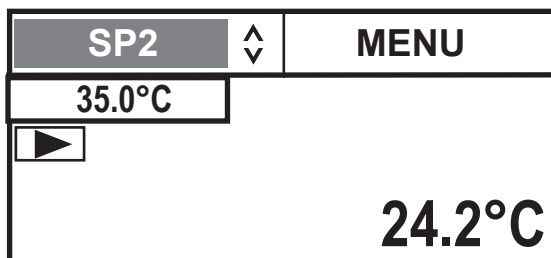

Use the up and down navigation arrows to bring up the desired setpoint and then press .

The display on the Setpoint Value Window will now indicate the corresponding setpoint's stored value.

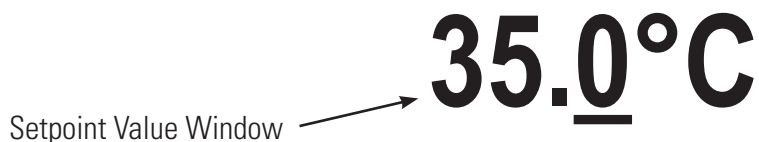

If desired, you can change the displayed setpoint value by using the navigation arrows to highlight the Setpoint Value Window and then pressing . The right-most digit will have a cursor beneath it.



Use the left and right arrows to move the cursor to the desired digit and then use the up and down arrows to change the value. Once all the desired changes are made, press  to save the change.

NOTE Using this procedure also changes the setpoint's stored value. ▲

Menu Displays

The controller uses menus to view/change the unit's settings.

NOTE The unit does not need to be running to view/change these settings. ▲

For all Menu displays, once  is pressed to change a display, you can press  to return to the previous screen.

1. Use the right arrow button to highlight **Menu** and the controller brings up the Main Menu Display.

SP1	▲ ▼	Menu
Settings		▲
System		
		▼

2. Use the up and down arrow to highlight the desired setting and then press  to bring up additional submenus.

Application Settings	▲
Display Options	
	▼
Menu	

See page 4-7.

SP1	▲ ▼	Menu
Settings		▲
System		
		▼

Messages	▲
Run Time	
Configuration	
Password/Reset	▼
Menu	

See page 4-12.

Menu

The **Menu** line, at the bottom of all the submenu displays, is another way to return the controller back to the Main Menu Display.

1. From any submenu display, use the down arrow button to highlight **Menu**.

Application Settings	▲
Display Options	
	▼
Menu	

2. Press  to return to the Main Menu Display.

SP1	▲ ▼	Menu
Settings		▲
System		
		▼

Pressing  from the Menu line returns you to the previous screen.

Menu Tree

Since the controller can only display five lines of text at a time, keep pressing the down arrow to view any additional options.

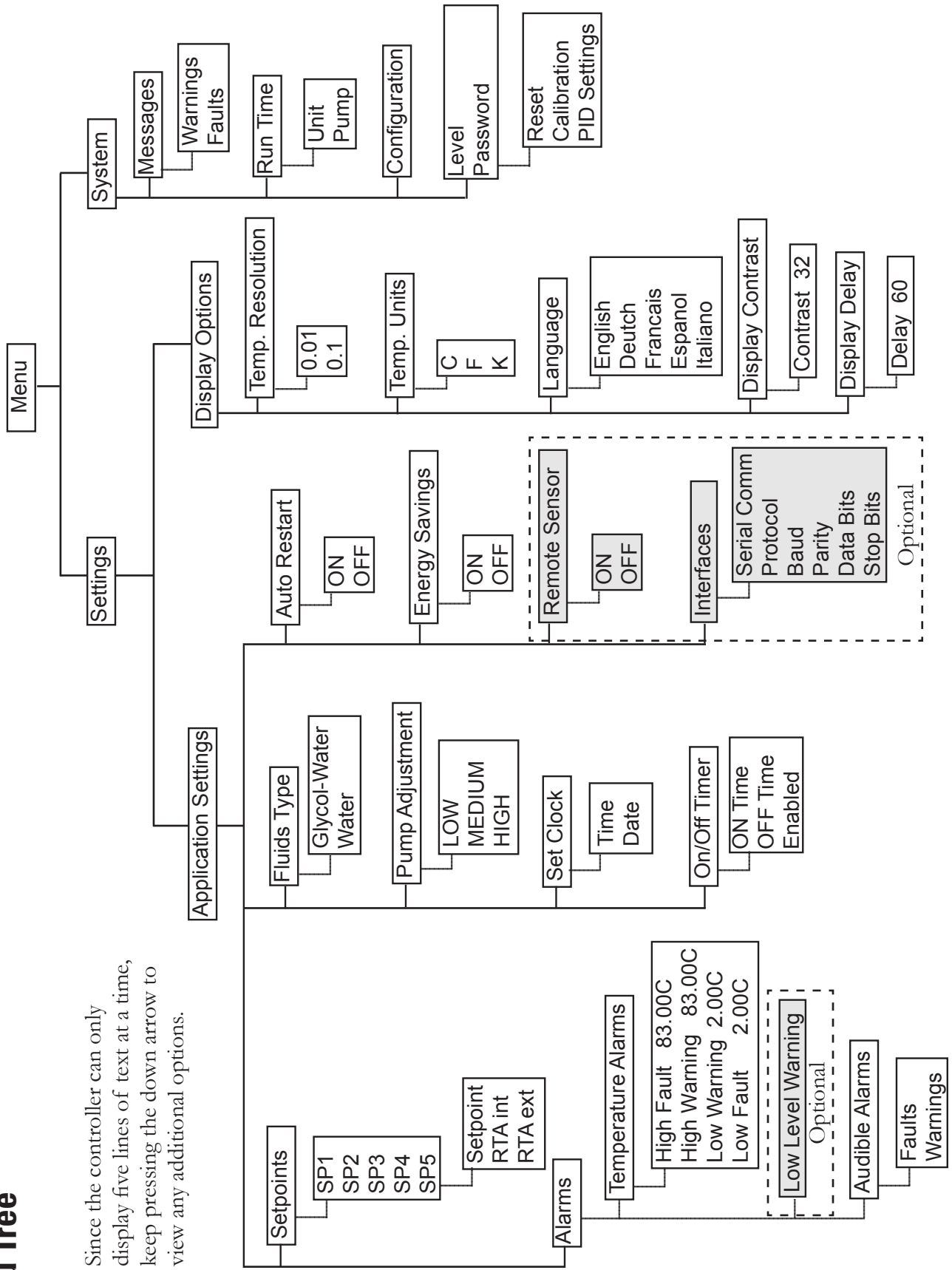

Settings - Application Settings is used to view/adjust the controller's five Setpoints and Real Temperature Adjustments (RTA) enable/disable the alarms, change the fluid type, set the pump speed, configure the interfaces (optional), set the clock, turn the timer on or off, and turn auto restart and energy savings on or off.

1. With **Application Settings** highlighted press  to view:

Setpoints	^
Alarms	
Fluid Type	
Pump Adjustment	v
Menu	

Scroll down for additional options:

Interfaces	^
Set Clock	
On/Off Timer	
Auto Restart	v
Menu	

2. With **Setpoints** highlighted, press  to display the list. Use the up/down arrows to highlight the desired **SP**. **NOTE** Use the down arrow to display **SP5**. ▲

SP1	^
SP2	
SP3	
SP4	v
Menu	

3. Press .



SP1	XX.X	^
RTA int	XX.X	
		v
Menu		

If this temperature on the Start/Status Displays does not accurately reflect the actual temperature in the reservoir, an RTA can be applied. The RTA can be set $\pm 10^{\circ}\text{C}$ ($\pm 18^{\circ}\text{F}$).

As an example, if the unit's temperature is stabilized and displaying 20°C but a calibrated reference thermometer reads 20.5°C , the RTA should be set to -0.5°C . After you enter a RTA value allow unit to stabilize before verifying the temperature in the bath. **NOTE** If display accuracy is required, we recommend repeating this procedure at various setpoint temperatures and on a regular basis. ▲

NOTE You cannot adjust the setpoint closer than 0.1°C to either of the fluid's system limits, see Fluids Type in this Section. ▲

4. With the desired line highlighted press .

The right-most digit will have a cursor beneath it. Use the left and right arrows to move the cursor to the desired digit and then use the up and down arrows to change the value. Once all the desired changes are made, press  to save the change. or  to cancel it.

35.0°C

Alarms is used to view/adjust the high and low temperature alarm limits, to enable/disable the audible alarms and to configure the optional low level warning reaction.

1. With **Alarms** highlighted, press  to display:

Temperature Alarms	^
Audible Alarms	
<input type="checkbox"/> Low Level Warning	
	v
Menu	

2. With **Temperature Alarms** highlighted, press  to display:

High Fault	83.0°C	^
High Warn	83.0°C	
Low Warn	2.0°C	
Low Fault	2.0°C	v
Menu		

3. Highlight the desired limit and press . Follow the same procedure used to change a setpoint.

If the Fault temperature is exceeded the unit will shut down and, if enabled, the audible alarm will sound. If the Warn temperature is exceeded the unit will continue to run and, if enabled, the audible alarm will sound. In both cases a message will be displayed.

High Fault cannot be set below **High Warn**.
High Warn cannot be set below **Low Warn**.
Low Fault cannot be set above **High Warn**.

Press , or use the **Menu** window, to save and return to the previous display.

1. With **Audible Alarms** highlighted, press  to display the alarms.

Highlight the desired alarm and press  to toggle between enable and disable mode.

<input checked="" type="checkbox"/> Faults	^
<input type="checkbox"/> Warnings	
	v
Menu	

1. With **Low Level** highlighted, press  to toggle the low level warning alarm on/off:

Temperature Alarms	^
Audible Alarms	
<input checked="" type="checkbox"/> Low Level Warning	
	v
Menu	

Press , or use the **Menu** window, to save and return to the previous display.

If **Faults** is enabled the alarm will sound when a fault occurs. If **Warnings** is enabled the alarm will sound when a warning occurs.

Press , or use the **Menu** window, to save and return to the previous display.

Fluids Type is used to identify the type of fluid used. The controller uses the fluid type to automatically set certain operating parameters.

1. With **Fluid Type** highlighted, press  to display the list of acceptable fluids.

Highlight the desired fluid and press  to select it.

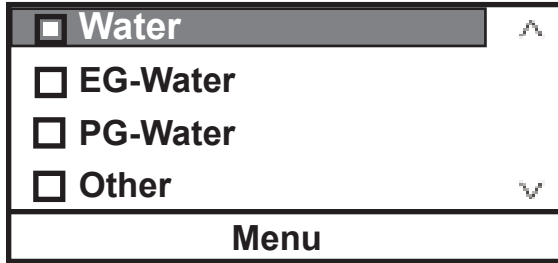

2. With the desired fluid selected press , or use the **Menu** window, to save and return to the previous display.

Pump Adjustment is used to review/set the desired pump speed.

1. With **Pump Adjustment** highlighted, press  to display the speeds.

Highlight the desired speed and press  to select it.

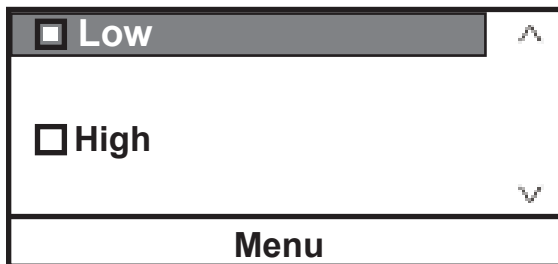

Fluid system limits **High °C** **Low °C**

For all circulators:

Water	+98	+2
EG-Water	+103	-33
PG-Water	+103	-33

For circulators 12120-01/08 12120-02/09

Other	+103	-33
--------------	------	-----

For circulators 12120-03/11 12120-04/12

Other	+103	-33
--------------	------	-----

SIL 100 +75 -30

SIL 180 +150 -30

SIL 300 +150 +80

SYNTH 60 +45 -30

SYNTH 200 +150 +30

SYNTH 260 +150 +45

For circulator 12120-13

Other +200 -90

SIL 100 +75 -75

SIL 180 +200 -40

SIL 300 +200 +80

SYNTH 60 +45 -50

SYNTH 200 +200 +30

SYNTH 260 +200 +45

NOTE The range is also limited by the bath temperature range, see Section 2. ▲

Set Clock is used to set the controller's time (hr : min : sec) and date (year - month - day).

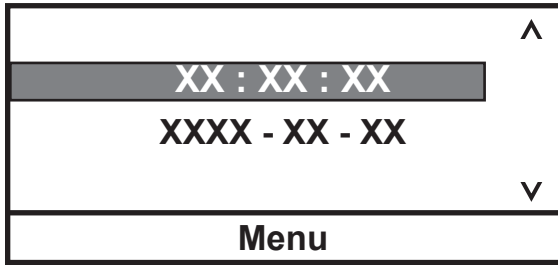

On/Off Timer is used to enable and set the controller's timer.

1. With **On/Off Timer** highlighted, press  to display the on (I) and off (O) time as well as the enable box.

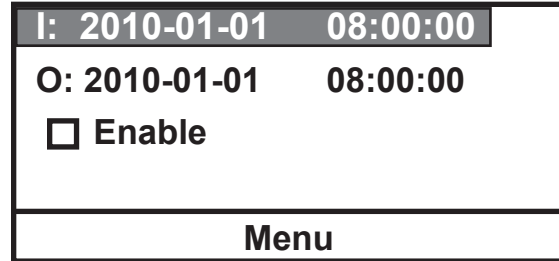

After setting the on and off times select **Enable** to activate the timer.

Auto Restart is used to enable the auto restart feature. When enabled, the unit will automatically restart after a power failure or power interruption condition.

1. With **Auto Restart** highlighted, press  to toggle between enable and disable.

Energy Saving is used to enable the energy savings mode. The Energy Saving mode is primarily designed for applications running under a stable load. Enabling the mode saves energy by reducing the unit's heater power and cooling requirements. This can result in substantial energy savings over the life of the unit. The default setting is **ON**.

1. With **Energy Saving** highlighted, press  to toggle between enable and disable.

Interfaces is used to enable/configure the optional serial communications feature.

1. With **Interfaces** highlighted, press  to display the list of parameters.

Highlight the desired parameter and press  to view the available options.

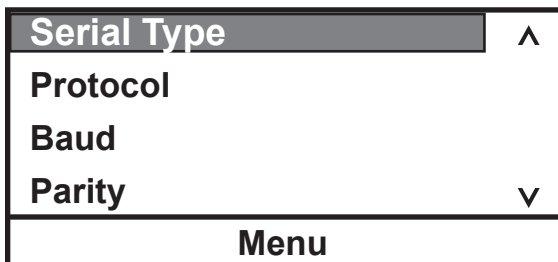

Available options:

Serial Type	USB, Off
Protocol	Standard, NC
Baud	19200, 9600, 4800, 2400, 1200, 600, 300
Parity	None, Odd, Even
Data Bits	8, 7
Stop Bits	1, 2

See the Appendix for additional information.

Settings - Display Options is used to view/adjust the controller's Temperature Units, the Temperature Resolution, the displayed Language, and the Display Contrast and Display Delay.

1. With **Temp. Unit** highlighted press . Use the up/down arrows to highlight the desired temperature scale.

Press .

<input checked="" type="checkbox"/> °C	^
<input type="checkbox"/> °F	
<input type="checkbox"/> °K	v
Menu	

2. With **Temp. Resolution** highlighted press .

Use the up/down arrows to highlight the desired resolution. Press .



<input type="checkbox"/> 0.01	^
<input checked="" type="checkbox"/> 0.1	
	v
Menu	

3. With **Language** highlighted press . Use the up/down arrows to highlight the desired language. (Scroll down for additional languages.)

Press .

<input checked="" type="checkbox"/> English	^
<input type="checkbox"/> Deutsch	
<input type="checkbox"/> Francais	
<input type="checkbox"/> Espanol	v
Menu	

4. With **Display Contrast** highlighted press .

Press  again and use the up/down arrows keys to change the contrast. With the desired contrast showing, press  again.

Contrast	32	^
		v
Menu		

NOTE Holding  for five seconds resets the display contrast to the default level and also brings up the language menu to change, if needed, the displayed language. ▲

5. With **Display Delay** highlighted press  to enable/disable it.

Use the up/down arrows to highlight the time and press  again.

Use the up/down arrows to change the value. Once the desired delay is displayed press .

<input checked="" type="checkbox"/> Delay	^
60 sec	
	v

With **Display Delay** enabled and the Start Display showing, if no arrows are pressed the Start Display will change to the Status Display after the delay expires.

System Messages is used to view any Warning or Fault messages.

1. With **Messages** highlighted, press  to display the options.

Warnings	^
Faults	
	v
Menu	

System Run Time is used to view the unit and pump operating hours.

1. With **Run Time** highlighted, press  to display the times.

Unit	xxx hours	^
Pump	xxx hours	
		v
Menu		

System Configuration is used to view the unit's configuration.

1. With **Configuration** highlighted, press  to display the settings.

Head	1
FW	XXXXXXXX.A
Checksum	XXXX
Bath	C6; 115V
FW	XXXXXXXX.A
Menu	

NOTE Non refrigerated units display **Bath Unknown.** ▲

System - Password/Reset is used only by a qualified technician. Changing the password enables controller reset options, the temperature sensor calibration procedure and displays PID values.

1. With **Password/Reset** highlighted, press  to display:

Level	User	^
Password	0	
		v
Menu		

2. Press  and change the number to **1**.

Level	User	^
Password	1	
		v
Menu		

3. Press  to display:

Level	Operator	^
Password	1	
Reset		
Calibration		v
Menu		

NOTE The controller resets to the **User** mode whenever the unit is turned off. The controller also resets to the **User** mode whenever the Start/Status Display is displayed continuously for 10 minutes. ▲

Scroll down to display **PID Tuning**.

1. If desired, highlight **Reset** and press  to display:

Reset user settings	^
Reset PID settings	
Reset both	
	v
Menu	

Highlight the desired reset option and press .

A confirmation message will appear, press  again.

1. To calibrate the temperature sensor highlight **Calibration** and press  to display:

NOTE Ensure the RTA is set to 0 before doing a calibration. ▲

Internal RTD	▲
External RTD	
	▼
Menu	

2. With the desired sensor highlighted, press  to display:

Calibrate	▲
Restore User Cal	
Save User Cal	
Restore Factory Cal	▼
Menu	

3. With **Calibrate** highlighted, press  to display:

Internal RTD	xx.x	▲
High	xx.x	
Low	xx.x	
Calibrate	SP	xx.x ▼
Menu		

4. Highlight the **SP** temperature box and enter either the desired high or low setpoint value.

Internal RTD	xx.x	▲
High	xx.x	
Low	xx.x	
Calibrate	SP	xx.x ▼
Menu		

5. Press  and enter the desired calibration temperature .

Internal RTD	xx.x	▲
High	xx.x	
Low	xx.x	
Calibrate	SP	xx.x ▼
Menu		

6. Highlight **Calibrate** and the press  to complete the procedure.

Internal RTD	xx.x	▲
High	xx.x	
Low	xx.x	
Calibrate	SP	xx.x ▼
Menu		

7. Repeat for the other calibration point.

Once the calibration is complete you can store it into the controller's memory by selecting **Save User Cal** and pressing .

You can later restore the same calibration by highlighting **Restore User Cal** and pressing .

Another option is to restore the factory calibration values by highlighting **Restore Factory Cal** and pressing .

The **Save Factory Cal** option is designed to be used only by a qualified technician.

1. With **PID Tuning** highlighted, press  to display:

Cool PID	^
Heat PID	
	v
Menu	

2. Highlight the desired PID and press  to display:

P	xx.x	^
I	x.xx	
D	x.xx	
		v
Menu		

3. If required, press  to change the value.

P	xx.<u>x</u>	^
I	x.xx	
D	x.xx	
		v
Menu		

Factory values are:



P = 05.0

I = 0.10

D = 0.00

Stopping the Unit

Ensure the stop symbol is highlighted, if not use the arrow keys to navigate to the symbol.

Press . The unit will stop and the stop symbol will turn into a start symbol ().

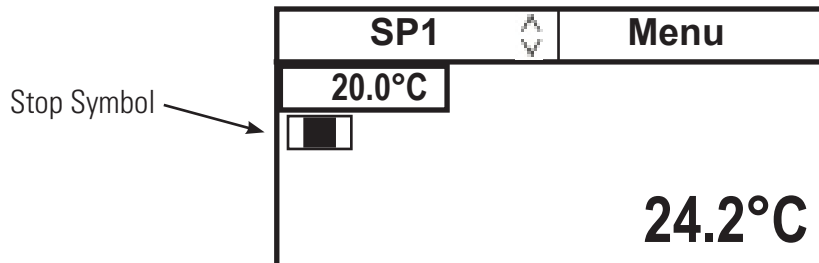

Power Down

Press . The controller's screen will go blank.

Shut Down

Place the circuit protector on the front of the unit to the  position.



Using any other means to shut the unit down can reduce the life of the compressor. ▲



Always turn the unit off and disconnect it from its supply voltage before moving the unit. ▲



The circuit protector located on the front of the unit is not intended to act as a disconnecting means. ▲

Restarting

NOTE When quickly restarting, the compressor may take up to 10 minutes before it starts to operate. ▲

Section 5 Preventive Maintenance



Disconnect the power cord prior to performing any maintenance. ▲

Handle the unit with care. Sudden jolts or drops can damage the unit's components. ▲

Cleaning

After time, the unit's stainless steel surfaces may show spots and become tarnished. Normal stainless steel cleaners can be used.

Clean the bath vessel and built-in components at least every time the bath liquid is changed. Use water and a soft cloth.



Do not use scouring powder. ▲

The inside of the bath must be kept clean in order to ensure a long service life. Substances containing acidic or alkaline substances and metal shavings should be removed quickly as they could harm the surfaces causing corrosion. If corrosion (e.g., small rust marks) should occur in spite of this, cleaning with stainless steel caustic agents has proved to be suitable. These substances should be applied according to the manufacturer's recommendations.



For cleaning the baths do not use any substances which contain solvents. ▲

Condenser Fins

In order to maintain the cooling capacity of the unit, clean the fins two to four times per year, depending on the operating environment.

Switch off the unit and unplug the power cord.

Clean the fins with compressed air.

For extreme soiling a qualified technician will need to remove the cooling compressor casing.

Testing the Safety Features

The safety features for high temperature protection and low liquid level protection must be checked at regular intervals. The frequency depends on the unit's designated application and the heat transfer fluid used.



High temperature protection

Set a cut-off temperature that is lower than the desired setpoint temperature.

Switch on the circulator and ensure the unit shuts down at the set cut-off temperature.

If the unit does not shut down have the unit checked by a qualified technician.



Acrylic unit's maximum high temperature setting should be limited to the temperature indicated on the label on the front of the bath, 80°C. ▲

Low liquid level protection

With the unit on, slowly drain the bath fluid (use a drainage tap if necessary) and ensure the unit shuts down.

If not, have the unit checked by qualified a technician.

Section 6 Troubleshooting

Error Displays

Error messages are cleared by pressing the enter key (). Once the cause of the error message is identified and corrected, to restart the unit - on units with an HTC error press the black ring surrounding the red dial - and then for all units press the enter key again. If **Auto start** is enabled the unit will restart, if disabled use the Start Up procedure.

<p>FAULT: HTC HIGH TEMP. CUTOUT- PRESS ENTER</p>
--

Error Message (Typical)

Fault Displays

The heating element, pump and, if applicable, refrigeration shut down with a fault. A fault also sounds the alarm, if enabled.

Message	Action
High Fixed Temp.	<ul style="list-style-type: none"> • unit's nonadjustable high temperature protection limit exceeded • check fluid selection • check environmental conditions
High Temperature	<ul style="list-style-type: none"> • adjustable high temperature protection limit exceeded • check limit setting • check fluid selection • ensure unit has adequate ventilation
High Temperature Refrigeration	<ul style="list-style-type: none"> • check voltage supply • the refrigeration may need servicing
HPC High Press. Cutout	<ul style="list-style-type: none"> • check for obstructions to air flow • the refrigeration may need servicing
HTC High Temp. Cutout	<ul style="list-style-type: none"> • high temperature protection limit exceeded • check limit setting • allow unit to cool down • reset HTC by pressing black ring
LLC Low Level Cutout	<ul style="list-style-type: none"> • reservoir fluid level too low for safe operation • check fluid level • check for leaks
Low Fixed Temp.	<ul style="list-style-type: none"> • unit's nonadjustable low temperature protection limit exceeded • check fluid selection

Low Temperature	<ul style="list-style-type: none"> • adjustable high temperature protection limit exceeded • check limit setting • check fluid selection
Motor Fault	<ul style="list-style-type: none"> • it can take over 10 minutes for the motor temperature to get low enough before the unit can be restarted
MOL Motor Overload	<ul style="list-style-type: none"> • allow unit to cool down
Open RTD1 Internal	<ul style="list-style-type: none"> • open internal temperature sensor
Open RTD2 External	<ul style="list-style-type: none"> • open external temperature sensor
Shorted RTD1 Internal	<ul style="list-style-type: none"> • shorted internal temperature sensor
Shorted RTD2 External	<ul style="list-style-type: none"> • shorted external temperature sensor

Warning Displays

The unit will continue to run with a warning. A warning also sounds the alarm, if enabled.

Bad Calibration	<ul style="list-style-type: none"> • redo calibration
High Temperature	<ul style="list-style-type: none"> • adjustable high temperature protection limit exceeded • check limit setting • check fluid selection
Low Level	<ul style="list-style-type: none"> • reservoir fluid level too low for safe operation • check fluid level
Low Temperature	<ul style="list-style-type: none"> • adjustable low temperature protection limit exceeded • check limit setting • check fluid selection

Checklist

Unit will not start

Check the controller for error codes, see Error Codes in this section.

Ensure the circuit protector is in the on (I) position.

Make sure supply voltage is connected and matches the unit's nameplate rating $\pm 10\%$

No display on controller

Recycle the circuit protector on the rear of the controller.

Unit will not circulate process fluid

Check the reservoir level. Fill, if necessary.

Check the application for restrictions in the cooling lines.

The pump motor overloaded. The pump's internal overtemperature overcurrent device will shut off the pump causing the flow to stop. This can be caused by low fluid, debris in system, operating unit in a high ambient temperature condition or excessively confined space. Allow time for the motor to cool down.

Make sure supply voltage matches the unit's nameplate rating $\pm 10\%$.

Inadequate temperature control

Verify the setpoint.

Make sure the condenser is free of dust and debris.

Check the fluid concentration.

Ensure unit installation complies with the site requirements in Section 3.

Make sure supply voltage matches unit nameplate rating $\pm 10\%$.

If the temperature continues to rise, make sure your application's heat load does not exceed the rated specifications.

Check for high thermal gradients (e.g., the application load is being turned on and off or rapidly changing).

Unit shuts down

Ensure  button wasn't accidentally pressed.

Ensure the circuit protector is in the on (I) position.

Check the controller for error codes.

Make sure supply voltage is connected and matches the unit's nameplate rating $\pm 10\%$.

Restart the unit.

USB Driver Not Recognized

If your operating system does not automatically recognize the optional driver log on to:

<http://www.ftdichip.com/FTDrivers.htm>

for instructions.

Appendix NC Serial Communications Protocol

NOTE This appendix assumes you have a basic understanding of communications protocols. ▲

Serial communication is accomplished either through the optional 9-pin Serial Communications Box or through the USB port on the controller. (Instructions for the box installation are at the end of this appendix.)

All data is sent and received in binary form, do not use ASCII. In the following pages the binary data is represented in hexadecimal (hex) format.

The NC Serial Communications Protocol is based on a master-slave model. The master is a host computer, while the slave is the chiller's controller. Only the master can initiate a communications transaction (half-duplex). The slave ends the transaction by responding to the master's query. The protocol uses an RS-232/RS-485 serial interface with the default parameters: 9600 baud, 8 data bits, 1 stop bit, no parity and no RS-232 handshaking. RS-485 offers a slave address selection from 1 to 100, default parameter: 1.

All commands must be entered in the exact format shown in the tables on the following pages. The tables show all commands available, their format and responses. Controller responses are either the requested data or an error message. The controller response *must* be received before the host sends the next command.

The host sends a command embedded in a single communications packet, then waits for the controller's response. If the command is not understood or the checksums do not agree, the controller responds with an error command. Otherwise, the controller responds with the requested data. If the controller fails to respond within 1 second, the host should resend the command.

NOTE All byte values are shown in hex, hex represents the binary values that must be sent to the chiller. **Do not use ASCII.** ▲

The framing of the communications packet in both directions is:

Checksum region								
Lead char CA or CC	Addr-MSB 0	Addr-LSB 1	Command	n d-bytes	d-byte 1	...	d-byte n	Checksum
Lead char	0xCA (RS-232) 0xCC (RS-485)							
Addr-msb	Device address is 1 (RS-232)							
Addr-lsb	Most significant byte of device address (RS-232: 0).							
Command	Least significant byte of device address is 1 (RS-232).							
n d-bytes	Command byte (see Table 1).							
d-byte 1	Number of data bytes to follow (00 to 03 hex).							
...	1 st data byte (the qualifier byte is considered a data byte).							
d-byte n	...							
Checksum	n th data byte.							
	Bitwise inversion of the 1 byte sum of bytes beginning with the most significant address byte and ending with the byte preceding the checksum. (To perform a bitwise inversion, "exclusive OR" the one byte sum with FF hex.)							

The master requests information by sending one of the Read Functions as shown in Table 1. Since no data is sent to the chiller during a read request, the master uses 00 for the number of data bytes following the command byte.

The chiller will respond to a Read Function by echoing the lead character, address, and command byte, followed by the requested data and checksum. When the chiller sends data, a qualifier byte is sent first, followed by a two byte signed integer (16 bit, MSB sent first). The qualifier byte indicates the precision and units of measure for the requested data as detailed in Table 2.

As an RS-232 example, the master requests to read internal temperature unit address 01 by sending:



If the temperature is -12°C, the unit would reply:

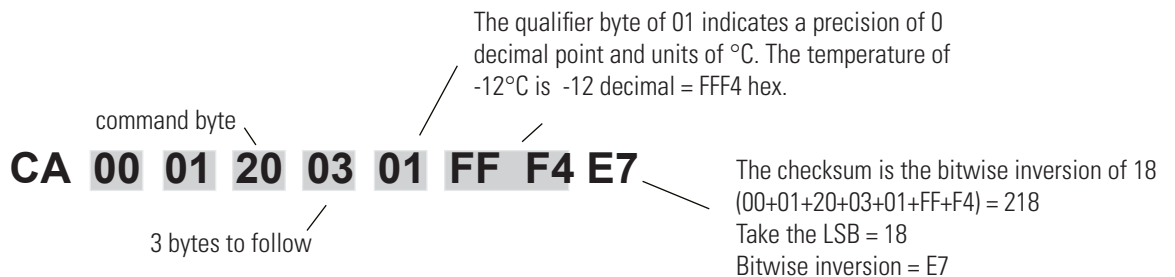

The master sets parameters in the chiller by sending one of the Set Functions as shown in Table 1. The master does not send a qualifier byte in the data field. The master should be preprogrammed to send the correct precision and units (it could also read the parameter of interest first to decode the correct precision and units needed).

As an example, if the master wants to set the setpoint to 30°C, it would send :

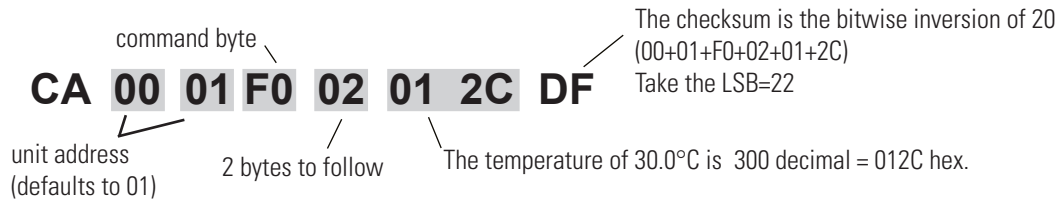

Unit responds:

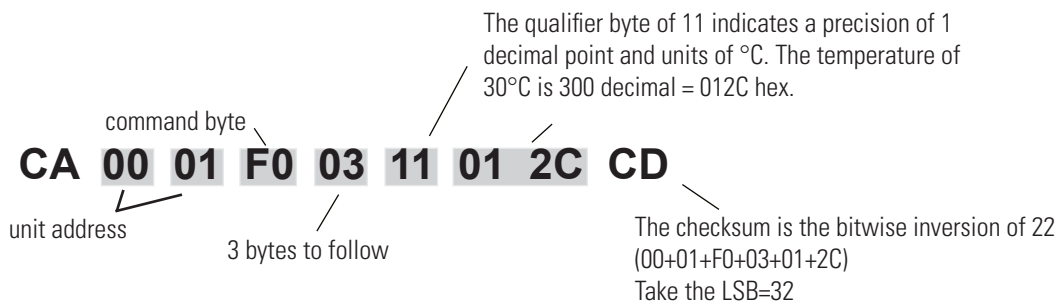

Table 1 Commands (All bytes are in hex)

FUNCTION	MASTER SENDS	UNIT RESPONDS
Read Acknowledge	CA 00 01 00 00 FE	CA 00 01 00 02(v1)(v2)(cs)
Read Status (see Table 3)	CA 00 01 09 00 F5	CA 00 01 09 02(d1)(d2)(cs)
Error	CA 00 01 0F 02(en)(ed)(cs)	CA 00 01 0F 02(en)(ed)(cs)
Read Internal Temperature (RTD1)	CA 00 01 20 00 DE	CA 00 01 20 03(qb)(d1)(d2)(cs)
Read External Temperature (RTD2)	CA 00 01 21 00 DD	CA 00 01 21 03(qb)(d1)(d2)(cs)
Read Setpoint One	CA 00 01 70 00 8E	CA 00 01 70 03(qb)(d1)(d2)(cs)
Read Low Temperature Warning	CA 00 01 40 00 BE	CA 00 01 40 03(qb)(d1)(d2)(cs)
Read Low Temperature Fault	CA 00 01 41 00 BE	CA 00 01 41 03(qb)(d1)(d2)(cs)
Read High Temperature Warning	CA 00 01 60 00 9E	CA 00 01 60 03(qb)(d1)(d2)(cs)
Read High Temperature Fault	CA 00 01 61 00 BE	CA 00 01 61 03(qb)(d1)(d2)(cs)
Read Cool Proportional Band (P)	CA 00 01 74 00 8A	CA 00 01 74 03(qb)(d1)(d2)(cs)
Read Cool Integral (I)	CA 00 01 75 00 89	CA 00 01 75 03(qb)(d1)(d2)(cs)
Read Cool Derivative (D)	CA 00 01 76 00 88	CA 00 01 76 03(qb)(d1)(d2)(cs)
Read Heat Proportional Band (P)	CA 00 01 71 00 8D	CA 00 01 71 03(qb)(d1)(d2)(cs)
Read Heat Integral (I)	CA 00 01 72 00 8C	CA 00 01 72 03(qb)(d1)(d2)(cs)
Read Heat Derivative (D)	CA 00 01 73 00 8B	CA 00 01 73 03(qb)(d1)(d2)(cs)

command bytes shown in **bold**
 qb = qualifier byte, see Table 2
 d1,d2 = 16 bit signed integer of the value being sent or received
 cs = the checksum of the string (see text)

v1, v2 = protocol version
 ed Bad command byte gets echoed
 en (error number) 01 = Bad command, 02 = Bad checksum
 xx = no valid data, include in checksum

Table 1 Commands (continued) (All bytes are in hex)

FUNCTION	MASTER SENDS	UNIT RESPONDS
Set Setpoint One*	CA 00 01 F0 02(d1)(d2)(cs)	CA 00 01 F0 03(qb)(d1)(d2)(cs)
Set Low Temp Warning	CA 00 01 C0 02(d1)(d2)(cs)	CA 00 01 C0 03(qb)(d1)(d2)(cs)
Set Low Temp Fault	CA 00 01 C1 02(d1)(d2)(cs)	CA 00 01 C1 03(qb)(d1)(d2)(cs)
Set High Temp Warning	CA 00 01 E0 02(d1)(d2)(cs)	CA 00 01 E0 03(qb)(d1)(d2)(cs)
Set High Temp Fault	CA 00 01 E1 02(d1)(d2)(cs)	CA 00 01 E1 03(qb)(d1)(d2)(cs)
Set Cool Proportional Band (P = 0.1 - 99.9)	CA 00 01 F4 02(d1)(d2)(cs)	CA 00 01 F4 03(qb)(d1)(d2)(cs)
Set Cool Integral (I = 0 - 9.99)	CA 00 01 F5 02(d1)(d2)(cs)	CA 00 01 F5 03(qb)(d1)(d2)(cs)
Set Cool Derivative (D = 0 - 5.0)	CA 00 01 F6 02(d1)(d2)(cs)	CA 00 01 F6 03(qb)(d1)(d2)(cs)
Set Heat Proportional Band (P = 0.1 - 99.9)	CA 00 01 F1 02(d1)(d2)(cs)	CA 00 01 F1 03(qb)(d1)(d2)(cs)
Set Heat Integral (I = 0 - 9.99)	CA 00 01 F2 02(d1)(d2)(cs)	CA 00 01 F2 03(qb)(d1)(d2)(cs)
Set Heat Derivative (D = 0 - 5.0)	CA 00 01 F3 02(d1)(d2)(cs)	CA 00 01 F3 03(qb)(d1)(d2)(cs)
Set On/Off Array		

The Set On/Off Array command is used to set and/or request unit settings. The master can send the array with a value of 0 (turn off/disable), 1 (turn on/enable), or 2 (do not change). 0 or 1 causes the unit to change the setting, 2 only requests the state of a setting. The slave returns values of 0 (off/disabled) or 1 (on/enabled).

(SW Version 02950.1A-E)	CA 00 01 81 01(d1)(cs)	CA 00 01 81 01(d1)(cs)
Sample - turn unit on	CA 00 01 81 01 01 7B	

* = limited to the range of the chiller
command bytes shown in **bold**

qb = qualifier byte, see Table 2

d1,d2 = 16 bit signed integer of the value being sent or received

cs = the checksum of the string (see text)

**d1 - unit off = 0, on = 1

d2 - external sensor disabled = 0, enabled = 1

d3 - fault mode disabled = 0, enabled = 1

d4 - tenths display disabled = 0, enabled = 1

d5 - Alarms on internal = 0, or external sensor = 1, (1 is invalid when d2 = 0, external sensor disabled)

Table 2**QUALIFIER BYTE**

00	0 precision, no units of measure
01	0 precision, °C
10	1 precision, no units of measure
11	1 precision, °C
20	2 precision, no units of measure

Example: The temperature of 45.6°C would be represented by the qualifier 11 hex, followed by the 2 bytes 01 C8 hex (456 decimal).

Table 3 READ STATUS

BIT	d1	d2
b.7	Low Temp Fault	
b.6	High Temp Fault	HTC Fault
b.5	Low Temp Warning	MOL Fault
b.4	High Temp Warning	Pump Speed Fault
b.3	RTD2 Open/Short	High RA Temp
b.2	RDT1 Open/Short	HPC Fault
b.1	Unit Faulted	Low Level Fault/Warning
b.0	Unit Running	High Level Fault/Warning

	Unit of Measure
Index	Unit
0	NONE
1	Temperature in °C
2	Temperature in °F
3	Flow liters per minute
4	Flow in gallons per minute
5	Time in seconds
6	Pressure in PSI
7	Pressure in bars
8	Resistivity in MΩ-cm
9	%
10	Volts
11	Pressure in kPa

Optional Serial Communications Adapter

Tools required:

- None

Procedure:



Turn off the unit before installing the adapter. ▲

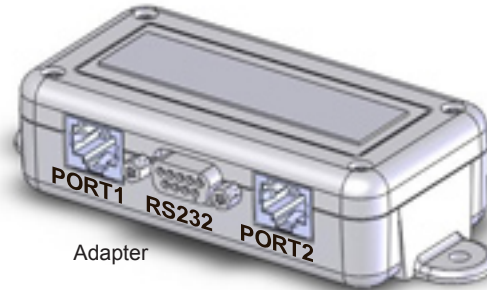

Adapter



Pin #	Function
1	No connection
2	TX
3	RX
4	No connection
5	GND = Signal ground
6 - 9	No connection

Pin #	Function
1-7	No connection
8	T+
9	T-

TX = Transmitted data from thermostat
 RX = Received data to thermostat.

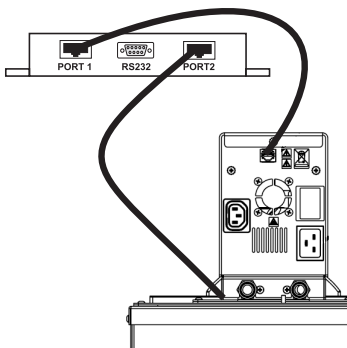

1. If the unit already has a communication cable installed, remove the cable from the rear of the immersion circulator and plug that cable into PORT 2 on the adapter.
2. Plug the supplied cable into PORT 1 on the adapter and the other end into the circulator. Regardless of the configuration, the supplied cable *always* goes from the circulator to PORT 1.
3. Plug the supplied serial communications cable into the communication port on the adapter and then the other end into your computer.
4. If desired, use the supplied Velcro[®] tape to attach the adapter to a convenient location on the unit.

DECLARATION OF CONFORMITY

Manufacturer: Cole Parmer
Address: 625 East Bunker Court
Vernon Hills, IL 60061



Year of inception 2011

We declare that the following products conform to the Directives and Standards listed below.

Products: Polystat refrigerated and heated liquid baths, non refrigerated heated liquid baths and immersion liquid circulators.

Refrigerated and non refrigerated heated liquid baths:

Models: C6, C6F, C15 and C15++, W7, W11, W24, W5P, W14P, W21P, W6A, W12A, W19A,.
All with control head models 1H, 2H & 3H.

Immersion circulators:

Models: 1BR, 2BR, 3BR, 1CL and 2CL.

All models rated :

1. 115 Volts, 60 Hz or
2. 230 Volts, 50 Hz

Equipment Class:

Measurement, control and laboratory.

Directives and Standards:

2004/108/EC – Electromagnetic Compatibility (EMC Directive):

EN 61326-1: 2006 – Electrical equipment for measurement, control, and laboratory use – EMC Requirements - EMC Class A.

2006/95/EC – Low Voltage Directive (LVD):

EN 61010-1: 2001 – Safety requirements for electrical equipment for measurement, control, and laboratory use – General Requirements.

EN 61010-2-010: 2003 – Safety requirements for electrical equipment for measurement, control, and laboratory use – Part 2-010: Particular requirements for laboratory equipment for the heating of materials.

Manufacturer's Authorized Representative:

Date:

A handwritten signature in black ink, appearing to read 'Mark Sinclair', is written over a horizontal line.

Mark Sinclair
R & D Manager

29 June 2011

RoHS DECLARATION OF CONFORMITY

Manufacturer: Cole Parmer

Address: 625 East Bunker Court
Vernon Hills, IL 60061

Products: Standard Polystat refrigerated and non refrigerated heated liquid baths, models: C6, C6F, C15 and C15++, W7, W11, W24, W5P, W14P, W21P, W6A, W12A, W19A, all with control head models 1H or 2H or 3H.

Polystat immersion circulator models: 1BR, 2BR, 3BR, 1CL and 2CL.

Cole Parmer certifies that the above Polystat models meet the requirements of DIRECTIVE 2002/95/EC, Restriction of Hazardous Substances Directive (RoHS). Cole Parmer certifies that these Polystat models contain less than the following indicated amounts of the six RoHS banned substances with the exemption stated in Note 2 below:

Substance		Threshold Level
Lead...	Pb	Less than 0.1% ^{1 & 2}
Mercury...	Hg	Less than 0.1% ¹
Hexavalent Chromium ...	Cr (VI)	Less than 0.1% ¹
Polybrominated Biphenyls ...	PBB	Less than 0.1% ¹
Polybrominated Diphenyl Ethers ...	PBDE	Less than 0.1% ¹
Cadmium ...	Cd	Less than 0.01% ¹
Notes: 1. Tolerated maximum concentration value by weight in homogeneous materials. 2. Exemptions - Lead as an alloying element in steel containing up to 0.35% lead by weight, aluminum containing up to 0.4% lead by weight and as a copper alloy containing up to 4% lead by weight.		

Manufacturer's Authorized Representative:

Date:



Mark Sinclair
R & D Manager

29 June 2011