

Owner's booklet.

Here's everything
you'll need to know.

ONETOUCH
((ping))

Glucose Management System



Welcome

Congratulations. You have chosen one of the most advanced diabetes management systems available today. Your OneTouch® Ping® Glucose Management System will play an integral part in the blood glucose management and continuous insulin delivery regimen that you have established with your health care professional.

Your OneTouch® Ping® System combines the functionality of a OneTouch® Ping® Insulin Pump and a OneTouch® Ping® Meter Remote through radio frequency (RF) communication. Both devices will work independently of one another, but using them together can provide you with options to help make insulin delivery more discreet and flexible.

Your OneTouch® Ping® Insulin Pump uses advanced technology, providing continuous insulin delivery to help maintain your blood glucose targets as recommended by your health care professional. It delivers insulin in two ways: 1) continuous “basal” insulin delivery and 2) “bolus” insulin delivery to cover foods eaten and/or reduce a high blood glucose level.

Your OneTouch® Ping® Meter Remote combines the accuracy expected from OneTouch® products with features designed to make testing and tracking more convenient. These include a meter remote memory that serves as an electronic logbook for storing all your glucose test results along with other diabetes-related health records. Another new feature is a Food Database which can be easily accessed on your meter remote. The Food Database helps take the guesswork out of carb counting.

When the devices are used together, your OneTouch® Ping® Meter Remote gives you convenient remote access to insulin delivery functions available with the OneTouch® Ping® Insulin Pump. Your OneTouch® Ping® System also allows your most recent blood glucose results from the OneTouch® Ping® Meter Remote to be automatically entered into bolus insulin calculations to cover carbohydrates in food or to correct for a high blood glucose level.

This Owner's Booklet is designed to provide the information that you are looking for, when you need it. We hope you keep it handy.

Of course you may still have questions. If you do, our customer service representatives will be happy to answer your call. You can reach them at Customer Service at 1 877 937-7867. You can also obtain information at www.animas.com.

TABLE OF CONTENTS

BEFORE YOU BEGIN	I
------------------------	---

SECTION I ONETOUCH® PING® INSULIN PUMP

CHAPTER 1 - Important information	1
CHAPTER 2 - Explanation of symbols	15
CHAPTER 3 - Introduction to your Onetouch® Ping® Insulin Pump	16
CHAPTER 4 - Getting your pump ready	23
CHAPTER 5 - Using the Normal Bolus feature	38
CHAPTER 6 - Using Basal Program features	40
CHAPTER 7 - Suspend/Resume feature	50
CHAPTER 8 - History feature	52
CHAPTER 9 - Status feature	59
CHAPTER 10 - Advanced features/Setup and activation	63
CHAPTER 11 - Using Advanced features	78
CHAPTER 12 - Care and maintenance	96
CHAPTER 13 - Safety system and alarms	98
CHAPTER 14 - Troubleshooting guidelines	119
CHAPTER 15 - Sick day guidelines	128
CHAPTER 16 - Lifestyle issues	130
CHAPTER 17 - My information	133
CHAPTER 18 - Warranty and other technical information	140

SECTION II ONETOUCH® PING® METER REMOTE

CHAPTER 1 - Setting up your OneTouch® Ping® Meter Remote.....	155
CHAPTER 2 - Setting up and using the Food Database	180
CHAPTER 3 - Estimating bolus insulin amounts with the bolus calculator.....	183
CHAPTER 4 - Testing your blood glucose	184
CHAPTER 5 - Adding comments to glucose test results	203
CHAPTER 6 - Making logbook entries	208
CHAPTER 7 - FastFacts® / Using your meter remote logbook.....	215
CHAPTER 8 - Control solution testing.....	228
CHAPTER 9 - Caring for your meter remote and test strips	233
CHAPTER 10 - Understanding meter remote error and other messages.....	237
CHAPTER 11 - Detailed information about your meter remote and test strips.....	243

SECTION III ONETOUCH® PING® SYSTEM / USING YOUR ONETOUCH® PING® METER REMOTE AND ONETOUCH® PING® INSULIN PUMP TOGETHER

CHAPTER 1 - Overview of your OneTouch® Ping® System	251
CHAPTER 2 - Establishing communication between your meter remote and your insulin pump.....	252
CHAPTER 3 - Pump Home and Meter Home screens on your meter remote.....	269
CHAPTER 4 - Insulin delivery functions on your meter remote	271
CHAPTER 5 - Checking the status of your OneTouch® Ping® System	289
CHAPTER 6 - Troubleshooting your OneTouch® Ping® System	292
CHAPTER 7 - OneTouch® Ping® System Communication Technical Specifications.....	309
Appendix A: Glossary	319
Index.....	323

BEFORE YOU BEGIN



Do Not attempt to connect to your pump before you have been trained on your pump, or until you have watched the training video. Check with your health care professional regarding your individual training needs.

As part of your training, your health care professional will assist you in making the appropriate selections for your insulin pump and meter remote settings. Your insulin pump must be programmed for your own personal use. Your insulin pump settings impact the calculations for insulin delivery using either your meter remote or insulin pump. Be comfortable with using your insulin pump before you activate the RF feature on your insulin pump and meter remote. See the appropriate chapters in *Section I*, for the steps on setting up and using your insulin pump.

The following insulins have been tested by the pump manufacturer and found to be safe for use in the insulin cartridge of the pump: Humalog® and Novolog®. Before using a different insulin with this pump, check the insulin drug label to make sure it can be used with the pump.

Many people also find it helpful to practice the blood glucose test process with control solution before testing with blood for the first time. See *Chapter 8* in *Section II*.

For best results the use of your insulin pump, or your meter remote to access pump functions, is recommended for people with diabetes who:

- Test their blood glucose levels four to six times per day or as recommended by their health care team.
- Demonstrate adequate carbohydrate counting skills.
- Maintain good diabetes self-care skills.
- See their health care professional regularly.
- Have adequate vision and hearing to recognize the pump alerts.

II : BEFORE YOU BEGIN

You should carefully read this Owner's Booklet and any inserts that come with your OneTouch® Ping® System. These include inserts for:

- OneTouch® Ultra® Test Strips
- OneTouch® Ultra® Control Solution

While reading this Owner's Booklet, please note the following:

- Display screens throughout the Owner's Booklet are examples only. They should not be considered suggestions for individual programming and may not be representative of current health states.
- "Blood Glucose" is often abbreviated as BG in both instructional copy as well as in example display screens.
- Your OneTouch® Ping® Insulin Pump will often be referred to as simply "your pump". Similarly, your OneTouch® Ping® Meter Remote will often be referred to as "your meter remote". "The devices" will often be used when referring to both the OneTouch® Ping® Insulin Pump and OneTouch® Ping® Meter Remote.

Take special note of Warnings and Cautions throughout this Owner's Booklet, which are identified with .

Intended use

Your OneTouch® Ping® Glucose Management System is indicated for the treatment of insulin-requiring diabetes and for the quantitative measurement of glucose in fresh capillary whole blood.

Your OneTouch® Ping® Insulin Pump is indicated for continuous subcutaneous infusion of insulin for the treatment of insulin-requiring diabetes.

Your OneTouch® Ping® Meter Remote Glucose Monitoring System is intended to be used for the quantitative measurement of glucose in fresh capillary whole blood. When used together with the OneTouch® Ping® Insulin Pump, it also functions as a wireless (RF) remote control to deliver insulin from the pump. Your OneTouch® Ping® Meter Remote Glucose Monitoring System is intended for use for self-testing outside the body (*in vitro* diagnostic use) by people with diabetes at home and by health care professionals in a clinical setting as an aid to monitor the effectiveness of diabetes control. Your OneTouch® Ping® Meter Remote Glucose Monitoring System is specifically indicated for use on the finger, forearm or palm. It should not be used for the diagnosis of diabetes or testing of newborns.

About radio frequency (RF) communication

Your meter remote and pump have built-in RF capability. RF is a type of wireless communication. Cell phones use RF technology, as do many other devices. RF is how your meter remote and pump communicate and share data.

The RF feature on your meter remote and pump will be deactivated when you first receive them. In order to begin using your meter remote and pump together as a system, RF must be activated on both devices and they must be paired (synchronized). Activating RF opens a line of communication on both devices and pairing ensures communication will take place only between one meter remote and one pump.

RF communication between your meter remote and pump will work up to a distance of about 10 feet (3.0 meters) and will transmit through clothing. Direct line of sight is not required for RF communication. As long as you have a good RF signal and are within range, you can use your meter remote to access pump functions.

IV : BEFORE YOU BEGIN

When conditions or distance cause RF communication to be lost or interrupted, you will not be able to use your meter remote to access pump functions. This also means that data transfer between the two devices will stop temporarily. As soon as the problem is resolved, RF communication will resume. Any status records stored in your pump during the RF interruption will then be sent to your meter remote.

Your meter remote and pump are subject to and comply with U.S. Federal regulations, Part 15 of the Federal Communications Commission (FCC) Rules regarding devices with RF capability. From these regulations, the two conditions of operation specific to your device are given in the following FCC required statement:

This device complies with Part 15 of the FCC Rules. Operation is subject to the following two conditions: 1) this device may not cause harmful interference, and 2) this device must accept any interference received, including interference that may cause undesired operation.

Compliance with these guidelines means that under normal day-to-day circumstances your OneTouch® Ping® System should not affect the operation of other devices. Additionally, your OneTouch® Ping® System should operate normally in the presence of other devices in a normal household environment.

In the event there is interference from another device, it is recommended that you increase distance between your system and that device, or turn off the interfering device. Alternatively, you may turn off RF communication between the meter remote and pump and perform insulin delivery functions directly from your pump (see *Chapter 2* in *Section III*).

Changes or modifications not expressly approved by the manufacturer (Animas® Corporation) could void the user's authority to operate the equipment.



There are environments where it is recommended that you not use the RF communication feature linking your meter remote and pump. When you are in radiology and MRI departments and around radiology equipment, it is recommended you first deactivate the RF communication feature on both your meter remote and your pump. **Then you must remove both devices and leave them outside the MRI room. Any metal needle infusion sets should also be removed and left outside the MRI room.**

Likewise, during air travel your airline may have specific restrictions about using your System with RF communication activated. It is recommended that you deactivate the RF feature on your pump and meter remote during flights, or check with your airline's RF restrictions when making your travel plans. To learn more about deactivating the RF feature on your pump and meter remote, see *Chapter 2* in *Section III*.

Your pump has additional environmental restrictions. See *Chapter 1* in *Section I*, for recommendations regarding the use of pumps in the presence of radiology equipment.

Using your meter remote and pump together as a system

Once you have established communication between your meter remote and pump, you can access certain pump functions directly from your meter remote. These include delivering a bolus, monitoring pump status, and confirming many pump alarms and warnings.

Your pump has its own set of display screens and buttons to provide stand-alone insulin delivery without the use of your meter remote. Some of the buttons work the same way as the buttons on your meter remote. One example is the  button on your pump. Like the  button on your meter remote, the  button on your pump is used to confirm entries. Be sure you know how the buttons work on both your pump and meter remote before you begin using the devices together as a system.

When you use your meter remote to access pump functions, your meter remote display screens will closely resemble your pump display screens.

OneTouch® Ping® System Carton Contents

Your OneTouch® Ping® System carton includes your insulin pump, your meter remote, and other accessories you will need to begin using both devices. Your meter remote and BG testing supplies are included within a separate kit within the carton. Check the contents of your carton to make sure all items are included. If any items are missing call Customer Service at 1 877 937-7867.

Your OneTouch® Ping® System carton includes:

- The OneTouch® Ping® Insulin Pump and pump accessories:

- a. OneTouch® Ping® Insulin Pump
- b. One Energizer® Lithium L91 AA battery (1.5V) for your pump
- c. Low Profile Clip
- d. Owner's Booklet*

* Not pictured above



- The OneTouch® Ping® Meter Remote kit which includes:

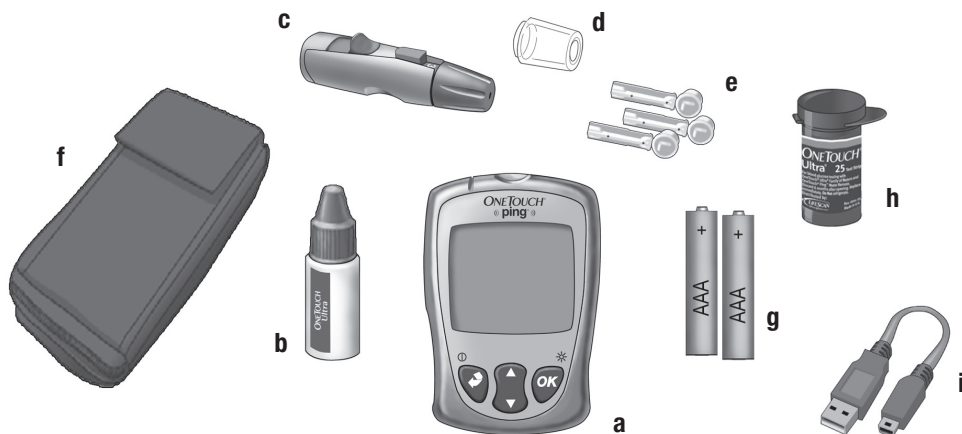

- a.** OneTouch® Ping® Meter Remote
- b.** OneTouch® Ultra® Control Solution
- c.** OneTouch® Lancing Device
If another type of lancing device is included, see the separate instructions for that lancing device.
- d.** OneTouch® AST™ Clear Cap
- e.** OneTouch® UltraSoft® Sterile Lancets
- f.** Carrying Case

- g.** Two 1.5V AAA Alkaline Batteries* (batteries included but not installed)
- h.** OneTouch® Ultra® Test Strips
- i.** USB Cable

A warranty card for your meter remote is also included.

** See Chapter 9 in Section II, for important information on the correct way to install the batteries in your meter remote.*

⚠ WARNING: Keep the pump, meter remote, and accessories away from young children. Small items such as the battery door, batteries, battery cap, clip, test strips, lancets, protective disks on the lancets, and control solution vial cap are choking hazards.

Supply Reordering

You can place orders for cartridges, infusion sets, skin prep, test strips, batteries and many meter remote and pump accessories by calling our Reorder Department or by visiting our eStore at <https://estore.animascorp.com/>. In the United States and Puerto Rico, you may also call 1 877 937-7867.

Emergency Kit

Keep an emergency kit with you at all times to make sure you always have necessary supplies. This kit should include but is not limited to:

- Quick-acting glucose tablets or gel
- BG monitoring supplies including meter, test strips, lancing device, lancets, meter remote batteries (2 AAA alkaline)
- Blood or urine ketone testing supplies
- Rapid-acting and other insulin as recommended by your health care team
- Extra infusion sets and Animas® 2.0mL Cartridges (200 unit/2ml)
- Dressing and adhesive, if used
- An extra Energizer® Lithium L91 AA battery for your pump
- An extra pump battery cap

- An extra pump cartridge cap (In the U.S. and Puerto Rico, call 1 877 937-7867 to order an extra cartridge cap. All other customers contact your local Animas® distributor.)
- Glucagon Emergency Kit®
- Emergency contact phone numbers

Be sure to inform a family member, co-worker and/or friend where this emergency kit is kept.

X ⋮ BEFORE YOU BEGIN

Section I

OneTouch® Ping® Insulin Pump

Welcome

You have begun a new way of life with your OneTouch® Ping® Insulin Pump.

Your choice of pump therapy is a sign that you are committed to taking excellent care of yourself. Your pump has been specially designed to help you manage your diabetes, using advanced technology and sophisticated safety systems.

Your pump is used for insulin therapy to help maintain your blood glucose (BG) targets as recommended by your health care team. You program it to deliver two ways: a continuous, 24-hour “basal” rate and “bolus” insulin deliveries to accommodate for immediate doses to cover foods eaten and high BG. It is important to remember that successful pump therapy is a partnership of advanced technology and responsible self-care.

Please take a moment to look at the back of your pump and write down the serial number.

My pump serial number/SN is: _____



Technical Assistance

Animas Customer Service is available 24 hours a day. Our representatives are trained on the operation and set up of our products and are able to provide technical assistance or answer your product related questions. In the United States and Puerto Rico, call 1 877 937-7867. When calling, please have your pump and serial number available. The serial number is located on the back of the pump. For non-urgent technical questions, please email customersupport@anmus.jnj.com.

Important Note

Do Not Remove the New Factory-Installed Plastic Display Lens Protection Film.

Your pump now comes with a new factory-installed transparent plastic lens protection film covering the display lens. This protective film is highly durable and is designed to protect your pump display lens from incidental damage. **Please do not attempt to remove this film. This protective film must remain in place at all times to fully protect your pump display lens from scratches and other cosmetic damage.** This film will not protect your pump display lens from extreme abuse.

Should the pre-installed lens protection film become damaged or separate from the display, the film should be replaced. Replacement films are available through the following source:

In the United States and Puerto Rico, call Animas® at 1 877 YES-PUMP (1 877 937-7867) and press 2 for Reorders.

Please note that the OneTouch® Ping® Insulin Pump limited warranty does not cover damage resulting from normal wear and tear, accidents, negligence or misuse, and abuse, including scratched display lenses. We urge you to protect your pump screen from damage and use a lens protection film at all times.

Do Not Adjust the Pump Time and/or Date on February 29, 2016 (Leap Day/Leap Year).

If you make changes to the time and/or date of your OneTouch® Ping® Insulin Pump on February 29, 2016, the changes will not be saved in the pump.

You may feel you have to change the time and/or date of your pump on this particular date because:

- You are starting your pump for the first time on that day.
- You are re-starting your pump on that day after the battery power has been depleted for more than 24 hours.
- You are traveling across time zones on that day.

If this is the case, wait until the next day (March 1, 2016) to change the time and/or date so that your changes will be saved in your pump.

If you do not make any changes to the time or date on your pump on February 29, 2016, your pump will recognize that day as a valid date and operate as expected to deliver insulin and record insulin usage.

You will not experience this issue on any other Leap Day/Leap Year.

This section of the Owner's Booklet contains information about how to use, program and maintain your new pump. It is important to read it carefully.

Even if you are an experienced pumper, keep your Owner's Booklet handy for reference. Warnings, cautions and safety tips are found throughout this Owner's Booklet, indicated by a  symbol.

 **WARNING:**

- **Do Not** attempt to connect to your pump before you have been trained on your pump or unless your certified OneTouch® Ping® Insulin Pump trainer is present.
- Incorrect use of your pump, failure to follow the instructions in this Owner's Booklet or improper/inadequate self-care and troubleshooting techniques can lead to death or serious injury. If you do not understand something or have questions, ask your health care team or call our Customer Service representatives at 1 877 937-7867.
- Your pump is designed to deliver insulin reliably, but because your pump uses only rapid-acting insulin, you will not have long-acting insulin in your body. To avoid the risk of diabetic ketoacidosis (DKA) or very high BG, you must be prepared to give yourself an injection of insulin if delivery is interrupted for any reason.
- Your pump is designed and calibrated to deliver U100 insulin. Use of any insulin with lesser or greater concentration can result in serious injury or death.

 **WARNING:**

- Never start the Prime/Rewind sequence on your pump while the infusion set is connected to your body. The Prime/Rewind sequence includes steps for rewinding the pump motor, loading an insulin cartridge and tightening the cartridge cap, and priming the infusion set tubing. Failure to disconnect your infusion set from your body before performing these steps can result in over delivery of insulin, and possible injury or death. If your pump sustains internal damage, the amount of unintended insulin delivery could be significant. This could result in serious injury or death from hypoglycemia.
- The end of operational life of your pump is December 31, 2022.

Warnings and Precautions

Radiology Equipment

Your pump has been designed to operate in the presence of common sources of electrostatic and electromagnetic interference, such as store security systems. However, like all portable electronic devices, your pump should not be exposed to very strong electromagnetic fields, such as in MRI's, RF welders or magnets used to lift automobiles. Very strong magnetic fields, such as in an MRI, can re-magnetize the portion of the motor that regulates insulin delivery. **If you plan to undergo an MRI, remove your pump beforehand and keep it outside the room during the procedure.**

Medical Procedures and Equipment

Procedure	Patient is Pumper	Health Care Professional/ Technician is Pumper
Pacemaker/Automatic Implantable Cardioverter-Defibrillator (AICD)	<ul style="list-style-type: none"> • Disconnect pump and leave outside room during insertion of device and reprogramming. • Infusion set can remain in place. 	<ul style="list-style-type: none"> • Follow normal safety practices and proceed to the designated safe area while each X-ray is taken and during reprogramming.
EKG	<ul style="list-style-type: none"> • No need to disconnect. 	<ul style="list-style-type: none"> • No need to disconnect.
Cardiac Catheterization	<ul style="list-style-type: none"> • Disconnect pump and leave outside room during procedure. 	<ul style="list-style-type: none"> • Follow normal safety practices and proceed to the designated safe area while each X-ray is taken.
Nuclear Stress Test	<ul style="list-style-type: none"> • Disconnect pump and leave outside room during scan. • Can remain connected during injection of radioisotope. 	<ul style="list-style-type: none"> • Follow normal safety practices and proceed to the designated safe area while each X-ray is taken.

For procedures not included above or on the chart on the following pages, call **(in advance of your procedure)** 1 877 937-7867 in the U.S. and Puerto Rico.

Medical Procedures and Equipment

Procedure	Patient is Pumper	Health Care Professional/ Technician is Pumper
Colonoscopy	<ul style="list-style-type: none"> • No need to disconnect. 	<ul style="list-style-type: none"> • No need to disconnect.
Laser Surgery	<ul style="list-style-type: none"> • Pump and infusion set can be worn; however some lasers can create interference and cause pump to alarm. 	<ul style="list-style-type: none"> • Pump and infusion set can be worn; however some lasers can create interference and cause pump to alarm.
General Anesthesia	<ul style="list-style-type: none"> • Determination based on what medical equipment is being used in the procedure. 	<ul style="list-style-type: none"> • Determination based on what medical equipment is being used in the procedure.
Dental X-Rays	<ul style="list-style-type: none"> • No need to disconnect. • Pump should remain covered by lead apron placed on the patient by the dentist or technician. 	<ul style="list-style-type: none"> • No need to disconnect. • Follow normal X-ray safety practices and proceed to the designated safe area when each X-ray is taken.
Ultrasound	<ul style="list-style-type: none"> • No need to disconnect. • Transducer should not be pointed directly at pump or site. If site is directly in range of transducer, site should be removed. 	<ul style="list-style-type: none"> • No need to disconnect. • Transducer should not be pointed directly at pump or site.

Medical Procedures and Equipment

Procedure	Patient is Pumper	Health Care Professional/ Technician is Pumper
Mammogram and Bone Density Test	<ul style="list-style-type: none"> • Do Not expose pump to test. • Disconnect pump prior to test and leave pump in locked dressing room. • Infusion set can remain in place during test. 	<ul style="list-style-type: none"> • No need to disconnect. • Follow normal safety practices and proceed to the designated safe area while each test is being performed.
Body X-Rays, Fluoroscopy (chest, neck, abdomen, torso, etc.)	<ul style="list-style-type: none"> • Do Not expose pump to X-ray beam. • Disconnect pump prior to exam and leave pump in locked dressing room. • Infusion set can remain in place during X-ray. 	<ul style="list-style-type: none"> • No need to disconnect. • Follow normal X-ray safety practices and proceed to the designated safe area when each X-ray is taken.
Therapeutic Radiation/Oncology (cancer treatment radiation)	<ul style="list-style-type: none"> • Do Not expose pump to radiation treatment. • Disconnect pump prior to radiation treatment and leave pump in locked dressing room. • If the infusion set doesn't interfere with the area being treated, the set can remain in place during radiation. 	<ul style="list-style-type: none"> • No need to disconnect. • Follow normal radio-protection practices and proceed to the designated safe area while the patient is undergoing treatment.

Medical Procedures and Equipment

Procedure	Patient is Pumper	Health Care Professional/ Technician is Pumper
CT Scans and MRI's (Magnetic Resonance imaging)	<ul style="list-style-type: none"> • Do Not bring pump into the exam room at any time. • Disconnect pump and metal needle infusion set prior to exam and leave in a locked dressing room. • Soft cannula infusion sets can remain in place. • If pump is accidentally allowed in the exam room disconnect pump immediately and contact Customer Service for instructions. 	<ul style="list-style-type: none"> • MRI: Do Not bring pump into the same room as the MRI machine at any time. • If pump is accidentally allowed in the MRI room disconnect pump immediately and contact Customer Service for instructions. • CT Scan: No need to disconnect. • Follow normal CT Scan safety practices and proceed to the designated safe area when each Scan is performed.
Electro-cautery surgery	<ul style="list-style-type: none"> • Disconnect from pump during surgery. • Disconnect prior to surgery and leave pump in locked dressing room. • If the infusion set doesn't interfere with the area being treated, the set can remain in place during surgery. 	<ul style="list-style-type: none"> • No need to disconnect.

When in doubt, disconnect and leave pump in locked dressing room. Follow usual instructions for bolusing to cover any missed basal insulin when you reconnect.

⚠ Amusement Parks

Very powerful electromagnets are sometimes used on “free-fall” amusement park rides. **Pumps should be removed and not taken on these “free-fall” types of rides.**

High gravity forces can be experienced when riding on some roller-coasters. It is recommended that you disconnect (NOT suspend) your pump while on roller-coaster rides.

⚠ Aircraft without Cabin Pressurization

If flying in aircraft without cabin pressurization or flying in aircraft used for aerobatics or combat simulation (pressurized or not), it is recommended that you disconnect (NOT suspend) pump.

Precautions

- Your pump is a sealed device that should be opened **ONLY** by the manufacturer. If your pump seal is broken by anyone other than an authorized Animas® factory technician, the warranty is voided and your pump is no longer waterproof. If the back label on your pump is removed or damaged, the warranty is voided and your pump is no longer waterproof.
- When using your pump, if the pump is placed at a vertically higher position than the infusion site, a very small amount of additional insulin infusion may occur. To minimize this condition and maintain pump delivery accuracy, the vertical distance between your pump and the infusion site should be no more than 12 inches (30 centimeters). If your pump is placed at a vertically lower position than the infusion site, this condition is eliminated.
- Occasionally check the infusion site for proper placement and leaks. Improperly placed infusion sites or leaks around the infusion site can result in under infusion.
- Occasionally check the infusion set tubing for any damage, leaks or kinks while using your pump. Damaged, leaking or kinked tubing may restrict or stop insulin delivery and result in under infusion.

- Only use Animas® 2.0mL Cartridges (200 unit/2ml) infusion sets with a standard Luer connector. Efficacy of pump cannot be guaranteed if cartridges other than those manufactured by Animas® Corporation are used or if cartridges are used more than once.
- Always dispose of used cartridges and infusion sets following the regulations in your community. Failure to follow these guidelines may pose health hazards.
- Prior to replacing the battery cap, make sure the o-ring fits securely and is not damaged. A damaged o-ring may impact the battery contact and/or the waterproof feature of your pump. See *Chapter 4 in Section I*.
- Prior to inserting a cartridge into your pump, check the o-rings on the cartridge to be sure they are not damaged. Damaged cartridge o-rings can result in under or over delivery of insulin.
- Occasionally check the vents to be sure they are clear of debris. See *Chapter 12 in Section I*.
- Occasionally check that your pump personal settings are correct.
- Occasionally check to make sure your pump emits audible tones that are easily detectable and that the vibrate feature is working correctly. For example, audible tones should be heard and the vibration pulse felt every time you replace the battery.
- If using the upload or download feature, keep the communication window free of obstructions and refer to the *Instructions for Use* included with the wireless download cable. Contact your local Animas® distributor for information on ezManager® Software and wireless download cable.

NOTE: Your pump uses battery power to notify you of alerts, warnings, and alarms. If you do not confirm the notification, your pump will continue to use battery power as the notifications repeat and progress. This will result in reduced battery life and the Replace Battery Alarm screen appearing sooner than expected.

Additionally, certain warnings (e.g., Low Cartridge Warning, Occlusion Alarm) take precedence over less critical ones (e.g., Low Battery Warning). This means if you do not confirm the more critical warning, battery life will be reduced and your pump may skip the Low Battery Warning and go directly to the Replace Battery Alarm, or battery life will end before a Replace Battery Alarm is displayed.

 WARNING: CONFIRM all pump alerts, alarms and warnings as soon as possible.

Not confirming alerts, alarms and warnings can affect insulin delivery as follows:

- Pump battery power may be drained much sooner than expected, leaving you without a way to deliver insulin if you do not have a replacement battery.
- The calculation of Insulin on Board (IOB) when using the bolus calculator feature may not be as accurate, resulting in the “suggested” bolus amount being less than what it should be.
- Basal and bolus delivery may be suspended for up to 2 hours once the alert, alarm or warning is confirmed without the pump directly notifying the user.
- Any Combo Bolus or Temp Basal in effect may be canceled without the pump directly notifying the user.

Any of these situations can result in over delivery or under delivery of insulin, resulting in serious injury or death.

 Safety Information

- Your pump is designed only for Continuous Subcutaneous Insulin Infusion (CSII). It is not intended for use with any other delivery substance.
- This section of the Owner’s Booklet gives instruction on how to program and operate your pump. Animas® Corporation does not make any recommendations on specific programming related to your diabetes care program. Consult your health care team for instructions specific to your treatment plan.
 - Consult your health care team before using your pump to determine which programming features are appropriate for you. Some features require a greater knowledge of insulin pumping and advanced self-care skills. Additionally, some advanced programming features require that testing and fine-tuning of basic settings be completed in order to achieve the best possible results. Your health care team will give you specific training on programming and using your pump.

- Use of Extended Bolus, Combo Bolus, ezCarb (carb calculator), Insulin on Board (IOB) and ezBG (BG correction calculator) all require input from your health care team. **Do Not** attempt to use these features until you have specific information for your treatment plan and have had specific training on each programming feature.
- Only your health care team can determine your Insulin to Carbohydrate (I:C) ratios, Insulin Sensitivity Factors (ISFs), BG Target ranges and duration of Insulin on Board (IOB).
- Basal rates that are too high or too low can adversely affect BG levels. Work with your health care team to fine-tune basal rates.
- The way your body uses insulin can be affected by many things. Contact your health care team about lifestyle changes such as starting/stopping your exercise program or significant weight loss/gain. Your basal rates may need to be modified.
- **Do Not** stop using your pump if you are ill. Even when you're sick, your body still needs insulin. See *Chapter 15* in *Section I*.
- When you begin using the Audio Bolus feature, always look at the screen as you program so that you are completely comfortable with the feature before delivering a bolus via audio prompts only.
- Animas® Corporation recommends that you have someone around you (family, friends, etc.) who understands diabetes and pump therapy, so in the event of an emergency, they can help you. Be sure they are familiar with any information given to you by your health care team.
- Before Bedtime
 - Try to arrange infusion set changes at meals or one to two hours before bedtime. If a change is needed at bedtime, then check BG in one to two hours. Always check BG one to two hours after infusion set change.
 - Always check that your cartridge has enough insulin to last through the night before going to bed. Unless otherwise recommended by your health care team, **Do Not** use the vibrate feature during sleep. It is recommended that you set the volume to high for all warnings and alarms before going to sleep.

- Always remove all air bubbles from cartridge and tubing before beginning insulin delivery. Air bubbles can compromise accuracy of delivery. Refer to the *Instructions for Use* included with your cartridge packaging.
- Interference with your pump electronics by cell phones can occur if worn in close proximity. It is recommended that you wear your pump and cell phone at least 6 inches (15.2 centimeters) apart. When RF is turned on and you are using your pump and meter remote together as a system, RF interference is possible. See *Chapter 7 in Section III*.
- If you return your pump for service and a replacement pump is sent, **Do Not** use the replacement pump until all the settings specific to your treatment plan have been programmed.
- If you drop your pump or it has been hit against something hard, inspect it to be sure it is still working properly. Check that the display screen is working and clear, that the cartridge cap, battery cap and infusion set are properly in place. Check for leaks around the cartridge by wrapping a piece of tissue around the connection area. Cracks, chips or damage to your pump may impact the battery contact and/or the waterproof feature of your pump. Call our Customer Service representatives at 1 877 937-7867 if you identify or suspect your pump has been damaged. They will help determine if your pump should be replaced.
- Your pump is designed to operate in conditions where temperatures are between 40°F (5°C) and 104°F (40°C). If your pump is exposed to temperatures outside these parameters, extra care should be taken to protect it from extreme temperatures.
- Your pump and pump cartridges are latex free.
- To avoid risk of explosion, **Do Not** use your pump in the presence of explosive gases.
- Your pump is designed to achieve optimum performance and battery life with an Energizer® Lithium L91 AA battery (1.5V). Rechargeable batteries and Carbon-Zinc batteries do not have the necessary characteristics to power your pump and should not be used. Some AA lithium batteries are available with other voltages such as 3.6V or 4.0V. **Do Not** use these batteries. Use of anything other than a 1.5V battery could permanently damage your pump and voids its warranty.

- **Do Not** use household cleaners, chemicals, solvents, bleach, scouring pads or sharp instruments to clean your pump. Never put your pump in the dishwasher or use very hot water to clean it.
- Never use a hair dryer, microwave oven or baking oven to dry your pump. Use a soft towel.

 **WARNING:** Your pump and pump accessories include small component pieces that could pose a choking hazard for small children.

CHAPTER 2 - Explanation of symbols

Shown below are symbols you will find on your OneTouch® Ping® Insulin Pump or its packaging.

On your system packaging:



Do Not Reuse

On the front of your pump:



Up Arrow button



Down Arrow button



OK button

On the top of your pump:



Contrast button

On the back of your pump:



Important Information (See Owner's Booklet for *Instructions for Use*)

S/N

Serial Number



Date of Manufacture

IPX8

Waterproof Equipment (protected against the effects of submersion; tested to 12 feet (3.6 meters) for 24 hours)



Type BF Medical Equipment (patient isolated, not defibrillator protected)



Rx Only

CAUTION: Federal (U.S.) law restricts this device to sale by, or on the order of a physician.



Consult Owner's Booklet



Do Not wear or operate around MRI devices. Remove and leave outside MRI room before entering.

16 : CHAPTER 3 - Introduction to your Onetouch® Ping® Insulin Pump



An insulin pump is a tool to allow you to better manage your diabetes. When connected to a properly inserted infusion set, your pump delivers insulin at a continuous level (basal rate), 24 hours a day. You program delivery of an immediate dose (bolus) of insulin to cover food eaten or to correct high BG.

Your pump is engineered and manufactured to the highest standards of quality.

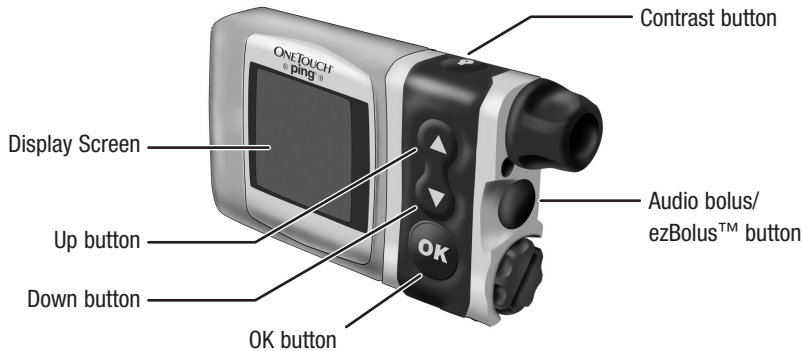
Get to Know Your OneTouch® Ping® Insulin Pump



Main Programming Buttons

There are 3 buttons for main programming functions. The  and  buttons allow you to move through screen selections and to scroll up and down to enter values such as a bolus amount. The  button allows you to select an item or activate a function.



Programming Basics

- Use the / buttons to scroll to the desired selection and then press the  button to select. If the cursor is flashing, it means your pump is in Edit mode and by scrolling with the / buttons, you can edit the flashing field.
- Once you have finished editing, press the  button to confirm your entry and to exit the Edit mode.

Display Screen

All programming, operations, warnings and alarms are shown on the display screen.

Contrast Button

Pressing this button adjusts the contrast of your display. There are three contrast levels: Dim, Default and Bright. To preserve battery life, your pump display will Auto-dim when a button is not pressed for half the time your display time-out is set. While in **Auto-dim** mode, you can restore the default contrast level you have set by pressing the  button on top of your pump. Pressing a function button while in Auto-dim mode will restore the default contrast level as well as perform the function of the key. To adjust contrast during a Call Service alarm, you must use the  button. See *Chapter 10 in Section I*.

NOTE: When viewing your pump display in bright sunlight, it is recommended you shade the screen or move to a shady area for best visibility.

Audio Bolus/ezBolus™

This button allows you to program a bolus without looking at your pump, by using audible tones to confirm programming and delivery. If you choose not to activate the Audio Bolus feature, this button provides a shortcut to the Normal Bolus screen.

NOTE: When you first use the Audio Bolus feature, you should always look at the screen to confirm correct programming until you are comfortable with using audio feedback to program a bolus. See *Chapter 10* in *Section I*.

Battery Cap/Vent

This cap unscrews easily with a coin to replace and secure your battery. There is an o-ring around the cap, which prevents water from entering. The battery cap also is equipped with a built-in vent to allow air to enter your pump to maintain pressurization but prevent water from entering. Be careful not to over tighten the battery cap. See *Chapter 4* in *Section I*.

Primary Vent

This vent is part of the redundant vent safety system, which allows air inside your pump to maintain equalized pressure but prevents water from getting inside.

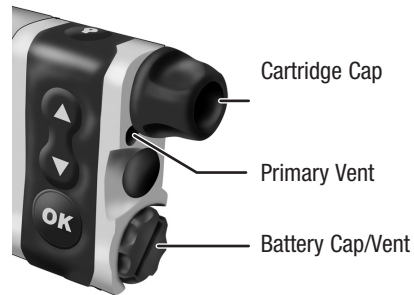

⚠ WARNING: Under no circumstances should you introduce any kind of sharp object into the vent openings to clean them. Doing so will compromise your pump's waterproof capabilities. If at any time you suspect the vent openings are clogged, replace the battery cap or call Animas® Customer Service for questions about the Primary Vent.

Cartridge Compartment Cap

This cap secures your cartridge and infusion set in your pump.

⚠ WARNING: Never tighten the cartridge cap when your infusion set is attached to your body. Tightening the cartridge cap while your infusion set is attached to your body may result in unwanted insulin delivery, which can result in serious injury or death.

IR Window for Download

The IR window is framed in blue. This is the infrared communication window used for downloading your pump data.

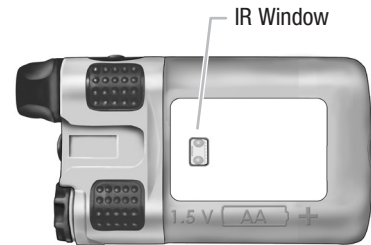

Sounds

Your pump allows you to customize the volume level or use the vibrate function to notify you of warnings and alarms and to confirm certain deliveries. With ezManager® Software, you can also add tunes to play as your initial audible notification for some Alerts, Reminders, Warnings and Alarms. Refer to your ezManager® User Guide included with the software.

Tamper Resistant (Locked) Feature

You can use the tamper resistant feature to prevent accidental button pressing. Simply wake up your pump and press and hold the  and  buttons at the same time until the screen reads "(LOCKED)". This locks your pump buttons. To unlock your pump, wake up your pump so the screen reads "(LOCKED)" and press and hold the  and  buttons at the same time until the screen display wakes up.

Basic Display Screens

Verify Screen

When you insert a battery, an all-black screen with an hourglass symbol will appear followed by the VERIFY screen. From here you should verify the settings for time, date, language and battery type. With “Confirm” highlighted, press  to confirm the settings and go to the Home screen.

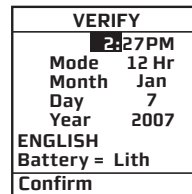

NOTE: If you do not confirm the settings on the VERIFY screen, you will be notified with an alarm beep sequence on your pump. If not confirmed after 1 hour, the sequence will progress to 3 chirps/vib and then 4 long tones/vib within an hour.

Home Screen

Once you have your pump set up, the Home screen is the first screen that is displayed when you “wake up” your pump. Press any button to wake up your pump. The Home screen shows the time of day, a battery life indicator, if you have an extended bolus or temp basal currently active, current basal rate, and how much insulin remains in your cartridge. You access the Main Menu from here or you can take a shortcut to the Status screen. The battery life indicator is shaded to show approximate battery life remaining.

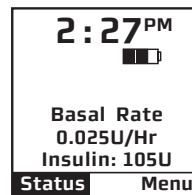

NOTE: When the RF feature is activated on your pump, an RF  symbol will appear on the top left of your pump Home screen.

After a set amount of time with no button presses, your pump display screen will “time out” to conserve battery life. When your pump times out, the screen display is blank.

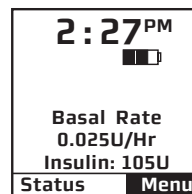

Main Menu Screen

This screen shows all Main Menu options.

MAIN MENU
Bolus
Suspend/Resum
History
Basal
Setup
Prime/Rewind
Status
Home

Bolus

This selection takes you to the Normal Bolus screen. If you have activated Advanced Bolus features, the Bolus Menu will be displayed. From the Bolus Menu you can select the bolus type, program and deliver the bolus dose.

Suspend/Resume

The Suspend function stops all insulin deliveries and Resume restarts basal delivery.

History

This option allows you to review history of boluses, total daily dose (TDD), alarms, primes, suspend and basal information.

Basal

The Basal Menu allows you to access and program your basal rate. This continuous rate maintains your blood glucose between meals. This rate will be determined by your health care team. The default Basal Menu will display one basal program and the Temp Basal option. You can activate additional basal program options with the Setup Advanced menu.

Setup

This menu allows you to personalize the settings and features of your pump, as well as add advanced features to the menu. Your health care team will advise you on which features are best suited for your plan of treatment, as well as train you to achieve the best results.

Prime/Rewind

This function enables you to properly align the cartridge and piston rod as well as prime your infusion set tubing and fill your cannula or needle before connecting to your pump.

Status

This feature allows you to quickly see your current/most recent settings and pump deliveries.

⚠ WARNING: Before proceeding with this chapter, you should have completed your pump training and/or watched your training video.

To complete this section, you will need the following items:

- OneTouch® Ping® Insulin Pump
- Energizer® Lithium L91 AA battery (1.5V)
- Coin
- Infusion set with standard Luer connector
- Animas® 2.0mL Cartridges (200 unit/2ml)
- Alcohol wipe (to clean top of insulin vial)
- Vial of U100 insulin (rapid-acting) at room temperature
- Skin prep such as IV Prep™ (to clean and prepare site for infusion set insertion)

⚠ CAUTION: Under no circumstances should you use an alcohol wipe or skin prep to clean your pump. See *Chapter 12* in *Section I*.

Battery Type

Your pump is designed to achieve optimum performance and battery longevity with an Energizer® Lithium L91 AA battery (1.5V).

⚠ CAUTION: It is possible to safely power your pump with a conventional AA Alkaline battery (1.5V), but battery life is significantly reduced. Be sure you select the correct Battery Type on the VERIFY screen when you change the battery to ensure accuracy of battery life indicator.

If you must use an AA Alkaline battery, the following is recommended:

- Energizer® E91 (labeled as Energizer® MAX)

⚠ WARNING:

- Rechargeable batteries and Carbon-Zinc batteries do not have the necessary characteristics to power your pump and must not be used. Use of these batteries voids your pump warranty.
- Under no circumstances should you attempt to power your pump with a high-energy 3.6V AA Lithium battery. Use of these batteries could permanently damage your pump and voids its warranty.

NOTE: Your pump uses battery power to notify you of alerts, warnings, and alarms. If you do not confirm the notification, your pump will continue to use battery power as the notifications repeat and progress. This will result in reduced battery life and the Replace Battery Alarm screen appearing sooner than expected.

Additionally, certain warnings (e.g., Low Cartridge Warning, Occlusion Alarm) take precedence over less critical ones (e.g., Low Battery Warning). This means if you do not confirm the more critical warning, battery life will be reduced and your pump may skip the Low Battery Warning and go directly to the Replace Battery Alarm, or battery life will end before a Replace Battery Alarm is displayed.

 WARNING: CONFIRM all pump alerts, alarms and warnings as soon as possible.

Not confirming alerts, alarms and warnings can affect insulin delivery as follows:

- Pump battery power may be drained much sooner than expected, leaving you without a way to deliver insulin if you do not have a replacement battery.
- The calculation of Insulin on Board (IOB) when using the bolus calculator feature may not be as accurate, resulting in the “suggested” bolus amount being less than what it should be.
- Basal and bolus delivery may be suspended for up to 2 hours once the alert, alarm or warning is confirmed without the pump directly notifying the user.
- Any Combo Bolus or Temp Basal in effect may be canceled without the pump directly notifying the user.

Any of these situations can result in over delivery or under delivery of insulin, resulting in serious injury or death.

Changing the Battery

Each time you change the battery

- A full rewind and prime sequence is required. See *Priming your Pump and Infusion Set*, in this chapter.
- The Insulin on Board (IOB) calculation starts over at zero.
- The Combo bolus returns to the factory set default duration and split.
- You should review your basal program settings.
- All user-programmable pump settings will be retained in the pump memory.

 WARNING: Low Battery Warning means battery life will only last a minimum of 30 minutes.

1. Use a coin to unscrew the battery cap with a counter-clockwise motion.
2. Check your battery cap for damage such as cracks or missing threads, and be sure the colored o-ring fits securely and is not torn or damaged.
3. Check the vent hole on the top of the battery cap to be sure it is clear of debris. This vent maintains pressurization while preventing water from entering the compartment.

NOTE: The battery cap should be replaced every 6 months, or if the o-ring or cap is damaged or the vent is clogged. See *Chapter 12 in Section I*.



4. Insert the Energizer® Lithium L91 AA (1.5V) battery into the battery compartment with the positive (+) end going in first.
5. Replace the cap by turning clockwise until you cannot see the o-ring. Then slowly tighten the cap until flush with pump body.

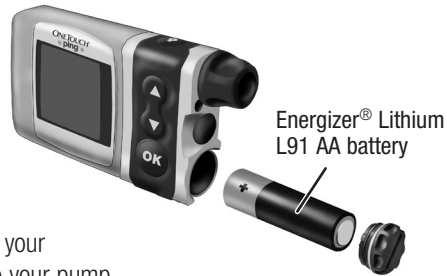

NOTE: Over tightening the battery cap can cause your pump case to crack. Cracks, chips, or damage to your pump may impact the battery contact and/or the waterproof feature of your pump.

6. Each time you change the battery, your pump will run a series of self-tests which will last a few seconds. An all black screen with an hourglass symbol will appear followed by the VERIFY screen. Your pump will give a beep to alert you to **verify** (or change) the time/date, language and battery type.
7. Check the displayed time/date, battery type and language. If correct, scroll down to highlight "Confirm" and press the **OK** button. The Home screen will be displayed. For more details on changing the time and date, see *Setup - Basics, Setting/Changing Time and Date*, in this chapter.

NOTE: The time and date must be programmed to confirm the VERIFY screen.

8. To change the battery type, highlight the “Battery” field and press **OK** to activate Edit mode (indicated by flashing cursor).

9. Use the **▲/▼** buttons to change battery type and press **OK** to confirm and exit Edit mode.

NOTE: The correct battery type must be selected in order for your battery life indicator to be accurate. “Lith” = Lithium, “Alkl” = Alkaline.

10. Scroll to “Confirm” and press **OK**. The Home screen is displayed.

NOTE: Until you have programmed a basal rate, the Alert screen shown here will appear when your pump is awakened. Simply scroll to “Confirm” and press **OK** to move past this Alert screen.

Setup – Basics

You can use your computer, with ezManager®, to upload Time/Date and Sound settings. For instructions on uploading Time/Date Sound settings, refer to your ezManager® User Guide.

Setting/Changing the Time and Date

When you change your battery, the VERIFY screen allows you to edit the time and date.

You can also access the Time/Date SETUP screen by selecting “Setup” from the MAIN MENU.

1. From the Home screen, press **OK** to select “Menu”. Scroll to “Setup” on the MAIN MENU. Press **OK**.
2. Scroll to “Time/Date” on the SETUP menu. Press **OK**.

2:27 PM	
	
Basal Rate	
0.025U/Hr	
Insulin: 105U	
Status	Menu

MAIN MENU
Bolus
Suspend/Resume
History
Basal
Setup
Prime/Rewind
Status
Home

SETUP
Time/Date
Sound
Advanced
Main Menu

3. Press the **OK** button to activate Edit mode (indicated by flashing cursor).
4. Use the **▲/▼** buttons to change to your desired settings. Press the **OK** button to confirm your setting and exit Edit mode.
5. Use the **▲/▼** buttons to select the next field. Repeat the above process. Scroll to highlight “Main Menu” and press **OK** button when finished. The MAIN MENU screen will be displayed.

SETUP	
Time/Date	
Hour: Minute	2: 27PM
Mode	12 Hr
Month	Jan
Day	29
Year	2007
Main Menu	

NOTE:

- If you select the 12-hour time format, the AM/PM indicators will change as you scroll to set the time. Be sure the desired AM or PM selection is correctly displayed when setting the time.
- If you select the 24-hour time format, the time will be shown in military time.
- **Do Not** change the pump time and/or date on February 29, 2016 (Leap Day/Leap Year). If you make changes to the time and/or date of your pump on February 29, 2016, the changes will not be saved in the pump. Wait until the next day (March 1, 2016) to change the time and/or date so that your changes will be saved in your pump. Refer to page 3 for more details.

Daylight Saving Time (certain states and countries only)

“Spring Forward”

If you advance the hour on your pump clock after **11pm but before midnight**, you must also manually forward the date by one day. If you change your pump clock **after midnight**, your pump date will have changed automatically to the appropriate date.

“Fall Back”

It is recommended that you set your clock back **before midnight on Saturday or after 1am on Sunday**. This keeps your pump set to the correct date. Your pump will register an additional hour in the Daily Totals History because the day has essentially been altered to consist of 25 hours. If you change

the clock between midnight and 1am, you must also change the date. This will result in a duplicate date entry in your history. (This duplicate entry will contain up to one hour's worth of insulin delivered.)

Sounds - Setting/Changing

Note that this menu only adjusts sounds. It does not activate the feature. For example, Audio Bolus Sound is adjusted in this menu, but to turn the Audio Bolus feature on, go to the Setup Advanced menu. See *Chapter 10* in *Section I*.

Your pump comes pre-loaded with a tune for most Alerts, Reminders and Alarms on medium and high volume settings. This tune plays only for the initial audible notification. If you do not confirm the initial notification, the next sound will be the factory default. If not confirmed, Warnings and Alarms will automatically progress to high volume and vibrate within one hour. With ezManager® Software, you can change or add tunes to play as your initial notification for some Alerts, Reminders, Warnings and Alarms. Refer to your ezManager® User Guide included with the software.

The options from the first SETUP SOUND menu are listed below. Normal Bolus Sound and Temp Basal Sound can be set to one of the following: Vibrate (Vib), Low volume (L), Medium volume (M), High volume (H) or can be shut off (OFF) completely. For safety reasons, some sounds **cannot** be turned off.

Normal Bolus Sound

Audio Bolus Sound (OFF is not an option for this sound setting)

Remote Bolus Sound (Vibrate and OFF are the only options for this sound)

Temp Basal Sound

The Remote Bolus Sound on your pump signals you when you use your meter remote to deliver a bolus from your pump. This setting applies only when you begin using your meter remote and pump together as a system (see *Section III*). Vibrate (Vib) is the default setting and OFF is the only other option for this sound setting.

The options from the second Setup Sound menu are listed below. They can be set to one of the following: Vibrate (Vib), Low volume (L), Medium volume (M), High volume (H) or can be shut off (OFF). For safety reasons, some sounds **cannot** be turned off.

Alert Sound

Reminder Sound (OFF is not an option for this sound setting)

Warning Sound (OFF is not an option for this sound setting)

Alarm Sound (OFF is not an option for this sound setting)

NOTE: If you download tunes from ezManager® Software to play on your initial audible notification, they will not play for any sound set at the Low volume (L) level.

⚠ CAUTION: Unless otherwise recommended by your health care professional, vibrate mode should not be used during sleep. It is recommended that you set the volume to high for all warnings before going to sleep.

1. From the MAIN MENU, scroll to “Setup”. Press the **OK** button.
2. Scroll to “Sound”. Press the **OK** button to go to the SETUP SOUND screen.
3. Use the **▲/▼** buttons to scroll to your selection. Press the **OK** button.
4. The cursor will flash to indicate you can edit the selection. Use **▲/▼** buttons to change to desired setting. Press the **OK** button to confirm.

MAIN MENU
Bolus
Suspend/Resum
History
Basal
Setup
Prime/Rewind
Status
Home

SETUP
Time/Date
Sound
Advanced
Main Menu

SETUP SOUND
N-Bolus H
A-Bolus L
R-Bolus Vib
T-Basal OFF
Next Menu
Main Menu

SETUP SOUND
Alert L
Reminder Vib
Warning M
Alarm H
Main Menu

5. Repeat for remaining selections.
6. Scroll to “Next Menu” to access second SETUP SOUND menu or scroll to “Main Menu” when finished to return to the MAIN MENU.

The Cartridge

Filling the Cartridge

Refer to the *Instructions for Use* included with your cartridges.

Connecting the Tubing to the Cartridge

To complete this section, you will need the following:

- Filled Animas® 2.0mL Cartridge (200 unit/2ml)
- Infusion set compatible with your OneTouch® Ping® Insulin Pump

⚠ WARNING: The efficacy of your pump cannot be guaranteed if cartridges other than those manufactured by Animas® Corporation are used.

Only infusion sets marketed for use with insulin infusion pumps using insulin-compatible tubing and with a standard Luer lock can be used with your OneTouch® Ping® Insulin Pump. The efficacy of your pump cannot be guaranteed if infusion sets other than those specified are used.

Do Not connect infusion set to your body until after you have completed the Prime process.

Never start the Prime/Rewind sequence on your pump while the infusion set is connected to your body. Failure to disconnect your infusion set from your body before you start the Prime/Rewind process can result in over delivery of insulin, and possible injury or death. If your pump sustains internal damage, the amount of unintended insulin delivery could be significant. This could result in serious injury or death from hypoglycemia.

1. Clean the workspace where you will be connecting the infusion set to the cartridge. Wash your hands thoroughly with soap and water.
2. Open sterile infusion set package carefully. If the package is damaged or opened, use another set and contact your supplier.
3. Unscrew the cartridge compartment cap from your pump, using a counter-clockwise motion.
4. Remove infusion set tubing cap from the Luer connector. (Not all infusion sets have these caps.)
5. After removing protective cap, thread the Luer connector of the infusion set through the top (smaller) opening of the cartridge compartment cap, being careful not to touch Luer tip with hands or work surface.
6. Remove cap from the filled cartridge tip. To avoid insulin spillage and introduction of air in the cartridge, it should never be filled beyond the 2.0 mL mark. The plunger is properly positioned for maximum fill when the black o-ring nearest the plunger tip is centered on the 2.0 mL mark. Attach infusion set Luer connector to cartridge tip using clockwise motion until finger tight **and then twist another quarter of a turn.**

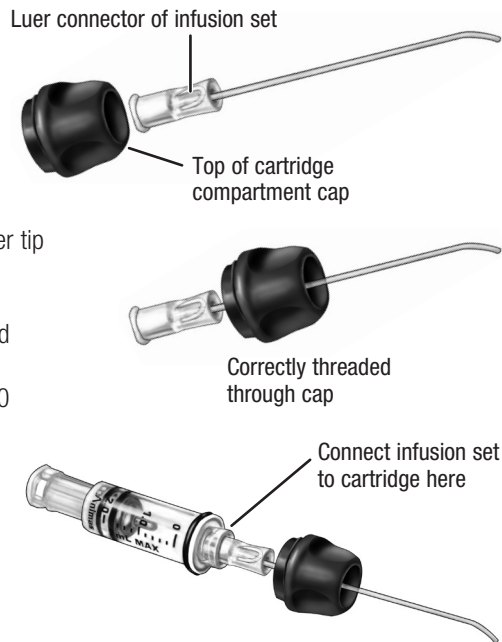

⚠ WARNING: Be sure to twist the Luer connector an extra quarter of a turn to ensure a secure connection. If the connection is not secure, insulin may leak around the cartridge, resulting in under delivery of insulin.

7. Put cartridge/tubing assembly aside.

NOTE:

- Check for leaks, cracks or damage each time you change your cartridge and infusion set. To avoid leakage, be sure to tighten the Luer connection securely. You can check for moisture periodically by wrapping a tissue around the Luer connection between the cartridge and infusion set.
- When handling the cartridge, take care not to twist or turn the plunger in the cartridge body. Maintaining straight alignment of the plunger keeps the o-rings properly seated, which minimizes the possibility of introducing air into the cartridge and will prevent insulin spillage.

Changing the Cartridge

1. Disconnect infusion set from your body.
2. Unscrew the cartridge cap, leaving tubing connected to the cartridge.
3. With the tubing connected to the cartridge, pull cartridge straight out of your pump.
4. Disconnect tubing from cartridge and discard. Proceed with filling the new cartridge as outlined above.

Priming your Pump and Infusion Set

NOTE: As each step is completed, the check box on the ezPrime menu will be shaded.

 **WARNING:** Never prime tubing or tighten the cartridge cap while the infusion set is connected to your body. Failure to disconnect your infusion set from your body before performing this step can result in over delivery of insulin, and possible injury or death. If your pump sustains internal damage, the amount of unintended insulin delivery could be significant. This could result in serious injury or death from hypoglycemia.

1. Make sure you are disconnected from your pump.

2. From the MAIN MENU, select “Prime/Rewind”.

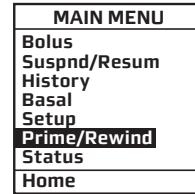

3. On the ezPrime menu, “Rewind” is highlighted. Press **OK**. The REWIND MOTOR screen is displayed.

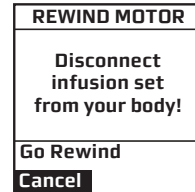
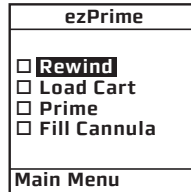

4. Scroll up to “Go Rewind”. Press **OK**. Your pump will rewind the piston rod.

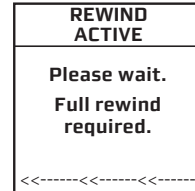
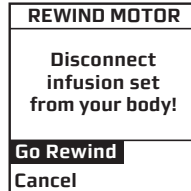

NOTE: Before starting the rewind, your pump will vibrate as it performs a self test.

5. When the rewind action is complete, the REWIND COMPLETE screen is displayed. Your pump will beep once to let you know the rewind is complete.

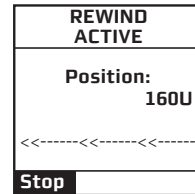

NOTE: If using a partially filled cartridge, you can select Stop during the Rewind Active function to stop the rewind at the position desired. After every third rewind, your pump is required to do a Full Rewind and will not offer the option of selecting the “Stop” position. A Full Rewind is always required when a battery is inserted.

6. Insert your filled cartridge.

7. Secure cartridge compartment cap to pump by turning in a clockwise motion until finger tight but **Do Not** over tighten.

⚠ WARNING: Never tighten the cartridge cap while the infusion set is connected to your body. Failure to disconnect your infusion set from your body before performing this step can result in over delivery of insulin, and possible injury or death. If your pump sustains internal damage, the amount of unintended insulin delivery could be significant. This could result in serious injury or death from hypoglycemia.

NOTE: If screen display has timed out while loading your cartridge, select Prime/Rewind from the MAIN MENU and highlight "Load Cart" from the ezPrime menu. Press **OK** to display the REWIND COMPLETE screen. Continue with Step 8.

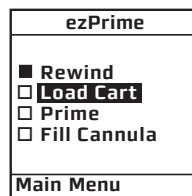

8. On the REWIND COMPLETE screen, "Continue" is highlighted. Press **OK**. Your pump will align the piston rod with the cartridge. The LOAD CARTRIDGE ACTIVE screen is displayed, followed by the PRIME screen. Your pump will beep once to let you know the cartridge is aligned with the piston rod.

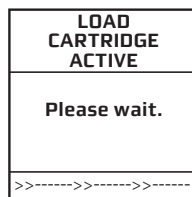
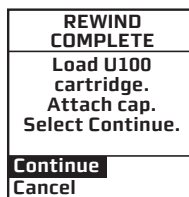

9. On the PRIME screen, "Continue" is highlighted. Press **OK**.

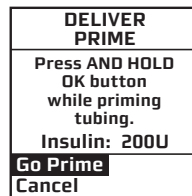
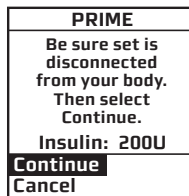

10. The DELIVER PRIME screen is displayed. **Be sure the infusion set is not connected to your body until the prime is complete.**

⚠ WARNING: Never prime while the infusion set is connected to your body. Failure to disconnect your infusion set from your body before performing this step can result in over delivery of insulin, and possible injury or death. If your pump sustains internal damage, the amount of unintended insulin delivery could be significant. This could result in serious injury or death from hypoglycemia.

11. Make sure “Go Prime” is highlighted. **Press and hold** the **OK** button until you see 5 drops of insulin come out the end of your infusion set. This means your tubing is primed. The PRIMING ACTIVE screen is displayed, followed by the PRIMING DONE screen.

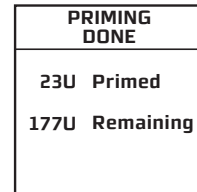
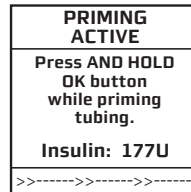

Refer to the *Instructions for Use* included with your infusion set for proper insertion guidelines. See *Selecting the Infusion Site and Inserting the Infusion Set* in this chapter.

12. From the ezPrime menu, “Fill Cannula” is highlighted. Press the **OK** button. The FILL CANNULA screen is displayed.

NOTE: This step is not necessary for needle sets.

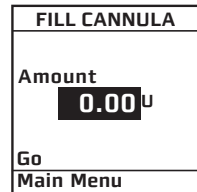
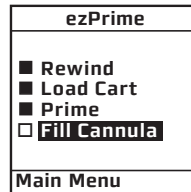

13. Use the **▲/▼** buttons to enter the amount of insulin needed to fill the cannula. Refer to the *Instructions for Use* included with your infusion set for details on how much insulin is required to fill the cannula. Press **OK**. “Go” is highlighted. Press **OK** to fill the cannula.

NOTE: The maximum Fill Cannula amount is 1U at a time.

If your pump is suspended, the screen will alert you with the ezPrime “Pump suspended” screen. You must resume delivery of your pump in order to complete the Priming function.

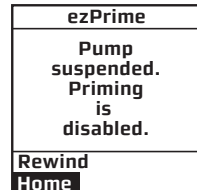

NOTE: The Fill Cannula step is not required for your pump to operate. For example, when you prime your pump after a battery change and you are not inserting a new infusion set, this step is not necessary. Filling the cannula when not necessary can result in unwanted delivery of insulin.

Selecting the Infusion Site and Inserting the Infusion Set

Your health care team will review appropriate site selections and techniques for insertion based on your body type. Refer to the *Instructions For Use* included with your infusion set for proper insertion guidelines.

⚠ WARNING: Do Not attempt to insert the infusion set into your body until you have been trained by your health care team. Improper insertion of your infusion set can lead to death or serious injury.

Changing the Cartridge and Infusion Set

Cartridges and infusion sets require replacement and are not to be reused. Infusion sets should be replaced approximately every 2–3 days or as directed by your health care team. Refer to the insulin labeling and follow the direction of your health care team for frequency of replacing the cartridge.

⚠ CAUTION: Occasionally check the infusion set tubing for any damage, air bubbles, leaks or kinking, which may restrict or stop insulin delivery and result in under infusion.

38 : CHAPTER 5 - Using the Normal Bolus feature

This chapter covers the basics of a Normal bolus, which is used to cover food you have eaten and high BG.

Your pump also offers advanced bolus features. See *Chapter 10* in *Section I*.

1. From the MAIN MENU, select “Bolus”.

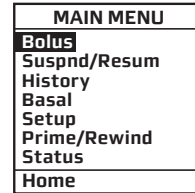

2. The cursor will flash over the amount field to indicate that it can be edited. Use the   buttons to enter desired bolus amount. Press .

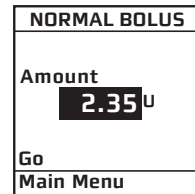
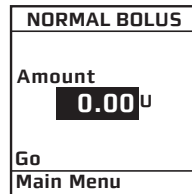

3. “Go” is highlighted. Press  to deliver the bolus.

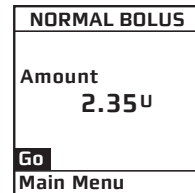

4. The DELIVERING bolus screen is displayed. If you have activated the Normal Bolus sound in the SETUP SOUND menu, your pump will beep to confirm start of delivery, as well as when delivery is complete.

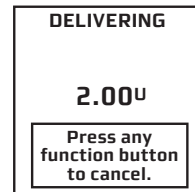

NOTE: During a bolus delivery, you can stop delivery at any time by pressing any button on the front panel of your pump. The Warning screen shown here will be displayed. Confirm the Warning by pressing **OK** and check your Bolus History for the amount delivered.

NOTE: You can check when you last gave a bolus by looking in History or Status. These features are covered later. See *Chapter 8* and *Chapter 9* in *Section 1*.

NOTE: If you have Advanced Bolus and Reminders features turned on, the BOLUS MENU at right will be displayed when you select “Bolus” from the MAIN MENU. Select “Normal” and press **OK**. Follow steps 2 through 4 in this chapter.

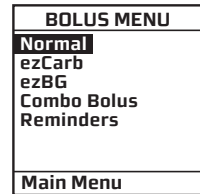
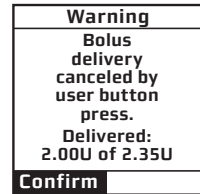





40 • CHAPTER 6 - Using Basal Program features

You can program your pump to display either 1 or 4 basal program options. Basal insulin is delivered continuously to help keep your BG in target between meals. Having more than one pre-set basal program makes it easy for you to switch based on your needs including weekends, weekdays, shift work, and menstruation. If you are new to pumping, your health care team may suggest you first become comfortable with one program before using multiple basal programs. The factory default displays one basal program and the temporary basal program. To display multiple basal options, see *Chapter 10* in *Section I*.

You can use your computer and ezManager® Software to upload basal program names as well as basal rates. For instructions on uploading basal program information, refer to the ezManager® User Guide included with the software.

Setting a Basal Program

Each basal program can be set with up to 12 different basal rates (doses) in a 24-hour period. These 12 start times can be set to accommodate your changing basal needs throughout the day. For example, your body may need more insulin in the early morning to compensate for the “dawn phenomenon.” You can program time segments to begin at any hour or half hour.

NOTE: The /  buttons will move the cursor through fields when not in Edit mode. When in Edit mode, the /  buttons will change the value of the field. If the cursor is flashing, that means you can edit the entry. Use the  button to start/stop Edit mode.

Use the *My Information* chart in *Chapter 17* in *Section I* to record and enter your basal program times and doses as recommended by your health care team.

- From the MAIN MENU, select “Basal”. Press **OK**.

The BASAL MENU displays the following:

- Total basal insulin programmed for the 24-hour period

MAIN MENU	
Bolus	
Suspend/Resume	
History	
Basal	
Setup	
Prime/Rewind	
Status	
Home	

- Temp (if you wish to program a Temporary Basal rate)
- The active basal program, designated by number and by name, as well as an “A” to indicate the active program. (If you have activated multiple basal programs in the Setup Advanced menu, all 4 basal program options will be displayed as shown on the far right.)

BASAL MENU	
Total	0.00U
Temp	
A1-WEEKDAY	
Main Menu	

BASAL MENU	
Total	0.00U
Temp	
A1-WEEKDAY	
2-other	
3-weekend	
4-exercise	
Main Menu	

- Scroll to select the program “1-WEEKDAY” and press **OK**.

NOTE: You do not have to Suspend your pump to edit an active program. When you select “Edit” from the BASAL MENU, your pump automatically suspends delivery. When you exit the Edit mode, the active program delivery automatically resumes.

BASAL MENU	
Total	0.00U
Temp	
A1-WEEKDAY	
Main Menu	

- The BASAL OPTIONS screen is displayed. “Edit” is highlighted. Press the **OK** button. From the EDIT BASAL screen, you can edit the basal segments of the selected program.

- Scroll to the desired “U/Hr” field. Press **OK** to activate Edit mode (indicated by flashing cursor).

EDIT BASAL	
Total	0.00U
Start	E U/Hr
12:00A	0.000
---:--	---:--
Save/Review	

5. Use **▲/▼** buttons to set desired basal rate. Press **OK** to confirm and exit Edit mode for this field.

6. Scroll down to select the next “Start” time field. Press the **OK** button to activate Edit mode (indicated by flashing cursor).

NOTE: The next available empty basal segment will appear automatically as you program the previous segment. If the next empty basal segment does not appear, you have programmed all 12 possible segments.

7. Change next “Start” time field as desired, press the **OK** button to exit Edit mode. Segments can start on the hour or half hour.

NOTE: The 24-hour Total changes automatically as you change U/Hr settings.

8. Continue until basal segments have been set as recommended by your health care team.

9. When finished, scroll to “Save/Review” and press **OK**. *If you have edited the active program, it is now resumed automatically.* The BASAL OPTIONS screen is displayed.

NOTE: If your screen display has timed out (gone to sleep) before you have selected Save/Review while editing, a Warning screen will remind you the basal edit has not been saved. See *Chapter 13* in *Section I*.

EDIT BASAL	
Total	0.60U
Start	E U/Hr
12:00A	0.025
---:--	---:--
Save/Review	

EDIT BASAL	
Total	0.60U
Start	E U/Hr
12:00A	0.025
4:00A	---:--
Save/Review	

EDIT BASAL	
Total	13.60U
Start	E U/Hr
12:00A	0.025
4:00A	0.675
---:--	---:--
Save/Review	

Warning
Basal edit not saved. Basal delivery suspended.
Edit Basal

- 10.** “Review” is highlighted. Press **OK** to review your entries for accuracy. Your basal segment settings are shown (5 on first screen, 5 on second screen and 2 on last screen). If you have more than 5 segments programmed, scroll to “Next” to see second and third screens as desired.
- 11.** “Options” is highlighted. Press **OK**. The BASAL OPTIONS screen is displayed.
- a.** If you’ve edited and saved/reviewed the active program, it is resumed automatically. You can also select “Go” and the Home screen is displayed, which shows the current rate of delivery for the program that is active.
- b.** If you’ve edited an inactive program and wish to activate it, select “Go” from the BASAL OPTIONS screen. When you select “Go”, the Home screen is displayed, which shows the current rate of delivery for the program that is active.

BASAL OPTIONS	
A1-WEEKDAY	
Total	13.60U
Clear	
Edit	
Review	
Go	
Main Menu	

BASAL OPTIONS	
A1-WEEKDAY	
Total	13.60U
Clear	
Edit	
Review	
Go	
Main Menu	

Adding/Changing Segments in an Existing Basal Program

- From the BASAL MENU, select desired program.
- “Edit” is highlighted. Press **OK**.
- Scroll to highlight the field you wish to change or to next available blank line to add a segment. Press **OK** to activate Edit mode. (The cursor will flash to indicate Edit mode.)
- Use **▲/▼** buttons to set Start times and U/Hr amounts.
- Check that the AM/PM settings are correct.

NOTE:

- If you program a segment to start at the same time as an existing segment, the previously entered segment is deleted.

- If you program a segment to start at a time that precedes an existing segment, the new segment is automatically inserted in the correct place. You must then scroll to the new segment, highlight the corresponding U/Hr field and enter or change amount, if desired.
6. When finished, scroll to “Save/Review” and press **OK**. If you have edited the active program, it is now resumed automatically. The BASAL OPTIONS screen is displayed.
 - a. Select “Review” from the BASAL OPTIONS screen to review your entries for accuracy. Your basal segment settings are shown (5 on first screen, 5 on second screen and 2 on last screen). If you have more than 5 segments programmed, scroll to “Next” to see second and third screens as desired.
 - b. If you’ve edited an inactive program, select the program from the BASAL MENU. Press **OK**. Select “Go” from the BASAL OPTIONS screen to activate the program you’ve selected.

When you select “Go”, the Home screen is displayed, which shows the current rate of delivery for the program that is active. (Or you can simply wait for your pump display to time out. When you press any button, your active basal program rate information is displayed on the Home screen.)

⚠ CAUTION: Always review changes to your basal program to be sure they are correct. Incorrect basal rates can result in under or over delivery of insulin. See *Reviewing Basal Programs* in this chapter.

Reviewing Basal Programs

1. From the BASAL MENU, scroll to highlight desired program. Press **OK**.

2. Scroll to “Review” from the BASAL OPTIONS screen.
Press **OK**. Your basal segment settings are shown (5 on first screen, 5 on second screen and 2 on last screen).
If you have more than 5 segments programmed, scroll to “Next” to see second and third screens as desired.

BASAL OPTIONS	
A1-WEEKDAY	
Total	13.60U
Clear	
Edit	
Review	
Go	
Main Menu	

A1-WEEKDAY	
Total	13.60U
Start	U/Hr
12:00A	0.025
4:00A	0.675
---:--	---:--
Options	Next

3. When finished, “Options” is highlighted. Press **OK**.

4. Scroll to “Main Menu” and press **OK**. The MAIN MENU screen is displayed. *The active basal program continues.*

5. If reviewing an inactive program and you wish to activate it, select the program you wish to activate from the BASAL MENU screen. Press **OK**.

6. Select “Go” from the BASAL OPTIONS screen to activate the program. The Home screen is displayed to show the current rate per hour of the program you have activated.

Clearing Basal Programs

This feature allows you to clear all information from a basal program.

1. From the BASAL MENU, scroll to desired program.
2. From the BASAL OPTIONS screen, scroll to “Clear”. Press **OK**.

If you press **OK** to select “Clear”, your pump will check to be sure you want to clear all the segments of the basal program selected. The Alert screen shown here is displayed. If you do wish to clear all the basal segments of the selected program, scroll to “Clear Program” and press **OK**.

If you do not wish to clear all the basal segments, scroll to “Basal Options” and press **OK**. The BASAL OPTIONS screen will be displayed.

If all segments of your active basal program are set to 0.000U/Hr your pump will not deliver any basal insulin. Each time you wake up your pump, the Alert screen shown here is displayed. If you have turned on the sound for Alerts, you will also be notified by a beep or vibrate. This Alert screen does not progress to higher audible alarms. You have the option to either select “Confirm” to quickly go to the MAIN MENU screen or select “Basal Menu” to reset rates in your active program. For more information see *Chapter 13* in *Section I*.

BASAL OPTIONS	
A1-WEEKDAY	
Total	13.60U
Clear	
Edit	
Review	
Go	
Main Menu	

Alert
Clear Program deletes all basal segments in this program.
Clear Program Basal Options

Alert
Your active basal program is empty. 0.000U/Hr
Confirm Basal Menu

Temporary Basal Feature

This feature allows you to increase your active basal delivery rate for events such as sick days or decrease for events such as exercise. You can decrease your basal rate by 90% (in 10% decrements) or increase your basal rate by 200% (in 10% increments). You can also set to OFF. You can set the duration up to 24 hours in half-hour increments. (If you have activated multiple basal programs in the Setup Advanced menu, all 4 basal program options will be displayed as shown on screen example below, right.)

⚠ CAUTION: The lowest basal delivery amount possible is 0.025U/Hr. The highest basal delivery amount possible is 25U/Hr or the Max Basal amount you set in the Setup Advanced menu in *Chapter 11*.

1. From the BASAL MENU, scroll to “Temp”. Press **OK**.

BASAL MENU	
Total	0.00U
Temp	
A1-WEEKDAY	
Main Menu	

BASAL MENU	
Total	0.00U
Temp	
A1-WEEKDAY	
2-other	
3-weekend	
4-exercise	
Main Menu	

2. The “Change” % field will flash to indicate Edit mode. Use the **▲/▼** buttons to enter the percentage change desired. Press the **OK** button to exit Edit mode.

A1-WEEKDAY TEMP BASAL	
Change:	0%
Duration:	4.0 Hr
Go	
Main Menu	

3. The “Duration” field is highlighted. Press **OK** to activate Edit mode.
4. Use the **▲/▼** buttons to enter the duration desired. Press **OK** to exit Edit mode.
5. “Go” is highlighted. Press **OK** to activate Temp Basal.

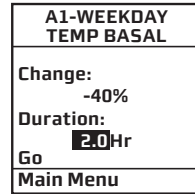

⚠ CAUTION: The lowest basal delivery amount possible is 0.025U/Hr. When you set a negative temporary basal rate, your pump will beep and display an Alert screen to remind you of the minimum delivery limit. This screen will display once for 5 seconds and give one audible alert (if you turned on Alert sounds in Setup).

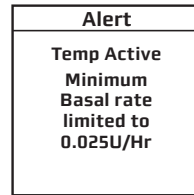

6. The Home screen is displayed and shows your Temp Basal is active, the percentage change, the duration and how much time is left. When the duration of time is complete, your pump will automatically resume the active basal program.

NOTE: If you turned on the Temp Basal sound in Setup, your pump will beep once every 30 minutes to remind you of Temp Basal status.

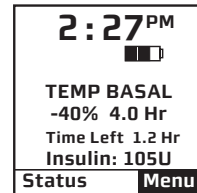

Canceling a Temporary Basal Program

1. From the BASAL MENU, select “TEMP BASAL”. Press **OK**.
2. Details of the current active Temp Basal program will be displayed. Scroll up to “CANCEL” and press **OK**.

Your previously active basal program will be activated and the Home screen will be displayed to show the current rate per hour of the active basal program.

NOTE: If you Suspend your pump while a Temp Basal program is active, the Temp Basal program will be canceled and an Alert screen will notify you that the Temp Basal program has been canceled. This Alert is displayed once and gives an audible tone once (if you turned on Alert sounds in Setup). Temp Basal is also canceled when you change the battery and/or prime.

A1-WEEKDAY TEMP ACTIVE
0.675 U/Hr -40% = 0.405 U/Hr Time left 1.2 Hr
CANCEL
Main Menu

Alert
Pump Suspended
If active, Temp Basal & Combo Bolus have been canceled.

⚠ CAUTION: When you switch to another basal program or set a Temp Basal, you will most likely be changing the total insulin units delivered over a period of time. Be sure to review the total insulin units before you switch basal programs or set a Temp Basal. Units that are too high or too low may result in a hypoglycemic or hyperglycemic event.

50 : CHAPTER 7 - Suspend/Resume feature

This feature allows you to stop and restart delivery quickly and easily.

It also cancels delivery of any Temp Basal or Bolus, including Combo Bolus that may be currently active. The Combo Bolus feature is covered in *Chapter 10* in *Section 1*.

Suspending Delivery

1. From the MAIN MENU, scroll to “Suspd/Resum” and press **OK**.
2. “Suspend” is highlighted. Press **OK**.

The screen will display a message reminding you that this mode not only suspends your active basal delivery but also *cancels* any Temp Basal or Combo Bolus that may be active.

3. The Home screen is then displayed, showing that pump deliveries are suspended.

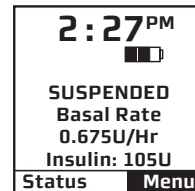
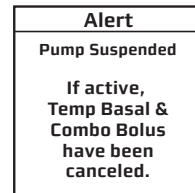
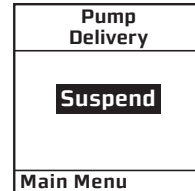
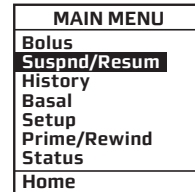

NOTE:

- Periodically, your pump will beep (or vibrate if that is the setting you selected) to remind you of the Suspend status. If not confirmed, the beeps will progress to high volume in one hour. You can confirm the Warning to reset the audible sequence. See *Chapter 13* in *Section I*.
- If pump battery power is interrupted for any reason while the pump was in Suspend mode, the pump will automatically be reset to Resume mode when power is restored. However, the pump will not resume insulin delivery until the Rewind/Prime and Load Cartridge sequence is completed.

Resuming Delivery

1. From the MAIN MENU, scroll down to “Suspd/Resum” and press **OK**.
2. “Resume” is highlighted. Press **OK**.
3. The Home screen is displayed to show you that your pump is no longer in Suspend mode. Your previously active basal program is automatically resumed.

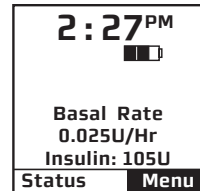
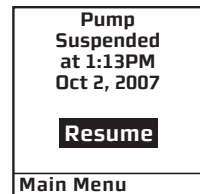
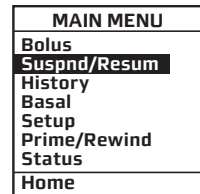
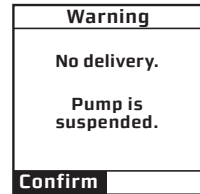

52 • CHAPTER 8 - History feature

Your pump stores important records for your review. You can access your pump's history and view it directly on your pump screen or download it onto your computer using ezManager® Software.

Refer to the User Guide included with the software. Certain information on your pump history screens will include a "(P)" or "(M)". This indicates if the action was initiated from your pump (P) or your meter remote (M) when you begin using the devices together as a system (see *Chapter 1 in Section III*).

Your pump stores basal rates, boluses, alarms and settings. Your pump stores these records indefinitely, even when batteries are removed.

From the MAIN MENU, select "History". The HISTORY menu is displayed.

MAIN MENU
Bolus
Suspend/Resume
History
Basal
Setup
Prime/Rewind
Status
Home

Bolus History

Your pump displays the last 500 Bolus records.

NOTE: BG values and carb values are not displayed on your pump. However, when you download your pump history with ezManager® Software, up to 500 bolus records, including any BG and Carb values used in bolus calculations, will be displayed on the ezManager® reports. Additionally, blood glucose values from your meter remote (900 total) will be stored in pump history and displayed on the ezManager® Software reports.

1. From the HISTORY menu, select “Bolus”. This screen displays the following:

- Bolus Record number
- Date of bolus
- Time of bolus
- Type of bolus delivered and whether it was initiated from your pump (P) or meter remote (M)
 - Normal
 - Combo
 - Audio
- Amount of bolus programmed and delivered
- Status of bolus
 - ACTIVE
 - COMPLETED
 - CANCELED and whether the bolus was canceled from your pump (P) or meter remote (M)
- If ezBG or ezCarb was used

HISTORY
Bolus
Total Daily
Dose (TDD)
Alarm
Prime
Suspend
Basal
Main Menu

BOLUS	
Record	1
Mar 23, 2007	
1:13PM	
NORMAL	(P)
2.80U of 2.80U	
COMPLETED	
ezCarb	
History Menu	

NOTE: If the pump battery power is interrupted for any reason during a Bolus delivery, the Bolus will be canceled and the insulin amount delivered may not be recorded in your pump’s history.

2. Scroll up to highlight the record field. Press **OK** to activate Review mode (indicated by flashing cursor).
3. Record 1 indicates the most recent record. Use the **▲**/**▼** buttons to scroll to other records.
4. When finished reviewing, press **OK** to exit Review mode.
5. “History Menu” is highlighted. Press **OK** to return to the HISTORY menu.

BOLUS	
Record	2
Mar 23, 2007	
12:13PM	
NORMAL	(P)
0.80U of 3.80U	
CANCELED	(M)
ezBG	
History Menu	

Total Daily Dose (TDD) History

Your pump displays the last 120 TDD records.

1. From the HISTORY menu, select “Total Daily Dose (TDD)”. This screen displays the following:

- Record number
- Date of record
- If Temp Basal was active on that date
- If Suspend was activated on that date
- Total Bolus for the date
- Total Basal for the date
- Total dose for the date

HISTORY
Bolus
Total Daily Dose (TDD)
Alarm
Prime
Suspend
Basal
Main Menu

TDD	
Record	1
Mar 23, 2007	
Temp	No
Suspend	No
Bolus	6.200U
Basal	0.700U
TOTAL =	6.900U
History Menu	

2. Scroll up to highlight the record field. Press **OK** to activate Review mode (indicated by flashing cursor).

3. Record 1 indicates the most recent record. Use the **▲**/**▼** buttons to scroll to other records.

4. When finished reviewing, press **OK** to exit Review mode.

5. “History Menu” is highlighted. Press **OK** to return to the HISTORY menu.

NOTE:

- Each daily total is the total delivered since midnight.
- Total Daily Dose (TDD) insulin amounts recorded in the pump are not affected by interruptions in pump battery power, as they reflect the total amount of insulin delivered in a 24-hour day that starts and ends at midnight. However, if pump battery power is interrupted for any reason during a Bolus delivery, the Bolus will be canceled and the insulin amount delivered may not be recorded in your pump's history.

Alarm History

Your pump displays the last 30 Alarm records.

1. From the HISTORY menu, select “Alarm”. The screen displays the following:

- Record number
- Date of alarm
- Time of alarm
- Alarm Code
- Alarm Type

HISTORY
Bolus
Total Daily Dose (TDD)
Alarm
Prime
Suspend
Basal
Main Menu

ALARM
Record 1
Mar 23, 2007 01:13PM
Code XXX-XXX
EMPTY CARTRIDGE
History Menu

2. Scroll up to highlight the record field. Press **OK** to activate Review mode (indicated by flashing cursor).
3. Record 1 indicates the most recent record. Use the **▲**/**▼** buttons to scroll to other records.
4. When finished reviewing, press **OK** to exit Review mode.
5. “History Menu” is highlighted. Press **OK** to return to the HISTORY menu.

Prime History

Your pump displays the last 60 Prime and Fill Cannula records. Prime and Fill Cannula records are stored as separate records.

1. From the HISTORY menu, select “Prime”. The screen displays the following:

- Record number
- Date of prime
- Time of prime
- Amount of prime

HISTORY
Bolus
Total Daily Dose (TDD)
Alarm
Prime
Suspend
Basal
Main Menu

PRIME
Record 1
Mar 23, 2007 01:15PM
Fill Cannula Total 1.0U
History Menu

2. Scroll up to highlight the record field. Press **OK** to activate Review mode (indicated by flashing cursor).

3. Record 1 indicates the most recent record. Use the **▲**/**▼** buttons to scroll to other records.

4. When finished reviewing, press **OK** to exit Review mode.

5. “History Menu” is highlighted. Press **OK** to return to the HISTORY menu.

PRIME
Record 2
Mar 23, 2007 01:13PM
Primed Total 23.7U
History Menu



Suspend History

Your pump displays the last 30 Suspend records.

- From the HISTORY menu, select "Suspend". The screen displays the following:

HISTORY
Bolus
Total Daily Dose (TDD)
Alarm
Prime
Suspend
Basal
Main Menu

SUSPEND
Record 1
Suspended
Mar 23, 2007 01:13PM
Resumed
Mar 23, 2007 01:13PM
History Menu

- Record number
 - Date and time pump delivery was suspended
 - Date and time pump delivery was resumed
- Scroll up to highlight the record field. Press **OK** to activate Review mode (indicated by flashing cursor).
 - Record 1 indicates the most recent record. Use the   buttons to scroll to other records.
 - When finished reviewing, press **OK** to exit Review mode.
 - "History Menu" is highlighted. Press **OK** to return to the HISTORY menu.

Basal History

Your pump displays the last 270 Basal delivery records.

1. From the HISTORY menu, select “Basal”. The screen displays the following:

- Record number
- Date and time basal rate was adjusted
- Basal rate adjustment

HISTORY
Bolus
Total Daily Dose (TDD)
Alarm
Prime
Suspend
Basal
Main Menu

BASAL
Record 1
Mar 23, 2007
01:13PM
Rate = 0.670
History Menu

2. Scroll up to highlight the record field. Press **OK** to activate Review mode (indicated by flashing cursor).

3. Record 1 indicates the most recent record. Use the **▲/▼** buttons to scroll to other records.

4. When finished reviewing, press **OK** to exit Review mode.

5. “History Menu” is highlighted. Press **OK** to return to the HISTORY menu.

NOTE: The History records each basal rate change. When no basal is being delivered, the Basal History Record will show 0 units delivered. This can happen for the following reasons:

- Cartridge change
- Basal segment set to 0
- Battery change
- Basal edit screen accessed
- Suspend
- Prime menu accessed
- Alarm
- Loss of prime

This feature gives you easy access to a summary of information about your pump's current programming and performance. There are six Status screens.

1. From the MAIN MENU or from the Home screen, scroll to "Status" and press **OK**.

MAIN MENU
Bolus
Suspend/Resum
History
Basal
Setup
Prime/Rewind
Status
Home

2:27PM	
	
Basal Rate	
0.025U/Hr	
Insulin: 105U	
Status	Menu

Status Screen 1 – Active Basal

The screen displays the following information:

- Which basal program is currently active
- The 24-hour total for the active basal program
- Units per hour currently being delivered
- Insulin currently remaining in cartridge

STATUS 1
ACTIVE BASAL
A1-WEEKDAY
24-Hr Total
13.60U
0.675U/Hr
Insulin: 105U
Main Menu



The cursor is flashing on the STATUS 1 screen. Press the **▲** button to move to the STATUS 2 screen or press **OK** to highlight "Main Menu" and exit Status screens.

Status Screen 2 – IOB, Last Bolus

The screen displays the following information:

- Amount of insulin currently “on board” (IOB). For more information on this feature, see *Chapter 10* in *Section I*.
- Type and amount of last completed bolus
 - N = Normal
 - C = Combo (normal portion only)
 - A = Audio
- Time and date of last bolus

STATUS 2 IOB=1.70U LAST BOLUS
N 3.30U 9:55AM Jul 8, 2007
Main Menu



The cursor is flashing on the STATUS 2 screen. Press the  button to move to the STATUS 3 screen or press  to highlight “Main Menu” and exit Status screens.

Status Screen 3 – Delivery Today

The screen displays the following information since midnight and up to the current time:

- Insulin type
- If Temp Basal has been active
- If Suspend has been active
- Total bolus amount delivered
- Total basal amount delivered
- Total insulin delivered (*excluding* prime amounts)

STATUS 3 DELIVERY TODAY
U100
Temp No
Suspend No
Bolus 9.400U
Basal 0.200U
TOTAL = 9.600U
Main Menu

The cursor is flashing on the STATUS 3 screen. Press the  button to move to the STATUS 4 screen or press  to highlight “Main Menu” and exit Status screens.



Status Screen 4 – Combo Bolus

The screen displays the following information:

- Most recent Combo Bolus status
 - Active or Completed or Canceled
 - Start date
 - Start time
 - End time
 - Amount delivered (if active, shows amount delivered as of current time)

STATUS 4	
COMBO BOLUS CANCELLED	
Mar 23, 2007	
Start	07:23AM
End	07:31AM
Delivered:	
3.28/9.00U	
Main Menu	

For more information on Combo Bolus, see *Chapter 10 in Section I*.



The cursor is flashing on the STATUS 4 screen. Press the  button to move to the STATUS 5 screen or press  to highlight “Main Menu” and exit Status screens.

Status Screen 5 – Temp Basal

The screen displays the following information:

- Most recent Temp Basal status
 - Active/Inactive
 - Start date
 - Start time
 - End time
 - % adjustment

STATUS 5	
TEMP BASAL ACTIVE	
Mar 23, 2007	
Start	04:00PM
End	06:00PM
Change:	-50%
Main Menu	

The cursor is flashing on the STATUS 5 screen. Press the  button to move to the STATUS 6 screen or press  to highlight “Main Menu” and exit Status screens.

Status Screen 6 – Codes

The screen displays the following information:

- Software revision
- Last seven digits of the serial number of your pump
- Codes for manufacturer's use

STATUS 6 CODES
REV M=XXX.XX.XX D=XXX P=XXX S/N# 76543-21
Main Menu

The cursor is flashing on the STATUS 6 screen. Press **OK** to highlight “Main Menu” and exit Status screens.

Now you've made it through the basics! Your pump offers many advanced features that you may find helpful in managing your diabetes. Consult with your health care team to determine which advanced features are appropriate for you.

This chapter tells you how to set up and turn on the advanced features. *Chapter 11* in *Section I* covers how to use each advanced feature.

You can also use your computer and ezManager® Software to upload settings for Advanced Setup. Refer to the ezManager® User Guide included with the software.

From the MAIN MENU screen, select "Setup". Then select "Advanced" from the SETUP screen and press **OK**.

MAIN MENU
Bolus
Suspend/Resume
History
Basal
Setup
Prime/Rewind
Status
Home

SETUP
Time/Date
Sound
Advanced
Main Menu

Setup Advanced Screen 1 – Audio Bolus Feature

This screen allows you to:

- Turn Audio Bolus on or off
- Select the Audio Bolus delivery step size
 - 0.1, 0.5, 1.0, 5.0 Units

1. Use the **▲/▼** buttons to scroll to the desired field.
2. Press **OK** to change to flashing cursor for Edit mode.
3. Use the **▲/▼** buttons to change to desired setting.
4. Press **OK** when setting is made.

SETUP ADV 1 AUDIO BOLUS	
Enable	OFF
Delivery Step	0.1U
Home	Next

NOTE: If Audio Bolus is activated, you cannot use the side button as a shortcut to Normal Bolus. You can still give a Normal Bolus via the MAIN MENU.

To move to the next Setup Advanced screen, scroll to the bottom of the screen and highlight “Next”. Press **OK**.

To return to the Home screen, scroll to “Home” and press **OK**. For more information, see *Chapter 11* in *Section I*.

Setup Advanced Screen 2 – Advanced Bolus Features and Multiple Basal Programs

This screen allows you to:

- Turn Advanced Bolus Features (ezCarb, ezBG, Combo Bolus) on or off
- Turn personal Reminders feature on or off
- Select bolus delivery speed (NRML (normal): 1U every second or SLOW: 1U every 4 seconds)

SETUP ADV 2	
BOLUS	
Adv. Bolus	OFF
Reminders	OFF
Delivery	NRML
BASAL	
Programs	4
Home	Next

NOTE: Users may experience a slight stinging sensation with normal bolus delivery. If this occurs changing the bolus delivery speed to “SLOW” may reduce the stinging sensation.

- Select either 1 basal program or 4 basal programs to be displayed in the BASAL MENU

NOTE: If a program other than 1-Weekday is active, you cannot change this setting to display 1 basal program. The Alert screen shown here will be displayed to remind you.

1. Scroll to the desired field.
2. Press **OK** to change to flashing cursor for Edit mode.
3. Use the **▲**/**▼** buttons to change to desired setting.
4. Press **OK** when setting is made.

To move to the next Setup Advanced screen, scroll to the bottom of the screen and highlight “Next”. Press **OK**.

To return to the Home screen, scroll to “Home” and press **OK**.

Alert
1-weekday must be the active program to change the basal display setting.
Confirm

Setup Advanced Screen 3 – Insulin Limits

This screen allows you to:

- Set maximum basal delivery per hour
- Set maximum bolus amount
- Set maximum daily (24-hour) delivery amount. Your pump checks that total insulin delivery each 24-hour period (running from midnight of the previous day to midnight of the current day) does not exceed this limit.
- Set maximum 2-hour delivery amount. Your pump checks that total insulin delivery over each rolling 2-hour period does not exceed this limit.

NOTE: If pump battery power is interrupted for any reason, the pump will record the amount of insulin delivered over the previous 2 hour period as 0 units, rather than the actual amount delivered before power was interrupted.

1. Scroll to the desired field.
2. Press **OK** to change to flashing cursor for Edit mode.
3. Use the **▲/▼** buttons to change to desired setting.
4. Press **OK** when setting is made. To move to the next Setup Advanced screen, scroll to the bottom of the screen and highlight “Next”. Press **OK**.

SETUP ADV 3 Max LIMITS	
Basal	25.00U/Hr
Bolus	35.00U
Daily	600.00U
2Hr	100.00U
Home	Next

To return to the Home screen, scroll to “Home” and press **OK**.

⚠ CAUTION: Should you attempt a delivery that exceeds the limits you have set, your pump will alert you and display a text message. See *Chapter 13 in Section I* for additional information.

Setup Advanced Screen 4 – Language Setup, Display Timeout, Contrast and Battery Type

This screen allows you to:

- Select a different language
- Set the length of time your display stays on before timing out to save battery life
 - 15, 30, 45 or 60 seconds
- Select a contrast setting
- Select Lithium (recommended) or Alkaline battery type. You can also change the battery type on the VERIFY screen when you insert a new battery.

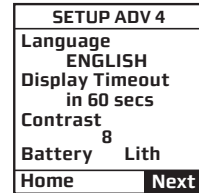





1. Scroll to the desired field.
2. Press **OK** to change to flashing cursor for Edit mode.
3. Use the **▲**/**▼** buttons to change to desired setting.
4. Press **OK** when setting is made.

To move to the next Setup Advanced screen, scroll to the bottom of the screen and highlight “Next”. Press **OK**.

To return to the Home screen, scroll to “Home” and press **OK**.

Contrast Button

Pressing the button on the top of your pump adjusts the contrast. There are three contrast levels: Dim, Default and Bright. To preserve battery life, your pump display will **Auto-dim** when a button is not pressed for half the time your display time out is set. While in Auto-dim mode, you can restore the default contrast level you have set by pressing the  button on top of your pump. Pressing a function button while in Auto-dim mode will restore the default contrast level as well as perform the function of the key. ***If in Call Service Alarm mode, you must use the  button to restore the default contrast level.***

To return contrast setting to original factory default, press the  button and  button at the same time. When the word “Contrast” is displayed on the screen, press any button to return to the default contrast setting.

NOTE: When viewing your pump display in bright sunlight, it is recommended you shade the screen or move to a shady area for best visibility.

Setup Advanced Screen 5 – Auto-OFF Feature

This screen allows you to set your pump to automatically suspend basal delivery and sound an alarm if no buttons are pressed in a user-selected number of hours. This feature can be used as a safeguard in case the user is unconscious.

1. Scroll to the desired field.
2. Press **OK** to change to flashing cursor for Edit mode.
3. Use the **▲**/**▼** buttons to change to desired setting.
4. Press **OK** when setting is made.

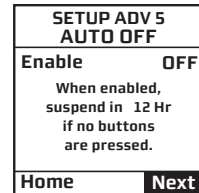

To move to the next Setup Advanced screen, scroll to the bottom of the screen and highlight Next.
Press **OK**.







To return to the Home screen, scroll to “Home” and press **OK**.

NOTE: If pump battery power is interrupted for any reason, the cumulative time that was recorded with the Auto-Off feature will be reset to 0 hours when power is restored.

Setup Advanced Screen 6 – Low Cartridge Warning Setting and Occlusion Sensitivity Setting

This screen allows you to:

- Set your low cartridge warning to alert you at 10, 20, 30, 40 or 50 units remaining
- Set your occlusion detection sensitivity to High (more sensitive) or Low (less sensitive)

1. Use the /  buttons to scroll to the desired field.
2. Press  to change to flashing cursor for Edit mode.
3. Use the /  buttons to change to desired setting.
4. Press  when setting is made.

To move to the next Setup Advanced screen, scroll to the bottom of the screen and highlight “Next”. Press .

To return to the Home screen, scroll to “Home” and press .

NOTE:

- The Low Cartridge Warning only alerts you one time. For example, if you have it set to 30U and receive an alert, and then change the setting to 20U, it will not alert at 20U until after the next cartridge has been primed.
- If a bolus is delivered which causes a Low Cartridge Warning, your remaining insulin may be less than the Warning screen displays.

SETUP ADV 6	
Low Cartridge Warning	20U
Occlusion Sensitivity	L
Home	Next

Warning
Low cartridge. 10U or less left.
Confirm

Setup Advanced Screen 7 – Personal Settings - Insulin to Carb (I:C) Ratios

Your health care team may recommend you use different Insulin to Carb (I:C) ratios for different times of day. When you use the ezCarb feature, your pump will automatically select the I:C ratio for the current time of day.

⚠ WARNING: Your health care team will determine your personal settings for the bolus calculator feature. Use of incorrect personal settings can result in over or under delivery of insulin.

This screen allows you to:

- Set different I:C ratios for 12 different time slots

NOTE: If you set only one ratio, it will be used for the entire 24-hour period.

From the SETUP ADV 7 screen, scroll up to “I:C Ratio”. Press **OK**.

SETUP ADV 7	
I:C Ratio	
ISF	
BG Target	
Home	Next

1. The first segment always starts at midnight. The last time slot available is 11:30pm. Use the **▲/▼** buttons to scroll to the “1U:” (grams) field.
2. Press **OK** to change to flashing cursor for Edit mode.
3. Use the **▲/▼** buttons to change to desired setting.
4. Press **OK** when setting is made.
5. To move to the next I:C Ratio screen, scroll to “--->>” and press **OK**.

I:C Ratio 1 of 12	
Time:	12:00A
1U:	13g
<<----	---->>
Done	Home

6. Scroll up to the “Time” field and press **OK** to change to flashing cursor for Edit mode.
7. Use the **▲/▼** buttons to change the segment start time. Press **OK**.
8. Scroll to the “1U:” (grams) field and press **OK** to change to flashing cursor for Edit mode.
9. Use the **▲/▼** buttons to change the “1U:” (grams) field as desired. Press **OK**. Repeat to set remaining segments per your health care team’s recommendations.

I:C Ratio 2 of 12	
Time: 6:00A	
1U:	15g
<<---->>	
Done	Home

To review your settings, highlight “-->>” and press **OK** to scroll through each segment. Confirm the times and setting values are correct.

When finished, scroll to “Done” and press **OK** to return to the SETUP ADV 7 screen.

To return to the Home screen, scroll to “Home” and press **OK**.

Setup Advanced Screen 7 – Personal Settings - Insulin Sensitivity Factor (ISF)

Your health care team may recommend you use different Insulin Sensitivity Factors (ISFs) for different times of day. When you use the ezCarb or ezBG feature, your pump will automatically select the ISF for the current time of day.















This screen allows you to:

- Set different ISFs for 12 different time slots

NOTE: If you set only one ratio, it will be used for the entire 24-hour period.

From the SETUP ADV 7 screen, scroll up to “ISF”. Press **OK**.

SETUP ADV 7	
I:C Ratio	
ISF	
BG Target	
Home	Next

1. The first segment always starts at midnight. The last time slot available is 11:30pm. Use the / buttons to scroll to the “1U:” (mg/dL) field.
2. Press  to change to flashing cursor for Edit mode.
3. Use the / buttons to change to desired setting.
4. Press  when setting is made.
5. To move to the next ISF screen, scroll to “--->>” and press .
6. Scroll up to the “Time” field and press  to change to flashing cursor for Edit mode.
7. Use the / buttons to change the segment start time. Press .
8. Scroll to the “1U:” (mg/dL units) field and press  to change to flashing cursor for Edit mode.
9. Use the / buttons to change the “1U:” (mg/dL units) field as desired. Press . Repeat to set remaining segments per your health care team’s recommendations.

To review your settings, highlight “--->>” and press  to scroll through each segment. Confirm the times and setting values are correct.

When finished, scroll to “Done” and press  to return to the SETUP ADV 7 screen.

To return to the Home screen, scroll to “Home” and press .

ISF 1 of 12	
Time:	12:00A
1U:	40 mg/dL
<<---->>---->>	
Done	Home

ISF 2 of 12	
Time:	6:00A
1U:	50 mg/dL
<<---->>---->>	
Done	Home

Setup Advanced Screen 7 – Personal Settings - BG Target Ranges

Your health care team may recommend you use different BG Target ranges for different times of day. When you use the ezCarb or ezBG feature, your pump will automatically select the BG Target range for the current time of day.

This screen allows you to:

- Set different BG Targets and ranges for 12 different time slots

NOTE: If you set only one ratio, it will be used for the entire 24-hour period.

From the SETUP ADV 7 screen, scroll up to “BG Target”. Press **OK**.

1. The first segment always starts at midnight. The last time slot available is 11:30pm. Use the **▲/▼** buttons to scroll to the BG Target field.

SETUP ADV 7	
I:C Ratio	
ISF	
BG Target	
Home	Next

2. Press **OK** to change to flashing cursor for Edit mode.

3. Use the **▲/▼** buttons to change to desired setting.

4. Press **OK** when setting is made.

5. Scroll to the “+/-”(range) field. Press **OK** to change to flashing cursor for Edit mode.

BG Target 1 of 12	
Time: 12:00A	
120 mg/dL	
+/- 10 mg/dL	
<<----->>	
Done	Home

NOTE: By setting a range (+/-) your pump will not calculate a BG correction dose if your actual BG is within that range. If you prefer to correct to one target number rather than a range, simply set your range to +/- 0. This screen allows you to:

6. Use the **▲/▼** buttons to change the range as desired. Press **OK**.

BG Target 1 of 12	
Time: 12:00A	
120 mg/dL	
+/- 5 mg/dL	
<<----->>	
Done	Home

7. To move to the next BG Target screen, scroll to “--->>” and press **OK**.

8. Scroll up to the “Time” field and press **OK** to change to flashing cursor for Edit mode.

9. Use the **▲/▼** buttons to change the segment start time. Press **OK**.

10. Scroll to the BG Target field. Press **OK** to change to flashing cursor for Edit mode.

11. Use the **▲/▼** buttons to change to desired setting.

12. Press **OK** when setting is made.

13. Scroll to the “+/-”(range) field. Press **OK** to change to flashing cursor for Edit mode.

14. Use the **▲/▼** buttons to change the range as desired. Press **OK**. Repeat to set remaining segments per your health care team’s recommendations.

To review your settings, highlight “--->>” and press **OK** to scroll through each segment. Confirm the times and setting values are correct.

When finished, scroll to “Done” and press **OK** to return to the SETUP ADV 7 screen.

To return to the Home screen, scroll to “Home” and press **OK**.

BG Target 2 of 12	
Time:	6:00A
+/-	120 mg/dL 10 mg/dL
<<----	---->>
Done	Home

Setup Advanced Screen 8 – Insulin on Board (IOB) Setting





This feature allows you to program the rate at which your body uses your bolus. Even with rapid-acting insulin, your body takes some time to use your entire bolus insulin. When this feature is activated and you give a bolus, your pump will tell you how much Insulin on Board (IOB) is currently remaining and will calculate a decreased bolus dose as an option. This helps to prevent “stacking” insulin and can help reduce your risk of hypoglycemia*. The duration of insulin action varies from person to person and can vary based on the infusion site you have selected and your activity level, among other factors. Your health care team will give you a recommended duration to program into your pump.

**Recommended reading for pump users includes:*

- *Pumping Insulin, by John Walsh, PA, CDE and Ruth Roberts, MA*
- *Smart Pumping, by Howard Wolpert, MD*

⚠ WARNING: This feature is intended for use only with U100 rapid-acting insulin analogs such as Novolog® or Humalog®. If you use an insulin other than Novolog® or Humalog®, **Do Not** use this feature. Use of any insulin with lesser or greater concentration can result in serious injury or death.

This screen allows you to:

- Turn the IOB feature on or off
 - Select the duration
1. Use the / buttons to scroll to the desired field.
 2. Press  to change to flashing cursor for Edit mode.
 3. Use the / buttons to change to desired setting.

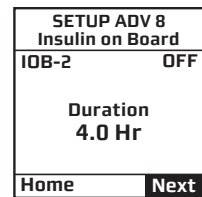

4. Press **OK** when setting is made.

To move to the next Setup Advanced screen, scroll to the bottom of the screen and highlight “Next”. Press **OK**.

To return to the Home screen, scroll to “Home” and press **OK**.

NOTE: Your pump is constantly tracking IOB, so when you turn on the feature, your pump will immediately take into account the current amount remaining from previous bolus doses within the time frame you’ve selected during set up of the feature.

Points to remember about the IOB feature on your pump

- A curvilinear algorithm is used, which more closely mimics the way drugs decay in the body versus a straight line decay.
- With **BG below target**, IOB amount is displayed and is subtracted from the carb portion of the bolus.
- With **BG within target**, IOB amount is displayed for reference but not subtracted from bolus total.

- With **BG above target**, IOB amount is displayed and is subtracted from BG bolus.

Setup Advanced Screen 9 – Sick Day Guidelines

During your pump training, your health care team will discuss guidelines to use when you're sick. This is a convenient way to store your basic sick day guidelines as recommended by your health care team. For more information on sick day guidelines, refer to *Chapter 15 in Section I* and contact your health care team.

This screen allows you to:

- Set a BG limit as a reminder for testing when sick
- Set the frequency of checking for ketones when sick
- Set the frequency of checking your BG when sick

To move to the next Setup Advanced screen, scroll to the bottom of the screen and highlight "Next". Press **OK**.

To return to the Home screen, scroll to "Home" and press **OK**.

NOTE: This screen is intended as a reference only. Alerts are NOT triggered based on values displayed on this screen.

SETUP ADV 9 Sick days	
BG over	240 mg/dL
Check ketones every	4 Hrs
Check BG every	2 Hrs
Home	Next

Setup Advanced Screen 10 – Establishing Communication with Your Meter Remote

This screen allows you to activate the RF and pairing features on your pump. When you are ready to begin using your pump and meter remote together as a system, you will need to activate RF communication and pair the devices. See *Chapter 2 in Section III*.

⚠ CAUTION: Using the features in this chapter requires an advanced understanding of insulin pump therapy and should not be used without training and advice from your health care team. In order to achieve optimal results, some of these features should only be used once you have tested and fine-tuned your basal rates and your health care team has determined your individual targets and ratios.

NOTE: Before using these features, you must turn them on in the Setup Advanced menu. See *Chapter 10* in *Section I*.

Audio Bolus and ezBolus™

The Audio Bolus feature of the OneTouch® Ping® Insulin Pump allows you to bolus without looking at the screen display. This is convenient if you wear your pump under your clothing. When first using the audio bolus feature, also check the display screen until you are comfortable with the programming steps. If you do not wish to use the Audio Bolus feature, this button serves as a shortcut to the Normal Bolus screen. See *ezBolus™* in this chapter.

⚠ CAUTION: When you first use the Audio Bolus feature, you should always look at the screen to confirm correct programming until you are comfortable with the feature.

1. Turn on Audio Bolus in the Setup Advanced menu and select your preferred step size. See *Chapter 10* in *Section I*.
2. The Audio Bolus button is the soft rubber button on the end of your pump. Press it once. Your pump will beep (or vibrate) to indicate you've accessed Audio Bolus mode as well as indicate the step size you've set up.

The number of beeps (or vibrate pulses) reminds you of the step size you've set.

- 1 indicates 0.1U step size
- 2 indicates 0.5U step size
- 3 indicates 1.0U step size
- 4 indicates 5.0U step size

3. Press the Audio Bolus button once for each step size you've programmed to reach the desired total amount. For example, if you are using 1.0U step size and you wish to bolus 4 units, press the button 4 times. You will hear a beep tone or vibrate for each button press. If you are using 0.5U step size and you wish to bolus 4 units, press the button 8 times.
4. Within 5 seconds, your pump will respond with a number of confirmation beeps equal to the number of times you pressed the Audio Bolus button.

NOTE: Do Not press any of the function buttons at this time unless you wish to cancel delivery.

5. Within 5 seconds, your pump will beep twice to "ask" you to confirm that you wish to activate delivery and "Confirm" is displayed on the Audio Bolus screen.

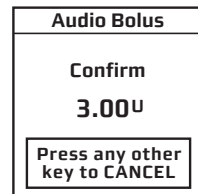
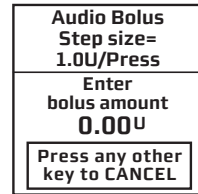

6. Within 5 seconds, press the button again to activate delivery. Your pump will beep twice to confirm your delivery command. The DELIVERING bolus screen is displayed and your pump will beep once to signal the start of delivery and once to signal end of delivery (if you turned on Normal Bolus Sounds in Setup).

If you wish to cancel the Audio Bolus, press any function button (not the contrast button).

If you cancel a bolus delivery after you've activated it, the screen at right will be displayed. See *Chapter 13 in Section I*.

NOTE: If during a bolus delivery your low cartridge level is reached, your pump will not display the warning until after the bolus is completed. So you could possibly have less insulin available than your low cartridge setting.

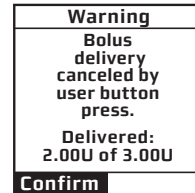
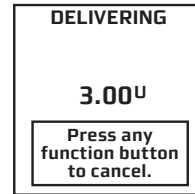

Example: Your low cartridge warning is set to 10 (units). You have 20 units of insulin remaining and you deliver a 15 unit bolus. The Low cartridge warning appears after bolus is completed and you have only 5 units left – not 10 units. The Wake up screen will show the remaining insulin amount.

The maximum number of Audio Bolus button presses is 20. Therefore, if you've set the step size to 0.1U, the maximum audio bolus amount is 2U. If you've set the step size at 0.5U, the maximum audio bolus amount is 10U and if your step size is 1.0U, the maximum audio bolus amount is 20U. With a 5.0U step size, the maximum cannot be greater than 35U, which is the maximum amount for any type of bolus.

ezBolus™

If you do not have your Audio Bolus feature turned on, the button on the end of your pump will function as a shortcut to the Normal Bolus screen.

1. Press the button on the end once. The Normal Bolus screen is displayed. Program a Normal Bolus as usual.

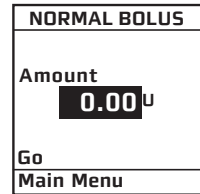

Advanced Bolus Features

- ezCarb
- ezBG
- Combo Bolus
- Reminders

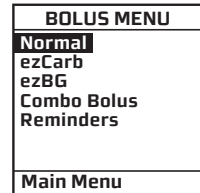

All Advanced Bolus features are activated in the Setup Advanced Menu. See *Chapter 10 in Section I*. When the Advanced Bolus features and Reminders are activated, the full BOLUS MENU is displayed.

⚠ WARNING: Be sure to review all the values used in bolus calculations to make sure they are correct. You may always adjust the insulin units up or down before you decide to administer your bolus. If you dose an insulin amount that is too high or too low, this may result in a hypoglycemic or hyperglycemic event. Please discuss the bolus calculator feature and all relevant personal settings with your health care professional before using the calculator for the first time.

ezCarb

This feature allows you to manually enter the number of carbs eaten, and your pump will automatically calculate your bolus dose, based on the I:C ratio, ISF and BG Target range you have entered for the current time of day. Consult your health care team for your personal I:C ratios, ISFs and BG Target ranges. See *Chapter 10* in *Section I*.

If the IOB feature is activated, your pump will calculate a reduced amount for high BG correction boluses and for Carb Boluses if you entered a below-target BG value.

When you use your meter remote to deliver an ezCarb Bolus, you may also select the number of carbs eaten directly from a Food Database stored in your meter remote, see *Chapter 4* in *Section III*. The Food Database is available through an upload to your meter remote from ezManager® Software. For instructions on uploading the Food Database, refer to the ezManager® User Guide included with the software.

Entering Carbs Manually

- From the BOLUS MENU, scroll to “ezCarb”. Press **OK**. The ezCarb Home screen is displayed.
- The cursor will flash on the “Carbs” field to indicate that you can edit the total number of carbs eaten. Use the **▲/▼** buttons to enter the number of carbs. Press **OK**. “Add BG” is highlighted. (See *Adding a BG Bolus to ezCarb* in this chapter.)

NOTE: The max limit for ezCarb Total is 999g.

- Check that the grams of carb entered and your I:C ratio at the top of the screen are correct.
 - If the entries are *correct*, scroll to “Show Result”. Press **OK** and go to Step 5.
 - If *not correct*, scroll up to highlight the field and press **OK** to activate Edit mode. Use **▲/▼** buttons to enter your I:C ratio and/or change the carb entry. Press **OK**.
- Scroll down to “Show Result”. Press **OK**.
- The Bolus Total screen is displayed. The bolus amount field is highlighted and flashing to indicate you can enter the total amount as shown or adjust as needed. Enter your bolus amount. Press **OK**.

NOTE: Calculated total units will be rounded to the nearest .05 units.

BOLUS MENU	
Normal	
ezCarb	
ezBG	
Combo Bolus	
Reminders	
Main Menu	

ezCarb Home		
Carbs:		34g
I:C	IU:	15g
Add BG		
Show Result		
Main Menu		

ezCarb Home		
Carbs:		34g
I:C	IU:	15g
Add BG		
Show Result		
Main Menu		

Bolus Total	
Carb	2.26U
BG +	0.00U
IOB	--- U
Total =	2.25U
Go	0.00U
Type	Normal
Main Menu	

Bolus Total	
Carb	2.26U
BG +	0.00U
IOB	--- U
Total =	2.25U
Go	2.25U
Type	Normal
Main Menu	

6. “Go” is highlighted. If you wish to give a Normal Bolus, press **OK** to deliver.

Bolus Total	
Carb	2.26U
BG +	0.00U
IOB	---U
Total =	2.25U
Go	2.25U
Type	Normal
Main Menu	

DELIVERING
2.25U
Press any function button to cancel.

7. If you wish to give a Combo Bolus, scroll to the “Type” field and press **OK** to edit.
8. Use the **▲**/**▼** buttons to select bolus type: “Normal” (default) or “Combo”. Press **OK**.
9. “Go” is highlighted. Press **OK**.

Bolus Total	
Carb	2.26U
BG +	0.00U
IOB	---U
Total =	2.25U
Go	2.25U
Type	Combo
Main Menu	

NOTE: If you select the Combo Bolus option, the Combo Bolus screen will be displayed. See *Combo Bolus* in this chapter for instructions on delivering the Combo Bolus.

Entering Carbs Using the Food Database

This feature is only available on your meter remote, and can be accessed when delivering an ezCarb Bolus from your meter remote. See *Chapter 4* in *Section III*.

ezCarb Home		
Carbs:		34g
I:C	IU:	15g
Add BG		
Show Result		
Main Menu		

Adding a BG Bolus to ezCarb

1. On the ezCarb Home screen, enter the number of carbs. Press **OK**.

2. “Add BG” is highlighted. Press **OK**. The BG CORRECT screen is displayed.

BG CORRECT		mg/dL
Actual	-	220
Target	= +	120
		100
ISF		37 mg/dL
Show Result		
Main Menu		

BG CORRECT		mg/dL
Actual		220
Target	= +	120
		100
ISF		37 mg/dL
Show Result		
Main Menu		

3. The “Actual” field is highlighted and flashing to indicate Edit mode. Use the **▲/▼** buttons to enter your BG value. Press **OK**. “Show Result” is highlighted.

4. Check that the BG Target range and ISF are correct.

a. If they are *correct*, press **OK** with “Show Result” highlighted.

b. If they are *not correct*, scroll up to highlight the fields and press **OK**. Use the **▲/▼** buttons to adjust the values. Press **OK** to exit Edit mode. Scroll down to “Show Result”. Press **OK**.

BG CORRECT		mg/dL
Actual	-	220
Target	= +	120
		100
ISF		37 mg/dL
Show Result		
Main Menu		

BG CORRECT		mg/dL
Actual		220
Target	= +	120
		100
ISF		37 mg/dL
Show Result		
Main Menu		

5. The Bolus Total screen is displayed and shows the calculated bolus units from your ezCarb Bolus. The bolus amount field is highlighted and flashing, and displays 0.00 units.

Bolus Total	
Carb	2.26U
BG +	2.70U
IOB	-- -- U
Total =	4.95U
Go	0.00U
Type	Normal
Main Menu	

6. Enter the Bolus amount and press **OK**. “Go” is highlighted. Press **OK** to deliver as a Normal Bolus or scroll to the “Type” field to select Combo Bolus, then select “Go”.

If you selected the Combo Bolus option, you will begin the steps for delivering the ezCarb units as a Combo Bolus (see *Combo Bolus* in this chapter). The bolus amount you entered on the Bolus Total screen in step 6 will appear in the “Total” field on the first Combo Bolus screen.

Bolus Total	
Carb	2.26U
BG +	2.70U
IOB	-- -- U
Total =	4.95U
Go	4.95U
Type	Normal
Main Menu	

ezBG

This feature allows you to enter your BG reading and your pump will automatically calculate a BG correction bolus based on the ISF and BG Target range for the current time of day. If the IOB feature is activated, your pump will calculate a reduced dose for high BG correction boluses.

1. From the BOLUS MENU, select “ezBG”. Press the **OK** button.

BOLUS MENU
Normal
ezCarb
ezBG
Combo Bolus
Reminders
Main Menu

2. The “Actual” field will be highlighted and flashing to indicate Edit mode. Use the / buttons to enter your actual BG reading. Press the button to confirm the entry and exit Edit mode.

ezBG	
	mg/dL
Actual	224
Target	- 120
	= + 104
ISF	37 mg/dL
Show Result	
Main Menu	

ezBG	
	mg/dL
Actual	224
Target	- 120
	= + 104
ISF	37 mg/dL
Show Result	
Main Menu	

3. Check to be sure the BG Target and Insulin Sensitivity Factor (ISF) are correct. Your health care team will give you these values. If you need to edit these fields, scroll up to highlight the field and press to activate Edit mode. Use / buttons to change target. Press to confirm and to exit Edit mode.

ezBG	
	mg/dL
Actual	224
Target	- 120
	= + 104
ISF	37 mg/dL
Show Result	
Main Menu	

4. “Show Result” is highlighted. Press .

ezBG	
	mg/dL
Actual	224
Target	- 120
	= + 104
ISF	37 mg/dL
Show Result	
Main Menu	

5. The ezBG Total screen is displayed with a suggested bolus amount. The bolus amount field is highlighted and flashing to indicate you can enter the total amount as shown or adjust as needed. Enter your bolus amount. Press to deliver.

ezBG Total	
BG	+ 2.81U
IOB	--- U
Total	= 2.80U
	0.00U
Go	
Main Menu	

ezBG Total	
BG	+ 2.81U
IOB	--- U
Total	= 2.80U
	2.80U
Go	
Main Menu	

DELIVERING	
2.80U	
Press any function button to cancel.	

NOTE: If the IOB feature is activated, your pump will calculate a reduced BG Bolus amount for your review.

ezBG Total		
BG	+	2.81U
IOB	-	1.00U
Total	=	1.80U
1.80U		
Go		
Main Menu		





NOTE: If you enter a BG amount below 70 mg/dL or above 250 mg/dL, your pump will alert you that you've entered an out of range BG. To confirm the Alert, press **OK**. Treat the out of range BG as recommended by your health care team.

Alert	
LOW BG	
Treat low BG.	
No bolus recommended.	
Monitor BG.	
Confirm	

Alert	
HIGH BG	
Treat high BG.	
Check site.	
Check ketones.	
Monitor BG.	
Confirm	

Combo Bolus



The Combo Bolus feature is used to give both a Normal and Extended Bolus. This feature is useful for consumption of high fat meals such as pizza, if you will be “grazing” over a few hours or if you have gastroparesis. You can program part of your bolus amount to be delivered immediately and part of it to be delivered slowly over the course of up to 12 hours. Your health care team can help you determine the “split” of Normal to Extended insulin amounts, as well as the duration that is most appropriate for you.

1. From the BOLUS MENU, select “Combo Bolus”. If you used the ezCarb Bolus option to calculate a bolus and chose to deliver it as a Combo Bolus, you will begin at the Combo Bolus screen in step 2.
2. Use the /  buttons to enter the Total bolus amount. Press . “Go” is highlighted. The factory default setting for Duration is 30 minutes, and the Ratio is 0% Normal and 100% Extended. If these settings are appropriate, press  to deliver.
3. To change either the Duration or Ratio, scroll up to the desired field and press  to activate Edit mode.

BOLUS MENU	
Normal	
ezCarb	
ezBG	
Combo Bolus	
Reminders	
Main Menu	

Combo Bolus	
Total	8.50U
Duration	0.5Hr
Normal: Extend	
0: 100%	
0.00: 0.00U	
Go	
Main Menu	

Combo Bolus	
Total	8.50U
Duration	4.0Hr
Normal: Extend	
30: 70%	
2.55: 5.95U	
Go	
Main Menu	

4. Use the / buttons to change settings. As you change the Ratio by percentage, the amount in units is automatically changed. *You cannot change the ratio by units, only by percentage.*
5. When settings are correct, press  to confirm and exit Edit mode.

Combo Bolus	
Total	8.50U
Duration	0.5Hr
Normal: Extend	
	30 70%
	2.55: 5.95U
Go	
Main Menu	

NOTE: Your pump is “smart”; it will remember your last duration and the ratio (as percentages) you programmed. So if you use the same duration and ratio for certain types of meals, you need only change the total bolus amount the next time you use this feature. However, the last programmed Combo Bolus settings will be cleared each time you change the battery.

6. Scroll to “Go” and press  to activate. The Home screen shows Combo Bolus active.

Combo Bolus	
Total	8.50U
Duration	4.0Hr
Normal: Extend	
	30: 70%
	2.55: 5.95U
Go	
Main Menu	

2:27PM	
	
BOLUS ACTIVE	
Basal Rate	
0.675U/Hr	
Insulin: 105U	
Status	Menu

To *cancel* an active Combo Bolus from the BOLUS MENU, select “Combo Bolus”. Details of the active Combo Bolus will be displayed.

Scroll to “CANCEL” and press  to cancel the Combo Bolus.

NOTE: If you Suspend your pump, any active Combo Bolus will also be canceled and the screen display will alert you. Combo Bolus is also canceled when you change the battery and/or prime your pump.

Combo Bolus ACTIVE	
Duration	0.0 : 4.0Hrs
Delivered	2.55U : 8.50U
CANCEL	
Main Menu	

Reminders

This feature allows you to set personal reminders. You can set two bolus reminders for times of day, and one reminder to check BG at a certain time after a bolus. Confirm the Reminder by pressing **OK**. Once you've confirmed the Reminder, you will not be alerted again.

BOLUS MENU
Normal
ezCarb
ezBG
Combo Bolus
Reminders
Main Menu

Bolus Reminders for Time of Day

1. From the BOLUS MENU, select "Reminders". Press **OK**.
2. The "Reminder-1" field will be highlighted with a flashing cursor to indicate Edit mode. Use the **▲/▼** buttons to turn on or off. Press **OK** to confirm and exit Edit mode.

REMINDERS
Reminder-1 OFF
Time = 12:00PM
Reminder-2 OFF
Time = 12:00PM
BG Check OFF
After Bolus = 1 Hr
Main Menu

3. The "Time" field for this reminder will be highlighted. Press **OK** to activate Edit mode. Use the **▲/▼** buttons to enter the time you wish a reminder to sound (or vibrate, if that is the setting you selected in the SETUP SOUND menu). Press **OK** to confirm your setting and exit Edit mode. When the feature is turned on, your pump will display the "Reminder" screen on the right at the selected time of day.

REMINDERS
Reminder-1 OFF
Time = 12:00PM
Reminder-2 OFF
Time = 12:00PM
BG Check OFF
After Bolus = 1 Hr
Main Menu

Reminder
12:00PM
Confirm

4. Repeat for the Reminder 2.

BG Check Reminder

- From the REMINDERS menu, select “BG Check”. Press **OK** to activate Edit mode to turn this reminder on or off. Press **OK** to confirm and exit Edit mode.
- Scroll down to highlight the “After Bolus” field. Press **OK** to select the field and activate Edit mode. Use the **▲/▼** buttons to enter how long after a Normal Bolus you wish your pump to sound (or vibrate) to remind you to check your BG. You can select a reminder time of 1, 2, 3 or 4 hours.

When this feature is turned on, your pump will display the BG Reminder screen immediately after a bolus. On this screen you can use the **▲/▼** buttons to select a different reminder time (1, 2, 3, or 4 hours), or opt not to be reminded by entering 0. For example, if you have given a bolus in the evening, you may not wish to have the Reminder sound while you are sleeping. If the Reminder is not confirmed, battery life will be reduced and the Replace Battery Alarm will appear sooner than expected.

NOTE:

- When you enter a time, your pump will sound a reminder and display this screen at that time after any Normal Bolus is programmed, including the Normal portion of a Combo Bolus. If you program an Extended Bolus only, the reminder will sound at the default time you have set.
- If pump battery power is interrupted for any reason, any BG Check Reminder scheduled to appear will be canceled when power is restored until the next Bolus is delivered.

- When finished setting reminders, scroll to “Main Menu” and press **OK** to display the MAIN MENU.

REMINDERS	
Reminder-1	OFF
Time =	12:00PM
Reminder-2	OFF
Time =	12:00PM
BG Check	OFF
After Bolus =	1 Hr
Main Menu	

REMINDERS	
Reminder-1	OFF
Time =	12:00PM
Reminder-2	OFF
Time =	12:00PM
BG Check	ON
After Bolus =	1 Hr
Main Menu	

BG Reminder	
Check BG in 1 Hr	
Confirm	

Reminder Check BG	
Last bolus 12:15PM	
Confirm	

Delivery Speed - Bolus

On rare occasions, usually with very large boluses, users may experience a slight stinging sensation with rapid bolus delivery. If this is a concern, you can set the bolus delivery speed to slow to accommodate your needs. If you use the slow setting, your pump will pause approximately 4 seconds in between delivery of each unit of insulin programmed.

Multiple Basal Programs

This feature allows 4 different Basal programs to show on your BASAL MENU screen. Users find this feature beneficial if their activity level is different during the week than on weekends. Switching work shifts at work is another reason to use multiple basal programs. Some use a different basal program during menstruation. An “A” will appear to the left of the basal program that is currently active.

NOTE: If a program other than 1-Weekday is active, you cannot change this setting to display 1 basal program. The Alert screen shown here will pop up to remind you.

BASAL MENU	
Total	13.60U
Temp	
A1-WEEKDAY	
2-other	
3-weekend	
4-exercise	
Main Menu	

Alert
1-weekday must be the active program to change the basal display setting.
Confirm

IOB

Even with rapid-acting insulin, your body takes some time to use the entire bolus amount. If you have activated this feature, your pump will track the bolus insulin remaining in your system - IOB - and calculate a suggested lower BG correction bolus dose. The lower dose is only recommended if you use the ezBG feature or if you add a BG bolus to an ezCarb bolus. For this feature to give optimal results, you should always use either ezBG or the Add BG feature during ezCarb programming when entering a BG correction bolus.

Bolus Total	
Carb	2.25U
BG	+ 2.70U
IOB	- 1.00U
Total	= 3.95U
	3.95U
Go	
Type	Normal
Main Menu	

⚠ CAUTION: Your health care team will give you recommendations specific to your plan of treatment.

In the examples shown here, the IOB amount is subtracted from the BOLUS TOTAL screen and the ezBG Total screen.

NOTE:

- When you replace the battery, the IOB amount is cleared.
- Your pump constantly tracks IOB. If you've given a bolus before turning on the feature, your pump will show the remaining amount from that bolus as IOB immediately.

ezBG Total	
BG	+ 2.81U
IOB	- 1.00U
Total	= 1.80U
	1.80U
Go	
Main Menu	

Sick Day Guidelines

To review your basic sick day guidelines, refer to this screen. For more information on sick day guidelines, refer to *Chapter 15* in *Section I* and contact your health care team.

1. From the SETUP menu, select “Advanced”.
2. Scroll to the Setup Advanced Screen 9.
3. Enter or review the guidelines as recommended by your health care team.

SETUP ADV 9	
Sick days	
BG over	240 mg/dL
Check ketones every	4 Hrs
Check BG every	2 Hrs
Home	Next

Establishing Communication with your Meter Remote

When you are ready to begin using your pump and meter remote together as a system, you will need to activate RF communication and pair the devices. See *Chapter 2* in *Section III*.

The Vents

Your pump features a redundant Vent Safety System. Vents serve two purposes. First, they allow air to enter and exit your pump so that pressure is equalized under a variety of environmental circumstances, such as changes in altitude. Second, the vents are backed by a special membrane, which keeps water from entering your pump.

Battery Cap with O-ring and Vent

Your battery cap contains an o-ring and vent. There is a tiny hole backed by a membrane, which allows air to pass through but prevents water from entering. The o-ring helps to keep your pump waterproof. It is recommended that you change the battery cap/vent every 6 months. If you work in a dusty environment such as a construction site, mill, cement factory, etc., or if you are a frequent swimmer, you should change your battery cap every 3 months. You can call Animas® to order an extra battery cap.



⚠ WARNING: Under no circumstances should you introduce any kind of sharp object into the vent openings to clean them. Doing so could compromise your pump's waterproof capabilities. If at any time you suspect the vent opening is clogged, replace the battery cap.

Cleaning

⚠ CAUTION: Do Not use household or industrial cleaners, chemicals, solvents, bleach, scouring pads or sharp instruments to clean your pump. Never put your pump in the dishwasher or use very hot water to clean it. Use only a very mild detergent (for example a drop of liquid soap in a glass of water) and a lint-free cloth.

Never put your pump in a microwave oven or baking oven to dry it. Use a soft towel.

Never clean the battery or insulin cartridge compartments.

General Wear and Tear

If you drop your pump or it has been hit against something hard, inspect it to be sure it is still working properly. Check that the display screen is working and clear, that the cartridge cap, battery cap and infusion set are properly in place. Check for leaks around the cartridge by wrapping a piece of tissue around the connection area. Cracks, chips or damage to your pump may impact the battery contact and/or the waterproof feature of your pump. Call our Customer Service representatives at 1 877 937-7867 if you identify or suspect your pump is damaged. They will help determine if your pump should be replaced.

Disposal

International and US regulations require controlled disposal of devices such as insulin pumps.

Dispose of batteries according to your local environmental regulations.

Alerts, Warnings and Alarms

Your pump has a progressive warnings and alarms safety system. This means if you do not confirm the warning or alarm, it will progress to the sweep alarm with vibrate within one hour. At the high volume stage, if you do not confirm the warning or alarm, the sweep alarm will begin and will not stop until appropriate action is taken.

NOTE: Your pump uses battery power to notify you of alerts, warnings, and alarms. If you do not confirm the notification, your pump will continue to use battery power as the notifications repeat and progress. This will result in reduced battery life and the Replace Battery Alarm screen appearing sooner than expected.

Additionally, certain warnings (e.g., Low Cartridge Warning, Occlusion Alarm) take precedence over less critical ones (e.g., Low Battery Warning). This means if you do not confirm the more critical warning, battery life will be reduced and your pump may skip the Low Battery Warning and go directly to the Replace Battery Alarm, or battery life will end before a Replace Battery Alarm is displayed.

Alerts are automatically displayed to remind you of a function that you've set or a condition that exists. Warnings are triggered for a variety of reasons. They require you to confirm the warning by pressing  and/or taking action to address the warning. Alarms are triggered by several conditions. All require you to address the alarm by taking appropriate action in order to clear the alarm condition.

 WARNING: CONFIRM all pump alerts, alarms and warnings as soon as possible.

Not confirming alerts, alarms and warnings can affect insulin delivery as follows:

- Pump battery power may be drained much sooner than expected, leaving you without a way to deliver insulin if you do not have a replacement battery.
- The calculation of Insulin on Board (IOB) when using the bolus calculator feature may not be as accurate, resulting in the “suggested” bolus amount being less than what it should be.
- Basal and bolus delivery may be suspended for up to 2 hours once the alert, alarm or warning is confirmed without the pump directly notifying the user.
- Any Combo Bolus or Temp Basal in effect may be canceled without the pump directly notifying the user.

Any of these situations can result in over delivery or under delivery of insulin, resulting in serious injury or death.

 - Indicates that this alert, warning or alarm can play a tune as the initial notification for medium and high volume settings. The pump default for sounds at the low volume setting is a factory-set sound and cannot be modified with ezManager® Software.

IMPORTANT: Many of the following pump alerts, warnings and alarms will also sound and/or display on your meter remote, once you begin using the devices together as a system. See Chapter 6 in Section III for a complete list.

NOTE: Alarms, warnings and alerts will display actual insulin units during pump operation, rather than the “XX” or “XXX” units displayed on some of the screens in this list.

Alerts, Warnings and Alarms

Alert: Active Basal Program Empty	
Cause	Active basal program is empty.
Effect	No basal deliveries.
Message	Displayed once until confirmed or until pump goes to sleep and each time manually awakened.
Action	None required but can confirm or select Basal Menu.
Beeps/Vib	User selected, one time and each time manually awakened. No progression.

Alert
Your active basal program is empty. 0.000U/Hr
Confirm Basal Menu

Alert: Temp Basal Minimum Rate	
Cause	Negative Temp Basal activated.
Effect	Basal delivery will not go below 0.025U/Hr.
Message	Displayed once for 3 seconds.
Action	None required.
Beeps/Vib	User selected, one time. No progression.

Alert
Temp Active Minimum Basal rate limited to 0.025U/Hr

Alerts, Warnings and Alarms

Alert: Suspend (Temp Basal/Combo Bolus Canceled)	
Cause	Pump suspended.
Effect	Any active Temp Basal/Combo Bolus canceled.
Message	Displayed once for 3 seconds.
Action	None required.
Beeps/Vib	User selected, one time. No progression.

Alert
Pump Suspended
If active, Temp Basal & Combo Bolus have been canceled.

Alert: Low BG 🎵	
Cause	BG entry below 70 mg/dL.
Effect	Requires user confirmation to continue.
Message	Displayed until confirmed or until pump goes to sleep.
Action	Press OK to confirm.
Beeps/Vib	User selected, one time. No progression.

Alert
LOW BG
Treat low BG. No bolus recommended. Monitor BG.
Confirm

Alerts, Warnings and Alarms

Alert: High BG 🎵	
Cause	BG entry above 250 mg/dL.
Effect	Requires user confirmation to continue.
Message	Displayed until confirmed or until pump goes to sleep.
Action	Press  to confirm.
Beeps/Vib	User selected, one time. No progression.

Alert
HIGH BG Treat high BG. Check site. Check ketones. Monitor BG.
Confirm

Alert: Clear Program Basal Segments	
Cause	Clear command selected from BASAL OPTIONS screen.
Effect	Requires user confirmation to continue.
Message	Displayed until one of the two options is selected or until pump goes to sleep.
Action	Select “Clear Program” or “Basal Options”.
Beeps/Vib	User selected, one time.

Alert
Clear Program deletes all basal segments in this program.
Clear Program Basal Options

Alerts, Warnings and Alarms



Alert: Basal Program Display Change 🎵	
Cause	Changing display of basals from 4 to 1 but program 1 is not currently active.
Effect	Requires user confirmation to continue.
Message	Displayed until confirmed or until pump goes to sleep.
Action	Press OK to confirm.
Beeps/Vib	User selected, one time.

Alert
1-weekday must be the active program to change the basal display setting.
Confirm

Warning: Basal Delivery Suspended 🎵	
Cause	Basal Edit was not saved.
Effect	Basal delivery stopped.
Message	Displayed when manually awakened until confirmed.
Action	Press OK to select “Edit Basal”. Review basal edits and select “Save/Review”.
Beeps/Vib	User selected, every 3 minutes until confirmed. If not confirmed, progresses to sweep/vibe within one hour.

Warning
Basal edit not saved. Basal delivery suspended.
Edit Basal

Alerts, Warnings and Alarms

Warning: Suspend 	
Cause	Pump suspended manually.
Effect	All deliveries stop.
Message	Displayed each time pump is awakened until confirmed and once every 15 minutes until action is taken.
Action	Press  to confirm. Resume delivery.
Beeps/Vib	User selected, once every 15 min. No progression if confirmed each time displayed. Sweep/vibe within one hour if not confirmed.

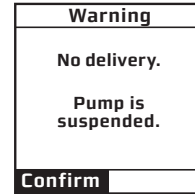

Alerts, Warnings and Alarms

Warning: No Cartridge Detected, Deliveries Disabled 🎵	
Cause	No cartridge detected after "Load cartridge" step during Rewind/Prime.
Effect	No deliveries.
Message	Displayed when manually awakened until confirmed.
Action	Press OK to confirm. Be sure Rewind/Prime sequence is completed with cartridge properly in place.
Beeps/Vib	User selected, once every 3 min. No progression if confirmed each time displayed. Sweep/vibe within one hour if not confirmed.

Warning
No cartridge detected.
Delivery disabled.
Confirm

Alerts, Warnings and Alarms

Warning: Low Battery 🎵	
Cause	Battery life will only last a minimum of 30 minutes.
Effect	Deliveries continue.
Message	Displays when pump is awake until confirmed. Displays when triggered by event (such as bolus) & when manually awakened.
Action	Press OK to confirm. Insert new battery.
Beeps/Vib	User selected, every 3 minutes until confirmed. If not confirmed, progresses to sweep/vibe within one hour.

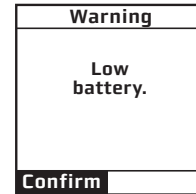

Warning: Low Cartridge 🎵	
Cause	Low insulin level reached.
Effect	Deliveries may continue until Empty Cartridge alarm is triggered.
Message	Displayed when manually awakened until confirmed.
Action	Press OK to confirm. Replace with filled cartridge.
Beeps/Vib	User selected, every 3 minutes until confirmed. If not confirmed, progresses to sweep/vibe within one hour.

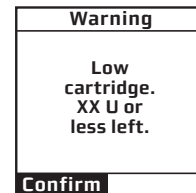

Alerts, Warnings and Alarms

Warning: Exceeds Max Bolus 🎵	
Cause	Audio bolus delivery exceeds user-set maximum.
Effect	Bolus delivery stops.
Message	Displayed when manually awakened until confirmed.
Action	Press OK to confirm. Reprogram max bolus amount in the Setup Advanced menu.
Beeps/Vib	User selected, every 3 minutes until confirmed. If not confirmed, progresses to sweep/vibe within one hour.

Warning
Exceeds max bolus XX.XX U.
No bolus delivery.
Confirm

Alerts, Warnings and Alarms

Warning: Exceeds Max TDD 🎵	
Cause	Bolus delivery exceeds user-set maximum.
Effect	All deliveries stop until action is taken. Any Combo Bolus or Temp Basal is temporarily suspended.
Message	Displayed when manually awakened until confirmed.
Action	Press OK to confirm. Reprogram max TDD amount in the Setup Advanced menu. If the Warning is not confirmed by the time your pump clock passes midnight, the message will continue to be displayed, but any Combo Bolus or Temp Basal that is currently suspended will resume.
Beeps/Vib	User selected, every 3 minutes until confirmed. If not confirmed, progresses to sweep/vibe within one hour.

Warning
Exceeds max TDD XXX U.
No delivery.
Confirm

Alerts, Warnings and Alarms

Warning: Exceeds Max Basal 🎵	
Cause	Basal delivery rate (or Temp Basal delivery) exceeds user-set maximum.
Effect	Basal delivery stops.
Message	Displayed when awakened (by basal delivery attempt every 3 min. or manually) until confirmed.
Action	Press OK to confirm. Reprogram Max Basal amount in the Setup Advanced menu (or reprogram Temp Basal).
Beeps/Vib	User selected, every 3 minutes until confirmed. If not confirmed, progresses to sweep/vibe within one hour.

Warning
Exceeds max basal XXX U/Hr. No basal delivery.
Confirm

Alerts, Warnings and Alarms

Warning: Exceeds Max 2-hour Delivery	
Cause	Combined basal and bolus delivery exceeds user-set 2-hour maximum.
Effect	Insulin delivery stops.
Message	Displayed when manually awakened until confirmed.
Action	Press OK to confirm. Reprogram Max 2-Hr amount in the Setup Advanced menu.
Beeps/Vib	User selected, every 3 minutes until confirmed. If not confirmed, progresses to sweep/vibe within one hour.

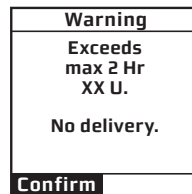

Alerts, Warnings and Alarms

Warning: Delivery Canceled due to Low Cartridge	
Cause	Basal or Bolus delivery exceeds insulin remaining in cartridge.
Effect	Basal or Bolus delivery stopped.
Message	Once per occurrence and each time awakened until confirmed.
Action	Press OK to confirm. Replace with full cartridge.
Beeps/Vib	User selected, every 3 minutes until confirmed. If not confirmed, progresses to sweep/vibe within one hour.

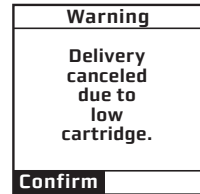

Alerts, Warnings and Alarms

Warning: No Prime, No Delivery 🎵	
Cause	Pump is not primed.
Effect	All deliveries stop.
Message	Every 3 minutes or when awakened manually.
Action	Press OK to confirm. Disconnect, reprime.
Beeps/Vib	User selected, every 3 minutes until confirmed. If not confirmed, progresses to sweep/vibe within one hour.

Warning
Pump is not primed. No delivery.
Confirm

Warning: Bolus Delivery Canceled 🎵	
Cause	User pressed function button on pump during bolus delivery.
Effect	Bolus delivery stopped.
Message	Every 3 minutes or when awakened manually.
Action	Press OK to confirm. If button was pressed accidentally, repeat steps to deliver remaining insulin units.
Beeps/Vib	User selected, every 3 minutes until confirmed. If not confirmed, progresses to sweep/vibe within one hour.



Warning
Bolus delivery canceled by user button press.
Delivered: X.XX U of X.XX U
Confirm

Alerts, Warnings and Alarms

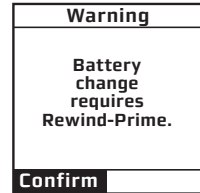
Warning: Battery Change Requires Rewind Prime 🎵	
Cause	Prime attempted without rewind.
Effect	All deliveries stopped.
Message	Every 3 minutes or when awakened manually.
Action	Press OK to confirm. Rewind and prime.
Beeps/Vib	User selected, every 3 minutes until confirmed. If not confirmed, progresses to sweep/vibe within one hour.



Alerts, Warnings and Alarms

Alarm: Occlusion 	
Cause	Occlusion detected.
Effect	All deliveries stop.
Message	Continuous until confirmed.
Action	Press  to confirm. Disconnect and prime to clear occlusion. Option to select Suspend (see Suspend Warning screen, page 104).
Beeps/Vib	User selected, every 3 minutes until confirmed. If not confirmed, progresses to sweep/vibe within one hour. (Once confirmed, No Prime warning triggered, see No Prime Warning screen, page 112.)

ALARM
OCCCLUSION DETECTED
No delivery.
Suspend
Confirm

Alerts, Warnings and Alarms

Alarm: Empty Cartridge 🎵	
Cause	Cartridge empty.
Effect	All deliveries stop.
Message	Continuous until confirmed.
Action	Press OK to confirm. Replace with full cartridge. Option to select "Suspend" (see Suspend Warning screen, page 104).
Beeps/Vib	User selected, every 3 minutes until confirmed. If not confirmed, progresses to sweep/vibe within one hour. (Once confirmed, No Prime warning triggered, see No Prime Warning screen, page 112.)

ALARM
EMPTY CARTRIDGE No delivery. Replace cartridge.
Suspend
Confirm

Alerts, Warnings and Alarms

Alarm: Replace Battery	
Cause	Battery either has minimum 3 minutes left or battery is dead.
Effect	All deliveries stop.
Message	Continuous until battery is removed.
Action	Remove battery to silence alarm. Insert new battery.
Beeps/Vib	MAX volume every 3 minutes until action taken. If not confirmed, will progress to 4 long tones/vib.

ALARM
REPLACE BATTERY
No delivery.
Remove battery to silence the alarm.

Alerts, Warnings and Alarms

Alarm: Call Service	
Cause	Hardware or software problem detected.
Effect	All deliveries stop.
Message	Continuous until battery is removed.
Action	Press OK to silence alarm for 30 minutes (alarm can only be silenced once). Call Customer Service at 1 877 937-7867.
Beeps/Vib	User-selected, every 3 minutes. If not confirmed, progresses to sweep/vibe within one hour.

NOTE: Some Call Service Alarms have a unique sound/vibration sequence and cannot be silenced by pressing **OK**.

For these Alarms the usual progression is replaced by 3 chirps/vib repeated every 9 minutes for the first half hour. This is followed by 4 long tones/vib after that.



Alerts, Warnings and Alarms

Alarm: Auto-Off 🎵	
Cause	Suspended due to no key press in user-set time period.
Effect	All deliveries stop.
Message	Continuous until confirmed.
Action	Press OK to confirm. Adjust time period in the Setup Advanced menu.
Beeps/Vib	MAX volume every 3 minutes. If not confirmed, progresses to sweep/vibe within one hour. (Once confirmed, No Prime warning triggered, see No Prime Warning screen, page 112.)



It's a good idea to set up a troubleshooting procedure to use anytime you suspect something might be wrong. Work with your health care team to establish guidelines* in the event of a problem.

Hypoglycemia

⚠ WARNING: Low blood glucose is a risk for anyone using insulin therapy. You may experience one or more of the following symptoms:

- Shakiness; rapid heart rate; nervousness; perspiration; cold, clammy skin; weakness; blurred or double vision; sudden hunger; tingling in your hands, lips, or tongue; headache and confusion.
- If you experience symptoms of hypoglycemia, you should immediately eat a quick-acting carbohydrate (glucose tablets, juice, or hard candy).
- If your BG is abnormally low, Do Not attempt to program your pump yourself. Get help.
- Treat hypoglycemia immediately.

* Walsh JA & Roberts R, *Pumping Insulin*. 2006. San Diego: Torrey Pine Press.

Rule of 15

- 1.** Consume 15 grams of quick-acting carbohydrate
- 2.** Wait 15 minutes
- 3.** Recheck BG
- 4.** If BG is < 70 mg/dL, repeat above

Troubleshooting hypoglycemia:

INSULIN PUMP

POSSIBLE CAUSE OF LOW BG	SUGGESTED SOLUTION
Basal rate programmed incorrectly	Check times and rates, remember to review basal programs when making any changes.
Clock time incorrect	Reset clock to current time, being careful to check AM & PM.
Pump exposed to MRI	Disconnect from pump. Call Customer Service at 1 877 937-7867.

FOOD INTAKE

POSSIBLE CAUSE OF LOW BG	SUGGESTED SOLUTION
Bolus too large	Check bolus amounts and times. Bolus only enough to lower your BG to normal level.
Low carbohydrate intake for bolus	Measure carbohydrates accurately. See dietitian for carb counting review. May need recalculation of I:C ratio; consult with health care team.
Improper timing of bolus	Match timing of bolus with intake of food. Check BG prior to meal bolus and adjust accordingly.
Alcohol consumption	May cause hypoglycemia. Eat food when drinking alcohol. Be cautious with bedtime bolus. Always check BG before going to bed. Check BG at 3 am. Consult health care team.

Troubleshooting hypoglycemia:**ACTIVITY**

POSSIBLE CAUSE OF LOW BG	SUGGESTED SOLUTION
Did not Suspend pump or activate Temp Basal	Consult health care team for guidelines for use of Temp Basal rate during exercise.
Low carbohydrate intake prior to exercise	If not decreasing insulin prior to exercise, may need to eat foods containing carbohydrate prior to exercise.
Unplanned activity (shopping)	If BG is <100 mg/dL, eat snack prior to exercise. Frequent BG testing before, during and after any activity.
Long or intensive exercise	Effects of exercise can be present for hours after activity has stopped. Consult with health care team for specific guidelines.

Preventing hypoglycemia:

- Check BG a minimum of four times a day, and more frequently with exercise.
- Keep accurate track of carbohydrates in the foods you eat.
- Consult your health care professional if you are experiencing frequent hypoglycemia.

If you experience frequent or severe episodes of hypoglycemia, contact your health care team. It may be necessary to adjust your basal rates, bolus doses, or review your BG Target goals, along with your daily regimen of food and exercise. If you have a low BG level (hypoglycemia), follow the routine established for you by your health care team.

- It is important to monitor your BG frequently, including periodic checks at 3:00 AM.
- Investigate the cause of hypoglycemia.

Hyperglycemia

Because your pump uses only rapid-acting insulin, you will not have a reserve of long-acting insulin in your body. This means that any interruption in the delivery of insulin by your pump can quickly result in a sharp rise of your BG levels.

Hyperglycemia (high BG) can occur within two to four hours after insulin delivery stops, and DKA (diabetic ketoacidosis) can develop within four to ten hours.

Several things can cause a high BG reading. The most common problems and causes of high BG are listed in the following table, as are some suggested solutions.

Troubleshooting hyperglycemia:

INFUSION SET

POSSIBLE CAUSE OF HIGH BG	SUGGESTED SOLUTION
Redness, irritation, inflammation, swelling, discharge or discomfort	Change infusion set tubing and site. Contact health care team.
Bump or nodule at infusion site	Change infusion set and rotate sites. Avoid this area for site selection.
Scar tissue	Avoid this area for site selection.
Catheter inserted in area of friction	Avoid waistline and friction areas.
Kink in tubing/catheter	Change infusion set tubing and site.
Infusion set not primed (air in tubing)	Disconnect tubing from body. Prime tubing completely.

Troubleshooting hyperglycemia:**INSULIN**

POSSIBLE CAUSE OF HIGH BG	SUGGESTED SOLUTION
Cloudy, clumpy, crystallized, or expired insulin, or insulin exposed to extreme temperatures	Remove infusion set and cartridge and discard. Use new insulin vial.

FOOD INTAKE

POSSIBLE CAUSE OF HIGH BG	SUGGESTED SOLUTION
Bolus insufficient or omitted	Review carbohydrate counting and I:C ratio settings.
High protein or fat intake	Consult dietitian; may need to count protein and fat.
Long meal (holiday), continuous snacking, slowly absorbed food (high fiber), delayed digestion (gastroparesis)	Consult health care team. May need to use extended bolus or combination bolus option.
Improper bolus timing	Consult health care team.

Troubleshooting hyperglycemia:

ACTIVITY

POSSIBLE CAUSE OF HIGH BG	SUGGESTED SOLUTION
Less activity	Use Temp Basal increase. Consult health care team.
Overuse of Temp Basal reduction	Record amount of time for changes. Frequent BG testing to document changes.
BG > 250 mg/dL with ketones before exercise	BG will increase with exercise when ketones are present. Do Not exercise when ketones are present. Consult health care team for exercise guidelines.

⚠ CAUTION: Infusion set should be changed every 2 to 3 days or as recommended by your health care team.

Always use clean technique!

Notify health care team with signs or symptoms of infection!

Troubleshooting hyperglycemia:

OTHER

POSSIBLE CAUSE OF HIGH BG	SUGGESTED SOLUTION
Medications (steroids, terbutaline, other hormone treatments)	Inform health care team of all medication changes or additions.
Infection, illness, virus	Refer to Sick Day Management Guidelines.
Pre-menstrual cycle	Consult health care team. May need to use Temp Basal or set additional Basal Program.
Pregnancy	Insulin requirements may increase in later trimesters. Consult health care team.
Weight changes	May need recalculation of basal or bolus doses. Consult health care team.

⚠ WARNING: Consult your health care team before making any changes in your basal rates, bolus ratios or correction factor.

When in doubt, change it out! 1. Follow guidelines provided by your health care team. 2. Change infusion set. 3. Check for ketones. 4. Take rapid-acting insulin by injection.

Problems with Infusion Sets, Sites and Cartridge

A number of problems can occur with infusion sets and sites, the most common of which are listed in the following table, along with some suggested solutions.

POSSIBLE PROBLEMS	SUGGESTED SOLUTION
Air bubbles in tubing	Always fill your pump cartridge with room temperature insulin. Check Luer lock connection and tubing; change infusion set if needed. If using a disconnect set, remove the set from your infusion site and prime the bubbles out. Check that cartridge plunger is straight and the cartridge is not filled with more than 2.0 mL of insulin.
Kinked tubing	Straighten tubing if needed; replace infusion set if needed.
Dislodged needle or cannula	Change infusion set and site. Consider using different tape, dressing or infusion set. A cannula cannot be pushed back into skin successfully.
Blood in tubing (insulin looks pink or red)	Change infusion set and site. Check needle/cannula angle at new infusion site.

POSSIBLE PROBLEMS	SUGGESTED SOLUTION
Insulin leak	Check Luer lock connection by wrapping a tissue around it to check for moisture; tighten or change cartridge and infusion set if needed. Check that cartridge is not filled with more than 2.0 mL of insulin.
Redness, tenderness, lumps, itching, warmth, discharge	Change infusion set and site; use clean technique. Treat old site for infection if necessary. Consult health care team.
Cartridge Reused	Do Not reuse cartridge. Cartridge is for single use only.

DKA (Diabetic Ketoacidosis)

Hyperglycemia can lead to DKA. If your BG is above 250 mg/dL, **check blood or urine ketones per your health care team**. Remember, the first signs of DKA are often nausea and vomiting. Also remember that because you no longer have long-acting insulin in your system, DKA can develop quickly if you ignore and/or fail to troubleshoot potential problems.

During periods of minor illness*, it may be more difficult to maintain good control of your diabetes. Examples of minor illness are: dental surgery, colds, nausea/vomiting, sore throat, mild infections, diarrhea, fever. However, you should call your health care team if:

- Illness persists without improvement for 24-48 hours.
- Temperature rises above 100° Fahrenheit.
- Vomiting or diarrhea continues longer than 4 hours.
- There are moderate to large amounts of ketones in urine.
- BG levels continue to run less than 60 mg/dL or above 250 mg/dL (above 130 mg/dL during pregnancy) after taking extra bolus doses as prearranged by your health care team.
- You show signs of ketoacidosis, dehydration or other serious problems such as: increased drowsiness, abdominal or chest pain, difficulty breathing, fruity odor to the breath, dry cracked lips, mouth or tongue.
- Any uncertainty as to what to do to take care of yourself.

Never omit your insulin! If you are ill and cannot eat, your need for insulin continues and may also increase.

- Continue your usual basal dose of insulin along with bolus insulin to cover food eaten or to correct high BG as prearranged with your health care team.
- You may need to temporarily increase or decrease your basal rate by using the Temp Basal feature as prearranged with your health care team.

Medication

Always let your health care team know ALL medications you are taking. Even medications you are taking for other reasons may impact your diabetes management, so it is important that you always let your health care team know all the medications you are taking.

Blood and Urine Testing

- Check your BG before your usual mealtime and every 2-4 hours if indicated.
- Test your blood or urine for ketones at least 4 times a day, or according to instructions from your health care team.

Fluids and Diet

Always follow your health care team's sick day guidelines. Fluid intake is essential with any illness. Consume 8 ounces of fluid per hour. Every third hour consume 8 ounces of a sodium-rich liquid, such as bouillon. You need to consume 150-200 grams of carbohydrates daily. If ketones are moderate, contact your health care team. Develop a sick plan with your health care team prior to illness.

* *Mensing C., The Art and Science of Diabetes Self-Management Education. 2006. Chicago: American Association of Diabetes Educators.*

Exercise and Sports

There are many options for wearing your pump during exercise and sports activities. During “low-contact” sport activities, such as walking, biking or aerobics, your pump can be clipped to the waistband, or for added security, placed in a “sport case.” During “contact” sports such as baseball, basketball or hockey, your pump can be disconnected for up to one hour. Always follow your health care team’s individual guidelines when disconnecting your pump because you may need to compensate for missed basal insulin. Before and after you disconnect for any length of time, remember to check your BG levels.

Swimming

Your pump is tested for immersion in water to a depth of 12 feet (3.6 meters) for 24 hours under normal swimming conditions. You should not wear your pump while scuba diving or when using high diving boards.

Your pump should not be taken into hot tubs, as the extreme temperature can adversely affect insulin quality.

If your pump has been dropped, examine it carefully for cracks or signs of damage. If the back label of your pump is not securely affixed or if you suspect your pump may have been damaged or otherwise had its waterproof integrity compromised, Do Not use in water. Call our Customer Service representatives at 1 877 937-7867.

Traveling

With a pump, traveling becomes less complicated and more enjoyable. However, traveling still requires preparation. Remember to order your pump supplies in advance and pack the following items:

- A letter from your health care team that explains the necessity of carrying insulin supplies and wearing a pump.
- A prescription for insulin, both rapid-acting for your pump and the type recommended by your health care team in case you need to take insulin by injection (Remember, your pump is designed and calibrated to use U100 concentration insulin only. Use of any insulin with lesser or greater concentration can result in serious injury or death.)
- Emergency supplies listed in *Before You Begin*.
- Accessible snacks.
- Bottled water to prevent dehydration while flying. (Remember to check your BG frequently to distinguish between high blood glucose dehydration and normal flight dehydration.)
- The name of a referral health care team at your final destination in case of an emergency.
- Pack your insulin carefully so that it is not exposed to extreme temperatures or temperature changes. (Refer to the instructions that came with your insulin for appropriate storage conditions.)
- Pack your pump supplies in carry-on luggage when traveling by air or train. **Do Not** pack your supplies in checked luggage. Contact the Federal Aviation Administration (or your country equivalent) or your local airport security office before traveling by air to obtain prescription/medical supply carry-on regulations.
- Adjust your pump's clock when crossing time zones. However, **Do Not** change the pump time and/or date on February 29, 2016 (Leap Day/Leap Year). If you make changes to the time and/or date of your pump on February 29, 2016, the changes will not be saved in the pump. Wait until the next day (March 1, 2016) to change the time and/or date so that your changes will be saved in your pump. Refer to page 3 for more details.

- Pumps will rarely set off airport metal detectors, so there is no need to remove your pump when passing through airport security. However, as airport security technology becomes more sophisticated, it is possible that a pump will set off the detector.

NOTE: While going through airport security, please keep these important things in mind. The pump should not go through the X-ray screening that is used for carry-on or checked luggage. The new airport screening, Whole Body Imaging Technology, is also a form of X-ray. If you are chosen to go through this form of screening, you will need to disconnect from the pump at your skin site prior to the scan and request alternate methods of screening the pump other than using X-ray. Your infusion set may remain in place.

For more information on traveling with pumps, visit the American Diabetes Association (ADA) website (www.diabetes.org) or call your local airport for security guidelines that may apply.

Intimacy

Your pump need not interfere with intimacy. You can disconnect most infusion sets. Always follow your health care team's guidelines when disconnecting from your pump. You may need to compensate for missed basal insulin. Also, before and after you disconnect for any length of time, remember to check your BG levels.

This chapter provides tables to record information needed for programming your personal settings into your pump. Consult your health care team for correct information for your personal treatment plan.

Insulin to Carb Ratios (I:C)

Daily Time Slot	My I:C ratio
12am	

Insulin Sensitivity Factor (ISF)

Time of Day	My ISF
12am	

BG Targets

Time of Day	My BG Target	My BG Target range (+/-)
12am		

Temp Basal Rate Decrease for Activity

Activity Type	% Decrease	Set Temp in advance of activity (yes or no)	Minutes to set in advance
Light (gardening, walking, shopping)			
Moderate (leisurely biking, golf {no cart})			
Strenuous (basketball, jogging, swimming)			
Sustained (ice skating, rowing, hiking)			

My duration for Insulin on Board (IOB) is: _____

Basal Programming Date _____

Segment Start Time	Program 1 Weekday <hr/> Units/Hr	Program 2 Other <hr/> Units/Hr	Program 3 Weekend <hr/> Units/Hr	Program 4 Exercise <hr/> Units/Hr

Basal Programming Date _____

Segment Start Time	Program 1 Weekday <hr/> Units/Hr	Program 2 Other <hr/> Units/Hr	Program 3 Weekend <hr/> Units/Hr	Program 4 Exercise <hr/> Units/Hr

Basal Programming Date _____

Segment Start Time	Program 1 Weekday <hr/> Units/Hr	Program 2 Other <hr/> Units/Hr	Program 3 Weekend <hr/> Units/Hr	Program 4 Exercise <hr/> Units/Hr

Basal Programming Date _____

Segment Start Time	Program 1 Weekday <hr/> Units/Hr	Program 2 Other <hr/> Units/Hr	Program 3 Weekend <hr/> Units/Hr	Program 4 Exercise <hr/> Units/Hr

OneTouch® Ping® Insulin Pump Warranty

Animas warrants that the OneTouch® Ping® Insulin Pump will be free from defects in material and workmanship for a period of four (4) years from the date of purchase by the original purchaser. This limited warranty extends only to the original retail purchaser.

If, during the warranty period, the pump should fail because of a defect in material or workmanship, it may be returned to Animas and Animas will repair or replace your pump with a new or recertified pump, at Animas' option, without charge to the purchaser. In certain circumstances and at its sole discretion, Animas may instead elect to refund all or a portion of the purchase price of the pump to the purchaser. Freight and transportation charges, where applicable, incurred in shipping a pump to be repaired or replaced under this limited warranty will be paid by Animas. In the event a pump is replaced or repaired under this warranty, the warranty period shall not be extended. Once you have received your repaired or replaced pump, you must return your original pump to Animas. In the event it is not returned, this warranty shall be void and the user will not be entitled to future pump replacement or repairs.

This limited warranty is valid only if the OneTouch® Ping® Insulin Pump is used under normal use and conditions and in accordance with the manufacturer's instructions as detailed in the Owner's Book provided to you at time of purchase. This limited warranty does not extend to any damage resulting from the following:

- changes or modifications to the pump by the user or any other third person after the date of manufacture;
- service or repairs performed by any person or entity other than an Animas-authorized service person;
- a force majeure or other event beyond the control of Animas;
- accidents, negligence, misuse, or abuse of the pump by the user or any other third person, including, but not limited to, improper storage of or physical abuse such as dropping or otherwise damaging the OneTouch® Ping® Insulin Pump;
- normal "wear and tear," including but not limited to cosmetic damage such as scratched display lenses and/or scratched paint; or
- if damage results from use of non-Animas cartridges and/or infusion sets.

This limited warranty only covers the pump and does not cover batteries, infusion sets, cartridges, battery caps, or other accessories of the insulin pump.

Except as expressly set forth in this limited warranty, all other warranties are expressly disclaimed and excluded, including, without limitation, any warranties of merchantability or fitness for a particular purpose.

The remedies provided for in this warranty are the exclusive remedies available in the event of any breach hereof. Except for such remedies, Animas, its suppliers, and its distributors shall not be liable for any losses, liabilities, claims, or damages of any kind or nature whatsoever, including, without limitation, any indirect, consequential, incidental, or special damages caused by or arising from a defect of the insulin pump.

OneTouch® Ping® Insulin Pump Accessory Warranty

LIMITED PRODUCT WARRANTY FOR INSULIN PUMP ACCESSORIES (Cases, Clips, Skins, etc.)

Your OneTouch® Ping® Insulin Pump accessory is warranted against defects in materials and workmanship for a period of THREE (3) MONTHS from the date of original retail purchase. If a defect exists, Animas Corporation, at its option and to the extent permitted by law will (1) repair the product at no charge using new or refurbished parts, (2) exchange the product with a functionally equivalent product that is new or refurbished, or (3) refund the original purchase price. This warranty is available only to the original retail purchaser and excludes damage resulting from abuse, accident, modifications or other causes that are not defects in materials and workmanship. To the extent permitted by applicable law Animas is not liable for any direct, indirect, incidental or consequential damages arising out of the use or service of the product. The warranty and remedies described above are exclusive and in lieu of all other warranties, remedies, and conditions, whether oral, written, express, statutory or implied. To the extent permitted by applicable law Animas disclaims all implied and statutory warranties, including, warranties of merchantability and fitness for a particular purpose. If implied warranties cannot be disclaimed, then such warranties are limited in duration to the duration of this warranty. Any recovery is limited to the original purchase price. No other person is authorized to modify this limited warranty. Some states do not allow limitations on how long an implied warranty lasts, or exclusions of incidental or consequential damages, so the above limitations may not apply to you. This warranty gives you specific legal rights, and you may have other rights, which vary from state to state.

OneTouch® Ping® Insulin Pump Maintenance Parts Warranty

LIMITED PRODUCT WARRANTY FOR INSULIN PUMP MAINTENANCE PARTS (Battery Caps, Cartridge Caps, etc.)

Your OneTouch® Ping® Insulin Pump maintenance part is warranted against defects in materials and workmanship for a period of SIX (6) MONTHS from the date of original retail purchase. If a defect exists, Animas Corporation, at its option and to the extent permitted by law will (1) repair the product at no charge using new or refurbished parts, (2) exchange the product with a functionally equivalent product that is new or refurbished, or (3) refund the original purchase price. This warranty is available only to the original retail purchaser and excludes damage resulting from abuse, accident, modifications or other causes that are not defects in materials and workmanship. To the extent permitted by applicable law Animas is not liable for any direct, indirect, incidental or consequential damages arising out of the use or service of the product. The warranty and remedies described above are exclusive and in lieu of all other warranties, remedies, and conditions, whether oral, written, express, statutory or implied. To the extent permitted by applicable law Animas disclaims all implied and statutory warranties, including, warranties of merchantability and fitness for a particular purpose. If implied warranties cannot be disclaimed, then such warranties are limited in duration to the duration of this warranty. Any recovery is limited to the original purchase price. No other person is authorized to modify this limited warranty. Some states do not allow limitations on how long an implied warranty lasts, or exclusions of incidental or consequential damages, so the above limitations may not apply to you. This warranty gives you specific legal rights, and you may have other rights, which vary from state to state.

Technical Specifications

NOTE: When applicable, testing used 23" Comfort™ infusion set and temperature of 73°F ± 2°F (23°C ± 1°C)

Number of Basal Segments	12 per Program
Number of Basal Programs	4
Basal Delivery Frequency (Basal rates of 0.2 U/hr or higher)	every 3 minutes
Temp Basal Range	-90% to +200%, in 10% increments, OFF
Temp Basal Duration	0.0 hr to 24 hrs in 0.5 hr increments
Extended Bolus Duration	0.1 hr to 12 hrs, with 0.5 hr increments for 0.5 hr to 12 hrs
Battery Type	1.5 Volt Energizer® AA L91 Lithium or 1.5 Volt AA Alkaline
Number of Batteries	1
Battery Life, Typical use	approximately 5 to 7 weeks for a lithium battery and approximately 2 to 3 weeks for an alkaline battery
End of Operational Life	December 31, 2022
Maximum volume infused under single fault condition	Max 2.0U
Cartridge Capacity up to	2.0 mL or 200 units

Technical Specifications – Animas® Vibe™ Insulin Pump *(continued)*

Storage Conditions	<p>-4°F (-20°C) to +140°F (+60°C) 10% to 100% relative humidity, including condensing</p> <p>Atmospheric pressure: 500 Hpa to 1060 Hpa</p> <p>Batteries must be removed during storage periods exceeding 2 weeks.</p>
Operating Conditions	<p>+40°F (+5°C) to +104°F (+40°C) Outside these temperatures, the flow accuracy and time to occlusion could be compromised.</p> <p>20% to 90% relative humidity, including condensing</p> <p>Atmospheric pressure: 700 Hpa to 1060 Hpa</p>
Pump Disposal	Contact Animas® Corporation for pump disposal information
Audio Bolus Range	<p>0.1–2.0U in 0.1U step</p> <p>0.5–10.0U in 0.5U step</p> <p>1.0–20.0U in 1.0U step</p> <p>5.0–35.0U in 5.0U step</p>

Flow Rate Accuracy

Delivery Mode	Accuracy
Bolus	+/- 5%
Basal	+/- 5%

Maximum Time to Occlusion Alarm*

Basal/Bolus Delivery	Low Occlusion Sensitivity Setting	Maximum Occlusion Sensitivity Setting
0.025U/Hr basal	120 hours	72 hours
1.0U/Hr basal	3 hours	1.5 hours
3U or more bolus	30 seconds	8 seconds

* *Maximum Time to Occlusion will vary based upon user-selected delivery rates. Certain factors, such as the presence of air in the infusion set or the cartridge and/or ambient temperature changes, can delay an occlusion alarm.*

Occlusion Pressure Threshold	75 kPa typical, 241 kPa max.
Bolus Volume after Occlusion release (1.0U/Hr basal)	<ul style="list-style-type: none"> • 1.0U max with occlusion sensitivity set to high • 3.0U max with occlusion sensitivity set to low
Delivery Rates	<ul style="list-style-type: none"> • Bolus, under 1U: 1.1 to 2.2U/sec • Bolus, 1U or more (normal delivery speed): 0.5 to 0.9U/sec • Bolus, 1U or more (slow delivery speed): 0.2 to 0.4U/sec • Prime: 1.7 to 3.3U/sec
Insulin Types Used	Rapid-acting U100 insulin
Basal Rate Range	0.025-25U/Hr in 0.025U/Hr steps
Bolus Range	0.05-35U in 0.05U steps
Protection from equipment error	More than 1.5 million redundant safety cross-checks per day for both hardware and software functionality

Continuous Operation, Internally Powered Device

Type BF Medical Equipment (Patient isolated, not defibrillator protected)

Waterproof Equipment, IPX8 (protected against the effects of submersion, tested at 12 feet (3.6 meters) for 24 hours).

Infrared communication port

Patient's Bill of Rights and Responsibilities

It is the intent of Animas Corporation to address and respect patients' rights in providing care and services. It is the policy of Animas Corporation to provide services to all patients without regard to race, color, national origin, religion, sex, age or disability. No person shall be excluded from participation in or be denied the benefits of any service, or be subject to discrimination because of race, color, national origin, religion, sex, age or disability.

It is the responsibility of all Animas[®] employees involved in interaction with the patient through sales, education programs, customer service or any other means to understand and promote this policy. It is the responsibility of patients of Animas Corporation to actively participate in his or her care.

- The patient is given information to allow decision making regarding care or services. The patient is responsible for providing accurate and complete information about his or her health and medical conditions.
- The patient is involved in conflict resolution. The patient should inform Animas[®] about his or her expectations and satisfaction with care.
- Patient complaints will be heard, reviewed and resolved to the best of our ability. The patient should ask questions when they do not understand his or her care, treatment, services, or what they are expected to do.
- The patient should follow the treatment plan or contact his or her health care professional if unable to do so. The patient should also express any concerns about his or her ability to follow the instructions and should report changes in his or her condition as appropriate. If they do not follow the instructions, the patient should accept shared responsibility for the outcomes of care, treatment, services, or what they are expected to do.
- The patient is involved in resolving ethical issues.
- The patient has a right to confidentiality and privacy with regards to his or her medical information. The patient should notify Animas[®] Customer Support with concerns related to product or safety issues.

- The patient has a right to have his or her property respected. The patient should be considerate and respectful of Animas® employees.
- The patient should meet any financial obligation agreed to with Animas®. The Animas® Inside Sales Department will discuss billing of co-pays and deductibles, including whether the patient has ongoing ability to pay for supplies. Animas® will also address patients who lose insurance coverage.
- The patient has a right to have his or her communication needs met. Animas® will work with the patient to ensure that any language requirements, including sign language and any additional educational needs, are met.

If the patient believes that they have been denied a benefit of service because of race, color, national origin, religion, sex, age or disability, they may file a Complaint of Discrimination with the Manager of Animas®' Customer Service Department, either verbally or in writing.

If the complaint is filed in writing, it should include a name, address, phone number and a brief description of what occurred which led to the belief that the individual was discriminated against. In this way the appropriate person may respond to the complaint. The complaint may also be filed with external agencies such as the State Department of Social Services, or the State Department of Health and Human Services.

Please contact Animas Corporation if there are any questions or concerns regarding this information.

The Joint Commission

Animas® is committed to the safety and care of its patients. As part of this commitment, Animas® is accredited by The Joint Commission, which sets the standards for quality of care in the health care community. If you would like to contact The Joint Commission regarding an issue, you may do so by fax (630-792-5636) or mail (Office of Quality Monitoring, The Joint Commission, One Renaissance Boulevard, Oakbrook Terrace, IL 60181). You will need to complete a Quality Incidence Report Form, which is available from The Joint Commission.

Medicare DMEPOS Supplier Standards

NOTE: This is an abbreviated version of the supplier standards Medicare DMEPOS suppliers must meet. These standards are listed in their entirety in the Code of Federal Regulations - 42 C.F.R. 424.57(c). The full text of these standards can be obtained at <http://ecfr.gpoaccess.gov>. Upon request, we will furnish you a written copy of the standards.

- 1.** A supplier must be in compliance with all applicable Federal and State licensure and regulatory requirements and cannot contract with an individual or entity to provide licensed services.
- 2.** A supplier must provide complete and accurate information on the DMEPOS supplier application. Any changes to this information must be reported to the National Supplier Clearinghouse within 30 days.
- 3.** An authorized individual (one whose signature is binding) must sign the application for billing privileges.
- 4.** A supplier must fill orders from its own inventory, or must contract with other companies for the purchase of items necessary to fill the order. A supplier may not contract with any entity that is currently excluded from the Medicare program, any State health care programs, or from any other Federal procurement or nonprocurement programs.
- 5.** A supplier must advise beneficiaries that they may rent or purchase inexpensive or routinely purchased durable medical equipment, and of the purchase option for capped rental equipment.

- 6.** A supplier must notify beneficiaries of warranty coverage and honor all warranties under applicable State law, and repair or replace free of charge Medicare-covered items that are under warranty.
- 7.** A supplier must maintain a physical facility on an appropriate site. This standard requires that the location is accessible to the public and staffed during posted hours of business. The location must be at least 200 square feet and contain space for storing records.
- 8.** A supplier must permit CMS or its agents to conduct on-site inspections to ascertain the supplier's compliance with these standards. The supplier location must be accessible to beneficiaries during reasonable business hours, and must maintain a visible sign and posted hours of operation.
- 9.** A supplier must maintain a primary business telephone listed under the name of the business in a local directory or a toll free number available through directory assistance. The exclusive use of a beeper, answering machine, answering service or cell phone during posted business hours is prohibited.
- 10.** A supplier must have comprehensive liability insurance in the amount of at least \$300,000 that covers both the supplier's place of business and all customers and employees of the supplier. If the supplier manufactures its own items, this insurance must also cover product liability and completed operations.
- 11.** A supplier must agree not to initiate telephone contact with beneficiaries, with a few exceptions allowed. This standard prohibits suppliers from contacting a Medicare beneficiary based on a physician's oral order unless an exception applies.
- 12.** A supplier is responsible for delivery and must instruct beneficiaries on use of Medicare-covered items, and maintain proof of delivery.
- 13.** A supplier must answer questions and respond to complaints of beneficiaries, and maintain documentation of such contacts.
- 14.** A supplier must maintain and replace at no charge or repair directly, or through a service contract with another company, Medicare-covered items it has rented to beneficiaries.

- 15.** A supplier must accept returns of substandard (less than full quality for the particular item) or unsuitable items (inappropriate for the beneficiary at the time it was fitted and rented or sold) from beneficiaries.
- 16.** A supplier must disclose these supplier standards to each beneficiary to whom it supplies a Medicare-covered item.
- 17.** A supplier must disclose to the government any person having ownership, financial, or control interest in the supplier.
- 18.** A supplier must not convey or reassign a supplier number; i.e., the supplier may not sell or allow another entity to use its Medicare billing number.
- 19.** A supplier must have a complaint resolution protocol established to address beneficiary complaints that relate to these standards. A record of these complaints must be maintained at the physical facility.
- 20.** Complaint records must include: the name, address, telephone number and health insurance claim number of the beneficiary, a summary of the complaint, and any actions taken to resolve it.
- 21.** A supplier must agree to furnish CMS any information required by the Medicare statute and implementing regulations.
- 22.** All suppliers must be accredited by a CMS-approved accreditation organization in order to receive and retain a supplier billing number. The accreditation must indicate the specific products and services, for which the supplier is accredited in order for the supplier to receive payment of those specific products and services (except for certain exempt pharmaceuticals). *Implementation Date - October 1, 2009*
- 23.** All suppliers must notify their accreditation organization when a new DMEPOS location is opened.
- 24.** All supplier locations, whether owned or subcontracted, must meet the DMEPOS quality standards and be separately accredited in order to bill Medicare.

- 25.** All suppliers must disclose upon enrollment all products and services, including the addition of new product lines for which they are seeking accreditation.
- 26.** Must meet the surety bond requirements specified in 42 C.F.R. 424.57 (c). *Implementation Date - May 4, 2009*
- 27.** A supplier must obtain oxygen from a state-licensed oxygen supplier.
- 28.** A supplier must maintain ordering and referring documentation consistent with provisions found in 42 C.F.R. 424.516(f).
- 29.** DMEPOS suppliers are prohibited from sharing a practice location with certain other Medicare providers and suppliers.
- 30.** DMEPOS suppliers must remain open to the public for a minimum of 30 hours per week with certain exceptions.

NOTE: Medicare defines an insulin pump as a capped rental.

- Medicare will pay a monthly rental fee for a period not to exceed 13 months, after which ownership of the equipment is transferred to the Medicare beneficiary.
- After ownership of the equipment is transferred to the Medicare beneficiary, it is the beneficiary's responsibility to arrange for any required equipment service or repair.

Section II

OneTouch® Ping® Meter Remote

Getting to know your OneTouch® Ping® Meter Remote and Test Strips

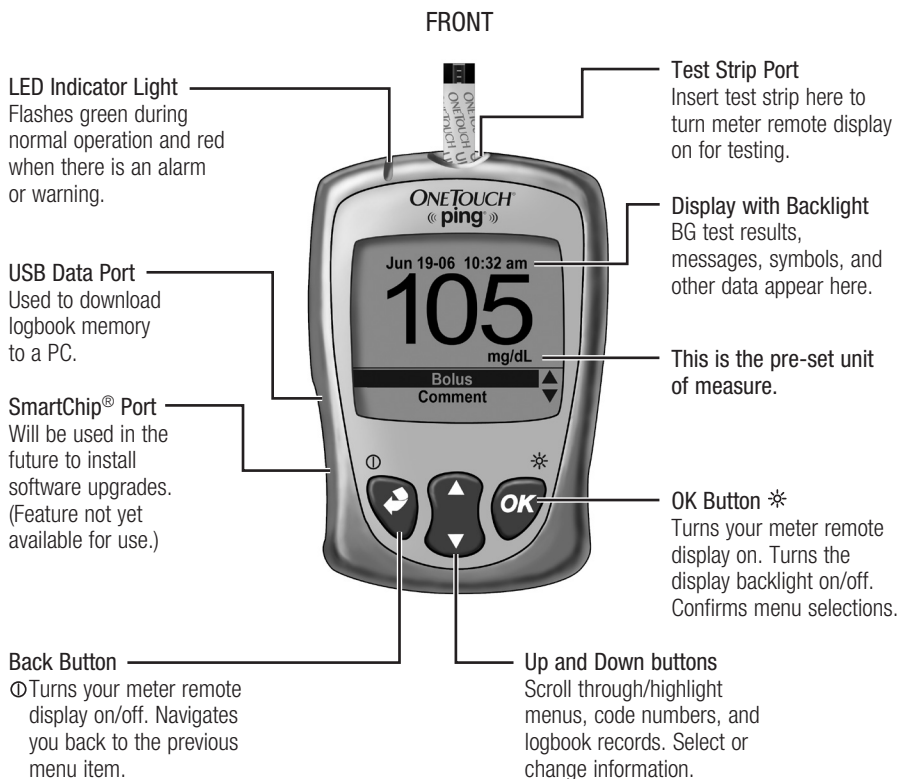

Getting to know your OneTouch® Ping® Meter Remote and Test Strips

SIDE

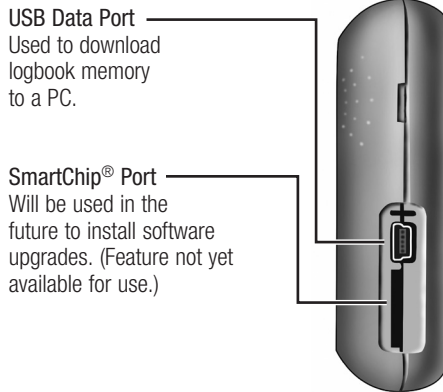

BACK

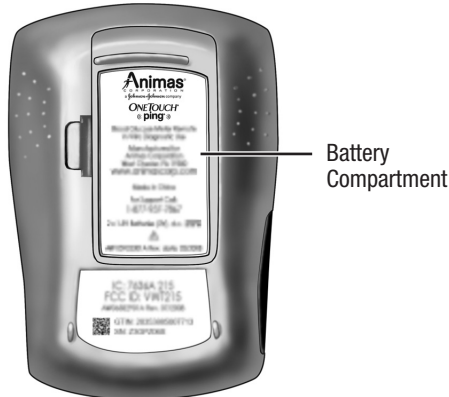



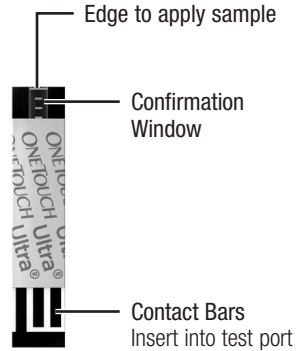





TEST STRIP



Display symbols

These symbols guide you while using your meter remote:





Navigation Symbols

Symbol	Meaning
	Scroll (move) up only.
	Scroll (move) down only.
	Scroll up or down.
	No value in the field (Set of dashes).
	Shows where you are on the display. A flashing highlight indicates the field can be edited. Press  to accept highlighted area.
	A meter remote display that involves a meter function.
	A meter remote display that involves a pump function.
	Your meter remote buttons are currently locked.

Navigation Symbols

Symbol	Meaning
	There is a short delay in information appearing on your meter remote display, such as when inserting the batteries.





Logbook Entry Symbols

Identifies the type of logbook entry when making a new entry.	
	Exercise entry.
	Health entry.
	Food entry.
	Infusion set change .





Display symbols

These symbols guide you while using your meter remote:

Battery Power Symbols

Symbol	Meaning
Power remaining in your meter remote or pump batteries.	
	Full power remaining.
	About two-thirds power remaining.
	About one-third power remaining.
	No power remaining. You must replace the batteries.



RF Signal Strength Symbols

Communication signal strength between your meter remote and pump.	
	Full strength.
	Medium strength.
	Low strength.
	The RF connection is lost or interrupted (no connection).
	RF communication has been deactivated by the user.

NOTE: If your meter remote and pump are not paired, no RF signal strength symbol will appear.

Turning your meter remote display on

You will first need to install the batteries before your meter remote display will turn on. See *Chapter 9* in *Section II*.

To turn your meter remote display on, press  or . An all-black start-up screen will appear followed by the hourglass symbol. The Meter Home screen will then be displayed.

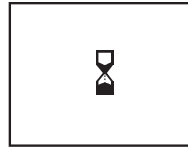

Meter Home	
10:32 am 	
Last BG Jun 19-06 7:40am 99	Aft Brkft Avg. 14 days 109

(Example)

⚠ CAUTION: If the graphics appear to be different, call Customer Service at 1 877 937-7867. There may be a problem with your meter remote.

your meter remote display does not power on, try changing your meter remote batteries. See *Chapter 9* in *Section II*.

You can also turn your meter remote on by inserting a test strip (see *Chapter 4* in *Section II*).

From the Meter Home screen you will have access to the Main Menu and all meter remote operations (see next page).

Using your meter remote display backlight

When your meter remote display is already on, press and hold  for two seconds to turn the backlight on or off.

NOTE: Turning the backlight on uses more battery power.

Turning your meter remote display off

There are several ways to turn your meter remote display off:

- Before or after completing a test, remove the test strip.
- If there is no test strip in your meter remote, press and hold  for two seconds.
- Your meter remote display will turn off by itself if left alone for a short time. However, you can extend battery life by turning it off as soon as you are finished.

Meter Home screen

The Meter Home screen displays the current time of day stored in your meter remote and battery power remaining. Your most recent BG test result appears along with the date and time of the test. Your average BG test results for the current meal period appears next to your most recent BG test result. Averages are based on the number of days you select when you set up your meter remote. See *Advanced features* in this chapter.

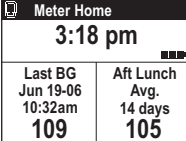

Meter Home	
3:18 pm 	
Last BG Jun 19-06 10:32am 109	Aft Lunch Avg. 14 days 105

To go to the Main Menu screen, press .

Main Menu screen



The Main Menu screen provides access to all meter remote operations.

Main Menu screen options are as follows:

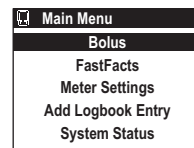
- Bolus - Once you activate RF communication on your meter remote and pump, and pair the devices, you will be able to use your meter remote to deliver a bolus from your pump. (See *Chapter 4* in *Section III*.)
- FastFacts - View on-screen summaries and graphs of BG test results and other health data stored in your meter remote memory.
- Meter Remote Settings - Customize your meter remote for your personal use.
- Add Logbook Entry - Add important health-related data to your meter remote memory.
- System Status - Review and/or troubleshoot pump, meter remote, and RF operations. You will not be able to review or troubleshoot pump operations from your meter remote until you activate RF communication on your meter remote and pump, and pair the devices. (See *Chapter 4* in *Section III*.)



To select any item on the Main Menu screen, press  to scroll to/highlight it on the screen and press .

NOTE: Many of your meter remote screens include an option to return to the Main Menu screen before and after completing a step or procedure. Simply press  to highlight “Main Menu” and press .

Setting up your meter remote

Your meter remote has settings that let you customize your meter remote for your personal use. Your meter remote comes pre-set at the factory with the display language and other features already selected. Before using your meter remote for the first time you should check and update these settings if necessary.

You can change or customize the other meter remote features as follows:

Basic

- Change the display language, time, or date.

NOTE: Once you activate RF communication on your meter remote and pump, and pair the devices, your meter remote automatically sets its time and date to match the pump time and date.

Customize

- Personalize features such as time and date formats, averages, meal schedule, “Before Meal” and “After Meal” glucose ranges, hypoglycemia level, and bolus calculator.

Lock Buttons

- Disable your meter remote buttons/functions to protect against unintentional use.

RF

- Activate and deactivate the RF feature, change the RF channel, activate pairing, and test RF communication between your meter and pump (once you begin using them together as a system).

Alerts

- Set your meter remote to alert you when specific actions have been taken or need to be taken or when there are problems using your meter remote. Alerts may be set using sound and/or LED light.

Your meter remote will provide an additional set of alerts once you activate RF communication on your meter remote and pump, and pair the devices. These include alerts when there are communication problems between the devices, when your intended actions require attention, and when there are problems with pump operation. Many pump alerts, warnings, and alarms will display and/or sound both on your pump and on your meter remote. You can use your meter remote to confirm and clear the alerts, warnings, and alarms from both devices. Pump sounds are set directly on your pump during your pump set-up procedure.

NOTE: You do not need to change any of your meter remote settings in order to begin BG testing. Simply insert a test strip to turn your meter remote display on and proceed with the test. See *Chapter 4* in *Section II*.

Following is a summary of meter remote settings that you can change or personalize for your own use. Factory settings refer to how your meter remote is set up when you receive it from the manufacturer. Custom settings refer to the alternate ways you can change or personalize the factory settings.

Meter Remote Settings

Option	Factory Settings	Custom Settings
Basic Set-up:		
Language	English	Spanish
Time	12:00 am	Change as necessary
Date	Jan 1-07	Change as necessary
Customize Settings:		
Time Format	am/pm	24-hour
Date Format	MM/DD/YY	DD/MM/YY
Begin of week	Sunday	Monday
Contrast	0	-10 to 10
Beeper volume	20	1 to 20
Advanced Features:		
Averages	14 Day	7, 30, 60, 90 Day
Schedule	Pre-set (see <i>Advanced Features</i> in this chapter)	Personal
Glucose Range		
<i>Before Meal</i>	90–130 mg/dL	Personal
<i>After Meal</i>	—	Personal
Hypo Level	70 mg/dL	Personal

Meter Remote Settings



Option	Factory Settings	Custom Settings
Calculator Set-up: This menu option is only available if your meter remote is not paired with your pump. When the devices are paired, these values are retrieved directly from your pump.		
I:C Ratio	1U:15g	Personal
BG Target	120 mg/dL	Personal
+/- (range)	10 mg/dL	Personal
Insulin Sensitivity (IS) Factor	1U:50 mg/dL	Personal
Lock Buttons	Unlocked	Locked
RF Activation	Off	On
Pairing	Off	On
Alerts: Warning Cue	On (Audio Beep)	Off
LED	Off	On

Basic Set-up

NOTE:

- After installing the batteries for the first time, your meter remote will automatically enter Basic Set-up (at step 3) when you turn your meter remote display on. There will be a short delay of up to 30 seconds as your meter remote performs a power-on self test. An hourglass symbol (⌚) will appear on the display during that time.
- See *Chapter 9* in *Section II* for important information on the correct way to install the batteries.

1. Go to Meter Settings mode

On the Main Menu screen press  to highlight “Meter Settings”. Press  to confirm your selection and go to the Meter Settings screen.

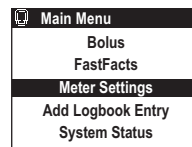

2. Go to Basic Set-up

“Basic” will be highlighted. Press  to confirm your selection and go to the Basic Set-up screen.

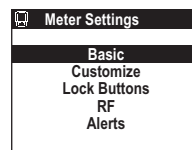

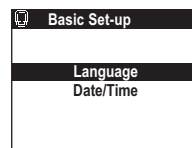

3. Choose a display language

“Language” will be highlighted. Press  to confirm your selection and go to the Language Set-up screen.



4. Set the display language

English is the language that has been pre-set at the factory. Press  for English, or highlight “Español” and press  for Spanish.

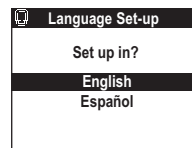

NOTE: Once you begin using your meter remote and pump together as a system, the language on your meter remote must be set to the same language as your pump to use your meter remote to access pump functions.

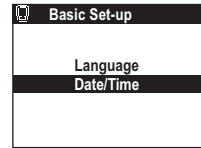

5. Set the time of day

On the Basic Set-up screen, press  to highlight "Date/Time". Press  to confirm your selection.



Press  to scroll to the correct hour. Press  to confirm your selection.

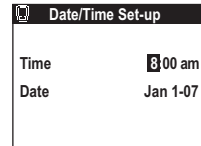

Press  to scroll to the correct minutes and press .

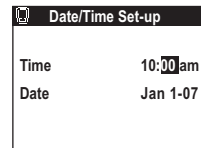

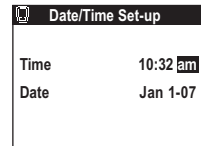

"am" or "pm" is now highlighted next to minutes. Press  to scroll to the correct am or pm setting. Press  to confirm your selection.

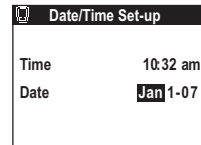

The month is now highlighted.



6. Set the date

Press  to scroll to the correct month and press . Repeat these steps to select the day and then the year. To confirm each selection, press .

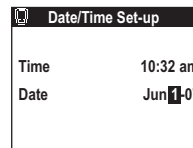

After you confirm the final selection for year, you will return to the Meter Settings screen where you can begin the Customize Set-up.

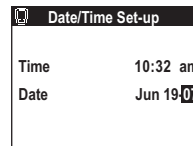
**NOTE:**

- If more than two minutes elapse during battery replacement, you may have to re-set the date and time. All other meter remote settings remain saved in the meter remote memory.
- You will need to manually adjust your meter remote clock time to reflect any Daylight Saving Time adjustments in your local area.
- Once you activate RF communication on your meter remote and pump, and pair the devices, your meter remote's clock time will be set to match the pump's clock time.

Customize

On the Meter Settings screen, press  with "Customize" highlighted.

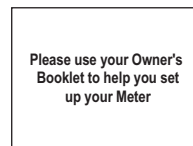
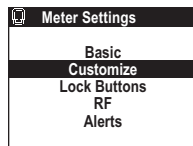

You will be reminded to have your Owner's Booklet available as a reference while customizing your meter remote.

When you choose "Customize" on the Meter Settings screen, an additional menu of options appears. You must review all the menu options and make selections for each for your settings to be saved. Press  to begin with "Settings".

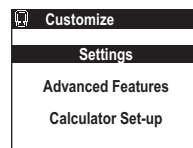



The Calculator Set-up option on your meter remote is available only when your meter remote is not paired with your pump.

Settings

“Time Format” is now highlighted.



1. Set the time format

Press  to highlight the time format you prefer – am/pm or 24 hour. Press  to confirm your selection.

Settings	
Time Format	am/pm
Date Format	24 hour
Begin of week	Sunday
Contrast	8
Beeper volume	20

“Date Format” is now highlighted.



2. Set the date format

Press  to highlight the date format you want your meter remote to display – month first (MM/DD/YY) or day first (DD/MM/YY). Press  to confirm your selection.

Settings	
Time Format	am/pm
Date Format	MM/DD/YY
Begin of week	DD/MM/YY
Contrast	8
Beeper volume	20

“Begin of week” is now highlighted.



3. Set the day your week starts on

For record-keeping purposes you can begin your week on Sunday or Monday. Press  to highlight your choice and press  to confirm your selection.

Settings	
Time Format	am/pm
Date Format	MM/DD/YY
Begin of week	Sunday
Contrast	Monday
Beeper volume	20

“Contrast” is now highlighted.

4. Select the display contrast

You can adjust the contrast level of your meter remote display from -10 (low contrast) to 10 (high contrast) to help with viewing. To change the contrast level, press  to select the desired level. As you scroll, the display contrast changes automatically to help you make your choice. Press  to confirm your selection.

Settings	
Time Format	am/pm
Date Format	MM/DD/YY
Begin of week	Sunday
Contrast	8
Beeper volume	20

“Beeper volume” is now highlighted.

5. Set the beeper volume

Your meter remote was set at the factory to give audio signals (beeps) at key points in the test procedure. Beeps are also used to sound warnings and alarms that arise from meter remote or pump operation. Beep volume may be set anywhere from 1 (barely audible) to 20 (loudest).

Settings	
Time Format	am/pm
Date Format	MM/DD/YY
Begin of week	Sunday
Contrast	8
Beeper volume	20

To change the volume, press  to select the desired level. Press  to confirm your selection.

You will return to the Customize screen.

NOTE:

- You cannot turn the beep completely off.
- Your settings are not saved until you have made a selection for each and pressed  after the last setting (Beeper volume).

Advanced features

You can choose the number of days to be included in your BG test averages, and set your personal meal schedule, before-meal and after-meal glucose ranges, and target hypoglycemic level.

On the Customize screen, press  with “Advanced Features” highlighted.

Customize	
Settings	
Advanced Features	
Calculator Set-up	

1. Set the days included for test averages

“Averages” is now highlighted. Your meter remote is pre-set to display a 14-day average of your BG test results on the Meter Home screen, and when you compare your current BG test result to your previous BG test result. You can change the number of days that make up this average to include the last 7, 30, 60, or 90 days. Press to choose the number of days you want to include and press .

Advanced Features	
Averages	7 Day
Schedule	14
Glucose Range	30
Before Meal	60
After Meal	90
Hypo Level	70

“Schedule” is now highlighted.

NOTE: You can still look at averages for all five time periods by reviewing your meter remote logbook.

2. Set your meal schedule

Next, your meter remote will prompt you to select time periods for your usual meal schedule. When you set this feature all of your BG test results will automatically be tagged with the mealtime.

Advanced Features	
Averages	14 Day
Schedule	Pre-set
Glucose Range	Personal
Before Meal	90-130
After Meal	--- ---
Hypo Level	70

To view the pre-set meal schedule highlight “Pre-set” and press .

The pre-set schedule will appear on the screen. Both “Before Meal” and “After Meal” times are pre-set (“a” refers to am and “p” refers to pm). Whenever you test, these mealtimes will be recorded in your meter remote memory whether or not you have actually eaten according to this schedule. To use the pre-set schedule, press .

Pre-set Schedule		
Bef Brkft	6:00 a-	9:00 a
Aft Brkft	9:00 a-	11:00 a
Bef Lunch	11:00 a-	2:00 p
Aft Lunch	2:00 p-	5:00 p
Bef Dinner	5:00 p-	8:00 p
Aft Dinner	8:00 p-	11:00 p
Night	11:00 p-	6:00 a

To personalize your schedule, press , choose “Personal”, and press .

To change all or some of the personal meal schedule:

- Press to scroll through each mealtime.
- Press to select the correct hours and minutes (in 15-minute steps).
- Press to confirm your selection and move to/highlight the next mealtime.
- If you make a mistake, press to return to any mealtime and make corrections.

Personal Schedule		
Bef Brkft	6:00 a	9:00 a
Aft Brkft	9:00 a-	11:00 a
Bef Lunch	11:00 a-	2:00 p
Aft Lunch	2:00 p-	5:00 p
Bef Dinner	5:00 p-	8:00 p
Aft Dinner	8:00 p-	11:00 p
Night	11:00 p-	6:00 a

You only need to set the start times for each mealtime. End times will automatically change to match the start time of the next time period. For example, if you set the start time of “Bef Lunch” for 10:00 am, the end time of the previous “Aft Brkft” will automatically change to 10:00 am.

Personal Schedule		
Bef Brkft	7:00 a-	9:00 a
Aft Brkft	9:00 a-	10:00 a
Bef Lunch	10:00 a-	1:00 p
Aft Lunch	1:00 p-	5:00 p
Bef Dinner	5:00 p-	8:00 p
Aft Dinner	8:00 p-	11:00 p
Night	11:00 p-	7:00 a

End time of “Aft Brkft” is the same as the start time of “Bef Lunch”.

When you are finished, press  to save your personal schedule.



NOTE: You have the option to modify the mealtime for any test if necessary. See *Advanced Features*, in this chapter.



NOTE: It is important that your meter remote date and time are correct. That way your BG test results and other health information will be stored correctly in your meter remote memory. The lower end of the “Before Meal” Glucose Range is now highlighted.

Personal Schedule		
Bef Brkft	7:00 a-	9:00 a
Aft Brkft	9:00 a-	10:00 a
Bef Lunch	10:00 a-	1:00 p
Aft Lunch	1:00 p-	5:00 p
Bef Dinner	5:00 p-	8:00 p
Aft Dinner	8:00 p-	11:00 p
Night	11:00 p-	7:00 a

3. Set your before-meal and after-meal glucose ranges

The “Before Meal” glucose range is pre-set to 90–130 mg/dL. To use this range, press  twice. You can change this range to one recommended by your health care professional.

Press  to change the lower end of the range in 1 mg/dL steps, and press . Repeat these steps to enter a value for the upper end.



There is no pre-set “After Meal” glucose range. If you have an “After Meal” glucose range recommended by your health care professional, press  and then  to select to your target numbers.

The factory-set hypoglycemic level (“Hypo Level”) is now highlighted.

Advanced Features	
Averages	14 Day
Schedule	Personal
Glucose Range	
Before Meal	90-130
After Meal	--- - ---
Hypo Level	70

Advanced Features	
Averages	14 Day
Schedule	Personal
Glucose Range	
Before Meal	90-130
After Meal	--- - ---
Hypo Level	70

4. Set your target hypoglycemic level

The factory-set hypoglycemia level is 70 mg/dL. If your health care professional has advised you to use a different level, press  to select the correct number and press .

Advanced Features	
Averages	14 Day
Schedule	Personal
Glucose Range	
Before Meal	90-130
After Meal	--- ---
Hypo Level	70

NOTE: Your Advanced Features settings are not saved until you have made a selection for each and pressed  after the last setting (Hypo Level).

Calculator Set-up

The last item on the Customize screen is “Calculator Set-up”. This feature is mainly intended for use once you have completed pump training and fully understand the ezCarb and ezBG functions on your pump. See *Chapter 10* in *Section I*.

NOTE: Please discuss the Calculator Set-up with your health care professional before using this feature.

The ezCarb and BG Bolus screens on your meter remote allow you to automatically calculate a bolus to cover carbs eaten and/or correct a high BG. Before you begin using your meter remote and pump together as a system (see *Section III*), the Calculator Set-up on your meter remote lets you enter a series of bolus calculator settings that are used on the ezCarb and ezBG Bolus screens. **The Calculator Set-up feature on your meter remote will only be available when the devices are not paired (see *Chapter 4* in *Section III*).**

Customize
Settings
Advanced Features
Calculator Set-up

 **WARNING:** Be sure to enter and store the correct values for each of the items in the Calculator Set-up screen. Incorrect values can lead to calculated insulin units that may be too high or too low for your current profile and situation.

1. Set your I:C Ratio



Your I:C ratio is used to help calculate a bolus to cover the number of carbs in a meal or snack. It is defined as the approximate number of carbs (grams) that you can cover with 1 unit of insulin. You can change your I:C ratio by pressing  to select the desired number.

Press  to confirm your I:C ratio value.

The “BG Target” field is now highlighted.



NOTE: When using the Calculator Set-up on your meter remote, the I:C ratio you set applies to all times of the day. However, you may make changes to the I:C ratio as needed through the Calculator Set-up or during bolus calculations on the ezCarb and ezBG Bolus screens.

2. Set your default BG Target

Your BG target represents your goal for achieving good glycemic (BG) control. To choose a different target, press  to select the desired BG Target and press .

The “+/-” field is now highlighted.

3. Set your default +/- (range) value

By setting a range (+/-), your meter remote will not calculate a BG correction if your actual BG is within that range. If you prefer to correct to a single target rather than a target range, set your range to “+/- 0”. Press  to select the desired BG target range and press .

The “IS Factor” field is now highlighted.

Calculator Set-up	
I:C Ratio	1U:15 g
BG Target	120 mg/dL
	+ / - 10 mg/dL
IS Factor	1U:50 mg/dL

Calculator Set-up	
I:C Ratio	1U:15 g
BG Target	120 mg/dL
	+ / - 10 mg/dL
IS Factor	1U:50 mg/dL

Calculator Set-up	
I:C Ratio	1U:15 g
BG Target	120 mg/dL
	+ / - 10 mg/dL
IS Factor	1U:50 mg/dL

4. Set your default Insulin Sensitivity (IS) Factor

“IS Factor” is the approximate amount by which you can lower your BG level (in mg/dL) with one unit of insulin. You can change your IS Factor by scrolling to the desired number and pressing .

Calculator Set-up	
I:C Ratio	1U:15 g
BG Target	120 mg/dL + / - 10 mg/dL
IS Factor	1U:50 mg/dL

After setting your IS Factor and pressing , you will return to the Meter Settings screen with “Lock Buttons” highlighted.

 **WARNING:** Bolus units that are computed with the calculator may not take all your other health factors into consideration. These include:

- Your stress level.
- Whether you plan to exercise.
- Any IOB from a syringe, pen, or pump bolus.

You may always adjust the insulin units up or down before you decide to administer your bolus. If you dose an insulin amount that is too high or too low, this may result in a hypoglycemic or hyperglycemic event. Please discuss the bolus calculator feature and all relevant personal settings with your health care professional before using the calculator for the first time.

Lock Buttons

The Lock Buttons feature lets you protect your meter remote from unintentional use. For example, locking your meter remote buttons can help prevent unintended insulin delivery once you begin using your meter remote and pump together as a system. While buttons are locked, you will have limited ability to navigate through meter remote operations.

1. Go to Lock Buttons

On the Meter Settings screen press  with “Lock Buttons” highlighted.

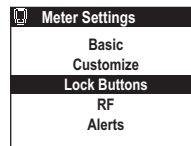



2. Lock your meter remote buttons

“Cancel” will be highlighted. To lock the buttons, highlight “Lock” and press .

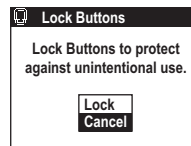

You will go to the Meter Home screen.



NOTE:

- You can also lock your meter remote buttons simply by pressing and holding  and  at the same time for about three seconds after your meter remote display has been turned on.
- Once your meter remote buttons are locked, you will only have access to the Meter Home screen. The lock symbol  will appear on top of the screen. Buttons will remain locked even if you turn your meter remote display on or off.
- While the buttons are locked, you will still be able to perform a BG test. Pending alarms and warnings will still be displayed.
- The Lock Buttons feature only affects the buttons on your meter remote. It does not affect the buttons on your pump.
- You may also lock the buttons on your pump using the Tamper Resistant feature on your pump. See *Chapter 4 in Section I*.

Unlocking your meter remote buttons

To unlock the meter remote buttons, press and hold  and  at the same time for about three seconds after your meter remote display has been turned on.

RF and Pairing

The RF and Pairing features on your meter remote and pump are used to establish communication between the two devices. This way you can use your meter remote display for remote access to many pump functions. The RF feature also makes it easy for BG test results from your meter remote to be incorporated into bolus calculations on the ezCarb and ezBG Bolus screens. When you are ready to begin using your meter remote to access pump functions, see *Chapter 1* in *Section III*.

Alerts

Your OneTouch® Ping® Meter Remote will alert you to specific alarms and warnings that result from meter remote operation. In addition to text messages (Notification screens) that appear on your meter remote display, you can choose how you would like to be alerted with audio beeps or LED signals. See *Chapter 10* in *Section II* for a description of meter remote-specific alerts that will sound and display on your meter remote. That chapter provides tips for taking the appropriate action to clear the problem and continue use.

Your meter remote will provide an additional set of alerts once you have activated RF communication on your meter remote and pump, and pair the devices. These include alerts when there are communication problems between the devices or if your intended actions might require additional attention. Many alerts, warnings, and alarms related to insulin delivery from your pump will also display and/or sound both on your meter remote and your pump. See *Chapter 6* in *Section III* for a description of these types of messages/alerts. That chapter also provides tips for taking the appropriate action to clear the problem and continue use.

Your pump has a progressive warnings and alarms safety system. This means that if you do not confirm the warning or alarm, your pump will begin to beep louder and start to vibrate within one hour. At that time, if you do not confirm the warning or alarm, it will continue until the necessary action is taken. You may confirm the alarm or warning on either your meter remote or your pump. Certain pump conditions, such as the “Replace Battery” warning, require taking action directly on your pump to clear the problem. See *Chapter 6* in *Section III* for information on clearing alerts, warnings, and alarms from your pump and meter remote.

1. Go to Alerts

On the Meter Settings screen press  with “Alerts” highlighted.

“Warning Cue” is now highlighted.

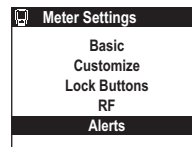

2. Set the Warning Cue (Audio beeps) mode

You may choose to be alerted to warnings on your meter remote by audio beeps. When you activate the Warning Cue, this also specifies that warnings on your pump will also sound on your meter remote after you activate RF communication and pair the devices. Once you begin using your meter remote and pump together as a system (see *Chapter 1 in Section III*), you may wish to review or change this setting.

To activate the Warning Cue, press  with “On” highlighted.

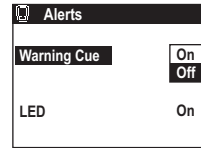

3. Set the LED mode

Your meter remote has an LED indicator light located on the top of your meter remote. You may use the LED to visually signal you if there is an alarm, warning, or notification on your meter remote. LED alerts are in addition to text and audio alerts. During normal operation, the LED flashes green. A flashing red LED indicates an alarm, warning, or notification. When you activate the LED mode, this also specifies that alarms, warnings, or alerts on your pump will also flash on your meter remote after you activate RF communication and pair the devices. Once you begin using your meter remote and pump together as a system (see *Chapter 1 in Section III*), you may wish to review or change this setting.



To activate the LED alerts, press  with “On” highlighted.

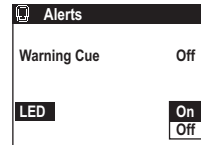

You will return to the Meter Settings screen.

NOTE:

- Whenever your meter remote alerts you to an alarm or warning, you must confirm the message on either your meter remote or pump. If the alarm or warning requires corrective action before normal operation can continue, you must take the appropriate steps to resolve the problem.
- Setting the LED to “On” will use more battery power.

Food Database

Your meter remote comes from the factory with a basic Food Database pre-loaded.

The Food Database contains pre-calculated carbohydrate, fat, protein, and fiber amounts for 500 food choices. You may use ezManager® Software on your PC to update the Food Database in your meter remote memory choosing from a comprehensive library of over 5,000 food choices.

The Food Database provides you with an easy and accurate way to obtain carb totals when using the bolus calculator in the ezCarb Bolus screen. You can also use the Food Database for making logbook entries. A special “Favorites” selection in the Food Database lets you create a separate library of food items and carb amounts for your most preferred or frequently consumed food items.

NOTE: When selecting and totaling carb amounts from the Food Database for use in the bolus calculator in the ezCarb Bolus screen, a maximum of 999 grams(g) will be used in the calculations – even if you selected a “Total” amount greater than 999g.

Updating the food database from your PC

Follow instructions in the ezManager® User Guide for updating the Food Database on your meter remote.



Making selections from the food database

You can access the Food Database from either the ezCarb Bolus screen (see *Chapter 4 in Section III*) or by making a Food Logbook entry (see *Chapter 6 in Section II*).

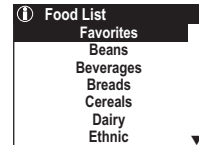
From either starting point, the Food List screen will appear where you can access 16 food categories. The first six food categories appear on the Food List screen. Press  to scroll to the other food categories.





1. Choose a food category

Press  to highlight the desired category and press . A second menu of brand choices for that category appears.





2. Choose a food brand/type

An additional menu of brand choices appears along with the carb totals for a typical serving size. Press  to highlight the desired brand/type, and then press  to display nutritional information for that food brand/type.

Canned	
	Carbs(g)
Bushes Baked	29
Garbanzo Beans	27

If you do not see the desired food item in the list, you may add it for future reference by following instructions in the ezManager® User Guide.

3. Adjust your serving size

Nutritional information is displayed for the standard serving size of that food item. The “Serving” field is highlighted. Press  to adjust the serving size as needed and press . As you adjust the serving size, the nutritional units will automatically be re-calculated.

Bushes Baked	
Serving:	1.0
SvgSize = 1/2 cup	
Carbs	29.0
Fat	1
Protein	6
Fiber	5
Add More Items	Total

4. Add or edit additional food items as needed

“Add More Items” will be highlighted. Up to nine food items may be selected for use with the bolus calculator or when making a logbook entry.

Bushes Baked	
Serving:	1.0
SvgSize = 1/2 cup	
Carbs	29.0
Fat	1
Protein	6
Fiber	5
Add More Items	Total

Press  to return to the Food List screen, and repeat steps 1–4 to add additional food items and carbs to your total.

When you are finished, press  to highlight “Total” and press .



Bushes Baked	
Serving:	1.0
SvgSize = 1/2 cup	
Carbs	29.0
Fat	1
Protein	6
Fiber	5
Add More Items	Total

The ezCarb Total or Food Entry Total screen will appear and will list all your food items and their specific carb amounts. “Done” will be highlighted. “Max Carbs = 999 g” will appear to let you know that 999 is the maximum carb value used in the bolus calculation, regardless of the “Total” that appears. If you have selected more than three food items, press  to display the rest of your entries.

ezCarb Total	
Item	Carbs(g)
Bushs Baked Beans	29
Chickpeas Canned	54
Kidney Beans Can	38
Total	121 g
Max Carbs = 999 g	
Add More Items	Done

If the food items and carb amounts are correct, press .

If you need to add additional food items, highlight “Add More Items” and press . Then follow the same steps above for adding new items.

If you need to make a change to a particular food item, press  to highlight the food item you wish to edit and press . Nutritional information will appear on the display and you may adjust the serving size as needed. To delete a food item, change the serving size to 0. When you are finished, press  with “Total” highlighted.

When all entries are completed, highlight “Done” and press .

Your meter remote includes an ezCarb and ezBG Bolus calculator feature. This feature lets you calculate a bolus to cover carbs eaten and/or correct a high BG. ezCarb and ezBG Bolus calculations on your meter remote work much like the calculations on your pump with a few differences:

- You will not be able to use your meter remote to deliver the bolus from your pump. But you will be able to use the information to manually enter and deliver a bolus amount directly on your pump, or for a pen/syringe bolus.
- Your meter remote does not allow you to include any IOB in the calculations.
- Your meter remote uses settings from the Calculator Set-up (see *Chapter 1 in Section II*) as initial inputs for the ezCarb and ezBG Bolus calculator screens.

When you begin using your devices together as a system, the meter remote will replace settings from the Calculator Set-up with settings that are saved in your pump and that apply to the current time of day. Any IOB will also be included in the calculations if the IOB feature is activated on your pump. And you will be able to use your meter remote to deliver the bolus from your pump. See *Chapter 4 in Section III* for instructions on using the ezCarb and/or ezBG Bolus calculator feature on your meter remote.

To access the ezCarb and ezBG feature on your meter remote, highlight “Bolus” on the Main Menu screen and press . You have the option of selecting an ezCarb or ezBG Bolus calculation.

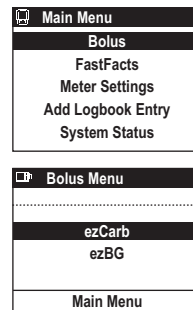

BG test principle

When using your meter remote to test your BG, glucose in the blood sample mixes with special chemicals in the test strip and a small electric current is produced. The strength of this current changes with the amount of glucose in the blood sample. Your meter remote measures the current, calculates your BG level, displays the BG test result, and stores it in its memory.

Starting the test process

Have these things with you when you test your BG level:

- OneTouch® Ping® Meter Remote
- OneTouch® Ultra® Test Strips
- Lancing device
- Sterile lancets with protective disks
- OneTouch® Ultra® Control Solution

 **CAUTION:** If you cannot test due to a problem with your testing supplies, contact your health care professional or Customer Service at 1 877 937-7867. Failure to test could delay treatment decisions and lead to a serious medical condition.

 **CAUTION:** The test strip vial contains drying agents that are harmful if inhaled or swallowed and may cause skin or eye irritation.

NOTE:

- Use only OneTouch® Ultra® Test Strips with your meter remote.
- Make sure your meter remote and test strips are about the same temperature before you test.
- OneTouch® Ultra® Test Strips are for single use only. Never re-use a test strip that had either blood or control solution applied to it.
- Testing must be done within the operating range (43°–111°F/6°–44°C). For the most accurate BG test results, try to test as close to room temperature (68°–77°F/20°–25°C) as you can.

1. Check the code on the test strip vial before inserting the test strip

Code numbers are used to calibrate your meter remote with the test strips you are using.

**2.** Insert a test strip

Remove the test strip from its vial and immediately replace the vial cap and close it tightly. With clean, dry hands, you may touch the test strip anywhere on its surface. **Do Not** bend, cut or modify the test strips in any way. Use each test strip immediately after removing it from the vial.

Insert the test strip into the test port as shown. Make sure the three contact bars are facing you. Push the test strip in as far as it will go. **Do Not** bend the test strip.





An all-black start-up screen will be followed by an hourglass symbol and then the Match Code screen. The Match Code screen will display the pre-set numeric code “25”.

NOTE: If you insert a test strip while your meter remote is in the middle of certain insulin delivery procedures (e.g., delivering a Normal Bolus or the Normal portion of a Combo Bolus), you must either allow that procedure to complete, or cancel the operation so you can continue with the test.

3. Confirm that the code displayed on your meter remote matches the code on the test strip vial

If the code on your meter remote does not match the code number on the test strip vial, press  to match the code number on the test strip vial. The new code number will flash on the display for three seconds, after which the display will advance to the Test/Apply Blood screen.

If the codes already match, press  to go to the Test/Apply Blood screen. When you do not make a change after three seconds, the display will advance to the Test/Apply Blood screen.

 **CAUTION:** Matching the code on your meter remote and the code on the test strip vial is essential to obtain accurate BG test results. Each time you test, check to make sure the code numbers match.

Your meter remote is now ready to perform a BG test.

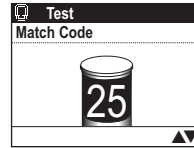
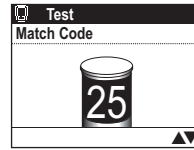

4. Select the test mode

There are two options for testing:

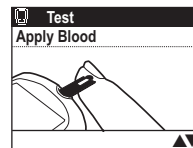

“Test/Apply Blood” for fingertip, forearm, or palm testing. When “Test/Apply Blood” is at the top of the screen you may test using a fingertip, forearm, or palm blood sample.

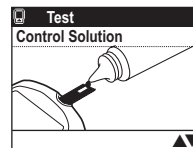

“Test/Control Solution” for a control solution test. If you are performing a control solution test, press  to scroll to the Test/Control Solution screen. See *Chapter 8 in Section II*.



NOTE:

- If the Test/Apply Blood screen appears before you are sure the codes match, press  to go back to the Match Code screen. Or, remove the test strip and re-start from step 1. See *Starting the Test Process* in this chapter.
- If you change from the Test/Apply Blood screen to the Test/Control Solution screen by mistake, press  to change it back to the Test/Apply Blood screen.

Getting a blood sample

Overview of the OneTouch® Lancing Device

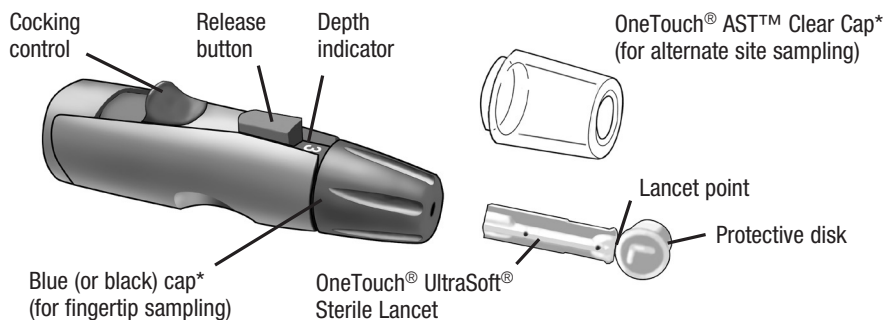

**The blue (or black) cap and OneTouch® AST™ Clear Cap are also used for depth adjustment.*

⚠ CAUTION: To reduce the chance of infection:

- Make sure to wash the puncture site with soap and water before sampling.
- Never share a lancet or lancing device with anyone.
- Always use a new, sterile lancet – lancets are for single use only.
- Keep your meter remote and lancing device clean. See *Chapter 9* in *Section II*.

NOTE: If you do not have a OneTouch® Lancing Device, please refer to the instructions that came with your lancing device.

Choosing the right sampling site at the right time

Your meter remote allows you to sample blood from your fingertip, forearm, or palm. Forearm and palm testing is also referred to as “alternate site testing” (AST). At times, BG test results obtained at the forearm or palm may be different from a fingertip measurement. Talk to your health care professional before you begin using your forearm or palm for sampling.

If you are testing:	Use blood sample from your:
<p>Routinely before meals</p> <p>Prior to or more than two hours after:</p> <ul style="list-style-type: none"> • a meal • a rapid-acting insulin injection or pump bolus • exercise 	<p>Fingertip, forearm, or palm</p>
<p>When your BG is changing rapidly, such as:</p> <ul style="list-style-type: none"> • within two hours after a meal • within two hours after a rapid-acting insulin injection or pump bolus, or • during or within two hours after exercise <p>When you are concerned about the possibility of hypoglycemia (low blood glucose)</p>	<p>Fingertip</p>

 **CAUTION: Do Not** test on your forearm or palm when:

- You think your BG is rapidly falling, such as within two hours of exercise or a rapid-acting insulin injection or pump bolus. Testing with a fingertip sample may identify hypoglycemia or an insulin reaction sooner than testing with a forearm or palm sample.
- It has been less than two hours after a meal, a rapid-acting insulin injection or pump bolus, physical exercise, or you think your BG level is changing rapidly.
- You are concerned about the possibility of hypoglycemia or an insulin reaction, such as when driving a car. This is especially important if you suffer from hypoglycemia unawareness (lack of symptoms to indicate an insulin reaction).

Remember: Consult your health care professional before using your forearm or palm for testing.

Choose a different puncture site each time you test. Repeated punctures in the same spot may cause soreness and calluses.

If bruising occurs at an alternate site or you have difficulty getting a sample, consider sampling from a fingertip instead. You may want to review the choice of sites with your health care professional.

Preparing your sample site

Before you test your BG, wash your hands and forearm (if applicable) thoroughly with warm, soapy water. Rinse and dry.



Lancing and sampling from your fingertip

1. Remove the blue (or black) cap by snapping it off
2. Install a sterile lancet into the OneTouch® Lancing Device

Insert the lancet into the holder and push in firmly. Twist the protective disk until it separates from the lancet and save the disk for later use. **Do Not** twist the lancet.

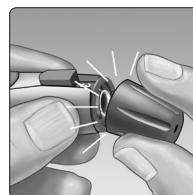

3. Replace the blue (or black) cap by snapping it back on

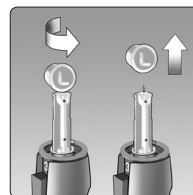
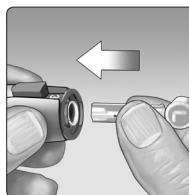

4. Adjust the depth setting

The OneTouch® Lancing Device has nine puncture depth settings, numbered 1 through 9. The smaller numbers are for a shallower puncture and the larger numbers are for a deeper puncture. Shallower punctures work for children and most adults. Deeper punctures work well for people with thick or calloused skin. Twist the blue (or black) cap until the correct setting appears.

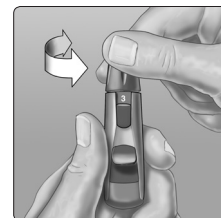

NOTE: A shallower puncture may be less painful. Try a shallower setting first and increase the depth until you find the one deep enough to get a sufficient drop of blood for testing (● sample size).

5. Cock the OneTouch® Lancing Device

Slide the cocking control back until it clicks. If it does not click, it may have been cocked when you inserted the lancet.

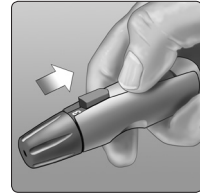

6. Puncture your finger

Hold the OneTouch® Lancing Device firmly against the side of your finger. Press the release button. Remove the OneTouch® Lancing Device from your finger.

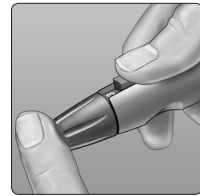

7. Get a round drop of blood

Gently squeeze and/or massage your fingertip until a round drop of blood sufficient for testing forms (● sample size) on your fingertip.

If the blood smears or runs, **Do Not** use that sample. Dry the area and gently squeeze another drop of blood or puncture a new site.

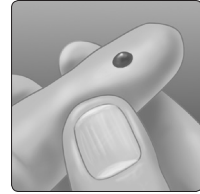

Lancing and sampling from an alternate site

Sampling from your palm or forearm allows you to use your fingertips less often. You may find that obtaining a blood sample from an alternate site is less painful than using a fingertip. Getting a blood sample from your forearm or palm is different than getting a sample from your fingertips.

Forearm sampling

Choose a fleshy area of the forearm away from bone, visible veins and hair. Sometimes there is less blood flow to the forearm than to the fingertips. To help you get a large enough drop of blood, you may gently massage or apply warmth to the site to increase blood flow.

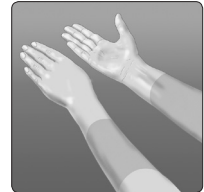

Forearm

Palm sampling

Choose a fleshy area on the palm below your thumb or pinky finger. Select a spot with no visible veins and away from deep lines which may cause your blood sample to smear.

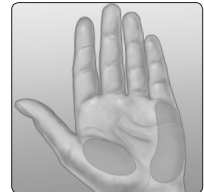

Palm

Blue (or black)
cap for fingertip
sampling only

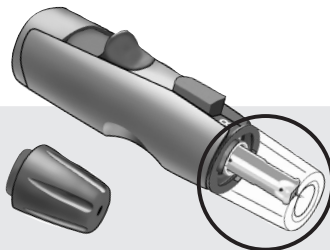

The OneTouch® AST™ Clear Cap is used for forearm and palm sampling only. Replace the blue (or black) cap with the OneTouch® AST™ Clear Cap.

1. Remove the blue (or black) cap by snapping it off

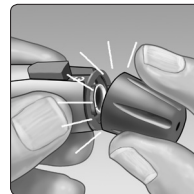

2. Insert a sterile lancet into the OneTouch® Lancing Device

Insert the lancet into the holder and push in firmly. Twist the protective disk until it separates from the lancet and save the disk for later use. **Do Not** twist the lancet.

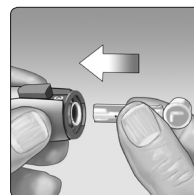

3. Install the OneTouch® AST™ Clear Cap on the OneTouch® Lancing Device by snapping it on

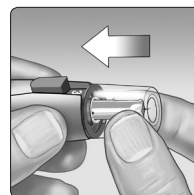

4. Adjust the depth setting

You may have to adjust the OneTouch® Lancing Device to a deeper setting to get a large enough drop of blood from your forearm or palm. Twist the OneTouch® AST™ Clear Cap toward the larger numbers to increase the depth.

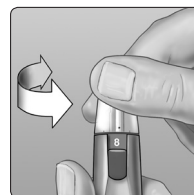

5. Cock the OneTouch® Lancing Device

Slide the cocking control back until it clicks. If it does not click, it may have been cocked when you inserted the lancet.

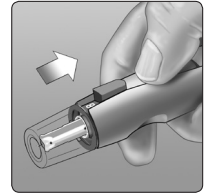

6. Puncture your forearm or palm

Firmly press and hold the lancing device against your forearm or palm for a few seconds. **Wait until the skin surface under the OneTouch® AST™ Clear Cap changes color (as blood collects beneath the skin). This tells you there is enough blood flow for a good sample.** Then press the release button while continuing to apply pressure. Keep holding the lancing device against your skin until a round drop of blood forms under the cap.

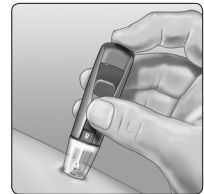

Forearm

When sampling blood from your forearm or palm, make sure the drop of blood is sufficient for testing (● sample size) before you release pressure and remove the lancing device.

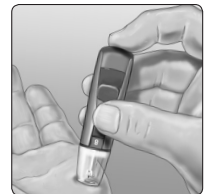

Palm

7. Remove the OneTouch® Lancing Device

Carefully lift the lancing device away from your skin. **Do Not** smear the blood sample.

NOTE:

- You may need to wait a little longer to get a large enough drop of blood from the forearm or palm. **Do Not** squeeze the site excessively.
- If the sample drop of blood runs or spreads due to contact with hair or with a line in your palm, **Do Not** use that sample. Try puncturing again in a smoother area.
- Remember: You may have to adjust the lancing device to a deeper setting to get a large enough drop of blood (● sample size).

Applying blood and reading BG test results

Once you have a blood sample and your meter remote shows the Test/Apply Blood screen, you are ready to obtain a BG test result. If your meter remote does not show the Test/Apply Blood screen, remove the unused test strip and re-start the test process. See *Starting the Test Process* in this chapter.

1. Prepare to apply the sample

Keeping your finger extended and steady, move your meter remote and test strip toward the blood drop.

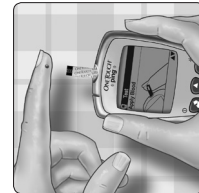

Fingertip

Do Not apply blood on the top of the test strip.

Do Not hold your meter remote and test strip underneath the blood drop. This may cause blood to run into the test port and damage your meter remote.



When applying a drop of blood from your forearm or palm, keep your palm or forearm steady and bring the top edge of the test strip to the drop of blood with your other hand.

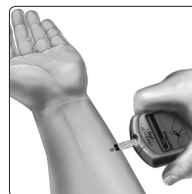

Forearm



Palm

2. Apply the sample

Line up the test strip with the blood drop so that the narrow channel on the edge of the test strip is almost touching the edge of the blood drop.

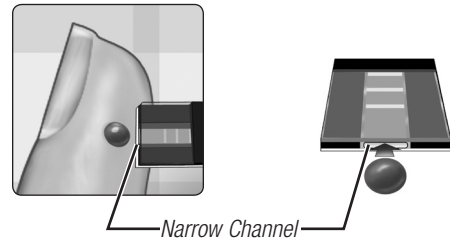

Gently touch the channel to the edge of the blood drop.

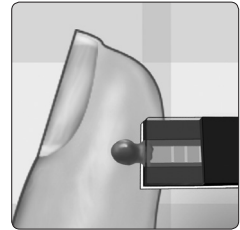

Be careful not to push the test strip against your fingertip or the test strip may not fill completely.

NOTE:

- **Do Not** smear or scrape the drop of blood with the test strip.
- **Do Not** apply more blood to the test strip after you have moved the drop of blood away.
- **Do Not** move the test strip in your meter remote during a test.

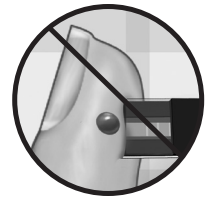

⚠ CAUTION: You may get an ERROR 5 message or an inaccurate BG test result if the blood sample does not fill the confirmation window completely. See *Chapter 10* in *Section II*. Discard the test strip and re-start the test process.

3. Wait for the confirmation window to fill completely

The blood drop will be drawn into the narrow channel and the confirmation window should fill completely.

When the confirmation window is full, this means you have applied enough blood. Now you can move the test strip away from the blood drop and wait for your meter remote to count down from 5 to 1.

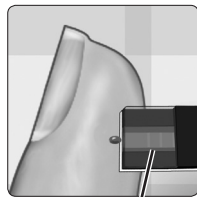

Confirmation Window



Full



Not Full

4. Read your BG test result on your meter remote

Your BG level appears on the display, along with the unit of measure, and the date and time of the test. BG test results are automatically stored in your meter remote's memory.

*(Example)*

⚠ WARNING: If mg/dL does not appear with the BG test result, call Customer Service at 1 877 937-7867. Use of the wrong unit of measure may cause you to misinterpret your BG level, and may lead to incorrect treatment.

⚠ CAUTION: If you test at the low end of the operating range (43°F/6°C) and your BG is high (over 180 mg/dL), the reading on your meter remote may be lower than your actual BG. In this situation, repeat the test in a warmer environment with a new test strip as soon as possible.

Error messages

If you get an ERROR message on your screen rather than a BG test result, see *Chapter 10* in *Section II*.

Unexpected BG test results

Refer to these cautions  whenever your BG test results are lower than, higher than, or not what you expect.

CAUTION: Dehydration and low BG test results

You may get false low BG test results if you are severely dehydrated. If you think you are severely dehydrated, contact your health care professional immediately.

CAUTION: Low BG test results

If your BG test result is lower than 70 mg/dL or is shown as LOW GLUCOSE, it may mean hypoglycemia (low BG). This may require immediate treatment according to your health care professional's recommendations. Although this BG test result could be due to a test error, it is safer to treat first, then do another test.

CAUTION: High BG test results

If your BG test result is higher than 180 mg/dL, it may mean hyperglycemia (high BG). If you are uncertain about this BG test result, consider re-testing. Your health care professional can work with you to determine what actions, if any, you should take if your BG test results are higher than 180 mg/dL.

If your meter remote displays HIGH GLUCOSE, you may have a very high BG level (severe hyperglycemia) exceeding 600 mg/dL. Re-check your BG level. If the BG test result is HIGH GLUCOSE again, this may indicate a severe problem with your BG control and it is important that you obtain and follow instructions from your health care professional without delay.

⚠ CAUTION: Repeated unexpected BG test results

If you continue to get unexpected BG test results, check your system with control solution. See *Chapter 8* in *Section II*.

If you are experiencing symptoms that are not consistent with your BG test results and you have followed all instructions in this booklet, call your health care professional. Never ignore symptoms or make significant changes to your diabetes control program without speaking to your health care professional.

⚠ CAUTION: Unusual red blood cell count

A hematocrit (percentage of your blood that is red blood cells) that is either very high (above 55%) or very low (below 30%) can cause false BG test results.

After getting a BG test result

Once you have read your BG test result, you may:

- Go directly to the Bolus Menu screen where you can calculate a bolus

“Bolus” will be highlighted. Press . See *Chapter 4* in *Section III*, for using your meter remote to deliver a bolus.



NOTE:

- RF communication must be activated on your meter remote and your pump, and the devices must be paired, before you will be able to use your meter remote to access pump functions. See *Chapter 2* in *Section III* for completing these procedures.

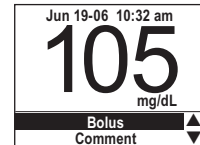
or



- Add comments to your BG test result that will be stored in your meter remote memory

Press  to highlight “Comment” and press . See *Chapter 5 in Section II*. You may also add a comment after you calculate and deliver a bolus, or to a BG test result that is already stored in your meter remote memory.

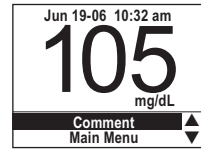

or

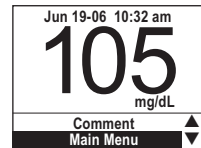

- Go to the Main Menu screen where you have access to all meter remote functions

Press  to highlight “Main Menu” and press .



or

- Compare your previous BG test result and average with your current BG test result

Press  to highlight “Compare Result” and press . Your last BG test result and your average for the current meal period will appear on the screen.

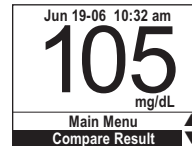

Your Result:		105
Previous Jun 19-06 7:40am	Aft Brkft Avg. 14 days	
99	109	

or

- Remove the test strip to turn off your meter remote

Removing the used lancet

Remove the lancing device cap by snapping it off. **Cover the exposed lancet tip before removing the lancet.** Place the lancet protective disk on a hard surface. Push the lancet tip into the disk. Remove the lancet and place it in a container for sharp objects. Replace the cap.

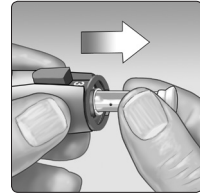

Disposing of the used lancet and test strip

It is important to discard the used lancet carefully after each use to avoid unintended lancet stick injuries. Used test strips and lancets may be considered biohazardous waste in your area. Be sure to follow your local regulations for proper disposal, or follow your health care professional's recommendations for proper disposal of biohazardous waste.

CHAPTER 5 - Adding comments to glucose test results

You may add comments to specific BG test results at the time of the test or at a later time. A food comment (indicating before-meal or after-meal testing) is automatically added to every BG test result. You may also add comments to note if the test was taken before, during, or after exercise, and how you were feeling at the time of the test. In all, you may add one food comment, one exercise comment, and up to six health comments to a BG test result.





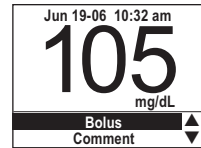

If you would like to add a comment just after taking a test, press  to highlight "Comment" and press .

The following types of comments may be added:



Types of comments	Choices	
Food	Before Breakfast	After Breakfast
	Before Lunch	After Lunch
	Before Dinner	After Dinner
	Night	
Health	Stress	Feel Hypo
	Illness	Menses (period)
	Vacation	Other
Exercise	Before	
	During	
	After	

Rules for adding comments to BG test results

- If you wish to add a comment to the current BG test result, press  to highlight “Comment” while viewing the BG test result and press . If you wish to add a comment to a BG test result at a later date, display the logbook record for that BG test result and press . See *Chapter 7 in Section II*.
- A food comment is automatically assigned to every BG test result based on the pre-set or your personal meal schedule (see *Chapter 1 in Section II*). You may edit that food comment as necessary.
- Press  to scroll up or down through the various menus and choices.
- Press  to make selections.
- You must save your selections by highlighting “Save” and then pressing .
- If you insert a test strip while you are adding comments to a BG test result, your comments (other than the food comment) will not be saved.
- To remove an entry, highlight “---” from the menu.

How to add a comment

Following are the steps you take to add a comment. In this example, we will add a food, exercise, and health comment to a BG test result.

With any BG test result on the display, highlight “Comment” and press .

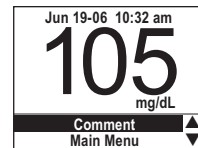

“Health” is always highlighted first since the food comment is automatically assigned based on the pre-set or your personal meal schedule.







Food comments

If you wish to change the food comment to a different mealtime, press  to highlight "Food" and press .

Press  to highlight your mealtime and press  again.

Your choices are "Bef Brkft", "Aft Brkft", "Bef Lunch", "Aft Lunch", "Bef Dinner", "Aft Dinner", and "Night".

Once you select your mealtime, "Health" is highlighted again.

If you are finished commenting, press  to highlight "Save" and press . If you do not press , your entries will not be saved. If you wish to enter other comments, press  to highlight another menu choice and then press .

Jun 19-06 10:32 am Gluc.105 Comment	
Food	Aft Brkft
Health	-----
Exer	-----
Save	

Jun 19-06 10:32 am Gluc.105 Comment	
Food	----- ▲
Health	Bef Brkft
Exer	Aft Brkft
Save	Bef Lunch
	Aft Lunch ▼

Jun 19-06 10:32 am Gluc.105 Comment	
Food	Bef Lunch
Health	-----
Exer	-----
Save	

Jun 19-06 10:32 am Gluc.105 Comment	
Food	Bef Lunch
Health	-----
Exer	-----
Save	

Health comments

You can comment on a BG test result with notes about your overall health at the time of the test. Press **OK** with “Health” highlighted. You may add up to six descriptors from this menu:

- Stress Menses (period)
- Feel Hypo Vacation
- Illness Other

After adding your first health comment, “Health 2” will automatically appear on the screen.

To add additional health comments, press **OK** and select another one from the menu. Note that your previous comment is no longer available.

When you have completed adding comments, press **Save** to highlight “Save” and press **OK**. If you do not press **OK**, your entries will not be saved.

Exercise comments

You can comment on a BG test result as occurring before, during, or after exercise.

After you add the exercise comment, “Save” will automatically be highlighted.

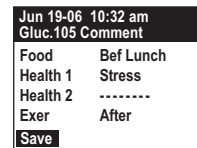
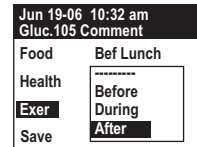
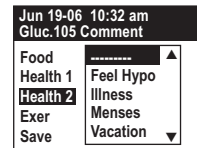
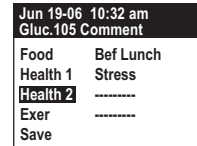
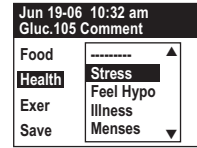

If you press **OK**, all of the comments you have entered will appear with the BG test result in the logbook, as in this example.

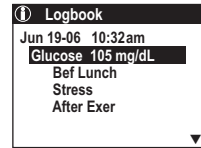

Editing or deleting comments (example)

To edit or delete a comment from a BG test result, first display that BG test result in your meter remote logbook (see *Chapter 7 in Section II*). Be sure the highlight is on the BG test result to which the comment is attached. Press **OK**.

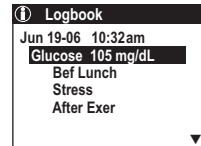

To change the mealtime, highlight “Food” and press **OK**.

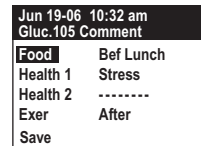

Highlight the desired mealtime and press **OK** again. You may edit other comments at this time.

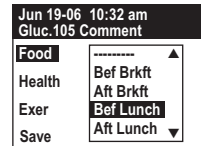

To delete a comment, press **⬇** to highlight “- - -” and press **OK**. When you have completed editing the comments, press **⬇** to highlight “Save” and press **OK**.

Your edited comment will appear this way in your meter remote logbook.

NOTE: You can delete or edit comments, but you cannot delete a BG test result.

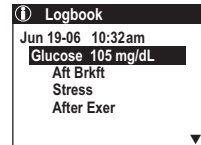





208 : CHAPTER 6 - Making logbook entries

Logbook entries let you store separate records concerning exercise, health, and food that are not associated with a BG test result. Logbook entries are different than comments, which are added to a specific BG test result. You do not have to perform a BG test in order to add valuable information to your meter remote logbook.



Entries are saved as stand-alone logbook records with an assigned date and time.

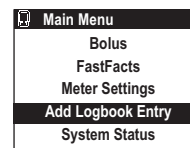

Rules for adding logbook entries

Entry Types	Choices			
Exercise	<i>Level:</i>	Mild	Moderate	Hard
	<i>Duration:</i>	Length of time		
Health	<i>Health Notes:</i>			
	Stress	Feel Hypo	Illness	
	Menses (period)	Vacation	Other	
Food	Carbs	(total carb amounts for a meal or snack)		
Pump	Date and time of infusion set changes			

- If you wish to add a new logbook entry, press  to highlight “Add Logbook Entry” on the Main Menu screen and press . Press  to highlight the entry type on the Add New Entry screen and press . A graphic icon representing the entry type will appear in the upper left-hand corner of the screen.





- Before adding an entry, the date and time must be selected. Press  to choose either the current date and time displayed or “Other Time”.
- Press  to confirm your choices and the logbook record screen will appear. If no logbook record screen appears, your entries have not been saved.

- If you insert a test strip while you are adding a logbook record, your record will not be saved.
- It is possible to enter the same entry type more than once for a given date and time.
- To remove an entry, press  to highlight “---” from the menu.
- Prior to viewing the logbook record screen, you may press  and return to the previous screen to review or edit the information you have entered.
- When making logbook entries, the starting values for entering data will be the ones you last saved.

Entering the date and time for an entry





A date and time must be selected after choosing an entry type. In this example, the date and time will be selected for an Exercise entry.

If the entry is for the current date and time, press .

If the entry is for a previous date and time, press  to highlight “Other Time” and press .

A calendar will appear on the screen for the current month as it is stored in your meter remote, and the current day will be highlighted. Press  to scroll to the desired day for the logbook entry. Each time you scroll backward past the first day of the month, the previous month’s calendar will appear.

Press  when you have the correct month and day highlighted.

Press  to enter the time in hours and minutes and then press  after each selection. If you have selected the am/pm time format, “am” or “pm” will be displayed next to the minutes and will be highlighted. Press  to scroll to the correct am or pm setting. Press  to confirm your selection.

Then make your logbook entry.

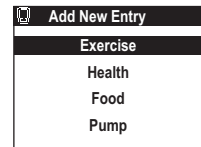
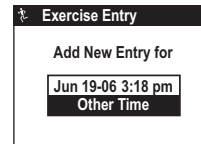
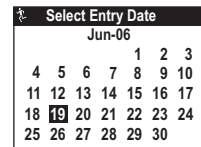







Jun-06						
			1	2	3	
4	5	6	7	8	9	10
11	12	13	14	15	16	17
18	19	20	21	22	23	24
25	26	27	28	29	30	



Exercise entries

Press  to highlight “Exercise” on the Add New Entry screen and press .

If the entry is for the current date and time press . Press  to highlight “Other Time” and press  if the entry is for a previous date and time.

Press  to rate the exercise you performed as Mild, Moderate, or Hard.
Press .

Then press  to record the duration of the exercise to the nearest five minutes.
Press  to save the entry.

The exercise entry will be saved this way in your meter remote logbook.

Add New Entry	
Exercise	
Health	
Food	
Pump	



Exercise Entry	
Add New Entry for	
Jun 19-06 3:18 pm	
Other Time	

Jun 19-06 3:18 pm Exercise Entry	
Exercise	-----
Duration	Mild
	Moderate
	Hard

Jun 19-06 3:18 pm Exercise Entry	
Exercise	Moderate
Duration	00:45

Logbook	
Jun 19-06 3:18 pm	
Exercise	
Moderate	00:45

Health entries

Health entries let you enter information about your health status. To add a health entry, press  to highlight “Health” on the Add New Entry screen and press .

Follow the steps as described in the *Entering the date and time for an entry* in this chapter to select the correct time and date of the new entry.

Choose from this menu:

Stress	Menses (period)
Feel Hypo	Vacation
Illness	Other

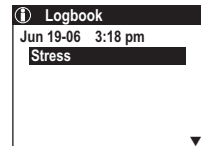
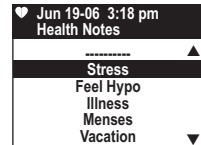
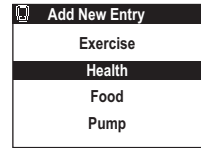

Press  to save and view the Health Notes entry.

The health entry with your Health Note will be saved this way in your meter remote logbook.



Food entries

Food and BG levels are closely linked. Food entries let you keep track of carb amounts either entered manually, or selected from the Food Database.

Press  to highlight “Food” on the Add New Entry screen and press . Follow the same steps to select the correct time and date of the new entry.



Select the desired meal, snack, or alcohol descriptor and press .

On the Food Entry/Edit screen highlight “Carb Entry” if you would like to add a carb amount manually, or “Food List” if you would like to refer to the Food Database. The Food Database includes carb amounts for hundreds of food types.

NOTE: If you select “Alcohol” from the Food Entry screen above, you will not be able to enter a specific carb amount. Instead, a logbook entry will be made indicating “Alcohol” at the time and date for the logbook entry.

Manual carb entry

To add a carb amount manually, highlight “Carb Entry” and press .

Then press  to highlight the desired carb amount. Carbs are entered in 1-gram steps in the range of 0 to 999. Press  when finished.

The food entry will be saved this way in your meter remote logbook.

NOTE: If you enter “0” carbs, this value will be included in your Food averages when viewing data (see *Chapter 7 in Section I*). **Do Not** enter “0” (leave entry as “-----”) if you do not want this value included in your averages.

Add New Entry	
Exercise	
Health	
Food	
Pump	

Jun 19-06 3:18 pm Food Entry	

Breakfast	
Lunch	
Dinner	
Snack	
Alcohol	

Food Entry Edit	
Carb Entry	
Food List	

Logbook	
Jun 19-06	3:18 pm
Lunch	
Carbs:	60



Lunch Information	
Carb:	-----

Food Database carb entry

To add a carb amount from the Food Database, highlight “Food List” and press . Then follow the instructions in the Food Database chapter (see *Chapter 2* in *Section II*) for making selections. When you are finished choosing your carb amount from the Food Database, you will go to the Logbook screen for your selected meal where you can modify or delete your entry in your meter remote logbook.

Pump entries

Once you begin using your meter remote and pump together as a system, you may also wish to keep track of your infusion set changes in your meter remote logbook.

Press  to highlight “Pump” on the Add New Entry screen and press . Follow the steps for selecting the correct time and date of the new entry. You may track the date and time of every infusion set change.

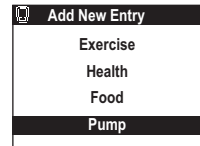

To record when you changed your infusion set, press  to highlight “Infusion Set Change” and press .

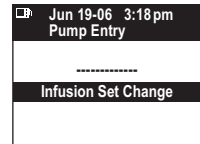

Your pump entry will be saved this way in your meter remote logbook.

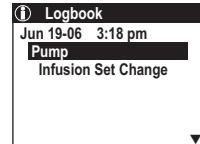

Editing or deleting logbook entries

To edit or delete a logbook entry, first display that logbook entry in your meter remote logbook (see *Chapter 7* in *Section II*). Make sure the logbook entry icon, date and time, and description are correct for the logbook entry you wish to edit or delete. Then press **OK**.

Select “Edit” to change the logbook entry or “Delete” to remove it completely, and then press **OK**.

To edit an entry, highlight the descriptor you would like to change and press **OK**. Press **▲** to change the entry and press **OK**.

For example, the edited entry will appear this way in your logbook if you choose to select “Illness” instead of “Stress”.

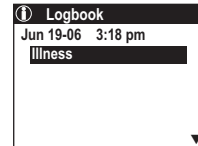
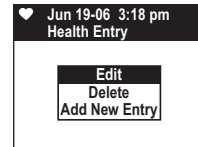
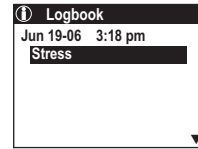

The FastFacts screen lets you review and edit data records stored in your meter remote memory. You can also perform on-screen trending of BG, and other health-related data.

To get to the FastFacts screen, press  to highlight “FastFacts” on the Main Menu screen and press .

When you choose “FastFacts” on the Main Menu screen, an additional menu of options appears.

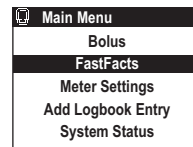

FastFacts screen options

Logbook (Meter Remote Memory)

Scroll through BG test results and other health data entries, by date and time.

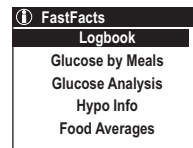

Glucose by Meals

Display BG test results by date, before and after meals.

Glucose Analysis

Analyze your BG test results in more detail through charts and graphs that organize your data several different ways.

- Graph of All Results - An interactive graph of all BG test results by date.
- Graph by Time of Day - A graph of BG test results by time of day.
- Average of All Results - The average of all BG test results taken for the last 7, 14, 30, 60, and 90 days.
- Average by Time of Day - BG test result averages by time of day for the last 7, 14, 30, 60, and 90 days.

- Average by Exercise - BG test result averages before, during, and after exercise.
- Glucose Range Info - The percent of BG test results within, above, and below your target range, before and after meals, for the last 7, 14, 30, 60, and 90 days.

Hypo Info

Review incidents of hypoglycemic events (BG test results below your pre-set or personal level stored in your meter remote), before and after meals, for the last 7, 14, 30, 60, and 90 days. See *Chapter 1* in *Section II* and consult with your health care professional before setting your hypoglycemic level.

Food Averages

Average your daily intake of carbohydrates, for the last 7, 14, 30, 60, and 90 days.

Logbook

Your meter remote logbook stores at least 20,000 logbook records. Logbook records are created whenever data are saved for a particular time and date. Three types of logbook records are stored in your meter remote:

- **BG test results with or without added comments**

BG test results from your meter remote are automatically stored as logbook records whenever you take a test. Date and time are tagged to the BG test result. A food comment is always attached to the BG test result based on the pre-set or your personal meal schedule. You may add other comments to the BG test result by accessing the logbook at the time of the test or at a later time. You may also edit or delete comments attached to the BG test result.

BG test results may not be deleted from the logbook.

- **Health-related data (logbook entries) not associated with a BG test result**

Health-related data may be added either as stand-alone logbook entries for a specific date and time. As with comments, you may also edit or delete health-related logbook records.

Viewing logbook records

To review your logbook entries, press  to highlight “Logbook” on the FastFacts screen and then press .

Your most recent logbook entry will appear on the display.

Press  to scroll through previous logbook records.



To edit or delete a data record, press  when that data record is on the display. You will then have the option to edit, delete, and/or add a new logbook entry. Your options are defined by the type of data record you were viewing on the display.

NOTE:

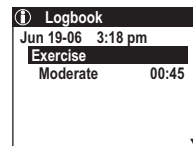
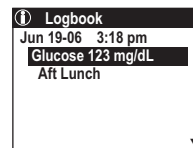
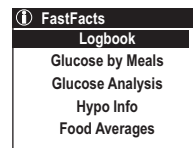
- You cannot delete or edit a BG test result, but you can edit any comment associated with those types of records. You can, however, delete any logbook record that is not associated with a BG test result.
- When adding a new logbook entry, you have the option of creating a record for the current time and date or for a previous time and date.



Glucose by Meals

To review before-meal and after-meal BG test results, press  to highlight “Glucose by Meals” on the FastFacts screen and press .

FastFacts
Logbook
Glucose by Meals
Glucose Analysis
Hypo Info
Food Averages

Highlight the desired mealtime and press .

Glucose by Meals
Breakfast
Lunch
Dinner
Night



A summary of all BG test results by date before and after the chosen meal (or at night) will appear. Press  to view more entries.

Press  to return to the FastFacts screen.

Glucose by Meals			
	Bef	Brkft	Aft Brkft
Jun 19	80	120	▲
Jun 18	100	115	
Jun 17	70	125	
Jun 16	140	110	
Jun 15	70	95	
Jun 14	95	112	▼

Glucose Analysis



When you select “Glucose Analysis” on the FastFacts screen, an additional menu of choices appears.

Press  to highlight the desired choice and then press .

FastFacts
Logbook
Glucose by Meals
Glucose Analysis
Hypo Info
Food Averages

Glucose Analysis
Graph of All Results
Graph by Time of Day
Average of All Results
Average by Time of Day
Average by Exercise
Glucose Range Info

Graph of All Results

To view an interactive graph of three days (at a time) of BG test results, press  and press  to highlight “Graph of All Results” on the Glucose Analysis screen and press .

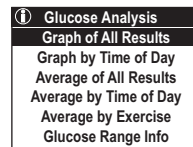

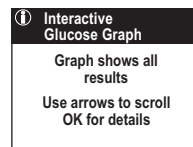

The first screen provides instructions for moving from one time period to the next, and for examining a particular BG test result more closely. Press  to continue.



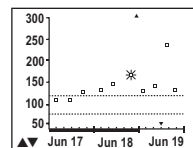

The most recent three days of BG test results appear on a graph with the currently selected BG test result flashing.

A bold bar above the dates indicates a weekend. The two dotted lines indicate the lowest and highest values of your before-meal and after-meal glucose ranges (see *Chapter 1 in Section II*). If you have not selected an after-meal range, only the before-meal range will appear. BG test results above 300 mg/dL or below 50 mg/dL are indicated by an arrow at the top or bottom edge of the graph.

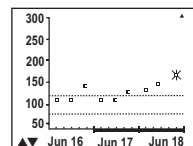

You may scroll backward or forward in time on the graph by pressing  to move from one point to another. Individual BG test results will flash as you scroll.



To view the details of a test, press  while that BG test result is flashing. Press  to return to the graph. You may move back and forth between the graph and the logbook as often as you wish.

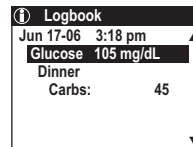

Press  while any graph is displayed to return to the Glucose Analysis screen.

Graph by Time of Day

You may view BG test results on a graph by time of day when you select “Graph by Time of Day” on the Glucose Analysis screen and press **OK**.

Highlight the desired time of day and press **OK**. The time of day is based on the pre-set or your personal meal schedule (see *Chapter 1* in *Section II*).

You will be reminded of the time period you chose for the graph that follows. Press **OK** to continue.

The most recent seven days of BG test results appear on a graph.



A bold bar above the dates indicates a weekend. The two dotted lines indicate the lowest and highest values of your before-meal and after-meal glucose ranges (see *Chapter 1* in *Section II*). If you have not selected an after-meal range, only the before-meal range will appear. BG test results above 300 mg/dL or below 50 mg/dL are indicated by an arrow at the top or bottom edge of the graph.

Press **Left Arrow** to scroll forward or backward in time. The graph will update (move one day) with each press of **Left Arrow**.

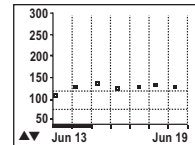
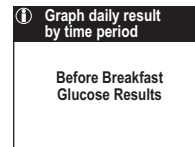
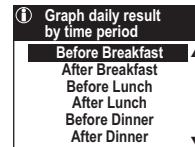
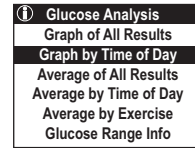
Press **OK** to return to the Glucose Analysis screen.



Average of All Results

To view your BG test result averages over a pre-defined number of days, press  to highlight “Average of All Results” on the Glucose Analysis screen and press .



BG test result averages are displayed for the last 7, 14, 30, 60, and 90 days with the number of tests completed during that time period included in parentheses.

Press  to return to the Glucose Analysis screen.

①	Glucose Analysis
	Graph of All Results
	Graph by Time of Day
	Average of All Results
	Average by Time of Day
	Average by Exercise
	Glucose Range Info

①	Average of all Results
	Number of Days Avg
(31)	7 115
(42)	14 119
(48)	30 120
(54)	60 118
(73)	90 157

Average by Time of Day

To view your BG test result averages by time of day, press  to highlight “Average by Time of Day” on the Glucose Analysis screen and press .

Test averages by time of day are available for the last 7, 14, 30, 60, and 90 days. Highlight the desired time period and press .

①	Glucose Analysis
	Graph of All Results
	Graph by Time of Day
	Average of All Results
	Average by Time of Day
	Average by Exercise
	Glucose Range Info

①	Average by Time of Day
	7 14 30 60 90 Days

BG test result averages are displayed for the period you selected, with the number of tests completed during that time period included in parentheses. The time of day is based on the pre-set or your personal meal schedule (see *Chapter 1* in *Section II*).

Press  to return to the Glucose Analysis screen.

①	Avg. by Time of Day - 14 Days
(14)	Bef Brkft 95
(14)	Aft Brkft 135
(14)	Bef Lunch 80
(14)	Aft Lunch 128
(6)	Bef Dinner 125
(7)	Aft Dinner 155

Average by Exercise

To view your BG test result averages before, during, and after exercise, press  to highlight “Average by Exercise” on the Glucose Analysis screen and press .

BG test result averages before, during, and after exercise are available for the last 7, 14, 30, 60, and 90 days. Highlight the desired time period and press .

BG test result averages are displayed before, during, and after exercise for the period you selected, with the number of tests completed during that time period included in parentheses.

Press  to return to the Glucose Analysis screen.

① Glucose Analysis	
Graph of All Results	
Graph by Time of Day	
Average of All Results	
Average by Time of Day	
Average by Exercise	
Glucose Range Info	

① Average by Exercise	
	7
	14
	30
	60
	90
	Days

① Avg. by Exercise		
14 Days		
(14)	Before Exercise	125
(3)	During Exercise	103
(14)	After Exercise	110

Glucose Range Info

To review the percentage of your BG test results that are above, below, and within your target ranges, press  to highlight “Glucose Range Info” on the Glucose Analysis screen and press .

Percentages will be calculated for the before- and after-meal ranges you entered in the Set-up mode.

Choose either “Before Meal” or “After Meal” averages and press .

“Before Meal” and “After Meal” BG test results are based on the pre-set or your personal meal schedule (see *Chapter 1 in Section II*).

Highlight the desired time of day and press .

Percentages can be viewed for the last 7, 14, 30, 60, or 90 days. Highlight the desired time period and press .

The percentage of your BG test results that are above, below, and within your target range will appear for the time period selected, with the number of tests that make up that percentage included in parentheses.

NOTE: Sometimes percentages may not total 100% exactly due to rounding.

Press  to return to the Glucose Analysis screen.

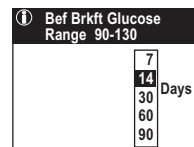
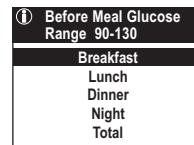
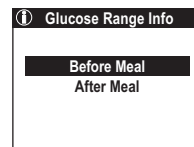
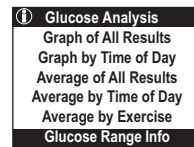

① Bef Brkft Glucose Range 90-130		
(6)	Above	20%
(5)	In Range	70%
(3)	Below	10%

Hypoglycemia Information

If you select “Hypo Info” on the FastFacts screen, your meter remote will display the actual number of hypoglycemic events by time of day, defined by the hypo level set in Advanced Features (see *Chapter 1* in *Section II*).

Highlight the desired time period for viewing the number of hypoglycemic events and press **OK**.

The number of events before and after meals and during the night for the selected time period is displayed.

Before-meal and after-meal events are based on the pre-set or your personal meal schedule (see *Chapter 1* in *Section II*).

Press **OK** to return to the FastFacts screen.

FastFacts	
Logbook	
Glucose by Meals	
Glucose Analysis	
Hypo Info	
Food Averages	



Hypo Info (70 mg/dL or less)	
	7
	14
	30
	60
	90
	Days

Hypo Info (70 mg/dL or less)	
Total - 14 Days:	4
Bef Brkft	1
Aft Brkft	0
Bef Lunch	2
Aft Lunch	0

Food Averages

Select “Food Averages” on the FastFacts screen to view average daily intake of carbohydrates over the last 7, 14, 30, 60, and 90 days. Averages may be displayed for the meal periods you selected when making logbook entries, or as a daily average.

Press  to select the desired meal period and press .

Then press  to select the number of days and press .

Your daily carbohydrate average will appear to the right on the screen. The number of entries used for that average appears in parentheses to the left.

Press  to return to the FastFacts screen.

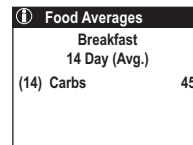
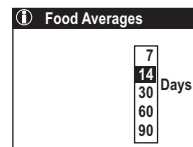
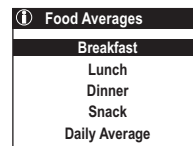
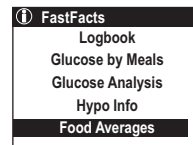

Downloading meter remote logbook records to a PC

It's important to save the data in your meter remote memory on a regular basis. Your meter remote memory will store at least 20,000 records but will eventually fill up if you do not transfer the data to a PC and/or other storage device. If your meter remote memory becomes full, the oldest records will be replaced by the newest records as they are created. You can use your meter remote with ezManager® Software (provided with your pump) for storing your records, and to help you spot patterns for planning meals, exercise, and medication. ezManager® Software puts information downloaded from your meter remote into charts and graphs.

Transferring BG test results to your PC for storage or home viewing requires ezManager® Software from Animas® and a USB 2.0 compliant Type 'A' to Mini 'B' Interface Cable. The USB Interface Cable is included with your OneTouch® Ping® System Kit.

NOTE: To ensure safe operation of your meter remote when connecting it to a PC, the computer must have an appropriate safety approval as indicated by the presence of one or more of the following logos (UL, CSA, or CE) on the PC or monitor. Also check to see if the PC is connected correctly to its power source.

WARNING:

- Electrostatic discharge (ESD) can build up when it's very dry and/or while you are wearing certain synthetic clothing. To reduce ESD build-up and possible damage to your meter remote, first touch a grounded metal surface (such as a doorknob) before connecting your meter remote to a PC with the USB Cable.
- To avoid a possible shock, **Do Not** insert a test strip or change the batteries when your meter remote is connected to a PC with the USB Cable.

1. Install the software on your PC

Follow the installation instructions provided with ezManager® Software.

2. Get ready to transfer readings

Connect the Type 'A' end of the USB Cable to a USB port on your PC. With your meter remote turned on, connect the Mini 'B' end of the USB Cable to the data port located on the lower left side of your meter remote. Be sure the Mini 'B' plug is inserted all the way.

After you plug the USB Cable into the data port, "PC" will appear on your meter display. This indicates that your meter remote is in communication mode. You will not be able to perform a test when your meter remote is in communication mode.

If the data transfer command is not received within one minute, your meter remote will turn itself off. Press the **OK** button to turn the meter back on.

3. Transfer data

Follow the instructions provided with ezManager® Software to download the BG test results from your meter remote. Once you begin using your meter remote and pump together as a system, you can use ezManager® Software to download and combine insulin delivery data from your pump with BG management data from your meter remote.

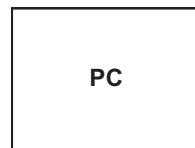
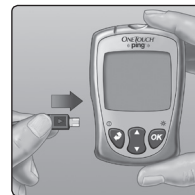

Control solution testing

OneTouch® Ultra® Control Solution contains a known amount of glucose and is used to check that your meter remote and the test strips are working properly.

Do a control solution test:

- To practice the test process instead of using blood.
- Once a week.
- Whenever you open a new vial of test strips.
- If you suspect your meter remote or test strips are not working properly.
- If you have had repeated unexpected BG test results (as described in *Unexpected BG test results* in Chapter 4 in Section II).
- If you drop or damage your meter remote.

CAUTION:

- **Do Not** swallow control solution; it is not for human consumption.
- **Do Not** apply control solution to the skin or eyes as it may cause skin or eye irritation.
- The control solution range printed on the test strip vial is for OneTouch® Ultra® Control Solution only. It is not a recommended range for your blood glucose level.
- If you continue to get control solution test results that fall outside the range printed on the test strip vial, **Do Not** use your meter remote, the test strips, or control solution. Call Customer Service at 1 877 937-7867.

NOTE:

- Use OneTouch® Ultra® Control Solution with your meter remote. For information on a second level of control solution, contact Customer Service.
- Control solution tests must be done at room temperature (68°–77°F/20°–25°C). Make sure your meter remote, test strips, and control solution are at room temperature before testing.

Performing a control solution test

1. Check the code on the test strip vial before inserting the test strip
2. Insert a test strip to turn on your meter remote

Make sure the three contact bars are facing you. Push the test strip in as far as it will go. **Do Not** bend the test strip.

An all-black start-up screen will be followed by an hourglass symbol and then the Match Code screen.

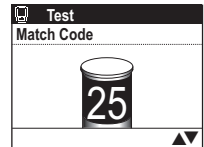



(Example)

⚠ CAUTION: If the graphics appear to be different, call Customer Service at 1 877 937-7867. There may be a problem with your meter remote.

3. Confirm that the code displayed on your meter remote matches the code on the test strip vial

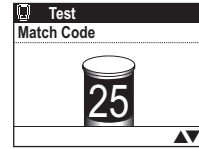
If the code on your meter remote does not match the code on the test strip vial, press  to match the code number on the test strip vial. The new code number will flash on the display for three seconds, after which the display will advance to the Test/Apply Blood screen.



If the codes already match, press  to go to the Test/Apply Blood screen. When you do not make a change after three seconds, the display will advance to the Test/Apply Blood screen.

4. Set your meter remote for a control solution test

Press  to change "Apply Blood" to "Control Solution". To mark a test as a control solution test, you must change "Apply Blood" to "Control Solution" before you apply the solution. It cannot be changed later.

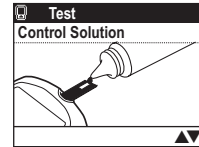
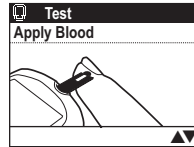

 **WARNING:** It is important that your control solution tests are marked correctly, as test results on your meter remote are used in ezCarb and ezBG Bolus calculations. Control solution tests that are not correctly marked can be used in bolus calculations. This may result in suggested bolus amounts that may be too high or too low, which can cause serious injury or death.

Your meter remote is now ready to perform a control solution test.

5. Prepare and apply the control solution

Shake the control solution vial before each control solution test. Remove the cap and squeeze the vial to discard the first drop. Then wipe the tip with a clean tissue or cloth. Hold the vial upside down and gently squeeze a hanging drop.

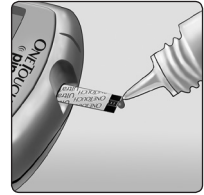

Touch and hold the hanging drop of control solution to the narrow channel in the top edge of the test strip. Make sure the confirmation window fills completely. Control Solution should not be applied to the flat face of the test strip.

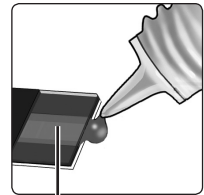
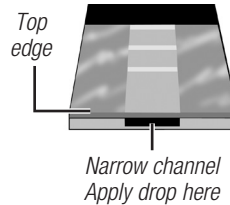

Confirmation Window

6. Read your result

When the confirmation window is full, your meter remote will count down from 5 to 1.

Your control solution result will then appear on the screen, along with the date, time, unit of measure, and the words "Control Solution".

The control solution results can be viewed in the list of past results, but are not counted in your result averages.



7. Check if the result is in range

Compare the result displayed on your meter remote to the control solution range printed on the test strip vial. Each vial of test strips may have a different control solution range. If the results you get are not within this range, your meter remote and test strips may not be working properly. Repeat the control solution test.

Out-of-range results may be due to:

- Not following the instructions detailed in this chapter.
- Expired or contaminated control solution.
- Expired or damaged test strip.
- Use of a test strip or control solution past its discard date.
- A problem with your meter remote.

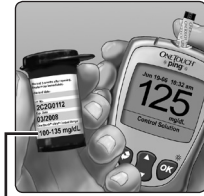

100-135 mg/dL
Example

⚠ CAUTION: Do Not use the test strips or control solution after the expiration date printed on the vial or discard date, whichever comes first, or BG test results may be inaccurate.

⚠ CAUTION: Do Not use the test strips if your vial is damaged or left open to the air. This could lead to error messages or tests that read higher than the actual value. Call Customer Service at 1 877 937-7867 immediately if the test strip vial is damaged.

Your meter remote does not need any special maintenance.

Storing your system

Store your meter remote, test strips, control solution and other items in your carrying case after each use. Store each item in a cool, dry place below 86°F (30°C), but **Do Not** refrigerate. Keep all items away from direct sunlight and heat.

Tightly close the cap on the test strip vial and/or control solution vial immediately after use to avoid contamination or damage. Store test strips only in their original vial.

Checking for expiration or damage

Test strips and control solution have expiration dates printed on their vials. When you first open a test strip or control solution vial, you must record the discard date (date opened plus three months) in the space provided on the label.

Cleaning your meter remote

To clean your meter remote, wipe the outside with a soft cloth dampened with water and mild detergent. **Do Not** use alcohol or another solvent to clean your meter remote.

Do Not get any liquids, dirt, dust, blood, or control solution inside your meter remote through the test port or the data port. Never spray cleaning solution on your meter remote or immerse it in any liquid.

Cleaning your OneTouch® Lancing Device and OneTouch® AST™ Clear Cap

To clean these items, wipe them with a soft cloth dampened with water and mild detergent. **Do Not** immerse the OneTouch® Lancing Device in any liquid.

To disinfect these items, prepare a solution of one part household bleach to ten parts water. Wipe the OneTouch® Lancing Device with a soft cloth dampened with this solution. Immerse the **caps only** in this solution for 30 minutes. After disinfecting, rinse briefly with water and allow both to air dry.

Batteries

Your meter remote uses two AAA alkaline batteries. Batteries are provided with your meter remote but must be installed for your meter remote to power on. Replacement batteries can be found in most stores where batteries are sold.

NOTE: Do Not use lithium batteries in your meter remote. The use of lithium batteries will significantly reduce the number of tests you can complete after the Low Meter Batteries warning screen appears.

Low meter remote battery

When this message appears on the screen, the batteries are low and should be replaced as soon as possible. The backlight will no longer turn on.

You can complete about 100 more BG tests from the time this symbol first appears if you are using alkaline batteries.

When this message appears on the screen, you cannot test, enter data in your meter remote logbook, use your meter remote to access pump functions, or use the FastFacts® feature. You must replace the batteries before using your meter remote.

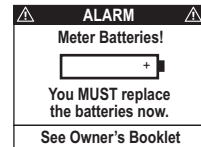
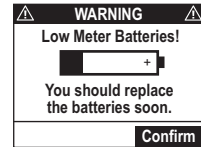

⚠ WARNING: Certain batteries may cause leaking, which can damage your meter remote or cause the batteries to lose power sooner than normal. As a result, your meter remote display may not turn on or may show a battery warning sooner than may be expected.

⚠ WARNING: To avoid a possible shock, **Do Not** change the batteries while your meter remote is connected to a PC with the USB Interface Cable.

Installing/Replacing the batteries

1. Remove the old batteries (if replacing the batteries).

Open the battery compartment by pressing the tab to the right and lifting the compartment cover to remove it.

NOTE: Do Not use lithium batteries in your meter remote. The use of lithium batteries will significantly reduce the number of tests you can complete after the Low Meter Batteries warning screen appears.

Lift both batteries out of the compartment by pulling up on the ribbon.

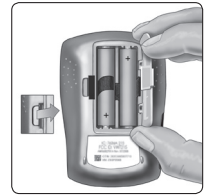

2. Insert the new batteries.

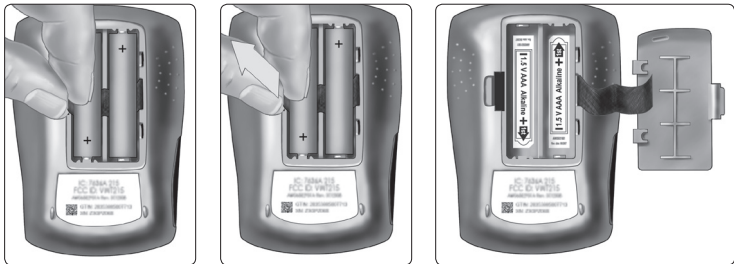

Locate the plus (+) signs inside the battery compartment and on your fresh AAA alkaline batteries. Take the plus (+) end of one battery and insert it underneath the plastic tab that sticks out at the top of the compartment. Then push down on the minus (-) end of the battery until it clicks into place.

Repeat these steps with the second battery. Both batteries should be fresh.

NOTE: You must insert the plus (+) end of each battery before the minus (-) end for the batteries to be installed correctly.

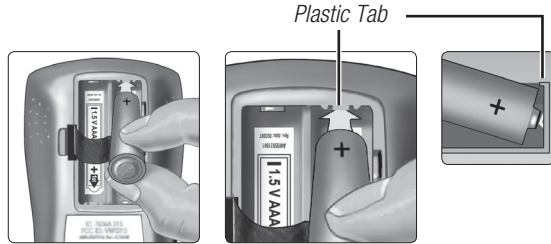

3. Replace the cover.

Insert the two compartment cover tabs into the matching holes, and push down until you hear the door click into place.

NOTE: When you install batteries, there will be a short delay of up to 30 seconds, as your meter remote performs a power-on self test. An hourglass symbol (⌚) will appear on the screen during that time.











4. Dispose of batteries according to your local environmental regulations.







NOTE:

- Your meter remote will automatically enter Basic Set-up mode when you turn your meter remote display on after installing batteries for the first time.
- Every time you replace your meter remote batteries, you have two minutes to complete the procedure for your date and time settings to remain saved in your meter remote memory. If more than two minutes elapse before the batteries are replaced, you may have to re-set the date and time. All other meter remote settings remain saved in your meter remote memory.



Your meter remote displays messages when there are problems with the test strip, with your meter remote, and when your BG levels are beyond the measurement limits (higher than 600 mg/dL or lower than 20 mg/dL). Display messages are in addition to LED and audio cues that alert you to meter remote problems. Messages do not appear in all cases when a problem has occurred. Improper use may cause an inaccurate BG test result without producing an error message. To clear a notification, warning, or alarm, you may need to remove the test strip and/or follow the prompts on your meter remote screen.





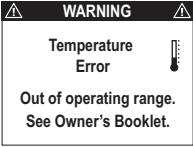
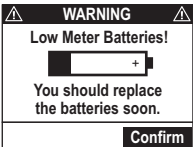

IMPORTANT: There are additional special messages that are displayed on your meter remote when you begin using your meter remote and pump together as a system. These include messages regarding communication problems between the devices or if your intended actions might require additional attention. A third set of special messages covers pump warnings, alarms, and alerts that appear on both your pump and meter remote displays. If a message is displayed on your meter remote and is not included in the list that follows, see *Chapter 6 in Section III* for a list of additional special messages.

Indicates	What to do
 WARNING  <div style="border: 1px solid black; padding: 5px; text-align: center;"> LOW GLUCOSE </div> <div style="border: 1px solid black; padding: 2px; text-align: center; font-size: small;"> Below 20 mg/dL </div> <p>You may have a very low BG level (severe hypoglycemia) lower than 20 mg/dL. Although this message could be due to a test error, it is safer to treat first, and then do another test.</p>	<p>This may require immediate treatment according to your health care professional's recommendations. Although this message could be due to a test error, it is safer to treat first, and then do another test.</p>
 WARNING  <div style="border: 1px solid black; padding: 5px; text-align: center;"> HIGH GLUCOSE </div> <div style="border: 1px solid black; padding: 2px; text-align: center; font-size: small;"> Above 600 mg/dL </div> <p>You may have a very high BG level (severe hyperglycemia) exceeding 600 mg/dL.</p>	<p>Re-check your BG level. If the BG test result is HIGH GLUCOSE again, obtain and follow instructions from your health care professional without delay.</p>
 WARNING  <div style="border: 1px solid black; padding: 5px; text-align: center;"> LOW CONTROL </div> <div style="border: 1px solid black; padding: 2px; text-align: center; font-size: small;"> Below 20 mg/dL </div> <p>Your control solution test result is very low and below the lower range printed on the test strip vial.</p>	<p>Repeat the test. If you continue to get control solution test results that fall below the range, Do Not use your meter remote. Call Customer Service at 1 877 937-7867.</p>
 WARNING  <div style="border: 1px solid black; padding: 5px; text-align: center;"> HIGH CONTROL </div> <div style="border: 1px solid black; padding: 2px; text-align: center; font-size: small;"> Above 600 mg/dL </div> <p>Your control solution test result is very high and above the upper range printed on the test strip vial.</p>	<p>Repeat the test. If you continue to get control solution test results that fall above the upper range, Do Not use your meter remote. Call Customer Service at 1 877 937-7867.</p>

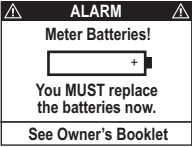
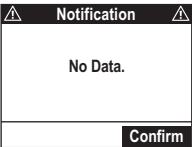
Indicates	What to do
 WARNING  Error 1 Meter problem. Call Customer Service. SC: XXX	<p>There is a problem with your meter remote.</p> <p>Do Not use your meter remote. Contact Customer Service at 1 877 937-7867 for a replacement.</p>
 WARNING  Error 2 Meter or strip problem. Retest with a new strip.	<p>Error message could be caused either by a used test strip or a problem with your meter remote.</p> <p>Repeat the test with a new test strip; see <i>Chapter 4 in Section II</i>. If this message continues to appear, contact Customer Service at 1 877 937-7867.</p>
 WARNING  Error 3 Meter was not ready. Retest with a new strip.	<p>The sample was applied before your meter remote was ready.</p> <p>Repeat the test with a new test strip. Apply a blood or control solution sample only after “Test/Apply Blood” or “Test/Control Solution” appears on the screen. If this message continues to appear, call Customer Service at 1 877 937-7867.</p>

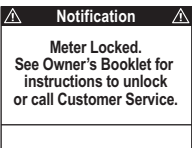
Indicates	What to do
<div data-bbox="136 251 326 396" style="border: 1px solid black; padding: 5px;"> <p style="text-align: center;">WARNING</p> <p style="text-align: center;">Error 4 Strip problem. See Owner's Booklet.</p> </div> <p><i>One of the following may apply:</i></p> <p>You may have high BG and have tested in an environment near the low end of the system's operating temperature range (43°–111°F/6.1°–43.9°C).</p> <p>or,</p> <p>There may be a problem with the test strip. For example, it may have been damaged or moved during testing.</p> <p>or,</p> <p>The sample was improperly applied.</p> <p>or,</p> <p>There may be a problem with your meter remote.</p>	<p>If you tested in a cool environment, repeat the test in a warmer environment with a new test strip; see <i>Chapter 4</i> in <i>Section II</i>.</p> <p>If you tested in a normal or warm environment, repeat the test with a new test strip; <i>Chapter 4</i> in <i>Section II</i>.</p> <p>If you applied the blood incorrectly, review <i>Chapter 4</i> in <i>Section II</i> and repeat the test with a new test strip.</p> <p>If the error message appears again, contact Customer Service at 1 877 937-7867.</p>
<div data-bbox="136 819 326 964" style="border: 1px solid black; padding: 5px;"> <p style="text-align: center;">WARNING</p> <p style="text-align: center;">Error 5 Strip problem or sample too small. Retest with a new strip.</p> </div> <p>Your meter remote has detected a problem with the test strip. Possible causes are test strip damage or an incompletely filled confirmation window.</p>	<p>Repeat the test with a new test strip. Refer to <i>Chapter 4</i> in <i>Section II</i>.</p>

Indicates	What to do
 <p>Error 6</p>	<p>Call Customer Service at 1 877 937-7867.</p>
 <p>Error 7</p>	<p>Call Customer Service at 1 877 937-7867.</p>
 <p>WARNING</p> <p>Temperature Error</p> <p>Out of operating range. See Owner's Booklet.</p>	<p>Meter remote is too hot (above 111°F/44°C) or too cold (below 43°F/6°C) to work correctly.</p> <p>Wait a few minutes and insert a new test strip. If you do not get TEMPERATURE ERROR message, your meter remote is now within operating range.</p>
 <p>WARNING</p> <p>Low Meter Batteries!</p> <p>You should replace the batteries soon.</p> <p>Confirm</p>	<p>Meter remote batteries are low but still have enough power to perform a test.</p> <p>Press OK to confirm the Warning. You can complete about 100 more tests from the time this message first appears if you are using alkaline batteries. Test results will still be accurate, but replace the batteries as soon as possible.</p>

Indicates	What to do
 <p>Meter remote batteries do not have enough power to perform a test.</p>	<p>Replace your meter remote batteries.</p>
 <p>You have accessed your meter remote memory (logbook) but there are currently no data available for this particular meter remote procedure.</p>	<p>Press  to confirm the Notification. Repeat the procedure after data records have been stored.</p>
 <p>Your meter remote buttons are currently locked. You will have very limited access to meter remote functions.</p>	<p>To unlock your meter remote buttons, press and hold  and  at the same time for about three seconds.</p>
 <p>You selected a food category for which there are no data in the Food Database stored in your meter remote.</p>	<p>Press  to confirm the Notification. Data may be available for this food category when you update the Food Database using ezManager® Software.</p>

Comparing meter remote and lab results

BG test results with your meter remote are plasma-calibrated. This helps you and your health care professional compare your meter remote results with laboratory tests. If you have been using another type of meter – one that provides whole-blood-calibrated BG test results – you may notice that BG test results with your meter remote are approximately 12% higher.

Your meter remote BG test results and laboratory test results both are expressed in plasma-equivalent units. However, your meter remote BG test result may differ from your laboratory result due to normal variation. Meter remote BG test results can be affected by factors and conditions that do not affect laboratory results in the same way.

Your meter remote BG value is considered accurate when it is within $\pm 20\%$ of the laboratory measurement. There are some specific situations that could cause a difference of more than $\pm 20\%$:

- You have eaten recently. The BG level from blood obtained from a fingertip can be up to 70 mg/dL higher than blood drawn from a vein (venous sample) used for a lab test.¹
- Your hematocrit (percentage of your blood that is red blood cells) is high (above 55%) or low (below 30%).
- You are severely dehydrated.
- You tested at a temperature near the low end of the operating range (43°F/6.1°C) and you get a high BG test result (i.e., greater than 180 mg/dL). In this situation, repeat the test in a warmer environment with a new test strip as soon as possible.

¹ Sacks, D.B. "Carbohydrates." Burtis, C.A., and Ashwood E.R. (ed.), *Tietz Textbook of Clinical Chemistry*. Philadelphia: W.B. Saunders Company, (1994), 959.

For accuracy and precision data and for important information on limitations, see the insert that comes with your test strips.

To maximize your chances of an accurate comparison between meter remote and laboratory results, follow a few basic guidelines:

Before going to the lab

- Perform a control solution test to make sure your meter remote is working properly.
- **Do Not** eat for at least eight hours before you test your blood.
- Take your meter remote with you to the lab.



While at the lab

- Conduct your meter remote test within 15 minutes of the lab test.
- Use only fresh, capillary blood obtained from the fingertip.
- Follow all instructions in this Owner's Booklet for performing a BG test with your meter remote.

Technical Specifications

Reported BG Test Result Range	20 to 600 mg/dL
Calibration	Plasma-equivalent
Sample	Fresh capillary whole blood
Test Time	5 seconds
Assay Method	Glucose oxidase biosensor
Power Source	Two 1.5V AAA alkaline batteries
Unit of measure	mg/dL
Memory	At least 20,000 records
Automatic Shutoff	Three minutes after inserting a test strip if sample has not been applied or during pairing; one minute after all other user actions
Size:	3.80 x 2.46 x 1.12 inches
Weight	Approximately 3.88 ounces (with batteries)
Operating Ranges	<p>Temperature: 43°–111°F (6–44°C)</p> <ul style="list-style-type: none"> • Relative Humidity: 10–90%, Altitude: up to 10,000 feet (3048 meters) • Hematocrit: 30–55%
Battery ratings:	<p>2 x 1.50 V d.c.</p> <ul style="list-style-type: none"> • (2 x AAA alkaline batteries) •  direct current

Technical Specifications *(continued)*

<p>Symbols</p>	<p> Please refer to safety-related notes in the owner's booklet and inserts that come with your OneTouch® Ping® Meter Remote.</p> <p> Direct current</p> <p> Do Not Reuse</p>
<p>Electrical Standards:</p>	<p>Your meter remote complies with applicable EMC emission requirements. Emissions of the energy used are low and not likely to cause interference in nearby electrical equipment.</p> <p>Your meter remote complies with US Federal Regulations 47 CFR Part 15. Your meter remote has been tested for immunity to electrostatic discharge (ESD) as specified in ISO 15197 and IEC 61000-4-2.</p> <p>Your meter remote has been tested for immunity to radio frequency interference at the frequency range and test levels specified in ISO 15197.</p>
<p>Guarantee</p>	<p>Animas® guarantees that your OneTouch® Ping® Meter Remote will be free of defects in material and workmanship for four years, valid from the date of purchase. The guarantee extends only to the original purchaser and is not transferable. If your meter remote should fail during the guarantee period because of a defect in material or workmanship, Animas® will replace your meter remote.</p>

Analytical Performance Characteristics

System Accuracy

The accuracy of the blood glucose monitoring function of the OneTouch® Ping® Meter Remote was assessed by comparing blood glucose test results on 141 subjects with those obtained using a YSI Model 2300 Glucose Analyzer. Six results were obtained for each subject (each tested in duplicate with three test strip lots). The following results were obtained:

System Accuracy Results for Glucose Concentration <75 mg/dL

Within ± 5 mg/dL	Within ± 10 mg/dL	Within ± 15 mg/dL*
111/162 (68.5%)	154/162 (95.1%)	162/162 (100%)

System Accuracy Results for Glucose Concentration ≥ 75 mg/dL

Within $\pm 5\%$	Within $\pm 10\%$	Within $\pm 15\%$	Within $\pm 20\%*$
282/684 (41.2%)	516/684 (75.4%)	639/684 (93.4%)	680/684 (99.4%)

System Accuracy Results across the entire Glucose Range

Within ± 15 mg/dL or $\pm 20\%$	842/846 (99.5%)
-------------------------------------	-----------------

These results indicate that the blood glucose monitoring function of the OneTouch® Ping® Meter Remote meets the ISO 15197 requirements for accuracy.

* ISO 15197 Minimum Acceptable Accuracy Requirements:

- 95% of individual glucose results must fall within ± 15 mg/dL of the YSI reference at glucose concentrations < 75 mg/dL
- 95% of individual glucose results must fall within $\pm 20\%$ of the YSI reference at glucose concentrations ≥ 75 mg/dL

Regression Statistics

# of Subjects	# of Readings	Slope (mg/dL)	Intercept (mg/dL)
141	846	0.988	-3.68
95% CI Slope	95% CI Intercept	Std. Error ($S_{y,x}$)	R ²
(0.98, 1.00)	(-5.54, -1.81)	14.3	0.984

These results indicate that the OneTouch® Ping® Meter Remote compares well with a laboratory method.

Abbreviations:

CI	Confidence Interval	Std.	Standard
$S_{y,x}$	Standard Error	R ²	Coefficient of Determination

Precision

Within Run Precision

Within Run Precision (100 venous blood tests)			
Target Glucose (mg/dL)	Mean Glucose (mg/dL)	Standard Deviation (mg/dL)	Coefficient of Variation (%)
40	44	1.4	3.2
100	106	2.6	2.5
130	133	2.9	2.1
200	204	3.5	1.7
300	316	6.1	1.9

Total Precision

Total Precision (200 control solution tests)			
Glucose Level (mg/dL)	Mean Glucose (mg/dL)	Standard Deviation (mg/dL)	Coefficient of Variation (%)
Low	43	1.3	2.9
Normal	122	2.2	1.8
High	350	6.1	1.7

Results show that the greatest variability observed (of two lots tested) is 3.2% or less.

Section III

OneTouch® Ping® System / Using your OneTouch® Ping® Meter Remote and OneTouch® Ping® Insulin Pump together

Once you have been trained on your pump and meter remote, you are ready to learn how to use the devices together as a system. Using them together can provide you with options to help make insulin delivery more discreet and flexible.

When the devices are used together as a system, your meter remote will give you convenient remote access to certain pump functions, including calculating and delivering a bolus.

When using the devices together, your most recent BG test results from your meter remote are automatically entered into bolus calculations.

Before you begin using your devices together as a system, you must establish communication between your meter remote and pump. The procedure for establishing communication will be covered in the next chapter in *Section III*.

NOTE:

- You should review your pump and meter remote settings and make any desired changes before using the devices together as a system.
- When using your devices together as a system, you will sometimes need to access both devices. Examples of this are when you are establishing communication between your meter remote and pump, when RF communication is lost or deactivated, or when you need to resolve certain warnings, alarms or alerts.
- Your OneTouch® Ping® Meter Remote and OneTouch® Ping® Insulin Pump are designed to communicate via RF only with each other. They will not communicate with any other devices.

⚠ WARNING: You must complete the Animas® pump training before using your meter remote to access pump functions. During pump training, your health care professional will assist you in making the appropriate selections for your pump settings. Your pump settings directly impact dosing calculations when using your meter remote to deliver insulin from your pump. You are not able to modify pump settings from your meter remote. It is important to have pump settings programmed before using your meter remote to access pump functions.

252 **CHAPTER 2 - Establishing communication between your meter remote and your insulin pump**

Establishing communication between your meter remote and pump requires that the RF feature is activated on both devices, and the devices are paired. Activating RF opens a line of communication on both devices, and pairing ensures communication will take place only between one meter remote and one pump. Once RF communication is activated and the devices are paired, communication will take place even when one or both displays have been turned off or have timed out automatically.

If you deactivate the RF feature on one or both devices, or if RF communication is lost, you will not be able to use your meter remote to access pump functions. This also means no data will be exchanged during that time. Once RF communication is re-established, you will be able to resume using your devices together as a system. Any new data generated since the last data transfer will be exchanged on the devices at that time.

NOTE:

- The procedure for activating RF and pairing is done separately on each device.
- The RF feature on your meter remote will automatically be activated when you begin the pairing procedure on your meter remote.

Pairing your meter remote and pump

You pair the devices by first activating RF communication and pairing on your pump, and then activating pairing on your meter remote. The RF channel on your pump will be automatically set to match the one on your meter remote.

If you want to separately activate or deactivate the RF feature on either your meter remote or pump, see *Reactivating/deactivating the RF feature on your meter remote* in this chapter, and *Reactivating/deactivating the RF feature on your pump* in this chapter.

NOTE: For the pairing to be successful, the pump must be awake (display on) and “searching” at the same time you select “Start Pairing” on your meter remote. If either your pump or meter remote display times out before pairing is completed, you will need to repeat the steps to pair the devices. It is recommended that you keep your pump display on the SETUP ADV 10 screen and actively searching until you have activated pairing on your meter remote. You can keep the pump from timing out by pressing and releasing the contrast button on top of the pump every few seconds while the SETUP ADV 10 screen is displayed.

Activate the RF feature on your pump

1. Select “Setup” from the Main Menu screen on your pump display and press **OK**.
2. Select “Advanced” on the SETUP screen on your pump display and press **OK**.
3. With “Next” highlighted on your pump display, continue to press **OK** to scroll through the SETUP ADV screens until the SETUP ADV 10 screen is displayed.
4. Press **▲** on your pump until the “RF” field is highlighted. Press **OK** on your pump so that the highlight is flashing.
5. Press **▲** or **▼** on your pump to change “OFF” to “ON” and then press **OK**.

SETUP ADV 10 METER	
RF	OFF
Search	----
Channel	Auto
Home	Next

Pump display

SETUP ADV 10 METER	
RF	ON
Search	----
Channel	Auto
Home	Next

Pump display

Activate the pairing feature on your pump

1. With the “Search” field highlighted, press **OK** so that the highlight is flashing.
2. Press **▲** or **▼** on your pump to change “----” to “ON” and then press **OK**.
3. The pairing feature is activated when “[Searching]” appears on the display.
4. Continue with the steps below for activating the pairing feature on your meter remote. **Remember to keep the pump awake (display on) by pressing and releasing the contrast button on top of the pump.**





SETUP ADV 10 METER	
RF	ON
Search	----
Channel	Auto
Home	Next

Pump display

SETUP ADV 10 METER	
RF	ON
Search	ON
Channel	Auto
[Searching]	
Cancel	
Home	Next

Pump display

Activate the pairing feature on your meter remote

1. Select “Meter Settings” from the Main Menu screen on your meter remote display and press .
2. Highlight “RF” from the Meter Settings screen on your meter remote display and press .
3. Select “Pairing” from the RF Set-up screen on your meter remote display and press .
4. Check that your pump is awake (display on) and the SETUP ADV 10 screen on your pump display has the “RF” and “Search” fields set to “ON”, and “[Searching]” displayed.
5. Highlight “Start Pairing” on the meter remote display and press . The meter remote will automatically search for a pump within RF range.

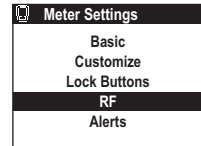

Meter remote display

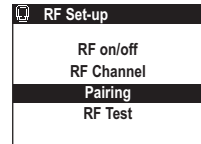

Meter remote display

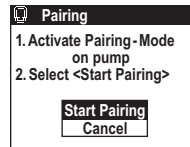

Meter remote display

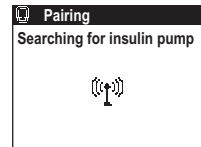

Meter remote display

Confirm pairing on your pump

1. Verify that the meter remote serial number displayed on your pump matches the one on the back of your meter remote. With “Confirm” highlighted and flashing on your pump display, press  to confirm the pairing on your pump. “Next” will be highlighted on your pump display.

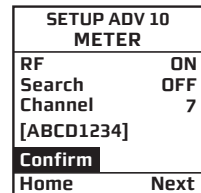

Pump display

Accept pairing on your meter remote



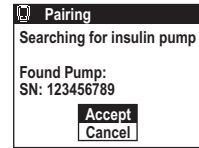

1. Verify that the pump serial number displayed on the meter remote matches the serial number on the back of your pump. Highlight “Accept” on your meter remote display and press  to confirm the pairing on your meter remote. You will go directly to the Pump Home screen on your meter remote display (see *Chapter 3* in *Section III*).



Meter remote display

Whenever the devices are paired, the Pump Home screen will be the first screen displayed on your meter remote when you turn it on.

NOTE:

- You must confirm pairing on your pump first, and then on your meter remote for pairing to be successful.
- If either your pump or meter remote display times out before the pairing is completed, you will need to repeat the steps to activate and confirm the pairing on both devices. **For the pairing to be successful, the pump must be awake (display on) and “Searching” at the same time you select “Start Pairing” on your meter remote.**
- To cancel pairing on your pump, press  or  on your pump while “Confirm” is highlighted and flashing on the SETUP ADV 10 screen on your pump display. “Confirm” will change to “Cancel”. Press  on your pump to cancel the pairing on your pump. To cancel on your meter remote, highlight “Cancel” on the Pairing screen on your meter remote display. Press  on your meter remote to cancel pairing on your meter remote.

⚠ WARNING: If the pump serial number displayed on your meter remote does not match the serial number on the back of your pump, turn the RF feature off on your meter remote and pump and call Customer Service at 1 877 937-7867 immediately.

After your devices are paired, the ezCarb and ezBG Bolus screens on your meter remote display will retrieve the bolus calculator values (settings) that are set and saved on your pump. **You will not have access to the Calculator Set-up option on your meter remote.** You will be reminded on your meter remote display that the bolus calculator settings from Calculator Set-up on your meter remote have been replaced.

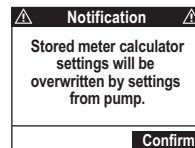

Meter remote display

Press **OK** on your meter remote to confirm the Notification. You will go to the Pump Home screen on your meter remote display (see *Chapter 3* in *Section III*).

NOTE: Your meter remote and pump must use the same unit of measure (mg/dL) for BG measurements or the devices cannot be paired. The BG unit of measure for both devices is set at the factory and cannot be changed.

If the BG unit of measure is not the same on both devices, you will be notified on your meter remote display during the pairing procedure.

Contact Customer Service at 1 877 937-7867 for instructions on replacing your meter remote or pump with one that has the correct glucose unit of measure.

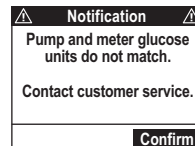

Meter remote display

This Notification screen will be followed by a Warning screen on your meter remote display indicating that the pairing procedure has failed. Press **OK** on your meter remote to confirm the Warning. You will not be able to use your meter remote to access pump functions unless both devices have the same glucose unit of measure (mg/dL).

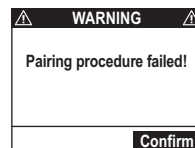





Meter remote display

Performing a new pairing with a replacement meter remote or pump

If you obtain a replacement meter remote or pump, you will have to complete the pairing procedure again so that the new device is recognized. Any new pairing will automatically cancel the previous pairing.



1. Reactivate the pairing feature on your pump

Go to the SETUP ADV 10 screen on your pump. Press  on your pump so that the “Search” field is highlighted on your pump display. Press  on your pump so that the highlight is flashing. Press  or  on your pump to change “OFF” to “ON” and press  to reactivate the pairing feature on your pump.

SETUP ADV 10 METER	
RF	ON
Search Channel	OFF 7
[ABCD1234]	
Home	Next

Pump display

2. Go to Pairing on your meter remote display

Press  on your meter remote to highlight “Pairing” on the RF Set-up screen. Then press  on your meter remote.

RF Set-up
RF on/off
RF Channel
Pairing
RF Test

Meter remote display

Select “New Pairing” on the Pairing screen on your meter remote display and press . Then follow the same steps for confirming the pairing on your meter remote and pump (see *Pairing your meter remote and pump* earlier in this chapter).

Pairing
Meter is already paired with pump SN: 123456789. Would you like to unpair or pair with a new pump?
Unpairing
New Pairing
Cancel

Meter remote display

Unpairing your meter remote and pump

1. Go to Pairing on your meter remote display

To unpair the two devices, first press  on your meter remote to highlight “Pairing” on the RF Set-up screen on your meter remote. Then press  on your meter remote.

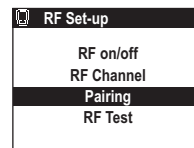

Meter remote display

2. Select Unpairing on your meter remote display

Select “Unpairing” from the Pairing screen on your meter remote display and press .

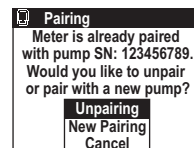

Meter remote display

NOTE: If you unpair your meter remote and pump, they will not be able to communicate and share data, and you will not be able to use your meter remote to access pump functions.

Because you unpaired the devices a Notification screen will appear on your meter remote display. The Notification screen will remind you that the current calculator settings last saved on your pump may not be appropriate for the current time of day. **It is important that you review these settings before using the ezCarb or ezBG feature on your meter remote to see that they still would apply.** You may always edit these settings by changing the settings in Calculator Set-up under the Meter Settings screen on your meter remote display, or directly on the ezCarb and ezBG Bolus screens on your meter remote display.

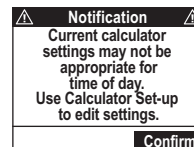

Meter remote display

3. Confirm the unpairing

Press  on your meter remote to confirm the Notification on your meter remote.

A second Notification screen will appear on your meter remote display to let you know that your meter remote and pump are now unpaired. Press  on your meter remote display to confirm the Notification. You will go to the Meter Home screen on your meter remote display (see *Chapter 3* in *Section III*).

NOTE: There is no separate unpairing procedure on your pump. Your pump remains ready to re-establish an RF link with the last paired meter remote, or to pair with a new meter remote.

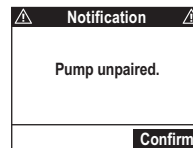

Meter remote display

Reactivating/deactivating the RF feature on your meter remote

NOTE: The “RF on/off” menu option on the RF set-up screen on your meter remote is only available if your meter remote and pump are paired.

Deactivating RF communication on your meter remote

There are times when you might want or need to deactivate the RF feature on your meter remote. One situation is when you are on an airplane. Follow these instructions for deactivating the RF feature on your meter remote if it is activated.

1. Go to RF on/off on your meter remote display

Highlight “RF on/off” on the RF Set-up screen on your meter remote display and then press **OK**.

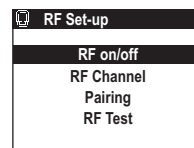

Meter remote display

2. Deactivate the RF feature on your meter remote

You will be reminded on your meter remote display that the RF feature is activated. To deactivate the RF feature, highlight “RF off” on your meter remote display and press **OK**. All communication between your meter remote and pump will be stopped.

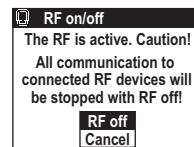

Meter remote display

3. Wait for confirmation that the RF feature on your meter remote is deactivated

A Notification screen will appear on your meter remote display to remind you that the RF feature is deactivated on your meter remote.

Press **OK** on your meter remote to confirm the Notification. You will go to the Meter Home screen on your meter remote display (see *Chapter 3* in *Section III*).

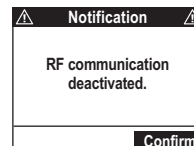

Meter remote display



Reactivating RF communication on your meter remote

Follow these instructions to reactivate the RF feature on your meter remote if it is deactivated.

1. Go to RF on/off on your meter remote display

Highlight “RF on/off” on the RF Set-up screen on your meter remote and then press .

2. Reactivate the RF feature on your meter remote

To reactivate RF communication, highlight “RF on” on your meter remote display and then press . To cancel, highlight “Cancel” on your meter remote display, and press  to return to the RF Set-up screen.

3. Wait for communication to be re-established between your meter remote and pump

When communication is re-established, you will go to the Pump Home screen on your meter remote.

If your meter remote and pump are unable to re-establish communication, you will be notified on your meter remote. Press  on your meter remote to confirm the Notification. You will go to the Meter Home screen on your meter remote display (see *Chapter 3 in Section III*).

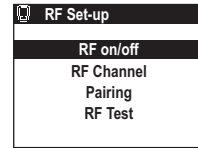

Meter remote display

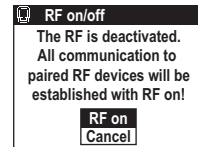

Meter remote display

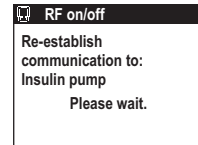

Meter remote display

Reactivating/deactivating the RF feature on your pump

Deactivating RF communication on your pump

There are times when you might want or need to deactivate the RF feature on your pump. One situation is when you are on an airplane. Follow these instructions to deactivate the RF feature on your pump if it is activated.

1. Go to the SETUP ADV 10 screen on your pump

Select "Setup" from the Main Menu screen on your pump display and press **OK**. Then select "Advanced" on the SETUP screen on your pump display and press **OK**. With "Next" highlighted on your pump display, continue to press **OK** to scroll through the SETUP ADV screens until the SETUP ADV 10 screen is displayed.

SETUP ADV 10 METER	
RF	ON
Search	OFF
Channel	7
[ABCD1234]	
Home	Next

Pump display

2. Go to RF on your pump display

Press **▲** on your pump until the "RF" field is highlighted on your pump display. Then press **OK** on your pump so that the highlight is flashing. Press **▲** or **▼** on your pump to change "ON" to "OFF" and then press **OK** to deactivate the RF feature on your pump.

"Next" will be highlighted on your pump display. With "Home" highlighted, press **OK** on your pump to return to the Home screen on your pump display.

SETUP ADV 10 METER	
RF	OFF
Search	----
Channel	Auto
Home	Next

Pump display

Reactivating RF communication on your pump

Follow these instructions to activate the RF feature on your pump if it is deactivated.

1. Go to the SETUP ADV 10 screen on your pump display

Select “Setup” from the Main Menu screen on your pump display and press **OK**. Then select “Advanced” on the SETUP screen on your pump display and press **OK**. With “Next” highlighted on your pump display, continue to press **OK** to scroll through the SETUP ADV screens until the SETUP ADV 10 screen is displayed.

SETUP ADV 10 METER	
RF	OFF
Search	----
Channel	Auto
Home	Next

Pump display

2. Go to RF on your pump display

Press **▲** on your pump until the “RF” field is highlighted on your pump display. Then press **OK** on your pump so that the highlight is flashing. Press **▲** or **OK** on your pump to change “OFF” to “ON” and then press **OK** to reactivate the RF feature on your pump.

SETUP ADV 10 METER	
RF	ON
Search	OFF
Channel	7
[ABCD1234]	
Home	Next

Pump display

“Next” will be highlighted on your pump display. With “Home” highlighted, press **OK** on your pump to return to the Home screen on your pump display.

Troubleshooting RF communication between your meter remote and pump

Certain conditions may cause RF communication between your meter remote and pump to be lost or interrupted. One situation is when your devices are not within RF range of each other (about 10 feet/3.0 meters). Another condition is dampness from wet clothing. If RF communication is lost, make sure your devices are within RF range and you have removed any wet clothing. If RF communication problems continue, you can use the RF test feature on your meter remote to help troubleshoot the problem.

The RF Test feature on your meter remote displays information about the RF connection between your meter remote and pump. In the event your meter remote indicates repeated communication errors, or you are having continuing difficulties in using your meter remote to access pump functions, contact Customer Service at 1 877 937-7867 and be prepared to follow the steps below.

NOTE: The “RF Test” menu option on the RF set-up screen on your meter remote is only available if your meter remote and pump are paired.

RF Test

If your meter remote and pump are paired, you may troubleshoot the RF connection by checking the RF channel, and the RF signal strength and quality.

1. Go to RF Test on your meter remote display

Highlight “RF Test” on the RF Set-up screen on your meter remote display. Then press  on your meter remote.

If the devices are not paired, you will be notified on your meter remote display. If your meter remote and pump are paired, you will see the serial number of the paired pump on the RF Test screen on your meter remote display.

2. Start the RF Test from your meter remote

“Start” is highlighted. Press  on your meter remote to continue with the RF Test.

3. Contact Customer Service for further instructions

Information about the RF channel, and RF signal strength and quality will appear on the display. Customer Service may use this information to help resolve problems with RF communication, including manually setting the RF channel on your meter remote and pump. Press  to return to the Main Menu screen.

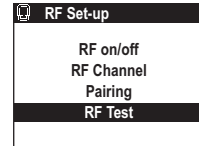

Meter remote display

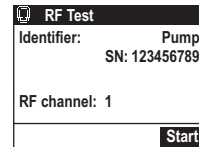

Meter remote display

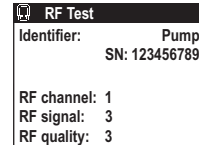

Meter remote display

Changing the RF channel on your meter and pump

The RF channel on your meter remote must always match the RF channel on your pump. When you pair your meter remote and pump, the RF channel is automatically set to match on both devices. To avoid interference from another device or improve communication between your meter remote and pump, you can also manually change/set the RF channel on your meter remote and pump to match.

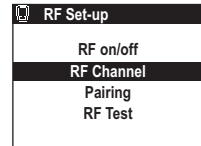

NOTE: The “RF Channel” menu option on the RF set-up screen on your meter remote is only available if your meter remote and pump are paired.



Meter remote display

Manually set the RF channel on your meter remote

1. Go to RF Channel on your meter remote display

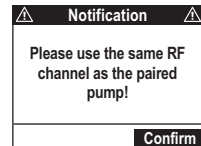

Press  on your meter remote to highlight “RF Channel” on the RF Set-up screen. Then press  on your meter remote.

A Notification screen will appear on your meter remote display to remind you to set the RF channel on your meter remote to match the one on your pump. Press  to confirm the Notification on your meter remote display.



Meter remote display

2. Set the RF Channel on your meter remote

Press  on your meter remote to manually select the desired channel. Then press  on your meter remote.

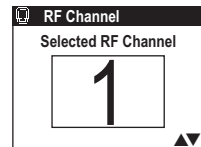

After making your selection, you will return to the RF Set-up screen on your meter remote display. You will then need to manually set the RF channel on your pump to match the channel you set on your meter remote.



Meter remote display

Manually set the RF channel on your pump



1. Go to Channel on your pump display

Go to the SETUP ADV 10 screen on your pump display. Press  on your pump until the “Channel” field is highlighted. Then press  on your pump so that the highlight is flashing.

SETUP ADV 10 METER	
RF	ON
Search	OFF
Channel	 9
[ABCD1234]	
Home	Next

Pump display

2. Set the RF Channel on your pump

Press  or  on your pump to change the current channel to match the RF channel you selected on your meter remote. Then press  on your pump.

“Next” will be highlighted on your pump display. With “Home” highlighted, press  on your pump to return to the Home screen on your pump display.

SETUP ADV 10 METER	
RF	ON
Search	OFF
Channel	 1
[ABCD1234]	
Home	Next

Pump display

NOTE: Unless otherwise specified, all references to screens and buttons apply to your meter remote from this chapter forward.

Once RF communication is activated on your meter remote and pump and the devices are paired, you are ready to begin using the devices together as a system. This means many of the pump functions will now be available on your meter remote. You will still need to access your pump directly for specific set-up and delivery functions, and to resolve certain pump warnings and alarms. In the event RF communication between the devices is lost, you can access all pump functions directly on the pump.

When your devices are paired, your meter remote provides two Home screens: a Pump Home screen and a Meter Home screen. From either of these Home screens, you can go to the Main Menu screen on your meter remote where you have access to all meter remote functions, including certain pump functions. The Main Menu screen on your meter remote display is the same Main Menu screen you had access to before the devices were paired.

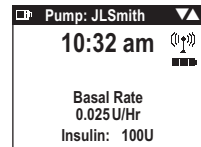

NOTE: The Pump Home screen and Main Menu screen on your meter remote display are not the same as the Home screen and Main Menu screen on your pump display. Be sure you understand the differences between these screens before using the devices together as a system.

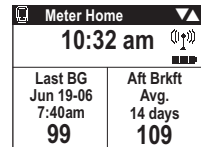

Using your meter remote once your devices are paired

Turn your meter remote display on by pressing  or  on your meter remote.

After an all-black start-up screen appears on your meter remote display, an hourglass symbol will appear as your meter remote searches for a paired pump. This will be followed by the Pump Home screen. You can switch between the Pump Home screen and the Meter Home screen by pressing  on your meter remote.

NOTE: If your meter remote is not currently paired with your pump, the Meter Home screen will appear instead of the Pump Home screen.

Pump Home screen on your meter remote display

The Pump Home screen on your meter remote displays the current time of day stored in your pump, RF signal strength, the insulin units and battery power remaining in your pump, and other information about your current basal or bolus insulin delivery. The unique ID name/number of your pump will also appear at the top. To create a unique ID for your pump, refer to your ezManager® Software User Guide. If you do not create a unique ID for your pump, the first 7 digits of the pump serial number will appear at the top.

In this example Pump Home screen, “BOLUS ACTIVE” indicates that your pump is currently delivering an extended bolus dose. “TEMP BASAL” indicates that a temporary basal rate (a decrease of 40% in this example) was set for four hours, with two hours remaining.

Pump: JLSmith	
3:18 pm	
BOLUS ACTIVE	
TEMP BASAL	
-40%	4.0 Hr
Time left:	2.0 Hr
Insulin: 100U	

(Example)

From the Pump Home screen you can view the Meter Home screen or go to the Main Menu screen.

To view the Meter Home screen, press . To go to the Main Menu screen, press .

Meter Home screen on your meter remote

The Meter Home screen displays the current time of day stored in your meter remote, RF signal strength, and battery power remaining in your meter remote. Your most recent BG test result appears along with the date and time of the test. Your average BG test results for the current meal period appears next to your most recent BG test result. Averages are based on the number of days you select when you set up your meter remote (see *Chapter 1* in *Section II*).

Meter Home	
3:18 pm	
Last BG Jun 19-06 10:32am 109	Aft Lunch Avg. 14 days 105

To go back to the Pump Home screen, press . To go to the Main Menu screen, press .

NOTE: Once your devices are paired, the clock time on your meter remote will be automatically set to match the clock time on your pump.

Calculating and delivering a bolus

You can use your meter remote to deliver any bolus type that is available with your pump. The procedures for delivering boluses from your meter remote are very similar to delivering boluses from your pump.

Your bolus options are:

- Normal
- ezCarb
- ezBG
- Combo Bolus

 **WARNING:** Be sure to review all the values used in bolus calculations to make sure they are correct. You may always adjust the insulin units up or down before you decide to administer your bolus. If you dose an insulin amount that is too high or too low, this may result in a hypoglycemic or hyperglycemic event. Please discuss the bolus calculator feature and all relevant personal settings with your health care professional before using the calculator for the first time.



As long as RF communication is activated on your meter remote and pump, and the devices are paired, you may deliver a Normal Bolus using your meter remote. The other bolus types are available only if you enabled the Advanced Bolus features on your pump. **If insulin delivery is suspended on your pump, or if RF communication is lost or deactivated, you will not be able to use your meter remote as a remote control to deliver any type of bolus.**

NOTE: You can administer insulin directly from your pump under any situation where you are unable to do so using your meter remote (e.g., RF communication is lost or deactivated, or your meter remote and pump are out of RF range).

There are two ways to get to the Bolus Menu screen on your meter remote.

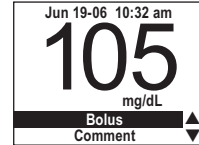
The first way is right after you take a BG test. When your result appears on the screen, “Bolus” will be highlighted. Press  if you would like to go directly to the Bolus Menu screen. You may still add a comment to the test result after you deliver the bolus.



The second way is to press  to highlight “Bolus” on the Main Menu screen and press .

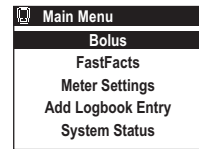

In this example, all bolus options are available on the screen.

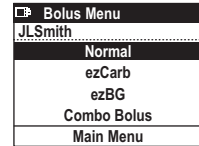

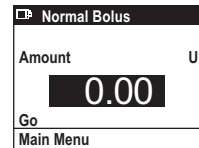

NOTE: If Advanced features are not enabled on your pump, selecting “Bolus” from the Main Menu screen takes you directly to the Normal Bolus screen.



Normal Bolus

NOTE: Bolus delivery speed can be adjusted in the Setup Advanced menu on your pump.

1. Select a Normal Bolus

To deliver a Normal Bolus, press  to highlight “Normal” on the Bolus Menu screen and press .

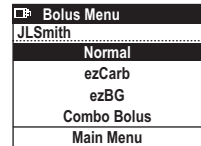

2. Choose the bolus amount

The “Amount” field is highlighted and flashing. Press  to enter the bolus units and press .

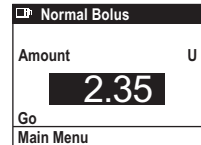
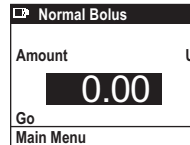

3. Confirm you want to deliver the bolus

“Go” is now highlighted. Press  to deliver the bolus or  to return to the Bolus Menu screen.

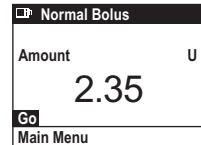

When you press , “DELIVERING” will appear at the top of the screen and the units will count down to 0. After the bolus is delivered, you will return to the Pump Home screen, or to your BG test result if you began the bolus procedure from that screen.

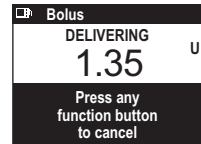

Canceling a Normal Bolus

You may stop the undelivered bolus amount by pressing any button on the meter remote (or pump) while “DELIVERING” still appears at the top of the screen. After pressing any button, a Warning screen will appear that prompts you to confirm that you canceled bolus delivery. Insulin units that were delivered before the bolus was canceled appear at the bottom of the screen.

Press **OK** to confirm the Warning. You will return to the Pump Home screen, or to your BG test result if you began the bolus procedure from that screen. You may also press **OK** on your pump to confirm the Warning.

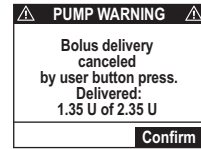

Special messages during Normal Bolus Delivery

Certain messages may appear at the top of the Normal Bolus screen (or as separate screens) after you press **OK** to confirm the desired bolus units.

“COMBO ACTIVE” will appear if a Combo Bolus (see *Combo Bolus* in this chapter) is already in progress. This lets you know that you will be adding a Normal Bolus on top of an extended bolus.

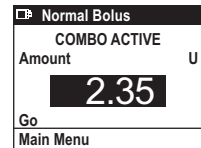

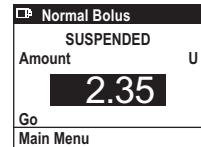

“SUSPENDED” will appear if you try to set and deliver a Normal Bolus while insulin delivery is suspended (see *Chapter 7* in *Section 1*). You cannot deliver a Normal Bolus until you resume insulin delivery from your pump.



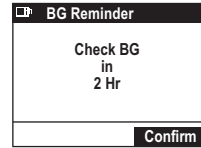

If you set up your pump to remind you to test your BG, (see *Chapter 10* and *Chapter 11* in *Section I*) you will be prompted to confirm the reminder on the display after the bolus is delivered. This screen also lets you change when you will be reminded to check your BG. In this example, you will be reminded to check your BG two hours after you deliver the bolus. To confirm the reminder time on the screen, press .



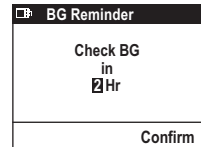

To select a different reminder time, first press  so that the “Hr” field is highlighted. Then press  so the highlight is flashing.

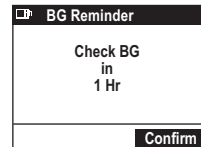

Press  to select a reminder time of one to four hours, or “0” to turn the reminder feature off for this particular bolus. Press  after you make your selection.



Press  again to confirm the Check BG reminder time. You will return to the Pump Home screen, or to your BG test result if you began the bolus procedure from that screen.

NOTE: A Warning screen will appear if a bolus exceeds the limits that you set and saved on your pump. Press  to confirm the Warning and follow the appropriate steps for adjusting the limits that are stored in your pump. You may also press  on your pump to confirm the Warning.

ezCarb Bolus

The ezCarb feature allows you to enter the number of carbs eaten, and then have your meter remote automatically calculate and deliver a bolus from your pump. The calculator is based on the I:C ratios that you have set and stored in your pump, and the number of carbs you plan to consume. Carb totals may be entered manually for the calculator, or may be selected from the Food Database stored in the meter remote.

You may also include a BG correction in your ezCarb bolus calculation. The BG correction is based on the ISF and BG Target you have set and stored in your pump, and your current BG test result.

If the IOB feature is enabled on your pump, your meter remote will calculate a reduced bolus amount if there is any IOB left from a previous bolus.

Be sure to discuss your personal I:C ratios, ISFs, BG Targets and IOB with your health care professional before you use the ezCarb feature.

1. Select an ezCarb Bolus

1a. To use the ezCarb feature, press  to highlight “ezCarb” on the Bolus Menu screen. Then press .

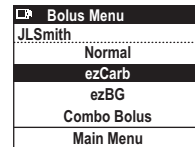

1b. In anticipating that you might want to add a BG correction to your ezCarb Bolus, your meter remote will first check if the most recent BG test on your meter remote was taken within the last 15 minutes. If it was, you will go directly to the ezCarb Home screen below. Your most recent BG test result will appear in the “Actual” field on the BG Correct screen that is displayed if you decide to add a BG correction to your ezCarb Bolus (see *step 4, Add a BG correction*).

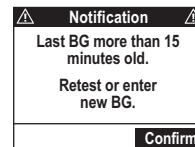

If your most recent glucose test was taken more than 15 minutes ago, you will be notified on the display. You will be prompted to re-test or manually enter a new BG value if you are planning to add a BG correction to your ezCarb Bolus (see *step 4, Add a BG correction*). Press  to confirm the Notification and go to the ezCarb Home screen below.



1c. The ezCarb Home screen will appear. On the ezCarb Home screen, you can either manually enter carbs or automatically enter carbs from the Food Database. Carb entries made with the ezCarb feature on your meter remote are saved in your meter remote memory (see *Chapter 7 in Section II*), and in your pump (see *Chapter 8 in Section I*). The maximum carbs that can be entered in the ezCarb Bolus calculations is 999 grams(g) – even if the selected and totaled amount from the Food Database is greater than that amount.

ezCarb Home	
Carbs:	0g
I: C=	1U:15g
Food List	
Review Total	
Add BG	
Show Result	
Main Menu	

2. Enter a carb amount

To enter carbs manually, press  to enter the number of carbs you have eaten and press . You will go to step 3 and “Add BG” will be highlighted.

ezCarb Home	
Carbs:	34g
I: C=	1U:15g
Food List	
Review Total	
Add BG	
Show Result	
Main Menu	

To enter carbs from the Food Database, press  while the “Carbs:” field has a value of 0 and is highlighted and flashing.

“Food List” will be highlighted. Press  to go to the Food Database where you can make your food selections with their corresponding carb amounts. Please see *Chapter 2 in Section II* for more information on the Food Database. When you are finished making food selections your total carbs will appear in the “Carbs:” field.

ezCarb Home	
Carbs:	0g
I: C=	1U:15g
Food List	
Review Total	
Add BG	
Show Result	
Main Menu	

3. Review/change your carbs and/or I:C ratio

“Add BG” will be highlighted.

Now you have the option to make changes to your carbs and/or I:C ratio, add a BG correction, or simply show the calculated carb bolus amount.



ezCarb Home	
Carbs:	34g
I: C=	1U:15g
Food List	
Review Total	
Add BG	
Show Result	
Main Menu	

3a. To change your carbs manually, press  to highlight the “Carbs:” field and press . With the highlight flashing, press  to change the amount and press  when finished. “Add BG” will be highlighted again.





ezCarb Home	
Carbs:	34g
I: C=	1U:15g
Food List	
Review Total	
Add BG	
Show Result	
Main Menu	

3b. To review the carbs that you selected from the Food Database, press  to highlight “Review Total” and press . You will go to the ezCarb Total screen on your meter remote display. When you are done changing, deleting or adding food items you will return to the ezCarb Home screen.

ezCarb Home	
Carbs:	34g
I:C=	1U:15g
Food List	
Review Total	
Add BG	
Show Result	
Main Menu	

3c. To go directly to the Food Database where you can also change, delete, or add food items to the ezCarb Total List, press  to highlight “Food List” and press . You will return to the ezCarb Home screen when you are finished selecting foods.

ezCarb Home	
Carbs:	34g
I:C=	1U:15g
Food List	
Review Total	
Add BG	
Show Result	
Main Menu	

3d. The I:C ratio that appears on the screen is the one that you stored in your pump for this time of the day. To change your I:C ratio, press  to highlight the “I:C=” field and press . With the highlight flashing, press  to change the I:C ratio and press  when finished. “Add BG” will be highlighted again.



ezCarb Home	
Carbs:	34g
I:C=	1U: 13 g
Food List	
Review Total	
Add BG	
Show Result	
Main Menu	



3e. To add a BG correction, continue with step 4.

NOTE: Changes made to your I:C ratio during ezCarb calculation apply to this bolus only and will not affect the I:C ratios you have stored in your pump.



ezCarb Home	
Carbs:	34g
I:C=	1U:15g
Food List	
Review Total	
Add BG	
Show Result	
Main Menu	

4. Add a BG correction

You have the option to add a BG correction to your ezCarb Bolus. Press  with “Add BG” highlighted to do so. If you do not want to add a BG correction, press  to highlight “Show Result” and press . This will bypass the BG correction step and take you to the Bolus Total screen in step 5.

4a. In this example, the most recent BG test result on your meter remote (220 mg/dL) was taken within the last 15 minutes and that value appears in the “Actual” field. You may adjust the BG level up or down using . Press  when finished.

BG Correct	
Actual	220 mg/dL
Target	-120 mg/dL
=	+100 mg/dL
IS Factor	37 mg/dL
Show Result	
Main Menu	

NOTE: If the most recent BG test result on your meter remote was taken more than 15 minutes ago, three dashes (“---”) will appear in the “Actual” field on the BG Correct screen. You have the option to manually enter a more recent BG test result or to re-test. Press  to manually enter a new BG value, or insert a new test strip to re-test. If you decide to re-test, you will have to repeat the steps for starting an ezCarb Bolus when your BG test result appears on the display. When you return to the BG Correct screen and you have the desired BG value in the “Actual” field, press .

BG Correct	
Actual	--- mg/dL
Target	-120 mg/dL
=	--- mg/dL
IS Factor	37 mg/dL
Show Result	
Main Menu	

4b. “Show Result” is highlighted. Values appear on the screen for your “Target” and your “IS Factor”. Target refers to the BG Target level that you stored in your pump. IS Factor is the ISF that you stored in your pump.

BG Correct	
Actual	220 mg/dL
Target	-120 mg/dL
=	+100 mg/dL
IS Factor	37 mg/dL
Show Result	
Main Menu	

4c. If all your entries are correct, press  with “Show Result” highlighted on the BG Correct screen. If you need to adjust any entry, press  to first highlight it, and then press . Use  to make the change and then press  again.

NOTE: Changes made to your IS Factor or BG Target during ezCarb calculations apply to this bolus only and will not affect the IS Factor or BG Target you have stored in your pump.

Before calculating an estimated BG correction, your meter remote will first check to see if your Actual BG is within the range 70–250 mg/dL. If your Actual BG falls below 70 mg/dL or above 250 mg/dL, you will be prompted with either a LOW BG or HIGH BG Pump Alert screen.

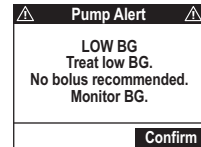

Press  on your meter remote or  on your pump to confirm the Alert. Treat a LOW BG or HIGH BG immediately according to your health care professional’s recommendation.

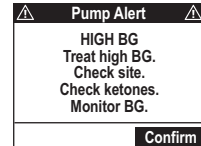

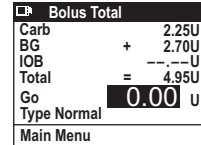

5. Review and deliver your ezCarb Bolus

The Bolus Total screen shows the Carb and BG correction amounts calculated from your previous entries. If the IOB feature is enabled on your pump, the suggested total bolus amount will be adjusted accordingly. “Total” units are rounded to the nearest .05 units. The amount field will be highlighted and flashing, and will display 0.00 units.



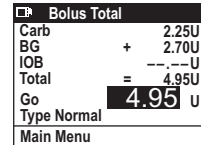



NOTE: If you have not enabled the IOB feature on your pump, a set of dashes (“---”) will appear as the IOB amount.



5a. Press  to enter either the suggested “Total” units or a different bolus amount. Press  once you have selected the desired bolus amount.

5b. “Go” is highlighted. You can deliver the ezCarb Bolus either as a Normal Bolus or as a Combo Bolus by making your selection in the “Type” field. The pre-set delivery type for an ezCarb Bolus is Normal.

5c. To deliver your ezCarb Bolus as a Normal Bolus, make sure “Normal” appears in the “Type” field. With “Go” highlighted, press . This will begin delivery of the units as a Normal Bolus.

5d. To deliver an ezCarb Bolus as a Combo Bolus, first press  to highlight the “Type” field. Then press  so that the highlight over “Normal” is flashing. Press  so that “Combo” appears on the screen and is highlighted. Press  to continue.

“Go” is highlighted again. Press  to begin the steps for delivering the ezCarb units as a Combo Bolus (see *Combo Bolus* in this chapter). The bolus amount you entered in the Bolus Total screen in step 5 will appear in the “Total” field on the first Combo Bolus screen.

Bolus Total	
Carb	2.25U
BG	+ 2.70U
IOB	-- --U
Total	= 4.95U
Go	4.95 u
Type	Normal
Main Menu	

Bolus Total	
Carb	2.25U
BG	+ 2.70U
IOB	-- --U
Total	= 4.95U
Go	4.95 u
Type	Normal
Main Menu	



Bolus Total	
Carb	2.25U
BG	+ 2.70U
IOB	-- --U
Total	= 4.95U
Go	4.95 u
Type	Combo
Main Menu	

Bolus Total	
Carb	2.25U
BG	+ 2.70U
IOB	-- --U
Total	= 4.95U
Go	4.95 u
Type	Combo
Main Menu	

Combo Bolus

A Combo Bolus is used to deliver both a Normal and an Extended Bolus. See *Chapter 11* in *Section I* for information on Combo Boluses.

1. Select a Combo Bolus



On the Bolus Menu screen, press  to highlight “Combo Bolus” and press .

If you used the ezCarb Bolus option to calculate a bolus and chose to deliver it as a Combo Bolus, you will begin at the Combo Bolus screen in step 2.

2. Review/change your bolus amount, duration, and/or split percentages

Total Combo Bolus units will be highlighted in the “Total” field. Your starting point will be “0.00” units if you are initiating the Combo Bolus from the Bolus Menu screen.

2a. Press  to adjust the amount and press  when finished.

NOTE: You may not start a new Combo Bolus if another one is active. If a Combo Bolus is active, “ACTIVE” will appear on the top of the screen and the duration and units delivered so far will appear below. To cancel the current active Combo Bolus, press  to highlight “CANCEL” and press . Any remaining insulin from the current active Combo Bolus will be canceled. You will return to the Pump Home screen.

 Bolus Menu
JL.Smith
Normal
ezCarb
ezBG
Combo Bolus
Main Menu

 Combo Bolus
Total 0.00U
Duration 0.5Hr
Norm:Ext 0 : 100%
0.00 : 0.00U
Go
Main Menu

 Combo Bolus
Total 8.50U
Duration 0.5Hr
Norm:Ext 0 : 100%
0.00 : 8.50U
Go
Main Menu

- 2b.** “Go” is highlighted. Values appear on the screen for “Duration” and “Norm:Ext”. “Duration” is the amount of time you would like to extend the bolus. “Norm:Ext” refers to how you want to split your total bolus into normal (Norm) and extended (Ext) units. Splits are represented as percentages that total 100%.

Combo Bolus	
ACTIVE	
Duration	0.0 : 4.0 Hrs
Delivered	0.60 U : 2.00 U
CANCEL	
Main Menu	

The duration time displayed is the duration time of your last Combo Bolus. Likewise, the splits displayed are the splits of your last Combo Bolus. If you are using the Combo Bolus feature for the first time, the displayed values will be the pre-set values stored in your pump (30 minutes duration, 0% and 100% for normal and extended units).

- 2c.** If all your entries are correct, press **OK** with “Go” highlighted. If you need to adjust any entry, press **⬇** to highlight it, and then press **OK**. Use **⬆** to make the change and press **OK** again. “Go” will be highlighted after each change is made.

Combo Bolus	
Total	8.50U
Duration	0.5 Hr
Norm:Ext	30 : 70%
	2.55 : 5.95U
Go	
Main Menu	

For example, to change your split, highlight the “Norm:Ext” field and press **OK**. Press **⬇** to enter the desired split percentages. As you scroll, normal (Norm) and extended (Ext) units appear on the screen below the percentages (%). When you are finished, press **OK** again.

Combo Bolus	
Total	8.50U
Duration	0.5 Hr
Norm:Ext	30 : 70%
	2.55 : 5.95U
Go	
Main Menu	

You can use the same steps to go back and change the duration time. Press **OK** when finished.

3. Start delivery of the Combo Bolus

With “Go” highlighted, press **OK** to begin delivering the bolus.

Combo Bolus	
Total	8.50U
Duration	0.5 Hr
Norm:Ext	30 : 70%
	2.55 : 5.95U
Go	
Main Menu	

ezBG Bolus

ezBG Bolus lets you calculate and deliver a BG correction bolus. The steps for ezBG Boluses are the same as for adding a BG correction bolus under the ezCarb feature. All ezBG Boluses are delivered as Normal boluses.



1. Select an ezBG Bolus

1a. Press  to highlight “ezBG” on the Bolus Menu screen and press .



1b. Your meter remote will first check if the most recent BG test on your meter remote was taken within the last 15 minutes. If it was, you will go to the ezBG screen in step 2. Your most recent BG test result will appear in the “Actual” field on the ezBG screen.

If your last BG test was taken more than 15 minutes ago, you will be notified on the display. You will be prompted to re-test or manually enter a new BG value. Press  to confirm the Notification and go to the ezBG screen in step 2.

2. Review/change your BG value

In this example, the most recent BG test result on your meter remote (224mg/dL) was taken within the last 15 minutes. You may adjust the level up or down using . Press  when finished so that “Show Result” is highlighted.

 Bolus Menu
JL.Smith
Normal ezCarb
ezBG
Combo Bolus
Main Menu

 Notification 
Last BG more than 15 minutes old.
Retest or enter new BG.

 ezBG
Actual 224 mg/dL
Target -120mg/dL
= +104 mg/dL
IS Factor 37 mg/dL
Show Result
Main Menu

NOTE: If the most recent BG test result on your meter remote was taken more than 15 minutes ago, three dashes (“---”) will appear in the “Actual” field on the ezBG screen. You have the option to manually enter a new BG value or to re-test. Press to manually enter a more recent BG test result, or insert a new test strip to re-test. If you decide to re-test, you will have to repeat the steps for starting a new BG Bolus when your BG test result appears on the display. When you return to the ezBG screen and you have the desired BG value in the “Actual” field, press .

ezBG	
Actual	--- mg/dL
Target	-120mg/dL
=	--- mg/dL
IS Factor	37 mg/dL
Show Result	
Main Menu	

3. Review/change your BG Target and/or IS Factor as needed

Values appear on the screen for your “Target” and your “IS Factor”. Target refers to the BG target that you stored in your pump. Your IS Factor is the ISF that you stored in your pump.

If all your entries are correct, press with “Show Result” highlighted. If you need to adjust any entry, press to highlight it, and then press . Use to make the change and press again.

ezBG	
Actual	224 mg/dL
Target	-120mg/dL
=	+104 mg/dL
IS Factor	37 mg/dL
Show Result	
Main Menu	

Use the same steps to go back and change your glucose target or your Actual BG. When all changes have been made and “Show Result” is highlighted, press to go to the ezBG Total screen in step 4.



NOTE: Changes made to your IS Factor or BG Target during ezBG calculations apply to this bolus only and will not affect the IS Factor or BG Target you have stored in your pump.

4. Review and deliver your ezBG bolus

The ezBG Total screen shows the calculated BG correction amount from your ezBG screen entries. If the IOB feature is enabled on your pump, the suggested total bolus amount will be adjusted accordingly. “Total” units are rounded to the nearest .05 units. The amount field will be highlighted and flashing, and will display 0.00 units.

ezBG Total	
BG	+ 2.80U
IOB	---U
Total	= 2.80U
Go	0.00U
Main Menu	

NOTE: If you have not enabled the IOB feature on your pump, “-.-.-” is shown as the IOB amount.

Press  to enter the calculated “Total” units from above or a different bolus amount. Press  once you have entered the desired bolus amount.

ezBG Total	
BG	+ 2.80U
IOB	---U
Total	= 2.80U
	2.80U
Go	
Main Menu	

“Go” is highlighted. Press  to deliver the bolus.

ezBG Total	
BG	+ 2.80U
IOB	---U
Total	= 2.80U
	2.80U
Go	
Main Menu	

⚠ WARNING: If RF communication is lost during the delivery of a Normal Bolus or the normal portion of a Combo Bolus, the bolus will be discontinued. Any remaining normal bolus units will not be delivered. Delivery of the extended portion of a Combo Bolus continues even if RF communication is lost or interrupted.

- A Warning screen will appear on your meter remote display to remind you that the bolus was discontinued. A similar Warning screen will appear on your pump display, and will indicate the number of insulin units delivered before the bolus was discontinued.
- You must confirm the Warning on either your meter remote or pump to continue.

⚠ WARNING ⚠	
Bolus canceled. Move devices closer, or change channel. Delivered: see pump	
Confirm	

Using the ezCarb and ezBG calculator feature when your devices are not paired

When you use the bolus calculator feature, your meter remote gets important information from your pump. If your meter remote is not currently paired with your pump, the meter remote cannot get that data.

There may be times when the two devices are not paired but you would still like to use the calculator feature on your meter remote. An example might be when you want to give yourself a bolus from a pen or syringe. You will still be able to use the ezCarb or ezBG calculator feature on the ezCarb and ezBG Bolus screens.

In cases where your devices are not paired and you access the Bolus Menu on your meter remote, a Notification screen will appear on your meter remote display. It will remind you that the bolus calculator values last set and saved on your pump may not be appropriate for the current time of day.

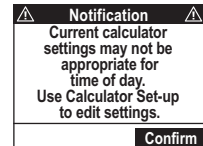

If the devices are not paired, the Bolus Menu screen will only include the ezCarb and ezBG options. The steps for calculating a bolus will be the same as when the devices are paired. The ezCarb and ezBG Bolus screens will use the bolus calculator settings last set and saved on your pump prior to the unpairing. You may edit the bolus calculator settings using the Calculator Set-up feature on your meter remote or directly on the ezCarb or ezBG screens.

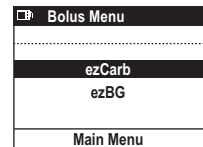

Note that the ezCarb and ezBG Bolus screens will be similar to the display screens when your meter remote and pump are paired, with a few exceptions:

1. The IOB amount will appear as “- -,- -” to indicate that the IOB stored in your pump is not available for use in the calculation.
2. “Go” is replaced by “Done” to indicate that you are calculating a bolus but will not be using your meter remote to deliver it from your pump.

See *Chapter 1 in Section II*, for a complete explanation of settings from Calculator Set-up and how they are used on the ezCarb and ezBG Bolus screens.

Unless you re-set/save the calculator settings on your meter remote using the Calculator Set-up screen, a Notification screen will appear every time you use the ezCarb or ezBG calculator feature while the devices are unpaired. This is to remind you that the current bolus calculator settings last set and saved on your pump may not be appropriate for the current time of day.

It is important that you review these settings before using the ezCarb or ezBG feature on your meter remote to see that they still would apply. You may always edit these settings by changing the settings in Calculator Set-up under the Meter Settings screen on your meter remote display, or directly on the ezCarb and ezBG Bolus screens on your meter remote display.

Press  to confirm the Notification.

Bolus Total	
BG	+ 0.25U
IOB	--,-,-U
Total	= 1.45U
Done	
Main Menu	

(Example ezBG screen when your meter remote and pump are not paired.)

Notification	
Current calculator settings may not be appropriate for time of day.	
Use Calculator Set-up to edit settings.	
Confirm	

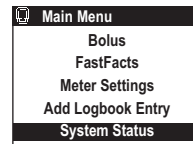

You may review the status of various pump functions and features directly on your meter remote display. You may also verify your meter remote serial number and software version number. Your meter remote and pump must be paired, and RF activated, in order to access pump status screens on your meter remote display.

Press  to highlight “System Status” on the Main Menu screen and press .



Checking Pump Status

With “Pump Status” highlighted, press  to access a series of screens with information about your insulin delivery.

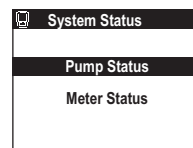

Six status screens are available. They are labeled 1 through 6 on the top right of the screen. Basal and bolus data appear in the first five screens. Your pump serial number and pump software version number appear on the final screen. Press  to scroll from one status screen to the next, and press  twice to highlight and then return to the Main Menu screen.



Status Screen 1 - Active Basal

The first status screen shows which basal program is currently active, the 24-hour total for the active basal program, units per hour for the current time segment, and insulin remaining in your pump. The (status screen) number “1” will be flashing on the top right of the screen. This indicates that you are in Review mode and can scroll up or down to view other status screens.

To continue scrolling through the status screens, press  while the number “1” is highlighted and flashing. This will take you to the next status screen.

To return to the Main Menu screen, press  so that “Main Menu” is highlighted. Press  again to return to the Main Menu screen.

Status		1
Active Basal		
A1-WEEKDAY		
24-Hr Total	13.60 U	
0.675 U/Hr		
Insulin 100 U		
Main Menu		

Flashing Number

Status		1
Active Basal		
A1-WEEKDAY		
24-Hr Total	13.60 U	
0.675 U/Hr		
Insulin 100 U		
Main Menu		

Flashing Number

Status Screen 2 - IOB, Last Bolus

The second status screen displays the current IOB amount, even if the IOB feature on your pump is disabled. This screen also shows the type (“N” = Normal, “C” = Combo [normal portion only], “A” = Audio), amount, time and date of your last completed bolus. See *Chapter 5* and *Chapter 11* in *Section I* for an explanation of bolus types.

Status		2
IOB = 0.0 U		
Last Bolus		
N	3.30 U	
	8:35 am	
		Jun 19-06
Main Menu		

Status Screen 3 - Delivery Today

Total bolus and basal amounts delivered for the current day (from midnight to the current time) appear on the third status screen. Any Temp Basal amounts are included in the total. The screen will indicate if a Temp Basal had been set (“Yes” or “No”) or if insulin delivery had been suspended (“Yes” or “No”).

Status		3
Delivery Today U100		
Temp		No
Suspend		No
Bolus	9.400U	
Basal	0.200U	
Total	9.600U	
Main Menu		

Status Screen 4 - Combo Bolus

The date, time period (start and end time), and total units of your last Combo Bolus will appear on the next screen. “COMPLETED” will appear to indicate the entire bolus was delivered. “ACTIVE” will appear if bolus delivery is still in progress. “CANCELED” will appear if you used your meter remote or pump to cancel the bolus.

Status	4
Combo Bolus	
COMPLETED	
Jun 19-06	
Start time	12:00 pm
End time	2:00 pm
Delivered	8.50 / 8.50U
Main Menu	

Status Screen 5 - Temp Basal

The fifth status screen indicates the date, time period (start and end time) of your last Temp Basal, and the percentage increase or decrease in units from the basal program that was in effect at the time.



Status	5
Temp Basal	
ACTIVE	
Jun 19-06	
Start	4:00 pm
End	6:00 pm
Change	-50%
Main Menu	

Status Screen 6 - Codes

The pump software version number and the last seven digits of your pump serial number appear on the sixth (last) status screen.

Status	6
Codes	
REV XXX.XX.XX	
S/N# 76543-21	
Main Menu	

Checking Meter Remote Status

To check your meter remote serial number and the current version of the software loaded inside your meter remote, press  to highlight “Meter Status” and then press .

Your meter remote serial number and current meter remote software version number will appear on the screen.



System Status	
Pump Status	
Meter Status	

Meter Status	
S/N:	87654321
SW Version:	V01.00



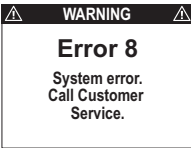
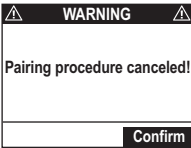

Once you activate RF communication and pair the devices, your meter remote will display additional special messages. These include messages regarding communication problems between the devices or if your intended actions might require additional attention.

IMPORTANT: If a message is displayed on your meter remote and is not included in the list that follows, it may be due to an error specific to your meter remote (see *Chapter 10 in Section II*) or a pump related message that appears on both your pump and meter remote displays (see the list of pump related messages that follows in this chapter).





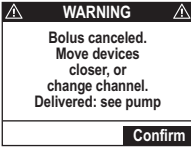

System error messages on your meter remote

	Indicates	What to do
	There are RF communication problems between your meter remote and pump.	Call Customer Service at 1 877 937-7867 for more information.
	Your meter remote was able to locate an insulin pump but the pairing procedure was canceled before it was completed.	Press  to confirm the Warning. If you would like to pair your meter remote with the same pump or another pump, repeat the pairing procedure.

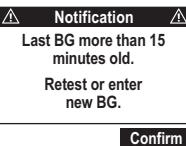

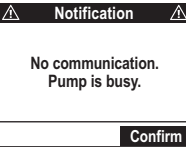

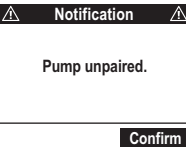
System error messages on your meter remote *(continued)*

	Indicates	What to do
	<p>Your meter remote was unable to locate a pump during the pairing procedure. Your pump may not be within RF range (approximately 10 feet/3.0 meters), or you may not have activated the Pairing mode on your pump.</p>	<p>Press  to confirm the Warning. Activate the Pairing mode on your pump (see pages 252-257) and make sure it is within RF range (approximately 10 feet/3.0 meters) of your meter remote. Repeat the steps for pairing your meter remote with your pump.</p>
	<p>Bolus was canceled because RF communication was lost during bolus delivery, and has not been re-established.</p>	<p>Press  to confirm the Warning. Make sure your meter remote and pump are within RF range, and/or try troubleshooting the RF connection with Customer Service at 1 877 937-7867 using the RF Test feature on your meter remote. Please refer to your pump to see how many insulin units were delivered before the bolus was canceled. You will still be able to deliver insulin directly from your pump or as an insulin injection.</p>



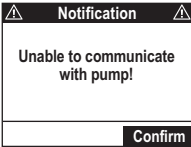

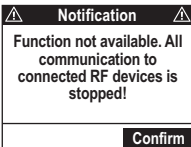

System error messages on your meter remote *(continued)*

Indicates	What to do
 <p>Notification</p> <p>Last BG more than 15 minutes old. Retest or enter new BG.</p> <p>Confirm</p>	<p>The last BG test taken on your meter remote was more than 15 minutes ago, and may not be current enough for calculating a BG correction.</p> <p>Press  to confirm the Notification. You will be prompted to re-test or manually enter a more recent BG test result.</p>
 <p>Notification</p> <p>No communication. Pump is busy.</p> <p>Confirm</p>	<p>There is no communication between your meter remote and pump because your pump is in the middle of a procedure.</p> <p>Your pump must complete the procedure before it can respond to your meter remote command. Press  to confirm the Notification. Wait a few seconds for your pump to complete the procedure. If the message appears again, check the RF status.</p>
 <p>Notification</p> <p>Pump unpaired.</p> <p>Confirm</p>	<p>Your meter remote and pump are no longer paired, and will not be able to communicate or share data. You will not be able to use your meter remote to deliver insulin from your pump while the devices are unpaired.</p> <p>Press  to confirm the Notification. To re-pair your meter remote with your pump, or to pair your meter remote with a new pump, complete the pairing procedure (see page 258). In cases where you are not able to use your meter remote to access pump functions, you will still be able to deliver insulin directly from your pump or as an insulin injection.</p>

System error messages on your meter remote *(continued)*

	Indicates	What to do
 <p>Unable to communicate with pump!</p> <p>Confirm</p>	<p>Your meter remote and pump are unable to communicate. Possible causes are that the devices are not within RF range or there is RF interference. You will not be able to use your meter remote to deliver insulin from your pump when the devices are unable to communicate.</p>	<p>Press  to confirm the Notification. See if your meter remote and pump are within RF range (about 10 feet/ 3.0 meters of one another), and use the RF Test feature on your meter remote to check the strength and quality of the RF signal (see page 265-266). In cases where you are not able to use your meter remote to access pump functions, you will still be able to deliver insulin directly from your pump or as an insulin injection.</p>
 <p>Function not available. All communication to connected RF devices is stopped!</p> <p>Confirm</p>	<p>Your meter remote and pump are unable to communicate. A possible cause is that RF communication has been deactivated.</p>	<p>Press  to confirm the Notification. Check to see if you have deactivated RF communication on either your meter remote or pump (see pages 261-263). In cases where you are not able to use your meter remote to access pump functions, you will still be able to deliver insulin directly from your pump or as an insulin injection.</p>

System error messages on your meter remote *(continued)*

















Indicates	What to do
<p data-bbox="138 296 322 427">  Notification  Unable to communicate with pump! Bolus settings may not be current. Verify & edit bolus settings as needed. </p> <p data-bbox="256 427 322 447" style="text-align: right;">Confirm</p>	<p data-bbox="348 296 704 546">You have accessed the bolus calculator on either the ezCarb or ezBG Bolus screens, but your meter remote and pump are unable to communicate. The ezCarb and ezBG Bolus screens will use the bolus calculator values last set and saved on your pump.</p>
<p data-bbox="138 625 322 730">  Notification  Stored meter calculator settings will be overwritten by settings from pump. </p> <p data-bbox="256 750 322 769" style="text-align: right;">Confirm</p>	<p data-bbox="348 625 704 776">Your meter remote and pump are now paired, and the bolus calculator settings from Calculator Set-up will be replaced by those last set and saved on your pump.</p>
<p data-bbox="138 796 322 914">  Notification  Current calculator settings may not be appropriate for time of day. Use Calculator Set-up to edit settings. </p> <p data-bbox="256 921 322 940" style="text-align: right;">Confirm</p>	<p data-bbox="348 796 704 947">You have chosen to unpair your meter remote and pump. The current calculator settings last saved may not be appropriate for the current time of day.</p>

The values last set and saved on your pump may not be appropriate for the current time of day. Press  to confirm the Notification. You may edit the values as necessary in Calculator Set-up under the Meter Settings screen if your meter remote and pump are unpaired. You may also edit the values directly on the ezCarb and ezBG Bolus screens.

Press  to confirm the Notification. You may edit the settings on the ezCarb and ezBG Bolus screens.

Press  to confirm the Notification. **It is important that you review these settings before using the ezCarb or ezBG feature on your meter remote to see that they still would apply.** You may edit the settings in Calculator Set-up under the Meter Settings screen if your meter remote and pump are unpaired. You may also edit the settings directly on the ezCarb and ezBG Bolus screens.

System error messages on your meter remote *(continued)*

	Indicates	What to do
 Notification  Function not available. Device must be paired. 	You have tried to initiate a pump function, but your meter remote and pump are not currently paired.	Press  to confirm the Notification. Complete the pairing procedure on your meter remote and pump.
 Notification  Pump and meter glucose units do not match. Contact Customer Service. 	The glucose unit of measure on your meter remote does not match the glucose unit of measure on your pump. They must match for the pairing procedure to be successful.	Press  to confirm the Notification. Call Customer Service immediately at 1 877 937-7867.
 Notification  RF communication deactivated. 	You have deactivated RF communication between your meter remote and pump.	Press  to confirm the Notification.
 Notification  Please use the same RF channel as the paired pump! 	The RF channel on your meter remote and pump must be set to match for the devices to communicate.	Press  to confirm the Notification. If you are manually setting the RF Channel on your meter remote, make sure it matches the RF channel on your pump (see pages 252-253).

There are a series of pump alarms, warnings, and alerts that display and/or sound both on your meter remote and pump. It is possible that pump warnings, alarms, or alerts may sound and display first on your pump before doing so on your meter remote. **Pump alarms, warnings, and alerts require you to confirm the message on either your meter remote or pump, and then take appropriate action on your pump to address the problem.** Some pump alarms also provide an option to suspend insulin delivery.

Your pump has a progressive warnings and alarms safety system. This means that if you do not confirm the warning or alarm, your pump will begin to beep louder and start to vibrate within one hour. At that time, if you do not confirm the warning or alarm, it will continue until the necessary action is taken.

NOTE: Your pump uses battery power to notify you of alerts, warnings, and alarms. If you do not confirm the notification, your pump will continue to use battery power as the notifications repeat and progress. This will result in reduced battery life and the Replace Battery Alarm screen appearing sooner than expected.

Additionally, certain warnings (e.g., Low Cartridge Warning, Occlusion Alarm) take precedence over less critical ones (e.g., Low Battery Warning). This means if you do not confirm the more critical warning, battery life will be reduced and your pump may skip the Low Battery Warning and go directly to the Replace Battery Alarm, or battery life will end before a Replace Battery Alarm is displayed.

⚠ WARNING: CONFIRM all pump alerts, alarms and warnings as soon as possible.

Not confirming alerts, alarms and warnings can affect insulin delivery as follows:







- Pump battery power may be drained much sooner than expected, leaving you without a way to deliver insulin if you do not have a replacement battery.
- The calculation of Insulin on Board (IOB) when using the bolus calculator feature may not be as accurate, resulting in the “suggested” bolus amount being less than what it should be.
- Basal and bolus delivery may be suspended for up to 2 hours once the alert, alarm or warning is confirmed without the pump directly notifying the user.
- Any Combo Bolus or Temp Basal in effect may be canceled without the pump directly notifying the user.

Any of these situations can result in over delivery or under delivery of insulin, resulting in serious injury or death.

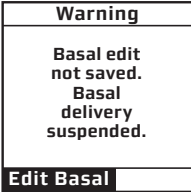
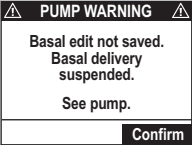
IMPORTANT: If a message is displayed on your meter remote and is not included in the list that follows, it may be due to an error specific to your meter remote (see *Chapter 10 in Section II*), or a communication error between the devices (see the list of communication-related messages in this chapter).

Pump alarms, warnings, and alerts that display on both devices

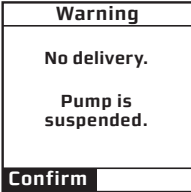
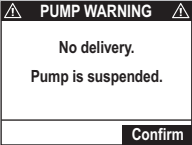
NOTE: When pump alarms, warnings, and alerts display on both devices, there are slight differences in how the messages appear on your meter remote and pump displays. Where applicable, alarms, warnings, and alerts will display actual insulin units during pump operation, rather than the “XX” or “XXX” units displayed on some of the screens in this list.

Pump Display	Meter Remote Display	Indicates	What to do
 <p>Warning</p> <p>Basal edit not saved. Basal delivery suspended.</p> <p>Edit Basal</p>	 <p>PUMP WARNING</p> <p>Basal edit not saved. Basal delivery suspended. See pump.</p> <p>Confirm</p>	The basal program edit was not saved on your pump. Basal delivery is currently stopped.	Press  on your meter remote or  on your pump to confirm the Warning. If you press  on your pump, you will go to the Edit Basal screen where you can review and save your basal program edits.
 <p>Warning</p> <p>No delivery. Pump is suspended.</p> <p>Confirm</p>	 <p>PUMP WARNING</p> <p>No delivery. Pump is suspended.</p> <p>Confirm</p>	You manually suspended insulin delivery on your pump. All insulin delivery is stopped.	Press  on your meter remote or  on your pump to confirm the Warning. Follow steps for resuming insulin delivery using your pump.

Pump alarms, warnings, and alerts that display on both devices *(continued)*

Pump Display	Meter Remote Display	Indicates	What to do
<p>Warning</p> <p>Low battery.</p> <p>Confirm</p>	<p>⚠ PUMP WARNING ⚠</p> <p>Low pump battery.</p> <p>Confirm</p>	Your pump battery is very low and will only last a minimum of thirty minutes.	Press OK on your meter remote or OK on your pump to confirm the Warning. Replace your pump battery as soon as possible.
<p>Warning</p> <p>Exceeds max bolus XX.XX U.</p> <p>No bolus delivery.</p> <p>Confirm</p>	<p>⚠ PUMP WARNING ⚠</p> <p>Exceeds max bolus XX.XX U.</p> <p>No bolus delivery.</p> <p>Confirm</p>	The audio bolus exceeds the bolus limit (xx.xx units in this example) you set and saved in your pump. Audio bolus delivery is currently stopped.	Press OK on your meter remote or OK on your pump to confirm the Warning. You may need to adjust the limit that is stored in your pump.
<p>Warning</p> <p>Exceeds max 2Hr XX U.</p> <p>No delivery.</p> <p>Confirm</p>	<p>⚠ PUMP WARNING ⚠</p> <p>Exceeds max 2Hr XX U.</p> <p>No delivery.</p> <p>Confirm</p>	Combined basal and bolus delivery exceeds the 2-hour delivery limit (xx units in this example) you set and saved in your pump. Insulin delivery is currently stopped.	Press OK on your meter remote or OK on your pump to confirm the Warning. You may need to adjust the limit that is stored in your pump.

Pump alarms, warnings, and alerts that display on both devices *(continued)*

Pump Display	Meter Remote Display	Indicates	What to do
<p>Warning</p> <p>Exceeds max TDD XXX U.</p> <p>No delivery.</p> <p>Confirm</p>	<p>⚠ PUMP WARNING ⚠</p> <p>Exceeds max TDD XXX U. No delivery.</p> <p>Confirm</p>	<p>The bolus exceeds the Total Daily Dose (TDD) limit (xxx units in this example) you set and saved in your pump. All insulin delivery is currently stopped. Any Combo bolus or Temp Basal is temporarily suspended.</p>	<p>Press OK on your meter remote or OK on your pump to confirm the Warning. You may need to adjust the limit that is stored in your pump. If the Warning is not confirmed by the time your pump clock passes midnight, the message will continue to be displayed, but any Combo Bolus or Temp Basal that is currently suspended will resume.</p>
<p>Warning</p> <p>Low cartridge. XX U or less left.</p> <p>Confirm</p>	<p>⚠ PUMP WARNING ⚠</p> <p>Low cartridge. XX U or less left.</p> <p>Confirm</p>	<p>The insulin units remaining in your pump cartridge are less than the warning level (xx units in this example) you set and saved in your pump. Insulin deliveries will continue until the Empty Cartridge alarm goes off.</p>	<p>Press OK on your meter remote or OK on your pump to confirm the Warning. Replace the insulin cartridge in your pump.</p>

Pump alarms, warnings, and alerts that display on both devices *(continued)*

Pump Display	Meter Remote Display	Indicates	What to do
<p>Warning</p> <p>Exceeds max basal XX.XX U/Hr.</p> <p>No basal delivery.</p> <p>Confirm</p>	<p>⚠ PUMP WARNING ⚠</p> <p>Exceeds max basal XX.XX U/Hr</p> <p>No basal delivery.</p> <p>Confirm</p>	Basal delivery (or a Temp Basal) exceeds the basal limit (xx.xx units in this example) you set and saved in your pump. Basal delivery is currently stopped.	Press OK on your meter remote or OK on your pump to confirm the Warning. You may need to adjust the limit that is stored in your pump or adjust the Temp Basal.
<p>Warning</p> <p>Delivery canceled due to low cartridge.</p> <p>Confirm</p>	<p>⚠ PUMP WARNING ⚠</p> <p>Delivery canceled due to low cartridge.</p> <p>Confirm</p>	Bolus delivery will exceed the insulin units remaining in your pump cartridge. Bolus delivery has been canceled.	Press OK on your meter remote or OK on your pump to confirm the Warning. Replace the insulin cartridge on your pump.
<p>Warning</p> <p>No cartridge detected.</p> <p>Delivery disabled.</p> <p>Confirm</p>	<p>⚠ PUMP WARNING ⚠</p> <p>No cartridge detected.</p> <p>Delivery disabled.</p> <p>Confirm</p>	There is no insulin cartridge in your pump. All insulin delivery is currently stopped.	Press OK on your meter remote or OK on your pump to confirm the Warning. Install a new insulin cartridge and prime it.

Pump alarms, warnings, and alerts that display on both devices *(continued)*

Pump Display	Meter Remote Display	Indicates	What to do
<p>Warning</p> <p>Pump is not primed. No delivery.</p> <p>Confirm</p>	<p>⚠ PUMP WARNING ⚠</p> <p>Pump is not primed. No delivery.</p> <p>Confirm</p>	Your pump is not primed. All insulin delivery is currently stopped.	Press OK on your meter remote or OK on your pump to confirm the Warning. Disconnect and then re-prime your pump.
<p>Warning</p> <p>Bolus delivery canceled by user button press.</p> <p>Delivered: x.XX U of x.XX U</p> <p>Confirm</p>	<p>⚠ PUMP WARNING ⚠</p> <p>Bolus delivery canceled by user button press. Delivered: x.XX U of x.XX U</p> <p>Confirm</p>	The bolus was canceled because you pressed a button on your meter remote or pump while the bolus was being delivered. The number of insulin units delivered (x.xx of x.xx units in this example) before the bolus was canceled appears at the bottom of the screen.	Press OK on your meter remote or OK on your pump to confirm the Warning.

Pump alarms, warnings, and alerts that display on both devices *(continued)*

Pump Display	Meter Remote Display	Indicates	What to do
<p>Warning</p> <p>Bolus canceled.</p> <p>Move devices closer, or change channel.</p> <p>Delivered: X.XX U of XX.XX U</p> <p>Confirm</p>	<p>⚠ PUMP WARNING ⚠</p> <p>Bolus canceled. Move devices closer, or change channel.</p> <p>Delivered: XX.XX U of XX.XX U</p> <p>Confirm</p>	<p>The bolus was canceled because RF communication was lost during bolus delivery, and then re-established.</p>	<p>Press OK on your meter remote or OK on your pump to confirm the Warning. Make sure your meter remote and pump are within RF range, and/or try troubleshooting the RF connection with Customer Service at 1 877 937-7867 using the RF Test feature on your meter remote. Please refer to your pump display to see how many insulin units were delivered (xx.xx of xx.xx units in this example) before the bolus was canceled. You will still be able to deliver insulin directly from your pump or as an insulin injection.</p>

Pump alarms, warnings, and alerts that display on both devices *(continued)*

Pump Display	Meter Remote Display	Indicates	What to do
<div style="border: 1px solid black; padding: 5px; margin-bottom: 5px;"> <p style="text-align: center;">ALARM</p> <p style="text-align: center;">CALL SERVICE</p> <p style="text-align: center;">No delivery. XXX-XXXX</p> <div style="border: 1px solid black; padding: 2px; text-align: center; margin-top: 5px;"> <p>Remove battery to silence the alarm.</p> </div> </div>	<div style="border: 1px solid black; padding: 5px; margin-bottom: 5px;"> <p style="text-align: center;">⚠ PUMP ALARM ⚠</p> <p style="text-align: center;">CALL CUSTOMER SERVICE</p> <p style="text-align: center;">No delivery. XX-XXXX</p> <div style="border: 1px solid black; padding: 2px; text-align: center; margin-top: 5px;"> <p>Remove pump battery to silence the alarm.</p> </div> </div>	<p>There is a problem with your pump hardware or software. All insulin delivery is currently stopped.</p>	<p>Press OK on your pump to confirm the Alarm and silence it for the next 30 minutes. Remove your pump battery to completely silence the alarm. Call Customer Service at 1 877 937-7867 immediately. To clear the alarm from your meter remote, you must turn the meter remote off and then back on.</p>
<div style="border: 1px solid black; padding: 5px; margin-bottom: 5px;"> <p style="text-align: center;">ALARM</p> <p style="text-align: center;">AUTO-OFF</p> <p style="text-align: center;">No delivery.</p> <p style="text-align: center;">No button presses in last XX hours.</p> <div style="border: 1px solid black; padding: 2px; text-align: center; margin-top: 5px;"> <p>Confirm</p> </div> </div>	<div style="border: 1px solid black; padding: 5px; margin-bottom: 5px;"> <p style="text-align: center;">⚠ PUMP ALARM ⚠</p> <p style="text-align: center;">AUTO-OFF</p> <p style="text-align: center;">No delivery. No button presses in last XX hours.</p> <div style="border: 1px solid black; padding: 2px; text-align: center; margin-top: 5px;"> <p>Confirm</p> </div> </div>	<p>There were no button presses on your pump or meter remote within the allowable Auto-off time limit (xx hours in this example) you set and saved in your pump. All insulin delivery is currently suspended.</p>	<p>Press OK on your meter remote or OK on your pump to confirm the Alarm. Once confirmed, the No Prime Warning is triggered.</p>

Pump alarms, warnings, and alerts that display on both devices *(continued)*

Pump Display	Meter Remote Display	Indicates	What to do
<p>ALARM</p> <p>EMPTY CARTRIDGE No delivery.</p> <p>Replace cartridge.</p> <p>Suspend Confirm</p>	<p>PUMP ALARM</p> <p>EMPTY CARTRIDGE No delivery.</p> <p>Replace cartridge.</p> <p>Confirm</p>	<p>The insulin cartridge in your pump is empty. All insulin delivery is currently stopped.</p>	<p>Press OK on your meter remote or OK on your pump to confirm the Alarm. Replace the insulin cartridge in your pump. You also have the option to suspend insulin delivery from your pump.</p>
<p>ALARM</p> <p>OCCUSION DETECTED</p> <p>No delivery.</p> <p>Suspend Confirm</p>	<p>PUMP ALARM</p> <p>OCCUSION DETECTED No delivery.</p> <p>Confirm</p>	<p>An occlusion was detected. All insulin delivery is currently stopped.</p>	<p>Press OK on your meter remote or OK on your pump to confirm the Alarm. You also have the option to suspend insulin delivery from your pump. Disconnect and re-prime to clear the occlusion.</p>
<p>ALARM</p> <p>REPLACE BATTERY</p> <p>No delivery.</p> <p>Remove battery to silence the alarm.</p>	<p>PUMP ALARM</p> <p>REPLACE PUMP BATTERY No delivery.</p> <p>Remove pump battery to silence the alarm.</p>	<p>Your pump battery has only enough power for about another three minutes of use. All insulin delivery is currently stopped.</p>	<p>Replace your pump battery immediately.</p>

Pump alarms, warnings, and alerts that display on both devices *(continued)*

Pump Display	Meter Remote Display	Indicates	What to do
<p>Alert</p> <p>Your active basal program is empty. 0.000U/Hr</p> <p>Confirm</p> <p>Basal Menu</p>	<p>Pump Alert</p> <p>Your active basal program is empty. 0.000 U/Hr</p> <p>Confirm</p>	The active basal program is empty.	Press OK on your meter remote or OK on your pump to confirm the Alert. Or, highlight "Basal Menu" on your pump to go to the Basal Menu screen where you can make adjustments to your active basal program.
<p>Alert</p> <p>LOW BG</p> <p>Treat low BG. No bolus recommended. Monitor BG.</p> <p>Confirm</p>	<p>Pump Alert</p> <p>LOW BG Treat low BG. No bolus recommended. Monitor BG.</p> <p>Confirm</p>	The Actual BG value you entered on the ezCarb or ezBG Bolus screen is below 70 mg/dL. A bolus is not recommended.	Press OK on your meter remote or OK on your pump to confirm the Alert. Treat a LOW BG immediately according to your health care professional's recommendations.
<p>Alert</p> <p>HIGH BG</p> <p>Treat high BG. Check site. Check ketones. Monitor BG.</p> <p>Confirm</p>	<p>Pump Alert</p> <p>HIGH BG Treat high BG. Check site. Check ketones. Monitor BG.</p> <p>Confirm</p>	The Actual BG value you entered on the ezCarb or ezBG Bolus screen is above 250 mg/dL.	Press OK on your meter remote or OK on your pump to confirm the Alert. Treat a HIGH BG immediately according to your health care professional's recommendations.

Electromagnetic Emissions:

The information contained in this section is intended to provide guidance on the proper operation of the OneTouch® Ping® System with respect to electromagnetic compatibility (EMC). Following this guidance will not guarantee faultless operation but should provide reasonable assurance of such. The tables in this section are required by the EMC standard, IEC 60601-1-2.

Medical electrical systems need special precautions regarding electromagnetic compatibility (EMC) and need to be installed and put into service according to the EMC information provided in this Owner's Booklet.

Portable and mobile RF equipment can effect medical electrical systems.

Cables and accessories not specified for use with the OneTouch® Ping® System by Animas® are not authorized. Use of such unauthorized cables or accessories may adversely impact safety, performance and EMC (increased emissions or decreased immunity).

Care should be taken if the OneTouch® Ping® System is adjacent to or stacked upon other electrical equipment. If such use is unavoidable, it should be verified through observation that neither product is affected by the proximate use.

Guidance and Manufacturer's Declaration on Electromagnetic Emissions

The OneTouch® Ping® System is intended for use in the electromagnetic environment specified below. The customer or the user of the OneTouch® Ping® System should assure that it is used in such an environment.		
Emissions Test	Compliance	Electromagnetic Environment – Guidance
RF emissions CISPR 11	Group 1	The OneTouch® Ping® System uses RF energy only for its internal function. Therefore, its RF emissions are very low and are not likely to cause any interference in nearby electronic equipment.
RF emissions CISPR 11	Class B	
Harmonic emissions IEC 61000-3-2	Not applicable	
Voltage fluctuations/ flicker emissions IEC 61000-3-3	Not applicable	

Guidance and Manufacturer's Declaration – Electromagnetic Immunity

The OneTouch® Ping® System is intended for use in the electromagnetic environment specified below. The customer or the user of the OneTouch® Ping® System should assure that it is used in such an environment.			
Immunity Test	IEC 60601 Test Level	Compliance Level	Electromagnetic Environment – Guidance
Electrostatic-discharge (ESD) IEC 61000-4-2	± 6 kV contact ± 8 kV air	± 8 kV contact ± 15 kV air (pump, IEC 60601-2-24) ± 6 kV contact ± 8 kV air (CGM Transmitter)	Floors should be wood, concrete or ceramic tile. If floors are covered with synthetic material, the relative humidity should be at least 30%.
Electrical fast transient/burst IEC 61000-4-4	± 2 kV for power supply lines ± 1 kV for input/output lines	Not applicable	Not applicable
Surge IEC 61000-4-5	± 1 kV line(s) to line(s) ± 2 kV line(s) to earth	Not applicable	Not applicable

Guidance and Manufacturer's Declaration – Electromagnetic Immunity

The OneTouch® Ping® System is intended for use in the electromagnetic environment specified below. The customer or the user of the OneTouch® Ping® System should assure that it is used in such an environment.			
Immunity Test	IEC 60601 Test Level	Compliance Level	Electromagnetic Environment – Guidance
Voltage dips, short interruptions and voltage variations on power supply input lines IEC 61000-4-11	<5 % U_T (>95 % dip in U_T) for 0,5 cycle 40 % U_T (60 % dip in U_T) for 5 cycles 70 % U_T (30 % dip in U_T) for 25 cycles <5 % U_T (>95 % dip in U_T) for 5 s	Not applicable	Not applicable
Power Frequency (50/60 Hz) magnetic field IEC 61000-4-8	3 A/m	400 A/m (pump, IEC 60601-2-24) 3 A/m (CGM Transmitter)	Power frequency magnetic fields should be at levels characteristic of a typical location in a typical commercial or hospital environment.

NOTE: U_T is the a.c. mains voltage prior to application of the test level.

Guidance and Manufacturer's Declaration – Electromagnetic Immunity

The OneTouch® Ping® System is intended for use in the electromagnetic environment specified below. The customer or the user of the OneTouch® Ping® System should assure that it is used in such an environment.			
Immunity Test	IEC 60601 Test Level	Compliance Level	Electromagnetic Environment – Guidance
Conducted RF IEC 61000-4-6	3 Vrms 150 kHz to 80 MHz	Not applicable	
Radiated RF IEC 61000-4-3	3 V/m 80 MHz to 2,5 GHz	10 V/m	<p>Portable and mobile RF communications equipment should be used no closer to any part of the OneTouch® Ping® Insulin Pump, including cables, than the recommended separation distance calculated from the equation applicable to the frequency of the transmitter.</p> <p>Recommended separation distance: $d = 0.35 \sqrt{P}$ 80 MHz to 800 MHz $d = 0.7 \sqrt{P}$ 800 MHz to 2,5 GHz</p> <p>where P is the maximum output power rating of the transmitter in watts (W) according to the transmitter manufacturer and d is the recommended separation distance in meters (m).</p> <p>Field strengths from fixed RF transmitters, as determined by an electromagnetic site survey, should be less than the compliance level in each frequency range^b.</p> <p>Interference may occur in the vicinity of equipment marked with the following symbol: </p>

NOTE 1: At 80 MHz and 800 MHz, the higher frequency range applies.

NOTE 2: These guidelines may not apply in all situations. Electromagnetic propagation is affected by absorption and reflection from structures, objects and people.

a Field strengths from fixed transmitters, such as base stations for radio (cellular/cordless) telephones and land mobile radios, amateur radio, AM and FM radio broadcast and TV broadcast cannot be predicted theoretically with accuracy. To assess the electromagnetic environment due to fixed RF transmitters, an electromagnetic site survey should be considered. If the measured field strength in the location in which the OneTouch® Ping® System is used exceeds the applicable RF compliance level above, the OneTouch® Ping® System should be observed to verify normal operation. If abnormal performance is observed, additional measures may be necessary, such as re-orienting or relocating the OneTouch® Ping® System.

b Over the frequency range 150 kHz to 80MHz, field strengths should be less than 3 V/m.

Separation Distance

Because there are many devices that use RF technology, it is possible to experience communication interference between your pump and meter remote from other RF devices. Examples of devices that use RF technology and may cause communication interference with your OneTouch® Ping® System include cell phones, baby monitors, cordless phones and wireless Local Area Network (LAN) routers.

The OneTouch® Ping® System is intended for use in an electromagnetic environment in which radiated RF disturbances are controlled. The user of the OneTouch® Ping® System can help prevent electromagnetic interference by maintaining a minimum distance between portable and mobile RF communications equipment (transmitters) and the OneTouch® Ping® System as recommended in the table below. For devices with output power greater than what is listed below, please contact Customer Service.

Device Output Power/Frequency	Recommended Separation Distance From Other RF devices		
	150 kHz to 80 MHz	80 MHz to 800 MHz	800 MHz to 2.5 GHz
0.01W	0.4 feet (0.12 meters)	0.4 feet (0.12 meters)	0.8 feet (0.23 meters)
0.1W	1.2 feet (0.37 meters)	1.2 feet (0.37 meters)	2.4 feet (0.74 meters)
1W	3.8 feet (1.17 meters)	3.8 feet (1.17 meters)	7.6 feet (2.33 meters)
10W	12.1 feet (3.69 meters)	12.1 feet (3.69 meters)	24.2 feet (7.38 meters)
100W	38.3 feet (11.67 meters)	38.3 feet (11.67 meters)	76.5 feet (23.33 meters)

Operating Range Minimum 3.3 feet (1 meter) obstructed
Minimum 9.8 feet (3 meters) unobstructed

Communication Time Minimum 0.5 seconds (approximately)
Maximum 10.5 seconds (approximately)

Frequency Range 902–928 MHz

Operating Channels 16

Pump flow accuracy upon initial start up (per IEC 60601-2-24)

Average flow rate during a 30 minute period. The measurements were taken at an intermediate basal rate of 2.0 U/hr in accordance with 60601-2-24:1998 at room temperature.

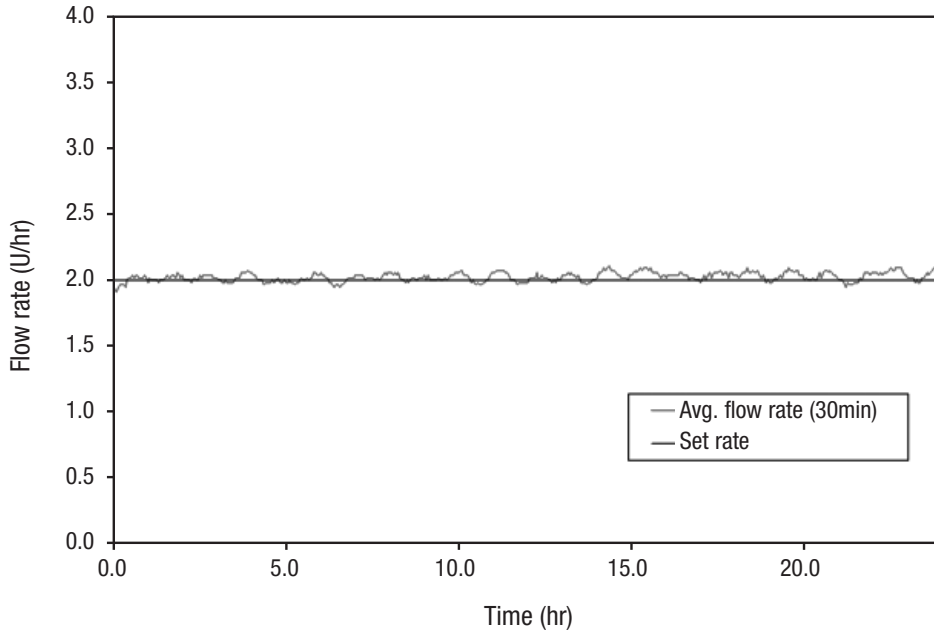

Pump flow accuracy after initial stabilization period (per IEC 60601-2-24)

The Trumpet curve shows the accuracy of the flow rate during a 5 hour period (300 deliveries) as a function of an averaging window. The reported percent error deviation is calculated from the overall weight increase over the full T_2 time period.

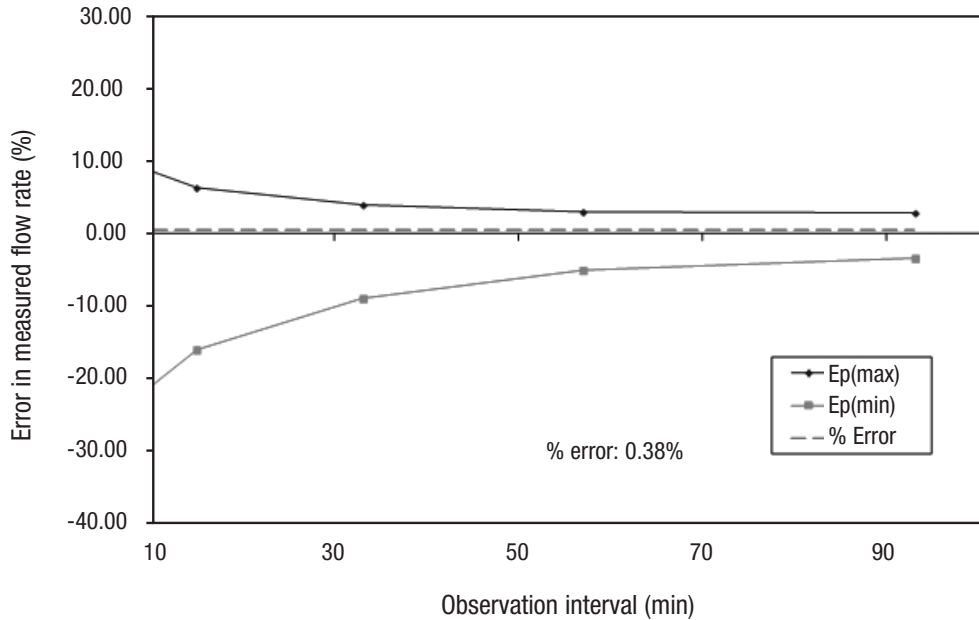

(The above pump flow test indicates that the insulin pump delivered with an accuracy of 0.38%).

Appendix A: Glossary

Glossary

alpha cells - Alpha cells are found in the pancreas. They produce a hormone called glucagon, which raises BG levels.

basal rate - The basal rate is the amount of insulin that is continuously delivered by an insulin pump. It is measured in units per hour (U/Hr). The basal rate usually provides about 40% to 60% of the daily total delivery of insulin.

beta cells - Beta cells are found in the pancreas. They produce insulin, which lowers BG levels. In type 1 diabetes mellitus, the beta cells are destroyed, so the body can no longer produce insulin.

blood glucose (BG) levels - BG levels are the measure of how much glucose (sugar) is in the blood. The normal level is about 70–110 mg/dL.

bolus - A bolus is the amount of insulin delivered at one time, usually before a meal or when BG is high.

cannula - A cannula is a small tube that is inserted into the body. Some infusion sets are designed so that only the cannula remains in the body and the needle used for insertion is removed.

dawn phenomenon - More insulin may be required in the early morning hours of normal sleep to counteract the release of several hormones that act to increase BG levels. This increased need for insulin is known as dawn phenomenon and may cause a person with diabetes to have a high BG level in the morning upon waking. Basal rate delivery by the OneTouch® Ping® Insulin Pump can be programmed to compensate for dawn phenomenon.

diabetes - Diabetes is a complex disease in which the body cannot maintain healthy BG levels because either enough insulin cannot be produced or the body cannot appropriately use insulin. In type 1 diabetes, the body no longer produces insulin and in type 2 diabetes, the body cannot use insulin properly.

diabetic ketoacidosis (DKA) - DKA results when there is not enough insulin available to help glucose enter the cells where it is used for energy. The body, in turn, burns muscle and fat for energy. A waste product of fat burning is ketones. Ketones accumulate in the blood and then pass through the urine and lungs. This condition can be identified by urine and/or blood tests. DKA usually requires hospitalization and can be fatal if not promptly treated.

gastroparesis - Gastroparesis is a complication of diabetes that causes delayed emptying of the stomach, resulting in unpredictable swings in BG levels.

gestational diabetes - Gestational diabetes is a form of diabetes that may develop during pregnancy. In some women, certain hormones normally produced by the body during pregnancy can result in unusually high BG levels. If the body cannot produce enough insulin, this can lead to hyperglycemia and may require treatment with insulin. Gestational diabetes usually ends when the baby is born, but many mothers who experience gestational diabetes may later develop Type 2 diabetes.

glucagon - Glucagon is a hormone produced by the alpha cells in the pancreas. It causes BG levels to rise.

glucose - Glucose is a carbohydrate and the body's most important source of energy. It is produced from digested food, by the normal action of the liver, and is carried by the blood throughout the body.

hyperglycemia - Hyperglycemia is also known as high blood glucose. It occurs when BG levels rise above 180 mg/dL, and the body does not have enough or cannot use insulin to process food. Symptoms of hyperglycemia include nausea, vomiting, muscle and joint aches, blurred vision,

excessive thirst, and frequent urination. Over time, weight loss can result. Hyperglycemia can occur even while using an insulin pump and can lead to diabetic ketoacidosis (DKA) if untreated.

hypoglycemia - Hypoglycemia is also known as low blood glucose. It occurs when BG levels drop to below 70 mg/dL. This can happen if a person with diabetes has taken too much insulin or has exercised more than usual. Symptoms of hypoglycemia include dizziness, shakiness, rapid heartbeat, sudden hunger, cold or clammy skin, fuzzy vision, confusion, mood changes, and tingling or numbness in the hands, arms, tongue, or lips. Hypoglycemia can occur even while using an insulin pump, and if left untreated, can lead to unconsciousness and diabetic coma.

infrared - Infrared is a wireless means by which the OneTouch® Ping® Insulin Pump communicates with external devices using an optical signal which is invisible to the human eye.

infusion set - An infusion set consists of a length of thin plastic tubing (available in various lengths) with a Luer-lock connector at one end, and at the other end, a very small cannula that is placed under the skin. It is connected to the insulin pump and used to deliver insulin to the body.

infusion site - The infusion site is the place on the body where the infusion set needle is inserted under the skin.

insulin - Insulin is a hormone produced by the beta cells in the pancreas. Insulin is needed by the body to regulate the production and use of glucose.

insulin limits - Insulin limits are a programmable feature of the OneTouch® Ping® Insulin Pump. After consulting with your health care team, you can use the Advanced Setup menu to program maximum limits for basal rate delivery, bolus delivery, and total daily delivery.

insulin pump - An insulin pump is a small, battery-powered device that mechanically pumps measured amounts of insulin through an infusion set into the body. THE PUMP IS NOT AUTOMATIC. You program and control it, and you must perform four to six BG tests daily to ensure delivery of appropriate amounts of insulin by the pump.

ketones - Ketones, or ketone bodies, are substances produced by normal liver activity, and used by muscle tissue. In uncontrolled diabetes, the process becomes unbalanced and ketones can accumulate in the blood, pass through the urine and ultimately result in diabetic ketoacidosis (DKA).

Luer-lock - A Luer-lock, or Luer connection, is a standardized, specially threaded fitting used to connect the infusion set to the pump's insulin cartridge.

mg/dL - mg/dL is the unit used to measure BG levels. It is the abbreviation for milligrams of glucose per deciliter of blood. To convert mg/dL to mmol/L, divide by 18 or multiply by 0.055.

mmol/L - mmol/L is an alternative unit used to measure BG levels. It is the abbreviation for millimoles/liter. To convert mmol/L to mg/dL, multiply by 18 or divide by 0.055.

occlusion - Occlusion means "blockage." The OneTouch® Ping® Insulin Pump is designed to be able to sense when delivery of the insulin is being blocked for some reason. The pump will automatically stop delivering insulin and give an alarm to alert you to clear the occlusion and re-start the pump.

o-ring - Both the cartridge and the battery cap contain an "o" shaped ring made of a soft material that functions as a seal when compressed. O-rings operate properly only if the surface is free of defects (cuts, scratches, abrasion).

pancreas - The pancreas is a glandular organ just behind the stomach, next to the liver. It produces digestive enzymes used to break down proteins in food. It contains alpha cells, which produce glucagon, and beta cells, which produce insulin.

stress hormones - Stress hormones (or “counter-regulatory” hormones) are released by the body in times of intense physical or emotional stress. These hormones cause the body to release glucose. If the glucose is not used as energy, hyperglycemia and ketoacidosis can result.

subcutaneous - Subcutaneous means beneath the skin. The infusion set needle is placed subcutaneously.

type 1 diabetes - Type 1 diabetes results from destruction of the beta cells in the pancreas. People with type 1 diabetes mellitus must use insulin to regulate their BG levels.

type 2 diabetes - Type 2 diabetes usually occurs in people 40 years or older. People with type 2 diabetes have a progressive loss of beta cells over time. They can sometimes regulate their BG levels by following an individual meal plan, exercising and taking antidiabetic pills. They frequently require insulin for optimal BG control.

Index

A

Accuracy, meter remote247
 Active basal program empty alert100
 Adding logbook entries208
 Advanced bolus39, 64, 81
 Advanced features, insulin pump63
 Advanced features, meter remote164, 170
 AICD5
 Air bubbles13
 Aircraft9
 Alarm history55
 Alarms, insulin pump98
 Alarms, meter remote163, 178, 237
 Alarms, meter remote and
 insulin pump163, 178, 300
 Alerts, insulin pump30, 98
 Alerts, meter remote163, 178
 Alerts, meter remote and
 insulin pump163, 178, 300
 Alternate site testing procedure189, 193
 Amusement parks9
 Audio bolus12, 29, 63, 78
 Audio bolus delivery step size63
 Auto-dim17
 Auto-off alarm118, 306
 Auto-off feature68
 Average, by exercise222
 Average, by time of day221
 Average, of all results221

B

Backlight/button, meter remote155, 160
 Basal delivery suspended warning103, 300
 Basal history58
 Basal program, features40
 Basal program, reviewing45
 Basal program, temp basal47
 Basic set-up, insulin pump27
 Basic set-up, meter remote164, 166
 Batteries, insulin pump13, 25
 Batteries, meter remote234
 Battery cap, insulin pump26, 96
 Battery cap/vent, insulin pump26
 Battery insertion, insulin pump26
 Battery insertion, meter remote235
 Beep, insulin pump19, 51
 Beep, meter remote169, 178
 BG/check reminder, insulin pump92
 BG/check reminder, meter remote275
 BG correction calculator86
 BG targets/ranges, insulin pump73
 BG targets/ranges, meter remote174
 BG test result screen, meter remote198, 200
 Bolus, combo, insulin pump89
 Bolus, combo, meter remote282
 Bolus delivery speed64, 93
 Bolus, ezBG, insulin pump86
 Bolus, ezBG, meter remote284
 Bolus, ezCarb, insulin pump82
 Bolus, ezCarb, meter remote276
 Bolus, history52

Bolus, normal, insulin pump	38
Bolus, normal, meter remote	273
Buttons, insulin pump	16
Buttons, meter remote	155

C

Cable, USB for meter remote	226
Calculator feature, insulin pump.....	86
Calculator feature, meter remote.....	173, 183
Calculator set-up, meter remote	173, 183, 257, 287
Call service alarm	117, 306
Cancel a bolus, insulin pump.....	39
Cancel a bolus, meter remote.....	274
Carb calculator	82
Carbon-zinc batteries	13, 24
Cardiac catheter	5
Carton contents	VI, VII
Cartridge	10, 12, 31
Cell phones	13
Changing the batteries, meter remote	235
Changing the battery, insulin pump.....	25
Changing the cartridge.....	33
Cleaning your insulin pump.....	14, 97
Cleaning your meter remote and lancing device	233
Clear program basal segments alert.....	102
Coding the meter remote.....	185, 229
Colonoscopy	6
Combo bolus, insulin pump	61, 89
Combo bolus, meter remote	282
Comment, adding to BG test result.....	203

Comment, editing or deleting.....	207
Comments, exercise.....	206
Comments, food	205
Comments, health.....	206
Confirmation window.....	156, 198, 231
Connecting to a PC, meter remote	226
Contrast/button, insulin pump.....	16, 17, 67
Contrast, meter remote	164, 169
Control solution.....	228
Control solution, result range	232
Control solution, storing.....	233
Control solution, testing.....	228
Correction bolus.....	86
Customize set-up, meter remote.....	162, 168

D

Damage, insulin pump	13
Data port	155, 156, 227
Date format, meter remote	164, 169
Date setting, insulin pump	27
Date setting, meter remote.....	168
Daylight saving time, insulin pump	28
Daylight saving time, meter remote	168
Dehydration	128, 131, 199
Discard date, control solution.....	233
Discard date, test strips.....	233
Display check, meter remote	186
Display contrast, insulin pump	16, 17, 67
Display contrast, meter remote	164, 169
Display language, insulin pump.....	20, 66
Display language, meter remote.....	164, 166
Display timeout setting, insulin pump	66

Disposal, insulin pump	97
Disposal, lancet and test strips	202
DKA	4, 127, 128
Download, insulin pump	19, 52
Download, meter remote	226
Drop of blood.....	192, 195

E

Editing comments	207
Editing logbook entries	214
Edit mode.....	17
EKG	5
Electromagnetic fields	5
Electromagnets.....	9
Empty cartridge alarm	115, 307
Error messages, meter remote.....	292
Exceeds insulin remaining	111
Exceeds max basal warning.....	109, 303
Exceeds max bolus warning.....	107, 301
Exceeds max TDD warning	108, 302
Exercise and sports.....	130
Exercise comments.....	206
Exercise logbook entries	210
Expiration date, control solution	233
Expiration date, test strips	233
Extended bolus	61, 89, 282
ezBG bolus, insulin pump	86
ezBG bolus, meter remote	284
ezCarb bolus, insulin pump.....	82
ezCarb bolus, meter remote.....	276
ezManager® software program	19, 27, 29, 40, 52, 63, 82, 181

F

FastFacts® Menu	215
Fingertip testing procedure.....	191
Food averages	216, 225
Food comments.....	205
Food database	180
Food list	180, 212
Food logbook entries.....	212
Forearm	189, 193, 195
Forearm or palm sampling, important information.....	189, 195

G

General anesthesia	6
Glucose analysis	218
Glucose analysis, average by exercise	222
Glucose analysis, average by time of day.....	221
Glucose analysis, average of all results.....	221
Glucose analysis, by time of day	220
Glucose analysis, glucose range info	223
Glucose analysis, graph of all results.....	219
Glucose, by meals.....	218
Glucose range, after-meal	223
Glucose range, before-meal.....	223
Graph, all results.....	219
Graph, by time of day.....	220
Guarantee, meter remote	246

H

Health comments.....206
 Health logbook entries.....211
 Help, insulin pump2
 High BG alert, insulin pump102, 308
 High blood glucose.....128
 HIGH CONTROL warning.....238
 HIGH GLUCOSE warning,
 meter remote 199, 238
 History feature52
 Home screen, insulin pump20
 Home screens, meter remote..... 160, 270
 Hyperglycemia122, 127, 199
 Hypoglycemia75, 119, 189, 199
 Hypo level, meter remote.....172, 216, 224

I

Infection, reduce the chance.....188
 Infusion set.....33, 37, 122
 Insulin limits65
 Insulin on board (IOB), insulin pump75, 94
 Insulin on Board (IOB), meter remote.....285, 288
 Insulin on Board (IOB), setting.....75
 Insulin sensitivity factor (ISF), insulin pump71
 Insulin sensitivity (IS) factor, meter remote.....175
 Insulin to carb (I:C) ratio, insulin pump.....70
 Insulin to carb (I:C) ratio, meter remote.....174
 Intended use.....III
 Intimacy132
 IR (infra-red)19

L

Lab results, comparing with
 meter remote results243
 Lancet, disposal.....202
 Lancet, inserting in lancing device191, 194
 Lancet, protective disk188, 191, 194, 202
 Lancing191, 193
 Lancing device and cap.....188, 191, 193
 Lancing device, depth setting188, 191, 194
 Lancing device,
 OneTouch® AST™ Clear Cap.....188, 193, 194
 Language setup, insulin pump20, 66
 Language setup, meter remote164, 166
 Laser surgery on the eye6
 LED.....165, 179
 LED mode179
 Locked buttons, insulin pump19
 Locked buttons, meter remote162, 165, 176
 Locked feature, insulin pump.....19
 Locked feature, meter remote.....165, 176
 Logbook entries208
 Logbook entries, editing or deleting.....214
 Logbook entries, exercise210
 Logbook entries, food.....212
 Logbook entries, health211
 Logbook entries, pump.....213
 Logbook feature, meter remote.....216
 LOW BATTERY alarm, meter remote.....234, 241
 Low battery warning, insulin pump.....25, 106
 LOW BATTERY warning,
 meter remote234, 241

Low BG alert, insulin pump.....101, 308
 Low cartridge80
 Low cartridge warning.....106, 302
 Low cartridge warning setting.....69
 LOW CONTROL warning238
 LOW GLUCOSE warning,
 meter remote199, 238

M

Magnets.....5
 Main menu screen, insulin pump21
 Main Menu Screen, meter remote.....161
 Maintenance, insulin pump.....96
 Meal schedule164, 171
 Meter remote alerts.....163, 178, 300
 Meter remote Home screens.....160, 270
 Meter remote notification messages.....292
 Meter remote status, meter remote.....291
 Meter remote
 warning messages.....237, 292, 300
 mg/dL155, 198, 257
 MRI.....5
 Multiple basal programs40, 45, 93

N

No cartridge detected,
 deliveries disabled warning105, 303
 No prime, no delivery warning.....112, 304
 Normal bolus, insulin pump38

Normal bolus, meter remote273
 Notification messages, meter remote292
 Nuclear stress test5

O

Occlusion alarm.....114, 307
 Occlusion sensitivity setting69
 OneTouch® AST™ Clear Cap188
 O-ring26, 32

P

Pacemaker.....5
 PairingIII, 77, 95, 252
 Pairing procedure252
 Palm189, 193, 195
 Patient's bill of rights.....148
 PC communication mode, meter remote.....226
 Precautions, insulin pump9
 Precision, meter remote249
 Primary vent18
 Prime history56
 Prime/rewind.....22
 Priming the pump33
 Programming buttons, insulin pump.....16, 17
 Pump alarms98, 300
 Pump alerts.....98, 237, 300
 Pump history52
 Pump history, alarms54
 Pump history, basal58
 Pump history, bolus52
 Pump history, prime.....56
 Pump history, suspend.....57

Pump history, total daily dose (TDD)	54
Pump Home screen, insulin pump	20
Pump Home screen, meter remote	270
Pump ID on your meter remote display	270
Pump logbook entries	213
Pump status, insulin pump	59
Pump status, meter remote	289
Pump warnings	98, 300

R

Radio Frequency (RF)	III, IV
Radiology equipment	5
Rechargeable batteries, insulin pump	13, 24
Reminders	81, 91
Repeated unexpected BG test results	199
Replace battery alarm, insulin pump	116, 301
Replacement pump	13
Resume insulin delivery	51
RF activation	I, 77, 95, 252, 261, 263
RF channel	252, 267
RF communication	III, 158, 251, 252, 265
RF interference	IV, V, 265
RF on/off, insulin pump	252, 263
RF on/off, meter remote	261
RF test	266
RF welders	5
Roller-coasters	9

S

Safety information, insulin pump	11
Schedule, meal	164, 171
Serial number, insulin pump	15, 62, 256, 291
Serial number, meter remote	256, 291
Setting the time and date, insulin pump	27
Setting the time and date, meter remote	167
Set-up, advanced features, insulin pump	63
Set-up, advanced features, meter remote	170
Set-up, basic, insulin pump	27
Set-up, basic, meter remote	164, 166
Setup – Basics	27
Set-up, customize, meter remote	162, 168
SmartChip port	155, 156
Sounds setting/changing, insulin pump	29
Start-up screens, meter remote	159, 186, 229
Status feature, insulin pump	59
Status feature, meter remote	289
Storing your control solution	233
Storing your meter remote	233
Storing your test strips	233
Supplier standards	150
Supply reordering	VIII
Suspend history	57
Suspend insulin delivery	50
Suspend (temp basal/combo bolus canceled) alert	101
Suspend warning	103, 300
Swimming	130
Symbols, insulin pump	15
Symbols, meter remote	157, 246

System communication	
technical specifications	309
System status feature, meter remote.....	289

T

Tamper resistant (Locked) feature,	
insulin pump	19
Technical and clinical help.....	2
Technical specifications, insulin pump.....	144
Technical specifications, meter remote.....	245
Temp basal	47, 49, 50, 54, 61
Temp basal minimum rate alert	100
Temperature.....	13, 198, 228, 245
Testing procedure.....	184
Test strip, applying drop of blood	196
Test strip, care of.....	233
Test strip, confirmation window	156, 198, 231
Test strip, contact bars.....	156, 185, 229
Test strip, disposal.....	202
Test strip port.....	155, 185, 229
Time format, insulin pump.....	27
Time format, meter remote.....	164, 169
Time out, insulin pump.....	20, 66
Time setting, insulin pump.....	20, 27
Time setting, meter remote.....	164, 167
Total daily dose (TDD) history.....	54
Traveling	131
Troubleshooting, insulin pump	98, 119
Troubleshooting, meter remote	237
Troubleshooting, system.....	292, 300
Turning meter remote display off	160
Turning meter remote display on.....	159

U

Unexpected BG test results.....	199
Unit of measure	155, 198, 231, 257
Unpairing.....	259
Unpairing procedure.....	259
Upload, insulin pump.....	10
USB cable for meter remote.....	226
USB data port	155, 156, 227

W

Wake up screen, insulin pump.....	20
Warning cue, meter remote	165, 179
Warning messages, insulin pump.....	98
Warning messages, meter remote	237, 292
Warning messages, meter remote and insulin pump	300
Warranty, insulin pump	140
Waterproof	9, 13, 96

X

X-rays	6, 7
--------------	------

Patent information

This blood glucose monitoring system described herein is covered by one or more of the following U.S. patents: 5,708,247; 5,951,836; 6,241,862; 6,284,125 and 7,112,265. Use of the monitoring device described herein is protected under one or more of the following U.S. patents: 6,413,410; 6,733,655; 7,250,105. Purchase of the monitoring device described herein does not act to grant a use license under these patents. Such a license is granted only when the device is used with OneTouch® Ultra® Test Strips. No test strip supplier other than LifeScan, Inc. is authorized to grant such a license. The accuracy of results generated with LifeScan meters using test strips manufactured by anyone other than LifeScan has not been evaluated by LifeScan.



200 Lawrence Drive
West Chester, PA 19380, USA

Animas® has received both ISO 13485:2003 (International Organization for Standardization) certification and The Joint Commission accreditation. By meeting these most rigorous standards, Animas® is committed to superior quality and safety for its customers.

Customer Service is available 24 hours a day, 7 days a week.

U.S. & Puerto Rico: 1 877 YES-PUMP (937-7867)

Visit us at www.animas.com.

CAUTION: Federal (U.S.) law restricts this device to sale by, or on the order of a physician.

© 2015 Animas® Corporation. All rights reserved.

This product is covered by one, or more, U.S. patents including 6,656,148. Other patents pending. Glucagon Emergency Kit® is a trademark of Eli Lilly and Company. Energizer® is a trademark of the Eveready Company. OneTouch® Ultra® and OneTouch® UltraSmart® are trademarks of Johnson & Johnson. Novolog® is a trademark of Novo Nordisk A/S. Humalog® is a trademark of Eli Lilly and Company.



41029400

P/N: 41029400 Rev. C
Rev. Date: 2016/07