

# electronics®

## DIODE SPANS 30 MILES

*Infrared beam  
carries video, p 38*

## SIDEBAND FOR MILITARY

*Latest transceiver  
designs, p 29*

## CAN RADIO STOP MISSILES?

*Army studies effect  
on warheads, p 16*

*GAS LASER reads information on magnetic disk, p 48*

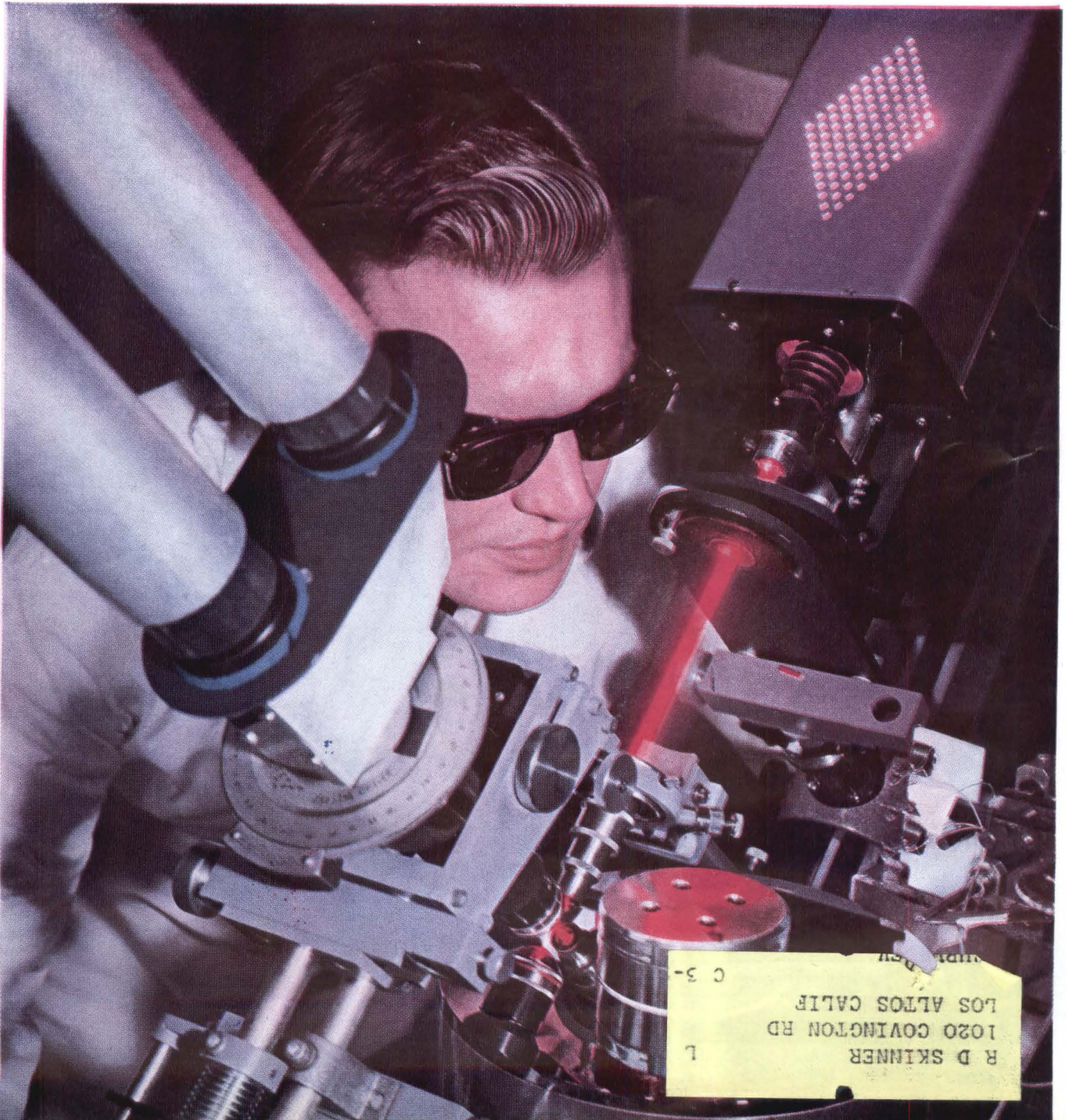



*with these features:*

**Length, delay continuously adjustable!**  
**Constant 50 ohm output impedance!**  
**Rise, decay time less than 1 nsec!**

New **hp** 215A Pulse Generator is the ideal instrument for measuring switching, recovery and storage time of diodes, transistors and thin film memory units. The 215A is useful for locating reflection sources in transmission and delay lines, measuring electrical length of cables, determining step response of circuits.

The 215A gives you clean pulses with 1 nanosecond rise and decay time. Constant 50 ohm output impedance, during all portions of pulse, allows operation into any load with freedom from multiple reflections. Calibrated front panel controls adjust pulse length from 2 to 100 nanosec-

onds, attenuation from 1 to 12 db, and delay, —10 to 140 nanoseconds after trigger output pulse. Positive and negative pulses are selectable from front panel.

Trains of pulses, either internally or externally triggered, can be generated by gating the pulser with a +1 volt signal. Internal repetition rate is 100 cps to 1 mc or pushbutton for single pulses. Pulses can be triggered by an external 10 cps to 1 mc source. Count down circuitry permits synchronization on external signals up to 100 mc. Solid state design makes the **hp** 215A compact, rugged and reliable.

*Write or call your hp rep or Hewlett-Packard direct for a demonstration on your bench.*

## SPECIFICATIONS

**Rise time:** Less than 1 nsec  
**Decay time:** Less than 1 nsec  
**Output:** At least 10 v peak into 50 ohms  
20 v peak open circuit  
**Polarity:** Positive or negative, selectable  
**Attenuator:** 1 to 12 db, calibrated  
**Pulse length:** Continuously adjustable, 2 to 100 nsec, calibrated dial  
**Pulse delay:** Continuously adjustable, —10 to 140 nsec after trigger output pulse, calibrated dial  
**Internal repetition rate:** 100 cps to 1 mc or pushbutton for single pulses

**External trigger:** Input voltage 1 v peak-to-peak; pulses 0 cps to 1 mc, 30 nsec min. duration; sine waves 10 cps to 1 mc; synchronizes to 100 mc, 1  $\mu$ sec min. pulse spacing for random repetition rate

**Output impedance:** 50 ohms

**Gate input:** +1 v to turn on

**Trigger output:** Amplitude, at least 1 v peak into 50 ohms, either polarity; rise time, better than 5 ns; duration, approximately 50 nsec

**Dimensions:** 5 $\frac{1}{2}$ " high, 16 $\frac{3}{4}$ " wide, 18 $\frac{3}{8}$ " deep. Converts to rack mount with furnished brackets. 33 lbs.

**Price:** \$1,875.00

*Data subject to change without notice. Price f.o.b. factory.*

## HEWLETT-PACKARD COMPANY

1501 Page Mill Road, Palo Alto, California, Area Code 415, DA 6-7000  
Sales and service representatives in all principal areas

Europe, Hewlett-Packard S.A., 54-54bis Route des Acacias, Geneva

Canada, Hewlett-Packard (Canada) Ltd., 8270 Mayrand St., Montreal



7926

CIRCLE 900 ON READER SERVICE CARD

# *From this new pulse generator...*

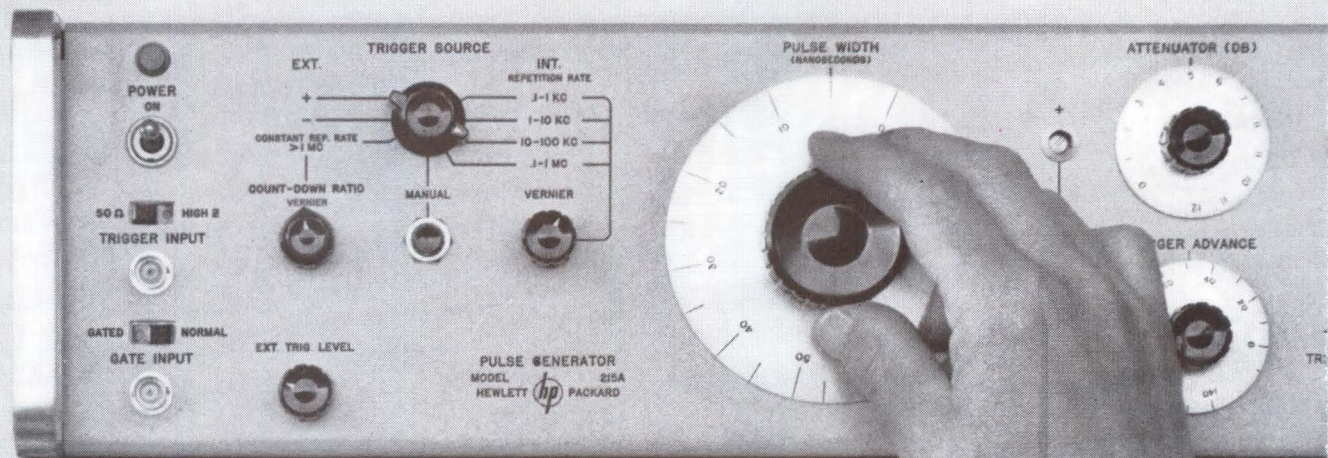

*this pulse*



Sweep time: 1 nsec/cm

# *Nanosecond Pulses Custom Designed*

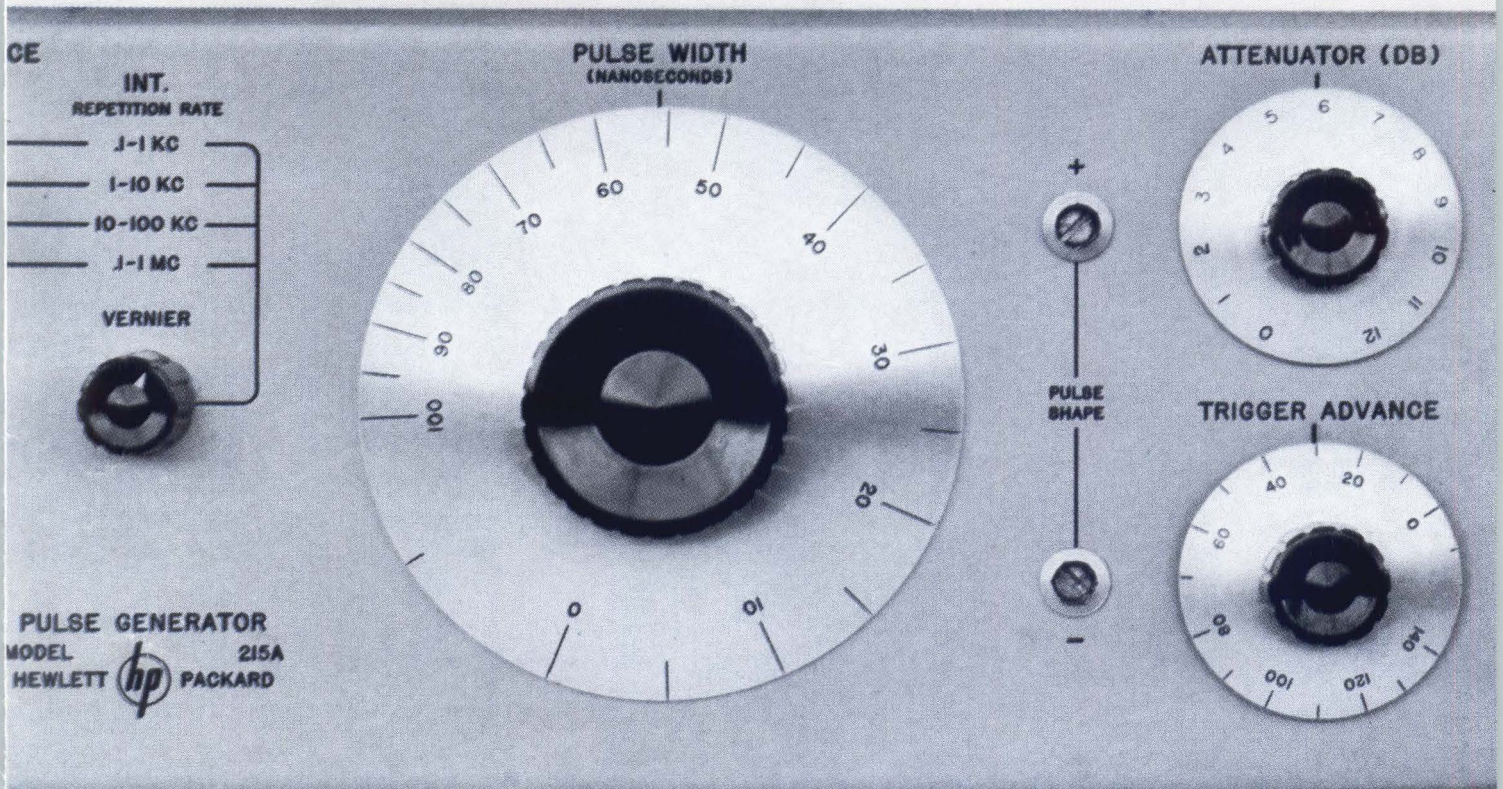

## *New hp 215A Pulse Generator*

*This pulse generator  
gives you 1 nsec rise, decay time . . .  
and lets you continuously control  
pulse length and delay!*

*Turn the page for details*

# electronics

A McGraw-Hill Weekly 75 Cents



**W. W. MacDONALD, Editor**

**J. M. CARROLL, Managing Editor**

**SENIOR EDITORS**

Samuel Weber, George W. Sideris

**SENIOR ASSOCIATE EDITORS**

Michael F. Wolff, John F. Mason

**ASSOCIATE EDITORS**

Michael F. Tomaino, Sylvester P. Carter, William P. O'Brien, Sy Vogel, Leslie Solomon, George J. Flynn, Laurence D. Shergalis, George V. Novotny, Leon H. Dulberger

**ASSISTANT EDITORS**

Nilo Lindgren, Stanley Froud, Stephen B. Gray, Roy J. Bruun, Barry A. Briskman

**REGIONAL EDITORS**

Harold C. Hood (Pacific Coast, Los Angeles), Thomas Maguire (New England, Boston), Cletus M. Wiley (Midwest, Chicago)

**ART DIRECTOR**

Howard R. Berry

**ASSISTANT ART DIRECTOR**

John C. Wright, Jr

**EDITORIAL ASSISTANTS**

Lorraine Rossi, Virginia T. Bastian, Lynn Emery, Ann Mella, Lorraine Werner, Alice M. O'Brien, Sharon Parks, Patricia Mitchell, Claire Benell

**FOREIGN NEWS BUREAU**

DIRECTOR, John Wilhelm; Alyne Elias, Charles Obertance

LONDON—John Shinn, Derek Barlow, Nicholas Landon

BONN—Bruce Bendow, Richard Mikton, Silke McQueen

BRUSSELS—Peter Forbath

PARIS—Robert Farrell, Arthur Erikson

MILAN—Marc A. Messina

MEXICO CITY—Wesley Perry, Jr

RIO DE JANEIRO—Leslie Warren

MOSCOW—Stewart Ramsey

TOKYO—Richard Halloran, Charles Cohen, John Yamaguchi

**CIRCULATION MANAGER**

Hugh J. Quinn

**W. W. GAREY, Publisher**

**LASER READS MAGNETIC DISK.** Continuous gas laser by IBM scans magnetic disk as Kerr magneto-optical effect from recorded information modulates the reflected beam. At present nonreturn-to-zero information at 500 bits per inch is read back at a 250-Kc rate. *Ability to detect 250,000 bits per square inch seems possible. See p 48* COVER

**ARMY PROTECTS MISSILES** Against Stray R-F. Develops new techniques to keep warheads safe near strong transmitters. *Conceivably, the work could also lead to antimissile techniques* 16

**ELECTROSTATIC Film Can Be Erased.** Charged photoconductive plastic provides a fast, reusable, radiation-safe film. *Among expected uses are X-ray movies, rapid projection of radar data* 17

**RADA WIDEBAND SYSTEM** May Revolutionize Army Communications. RADA, for Random Access Discrete Address, time-shares messages in a single, broad frequency channel. *Three companies are competing in feasibility studies* 18

**IEEE SHOW: Less Life, More Service.** The glamor of past IRE Shows is replaced by more engineering help for customers. *As the show opened, more new products were introduced* 18

**EAST LAGS WEST** in Electronics. Communist countries show advanced prototypes, but production models are behind the times. *We're ahead 5 to 10 years in computers, for example* 22

**WILL LASERS SETTLE DOWN?** IEEE panel agrees some brilliant engineering is now needed to turn "playboy" into workhorse. *An estimated \$25 million is being spent on laser work this year* 24

**SINGLE SIDEBAND: Major Trend in Military Communications.** Technique uses small, lightweight transmitters and affords high readability under irregular propagation conditions. *Recent developments include mobile transistor receiver, 100-watt packet transceiver and 900-watt jeep-mounted unit.* 29  
By B. A. Briskman

**TO DETECT 100 FEMTOAMPERES:** Use a Tunnel Diode. Low-current instruments are becoming increasingly important in measuring characteristics of improved silicon semiconductors. *This instrument uses the negative-resistance characteristic of the tunnel diode to measure down to 100 femtoamperes (10<sup>-15</sup>).* 33  
By C. D. Todd, Hughes Aircraft

**MODULATED INFRARED DIODE** Spans 30 Miles. Infrared emission from a gallium-arsenide diode has carried both audio and video signals over a 30-mile path. *Receiver is a 5-ft searchlight with a multiplier phototube at its focus.* 38  
By R. J. Keyes, T. M. Quist, R. H. Rediker, M. J. Hudson, C. R. Grant and J. W. Meyer, Lincoln Lab, MIT

Published weekly, with Electronics Buyers' Guide as part of the subscription, by McGraw-Hill Publishing Company, Inc. Founder: James H. McGraw (1860-1948).

Title ® registered U.S. Patent Office; © copyright 1963 by McGraw-Hill Publishing Co., Inc. All rights reserved, including the right to reproduce the contents of this publication, in whole or in part.

Executive, editorial, circulation and advertising offices: McGraw-Hill Building, 330 West 42nd Street, New York 36, N. Y. Telephone Longacre 4-3000. Teletype TWX N.Y. 212-640-4646. Cable McGrawhill, N. Y. PRINTED IN ALBANY, N. Y.; second class postage paid at Albany, N. Y.

OFFICERS OF THE PUBLICATIONS DIVISION: Shelton Fisher, President; Vice Presidents: Joseph H. Allen, Operations; John R. Callahan, Editorial; Ervin E. DeGraff, Circulation; Donald C. McGraw, Jr., Advertising Sales; Angelo R. Venezian, Marketing.

OFFICERS OF THE CORPORATION: Donald C. McGraw, President; Hugh J. Kelly, Harry L. Waddell, Executive Vice Presidents; L. Keith Goodrich, Executive Vice President and Treasurer; John J. Cooke, Vice President and Secretary.

Subscriptions are solicited only from those actively engaged in the field of the publication. Position and company connection must be indicated on orders. Subscription rates: United States and Possessions, \$6.00 one year, \$9.00 two years, \$12.00 three years. Canada: \$10.00 one year. All other countries \$20.00 one year. Single copies, United States and Possessions and Canada 75¢. Single copies all other countries \$1.50.

THE PUBLISHER, UPON WRITTEN REQUEST FROM ANY SUBSCRIBER TO OUR NEW YORK OFFICE AGREES TO REFUND THAT PART OF THE SUBSCRIPTION PRICE APPLYING TO COPIES NOT YET MAILED.

Subscribers: Please address change of address notices, subscription orders or complaints to Fulfillment Manager, Electronics, at above address. Change of address notices should provide old as well as new address, including postal zone number if any. If possible, attach address label from recent issue. Allow one month for change to become effective.

Postmaster: Please send Form 3579 to Fulfillment Manager, Electronics, 330 West 42nd Street, New York 36, New York.



Audited Paid Circulation

CONTENTS continued

**SIMPLE TESTER FOR COUNTERS** Uses Cascaded One-Shots. Bursts of 2-Kc pulses at a low repetition rate were needed to test some fast-driven digital counters. *The burst generator consists of a chain of monostable multivibrators—the 12 transistors used cost less than 50 cents apiece.* By J. Gaon, Standard Instrument 40

**MEASURING THE FREQUENCY OF A SINGLE PULSE.** Smart radar officers don't pulse away all day for the convenience of intercept operators on ferrets. In fact, some modern side-looking radar can get a lot of information from a single pulse. *This equipment uses the cyclic impedance variations of long transmission lines to generate a binary-coded indication of input frequency.* By R. F. Morrison, Jr., and M. N. Sarachan, General Dynamics/Electronics 42

DEPARTMENTS

Crosstalk. *Less Talk, More Discussion* 3

Comment. *Employment of the Handicapped. Bombers and Radar* 4

Electronics Newsletter. *New Ionospheric Layer May Limit Anti-ICBM Radar* 7

Washington This Week. *NASA to Put Pressure on Contractors* 12

Meetings Ahead. *National Space Electronics Symposium* 25

Research and Development. *Kerr-Effect Readout Uses Gas Laser* 48

Components and Materials. *Making the Right Connection* 52

Production Techniques. *System Packaging Uses Book Configuration* 56

New Products. *Vertical Sensors Made of Glass* 60

Literature of the Week 70

People and Plants. *Sanders Erecting New Facility* 72

Index to Advertisers 80

# Less Talk, More Discussion

**WE HAVE AGAIN** returned from an important technical conference where the informal evening discussion sessions attracted capacity audiences. The eagerness with which these sessions are awaited prompts us to ask why such a program must be the exception rather than the rule at electronics engineering meetings.

Much has been said in the past few years about the inadequacy of technical meetings that are devoted solely or primarily to the reading of papers. Complexity of developments reported in most papers is such that the details cannot fully be absorbed when hearing them for the first time—especially by those in the back rows of crowded auditoriums. Without a prior reading and chance for subsequent discussion much of the value of these papers is lost, the audience goes home unhappy and management wonders whether its travel budget is not too high.

Growing awareness of this problem has brought some improvements. We notice, for example, more panel discussions, particularly in areas of high current interest such as millimeter waves and lasers. These seem to be always well attended, proof to us that they fill a need.

Another innovation appeared at a recent technical meeting in New York. Here a 2½-hour session on d-c transmission was devoted entirely to a floor discussion of the formal papers. These papers had been reviewed beforehand by a "General Reporter" who then posed the key discussion questions.

This procedure has been used at European technical meetings, was reported to have won the approval of a majority of the audience for future meetings. We would like to see more of it, particularly in rapidly evolving areas such as lasers and microelectronics where both commercial and technical controversy abounds and interest is high.

Regardless of the mechanism, two things are clear:

- Every attendee should have a chance to read papers beforehand—even if they are only made available the night before in mimeographed form

- An important paper on a complex technical subject cannot then be discussed in three minutes—more discussion time must be made available in some form. And this means speakers should stick around—sometimes we notice they are the first out the door.



**TERMINOLOGY.** Out of curiosity, we looked through every dictionary in the house for a definition of the prefix femto—used in the word femtoampere headlined on page 33 this week. It isn't in any of the standard dictionaries, but it is a "legal" word. It is the proper prefix for  $10^{-15}$  and much simpler than micronano, millimicromicro or any other combination of better-known prefixes. For the record, after femto comes atto, for  $10^{-18}$ . There is not yet much cause to use atto, but when the day comes atto will avoid such terms as micromicromicro.

## Coming In Our April 12 Issue

**RABBIT'S FOOT.** Naturalists tell us that rabbits have since time immemorial used the earth as a communications channel to warn other rabbits of danger. If an enemy approaches during feeding time, a watchful rabbit will thump on the ground with his hind leg whereupon all the rabbits go down their holes.

Now modern man is catching on to the same transmission scheme (as opposed to the ear-to-the-ground passive listening used by man since primitive times). Next week, K. Ikrath and W. Schneider, of the U.S. Army Electronic R&D Lab, describe their approaches to seismological communications. One of the developments is a transducer that matches signal energy to the earth's impedance.

Other article topics next week include:

- An unusual waveform analyzer
- Multivibrator stabilized by piezoelectric crystals
- Eight ways to get reliability in semiconductor circuits
- Low-noise preamplifier using field-effect transistors
- Solid-state photoflash control
- Graphical design of thin-film resistors.

# When You Need ELECTRIC WAVE FILTERS Depend on Sprague for

✓ SERVICE  
✓ DELIVERY  
✓ RELIABILITY



Sprague Electric Wave Filters for use in telemetry, telephony, and various types of communications systems and laboratory equipment which require selection and/or rejection of specific frequencies are now being designed by *Modern Network Synthesis*, which assures exact matching of wave filter characteristics to application requirements for Low Pass, High Pass, Band Pass, and Band Rejection filters.

Drawing on Sprague's long experience in component manufacture, wave filter engineers are able to employ capacitor, inductor and resistor production facilities for particular sizes, shapes, and materials best suited for specific filter applications. Unlike most filter manufacturers, Sprague is not dependent upon other component suppliers, therefore faster deliveries can be provided.

To further Sprague capabilities, wave filter design and field engineering offices as well as pilot production facilities are maintained in North Adams, Mass.; Vandalia, Ohio; and Los Angeles, Calif. Specialized mass production facilities are located at Visalia, Calif. and North Adams.

For additional information on Sprague Electric Wave Filters, write for Engineering Bulletin 46000 to Technical Literature Section, Sprague Electric Company, 35 Marshall Street, North Adams, Massachusetts.



## COMMENT

### Employment of the Handicapped

Thanks so much for your story on our "Employer of the Year" (p 86, March 8).

Our thanks to you, your New England regional editor, and your *People and Plants* editor, whose efforts may ultimately result in more jobs in the electronics industry for handicapped men and women.

PATRICIA FENTON

The President's Committee on

Employment of the Handicapped  
Washington, D.C.

### Postal-Card Compliment

A card I *do* send is better than the letter I don't get around to. I wanted to compliment you on some nontechnical aspects of the magazine.

The summaries (abstracts) of articles, both in text and table of contents, are a good feature. Like also your use of "ordinary" type as headlines, etc. — very attractive (looks much better than one would expect!).

Also liked Jan. 25 cover—color is used artistically. Appreciate your international authorship—and errors seem to be decreasing.

NICHOLAS BODLEY

Castleton, New York

### Bombers and Radar

The editorial in the Jan. 11 issue, *We Need Bombers Too* (p 3), comments unfavorably on the statements of Mr. Harold Brown, Director of Defense Research and Engineering, regarding radar and mach-3 planes.

My personal experience with a number of systems involving military radar units supports Mr. Brown's comments. Problems of maintainability, reliability, and operational capability are inherent in most of the designs. The majority of radar equipment presently supplied is inferior in reliability and mean-time-to-failure of other equally complex electronics equipment such as computers and communications equipment.

The statement that as a result of Mr. Brown's attitude, "state-of-the-art progress grinds to a halt" is, I believe, in error. The proper rebuttal to Mr. Brown's remarks will be in the form of an all-solid-state radar meeting the mach-3 and higher requirements, with maintainability and reliability numbers comparable to those of other electronic devices of like complexity.

Let us consider comments such as these as a challenge to the industry and the engineering profession, rather than an edict to stop progress.

One last comment: none of the 3,200 V-2 rockets fired at England had an atomic warhead, and I doubt if England could have survived a bombardment of even one percent of that total if today's warheads had been used.

R. W. TACKETT

Wayne, Michigan

We, too, feel that the proper reaction to the pessimism of Dr. Brown (PhD in nuclear physics, not electronics) in regard to radar for a mach-3 plane, should be a desire to prove he is wrong.

The fact that V-2 rockets fired at England did not carry atomic warheads, was precisely the point we were trying to make. They carried conventional warheads, and therefore caused little damage. For this reason we find Defense Secretary McNamara's suggestion that ICBMs might carry conventional warheads all the more surprising.

### Snap-Off Diodes

Referring to my article, *Improving Pulse Rise Time With Snap-Off Diodes* (p 68, Feb. 15):

The caption for Fig. 5 should read: "Switching circuit signal waveforms obtained by the use of strobing pulses from one (A), two (B) and three (C) charge-storage diodes are shown at 0.2 nsec per division."

On p 69, column 4, 4th line from bottom, Fig. 4 should read as Fig. 5.

K. C. HU

David Sarnoff Research Center  
Radio Corporation of America  
Princeton, New Jersey



HERE'S AN INDICATOR TUBE THAT'S HIGHLY RELIABLE AS WELL AS ECONOMICAL

TUNG-SOL 6977  
SUBMINIATURE INDICATOR TUBE

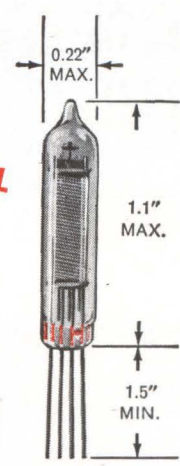

The Tung-Sol 6977 is a filamentary, high-vacuum, subminiature indicator with a fluorescent anode. It operates with AC or DC current, direct or parallel supply, and is designed for mounting flat on printed circuit boards behind display panels.

The 6977, now available in volume quantities, meets the high reliability requirements of specification MIL-E-1/1466A (EL). Electrical, environmental and life-test procedures insure that the Tung-Sol 6977 will perform reliably despite shock, vibration and critical life requirements. Computer, business machine, instrumentation and control equipment manufacturers can confidently place this tube on their own "qualified" products list. The Tung-Sol 6977 also provides true operating economy. Its high input impedance, low B+ feature and small signal requirements make it adaptable for transistor circuits. Power drain is exceptionally low. A single 6977 requires less than 1/4 square inch of panel display space. Mounted in multi-tube arrays on printed circuit boards, 40 tubes can be packed into 10 square inches of panel display space.

For further details on operating characteristics and specifications, and for information on indicating circuit configurations, consult Tung-Sol Electric Inc., Newark 4, New Jersey. TWX: 201-621-7977.

TYPICAL OPERATION	
Heater Voltage AC	1.0 volt
Heater Current	30 mA
Anode Voltage DC	50 volts
Grid Resistance	100,000 ohms
Grid Supply Voltage	
-for max. light output	0 volt
-at zero light output	-3 volts
Anode Current	
-for max. light output	585 $\mu$ A
-at zero light output	5 $\mu$ A max.

Technical assistance is available through: Atlanta, Ga.; Columbus, Ohio; Culver City, Calif.; Dallas, Tex.; Denver, Colo.; Detroit, Mich.; Melrose Park, Ill.; Newark, N. J.; Seattle, Wash. In Canada: Abbey Electronics, Toronto, Ont.





Some . . .



like it hot!

Go as high as you want and as hot as 1200° F. and our STRATOTHERM\* terminals and splices perform with utmost reliability . . . all the way! In a vapor-trailed jet at 35,000 feet or a cherry-nosed missile braked by earth's atmosphere, STRATOTHERM brand products easily ride out vibration, corrosion, heat, cold and other extremes that go with pushing beyond sound or into space.

You can choose from three basic, temperature-oriented types: uninsulated (650° F. or 1200° F.), pre-insulated (550°F.) and post-insulated (500° F.). Splices (sealed or unsealed) for single or multiple wire applications. Caps for pigtail splices and spare wire caps . . . all part of the largest line of high-temperature, high-altitude connection devices available anywhere.

Quite by design, our STRATOTHERM terminal and splice line offers many other advantages including:

- choice of plating predicated on temperature requirements
- color coding of sleeve or crimping rings
- precision controlled crimping with matching A-MP\* tools—hand or automatic
- wire size range—AWG 26-2/0
- TEFLON® insulation used throughout

There's more to tell; all of it convincing, if your needs are in high-temperature, high-altitude connections. So, send now for complete information on AMP STRATOTHERM terminals and splices.

\*Trademark of AMP INCORPORATED.

TEFLON® Trademark of E. I. Du Pont



AMP products and engineering assistance are available through subsidiary companies in: Australia • Canada • England • France • Holland • Italy • Japan • Mexico • West Germany

# Fifth Layer May Limit Anti-ICBM Radar

**PREVIOUSLY UNKNOWN** ionospheric layer may exist 330 miles above the earth, restricting the useful power of missile-detecting radars, says Richard C. Beitz of Cornell Aeronautical Laboratory.

Beitz in an IEEE paper, said that during investigation of the ionosphere with the CAL 48-Mw, 2,850-Mc, pulse radar, distinct returns were received from this layer. Odds are 400 to 1 against the returns being random noise, he said. The layer would be the fifth in the ionosphere, above the F-layers.

Beitz pointed out that anti-missile radar noise limits are set by energy backscatter from the target region. If a missile, particularly a small missile, flew in and around this new layer, backscatter could conceal it. Increasing radar power would not improve detection, just as more powerful auto headlights do not give better vision in fog.

Beitz said the layer is apparently a cloud of electrons about 10 miles thick with other dimensions unknown. How many clouds there are, their exact composition and orbit paths are not known.

In recent months, the Alouette sounding satellite has indicated that something does exist around this altitude but nothing could be seen with conventional radars. Beitz said these lack sufficient transmitter power and the computer integration systems CAL employed to detect the clouds. There is no evidence that the clouds are the result of high-altitude nuclear shots.

## Bill Would Protect Employee-Inventors

BILL HAS BEEN introduced in the House of Representatives by Rep. George E. Brown Jr. that would outlaw agreements giving employers the patent rights to their employees' inventions when such agreements are a condition of employment.

Sponsor is the Council of Engineers and Scientists Organizations—West, which says it represents over 20,000 engineers and scientists primarily employed in the California aerospace industry. The Council said: rights of employee-inventors were ignored in hearings just completed in the Senate on government ownership of patents (p 12, March 29, and p 12, March 15).

## Ionospheric Sounder May Detect Nuclear Debris

SAN FRANCISCO — Granger Associates has just completed operational tests of ionospheric sounding equipment to determine its utility in improving efficiency and reliability of h-f communications.

Tests were conducted with the AF along a 2,000-mile transmission path from Elmendorf Field, Alaska, to McClellan Field, Calif. The system gives a crt display of distortion and time delay of transmitted pulses. Pulses at up to 120 different frequencies between 4 and 32 Mc are transmitted. Granger says the tests furnished operators with data on the highest and lowest usable frequencies, as well as multi-path distortion at all times.

The equipment is being suggested in some circles as an effective means of detecting nuclear

## Adaptive Trainer

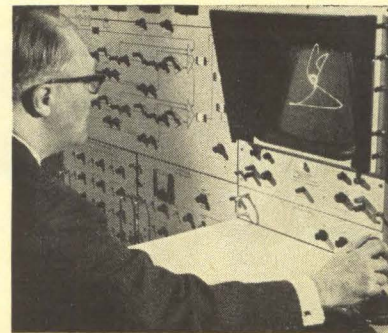

**TRACKING SIMULATOR** that adapts to the efficiency level of the trainee uses an analog computer with servo feedbacks to measure and control six flight characteristics. Servos feed error signals back into the computer to cope with trainee's changing proficiency. Otis Elevator says training time is cut 250 percent

debris in the ionosphere, since high altitude particles caused by nuclear blasts might distort or delay transmitted impulses. Granger, however, would not comment on this.

## 100-mw Gas Laser Output At 6,328 A Is Reported

GAS LASER that produces more than 100 mw of c-w power at 6,328 A and a method for mechanically tuning gas lasers have been developed by Spectra-Physics scientists.

## Attendance Down at IEEE Show

ATTENDANCE at last week's IEEE Show dropped to 70,432 from last year's IRE Show total of 73,400, the IEEE said.

Donald G. Fink, IEEE general manager, replied, "Your guess is as good as mine," when asked for a reason for the decline. He guessed that tighter government restrictions on expense-account spending—by Internal Revenue Service and DOD—were partly responsible.

"But it's silly to get in a numbers race," he said. "The main thing is the convention doing the job it's intended to do?" Judging by the comments of many exhibitors, who praised the quality of attendance, "this is the most effective convention we've had yet," Fink said

The 100-mw laser, constructed by Earl Bell, is four times more powerful than any gas laser previously reported, Spectra-Physics said. It is 3 meters long and 15 mm in diameter. An internal confocal mirror resonator is used. Firm says it may eventually give several watts.

Arnold Bloom reports suppressing the dominance of the 6,328-A transition in a gas laser over other population inversions between 3s<sub>2</sub> and 2p levels by incorporating a fused quartz prism into the laser resonator cavity. Visible lines were observed at 6,403, 6,293 and 6,118 Å. The latter is the shortest wavelength gas laser transition to date, it was reported. The various laser outputs were made visible by mechanical adjustment of a mirror.

## Spectrum Display Spots Tv, F-M Troubles

CHICAGO — Spectrum display for spotting spurious radiations and other troubles was described by Granville Klink of WTOP, Washington, D. C., Monday at opening session of Broadcast Engineering Conference here. Monitor displays f-m and vhf-tv spectrum in segments—from 50 Kc to 2 Mc—on a 5-inch screen calibrated horizontally in frequency deviation and vertically in db.

In another paper, Robert Morris of ABC said that government radio reference signals permit low-cost broadcast of split screen or montage pictures from several widespread sources without pulling or flipovers. Canal Zone 18 Kc vlf-station NBA has sufficient power for remote point synchronization over most of the country, he said.

ABC experimental setup, operating in the nanosecond range, calibrates the NBA signal against the locally available sync signal, figures out the difference, and corrects to the standard set up by the mixing point.

## NAB Challenges FCC On Loud Commercials

NAB OBJECTED last week to the FCC's probe into overly loud radio and tv commercials (p 18, Jan. 18).

It said loudness is apparently a "subjective and psychological" phenomena which lies outside FCC jurisdiction. However, commercials are sometimes louder than the adjoining program material, NAB said. Producers of commercials, it explained, often strive for a "brilliant" sound.

## Wireless Transmission Of Power Improved

WIRELESS TRANSMISSION of power (p 7, July 6, 1962) has been increased to 70 percent efficiency, said Profs. R. H. George and E. M. Sabbagh, of Purdue University at the IEEE Convention.

They said they transmit power in a sharp beam of microwaves and convert it into d-c at the receiver. Special semiconductor diodes, they believe, will achieve efficiencies over 90 percent and increased power. They have produced up to 40 w with their present model.

## Refractometer to Give Microwave Index

BEDFORD, MASS.—Light, inexpensive refractometer to be flown on conventional weather balloons is under development at AF Cambridge Research Labs to provide continuous profile of microwave index of refraction for radar tracking of missiles and rockets during launch. Instrument will consist of dual microwave cavity, one end open to the air and the other sealed but connected to exposed cavity. Proposed 5-inch model will operate at about 1 Gc.

## British Setting Up Exhibit in Red China

HONGKONG—British sources here say that negotiations are now going on for a British exhibition of scientific instruments and associated equipment in Peking at the end of this year. It will be the first of four trade fairs to be held in Communist China by British manufacturers. The fairs follow a request by the Chinese Communist government trade organization to the Sino-British Trade Council.

## In Brief . . .

MOSCOW SAYS the Soviet Mars probe, launched last November, is expected to "rendezvous" with the planet June 19. Vehicle will have traveled 500 million kilometers by then.

JAPAN PLACED restrictions on production of two-transistor radios April 1.

R&D CONTRACT for gas discharge ion rocket space propulsion system was awarded Electro-Optical Systems, Inc. by NASA.

PURCHASE of Auto Data, Inc. was announced by Houston Instrument.

HONG KONG'S trade in electronic instruments last year hit \$25.5 million (in U.S. dollars).

AMERICAN engineering schools can use three times as many graduate fellowships as are now available, according to Engineers Joint Council survey.

TELSTAR II, now scheduled for launch early in May, will be put into an elliptical orbit of 500 to 6,000 miles to help protect it from radiation (p 30, Jan. 11).

HIGH-PRICED microwave tubes would be leased, instead of sold, to the government under a plan proposed by Warnecke.

NASA GAVE Lear Siegler three contracts totaling \$6,577,000 for electronic systems at Marshall Space Flight Center.

ARMED FORCES DAY military-amateur radio communications program will be held May 18.

DIXSON PRODUCTS and General Meters, Inc. will merge.

FAA ORDERED 8 more bright-display systems from Raytheon for \$3.4 million. This makes 68 it has bought from Raytheon at a total cost of \$18.5 million.

LIBRARY OF CONGRESS has opened a referral center for science and technology.



**SPRAGUE HYREL® ST  
SOLID TANTALUM CAPACITORS  
Meet Minuteman Goal April, 1962**

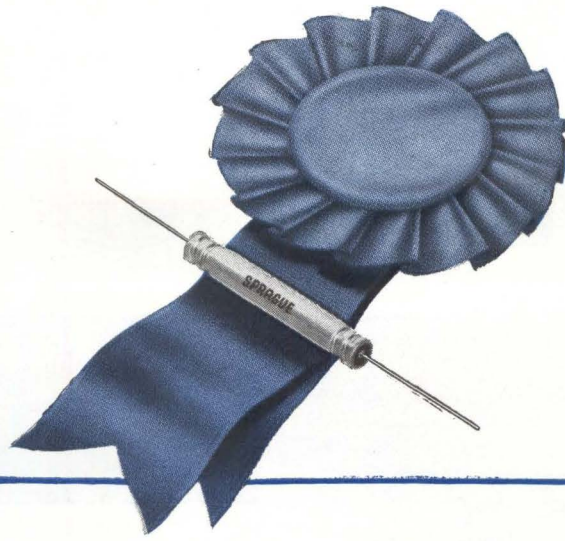

**...AND NOW HYREL® FT  
FOIL TANTALUM CAPACITORS  
NOVEMBER, 1962**

# SPRAGUE HYREL® FT FOIL TANTALUM CAPACITORS SURPASS MINUTEMAN PROJECT GOAL!

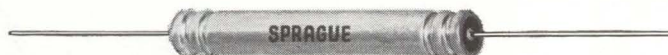

**SPRAGUE successfully meets 2nd of two Minuteman targets,  
having previously achieved solid tantalum capacitor goal**

**Failure Rate Goal of .001%/1000 hrs.\*  
has been bettered by wide margin!**

Sprague HYREL FT Foil Tantalum Capacitors have exceeded Minuteman's component development objective, attaining a use condition failure rate of .00045% per 1000 hours in recently completed tests. Sprague's qualification to the Minuteman Foil Tantalum Capacitor Specification, like its earlier qualification to the Minuteman Solid Tantalum Capacitor Specification, is unrestricted and "across-the-board."

Backing this performance is Sprague's record of pioneering in highly reliable capacitors, which earned the opportunity to

participate in the Air Force's Minuteman Component Development Program at Autonetics, a division of North American Aviation, Inc.

All of the special processes and quality control procedures that make HYREL FT Foil Tantalum Capacitors so reliable can now help improve the dependability of your military and aerospace electronic equipment. A tantalum capacitor engineer will be glad to discuss the application of these capacitors to your projects. For engineering assistance without obligation, write to Mr. C. G. Killen, Vice-President, Industrial and Military Sales, Sprague Electric Company, 35 Marshall Street, North Adams, Massachusetts.

\*at 60% confidence level by accelerated qualification tests.

## SPRAGUE COMPONENTS

CAPACITORS

TRANSISTORS

MAGNETIC COMPONENTS

RESISTORS

MICROCIRCUITS

INTERFERENCE FILTERS

PULSE TRANSFORMERS

PIEZOELECTRIC CERAMICS

PULSE-FORMING NETWORKS

TOROIDAL INDUCTORS

HIGH TEMPERATURE MAGNET WIRE

CERAMIC-BASE PRINTED NETWORKS

PACKAGED COMPONENT ASSEMBLIES

FUNCTIONAL DIGITAL CIRCUITS

ELECTRIC WAVE FILTERS

**SPRAGUE®**  
THE MARK OF RELIABILITY

'Sprague' and '®' are registered trademarks of the Sprague Electric Co.

# NEW!



# volt-pac<sup>®</sup>

## DOLLAR SAVINGS—

19 Basic Single-core Ratings  
Wider Selection  
Industry's Most Complete Line

## LONGER LIFE—

30-100% Greater Overload Capability

## SPACE SAVINGS—

Up to 33% Greater Over-all Capacity  
in Same Physical Size

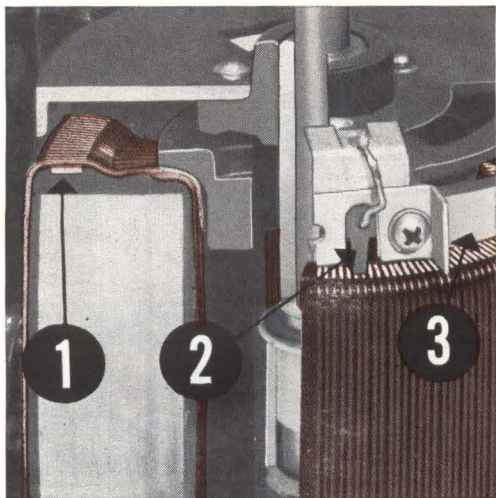

You benefit three big ways with General Electric's new *volt-pac* variable transformer line.

**First**, G.E.'s wider selection offers big dollar savings. You can choose from nineteen basic G-E 120- and 240-volt, single-core ratings—more than ever before—to more precisely meet your applications. By making smaller jumps between ratings, you save the difference in dollars. And G.E.'s 2-65 amp single-core current range, 15 amps more than previously available, means one *volt-pac* unit can replace two stacked units in these higher ratings. You lower costs and space requirements too!

**Second**, you get longer life—the result of three exclusive *volt-pac* features. G.E.'s **1** new unique heat-sink ring\* located beneath the gold-plated brush track quickly dissipates heat from the hot spot. The **2** solid-carbon, grain-oriented brush and the **3** quick-transfer current collector\* provide more reliable operation. Total effect: up to 100% greater overload capability than previously available.

**Third**, you get up to 33% more over-all capacity in existing core sizes. And in the popular sizes through 10 amps, G-E units are directly interchangeable with your present mounting arrangements.

\* Patent Pending

# *variable transformers*

Actual Size  
10.0 Amperes

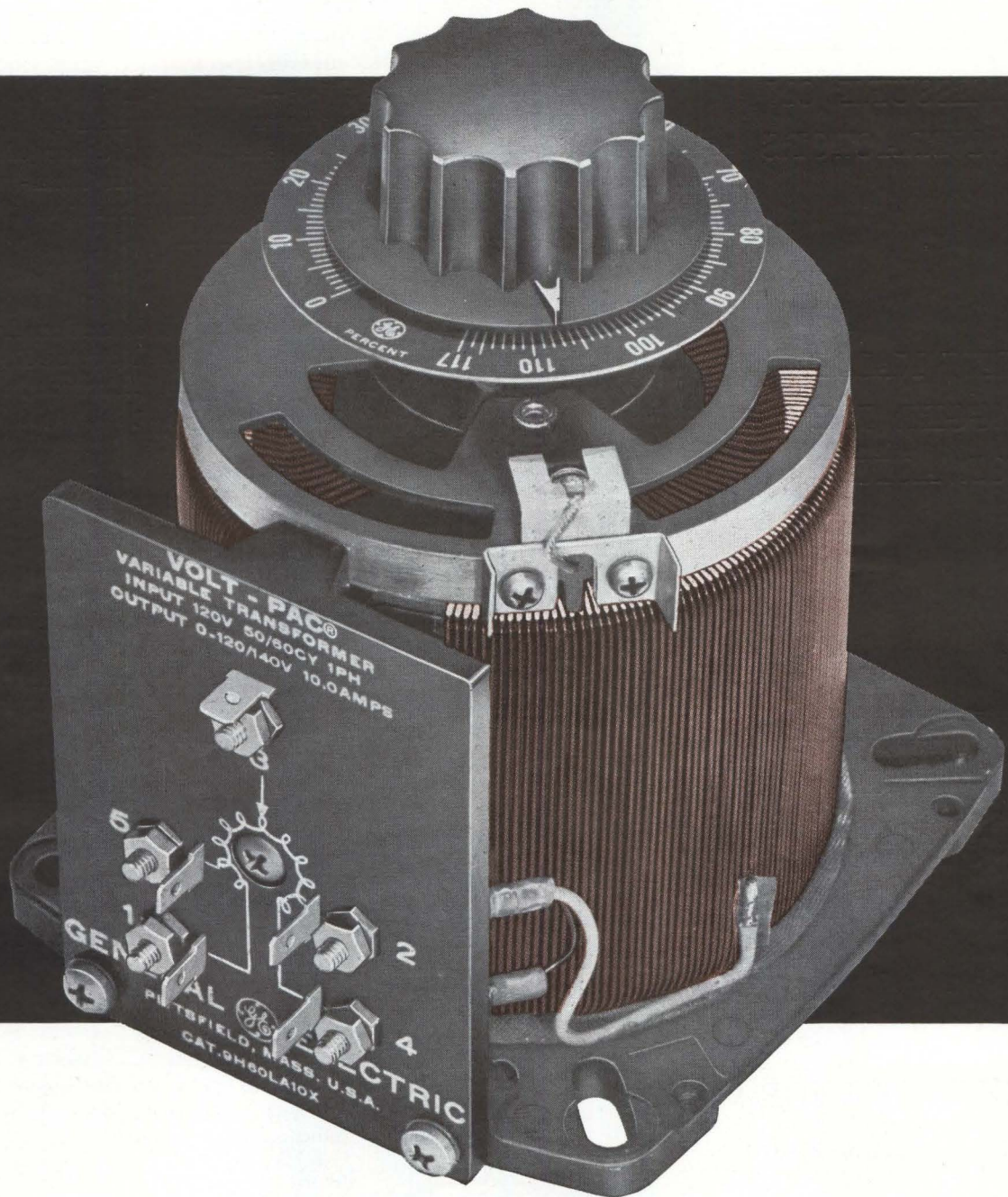

---

For the full story on General Electric's manual and motor-operated *volt-pac* lines, and the automatic line with solid-state SCR control, see your G-E Sales Engineer or authorized G-E Electronics Distributor. Or write for your free copy of Bulletin GEA-7751 to Section B458-01, General Electric Company, Schenectady 5, New York.

---

*Progress Is Our Most Important Product*

GENERAL  ELECTRIC

CIRCLE 11 ON READER SERVICE CARD

# WASHINGTON THIS WEEK

## NASA TO PUT PRESSURE ON CONTRACTORS

SPACE CONTRACTORS can expect tighter contract monitoring by NASA, reports Administrator James E. Webb. Emphasis on maintaining cost and performance schedules will be increased. One reason is to insure that all elements of the manned lunar program mate for a moon landing around 1967-69—hopefully ahead of the Soviets.

Also, Congress is taking closer looks at NASA's budget and space program management. Webb defends every dollar of the \$5.7-billion budget for fiscal 1964 as essential to meet the lunar-landing goals. He doesn't want Congress finding loose management to criticize—such as occurred in the Centaur rocket program.

## NEW NAME, BIGGER JOB FOR ASTIA

ASTIA, the Armed Services Technical Information Agency, has been reorganized and renamed by the Pentagon. Now the Defense Documentation Center for Scientific and Technical Information (DDC), it will be a clearing house on defense research efforts and absorb the functions of other military document centers. Aim is to get classified documents more quickly to eligible contractors, set up technical report quality standards, and press the military services to enforce contractor obligations to submit technical reports.

## BIOMEDICAL COMPUTER GROUP FORMED

CORNERSTONE of a growing program to develop versatile desk-sized computers for biomedical sciences is laid by a new NASA-Public Health Service contract to an MIT group from Lincoln Lab. A team of life and electronic scientists will be developed to build, use and evaluate the Linc computer (ELECTRONICS, p 8, Jan. 18) as a plug-in tool for lab experiments. Linc (Laboratory Instrument Computer) is designed for real-time readout, and feedback of experimental data into the experiments.

Later, the team is expected to expand work on faster, versatile laboratory computers. They will also become the core of a New England-wide center of life/electronic science competence where Linc-type computer technology will be expanded and information handling for life sciences considered.

## FORECAST FOR THE YEAR 2,000

LONG LOOK into the future, published by Resources for the Future, Inc., after five years of research, sees costly electronic equipment getting an even bigger share of defense spending, due to multiplication of R&D, missile and space spending. A defense effort around \$220 billion annually is foreseen for the year 2,000, with R&D getting \$42 billion, and missiles and spacecraft about \$50 billion.

## NO FAVORS FOR COMPANIES IN DISTRESS AREAS

DEFENSE SECRETARY McNAMARA has reaffirmed that the administration will not use price differentials on procurement contracts to relieve economic distress. He told the House Appropriations Committee that Pentagon policy "is to procure what we need when we need it at the lowest cost to the government, quality and delivery schedules considered." Defense Department will continue to aid smaller firms and companies in areas with high unemployment by keeping them informed of contract opportunities and by encouraging more subcontracting by prime contractors.





CHECK YOUR PRODUCT LIST TO SEE HOW ALLEN-BRADLEY QUALITY

# Ferrites

CAN GIVE YOU A COMPETITIVE EDGE:

**SMALLER SIZE  
LIGHTER WEIGHT  
LOWER COST  
BETTER PERFORMANCE**

- Television
- Radio
- Missiles
- Hi-Fi Stereo
- Motors
- HF Fluorescent Lights
- Electronic Organs
- Automatic Machine Tools
- Telephone Systems
- Radar

APPLICATION	A-B FERRITE	PREFERRED CHARACTERISTICS
<b>TELEVISION, RADIO</b> Deflection Yokes	W-03 W-01	High permeability High resistivity
Flyback Transformers	W-04	Low losses, high $B_{max}$ , high permeability, high Curie temp
Convergence Cores	W-01	Low residual with large gap
R.F. Tuning Coil (fixed or permeability tuned)	R-02	Low losses. Temperature stable permeability, minimum hysteresis for permeability tuning
<b>TELEPHONE SYSTEMS</b> Interstage and Matching Transformers	W-03	High permeability, low losses
<b>H. F. FLUORESCENT LIGHTS</b> Loading Reactors	W-07	High flux density
Transformers	W-04	High permeability, low losses, high $B_{max}$
<b>ELECTRIC ORGANS AND HI-FI STEREO</b> Oscillator Inductors	W-03	High permeability, temperature stable, linear B vs H
Output Transformers	W-04	High permeability, high $B_{max}$ , low losses
<b>AUTOMATIC MACHINE TOOLS</b> Magnetic Amplifiers	R-03	Rectangular hysteresis loop, high $B_{max}$
Logic elements for high-power levels	R-03	Rectangular hysteresis loop, high $B_{max}$
Matching Transformers	W-04	High permeability, low losses, high $B_{max}$
<b>MOBILE POWER SUPPLIES</b> Static Inverters	R-03	Rectangular hysteresis loop, high $B_{max}$
<b>RADAR, MISSILES</b> Pulse Transformers	W-04 R-02 (for short pulses)	High pulse permeability, high $B_{max}$ , low losses
<b>PERMANENT MAGNETS</b> Segments for D.C. Motors and Generators. Holding Magnets, Bias Magnets, Clutch Drives	M-05C M-01 M-01C	Good mechanical strength, high energy factor, high coercive force

From the broad line of Allen-Bradley *quality* ferrites, more and more designers are finding they can obtain the exact characteristics to meet their specific needs. Allen-Bradley's precise quality control methods insure continuously uniform electrical and mechanical properties—and A-B has the facilities for supplying ferrites in quantity. Listed to the left are a number of areas in which A-B ferrites have helped the manufacturer to reduce the product size, weight, or cost, and frequently the performance has been improved. If you have problems along this line, please let our engineers work with you in solving them.



# ALLEN-BRADLEY

Quality Electronic Components

Allen-Bradley Co., 110 W. Greenfield Ave., Milwaukee 4, Wisconsin • In Canada: Allen Bradley Canada Ltd., Galt, Ontario

# These products are winning Cubic world leadership for reliable digital instruments

1. V-71 reed relay voltmeter w/automatic ranging and polarity; 2. S-71 system w/converter added; 3. VRO-70 combination voltmeter, ratiometer and ohmmeter; 4. V-70 reed relay voltmeter; 5. V-45 low cost voltmeter;

6. Typical data system; 7. VR-2100 voltmeter for rugged environments; 8. V-72 militarized voltmeter; 9. Special militarized voltmeter; 10. A-85 pre-amplifier; 11. V-51/C-1A voltmeter; 12. AC-45 AC-DC converter; 13. V-46A



Big things are happening at Cubic Corporation . . . new products . . . new plans . . . and a new field engineering and sales organization to serve you. Already, these changes are making themselves felt. A recent national survey of digital instrument buyers disclosed that Cubic is becoming the best-known and most highly respected name in the industry. The most important reasons for the growing prestige of Cubic are contained in the reliable digital instruments shown in the photo.

Cubic offers a full line of digital instruments, available in a wide range of sophistications, with dozens of options and accessories available to meet specific measurement problems. The Cubic line is designed for easy integration into flexible, multi-purpose systems. Write today for additional technical data. Cubic Corporation, Industrial Division, Dept. B-134, 9233 Balboa Avenue, San Diego 23, California.

low cost voltmeter w/automatic ranging and polarity; 14. 1010 DC amplifier; 15. Special scanner; 16. AC-85 AC-DC converter; 17. Special AC-DC system.

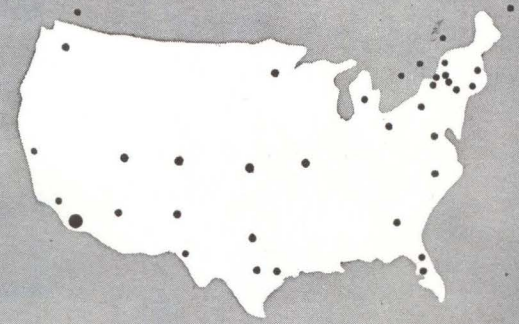
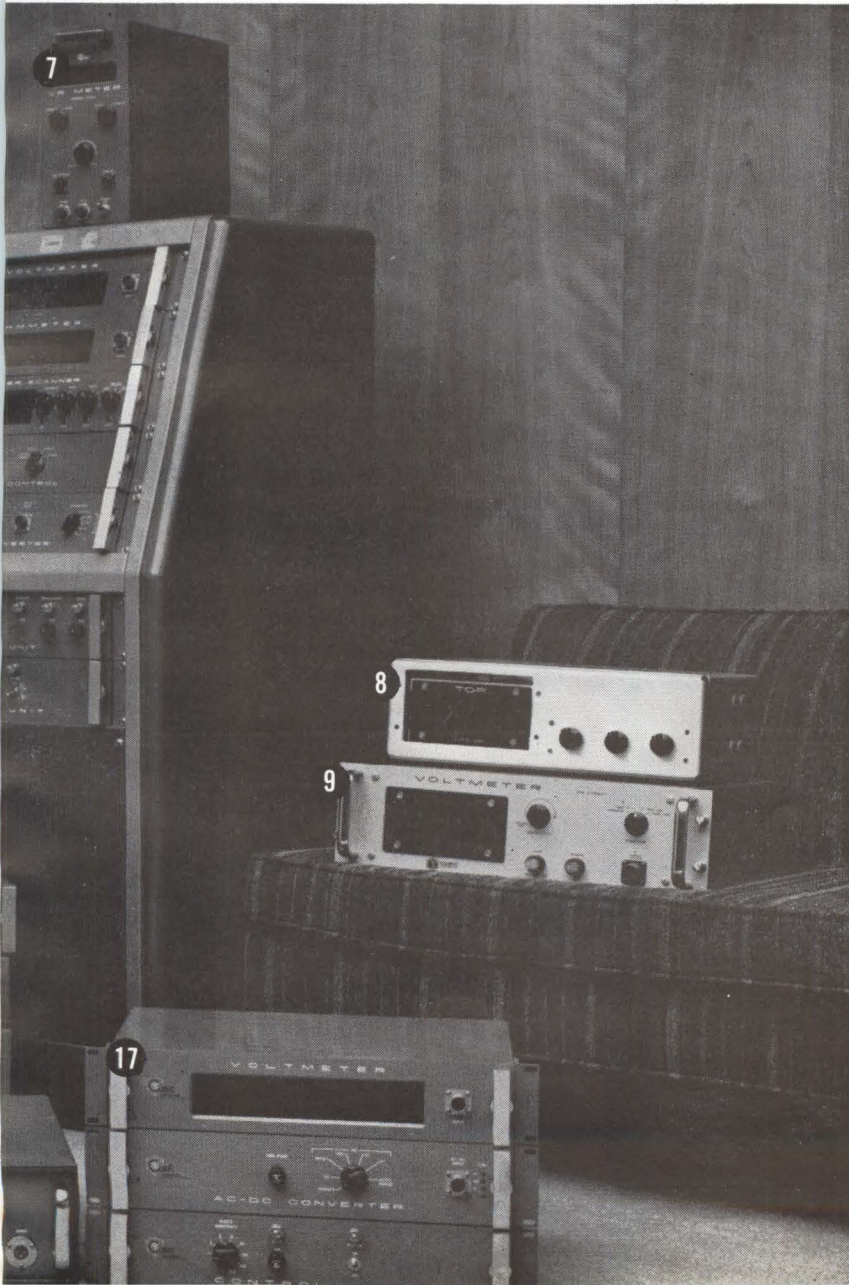

**THIS IS THE BRAND NEW CUBIC  
FIELD ENGINEERING AND SALES ORGANIZATION  
THAT WILL MEAN BETTER SERVICE FOR YOU**

**ARIZONA**  
R. A. MAYES CO.  
3431 N. 43rd St., Phoenix

**CALIFORNIA**  
CUBIC CORPORATION  
9047-J East Florence,  
Downey  
THE MAULDIN CO.  
P.O. Box 11336, Palo Alto

**COLORADO**  
AZTEC ENTERPRISES, INC.  
3385 S. Bannock,  
Englewood

**CONNECTICUT**  
GEORGE GREGORY ASSOC.  
9 S. Main, Cheshire

**FLORIDA**  
ECRA, INC.  
P.O. Box 8215,  
St. Petersburg  
P.O. Box 656, Maitland

**GEORGIA**  
ECRA, INC.  
P.O. Drawer 150, Decatur

**ILLINOIS**  
BARD ASSOCIATES, INC.  
La Grange Industrial Park  
Shawmut at Beach Ave.,  
La Grange

**KANSAS**  
HALGIN SALES  
5920 Nall, Mission

**MARYLAND**  
QED ELECTRONIC SALES,  
INC.  
933 Gist Ave.,  
Silver Spring

**MASSACHUSETTS**  
GEORGE GREGORY ASSOC.  
7 Erie Dr., Natick

**MICHIGAN**  
CARTER, MC CORMIC &  
PEIRCE, INC.  
16239 Wyoming, Detroit

**MINNESOTA**  
LIND ELECTRONICS CO.  
9781 Circle Pines Ave.,  
Circle Pines

**MISSOURI**  
HALGIN SALES  
201 S. Central, Clayton

**NEW MEXICO**  
R. A. MAYES CO.  
P.O. Box 11098-E,  
Albuquerque

**NEW YORK**  
NACO ELECTRONICS CORP.  
119 Luther Ave., Liverpool  
74 Park Ave., Rochester  
261 Genesee, Utica  
245 Main, Vestal  
704 Allen Rd., N. Syracuse  
QED ELECTRONIC SALES,  
INC.  
9 Elm Ave., Mt. Vernon

**NORTH CAROLINA**  
ECRA, INC.  
P.O. Box 627, Greensboro

**OHIO**  
WKM ASSOC.  
7710 Wainstead Dr.,  
Cleveland

**PENNSYLVANIA**  
QED ELECTRONIC SALES,  
INC.  
1418 Walnut, Philadelphia  
WKM ASSOC.  
207 Grandview Dr.,  
Canonsburg

**TEXAS**  
R. A. MAYES CO.  
6601-B Montana Avenue,  
El Paso  
N. Y. SCHOONMAKER CO.  
P.O. Box 35266, Dallas  
107 Winnetka, San Antonio  
P.O. Box 19502, Houston

**UTAH**  
AZTEC ENTERPRISES, INC.  
138 S. 2nd East,  
Salt Lake City

**WASHINGTON**  
TESTCO  
Boeing Field, Rm. 114,  
Seattle

**CANADA**  
ELECTRODESIGN, LTD.  
9124 St. Lawrence Blvd.,  
Montreal

**EUROPE**  
CUBIC EUROPA, S.p.A.  
Via Salaria 1259  
Settebagni  
Rome, Italy



**CUBIC  
CORPORATION**  
SAN DIEGO 23, CALIFORNIA  
**INDUSTRIAL DIVISION**

CIRCLE 15 ON READER SERVICE CARD

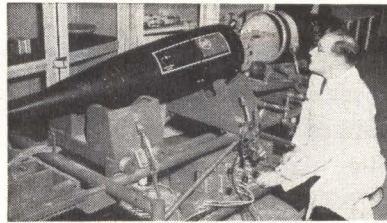
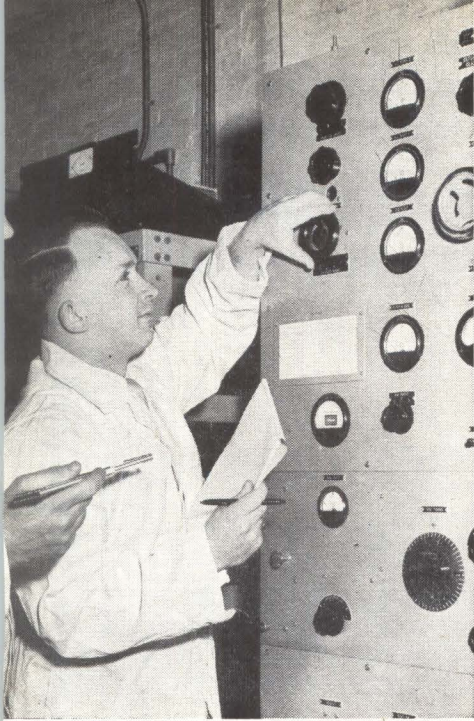

**LITTLE JOHN** missile warhead being prepared for r-f test by A. Grinoch, unit chief, Technical Services Lab

**SIGNAL CORPS BC-339-N transmitter**, shown here under adjustment, is one of two that cover short-wave range of hazards facility

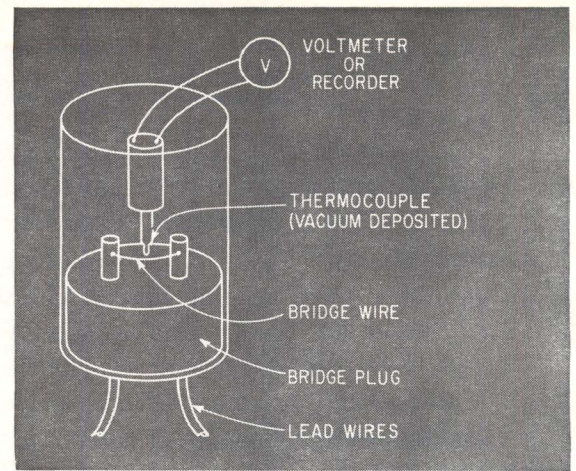

**R-F HAZARDS SENSORS** are a and a crystal video detector, right, caps, used in missiles both to

*Develops new techniques to keep warheads safe near strong transmitters*

By **GEORGE V. NOVOTNY**  
Associate Editor

**DOVER, N.J.** — AA2XV are the call letters assigned by FCC two weeks ago to a unique radio station authorized to operate on all frequencies from 100 Kc to 10 Gc.

Its task is to protect our missiles and ordnance items from being blown up accidentally by a burst of radiated r-f from a radar, communication, or command transmitter that has just the right frequency and field strength to actuate the warhead squibs.

Station AA2XV is part of a new installation being raised by Army's

Munitions Command at Picatinny Arsenal, to study the effects of radiated r-f on nuclear and conventional warheads, projectiles and other electrically triggered ordnance items.

The facility will base a continuing program to test all ordnance items as developed for susceptibility to r-f heating. Testing has started on warheads to develop standards for r-f environment tolerances at weapon sites.

Picatinny is also developing protective filters to keep harmful r-f radiation out of explosive squibs in ordnance items, and studying skin shielding techniques. Other protective measures may include coded actuating devices not susceptible to ordinary r-f.

**SIX TRANSMITTERS**—The wide frequency range will be covered by

six separate transmitters, with radiated power capability of 250 to 500 watts c-w and pulses over 1 Kw in the 350 Mc to 10 Gc range, and over 1 Kw in the lower ranges; there will be provisions for frequency sweep, modulation, and for vertical, horizontal or circular polarization. Field strengths at the site will range up to 100 volts/meter for the far-field tests.

**POWER SENSORS** — Warhead tests are conducted on specimens wired with sensitive ambient-temperature-compensated vacuum-deposited thermocouples, installed within 0.003 in. of the squib bridge wires.

Developed by the Naval Weapons Lab in Dahlgren, Va., these sensors can detect power levels of 200 microwatts in the bridge wires, without disturbing in any way the r-f integrity of the missile. Other r-f sensing devices are small crystal video detectors, which are more sensitive but have to be wired into the missile circuit.

Army spokesmen said Picatinny will conduct further development of more sensitive sensing devices, and testing techniques such as the use of modulated r-f to eliminate effects of noise and temperature variations.

**TEST FACILITIES**—When completed, the Army facility will have a large r-f anechoic chamber where smaller items can be tested without outside radiation. For low

### RADIATION AS A WEAPON?

Can r-f radiation be used to down enemy missiles, either as an offensive weapon or as a protective shield surrounding a large area?

Army won't say, and Picatinny is not working on this aspect of the problem for the time being. It appears that a lot of power is required for such action—too much, with available power sources, for mobile r-f antimissile projector units. An r-f shield protecting a country would be a mammoth project using the power of many Niagaras, and probably could not guarantee any results.

But all this may change as we learn more about what happens when r-f gets inside a missile, and as smaller and more powerful energy sources are developed

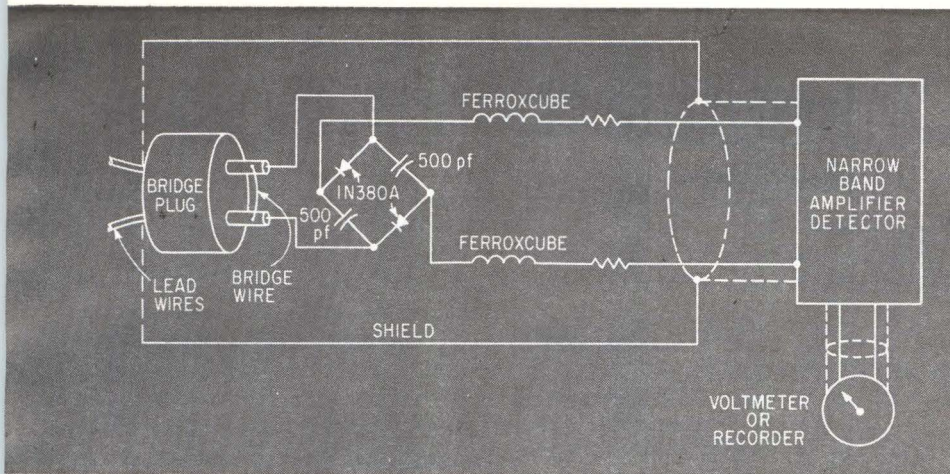

thermocouple detector, inserted in a squib but not touching bridge wire, left, connected in parallel with bridge wire. Squibs are d-c current-operated explosive detonate charges and as relays to operate switches

## Against Stray R-F

r-f frequencies, a cage is being developed in which low-frequency radiations will be simulated by generating alternate electric and magnetic fields perpendicular to each other at the correct intervals.

Although the other two services, as well as the AEC, are doing work

in this area, Army spokesmen indicated the Picatinny installation will be the largest and most complete of its kind. A conference on Hero (Hazards of Electromagnetic Radiation to Ordnance) techniques will be held in May at the Franklin Institute in Philadelphia.

## Electrostatic Film Erases

**TECHNIQUE** for producing dry-processed pictures in 0.1 to 0.01 sec by focusing a light image on an electrostatically charged photoconductive plastic film has been developed by General Electric.

Military applications—such as immediate display of radar images by a projector—will see first use of the technique, according to Joseph Gaynor of GE's Advance Technology Laboratory, inventor of the process. PPR may make pos-

TWO-INCH Section of picture that has been recorded twice on the same film. First image was erased

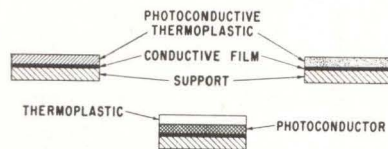
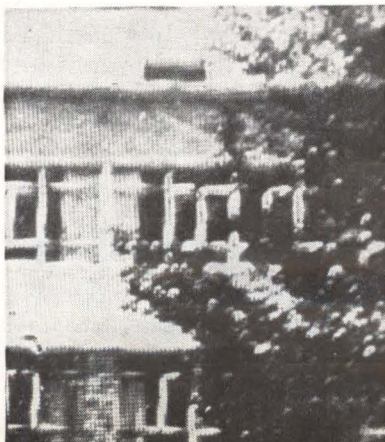

PHOTOPLASTIC layers of film may be transparent or opaque

sible "instant X-ray or even X-ray movies," Gaynor said.

PPR reportedly produces grainless pictures that can be developed and erased by heating the film. Up to 144 photos can be produced in a 2-inch square. The film is reusable, can be made either sensitive or insensitive to nuclear radiation, clear or opaque.

The charge on the photoconductive film is dissipated when light strikes it, but is retained under the dark portion of the image. After the film is softened by heating, microscopic depressions are formed in it by the electrostatic charges—conforming to the pattern of the image. The film is then cooled to seal in the depressions.

## WHAT ARE YOUR DELIVERY REQUIREMENTS?

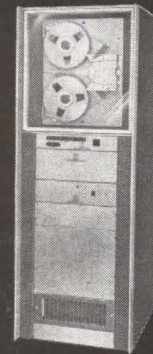

STANDARD TAPE TRANSPORTS  
**4 WEEKS**

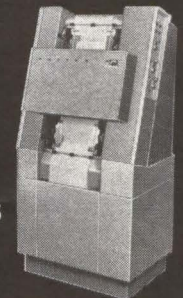

STANDARD PRINTERS  
**12 WEEKS**



NEW PRINTER DIVISION

Broad acceptance of our product line coupled with the fact that so many Potter "specials" are now industry standards has resulted in such dramatic growth that we have increased our plant and production capacity by more than 65%. This new production capability can directly benefit you through faster delivery.

For example, we can deliver our standard transports in 4 weeks, and standard printers in 12 weeks from receipt of order.

If you require fast delivery — with no sacrifice in performance or reliability, write us today.



POTTER INSTRUMENT CO., INC.

TAPE TRANSPORT DIVISION  
151 Sunnyside Boulevard • Plainview, New York

PRINTER DIVISION  
East Bethpage Road • Plainview, New York

# Wideband Communications Is Army

*Outcome of feasibility studies will determine big procurement program*

**WHAT IS EXPECTED** to develop into the Army's largest communications procurement depends on the outcome of the three one-year feasibility studies of the Rada system (Random Access and Discrete Address) awarded last month (ELECTRONICS, p 8, March 29). Rada may displace all other switched communications used in Army divisions.

The companies receiving contracts, each for almost \$2 million,

are Martin Marietta, Motorola and RCA. What Army wants is a wideband system in which many users would share a common band.

An Army source said Martin was selected on the basis of its work on Racep (Random Access and Correlation for Extended Performance). This system (ELECTRONICS, p 64, Oct. 26, 1962) handles up to 700 subscribers over a single 4-Mc channel and permits direct dialing. Voice and data transmissions can be handled simultaneously. Martin says that it will continue development of Racep and will also be working on other techniques.

An RCA spokesman this week declined to reveal information on the techniques RCA is considering,

stating that company and military clearance had not yet been obtained.

Motorola reports it has developed techniques that would permit thousands of talkers to use a single uhf-vhf channel. Delta modulation samples voice analog waveforms and converts them (see diagrams) into a train of 26- $\mu$ sec pulses, or to no pulse. A time-slot selector in the transmitter tags each bit with a discrete address. Every modulation pulse is transmitted by three or four bursts of carrier, 0.5  $\mu$ sec or longer. Changing the spacing between pulses and frequency selection of bursts offers several thousand different time-frequency-pattern addresses.

Address recognition precedes the demodulator in the receiver. Discrete addresses gate the preset time slots at the previously chosen frequencies, Henry Magnuski, Motorola's associate director of research, explained to ELECTRONICS. A counter monitors this operation.

Magnuski said the elimination of tuning and frequency control circuits means the wideband equipment would cost one-third or one-half as much as narrow-channel variable frequency equipment covering the same frequency spectrum. Integrated circuit techniques are especially suited to this type of digital operation, he added. Frequencies in the 150 to 450-Mc range

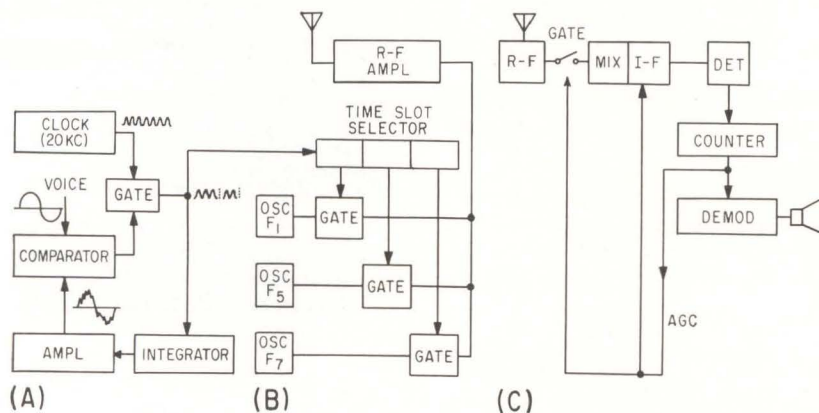

DELTA MODULATOR in Motorola concept (A) feeds coded voice to the transmitter (B). At right is the receiver (C)

## IEEE Show: Less Life, More Service

**NEW YORK**—Much of the razzle-dazzle of past IRE Shows was missing last week at the IEEE Show. The tone of this year's show was reflected in the lack of glamorous—as opposed to salable—equipment at the Coliseum.

Where visiting engineers used to see huge antennas rotating on pedestals, monkeys in space capsules and exhibitors dressed as

spacemen, only the pretty models reminded one of flashier shows.

On the other hand, the caliber of sales engineering rose. Exhibitors concentrated more on getting to know customer problems. The model was often supplanted—or replaced—by an engineer with a nomograph.

**MORE NEW PRODUCTS**—In addition to its new annular process transistors (ELECTRONICS, p 7, March 29), Motorola Semiconductor Products introduced a new silicon gate-controlled switch that can be turned on and off by pulses of op-

**WIDEBAND**, four-resonator, c-w klystron for space communications system. Toshiba tube puts out 3.5 Kw, has gain of 34 db and is tunable between 6,340 and 6,440 Mc

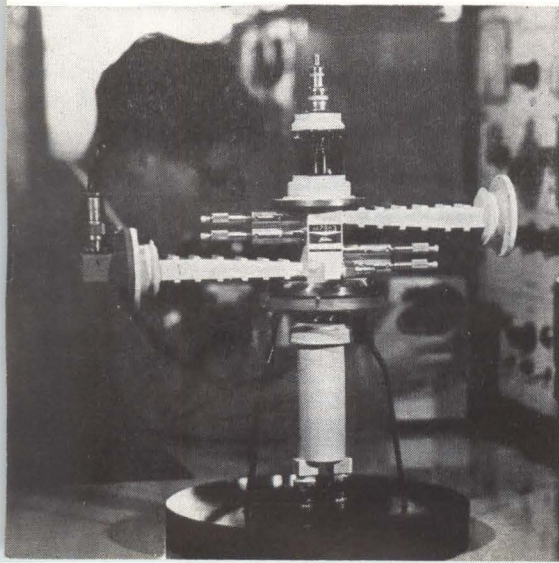

# Plan

would provide a wide spectrum, localize radiation and avoid skips. Motorola also sees as a likely civilian application mobile telephony at 700 to 900 Mc.

UNLIKE narrow-band systems (A), Motorola's assigns wideband channels (B). Sampled voice waveform (C) is converted to digital (D). Addressed r-f signal is shown in (E) and the time-frequency matrix in (F)

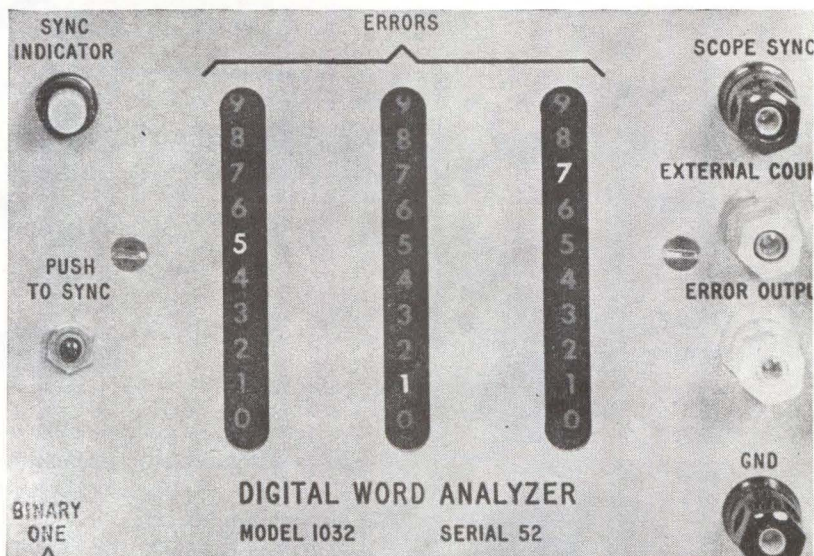
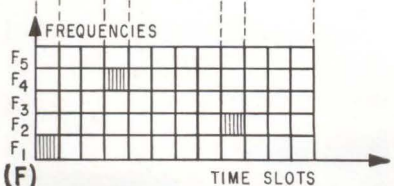
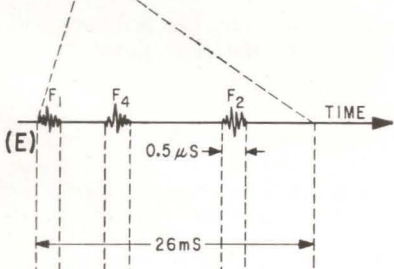
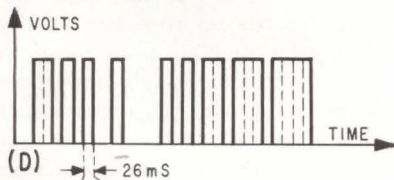
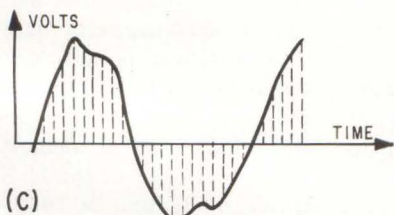
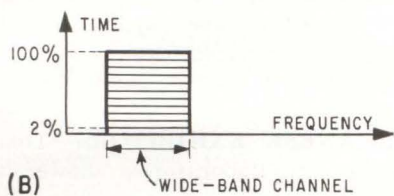
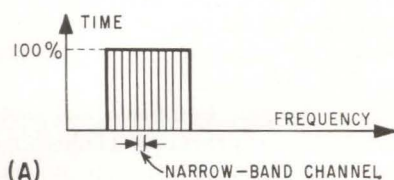

## For Sale: Machine Talk

Data transmission systems periodically require testing, trouble shooting, and evaluation, and two extremely valuable instruments for system checkout are Rixon's model 132 Digital Word Generator, and model 1032 Digital Word analyzer.

The Word Generator provides a repetitive digital word in length up to 32 bits for transmission through the system. The Word Analyzer at the receive location generates an identical word, comparing this with the received word. Discrepancies between these two words are totalized by a three digit error counter and visually displayed on the front panel of the analyzer. Other features?

- EIA input/output interfaces . . .
- line loop back unnecessary . . .
- word bit length to 32 bits . . .
- instant push button sync . . .
- compatible with data rates to 9600 bps . . .

For further information, contact our Marketing Department.

**RIXON ELECTRONICS, INC.**

2121 INDUSTRIAL PARKWAY—MONTGOMERY INDUSTRIAL PARK—SILVER SPRING, MARYLAND  
TELEPHONE: 622-2121 TWX: 301 622-2292

# VOLTAGE/CURRENT REFERENCE .001% STABILITY / .01% ACCURACY

- voltage mode: 0 to 100 V at 200 ma max.
- current mode: 0 to 100 ma at 100 V max.
- .0001% line and load regulation
- digital output selector, 5-decade resolution
- 3 full-scale ranges of 1, 10, and 100 volts/ma
- electronic chopper-stabilized amplifier
- temperature controlled and stabilized zener reference
- complete short circuit protection
- extremely low ripple and noise
- completely solid state
- price: \$1800.00

**PAR**

**PRINCETON APPLIED RESEARCH CORPORATION**

Box 565 / Princeton, N. J. / Tel: 799-1222, area code 609

Write for Bulletin No. 105

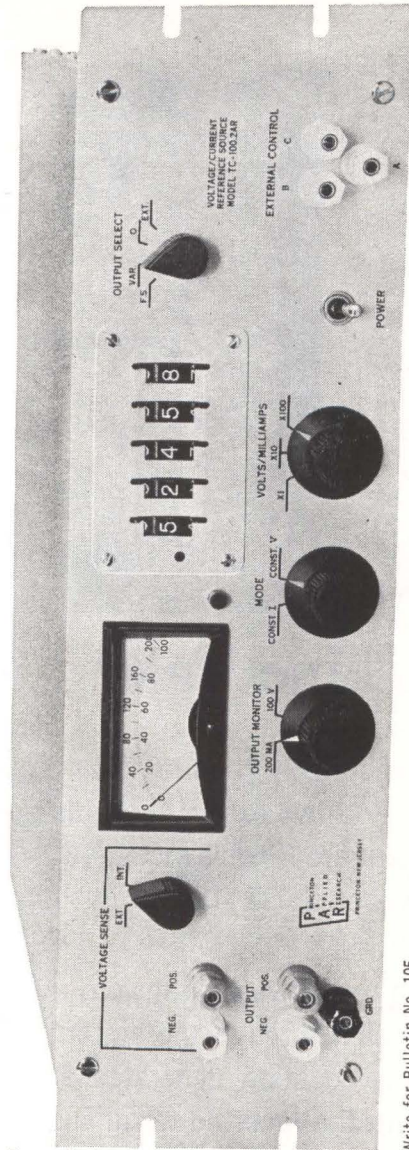

ULTRASONIC welder, by Sonobond, is combined with Kulicke & Soffa micropositioner. Dual settings allow two different combinations of metals to be welded

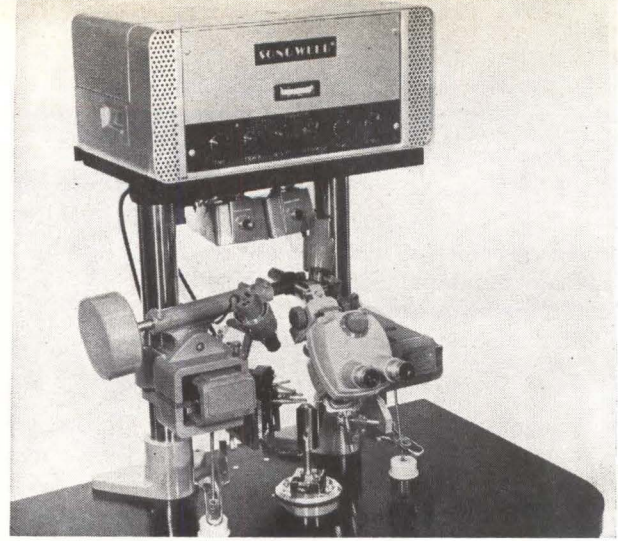

posite polarities. Another new one is an epitaxial-base germanium transistor for tv flyback circuits and similar applications.

A cuprous-chloride light modulator making possible low-power, high-frequency modulation of laser beams and a dysprosium-doped calcium-fluoride c-w laser crystal were displayed among RCA's electro-optical devices.

Allen-Bradley entered shift registers and matrix switch modules using reed switches, for industrial control applications.

**EQUIPMENT** — Pulse-generator module by Texas Instruments Incorporated has a rise and fall time adjustable from 20 to 500 nsec, pulse width from 40 nsec to 1 msec, and pulse delay from 90 nsec to 1 msec. Applications in computer design and semiconductor research are anticipated.

A complete dual-channel parametric amplifier subsystem, designed for troposcatter front ends, was shown by Airtron division of Litton Industries. Frequency is 4.4 to 5 Gc, system noise figure 3.5 db maximum, instantaneous bandwidth 25 Mc and gain 17 db min.

A solid-state printer that uses flux reversal of magnets to control cam hammers was shown by Monroe Calculating Machine. It operates on a four-line coded input, prints 1,040 lines a minute.

**PRODUCTION GEAR**—Universal Instruments had an axial-lead component sorter that also orients the parts and straightens leads. It automatically sorts capacitors, inductors, resistors and diodes according to impedance.

Several precision welders were shown. One, by Taylor-Winfield,

uses a two-stage electrode-force setup aimed at eliminating erratic results when copper lead wires are welded to nickel ribbon. Automatic prevention of excess force is also a feature of Sippican's welders.

In a Norton Company machine, thin steel reciprocating blades and fine abrasive slice through quartz, silicon, germanium and glass. Wafers produced are parallel within 0.0005 inch and kerf loss is as little as 0.006 inch, Norton says.

**JAPANESE EXHIBITORS**—Tokyo Radio Coil Laboratories showed a woven memory matrix, made up of insulated wire and wire coated with a thin layer of ferromagnetic material. Weave crossover points serve as memory elements. Readout speed is 80 msec, operating temperature up to 150 C. This kind of memory has also been developed in the U. S. (ELECTRONICS, p 59, June 29, 1962).

Toshiba's slow-speed tape recorder records up to 6 hours on a 5-inch tape reel at a speed of 1/8 inch per second. Sony's new video tape recorder uses standard 2-inch tape with an added layer of molybdenum that extends magnetic head life. New 5-lb tv camera, shown by Nippon Electric, has a 1-inch vidicon, can be battery operated.

**CITIZENS BAND 25 to 30-Mc receiver puts out 1 mw, has 1/2-mile range. Receiver is at right, 6-v power supply at left. Westinghouse Air Arm division built it with four standard integrated-circuit functional blocks**





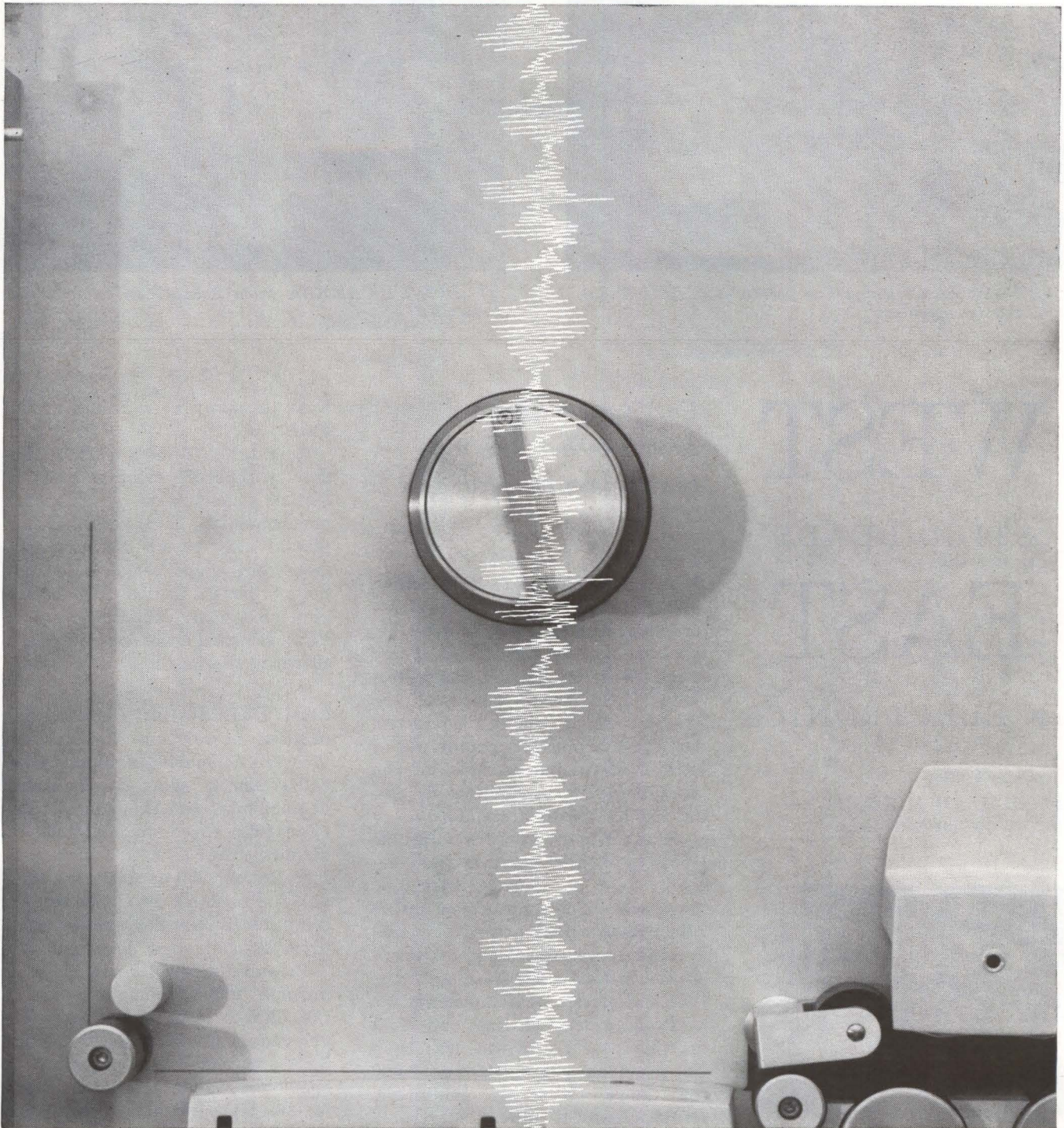

**Who has both: 1.5 Mc recorder and 1.5 Mc tape?**

**AMPEX**

We just don't like to leave things undone. Recently, our engineers developed the first 1.5 Mc per track, multi-track recorder—the FR-1400. Like every Ampex recorder, it gives you outstanding performance. We felt we had to develop a tape that equalled the FR-1400 in quality of performance. Hence: Ampex 9101—a 1.5 Mc tape. This new tape is a high resolution, heavy duty type with excellent wear characteristics. It offers high reliability

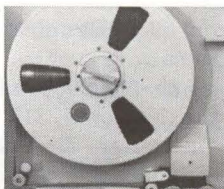

and superior performance. And can record 1.5 Mc of data at a speed of 120 ips. Ampex 9101 tape rounds out a recording system that gives you the highest frequency in longitudinal recording today. For more information write the only company providing recorders, tapes and memory devices for every application: Ampex Corp., 934 Charter St., Redwood City, Calif. Worldwide sales and service.

**AMPEX**

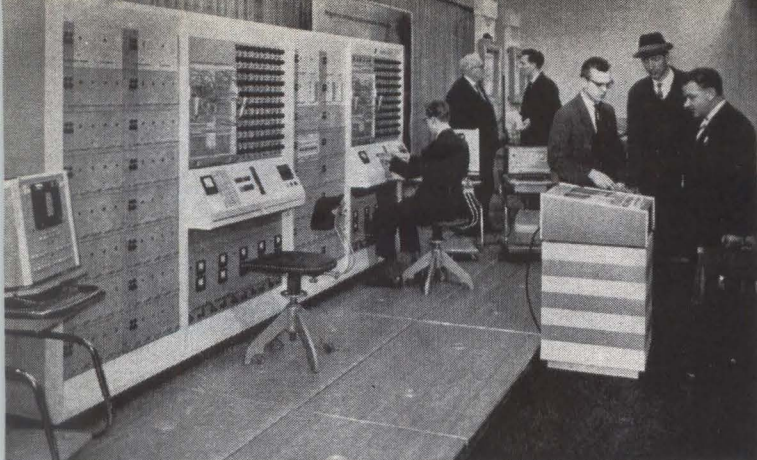

EAST GERMANY shows two parallel-connected Endim 2000 analog computers



STUDIO TV CAMERA from Poland can be remotely controlled

# WEST STILL LEADS EAST IN ELECTRONICS

By RICHARD MIKTON  
McGraw-Hill World News

*East's prototypes are advanced, but they are behind in gear produced*

BONN, GERMANY—East Bloc electronics manufacturers showcased a wide variety of new developments at the 1963 Spring Trade Fair in Leipzig, East Germany, last month. Some of the designs are surprisingly advanced, but these are mostly prototypes or still in development. Most of the equipment in production is outmoded by Western standards.

East Germany appears to lag the West by 5 to 10 years in the computer field, as do most East Bloc countries. The one exception is the USSR, whose new Ural model is said to be equivalent to recent Univacs. Nor is the East up to the West in electronic components.

Trading between East and West at this year's fair was less than in previous years. Of the 2,000 or more Western exhibitors, only a handful showed electronic equipment. The Westerners explained that although the East wants to buy, it is short on Western currency. Western firms are not enthusiastic about bartering computers for nails or minerals.

**EAST-WEST TRADE** — Several Western exhibitors displayed punched-card equipment. Only two British firms made significant sales. Elliot Automation reports a contract for some \$500,000 with Poland for the National 315. International Computer & Tabulator will sign a \$250,000 contract with

East Germany as a result of the Fair.

Remington Rand's Dutch subsidiary reported much interest in Univac computers by Eastern governments. This year, it displayed only punched-card equipment, but a spokesman said they hope to have a Univac 1004 on display next year. Machines Bull of Paris reported lower interest due to currency shortages.

**COMPUTERS**—East Germany has decided to rely on Russian and Western computing equipment because she is short of electronic components and know-how. Despite this, three models were on display: the ZRA-1, which performs about 250 operations a minute, the recently developed analog computer Endim 2000 and a small program-controlled desk model.

Poland displayed a new general-purpose digital computer, called the ZAM-2. It uses the Polish-developed symbolic address system SAS and the SAKO autocode to speed programming. Word length is 36 bits, working storage is 1,024 short words, with an average access time of 0.36 msec. An auxiliary magnetic-drum storage permits 16,384 long words to be stored. Average operating speed for addition and subtraction is 1000 operations/sec, for multiplication and division 260 operations/sec. The printer and other accessories come from Western suppliers, including Ferranti.

**AUTOMATION PLANS** — East Germany plans to increase electronics production by 360 percent between 1963 and 1970. Emphasis



WESTERN OBSERVERS were surprised by the quality of this East German line for automatically producing resistors. Three people run it



STANDARDIZATION of panels and components is new look in East German equipment



POLAND'S ZAM-2 digital computer is slow by Western standards

is being placed on standardizing components and their production in highly automated equipment.

Panels and related components on scientific and technical apparatus are now standardized. Conventional printed circuits, three-dimensional elements and micromodules are still in the prototype stage, but plans are to produce standard sizes automatically.

Typical of emphasis on automation was a new automatic line for the production of  $\frac{1}{2}$ -watt carbon-coated resistors at 2,500 an hour.

**TRANSISTORS** — East German progress in transistors is retarded by Western standards because of reliance on tubes. Mass-produced transistors now have a frequency limit of 100 Mc. Mesa types for up to 1 Gc are expected for laboratory use sometime in 1964. Power transistors up to 4 watts are now being produced. The first silicon transistors of the state-run Institute for Transistor Development were exhibited, but no production data was available.

**TV CAMERAS** — East German products included an 11-lb tv camera, an infrared vidicon and a new directional beacon set that permits transmission of 600 telephone calls or one tv signal including audio. The Poles showed a new series of tv studio cameras that can be remotely controlled, industrial tv systems, and a variety of other tv station gear.

In all, there were 9,000 exhibitors at the show. The bulk—about 6,000—were East German firms. Other East Bloc countries were represented by 250 trade missions.

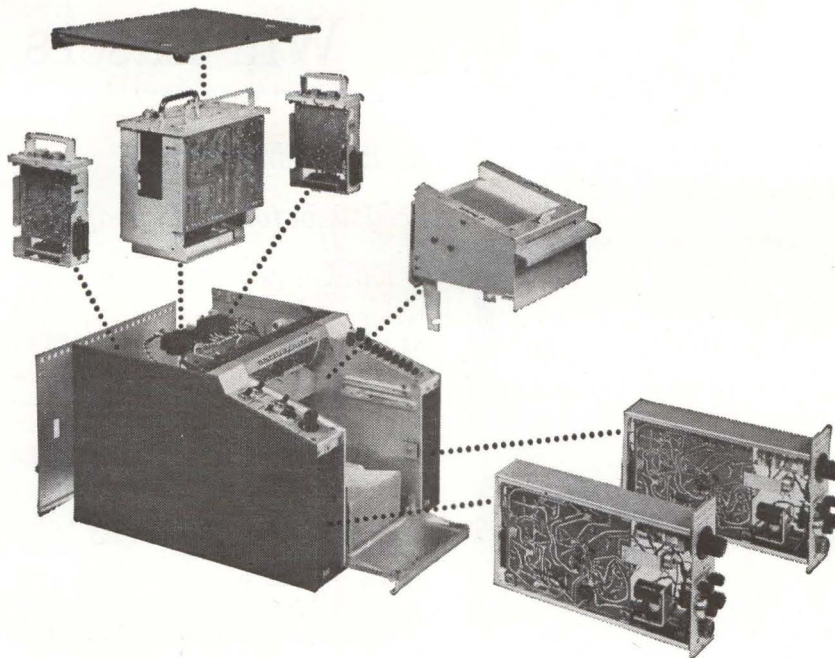

## All the features you want in a medium frequency recorder

The *oscillo/riter*\* recorder incorporates all the features you want for top performance, convenience and reliability. Modular construction and all transistorized electronics provide complete

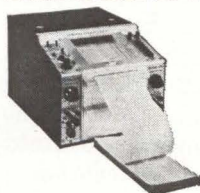

accessibility and maximum reliability; interchangeable

able amplifiers handle more recording jobs; extended frequency response; top panel push buttons select 8 chart speeds from 1 mm/sec to 250 mm/sec; choice of roll or Z-fold chart paper, interchangeable ink or heat writing with Texas Instruments exclusive rectilinear recording system. Write for full information.

\*A trademark of Texas Instruments Incorporated.

INDUSTRIAL  
PRODUCTS  
GROUP



**TEXAS INSTRUMENTS**  
INCORPORATED  
P. O. BOX 66027 HOUSTON 6, TEXAS

SENSING • RECORDING • TESTING • DIGITIZING INSTRUMENTS  
THE INSTRUMENTS OF TEXAS INSTRUMENTS

566

CIRCLE 23 ON READER SERVICE CARD

**HELP YOUR POST OFFICE  
TO SERVE YOU BETTER  
BY  
MAILING EARLY IN THE DAY  
NATIONWIDE IMPROVED MAIL SERVICE  
PROGRAM**

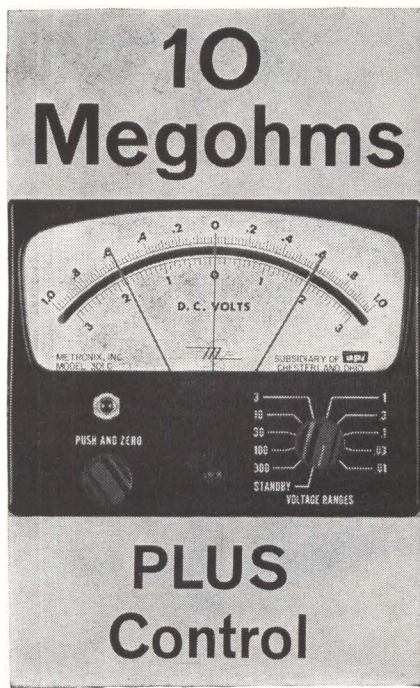

### An electronic voltmeter with a meter-relay

This happy combination makes an extremely versatile and acute instrument.

It has critical measuring ability that goes with high input impedance, in space-saving panel-mounting style.

It also has the reliable, simple control of a locking contact meter-relay, with adjustable set points.

Many difficult functions can be easily controlled: conductivity cells, life testing of components or systems, production testing and sorting, automatic Go-No Go of missile circuits.

### Ready When Needed

Metronix DC instruments such as Model 301-C-CMR (illustrated) have input resistances up to 10 megohms. AC input impedances go as high as 5 megohms. Like all Metronix panel-mounting electronic voltmeters (PMEV's), they are always connected—immediately available for continuous monitoring of critical parameters.

Send for data sheets describing Metronix PMEV's in single or multiple ranges, DC or AC, with either meter-relays or conventional indicating meters.



**METRONIX**  
The Electronic Instrument Division  
of Assembly Products, Inc.  
Chesterland, Ohio

Telephone: HAmilton 3-4440

## Will Lasers Settle Down?

*Brilliant engineering needed before "playboy" is workhorse, says panel*

**NEW YORK**—Although the era of unexpected breakthroughs in lasers is not yet over, the vital need now is for engineering—straight-forward, brilliant and interdisciplinary. This was the consensus of an IEEE panel discussion Tuesday night on "Optical Maser—Workhorse or Playboy?"

An effective combination of workers in electronics, quantum mechanics, optics and spectroscopy is needed for further development, said Charles H. Townes, MIT provost and panel moderator.

Robert H. Kingston, of MIT Lincoln Laboratory, reported that government supports about \$15 million of laser work a year, and industry \$5 million to \$10 million. Some 40 percent of the funding goes for devices and techniques, 25 percent for materials study, 20 percent for prototype applications, 10 percent for optical components and 5 percent to find new materials. He estimated 600 to 700 scientists and engineers are working in the field.

**NOT COMMUNICATIONS?**—Rudolph H. Kompfner, of Bell Telephone Laboratories, disagreed with claims that communications will be the laser's most important application, pointing out the atmospheric attenuation problem. But he said lasers could be useful in space and, if shielded by pipes, in earthbound applications. However, the laser can communicate in the plasma sheath while microwaves cannot. He indicated that efforts are being made to use lasers—even diodes operating in a noncoherent mode—for reentry communications.

"But it is really useless to talk about systems until component techniques are worked out," he added.

**PROCESSING AID**—Arthur L. Schawlow, of Stanford University,

thought that the laser's most important application ultimately will be probing and processing chemical reactions.

George F. Smith, of Hughes Laboratories, predicted that among other uses will be emission spectroscopy. He cited work at Jarrell-Ash Co., where Frederick Brech is identifying material traces down to  $10^{-11}$  gram.

Townes saw promise in seismography and meteorology. The surface of a parabolic antenna can be measured to one wavelength, "but in the present state of technology we don't know what to do with that degree of accuracy."

### See Hospitals Buying Patient-Monitor Devices

AVERAGE HOSPITAL operating room may soon require \$100,000 in patient-monitoring equipment, predicts John E. Jacobs, professor of electrical engineering at Northwestern. There are about 7,000 hospitals in the U.S. Jacobs also sees a potential market of \$1,000 per hospital bed for such devices.

### Tv Camera Unveiled



LOW-COST vidicon tv camera introduced by General Precision at this week's meeting of the National Association of Broadcasters in Chicago features 8-inch viewfinder and 6,000 to 1 automatic light compensation

## MEETINGS AHEAD

PROTECTIVE RELAY ENGINEERS CONFERENCE, A & M College of Texas; at Texas A & M, College Station, Texas, April 8-10.

ENGINEERING ASPECTS OF MAGNETO-HYDRODYNAMICS SYMPOSIUM, IEEE, IAS, University of California; Berkeley, Calif., April 10-11.

RADIATION DAMAGE TO SOLAR CELLS SYMPOSIUM, IEEE-PTGED; Statler-Hilton Hotel, Washington, D. C., April 10-11.

OPTICAL MASER SYMPOSIUM, Electrochemical Society; Penn Sheraton Hotel, Pittsburgh, Pa., April 15-16.

OHIO VALLEY INSTRUMENT-AUTOMATION SYMPOSIUM, ISA, et al; Cincinnati Gardens, Cincinnati, Ohio, April 16-17.

CLEVELAND ELECTRONICS CONFERENCE, IEEE, Case Institute, Western Reserve University, ISA; Hotel Sheraton, Cleveland, O., April 16-18.

OPTICAL MASERS SYMPOSIUM, IEEE, American Optical Society, Armed Services, et al; Waldorf Astoria Hotel, New York City, April 16-18.

INTERNATIONAL NONLINEAR MAGNETICS CONFERENCE, IEEE; Shoreham Hotel, Washington, D. C., April 17-19.

SOUTHWESTERN IEEE CONFERENCE & ELECTRONICS SHOW, IEEE (Region 5); Dallas Memorial Auditorium, Dallas, Texas, April 17-19.

BIO-MEDICAL ENGINEERING SYMPOSIUM, IEEE, et al; Del Webb's Ocean House, San Diego, Calif., April 22-24.

NATIONAL ELECTROMAGNETIC RELAY CONFERENCE; Oklahoma State University; OSU, Stillwater, Okla., April 23-25.

POWER INDUSTRY COMPUTER CONFERENCE, IEEE; Westward-Ho Hotel, Phoenix, Ariz., April 24-26.

WESTERN ELECTRONIC SHOW AND CONFERENCE, WEMA, IEEE; Cow Palace, San Francisco, Calif., Aug. 20-23.

### ADVANCE REPORT

NATIONAL SPACE ELECTRONICS SYMPOSIUM, IEEE-PTGSET; Hotel Fontainebleau, Miami Beach, Fla., Oct. 1-3. April 15 is deadline for submitting 500-word abstract to: Dr. H. Nelson Upthegrove, PGSET Technical Papers Chairman, Bell Telephone Laboratories, Whippany, N. J. Papers describing original investigations and developments in following areas are solicited: space communications; electronics and space environment; electronics for interplanetary missions; electronic aids for men in space; electronics in unmanned spacecraft; electronics for command guidance and control.

Pulsed amplifier klystrons, with a history of reliable long life performance in early warning systems, are part of the extensive line of Litton microwave tubes and display devices. San Carlos, California. Europe: Box 110, Zurich 50, Switzerland.

**LITTON INDUSTRIES**  
ELECTRON TUBE DIVISION

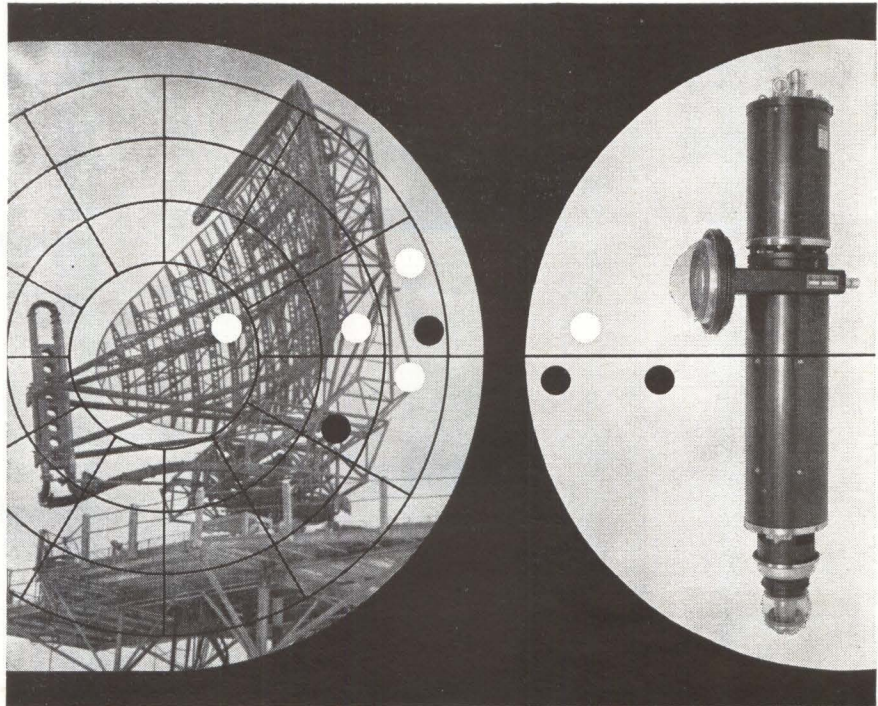

CIRCLE 200 ON READER SERVICE CARD

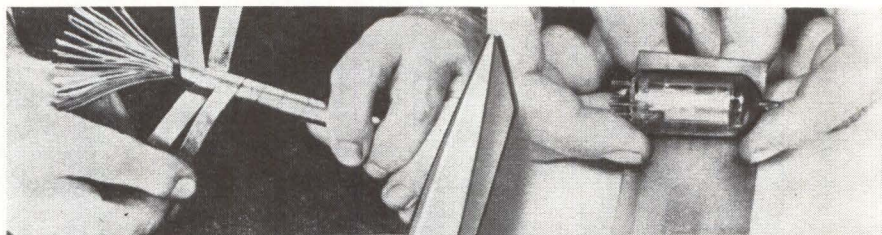

## CUT IT, WRAP IT!

NETIC AND CO-NETIC  
MAGNETIC SHIELDS  
APPLIED  
IN SECONDS

Guard against performance degradation from unpredictable magnetic field conditions to which your equipment may be exposed. Economical CO-NETIC and NETIC Magnetic Shielding Foils are adaptable to any size or shape components. Simply cut with ordinary scissors. Available in continuous lengths on rolls up to 15" wide. Furnished in final annealed state.

Co-Netic and Netic alloys are not affected significantly by vibration or shock, assuring components performance repeatability over a wider range of flux intensities. They are also non-retentive and do not require periodic annealing. When grounded, they shield electrostatic as well as magnetic fields. They have many applications in satellite instrumentation and many other magnetically sensitive devices.

**MAGNETIC SHIELD DIVISION**

Perfection Mica Co. Phone EVerglade 4-2122  
1322 North Elston Avenue, Chicago 22, Illinois

**FOUR YEARS OF PERFORMANCE – FOUR YEARS OF EXPONENTIAL GROWTH**

Many test instruments have been shipped thru our doors since we first opened them in 1959 and it leaves us with a feeling of appreciation to our customers—not just because you have bought our products but because you have recognized our pledge to maintain performance, reliability, flexibility and instrument accessibility. We estimate some 20 million charts may have been plotted on our equipment by now. But the chart we're proudest of was not plotted on **one** of our recorders . . . but **by ALL** of them. That is our own growth chart. It's fun looking at a growth curve that just goes up. Of course, we're not getting smug about it . . . we know we're not the biggest in the field. We're just going to keep adding to our line with one thought in mind: our growth can only result by a continuous, successful striving for designed simplicity. May we send you a brochure?

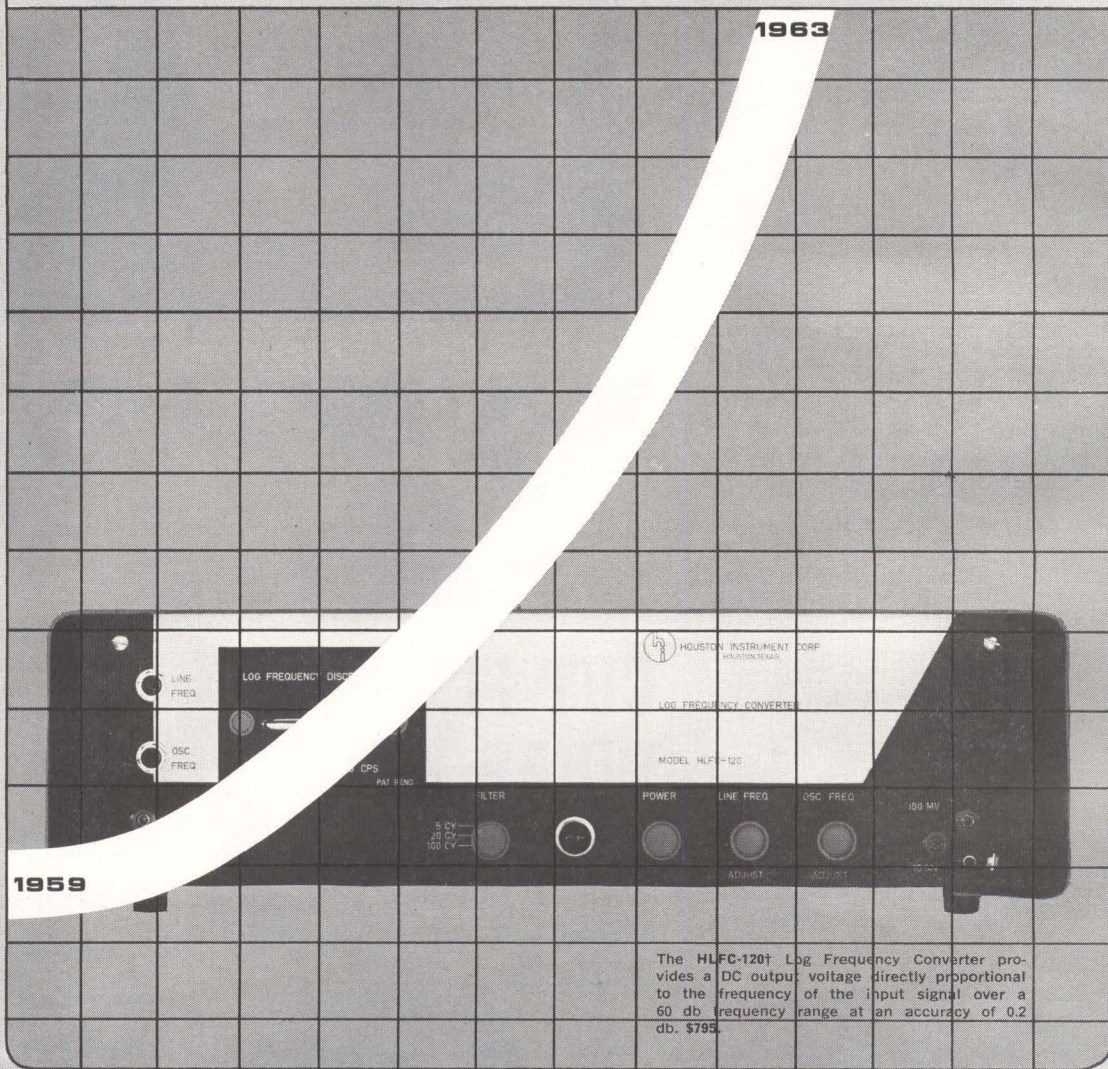

The HLFC-120† Log Frequency Converter provides a DC output voltage directly proportional to the frequency of the input signal over a 60 db frequency range at an accuracy of 0.2 db. \$795.

COMPLETE LINE OF 20 RECORDERS FROM WHICH TO CHOOSE. SEND FOR SHORT FORM CATALOG.

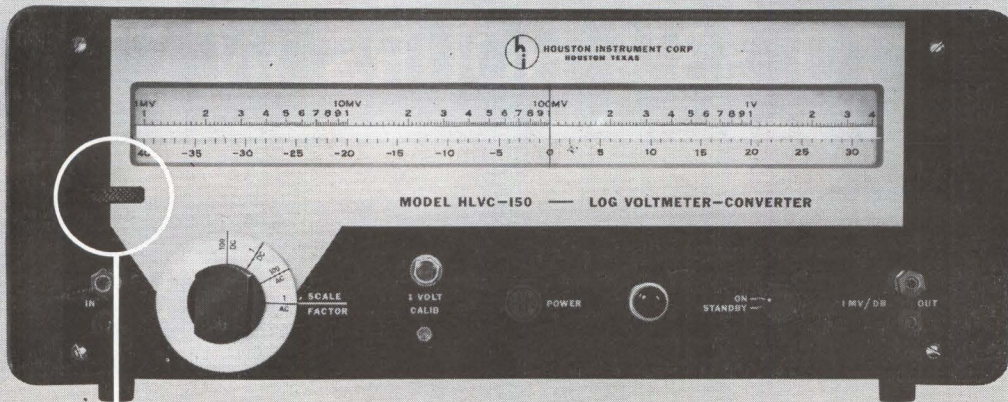

**HLVC 150** The **HLVC-150** log voltmeter-converter's new design principle† permits measurements accurate to 0.2 db of voltage or voltage ratios on a true logarithmic scale over a 3160:1 or 70 db continuous range. AC or DC inputs, DC output for recording. \$1450.

**EXCLUSIVE**  
Moveable  $\pm$   
75db scale with  
Thumbwheel Adjust



**HR 95**

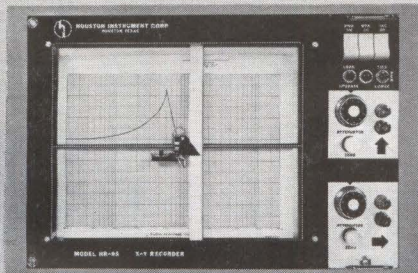

The **HR-95** Recorder, a high performance 8½ x 11" recorder featuring plug-in modules and dual regulated zener reference supplies. Front recording panel swings open for easy access to all of the electrical and mechanical components. \$1250.

**HR 80**

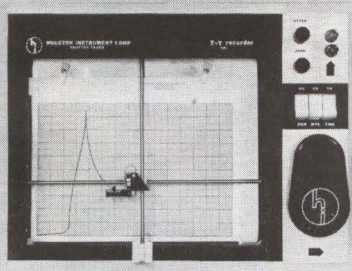

The **HR 80 T-Y\*** recorder provides rectilinear recording as a function of time on standard graph paper of any variable expressible as DC voltage. \$475.

\* TM Houston Instrument Corporation

**HR 97**

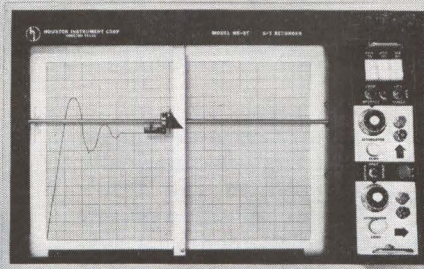

Emphasizing a straightforward design approach, the **HR-97** is an 11 x 17" XY recorder with 1 mv/in. basic sensitivity, 0.25% of full scale accuracy, 15 in/sec. pen speed, zener reference voltages, snap-on pen assembly and vacuum paper hold-down. \$1350.

**HR 96**

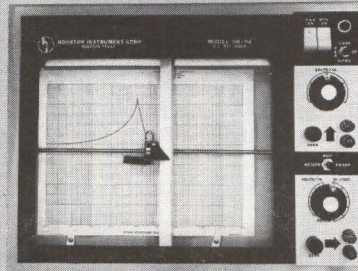

The **HR 96** is an 8½ x 11" XY recorder with a 1 mv/in basic sensitivity, 0.25% accuracy, 10 in/sec. pen speed, zener reference voltages, snap-on pen assembly and 0.5 to 2 in/sec. time base. \$895.

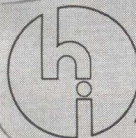

**houston instrument** Corporation

4950 TERMINAL AVENUE / BELLAIRE 101, TEXAS / MOhawk 7-7403 / Cable: HOINCO TWX: 713-571-2063 † PATENTS PENDING

500 MAN HOURS

CUT TO 33½ HOURS IN

32,000 PRINTED CARD TESTS!

BETTER  
MEASURING  
FROM



Engineers of the Martin Company have developed an automatic card testing machine that electronically inspects printed circuit cards used in the firm's PERSHING, BULLPUP, GAM-83 missile systems as well as its air defense and communications systems. Key to the speed, simplicity and cost savings of the machine is the EI Digital Multimeter which displays test results of the tape program at the push of a button!

Each of the 1000 printed circuit cards produced daily by Martin can now be given 32 quality tests in less than 2 minutes — work which formerly took an experienced electronics technician and inspector 15 to 45 minutes *per card!*

As in the case of Martin, EI *all solid state* Digital Multimeters are your answer to greater speed, higher reliability, significant cost savings and a much lower investment.

Whether your interest lies in spacecraft, electronic components or industrial processes, we can demonstrate to you the advantages of EI digital instruments in measuring DC volts, AC volts, DC ratios, resistance, capacitance, inductance and impedance. Let EI *all solid state* Digital Multimeters provide you with swift, accurate, low cost solutions to your measurement and display problems.

*For full details on EI's individual digital instruments, or our complete capabilities in the field of measurement, display and recording—write direct in care of Dept. ET-31.*

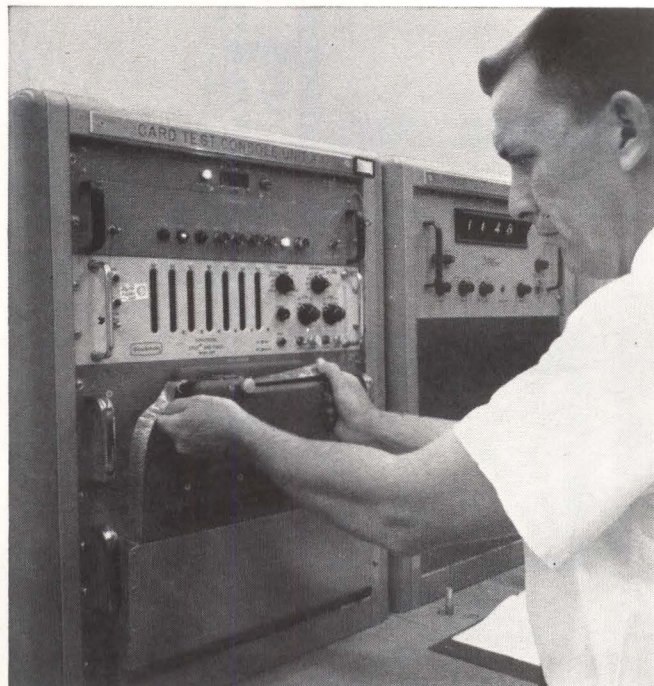

Carle W. Collins, production test engineer, Martin Company's Orlando (Fla.) Division, inserts coded Mylar tape into the reader unit of the Tape Programmed Automatic Tester which he designed.



**Electro Instruments, Inc.**  
8611 Balboa Avenue, San Diego 12, California



ARMY is deploying the AN/GRC-106 transistor vehicular ssb transceiver. This unit has excellent stability through the use of a frequency synthesizer



## MILITARY RADIO Swinging To SSB

*Single sideband has been growing up during the last decade. Today the mode is important in military communications. It permits smaller, lighter equipment and increases mobility.*

*Here are some reasons why*

By BARRY A. BRISKMAN Assistant Editor

**THE COMPLEXITY** and speed of today's military operations requires a speedup in communications. In radio systems, this means an increase in efficiency, reliability and the simplification of equipment.

During the last decade, single sideband has become important in military communications. It affords advantages of small size and low weight of transmitters and power supplies as well as high readability under irregular propagation conditions. United States military services are switching to ssb systems



## SSB AND THE AIR FORCE

Single sideband is of vital importance to today's air defense. It has proven itself again and again in both communications effectiveness and reliability. Moreover, the simplification of airborne ssb equipment has done much to eliminate human error where we can least afford it. Militarily, the mode has a bright future.

Francis H. Griswold  
Lt. General, USAF

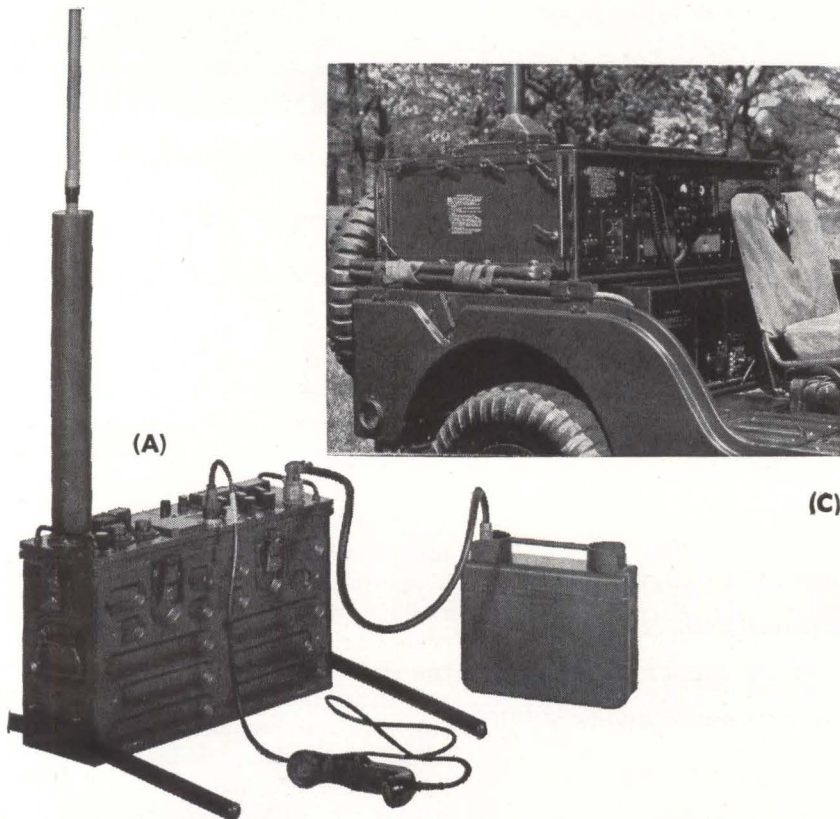
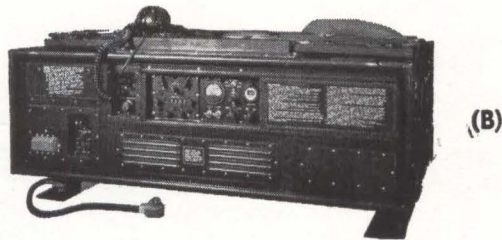

PACKSET AN/PRC-47 is an ssb transceiver with 100 watts output between 2 and 12 Mc (A); AN/TRC-75 can deliver 900 watts pep output at any 1-Kc increment between 2 and 29.999 Mc (B); the AN/TRC-75 can be mounted on an M38A1 jeep to form the AN/MRC-83 mobile system (C)—Fig. 1

for many of their high-frequency communications needs. For example, Army and Air Force use single sideband widely for airborne and front line radio.

**WHY?**—While single sideband cannot accurately be called a distinct form of modulation, it does have spectral-energy distributions and wave-forms that are different from f-m and conventional a-m. Reduced bandwidth requirements are important to the military, since they desire to make maximum use of a limited spectrum to perform a given communications function. The narrow-band characteristics of ssb permit channel splitting on nearly a two-to-one basis, and the nature of the mode increases reliability by reducing splatter, unwanted beats and phase distortion due to fading. Moreover, reduced bandwidth in ssb receivers enhances noise discrimination, a factor of importance where radio equipment is used in vehicular and airborne environments.

Except for fixed, point-to-point use, most military radio systems cannot use large, high-gain antenna systems. When rudimentary radiators such as simple whips and dipoles are used, transmitters must have high efficiency and power output to successfully accomplish their missions. Requirements for high mobility mean that loss of antenna gain cannot be compensated for with larger equipment; many ssb systems are now operational that occupy as little as  $\frac{1}{4}$  the space of an a-m or f-m unit that could accomplish the same military function.

The use of semiconductors and computer techniques in ssb systems now permits military equipment to have high frequency-selecting accuracy. Digital readout for new ssb equipment reduces operator errors and substantially simplifies equipment operation.

**AIR FORCE**—According to Major General John B. Bestic, ex-Director of Telecommunications of the Strategic Air Command and present Deputy Director of the National Military Command Systems, ssb has had a significant impact on Air Force high-frequency communications. General Bestic says that while multichannel, multiplex ssb

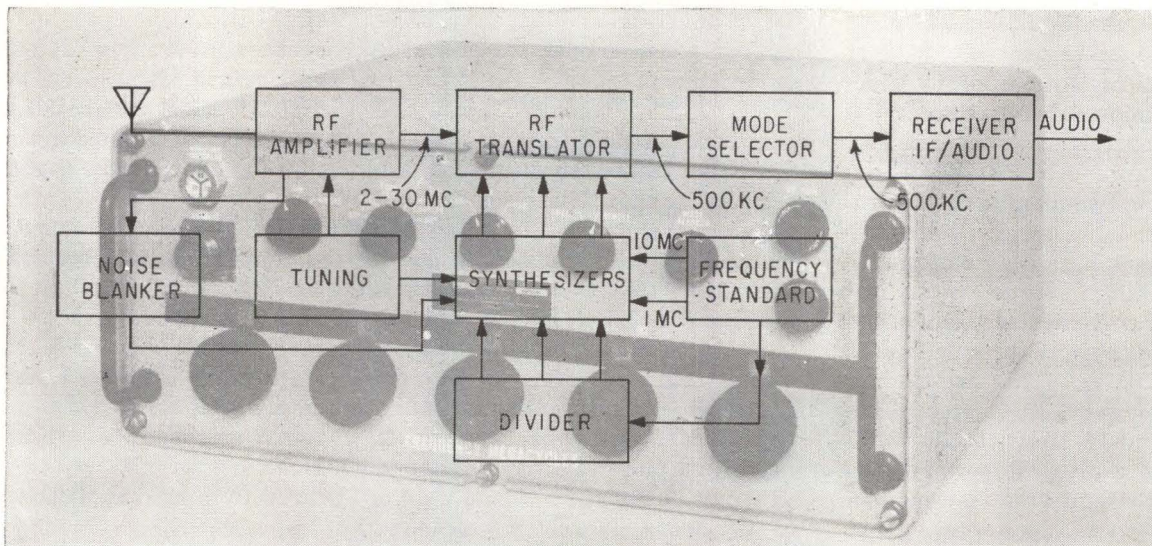

TRANSCEIVER SC-901X weighs only 47 pounds. This unit has a frequency synthesizer and consumes 75 watts in the transmit position—Fig. 2

systems have been functioning in commercial and military systems for years, many dramatic advances accredited to ssb have taken place in high-frequency, single-channel voice systems.

Military high-frequency voice systems have been greatly extended with the advent of ssb; SAC has switched to single sideband for airborne h-f radio communications and has an elaborate point-to-point network in use for urgent operational needs. In addition, Tactical Air Command has changed to ssb and airways communications stations of the Air Force Communications Service have followed suit. Moreover, new production aircraft with h-f radio requirements are production-line equipped with single sideband.

General Bestic says that "The dramatic conversion to single sideband is the result of three primary factors. Carrier suppression gave ssb its initial boost in system reliability by providing a most sizable increase in talk-power over conventional amplitude modulated transmitters of comparable input power. This increase in power was accompanied by other benefits like a decrease in equipment weight and size, a substantial saving in input power and a reduction in the power-handling tolerances of individual components". He continues by saying, "The end result can best be illustrated by comparing the standard airborne transceiver with the

equipment it replaced. The 1,000-watt ssb unit requires one-third less space than its 100-watt a-m predecessor".

"As I see it, the increases in the effective power obtained by converting the old a-m carrier into effective sideband talk-power is the key to the Air Force success with ssb. Side-by-side tests between comparable a-m and ssb units have proven the superiority of single sideband under marginal propagation conditions. Signals that were unreadable on the a-m systems were communications quality when transmitted over the same path by ssb. Moreover, a substantial economy has been effected in frequency conversion by eliminating the unwanted sideband. Particularly on the lower frequencies, we have been able to split old-single-channel a-m frequencies into two ssb channels", says General Bestic.

The Air Force has pointed out that problems of frequency calibration, tuning and loading had made the operator essential, but that with the development of more stable oscillators and error sensing devices, automatic tuning and loading is now an Air Force way of life. Airborne tuning equipments now consist of digital frequency displays, a sideband selector and a volume control. All these factors contribute to simplicity of operation and often eliminate the need for the airborne radio operator-technician. Simple digital computer circuits tune equipments

with six, single-conductor wires from the pilot's position. Savings in payload in operator elimination plus added flexibility and convenience obtained by locating the equipment remote from the pilot, may have more than paid for development costs.

General Bestic also feels that along with human engineering in the airborne field, similar developments have taken place in the ground system. Operator skills have been advanced by simplified automation and technical development—translated into tremendous flexibility in the ground environment.

Direct radio relay between ground stations has become increasingly common. Strategically placed stations (illustrated by the SAC commanders' net) using ssb systems are now, to a large extent, independent of propagation conditions. Signals are relayed from ground station to ground station when conditions prohibit direct point-to-point contact from originating station to destination, providing the calling and called parties the same service as direct, point-to-point radio contact.

These factors hold true for all the military branches. Some observers feel that almost 90-percent of all h-f military communications functions will be by single sideband within the next ten years.

**ARMY** — Front-line communications dependability is important for

ground forces. Equipment such as the walkie-talkie or radio packset have been revolutionized by sideband techniques. A modern man-carried transceiver is shown in Fig. 1A. This unit (AN/PRC-47) is designed for a two-man team and provides dependable, tactical communications plus a high degree of battle-front mobility. It is alternately suitable for vehicular installation and can be powered directly from a storage battery. This transceiver operates on any 1-Kc increment between 2 and 12 Mc with 100 watts pep (peak equivalent power) output on either upper or lower sideband or c-w and has a total weight of only 40 pounds. World War II packsets weighed as much or more, and seldom exceeded 25 watts output using a-m or f-m systems.

Transceivers with power outputs up to or greater than 1,000 watts pep, are also designed for front-line, vehicular use. The AN/TRC-75 pictured in Fig. 1B can be installed on a M-38A1 jeep as shown in Fig. 2C, to form a flexible mobile communications system. This ssb transceiver will deliver 750 to 900 watts pep output on upper or lower sideband, c-w, fsk or compatible a-m, on any frequency between 2 and 29.999 Mc.

Both the AN/TRC-75 and AN/PRC-47 have excellent frequency stability and resetability under battle conditions. These features are achieved with frequency synthesis techniques that provide up to 28,000 separate automatically tuned channels that are presented digitally. The application of frequency synthesis to ssb equipment has fulfilled military requirements for bet-

ter-than-crystal stability even when the equipment is operated in hostile environments.

The Army recently announced that it has standardized on the AN/GRC-106 transistor vehicular ssb transceiver shown in the lead photograph of this article. This unit is a 400 watt pep ssb transmitter and a superhet receiver contained in a small and lightweight (100 pound) package. It will provide reliable communications over a 50-mile range with modest antennas and is capable of worldwide coverage if used with more effective radiators. The unit is half the size and weight of the transceiver it replaces and provides ten times the effective signal power of the old set. The AN/GRC-106 is capable of operation on any one of 28,000 rapidly selectable channels. The exact operating frequency appears digitally on its front panel.

Sophisticated mobile com centers such as the AN/MRC-87 provide 1,000 watts or more output between 2 and 30 Mc and also include vhf and uhf ssb facilities at reduced power. These systems can be expanded to handle powers up to 10 kw and often include as many as five separate radio stations for simultaneous, multiband operation.

Figure 2 shows the completely transistor SC-901X ssb transceiver that operates between 2 and 30 Mc with 28,000, 1-Kc channels having a stability of 1 part in  $10^7$  per week. Though only  $17 \times 18 \times 7$  inches and 47 pounds, this unit contains a complete ssb transceiver plus a frequency synthesizer, and consumes only 75 watts in the transmit posi-

tion. Harmonic and spurious responses, unwanted sideband and carrier are down 50 db, and image and i-f rejection are 80 db down. A functional block diagram of the SC-901X appears in Fig. 2.

**NAVY** — Naval communications equipment has also been affected by the transition to single sideband. Many ships now use ssb for communications between land and sea stations on low and high frequencies. Naval aircraft equipment contains sideband transmitters and receivers for aircraft to land and aircraft to ship applications.

**OUTLOOK**—Single sideband has added a substantial increase in versatility to military communications equipment. The dissemination of government contracts for the design and development of ssb equipment and systems is on the upswing. For example, expanded airborne requirements have generated R&D contracts that will result in still smaller and lighter high-power ssb transceivers that attain complete coverage of the spectrum between 2 and 30 Mc with frequency-standard stability. The complex equipment required for precise frequency control is being manufactured by many companies here and abroad. A typical synthesizer is shown in Fig. 3.

Many contracts call for the design and production of uhf ssb equipment. New, high-linearity transmitting tubes, coupled with high stability oscillators and improved methods of generation, are making ssb equipment for the gigacycle ranges practical.

Advances in linear amplifier tubes are permitting high-power tubes to assume a smaller silhouette. Many new types are of ceramic-metal construction and have external fin-type anodes for increased plate dissipation. As a direct result of improvements in transmitting tubes, linear amplifiers are appearing that require less space than a typical buffer stage in the 100-watt transmitter of 15 years ago.

Engineering advances commensurate with increased requirements for ssb equipment should continue to result in widespread circuit and component improvements, for even higher efficiency and reliability.

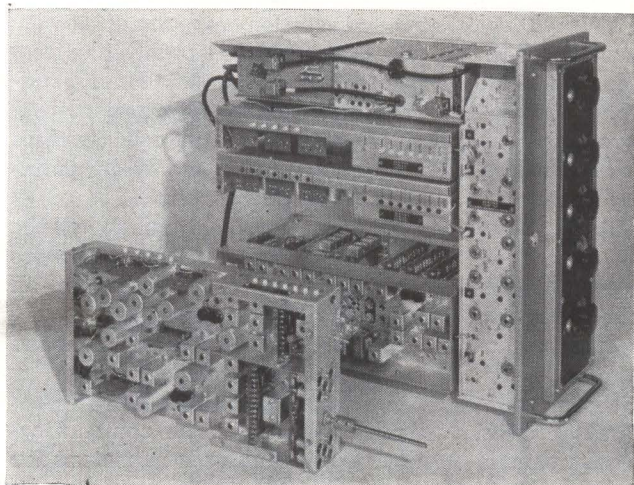

**FREQUENCY CONTROL** is now often accomplished by frequency synthesis. This Marconi unit is also typical in that it has modular construction—*Fig. 3*

# Tunnel Diode Detects Currents Down to 100 Femtoamperes\*

*Attribute testing of reverse leakage currents in semiconductor diodes and transistors is one of many applications of this low-level current detector*

By **CARL DAVID TODD**

Head of Engineering, Modular Circuits Dept.  
Hughes Aircraft Co., Newport Beach, Calif

**LOW-LEVEL** currents can be measured directly or compared by a simple circuit that uses the negative resistance characteristic of a tunnel diode. The economical current detector, which has measured currents of 0.1 picoampere, provides rapid recovery from overloads. Detector output is in binary form and may be a voltage, closure of a relay or the lighting of a lamp.

Low-level current instrumentation has become increasingly important for measuring some of the parameters of the improved silicon semiconductor devices that have become available. Measuring small currents is also a basic requirement in such other areas as nuclear electronics.

Currents below 1 nanoampere are

usually measured with relatively expensive electrometers. However, this expenditure is often difficult to justify, particularly when measurements are on an attribute or go no-go basis. In addition, recovery of these instruments after severe overloads is often intolerably long. A simple current detector that re-

covers rapidly from overloads can be designed using a tunnel diode as a threshold triggering device and also as a memory.

**TUNNEL DIODE SWITCH** — The tunnel diode can easily be biased for bistable operation because of its negative resistance characteristic. The load-line conditions are shown in Fig. 1A, where points A and C correspond to the two possible states. When operating at point A, voltage drop across the tunnel diode is typically only about 30 mv. During operation at point C, the voltage drop is about 450 mv for a germanium device.

If the tunnel diode in the circuit in Fig. 1B is operating at point A, operation can be switched to point

*AUTHOR TODD uses simple tunnel-diode circuit to make low-level current measurements*

\* NEW UNIT  
1 femtoampere =  $1 \times 10^{-15}$  ampere

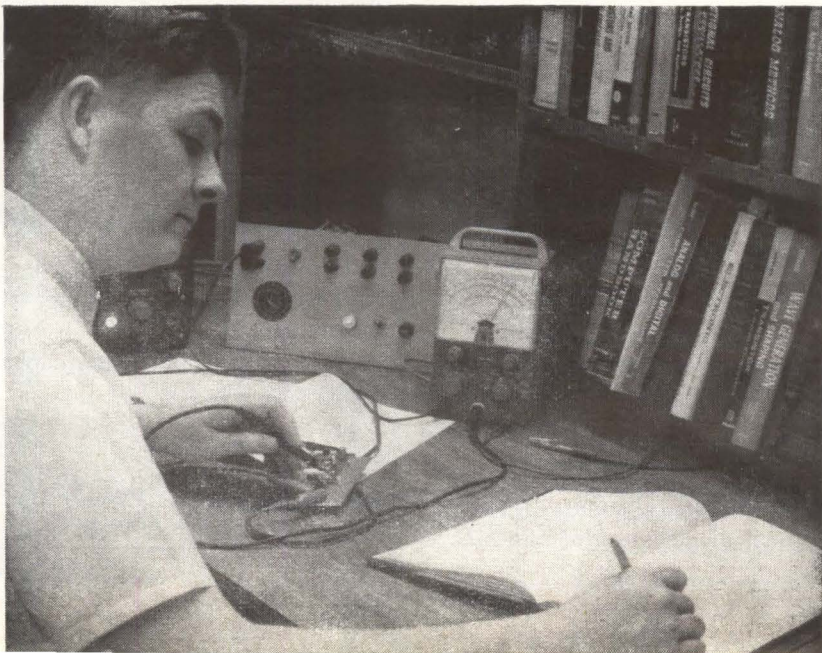

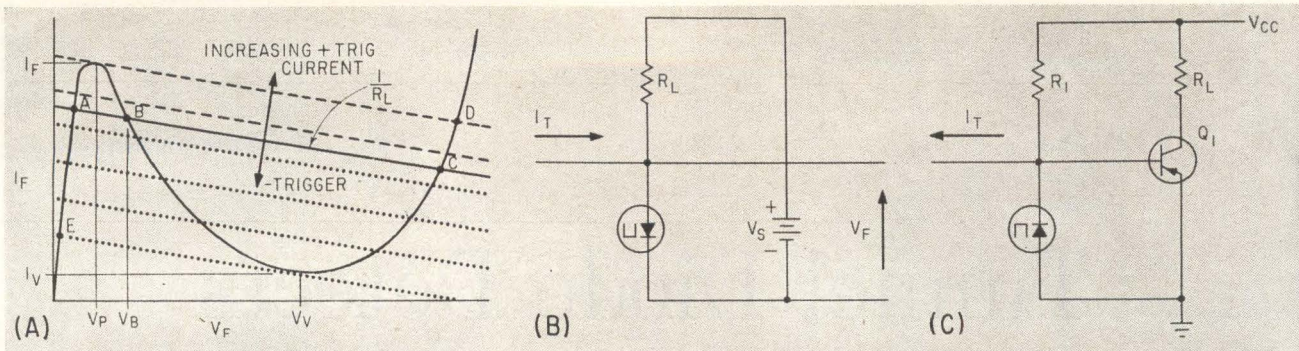

C by momentarily increasing current through the diode above peak current  $I_p$ . Similarly, operation can be switched back to point A by supplying a negative trigger current that reduces current through the tunnel diode below valley current  $I_v$ . Because of the general shape of the tunnel diode characteristic curve, much less energy is required to switch from A to C than from C to A.

Switching can be initiated either by applying a trigger current as indicated or by switching a capacitor across the tunnel diode that has been charged in the correct polarity to a sufficient amplitude. The energy requirements are such that the initial voltage must slightly exceed  $V_b$ . If shunt capacitance across the tunnel diode is appreciable compared to the triggering capacitance, the initial voltage must be sufficient to charge all capacitance shunting the tunnel diode and still exceed  $V_b$ .

Thus, if operation was originally at point A and the triggering capacitor has been switched across the tunnel diode, measuring the voltage across the tunnel diode determines whether the initial charge was adequate and of the correct polarity to switch the state of the tunnel diode.

**TRANSISTOR AMPLIFIER**—Using the simple tunnel diode switch, the change in output voltage is small and output power is not adequate for many applications. A transistor can be added to provide output at a more useful level, as shown in Fig. 1C. Operating conditions are shown in Fig. 2D, where characteristics of the emitter-base junction of the transistor and those of the tunnel diode are shown in the composite curve.

If the second bias point on the composite curve falls close to  $I_v$  of the tunnel diode, most of the bias

current will flow in the transistor base in Fig. 1C. When operating at point A in Fig. 1D, base current is practically zero so collector current is small. However, when operation is switched to the conditions at point C, substantial base current flows, and collector current is  $h_{FE}I_B$ . Thus, even with a 1-milliamperere tunnel diode, 50 ma or more can be switched in the collector circuit. In addition, the voltage swing can be as large as the transistor will permit.

#### SIMPLE CURRENT DETECTOR

—In Fig. 2A, capacitor  $C_1$  charged by unknown current  $I_x$  can be connected directly across the tunnel diode by closing switch  $S_1$ . If the tunnel diode is in the low-voltage state and if the initial voltage exceeds  $V_b$  in Fig. 1A, switching will be initiated. If  $I_x$  were in the opposite direction to that shown, the polarity of the voltage across  $C_1$  would not cause the desired switching.

Closing  $S_2$  resets the tunnel diode back to the low-voltage state. If  $S_2$  is closed before  $S_1$  is released, the capacitor will be fully discharged. If  $S_1$  and then  $S_2$  are released, after time  $t_1$ , the charge on  $C_1$  can again be used for interrogation.

The charge on the capacitor is

directly related to the value of the capacitor, current  $I_x$  and the time between complete reset and interrogation. Assuming that  $I_x$  is constant with time, the relationship is

$$V_{C(t)} = I_x t_1 / C_1 \quad (1)$$

Eq. 1 can be rearranged to indicate the value of  $I_x$  required to produce voltage  $V_b$  that is adequate to switch the tunnel diode to the high-voltage state

$$I_x = V_b C_1 / t_1 \quad (2)$$

A typical value of  $V_b$  for a germanium tunnel diode is 85 mv. Assuming a value of 120 picofarads for  $C_1$  and allowing  $t_1$  to be 1 second,  $I_x$  need only be 10 picoamperes. By extending the charging time to 10 seconds, 1 picoampere can be detected.

A transistor amplifier can be added to the circuit in Fig. 2A to drive a lamp that indicates directly operation of the tunnel diode in the high-voltage state.

#### TRANSISTOR SWITCHING

—Switches  $S_1$  and  $S_2$  in Fig. 2A can be replaced with transistors so that the interrogation and reset operations can be controlled by appropriate pulse sequences, as in Fig. 2B. For the polarities shown,  $S_1$  must be replaced by an npn transistor for interrogation. The collector leakage current that flows

#### APPLYING NEWER COMPONENTS

Many new devices have become available to the electronics engineer in recent years. They usually cost more than conventional components. Their behavior under a wide variety of conditions is not always completely understood. When is their use in circuits justified? The new device may enable a circuit to perform its intended function better. Its use may simplify the circuit, improve reliability, lower overall costs. Here is a group of circuits using the tunnel diode to detect low-level currents that meets all of these criteria and more

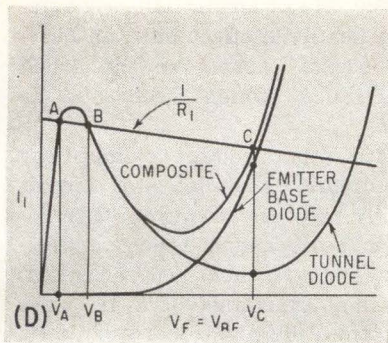

TUNNEL diode can operate in two stable states (A) with suitable biasing (B). Transistor amplifier (C) provides useful output under conditions shown in curves (D)—Fig. 1

SWITCHING operating states of tunnel diode (A) can be done with transistors (B)—Fig. 2

when  $Q_1$  is off must be much less than unknown current  $I_x$ . The base of  $Q_1$  is therefore driven negative during the off state so that leakage current will be slightly less than  $I_{cbo}$ . Even with the best transistors, basic detector sensitivity is limited by leakage current, which is about 1 nanoampere and depends heavily on temperature.

Switch  $S_2$  could be replaced directly with a *pnp* transistor, although the slightly modified reset circuit in Fig. 2B provides some additional advantages. The bias resistor for the tunnel diode has been replaced by two separate resistors— $R_1$  and  $R_2$ . With the collector of  $Q_2$  connected to the junction of  $R_1$  and  $R_2$  rather than directly to the tunnel diode, the transistor need not be driven into saturation for adequate reset. In addition, shunt capacitance associated with  $Q_2$  is removed from the tunnel diode.

The switches in Fig. 2A may be manually operated, although control of timing will be somewhat poor except for longer periods. A control circuit can be used to obtain the desired sequence of closure and release. Relays can replace the switches, or the circuit in Fig. 2B may be used.

Although both  $S_1$  and  $S_2$  must be closed to reset the circuit completely, the tunnel diode memory will be reset if only  $S_2$  is closed. After the tunnel diode has been switched to the high-voltage state, capacitor  $C_1$  will not discharge fully. In fact, it will normally continue to charge to a voltage equal to  $V_c$  in Fig. 1D. This voltage would be adequate to assure triggering of the tunnel diode on the next interrogation even if  $I_x$  had dropped to zero.

Because of the switching sequence required for the circuit in Fig. 2A, the output signal (indicating that the memory has been set)

may not be present during the charging cycle. However, the required control sequence can be greatly simplified by making a minor modification in the circuit.

In the circuit in Fig. 3A, the triggering capacitor is isolated by a diode rather than being connected directly to the tunnel diode. If the capacitor is adequately charged in the correct polarity, it may still trigger the tunnel diode. However, as soon as the tunnel diode has switched to the high-voltage state, coupling diode  $D_1$  is reverse biased and the voltage across  $C_1$  cannot be increased by the tunnel diode. With diode  $D_1$  in series with the tunnel diode,  $C_1$  must be charged to an appreciably higher level of about 200 to 300 mv. Although this can be provided, basic detector sensitivity will be reduced.

If interrogation is continued after the tunnel diode has been triggered ( $S_1$  remains closed),  $C_1$  will begin discharging through resistor  $R_2$  in Fig. 3A. Thus, interrogation during reset is no longer necessary to assure discharge of  $C_1$ .

With the simplified control arrangement, the circuit can be interrogated, which also discharges the capacitor, and then reset just before the next interrogation. The output thus indicates the state of the memory throughout the charging cycle and reflects the integrated current that has flowed during the last charging cycle. For the memory to remain set,  $I_x$  must adequately charge the capacitor during each charging cycle.

**COMPLETE UNIT**—A practical low-level current detector and memory unit is shown in Fig. 3A. When a negative input pulse is applied to  $Q_1$ , the transistor drives relay  $K_1$ , which performs the interrogation. A dry-reed relay is used to provide

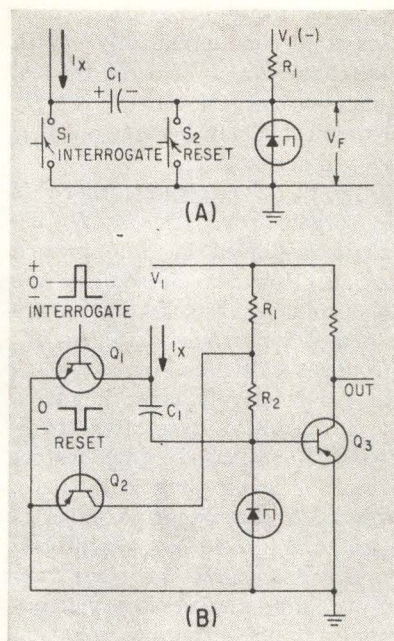

adequate speed with low leakage current.

Diode  $D_1$  isolates trigger capacitor  $C_1$  from the tunnel diode after it has been triggered, and  $R_2$  assures adequate discharge of  $C_1$  during the latter portion of the interrogation period. A negative pulse applied to the base of  $Q_2$  causes the transistor to reset the tunnel diode. Transistor amplifier  $Q_3$  drives a lamp to indicate that  $I_x$  has been of sufficient amplitude and correct polarity to trigger the tunnel diode memory. If desired, a relay or resistor may be substituted for the lamp.

The circuit in Fig. 3A requires the two pulses in the prescribed sequence for interrogation and reset. Pulse widths are generally not critical if the reset pulse is followed shortly by the interrogation pulse. Time between interrogation pulses should be controlled since it affects detector sensitivity.

**CONTROL UNIT**—The circuit in Fig. 3B provides the control pulses in the proper sequence to the detector and memory unit in Fig. 3A. Basic timing is accomplished by a silicon unijunction transistor operated in a relaxation oscillator circuit. For a given unijunction transistor, the period between pulses is determined by the product  $R_3C_2$ . Thus, to change basic sensitivity of the detector, it is only necessary to change  $R_3$  or  $C_2$ .

As  $C_2$  is charged through  $R_3$  to the level where  $Q_1$  is triggered, a

pulse is fed to the base of  $Q_5$ , which causes it to conduct heavily. With  $Q_5$  on, capacitor  $C_3$  charges toward the supply voltage level through  $D_2$ , and simultaneously a reset pulse is developed across  $R_1$ .

While  $C_3$  is charging, there is little forward drop across  $D_2$  because it is biased in the forward direction. However, as soon as the pulse produced by  $Q_4$  disappears and transistor  $Q_5$  is switched off,  $C_3$  produces a reverse bias across  $D_2$  so that a relatively large negative pulse is fed to the base of  $Q_6$ . Normally,  $Q_6$  is saturated and collector-emitter voltage is practically zero. However, as the negative pulse is applied to the base,  $Q_6$  is switched off and collector voltage rises rapidly, providing the necessary negative pulse to drive the interrogation circuit.

**LIMITING**—In many applications, it is important that the current detector recover rapidly from a temporary overload. Although the circuit in Fig. 3A provides relatively fast recovery, especially for large positive values of  $I_x$ , limiting can improve recovery time after overloads of either polarity. Two basic approaches can be used to limit the effects of large currents in this circuit: a current-limiting device can be connected in series with the input or some form of shunt limiting can be used.

If the source of the unknown current is assumed to have a high output resistance, as is often the case, inserting a resistor in series with the input in an attempt to limit current will have little effect. How-

ever, the relatively constant current characteristics of a semiconductor diode biased in the reverse direction can be used. A typical characteristic curve is shown in Fig. 4A. If current through the limiting diode in the reverse direction is considerably less than  $I_1$ , voltage drop across the diode will not be significant. However, as current through the diode tends to increase beyond  $I_1$ , voltage drop across the diode becomes larger. If a diode is chosen with a breakdown voltage larger than the voltage compliance of the unknown current source, input current to the detector will be limited to about  $I_1$ .

The type diode is determined by the level of current being measured. A good silicon diode limits current to about 1 nanoampere at room temperature. This level can be increased by using devices with larger areas. Germanium diodes can limit current to about 1 microampere. Two diodes connected back to back can be used for series limiting of currents of either polarity.

In a shunt limiting circuit connected directly across the input, silicon diodes could limit input voltage to about 0.6 or 0.7 volt. Therefore, this approach might be used at high current levels. However, even a silicon diode conducts when it is forward biased only a few hundred millivolts. If the current is larger than  $I_x$ , the circuit will not operate.

Two shunt diodes can be connected across  $R_2$  in Fig. 3A to limit maximum voltage applied to the tunnel diode through  $D_1$ . The diodes will not conduct until the interrogation period and even then the

current will be small. This arrangement has little effect until an overload occurs except for the added capacitance, which need not be large.

With input voltage clamped by the diodes, the detector circuit usually recovers during the interrogation pulse and is ready immediately for the next measurement. The small resistance of  $R_1$  in series with the interrogation relay limits peak current after an overload.

**APPLICATIONS** — The low-level current detector can be used to measure current directly. The current is simply injected at the input terminal. If the unknown current is large enough to charge the triggering capacitor adequately, the tunnel diode memory will be set by interrogation and lamp  $L_1$  in Fig. 3A will be switched on.

The triggering threshold, and hence the magnitude of  $I_x$  required to set the memory, is a function of temperature primarily because of the variation in the voltage drop across  $D_1$ . Thus, if accurate discrimination is required over a range of temperatures, the circuit must be compensated to reduce the threshold variation.

The low-level current detector can also be used as a current comparator by making its sensitivity much greater than the value of the unknown current. A negative reference current is summed with the unknown current, and the detector is used to determine whether  $I_x$  is larger or less than the reference by detecting the polarity of the summed currents. Resolution de-

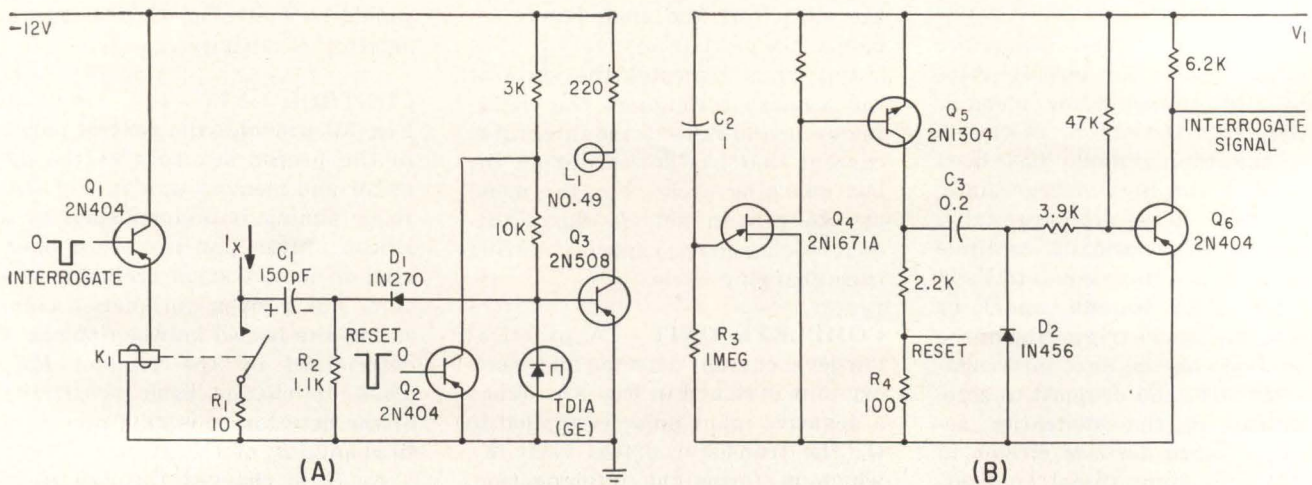

LOW-LEVEL trigger and memory unit (A) is provided with pulses (B) by control circuit—Fig. 3



depends on sensitivity of the detector circuit and may be made less than 10 picoamperes if required.

Another application of the low-level current detector is attribute testing of reverse leakage currents in semiconductor diodes and transistors. A typical test configuration is shown in Fig. 4B. The limit of current that can be tested is determined by  $V_1/R_1$ . If  $V_1$  is not well enough regulated to provide the necessary precision in the reference current, a voltage regulating circuit can provide the necessary drive for  $R_1$ . Close regulation of overall supply voltage is not usually necessary.

If leakage current through the transistor junction is less than the reference current, net current  $I_z$  into the input terminal will be negative, the memory will not be triggered, and the lamp will remain off. However, if  $I_{CBO}$  exceeds reference current  $I_y$  by the design threshold value of the detector, the memory will be set by each successive interrogation and the lamp will glow.

A simple but excellent attribute test set is thus provided by the circuit in Fig. 4B. The reject limit can be controlled by varying either  $R_1$  or the voltage applied to  $R_1$ . It is possible to test to a limit of 1 nanoampere. In addition to its basic simplicity and high accuracy, by using series limiting in the detector, no further limiting is required to protect the transistor or diode under test against the possibility of test voltage exceeding breakdown voltage.

A similar arrangement can be used for testing leakage resistance in switches, relays, capacitors and printed circuits. Large resistances can be tested on an attribute basis without subjecting the device under test to the high voltages encountered in many high resistance testers. Avoiding these higher voltages is especially important where voltage-sensitive devices are used in parts of the circuit.

The test circuit used for attribute measurement of high resistances is shown in Fig. 4C. Negative voltage supply  $V_1$  produces current through standard resistor  $R_s$  that opposes current produced through unknown resistance  $R_x$  by positive voltage supply  $V_2$ . When resistance  $R_x$  is high enough so that net current entering the detector is either nega-

tive or below the positive threshold value, lamp  $L_1$  remains off. As  $R_x$  decreases, a point is reached where  $I_x$  equals the threshold value and is of the correct polarity to set the tunnel diode memory and cause  $L_1$  to glow. The mathematical relationship governing threshold resistance  $R_{XT}$  is

$$R_{XT} = R_s(V_2 - V_T) / (I_T R_s + V_1 + V_T) \quad (3)$$

where  $I_T$  is threshold current of the detector and  $V_T$  is detector input voltage under threshold current conditions.

When threshold voltage  $V_T$  is insignificant compared with  $V_1$  and  $V_2$ , Eq. 3 reduces to

$$R_{XT} = V_2 R_s / (I_T R_s + V_1) \quad (4)$$

If the detector current threshold limit is made low compared with current flowing through  $R_s$ , the relationship can be further simplified to

$$R_{XT} = (V_2 / V_1) R_s \quad (5)$$

which indicates the case where the magnitudes of  $V_1$  and  $V_2$  are made equal. In this case, the threshold value of  $R_x$  is equal to standard resistance  $R_s$ .

Using this technique, leakage resistances of about  $10^{12}$  ohms can be measured with reasonable accuracy and speed using only 28-volt supplies.

In the equations given thus far, it has been assumed that  $I_x$  remained constant during charging time. For the more general case in which  $I_x$  may vary with time

$$V_{C(t)} = \frac{1}{C} \int_0^t i_x dt \quad (6)$$

Thus, the actual triggering threshold condition depends on both time and current. Therefore, a detector can be made that responds to the current value integrated over a period of time, which can be controlled by modifying the control circuit to interrogate on command of an external synchronizing signal.

**MEASURED RESULTS**—The basic circuit in Fig. 2A has been used to measure a current of 0.1 picoampere, using carefully cleaned components and a charging time of about 1 minute. The circuit in Fig. 3A with the control circuit in Fig. 3B has been used to measure currents of about 1 picoampere, again using carefully cleaned components but with a charging time of about 10 seconds. With charging time reduced to 100 milliseconds so that

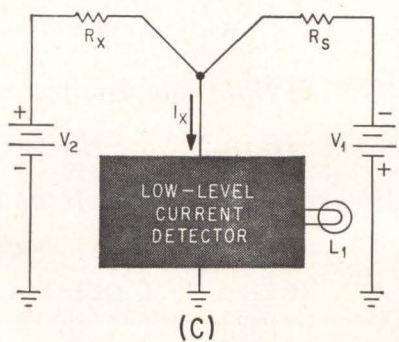
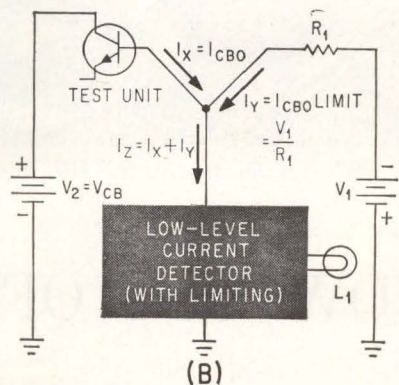
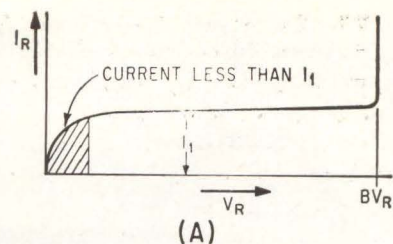

CHARACTERISTIC curve (A) indicates current-limiting effect of semiconductor diode. Low-level current detector can be used for production testing of transistors (B) and high-resistance measurements (C)—Fig. 4

10 readings are taken each second, currents less than 300 picoamperes were sufficient for reliable triggering.

Using 1-second timing and a threshold of  $10^{-10}$  ampere, the circuit was tested for severe overload. With no limiting, overloads exceeding 10:1 caused no problems regardless of polarity. Overloads exceeding 100:1 would not trigger the memory because of ringing in the tunnel diode circuit.

A simple shunt limiter consisting of two diodes placed across  $R_1$  in Fig. 3A made the circuit relatively immune to overloads of 1 million to 1. Recovery usually occurred within one or two interrogation periods, and the lamp always indicated the proper relationship of threshold to unknown current.

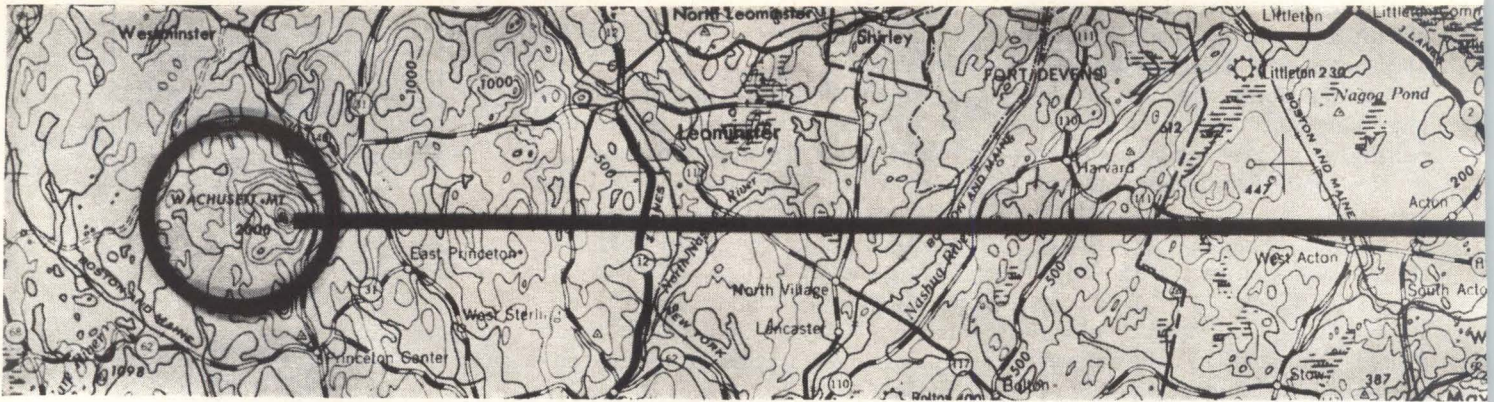

MAP showing the 30 nautical-mile line-of-sight path from Mt. Wachusett, Princeton, Mass., to Lincoln Laboratory,

## NOW OUT OF THE LAB

# Modulated Infrared Diode

*Modulated light sources for communication are being applied to practical systems. Here is how the infrared emissions from a GaAs diode have permitted audio and video signals to be sent and received over a path that is 30 nautical miles long*

By R. J. KEYES, T. M. QUIST, R. H. REDIKER, M. J. HUDSON, C. R. GRANT and J. W. MEYER  
Lincoln Laboratory\*, Massachusetts Institute of Technology, Lexington, Mass.

WITH the development of each new source of electromagnetic radiation, a host of applications occur to communications engineers plagued by the problems associated with more familiar regions of the spectrum. Not the least of these, is increasing congestion in the radio and microwave bands and the resultant shortage of allocations therein.

Other problems are overall conversion efficiency from prime to radiated power and the complications encountered in the impression of information on the carrier.

Recombination radiation from semiconductors offers a source of remarkable efficiency that is simple to modulate. Moreover, its spectral width is very narrow, even for incoherent operation. This latter feature permits the use of narrow-band filters that discriminate against background grey-body noise.

**IMPLICATIONS**—According to the communications range equation,  $R_{\max} = K (P_T G_T A_R / P_R)^{1/2}$ , where  $K$  is a proportionality factor including those characteristics of the system not explicitly expressed by  $P_T$ , the power of the transmitter;  $G_T$ , the transmitter gain;  $A_R$ , the effective area of the receiver aperture and  $P_R$ , the minimum power required at the receiver input to do the job at hand.

The optical equivalent of the effective radiated

power  $P_T G_T$ , shows the effectiveness of the transmitter optics in concentrating the source power into a narrow beam. Except for propagation effects and the differences in receiver sensitivity, it appears that the wavelength used makes little difference. Propagation effects, however, such as scatter and scintillation, are so strongly dependent upon the vagaries of weather and other environmental conditions such as smoke and haze, that these effects can be only roughly estimated. Thus, the proof of this promising technique required a test demonstration. This experiment was just such a demonstration, severe enough to produce *a priori* doubts that it could be done; but, as accomplished, revealing new possibilities in the communications art.

**GaAs RADIATION**—Audio and video signals have been successfully transmitted over a distance of 30 nautical miles with 8400 angstrom radiation emitted by a gallium arsenide diode. Previous papers have described the diode<sup>1</sup> and techniques<sup>2</sup> with which audio and video signals are transmitted by modulating the diode radiation.

The transmission path between Mt. Wachusett, Princeton, Mass., and the roof of Lincoln Laboratory, Lexington, Mass., a distance of 30 nautical miles, is shown in Fig. 1.

The transmitter situated atop Mt. Wachusett, was basically a small (0.010-inch diameter) GaAs

\* Operated with support from the U. S. Army, Navy and Air Force.



Lexington, Mass.—Fig. 1

## Spans 30 Miles

diode placed at the focal plane of a 5-inch reflecting telescope. This telescope, as shown in Fig. 2, had an effective aperture of  $f/1.25$ , and confined the diode radiation within a beam of 0.002 radian. The current through the diode, which was immersed in liquid nitrogen, was 300 ma, and the power in the 0.002 radian beam was about 5 milliwatts. The receiver shown in Fig. 3, consisted of a 7102 multiplier phototube placed at the focal point of a 5-foot army surplus searchlight. A filter that rejected all visible radiation, was placed over the face of the multiplier phototube to reduce the noise signals produced by stray radiation from the laboratory and nearby airfield lights. Originally, a spike-reflection filter that was designed to transmit only the 8400 Å diode radiation was used. Because of the short focal length of the searchlight, much of the infrared radiation converged on the multiplier phototube at large angles. Hence, this filter rejected a significant amount of the signal and had to be abandoned.

The communication experiment was performed at night at a time when the atmospheric attenuation of the radiation over the path was about 5 db. Voice and audio communication was of very high quality and the signals received were two orders of magnitude above the system noise.

Television pictures were also transmitted and received. Under best operating conditions, the peak-to-peak television signals were approximately a factor of 20 greater than the system noise. If a properly designed spike filter had been used, the signal-to-noise ratios would have been increased by a factor of 3.

**SUMMARY** — Although this experiment clearly showed the ability of the GaAs diode to function as a high data rate, long-distance communication device, weather conditions were very good during the experiment, and atmospheric attenuation was relatively low. The system performance will be markedly influenced, however, by the visibility during the time of trans-

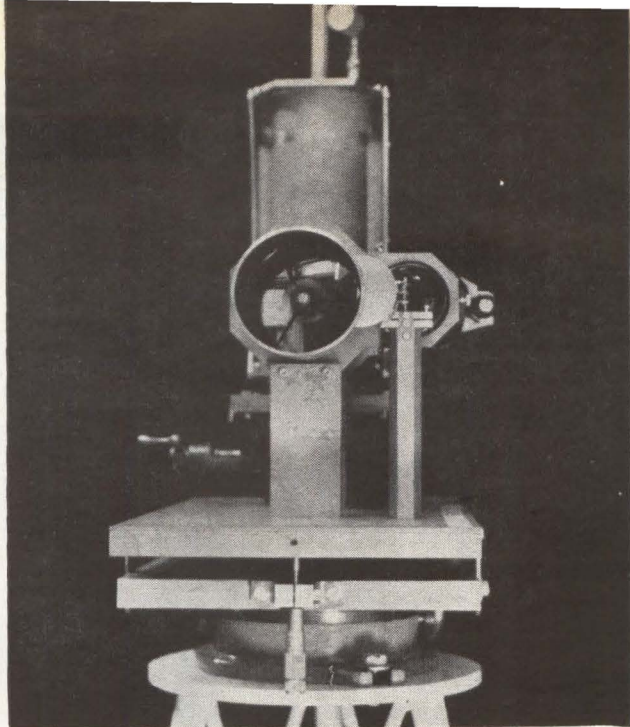

REFLECTING telescope in the transmitter has an effective aperture of  $f/1.25$  and a field-finder monocular for coincidence viewing of the target—Fig. 2

mission. Signal attenuation in the atmosphere is due mainly to the scattering of radiation by moisture and foreign matter. The major source of noise at the receiver is the background photon noise produced by terrestrial lights and the sun.

The authors wish to thank D. S. Grey for designing the transmitter telescope, J. F. Hutzenlaub, W. C. Erwin and D. G. Stuart for supervising the construction of the necessary optics, and J. M. McPhie for technical assistance.

### REFERENCES

- (1) R. J. Keyes and T. M. Quist, *Proc. IRE*, 50 No. 8, 1822 (1962).
- (2) R. H. Rediker, R. J. Keyes, T. M. Quist, M. J. Hudson, C. R. Grant, and R. G. Burgess, *Electronics*, 35 No. 40, October 5, 1962.

FIVE-FOOT searchlight with multiplier phototube at focus was used in the receiver for these tests—Fig. 3

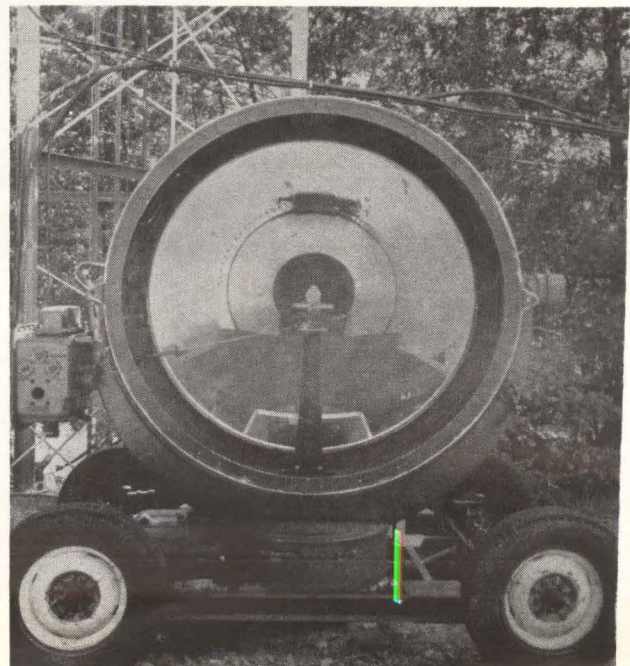

TWELVE transistors costing less than 50 cents apiece deliver 11 output pulses for each trigger-input. Author checks out his circuit on double-beam oscilloscope

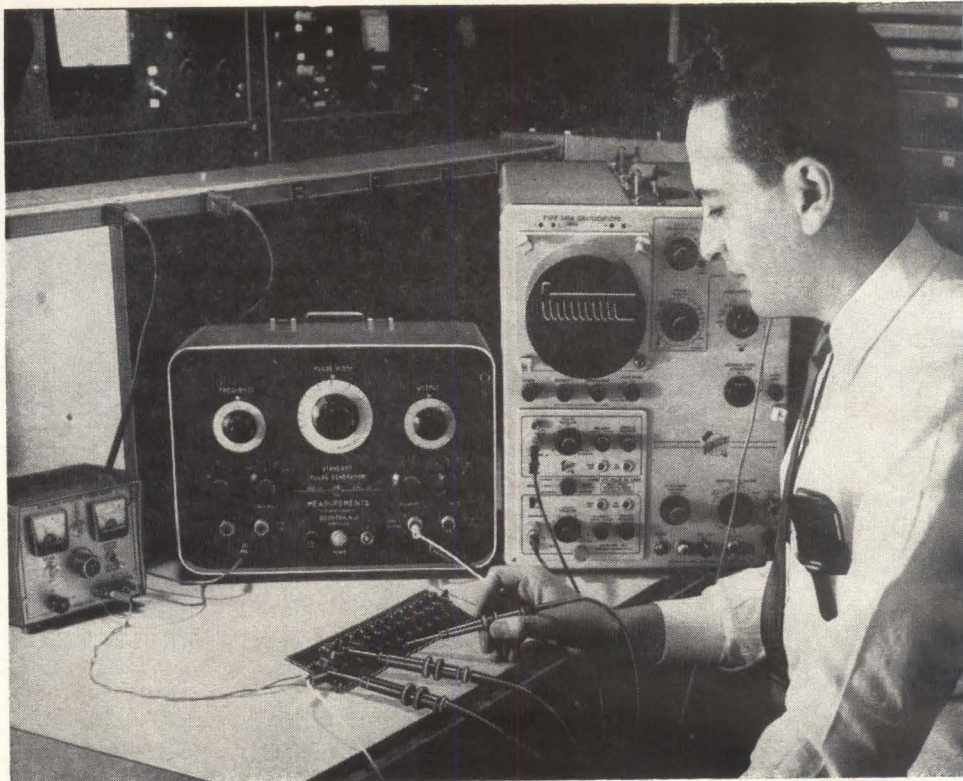

BASIC one-shot (opposite page) with timing network isolated by dotted lines (A), foundation of pulse-forming chain repeats just the timing stages, not the whole one-shots (B), typical one-shot chain has provision for parallel outputs plus diode gates for serial output (C), waveforms show 11 pulses delivered from each input trigger (D)

## Simple Counter Tester

*Inexpensive technique generates bursts of 2-Kc pulses at a low repetition rate, permits visual inspection of fast-driven digital counters*

By **JOE GAON**, Chief Project Engineer,  
Standard Instrument Corp., New York, N. Y.

---

### ULTIMATE SIMPLICITY

How would you generate pulses at a 2-Kc repetition rate, yet have these pulses come in bursts of 11 pulses once every 1/10 second? Perhaps the first approach would be an elaborate array of logic modules to gate the 11 pulses from a 2-Kc oscillator to the point where they were required!

Joe Gaon of Standard Instrument Corp. is more subtle. He gets his 11 pulses with the minimum of sweat and runs up a bill for material of less than a dollar per pulse. As you can see, the circuit could scarcely be simpler, yet it would be hard to find a more effective source of counter-testing pulses

---

**THE USEFULNESS** of a conventional monostable multivibrator, or one-shot, can be extended by adding redundant stages identical to the timing portion of the basic circuit shown in Fig. A. Figure B illustrates the addition of two identical timing stages to the basic one-shot circuit.

The operation is as follows: during the quasistable state of the basic one-shot chain, transistors,  $Q_1$ ,  $Q_2$ , and  $Q_3$  are on an  $Q_1$  is off. Since the collector of  $Q_1$  is at +Vcc potential, capacitor  $C_2$  is charged to the same potential through  $R_1$  and the forward biased base-emitter junction of  $Q_2$ . When the one-shot reverts to its stable state,  $Q_1$  is turned on abruptly, causing its collector-emitter potential to drop to a few tenths of a volt; at that instant the base of  $Q_2$  becomes reverse biased by a voltage of magnitude  $-V_{ce}$ , turning off  $Q_2$ . Transistor  $Q_2$  remains turned off until its base be-

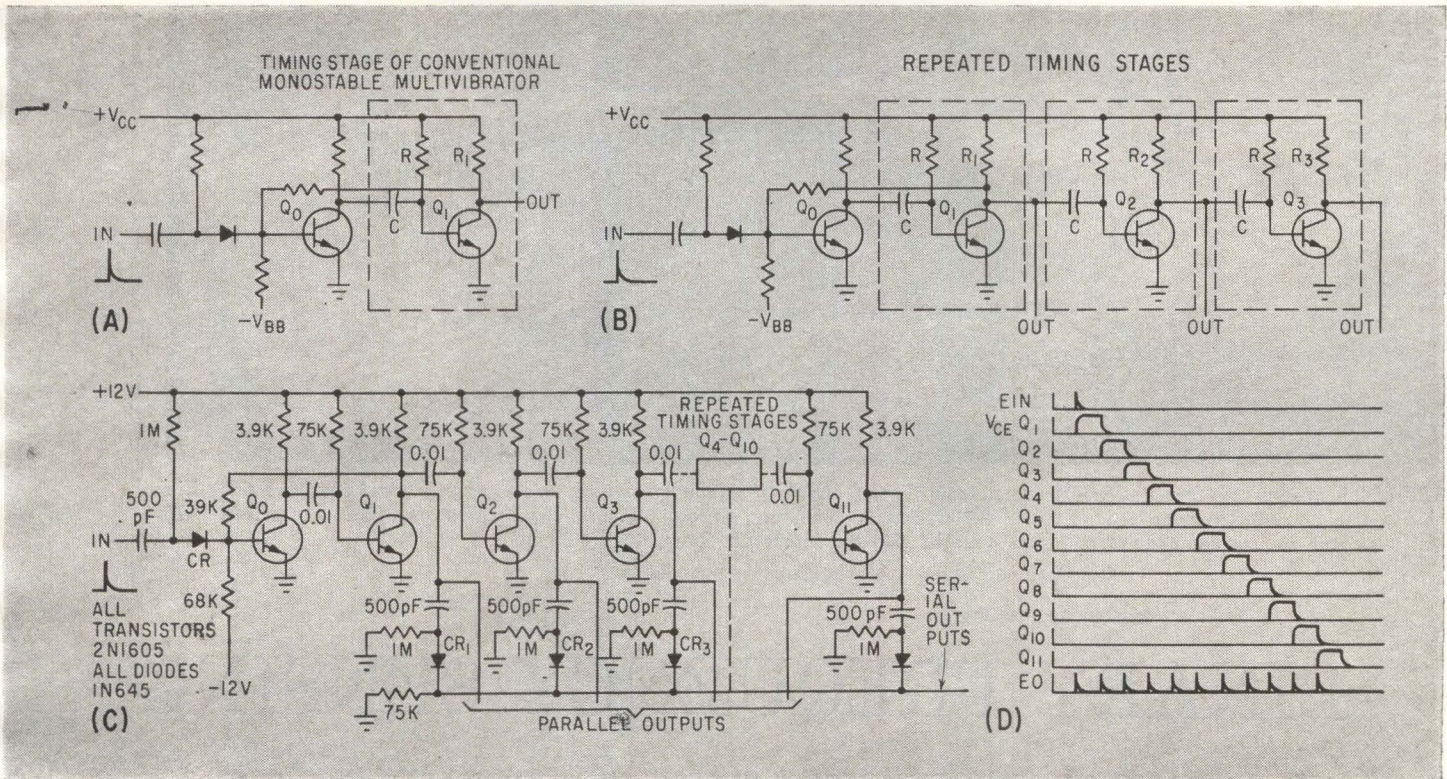

## Uses Cascaded One-Shots

comes forward biased, at which time the potential at the collector of  $Q_2$  drops, causing  $Q_3$  to go off in the same way that  $Q_1$  turned  $Q_2$  off.

In this way it is possible to add as many stages as required; the resulting circuit is analogous to a digital delay line.

The timing period of each stage may be calculated from the relation  $T = 0.69RC$ , where  $R$  is in ohms and  $C$  is in farads. The total delay is then  $T = n(0.69RC)$  where  $n$  is the number of timing stages, assuming that all the stages have the same time constant.

Of the many possible applications, two configurations: the sequential pulse distributor and pulse train generator, are described.

**SEQUENTIAL PULSE DISTRIBUTOR** — In parallel-entry-serial-output counters, it is necessary to sequentially interrogate the memory circuits, a function usually per-

formed by a ring counter. This operation can be greatly simplified by a one-shot chain. The circuit and the resulting input and output wave shapes are shown in Figs. (C) and (D).

When a pulse or positive step is applied to  $Q_0$ , the following timing stages will be turned off and on sequentially, the swing at the collector of each stage interrogating the memory circuits in turn.

**PULSE TRAIN GENERATOR** — When the outputs of the collectors of all the timing stages of a monomulti chain are connected to an a-c coupled OR gate, leading to the serial-output terminal in Fig. C, a pulse train generator is realized. The output is a number of pulses equal to the number of timing stages. The circuit is used to test individual decades of electronic decimal counters. A burst of eleven pulses is generated at a rate of ten

bursts per second, the frequency of the pulses is 2Kc.

Whenever a burst of pulses appears at the input terminals of the counter under test, the counter advances by eleven counts in a span of 5.5 milliseconds (eleven pulses 0.5 milliseconds apart) and then rests for 94.5 milliseconds until the next burst arrives.

This testing technique enables the inspector to visually examine the performance of a counter while it is being tested at relatively high counting rates.

At the end of each burst of 11 pulses at the 2Kc rate, the units decade (the decade under test) of the counter will advance one digit. For the duration of each burst, the inspector will see a blur, but at the end of the burst the readout will persist long enough (94.5 msec.) for him to detect this one-digit advance indicating a properly functioning instrument.

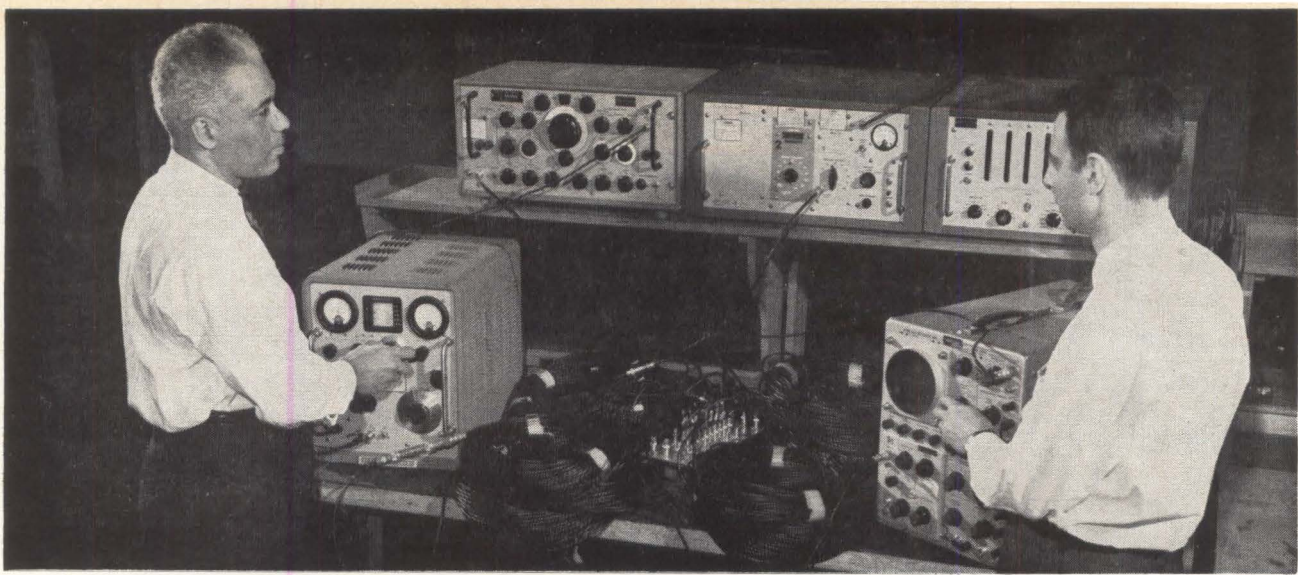

AUTHORS Morrison (left) and Sarachan test the *i-f* BESS breadboard model, in an arrangement that provides high resolution with an operating bandwidth of 1.25 Mc at 60-Mc center frequency. The eight pairs of coils are of slightly different lengths to provide staggered crossovers at 156-Kc intervals

## BINARY FREQUENCY SENSING

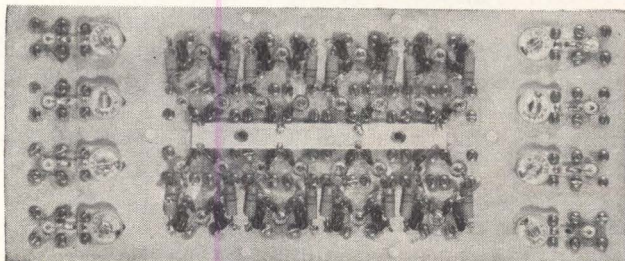
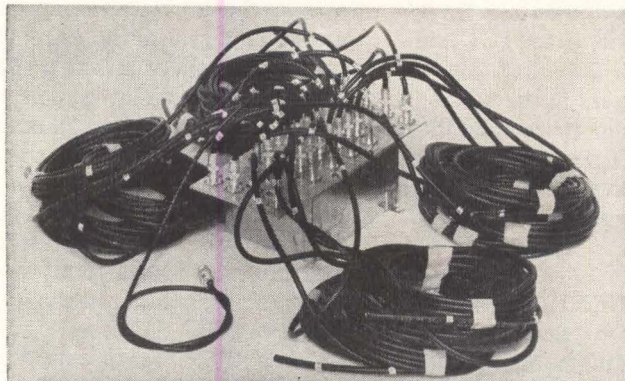
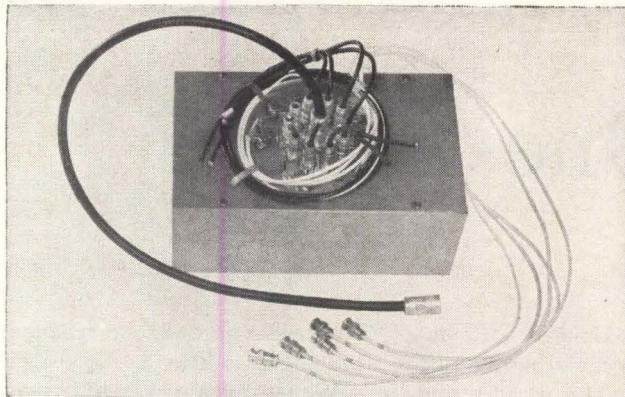

*Cyclic impedance variations  
output indication of the input*

**THE BESS CONCEPT** (see box) makes use of the cyclic impedance variations of long transmission lines, terminated in open circuits or short circuits, to generate a binary code output indication of the signal frequency. Several frequency-sensing circuits are used, and each generates one digit in a binary number corresponding to the signal frequency. If five sensing circuits are used to cover an octave in frequency, there are 32 ( $2$  to the 5th power) discrete frequency indications possible. Increased resolution is readily obtained by using additional sensing circuits, as the number of discrete frequency indications is doubled as each sensing circuit is added.

The output indication from the frequency sensing circuits is positive or negative pulses. Diode logic circuits convert the binary coded

ENGINEERING MODEL of *r-f* discriminator for 1.0 to 2.0-Gc frequency meter (top); *r-f* discriminator for *i-f* digital frequency meter, with 10-Mc bandwidth (center); detector circuit for *i-f* frequency meter (bottom)—Fig. 1

---

## FREQUENCY MEASUREMENT WITH BESS

Many techniques have been used for the detection and identification of radio frequency signals. If the signal is of low amplitude and unknown frequency, the receiver must combine high sensitivity and broad bandwidth. If the signal consists of short pulses with a random repetition rate, the receiver must have broad instantaneous bandwidth if a high probability of intercept is to be obtained. The binary electromagnetic signal signature (Bess) concept is capable of detecting and determining the frequency of a single radio frequency pulse at any frequency within the range of the system. Receivers using coaxial components can be designed to cover the entire range of 100 Mc to 4,000 Mc in a single unit, while waveguide versions are expected to operate over an entire waveguide band. All signals in a multiple signal environment can be identified and displayed simultaneously

---

By R. F. MORRISON, Jr., and M. N. SARACHAN  
General Dynamics/Electronics, Rochester, New York

# MEASURES A SINGLE PULSE

*of long transmission lines, terminated in open or short circuits, generate a binary-coded frequency. Meters operating at 1 to 2 Gc and 55 to 65 Mc are described*

information from the frequency sensing circuits to the desired frequency indication.

**FREQUENCY SENSING**—The frequency-sensing circuits are discriminators that are cyclic in nature. The basic discriminator circuit consists of two transmission lines coupled to the input terminal by equal resistors whose resistance is greater than the characteristic impedance of the transmission lines. The transmission lines are equal in length; one is terminated in an open circuit, the other in a short circuit. If the input voltage is maintained constant and the frequency is varied, the voltage at the junction of the open-circuited transmission line and the coupling resistor will pass through minimum values when the length of the line is equal to an odd number of quarter wavelengths, while the voltage at the junction of the short-circuited transmission line and the coupling resistor will pass through minimum values when the length of the line is equal to an even number of quarter wavelengths. The

voltages at the two junctions will be equal whenever the line lengths are equal to an odd number of eighth wavelengths. Diode detectors convert the r-f voltage at the junctions to video pulses. One of the diodes produces positive pulses, the other produces negative pulses. An indication of the relationship between the transmission line length and the input wavelength is obtained by adding the video pulses and observing the polarity. The frequency interval between polarity reversals is inversely proportional to the length of the transmission lines. An unambiguous indication of the input frequency can be obtained by using several pairs of lines of different lengths, so that each pair of lines contributes one digit to a binary indication of the input frequency.

This discriminator circuit operates satisfactorily over a wide dynamic range because the amplitude of the combined video output pulse is not significant. Variation in the responses of the two detectors will cause some variation in the frequency at which polarity reversal

takes place, but this variation is minimized by choosing diodes with similar characteristics. The non-linear response of the detectors is not significant as long as both diodes exhibit the same characteristics. The effect of differences between detectors is further minimized by the fact that the voltage applied to both diodes varies rapidly with frequency in the vicinity of the frequency at which polarity reversal takes place.

A different type of discriminator circuit has been used with waveguide components. The discriminator is made up of two hybrid tee junctions, two transmission lines of unequal length and a balanced detector. The signal enters the discriminator through the H-plane arm of one hybrid tee and proceeds through the unequal paths to the second hybrid tee, which it enters through the two collinear arms. The signal will emerge at the E and H arms of the tee junction, and the ratio of the signal amplitudes at these arms is determined by the frequency of the input signal and the difference in the lengths of the

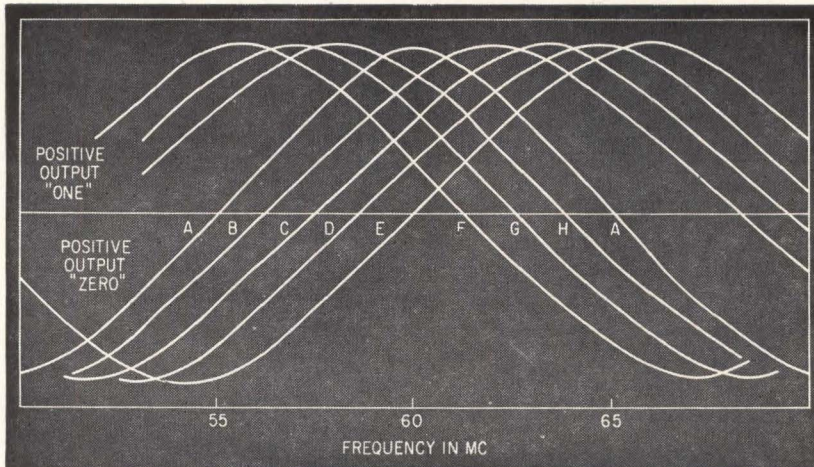

DETECTOR OUTPUT POLARITY versus frequency, for *i-f* frequency meter with 10-Mc bandwidth—Fig. 2

two paths connecting the hybrid tees. The amplitudes will be equal at all frequencies that result in a differential phase shift of 90 degrees for the two paths. Diode detectors connected to the E-plane and H-plane arms of the tee junction produce negative and positive video pulses, respectively, and the video voltages are added so that a null results when the amplitudes are equal. Polarity reversals take place each time the frequency changes by an amount sufficient to change the differential path length by one-half wavelength. Several waveguide discriminators of different lengths are used to produce a binary code indicative of the signal frequency.

**BESS RECEIVER**—One Bess receiver was designed to operate in the 1.0 to 2.0-Gc frequency range. The coaxial lines used as discriminators are shown in Fig. 1 (top). The equivalent free space length of the shortest pair of lines is three inches; the equivalent length of the longest pair is 48 inches. The shortest pair produces polarity reversals or crossovers at 1,000-Mc intervals with the first reversal at 500 Mc; the next pair produces reversals at 500-Mc intervals starting at 250 Mc; and the longest pair produces reversals at 62.5-Mc intervals starting at 31.25 Mc. The reversals of the five lines overlap to form a Gray code dividing the 1.0 to 2.0-Gc region into 32 slots of 31.25 Mc each.

The five-pair discriminator produces erroneous frequency indica-

tions if frequencies below 1.0 Gc or above 2.0 Gc are introduced. These erroneous responses can be eliminated by the use of two additional pairs of transmission lines of proper lengths to produce first reversals at 1.0 Gc and 2.0 Gc. The frequency sensitivity of these lines is much less than that of the longer lines so the location of the band edges will not be accurate unless additional longer lines of appropriate length are used to improve the resolution in the vicinity of the band edges.

The digital circuits consist of a solid-state pulse shaper for each diode detector, decode logic and display unit.

Each pulse shaper consists of a nonlinear amplifier with a voltage gain of 60 db, an input signal dynamic range of 20 db, and capable of responding to pulse widths ranging from 100 nsec to several msec. The amplifiers will respond to positive polarity input pulses only, and are followed by pulse shapers that produce shaped pulses of one microsecond duration at an amplitude compatible with the requirements of the logic modules. The shaper output is fed into the decode logic.

Conventional multilevel diode gating, as dictated by the optimum solution of the Boolean equations, is used for decoding the five-bit Gray code detector outputs into 32 discrete frequency slots. Ambiguities, which inherently occur at the crossover frequencies, are resolved by defining these points as binary zeros. This is accomplished by

TABLE—DIGITAL OUTPUT CODE

Frequency in Mc	A	B	C	D	E	F	G	H
45.00 to 55.00	0	-	-	-	-	-	-	-
55.00 to 56.25	1	0	0	0	0	1	1	1
56.26 to 57.50	1	1	0	0	0	1	1	1
57.51 to 58.75	1	1	1	0	0	1	1	1
58.76 to 60.00	1	1	1	1	0	1	1	1
60.01 to 61.25	1	1	1	1	1	1	1	1
61.26 to 62.50	1	1	1	1	1	0	1	1
62.51 to 63.75	1	1	1	1	1	0	0	1
63.76 to 65.00	1	1	1	1	1	0	0	0
65.00 to 75.00	0	-	-	-	-	-	-	-

strobing the output of each pulse shaper. The presence of a shaper output, or ONE bit, will inhibit the strobe from the ZERO line. At any shaper output for which the ONE pulse is not present (regardless of whether the outputs of the associated line pairs are in the negative or null configuration), the strobe pulse will be enabled. As a result, whenever an input signal is present, a pulse will be present on either the ONE or the ZERO line corresponding to each of the five detector outputs.

The strobe pulse is produced by ORing the outputs of the shapers associated with the two shortest line pairs along with the ZERO output of the shortest line pair. The shortest line pair is the only one for which the negative or ZERO detector output is amplified.

Pulse stretchers are provided at each of the 32 decoded output lines to provide a 400- $\mu$ sec pulse, which is sufficient duration to illuminate the display. This technique enables the frequency measurement of two pulses whose leading edges are approximately 2  $\mu$ sec apart. If this resolution is not required, the output pulse stretchers can be eliminated and the amplifier pulse shapers modified to produce the 400- $\mu$ sec pulses.

The display currently in use consists of an in-line array of neon indicator tubes. A diode-capacitor storage circuit maintains reasonable persistence of the neon bulb. A multivibrator storage circuit could be substituted to hold the indicator on until reset. Each tube



represents one decoded frequency slot, offering the advantages of similarity to the familiar panoramic type of frequency display and the capability of indicating several frequencies simultaneously.

The Gray-code frequency information can also be encoded into any desired form (binary, binary coded decimal or decimal) by similar techniques. Information storage by core matrix, disk, tape, or delay line can readily be incorporated. Digital displays of the Nixie or electro-luminescent type or analog displays (oscilloscope) can be substituted for the in-line readout.

**I-F BESS UNIT**—The Bess unit shown in Fig. 1 (center and bottom) is designed for operation in the vicinity of 60 Mc. This version of the device is intended for high-resolution frequency measurement of pulsed signals after conversion to an intermediate frequency in the vicinity of 60 Mc. The Bess unit shown uses eight pairs of transmission lines to divide a band into eight equal segments. The device as shown operates over a 10-Mc band centered at 60 Mc. The longest pair of transmission lines has an equivalent free-space length of 750 cm, and it produces polarity reversals at 10-Mc intervals starting at 5 Mc. The other seven pairs are shorter than the first pair. Each pair produces one reversal between 55 Mc and 65 Mc, so that the eight pairs produce nine reversals, dividing the band into 1.25-Mc intervals. The manner in which the 10-Mc band is divided and the resulting digital code is shown in Fig. 2 and the table.

A schematic diagram of the i-f Bess unit is shown in Fig. 3. The 2.2- $\mu$ h chokes maintain balanced d-c conditions for the two detectors, while the 1,000-ohm resistors in series with the diodes help to stabilize balance conditions by equalizing the series resistances in the detector circuits. The open-circuited lines are terminated in variable capacitors which are used for fine adjustment of the crossover frequency.

For the i-f Bess units, the same pulse-shaper and display techniques are used, the only area of difference being in the decode logic. In this

case, one pair of coax lines defines the actual i-f band being measured; that is, if the bandwidth of interest is 10 Mc, the crossover points of this line would be 10 Mc apart and equidistant from the mean i-f frequency. The amplified and shaped output of this line is used as the strobe for producing the binary ZEROS for the remaining seven detector outputs. Otherwise the technique for avoiding ambiguity is identical to that used in the 1.0 to 2.0-Gc unit.

Since each of seven of the coax line pairs has only one crossover point within the frequency range of interest, the code produced does not follow any standard pattern. The information, however, can still be decoded into the eight slots required for the in-line array type of display, or converted into any standard code using standard logic techniques.

**LIMITATIONS**—In theory, it appears that the resolution of the Bess concept can be increased without limit by using extremely long transmission lines. In practice, the length of the transmission lines is limited by line attenuation and the

requirement that the pulse duration must exceed the two-way propagation time along the transmission line. Satisfactory operation has been obtained with a pulse duration equal to twice the two-way propagation time. If it is assumed that the propagation time should not exceed twice the pulse duration, the maximum line length for 0.25- $\mu$ sec pulses is about 60 feet and the corresponding frequency interval between polarity reversals is 4.0 Mc.

The maximum line length is also limited by the attenuation of the transmission lines. This is particularly true of the small diameter coaxial lines which can be packaged in a small volume.

The magnitude of the signal reflected from the end of the transmission line will be small if the line has high attenuation and the variation of the detector voltages with frequency will be correspondingly small. If the two-way line attenuation is 6 db, the reflected voltage magnitude is half the incident voltage and the variation of detector voltage with line length is 3 to 1, which is adequate for good frequency resolution.

The maximum usable line length

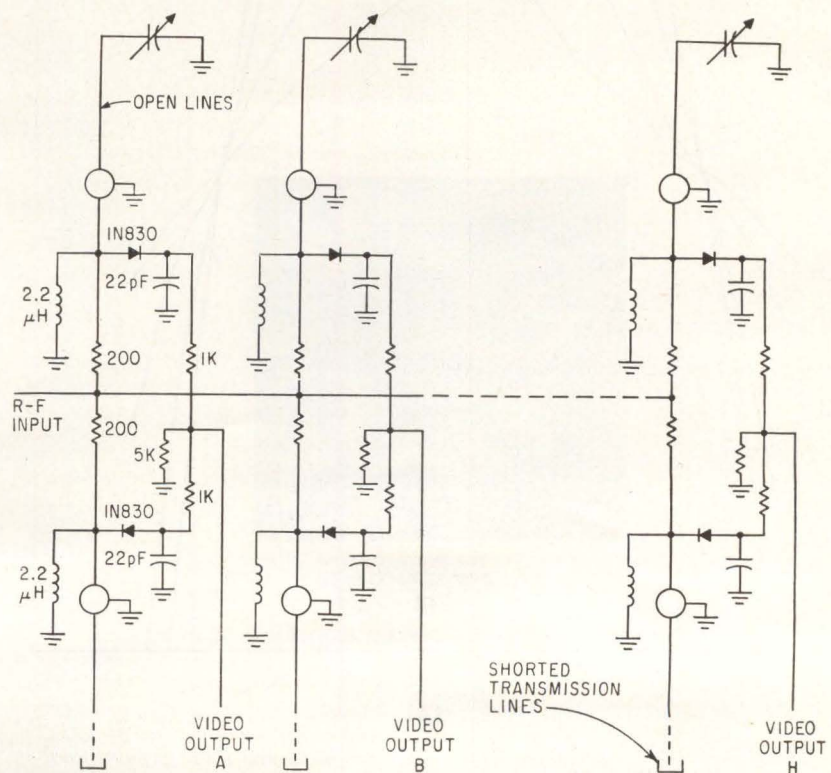

I-F DIGITAL frequency meter—Fig. 3

based on a maximum attenuation of 6 db varies as a function of frequency and is directly related to cable size. At a frequency of 3 Gc, the maximum usable length of RG-62A/U cable is about 16 feet, which provides a frequency resolution of 12 Mc between polarity reversals. The attenuation of this cable decreases with frequency, so that at a frequency of 100 Mc, the maximum usable length is over 100 feet with polarity reversals of less than 2 Mc.

**SIGNAL LEVEL**—The relationship between frequency and detector output voltage is shown for several signal levels in Fig. 4A. The frequency at which a null occurs in the output voltage does not change significantly with signal level, but the slope of the detector

response will cause an apparent shift of the null frequency with signal level if a specific threshold detection level such as 2 mv is assumed.

The accuracy of frequency measurement is not appreciably changed by amplitude effects, because the shift in the apparent location of the null is small compared to the separation of the nulls.

The signal power level required to produce a usable output pulse is about -10 dbm. This is much greater than the available signal power in many applications and amplification will be required. The sensitivity that can be achieved is related to the amplifier noise figure and bandwidth.

Wideband noise does not change the d-c level at the output of the balanced detectors, but it does gen-

erate a background video level that the signal must exceed to be recognized. The video pulse voltage resulting from the detection of an input signal is a function of the signal frequency and signal power level.

The signal-to-noise ratio required is determined by the frequency accuracy requirements and the permissible false indication rate. Infrequent noise pulses that exceed the average noise level by a large amount will cause false indication if the threshold level is set too close to noise level. Setting the threshold detection level too high decreases the frequency accuracy, by shifting the apparent null locations for weak signals.

The relationship between signal-to-noise ratio and measurement accuracy was investigated by using a tee junction to connect a broadband noise source and a pulsed signal generator to the input of the i-f Bess unit.

The results shown in Fig. 4B are for a pair of transmission lines that produced polarity reversals at 10-Mc intervals. The curve plotted shows the combination of signal-to-noise ratio and frequency deviation from the null frequency required to produce a signal video pulse amplitude equal to twice the apparent maximum noise amplitude.

A signal-to-noise ratio of 15 db is sufficient to provide a null location accuracy of about 3 percent of the frequency interval between polarity reversals.

The minimum detectable signal level is determined by the receiver bandwidth, the amplifier noise figure and the signal-to-noise ratio. An i-f Bess unit with an amplifier bandwidth of 20 Mc and a noise figure of 5 db would be capable of detecting signals at a level of -80 dbm with good accuracy, and -85 dbm signals with decreased accuracy. Similar considerations result in an estimated sensitivity of -60 dbm for an S-band Bess receiver with a low-noise traveling wave r-f amplifier and a bandwidth of 2,000 Mc.

The authors acknowledge the assistance of N. Y. Woo in conducting the major portion of the experimental work on this project.

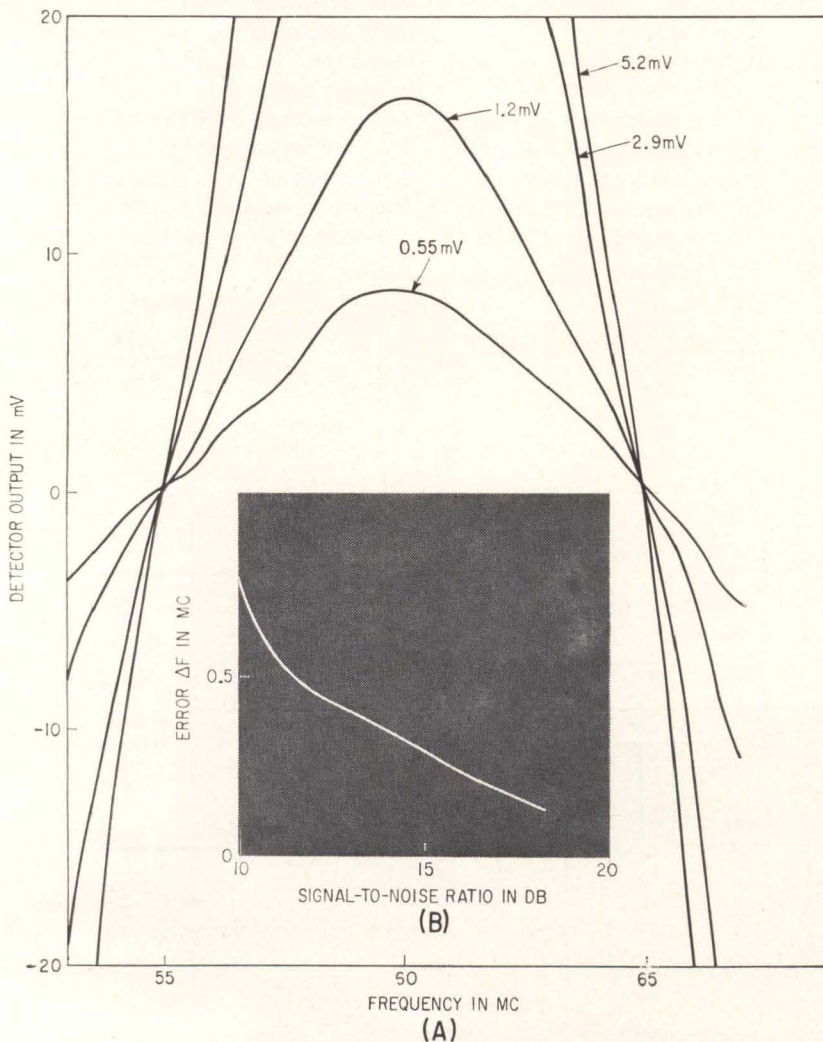

VOLTAGE versus frequency at video output A of Fig. 3 (A); input signal-to-noise ratio versus frequency deviation from null to produce video signal-to-noise ratio of 6 db (B)—Fig. 4

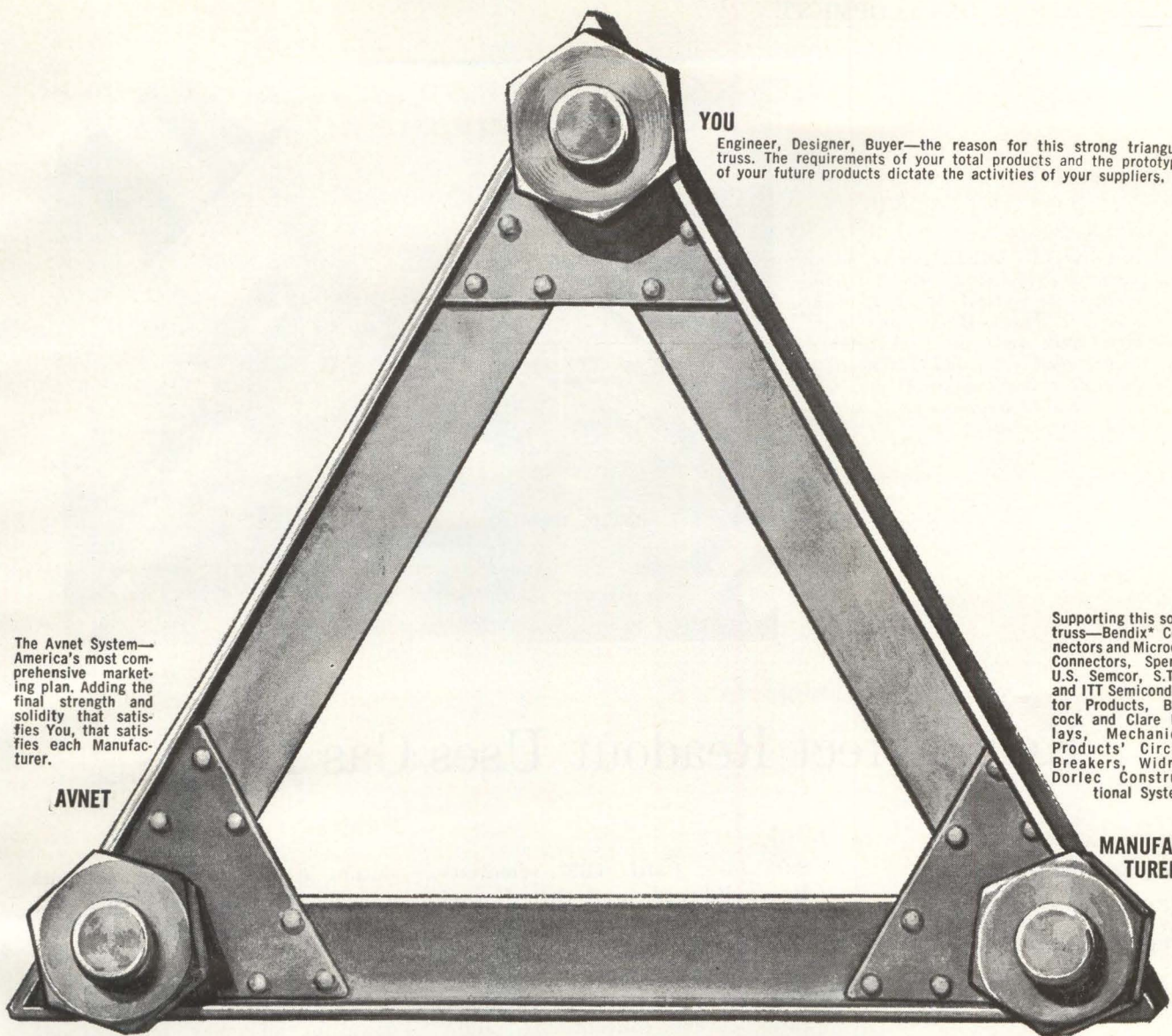

**YOU**

Engineer, Designer, Buyer—the reason for this strong triangular truss. The requirements of your total products and the prototypes of your future products dictate the activities of your suppliers.

The Avnet System—America's most comprehensive marketing plan. Adding the final strength and solidity that satisfies You, that satisfies each Manufacturer.

**AVNET**

Supporting this solid truss—Bendix\* Connectors and Microdot Connectors, Sperry, U.S. Semcor, S.T.C. and ITT Semiconductor Products, Babcock and Clare Relays, Mechanical Products' Circuit Breakers, Widney Dorlec Constructional System.

**MANUFACTURERS**

# STRONG SOLID

A triangular truss is strong, solid. It gives support where required, gives a rigid foundation upon which to build. You, a few key Manufacturers, and Avnet have built such a truss. It is a unique marketing operation in any industry—the strongest in the electronics industry. You can rely on it—for the right deliveries, the right application data, the right service, the right amount of support exactly where, when and how you want it. **THE AVNET SYSTEM**

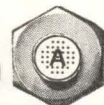

Avnet Electronics Corp.  
Men/Methods/Materials/Management

LOS ANGELES, CAL. phone 213-UP 0-6141; SUNNYVALE, CAL. phone 408-RE 6-0300; SEATTLE, WASH. phone 206-GL 4-4911; PHOENIX, ARIZ. phone 602-273-1261; SALT LAKE CITY, UTAH phone 801-486-7566; CHICAGO, ILL. phone 312-GL 5-8160; SYRACUSE, N. Y. phone 315-454-3238; WESTBURY, L. L., N. Y. phone 516-ED 3-5800; BURLINGTON, MASS. phone 617-BR 2-3060. \* REG. T.M. of BENDIX CORP.

MAGNETIC DISK, center, is on variable precision spindle. Variable inclination optical benches, right and left, carry He-Ne gas laser, left, and multiplier phototubes, right, that read out information through a microscope. At rear left is a movable magnetic head mechanism for recording

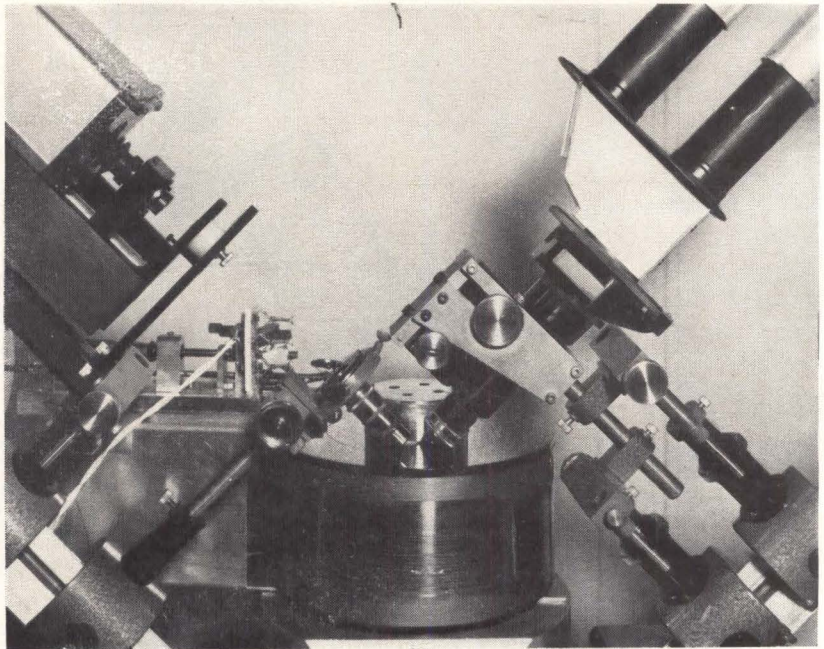

## Kerr-Effect Readout Uses Gas Laser

*Higher packing density,  
faster readout rate  
with coherent light*

**MAGNETIC DISK READOUT** by the Kerr magneto-optical effect, using a neon-helium gas continuous laser for a light source, has been achieved by IBM's General Products Development Labs in

San Jose, Calif. IBM scientists Bruce Edwards and Otto Kornei told *ELECTRONICS* that the continuous gas laser offers a substantial improvement in resolution and in readout signal-to-noise ratio over conventional light sources, that have been used with the Kerr effect in the past.

The experimental system, shown on the cover and in the figure, uses a Perkin-Elmer Spectra-Physics gas laser, giving a 10-milliwatt

output at 6,328 Å, aimed through a condenser lens at an 8-inch disk with a magnetic coating of high coercivity. PhotoMultiplier phototube used for the readout has a low-noise, high-sensitivity and high quantum efficiency photocathode at the laser wavelength. A gliding magnetic head access mechanism is provided for experimental writing.

Because of its spatial coherence and the resulting high power density, the laser beam can be focused on a spot limited in size only by optical resolution; this enables readout of magnetic spots 5 microns in diameter. Since the readout signal-to-noise ratio varies as the square root of the power density, the ratio is improved by a factor of about 30 over conventional light sources.

Readout has been carried out at 250 kilocycles. Since the lineal information density is being resolved by an approximately circular focused spot, it will be possible to read out information with an area density of at least 250,000 bits per square inch. Presently

---

### THE KERR EFFECTS

Kerr **magneto-optical** effect, used in this story, should not be confused with the Kerr **electro-optical** effect, also much in the news these days. They're two different things.

If plane-polarized light is reflected from the polished pole of a strong magnet, the light becomes slightly elliptically polarized; this can be measured as a rotation of the plane of vibration through an angle proportional to the magnetizing force. This is Kerr **magneto-optical** effect. The polarized light is here provided by the Brewster-angle quartz windows of the gas laser.

Kerr **electro-optical** effect says that an isotropic substance, such as nitrobenzene, becomes anisotropic in presence of an electric field—this is used in Kerr cells, for modulating laser light beams

---

**LOW COST**  
**POWER SUPPLIES**  
**WIDE RANGE**  
**FLEXIBILITY**

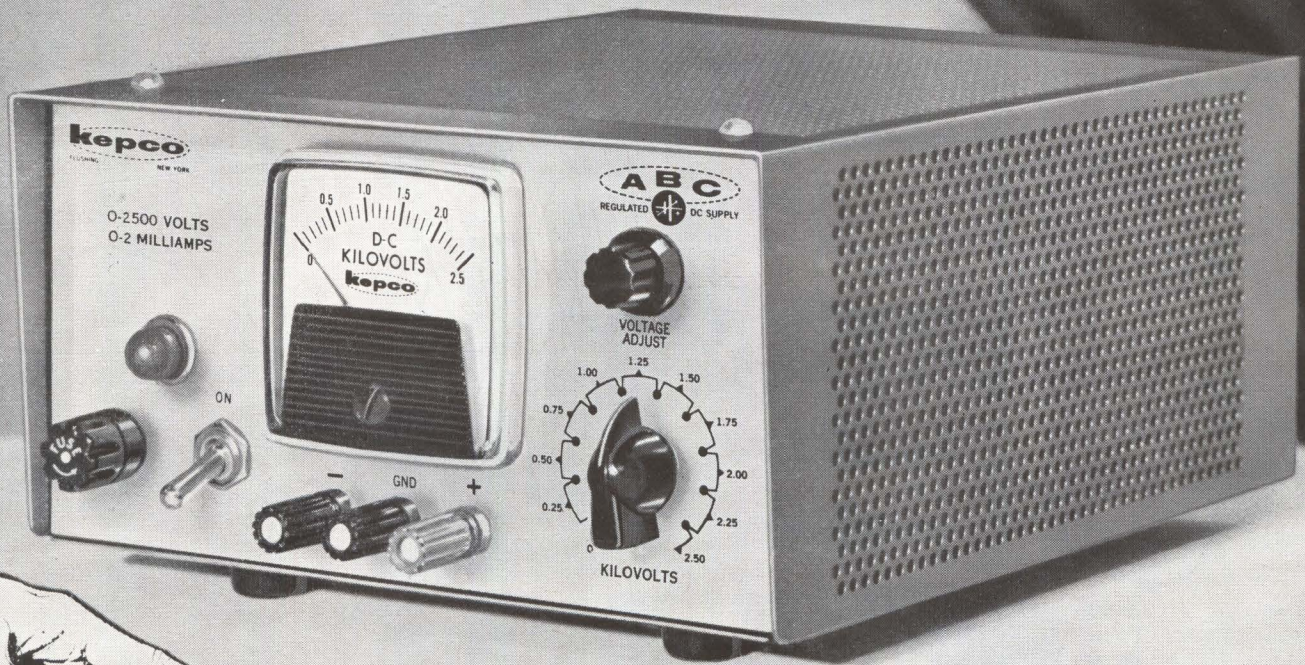

**CHECK KEPSCO**



**10 MODELS**  
**from 0-2V/1A**  
**to 0-2500V/2ma**

**STABILITY:** Less than 0.05% or 3 mv, whichever is greater, over a period of 8 hours at constant ambient temperature.

**RIPPLE:** Less than 0.5 millivolt rms.

**RECOVERY TIME:** 50 microseconds.

**AMBIENT OPERATING TEMPERATURE:** -20°C to +50°C maximum.

**TEMPERATURE COEFFICIENT:** Output voltage changes less than 0.05% per °C.

**INPUT REQUIREMENTS:** 105-125v ac, 50-440 cycles.

**PROMPT DELIVERY . . . MOST MODELS FROM STOCK**

**0.05% REGULATION and STABILITY**  
**TRANSISTORIZED MODELS**

MODEL	DC OUTPUT RANGE		INPUT AMPS (MAX.)	OUTPUT IMPEDANCE OHMS MAX.			PRICE
	VOLTS	AMPS		DC to 100 CPS	100 CPS to 1 KC	1 KC-100 KC (+ μhy)*	
ABC 2-1M	0-2	0-1	0.3	0.001	0.01	0.1 +0.5	\$179
ABC 7.5-2M	0-7.5	0-2	0.5	0.002	0.01	0.05+0.5	\$159
ABC 15-1M	0-15	0-1	0.5	0.008	0.01	0.02+0.2	\$159
ABC 30-0.3M	0-30	0-0.3	0.3	0.05	0.02	0.1 +1	\$119
ABC 40-0.5M	0-40	0-0.5	0.5	0.04	0.02	0.04+0.2	\$159

**HYBRID MODELS**

MODEL	DC OUTPUT RANGE		INPUT AMPS (MAX.)	OUTPUT IMPEDANCE OHMS MAX.			PRICE
	VOLTS	MA		DC to 100 CPS	100 CPS to 1 KC	1 KC-100 KC (+ μhy)*	
ABC 200M	0-200	0-100	0.5	1	0.5	2+1	\$199
ABC 425M	0-425	0-50	0.5	4	1	2+1	\$199
ABC 1000M	0-1000	0-20	0.5	25	2	2+1	\$274
ABC 1500M	0-1500	0-5	0.3	150	2	2+1	\$274
ABC 2500M	0-2500	0-2	0.3	625	2	2+1	\$334

\*Effective series inductance.

FOR DETAILED SPECIFICATIONS ON MORE THAN 250 STANDARD MODEL POWER SUPPLIES SEND FOR KEPSCO CATALOG B-621



131-38 SANFORD AVENUE • FLUSHING 52, N.Y., U.S.A. • Phone (212) IN 1-7000  
 TWX# (212) 539-6623 • Cable Address: KEPSCOPOWER, NEWYORK

See our Catalog in  
**eem File System** Sec. 4000  
 electronic engineers master

# INSTRUMENT SERVOS

for measurement, remote display, data conversion, control, computation

North Atlantic's Series 7000 and 8000 Instrument Servos are designed to meet exacting requirements in airborne, ground support and industrial applications. Types available to accommodate most input signals, and providing a wide range of visual, shaft position and signal outputs.



MODEL	OUTPUT	ACCURACY (% full scale)
SBI-7000	single pointer dial	±0.2% to ±0.5%
	linear dial, single pointer	±0.2% to ±0.5% f.s. numerator
SBI-7070	dual pointer; coarse and 10:1 vernier	±0.1%
SBI-8000	single or dual pointer, counter-pointer	±0.1% to ±0.5%
SBI-7080	counter or counter-pointer	±0.1% to ±0.5%
SBI-7090	digital encoder	±0.1%
SBI-8010	1/4" dia. shaft	±0.1% to ±0.5% with 15 oz. in. load
SBI-8020	0-999 decimal counter	±0.05% to ±0.1%
SBI-8050	pointer and subdial vernier	±0.05% to ±0.1%

Specifications are for typical production models.

For complete data request SFC-1

**NORTH ATLANTIC**  
industries, inc.  
TERMINAL DRIVE, PLAINVIEW, L.I., NEW YORK  
Telephone: OVerbrook 1-8600

realizable is the readout of 1,000 bits per inch at speeds of 500 Kc, and a density of 500 bits per

inch has actually been achieved with recording of non-return-to-zero coded information.

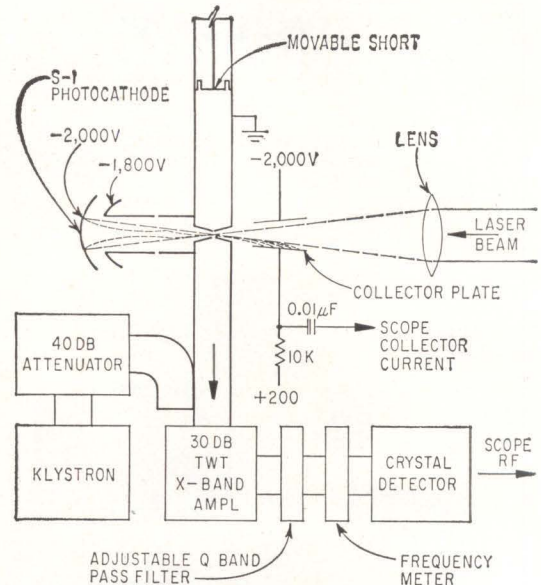
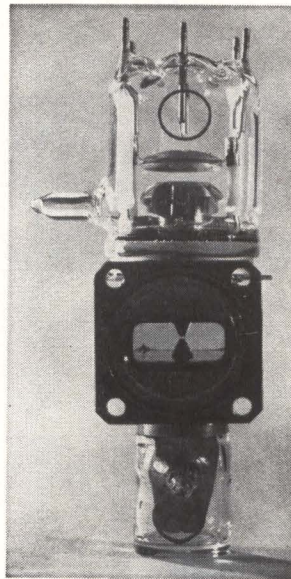

MICROWAVE PHOTOTUBE, showing the interaction gap in the center, and photoemissive surface at top, left. Experimental setup illustrates demodulation process, right.

## X-Band Microwave Laser Demodulator

MICROWAVE PHOTOTUBE for demodulation of laser light beams has been developed by National Engineering Science Co., Pasadena, Calif. The new detector tube, jointly sponsored by Douglas Aircraft Co., demodulates frequencies of 8 to 12 Gc from a 0.3 to 1.2 micron laser beam.

Microwave power levels down to the order of a nanowatt can be demodulated, with a signal-to-noise ratio of 10 on input light power of 50 microwatts for a-m, and 10 microwatts for f-m signals. The tube has flanges for fitting an X-band waveguide.

The experimental setup shown in the figure uses an S-1 (silver-oxide-cesium oxide) photocathode with a broad-wave microwave interaction structure. The cathode is part of an electron gun that focuses the photocurrent as it passes, in a narrow beam, through an interaction gap set up by two hollow reentrant cones mounted in the walls of an X-band waveguide. The beam tunnel at the interaction gap is 0.045 in. in diameter, and the gap is 0.025 in. wide.

By focusing the light through the interaction gap, the cathode is illuminated over an area about 1.5 cm in diameter.

The tube has been studied by photomixing neighboring axial mode emissions from a ruby laser.

The ruby laser is pumped above threshold, and produces a large number of overlapping coherent pulses a few microseconds in duration. Each pulse is the result of a given axial or near-axial mode of the resonator being driven by stimulated emission; the optical frequencies of the various modes are distributed about the center frequency of the crystal fluorescence and are separated by microwave frequencies that are related to the length and index of refraction of the particular ruby rod.

When the laser beam hits the photocathode, it emits current consisting of two components: a large component that has no microwave modulation, and a small microwave modulated component due to the "square-law" demodulation of beats during overlap of different axial-mode pulses.

# New Mallory packaged doubler priced 30% under dual rectifiers



Here's a tremendous breakthrough in silicon rectifiers—the new Mallory Type VBM. It is a packaged voltage doubler circuit priced 30% below the cost of a pair of single rectifiers. And it has superior reliability—for it uses the same rectifier cell, the same encapsulating technique, as Mallory single unit rectifiers that have racked up a field return rate of only 0.019% over the past three years.

The Type VBM is a three terminal device containing two series connected rectifier cells. You have *one less* soldered connection to make... thus, you save an added one to two cents per

device in assembly costs. And you increase overall reliability.

Current rating of the Type VBM is 350 milliamperes at 85°C. It is available in PRV values from 50 to 600 volts. Forward voltage drop and reverse leakage are exceptionally low—0.5 volt and 0.1 milliamperes respectively, full cycle average at rated current and maximum ambient temperature. This unusual device is also available in center tap configurations, with either positive or negative output.

Write today for complete data.

*Mallory Semiconductor Company  
Du Quoin, Illinois  
a division of*

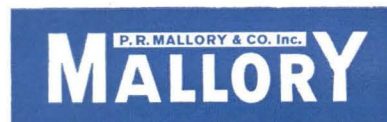

Silicon rectifiers • Packaged rectifier circuits • Zener diodes • Silicon controlled rectifiers

## Making the Right Connection

*Connector firm supplies their own circuits, integrates design package*

**LARGE** connector company now plans to go beyond limits of their traditional connector business, and encompass all phases of circuit design and packaging.

Amphenol-Borg plans to develop and produce packaged circuits of all types. Unified systems will include cordwood modules, entire motherboards, thin-film devices, and integrated circuits.

Company's existing products—connectors—will still be emphasized. They remain interconnection specialists. "But today's complex electronics circuits demand consideration of unified interconnection systems rather than the piece-by-piece design approach used up until now", says division president J. Frank Leach.

Decision to encompass systems was prompted, in part, by customer need for technical advice on how to interconnect circuits. This includes questions customers raise on how to make interconnections smaller, more economical and more reliable.

**NATURAL GROWTH**—Company still believes conventional connectors will handle significant percentage of interconnecting applications in foreseeable future. But natural growth of electronics means continued growth for them, they say. Even though they introduced no radically new products or concepts themselves.

Leslie E. Roby, manager of Interconnections/Systems Packaging group, would not reveal details now, but hints at new techniques for interconnecting thin-film devices and integrated circuits. Announcement of this development is expected within the year.

Richard E. Hall, vice-president

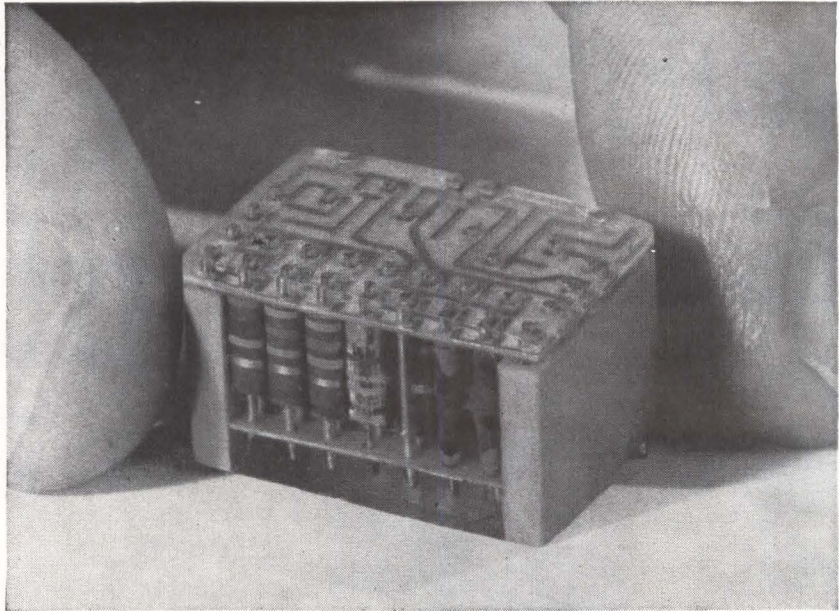

CONNECTORS make up sides of cordwood package and provide plug-in connections to other equipment. Intercon printed circuit boards on top and bottom provide wiring. Amphenol-Borg says this is only one phase of their complete interconnections-systems program

of marketing, says the conventional connector industry sales represents about 1.8 percent of the \$13 billion electronic equipment market. He estimates the potential for interconnected packages runs between 15 and 40 percent of the electronic equipment sales dollar.

Potential for interconnecting subsystems modules on one computer accounts for 33 percent of total cost.

Hall says these figures show company's systems approach will enable them to go after much broader sales market.

## Superconductor Faces Neutron Irradiation

**SUPERCONDUCTING** magnet at Wright-Patterson AFB will be exposed to neutron irradiation to find out what changes might take place in its characteristics, such as critical field and transition temperature. Magnion is now being developed by Magnion, Inc.

Eventually, it will be used for research on plasma and electrical and electromagnetic propulsion systems. It is designed to reach a field of 26,000 gauss. It will be 4 in. length and have a 2-in. ID (1½-inch work-

ing volume at room temperature).

Another Magnion superconductor has been delivered to NASA's Goddard Space Flight Center. Tests will determine the feasibility of using such devices to measure the ion composition in the lower atmosphere. It obtains a maximum field strength of over 26,000 gauss in air at room temperature in a working volume ½-in. in diameter by 8 in. long. The niobium-zirconium solenoid itself has a 2-in. ID.

A superconducting solenoid that



# CAPACITORS OF MYLAR®

# SAME PRICE RANGE

# AS PAPER

# BUT WITH EXTRA RELIABILITY

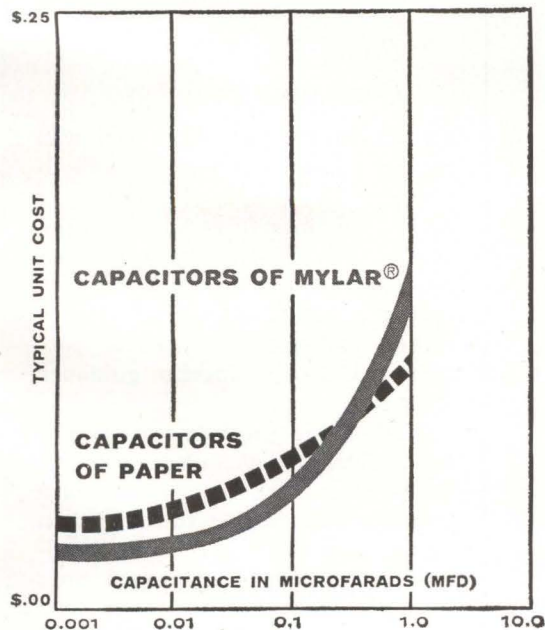

You may not realize it, but you can benefit from the higher dielectric strength, moisture resistance and reduced size of capacitors of "Mylar"\* polyester film without paying a premium price. An industry study of manufacturer prices shows THAT OVER A RANGE OF SIMILAR CAPACITANCES AND RATINGS, UNITS OF "MYLAR" COMPARE CLOSELY IN COST WITH THOSE OF PAPER.

According to a recent survey, few engineers are aware of this close price comparison . . . although they recognize the outstanding properties of "Mylar". Look into it yourself. Before specifying capacitors for your design, get this free booklet study with performance facts and price charts. Write: Du Pont Co., Film Dept., Wilmington 98, Delaware.

\*Du Pont's registered trademark for its polyester film.



REG. U. S. PAT. OFF.

BETTER THINGS FOR BETTER LIVING . . . THROUGH CHEMISTRY

only DU PONT makes

**MYLAR®**  
POLYESTER FILM

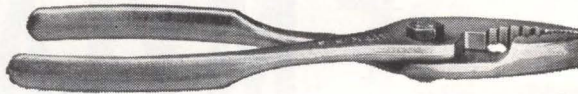

*a pair of pliers is just a pair  
of pliers... unless it's*

# UTICA

## THEN IT'S AN INSTRUMENT

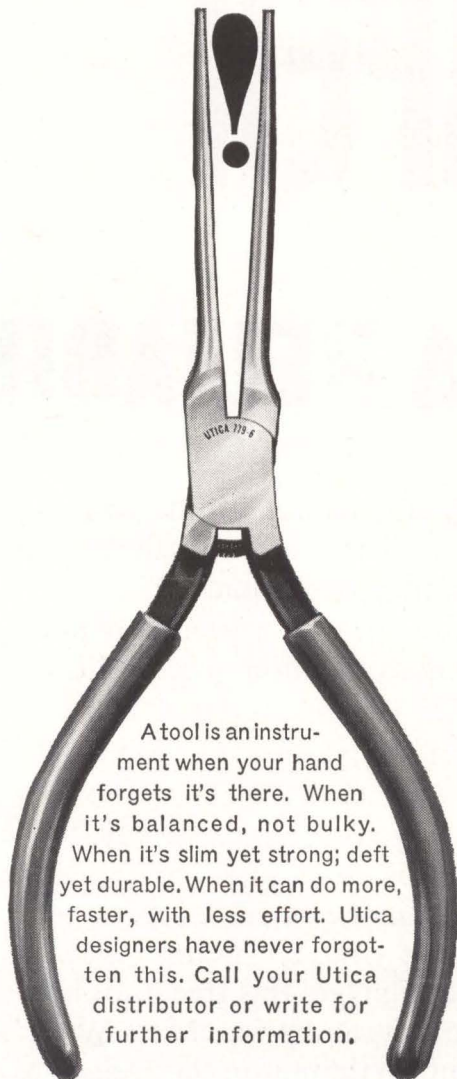

A tool is an instrument when your hand forgets it's there. When it's balanced, not bulky. When it's slim yet strong; deft yet durable. When it can do more, faster, with less effort. Utica designers have never forgotten this. Call your Utica distributor or write for further information.

# UTICA

DROP FORGE & TOOL DIVISION • KELSEY-HAYES COMPANY • ORANGEBURG, S. C.

is compensated by varying the winding density to increase uniformity of the magnetic field along its axis has been delivered to General Electric to test superconducting materials.

The niobium-zirconium solenoid, also made by Magnion, produces a peak field of 50,000 gauss. It has a 1/2-in. ID, 4-in. OD, and an active coil length of 3 in. To achieve the same degree of uniformity without compensation, the coil would have to be more than twice as long, company says.

### Increased Power For Silicon Planar Devices

TWENTY amp silicon npn power transistor will be introduced by Honeywell Semiconductor Products in a month or so. Component will be a planar, triple-diffused high-frequency high gain unit. Device is a beefed up version of Honeywell's 10 amp unit, shown last week at the IEEE show. Company will aim for big market seen in power devices of this type for d-c amplifiers, d-c a-c inverters, and rf amplifiers.

### Foam Sealant Solves Computer Problem

AN AIR-TIGHT permanent seal was required in a computer console to prevent the escape of cooling air from the interface between the cooling fan housing and the console bulkhead. The computer operates in controlled environments to collect and collate essential performance data on inertial guidance systems.

The sealing problem was reportedly solved by a foamed polyurethane plastic whose cell walls are coated with asphalt bitumen. When compressed to fit into joints, resilient Compribrand sealant grips onto joint interfaces and maintains firm adhesion in spite of movement, vibration and temperature changes.

The joint sealant combines a spongy compressible foam with an asphalt adhesive.

Recovery and expansion characteristics of the sealant can be used between any two materials. Ma-

terial has been available since 1961 but until recently has been imported from Holland. Sealant is now available from Pacific Sealants, Hawthorne, California.

## Bilateral Switch Controls Both Parts of Cycle

LAST WEEK, Transatron announced switching diode that replaces 2 controlled rectifiers. Essentially a two-lead bilateral unit, the Bi-Switch, is mounted in a top-hat rectifier package, modified for heat sinking purposes.

Specific applications are seen for motor controls, light dimmers, temperature controls and transient protection.

Initial types now in production are 200 volts, 5 amp; 200 volt 3 amp; and 200 volt one amp units, specifically designed for a-c phase control applications.

Switching diodes can also be used in transient protective circuits. At a latter date, Transatron expects to market both higher and lower voltage units.

The TBS-20A type is rated for operation up to 150 C and can carry 5 amps rms at 100 C case temperature. Control is achieved both in the negative and positive parts of the cycle due to the bilateral symmetrical nature of the switch. Hence the unit basically replaces two silicon controlled rectifiers.

## Winding for 50,000 Gauss



SUPERCONDUCTING magnet being wound at Westinghouse Electric



Photo by Reeves Instrument Corporation  
Garden City, New York

## Inland Gearless Torquers give 2-axis precision to Reeves Radar Pedestals

**Precision Radar Pedestals** . . . manufactured by Reeves Instrument Corporation, Subsidiary of Dynamics Corporation of America . . . play vital roles in major satellite and missile programs. Designed to accommodate reflectors up to 30-feet in diameter, they feature 5-second angular accuracy, azimuth load bearing ratings at 250,000 pounds and tracking rates from zero to 10 rpm in azimuth and from zero to 1/2 radian/second in elevation.

**Accurate 2-axis servo-positioning** of these Reeves Pedestals is effected by Inland Gearless Torquers ranging in torque output from 500 to 3,000 pound-feet.

**Fast, high-resolution response to servo-position error signals** is a major reason why Inland Gearless Torquers win so many missile and space-vehicle assignments. The superior performance of these direct-drive d-c torque motors comes from torque-to-inertia ratios 10 times higher than equivalent gear-train servo motors. Moreover, their compact pancake configuration meets space and weight restrictions.

**What's your problem?** If you're currently planning a servo system calling for output torque between 20 ounce-inches and 3000 pound-feet\*, compare Inland Gearless Torquers with any alternative. Write for all the facts today, 347 King Street, Northampton, Massachusetts.

\*Higher torque output levels can be provided on special order.

 **INLAND MOTOR**  
CORPORATION  
SUBSIDIARY OF **KOLLMORGEN**

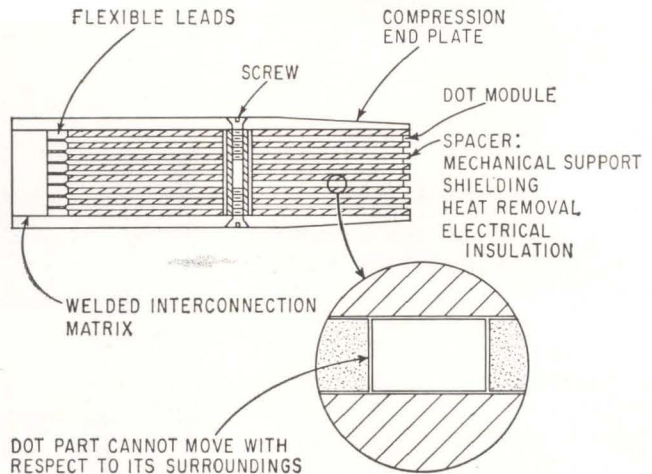
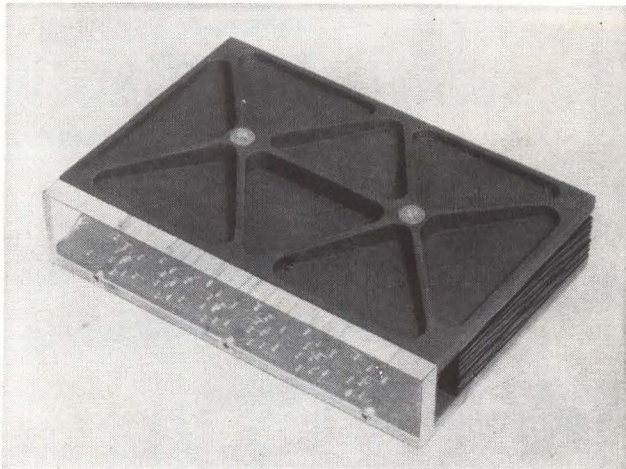

SYSTEM ASSEMBLY has welded tube matrix that acts as "book binder" and holds leads connecting thin card-shaped dot-or-pellet modules. End-plates and foil-clad balsa wood spacers provide a prestressed system structure—Fig. 1

## System Packaging Uses Book Configuration

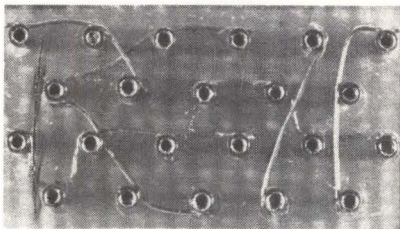

HOLLOW TUBES welded together receive module interconnecting leads that are soldered inside tubes at end of assembly procedure—Fig. 2

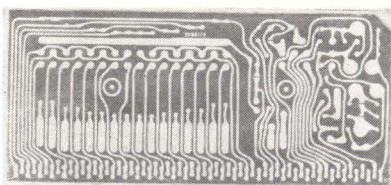
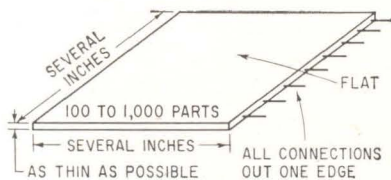

IDEALIZED module geometry decreases number of system connections (top). Dot-or-pellet components (bottom) enable desired thinness of modules—Fig. 3

*Seven thin modules hold 1,200 parts, package highly resistant to shock*

By J. R. GOODYKOONTZ  
Space Technology Laboratories, Inc.  
Redondo Beach, California

**DIGITAL** telemetry unit now being built exemplifies the system packaging uniformity attained with card-shaped dot-or-pellet modules. Previously the unit was packaged using welded cordwood modules. The new packaging concept provides advantages with respect to: reliability, fabrication ease, repairability, etc. in this particular application.

**OVERALL UNIT**—The unit (Fig. 1) consists of some 1,200 parts disposed on the 7 card-shaped modules that measure 3 inches by 6.7 inches by 0.03 inch. Made of molded epoxy, the modules are color-coded for assembly as well as for trouble shooting purposes. Intraconnections within individual modules are made with silk-screened conductive adhesive. Interconnections between

modules are brought-out along one edge of each module in the form of flexible, multistranded wires. An interconnection matrix with a horizontal-welded-tube configuration accepts those wires which are solder-connected inside tubes. Acting as a "book binder," the tube matrix provides a "book" configuration for the system package. By treating the modules as pages in a book, all parts are accessible for inspection or replacement without disconnecting any part of the system. Modules are held separate by means of foil-clad balsa wood spacers. These, together with rigid end-plates containing screws, provide a compact, prestressed structure highly resistant to shock and vibration.

**INTERCONNECTION MATRIX**—Hollow tubes making up the interconnection matrix are welded together to form the necessary interconnections (Fig. 2). The flexible leads, or pigtailed, of the modules are not placed in the tubes and soldered in place until the final assembly stage is reached.

**MODULES**—Modules should be made as large and thin as possible commensurate with limiting fac-

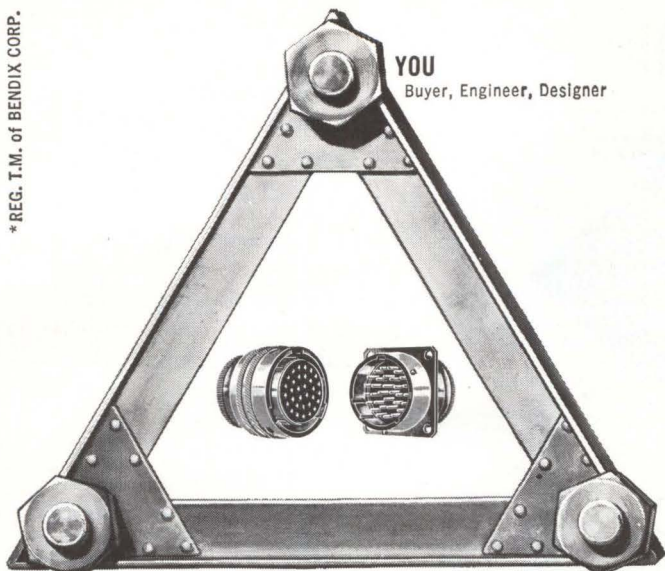

**AVNET**  
Satisfying the needs  
of you and  
the manufacturer

**MANUFACTURER**  
Bendix\* Connectors

**Avnet service is strong, solid . . .**

. . . like a triangular truss. Gives support where required, gives a rigid foundation. Rely on this strength for on-time deliveries of your emergency or prototype Bendix Connector needs. For the right support, call Avnet.



Los Angeles, Sunnyvale, Cal., Seattle, Salt Lake City, Phoenix, Chicago, Westbury, L.I., N.Y., Syracuse, N.Y., Burlington, Mass.

**AVNET**  
THE AVNET SYSTEM  
Men/Methods  
Materials/Management  
Avnet Electronics Corp.

CIRCLE 201 ON READER SERVICE CARD



**Are you a COMPLETELY INFORMED electronics engineer?**

Today you may be working in microwaves. But on what project will you be working tomorrow? You *could* have read **electronics** this past year

and kept abreast of, say, microwave technology. *There were 96 individual microwave articles between July, 1961 and June, 1962!*

But suppose tomorrow you work in some area of standard electronic components, in semiconductors, in systems? Would you be up-to-date in these technologies? Did you read the more than 3,000 editorial pages that **electronics'** 28-man editorial staff prepared last year?

**electronics** is edited to keep you current *wherever* you work in the industry, *whatever* your job function(s). If you do not have your own copy of **electronics**, subscribe today via the Reader Service Card in this issue. Only 7½ cents a copy at the 3 year rate.

**electronics**

**KINNEY . . . EVERYTHING IN VACUUM**

**TOTAL RANGE  
MAXIMUM ACCURACY**

**KINNEY VACUUM GAUGES**



**THERMOCOUPLE VACUUM GAUGE . . . MODEL KTG**

The Model KTG Thermocouple Gauge features a transistorized control circuit and printed circuit wiring, in one through six station cabinet or panel mounted units, to indicate pressures from 3000 microns to one micron. The control unit is pre-calibrated and all thermocouple tubes are matched to allow complete interchangeability without recalibrations.

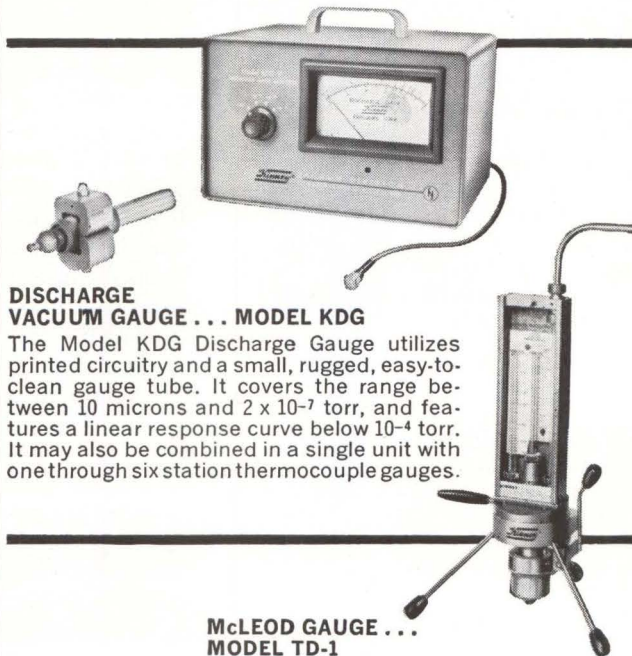

**DISCHARGE VACUUM GAUGE . . . MODEL KDG**

The Model KDG Discharge Gauge utilizes printed circuitry and a small, rugged, easy-to-clean gauge tube. It covers the range between 10 microns and  $2 \times 10^{-7}$  torr, and features a linear response curve below  $10^{-4}$  torr. It may also be combined in a single unit with one through six station thermocouple gauges.

**McLEOD GAUGE . . .  
MODEL TD-1**

The Model TD-1 McLeod Gauge accurately indicates pressures between 150 torr and one micron, easily and without adjustment. It is light weight, sturdily constructed, and more compact than most comparable gauges and is readily disassembled for cleaning.

**KINNEY VACUUM**

DIVISION THE NEW YORK AIR BRAKE COMPANY  
3529 WASHINGTON STREET • BOSTON 30, MASS.

# True Torque Control

NO MORE SCRATCHED FIXTURES



**ELECTRONIC COMPONENT MANUFACTURER USES CLECOMATIC\* BECAUSE . . .**

(1) Fragile cabinets were being marred by old fastening methods. The Model 10RSA-10 CLECOMATIC with the automatic start/stop feature has eliminated damaged screw heads, scratched cabinets and cracked surfaces.

(2) Air tool operates only while driving the fastener. Wasted air is eliminated. Parts wear drastically reduced.

If you have a trouble spot on your production line, call your nearest CLECO Representative. He can help you.

\*Fully warranted for one year by the GOLDEN CIRCLE guarantee



A DIVISION OF  
**REED ROLLER BIT COMPANY**  
 P. O. Box 2541 • Houston, Texas

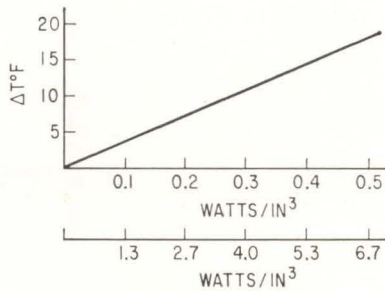
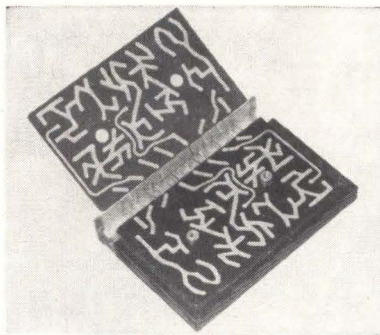

NOTE: SPACER CLAD MATERIAL  
 30 MIL ALUMINUM

**THERMAL-TEST** assembly (top) showed that with a heat-dissipation rate of 3 watts/in<sup>2</sup>, the rise within the system assembly is only 7.5 degrees F (bottom)—Fig. 4

tors such as manufacturability and cooling (Fig. 3). This helps reduce the number of necessary intraconnections and interconnections, and enables all intraconnections to be placed along one edge of each module so as to make possible the book packaging configuration. The use of dot-or-pellet components makes construction of such modules relatively simple and straightforward.

With dot-and-pellet modular construction, heat is easily removed. If the foil around the spacers is aluminum, it is virtually impossible to achieve a significant temperature rise within the assembly. This has been demonstrated by means of a thermal test assembly (Fig. 4) that detects the difference in temperature between the outer edge of a thermal spacer and the warmest region within the assembly exclusive of the heat generating parts themselves. Fig. 4 shows that with a heat-dissipation rate of 3 watts/in<sup>2</sup>, the rise within the assembly is only 7.5 degrees F.

Modules are fabricated as follows:

- Dots or pellets are placed by hand in an open mold in accord-

ance with a pattern printed on mylar and held in place by an adhesive

- The mold is then closed, turned on edge and filled with an epoxy encapsulating material
- After curing, module is removed from mold and adhesive cleaned from part terminals. To these are cemented contacts that are dot-shaped brass slugs which holds a flexible wire
- Silk screening is used to apply the conductive adhesive pattern followed by a cure. Then adhesive-backed teflon tape is applied to both sides of module, completing fabrication.

**COST**—Uniformity of dots or pellets will result in considerable assembly cost savings and make automated assembly a practical actuality. Automated assembly would make use of standard mounting cards that lend themselves to handling by low-cost automation machinery. The conductive adhesive process should be extremely inexpensive since many hundreds of connections can be made in a single operation using silk screening or stencil processes. Conductive adhesive connections have the added advantage of being "cold" so that parts cannot be damaged by thermal shock. Also, they are easily repaired during assembly or in the field.

## Welding with Microscope

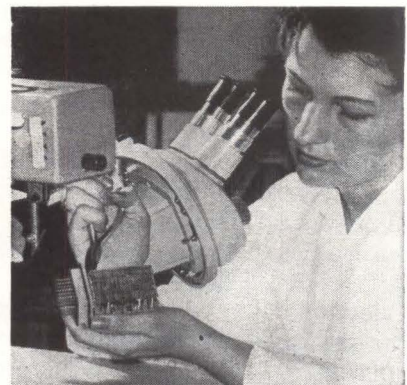

**STEREO MICROSCOPES** of 10-power magnification are used in resistance welding of 225 separate parts in a cigarette-pack sized package at Lockheed Missiles and Space Company

# System engineering for airborne weapon systems

## FIRE CONTROL SYSTEM FUNCTIONAL DESIGN

**Responsibilities:** The determination of detailed functional design requirements for complex Airborne Weapon Control Systems; system design per customer requirements; theoretical analysis of system performance and liaison assistance to engineering departments to develop equipment to fulfill system requirements.

**Experience** in one or more of these areas: **1.** System engineering involving missile or fire control systems. **2.** Field engineering on airborne systems. **3.** Test evaluation. **4.** Pulse doppler and other radar systems. **5.** Digital computer—airborne system. **6.** Inertial and microwave components. **7.** Circuit design, electrical power, armament control and IR subsystems, navigation and target tracking systems. **8.** Aircraft display and controls, human factors and electronic packaging.

**Education:** B.S. in E.E., M.E. or Physics. Applicants should be articulate in writing and communication as related to their responsibilities. U. S. citizenship required.

## MISSILE SYSTEM FUNCTIONAL DESIGN

**Responsibilities:** Determine functional design requirements for advanced air-launched missiles; the design of such systems to meet customer requirements and theoretical analysis of system performance; coordinate and assist engineering departments in the development of equipment to fulfill the system requirements.

**Experience:** Two years minimum in one or more of the following fields: **1.** System engineering on missile or fire control systems. **2.** Field engineering on airborne fire control systems or missile systems. **3.** Test and evaluation of comparable systems. **4.** Radar systems (pulse doppler). **5.** Target tracking systems. **6.** Autopilot and control systems. **7.** Microwave systems. **8.** Digital computers. **9.** Navigation systems. **10.** Inertial components. **11.** Electrical power and armament control subsystems. **12.** Circuit design and electronic packaging.

**Education:** B.S. in E.E., M.E. or Physics. Articulate in communications. U.S. citizenship required.

*For immediate consideration,  
please airmail your resume to:*

**MR. ROBERT A. MARTIN**  
Head of Employment  
Hughes Aerospace Divisions  
11940 W. Jefferson Blvd.  
Culver City 62, California

*Creating a new world with electronics*

**HUGHES**

HUGHES AIRCRAFT COMPANY  
AEROSPACE DIVISIONS

An equal opportunity employer



# Vertical Sensors Made of Glass

*Output level proportional to tilt while phase is proportional to direction*

**MANUFACTURED** by Kearfott Div., of General Precision, Inc., 1150 McBride Ave., Little Falls, New Jersey, are a series of miniature vertical sensing elements that provide an a-c output proportional to tilt around their sensitive axes. Model C70 1808 000 is a single-axis, low-cross-coupling error, damped vertical sensor that operates in either direction from level to 1 degree. Beyond this point output increases slightly until saturation at approximately 10 degrees. From here to 170 degrees, output remains constant. When tilted to near 180 degrees, output decreases to minimum. Repeatability is approximately  $\pm 3$  arc seconds. It can drive a torquer motor without use of amplifiers and can be used as a level sensor. Model C70 1809 000 is a two-axis vertical sensor that detects angular displacement about two orthogonal horizontal axes. Mechanical tilting from true horizontal

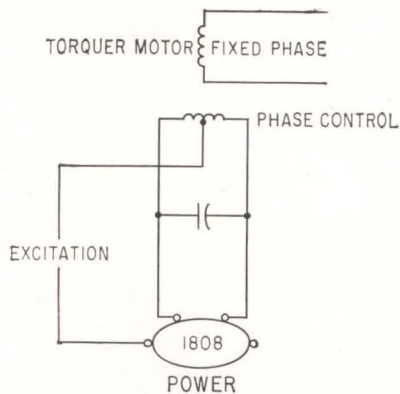

generates an a-c signal proportional to tilt angle. Output voltage phase indicates direction of tilt while output voltage level is proportional to angular displacement. It operates from null to  $\pm 1$  degree and beyond this point output increases slightly until saturation at approximately  $\pm 10$  degrees. Output remains constant to  $\pm 175$  degrees and from here to about 180 degrees, output decreases to null. Output voltage slope around the 180-degree point is sufficiently steep to prevent element stabilization that prevents inverted gimbal erection without the necessity for a gimbal brake to restrict roll axis to  $\pm 90$  degrees. This unit can also drive torquers

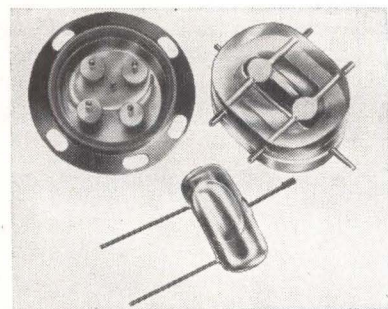
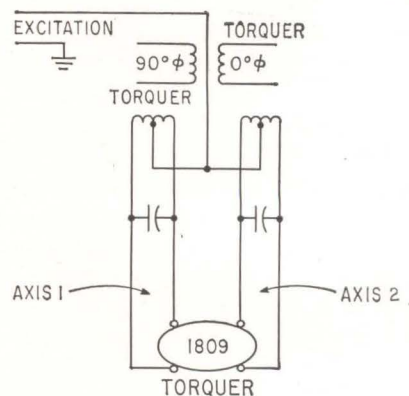

without amplification. The C70 1809 000 is approximately  $\frac{1}{8} \times \frac{3}{4} \times \frac{1}{4}$  inch and weighs 5 grams. The C70 1808 000 is approximately  $1\frac{1}{2}$ -in. in diameter,  $\frac{1}{8}$ -in. thick and weighs 15 grams.

CIRCLE 301, READER SERVICE CARD

## Lightning Warning System Gives Advance Notice

**NEWLY** developed by B. K. Sweeney Mfg. Co., 6300 East 44th Avenue, Denver 16, Colorado, the model SWE-1196 lightning warning system provides means of continuously monitoring and measuring atmospheric gradient conditions that

could produce lightning in the vicinity of missile and aircraft fueling or other hazardous explosive areas. Other methods, such as radar, have no value if the electrified clouds are free of precipitation and it is impossible to have a lightning stroke to earth without first having a rise in the potential gradient. Linear voltage gradient range is 0 to 5 Kv/m and 0 to 1 Kv/m, both negative and positive polarity; resolution and accuracy is 4 percent full scale; there are two readouts, a strip chart recorder and a contact meter; both audible and visual alarms are available; and the device

is fail-safe and self checking. The probe need not be mounted above the highest objects in the area and can be located as much as 50 miles or more from the control equipment. When the gradient exceeds the predetermined values, an audible alarm operates to warn of hazardous gradient conditions. (302)

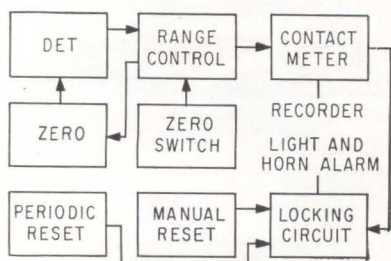

## Voltage-Variable Capacitor Goes to 500 pf 8 V

ON THE MARKET from Philco Corporation, Dept. PR-315, Lansdale,





The day when the designer selected his materials all by his lonesome is past—especially in electronics. Lots of engineers, from many departments, get into the electronics buying act with the design engineer today. Production engineers, for example, feel free to bare their fangs at any specified product they feel would snafu the production line. Procurement people growl for their freedom to respecify for the sake of better prices or delivery. Service engineers, once burned by a faulty component or subassembly, are twice shy and thrice loud about its inclusion in future equipment. And management's oxen are notoriously goreable. That's what makes electronics marketers turn gray. The advertiser today must

reach the design engineer *and* everyone else in electronics engineering. He can do so either through a passel of splinter publications, or through electronics.

Well, that's the price of progress.

electronics is the weekly, contemporary engineering publication of the modern electronics industry. It integrates the interests of 57,000 engineers in all phases and functions of electronics—the people who pass on your products before they are bought. In a field abounding with free publications, these 57,000 engineers pay up to \$6 a year to subscribe to electronics. They need electronics. You need them. Advertise in electronics.

**electronics:** your basic buy for electronics advertising | A MCGRAW-HILL PUBLICATION

330 West 42nd St., New York 36, N.Y.



Pennsylvania, the Voltacap voltage-variable capacitor has capacitance as high as 500 pf at 8 v, high Q and reverse breakdown voltage greater than 100 v. The type V-2853 has a capacitance of 47 pf at 8 v, maximum working voltage of 100 v and a Q of 100 at 50 Mc (8 v min). The V-2854 has a capacitance of 150 pf

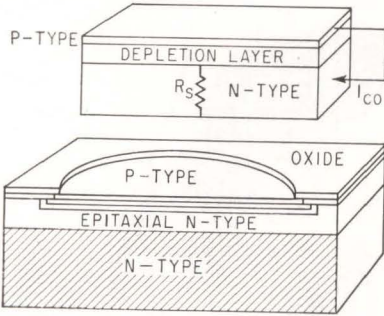

at 8 v, maximum working voltage of 100 v, and a Q of 200 at 25 Mc (8 v minimum). Devices with 8-v capacitances of 250 and 500 pf will be available in the near future. The new semiconductor combines

epitaxial growth with planar technology to control high voltage over a large semiconductor area. Design criteria (see sketch) shows use of N+ silicon layer to gain low series resistance and high Q value. An epitaxial N-type silicon of high resistivity permits high reverse breakdown voltage (large capacitance change ratio). Low leakage currents are insured by a p-n planar junction.

CIRCLE 303, READER SERVICE CARD

### Portable Meters Use Light-Beam Principle

ANNOUNCED by Weston Instruments and Electronics Div., of Daystrom, Inc., 614 Freylinghuysen Ave., Newark, New Jersey, are a series of portable taut-band suspension instruments using light-beam projection. The series include wattmeters, voltmeters and ammeters. Accuracies range from 0.1 to 0.5 percent. Units are capable of full-

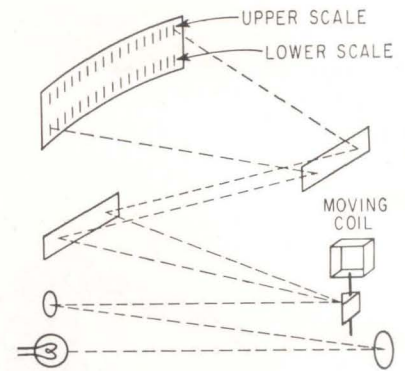

scale measurements from unity power factor down to 0.125 power factor and special ones are available capable of measuring 0.0125 units. The light-beam system is shown in the sketch. The beam originates from a lamp and is filtered through a condenser and object lens, deflected through two mirrors and reflected from a mirror driven from the meter moving-coil. This dual-face surface-type ground mirror splits the beam into two paths. One path scans an upper set of scale divisions while the other scans the

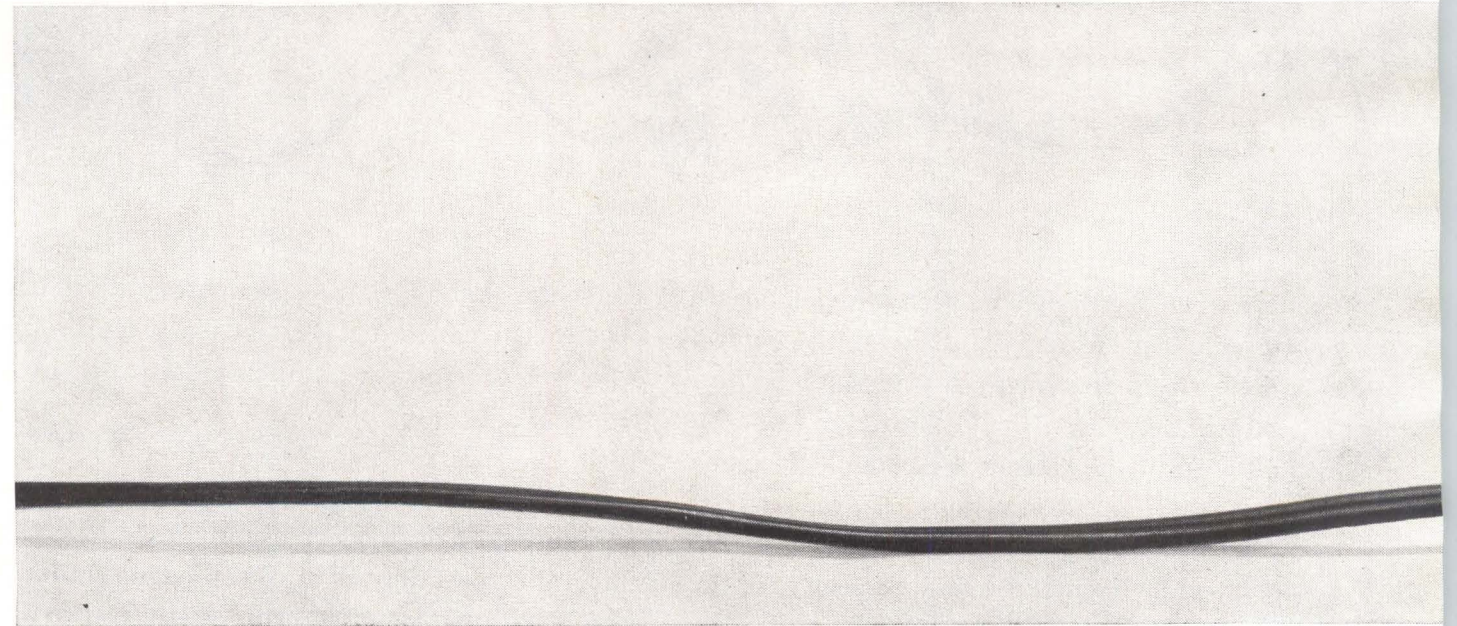

lower set. The beams are split by exactly one scale length and when at zero, only the upper scale is at zero. As the signal deflects the upper scale beam to full scale, the lower beam will come on scale. This system eliminates parallax error and the instrument can be read in daylight without screening. (304)

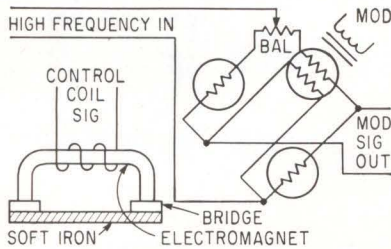

### Thin-Film Integrated Wheatstone Bridge

NEW from American Aerospace Controls, Inc., 123 Milbar Blvd, Farmingdale, New York, is a thin-film integrated magnetostrictive Wheatstone bridge circuit composed

of four MistoR magnetic, flux-sensitive resistors simultaneously deposited on the same substrate. Resistance of each bridge element is between 1,250 and 5,000-ohms in five discrete values, magnetic field density is from zero to more than 50,000 gauss, bridge element current is up to 5 ma and magnetic flux sensitivity for each bridge element is 4 percent per 1,000 gauss. Applications include modulators, displacement transducers, multipliers, signal generators, computer functions and solid-state switches. Since the device is composed of high-impedance elements, high signal output voltages are attained without amplifications when appropriate a-c or d-c excitation voltages are used. The sketch shows use in a magnetic modulator. (305)

### D-C/D-C Converters in Two Modular Types

BURROUGHS CORP., Plainfield, N.J., has developed a line of d-c to d-c

converters for operating Nixie tubes in electronic equipment where only low-level d-c power is available. Two modules which provide the required 170 v d-c output are converter modules VC12-170 and VC28-170. Former accepts 12 v d-c and the latter operates from 28 v d-c. The d-c to d-c converters can be used with miniature, standard, super and large Nixie indicator tubes. Voltage level conversion is obtained by means of a transistor oscillator, transformer and rectifier technique. (306)

### Tantalum Capacitors Have Long Life

TANSITOR ELECTRONICS, INC., West Road, Bennington, Vt. Hermetic glass-to-metal seals between terminals and case enable type R tantalum capacitors to withstand vacuum equivalent to outer space for a minimum of 2,000 hr. The rectangular units can be completely in-

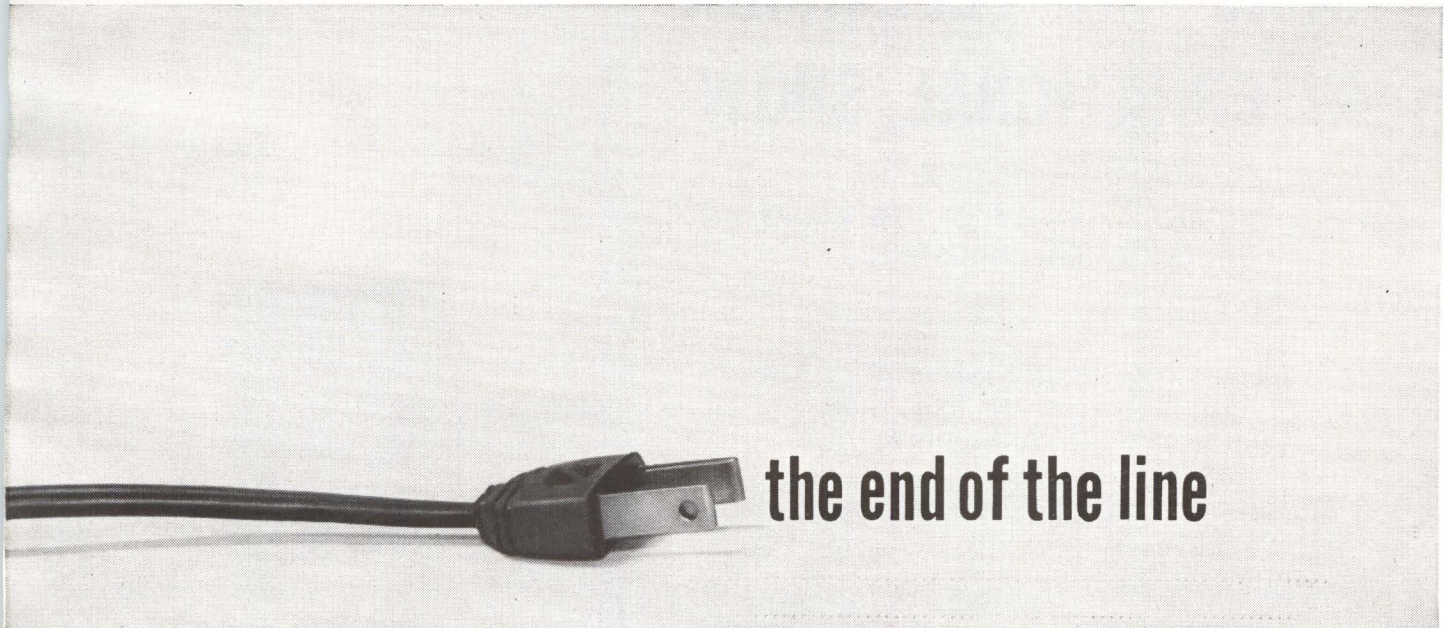

the end of the line

In just a few more years, the electric cord may become as old-fashioned as the hand crank and the kerosene lamp, for unlimited applications. Cordless power will make it so . . . the kind of power provided by Sonotone rechargeable sintered-plate, nickel-cadmium batteries. Sonotone pioneered in the field of rechargeable power, and today Sonotone batteries are used wherever high-surge/low-weight cells and batteries are required . . . in everything from Titan missiles to delicate medical instruments

to shavers and toothbrushes. If you're designing portable products, Sonotone is ready to help solve your power problems . . . no matter how difficult they may seem. Drop us a line today, stating your application requirements, and we'll send you the technical data you need. You may be surprised at how easy it is to cut the electrical cord out of your plans. **Sonotone Batteries** portable power for progress

Battery Division, Dept. B24-43, Sonotone Corporation, Elmsford, New York

Cartridges • Speakers • Tape Heads • Microphones • Headphones • Electron Tubes • Hearing Aids • Rechargeable Batteries



A MAJOR EVENT IN THE HISTORY  
OF OUR INDUSTRY

For the First Time  
an International  
Exhibition  
from September 5 to 15  
1963

at the

# RADIO AND TELEVISION INTERNATIONAL SHOW

Paris (Porte de Versailles)

THE 1st WORLD ASSEMBLY OF THE RADIO AND  
TELEVISION INDUSTRIES

REQUEST FOR FURTHER INFORMATION ON  
THE 1st RADIO AND TELEVISION  
INTERNATIONAL SHOW

Detach this coupon and mail in envelope addressed to:  
S.D.S.A., 23, rue de Lubeck, Paris 16<sup>e</sup>  
(Phone: PASSY 01-16)

(PLEASE PRINT)

NAME .....

COMPANY .....

COMPLETE ADDRESS .....

.....

PRODUCTS MANUFACTURED .....

.....

Signature:

Your company function .....

sulated between their internal components and external cases. At 125 C capacitance varies from 3  $\mu$ f at 100 v d-c in the smallest sized non-polar unit to 3,500  $\mu$ f at 10 v d-c in the largest sized polar unit. Size ranges from  $\frac{3}{4}$  in. by  $\frac{3}{4}$  in. by  $\frac{1}{2}$  in. to 1 $\frac{5}{8}$  in. by  $\frac{3}{4}$  in. by 2 $\frac{1}{2}$  in.

CIRCLE 307, READER SERVICE CARD

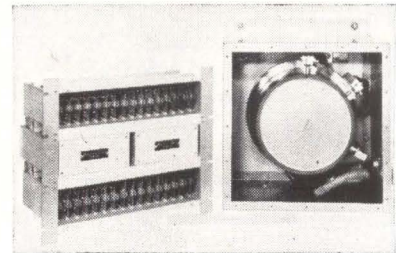

## Delay/Memory System For Process Control

ELECTRON OHIO, INC., 1111 Power Ave., Cleveland 14, O. An expanded 15 channel magnetic drum delay/memory system is available for process control to store, delay and release data in operations in which the product is in motion during manufacture, inspection or distribution. Speed range is from a low of  $\frac{1}{2}$  rpm to a present high of 600 rpm, thus providing long delays with close resolution. Recording and read heads do not contact the drum and are adjustable around circumference of drum permitting infinitely variable delays. (308)

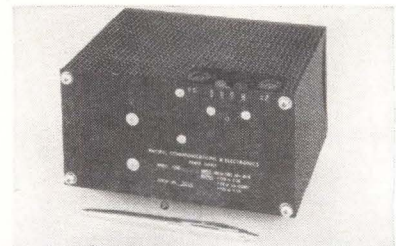

## Logic Power Supply Operates from -20 to 90 C

PACIFIC COMMUNICATIONS & ELECTRONICS, INC., 3102 Rolison Road, Redwood City, Calif. The all silicon series 3150 power supplies operate at temperatures of -20 C to 90 C without forced air cooling. All of the regulated voltage sources and loads for data processing assemblies mount in the shelf with the data equipment. A typical model provides +12 v at 3.5 amp, -12 v

at 0.5 amp and +4 v load at 2.0 amp with better than 1 percent regulation for line, load and temperature. Price is \$635. (309)

## Relays

GENERAL ELECTRIC CO., Schenectady 5, N. Y. Half-size two-pole and the four-pole Unimites feature isolated contact chambers and excellent environmental characteristics similar to the earlier and proved single-pole Unimite. (310)

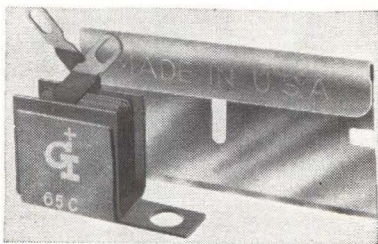

## Selenium Rectifier Features Small Size

RECTIFIER DIVISION, General Instrument Corp., 65 Gouverneur St., Newark 4, N. J., offers a low-cost, small-sized 65 ma selenium rectifier primarily intended for rectification of line voltage. Device is 0.375 in. thick and less than an inch long and wide. It incorporates a mounting bracket for easy bolting or riveting to the chassis. Maximum prv of the type GI65C is 380 v and max rms input voltage is 130 v. (311)

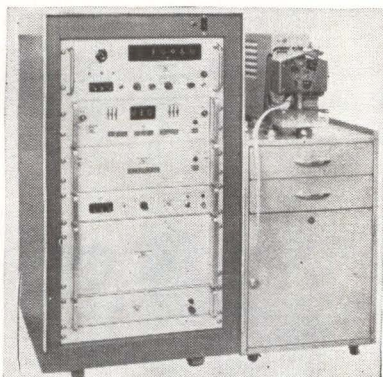

## Digital System Logs Millivolt Signals

DYMEC DIVISION, Hewlett-Packard Co., 395 Page Mill Road, Palo Alto, Calif., announces a digital data acquisition system designed to accu-

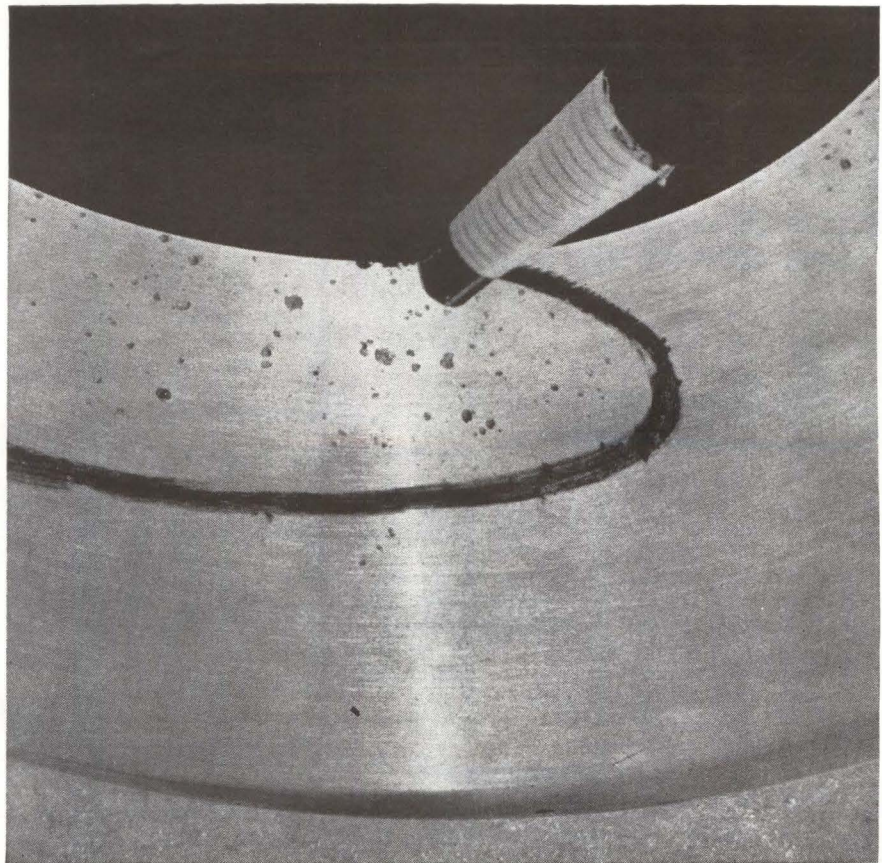

# POROSITY?

*If you machine into a flaw in a Morris Bean casting, we'll replace the casting and pay you for lost machining time.*

And no arguments. We take full responsibility for the quality of our castings. The guarantee is called the Machining Bond on Castings. If you like this way of doing business, send us a print for quotation.

Request free Resources & Capabilities booklet:  
**Morris Bean & Company**  
Yellow Springs 8, Ohio.  
aluminum & ductile iron foundries



**Magneline®**  
THE INDICATOR WITH INHERENT MEMORY

Two new series for digital readout,  
ideal for multiplex applications

**SERIES 14000—FOR SOLID STATE LOGIC**  
Character Size..... $\frac{3}{32}$ " x  $\frac{1}{4}$ "  
No. of Characters.....Up to 11  
Leads.....11 plus a common  
Watts.....2.4

**SERIES 15000—FOR RELAY LOGIC**  
Character Size..... $\frac{5}{16}$ " x  $\frac{1}{4}$ "  
No. of Characters.....Up to 10  
Leads.....5 plus a common\*  
Watts.....1.3—1.7

\*Requires switching of lead in combination with reversal of polarity to change indicator.

Units hold last reading without power. Totally enclosed, self-stacking housing for front or rear mounting. Jewel bearings, only one moving part. Standard voltages 6, 12, 24, or 28 V.D.C. Readability 12 feet at normal room lighting. Options include special voltage, special characters, and internal lighting for dark room applications.

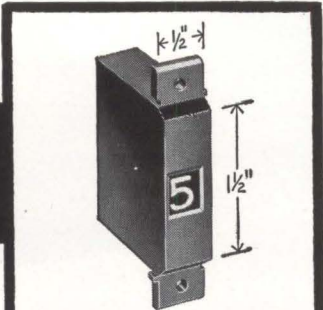

External appearance of 14000 or 15000 series

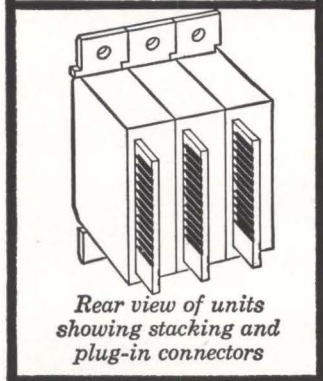

Rear view of units showing stacking and plug-in connectors

Write or teletype  
(203-753-9341)  
for free literature

**PATWIN® ELECTRONICS**  
A DIVISION OF THE PATENT BUTTON COMPANY  
WATERBURY 20, CONNECTICUT

CIRCLE 202 ON READER SERVICE CARD

**COMINCO**  
HIGH PURITY METALS  
AVAILABLE FORMS

clip and save

Product	ALUMINUM	ANTIMONY	ARSENIC	BISMUTH	CADMIUM	GOLD	INDIUM	LEAD	SILVER	TIN	ZINC
BARS	✓	✓	✓	✓	✓	✓	✓	✓	✓	✓	✓
SHEETS	✓				✓	✓	✓	✓	✓	✓	✓
WIRE	✓				✓		✓	✓		✓	✓
POWDER		✓	✓	✓	✓	✓	✓	✓	✓	✓	✓
SHOT		✓		✓	✓	✓	✓	✓	✓	✓	✓
ROD	✓			✓	✓		✓	✓	✓	✓	✓
RIBBON							✓	✓			
PRE-FORMS	✓				✓	✓	✓	✓	✓	✓	✓
SALTS					✓		✓				

**COMINCO PRODUCTS, INC.**

electronic materials division  
933 West Third Avenue, Spokane 4, Washington  
Phone Area Code 509 RI 7-7103 • TWX 509 328-1207

3602

66 CIRCLE 66 ON READER SERVICE CARD

rately measure and record information produced by multiple millivolt-level signal sources, such as thermocouples and strain gage bridges. The DY-2010G thermocouple/strain gage bridge measuring system provides high accuracy measurements in the presence of severe common mode noise. Floated and guarded input scanner, amplifier and digital voltmeter assures better than 120 db effective common mode rejection at all noise frequencies including d-c.

CIRCLE 312, READER SERVICE CARD

**I-F Amplifier Has Compact Design**

INSTRUMENTS FOR INDUSTRY, INC., Hicksville, L.I., N.Y. A 30-Mc transistorized i-f amplifier, designed for maximum compactness, maintains gain stability within 3 db, from -45 C to 72 C. (313)

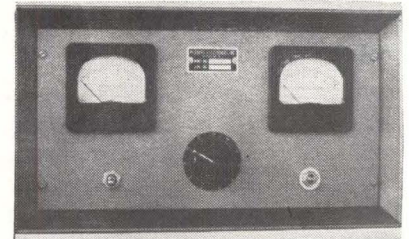

**High Potential Tester Features Reliability**

PESCHEL INSTRUMENTS INC., Route 216, Towners, Patterson, N.Y. Model S5 h-v d-c Hipot tester features both voltage and current meters, continuously adjustable output from 0 to 5,000 v d-c, with self-protecting circuit and automatically current limited to a safe value of 5 ma. It is ideal for impulse testing and capacitor charging. Price is \$179. (314)



**Actuator Has Only One Moving Part**

THERMAL HYDRAULICS, INC., 517 West 40th Ave., Denver, Colo. The

500 series actuator comes with a choice of two cases, anodized aluminum or brass. The stroke, at 30 w input, is from 0 to  $\frac{1}{2}$  in. Unit can be used with four different operating voltages—6, 12, 24 and 28 v, a-c or d-c. Thrust of the output shaft is as high as 250 lb. This type of actuator is suited for valve actuation, modulation, linear actuators, hold down, latching, unlocking, and various control applications. (315)

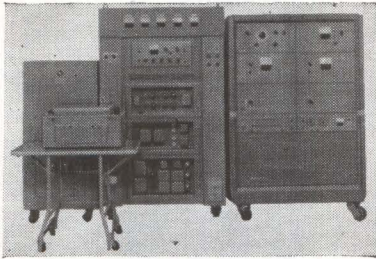

### Hysteresis Loop Tracer For Magnetic Materials

YOKOGAWA ELECTRIC WORKS, INC., 40 Worth St., New York 13, N. Y. Model SRB-32 magnetic hysteresis loop tracer is designed for graphical analysis of soft magnetic materials. It traces automatically on 7 in. by 9 $\frac{1}{2}$  in. charts: (1) magnetic hysteresis curve (B-H curve), and (2) waveforms of magnetizing force, induction and induced voltage. A complete B-H curve is recorded in 30 seconds. Curves are traced at desired frequencies between 50 cps and 10 Kc. Plottings are within an accuracy of  $\pm 2$  percent. (316)



### Pushbutton Switches In Compact Design

CHICAGO DYNAMIC INDUSTRIES, INC., 1725 Diversey Blvd., Chicago 14, Ill., announces multifunction 10-position digital and binary modular pushbutton switches. Each p-c module is manually operated by simply pressing a "O" ring sealed pushbutton. Panel portions of ex-

electronics • April 5, 1963



## The New NEMS-CLARKE® Receiver Is Easy To Change!

1. Solid State and Nuistorized
2. Modularized construction
3. Plug-in Spectrum Display
4. Meets IRIG Standards
5. Provides All Standard Modulation Modes

The new 1037 solid state modularized receiver with plug-in front end modules reduces obsolescence and affords complete frequency coverage of all authorized telemetry bands. Modular RF Tuners are available covering frequency range from 55 to 2350 mc; all IRIG IF bandwidths from 12.5 kc to 1.5 mc are available with individually matched FM discriminators. Phase lock FM demodulation and synchronous PM and AM demodulation can be added. Send today for a free brochure on the newest and most easy-to-change telemetry receiver: The Nems-Clarke 1037.

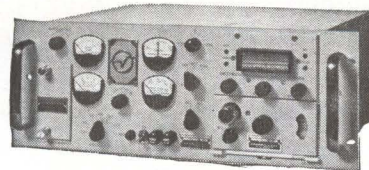

For further information, write: Dept. 550 Vitro Electronics, 919 Jesup-Blair Drive, Silver Spring, Maryland.  
Sales Offices: Houston and Los Angeles  
A Division of Vitro Corporation of America

**Vitro ELECTRONICS**

#### Specifications:

1. Nine plug-in front ends . . . (55-2350 mc)
2. IF bandwidths . . . 12.5, 25, 50, 100, 300, 500, 750, 1000, 1500 kc standard.
3. Video Filter . . . selectable cut-off frequencies of 12.5, 25, 50, 100, 300, 500, 1000 kc; attenuation slope 18db/octave
4. Demodulation FM and AM Standard; PM, Synchronous AM, and phase lock FM can be added.

CIRCLE 67 ON READER SERVICE CARD

67

**WANTED:**  
**ENGINEERS WHO**  
**KNOW THEIR WAY**  
**AROUND IN SPACE!**

**GROW WITH HONEYWELL**

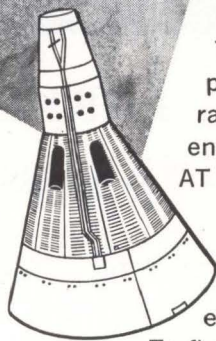

Gifted "Guidance" Engineers and Scientists are invited to consider the many advantages of a career with Honeywell in Florida. We offer a chance to build a future with a space-age leader, a chance to contribute your talent to solving the precision guidance and navigation problems of the '70s. Currently, systems and components work goes forward on Polaris, Gemini, X-20A, and Centaur. These, plus our classified projects, provide unique long range opportunities for engineers and scientists, **AT EVERY LEVEL OF EXPERIENCE!**

Along with the rewards of professional achievement you and your family will enjoy Florida's Suncoast living.

To find out how you can **GROW WITH HONEYWELL**, Send a brief note describing your education, experience and specific job interests to L. E. Ericson Honeywell, 13350 U. S. Highway 19, St. Petersburg, Florida. We promise a prompt, confidential reply.

**Honeywell**

AN EQUAL OPPORTUNITY EMPLOYER

To investigate openings at other Honeywell facilities, send resume to H. F. Eckstrom, Honeywell, Minneapolis 8, Minnesota.

posed switch are completely sealed against dust and are drip and splash proof. Two widths are available, one requiring only 1 in. panel space for digital or alpha readouts, the other 1 3/4 in. panel space for function readout. Prices begin at \$24.00.

CIRCLE 317, READER SERVICE CARD

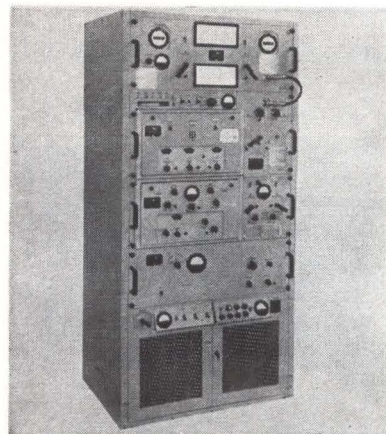

**Transmitter with a Range of 2 to 30 Mc**

MARS ELECTRONICS, Syosset, L.I., N.Y. The TR-302 is a 500-w transmitter capable of delivering full power for c-w radio telegraph, frequency shift telegraph, modulated c-w telegraph, facsimile or radio telephone over its entire frequency range. Unit may be obtained with either a synthesized variable frequency oscillator or a conventional vfo. All models have 10 crystal controlled channels. (318)



**Pressure Transducer Has Long Life**

COMPUTER INSTRUMENTS CORP., 92 Madison Ave., Hempstead, L. I., N. Y. Model 4000 carbon-film pressure transducer, with prices starting at \$125, was designed for industrial and commercial applications. It offers life in excess of 3 million cycles, depending upon cir-



cuity, with repeatability at least 10 times better than comparably priced units. Linearity can be as good as  $\pm 0.3$  percent, according to need. Practically impervious to temperature changes, the operating range is  $-55$  C to  $+85$  C. Unit can meet vibration specifications up to 5 g and 2,000 cycles; and withstand 50 g shock for 11 msec. (319)

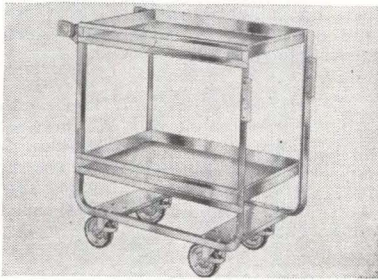

### Guard Rail Cart for Test Equipment



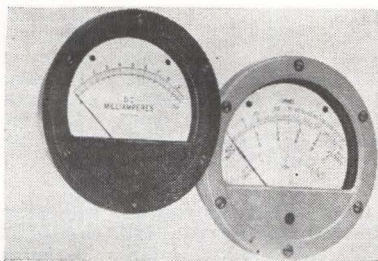



LAKESIDE MFG., INC., 1977 South Allis St., Milwaukee 7, Wisc. The heavy duty guard rail cart has Springlide casters. The Springlide, a 5 in. diameter rubber-tired wheel, is designed with a rear spray that absorbs most jar and vibrations during transporting delicate equipment. Cart is available in shelf sizes from 18 in. by 27 in. to 21 in. by 33 in. in a choice of 4 models. Prices start at \$121.25. (320)

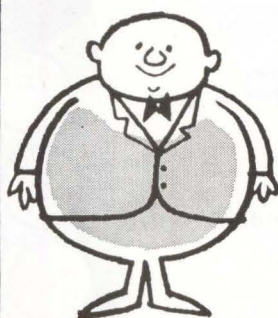
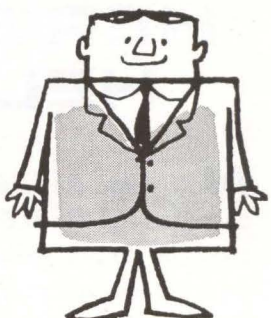

### Panel Meters Are Ruggedized, Sealed

WACLIN METERS, 35 S. St. Clair St., Dayton 2, O., offers standard and custom manufactured  $4\frac{1}{2}$  in. round, ruggedized and sealed electrical indicating panel meters suitable for a wide variety of military and commercial uses. Standard meters conform to MIL-M-10304 for size, performance and reliability. Custom meters are manufactured to similar specifications, and are tailored to meet the particular requirements of each individual user. (321)

## SUPERIOR SUPPLIES CATHODES FOR EVERY ENGINEER'S REQUIREMENTS

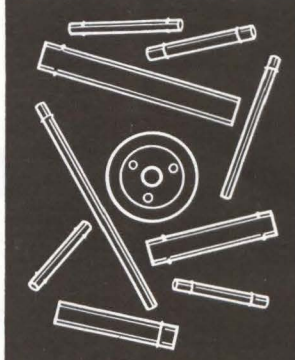
		
I want high-purity nickel	I want round shape	I want square shape
		
I want king size	I want active	I want passive
		
I want all-purpose	I want high strength	Which kind do you want?

Whatever kind of cathodes you need, Superior can supply them. For all sizes of receiving tubes, transmitting tubes, special purpose tubes. Seamless, WELDRAWN,<sup>®</sup> Lockseam,<sup>\*</sup> lapseam. Choice of over 25 different alloys. Shaped, beaded or tabbed. Disc cathodes in standard, miniature and subminiature sizes. Quality is unmatched. Fast delivery. Write for selector guide. Superior Tube Co., 2500 Germantown Avenue, Norristown, Pa. <sup>\*</sup>Manufactured under U.S. patents

# Superior Tube

The big name in small tubing  
NORRISTOWN, PA.

Johnson & Hoffman Mfg. Corp., Mineola, N.Y.

—an affiliated company making precision metal stampings and deep-drawn parts

# PRECISION TIMING A PROBLEM?

## HERE'S HELP...

New, complete catalog describes full line of Standard precision timers. Various models have scale divisions from 1/1000 sec. to 1/5 sec., totalize from .360 sec. to 60 min., are available in accuracy range from  $\pm .0002$  sec. to  $\pm .1$  sec.

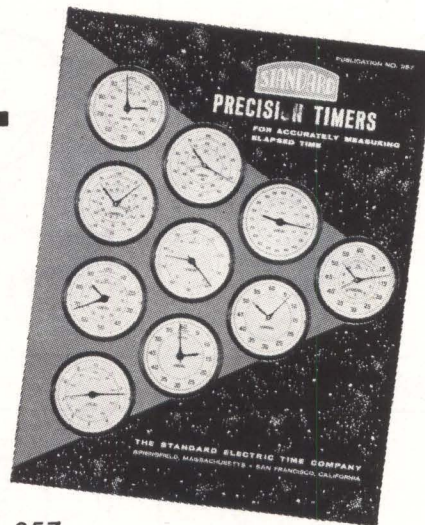

REQUEST Catalog No. 257



THE ONE TIMER WITH ALL THE FEATURES

**THE STANDARD ELECTRIC TIME COMPANY**

89 LOGAN STREET • SPRINGFIELD, MASSACHUSETTS

CIRCLE 203 ON READER SERVICE CARD

# NEW

## HIGH VOLTAGE POWER SUPPLIES

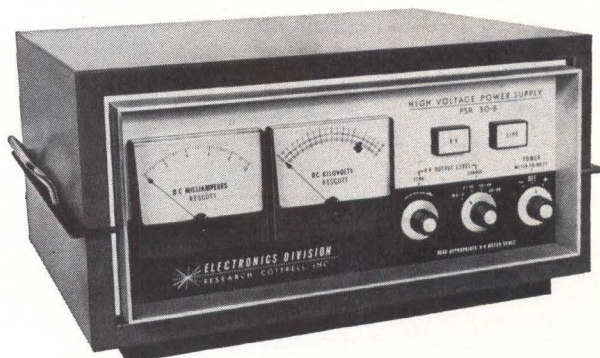

PSR Series, pictured above offer these important features: Range 5 to 30 KV, 2 to 30 MA • Regulation  $\pm .05\%$  • Ripple .1% RMS • Completely Solid State Circuitry • Light Weight • Rack Height 8 $\frac{3}{4}$ " maximum • Dry Insulation • Overload Protection • Reversible Polarity • Simplified Controls; coarse and fine voltage, ON-OFF meter reversing switch • Triple-Range Kilovoltmeter and Milliammeter. Write for New 1963 High Voltage Bulletin.



**ELECTRONICS DIVISION**

**RESEARCH-COTTRELL, INC., BOUND BROOK, NEW JERSEY**

70 CIRCLE 70 ON READER SERVICE CARD

## Literature of the Week

**PROTECTIVE COATINGS** Columbia Technical Corp., 24-30 Brooklyn-Queens Expressway West, Woodside 77, N. Y. The 1963 HumiSeal index conveniently lists different applications of protective materials. CIRCLE 322, READER SERVICE CARD

**MINIATURE BELLOWS COUPLINGS** Nilsen Mfg. Co., P. O. Box 127 Haines City, Fla., has available a data sheet describing a series of miniature bellows couplings for precision instrument drives. (323)

**TWT AMPLIFIERS** American Electronic Laboratories, Inc., 301 Richardson Road, Colmar, Pa. Bulletin 62-49 describes five types of traveling wave tube amplifiers (four octave band and one very broad band unit). (324)

**COMPUTER EVALUATION PROGRAM** Compress, Inc., 2916 V St., N. E., Washington 18, D. C. has published a brochure announcing SCERT, a new EDP Systems and Computers Evaluation and Review Technique. (325)

**DATA REDUCTION SYSTEM** The Gerber Scientific Instrument Co., P. O. Box 305, Hartford, Conn. Model GADRS —4 data reduction system is the subject of a new folder. (326)

**MAGNETOSTRICTIVE DELAY LINES** Andersen Laboratories, Inc., 501 New Park Ave., West Hartford, Conn., has published a brochure on magnetostrictive delay lines to aid digital circuit engineers. (327)

**R-F AMPLIFIER** Microwave Cavity Laboratories, Inc., 10 North Beach Ave., LaGrange, Ill., has published a data sheet on a tetrode cavity amplifier for use in the 400-450 Mc frequency range. (328)

**RESISTORS** CTS of Berne, Inc., Berne, Ind. A 12-page catalog features the complete line of Cermet high temperature variable and microminiature fixed resistors. (329)

**COMPONENT OVENS** Control Indicating Corp., Spring St. and Route 75, Windsor Locks, Conn. Technical bulletin gives complete data on series PC proportional control component ovens. (330)

**SILICON TRANSISTOR OSCILLATOR** Solid State Electronics Co., 15321 Rayen St., Sepulveda, Calif., offers a bulletin on model C-110 crystal and heater controlled silicon transistor oscillator. (331)

**PERMANENT MAGNET MANUAL** General Electric Co., Schenectady 5, N. Y., offers PM-200, a 40-page illustrated brochure on the theory, characteristics, design and application of permanent magnets. (332)

**COMPUTER BROCHURES** Digital Equipment Corp., 146 Main St., Maynard, Mass. Two brochures describe a general purpose, high speed, solid

April 5, 1963 • electronics

state computer and a systems-type computer for inter-device information control. (333)

**CODE FORMAT CONVERTER** Frederick Electronics Corp., 414 Pine Ave., Frederick, Md. Product data sheet illustrates and describes model 660 code format converter. (334)

**A/D CONVERTER** Systems Engineering Laboratories, Inc., 4066 Northeast Fifth Ave., Fort Lauderdale, Fla. Bulletin covers the ADC-1B analog-to-digital converter. (335)

**STEP-SERVO MOTORS** IMC Magnetics Corp., 6058 Walker Ave., Maywood, Calif. A 10-page booklet describes theory and operation of incremental step-servo motors. (336)

**GAS LASERS** Sylvania Electric Products Inc., 1100 Main St., Buffalo 9, N. Y., is offering a brochure describing its line of continuous wave gas lasers. (337)

**CAPACITORS** Dearborn Electronic Laboratories Inc., P. O. Box 3431, Orlando, Fla., has available a short-form data describing miniature, plastic dielectric, tubular, fixed capacitors meeting MIL-C-27287 (USAF). (338)

**ENAMELED WIRE TESTING** Brinkmann Instruments, Inc., 115 Cutter Mill Road, Great Neck, L. I., N. Y., has available a bulletin describing the Phywe Fault Counter and other testing and supervisory equipment for enameled wire. (339)

**INSTRUMENT SERVOS** North Atlantic Industries, Inc., Terminal Drive, Plainview, N. Y. Technical bulletin TB-103 is a state-of-art survey on servo data conversion. (340)

**FILTER** Microwave Development Laboratories, Inc., 15 Strathmore Road, Natick Industrial Centre, Natick, Mass. Data sheet illustrates and describes the WR137 two-cavity directional filter. (341)

**SERVO MOTOR CATALOG** Bowmar Instrument Corp., 8000 Bluffton Road, Fort Wayne, Ind. A 6-page short-form catalog provides detailed specifications dimension drawings and photo illustrations for 34 servo motors and motor-gearhead combinations. (342)

**INFRARED TRANSMITTING GLASS** Kollmorgen Corp., Northampton, Mass. Product bulletin No. 105 illustrates and describes Barr and Stroud calcium aluminate infrared transmitting glass. (343)

**ELECTRIC OVEN** Gruenberg Electric Co., Inc., 9 Commercial Ave., Garden City, N. Y., offers a bulletin describing an electric oven for paint drying, plastic curing, annealing and general baking where low heat is required. (344)

**CRYSTAL FILTERS** Hill Electronics, Inc., Mechanicsburg, Pa. Bulletin F-101 gives technical specifications on the 475-000 series of crystal filters with center frequencies of around 1.75 Mc. (345)

**MOISTURE RESISTANCE TEST** per MIL-R-10509D Characteristics C and E  
**TEMPERATURE CYCLING TEST** per MIL-R-10509D Characteristics C and E

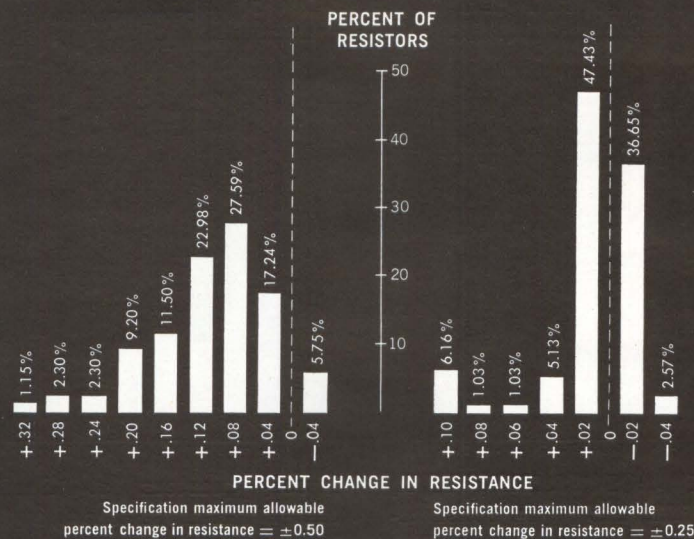

## METOHM—charts new plateaus in metal film resistor performance

### Ward Leonard reports unmatched test results

Top reliability in metal film precision resistors—highest known today—is proved in Ward Leonard's new Bulletin 50A. Ward Leonard tested over 700 resistors over a 12 month period to document these results.

Example: take two critical tests (of the 22 run)—moisture resistance and temperature cycling.

Here's the MIL Spec and the Ward Leonard Result—

Test	MIL-R-10509D Maximum Deviation	METOHM Performance
Moisture Resistance	±0.5%	−0.04 to +0.32
Temperature Cycling	±0.25%	−0.04 to +0.10

Other rigorous tests such as vibration, load life and shock show equally impressive results. In addition, each METOHM® resistor logs 7 inspections, 8 quality-control checks, and 7 tests prescribed by MIL-R-10509D and MIL-STD 202B specifications.

Write for Bulletin 50A and ask for samples—available in these ratings: RN55-1/10 W; RN60-1/8 W; RN65-1/4 W; RN70-1/2 W. For Stock Orders call your nearest Authorized Industrial Distributor. Ward Leonard Electric Co., Metal Film Division, 30 South Street, Mount Vernon, N. Y. 2.28



METAL FILM DIVISION  
**WARD LEONARD**  
**ELECTRIC CO.** MOUNT VERNON NEW YORK  
RESISTORS • RHEOSTATS • RELAYS • CONTROLS • DIMMERS

## Sanders Erecting New Facility

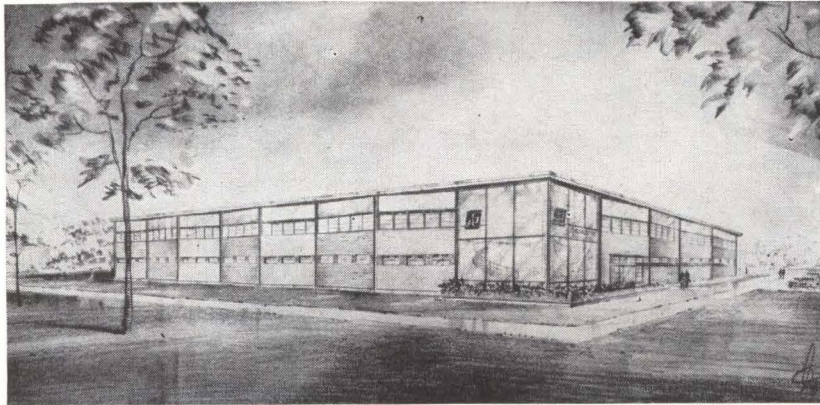

**SANDERS ASSOCIATES, INC.**, Nashua, N.H., has begun construction of a 50,000 square foot facility in Bedford, Mass. A versatile two-story plant is designed to accommodate R&D and manufacturing operations, and is scheduled for completion by August, 1963, president Royden C. Sanders, Jr., announced.

Manufacturing operations at the plant will include new production programs of Sanders - developed electronic weapon systems. These programs will be phased into production as the projects develop.

Two advanced engineering groups will also be headquartered in the new plant. The Advanced Systems Laboratories and the Corporate Advanced Program Development group, presently located in

leased quarters at Burlington, Mass., will move into the plant by late summer.

The Sanders/Bedford facility is the third new plant to be built in three years in a program of rapid expansion. During this 3-year period the company's sales volume has climbed from about \$17 million in 1960 to a current annual rate of about \$60 million.

The 12-acre land site owned by Sanders provides room for future expansion. It will accommodate up to 200,000 square feet of plant space plus supporting facilities, Sanders pointed out. Plant layout of the new facility is flexible to allow adding new sections just as fast as the need develops, he said.

The missile-electronics company has as its headquarters a 500,000

## Davis to Receive EIA Medal of Honor



**L. BERKLEY DAVIS**, a vice president of the General Electric Co. and general manager of its Electronic Components division at Owensboro, Ky., has been named to receive the Electronic Industries As-

sociation's highest award, the EIA Medal of Honor.

Presentation of the medal, given annually since 1952 for "distinguished service contributing to the advancement of the electronics industry", will be made June 19 at an annual Award Dinner during the Association's 39th Annual Convention in Chicago.

Davis was first elected president of EIA in 1960. He was chosen for a second term the following year and recently has played a leading role in Association efforts to assist the Department of Defense in developing reliability specifications for military electronics.

square foot plant in Nashua, N.H., a manufacturing facility at Manchester, N.H., and the Geospace Electronics division at Plainview, L.I., N.Y.

## Announce Formation of New Company

**FORMATION** of Microphysics Inc., a new company devoted to the application of microminiature techniques to industrial and consumer products as well as military and electronic items, is announced by Franklin Meyer, former president and board chairman of Tempo Instrument Inc.

The new company has its headquarters in Huntington, N.Y. Meyer is its president.



## National Company Names Finke

**HERBERT A. FINKE** has been named president and chief executive officer of National Company, Inc., Malden, Mass. He will also serve as a member of the executive committee of which Louis C. Lerner is chairman.

Finke was formerly vice president of Varian Associates, Inc., Bomac division, of Beverly, Mass.

## Avco Acquires New Space Facility

**AVCO CORPORATION'S** Research and Advanced Development division, Wilmington, Mass., has purchased the recently vacated Raytheon plant in Lowell, Mass. The 200,000-sq ft

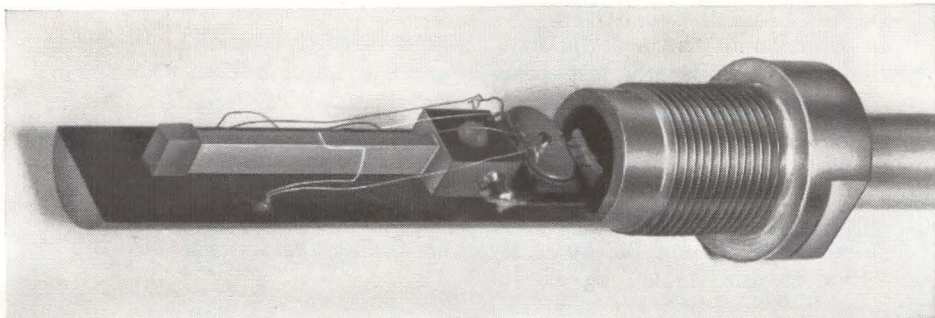

An elegant, but tiny refrigerator, utilizing the Nernst-Ettingshausen effect, has been demonstrated in the Solid State Physics Laboratories at Lockheed Missiles & Space Company. This type of cooling is applicable below 200° Kelvin, where thermoelectric cooling is no longer efficient. It shows particular promise for space application because of the reliability inherent in its all-solid state construction.

In the Nernst-Ettingshausen effect, heat is pumped as a result of an electrical current flowing in a magnetic field. The heart of the present device is a bismuth antimony single crystal. Other crystal systems are also being investigated.

This thermomagnetic cooling device is one of the results of the Lockheed research program in transport phenomena in solids.

Another investigation concerns the quantum theory of the electronic structure of crystals. An ingenious computer program has been devised for determining the essential features of the energy band structure of a wide variety of crystals. Results for a given case can be obtained in an hour or less. Conclusions drawn from the theoretical solution elucidate many of the electronic properties of crystals, and have widespread significance.

Lockheed scientists and engineers are also studying: Electron spin echo phenomena; the interaction of electrons with microwave phonons; coupled traveling waves in crystals; semiconductor lasers; antiferromagnetic resonance; various theoretical and experimental aspects of superconductivity.

#### **LOOK AT LOCKHEED...AS A CAREER**

Consider Lockheed's leadership in space technology. Evaluate its accomplishments—such as the Polaris missile, the Agena vehicle's superb record of space missions. Examine its outstanding advantages—location, advancement policies, creative climate, opportunity for recognition.

Then write for a brochure that gives you a more complete Look at Lockheed. Address: Research & Development Staff, Dept. M-45A, P.O. Box 504, Sunnyvale, California. Lockheed is an equal opportunity employer.

**SCIENTISTS & ENGINEERS:** In addition to solid state physicists and chemists, other important openings exist for specialists in: Inertial guidance • Orbit thermodynamics • Electromagnetics • Mission & trajectory analysis • Gas dynamics • Chemical & nuclear propulsion • Systems engineering • Computer research

## **LOCKHEED**

**MISSILES & SPACE COMPANY**

A GROUP DIVISION OF LOCKHEED AIRCRAFT CORPORATION

Sunnyvale, Palo Alto, Van Nuys, Santa Cruz, Santa Maria, California • Cape Canaveral, Florida • Huntsville, Alabama • Hawaii

## **LOOK AT LOCKHEED IN SOLID STATE PHYSICS:**

*Basic and applied research on the properties of solids*

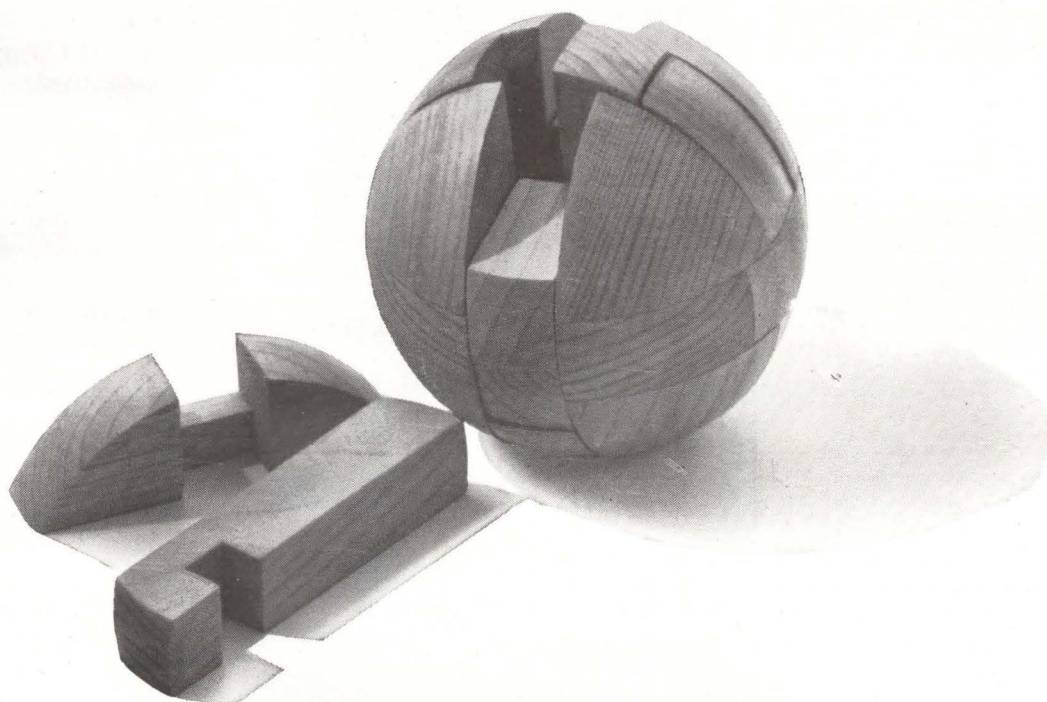



### OSCILLATIONS IN NONLINEAR SYSTEMS

**Just Out.** Deals with the theory of nonlinear oscillations for ordinary differential equations containing a small parameter. Gives a unified approach for obtaining periodic solutions of non-autonomous and autonomous differential equations. By **J. K. Hale**, Research Inst. for Adv. Studies. 192 pp., illus., \$9.00

### ELECTRONIC PROCESSES IN MATERIALS

**Just Out.** Unified approach, discussing properties based on electronic interaction in solids. Stresses the role of electrons and their behavior in various crystal structures and points out the common features of many phenomena. By **L. V. Azaroff** and **J. Brophy**, both of Illinois Inst. of Tech. 480 pp., illus., \$10.75

### PLASMA PHYSICS AND MAGNETOFLUIDMECHANICS

**Just Out.** Coordinates the many different aspects of plasma physics and magneto-fluidmechanics in a systematic and interdisciplinary manner. Especially applicable in the areas of energy conversions, propulsion, and gasdynamics of electrically conducting gases. By **A. B. Cambel**, Northwestern Univ. 320 pp., illus., \$11.50

### TUNNEL-DIODE AND SEMICONDUCTOR CIRCUITS

Practical treatment of the theory and application of semiconductor devices other than conventional transistors and diodes. Includes semiconductor circuits applied to microminiaturization of electronic equipment. Practical circuits are given, with component values. By **J. M. Carroll**, Electronics. 384 pp., 8-3/8 x 11, illus., \$9.75

## Exploring THE UNIVERSE

**Just Published.** This exciting and thought-provoking work presents the comments of 53 eminent scientists, scholars, and science writers, both ancient and modern—ranging from Aristotle to Einstein, Conant, and Huxley—on vital scientific subjects. Discusses such questions as How Was the Universe Made? Is There Other Life In It? Why Are We Exploring Space? Helps develop a truly mature understanding of the individual's role in the New Age of Science. Prepared by American Foundation for Continuing Education. 457 pp., 7 x 10, illus., \$6.95

### 10 DAYS' FREE EXAMINATION DIRECT FROM PUBLISHER

McGraw-Hill Book Co., Inc., Dept. L-4-5  
327 W. 41st St., N. Y. C. 36  
Send me book(s) checked below for 10 days' examination on approval. In 10 days I will remit for book(s) I keep, plus few cents for delivery costs, and return unwanted book(s) postpaid. (We pay delivery costs if you remit with this coupon—same return privileges.)

- Hale—Oscillations in Nonlin. Sys., \$9.00
- Azaroff & Brophy—Electronic Proc. in Matis., \$10.75
- Cambel—Plasma Phys. & Magneto-fluidmech., \$11.50
- Carroll—Tunnel-Diode & Semicon. Circ., \$9.75
- Amer. Found. for Con. Educ.—Exploring the Universe, \$6.95

(PRINT)  
Name .....  
Address .....  
City ..... Zone ..... State .....  
Company .....  
Position .....  
For price and terms outside U. S.  
Write McGraw-Hill Int'l., N. Y. C. L-4-5

building is adjacent to another Avco unit in the Lowell Industrial Park.

In addition to the new facility, the division has in the last year leased 150,000 sq ft in Lawrence; acquired 110,000 sq ft in Lowell, and added 70,000 sq ft in Wilmington to its headquarters. The Avco-Everett Research Laboratory has acquired an additional 33,750 sq ft in Everett and 11,200 sq ft in Haverhill. These plus the most recent announcement bring Avco's total space in the Boston area to over a million square feet.

Employment at the Research and Advanced Development division has grown in the past year from 3,130 to 4,342 persons. Of this increase, approximately 300 persons are working on research and engineering aspects of Avco's space programs.

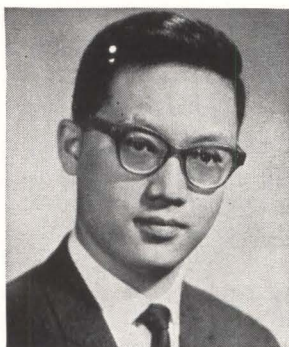

Frequency Electronics Elects John Ho

JOHN C. HO, formerly chief engineer, has been elected to the newly created post of vice president in charge of research and development at Frequency Electronics, Inc., Astoria, N. Y.

In his new position, Ho assumes full responsibility for development of quartz crystal controlled oscillators, proportional controlled ovens and complete frequency and timing control systems for military and industrial applications.

### Eitel-McCullough Appoints Bandes

HERBERT BANDES has been appointed director of research for Eitel-McCullough, Inc., San Carlos, Calif., electron power tube developers. He was formerly senior staff member with Arthur D. Little, Inc., at the

San Francisco Western Region headquarters.

In his new post, Bandes will supervise the activities of the firm's three research groups. They are advanced research headed by Oskar Heil, special studies headed by Donald H. Preist and the process and materials laboratory headed by Robert Culbertson.



ITT Names Wing a Vice President

INTERNATIONAL Telephone and Telegraph Corp. announces the election by the board of directors of A. K. Wing, Jr., as vice president-engineering of the ITT Electron Tube division.

Wing formerly was technical director-communications for ITT Federal Laboratories and has been associated with the ITT System for 22 years.



Rauland Corporation Hires Gleichauf

PAUL H. GLEICHAUF has joined The Rauland Corp., a wholly-owned subsidiary of Zenith Radio Corp., Chicago, Ill., as manager of the monochrome cathode ray tube research and development department.

Prior to joining Rauland, Gleichauf was with the General Electric Company's Electronics Laboratory in Syracuse, N.Y., for a period of

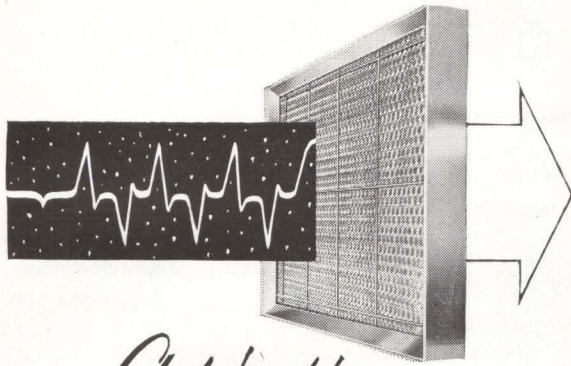

*Get both*  
**RF SHIELDING and  
 THOROUGH AIR CLEANING**

Now...any electronic package can be equipped with an air window that provides both RF shielding and air cleaning. Available in practically any size...all aluminum...washable and permanent. E Z Kleen Air Filters permit maximum air flow and minimum restriction. Ventilating air is scrubbed clean...and attenuation in excess of 50 db at 10,000 mc/s and in excess of 40 db at 1000, 10 and 1 mc/s is attained. Write for information.



RESEARCH PRODUCTS Corporation Dept. 241-D, Madison 1, Wis.  
 CIRCLE 204 ON READER SERVICE CARD

- NO Springs
- NO Wiring
- NO Soldering
- NO Mechanical Linkage
- NO Exposed Parts

AN ENTIRELY NEW  
 RELAY DESIGN

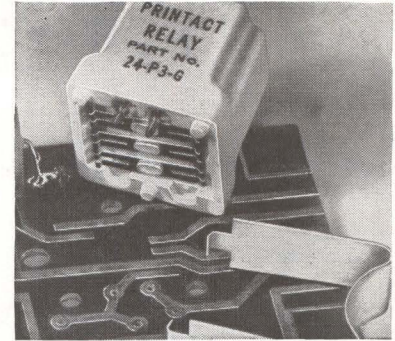

**Printact**® PERMANENT MAGNET  
 PRINTED CIRCUIT  
 PLUG-IN RELAY

PLATED CONDUCTORS ON YOUR PC BOARD  
 ARE THE FIXED CONTACTS

Many leading electronic OEMs are now saving SPACE, MONEY and MANHOURS with this new small, light weight, highly reliable PRINTACT Relay.

Available with Bifurcated Palladium, Gold-Alloy or Silver contacts for more than 5 million cycle 1, 2 or 3-pole switching. Handles up to 2 amp. res. loads. Coils from 20 to 10K ohms at 500 mw. Operating temperature -30°C to +95°C. Operate time 10 ms. The little gem is an 0.8 oz. 7/8" cube.

Quality features include: double-break contacts; balanced armature, enclosed housing, plug-in application; encapsulated coil; self-wiping contacts and inherent snap-action—and the cost is lower than you think!

Write today for additional data, prices and samples.

**Executone inc.** COMPONENTS DIVISION

47-37 Austell Place, Long Island City 1, N. Y.

CIRCLE 205 ON READER SERVICE CARD

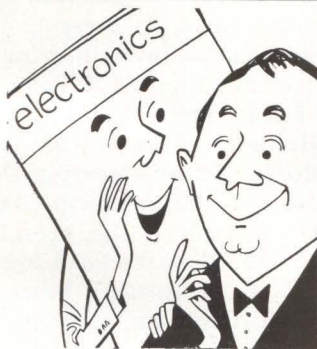

**electronics**  
 IS EDITED  
 TO KEEP YOU  
 FULLY INFORMED  
 — a "well-rounded"  
 engineer

What's your *present* job in electronics? Do you work on computers? (**electronics** ran 158 articles on computers between July, 1961 and June, 1962!) Are you in semi-conductors? (For the same period, **electronics** had 99 articles, not including transistors, solid-state physics, diodes, crystals, etc.) Are you in military electronics? (**electronics** had 179 articles, not including those on aircraft, missiles, radar, etc.)

In all, **electronics'** 28-man editorial staff provided more than 3,000 editorial pages to keep you abreast of all the technical developments in the industry. No matter where you work today or in which job function(s), **electronics** will keep you fully informed. Subscribe today via the Reader Service Card in this issue. Only 7½ cents a copy at the 3 year rate.

**electronics**

electronics • April 5, 1963

**NEW  
 MINIATURE  
 DELAY LINES**

¼ CU. INCH PER μSEC.

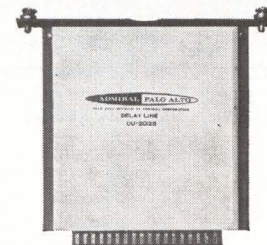

Total delay of 20.3 μsec. in  
 2 lines with 14 taps  
 Overall size 4" x 4"



- Total delay accuracy better than ½ of 1%
- Total delay to rise time ratio better than 30:1
- Distortion under 4%
- Temp. coefficients less than 50 ppm/°C

WRITE FOR DETAILS



Palo Alto Division of Admiral Corporation  
 Stanford Industrial Park, Palo Alto, California

CIRCLE 75 ON READER SERVICE CARD 75

# WHICH DEFLECTION YOKE FOR YOUR DISPLAY ?

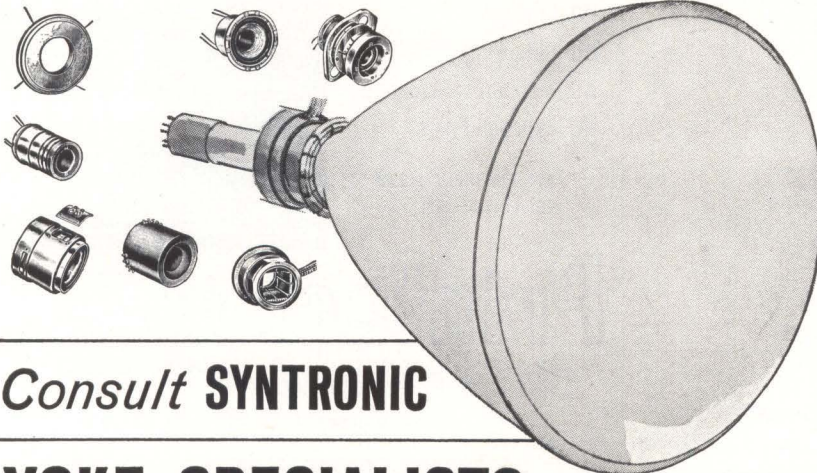

Consult **SYNTRONIC**

## YOKE SPECIALISTS

Syntronic's team of experts knows more about yoke design, engineering and quality control than anyone else. A solid 10-year record of leadership—acknowledged throughout the industry. Benefit from it.

***syntronic*** INSTRUMENTS, INC.  
100 Industrial Road, Addison, Illinois  
Phone: Kingswood 3-6444

CIRCLE 206 ON READER SERVICE CARD

## HERE IS THE WORLD'S SMALLEST MOTOR YET IT'S SO POWERFUL . . .

### MITSUMI MICRO MOTOR



MODEL MI-100

Less than 20mm in diameter, the new Mitsumi Micromotor provides a startling efficiency of over 50%, the barrier which miniature motors are not allowed to pass.

A novel construction principle helped to make this accomplishment possible. The form is more simplified by setting all the terminals at one position. Because the entire mechanism is given full protection against irregular revolution and above all, electrical noise is entirely eliminated, you may call this the most perfect micromotor yet devised. Please write for complete information on Mitsumi Micromotor, and we will send you specifications and data.



**MITSUMI PARTS**  
**MITSUMI ELECTRIC CO., LTD.**  
TOKYO • OSAKA • NEW YORK

over 10 years. For the past few years, he was a consulting engineer with GE.

### Reeves Instrument Elects Pastorino

ELECTION of E. T. Pastorino as executive vice president of Reeves Instrument Corp., Garden City, N.Y., subsidiary of Dynamics Corp. of America, is announced.

Pastorino joined Reeves in 1956, and in July, 1962, was appointed vice president for contract administration.

### PEOPLE IN BRIEF

David C. Steer promoted by Computer Sciences Corp. to head of its European offices. **Nicholas Frantzis**, formerly with Minneapolis Honeywell, elected exec v-p and appointed director of engineering for Semtran Instruments, Inc. **A. N. Bronson**, Pakco Companies, Inc., exec, appointed president of the recently acquired H. O. Boehme Co., Inc. **Charles W. Newhall, Jr.** moves up to v-p of The Marquardt Corp. Dow Corning Corp. advances three to v-p's: **R. William Caldwell**, director of engineering; **Howard N. Fenn**, director of manufacturing; and **Melvin J. Hunter**, director of research. Rocket Jet Engineering Corp. ups **John T. Soja** to v-p. **Arthur C. Davis** resigns the presidency of Sonotec Corp. to head up the new Electrical Research Products, Inc. **V. I. Robinson**, previously chief engineer, appointed director of engineering for Pacotronics, Inc. **Hugh E. Riordan** promoted to director of gyro dynamics research at General Precision's Kearfott div. **Stanley Cohen**, from chief engineer to v-p of engineering for Kollsman Motor Corp. **August F. Siemon**, Lt. Col., USAF Ret., has joined the Development div. of International Electric Corp. as senior system specialist. **Richard M. Hurst**, Brig. Gen., USA Ret., named v-p for planning at Textron's Bell Aerosystems Co. **Bertram A. Kramer**, ex-Fairchild Camera and Instrument Corp., appointed chief engineer for the Instrument & Systems section, Engelhard Industries, Inc.



# electronics

## WEEKLY QUALIFICATION FORM FOR POSITIONS AVAILABLE

### ATTENTION: ENGINEERS, SCIENTISTS, PHYSICISTS

This Qualification Form is designed to help you advance in the electronics industry. It is unique and compact. Designed with the assistance of professional personnel management, it isolates specific experience in electronics and deals only in essential background information.

The advertisers listed here are seeking professional experience. Fill in the Qualification Form below.

#### STRICTLY CONFIDENTIAL

Your Qualification form will be handled as "Strictly Confidential" by ELECTRONICS. Our processing system is such that your form will be forwarded within 24 hours to the proper executives in the companies you select. You will be contacted at your home by the interested companies.

#### WHAT TO DO

1. Review the positions in the advertisements.
2. Select those for which you qualify.
3. Notice the key numbers.
4. Circle the corresponding key number below the Qualification Form.
5. Fill out the form completely. *Please print clearly.*
6. Mail to: Classified Advertising Div., ELECTRONICS, Box 12, New York 36, N. Y. (No charge, of course).

COMPANY	SEE PAGE	KEY #
APPLIED PHYSICS LABORATORY The Johns Hopkins University Silver Spring, Maryland	78	1
ATOMIC PERSONNEL INC. Philadelphia, Penna.	78	2
HONEYWELL St. Petersburg, Fla.	68	3
INTERNATIONAL BUSINESS MACHINES CORP. Space Guidance Center Owego, New York	72*	4
ITT-INTELCOM, INC. Bailey Crossroads, Va.	72*	5
LOCKHEED MISSILES & SPACE COMPANY Div. of Lockheed Aircraft Corp. Sunnyvale, California	73	6
P 1823	78	7

\* These advertisements appeared in the March 29th issue.

(cut here)

### electronics WEEKLY QUALIFICATION FORM FOR POSITIONS AVAILABLE

(cut here)

(Please type or print clearly. Necessary for reproduction.)

#### Personal Background

NAME .....

HOME ADDRESS .....

CITY .....ZONE.....STATE.....

HOME TELEPHONE .....

#### Education

PROFESSIONAL DEGREE(S) .....

MAJOR(S) .....

UNIVERSITY .....

DATE(S) .....

#### FIELDS OF EXPERIENCE (Please Check)

4563

- |  |  |                                       |
|--|--|---------------------------------------|
| <input type="checkbox"/> Aerospace           | <input type="checkbox"/> Fire Control        | <input type="checkbox"/> Radar        |
| <input type="checkbox"/> Antennas            | <input type="checkbox"/> Human Factors       | <input type="checkbox"/> Radio—TV     |
| <input type="checkbox"/> ASW                 | <input type="checkbox"/> Infrared            | <input type="checkbox"/> Simulators   |
| <input type="checkbox"/> Circuits            | <input type="checkbox"/> Instrumentation     | <input type="checkbox"/> Solid State  |
| <input type="checkbox"/> Communications      | <input type="checkbox"/> Medicine            | <input type="checkbox"/> Telemetry    |
| <input type="checkbox"/> Components          | <input type="checkbox"/> Microwave           | <input type="checkbox"/> Transformers |
| <input type="checkbox"/> Computers           | <input type="checkbox"/> Navigation          | <input type="checkbox"/> Other .....  |
| <input type="checkbox"/> ECM                 | <input type="checkbox"/> Operations Research | <input type="checkbox"/> .....        |
| <input type="checkbox"/> Electron Tubes      | <input type="checkbox"/> Optics              | <input type="checkbox"/> .....        |
| <input type="checkbox"/> Engineering Writing | <input type="checkbox"/> Packaging           | <input type="checkbox"/> .....        |

#### CATEGORY OF SPECIALIZATION

Please indicate number of months experience on proper lines.

	Technical Experience (Months)	Supervisory Experience (Months)
RESEARCH (pure, fundamental, basic)	.....	.....
RESEARCH (Applied)	.....	.....
SYSTEMS (New Concepts)	.....	.....
DEVELOPMENT (Model)	.....	.....
DESIGN (Product)	.....	.....
MANUFACTURING (Product)	.....	.....
FIELD (Service)	.....	.....
SALES (Proposals & Products)	.....	.....

CIRCLE KEY NUMBERS OF ABOVE COMPANIES' POSITIONS THAT INTEREST YOU

1 2 3 4 5 6 7 8 9 10 11 12 13 14 15 16 17 18 19 20 21 22 23 24 25

# ELECTRONIC ENGINEERS FOR SATELLITE DESIGN PROJECTS

## TRANSIT • TRAAC • ANNA

Several Engineers are urgently needed to assist in designing memory systems for APL-developed TRANSIT, TRAAC and ANNA satellites. These are coincident current memories containing some 25,000 ferrite cores and 200 transistors driven by 1½ watts. Counting, scaling, satellite control and other functions as well as protective (fail-safe) circuits are integrated with the memories. Solutions will require many new and novel concepts.

Accepted applicants will be primarily concerned with magnetic logic and circuitry. They will collaborate closely with packaging designers to assure survival in severe launch and orbital environments. Simplified circuits, fewer components and easier fabrication leading to long life are major objectives. The positions require BS or MSEE degrees and a minimum of three years' experience in transistor circuit design for digital equipment.

A second assignment involves design, assembly and test of a small computer for shipboard doppler navigation. This is a low-speed serial device employing new and unique concepts of program control. Appointment to this group will afford an opportunity to learn magnetic design if desired. Respondents should have a BS or MS degree in EE or Physics, elementary understanding of computer logic, and experience in transistor design.

APL's modern and well equipped facilities are located an equal distance between Washington, D. C. and Baltimore, giving you a choice of country, suburban, or city living. Several nearby universities offer graduate study. Public schools in the area rate among the best in the nation.

Direct your inquiry to:  
Professional Staff Appointments

The Applied Physics Laboratory · The Johns Hopkins University

8633 Georgia Avenue, Silver Spring, Maryland  
(A residential suburb of Washington, D.C.)

An equal opportunity employer

## EMPLOYMENT OPPORTUNITIES



The advertisements in this section include all employment opportunities — executive, management, technical, selling, office, skilled, manual, etc.

Look in the forward section of the magazine for additional Employment Opportunities advertising.

### — RATES —

**DISPLAYED:** The advertising rate is \$40.17 per inch for all advertising appearing on other than a contract basis. Contract rates quoted on request.

An advertising inch is measured 7/8" vertically on a column—3 columns—30 inches to a page.

Subject to Agency Commission.

**UNDISPLAYED:** \$2.70 per line, minimum 3 lines. To figure advance payment count 5 average words as a line.

Box numbers—count as 1 line.

Discount of 10% if full payment is made in advance for 4 consecutive insertions.

Not subject to Agency Commission.

## ELECTRONIC ENGINEERS

- CAREER OPPORTUNITY
- CHALLENGING ASSIGNMENT
- TOP EARNINGS

Leading, independent research organization has a position available for a man with a BS or MS degree in Electronic Engineering. A man with experience in the development of vacuum tubes, transistor or relay circuits, or a recent outstanding college graduate will qualify. Interesting, unusual work in data transmission and retrieval and digital computing.

- NON-MILITARY WORK
- INDIVIDUAL EFFORT RECOGNIZED
- GOOD JOB SECURITY
- IDEAL WORKING CONDITIONS
- EXCELLENT EMPLOYEE BENEFIT PROGRAM
- LONG ESTABLISHED FIRM
- SPONSORED GRADUATE STUDY PROGRAM

Comfortable living in Chicago Suburban areas only minutes away.

## FORWARD YOUR RESUME IN CONFIDENCE

P-1823, Electronics  
645 N. Michigan Ave., Chicago 11, Ill.



### E. E.'s

for FEE-PAID Positions  
WRITE US FIRST!

Use our confidential application for professional, individualized service . . . a complete national technical employment agency.  
**ATOMIC PERSONNEL, INC.**  
Suite 1207L, 1518 Walnut St., Phila. 2, Pa.

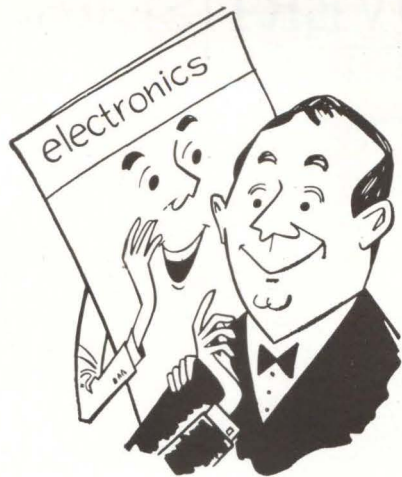

## electronics IS EDITED TO KEEP YOU FULLY INFORMED

— a "well-rounded" engineer

What's your *present* job in electronics? Do you work on computers? (**electronics** ran 158 articles on computers between July, 1961 and June, 1962!) Are you in semiconductors? (For the same period, **electronics** had 99 articles, not including transistors, solid-state physics, diodes, crystals, etc.) Are you in military electronics? (**electronics** had 179 articles, not including those on aircraft, missiles, radar, etc.)

In all, **electronics'** 28-man editorial staff provided more than 3,000 editorial pages to keep you abreast of all the technical developments in the industry. No matter where you work today or in which job function(s), **electronics** will keep you fully informed. Subscribe today via the Reader Service Card in this issue. Only 7½ cents a copy at the 3 year rate.

# electronics

### SEARCHLIGHT SECTION

(Classified Advertising)

BUSINESS OPPORTUNITIES  
EQUIPMENT - USED or RESALE

#### DISPLAYED RATE

The advertising rate is \$27.25 per inch for all advertising appearing on other than a contract basis. Contract rates quoted on request. AN ADVERTISING INCH is measured ⅜ inch vertically on one column, 3 columns—30 inches—to a page. EQUIPMENT WANTED or FOR SALE ADVERTISEMENTS acceptable only in Displayed Style.

#### UNDISPLAYED RATE

\$2.70 a line, minimum 3 lines. To figure advance payment count 5 average words as a line.

PROPOSALS, \$2.70 a line an insertion.

BOX NUMBERS count as one line additional in undisplayed ads.

DISCOUNT OF 10% if full payment is made in advance for four consecutive insertions of undisplayed ads (not including proposals).

#### RADIO RESEARCH INSTRUMENT CO.

AUTO-TRACK & TELEMETRY ANTENNA PEDESTALS  
3 & 10 CM. SCR. 564 AUTOTRACK RADARS.  
AN/TPS-1D SEARCH. AN/TPS-10 HT. FINDERS.  
AN/FPN-32GCA. AN/APS-10 NAVIG. & WEATHER.  
AN/APS-15B PRECISION. AN/APS-35B PRECISION.  
AN/APS-31A SEARCH. DOZENS MORE.  
S-1-2 MEGAWATT HIGH POWER PULSERS.

RADIO RESEARCH INSTRUMENT CO.  
550 Fifth Ave., New York Judson 6-4691

RADAR SYSTEMS & COMPONENTS/ IMMEDIATE DELIVERY

CIRCLE 950 ON READER SERVICE CARD

#### SPECIAL SERVICES

Technical Writing And Editing—Save time and energy; let us finish the rough draft of your article or book. Write for details. The Literary Forge, Port Republic, N. J.

## LOOKING FOR

USED/SURPLUS ELECTRONIC  
EQUIPMENT/COMPONENTS?

For an up-to-date listing of such equipment see Searchlight Section of March 8th issue.

## PROFESSIONAL SERVICES

GIBBS & HILL, Inc.  
Consulting Engineers

Systems Engineering  
Operations Research • Development  
Field Studies • Design • Procurement  
Power • Transportation • Communications  
Water Supply • Waste Treatment

393 Seventh Avenue New York 1, N. Y.

# INDEX TO ADVERTISERS

• AMP Incorporated .....	6	Kinney Vacuum Div. of New York Air Brake Co. ....	57	Texas Instruments Incorporated Industrial Products Group.....	23
Admiral Corp. ....	75	Kintel A Division of Cohu Electronics Inc. ....	3rd cover	• Tung-Sol Electric, Inc.....	5
Allen-Bradley Co. ....	13	• Litton Industries Electron Tube Division.....	25	• Utica Drop Forge & Tool Division, Kelsey-Hayes Co.....	54
Ampex Corporation .....	21	Lockheed Missiles & Space Co.....	73	• Vitro Electronics .....	67
• Avnet Electronics Corp.....	47, 57	• Magnetic Shield Division of Perfection Mica Co.....	25	• Ward Leonard Electric Co.....	71
Bean & Co., Morris.....	65	Mallory and Co., P. R.....	51	■	
Cleco Division of Reed Roller Bit Co.....	58	McGraw-Hill Book Co. ....	74	PROFESSIONAL SERVICES .....	79
Cominco Products, Inc. ....	66	Metronix, Inc. ....	24	CLASSIFIED ADVERTISING	
Cubic Corp. ....	14, 15	Mitsumi Electric Co., Ltd.....	76	F. J. Eberle, Business Mgr.	
duPont de Nemours & Co., Inc. E. I. .	53	• North Atlantic Industries, Inc.....	50	EMPLOYMENT OPPORTUNITIES... ..	78
Electro Instruments Inc.....	28	Patwin Electronics .....	66	SPECIAL SERVICE .....	79
Executone, Inc. ....	75	• Perfection Mica Co. Magnetic Shield Div.....	25	EQUIPMENT	
F. N. I. E. Radio-Television Show....	64	• Potter Instrument Co., Inc.....	17	(Used or Surplus New)	
• General Electric Co.....	10, 11	Princeton Applied Research Corp.....	20	For Sale .....	79
• Hewlett-Packard Company .....	Inside front cover	• Radio Corporation of America...4th cover		INDEX TO CLASSIFIED ADVERTISERS	
Honeywell .....	68	Research-Cottrell, Inc. Electronics Div. ....	70	Applied Physics Laboratory.....	78
Houston Instrument Corp.....	26, 27	Research Products Corp.....	75	Atomic Personnel Inc.....	78
Hughes Aircraft Co. Aerospace Divisions .....	59	• Rixon Electronics, Inc.....	19	• Radio Research Instrument Co.....	79
• Inland Motor Corp. Sub. of Kollmorgen.....	55	Sonotone Corp. Battery Div. ....	62, 63	■	
• Kepco, Inc. ....	49	Sprague Electric Co.....	4, 9	• See advertisement in the July 25, 1962 issue of Electronics Buyers' Guide for complete line of products or services.	
		Standard Electric Time Co., The.....	70		
		• Superior Tube Co.....	69		
		• Syntronic Instruments, Inc.....	76		

## electronics



Audit Bureau  
of Circulation



Associated Business  
Publications

Audited Paid Circulation

**JAMES T. HAUPTLI**

Advertising Sales Manager

**BEN ANELLO**

Market Services Manager

**DAVID CUNNIFF**

Promotion Manager

■  
**Electronics Buyers' Guide**

**R. S. QUINT**  
General Manager

■  
**RICHARD J. TOMLINSON**  
Business Manager

### ADVERTISING REPRESENTATIVES

#### ATLANTA (9):

Michael H. Miller, Robert C. Johnson  
1375 Peachtree St. N.E., Trinity 5-0523  
(area code 404)

#### BOSTON (16):

William S. Hodgkinson, Donald R. Furth  
McGraw-Hill Building, Copley Square,  
Congress 2-1160 (area code 617)

#### CHICAGO (11):

Harvey W. Wernecke, Robert M. Denmead  
645 North Michigan Avenue, Mohawk 4-5800  
(area code 312)

#### CLEVELAND (13):

Paul T. Fegley  
55 Public Square, Superior 1-7000  
(area code 216)

#### DALLAS (1):

Frank Le Beau  
The Vaughn Bldg., 1712 Commerce St.  
Riverside 7-9721 (area code 214)

#### DENVER (2):

John W. Patten  
Tower Bldg., 1700 Broadway,  
Alpine 5-2981 (area code 303)

#### HOUSTON (25):

Joseph C. Page, Jr.  
Prudential Bldg., Halcombe Blvd.,  
Riverside 8-1280 (area code 713)

#### LOS ANGELES (17):

Ashley P. Hartman, John G. Zisch,  
William C. Gries  
1125 W. 6th St., Huntley 2-5450  
(area code 213)

#### NEW YORK (36):

Donald H. Miller, Henry M. Shaw,  
George F. Werner  
500 Fifth Avenue, LO-4-3000  
(area code 212)

#### PHILADELPHIA (3):

Warren H. Gardner, William J. Boyle  
6 Penn Center Plaza, LOcust 8-4330  
(area code 215)

#### SAN FRANCISCO (11):

Richard C. Alcorn  
255 California Street, Douglas 2-4600  
(area code 415)

#### LONDON W1:

Edwin S. Murphy Jr.  
34 Dover St.

#### FRANKFURT/Main:

Matthé Herfurth  
85 Westendstrasse

#### GENEVA:

Michael R. Zeynel  
2 Place du Port

#### TOKYO:

George Olcott,  
1, Kotohiracho, Shiba, Minato-ku

which of these

13

KIN TEL instruments  
does your standards  
lab need?

Used in leading standards labs  
throughout the country, they may  
supply the exact degree of accuracy,  
stability, range, and versatility  
your applications demand.

CERTIFIED

#### STANDARDS

**1. DC Voltage Standard (Model 303A).** So accurate, so stable, you can use it to calibrate any digital voltmeter. Lets you control output from 0 to over  $\pm 1100$  volts in steps as small as 1 microvolt. Accurate to within 0.01% of the dial setting; stable to within 0.005%. Floating guarded circuit. Price: \$2995.

**2. AC Voltage Standard (Model 601A).** Output is 1 to 501 volts RMS AC, adjustable in 0.1 volt steps and between steps by a multi-turn potentiometer. Voltage accuracy is 0.1%, short term stability is 0.01%. Ideal for calibrating AC measuring instruments, designing servo or gyro equipment, evaluating magnetic properties. Price: \$4500.

**3. Programable DC Voltage Standard (Model 313).** You can select voltages—automatically and in any sequence—from 0 to  $\pm 1111.1110$  volts, with 0.01% accuracy and in steps as small as 1 microvolt. Parallel entry, 1-2-4-4 binary-coded-decimal signals. Stability: less than 0.005% for 30 days. Price: \$3995. Remote control unit available. Price: \$500.

**4. DC Voltage Standard and Null Voltmeter (Model 301).** Has an accuracy of 0.02% and stability of 0.01%. Measures and supplies DC from 1 to 501 volts. Price: \$995. Available in 1 to 502 volts (Model 302) with 0.01% accuracy, 0.002% stability. Price: \$1280.

Write for detailed literature or a demonstration of any of these exceptional instruments. Representatives in all major cities. All prices FOB, San Diego, Calif. (Additional export charge.)

#### VOLTMETERS

**5. AC/DC Digital Voltmeter (Model 502B).** Gives you DC accuracy within 0.01% of reading; over-ranging on both AC and DC; automatic ranging and remote (programable) control. Measures DC between  $\pm 100$  microvolts and  $\pm 1000$  volts, AC from 30 cps to 10 kc between 1 millivolt and 1000 volts. Four-digit readout. Price: \$4245. Available as a DC digital voltmeter only (Model 501B). Price: \$2995. Either of above models available with Zener diode reference source.

**6. DC Digital Voltmeter/Ratiometer (Model 507D).** Measures voltages between  $\pm 100$  microvolts and  $\pm 1000$  volts, ratios between  $\pm 0.0001:1$  and  $\pm 999.9:1$  with 0.01% (of reading)  $\pm 1$  digit accuracy. \$3835.

**7. AC/DC Digital Voltmeter/Ratiometer (Model 551).** Measures DC voltages between 0.0000 and  $\pm 999.99$ , ratios between  $.00000:1$  and  $\pm 99.999:1$ . Measures AC with optional plug-in AC converter from less than 30 to more than 10,000 cps between 0.0000 and 999.99 volts RMS. Accuracies: DC, 0.005% of full scale +0.005% of reading; AC, 0.05% of full scale +0.05% of reading; ratios, 0.005% of full scale +0.001% of reading. Price (without AC converter and readout): \$4150.

**8. DC Digital Voltmeter (Model 864A).** High speed, solid-state with basic DC voltage range of 0.000 to  $\pm 9.999$ ; plug-in accessories extend DC voltage measurement from .0000 to  $\pm 999.9$ . Accuracy: 0.02% of full scale +0.01% of reading ( $23^{\circ}\text{C} \pm 1^{\circ}\text{C}$ ); better than 0.05% of full scale ( $10^{\circ}$  to  $40^{\circ}\text{C}$ ). Price: \$3180.

**9. Militarized Digital Voltmeter (Model 412).** Rugged, programable, differential. Auto range, polarity. Measures AC and  $\pm$ DC potentials between 0.001 and 999.9 volts. Accuracy is 0.01% (of reading)  $\pm 1$  digit for DC, 0.1% of full scale for AC. Designed to MIL-E-4158A. Price: \$10,000.

#### LABORATORY INSTRUMENTS

**10. Meter Calibrators.** Provide voltages and currents calibrated in absolute units. Long term stability is  $\pm 0.01\%$ . Use as accurate reference, as wide range null voltmeters, as secondary voltage and current standards. Price: \$1150. to \$2995.

**11. Electronic Galvanometer and Amplifier (Model 204A).** A combination DC null detector, linear deflection indicator, microvolt ammeter, and inverting DC amplifier. Accurate measurement of voltages from 1 microvolt to 10 volts or currents from 100 microamperes to 1 milliampere at a constant input resistance of 10,000 ohms. Price: \$425.

**12. DC Microvolt Ammeter and Amplifier (Model 203A).** Drift-free stability, high input impedance. Measures voltages from 100 microvolts to 1000 volts, full scale; 19 current ranges cover from 1 millimicroampere to 1 ampere, full scale. 3% accuracy. Price: \$750.

**13. DC Microvoltmeter and Amplifier (Model 202B).** Provides high sensitivity, drift-free stability, high input impedance. Fourteen voltage ranges cover from 300 microvolts to 1000 volts, full scale. Measures as little as 10 microvolts. Price: \$500.



5725 Kearny Villa Road  
San Diego 12, California  
Phone 277-6700  
(Area Code 714)

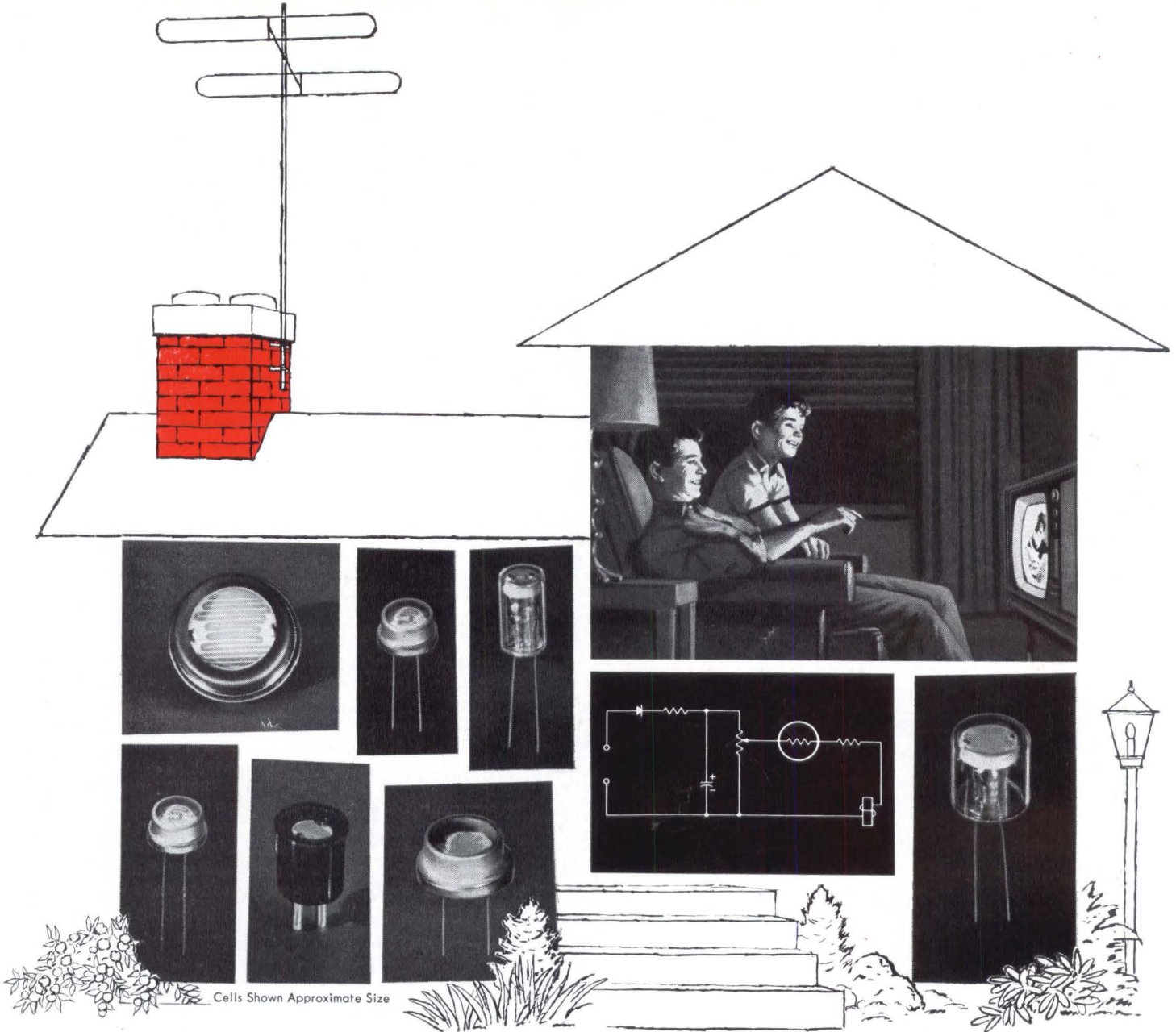

# RCA PHOTOCONDUCTIVE CELLS

Wide Choice of Types Offers Design Flexibility for Automatic Light-Operated Control of Home Appliances

RCA now offers designers of light-operated controls the industry's widest selection of cadmium sulfide photoconductive cells. These solid-state photocells are extensively used in TV brightness controls, pilot-flame monitoring in home heating systems, in automatic yard lighting control, and in burglar and other alarm systems.

To meet the high quality standards found in other RCA electron devices, these sturdy RCA photocells provide high photocurrents which in most applications are capable of operating relays directly.

The line includes a wide variety of glass or glass-metal types which provide choice and flexibility of mounting arrangements. For individual applications, cells can be customized to meet your electrical and mechanical requirements. Booklet 1CE-261, "RCA Photocells," contains technical information on RCA's line of photoconductive cells, including schematic diagrams of representative circuits. For your copy, see your RCA Industrial Tube Representative or write: Section D-19-Q-1, Commercial Engineering, RCA Electron Tube Division, Harrison, N. J.

RCA Type	Volts DC or Peak AC	Power Dissipation Watts		Photo-current (ma)	Volts	Illumination Foot Candles	Photocurrent (ma)	
		Contin-uous	Demand*				Min.	Max.
4403	250	0.3	0.75	50	50	1	7	16
4404	600	0.3	0.75	50	50	1	2.5	5
4448	600	0.3	0.75	50	50	1	1.5	4
4453	600	0.3	0.75	50	50	1	3	7
7163	600	0.3	0.75	50	50	1	1	3
4423	250	0.2	—	20	50	1	1.5	4
4424	110	0.2	—	50	12	1	3.6	14.5
4425	110	0.2	—	50	12	1	3.6	14.5
SQ2500	250	0.2	—	20	12	1	0.24	0.80
4402	200	0.05	—	5	12	10	1.6	—
4413	110	0.05	—	5	12	10	1.0	2.75
7412	200	0.05	—	1	12	1	0.065	0.275
7536	200	0.05	—	1	12	1	0.065	0.275
6694A	150	0.03	—	—	90	30	0.057	0.65

\*The demand rating may be utilized for a period of 20 minutes each time twice every 24 hours.



The Most Trusted Name in Electronics

**Industrial Tube Products Field Offices:** OEM SALES: Newark 2, N. J., 32-36 Green St., (201) 485-3900. Chicago 54, Ill., Suite 1154, Merchandise Mart Plaza, (312) 527-2900. Los Angeles 22, Calif., 6801 E. Washington Blvd., (213) RA 3-8361. GOVERNMENT SALES: Harrison, N. J., 415 South Fifth St., (201) 485-3900. Dayton 2, Ohio, 224 N. Wilkinson St., (513) BA 6-2366. Washington 6, D. C., 1725 "K" St., N.W., (202) FE 7-8500. INTERNATIONAL SALES: RCA International Div., Clark, N. J., (201) 382-1000.