

## ***OWNER'S MANUAL***

Operation  
Maintenance  
Specifications

All information in this Owner's Manual is current at the time of publication. However, HYUNDAI Auto Canada Corp. reserves the right to make changes at any time so that our policy of continual product improvement may be carried out.

This manual applies to all HYUNDAI models and includes descriptions and explanations of optional as well as standard equipment. As a result, you may find material in this manual that does not apply to your specific vehicle.

\* Trademarks and tradenames owned in Canada by HYUNDAI Auto Canada Corp. which carries on business as HYUNDAI Auto Canada.

## **CAUTION: MODIFICATIONS TO YOUR HYUNDAI**

Your HYUNDAI should not be modified in any way. Such modifications may adversely affect the performance, safety or durability of your HYUNDAI and may, in addition, violate conditions of the limited warranties covering the vehicle. Certain modifications may also be in violation of regulations established by the Department of Transportation and other government agencies in your country.

## **TWO-WAY RADIO OR CELLULAR TELEPHONE INSTALLATION**

Your vehicle is equipped with electronic fuel injection and other electronic components. It is possible for an improperly installed/adjusted two-way radio or cellular telephone to adversely affect electronic systems. For this reason, we recommend that you carefully follow the radio manufacturer's instructions or consult your HYUNDAI dealer for precautionary measures or special instructions if you choose to install one of these devices.

## SAFETY AND VEHICLE DAMAGE WARNING

This manual includes information titled as DANGER, WARNING, CAUTION and NOTICE. These titles indicate the following:

### DANGER

**DANGER** indicates a hazardous situation which, if not avoided, will result in death or serious injury.

### CAUTION

**CAUTION** indicates a hazardous situation which, if not avoided, could result in minor or moderate injury.

### WARNING

**WARNING** indicates a hazardous situation which, if not avoided, could result in death or serious injury.

### **NOTICE**

**NOTICE** indicates a situation which, if not avoided, could result in vehicle damage.

## INTRODUCTION

Congratulations, and thank you for choosing HYUNDAI. We are pleased to welcome you to the growing number of discerning people who drive HYUNDAIs. We are very proud of the advanced engineering and high-quality construction of each HYUNDAI we build.

Your Owner's Manual will introduce you to the features and operation of your new HYUNDAI. To become familiar with your new HYUNDAI, so that you can fully enjoy it, read this Owner's Manual carefully before driving your new vehicle.

This manual contains important safety information and instructions intended to familiarize you with your vehicle's controls and safety features so you can safely operate your vehicle.

This manual also contains information on maintenance designed to enhance safe operation of the vehicle. It is recommended that all service and maintenance on your car be performed by an authorized HYUNDAI dealer. HYUNDAI dealers are prepared to provide high-quality service, maintenance and any other assistance that may be required.

This Owner's Manual should be considered a permanent part of your vehicle, and should be kept in the vehicle so you can refer to it at any time. The manual should stay with the vehicle if you sell it to provide the next owner with important operating, safety and maintenance information.

## HYUNDAI AUTO CANADA

### CAUTION

**Severe engine and transaxle damage may result from the use of poor quality fuels and lubricants that do not meet HYUNDAI specifications. You must always use high quality fuels and lubricants that meet the specifications listed on Page 8-7 in the Vehicle Specifications section of the Owner's Manual.**

Copyright 2019, HYUNDAI Auto Canada Corp. All rights reserved. No part of this publication may be reproduced, stored in any retrieval system or transmitted in any form or by any means without prior written permission of HYUNDAI Auto Canada Corp.

All trademarks and tradenames owned in Canada by HYUNDAI Auto Canada Corp.

## GUIDE TO HYUNDAI GENUINE PARTS

### 1. What are HYUNDAI Genuine Parts?

HYUNDAI Genuine Parts are the same parts used by HYUNDAI Motor Company to manufacture vehicles. They are designed and tested for the optimum safety, performance, and reliability for our customers.



### 2. Why should you use genuine parts?

HYUNDAI Genuine Parts are engineered and built to meet rigid manufacturing requirements. Damage caused by using imitation, counterfeit or used salvage parts is not covered under the HYUNDAI New Vehicle Limited Warranty or any other HYUNDAI warranty.

In addition, any damage to or failure of HYUNDAI Genuine Parts caused by the installation or failure of an imitation, counterfeit or used salvage part is not covered by any HYUNDAI Warranty.

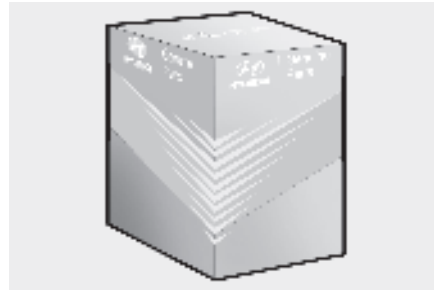

### 3. How can you tell if you are purchasing HYUNDAI Genuine Parts?

Look for the HYUNDAI Genuine Parts Logo on the package (see below).

HYUNDAI Genuine Parts exported are packaged with labels written only in English.

HYUNDAI Genuine Parts are only sold through authorized HYUNDAI Dealerships.

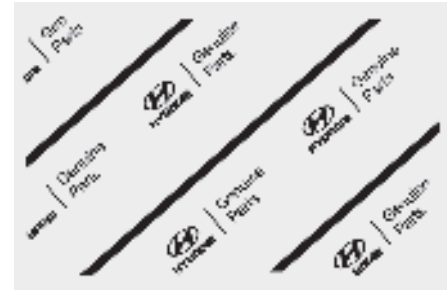

### HOW TO USE THIS MANUAL

We want to help you get the greatest possible driving pleasure from your vehicle. Your Owner's Manual can assist you in many ways. To gain an overview of the contents of your Owner's Manual, use the Table of Contents in the front of the manual. The first page of each Chapter includes a detailed Table of Contents of the topics in that Chapter.

To quickly locate information about your vehicle, use the Index in the back of the manual. It is an alphabetical list of what is in this manual and the page number where it can be found.

For your convenience, we have incorporated tabs on the right-hand page edges. These tabs are coded with the Chapter titles to assist you with navigating through the manual.

### SAFETY MESSAGES

Your safety, and the safety of others, is very important. This Owner's Manual provides you with many safety precautions and operating procedures. This information alerts you to potential hazards that may hurt you or others, as well as damage to your vehicle.

Safety messages found on vehicle labels and in this manual describe these hazards and what to do to avoid or reduce the risks.

Warnings and instructions contained in this manual are for your safety. Failure to follow safety warnings and instructions can lead to serious injury or death.

Throughout this manual DANGER, WARNING, CAUTION, NOTICE and the SAFETY ALERT SYMBOL will be used.



This is the safety alert symbol. It is used to alert you to potential physical injury hazards. Obey all safety messages that follow this symbol to avoid possible injury or death. The safety alert symbol precedes the signal words DANGER, WARNING and CAUTION.

#### DANGER

**DANGER** indicates a hazardous situation which, if not avoided, will result in death or serious injury.

#### WARNING

**WARNING** indicates a hazardous situation which, if not avoided, could result in death or serious injury.

 **CAUTION**

**CAUTION** indicates a hazardous situation which, if not avoided, could result in minor or moderate injury.

**NOTICE**

**NOTICE** indicates a situation which, if not avoided, could result in vehicle damage.

**FUEL REQUIREMENTS**

Your new vehicle is designed to obtain maximum performance with UNLEADED FUEL, as well as minimize exhaust emissions and spark plug fouling.

Your new vehicle is designed to use only unleaded fuel having an octane number ((R+M)/2) of 87 (Research Octane Number 91) or higher. (Do not use methanol blended fuels)

**NOTICE**

**To prevent damage to the engine and engine components, never add any fuel system cleaning agents to the fuel tank other than what has been specified.**

**Consult an authorized HYUNDAI dealer for additional information.**

 **WARNING**

- **Do not "top off" after the nozzle automatically shuts off when refueling.**
- **Always check that the fuel cap is installed securely to prevent fuel spillage in the event of an accident.**

***Gasoline containing alcohol or methanol***

Gasohol, a mixture of gasoline and ethanol (also known as grain alcohol) are being marketed along with or instead of leaded or unleaded gasoline. For example, "E15" is a gasohol comprised of 15% ethanol and 85% gasoline.

Do not use gasohol containing more than 15% ethanol, and do not use gasoline or gasohol containing any methanol. Either of these fuels may cause drivability problems and damage to the fuel system, engine control system and emission control system.

Discontinue using gasohol of any kind if drivability problems occur.

"E85" fuel is an alternative fuel comprised of 85 percent ethanol and 15 percent gasoline, and is manufactured exclusively for use in Flexible Fuel Vehicles. "E85" is not compatible with your vehicle. Use of "E85" may result in poor engine performance and damage to your vehicle's engine and fuel system. HYUNDAI recommends that customers do not use fuel with an ethanol content exceeding 15 percent.

### **NOTICE**

**To prevent damage to your vehicle's engine and fuel system:**

- **Never use gasohol which contains methanol.**
- **Never use gasohol containing more than 15% ethanol.**
- **Never use leaded fuel or leaded gasohol.**
- **Never use "E85" fuel.**

**Your New Vehicle Limited Warranty does not cover damage to the fuel system or any performance problems caused by the use of "E85" fuel.**

### ***Using Fuel Additives (except Detergent Fuel Additives)***

Using fuel additives such as:

- Silicone fuel additive
  - Ferrocene (iron-based) fuel additive
  - Other metallic-based fuel additives
- may result in cylinder misfire, poor acceleration, engine stalling, damage to the catalyst, or abnormal corrosion, and may cause damage to the engine resulting in a reduction in the overall life of the powertrain.
- The Malfunction Indicator Lamp (MIL) may illuminate.

### **NOTICE**

**Damage to the fuel system or performance problem caused by the use of these fuels or fuel additives may not be covered by your New Vehicle Limited Warranty.**

### ***Gasoline containing MMT***

Some gasoline contains harmful manganese-based fuel additives such as MMT (Methylcyclopentadienyl Manganese Tricarbonyl).

HYUNDAI does not recommend the use of gasoline containing MMT.

This type of fuel can reduce vehicle performance and affect your emission control system.

The malfunction indicator lamp on the cluster may come on.

### ***Detergent Fuel Additives***

HYUNDAI recommends that you use good quality gasolines treated with detergent additives such as TOP TIER Detergent Gasoline, which help prevent deposit formation in the engine. These gasolines will help the engine run cleaner and enhance performance of the Emission Control System. For more information on TOP TIER Detergent Gasoline, please go to the website ([www.toptiergas.com](http://www.toptiergas.com)).



For customers who do not use TOP Tier Detergent Gasoline regularly, and have problems starting or the engine does not run smoothly, detergent-based fuel additives that you can purchase separately may be added to the gasoline. If TOP TIER Detergent Gasoline is not available, one bottle of additive added to the fuel tank at every 12,000 km (7,500 miles) or 12 months is recommended.

Additives are available from your authorized HYUNDAI dealer along with information on how to use them. Do not mix other additives.

### ***Operation in foreign countries***

If you are going to drive your vehicle in another country, be sure to:

- Observe all regulations regarding registration and insurance.
- Determine that acceptable fuel is available.

## **VEHICLE MODIFICATIONS**

- This vehicle should not be modified. Modification of your vehicle could affect its performance, safety or durability and may even violate governmental safety and emissions regulations.

In addition, damage or performance problems resulting from any modification may not be covered under warranty.

- If you use unauthorized electronic devices, it may cause the vehicle to operate abnormally, wire damage, battery discharge and fire. For your safety, do not use unauthorized electronic devices.

## **VEHICLE BREAK-IN PROCESS**

By following a few simple precautions for the first 1,000 km (600 miles) you may add to the performance, economy and life of your vehicle.

- Do not race the engine.
- While driving, keep your engine speed (rpm, or revolutions per minute) between 2,000 rpm and 4,000 rpm.
- Do not maintain a single speed for long periods of time, either fast or slow. Varying engine speed is needed to properly break-in the engine.
- Avoid hard stops, except in emergencies, to allow the brakes to seat properly.

### VEHICLE DATA COLLECTION AND EVENT DATA RECORDERS

This vehicle is equipped with an event data recorder (EDR). The main purpose of an EDR is to record, in certain crash or near crash-like situations, such as an air bag deployment or hitting a road obstacle, data that will assist in understanding how a vehicle's systems performed. The EDR is designed to record data related to vehicle dynamics and safety systems for a short period of time, typically 30 seconds or less. The EDR in this vehicle is designed to record such data as:

- How various systems in your vehicle were operating;
- Whether or not the driver and passenger safety belts were buckled/ fastened;
- How far (if at all) the driver was depressing the accelerator and/or brake pedal; and,
- How fast the vehicle was traveling.

These data can help provide a better understanding of the circumstances in which crashes and injuries occur. **NOTE:** EDR data are recorded by your vehicle only if a non-trivial crash situation occurs; no data are recorded by the EDR under normal driving conditions and no personal data (e.g., name, gender, age, and crash location) are recorded. However, other parties, such as law enforcement, could combine the EDR data with the type of personally identifying data routinely acquired during a crash investigation.

To read data recorded by an EDR, special equipment is required, and access to the vehicle or the EDR is needed. In addition to the vehicle manufacturer, other parties, such as law enforcement, that have the special equipment, can read the information if they have access to the vehicle or the EDR.

## TABLE OF CONTENTS

Your Vehicle at a Glance	1
Safety System of Your Vehicle	2
Convenient Features of Your Vehicle	3
Infotainment System	4
Driving Your Vehicle	5
What to Do in an Emergency	6
Maintenance	7
Specifications	8
Index	I

## Hybrid System Overview

HEV (Hybrid Electric Vehicle) System.....	H2	Driving the Hybrid/Plug-in Hybrid Vehicle .....	H28
Hybrid Vehicle.....	H2	Starting the Vehicle.....	H28
PHEV (Plug-in Electric Vehicle) System.....	H3	Special Features.....	H29
Plug-in Hybrid Vehicle.....	H3	Hybrid System Gauge .....	H31
Charging the Plug-in Hybrid Vehicle.....	H4	Plug-in Hybrid Mode (Plug-in hybrid vehicle).....	H32
Charging Information .....	H4	Aux. Battery Saver+ (Plug-in hybrid vehicle) .....	H33
Charging Types .....	H4	Warning and Indicator Lights .....	H35
Charging Time Information.....	H4	LCD Display Messages.....	H36
Charging Status .....	H5	Energy flow.....	H45
Charging Connector AUTO/LOCK Mode .....	H6	Safety Precautions for Hybrid System .....	H49
Scheduled Charging.....	H7	High Voltage Battery System.....	H49
Charging Precautions.....	H8	Safety Plug.....	H52
AC Charge .....	H9	High Voltage Battery Cooling Duct .....	H53
Trickle Charge.....	H15	If an Accident Occurs.....	H54
Action to be taken when charging stops abruptly...H27		When the Hybrid Vehicle Shuts Off .....	H55

## HEV (HYBRID ELECTRIC VEHICLE) SYSTEM

### Hybrid Vehicle

The HYUNDAI Hybrid Electric Vehicle (HEV) uses both the gasoline engine and the electric motor for power. The electric motor is run by a high-voltage HEV battery.

Depending on the driving conditions, the HEV computer selectively operates between the engine and the electric motor or even both at the same time.

Fuel efficiency increases when the engine is off at idle, or when the vehicle is driven by the electric motor with the HEV battery.

The HEV battery charge must be maintained, so at times the engine will come on even at idle to act as a generator. Charging also occurs when decelerating or by regenerative braking.

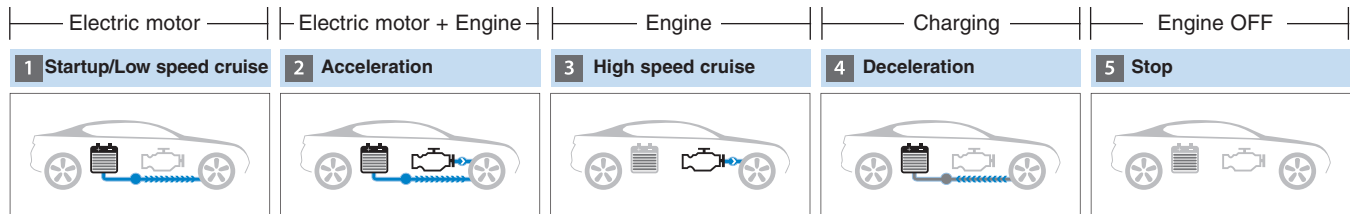

OAE056066

# PHEV (PLUG-IN ELECTRIC VEHICLE) SYSTEM

## Plug-in Hybrid Vehicle

The HYUNDAI Plug-in Hybrid Electric Vehicle (PHEV) shares the characteristics of both a conventional hybrid electric vehicle and an all-electric vehicle.

When used as a conventional hybrid electric vehicle, the HEV computer selectively operates between the engine and the electric motor or even both at the same time.

When it is operating in the electric vehicle mode, the vehicle is driven only using the electric motor over a certain distance until the hybrid battery becomes low. The driving distance in EV mode depends on customer driving style and road conditions. Aggressive driving maneuvers may at times temporarily enable the engine to operate for maximum power.

The hybrid battery can be fully charged by connecting a plug to an external electric power source.

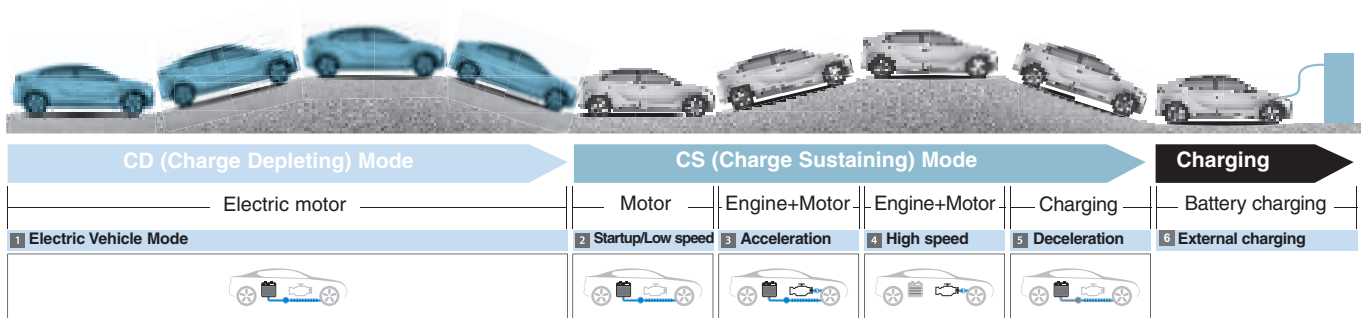

OAEPH057200L

## CHARGING THE PLUG-IN HYBRID VEHICLE

### Charging Information

- **AC Charge :**

The plug-in hybrid vehicle is charged by plugging into a AC charger installed in your home or a public charging station. (For further details, refer to the 'AC Charge'.)

- **Trickle Charge :**

The plug-in hybrid vehicle can be charged by using household electricity. The electrical outlet in your home must comply with regulations and can safely accommodate the Voltage / Current (Amps) / Power (Watts) ratings specified on the portable charge.

### Charging Time Information







- **AC Charge :**

Takes approximately 2 hours 15 minutes at room temperature. (Can be charged to 100%.)

- **Trickle Charge :**

For charging at home. Please note that Trickle Charger is slower than the AC Charger

### Charging Types

Category	Charging Inlet (Vehicle)	Charging Connector	Charging Outlet	How to Charge	Charging Time
AC Charge	 CAEEQ016020	 OLFP0Q5006K	 OLFP0Q4057N	Use AC charger installed in homes or public charging station	Approx. 2 hours 15 minutes (to fully charge, 100%)
Trickle Charge	 CAEEQ016020	 OLFP0Q5006K	 CAEEQ016024	Use household current	For charging at home. Please note that Trickle Charger is slower than the AC Charger.

- Depending on the condition and durability of the high voltage battery, charger specifications, and ambient temperature, the time required for charging the high voltage battery may vary.
- Actual charger image and charging method may vary in accordance with the charger manufacturer.

## Charging Status



When charging the high voltage battery, the charge level can be checked from outside the vehicle.

Operation of Charging Indicator Lamp			Details	
(1)	(2)	(3)		
○ (OFF)	○ (OFF)	○ (OFF)	Not Charged	
Blink	○ (OFF)	○ (OFF)	Charging	0~33%
● (ON)	Blink	○ (OFF)		34~66%
● (ON)	● (ON)	Blink		67~99%
● (ON)	● (ON)	● (ON)	Fully charged (100%)(turns OFF in 5 seconds)	
Blink	Blink	Blink	Error while charging	
○ (OFF)	○ (OFF)	Blink	Charging the 12 V auxiliary battery (Aux. Battery Saver+)	
○ (OFF)	Blink	○ (OFF)	- Reserved charging is operating (turns OFF after 3 minutes) - Charging is temporarily interrupted (e.g. power failure)	



## CHARGING THE PLUG-IN HYBRID VEHICLE (CONT.)

### Charging Connector AUTO / LOCK Mode

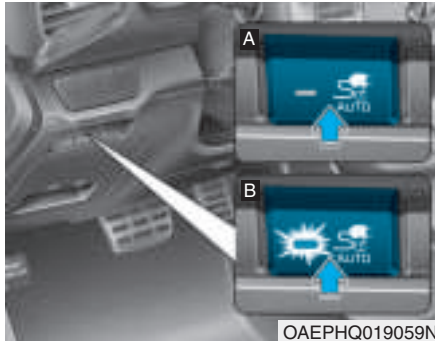

[A]: LOCK mode

[B]: AUTO mode

You may select when the charging connector can be locked and unlocked in the charging inlet.

Press the  button to change between AUTO mode and LOCK mode.

### When the Charging Connector is Locked

	LOCK	AUTO
Before charging	O	X
While charging	O	O
Finished charging	O	X

- LOCK mode (button indicator off) :  
The connector locks when the charging connector is plugged into the charging inlet. The connector is locked until all doors are unlocked by the driver. This mode can be used to prevent charging cable theft.
  - If the charging connector is unlocked when all doors are unlocked, but the charging cable is not disconnected within 15 seconds, the connector will be automatically locked again.
  - If the charging connector is unlocked when all doors are unlocked, but all doors are locked again, immediately, the connector will be automatically locked again.

- AUTO mode (button indicator on) :  
The connector locks when charging starts. The connector unlocks when charging is complete. This mode can be used when charging in a public charging station.

## Scheduled Charging (if equipped)

- You can set-up a charging schedule for your vehicle using the infotainment system or BlueLink application.

Refer to the infotainment system manual or the BlueLink manual for detailed information about setting scheduled charging.

- Scheduled charging can only be done when using a AC charger or the portable charger (ICCB: In-Cable Control Box).



- When scheduled charging is set and the AC charger or the portable charger (ICCB: In-Cable Control Box) is connected for charging, the indicator lamp in the middle blinks (for 3 minutes) to indicate that scheduled charging is set.
- When scheduled charging is set, charging is not initiated immediately when the AC charger or portable charger (ICCB: In-Cable Control Box) is connected. When immediate charging is required, use the infotainment system to deactivate the scheduled charge setting or press scheduled charging deactivation (⏸) button.



- If you press the scheduled charging deactivation (⏸) button to immediately charge the battery, charging must be initiated 3 minutes after the charging cable has been connected.

When you press the scheduled charging deactivation (⏸) button for immediate charging, the scheduled charge setting is not completely deactivated. If you need to completely deactivate the scheduled charge setting, use the infotainment system to finalize the deactivation.

Refer to "AC Charge or Trickle Charge" for details about connecting the AC charger and the portable charger (ICCB: In-Cable Control Box).

## CHARGING THE PLUG-IN HYBRID VEHICLE (CONT.)

### Charging Precautions

#### ■ AC Charger



Actual charger image and charging method may vary in accordance with the charger manufacturer.

#### **⚠ WARNING**

- Electromagnetic waves that are generated from the charger can seriously impact medical electric devices such as an implantable cardiac pacemaker.

When using medical electric devices such as an implantable cardiac pacemaker, make sure to ask the medical team and manufacturer whether charging your electric vehicle will impact the operation of the medical electric devices such as an implantable cardiac pacemaker.

- Check to make sure there is no water or dust on the charging cable connector and plug before connecting to the charger and charging inlet. Connecting while there is water or dust on the charging cable connector and plug may cause a fire or electric shock.

#### **⚠ WARNING**

- Be careful not to touch the charging connector, charging plug, and the charging inlet when connecting the cable to the charger and the charging inlet on the vehicle.
- Comply with the following in order to prevent electrical shock when charging:
  - Use a waterproof charger.
  - Be careful when touching the charging connector and charging plug with your hands wet, or when standing in water or snow while connecting the charging cable.
  - Be careful when there is lightning.
  - Be careful when the charging connector and plug is wet.

## **⚠ WARNING**

- Immediately stop charging when you find abnormal symptoms (odor, smoke).
- Replace the charging cable if the cable coating is damaged to prevent electrical shock.
- When connecting or removing the charging cable, make sure to hold the charging connector handle and charging plug. If you pull the cable itself (without using the handle), the internal wires may disconnect or get damaged. This may lead to electric shock or fire.

## **⚠ CAUTION**

- Always keep the charging connector and charging plug in clean and dry condition. Be sure to keep the charging cable in a condition where there is no water or moisture.
- Make sure to use the designated charger for charging the electric vehicle. Using any other charger may cause failure.
- Before charging the battery, turn the vehicle OFF.
- When the vehicle is switched OFF while charging, the cooling fan inside the motor compartment may automatically operate. Do not touch the cooling fan while charging.
- Be careful not to drop the charging connector. The charging connector can be damaged.

## **AC Charge**

### ■ AC Charger



OLFP0Q4057N

Actual charger image and charging method may vary in accordance with the charger manufacturer.

## CHARGING THE PLUG-IN HYBRID VEHICLE (CONT.)

### How to Connect AC Charger

1. Depress the brake pedal and apply the parking brake.
2. Turn OFF all switches, shift to P (Park), and turn OFF the vehicle.

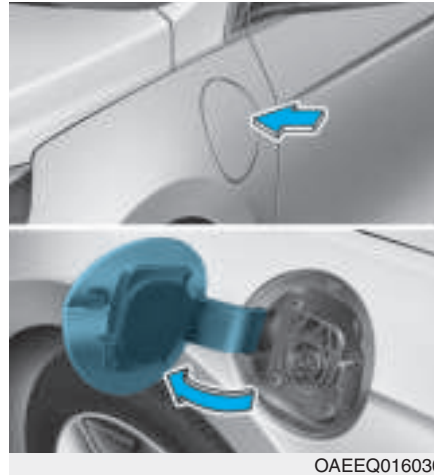

3. Press center edge of the charging door to open the charging door.

### **i** Information

**The charging door opens only when the door is unlocked.**

4. Check if there is dust on the charging connector and charging inlet.



5. Hold the charging connector handle and connect it to the vehicle AC charging inlet. Push the connector until you hear a "clicking" sound. If the charging connector and charging terminal are not connected properly, this may cause a fire.

## **i** Information

### Charging connector AUTO/LOCK mode

The charging connector is locked in the inlet at a different period according to which mode is selected.

- **LOCK mode** : The connector locks when the charging connector is plugged into the charging inlet.
- **AUTO mode** : The connector locks when charging starts.

For more details, refer to "Charging Connector AUTO/LOCK Mode" in this chapter.

■ AC Charger



6. Connect the charging plug to the electric outlet at a AC charging station to start charging.

■ Type A



7. Check if the charging indicator light of the high voltage battery on the instrument cluster is turned ON. Charging is not done when the charging indicator lamp is OFF.

When the charging connector and charging plug are not connected properly, reconnect the charging cable to charge.

## CHARGING THE PLUG-IN HYBRID VEHICLE (CONT.)

### **i** Information

- Even though charging is possible with the Engine Start/Stop button in the ON/START position, for your safety, start charging when the Engine Start/Stop button is in the OFF position and the vehicle shifted to P (Park). After charging has started, you can use electrical components such as the radio by pressing the Engine Start/Stop button to the ACC or ON position.
- During AC charging, the radio reception may be bad.
- Moving the shift lever from P (Park) to R (Reverse)/N (Neutral)/D (Drive) stops the charging process. To restart the charging process, move the shift lever to P (Park), place the Engine Start/Stop button to the OFF position, and disconnect the charging cable. Then, connect the charging cable.



OAEPHQ049818L

8. After charging has started, the estimated charging time is displayed on the instrument cluster for about 1 minute.

If you open the driver seat door while charging, the estimated charging time is also displayed on the instrument cluster for about 1 minute.

When scheduled charging is set, the estimated charging time is displayed as "--".

### **i** Information

Depending on the condition and durability of the high voltage battery, charger specifications, and ambient temperature, the time required for charging the battery may vary.

## Checking Charging Status



OAEEQ016025

When charging the high voltage battery, the charge level can be checked from outside the vehicle.

Operation of Charging Indicator Lamp			Details	
(1)	(2)	(3)		
○ (OFF)	○ (OFF)	○ (OFF)	Not Charged	
Blink	○ (OFF)	○ (OFF)	Charging	
● (ON)	Blink	○ (OFF)		0~33%
● (ON)	● (ON)	Blink		34~66%
● (ON)	● (ON)	● (ON)	67~99%	
● (ON)	● (ON)	● (ON)	Fully charged (100%) (turns OFF in 5 seconds)	
Blink	Blink	Blink	Error while charging	
○ (OFF)	○ (OFF)	Blink	Charging the 12 V auxiliary battery (Aux. Battery Saver+)	
○ (OFF)	Blink	○ (OFF)	- Reserved charging is operating (turns OFF after 3 minutes) - Charging is temporarily interrupted (e.g. power failure)	



## CHARGING THE PLUG-IN HYBRID VEHICLE (CONT.)

### How to Disconnect AC Charger

#### ■ AC Charger



OLFP0Q4057N

1. When charging is complete, remove the charging plug from the electrical outlet of the AC charging station.

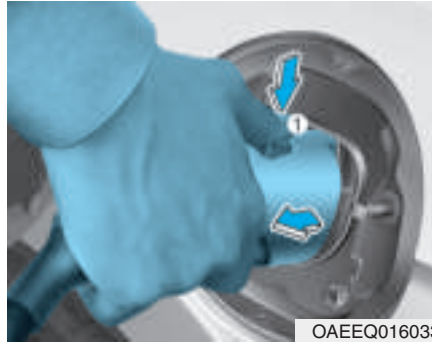

OAEEQ016033

2. Hold the charging connector handle and pull it while pressing the release button (1).

#### **i** Information

To prevent charging cable theft, the charging connector cannot be disconnected from the inlet when the doors are locked. Unlock all doors to disconnect the charging connector from the inlet.

However, if the vehicle is in the charging connector AUTO mode, the charging connector automatically unlocks from the inlet when charging is completed.

For more details, refer to "Charging Connector AUTO/LOCK Mode" in this chapter.

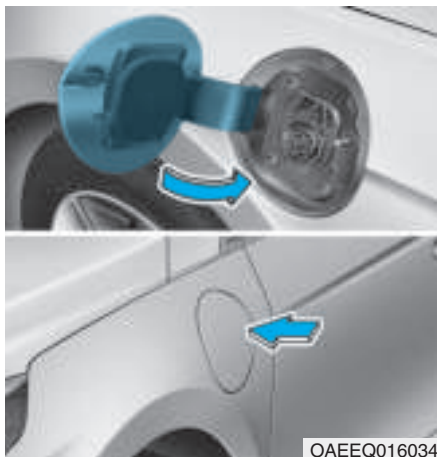

3. Make sure to completely close the charging door.

### **Unlock Charging Connector in Emergency**



If the charging connector does not disconnect due to battery discharge and failure of the electric wires, open the hood and slightly pull the emergency cable. The charging connector will then disconnect.

### **Trickle Charge**

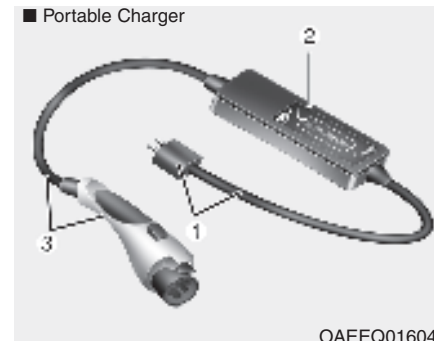

- (1) Code and Plug (Code set)
- (2) Control Box
- (3) Charging Cable and Charging Connector

Trickle Charge can be used when AC Charge is not available by using household electricity.

## CHARGING THE PLUG-IN HYBRID VEHICLE (CONT.)

### *How to set the charge level of the portable charger*

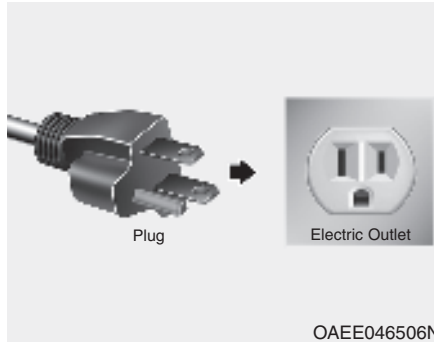

1. Check the rated current of the electric outlet prior to connecting the plug to the outlet.
2. Connect the plug to a household electric outlet.
3. Check the display window on the control box.

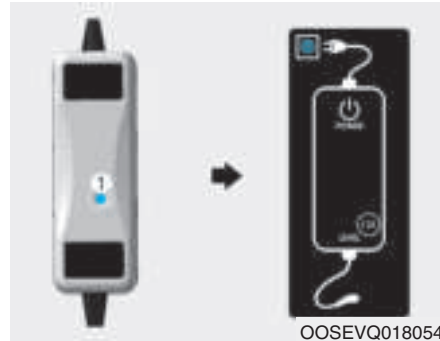

4. Press the button (1) on the back of the control box for more than 1 second to adjust the charge level. (Refer to charging cable type and example for setting the charge level.)
5. The display window on the control box changes from 12A and 10A to 8A every time you press the button (1).

6. When setting the charge level is complete, start charging according to the trickle charge procedure.

※ Example for setting the ICCB charge level  
 (The example is only for reference and may vary according to the surrounding environment.)

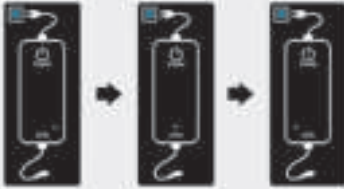
Outlet current	ICCB charge level	Control box display window
14-16A	12A	
13-12A	10A	
11-10A	8A	
9-8A	6A	

### ***How to Connect Portable Charger (ICCB: In-Cable Control Box)***

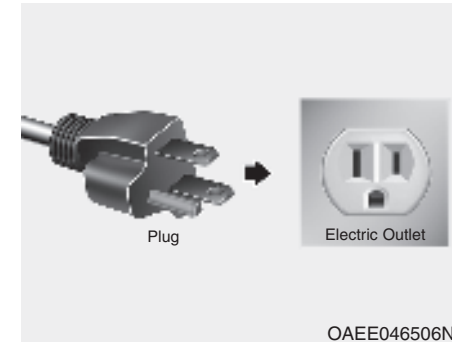

1. Connect the plug to a household electric outlet.

## CHARGING THE PLUG-IN HYBRID VEHICLE (CONT.)



2. Check if the power lamp (green) illuminates on the control box.
3. Depress the brake pedal and apply the parking brake.
4. Turn OFF all switches, shift to P (Park), and turn OFF the vehicle.

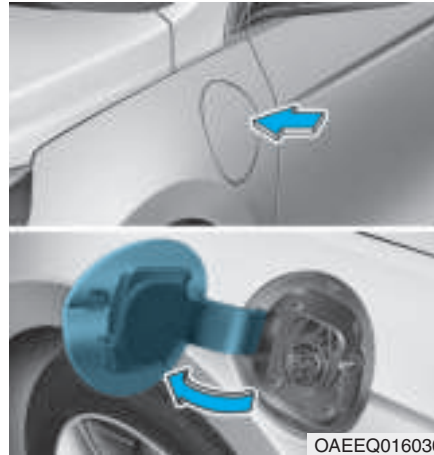

5. Press center edge of the charging door to open the charging door.

### **i** Information

**The charging door opens only when the door is unlocked.**

6. Check if there is dust on the charging connector and charging inlet.



7. Hold the charging connector handle and connect it to the vehicle AC charging inlet. Push the connector until you hear a "clicking" sound. If the charging connector and charging terminal are not connected properly, this may cause a fire.

## **i** Information

### Charging connector AUTO/LOCK mode

The charging connector is locked in the inlet at a different period according to which mode is selected.

- **LOCK mode** : The connector locks when the charging connector is plugged into the charging inlet.
- **AUTO mode** : The connector locks when charging starts.

For more details, refer to "Charging Connector AUTO/LOCK Mode" in this chapter.



8. Charging starts automatically (charging lamp blinks).

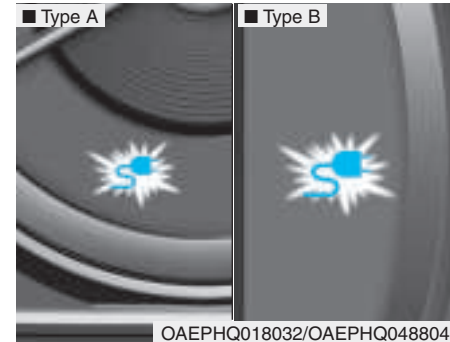

9. Check if the charging indicator light of the high voltage battery on the instrument cluster is turned ON. Charging is not done when the charging indicator lamp is OFF.

When the charging connector is not connected properly, reconnect the charging cable to charge it again.

## CHARGING THE PLUG-IN HYBRID VEHICLE (CONT.)

### **i** Information

- Even though charging is possible with the Engine Start/Stop button in the ON/START position, for your safety, start charging when the Engine Start/Stop button is in the OFF position and the vehicle shifted to P (Park).

After charging has started, you can use electrical components such as the radio by pressing the Engine Start/Stop button to ACC or ON position.

- Moving the shift lever from P (Park) to R (Reverse)/N (Neutral)/D (Drive) stops the charging process.

To restart the charging process, move the shift lever to P (Park), place the Engine Start/Stop button to the OFF position, and disconnect the charging cable. Then, connect the charging cable.



OAEPHQ049818L

10. After charging has started, the estimated charging time is displayed on the instrument cluster for about 1 minute. If you open the driver seat door while charging, the estimated charging time is also displayed on the instrument cluster for about 1 minute.

When scheduled charging is set, the estimated charging time is displayed as "--".

### **i** Information

Depending on the condition and durability of the high voltage battery, charger specifications, and ambient temperature, the time required for charging the battery may vary.

## Checking Charging Status



OAEEQ016025











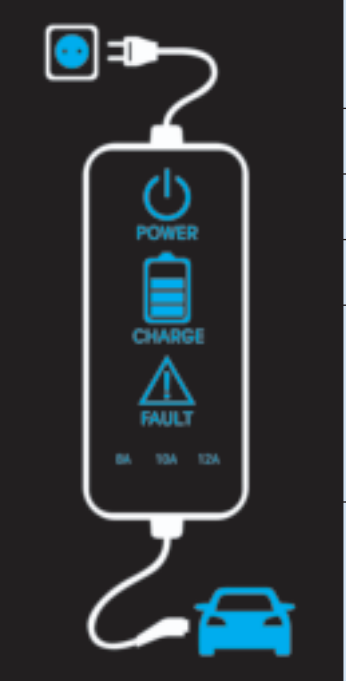

When charging the high voltage battery, the charge level can be checked from outside the vehicle.

Operation of Charging Indicator Lamp			Details	
(1)	(2)	(3)		
○ (OFF)	○ (OFF)	○ (OFF)	Not Charged	
Blink	○ (OFF)	○ (OFF)	Charging	
● (ON)	Blink	○ (OFF)		0~33%
● (ON)	● (ON)	Blink		34~66%
● (ON)	● (ON)	● (ON)	67~99%	
● (ON)	● (ON)	● (ON)	Fully charged (100%) (turns OFF in 5 seconds)	
Blink	Blink	Blink	Error while charging	
○ (OFF)	○ (OFF)	Blink	Charging the 12 V auxiliary battery (Aux. Battery Saver+)	
○ (OFF)	Blink	○ (OFF)	<ul style="list-style-type: none"> <li>- Reserved charging is operating (turns OFF after 3 minutes)</li> <li>- Charging is temporarily interrupted (e.g. power failure)</li> </ul>	

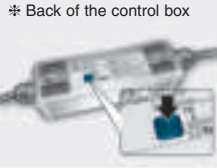





## CHARGING THE PLUG-IN HYBRID VEHICLE (CONT.)





### Charging Status Indicator Lamp for Portable Charger

Control Box	Indicator		Details		
	PLUG	 (Green)	On : Power on Blink : Plug temperature sensor failure		
		 (Red)	On : Plug high temperature protection Blink : Plug high temperature warning		
	POWER	 POWER	On : Power on		
	CHARGE	 CHARGE	Blink : Charging In power saving mode, only the CHARGE indicator is illuminated.		
	FAULT	 FAULT	Blink : Charging interrupted		
	CHARGE LEVEL	 12A	Charging current 12 A	The charging current changes (3 level) whenever the button (1) is pressed for 1 sec with the charger plugged into an electrical outlet but not the vehicle.	 * Back of the control box
		 10A	Charging current 10 A		
		 8A	Charging current 8 A		
	VEHICLE	 (Green)	Charging connector plugged		
		 (Blue)	Charging		
 (Red)		Blink : Charging impossible			

### Charging Status Indicator Lamp for Portable Charger

NO	Control Box	Status / Diagnosis / Countermeasure	NO	Control Box	Status / Diagnosis / Countermeasure
1		<ul style="list-style-type: none"> <li>• Charging connector plugged into vehicle (Green ON)</li> <li>• Plug temperature sensor failure (Green blink)</li> <li>• Plug high temperature protection (Red blink)</li> <li>• Plug high temperature warning (Red ON)</li> </ul> <p>Contact an authorized HYUNDAI dealer.</p>	2		<ul style="list-style-type: none"> <li>- Charging connector plugged into vehicle (Green ON)</li> </ul>
3		<ul style="list-style-type: none"> <li>- While charging               <ul style="list-style-type: none"> <li>• Charge indicator (Green blink)</li> <li>• Vehicle indicator (Blue ON)</li> </ul> </li> </ul>	4		<ul style="list-style-type: none"> <li>- Before plugging charging connector into vehicle (Red blink)               <ul style="list-style-type: none"> <li>• Abnormal temperature</li> <li>• ICCB (In-Cable Control Box) failure</li> </ul> </li> </ul> <p>Contact an authorized HYUNDAI dealer.</p>

## CHARGING THE PLUG-IN HYBRID VEHICLE (CONT.)

NO	Control Box	Status / Diagnosis / Countermeasure	NO	Control Box	Status / Diagnosis / Countermeasure
5		<ul style="list-style-type: none"> <li>- Plugged into vehicle (Red blink)</li> <li>• Diagnostic device failure</li> <li>• Current leakage</li> <li>• Abnormal temperature</li> </ul> <p>Contact an authorized HYUNDAI dealer.</p>	6		<ul style="list-style-type: none"> <li>- After plugging charging connector into vehicle (Red blink)</li> <li>• Communication failure</li> </ul> <p>Contact an authorized HYUNDAI dealer.</p>
7		<ul style="list-style-type: none"> <li>• Plug temperature sensor failure (Green blink)</li> <li>• Plug high temperature protection (Red blink)</li> <li>• Plug high temperature warning (Red ON)</li> </ul> <p>Contact an authorized HYUNDAI dealer.</p>	8		<ul style="list-style-type: none"> <li>- Power saving mode</li> <li>• 3 minutes after charging starts (Green blink)</li> </ul>

## How to Disconnect Portable Charger (ICCB: In-Cable Control Box)

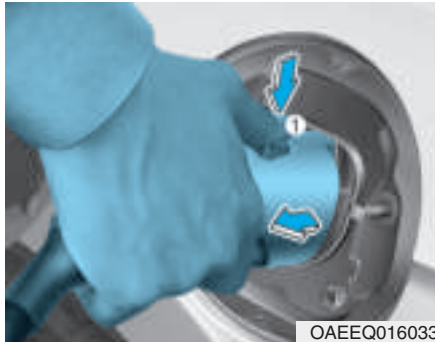

1. Hold the charging connector handle and pull it while pressing the release button (1).

### **i** Information

To prevent charging cable theft, the charging connector cannot be disconnected from the inlet when the doors are locked. Unlock all doors to disconnect the charging connector from the inlet. However, if the vehicle is in the charging connector AUTO mode, the charging connector automatically unlocks from the inlet when charging is completed. For more details, refer to "Charging Connector AUTO/LOCK Mode" in this chapter.

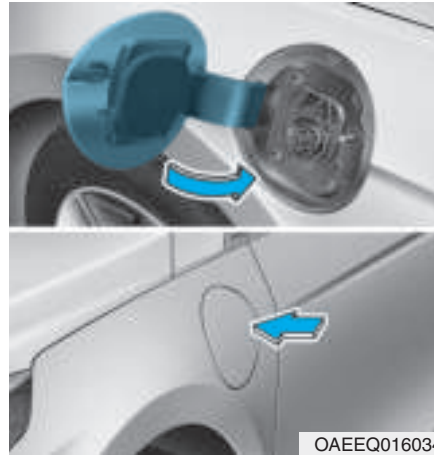

2. Make sure to completely close the charging door.

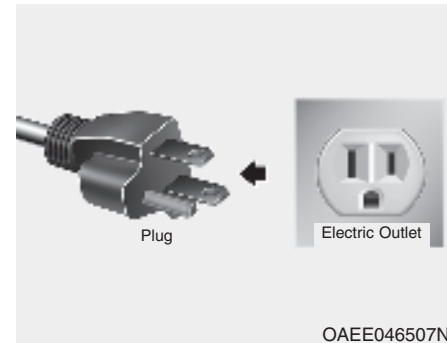

3. Disconnect the plug from the household electric outlet. Do not pull the cable when disconnecting the plug.
4. Close the protective cover for the charging connector so that foreign material cannot get into the terminal.
5. Put the charging cable inside the cable compartment to protect it.

## CHARGING THE PLUG-IN HYBRID VEHICLE (CONT.)

### **Unlock Charging Connector in Emergency**



If the charging connector does not disconnect due to battery discharge and failure of the electric wires, open the hood and slightly pull the emergency cable. The charging connector will then disconnect .

### **Precautions for Portable Charger (ICCB: In-Cable Control Box)**

- Use the portable charger that is certified by HYUNDAI Motors.
- Do not try to repair, disassemble, or adjust the portable charger.
- Do not use an extension cord or adapter.
- Stop using immediately when failure occurs.
- Do not touch the plug and charging connector with wet hands.
- Do not touch the terminal part of the AC charging connector and the AC charging inlet on the vehicle.
- Do not connect the charging connector to voltage that does not comply with regulations.
- Do not use the portable charger if it is worn out, exposed, or there exists any type of damage on the portable charger.
- If the ICCB case and AC charging connector is damaged, cracked, or the wires are exposed in any way, do not use the portable charger.
- Do not let children operate or touch the portable charger.
- Keep the control box free of water.
- Keep the AC charging connector or plug terminal free of foreign substances.
- Do not step on the cable or cord. Do not pull the cable or cord and do not twist or bend it.
- Do not charge when there is lightning.
- Do not drop the control box or place a heavy object on the control box.
- Do not place an object that can generate high temperatures near the charger when charging.
- Charging with the worn out or damaged household electric outlet can result in a risk of electric shock. If you are in doubt to the household electric outlet condition, have it checked by a licensed electrician.
- Stop using the portable charger immediately if the household electric outlet or any components is overheated or you notice burnt odors.

## Action to be taken when charging stops abruptly

When the high voltage battery does not charge, check the followings:

1. Check the charging setting for the vehicle.  
(e.g. When scheduled charging is set, charging is not initiated immediately when the AC charger or portable charger (ICCB: In-Cable Control Box) is connected.)
2. Check the operation status of AC charger, portable charger.  
(Charging Status Indicator Lamp for Portable Charger, refer to "Checking Charging Status" for trickle charge in this chapter.)  
※ Actual method for indicating the charging status may vary in accordance with the charger manufacturer.
3. When the vehicle does not charge and a warning message appears on the cluster, check the corresponding message. Refer to "LCD Display Messages", in this chapter.
4. If the vehicle is properly charged when charged with another normally working charger, contact the charger manufacturer.
5. If the vehicle does not charge when charged with another normally working charger, we recommend that you contact an authorized HYUNDAI dealer for inspection.

## DRIVING THE HYBRID/PLUG-IN HYBRID VEHICLE

### Starting the Vehicle

#### Vehicles with remote key system

1. Make sure the parking brake is applied.
2. Make sure the shift lever is in P (Park).
3. Depress the brake pedal.
4. Turn the ignition switch to the START position. Hold the key (maximum of 10 seconds) until the engine starts and release it.

#### Vehicles with smart key system

1. Carry the smart key or leave it inside the vehicle.
2. Make sure the parking brake is firmly applied.
3. Place the shift lever in P (Park). With the shift lever in N (Neutral), you cannot start the vehicle.
4. Depress the brake pedal.
5. Press the Engine Start/Stop button. If the hybrid system starts, the "" indicator will come on.

Whether the engine is cold or warm, it should be started without depressing the accelerator.

**After following the start procedures, "" indicator on the instrument cluster will turn on.**

**For more information, please check Chapter 5.**

#### ECONOMICAL and SAFE OPERATION of Hybrid system

- Drive smoothly. Accelerate at a moderate rate and maintain a steady cruising speed. Do not make "jack-rabbit" starts. Do not race between stoplights.

Avoid heavy traffic whenever possible. Always maintain a safe distance from other vehicles so you can avoid unnecessary braking. This also reduces brake wear.

- The regenerative brake generates energy when the vehicle decelerates.
- When the hybrid battery power is low, the hybrid system automatically recharges the hybrid battery.
- When the engine is running with the shift lever in N (Neutral), the hybrid system cannot generate electricity. The hybrid battery cannot recharge with the shift lever in N (Neutral).

## **i** Information

**In the hybrid system, the engine automatically runs and stops. When the hybrid system operates, the "🔌" indicator is illuminated.**

**In the following situation, the engine may operate automatically.**

- **When the engine is ready to run**
- **When the hybrid battery is being charged**
- **Depending on the temperature condition of the hybrid battery**

## Special Features

Hybrid vehicles sound different than gasoline engine vehicles. When the hybrid system operates, you may hear a sound from the hybrid battery system behind the rear seat. If you apply the accelerator pedal rapidly, you may hear an unconventional sound. When you apply the brake pedal, you may hear a sound from the regenerative brake system. When the hybrid system is turned off or on, you may hear a sound in the engine compartment. If you depress the brake pedal repeatedly when the hybrid system is turned on, you may hear a sound in the engine compartment. None of these sounds indicate a problem. These are normal characteristics of hybrid vehicles.

If any of following occur, it's a normal condition if you hear a motor sound in the engine compartment:

- After turning off the hybrid system, the brake pedal is released.
- When the hybrid system is turned off, the brake pedal is applied.
- When the driver door is opened.

When the hybrid system is turned ON, the gasoline engine may activate or may not. In this situation, you may feel a vibration. This does not indicate a malfunction. When the "🔌" indicator illuminates, the hybrid system is ready to begin driving. Even if the engine is off, you can operate the vehicle as long as the "🔌" indicator is illuminated.

### **NOTICE**

**The hybrid system contains many electronic components. High voltage components, such as cables and other parts, may emit electromagnetic waves. Even when the electromagnetic cover blocks electromagnetic emissions, electromagnetic waves may have an effect on electronic devices. When your vehicle is not used for a long period of time, the hybrid system will discharge. You need to drive the vehicle several times a month. We recommend driving at least for 1 hour or 10 miles. When the hybrid battery is discharged, or when it is impossible to jump start the vehicle, contact your HYUNDAI dealer.**



## DRIVING THE HYBRID/PLUG-IN HYBRID VEHICLE (CONT.)

### WARNING

- When you start the hybrid system with the shift lever in P (Park), the " " indicator illuminates on the instrument cluster. The driver can drive the vehicle, even when the gasoline engine is off.
- When you leave the vehicle, you should turn OFF the vehicle and place the shift lever in P (Park). If you depress the accelerator pedal by mistake, or when the shift lever is not in P (Park), the vehicle will abruptly move, possibly resulting in serious injury or death.



### **Virtual Engine Sound System (VESS)**

The Virtual Engine Sound System generates engine sounds for pedestrians to hear vehicle sound because there is limited sound while electric power is used.

### **What Does Regenerative Braking Do?**

It uses an electric motor when decelerating and when braking and transforms kinetic energy to electrical energy in order to charge the high voltage battery.

### **Battery**

- Hybrid vehicle
  - The vehicle is composed of a high voltage battery that drives the motor and air conditioner, and an integrated 12V lithium ion polymer battery with the HEV battery that drives the lamps, wipers, and audio system.
  - The integrated 12V battery is automatically charged when the vehicle is in the ready () mode.
- Plug-in hybrid vehicle
  - The vehicle is composed of a high voltage battery that drives the motor and air-conditioner, and an auxiliary battery (12 V) that drives the lamps, wipers, and audio system.
  - The auxiliary battery is automatically charged when the vehicle is in the ready () mode.

## Hybrid System Gauge

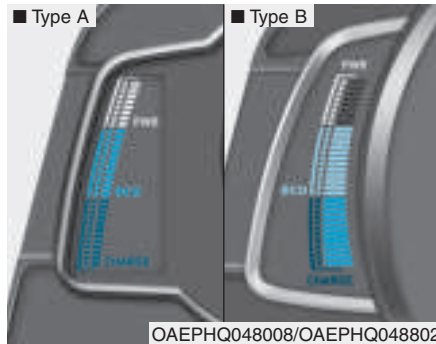

The hybrid system gauge indicates whether the current driving condition is fuel efficient or not.

- **CHARGE :**  
Shows that the energy made by the vehicle is being converted to electrical energy. (Regenerated energy)
- **ECO :**  
Shows that the vehicle is being driven in an Eco-friendly manner.
- **POWER :**  
Shows that the vehicle is exceeding the Eco-friendly range.

According to the hybrid system gauge area, the "EV" indicator comes on or off.

- "EV" indicator ON : Vehicle is driven using the electric motor or the gasoline engine is stopped.
- "EV" indicator OFF : Vehicle is driven using the gasoline engine.

## Battery State of Charge (SOC) gauge

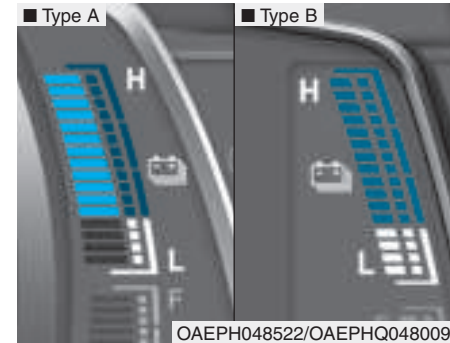

This gauge indicates the remaining hybrid battery power. If the SOC is near the "L (Low)" level, the vehicle automatically operates the engine to charge the battery.

However, if the Service Indicator (⚠) and Malfunction Indicator Lamp (MIL) (🔧) turn on when the SOC (State of charge) gauge is near the "L (Low)" level, have the vehicle checked by an authorized HYUNDAI dealer.

※ The actual cluster in the vehicle may differ from the illustration.

## DRIVING THE HYBRID/PLUG-IN HYBRID VEHICLE (CONT.)

### Plug-in Hybrid Mode (Plug-in hybrid vehicle)

#### HEV Button



Pressing the [HEV] button changes the plug-in hybrid system modes, among Electric (CD), AUTO and Hybrid (CS) mode.

Each time the mode is changed a corresponding indicator is displayed on the instrument cluster as follows.

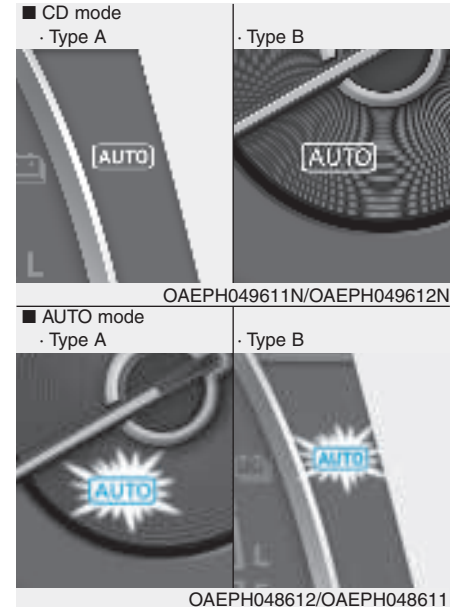

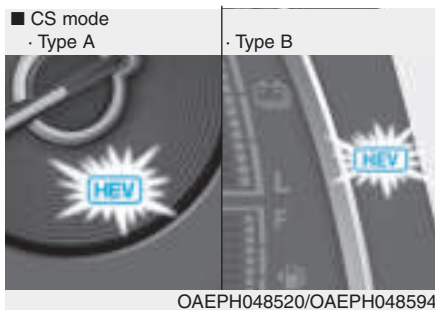

OAEPH048520/OAEPH048594

### Plug-in hybrid mode indicator

- CD (Charge Depleting, Electric) mode : The high-voltage (hybrid) battery is used to drive the vehicle.
- AUTO mode : CD mode and CS mode are selected automatically depending on road conditions.
- CS (Charge Sustaining, Hybrid) mode : The high-voltage (hybrid) battery and gasoline engine is used to drive the vehicle.

### **i** Information

Even when the battery charging rate is high and driving in electric mode is possible, engine may turn on in some areas to protect the system.

### Infotainment system Screen (Plug-in hybrid vehicle) (if equipped)



OAEPHQ049856L

Press [PHEV] on the [Home] screen or the [All menus] screen and the menus related to plug-in hybrid ([ECO driving], [Energy information], [EV range], [Set charging times], [Charging stations], [Petrol stations]) are displayed.

**For more information, please refer to the Infotainment System Manual that was separately supplied with your vehicle.**

### Aux. Battery Saver+ (Plug-in hybrid vehicle)

The Aux. Battery Saver+ is a function that monitors the charging status of the 12 V auxiliary battery.

If the auxiliary battery level is low, the main high voltage battery charges the auxiliary battery.

### **i** Information

**The Aux. Battery Saver+ function will be ON when the vehicle is delivered. If the function is not needed, you may turn it off in the Users Settings mode on the cluster. For more information, refer to the following page.**

## DRIVING THE HYBRID/PLUG-IN HYBRID VEHICLE (CONT.)

### Mode

- Cycle Mode :

When the vehicle is OFF with all doors, hood and liftgate closed, the Aux. Battery Saver+ activates according to the auxiliary battery status.

- Automatic Mode :

When the Engine Start/Stop button is in the ON position with the charging connector plugged in, the function activates according to the auxiliary battery status to prevent overdischarge of the auxiliary battery.

### **i** Information

- **The Aux. Battery Saver+ activates maximum of 20 minutes. If the Aux. Battery Saver+ function activates more than 10 times consecutively when in the automatic mode, the function will stop activating, judging that there is a problem with the auxiliary battery. In this case, drive the vehicle for some period of time or if the auxiliary battery returns to normal, the function will start activating.**
- **The Aux. Battery Saver+ function cannot prevent battery discharge if the auxiliary battery is damaged, worn out, used as a power supply or unauthorized electronic devices are used.**
- **If the Aux. Battery Saver+ function was activated, the high voltage battery level may have decreased.**

### System Setting

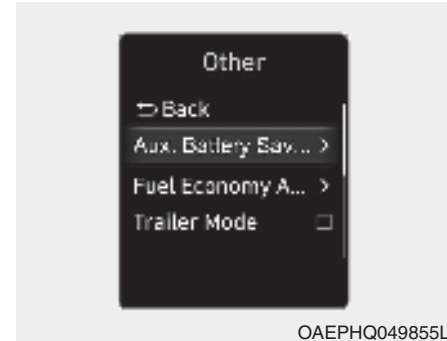

The driver can activate the Aux. Battery Saver+ function by placing the Engine Start/Stop button to the ON position and by selecting: 'User Settings → Other (Features) → Aux. Battery Saver+'

The Aux. Battery Saver+ function deactivates, when the driver cancels the system setting.

## WARNING

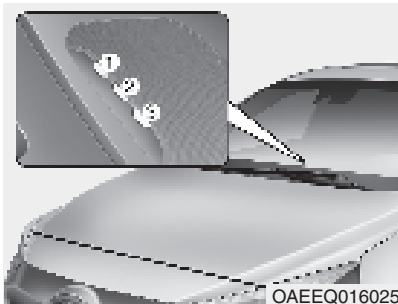

When the function is activating, the third Charging Indicator Lamp will blink and high voltage electricity will be flowing in the vehicle. Do not touch the high voltage electric wire (orange), connector, and all electric components and devices. This may cause electric shock and lead to injuries. Also, do not modify your vehicle in any way. This may affect your vehicle performance and lead to an accident.

## Warning and Indicator Lights

### Ready Indicator



This indicator illuminates :  
When the vehicle is ready to be driven.

- ON : Normal driving is possible.
- OFF : Normal driving is not possible, or a problem has occurred.
- Blinking : Emergency driving.

When the ready indicator goes OFF or blinks, there is a problem with the system. In this case, have your vehicle inspected by an authorized HYUNDAI dealer.

### Service Warning Light



This warning light illuminates :

- When you turn the ignition switch or the Engine Start/Stop button to the ON position.
  - It illuminates for approximately 3 seconds and then goes off.
- When there is a problem with the hybrid vehicle control system or hardware.

When the warning light illuminates while driving, or does not go OFF after starting the vehicle, have your vehicle inspected by an authorized HYUNDAI dealer.

### EV Mode Indicator

**EV**

This indicator illuminates when the vehicle is driven by the electric motor.

## DRIVING THE HYBRID/PLUG-IN HYBRID VEHICLE (CONT.)

### **Charging Cable Connection Indicator (Plug-in hybrid vehicle)**



This indicator illuminates in red when the charging cable is connected.

### **Regenerative Brake Warning Light**



This warning light illuminates :  
When the regenerative brake is not operating. This causes the Brake Warning light (red) and Regenerative Brake Warning Light (yellow) to illuminate simultaneously as soon as possible.

In this case, drive safely and have your vehicle inspected by an authorized HYUNDAI dealer.

The service brake still function, however, the operation of the brake pedal may be more difficult than normal and the braking distance can increase.

### **LCD Display Messages Check Hybrid system**



This message is displayed when there is a problem with the hybrid control system.

Refrain from driving when the warning message is displayed.

In this case, have your vehicle inspected by an authorized HYUNDAI dealer.

### **Check Hybrid system. Turn engine Off**



This message is displayed when there is a problem with the hybrid system. The "⚡" indicator will blink and a warning chime will sound until the problem is solved.

In this case, have your vehicle inspected by an authorized HYUNDAI dealer.

**Check Hybrid system. Do not start engine**



This message is displayed when the hybrid battery power (SOC) level is low. A warning chime will sound until the problem is solved.

In this case, have your vehicle inspected by an authorized HYUNDAI dealer.

**Stop vehicle and check power supply**



This message is displayed when a failure occurs in the power supply system.

In this case, park the vehicle in a safe location and tow your vehicle to the nearest authorized HYUNDAI dealer and have the vehicle inspected.

**Park with engine on to charge battery**



This message is displayed when the hybrid battery power (SOC) level is low.

In this case, park the vehicle in a safe location and wait until the hybrid battery is charged.

You can increase the hybrid battery charging rate by holding the accelerator pedal to the floor with transmission in P. The engine will rev high but it will be limited for charging purpose when you hold the pedal to the floor.



## DRIVING THE HYBRID/PLUG-IN HYBRID VEHICLE (CONT.)

### ***Refuel to prevent Hybrid battery damage***



OAEPHQ049824L

This message is displayed when the fuel tank is nearly empty. You should refill the fuel tank to prevent hybrid battery damage.

### ***Refill inverter coolant***



OAEPHQ049825L

This message is displayed when the inverter coolant is nearly empty. You should refill the inverter coolant.

### ***Check regenerative brakes/ Stop vehicle and check regenerative brakes***

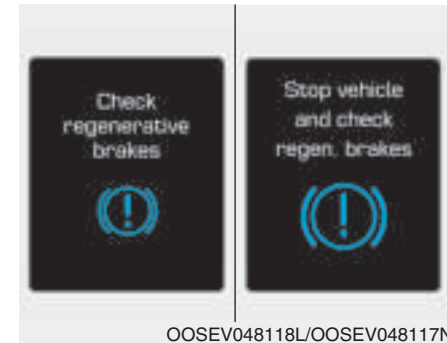

OOSEV048118L/OOSEV048117N

This warning message is displayed when the regenerative brake system does not work properly.

If this warning message is displayed, have the vehicle inspected by an authorized HYUNDAI dealer.

### **Check Virtual Engine Sound System**



This message is displayed when there is a problem with the Virtual Engine Sound System (V ESS). In this case, have your vehicle inspected by an authorized HYUNDAI dealer.

### **Unplug vehicle to start (Plug-in hybrid vehicle)**



This message is displayed when you start the engine without unplugging the charging cable. Unplug the charging cable, and then start the vehicle.

### **Charging stopped. Check the AC charger**



- This warning message is displayed when charging is stopped for the reasons below:
    - There is a problem with the external AC charger
    - The external AC charger stopped charging
    - The charging cable is damaged
- In this case, check whether there is any problem with the external AC and charging cable.

## DRIVING THE HYBRID/PLUG-IN HYBRID VEHICLE (CONT.)

If the same problem occurs when charging the vehicle with a normally operating AC charger or genuine HYUNDAI portable charger, we recommend that you have your vehicle inspected by an authorized HYUNDAI dealer.

### ***Charging stopped. Check the cable connection***

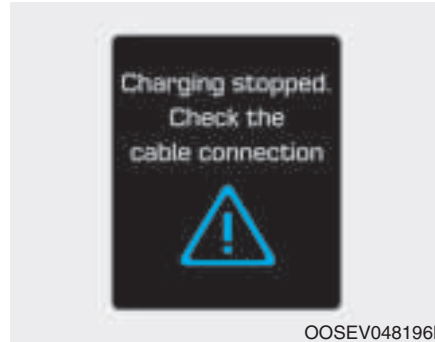

This warning message is displayed when charging is stopped because the charging connector is not correctly connected to the charging inlet

In this case, separate the charging connector and re-connect it and check whether there is any problem (external damage, foreign substances, etc.) with the charging connector and charging inlet.

If the same problem occurs when charging the vehicle with a replaced charging cable or genuine HYUNDAI portable charger, we recommend that you have your vehicle inspected by an authorized HYUNDAI dealer.

### ***Remaining time (Plug-in hybrid vehicle)***



This message is displayed to notify the remaining time to fully charge the battery.

**Wait until fuel door opens  
(Plug-in hybrid vehicle)**



This message is displayed when you attempt to open the fuel filler door with the fuel tank pressurized. Wait until the fuel tank is depressurized.

***i* Information**

It may take up to 20 seconds to open fuel filler door.

**Check fuel door (Plug-in hybrid)**



This message is displayed when there is a problem with the fuel filler door. Such as, when the fuel filler door does not open after 20 seconds at freezing temperature.

***i* Information**

When the fuel filler door is frozen and does not open after 20 seconds at freezing temperature, slightly tap the fuel filler door and then attempt to open it. In other cases, have your vehicle inspected by an authorized HYUNDAI dealer.

**Fuel door open  
(Plug-in hybrid vehicle)**



This message is displayed when the fuel filler door opens after the fuel tank is depressurized. If this message is displayed, you can refuel the fuel tank.

## DRIVING THE HYBRID/PLUG-IN HYBRID VEHICLE (CONT.)

### **Check fuel door (Plug-in hybrid vehicle)**



This message is displayed when the vehicle is driven with the fuel filler door opened. Close the fuel filler door and then start driving.

### **Shift to P to charge (Plug-in hybrid vehicle)**

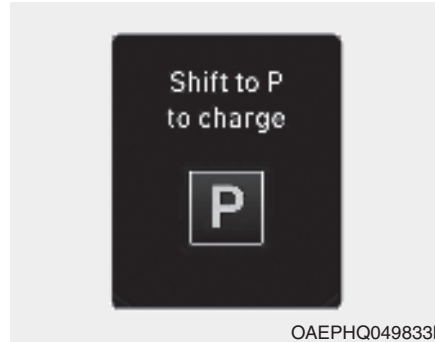

This message is displayed when the charging connector is plugged with the shift lever in R (Reverse), N (Neutral) or D (Drive). Move the shift lever to P (Park) and re-start the charging process.

### **Switching to Hybrid mode to allow heating or air condition- ing (Plug-in hybrid vehicle)**



This message is displayed when the vehicle automatically switches to HEV mode to allow heating or air conditioning. It is when the coolant temperature is low (below  $-14^{\circ}\text{C}$  ( $7^{\circ}\text{F}$ )) and the driver turns on the heating or cooling system.

If the coolant temperature gets higher than  $-14^{\circ}\text{C}$  ( $7^{\circ}\text{F}$ ) or the driver turns off the heating or cooling system the vehicle returns to its default (EV) mode.

**Maintaining Hybrid mode to continue heating or air conditioning (Plug-in hybrid vehicle)**



This message is displayed when the vehicle maintains the HEV mode to allow heating or air conditioning. The mode does not change when the driver presses the [HEV] button to switch from the HEV mode to EV mode while the heating and cooling system is on and the coolant temperature is below -14°C (7°F).

**Low/High System Temp. Maintaining Hybrid mode (Plug-in hybrid vehicle)**



This message is displayed when the temperature of the high-voltage (hybrid) battery is too low or too high. This warning message is to protect the battery and the hybrid system.

**Low/High System Temp. Switching to Hybrid mode (Plug-in hybrid vehicle)**



This message is displayed when the temperature of the high-voltage (hybrid) battery is too low or high. This warning message is to protect the battery and the hybrid system.

## DRIVING THE HYBRID/PLUG-IN HYBRID VEHICLE (CONT.)

**Switching to Hybrid mode to lubricate engine  
(Plug-in hybrid vehicle)**



This message is displayed when the vehicle is automatically switched to the HEV mode to lubricate engine while the Engine Start/Stop button is in the ON position.

**Maintaining Hybrid mode to protect engine  
(Plug-in hybrid vehicle)**



This message is displayed when the [HEV] button is pressed but it is impossible to switch from the HEV mode to EV mode due to engine lubrication.

**Exit SPORT mode to switch to EV  
(Plug-in hybrid vehicle)**



This message is displayed when [HEV] button is pressed but it is impossible to switch from the HEV mode to EV mode because the SPORT mode is engaged.

## Energy flow

The hybrid system informs the drivers its energy flow in various operating modes. While driving, the current energy flow is specified in 11 modes.

### Vehicle Stop

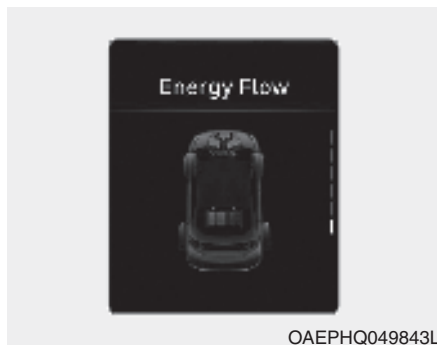

The vehicle is stopped.  
(No energy flow)

### EV Propulsion

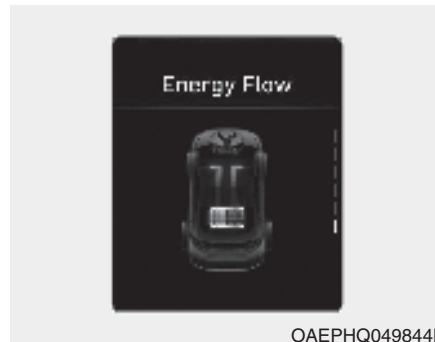

Only the motor power is used to drive the vehicle.  
(Battery → Wheel)

### Power Assist

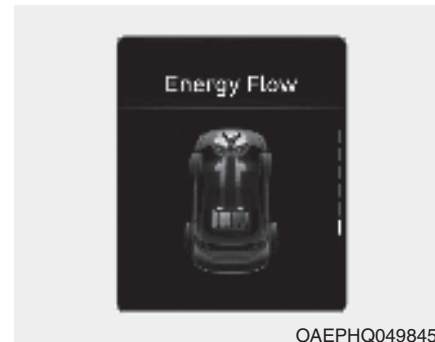

Both the motor and the engine power are used to drive the vehicle.  
(Battery & Energy → Wheel)



## DRIVING THE HYBRID/PLUG-IN HYBRID VEHICLE (CONT.)

### *Engine Only Propulsion*



Only the engine power is used to drive the vehicle.  
(Engine → Wheel)

### *Engine Generation*



When the vehicle is stopped, the high-voltage battery is charged up by the engine.  
(Engine → Battery)

### *Regeneration*



The high-voltage battery is charged up by the regenerative brake system.  
(Wheel → Battery)

### **Engine Brake**



The engine braking is used to decelerate the vehicle.  
(Wheel → Engine)

### **Power Reserve**



The engine is simultaneously used to drive the vehicle and to charge up the high-voltage battery.  
(Engine → Wheel & Battery)

### **Engine Generation/Motor Drive**



The engine charges up the high-voltage battery. The motor power is used to drive the vehicle.  
(Engine → Battery → Wheel)

## DRIVING THE HYBRID/PLUG-IN HYBRID VEHICLE (CONT.)

### *Engine Generation/Regeneration*



The engine and regenerative brake system charges up the high-voltage battery.

(Engine & Wheel → Battery)

### *Engine Brake/Regeneration*



The engine braking is simultaneously used to decelerate the vehicle and to charge up the high-voltage battery.

(Wheel → Engine & Battery)

## SAFETY PRECAUTIONS FOR HYBRID SYSTEM

### High Voltage Battery System

■ HPCU (Hybrid Power Control Unit)\*1

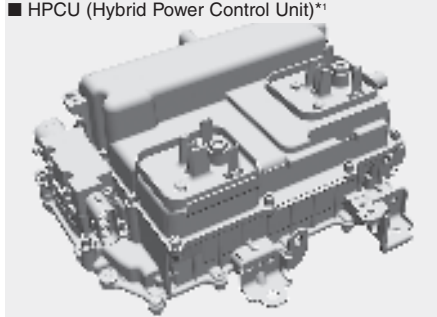

OAEPH088005

■ High Voltage Battery System\*2

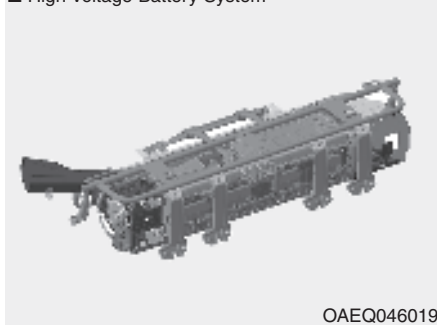

OAEQ046019

\*1: Located in the engine compartment

\*2: Located under the rear seats

#### WARNING

Never touch orange colored or high voltage labeled components, including wires, cables, and connections. When the insulators or covers are damaged or removed, severe injury or death from electrocution may occur.

#### WARNING

While replacing the fuses in the engine compartment, never touch the HPCU. The HPCU carries high voltage. Touching the HPCU may result in electrocution, serious injury, or death.

#### WARNING

In the hybrid system, the hybrid battery uses high voltage to operate the motor and other components. This high voltage hybrid battery system can be very dangerous. Never touch the hybrid system. When you touch the hybrid battery system, serious injury or death may occur.

## SAFETY PRECAUTIONS FOR HYBRID SYSTEM (CONT.)

### CAUTION

- Do not pile up any items in an area behind the high voltage battery. In a crash, the battery may become unstable, or its performance may degrade.
- Do not apply strong force nor pile up any items above the luggage compartment. Such an attempt may distort the high voltage battery case, causing a safety problem or degrading the performance.
- Be careful when loading flammable liquid in luggage compartment. It could cause operational and safety degradation if the liquid leaks and flows in high voltage battery.

■ Drive Motor \*3

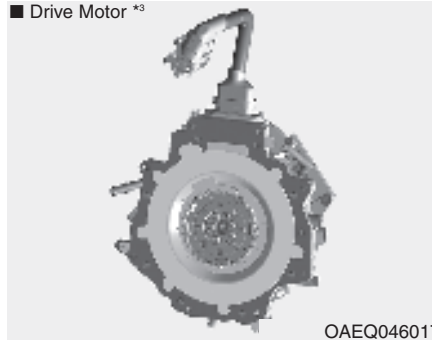

OAEQ046017

\*3: Located in the engine compartment

### WARNING

- Do not disassemble the high voltage motor connector. The high voltage motor connector may contain residual high voltage. Coming in contact with high voltage may result in death or serious injury.
- Your vehicle's hybrid system should only be inspected or repaired by an authorized HYUNDAI dealer.

### WARNING

- Do not disassemble or assemble the high voltage battery system. Doing so may result in electric shock, causing death or serious injury.
- If you disassemble or assemble hybrid system components improperly, it may damage the performance and reliability of your vehicle.
- If electrolyte comes in contact with your body, clothes or eyes, immediately flush with a large quantity of fresh tap water. Have your eyes examined by a doctor as soon as possible.

## WARNING

Never assemble or disassemble the high voltage battery system.

- If you assemble or disassemble the high voltage battery system, the durability and performance of the vehicle may be damaged.
- When you want to check the high voltage battery system, have the vehicle checked and inspected by an authorized HYUNDAI dealer.
- Do not touch the high voltage battery and high voltage cable connected to motor (orange color). Severe burns and electric shock may occur. For your safety, do not touch the cover of electronic components and electronic cable. Do not remove the cover of electronic components and electronic cable. In particular, never touch the high voltage battery system when the hybrid system in operation. It may result in death or serious injury.

## WARNING

- Never use the package modules (high voltage battery, inverter and converter) for any other purpose.
- Do not use an unauthorized battery charger to charge the high voltage battery. Doing so may result in death or serious injury.
- Never place the high voltage system near or in a fire.
- Never drill into or strike the package module. Otherwise, it may be damaged. An electric shock may occur, resulting in serious injury or death.

## NOTICE

- When the vehicle is paint baked, do not bake over 30 minutes in 70°C (158°F) or 20 minutes in 80°C (176°F) degree.
- Do not wash the engine compartment, using water. Water may cause an electric shock and damage the electronic components.

## WARNING

This hybrid vehicle uses the hybrid battery system inverter and converter to generate high voltage. High voltage in the hybrid battery system is very dangerous and may cause severe burns and electric shock. This may result in serious injury or death.

- For your safety, never touch, replace, disassemble or remove the hybrid battery system including components, cables and connectors. Severe burns or electric shock may result in serious injury or death when you fail to follow this warning.
- When the hybrid battery system operates, the hybrid battery system can be hot. Always be careful because burns or electric shock may be caused by high voltage.

(Continued)

## SAFETY PRECAUTIONS FOR HYBRID SYSTEM (CONT.)

(Continued)

- Do not drop water or liquid on to HPCU, HSG, motor and fuses. The hybrid system components are covered. If you drop water or liquid on to hybrid system components, it may result in electric shock.

### **i** Information

Gradual capacity reduction of the high voltage battery.

The high voltage Battery capacity gradually reduces with time and use. This is natural characteristic of the high voltage batteries. The extent at which capacity is reduced changes drastically depending on the environment(ambient temperature, etc.) and usage conditions such as how the vehicle is driven and how the high voltage battery is charged. Reduction of the high voltage battery capacity is not covered under warranty.

### Safety Plug

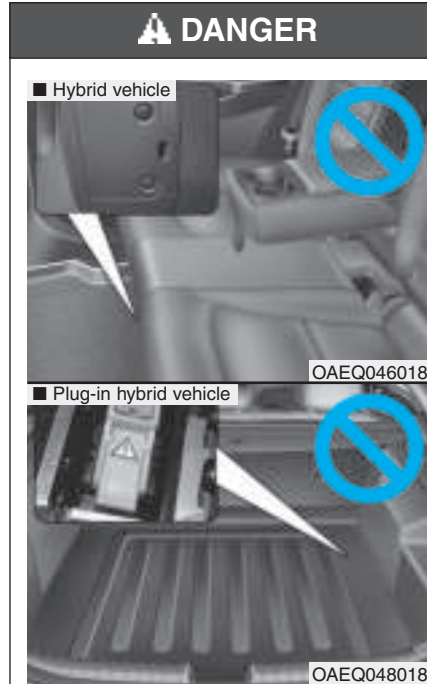

**Never touch the safety plug. The safety plug is attached to high voltage hybrid battery system.**

**(Continued)**

(Continued)

Touching the safety plug will result in death or serious injury. Service personnel should follow procedures in service manual.

## High Voltage Battery Cooling Duct

■ Hybrid vehicle

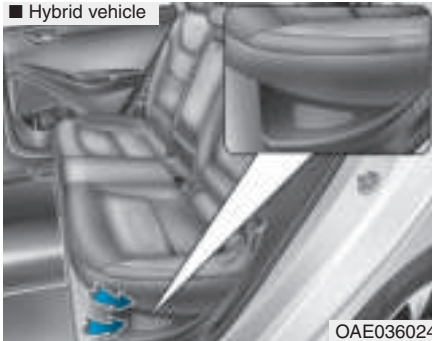

■ Plug-in hybrid vehicle



The high-voltage battery cooling duct is located on the left side of the rear seats.

The cooling duct cools down the high-voltage battery. When the high-voltage battery cooling duct is blocked, the high-voltage battery may be overheated and the vehicle performance may become limited and set a hybrid warning lamp. Do not obstruct the cooling duct with any other objects.

### WARNING

- **Never clean the cooling duct of the hybrid battery with a wet cloth. If any water enters in the cooling duct of the hybrid battery, the hybrid battery may cause an electric shock, serious damage, injury or death.**
- **The hybrid battery is composed of lithium-ion polymer. If the hybrid battery is improperly handled, it is dangerous to the environment. Also it may cause electrical shock and severe burns, resulting in serious injury or death.**
- **Do not spill liquid over the cooling duct of the hybrid battery. Doing so is very dangerous. It may cause electric shock or serious injury.**
- **Do not cover the cooling duct with objects.**

(Continued)



## SAFETY PRECAUTIONS FOR HYBRID SYSTEM (CONT.)

(Continued)

- Do not put any objects into the cooling duct of the hybrid battery. Doing so may cause loss of cooling duct volume to the hybrid battery. When the cooling duct is blocked with any objects, immediately contact your HYUNDAI dealer.
- Never place a container of liquid on or near the cooling duct. If the liquid spills, the hybrid battery located in the luggage compartment may be damaged.
- Secure all loads in the luggage compartment to prevent them from being tossed about before driving. If a sharp or heavy load impacts or pierces the interior luggage compartment wall, the hybrid battery system may be damaged, deteriorating its performance.

### Information

Clean the cooling duct for the hybrid battery with a dry cloth on a regular basis.

### If an Accident Occurs

#### WARNING

- For your safety, do not touch high voltage cables, connectors and package modules. High voltage components are orange in color.
- Exposed cables or wires may be visible inside or outside of the vehicle. Never touch the wires or cables, because it can cause an electrical shock, injury or death may occur.
- Any gas or electrolyte leakage from your vehicle is not only poisonous but also flammable. Upon witnessing one of those, open the windows, and remain a safe distance from the vehicle out of the road.  
Immediately contact an emergency response team and advise them that a hybrid vehicle is involved.

(Continued)

(Continued)

- When the vehicle is severely damaged, remain a safe distance of 50 feet (15 meter) or more between your vehicle and other vehicles/flammables.

#### WARNING

If a fire occurs :

If a small scale fire occurs, use a fire extinguisher (ABC, BC) that is meant for electrical fires. If it is impossible to extinguish the fire in the early stage, remain a safe distance from the vehicle and immediately call the fire department. Also, advise them that an electric vehicle is involved.

If the fire spreads to the high voltage battery, large amount of water is needed to put out the fire. Using small amount of water or fire extinguishers not meant for electrical fires could cause serious injury or death from electrical shocks.

## **WARNING**

**When a submersion in water occurs:**

**When your vehicle is flooded in water, a high-voltage battery may cause shock or fires. Thus, turn the hybrid system OFF, take the key in your possession and escape to a safe place. Never attempt physical contact with your flooded vehicle.**

**Immediately contact an emergency response team and advise them that a hybrid vehicle is involved.**

## **When the Hybrid Vehicle Shuts Off**

When the high voltage battery is discharged, when the 12-volt battery is discharged, or when the fuel tank is empty, the hybrid system may not operate while driving. When the Hybrid system does not operate, do the followings:

1. Gradually reduce the vehicle speed. Pull over your vehicle off the road in a safe area.
2. Locate the shift lever in P (Park).
3. Turn ON the hazard warning flashers.
4. Turn OFF the vehicle, and try to start the hybrid system again, while depressing the brake pedal and turning on the ignition switch.
5. When the hybrid system still does not operate, refer to "If the 12 Volt Battery Is Discharged" in chapter 6. Before jump-starting the vehicle, check the fuel level and the exact procedure to jump start. For further details, refer to "If the 12 Volt Battery Is Discharged" in the chapter 6. When the fuel level is low, do not attempt to drive the vehicle only with the battery power. The high voltage battery may be discharged, and the hybrid system will turn OFF.

# Your vehicle at a glance

## Hybrid Vehicle

- Exterior Overview .....1-2
- Interior Overview .....1-4
- Instrument Panel Overview .....1-5
- Engine Compartment .....1-6

## Plug-in Hybrid Vehicle

- Exterior Overview .....1-7
- Interior Overview .....1-9
- Instrument Panel Overview .....1-10
- Engine Compartment .....1-11

## EXTERIOR OVERVIEW – HYBRID VEHICLE

### ■ Front view



The actual shape may differ from the illustration.

1. Hood.....	3-45	6. Sunroof.....	3-41
2. Headlamp.....	7-56	7. Front windshield wiper blades.....	7-29
3. Daytime running light (DRL).....	3-115, 7-61	8. Windows.....	3-37
4. Tires and wheels.....	7-35, 8-5	9. Front ultrasonic sensors.....	3-134
5. Outside side view mirror.....	3-34	10. Front radar.....	5-69

OAEPH019018N

■ Rear view

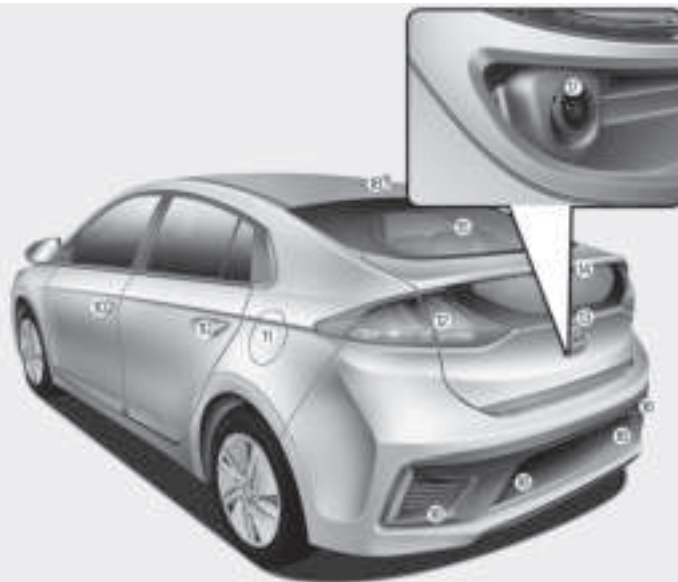

The actual shape may differ from the illustration.

- |                                  |      |                                   |       |
|----------------------------------|------|-----------------------------------|-------|
| 10. Doors .....                  | 3-14 | 15. Rear window defroster .....   | 3-153 |
| 11. Fuel filler door .....       | 3-49 | 16. Rear ultrasonic sensors ..... | 3-130 |
| 12. Rear combination lamp .....  | 7-61 | 17. Rear view camera .....        | 3-128 |
| 13. Tailgate .....               | 3-46 | 18. Antenna .....                 | 4-2   |
| 14. High mounted stop lamp ..... | 7-64 |                                   |       |

OAE018002

## INTERIOR OVERVIEW - HYBRID VEHICLE



- 1. Door lock/unlock button .....3-14
- 2. Side view mirror folding switch .....3-35
- 3. Side view mirror control switch .....3-34
- 4. Power window lock switch.....3-40
- 5. Central door lock switch .....3-16
- 6. Power window switches .....3-37
- 7. Instrument panel illumination control switch .....3-56
- 8. Blind-Spot Collision Warning system button .....5-90
- 9. Lane Keeping Assist system button .....5-80
- 10. ESC(Electronic Stability Control) OFF button .....5-44
- 11. Fuel filler door open switch.....3-48
- 12. 12V battery reset switch .....6-5
- 13. Hood release lever .....3-45
- 14. Steering wheel tilt/telescopic lever .....3-23
- 15. Steering wheel .....3-22
- 16. Seat.....2-4
- 17. Driver position memory system .....3-20

The actual shape may differ from the illustration.

OAEPH019009N

## INSTRUMENT PANEL OVERVIEW – HYBRID VEHICLE

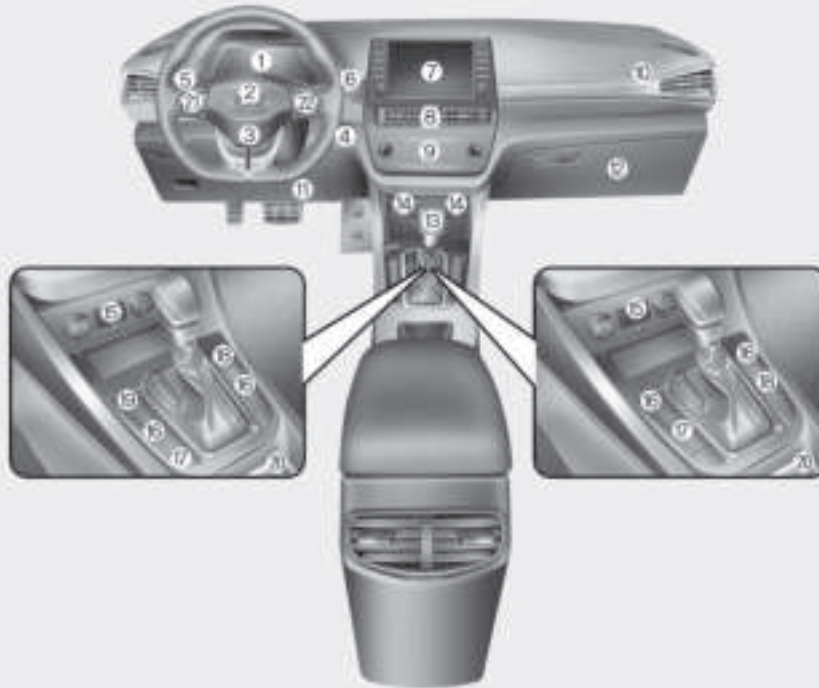

The actual shape may differ from the illustration.

1. Instrument cluster .....3-54
2. Horn .....3-23
3. Driver's front air bag .....2-49
4. Engine Start/Stop button .....5-8
5. Light control/Turn signals .....3-115
6. Wiper/Washer .....3-126
7. Infotainment system .....4-2
8. Hazard warning flasher .....6-2
9. Automatic climate control system ....3-139
10. Passenger's front air bag .....2-49
11. Knee air bag .....2-49
12. Glove box .....3-156
13. Dual clutch transmission .....5-15
14. Power outlet .....3-159
15. USB port .....4-2
16. Seat warmer switch .....2-21
17. Heated steering wheel switch .....3-24
18. Parking Distance Warning system  
ON button .....3-134
19. Electronic Parking Brake (EPB) .....5-32
20. Cup holder .....3-158
21. Steering wheel audio controls/  
Bluetooth® wireless technology  
hands-free controls .....4-3
22. Cruise Controls/ .....5-109  
Smart Cruise Control  
system button .....5-114

OAE018004

## ENGINE COMPARTMENT - HYBRID VEHICLE

### ■ Gasoline Engine (1.6 GDI)



- 1. Engine coolant reservoir .....7-19
- 2. Engine coolant cap .....7-20
- 3. Inverter coolant reservoir .....7-19
- 4. Brake fluid reservoir .....7-23
- 5. Air cleaner .....7-25
- 6. Engine oil dipstick .....7-17
- 7. Engine oil filler cap .....7-17
- 8. Windshield washer fluid reservoir .....7-24
- 9. Fuse box .....7-51

The actual engine compartment in the vehicle may differ from the illustration.

OAE078001



## EXTERIOR OVERVIEW – PLUG-IN HYBRID VEHICLE

■ Front view



The actual shape may differ from the illustration.

1. Hood.....	3-45	7. Front windshield wiper blades .....	7-29
2. Headlamp .....	7-56	8. Windows .....	3-37
3. Daytime running light (DRL) .....	3-115, 7-61	9. Front ultrasonic sensors .....	3-134
4. Tires and wheels .....	7-35, 8-5	10. Charging door .....	H4
5. Outside side view mirror.....	3-34	11. Front radar .....	5-69
6. Sunroof.....	3-41		

OAEPH019001N

■ Rear view



The actual shape may differ from the illustration.

10. Doors .....	3-14	15. High mounted stop lamp .....	7-64
11. Fuel filler door .....	3-49	16. Rear ultrasonic sensors .....	3-130
12. Rear combination lamp .....	7-61	17. Rear view camera .....	3-128
13. Tailgate .....	3-46	18. Antenna .....	4-2
14. Rear window defroster .....	3-153		

## INTERIOR OVERVIEW - PLUG-IN HYBRID VEHICLE

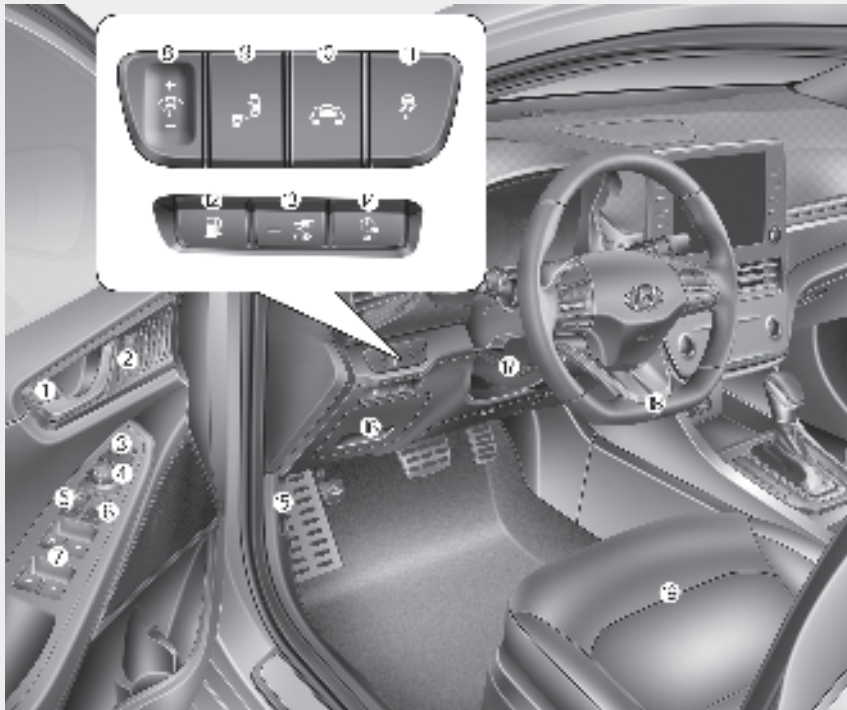

The actual shape may differ from the illustration.

1. Door lock/unlock button .....	3-14
2. Driver position memory system .....	3-20
3. Side view mirror folding switch .....	3-35
4. Side view mirror control switch .....	3-34
5. Central door lock switch .....	3-16
6. Power window lock switch.....	3-37
7. Power window switches .....	3-40
8. Instrument panel illumination control switch .....	3-56
9. Blind-Spot Collision Warning system button .....	5-90
10. Lane Keeping Assist system button ....	5-80
11. ESC(Electronic Stability Control) OFF button .....	5-44
12. Fuel filler door open switch.....	3-48
13. AUTO/LOCK mode selection button .....	H6
14. Scheduled charging deactivation button.....	H7
15. Hood release lever .....	3-45
16. Fuse box .....	7-51
17. Steering wheel tilt/telescopic lever .....	3-23
18. Steering wheel .....	3-22
19. Seat.....	2-4

## INSTRUMENT PANEL OVERVIEW – PLUG-IN HYBRID VEHICLE

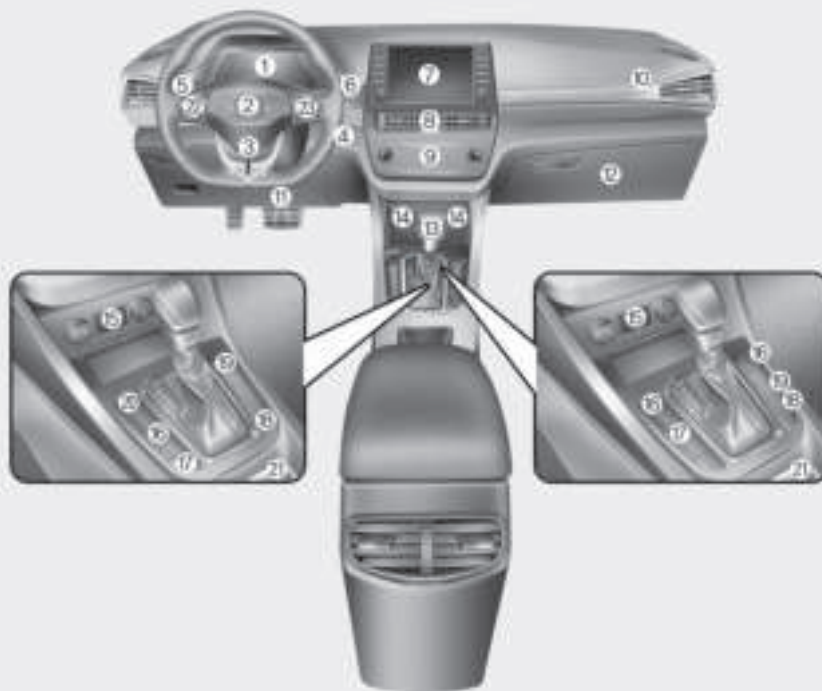

The actual shape may differ from the illustration.

1. Instrument cluster .....3-54
2. Horn .....3-23
3. Driver's front air bag .....2-49
4. Engine Start/Stop button .....5-8
5. Light control/Turn signals .....3-115
6. Wiper/Washer .....3-126
7. Infotainment system .....4-2
8. Hazard warning flasher .....6-2
9. Automatic climate control system ....3-139
10. Passenger's front air bag .....2-49
11. Knee air bag .....2-49
12. Glove box .....3-156
13. Dual clutch transmission .....5-15
14. Power outlet .....3-159
15. USB port .....4-2
16. Seat warmer switch .....2-21
17. Heated steering wheel switch .....3-24
18. HEV button .....H-32
19. Parking Distance Warning system  
ON button .....3-134
20. Electronic Parking Brake (EPB) .....5-32
21. Cup holder .....3-158
22. Steering wheel audio controls/  
*Bluetooth*<sup>®</sup> wireless technology  
hands-free controls .....4-3
23. Cruise Controls/ .....5-109  
Smart Cruise Control  
system button .....5-108

OAEPH018004

## ENGINE COMPARTMENT - PLUG-IN HYBRID VEHICLE

### ■ Gasoline Engine (1.6 GDI)



The actual engine compartment in the vehicle may differ from the illustration.

- 1. Engine coolant reservoir .....7-19
- 2. Engine coolant cap .....7-20
- 3. Inverter coolant reservoir .....7-19
- 4. Brake fluid reservoir .....7-23
- 5. Air cleaner .....7-25
- 6. Engine oil dipstick .....7-17
- 7. Engine oil filler cap .....7-17
- 8. Windshield washer fluid reservoir .....7-24
- 9. Fuse box .....7-51

※ The 12 volt battery is located in the luggage compartment.

# Safety system of your vehicle

This chapter provides you with important information about how to protect yourself and your passengers. It explains how to properly use your seats and seat belts, and how your air bags work. Additionally, this chapter explains how to properly restrain infants and children in your vehicle.

<b>Important safety precautions</b> .....	2-2	<b>Child restraint system (CRS)</b> .....	2-36
Always Wear Your Seat Belt .....	2-2	Children Always in the Rear .....	2-36
Restrain All Children .....	2-2	Selecting a Child Restraint System (CRS) .....	2-37
Air Bag Hazards.....	2-2	Installing a Child Restraint System (CRS).....	2-39
Driver Distraction .....	2-2	<b>Air bag</b>	
Control Your Speed.....	2-3	- <b>Advanced supplemental restraint system</b> .....	2-47
Keep Your Vehicle in Safe Condition.....	2-3	Where Are the Air Bags? .....	2-49
<b>Seats</b> .....	2-4	How Does the Air Bag System Operate?.....	2-52
Safety Precautions .....	2-5	What to Expect After an Air Bag Inflates.....	2-57
Front Seats .....	2-6	Occupant Classification System (OCS).....	2-58
Rear Seats.....	2-12	Why Didn't My Air Bag Go Off in a Collision? .....	2-63
Head Restraints .....	2-16	SRS Care.....	2-68
Seat warmers .....	2-20	Additional Safety Precautions .....	2-69
Battery Cooling Duct.....	2-22	Air Bag Warning Labels.....	2-70
<b>Seat belts</b> .....	2-23		
Seat Belt Safety Precautions.....	2-23		
Seat Belt Warning Light .....	2-24		
Seat Belt Restraint System.....	2-25		
Additional Seat Belt Safety Precautions.....	2-32		
Care of Seat Belts.....	2-35		

### IMPORTANT SAFETY PRECAUTIONS

You will find many safety precautions and recommendations throughout this section, and throughout this manual. The safety precautions in this section are among the most important.

#### Always Wear Your Seat Belt

A seat belt is your best protection in all types of accidents. Air bags are designed to supplement seat belts, not replace them. So even though your vehicle is equipped with air bags, **ALWAYS** make sure you and your passengers wear your seat belts, and wear them properly.

#### Restrain All Children

All children under age 13 should ride in your vehicle properly restrained in a rear seat, not the front seat. Infants and small children should be restrained in an appropriate child restraint. Larger children should use a booster seat with the lap/shoulder belt until they can use the seat belt properly without a booster seat.

#### Air Bag Hazards

While air bags can save lives, they can also cause serious or fatal injuries to occupants who sit too close to them, or who are not properly restrained. Infants, young children, and shorter adults are at the greatest risk of being injured by an inflating air bag. Follow all instructions and warnings in this manual.

#### Driver Distraction

Driver distraction presents a serious and potentially deadly danger, especially for inexperienced drivers. Safety should be the first concern when behind the wheel and drivers need to be aware of the wide array of potential distractions, such as drowsiness, reaching for objects, eating, personal grooming, other passengers, and using cellular phones.

Drivers can become distracted when they take their eyes and attention off the road or their hands off the wheel to focus on activities other than driving. To reduce your risk of distraction or getting into an accident:

- ALWAYS set up your mobile devices (i.e., MP3 players, phones, navigation units, etc.) when your vehicle is parked or safely stopped.
- ONLY use your mobile device when allowed by laws and when conditions permit safe use. NEVER text or email while driving. Most countries have laws prohibiting drivers from texting. Some countries and cities also prohibit drivers from using handheld phones.
- NEVER let the use of a mobile device distract you from driving. You have a responsibility to your passengers and others on the road to always drive safely, with your hands on the wheel as well as your eyes and attention on the road.

### Control Your Speed

Excessive speed is a major factor in crash injuries and deaths. Generally, the higher the speed, the greater the risk, but serious injuries can also occur at lower speeds. Never drive faster than is safe for current conditions, regardless of the maximum speed posted.

### Keep Your Vehicle in Safe Condition

Having a tire blowout or a mechanical failure can be extremely hazardous. To reduce the possibility of such problems, check your tire pressures and condition frequently, and perform all regularly scheduled maintenance.



## SEATS

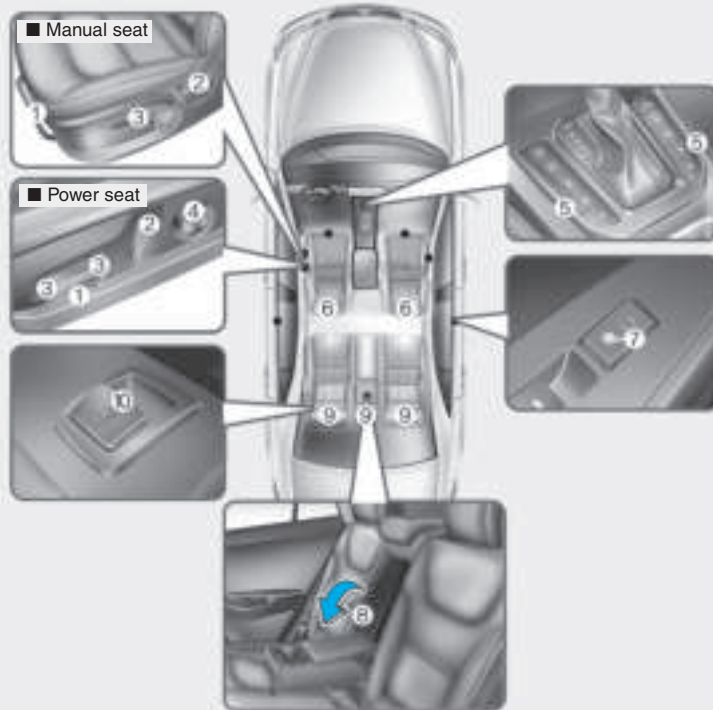

### Front seats

- (1) Forward and backward
- (2) Seatback angle
- (3) Seat cushion height
- (4) Lumbar support (Driver's seat)\*
- (5) Seat warmer\*
- (6) Headrest

### Rear seats

- (7) Seat warmer\*
- (8) Armrest\*
- (9) Headrest
- (10) Seatback folding

\* : if equipped

OAEFH038001

## Safety Precautions

Adjusting the seats so that you are sitting in a safe, comfortable position plays an important role in driver and passenger safety together with the seat belts and air bags in an accident.

### WARNING

**Do not use a cushion that reduces friction between the seat and the passenger. The passenger's hips may slide under the lap portion of the seat belt during an accident or a sudden stop. Serious or fatal internal injuries could result because the seat belt cannot operate properly.**

## *Air bags*

You can take steps to reduce the risk of being injured by an inflating air bag. Sitting too close to an air bag greatly increases the risk of injury in the event the air bag inflates.

Move your seat as far back as possible from front air bags, while still maintaining control of the vehicle.

### WARNING

**To reduce the risk of serious injury or death from an inflating air bag, take the following precautions:**

- **Adjust the driver's seat as far to the rear as possible while maintaining the ability to maintain full control of the vehicle.**
- **Adjust the front passenger seat as far to the rear as possible.**
- **Hold the steering wheel by the rim with hands at the 9 o'clock and 3 o'clock positions to minimize the risk of injuries to your hands and arms.**
- **NEVER place anything or anyone between the steering wheel and the air bag.**
- **Do not allow the front passenger to place feet or legs on the dashboard to minimize the risk of leg injuries.**

### **Seat belts**

Always fasten your seat belt before starting any trip.

At all times, passengers should sit upright and be properly restrained. Infants and small children must be restrained in appropriate child restraint systems. Adults and children who have outgrown a booster seat must be restrained using the seat belts.

### **WARNING**

**Take the following precautions when adjusting your seat belt:**

- **NEVER** use one seat belt for more than one occupant.
- **Always** position the seatback upright with the lap portion of the seat belt snug and low across the hips.
- **NEVER** allow children or small infants to ride on a passenger's lap.
- **Do not** route the seat belt across your neck, across sharp edges, or reroute the shoulder strap away from your body.
- **Do not** allow the seat belt to become caught or jammed.

### Front Seats

### **WARNING**

**Take the following precautions when adjusting your seat:**

- **NEVER** attempt to adjust the seat while the vehicle is moving. The seat could respond with unexpected movement and may cause loss of vehicle control resulting in an accident.
- **Do not** place anything under the front seats. Loose objects in the driver's foot area could interfere with the operation of the foot pedals, causing an accident.
- **Do not** allow anything to interfere with the normal position and proper locking of the seatback.
- **Do not** place a cigarette lighter on the floor or seat. When you operate the seat, gas may exit out of the lighter causing a fire.

(Continued)

(Continued)

- Use extreme caution when picking up small objects trapped under the seats or between the seat and the center console. Your hands might be cut or injured by the sharp edges of the seat mechanism.

### CAUTION

To prevent injury:

- Do not adjust your seat while wearing your seat belt. Moving the seat cushion forward may cause strong pressure on your abdomen.
- Do not allow your hands or fingers to get caught in the seat mechanisms while the seat is moving.

### **Manual adjustment (if equipped)**

The front seat can be adjusted by using the levers located on the outside of the seat cushion. Before driving, adjust the seat to the proper position so that you can easily control the steering wheel, foot pedals and controls on the instrument panel.

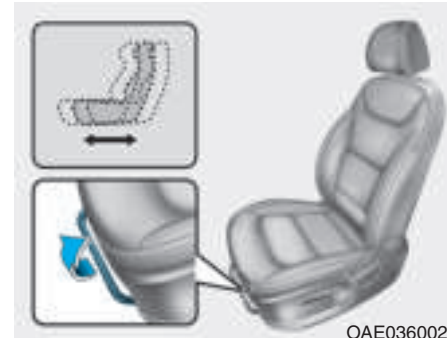

### **Forward and rearward adjustment**

To move the seat forward or rearward:

1. Pull up the seat slide adjustment lever and hold it.
2. Slide the seat to the position you desire.
3. Release the lever and make sure the seat is locked in place. Move forward and rearward without using the lever. If the seat moves, it is not locked properly.

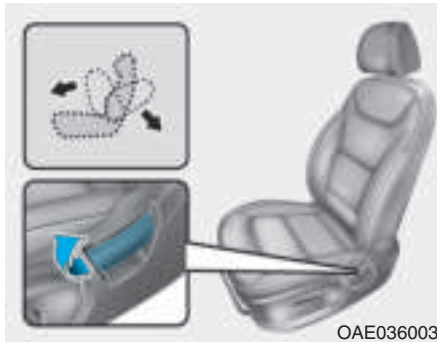

### Seatback angle

To recline the seatback:

1. Lean forward slightly and lift up the seatback lever.
2. Carefully lean back on the seat and adjust the seatback to the position you desire.
3. Release the lever and make sure the seatback is locked in place. (The lever **MUST** return to its original position for the seatback to lock.)

### Reclining seatback

Sitting in a reclined position when the vehicle is in motion can be dangerous. Even when buckled up, the protection of your restraint system (seat belts and air bags) is greatly reduced by reclining your seatback.

### **WARNING**

**NEVER** ride with a reclined seatback when the vehicle is moving.

**Riding with a reclined seatback increases your chance of serious or fatal injuries in the event of a collision or sudden stop.**

**Drivers and passengers should ALWAYS sit well back in their seats, properly belted, and with the seatbacks upright.**

Seat belts must be snug against your hips and chest to work properly. When the seatback is reclined, the shoulder belt cannot do its job because it will not be snug against your chest. Instead, it will be in front of you. During an accident, you could be thrown into the seat belt, causing neck or other injuries.

The more the seatback is reclined, the greater chance the passenger's hips will slide under the lap belt or the passenger's neck will strike the shoulder belt.

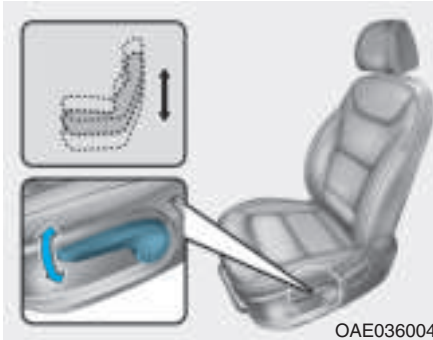

### Seat cushion height

To change the height of the seat cushion:

- Push down on the lever several times, to lower the seat cushion.
- Pull up on the lever several times, to raise the seat cushion.

### ***Power adjustment (for driver's seat, if equipped)***

The front seat can be adjusted by using the control switches located on the outside of the seat cushion. Before driving, adjust the seat to the proper position so that you can easily control the steering wheel, foot pedals and controls on the instrument panel.

### **⚠ WARNING**

**NEVER allow children in the vehicle unattended. The power seats are operable when the vehicle is turned off.**

### **NOTICE**

To prevent damage to the seats:

- **Always stop adjusting the seats when the seat has moved as far forward or rearward as possible.**
- **Do not adjust the seats for longer than necessary when the vehicle is turned off. This may result in unnecessary battery drain.**
- **Do not operate two or more seats at the same time. This may result in an electrical malfunction.**

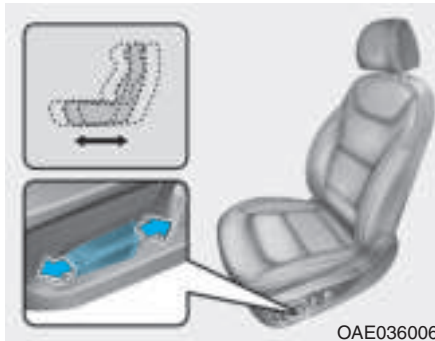

### Forward and rearward adjustment

To move the seat forward or rearward:

1. Push the control switch forward or rearward.
2. Release the switch once the seat reaches the desired position.

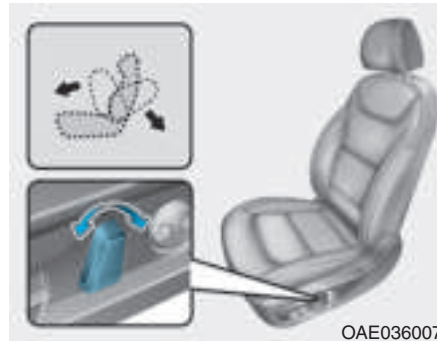

### Seatback angle

To adjust the seatback:

1. Rotate the top of control switch forward or rearward.
2. Release the switch once the seatback reaches the desired position.

### Reclining seatback

Sitting in a reclined position when the vehicle is in motion can be dangerous. Even when buckled up, the protections of your restraint system (seat belts and air bags) is greatly reduced by reclining your seatback.

### WARNING

**NEVER** ride with a reclined seatback when the vehicle is moving.

**Riding with a reclined seatback increases your chance of serious or fatal injuries in the event of a collision or sudden stop.**

**Driver and passengers should ALWAYS sit well back in their seats, properly belted, and with the seatbacks upright.**

Seat belts must be snug against your hips and chest to work properly. When the seatback is reclined, the shoulder belt cannot do its job because it will not be snug against your chest. Instead, it will be in front of you. During an accident, you could be thrown into the seat belt, causing neck or other injuries.

The more the seatback is reclined, the greater chance the passenger's hips will slide under the lap belt or the passenger's neck will strike the shoulder belt.

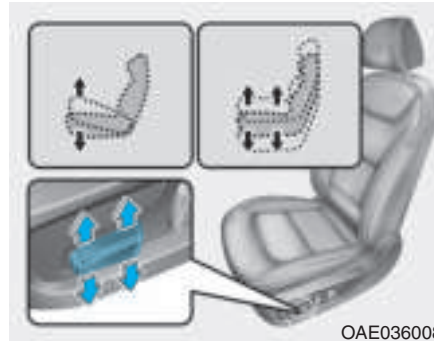

### Seat cushion height

To change the height of the seat cushion:

1. • Push the front portion of the control switch up to raise or down to lower the front part of the seat cushion.
  - Push the rear portion of the control switch up to raise or down to lower the height of the seat cushion.
2. Release the switch once the seat reaches the desired position.

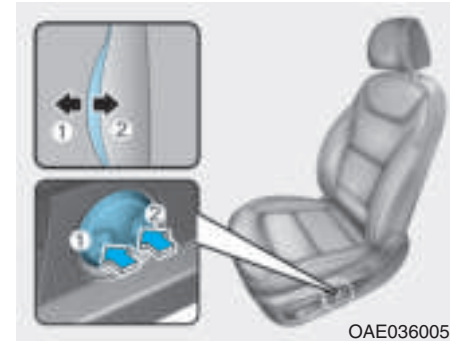

### Lumbar support (for driver's seat, if equipped)

To adjust the lumbar support:

1. Press the front portion of the switch (1) to increase support or the rear portion of the switch (2) to decrease support.
2. Release the switch once it reaches the desired position.



### Seatback pocket

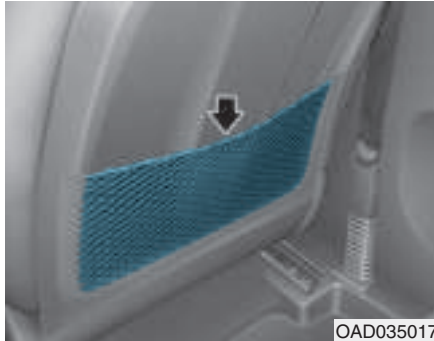

The seatback pocket is provided on the back of the front passenger's seatback.

#### WARNING

To prevent the Occupant Classification System from malfunctioning:

Do not hang onto the front passenger's seatback.

#### CAUTION

Do not put heavy or sharp objects in the seatback pockets. In an accident they could come loose from the pocket and injure occupants.

### Rear Seats

#### *Folding the rear seat*

The rear seatbacks can be folded to facilitate carrying long items or to increase the luggage capacity of the vehicle.

#### WARNING

- Never allow passengers to sit on top of the folded down seatback while the vehicle is moving. This is not a proper seating position and no seat belts are available for use. This could result in serious injury or death in case of an accident or sudden stop.
- Objects carried on the folded down seatback should not extend higher than the top of the front seatbacks. This could allow cargo to slide forward and cause injury or damage during sudden stops.

To fold down the rear seatback:

1. Set the front seatback to the upright position and if necessary, slide the front seat forward.

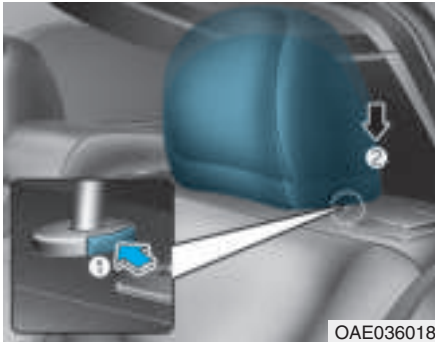

2. Lower the rear head restraints to the lowest position by pushing and holding the release button (1) and pushing down on the headrest (2).

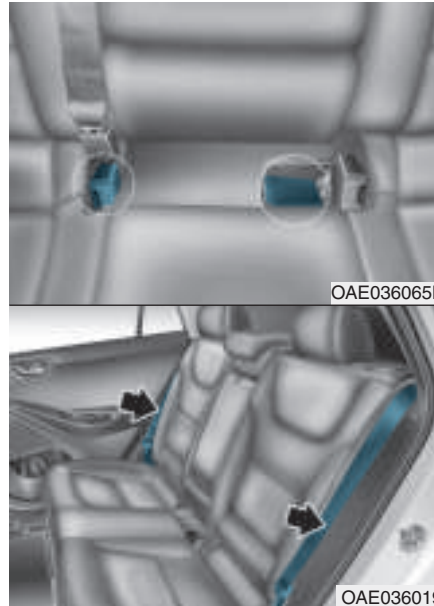

3. Insert the rear seat belt buckle in the pocket between the rear seatback and cushion.
4. Locate the seatbelt toward the outboard position before folding down the seatback. If not, the seatbelt system may be interfered by the seatback.



5. Pull on the seatback folding lever (1).

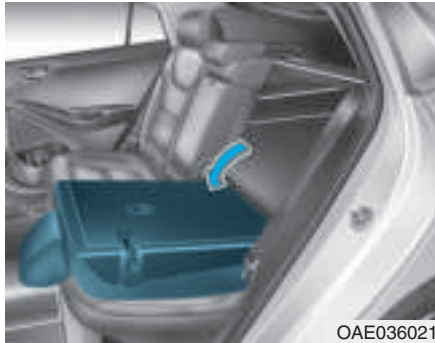

6. Fold the seatback toward the front of the vehicle.

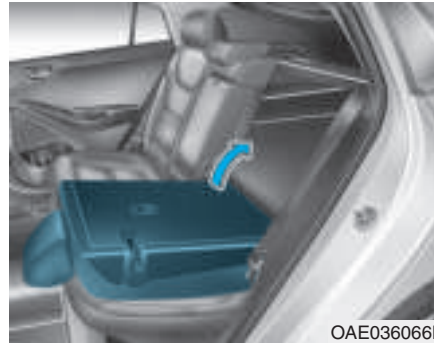

7. To use the rear seat, lift and unfold the seatback to the upright position. Push the seatback firmly until it clicks into place. Make sure the seatback is locked in place.

When you return the seatback to its upright position, always be sure it has locked into position by pushing on the top of the seatback.

**⚠ WARNING**

**When returning the rear seatback from a folded to an upright position, hold the seatback and return it slowly. Ensure that the seatback is completely locked into its upright position by pushing on the top of the seatback. In an accident or sudden stop, the unlocked seatback could allow cargo to move forward with great force and enter the passenger compartment, which could result in serious injury or death.**

**⚠ WARNING**

Do not place objects in the rear seats, since they cannot be properly secured and may hit vehicle occupants in a collision causing serious injury or death.

**⚠ WARNING**

Make sure the vehicle is off, the shift lever is in P (Park), and the parking brake is securely applied whenever loading or unloading cargo. Failure to take these steps may allow the vehicle to move if the shift lever is inadvertently moved to another position.

**Armrest (if equipped)**



The armrest is located in the center of the rear seat. Use the strap in the center of the armrest to pull it down.

**⚠ CAUTION**

- Be careful when loading cargo through the rear passenger seats to prevent damage to the vehicle interior.
- When cargo is loaded through the rear passenger seats, ensure the cargo is properly secured to prevent it from moving while driving.
- Unsecured cargo in the passenger compartment can cause damage to the vehicle or injury to its occupants.

### Head Restraints

The vehicle's front and rear seats have adjustable head restraints. The head restraints provide comfort for passengers, but more importantly they are designed to help protect passengers from whiplash and other neck and spinal injuries during an accident, especially in a rear impact collision.

#### WARNING

To reduce the risk of serious injury or death in an accident, take the following precautions when adjusting your head restraints:

- Always properly adjust the head restraints for all passengers **BEFORE** starting the vehicle.
- **NEVER** let anyone ride in a seat with the head restraints removed.

(Continued)

(Continued)



Adjust the head restraints so the middle of the head restraint is at the same height as the height of the top of the eyes.

- **NEVER** adjust the head restraint position of the driver's seat when the vehicle is in motion.
- Adjust the head restraint as close to the passenger's head as possible. Do not use a seat cushion that holds the body away from the seatback.
- Make sure the head restraint locks into position after adjusting it.

#### NOTICE

To prevent damage, **NEVER** hit or pull on the head restraints.

## Front seat head restraints

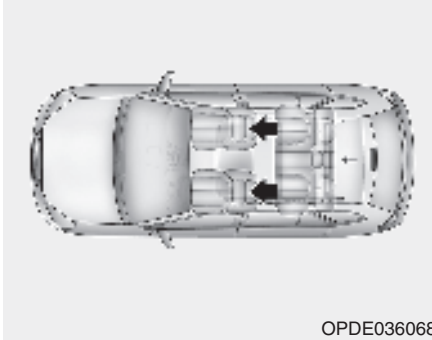

The vehicle's front and passenger's seats are equipped with adjustable head restraints for the passengers safety and comfort.

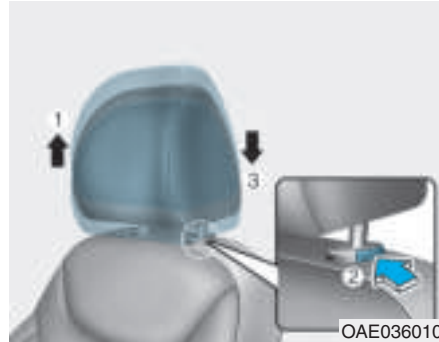

### Adjusting the height up and down

To raise the head restraint:

1. Pull it up to the desired position (1).

To lower the head restraint:

1. Push and hold the release button (2) on the head restraint support.
2. Lower the head restraint to the desired position (3).



### NOTICE

**If you recline the seatback towards the front with the head restraint and seat cushion raised, the head restraint may come in contact with the sunvisor or other parts of the vehicle.**

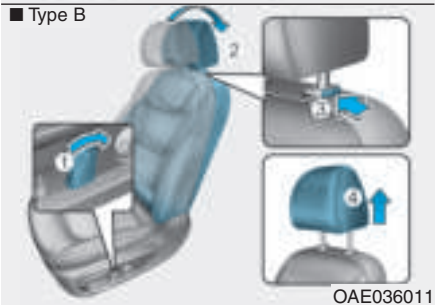
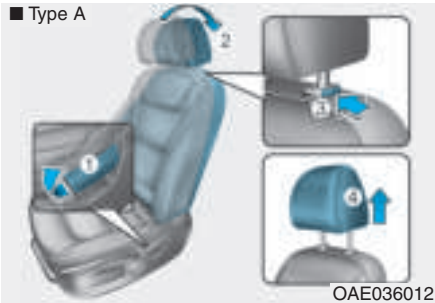

### Removal/Reinstallation

To remove the head restraint:

1. Recline the seatback (2) rearward using the seatback angle lever/switch (1).
2. Raise the head restraint as far as it can go.

3. Press the head restraint release button (3) while pulling the head restraint up (4).

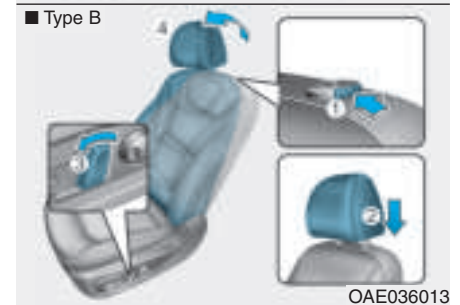
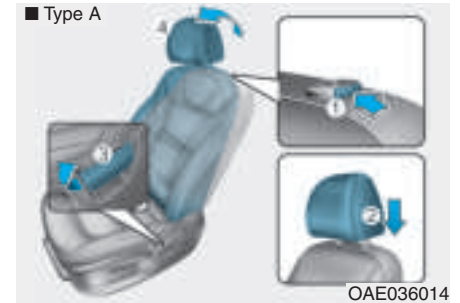

To reinstall the head restraint:

1. Put the head restraint poles (2) into the holes while pressing the release button (1).
2. Adjust the head restraint to the appropriate height.
3. Adjust the seatback (4) forward using the seatback angle lever/switch (3).

## Rear seat head restraints

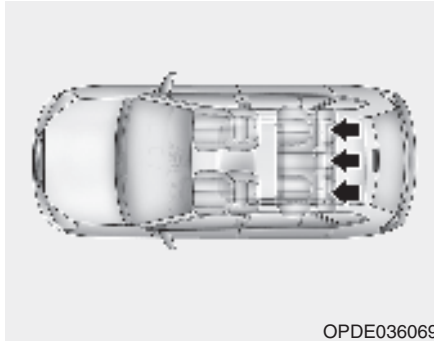

OPDE036069

The rear seats are equipped with head restraints in all the seating positions for the passenger's safety and comfort.

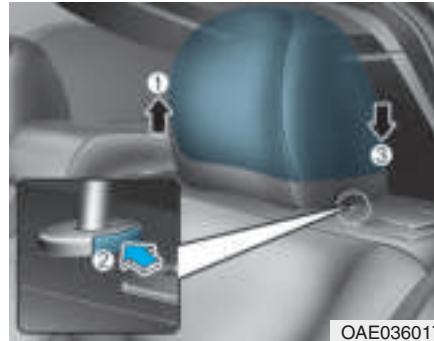

OAE036017

### Adjusting the height up and down

To raise the head restraint:

1. Pull it up to the desired position (1).

To lower the head restraint:

1. Push and hold the release button (2) on the head restraint support.
2. Lower the head restraint to the desired position (3).

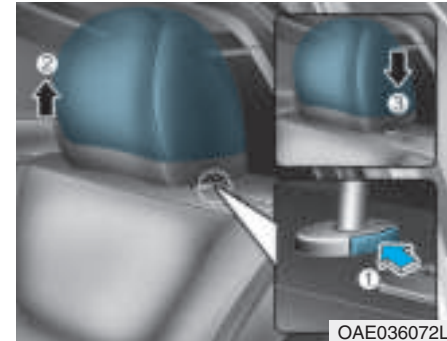

OAE036072L

### Removal/Reinstallation

To remove the head restraint:

1. Raise the head restraint as far as it can go.
2. Press the head restraint release button (1) while pulling the head restraint up (2).

To reinstall the head restraint:

1. Put the head restraint poles into the holes (3) while pressing the release button (1).
2. Adjust the head restraint to the appropriate height.



## Seat Warmers

### *Front seat warmers (if equipped)*

Seat warmers are provided to warm the seats during cold weather.

#### **WARNING**

The seat warmers can cause a **SERIOUS BURN**, even at low temperatures and especially if used for long periods of time.

Passengers must be able to feel if the seat is becoming too warm so they can turn it off, if needed.

(Continued)

#### (Continued)

People who cannot detect temperature change or pain to the skin should use extreme caution, especially the following types of passengers:

- Infants, children, elderly or disabled persons, or hospital outpatients.
- People with sensitive skin or who burn easily.
- Fatigued individuals.
- Intoxicated individuals.
- People taking medication that can cause drowsiness or sleepiness.

#### **WARNING**

**NEVER** place anything on the seat that insulates against heat when the seat warmer is in operation, such as a blanket or seat cushion. This may cause the seat warmer to overheat, causing a burn or damage to the seat.

#### **NOTICE**

To prevent damage to the seat warmers and seats:

- Never use a solvent such as paint thinner, benzene, alcohol or gasoline to clean the seats.
- Do not place heavy or sharp objects on seats equipped with seat warmers.
- Do not change the seat cover. It may damage the seat warmer.



While the vehicle is in the ready (🚗) mode, push either of the switches to warm the driver's seat or front passenger's seat.

During mild weather or under conditions where the operation of the seat warmer is not needed, keep the switches in the OFF position.

- Each time you push the switch, the temperature setting of the seat is changed as follows :

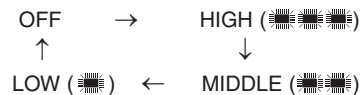

- When pressing the switch for more than 1.5 seconds with the seat warmer operating, the seat warmer will turn OFF.
- The seat warmer defaults to the OFF position whenever the ignition switch is in the ON position.

### **i** Information

**With the seat warmer switch in the ON position, the heating system in the seat turns off or on automatically depending on the seat temperature.**

### **Rear seat warmers (if equipped)**



While the vehicle is in the ready (🚗) mode, push either of the switches to warm the rear seat.

During mild weather or under conditions where the operation of the seat warmer is not needed, keep the switches in the OFF position.

Each time you push the switch, the temperature setting of the seat is changed as follows :

OFF → HIGH (☀️☀️☀️) → LOW (☀️)  
↑

The seat warmer defaults to the OFF position whenever the ignition switch is in the ON position.

### **i** Information

**With the seat warmer switch in the ON position, the heating system in the seat turns off or on automatically depending on the seat temperature.**

### Battery Cooling Duct

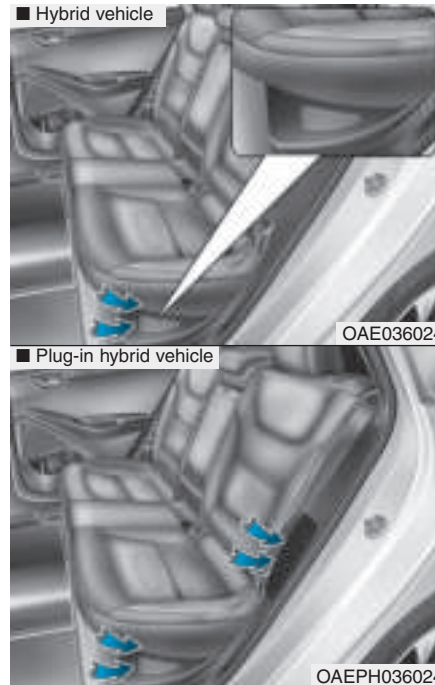

When the high voltage battery cooling duct is blocked, the high voltage battery may be overheated. Do not obstruct the cooling duct with any other objects.

The high voltage battery cooling duct is located on the left side of the rear seats. The cooling duct cools down the high voltage battery.

## SEAT BELTS

This section describes how to use the seat belts properly. It also describes some of the things not to do when using seat belts.

### Seat Belt Safety Precautions

Always fasten your seat belt and make sure all passengers have fastened their seat belts before starting any trip. Air bags are designed to supplement the seat belt as an additional safety device, but they are not a substitute. Most countries require all occupants of a vehicle to wear seat belts.

#### WARNING

Seat belts must be used by **ALL** passengers whenever the vehicle is moving. Take the following precautions when adjusting and wearing seat belts:

- **ALWAYS** properly restrain children under age 13 in the rear seats.

(Continued)

#### (Continued)

- **NEVER** allow children to ride in the front passenger seat. If a child age 13 or older must be seated in the front seat, move the seat as far back as possible and properly restrain them in the seat.
- **NEVER** allow an infant or child to be carried on an occupant's lap.
- **NEVER** ride with the seatback reclined when the vehicle is moving.
- Do not allow children to share a seat or seat belt.
- Do not wear the shoulder belt under your arm or behind your back.
- Always wear both the shoulder portion and lap portion of the lap/shoulder belt.
- Do not use the seat belt if it is twisted. A twisted seat belt will not protect you properly in an accident.

(Continued)

#### (Continued)

- Do not use a seat belt if the webbing or hardware is damaged.
- Do not latch the seat belt into the buckles of other seats.
- **NEVER** unfasten the seat belt while driving. This may cause loss of vehicle control resulting in an accident.
- Make sure there is nothing in the buckle interfering with the seat belt latch mechanism. This may prevent the seat belt from fastening securely.
- No modifications or additions should be made by the user which will either prevent the seat belt adjusting devices from operating to remove slack, or prevent the seat belt assembly from being adjusted to remove slack.

### WARNING

**Damaged seat belts and seat belt assemblies will not operate properly. Always replace:**

- Frayed, contaminated, or damaged webbing
- Damaged hardware
- The entire seat belt assembly after it has been worn in an accident, even if damage to webbing or assembly is not apparent

### Seat Belt Warning Light

***Seat belt warning light  
(for driver's seat)***

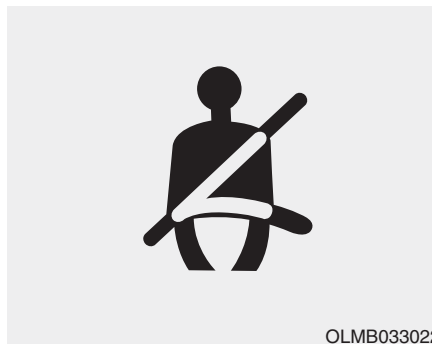

As a reminder to the driver, the seat belt warning light will illuminate and warning chime will sound for approximately 6 seconds each time you turn the ignition switch is ON if the seat belt is unfastened.

If you continue not to fasten the seat belt and you drive over 9 km/h (6 mph), the warning light will stay illuminated.

If you continue not to fasten the seat belt and you drive over 20 km/h (12 mph) the seat belt warning chime will sound for approximately 100 seconds and the corresponding warning light will blink.

If you unfasten the seat belt while driving under 20 km/h (12 mph), the seat belt warning light will illuminate until the seat belt is fastened.

If you unfasten the seat belt while driving over 20 km/h (12 mph), the seat belt warning chime will sound for approximately 100 seconds and the corresponding warning light will blink.

### **Seat belt warning light (for front passenger's seat)**

As a reminder to the front passenger, the front passenger's seat belt warning lights will illuminate for approximately 6 seconds each time you place the ignition switch to the ON position regardless of belt fastening.

If you continue not to fasten the seat belt and you drive over 9 km/h (6 mph), the warning light will stay illuminated.

If you continue not to fasten the seat belt and you drive over 20 km/h (12 mph) the seat belt warning chime will sound for approximately 100 seconds and the corresponding warning light will blink.

If you unfasten the seat belt while driving under 20 km/h (12 mph) the seat belt warning light will illuminate until the seat belt is fastened.

If you unfasten the seat belt while driving over 20 km/h (12 mph), the seat belt warning chime will sound for approximately 100 seconds and the corresponding warning light will blink.

### **▲ WARNING**

**The front passenger's seat belt warning light may not properly operate if the front passenger does not sit properly in the seat.**

### **Seat Belt Restraint System**

### **▲ WARNING**



OHSS038102

**Improperly positioned seat belts may increase the risk of serious injury in an accident. Take the following precautions when adjusting the seat belt:**

- **Position the lap portion of the seat belt as low as possible across your hips, not on your waist, so that it fits snugly.**

**(Continued)**

(Continued)

- Position one arm under the shoulder belt and the other over the belt, as shown in the illustration.
- Always position the shoulder belt anchor into the locked position at the appropriate height.
- Never position the shoulder belt across your neck or face.

### ***Seat Belt-Driver's 3-point system with emergency locking retractor***



#### **To fasten your seat belt:**

Pull the seat belt out of the retractor and insert the metal tab (1) into the buckle (2). There will be an audible "click" when the tab locks into the buckle.



You should place the lap belt (1) portion across your hips and the shoulder belt (2) portion across your chest.

The seat belt automatically adjusts to the proper length after the lap belt portion is adjusted manually so that it fits snugly around your hips. If you lean forward in a slow, easy motion, the belt will extend and move with you.

If there is a sudden stop or impact, the belt will lock into position. It will also lock if you try to lean forward too quickly.

## NOTICE

If you are not able to smoothly pull enough of the seat belt out from the retractor, firmly pull the seat belt out and release it. After release, you will be able to pull the belt out smoothly.

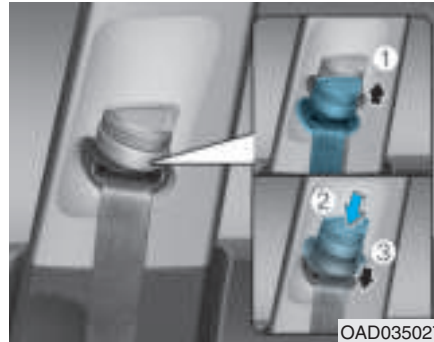

OAD035027

### Height adjustment

You can adjust the height of the shoulder belt anchor to one of the three different positions for maximum comfort and safety. The shoulder portion should be adjusted so it lies across your chest and midway over your shoulder nearest the door, not over your neck.

To adjust the height of the seat belt anchor, lower or raise the height adjuster into an appropriate position.

To raise the height adjuster, pull it up (1). To lower it, push it down (3) while pressing the height adjuster button (2).

Release the button to lock the anchor into position. Try sliding the height adjuster to make sure that it has locked into position.



OHSS038103

### To release your seat belt:

Press the release button (1) in the locking buckle.

When it is released, the belt should automatically draw back into the retractor. If this does not happen, check the belt to be sure it is not twisted, then try again.



### ***Rear Seat Belt – Passenger's 3-point system with convertible locking retractor***

This type of seat belt combines the features of both an emergency locking retractor seat belt and an automatic locking retractor seat belt. Convertible retractor type seat belts are installed in the rear seat positions to help accommodate the installation of child restraint systems. Although a convertible retractor is also installed in the front passenger seat position, NEVER place any infant/child restraint system in the front seat of the vehicle.

#### **To fasten your seat belt:**

Pull the seat belt out of the retractor and insert the metal tab into the buckle. There will be an audible "click" when the tab locks into the buckle. When not securing a child restraint, the seat belt operates in the same way as the driver's seat belt (Emergency Locking Retractor Type). It automatically adjusts to the proper length only after the lap belt portion of the seat belt is adjusted manually so that it fits snugly across your hips.

When the seat belt is fully extended from the retractor to allow the installation of a child restraint system, the seat belt operation changes to allow the belt to retract, but not to extend (Automatic Locking Retractor Type). Refer to the "Using a Child Restraint System" section in this chapter.

#### **NOTICE**

**Although the seat belt retractor provides the same level of protection for seated passengers in either emergency or automatic locking modes, the emergency locking mode allows seated passengers to move freely in their seat while keeping some tension on the belt. During a collision or sudden stop, the retractor automatically locks the belt to help restrain your body.**

**To deactivate the automatic locking mode, unbuckle the seat belt and allow the belt to fully retract.**



OHSS038103

### To release your seat belt:

Press the release button (1) in the locking buckle.

When it is released, the belt should automatically draw back into the retractor. If this does not happen, check the belt to be sure it is not twisted, then try again.

### Pre-tensioner seat belt (Driver and front passenger)

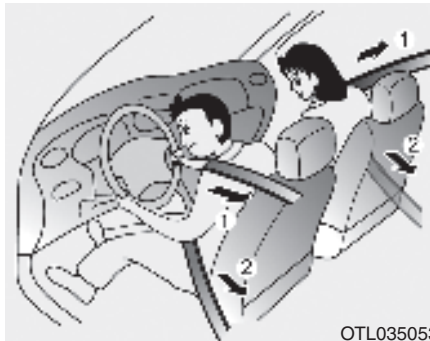

OTL035053

Your vehicle is equipped with driver's and front passenger's Pre-tensioner Seat Belts (Retractor Pretensioner and Emergency Fastening Device System). The purpose of the pre-tensioner is to make sure the seat belts fit tightly against the occupant's body in certain frontal or side collision(s). The Emergency Fastening Device System may be activated in certain crashes where the frontal or side collision(s) is severe enough, together with the air bags.

When the vehicle stops suddenly, or if the occupant tries to lean forward too quickly, the seat belt retractor will lock into position. In certain frontal or side collision(s), the pre-tensioner will activate and pull the seat belt into tighter contact against the occupant's body.

#### (1) Retractor Pretensioner

The purpose of the retractor pre-tensioner is to make sure that the shoulder belts fit in tightly against the occupant's upper body in certain frontal or side collision(s).

#### (2) Emergency Fastening Device System

The purpose of the Emergency Fastening Device System is to make sure that the pelvis belts fit in tightly against the occupant's lower body in certain frontal or side collision(s).

If the system senses excessive tension on the driver or passenger's seat belt when the pre-tensioner system activates, the load limiter inside the retractor pre-tensioner will release some of the pressure on the affected seat belt.

**⚠ WARNING**

- Always wear your seat belt and sit properly in your seat.
- Do not use the seat belt if it is loose or twisted. A loose or twisted seat belt will not protect you properly in an accident.
- Do not place anything near the buckle. This may adversely affect the buckle and cause it to function improperly.
- Always replace your pre-tensioners after activation or an accident.
- NEVER inspect, service, repair or replace the pre-tensioners yourself. This must be done by an authorized HYUNDAI dealer.
- Do not hit the seat belt assemblies.

**⚠ WARNING**

Do not touch the pre-tensioner seat belt assemblies for several minutes after they have been activated. When the pre-tensioner seat belt mechanism deploys during a collision, the pre-tensioners become hot and can burn you.

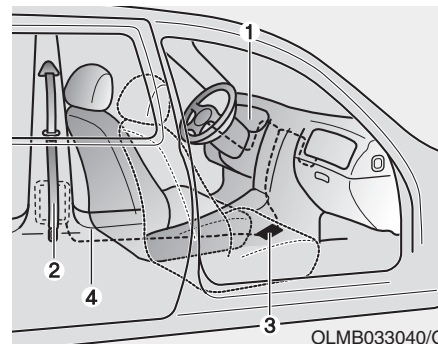

The Pre-Tensioner Seat Belt System consists mainly of the following components. Their locations are shown in the illustration above:

1. SRS air bag warning light
2. Retractor pre-tensioner
3. SRS control module
4. Emergency Fastening Device System

**NOTICE**

The sensor that activates the SRS air bag is connected with the pre-tensioner seat belts. The SRS air bag warning light on the instrument panel will illuminate for approximately 6 seconds after the ignition switch is in the ON position, and then it should turn off.

If the pre-tensioner is not working properly, the warning light will illuminate even if the SRS air bag is not malfunctioning. If the warning light does not illuminate, stays illuminated or illuminates when the vehicle is being driven, have an authorized HYUNDAI dealer inspect the pre-tensioner seat belts and SRS air bags as soon as possible.

**NOTICE**

- Both the driver's and front passenger's pre-tensioner seat belts may be activated in certain frontal or side collisions or rollovers.

(Continued)

(Continued)

- When the pre-tensioner seat belts are activated, a loud noise may be heard and fine dust, which may appear to be smoke, may be visible in the passenger compartment. These are normal operating conditions and are not hazardous.
- Although it is non-toxic, the fine dust may cause skin irritation and should not be inhaled for prolonged periods. Wash all exposed skin areas thoroughly after an accident in which the pre-tensioner seat belts were activated.

 **WARNING**

- Fasten your seat belt while sitting properly in an upright position to maximize the effectiveness of the pre-tensioner seat belt system.
- A pre-tensioner seat belt system is designed to activate only once. Replace the pre-tensioner seat belt system, if it was activated in an accident.

### Rear center seatbelt (3-point rear center seat belt)

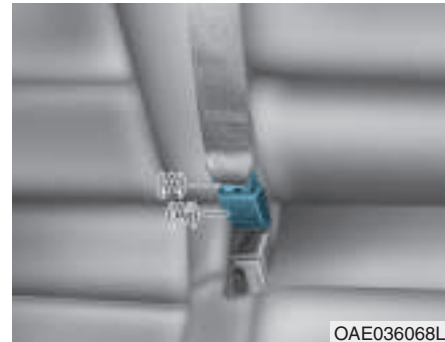

1. Insert the tongue plate (A) into the buckle (A') until an audible "click" is heard, indicating the latch is locked. Make sure the belt is not twisted.

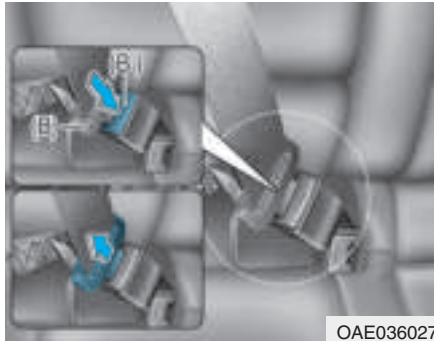

2. Pull the tongue plate (B) and insert it into the buckle (B') until an audible "click" is heard, indicating the latch is locked. Make sure the belt is not twisted.

When using the rear center seat belt, the buckle with the "CENTER" mark must be used.

### Additional Seat Belt Safety Precautions

#### *Seat belt use during pregnancy*

The seat belt should always be used during pregnancy. The best way to protect your unborn child is to protect yourself by always wearing the seat belt.

Pregnant women should always wear a lap-shoulder seat belt. Place the shoulder belt across your chest, routed between your breasts and away from your neck. Place the lap belt line so that it fits snugly and as low as possible across the hips, not across the abdomen.

### WARNING

- A pregnant woman or a patient is more vulnerable to any impacts on the abdomen during an abrupt stop or accident. If you are in an accident while pregnant, we recommend you consult your doctor.
- To reduce the risk of serious injury or death to an unborn child during an accident, pregnant women should **NEVER** place the lap portion of the seat belt above or over the area of the abdomen where the unborn child is located.

## **Seat belt use and children**

### **Infant and small children**

Most countries have child restraint laws which require children to travel in approved child restraint devices, including booster seats. The age at which seat belts can be used instead of child restraints differs among countries, so you should be aware of the specific requirements in your country, and where you are traveling. Infant and child restraints must be properly placed and installed in a rear seat. For more information refer to the "Child Restraint Systems" section in this chapter.

### **WARNING**

**ALWAYS properly restrain infants and small children in a child restraint appropriate for the child's height and weight.**

**To reduce the risk of serious injury or death to a child and other passengers, NEVER hold a child in your lap or arms when the vehicle is moving. The violent forces created during an accident will tear the child from your arms and throw the child against the interior of the vehicle.**

Small children are best protected from injury in an accident when properly restrained in the rear seat by a child restraint system that meets the requirements of the Safety Standards of your country. Before buying any child restraint system, make sure that it has a label certifying that it meets Safety Standards of your country. The restraint must be appropriate for your child's height and weight. Check the label on the child restraint for this information. Refer to the "Child Restraint Systems" section in this chapter.

### Larger children

Children under age 13 and who are too large for a booster seat must always occupy the rear seat and use the available lap/shoulder belts. A seat belt should lie across the upper thighs and be snug across the shoulder and chest to restrain the child safely. Check belt fit periodically. Children are afforded the most safety in the event of an accident when they are restrained by a proper restraint system and/or seat belts in the rear seat. Always have the LATCH system inspected by your authorized HYUNDAI dealer after an accident. An accident can damage the LATCH system and may not properly secure the child restraint.

If a larger child over age 13 must be seated in the front seat, the child must be securely restrained by the available lap/shoulder belt and the seat should be placed in the rear-most position.

If the shoulder belt portion slightly touches the child's neck or face, try placing the child closer to the center of the vehicle. If the shoulder belt still touches their face or neck they need to be returned to an appropriate booster seat in the rear seat.

#### WARNING

- **Always make sure children are wearing their seat belts and that they are properly adjusted before driving.**
- **NEVER allow the shoulder belt to contact the child's neck or face.**
- **Do not allow more than one child to use a single seat belt.**

### *Transporting an injured person*

A seat belt should be used when an injured person is being transported. Consult a physician for specific recommendations.

### *One person per belt*

Two people (including children) should never attempt to use a single seat belt. This could increase the severity of injuries in case of an accident.

### *Do not lie down*

Sitting in a reclined position when the vehicle is in motion can be dangerous. Even when buckled up, the protections of your restraint system (seat belts and air bags) is greatly reduced by reclining your seatback.

To reduce the chance of injuries in the event of an accident and to achieve the maximum effectiveness of the restraint system, all passengers should be sitting up and the front and rear seats should be in an upright position when the car is moving.

A seat belt cannot provide proper protection if the person is lying down in the rear seat or if the front or rear seats are in a reclined position.

 **WARNING**

- **NEVER ride with a reclined seatback when the vehicle is moving.**
- **Riding with a reclined seatback increases your chance of serious or fatal injuries in the event of a collision or sudden stop.**
- **Drivers and passengers should always sit well back in their seats, properly belted, and with the seatbacks upright.**

## Care of Seat Belts

Seat belt systems should never be disassembled or modified. In addition, care should be taken to assure that seat belts and belt hardware are not damaged by seat hinges, doors or other abuse.

### *Periodic inspection*

All seat belts should be inspected periodically for wear or damage of any kind. Any damaged parts should be replaced as soon as possible by an authorized HYUNDAI dealer.

### *Keep belts clean and dry*

Seat belts should be kept clean and dry. If belts become dirty, they can be cleaned by using a mild soap solution and warm water. Bleach, dye, strong detergents or abrasives should not be used because they may damage and weaken the fabric.

### *When to replace seat belts*

The entire seat belt assembly or assemblies should be replaced if the vehicle has been involved in an accident. This should be done even if no damage is visible. Additional questions concerning seat belt operation should be directed to an authorized HYUNDAI dealer.



## CHILD RESTRAINT SYSTEM (CRS)

### Children Always in the Rear

#### WARNING

**Always properly restrain children in the rear seats of the vehicle.**

**Children of all ages are safer when restrained in the rear seat. A child riding in the front passenger seat can be forcefully struck by an inflating air bag resulting in SERIOUS INJURY or DEATH.**

Children under age 13 must always ride in the rear seats and must always be properly restrained to minimize the risk of injury in an accident, sudden stop or sudden maneuver. According to accident statistics, children are safer when properly restrained in the rear seats than in the front seat. **Even with air bags, children can be seriously injured or killed.** Children too large for a child restraint must use the seat belts provided.

Most countries have child restraint laws which require children to travel in approved child restraint devices. The laws governing the age or height/ weight restrictions at which seat belts can be used instead of child restraints differs among countries, so you should be aware of the specific requirements in your country, and where you are travelling.

Child restraint systems must be properly placed and installed in the rear seat. You must use a commercially available child restraint system that meets the requirements of the Safety Standards of your country.

Child restraint systems are generally designed to be secured in a vehicle seat by lap belt portion of a lap/shoulder belt, or by a LATCH system in the rear seats of the vehicle.

#### ***Child restraint system (CRS)***

Infants and younger children must be restrained in an appropriate rear-facing or forward-facing CRS that has first been properly secured to the rear seat of the vehicle. Read and comply with the instructions for installation and use provided by the manufacturer of the child restraint.

#### WARNING

**An improperly secured child restraint can increase the risk of SERIOUS INJURY or DEATH in an accident. Always take the following precautions when using a child restraint system:**

- **NEVER install a child or infant restraint in the front passenger's seat.**
- **Always properly secure the child restraint to a rear seat of the vehicle.**

**(Continued)**

(Continued)

- Always follow the child restraint system manufacturer's instructions for installation and use.
- Always properly restrain your child in the child restraint.
- If the vehicle head restraint prevents proper installation of a child seat (as described in the child restraint system manual), the head restraint of the respective seating position shall be readjusted or entirely removed.
- Do not use an infant carrier or a child safety seat that "hooks" over a seatback, it may not provide adequate protection in an accident.
- After an accident, have a HYUNDAI dealer check the child restraint system, seat belts, tether anchors and lower anchors.

## Selecting a Child Restraint System (CRS)

When selecting a CRS for your child, always:

- Make sure the CRS has a label certifying that it meets applicable Safety Standards of your country.
- Select a child restraint based on your child's height and weight. The required label or the instructions for use typically provide this information.
- Select a child restraint that fits the vehicle seating position where it will be used.
- Read and comply with the warnings and instructions for installation and use provided with the child restraint system.

## Child restraint system types

There are three main types of child restraint systems: rear-facing seats, forward-facing seats, and booster seats. They are classified according to the child's age, height and weight.

### Rearward-facing child seats

#### WARNING

**NEVER install a child or infant restraint in the front passenger's seat.**

**Placing a rear-facing child restraint in the front seat can result in SERIOUS INJURY or DEATH if the child restraint is struck by an inflating air bag.**

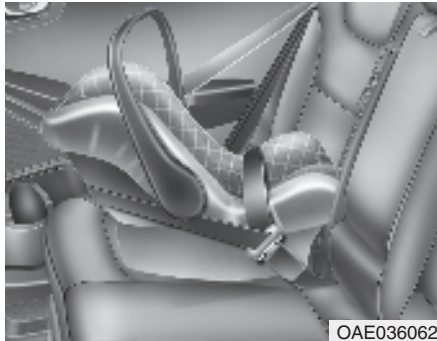

Continue to use a rear-facing child seat for as long as your child will fit within the height and weight limits allowed by the child seat manufacturer. It's the best way to keep them safe. Once your child has outgrown the rear-facing child restraint, your child is ready for a forward-facing child restraint with a harness.

A rear-facing child seat provides restraint with the seating surface against the back of the child. The harness system holds the child in place, and in an accident, acts to keep the child positioned in the seat and reduce the stress to the neck and spinal cord.

All children under age one must always ride in a rear-facing infant child restraint.

Convertible and 3-in-1 child seats typically have higher height and weight limits for the rear-facing position, allowing you to keep your child rear-facing for a longer period of time.

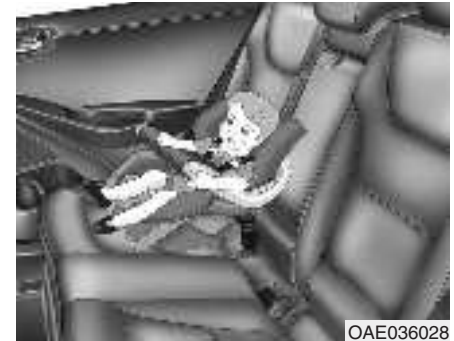

### **Forward-facing child restraints**

A forward-facing child seat provides restraint for the child's body with a harness. Keep children in a forward-facing child seat with a harness until they reach the top height or weight limit allowed by your child restraint's manufacturer.

Once your child outgrows the forward-facing child restraint, your child is ready for a booster seat.

### Booster seats

A booster seat is a restraint designed to improve the fit of the vehicle's seat belt system. A booster seat positions the seat belt so that it fits properly over the lap of your child.

Keep your child in a booster seat until they are big enough to sit in the seat without a booster and still have the seat belt fit properly. For a seat belt to fit properly, the lap belt must lie snugly across the upper thighs, not the stomach. The shoulder belt should lie snug across the shoulder and chest and not across the neck or face. Children under age 13 must always ride in the rear seats and must always be properly restrained to minimize the risk of injury.

### Installing a Child Restraint System (CRS)

#### WARNING

**Before installing your child restraint system always:**

- **Read and follow the instructions provided by the manufacturer of the child restraint.**
- **Read and follow the instructions regarding child restraint systems in this manual.**

**Failure to follow all warnings and instructions could increase the risk of the SERIOUS INJURY or DEATH if an accident occurs.**

#### WARNING

**If the vehicle headrest prevents proper installation of a child seat (as described in the child seat system manual, the headrest of the respective seating position shall be readjusted or entirely removed.**

After selecting a proper child seat for your child, check to make sure it fits properly in your vehicle. Follow the instructions provided by the manufacturer when installing the child seat. Note these general steps when installing the seat to your vehicle:

- **Properly secure the child restraint to the vehicle.** All child restraints must be secured to the vehicle with the lap part of a lap/shoulder belt or with the LATCH system.
- **Make sure the child restraint is firmly secured.** After installing a child restraint to the vehicle, push and pull the seat forward-and-back and side-to-side to verify that it is securely attached to the seat. A child restraint secured with a seat belt should be installed as firmly as possible. However, some side-to-side movement can be expected.
- **Secure the child in the child restraint.** Make sure the child is properly strapped in the child restraint according to the manufacturer instructions.

### CAUTION

**A child restraint in a closed vehicle can become very hot. To prevent burns, check the seating surface and buckles before placing your child in the child restraint.**

### ***Lower Anchors and Tether for Children (LATCH System)***

The LATCH system holds a child restraint during driving and in an accident. This system is designed to make installation of the child restraint easier and reduce the possibility of improperly installing your child restraint. The LATCH system uses anchors in the vehicle and attachments on the child restraint. The LATCH system eliminates the need to use seat belts to secure the child restraint to the rear seats.

Lower anchors are metal bars built into the vehicle. There are two lower anchors for each LATCH seating position that will accommodate a child restraint with lower attachments.

To use the LATCH system in your vehicle, you must have a child restraint with LATCH attachments.

The child seat manufacturer will provide you with instructions on how to use the child seat with its attachments for the LATCH lower anchors.

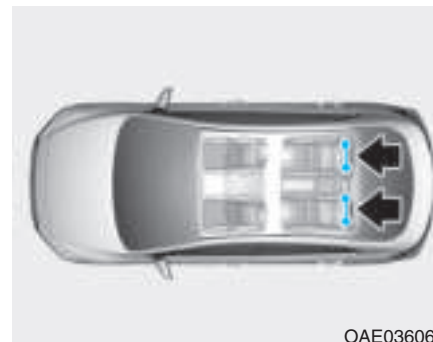

OAE036063

LATCH anchors have been provided in the left and right outboard rear seating positions. Their locations are shown in the illustration. There are no LATCH anchors provided for the center rear seating position.

## WARNING

Do not attempt to install a child restraint system using LATCH anchors in the rear center seating position. There are no LATCH anchors provided for this seat. Using the outboard seat anchors can damage the anchors which may break or fail in a collision resulting in serious injury or death.

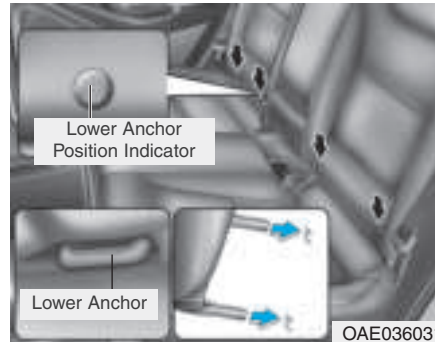

The lower anchor position indicator symbols are located on the left and right rear seat backs to identify the position of the lower anchors in your vehicle (see arrows in illustration).

The LATCH anchors are located between the seatback and the seat cushion of the rear seat left and right outboard seating positions.

## ***Securing a child restraint with the LATCH anchors system***

To install a LATCH-compatible child restraint in either of the rear outboard seating positions:

1. Move the seat belt buckle away from the lower anchors.
2. Move any other objects away from the anchors that could prevent a secure connection between the child restraint and the lower anchors.
3. Place the child restraint on the vehicle seat, then attach the seat to the lower anchors according to the instructions provided by the child restraint manufacturer.
4. Follow the child restraint instructions for properly adjusting and tightening the lower attachments on the child restraint to the lower anchors.

**⚠ WARNING**

Take the following precautions when using the LATCH system:

- Read and follow all installation instructions provided with your child restraint system.
- To prevent the child from reaching and taking hold of unretracted seat belts, buckle all unused rear seat belts and retract the seat belt webbing behind the child. Children can be strangled if a shoulder belt becomes wrapped around their neck and the seat belt tightens.
- **NEVER** attach more than one child restraint to a single anchor. This could cause the anchor or attachment to come loose or break.
- Always have the LATCH system inspected by your authorized HYUNDAI dealer after an accident. An accident can damage the LATCH system and may not properly secure the child restraint.

**Securing a child restraint seat with "Tether Anchor" system**



First secure the child restraint with the LATCH lower anchors or the seat belt. If the child restraint manufacturer recommends that the top tether strap be attached, attach and tighten the top tether strap to the top tether strap anchor.

Child restraint hook holders are located on the rear of the seatbacks.

**⚠ WARNING**

Take the following precautions when installing the tether strap:

- Read and follow all installation instructions provided with your child restraint system.
- **NEVER** attach more than one child restraint to a single tether anchor. This could cause the anchor or attachment to come loose or break.
- Do not attach the tether strap to anything other than the correct tether anchor. It may not work properly if attached to something else.
- Do not use the tether anchors for adult seat belts or harnesses, or for attaching other items or equipment to the vehicle.



To install the tether anchor:

1. Route the child restraint tether strap over the child restraint seat-back. Route the tether strap under the head restraint and between the head restraint posts, or route the tether strap over the top of the vehicle seatback. Make sure the strap is not twisted.
2. Connect the tether strap hook to the tether anchor, then tighten the tether strap according to the child seat manufacturer's instructions to firmly secure the child restraint to the seat.
3. Check that the child restraint is securely attached to the seat by pushing and pulling the seat forward-and-back and side-to-side.

### ***Securing a child restraint with lap/shoulder belt***

When not using the LATCH system, all child restraints must be secured to a vehicle rear seat with the lap part of a lap/shoulder belt.

#### **⚠ WARNING**

**ALWAYS** place a rear-facing child restraint in the rear seat of the vehicle.

**Placing a rear-facing child restraint in the front seat can result in serious injury or death if the child restraint is struck by an inflating air bag.**



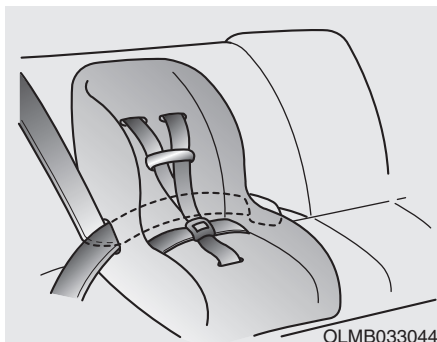

### Automatic locking mode

Since all passenger seat belts move freely under normal conditions and only lock under extreme or emergency conditions (emergency locking mode), you must manually pull the seat belt all the way out to shift the retractor to the "Automatic Locking" mode to secure a child restraint.

The "Automatic Locking" mode will help prevent the normal movement of the child in the vehicle from causing the seat belt to loosen and compromise the child restraint system. To secure a child restraint system, use the following procedure.

To install a child restraint system on the rear seats, do the following:

1. Place the child restraint system on a rear seat and route the lap/shoulder belt around or through the child restraint, following the restraint manufacturer's instructions.

Be sure the seat belt webbing is not twisted.

### NOTICE

**When using the rear center seat belt, you should also refer to the "Rear Seat Belt – Passenger's 3-point system" section in this chapter.**

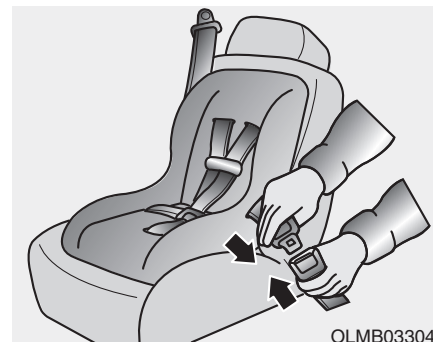

2. Fasten the lap/shoulder belt latch into the buckle. Listen for the distinct "click" sound.

### **i** Information

**Position the release button so that it is easy to access in case of an emergency.**



3. Pull the shoulder portion of the seat belt all the way out. When the shoulder portion of the seat belt is fully extended, it will shift the retractor to the "Automatic Locking" (child restraint) mode.



4. Slowly allow the shoulder portion of the seat belt to retract and listen for an audible "clicking" or "ratcheting" sound. This indicates that the retractor is in the "Automatic Locking" mode. If no distinct sound is heard, repeat steps 3 and 4.

5. Remove as much slack from the belt as possible by pushing down on the child restraint system while feeding the shoulder belt back into the retractor.

6. Push and pull on the child restraint system to confirm that the seat belt is holding it firmly in place. If it is not, release the seat belt and repeat steps 2 through 6.

7. Double check that the retractor is in the "Automatic Locking" mode by attempting to pull more of the seat belt out of the retractor. If you cannot, the retractor is in the "Automatic Locking" mode.

If your CRS manufacturer instructs or recommends you to use a tether anchor with the lap/shoulder belt, refer to the previous pages for more information.

### **NOTICE**

**When the seat belt is allowed to retract to its fully stowed position, the retractor will automatically switch from the "Automatic Locking" mode to the emergency lock mode for normal adult usage.**

### **WARNING**

**If the retractor is not in the "Automatic Locking" mode, the child restraint can move when your vehicle turns or stops suddenly. A child can be seriously injured or killed if the child restraint is not properly anchored in the car, including manually pulling the seat belt all the way out to shift the retractor to the "Automatic Locking" mode.**

To remove the child restraint, press the release button on the buckle and then pull the lap/shoulder belt out of the restraint and allow the seat belt to retract fully.

## AIR BAG – ADVANCED SUPPLEMENTAL RESTRAINT SYSTEM

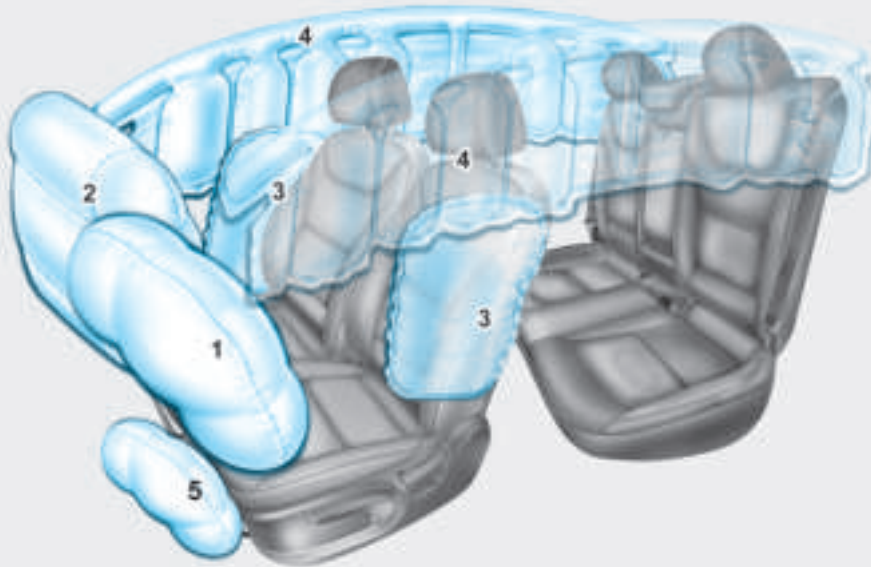

1. Driver's front air bag
2. Passenger's front air bag
3. Side air bag
4. Curtain air bag
5. Driver's knee air bag

The actual air bags in the vehicle may differ from the illustration.

OAEEO36035

This vehicle is equipped with an Advanced Supplemental Air Bag System for the driver's seat and front passenger's seats.

The front air bags are designed to supplement the three-point seat belts. For these air bags to provide protection, the seat belts must be worn at all times when driving.

You can be severely injured or killed in an accident if you are not wearing a seat belt. Air bags are designed to supplement seat belts, but do not replace them. Also, air bags are not designed to deploy in every collision. In some accidents, the seat belts are the only restraint protecting you.

### WARNING

#### **AIR BAG SAFETY PRECAUTIONS**

**ALWAYS** use seat belts and child restraints - every trip, every time, everyone! Even with air bags, you can be seriously injured or killed in a collision if you are improperly belted or not wearing your seat belt when the air bag inflates.

**NEVER** place a child in any child restraint or booster seat in the front passenger seat. An inflating air bag could forcefully strike the infant or child causing serious or fatal injuries.

**ABC - Always Buckle Children** under age 13 in the back seat. It is the safest place for children of any age to ride. If a child age 13 or older must be seated in the front seat, he or she must be properly belted and the seat should be moved as far back as possible.

**All occupants** should sit upright with the seatback in an upright position, centered on the seat cushion with their seat belt on, legs comfortably extended and their feet on the floor until the vehicle is parked and is turned off. If an occupant is out of position during an accident, the rapidly deploying air bag may forcefully contact the occupant causing serious or fatal injuries.

**You and your passengers** should never sit or lean unnecessarily close to the air bags or lean against the door or center console.

**Move your seat** as far back as possible from front air bags, while still maintaining control of the vehicle.

## Where Are the Air Bags?

### ***Driver's and passenger's front air bags***

Your vehicle is equipped with a Advanced Supplemental Restraint System (SRS) and lap/shoulder belts at both the driver and passenger seating positions.

The SRS consists of air bags which are located in the center of the steering wheel, in the driver's side lower crash pad below the steering wheel column and the passenger's side front panel pad above the glove box.

The air bags are labeled with the letters "AIR BAG" embossed on the pad covers.

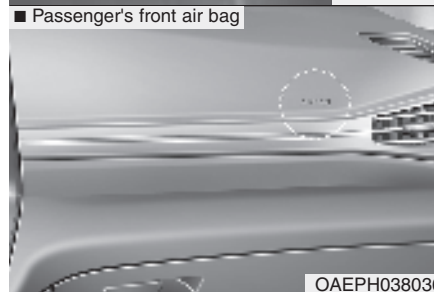
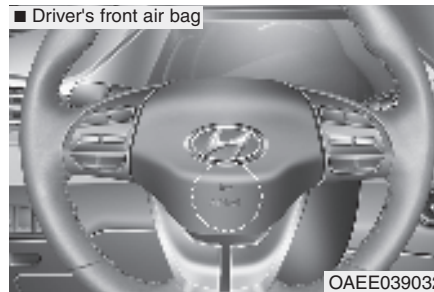

The purpose of the SRS is to provide the vehicle's driver and front passengers with additional protection than that offered by the seat belt system alone. The advanced SRS offers the ability to control the air bag inflation within two levels. A first stage level is provided for moderate-severity impacts. A second stage level is provided for more severe impacts.

According to the impact severity, the SRS Control Module (SRSCM) controls the air bag inflation. Failure to properly wear seat belts can increase the risk or severity of injury in an accident.

**⚠ WARNING**

To reduce the risk of serious injury or death from an inflating front air bags, take the following precautions:

- Seat belts must be worn at all times to help keep occupants positioned properly.
- Move your seat as far back as possible from front air bags, while still maintaining control of the vehicle.
- Never lean against the door or center console.
- Do not allow the front passenger to place their feet or legs on the dashboard.
- No objects (such as crash pad cover, cellular phone holder, cup holder, perfume or stickers) should be placed over or near the air bag modules on the steering wheel, instrument panel, windshield glass, and the front passenger's panel above the glove box. Such objects could cause harm if the vehicle is in a crash severe enough to cause the air bags to deploy.

**Side air bags**



Your vehicle is equipped with a side air bag in each front seat. The purpose of the air bag is to provide the vehicle's driver and the front passenger with additional protection than that offered by the seat belt alone.

The side air bags are designed to deploy only during certain side impact collisions, depending on the crash severity.

The side and curtain air bags on both sides of the vehicle may deploy if a rollover or possible rollover is detected.

The side air bags are not designed to deploy in all side impact or rollover situations.

**⚠ WARNING**

To reduce the risk of serious injury or death from an inflating side air bag, take the following precautions:

- Seat belts must be worn at all times to help keep occupants positioned properly.

(Continued)

(Continued)

- Do not allow passengers to lean their heads or bodies onto doors, put their arms on the doors, stretch their arms out of the window, or place objects between the doors and seats.
- Hold the steering wheel at the 9 o'clock and 3 o'clock positions, to minimize the risk of injuries to your hands and arms.
- Do not use any accessory seat covers. This could reduce or prevent the effectiveness of the system.
- Do not place any objects over the air bag or between the air bag and yourself. Also, do not attach any objects around the area the air bag inflates such as the door, side door glass, front and rear pillar.

(Continued)

(Continued)

- Do not place any objects between the door and the seat. They may become dangerous projectiles if the side air bag inflates.
- Do not install any accessories on the side or near the side air bags.
- Do not put any objects between the side airbag label and seat cushion. It could cause harm if the vehicle is in a crash severe enough to cause the air bags to deploy.
- Do not cause impact to the doors when the ignition switch is in the ON position as this may cause the side air bags to inflate.
- If the seat or seat cover is damaged, have the vehicle checked and repaired by an authorized HYUNDAI dealer.

### Curtain air bags

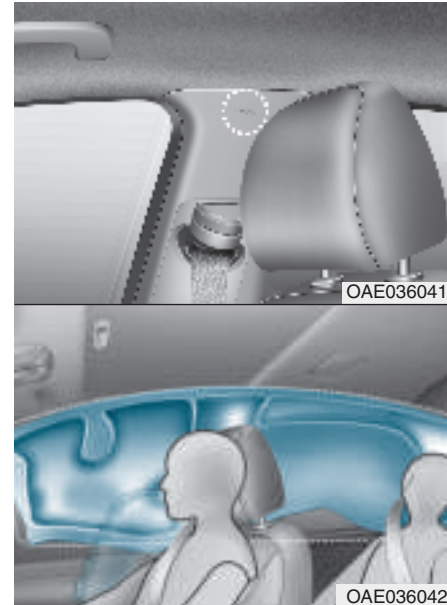

Curtain air bags are located along both sides of the roof rails above the front and rear doors.



They are designed to help protect the heads of the front seat occupants and the rear outboard seat occupants in certain side impact collisions.

The curtain air bags are designed to deploy only during certain side impact collisions, depending on the crash severity.

The side and curtain air bags on both sides of the vehicle may deploy if a rollover or possible rollover is detected.

The curtain air bags are not designed to deploy in all side impact or rollover situations.

### WARNING

To reduce the risk of serious injury or death from an inflating curtain air bag, take the following precautions:

- All seat occupants must wear seat belts at all times to help keep occupants positioned properly.

(Continued)

### (Continued)

- Properly secure child restraints as far away from the door as possible.
- Do not place any objects over the air bag. Also, do not attach any objects around the area the air bag inflates such as the door, side door glass, front and rear pillar, roof side rail.
- Do not hang other objects except clothes, especially hard or breakable objects. In an accident, it may cause vehicle damage or personal injury.
- Do not allow passengers to lean their heads or bodies onto doors, put their arms on the doors, stretch their arms out of the window, or place objects between the doors and seats.
- Do not open or repair the side curtain air bags.

## How Does the Air Bag System Operate?

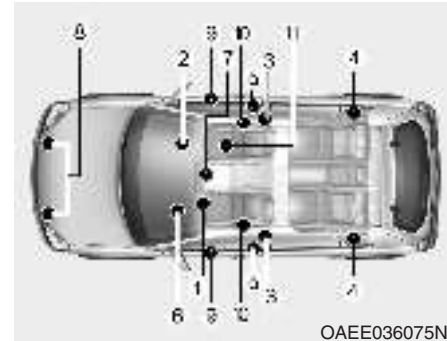

OAAE036075N

The SRS consists of the following components:

1. Driver's front air bag module/ Driver's knee airbag module
2. Passenger's front air bag module
3. Side air bag modules/ Side impact sensors
4. Curtain air bag modules
5. Retractor pre-tensioner assemblies
6. Air bag warning light
7. SRS control module (SRSCM)/ Rollover sensor

- 8. Front impact sensors
- 9. Side pressure sensors
- 10. Emergency Fastening Device System
- 11. Occupant classification system

The SRSCM (Supplemental Restraint System Control Module) continually monitors all SRS components while the ignition switch is in the ON position to determine if a crash impact is severe enough to require air bag deployment or pretensioner seat belt deployment.



SRS warning light

The SRS (Supplement Restraint System) air bag warning light on the instrument panel displays the air bag symbol depicted in the illustration. The system checks the air bag electrical system for malfunctions. The light indicates that there is a potential malfunction with your air bag system, which could include your side and curtain air bags used for rollover protection.

**⚠ WARNING**

**If your SRS malfunctions, the air bag may not inflate properly during an accident increasing the risk of serious injury or death.**

**If any of the following conditions occur, your SRS is malfunctioning:**

- **The light does not turn on for approximately six seconds when the ignition switch is in the ON position.**
- **The light stays on after illuminating for approximately six seconds.**
- **The light comes on while the vehicle is in motion.**
- **The light blinks when the vehicle is in the ready (🚗) mode.**

**Have an authorized HYUNDAI dealer inspect the SRS as soon as possible if any of these conditions occur.**

During a frontal collision, sensors will detect the vehicle's deceleration. If the rate of deceleration is high enough, the control unit will inflate the front air bags.

The front air bags help protect the driver and front passenger by responding to frontal impacts in which seat belts alone cannot provide adequate restraint. When needed, the side air bags help provide protection in the event of a side impact or rollover.

- Air bags are activated (able to inflate if necessary) only when the ignition switch is in the ON position.
- Air bags inflate in the event of certain frontal or side collisions to help protect the occupants from serious physical injury.
- Generally, air bags are designed to inflate based upon the severity of a collision, its direction, etc. These two factors determine whether the sensors produce an electronic deployment/inflation signal.

- Air bag deployment depends on a number of factors including vehicle speed, angles of impact and the density and stiffness of the vehicles or objects which your vehicle impacts during a collision. The determining factors are not limited to those mentioned above.

- The front air bags will completely inflate and deflate in an instant. It is virtually impossible for you to see the air bags inflate during an accident. It is much more likely that you will simply see the deflated air bags hanging out of their storage compartments after the collision.

- In addition to inflating in certain side collisions, vehicles equipped with a rollover sensor, side and curtain air bags will inflate if the sensing system detects a rollover.

When a rollover is detected, side and curtain air bags will remain inflated longer to help provide protection from ejection, especially when used in conjunction with the seat belts.

- To help provide protection, the air bags must inflate rapidly. The speed of air bag inflation is a consequence of extremely short time in which to inflate the air bag between the occupant and the vehicle structures before the occupant impacts those structures. This speed of inflation reduces the risk of serious or life-threatening injuries and is thus a necessary part of air bag design.

However, the rapid air bag inflation can also cause injuries which can include facial abrasions, bruises and broken bones because the inflation speed also causes the air bags to expand with a great deal of force.

- There are even circumstances under which contact with the air bag can cause fatal injuries, especially if the occupant is positioned excessively close to the air bag.

You can take steps to help reduce the risk of being injured by an inflating air bag. The greatest risk is sitting too close to the air bag. An air bag needs space to inflate. It is recommended that drivers sit as far as possible between the center of the steering wheel and the chest while still maintaining control of the vehicle.

## WARNING

**To reduce the risk of serious injury or death from an inflating air bag, take the following precautions:**

- **NEVER place a child restraint in the front passenger seat.**

**Always properly restrain children under age 13 in the rear seats of the vehicle.**

- **Adjust the front passenger's and driver's seats as far to the rear as possible while allowing you to maintain full control of the vehicle.**
- **Hold the steering wheel with hands at the 9 o'clock and 3 o'clock positions.**
- **Never place anything or anyone between the air bag and the seat occupant.**
- **Do not allow the front passenger to place their feet or legs on the dashboard.**



When the SRSCM detects a sufficiently severe impact to the front of the vehicle, it will automatically deploy the front air bags.

■ Driver's front air bag (2)



Upon deployment, tear seams molded directly into the pad covers will separate under pressure from the expansion of the air bags. Further opening of the covers allows full inflation of the air bags.

A fully inflated air bag, in combination with a properly worn seat belt, slows the driver or the front passenger forward motion, reducing the risk of head and chest injury.

■ Driver's front air bag (3)



■ Passenger's front air bag



After complete inflation, the air bag immediately starts deflating, enabling the driver to maintain forward visibility and the ability to steer or operate other controls.

### WARNING

To prevent objects from becoming dangerous projectiles when the passenger's air bag inflates:

- Do not install or place any objects (drink holder, CD holder, stickers, etc.) on the front passenger's panel above the glove box where the passenger's air bag is located.
- Do not install a container of liquid air freshener near the instrument cluster or on the instrument panel surface.

## What to Expect After an Air Bag Inflates

After a frontal or side air bag inflates, it will deflate very quickly. Air bag inflation will not prevent the driver from seeing out of the windshield or being able to steer. Curtain air bags may remain partially inflated for some time after they deploy.

### WARNING

**After an air bag inflates, take the following precautions:**

- **Open your windows and doors as soon as possible after impact to reduce prolonged exposure to the smoke and powder released by the inflating air bag.**
- **Do not touch the air bag storage area's internal components immediately after an air bag has inflated. The parts that come into contact with an inflating air bag may be very hot.**

(Continued)

(Continued)

- **Always wash exposed skin areas thoroughly with cold and mild soap.**
- **Always have an authorized HYUNDAI dealer replace the air bag immediately after deployment. Air bags are designed to be used only once.**

## ***Noise and smoke from inflating air bag***

When the air bags inflate, they make a loud noise and may produce smoke and powder in the air inside of the vehicle. This is normal and is a result of the ignition of the air bag inflator. After the air bag inflates, you may feel substantial discomfort in breathing because of the contact of your chest with both the seat belt and the air bag, as well as from breathing the smoke and powder. The powder may aggravate asthma for some people. If you experience breathing problems after an air bag deployment, seek medical attention immediately.

Though the smoke and powder are nontoxic, they may cause irritation to the skin, eyes, nose, throat, etc. If this is the case, wash and rinse with cold water immediately and seek medical attention if the symptoms persist.

### Occupant Classification System (OCS)



Your vehicle is equipped with an Occupant Classification System (OCS) in the front passenger's seat.

#### **Main components of the Occupant Classification System**

- A detection device located within the front passenger seat cushion.
- Electronic system to determine whether the passenger air bag systems should be activated or deactivated.
- An indicator light located on the instrument panel which illuminates the words "PASSENGER AIR BAG OFF" indicating the front passenger air bag system is deactivated.
- The instrument panel air bag indicator light is interconnected with the OCS.

The OCS is designed to help detect the presence of a properly-seated front passenger and determine if the passenger's front air bag should be enabled (may inflate) or not.

The purpose is to help reduce the risk of injury or death from an inflating air bag to certain front passenger seat occupants, such as children, by requiring the air bag to be automatically turned OFF.

For example, if a child restraint of the type specified in the regulations is on the seat, the occupant classification sensor can detect it and cause the air bag to turn OFF.

Front passenger seat adult occupants who are properly seated and wearing the seat belt properly, should not cause the passenger air bag to be automatically turned OFF. For small adults it may be turned OFF, however, if the occupant does not sit in the seat properly (for example, by not sitting upright, by sitting on the edge of the seat, or by otherwise being out of position), this could cause the sensor to turn the air bag OFF.

You will find the "PASSENGER AIR BAG OFF" indicator on the center fascia panel. This system detects the conditions 1-4 in the following table and activates or deactivates the front passenger air bag based on these conditions.

Always be sure that you and all vehicle occupants are seated properly and wearing the seat belt properly for the most effective protection by the air bag and the seat belt.

The OCS may not function properly if the passenger takes actions which can affect the classification system. These include:

- Failing to sit in an upright position.
- Leaning against the door or center console.
- Sitting towards the sides of the front of the seat.
- Putting their legs on the dashboard or resting them on other locations which reduce the passenger weight on the front seat.
- Wearing the seat belt improperly.
- Reclining the seatback.
- Wearing a thick cloth like ski wear or hip protection wear.
- Putting an additional thick cushion on the seat.
- Putting electrical devices (e.g. notebook, satellite radio) on the seat with inverter charging.

### Condition and operation in the front passenger Occupant Classification System

Condition detected by the occupant classification system	Indicator/Warning light		Devices
	"PASSENGER AIR BAG OFF" indicator light	SRS warning light	Front passenger air bag
1. Adult * <sup>1</sup>	Off	Off	Activated
2. Infant * <sup>2</sup> or child restraint system with 12 months old * <sup>3</sup> * <sup>4</sup>	On	Off	Deactivated
3. Unoccupied	On	Off	Deactivated
4. Malfunction in the system	Off	On	Activated

\*<sup>1</sup> The system judges a person of adult size as an adult. When a smaller adult sits in the front passenger seat, the system may recognize him/her as a child depending on his/her physique and posture.

\*<sup>2</sup> Do not allow children to ride in the front passenger seat. When a larger child who has outgrown a child restraint system sits in the front passenger seat, the system may recognize him/her as an adult depending upon his/her physique or sitting position.

\*<sup>3</sup> Never install a child restraint system on the front passenger seat.

\*<sup>4</sup> The PASSENGER AIR BAG "OFF" indicator may turn on or off when a child above 12 months to 12 years old (with or without child restraint system) sits in the front passenger seat. This is a normal condition.



**⚠ WARNING**

**Riding in an improper position or placing weight on the front passenger's seat when it is unoccupied by a passenger adversely affects the OCS. To reduce the risk of serious injury or death:**



- **NEVER** put a heavy load in the front seat or seatback pocket, or hang any items on the front passenger seat.



- **NEVER** ride with the seatback reclined when the vehicle is moving.



- **NEVER** place your feet on the front passenger seatback.



- **NEVER** place your feet or legs on the dashboard.



- **NEVER** sit with your hips shifted towards the front of the seat.



- **NEVER** lean on the door or center console or sit on one side of the front passenger seat.

(continued)

(continued)



- Do not sit on the passenger seat wearing heavily padded clothes such as ski wear and hip protector.



- Do not place electronic devices such as laptops, DVD player, or conductive materials such as water bottles on the passenger seat.
- Do not use electronic devices such as laptops and satellite radios which use inverter chargers.



- Do not use car seat accessories such as thick blankets and cushions which cover up the car seat surface.



- If large quantity of liquid has been spilled on the passenger seat, the air bag warning light may illuminate or malfunction. Therefore, make sure the seat has been completely dried before driving the vehicle.

- Do not place sharp objects on the front passenger seat. These may damage the occupant detection system, if they puncture the seat cushion.
- Do not place any items under the front passenger seat.
- When changing or replacing the seat or seat cover, use original items only. The OCS has been developed based on using original HYUNDAI car seats only. Altering or changing the authentic parts may result in system malfunction and increase risk of injury when in collision. Any of the above could interfere with the proper operation of the OCS sensor thereby increasing the risk of an injury in an accident.

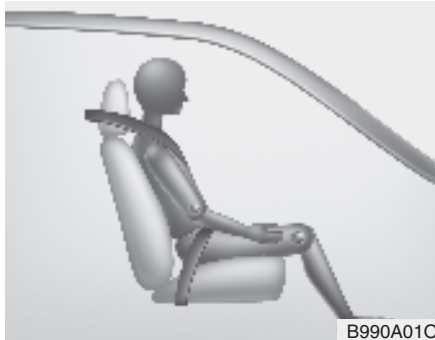

B990A010

### Proper seated position for OCS

If the "PASSENGER AIR BAG OFF" indicator is on when an adult is seated in the front passenger seat, place the ignition switch in the LOCK/OFF position and ask the passenger to sit properly (sitting upright with the seat back in an upright position, centered on the seat cushion with their seat belt on, legs comfortably extended and their feet on the floor). Restart the engine and have the person remain in that position. This will allow the system to detect the person and to enable the passenger air bag. If the "PASSENGER AIR BAG OFF" indicator is still on, ask the passenger to move to the rear seat.

### WARNING

Never allow an adult passenger to ride in the front passenger seat when the "PASSENGER AIR BAG OFF" indicator is illuminated. During a collision, the air bag will not inflate if the indicator is illuminated. Have your passenger reposition himself in the seat. If the "PASSENGER AIR BAG OFF" indicator remains illuminated after the passenger repositions himself properly and the vehicle is restarted, have the passenger move to the rear seat because the air bag will not inflate.

### NOTICE

The "PASSENGER AIR BAG OFF" indicator illuminates for approximately 4 seconds after the ignition switch is in the ON position or after the engine is started. If the front passenger seat is occupied, the OCS will then classify the front passenger after several more seconds.

### *Do Not Install a Child Restraint in the Front Passenger's Seat*



1JBH3051

Even though your vehicle is equipped with the OCS, never install a child restraint in the front passenger's seat. An inflating air bag can forcefully strike a child or child restraint resulting in serious or fatal injury.

**⚠ WARNING**

- **NEVER** place a rear-facing or front-facing child restraint in the front passenger's seat of the vehicle.
- An inflating frontal air bag could forcefully strike a child resulting in serious injury or death.
- Always properly restrain children in an appropriate child restraint in the rear seat of the vehicle.

**Why Didn't My Air Bag Go Off in a Collision?**

Air bags are not designed to inflate in every collision. There are certain types of accidents in which the air bag would not be expected to provide additional protection. These include rear impacts, second or third collisions in multiple impact accidents, as well as low speed impacts. Damage to the vehicle indicates a collision energy absorption, and is not an indicator of whether or not an air bag should have inflated.

***Air bag collision sensors*****⚠ WARNING**

To reduce the risk of an air bag deploying unexpectedly and causing serious injury or death:

- Do not hit or allow any objects to impact the locations where air bags or sensors are installed.

(Continued)

(Continued)

- Do not perform maintenance on or around the air bag sensors. If the location or angle of the sensors is altered, the air bags may deploy when they should not or may not deploy when they should.
- Do not install bumper guards or replace the bumper with a non-genuine HYUNDAI parts. This may adversely affect the collision and air bag deployment performance.
- Place the ignition switch in the LOCK/OFF or ACC position when the vehicle is being towed to prevent inadvertent air bag deployment.
- Have all air bag repairs conducted by an authorized HYUNDAI dealer.



- 1. SRS control module/Rollover sensor
- 2. Front impact sensor
- 3. Side pressure sensor
- 4. Side impact sensor

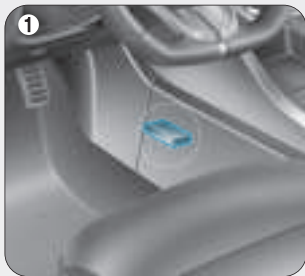

OAE038043/OAE036044/OAE038045/OAE036046/OAE036047

## Air bag inflation conditions

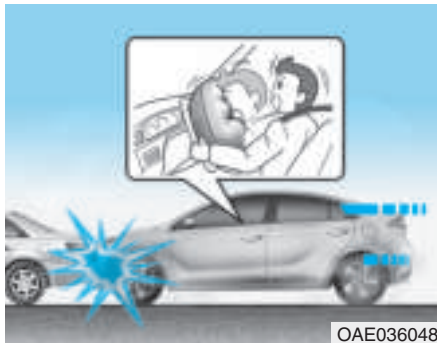

### Front air bags

Front air bags and the driver's knee air bag are designed to inflate in a frontal collision depending on the severity of impact of the front collision.



### Side and curtain air bags

Side and curtain air bags are designed to inflate when an impact is detected by side collision sensors depending on the severity of impact resulting from a side impact collision.

Although the driver's and front passenger's air bags are designed to inflate only in frontal collisions, they also may inflate in other types of collisions if the front impact sensors detect a sufficient impact. Side and curtain air bags are designed to inflate only in side impact collisions or rollover situations, but they may inflate in other collisions if the side impact sensors detect a sufficient impact.

If the vehicle chassis is impacted by bumps or objects on unimproved roads, the air bags may deploy. Drive carefully on unimproved roads or on surfaces not designed for vehicle traffic to prevent unintended air bag deployment.

### **Air bag non-inflation conditions**



In certain low-speed collisions the air bags may not deploy. The air bags are designed not to deploy in such cases because they may not provide benefits beyond the protection of the seat belts.



Front air bags are not designed to inflate in rear collisions, because occupants are moved backward by the force of the impact. In this case, inflated air bags would not provide any additional benefit.

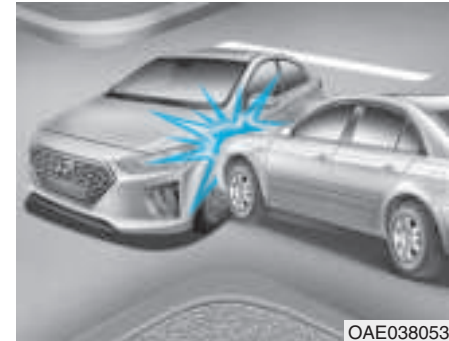

Front air bags may not inflate in side impact collisions, because occupants move in the direction of the collision, and thus in side impacts, front air bag deployment would not provide additional occupant protection.

However, side and curtain air bags may inflate depending on the severity of impact.



OAE036061

In an angled collision, the force of impact may direct the occupants in a direction where the air bags would not be able to provide any additional benefit, and thus the sensors may not deploy any air bags.



OAE036054

Just before impact, drivers often brake heavily. Such heavy braking lowers the front portion of the vehicle causing it to "ride" under a vehicle with a higher ground clearance. Air bags may not inflate in this "under-ride" situation because deceleration forces that are detected by sensors may be significantly reduced by such "override" collisions.

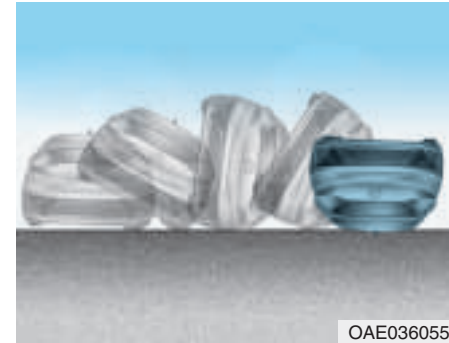

OAE036055

Front air bags may not inflate in rollover accidents because air bag deployment could not provide protection to the occupants.

However, side and curtain air bags may inflate when the vehicle is rolled over by a side impact collision.





Air bags may not inflate if the vehicle collides with objects such as utility poles or trees, where the point of impact is concentrated and the collision energy is absorbed by the vehicle structure.

### SRS Care

The SRS is virtually maintenance-free and there are no parts you can safely service by yourself. If the SRS air bag warning light does not illuminate when the ignition switch is in the ON position, or continuously remains on, have your vehicle immediately inspected by an authorized HYUNDAI dealer.

Any work on the SRS system, such as removing, installing, repairing, or any work on the steering wheel, the front passenger's panel, front seats and roof rails must be performed by an authorized HYUNDAI dealer. Improper handling of the SRS system may result in serious personal injury.

### WARNING

**To reduce the risk of serious injury or death, take the following precautions:**

- **Do not attempt to modify or disconnect the SRS components or wiring, including the addition of any kind of badges to the pad covers or modifications to the body structure.**
- **Do not place objects over or near the air bag modules on the steering wheel, instrument panel, or the front passenger's panel above the glove box.**
- **Clean the air bag pad covers with a soft cloth moistened with plain water. Solvents or cleaners could adversely affect the air bag covers and proper deployment of the system.**
- **Always have inflated air bags replaced by an authorized HYUNDAI dealer.**

**(Continued)**

(Continued)

- **If components of the air bag system must be discarded, or if the vehicle must be scrapped, certain safety precautions must be observed. Consult an authorized HYUNDAI dealer for the necessary information. Failure to follow these precautions could increase the risk of personal injury.**

### Additional Safety Precautions

**Passengers should not move out of or change seats while the vehicle is moving.** A passenger who is not wearing a seat belt during a crash or emergency stop can be thrown against the inside of the vehicle, against other occupants, or be ejected from the vehicle.

**Do not use any accessories on seat belts.** Devices claiming to improve occupant comfort or reposition the seat belt can reduce the protection provided by the seat belt and increase the chance of serious injury in a crash.

**Do not modify the front seats.**

Modification of the front seats could interfere with the operation of the supplemental restraint system sensing components or side air bags.

**Do not place items under the front seats.** Placing items under the front seats could interfere with the operation of the supplemental restraint system sensing components and wiring harnesses.

**Do not cause impact to the doors.** Impact to the doors when the ignition switch is in the ON position may cause the air bags to inflate.

### Modifications to accommodate disabilities.

If you require modification to your vehicle to accommodate a disability, contact the HYUNDAI Auto Canada at 1-888-216-2626.

### *Adding equipment to or modifying your air bag equipped vehicle*

If you modify your vehicle by changing your vehicle's frame, bumper system, front end or side sheet metal or ride height, this may affect the operation of your vehicle's air bag system.

### Air Bag Warning Labels



Air bag warning labels, required by the Canadian Motor Vehicle Safety Standards (CMVSS), are attached to alert the driver and passengers of potential risks of the air bag system. Be sure to read all of the information about the air bags that are installed on your vehicle in this Owners Manual.

## Convenient features of your vehicle

<b>Accessing your vehicle</b> .....	3-3
Remote Key .....	3-3
Smart Key.....	3-7
Immobilizer System .....	3-12
<b>Door locks</b> .....	3-14
Operating Door Locks from Outside the Vehicle.....	3-14
Operating Door Locks from Inside the Vehicle .....	3-16
Auto Door Lock/Unlock Features.....	3-18
Child-Protector Rear Door Locks.....	3-18
<b>Theft-alarm system</b> .....	3-19
<b>Driver position memory system</b> .....	3-20
Storing Positions into Memory .....	3-20
Recalling Positions from Memory.....	3-21
Easy Access Function.....	3-21
<b>Steering wheel</b> .....	3-22
Electric Power Steering (EPS) .....	3-22
Tilt Steering / Telescope Steering.....	3-22
Horn.....	3-23
Heated Steering Wheel .....	3-24
<b>Mirrors</b> .....	3-25
Inside Rearview Mirror .....	3-25
Side View Mirrors .....	3-33
Reverse Parking Aid Function .....	3-36
<b>Windows</b> .....	3-37
Power Windows.....	3-38
<b>Sunroof</b> .....	3-41
Sunroof Opening and Closing.....	3-42
Sliding the Sunroof.....	3-42
Tilting the Sunroof .....	3-43
Sunshade.....	3-43
Resetting the Sunroof .....	3-44
<b>Exterior features</b> .....	3-45
Hood .....	3-45
Tailgate.....	3-46
Fuel Filler Door (Hybrid vehicle).....	3-48
Fuel Filler Door (Plug-in hybrid vehicle) .....	3-51
<b>Instrument cluster</b> .....	3-54
Instrument Cluster Control.....	3-56
Gauges and Meters .....	3-56
Warning and Indicator Lights.....	3-63
LCD Display Messages.....	3-76
<b>LCD Display</b> .....	3-92
LCD Display Control.....	3-92
LCD display modes.....	3-93

Trip computer (hybrid vehicle) .....	3-105	Windshield defrosting and defogging .....	3-151
Trip modes .....	3-105	To Defog Inside Windshield.....	3-151
Trip computer (plug-in hybrid vehicle) .....	3-110	To Defrost Outside Windshield.....	3-152
Trip modes .....	3-110	Defogging Logic .....	3-152
Lighting.....	3-115	Rear Window Defroster .....	3-152
Exterior Lights .....	3-115	Auto Defogging System .....	3-153
Interior Lights .....	3-123	Climate control additional features.....	3-155
Welcome System .....	3-125	Automatic Ventilation .....	3-155
Wipers and washers .....	3-126	Sunroof inside air recirculation .....	3-155
Windshield Wipers .....	3-126	Storage compartment.....	3-156
Windshield Washers .....	3-127	Center Console Storage .....	3-156
Rear View Monitor (RVM) .....	3-128	Glove Box.....	3-156
Reverse Parking Distance Warning (PDW) ...	3-130	Sunglass Holder.....	3-157
Self-Diagnosis .....	3-133	Multi Box.....	3-157
Forward/Reverse Parking Distance		Interior features .....	3-158
Warning (PDW) .....	3-134	Cup Holder .....	3-158
Self-Diagnosis .....	3-138	Sunvisor.....	3-159
Automatic climate control system.....	3-139	Power Outlet .....	3-159
Automatic Heating and Air Conditioning.....	3-140	Wireless Cellular Phone Charging System .....	3-160
Manual Heating and Air Conditioning.....	3-141	Clock.....	3-162
System Operation .....	3-148	Clothes Hanger .....	3-163
System Maintenance.....	3-149	Floor Mat Anchor(s).....	3-163
		Cargo Security Screen.....	3-164

## ACCESSING YOUR VEHICLE

### Remote Key (if equipped)

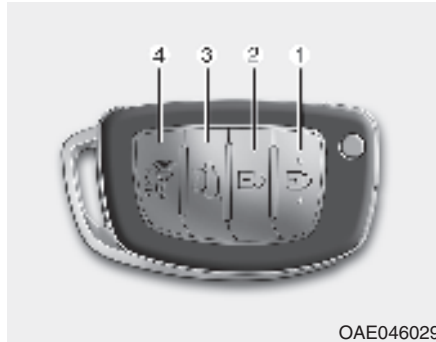

Your HYUNDAI uses a remote key, which you can use to lock or unlock a door (and tailgate) and even start the vehicle.

1. Door Lock
2. Door Unlock
3. Tailgate Unlock
4. Panic

### Locking

To lock :

1. Close all doors, engine hood and tailgate.
2. Press the Door Lock button (1) on the remote key.
3. The hazard warning lights will blink and the chime will sound once if the lock button is pressed once more within four seconds.
4. Make sure the doors are locked by checking the position of the door lock button inside the vehicle.

### **i** Information

**After locking the doors, if you press the Door Lock button again within four seconds, the hazard warning lights will blink and the horn will sound one time to confirm that the doors are locked.**

### **⚠** WARNING

**Do not leave the keys in your vehicle with unsupervised children. Unattended children could place the key in the ignition switch and may operate power windows or other controls, or even make the vehicle move, which could result in serious injury or death.**

### **Unlocking**

To unlock:

1. Press the Door Unlock button (2) on the remote key.
2. The driver's door will unlock. The hazard warning lights will blink two times.

Two press unlock setting:

Two press unlock setting can be changed according to owner's preference.

Select or deselect the 'Two Press Unlock' menu in the User Settings mode on the LCD display (User Settings → Door and select or deselect Two Press Unlock).

### **i Information**

After unlocking the doors, the doors will lock automatically after 30 seconds unless a door is opened.

### **Tailgate unlocking**

To unlock:

1. Press and hold the Tailgate Unlock button (3) on the remote key for more than one second.
2. The hazard warning lights will blink two times.

Once the tailgate is opened and then closed, the tailgate will lock automatically.

### **i Information**

The word "HOLD" is written on the button to inform you that you must press and hold the button for more than one second.

### **Panic button**

Press and hold the Panic button (4) for more than one second. The horn sounds and hazard warning lights flash for about 30 seconds.

To cancel the panic mode, press any button on the remote key.

### **Start-up**

For more information, refer to the "Key Ignition Switch" section in chapter 5.

### **NOTICE**

To prevent damaging the remote key:

- Keep the remote key away from water or any liquid and fire. If the inside of the remote key gets damp (due to drinks or moisture), or is heated, internal circuit may malfunction, excluding the car from the warranty.
- Avoid dropping or throwing the remote key.
- Protect the remote key from extreme temperatures.

### **Mechanical key**



If the remote key does not operate normally, you can lock or unlock the door by using the mechanical key.

To unfold the mechanical key, press the release button on the remote key.

To return the key to its stored position, press the release button and fold the key back into the remote.

### **Remote key precautions**

The remote key will not work if any of the following occur:

- The key is in the ignition switch.
- You exceed the operating distance limit (about 30 m [90 feet]).
- The remote key battery is weak.
- Other vehicles or objects may be blocking the signal.
- The weather is extremely cold.
- The remote key is close to a radio transmitter such as a radio station or an airport which can interfere with normal operation of the remote key.

When the remote key does not work correctly, open and close the door with the mechanical key. If you have a problem with the remote key contact an authorized HYUNDAI dealer.

If the remote key is in close proximity to your mobile phone, the signal could be blocked by your mobile phones normal operational signals. This is especially important when the phone is active such as making and receiving calls, text messaging, and/or sending/receiving emails.

When possible, avoid placing the remote key and your mobile phone in the same location such as pants or jacket pocket in order to avoid interference between the two devices.



### **i** Information

This device complies with Industry Canada RSS-210 standard.

Operation is subject to the following three conditions:

1. This device may not cause harmful interference, and
2. This device must accept any interference received, including interference that may cause undesired operation.
3. Changes or modifications not expressly approved by the party responsible for compliance could void the user's authority to operate the device.

### **NOTICE**

Keep the remote key away from electromagnetic materials that blocks electromagnetic waves to the key surface.

### **Battery replacement**

If the remote key is not working properly, try replacing the battery with a new one.



Battery Type: CR2032

To replace the battery:

1. Pry open the rear cover of the remote key.
2. Remove the old battery and insert the new battery. Make sure the battery position is correct.
3. Reinstall the rear cover of the remote key.

If you suspect your remote key might have sustained some damage, or you feel your remote key is not working correctly contact an authorized HYUNDAI dealer.

### **i** Information



An inappropriately disposed battery can be harmful to the environment and human health. Dispose of the battery according to your local law(s) or regulations.

### **IC WARNING**

This device complies with Industry Canada licence-exempt RSS standard(s).

Operation is subject to the following two conditions: (1) this device may not cause interference, and (2) this device must accept any interference, including interference that may cause undesired operation of the device.

## Smart Key

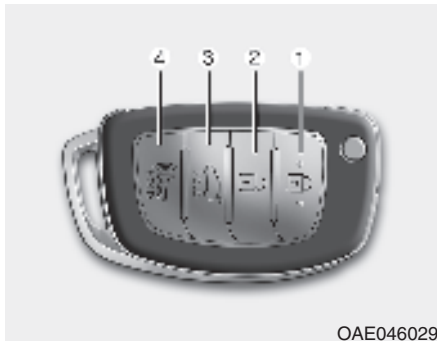

Your HYUNDAI uses a Smart Key, which you can use to lock or unlock a door (and tailgate) and even start the vehicle.

1. Door Lock
2. Door Unlock
3. Tailgate Unlock
4. Panic

## Locking

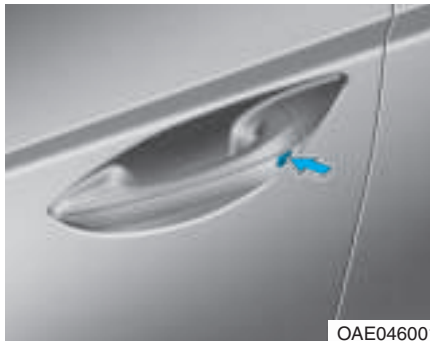

To lock :

1. Close all doors, hood and tailgate.
2. Either press the door handle button or press the Door Lock button (1) on the smart key.
3. The hazard warning lights will blink and the chime will sound once.
4. Make sure the doors are locked by checking the position of the door lock button inside the vehicle.

## Information

The door handle button will only operate when the smart key is within 0.7~1 m (28~40 inches) from the outside door handle.

Even though you press the outside door handle button, the doors will not lock and the chime will sound for three seconds if any of the following occur:

- The Smart Key is in the vehicle.
- The Engine Start/Stop button is in ACC or ON position.
- Any door except the tailgate is open.

## WARNING

**Do not leave the Smart Key in your vehicle with unsupervised children. Unattended children could press the Engine Start/Stop button and may operate power windows or other controls, or even make the vehicle move, which could result in serious injury or death.**

### Unlocking



To unlock:

1. Carry the Smart Key.
2. Either press the driver's outside door handle button or press the Door Unlock button (2) on the smart key.

3. The driver's door will unlock. The hazard warning lights will blink two times.

If you press the driver's outside door handle button or Door Unlock button on the smart key again within four seconds, then all the doors will unlock.

Two press unlock setting:

Two press unlock setting can be changed according to owner's preference.

Select or deselect the 'Two Press Unlock' menu in the User Settings mode on the LCD display (User Settings → Door and select or deselect Two Press Unlock).

### Information

- The door handle button will only operate when the smart key is within 0.7~1 m (28~40 inches) from the outside door handle and other people can also open the doors.
- If you press the front passenger's outside door handle, while carrying the Smart Key, all doors will unlock.
- After unlocking the doors, the doors will lock automatically after 30 seconds unless a door is opened.
- Either the driver or front passenger door can be opened with the door handle button when the smart key is within this range.

## **Tailgate unlocking**

To unlock:

1. Carry the smart key.
2. Either press the tailgate handle button or press and hold the Tailgate Unlock button (3) on the smart key for more than one second.
3. The hazard warning lights will blink two times.

### **i** Information

- The tailgate handle button will only operate when the smart key is within 0.7 m (28 inches) from the tailgate handle.
- The Tailgate Unlock button (3) will only unlock the tailgate. It will not release the latch and open the tailgate automatically. If the Tailgate Unlock button is used, someone must still press the tailgate handle button to open the tailgate.

## **Panic button**

Press and hold the Panic button (4) for more than one second. The horn sounds and hazard warning lights blink for about 30 seconds. To cancel the panic mode, press any button on the Smart Key.

### **Start-up**

You can start the vehicle without inserting the key.

For more information, refer to the "Engine Start/Stop Button" section in chapter 5.

### **NOTICE**

To prevent damaging the smart key:

- **Keep the smart key away from any liquid or fire. Internal circuits may malfunction if the inside of the smart key gets damp (from liquids or moisture) or if it is heated. This can exclude the smart key from warranty coverage.**
- **Avoid dropping or throwing the smart key.**
- **Protect the smart key from extreme temperatures.**

### **Mechanical key**

If the Smart Key does not operate normally, you can lock or unlock the driver's door by using the mechanical key.



Press and hold the release button (1) and remove the mechanical key (2). Insert the mechanical key into the key hole on the door.

To reinstall the mechanical key, put the key into the hole and push it until a click sound is heard.

### **Loss of a smart key**

A maximum of two Smart Keys can be registered to a single vehicle. If you happen to lose your smart key, you should immediately take the vehicle and remaining keys to your authorized HYUNDAI dealer or tow the vehicle, if necessary.

### **Smart key precautions**

The smart key may not work if any of the following occur:

- The smart key is close to a radio transmitter such as a radio station or an airport which can interfere with normal operation of the transmitter.
- The smart key is near a mobile two way radio system or a cellular phone.
- Another vehicle's smart key is being operated close to your vehicle.

If the smart key does not work correctly, open and close the door with the mechanical key. If you have a problem with the smart key, contact an authorized HYUNDAI dealer.

If the smart key is in close proximity to your mobile phone, the signal could be blocked by your mobile phone's normal operational signals. This is specifically relevant when the phone is active such as making and receiving calls, text messaging, and/or sending/receiving emails. Avoid placing the smart key and your mobile phone in the same location and always try to maintain an adequate distance between the two devices.

#### **NOTICE**

**Keep the smart key away from electromagnetic materials that blocks electromagnetic waves to the key surface.**

#### **NOTICE**

**Always have the smart key with you when leaving the vehicle. If the smart key is left near the vehicle, the vehicle battery may be discharged.**

## **i** Information

This device complies with Industry Canada RSS-210 standard.

Operation is subject to the following three conditions:

1. This device may not cause harmful interference, and
2. This device must accept any interference received, including interference that may cause undesired operation.
3. Changes or modifications not expressly approved by the party responsible for compliance could void the user's authority to operate the device.

## **Battery replacement**



If the Smart Key is not working properly, try replacing the battery with a new one.

Battery Type: CR2032

To replace the battery:

1. Pry open the rear cover of the smart key.
2. Remove the old battery and insert the new battery.
3. Reinstall the rear cover of the smart key.

If you suspect your smart key might have sustained some damage, or you feel your smart key is not working correctly, contact an authorized HYUNDAI dealer.

## **i** Information



An inappropriately disposed battery can be harmful to the environment and human health. Dispose of the battery according to your local law(s) or regulation(s).

## **IC WARNING**

**This device complies with Industry Canada licence-exempt RSS standard(s).**

**Operation is subject to the following two conditions: (1) this device may not cause interference, and (2) this device must accept any interference, including interference that may cause undesired operation of the device.**

### Immobilizer System

The immobilizer system helps protect your vehicle from theft. If an improperly coded key (or other device) is used, the engine's fuel system is disabled.

When the ignition switch is placed in the ON position, the immobilizer system indicator should come on briefly, then go off. If the indicator starts to blink, the system does not recognize the coding of the key.

Place the ignition switch to the LOCK/OFF position, then place the ignition switch to the ON position again.

The system may not recognize your key's coding if another immobilizer key or other metal object (i.e., key chain) is near the key. The vehicle may not start because the metal may interrupt the transponder signal from transmitting normally.

If the system repeatedly does not recognize the coding of the key, it is recommended that you contact your HYUNDAI dealer.

Do not attempt to alter this system or add other devices to it. Electrical problems could result that may make your vehicle inoperable.

#### WARNING

**In order to prevent theft of your vehicle, do not leave spare keys anywhere in your vehicle. Your immobilizer password is a customer unique password and should be kept confidential.**

#### NOTICE

**The transponder in your key is an important part of the immobilizer system. It is designed to give years of trouble-free service, however you should avoid exposure to moisture, static electricity and rough handling. Immobilizer system malfunction could occur.**

#### Information

**This device complies with Industry Canada RSS-210 standard.**

**Operation is subject to the following three conditions:**

- 1. This device may not cause harmful interference, and**
- 2. This device must accept any interference received, including interference that may cause undesired operation.**
- 3. Changes or modifications not expressly approved by the party responsible for compliance could void the user's authority to operate the device.**

### **"Limp Home" Mode and Related Procedures**

If the immobilizer warning indicator blinks for five seconds when the ignition key is turned to the "ON" position, this indicates the immobilizer system requires service. The engine cannot be started without using the procedure below.

The following procedure describes how to start the engine using the limp home function (0, 1, 2, 3 as a sample password).

#### **NOTICE**

**You can get a limp home password when the vehicle is first delivered to you. If you do not have a password, consult your authorized HYUNDAI dealer.**

1. To activate the password, turn the ignition key "ON" and "OFF" according to the digit numbers. The immobilizer indicator will blink along with the operation of the ignition key. For example, turn the ignition key once for digit number "1", and twice for "2", and so on. For the digit number "0", you must cycle the ignition key 10 times.
2. Wait for 3~10 seconds.
3. You may set the remaining number of digits by following steps 1 and 2.
4. If all of the four password digits have been successfully entered, turn the ignition key "ON" and check that the immobilizer indicator illuminates. From this time, you have to start your engine within 30 seconds. If you try to start your engine after 30 seconds, your engine will not start.

#### **NOTICE**

**If the engine stalls while driving in the "limp home" mode, you can start your engine within 3 seconds without re-entering the password.**

If the immobilizer indicator blinks for five seconds, you must re-enter the password (steps 1~4).

After performing the limp home activation procedure, consult with your authorized HYUNDAI dealer as soon as possible.

#### **CAUTION**

- If the password is entered incorrectly three consecutive times, wait for about one hour to perform the limp home activation procedure again.
- If you cannot start your engine using the limp home activation procedure, have your vehicle towed by an authorized HYUNDAI dealer.



## DOOR LOCKS

### Operating Door Locks from Outside the Vehicle

#### Mechanical key

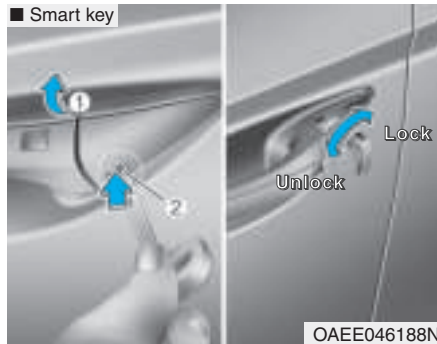

#### Smart key

To remove the cover:

1. Pull out the door handle (1).
2. Press the lock (2) located inside the bottom part of the cover with a key or flat-head screwdriver.
3. Push out the cover while pressing the lock.

To install the cover:

1. Pull out the door handle.
2. Install the cover.

#### Remote key and Smart key

If you lock the driver's door with a mechanical key, all vehicle doors will lock. If you unlock the driver's door with a mechanical key, the driver's door will unlock and the passenger doors will unlock according to the current two press unlock setting.

Once the doors are unlocked, they may be opened by pulling the door handle.

When closing the door, push the door by hand. Make sure that doors are closed securely.

#### Remote key

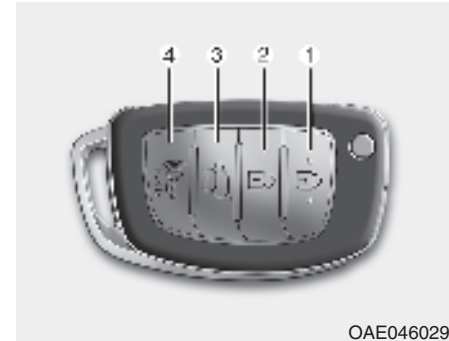

To lock the doors, press the Door Lock button (1) on the remote key.

Press the Door Unlock button (2) on the remote key, the driver's door will unlock. If you press the Door Unlock button on the remote key again within four seconds, then all the doors will unlock.

Once the doors are unlocked, they may be opened by pulling the door handle.

When closing the door, push the door by hand. Make sure that doors are closed securely.

### **i** Information

- In cold and wet climates, door lock and door mechanisms may not work properly due to freezing conditions.
- If the door is locked/unlocked multiple times in rapid succession with either the vehicle key or door lock switch, the system may stop operating temporarily in order to protect the circuit and prevent damage to system components.
- Two press unlock setting can be changed with the remote key or in the User Settings Mode in the cluster.

### Smart key



Press the button on the driver's outside door handle while carrying the Smart Key with you or press the Door Unlock button on the Smart Key, the driver's door will unlock. If you press the button on the front passenger's outside door, all doors will unlock.

Once the doors are unlocked, they may be opened by pulling the door handle.

When closing the door, push the door by hand. Make sure that doors are closed securely.

### **i** Information

- In cold and wet climates, door lock and door mechanisms may not work properly due to freezing conditions.
- If the door is locked/unlocked multiple times in rapid succession with either the vehicle key or door lock switch, the system may stop operating temporarily in order to protect the circuit and prevent damage to system components.
- Two press unlock setting can be changed with the smart key or in the User Settings mode on the cluster.

### Operating Door Locks from Inside the Vehicle

#### With the door lock button



- To unlock a door, pull the door lock button (1) to the "Unlock" position. The red mark (2) on the door lock button will be visible.
- To lock a door, push the door lock button (1) to the "Lock" position. If the door is locked properly, the red mark (2) on the door lock button will not be visible.
- To open a door, pull the door handle (3) outward.

- If the inner door handle of the driver's (or front passenger's) door is pulled when the door lock button is in the lock position, the button is unlocked and door opens.
- Front doors cannot be locked if the key is in the ignition switch and any front door is open. (for remote key)
- Doors cannot be locked if the smart key is in the vehicle and any door is open. (for smart key)

#### **i** Information

**If a power door lock ever fails to function while you are in the vehicle try one or more of the following techniques to exit:**

- **Operate the door unlock feature repeatedly (both electronic and manual) while simultaneously pulling on the door handle.**
- **Operate the other door locks and handles, front and rear.**
- **Lower a front window and use the mechanical key to unlock the door from outside.**

#### With the central door lock switch

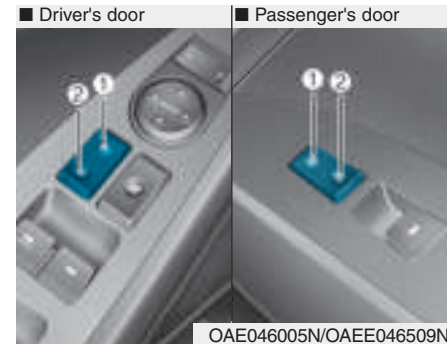

When pressing the (🔒) switch (1), all vehicle doors will lock.

When pressing the (🔓) switch (2), all vehicle doors will unlock.

- If the key is in the ignition switch and any door is opened, the doors will not lock even though the lock button (1) of the central door lock switch is pressed. (for remote key)
- If the smart key is in the vehicle and any door is opened, the doors will not lock even though the lock button (1) of the central door lock switch is pressed. (for smart key)

### WARNING

- The doors should always be fully closed and locked while the vehicle is in motion. If the doors are unlocked, the risk of being thrown from the vehicle in a crash is increased.
- Do not pull the inner door handle of driver's or passenger's door while the vehicle is moving.

### WARNING

Do not leave children or animals unattended in your vehicle. An enclosed vehicle can become extremely hot, causing death or serious injury to unattended children or animals who cannot escape the vehicle. Children might operate features of the vehicle that could injure them, or they could encounter other harm, possibly from someone gaining entry to the vehicle.

### WARNING

**Always secure your vehicle.**

Leaving your vehicle unlocked increases the potential risk to you or others from someone hiding in your vehicle.

To secure your vehicle, while depressing the brake, move the shift lever to the P (Park) position, engage the parking brake, and place the ignition switch in the LOCK/OFF position, close all windows, lock all doors, and always take the key with you.

### CAUTION

Opening a door when something is approaching may cause damage or injury. Be careful when opening doors and watch for vehicles, motorcycles, bicycles or pedestrians approaching the vehicle in the path of the door.

### WARNING

If you stay in the vehicle for a long time while the weather is very hot or cold, there are risks of injuries or danger to life. Do not lock the vehicle from the outside when someone is in the vehicle.

### Auto Door Lock/Unlock Features

#### **Impact sensing door unlock**

All doors will be automatically unlocked when an impact causes the air bags to deploy.

#### **Speed sensing door lock**

All doors will be automatically locked (when set on cluster) when vehicle speed exceeds 15 km/h (9 mph).

All of the doors will be automatically unlocked after the vehicle is turned off.

#### **Shift lever auto door lock**

All doors will be automatically locked when shifted out of P (Park) with the vehicle in the ready (  ) mode.

You can activate or deactivate the Auto Door Lock/Unlock features from the User Settings mode on the LCD display.

**For more information, refer to the "LCD Display" section in this chapter.**

### Child-Protector Rear Door Locks



The child safety lock is provided to help prevent children seated in the rear from accidentally opening the rear doors. The rear door safety locks should be used whenever children are in the vehicle.

The child safety lock is located on the edge of each rear door. When the child safety lock is in the lock position, the rear door will not open if the inner door handle is pulled.

To lock the child safety lock, insert a key (or screw driver) (1) into the hole and turn it to the lock position.

To allow a rear door to be opened from inside the vehicle, unlock the child safety lock.

#### **WARNING**

**If children accidentally open the rear doors while the vehicle is in motion, they could fall out of the vehicle. The rear door safety locks should always be used whenever children are in the vehicle.**

## THEFT-ALARM SYSTEM

This system helps to protect your vehicle and valuables. The horn will sound and the hazard warning lights will blink continuously if any of the following occur:

- A door is opened without using the remote key or smart key.
- The tailgate is opened without using the remote key or smart key.
- The engine hood is opened.

The alarm continues for 30 seconds, then the system resets. To turn off the alarm, unlock the doors with the remote key or smart key.

The Theft Alarm System automatically sets 30 seconds after you lock the doors and the tailgate. For the system to activate, you must lock the doors and the tailgate from outside the vehicle with the remote key or smart key or by pressing the button on the outside of the door handles with the smart key in your possession.

The hazard warning lights will blink and the chime will sound once to indicate the system is armed.

Once the security system is set, opening any door, the tailgate, or the hood without using the remote key or smart key will cause the alarm to activate.

The Theft Alarm System will not set if the hood, the tailgate, or any door is not fully closed. If the system will not set, check the hood, the tailgate, or the doors are fully closed.

Do not attempt to alter this system or add other devices to it.

### Information

- **Do not lock the doors until all passengers have left the vehicle. If the remaining passenger leaves the vehicle when the system is armed, the alarm will be activated.**
- **If the vehicle is not disarmed with the remote key or smart key, open the doors by using the mechanical key and place the ignition switch in the ON position (for remote key) or start the vehicle (for smart key) by directly pressing the ignition switch with the smart key.**
- **When the system is disarmed but a door or tailgate is not opened within 30 seconds, the system will be rearmed.**

## DRIVER POSITION MEMORY SYSTEM (IF EQUIPPED)



The Driver Position Memory System is provided to store and recall the following memory settings with a simple button operation.

- Driver's seat position
- Side view mirror position
- Instrument panel illumination intensity

If the battery is disconnected, the position memory will be lost and the driving positions must be stored in the system again.

If the Driver Position Memory System does not operate normally, have the system checked by an authorized HYUNDAI dealer.

### WARNING

**Never attempt to operate the driver position memory system while the vehicle is moving.**

**This could result in loss of control, and an accident causing death, serious injury, or property damage.**

### Storing Positions into Memory

1. Check that the shift lever is in P (Park) while the ignition switch is in the ON position.
2. Adjust the driver's seat position, side view mirror position and instrument panel illumination intensity to positions comfortable for the driver.
3. Press the SET button. The system will beep once and notify you "Press button to save settings" on the LCD display.
4. Press one of the memory buttons (1 or 2) within 4 seconds. The system will beep twice when the memory has been successfully stored.
5. "Driver 1 (or 2) settings saved" will appear on the LCD display.

## Recalling Positions from Memory

1. Check that the shift lever is in P (Park) while the ignition switch is in the ON position.
2. Press the desired memory button (1 or 2). The system will beep once, and then the driver's seat position, side view mirror position and instrument panel illumination intensity will automatically adjust to the stored positions.
3. "Driver 1(or 2) settings is applied" will appear on the LCD display.

### NOTICE

- **While recalling the "1" memory position, pressing the SET or 1 button temporarily stops the adjustment of the recalled memory position. Pressing the 2 button recalls the "2" memory position.**
- **While recalling the "2" memory position, pressing the SET or 2 button temporarily stops the adjustment of the recalled memory position. Pressing the 1 button recalls the "1" memory position.**
- **While recalling the stored positions, pressing one of the control buttons for the driver's seat, side view mirror or instrument panel illumination will cause the movement of that component to stop and move in the direction that the control button is pressed.**

## Easy Access Function

The system will move the driver's seat automatically as follows:

The shift lever is in P (Park)

- Without smart key system
  - It will move the driver's seat rearward when the ignition key is removed and the driver's door is opened.
  - It will move the driver's seat forward when the ignition key is inserted.
- With smart key system
  - It will move the driver's seat rearward when the Engine Start/Stop button is in the OFF position and the driver's door is opened.
  - It will move the driver's seat forward when the vehicle is turned ON or the driver's door is closed with the smart key with you.

You can activate or deactivate the Easy Access Function from the User Settings mode on the LCD display.

**For more information, refer to the "LCD Display" section in this chapter.**



## STEERING WHEEL

### Electric Power Steering (EPS)

The system assists you with steering the vehicle. If the vehicle is turned off or if the power steering system becomes inoperative, you may still steer the vehicle, but it will require increased steering effort.

Should you notice any change in the effort required to steer during normal vehicle operation, have the system checked by an authorized HYUNDAI dealer.

#### CAUTION

If the Electric Power Steering System does not operate normally, the warning light (⊕!) will illuminate on the instrument cluster. You may steer the vehicle, but it will require increased steering efforts. Take your vehicle to an authorized HYUNDAI dealer and have the system checked as soon as possible.

#### Information

The following symptoms may occur during normal vehicle operation:

- The steering effort may be high immediately after placing the ignition switch in the ON position.

This happens as the system performs the EPS system diagnostics. When the diagnostics are completed, the steering wheel will return to its normal condition.

- A click noise may be heard from the EPS relay after the ignition switch is in the ON or OFF position.
- Motor noise may be heard when the vehicle is at a stop or at a low driving speed.
- When you operate the steering wheel in low temperature, abnormal noise may occur. If temperature rises, the noise will disappear. This is a normal condition.
- When an error is detected from the EPS, the steering effort assist function will not be activated in order to prevent fatal accidents. Instrument cluster warning lights may be on or the steering effort may be high. When the following symptoms occur, immediately drive the vehicle to a safe area and check it.

### Tilt Steering / Telescope Steering

Adjust the steering wheel so it points toward your chest, not toward your face. Make sure you can see the instrument cluster warning lights and gauges. After adjusting, push the steering wheel both up and down to be certain it is locked in position. Always adjust the position of the steering wheel before driving.

#### WARNING

**NEVER** adjust the steering wheel while driving. This may cause loss of vehicle control resulting in an accident.



OAEPH048007

To change the steering wheel angle and height:

1. Pull down the lock-release lever (1).
2. Adjust the steering wheel to the desired angle (2) and distance forward/back (3).
3. Pull up the lock-release lever to lock the steering wheel in place.

### **i** Information

After adjustment, sometimes the lock release lever may not lock the steering wheel. It is not a malfunction. This occurs when two gears are not engaged correctly. In this case, adjust the steering wheel again and then lock the steering wheel.

### **⚠ CAUTION**

While adjusting the steering wheel height, please do not push or pull it hard since the fixture can be damaged.

### Horn



OAE046009

To sound the horn, press the area indicated by the horn symbol on your steering wheel (see illustration). The horn will operate only when this area is pressed.

### **NOTICE**

Do not strike the horn severely to operate it, or hit it with your fist. Do not press on the horn with a sharp-pointed object.

### Heated Steering Wheel (if equipped)

■ Type A

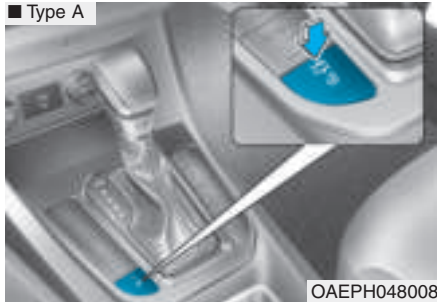

■ Type B

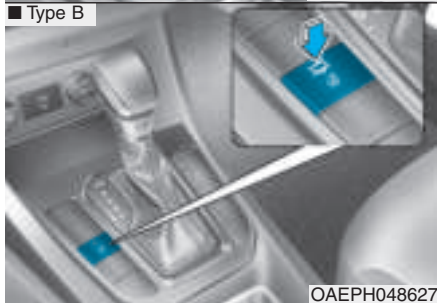

When the ignition switch is in the ON position or when the vehicle is in the ready (  ) mode, press the heated steering wheel button to warm the steering wheel. The indicator on the button will illuminate.

To turn the heated steering wheel off, press the button again. The indicator on the button will turn off.

The heated steering wheel will automatically turn off after approximately 30 minutes.

#### **NOTICE**

**Do not install any cover or accessory on the steering wheel. The cover or accessory could cause damage to the heated steering wheel system.**

## MIRRORS

### Inside Rearview Mirror

Before you start driving, adjust the rearview mirror to the center on the view through the rear window.

#### WARNING

Make sure your line of sight is not obstructed. Do not place objects in the rear seat, cargo area, or behind the rear headrests which could interfere with your vision through the rear window.

#### WARNING

To prevent serious injury during an accident or deployment of the air bag, do not modify the rearview mirror and do not install a wide mirror.

#### WARNING

**NEVER** adjust the mirror while driving. This may cause loss of vehicle control resulting in an accident.

#### NOTICE

When cleaning the mirror, use a paper towel or similar material dampened with glass cleaner. Do not spray glass cleaner directly on the mirror as that may cause the liquid cleaner to enter the mirror housing.

### Day/night rearview mirror (if equipped)



Make this adjustment before you start driving and while the day/night lever is in the day position.

Pull the day/night lever towards you to reduce glare from the headlights of the vehicles behind you during night driving.

Remember that you lose some rearview clarity in the night position.

**BlueLink® center (if equipped)**



OAD045011N

For details, refer to the BlueLink® Owner's Guide, Navigation Manual or Audio Manual.

**Electric chromic mirror (ECM) with compass and HomeLink® system**

Your vehicle may be equipped with a Gentex Automatic-Dimming Mirror with a Z-Nav™ Electronic Compass Display and an Integrated HomeLink® Wireless Control System.

During nighttime driving, this feature will automatically detect and reduce rearview mirror glare while the compass indicates the direction the vehicle is pointed. The HomeLink® Universal Transceiver allows you to activate your garage door(s), electric gate, home lighting, etc.



OAD045046N

- (1) Channel 1 button
- (2) Channel 2 button
- (3) Status indicator LED
- (4) Channel 3 button
- (5) Rear light sensor
- (6) Dimming ON/OFF button
- (7) Compass control button
- (8) Compass display

### **Automatic-Dimming Night Vision Safety™ (NVS®) Mirror (if equipped)**

The NVS® Mirror automatically reduces glare by monitoring light levels in the front and the rear of the vehicle. Any object that obstructs either light sensor will degrade the automatic dimming control feature.

**For more information regarding NVS® mirrors and other applications, please refer to the Gentex website:**  
[www.gentex.com](http://www.gentex.com)

The auto-dimming function can be controlled by pressing the ON/OFF button:

1. Pressing the button turns the auto-dimming function OFF which is indicated by the green Status Indicator LED turning off.
2. Pressing the button again turns the auto-dimming function ON which is indicated by the green Status Indicator LED turning on.



The mirror defaults to the ON position each time the vehicle is started.

### **Z-Nav™ Compass Display**

The NVS™ Mirror in your vehicle is also equipped with a Z-Nav™ Compass that shows the vehicle Compass heading in the Display Window using the 8 basic cardinal headings (N, NE, E, SE, etc.).

### **Compass function**

The Compass can be turned ON and OFF and will remember the last state when the ignition is cycled. To turn the display feature ON/OFF:



1. Press and release the  button to turn the display feature OFF.
2. Press and release the  button again to turn the display back ON.

Additional options can be set with press and hold sequences of the button and are detailed below.

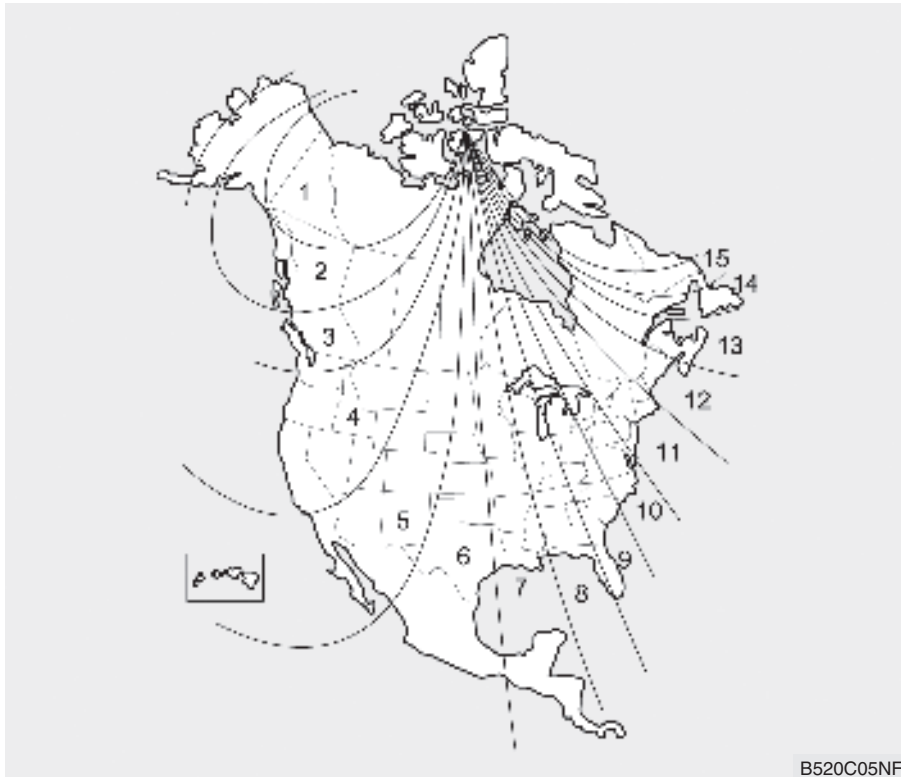
There is a difference between magnetic north and true north. To compensate for this difference you will need to adjust the Zone setting based on where you live.



To adjust the Zone setting:

1. Determine the desired Zone Number based upon your current location on the Zone Map.
2. Press and hold the  button for more than 3 but less than 6 seconds, the current Zone Number will appear on the display.
3. Pressing and holding the  button again will cause the numbers to increment (Note: they will repeat ...13, 14, 15, 1, 2, ...). Releasing the button when the desired Zone Number appears on the display will set the new Zone.
4. Within about 5 seconds the compass will start displaying a compass heading again.

There are some conditions that can cause changes to the vehicle magnets, such as installing a ski rack or a CB antenna. Body repair work on the vehicle can also cause changes to the vehicle's magnetic field. In these situations, the compass will need to be re-calibrated to quickly correct these changes.

If you need to recalibrate the compass:

1. Press and hold the  button for more than 6 seconds. When the compass memory is cleared a "C" will appear in the display.
2. Drive the vehicle in 2 complete circles at less than 8 km/h (5 mph).

### Integrated HomeLink® Wireless Control System

The HomeLink® Wireless Control System can replace up to three hand-held radio-frequency (RF) transmitters with a single built-in device. This innovative feature will learn the radio frequency codes of most current transmitters to operate devices such as gate operators, garage door openers, entry door locks, security systems, even home lighting. Both standard and rolling code-equipped transmitters can be programmed by following the outlined procedures.

Additional HomeLink® information can be found at: [www.homelink.com](http://www.homelink.com) or by calling 1-800-355-3515.

Retain the original transmitter of the RF device you are programming for use in other vehicles as well as for future HomeLink® programming. It is also suggested that upon the sale of the vehicle, the programmed HomeLink® buttons be erased for security purposes.

### WARNING

**Before programming HomeLink® to a garage door opener or gate operator, make sure people and objects are out of the way of the device to prevent potential harm or damage. Do not use the HomeLink® with any garage door opener that lacks the safety stop and reverse features required by federal safety standards (this includes any garage door opener model manufactured before April 1, 1982). A garage door that cannot detect an object - signaling the door to stop and reverse - does not meet current federal safety standards. Using a garage door opener without these features increases the risk of serious injury or death.**



### Programming HomeLink®

Please note the following:

- When programming a garage door opener, it is advised to park the vehicle outside of the garage.
- It is recommended that a new battery be placed in the hand-held transmitter of the device being programmed to HomeLink® for quicker training and accurate transmission of the radio-frequency signal.
- Some vehicles may require the ignition switch to be placed in the ACC (or "Accessories") position for programming and/or operation of HomeLink®.
- In the event that there are still programming difficulties or questions after following the programming steps listed below, contact HomeLink® at: [www.homelink.com](http://www.homelink.com) or by calling 1-800-355-3515.

### Rolling code programming

Rolling code devices which are "code-protected" and manufactured after 1996 may be determined by the following:

- Reference the device owner's manual for verification.
- The handheld transmitter appears to program the HomeLink® Universal Transceiver but does not activate the device.
- Press and hold the trained HomeLink button. The device has the rolling code feature if the indicator light flashes rapidly and then turns solid after 2 seconds.

To train rolling code devices, follow these instructions:

1. At the garage door opener receiver (motor-head unit) in the garage, locate the "learn" or "smart" button. This can usually be found where the hanging antenna wire is attached to the motor-head unit. Exact location and color of the button may vary by garage door opener brand. If there is difficulty locating the training button, reference the device owner's manual or please visit our Web site at [www.homelink.com](http://www.homelink.com).
2. Firmly press and release the "learn" or "smart" button (which activates the "training light"). You will have 30 seconds to initiate step 3.
3. Return to the vehicle and firmly press, hold for two seconds and then release the desired HomeLink® button. Repeat the "press/hold/release" sequence a second time to complete the programming. (Some devices may require you to repeat this sequence a third time to complete the programming.)

4. Press and hold the just-trained HomeLink® button and observe the red Status Indicator LED. If the indicator light stays on constantly, programming is complete and your device should activate.
5. To program the remaining two HomeLink® buttons, follow either steps 1 through 4 above for other Rolling Code devices or steps 2 through 5 in Standard Programming for standard devices.

#### *Standard programming*

To train most devices, follow these instructions:

1. For first-time programming, press and hold the two outside buttons, HomeLink® Channel 1 and Channel 3 Buttons, until the indicator light begins to flash (after 20 seconds). Release both buttons. Do not hold the buttons for longer than 30 seconds.
  2. Position the end of your hand-held transmitter 2-8 cm (1-3 inches) away from the HomeLink® buttons while keeping the indicator light in view.
  3. Simultaneously press and hold both the HomeLink® and hand-held transmitter button. DO NOT release the buttons until step 4 has been completed.
  4. While continuing to hold the buttons the red Indicator Status LED will flash slowly and then rapidly after HomeLink® successfully trains to the frequency signal from the hand-held transmitter. Release both buttons.
5. Press and hold the just-trained HomeLink® button and observe the red Status Indicator LED. If the indicator light stays on constantly, programming is complete and your device should activate when the HomeLink® button is pressed and released.
  6. To program the remaining two HomeLink® buttons, follow steps 2 through 5.

### *Gate operator & Canadian programming*

During programming, your handheld transmitter may automatically stop transmitting. Continue to press the Integrated HomeLink® Wireless Control System button (note steps 2 through 4 in the Standard Programming portion of this document) while you press and re-press ("cycle") your handheld transmitter every two seconds until the frequency signal has been learned. The indicator light will flash slowly and then rapidly after several seconds upon successful training.

### *Operating HomeLink®*

To operate, simply press and release the programmed HomeLink® button. Activation will now occur for the trained device (i.e. garage door opener, gate operator, security system, entry door lock, home/office lighting, etc.). For convenience, the hand-held transmitter of the device may also be used at any time.

### *Reprogramming a single HomeLink® button*

To program a new device to a previously trained HomeLink® button, follow these steps:

1. Press and hold the desired HomeLink® button. Do NOT release until step 4 has been completed.
2. When the indicator light begins to flash slowly (after 20 seconds), position the handheld transmitter 2-8 cm (1-3 inches) away from the HomeLink® surface.
3. Press and hold the handheld transmitter button. The HomeLink® indicator light will flash, first slowly and then rapidly.
4. When the indicator light begins to flash rapidly, release both buttons.
5. Press and hold the just-trained HomeLink® button and observe the red Status Indicator LED. If the indicator light stays on constantly, programming is complete and your new device should activate.

### *Erasing HomeLink® buttons*

Individual buttons cannot be erased. However, to erase all three programmed buttons:

1. Press and hold the two outer HomeLink® buttons until the indicator light begins to flash-after 20 seconds.
2. Release both buttons. Do not hold for longer than 30 seconds.

The Integrated HomeLink® Wireless Control System is now in the training (learn) mode and can be programmed at any time following the appropriate steps in the Programming chapters above.

NVS® is a registered trademark and Z-Nav™ is a trademark of the Gentex Corporation, Zeeland, Michigan. HomeLink® is a registered trademark owned by Johnson Controls, Incorporated, Milwaukee, Wisconsin.

**RSS ID: NZLZTVHL3**

**IC: 4112A-ZTVHL3**

## **i** Information

This device complies with Industry Canada RSS-210 standard.

Operation is subject to the following three conditions:

1. This device may not cause harmful interference, and
2. This device must accept any interference received, including interference that may cause undesired operation.
3. The transceiver has been tested and complies with RSS and Industry Canada rules. Changes or modifications not expressly approved by the party responsible for compliance could void the user's authority to operate the device.

## Side View Mirrors

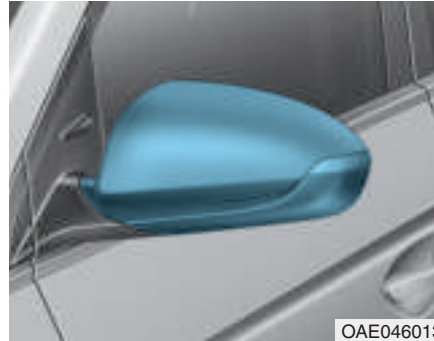

Be sure to adjust mirror angles before driving.

Your vehicle is equipped with both left-hand and right-hand side view mirrors. The mirrors can be adjusted remotely with the remote switch. The mirror heads can be folded to help prevent damage during an automatic car wash or when passing through a narrow street.

The right side view mirror is convex. Objects seen in the mirror are closer than they appear.

Use your interior side view mirror or direct observation to determine the actual distance of following vehicles when changing lanes.

### **⚠** WARNING

**Do not adjust or fold the side view mirrors while driving. This may cause loss of vehicle control resulting in an accident.**

### **NOTICE**

- **Do not scrape ice off the mirror face; this may damage the surface of the glass.**
- **If the mirror is jammed with ice, do not adjust the mirror by force. Use an approved spray de-icer (not radiator antifreeze) spray, or a sponge or soft cloth with very warm water, or move the vehicle to a warm place and allow the ice to melt.**

### Side view mirror control



Adjusting the side mirrors:

1. Press either the L (driver's side) or R (passenger's side) button (1) to select the side view mirror you would like to adjust.
2. Use the mirror adjustment control switch to position the selected mirror up, down, left or right.
3. After adjustment, put the button into neutral (center) position to prevent inadvertent adjustment.

### NOTICE

- The mirrors stop moving when they reach the maximum adjusting angles, but the motor continues to operate while the switch is pressed. Do not press the switch longer than necessary, because this can damage the motor.
- Do not attempt to adjust the side view mirrors by hand, because this can damage the motor.

### Folding the side view mirrors

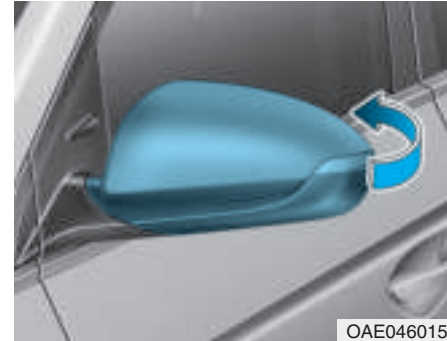

### Manual type

To fold the side view mirrors, grasp the housing of the mirror and then fold it toward the rear of the vehicle.



#### Electric type (if equipped)

**Left** : The mirror will unfold.

**Right** : The mirror will fold.

**Center (AUTO)** : The mirror will fold or unfold automatically as follows:

- Without smart key system
  - The mirror will fold or unfold when the door is locked or unlocked by the remote key.

- With smart key system
  - The mirror will fold or unfold when the door is locked or unlocked by the smart key.
  - The mirror will fold or unfold when the door is locked or unlocked by the button on the outside door handle.
  - The mirror will unfold when you approach the vehicle (all doors closed and locked) with a smart key in possession. (if equipped)

#### **NOTICE**

**The electric type outside rearview mirror operates even though the ignition switch is in the OFF position. However, to prevent unnecessary battery discharge, do not adjust the mirrors longer than necessary while the engine is not running.**

#### **NOTICE**

**Do not fold the electric type outside rearview mirror by hand. It could cause motor failure.**

### Reverse Parking Aid Function (if equipped)



When you move the shift lever to the R (Reverse) position, the side view mirror(s) will rotate downwards to aid with driving in reverse. The position of the side view mirror switch (1) determines whether or not the mirrors will move:

**Left/Right :** When either the L (Left) or R (Right) switch is selected, both side view mirrors will move.

**Neutral :** When neither switch is selected, the side view mirrors will not move.

The side view mirrors will automatically revert to their original positions if any of the following occur:

- The ignition switch is placed to either the LOCK/OFF position or the ACC position.
- The shift lever is moved to any position except R (Reverse).
- The remote control side view mirror switch is not selected.

## WINDOWS

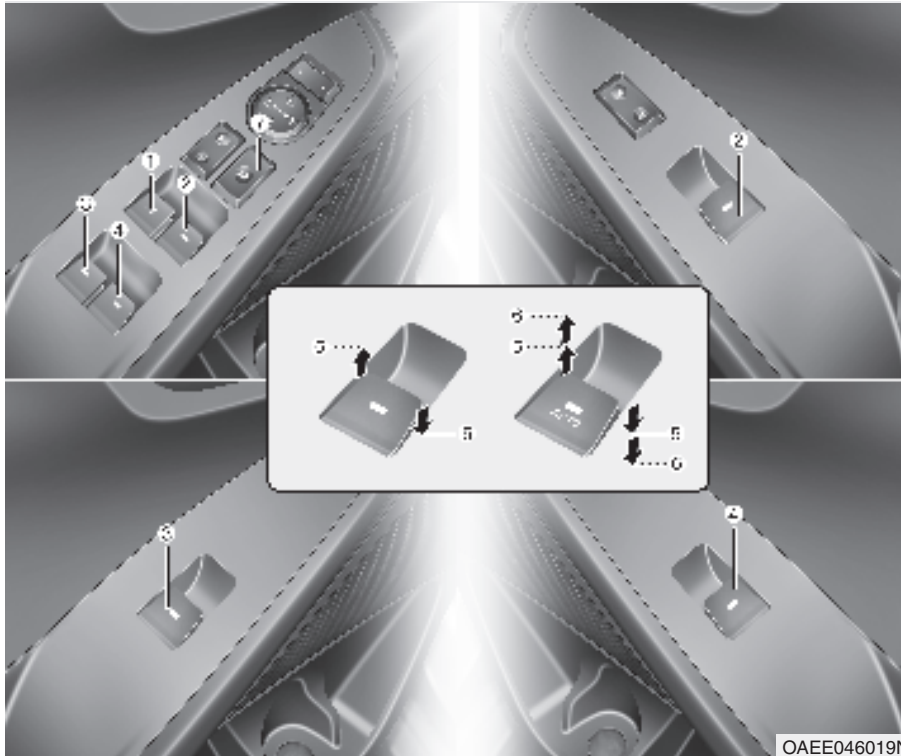

- (1) Driver's door power window switch
- (2) Front passenger's door power window switch
- (3) Rear door (left) power window switch
- (4) Rear door (right) power window switch
- (5) Window opening and closing
- (6) Automatic power window
- (7) Power window lock switch



### Power Windows

The ignition switch must be in the ON position to be able to raise or lower the windows. Each door has a Power Window switch to control that door's window. The driver has a Power Window Lock switch which can block the operation of passenger windows. The power windows will operate for approximately 30 seconds after the ignition switch is placed in the ACC or LOCK/OFF position. However, if the front doors are opened, the Power Windows will not operate even within the 30 seconds period.

#### WARNING

**To avoid serious injury or death, do not extend your head, arms or body outside the windows while driving.**

#### Information

- **In cold and wet climates, power windows may not work properly due to freezing conditions.**
- **While driving with the rear windows down or with the sunroof (if equipped) opened (or partially opened), your vehicle may demonstrate a wind buffeting or pulsation noise. This noise is normal and can be reduced or eliminated by taking the following actions. If the noise occurs with one or both of the rear windows down, partially lower both front windows approximately 2.5 cm (one inch). If you experience the noise with the sunroof open, slightly close the sunroof.**

### Window opening and closing



To open:

Press the window switch down to the first detent position (5). Release the switch when you want the window to stop.

To close:

Pull the window switch up to the first detent position (5). Release the window switch when you want the window to stop.

### ***Auto up/down window (if equipped)***

Pressing or pulling up the power window switch momentarily to the second detent position (6) completely lowers or lifts the window even when the switch is released. To stop the window at the desired position while the window is in operation, pull up or press down and release the switch.

### ***To reset the power windows***

If the power windows do not operate normally, the automatic power window system must be reset as follows:

1. Place the ignition switch to the ON position.
2. Close the window and continue pulling up on the power window switch for at least one second.

If the power windows do not operate properly after resetting, have the system checked by an authorized HYUNDAI dealer.

#### **WARNING**

**The automatic reverse feature doesn't activate while resetting the power window system. Make sure body parts or other objects are safely out of the way before closing the windows to avoid injuries or vehicle damage.**

### ***Automatic reverse (if equipped)***

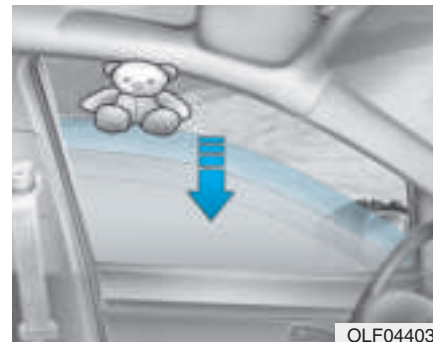

If a window senses any obstacle while it is closing automatically, it will stop and lower approximately 30 cm (12 inches) to allow the object to be cleared.

If the window detects the resistance while the power window switch is pulled up continuously, the window will stop upward movement then lower approximately 2.5 cm (1 inch).

If the power window switch is pulled up continuously again within 5 seconds after the window is lowered by the automatic window reverse feature, the automatic window reverse will not operate.

### **i** Information

The automatic reverse feature is only active when the "Auto Up" feature is used by fully pulling up the switch to the second detent.

### **⚠** WARNING

Make sure body parts or other objects are safely out of the way before closing the windows to avoid injuries or vehicle damage.

Objects less than 4 mm (0.16 inch) in diameter caught between the window glass and the upper window channel may not be detected by the automatic reverse window and the window will not stop and reverse direction.

### **NOTICE**

Do not install any accessories on the windows. The automatic reverse feature may not operate.

### Power window lock switch



OAE046021N

The driver can disable the power window switches on the rear passenger's doors by pressing the power window lock switch.

When the power window lock switch is pressed:

- The driver's master control can operate all the power windows.
- The front passenger's control can operate the front passenger's power window.
- The rear passenger's control cannot operate the rear passenger's power window.

### **⚠** WARNING

Do not allow children to play with the power windows. Keep the driver's door power window lock switch in the LOCK position. Serious injury or death can result from unintentional window operation by a child.

### **NOTICE**

- To prevent possible damage to the power window system, do not open or close two windows or more at the same time. This will also ensure the longevity of the fuse.
- Never try to operate the main switch on the driver's door and the individual door window switch in opposite directions at the same time. If this is done, the window will stop and cannot be opened or closed.

## SUNROOF (IF EQUIPPED)



If your vehicle is equipped with a sunroof, you can slide or tilt your sunroof with the sunroof control switch located on the overhead console.

The sunroof can only be opened, closed, or tilted when the ignition switch is in the ON position.

The sunroof can be operated for approximately 30 seconds after the ignition key is removed or turned to the ACC or LOCK (or OFF) position. However, if the front door is opened, the sunroof cannot be operated even within 30 seconds.

### **i** Information

- In cold and wet climates, the sunroof may not work properly due to freezing conditions.
- After the vehicle is washed or in a rainstorm, be sure to wipe off any water that is on the sunroof before operating it.

### **⚠** WARNING

- **Never adjust the sunroof or sunshade while driving. This could result in loss of control and an accident that may cause death, serious injury, or property damage.**
- **Make sure heads, hands, arms or any other body parts or objects are out of the way before operating the sunroof.**
- **Do not extend your head, arms or body outside the sunroof while driving, to avoid serious injury.**

(Continued)

(Continued)

- Do not leave the engine running and the key in your vehicle with unsupervised children. Unattended children could operate the sunroof, which could result in serious injury.
- Do not sit on the top of the vehicle. It may cause injury or vehicle damage.

### **NOTICE**

- Do not continue to move the sunroof control lever after the sunroof is fully opened, closed, or tilted. Damage to the motor or system components could occur.
- Make sure the sunroof is closed fully when leaving your vehicle.

If the sunroof is left open, rain or snow may wet the interior of the vehicle. Also, leaving the sunroof open when the vehicle is unattended may invite theft.

### Sunroof Opening and Closing



To open:

Press the sunroof control lever backward to the first detent position. Release the switch when you want the sunroof to stop.

To close:

Press the sunroof control lever forward to the first detent position. Release the switch when you want the sunroof to stop.

### Sliding the Sunroof

Pressing the sunroof control lever backward or forward momentarily to the second detent position completely opens or closes the sunroof even when the switch is released. To stop the sunroof at the desired position while the sunroof is in operation, press the sunroof control lever backward or forward and release the switch.

#### **i** Information

**To minimize wind noise while driving, it is recommended that you drive with the sunroof slightly closed (stop the sunroof about 7 cm (3 inch) before the maximum slide open position).**

### Automatic reverse (if equipped)



If the sunroof senses any obstacle while it is closing automatically, it will reverse direction then stop to allow the object to be cleared.

The auto reverse function does not work if a small obstacle is between the sliding glass and the sunroof sash.

You should always check that all passengers and objects are away from the sunroof before closing it.

## WARNING

Small objects that can get caught between the sunroof glass and the front glass channel may not be detected by the automatic reverse system. In this case, the sunroof glass will not detect the object and will not reverse direction.

## NOTICE

- Periodically remove any dirt that may accumulate on the sunroof guide rail or between the sunroof and roof panel which can make a noise.
- Do not try to open the sunroof when the temperature is below freezing or when the sunroof is covered with snow or ice, otherwise the motor could be damaged. In cold and wet climates, the sunroof may not work properly.

## Tilting the Sunroof



Tilt the sunroof open:

Push the sunroof control lever upward until the sunroof moves to the desired position.

To close the sunroof:

Push the sunroof control lever forward until the sunroof moves to the desired position.

## Sunshade



The sunshade will open automatically with the sunroof when the glass panel moves. If you want it closed, move the sunshade manually.

## NOTICE



**The sunroof is made to slide together with the sunshade. Do not leave the sunshade closed while the sunroof is open.**

### Resetting the Sunroof

The sunroof may need to be reset if the following conditions occur:

- The battery is discharged or disconnected or the sunroof fuse has been replaced or disconnected
- The sunroof control lever is not operating correctly

To reset the sunroof, perform the following steps:

1. Place the ignition switch to the ON position or start the vehicle (  indicator ON). It is recommended to reset the sunroof while the vehicle is in the ready (  ) mode.
2. Push the control lever forward. The sunroof will close completely or tilt depending on the condition of the sunroof.
3. Release the control lever when the sunroof stops moving.

4. Push the control lever forward about 10 seconds.

- When the sunroof is in the closed position :

The glass will tilt and slightly move up and down.

- When the sunroof is in the tilt position:

The glass will slightly move up and down.

Do not release the lever until the operation is completed.

If you release the lever during operation, start the procedure again from step 2.

5. Within 3 seconds, push and hold the control lever forward until the sunroof operates as follows:

Tilt down → Slide Open → Slide Close.

Do not release the lever until the operation is completed.

If you release the lever during operation, start the procedure again from step 2.

6. Release the sunroof control lever after all steps have completed. The sunroof system has been reset.

### Information

- If the sunroof is not reset when the vehicle battery is disconnected or discharged, or the sunroof fuse is blown, the sunroof may not operate normally.
- For more detailed information, contact an authorized HYUNDAI dealer.

## EXTERIOR FEATURES

### Hood

#### Opening the hood



1. Park the vehicle and set the parking brake.
2. Pull the release lever to unlatch the hood. The hood should pop open slightly.



3. Go to the front of the vehicle, raise the hood slightly, push up the secondary latch (1) inside the hood center and lift the hood (2).



4. Pull out the support rod and hold the hood open with the support rod (3).

#### WARNING

- Grasp the support rod in the area wrapped in rubber. The rubber will help prevent you from being burned by hot metal when the engine is hot.
- The support rod must be inserted completely into the hole provided whenever you inspect the engine compartment. This will prevent the hood from falling and possibly injuring you.



### ***Closing the hood***

1. Before closing the hood, check the following:
  - All filler caps in engine compartment must be correctly installed.
  - Gloves, rags or any other combustible material must be removed from the engine compartment.
2. Lower the hood halfway (lifted approximately 30 cm (12 inches) from the closed position) and push down to securely lock in place. Then double check to be sure the hood is secure. If the hood can be raised slightly, it is not securely locked. Open it again and close it with more force.

### **⚠ WARNING**

- **Before closing the hood, ensure all obstructions are removed from around the hood opening.**
- **Always double check to be sure that the hood is firmly latched before driving away. Check there is no hood open warning light or message displayed on the instrument cluster. Driving with the hood opened may cause a total loss of visibility, which might result in an accident.**
- **Do not move the vehicle with the hood in the raised position, as vision is obstructed, which might result in an accident, and the hood could fall or be damaged.**

### **Tailgate**

#### ***Opening the tailgate***

Make sure the shift lever is in P (Park).



Then do one of the following:

1. Unlock all doors with the Door Unlock button on your remote key or smart key. Press the tailgate handle button and open the tailgate.
2. Press and hold the Tailgate Unlock button on the remote key or smart key. Press the tailgate handle button and open the tailgate.
3. With the Smart Key in your possession, press the tailgate handle button and open the tailgate.

## Closing the tailgate



Lower the tailgate lid and press down until it locks.

To be sure the tailgate lid is securely fastened, always check by trying to pull it up again without pressing the tailgate handle button.

### NOTICE

In cold and wet climates, door lock and door mechanisms may not work properly due to freezing conditions.

### WARNING

The tailgate swings upward. Make sure no objects or people are near the rear of the vehicle when opening the tailgate.

### CAUTION

Make certain that you close the tailgate before driving your vehicle. Possible damage may occur to the tailgate lift cylinders and attached hardware if the tailgate is not closed prior to driving.

### WARNING



Do not hold the part (gas lifter) that supports the tailgate. Be aware that the deformation of the part may cause vehicle damage and a risk of safety accident.

### **Emergency tailgate safety release**



Your vehicle is equipped with an Emergency Tailgate Safety Release lever located inside the tailgate. When someone is inadvertently locked in the luggage compartment, the tailgate can be opened manually from inside the luggage compartment by performing the following steps :

1. Input the mechanical key into the hole.
2. Push the mechanical key to the right.
3. Push up the tailgate.

### **⚠ WARNING**

- **For emergencies, be fully aware of the location of the emergency tailgate safety release lever in this vehicle and how to open the tailgate if you are accidentally locked in the luggage compartment.**
- **No one should be allowed to occupy the luggage compartment of the vehicle at any time. The luggage compartment is a very dangerous location in the event of a crash.**
- **Use the release lever for emergencies only. Use extreme caution, especially while the vehicle is in motion.**

### **Fuel Filler Door (Hybrid vehicle)**

#### **Opening the fuel filler door**

The fuel filler door must be opened from inside the vehicle by pushing the fuel filler door open switch.



1. Turn the vehicle off.
2. Push the fuel filler door open switch.

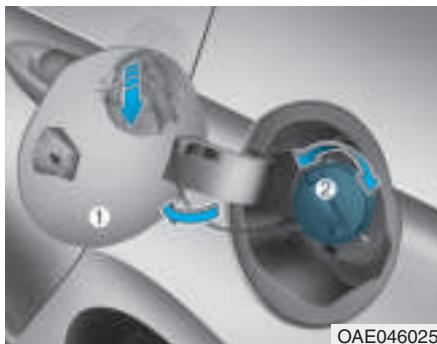

OAE046025

3. Pull the fuel filler door (1) out to fully open.
4. To remove the fuel tank cap (2), turn it counterclockwise. You may hear a hissing noise as the pressure inside the tank equalizes.
5. Place the cap on the fuel filler door.

### **i** Information

If the fuel filler door does not open because ice has formed around it, tap lightly or push on the door to break the ice and release the door. Do not pry on the door. If necessary, spray around the door with an approved de-icer fluid (do not use radiator anti-freeze) or move the vehicle to a warm place and allow the ice to melt.

### **Closing the fuel filler door**

1. To install the fuel tank cap, turn it clockwise until it "clicks" one time.
2. Close the fuel filler door until it is latched securely.

### **⚠ WARNING**

**Gasoline is highly flammable and explosive. Failure to follow these guidelines may result in SERIOUS INJURY or DEATH:**

- Read and follow all warnings posted at the gas station.
- Before refueling, note the location of the Emergency Gasoline Shut-Off, if available, at the gas station.
- Before touching the fuel nozzle, you should eliminate the potential build-up of static electricity by touching a metal part of the vehicle, a safe distance away from the fuel filler neck, nozzle, or other gas source, with your bare hand.

(Continued)

(Continued)

- Do not use cellular phones while refueling. Electric current and/or electronic interference from cellular phones can potentially ignite fuel vapors and cause a fire.
- Do not get back into a vehicle once you have begun refueling. You can generate a build-up of static electricity by touching, rubbing or sliding against any item or fabric capable of producing static electricity. Static electricity discharge can ignite fuel vapors causing a fire. If you must re-enter the vehicle, you should once again eliminate potentially dangerous static electricity discharge by touching a metal part of the vehicle, away from the fuel filler neck, nozzle or other gasoline source, with your bare hand.

(Continued)

(Continued)

- When using an approved portable fuel container, be sure to place the container on the ground prior to refueling. Static electricity discharge from the container can ignite fuel vapors causing a fire.

Once refueling has begun, contact between your bare hand and the vehicle should be maintained until the filling is complete.

- Use only approved portable plastic fuel containers designed to carry and store gasoline.
- When refueling, always move the shift lever to the P (Park) position, set the parking brake, and place the ignition switch to the LOCK/OFF position. Sparks produced by electrical components related to the engine can ignite fuel vapors causing a fire.

(Continued)

(Continued)

- Do not use matches or a lighter and do not smoke or leave a lit cigarette in your vehicle while at a gas station, especially during refueling.
- Do not over-fill or top-off your vehicle tank, which can cause gasoline spillage.
- If a fire breaks out during refueling, leave the vicinity of the vehicle, and immediately contact the manager of the gas station and then contact the local fire department. Follow any safety instructions they provide.
- If pressurized fuel sprays out, it can cover your clothes or skin and thus subject you to the risk of fire and burns. Always remove the fuel cap carefully and slowly. If the cap is venting fuel or if you hear a hissing sound, wait until the condition stops before completely removing the cap.

(Continued)

(Continued)

- Always check that the fuel cap is installed securely to prevent fuel spillage in the event of an accident.

### Information

Make sure to refuel your vehicle according to the "Fuel Requirements" suggested in the Introduction chapter.

### **NOTICE**

- Do not spill fuel on the exterior surfaces of the vehicle. Any type of fuel spilled on painted surfaces may damage the paint.
- If the fuel filler cap requires replacement, use only a genuine HYUNDAI cap or the equivalent specified for your vehicle. An incorrect fuel filler cap can result in a serious malfunction of the fuel system or emission control system.

## Fuel Filler Door (Plug-in hybrid vehicle)

### Opening the fuel filler door

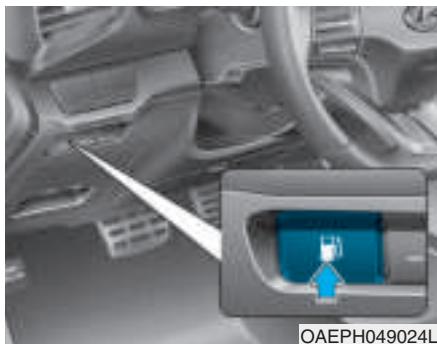

The fuel filler door must be opened from inside the vehicle by pushing the fuel filler door open switch.

1. Turn the vehicle off.
2. Push the fuel filler door open switch.



3. Wait until the fuel tank is depressurized.

The message "Fuel door open" is displayed when the fuel filler door opens after the fuel tank is depressurized.

### **i** Information

- It may take up to 20 seconds to open the fuel filler door.
- When the fuel filler door is frozen and does not open after 20 seconds at freezing temperature, slightly tap the fuel filler door and then attempt to open it.

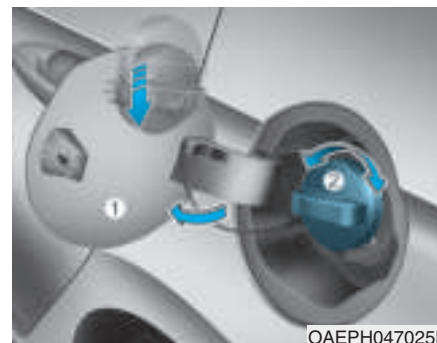

4. Pull the fuel filler door (1) out to fully open.
5. To remove the fuel tank cap (2), turn it counterclockwise. You may hear a hissing noise as the pressure inside the tank equalizes.
6. Place the cap on the fuel filler door.

 **WARNING**

- Add fuel into the fuel tank within 20 minutes after opening the fuel filler door. After 20 minutes, the fuel tank may shut off, causing fuel to overflow. In this case, re-press the fuel filler door opening button.
- Do not leave the fuel filler door opened for an extended period of time. It may discharge the battery.
- Close the fuel filler door after fueling the vehicle. If you start the vehicle with the fuel filler door opened, the message, "Check fuel door", illuminates on the LCD display.
- Avoid refueling the vehicle while charging the (high-voltage) hybrid battery. It may cause a fire or an explosion due to static electricity.

**Closing the fuel filler door**

1. To install the fuel tank cap, turn it clockwise until it "clicks" one time.
2. Close the fuel filler door until it is latched securely.

 **WARNING**

Gasoline is highly flammable and explosive. Failure to follow these guidelines may result in **SERIOUS INJURY** or **DEATH**:

- Read and follow all warnings posted at the gas station.
- Before refueling, note the location of the Emergency Gasoline Shut-Off, if available, at the gas station.
- Before touching the fuel nozzle, you should eliminate the potential build-up of static electricity by touching a metal part of the vehicle, a safe distance away from the fuel filler neck, nozzle, or other gas source, with your bare hand.

(Continued)

(Continued)

- Do not use cellular phones while refueling. Electric current and/or electronic interference from cellular phones can potentially ignite fuel vapors and cause a fire.
- Do not get back into a vehicle once you have begun refueling. You can generate a build-up of static electricity by touching, rubbing or sliding against any item or fabric capable of producing static electricity. Static electricity discharge can ignite fuel vapors causing a fire. If you must re-enter the vehicle, you should once again eliminate potentially dangerous static electricity discharge by touching a metal part of the vehicle, away from the fuel filler neck, nozzle or other gasoline source, with your bare hand.

(Continued)

(Continued)

- When using an approved portable fuel container, be sure to place the container on the ground prior to refueling. Static electricity discharge from the container can ignite fuel vapors causing a fire.

Once refueling has begun, contact between your bare hand and the vehicle should be maintained until the filling is complete.

- Use only approved portable plastic fuel containers designed to carry and store gasoline.
- When refueling, always move the shift lever to the P (Park) position, set the parking brake, and place the Engine Start/Stop button to the OFF position. Sparks produced by electrical components related to the engine can ignite fuel vapors causing a fire.

(Continued)

(Continued)

- Do not use matches or a lighter and do not smoke or leave a lit cigarette in your vehicle while at a gas station, especially during refueling.
- Do not over-fill or top-off your vehicle tank, which can cause gasoline spillage.
- If a fire breaks out during refueling, leave the vicinity of the vehicle, and immediately contact the manager of the gas station and then contact the local fire department. Follow any safety instructions they provide.
- If pressurized fuel sprays out, it can cover your clothes or skin and thus subject you to the risk of fire and burns. Always remove the fuel cap carefully and slowly. If the cap is venting fuel or if you hear a hissing sound, wait until the condition stops before completely removing the cap.

(Continued)

(Continued)

- Always check that the fuel cap is installed securely to prevent fuel spillage in the event of an accident.

### **i** Information

Make sure to refuel your vehicle according to the "Fuel Requirements" suggested in the Introduction chapter.

### **NOTICE**

- Do not spill fuel on the exterior surfaces of the vehicle. Any type of fuel spilled on painted surfaces may damage the paint.
- If the fuel filler cap requires replacement, use only a genuine HYUNDAI cap or the equivalent specified for your vehicle. An incorrect fuel filler cap can result in a serious malfunction of the fuel system or emission control system.



## INSTRUMENT CLUSTER

### ■ Hybrid vehicle

- Type A



- Type B



1. Power gauge
2. Fuel gauge
3. Speedometer
4. Warning and indicator lights
5. LCD display (including Trip computer)
6. Battery State of Charge (SOC) gauge

**The actual cluster in the vehicle may differ from the illustration.**

**For more details, refer to the "Gauges and Meters" in this chapter.**

OAEPH049197L/OAEPH049198L

## ■ Plug-in hybrid vehicle

### • Type A



### • Type B



1. Power gauge
2. Fuel gauge
3. Speedometer
4. Warning and indicator lights
5. LCD display (including Trip computer)
6. Battery State of Charge (SOC) gauge

**The actual cluster in the vehicle may differ from the illustration.**

**For more details, refer to the "Gauges and Meters" in this chapter.**

OAEPH048523/OAEPH048524

### Instrument Cluster Control

#### Instrument panel illumination

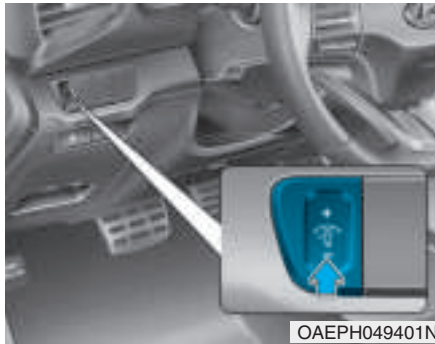

When the vehicle's position lights or headlights are on, press the illumination control button to adjust the brightness of the instrument panel illumination.

When pressing the illumination control button, the interior switch illumination intensity is also adjusted.

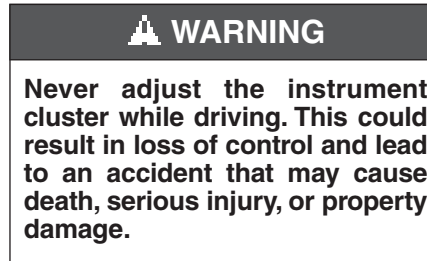

- The brightness of the instrument panel illumination is displayed.
- If the brightness reaches to the maximum or minimum level, a chime will sound.

### Gauges and Meters

#### Speedometer



- Type B
  - ECO mode selected



- Type B
- SPORT mode selected



The speedometer indicates the speed of the vehicle and is calibrated in MPH (miles per hour) and/or km/h (kilometers per hour).

The speedometer for cluster type B is displayed differently according to the mode selected, ECO or SPORT. If the shift lever is in S (Sport), SPORT mode is selected and if the shift lever is in D (Drive), ECO mode is selected.

**For more information, refer to "Dual Clutch Transmission" in chapter 5.**

## Tachometer

- Type B
- SPORT mode selected



The tachometer indicates the approximate number of engine revolutions per minute (rpm).

Use the tachometer to select the correct shift points and to prevent lugging and/or over-revving the engine.

### **NOTICE**

**Do not operate the engine within the tachometer's RED ZONE. This may cause severe engine damage.**

## Power gauge

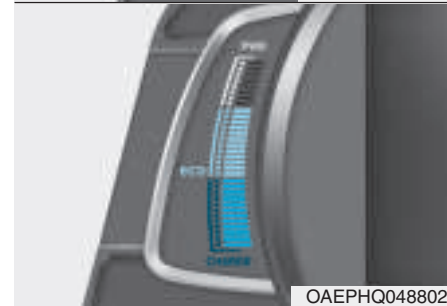

The power gauge indicates whether the current driving condition is fuel efficient or not.

- **CHARGE :**  
Shows that the energy made by the vehicle is being converted to electrical energy. (Regenerated energy)
- **ECO :**  
Shows that the vehicle is being driven in an Eco-friendly manner.
- **POWER :**  
Shows that the vehicle is exceeding the Eco-friendly range.

### **i** Information

Accordance to the power gauge area the "EV" indicator comes on or off.

- "EV" indicator **ON** : Vehicle is driven using the electric motor or the gasoline engine is stopped.
- "EV" indicator **OFF** : Vehicle is driven using the gasoline engine.

### Fuel gauge

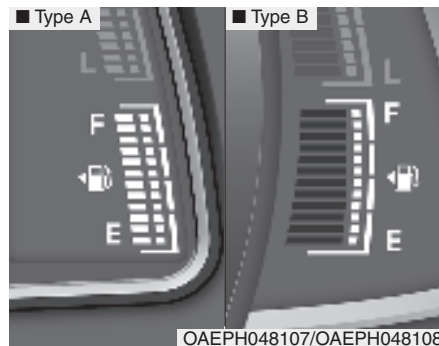

This gauge indicates the approximate amount of fuel remaining in the fuel tank.

### **i** Information

- The fuel tank capacity is given in chapter 8.
- The fuel gauge is supplemented by a low fuel warning light, which will illuminate when the fuel tank is nearly empty.
- On inclines or curves, the fuel gauge pointer may fluctuate or the low fuel warning light may come on earlier than usual due to the movement of fuel in the tank.

### **⚠** WARNING

**Running out of fuel can expose vehicle occupants to danger.**

**You must stop and obtain additional fuel as soon as possible after the warning light comes on or when the gauge indicator comes close to the "E (Empty)" level.**

### **NOTICE**

**Avoid driving with an extremely low fuel level. Running out of fuel could cause the engine to misfire damaging the catalytic converter.**

## Battery State of Charge (SOC) gauge

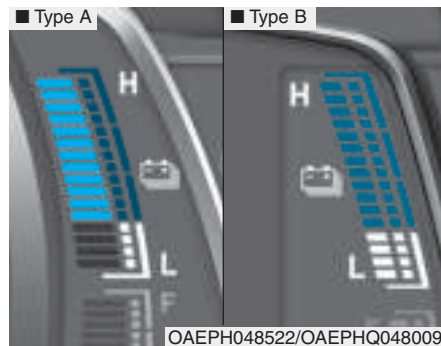

This gauge indicates the remaining hybrid battery power. If the SOC is near the "L (Low)" level, the vehicle automatically operates the engine to charge the battery. However, if the Service Indicator (⚠️) and Malfunction Indicator Lamp (MIL) (🔧) turn on when the SOC gauge is near the "L (Low)" level, have the vehicle be checked by an authorized HYUNDAI dealer.

\* The actual cluster in the vehicle may differ from the illustration.

### NOTICE

**Never try to start the vehicle if the fuel tank is empty. In this condition, the engine cannot charge the high voltage battery of the hybrid system. If you try to start the vehicle when the fuel is empty, the high voltage battery will become discharged and be damaged.**

## Plug-in hybrid mode indicator

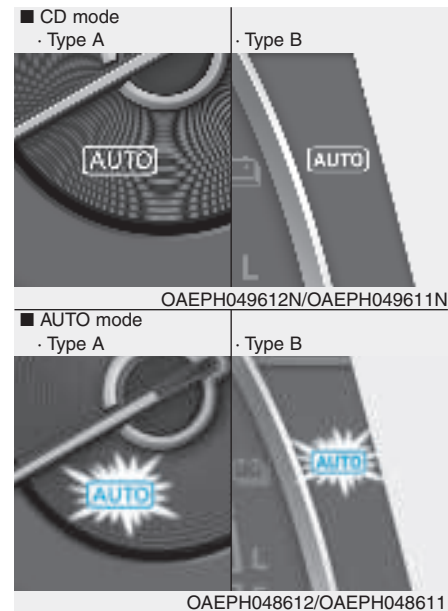

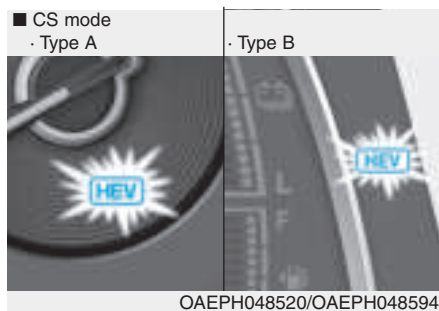

- CD (Charge Depleting, Electric) mode : The high-voltage (hybrid) battery is used to drive the vehicle.
- AUTO mode : CD mode and CS mode are selected automatically depending on road conditions.
- CS (Charge Sustaining, Hybrid) mode : The high-voltage (hybrid) battery and gasoline engine is used to drive the vehicle.

### **i** Information

Even when the battery charging rate is high and driving in electric mode is possible, engine may turn on in some areas to protect the system.

### Outside temperature gauge

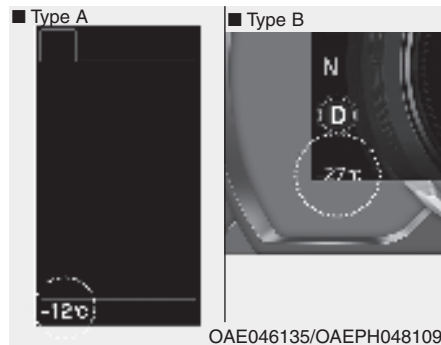

This gauge indicates the current outside air temperatures by 1°C (1°F).

- Temperature range : -40°C ~ 60°C  
(-40°F ~ 140°F)

The outside temperature on the display may not change immediately like a general thermometer (to avoid distracting the driver).

To change the temperature unit from °C to °F or °F to °C:

- Go to User Settings Mode → Other (Features) → Temperature Unit.

For vehicles equipped with Automatic Climate Control, you can also:

- Press and hold the AUTO and OFF buttons on the climate control unit for 3 seconds

Both the temperature unit on the cluster LCD display and climate control screen will change.

## Odometer

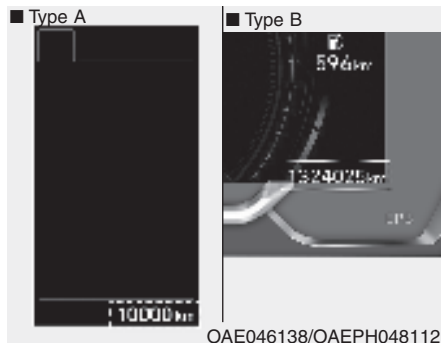

The odometer indicates the total distance that the vehicle has been driven and should be used to determine when periodic maintenance should be performed.

## Range

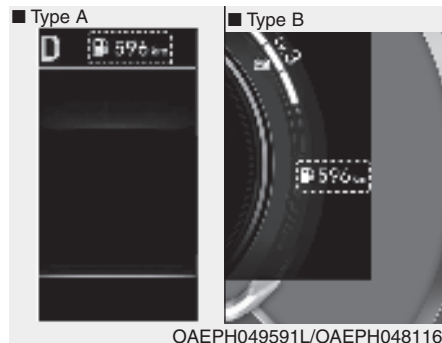

- The range is the estimated distance the vehicle can be driven with the remaining fuel.
- If the estimated distance is below 1 km (1 mi.), the trip computer will display "----" as range.

For more information, refer to "Dual Clutch Transmission" in chapter 5.

## **i** Information

- If the vehicle is not on level ground or the battery power has been interrupted, the range function may not operate correctly.
- The range may differ from the actual driving distance as it is an estimate of the available driving distance.
- The trip computer may not register additional fuel if less than 6 liters (1.6 gallon) of fuel are added to the vehicle.
- The range may vary significantly based on driving conditions, driving habits, and condition of the vehicle.



### Dual clutch transmission shift indicator

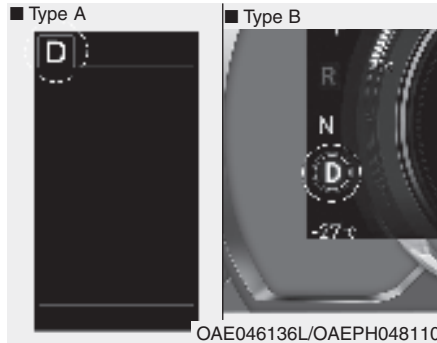

This indicator displays which shift lever position is selected.

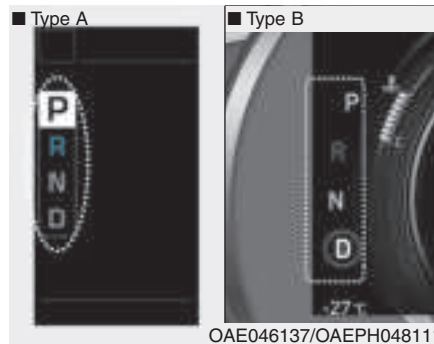

### Shift indicator pop-up (if equipped)

The pop-up indicates the current gear position displayed in the cluster for about 2 seconds when shifting into other positions (P/R/N/D).

### Regenerative braking level indicator

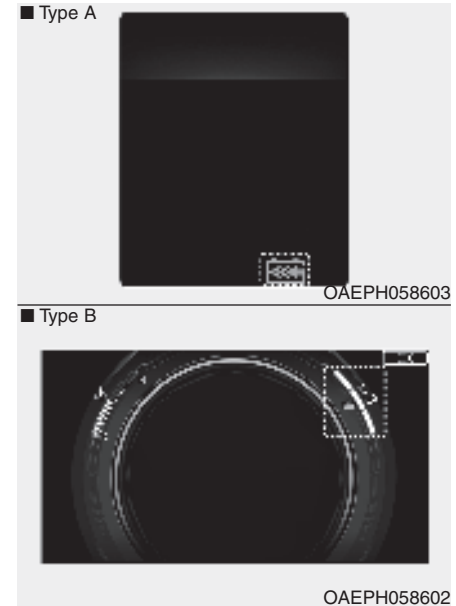

While using the regenerative brakes, you may select the regenerative braking level from 0 to 3 by pulling the paddle shifter.

For more details, refer to "Paddle shift" in chapter 5.

## Warning and Indicator Lights

### **i** Information

Make sure that all warning lights are OFF after starting the engine. If any light is still ON, this indicates a situation that needs attention.

#### *Ready Indicator*



**This indicator illuminates :**

When the vehicle is ready to be driven.

- ON : Normal driving is possible.
- OFF : Normal driving is not possible, or a problem has occurred.
- Blinking : Emergency driving.

When the ready indicator goes OFF or blinks, there is a problem with the system. In this case, have your vehicle inspected by an authorized HYUNDAI dealer.

#### *EV Mode Indicator*

EV

This indicator illuminates when the vehicle is driven by the electric motor.

#### *Service Warning Light*



**This warning light illuminates :**

- When you turn the ignition switch or the Engine Start/Stop button to the ON position.
  - It illuminates for approximately 3 seconds and then goes off.
- When there is a problem with the hybrid vehicle control system or hardware.

When the warning light illuminates while driving, or does not go OFF after starting the vehicle, have your vehicle inspected by an authorized HYUNDAI dealer.

### **Charging Cable Connection Indicator (Plug-in hybrid)**



This indicator illuminates in red when the charging cable is connected.

### **Air Bag Warning Light**



**This warning light illuminates:**

- When you turn the ignition switch or the Engine Start/Stop button to the ON position.
  - It illuminates for approximately 6 seconds and then goes off.
- When there is a malfunction with the SRS.

In this case, have the vehicle inspected by an authorized HYUNDAI dealer.

### **Seat Belt Warning Light**



This warning light informs the driver that the seat belt is not fastened.

**For more details, refer to the "Seat Belts" in chapter 2.**

### **Parking Brake & Brake Fluid Warning Light**



**This warning light illuminates:**

- When you turn the ignition switch or the Engine Start/Stop button to the ON position.
  - It illuminates for approximately 3 seconds.
  - It remains on if the parking brake is applied.
- When the parking brake is applied.

- When the brake fluid level in the reservoir is low.
  - If the warning light illuminates with the parking brake released, it indicates the brake fluid level in the reservoir is low.
- When the regenerative brake does not operate.

**If the brake fluid level in the reservoir is low:**

1. Drive carefully to the nearest safe location and stop your vehicle.
2. With the engine stopped, check the brake fluid level immediately and add fluid as required (**For more details, refer to "Brake Fluid" in chapter 7**). After adding brake fluid, check all brake components for fluid leaks. If a brake fluid leak is found, or if the warning light remains on, or if the brakes do not operate properly, do not drive the vehicle. Have the vehicle inspected by an authorized HYUNDAI dealer.

### Dual-diagonal braking system

Your vehicle is equipped with dual-diagonal braking systems. This means you still have braking on two wheels even if one of the dual systems should fail.

With only one of the dual systems working, more than normal pedal travel and greater pedal pressure is required to stop the vehicle.

Also, the vehicle will not stop in as short a distance with only a portion of the brake system working.

If the brakes fail while you are driving, shift to a lower gear for additional engine braking and stop the vehicle as soon as it is safe to do so.

### WARNING

#### **Parking Brake & Brake Fluid Warning Light**

**Driving the vehicle with a warning light ON is dangerous. If the Parking Brake & Brake Fluid Warning Light illuminates with the parking brake released, it indicates that the brake fluid level is low.**

**In this case, have the vehicle inspected by an authorized HYUNDAI dealer.**

### *Regenerative Brake Warning Light*



**This warning light illuminates :**

- When you turn the ignition switch or the Engine Start/Stop button to the ON position.
  - It illuminates for approximately 3 seconds.
- When the regenerative brake does not operate and the brake does not perform well. This causes the Brake Warning light and Regenerative Brake Warning Light to illuminate simultaneously.

In this case, drive safely and have your vehicle inspected by an authorized HYUNDAI dealer.

The operation of the brake pedal may be more difficult than normal and the braking distance can increase.

### Anti-lock Brake System (ABS) Warning Light



This warning light illuminates:

- When you turn the ignition switch or the Engine Start/Stop button to the ON position.
  - It illuminates for approximately 3 seconds and then goes off.
- When there is a malfunction with the ABS (The normal braking system will still be operational without the assistance of the anti-lock brake system).

In this case, have the vehicle inspected by an authorized HYUNDAI dealer.

### Electronic Brake Force Distribution (EBD) System Warning Light



These two warning lights illuminate at the same time while driving:

- When the ABS and regular brake system may not work normally.
  - In this case, have the vehicle inspected by an authorized HYUNDAI dealer.

#### WARNING

#### Electronic Brake Force Distribution (EBD) System Warning Light

When both ABS and Parking Brake & Brake Fluid Warning Lights are on, the brake system will not work normally and you may experience an unexpected and dangerous situation during sudden braking.

(Continued)

(Continued)

In this case, avoid high speed driving and abrupt braking.

Have the vehicle inspected by an authorized HYUNDAI dealer as soon as possible.

#### Information - Electronic Brake Force Distribution (EBD) System Warning Light

When the ABS Warning Light is on or both ABS and Parking Brake & Brake Fluid Warning Lights are on, the speedometer, odometer, or tripmeter may not work. Also, the EPS Warning Light may illuminate and the steering effort may increase or decrease.

In this case, have the vehicle inspected by an authorized HYUNDAI dealer as soon as possible.

### **Electronic Parking Brake (EPB) Warning Light (if equipped)**

**EPB**

**This warning light illuminates:**

When there is a malfunction with the EPB.

In this case, we recommend that you have the vehicle inspected by an authorized HYUNDAI dealer.

#### ***i* Information**

**The Electronic Parking Brake (EPB) Warning Light may illuminate when the Electronic Stability control (ESC) Indicator Light comes on to indicate that the ESC is not working properly (This does not indicate malfunction of the EPB).**

### **AUTO HOLD Indicator Light (if equipped)**

**AUTO HOLD**

**This indicator light illuminates:**

- [White] When you activate the auto hold system by pressing the AUTO HOLD button.
- [Green] When you stop the vehicle completely by depressing the brake pedal with the auto hold system activated.
- [Yellow] When there is a malfunction with the auto hold system.  
In this case, we recommend that you have the vehicle inspected by an authorized HYUNDAI dealer.

**For more details, refer to "Auto Hold" in chapter 5.**

### **Electric Power Steering (EPS) Warning Light**



**This warning light illuminates:**

- When you turn the ignition switch or the Engine Start/Stop button to the ON position.
  - It illuminates for approximately 3 seconds and then goes off.
- When there is a malfunction with the EPS.  
In this case, have the vehicle inspected by an authorized HYUNDAI dealer.

### Malfunction Indicator Lamp (MIL)

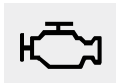

This warning light illuminates:

- When you turn the ignition switch or the Engine Start/Stop button to the ON position.
  - It illuminates for approximately 3 seconds and then goes off.
- When there is a malfunction with the emission control system.  
In this case, have the vehicle inspected by an authorized HYUNDAI dealer.

#### NOTICE

**Driving with the Malfunction Indicator Lamp (MIL) on may cause damage to the emission control system which could affect drivability and/or fuel economy.**

#### NOTICE

If the Malfunction Indicator Lamp (MIL) illuminates, potential catalytic converter damage is possible which could result in loss of engine power.

**In this case, have the vehicle inspected by an authorized HYUNDAI dealer as soon as possible.**

### Charging System Warning Light

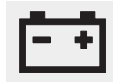

When this warning light illuminates while running the engine, the battery is not being charged. Immediately turn OFF all electrical accessories. Try not to use electrically operated controls, such as the power windows. Keep running the engine.

Have the vehicle inspected by an authorized HYUNDAI dealer as soon as possible.

### Engine Oil Pressure Warning Light



This warning light illuminates:

- When the engine oil pressure is low.

If the engine oil pressure is low:

1. Drive carefully to the nearest safe location and stop your vehicle.
2. Turn the engine off and check the engine oil level (**For more details, refer to "Engine Oil" in chapter 7**). If the level is low, add oil as required.

If the warning light remains on after adding oil or if oil is not available, have the vehicle inspected by an authorized HYUNDAI dealer as soon as possible.

### **NOTICE**

- If the engine does not stop immediately after the Engine Oil Pressure Warning Light is illuminated, severe damage could result.
- If the warning light stays on while the engine is running, it indicates that there may be serious engine damage or malfunction. In this case:
  1. Stop the vehicle as soon as it is safe to do so.
  2. Turn off the engine and check the oil level. If the oil level is low, fill the engine oil to the proper level.
  3. Start the engine again. If the warning light stays on after the engine is started, turn the engine off immediately. In this case, have the vehicle inspected by an authorized HYUNDAI dealer.

### **Low Fuel Level Warning Light**



This warning light illuminates:

- When the fuel tank is nearly empty. Add fuel as soon as possible.

### **NOTICE**

Driving with the Low Fuel Level warning light on or with the fuel level below "E" can cause the engine to misfire and damage the catalytic converter (if equipped).

### **Engine Coolant Temperature Warning Light**



This warning light illuminates:

- When the engine coolant temperature is above 120°C (248°F). This means that the engine is overheated and may be damaged.

If your vehicle is overheated, refer to "Overheating" in chapter 6.



### Master Warning Light



#### This indicator light illuminates:

- When there is a malfunction in operation in any of the following systems:
  - Forward Collision-Avoidance Assist system malfunction (if equipped)
  - Forward Collision-Avoidance Assist radar blocked (if equipped)
  - Blind-Spot Collision Warning system malfunction (if equipped)
  - Blind-Spot Collision Warning radar blocked (if equipped)
  - Smart Cruise Control malfunction (if equipped)
  - LED Headlamp malfunction
  - High Beam Assist malfunction (if equipped)
  - Tire Pressure Monitoring System (TPMS) malfunction (if equipped)

To identify the details of the warning, look at the LCD display.

### Low Tire Pressure Warning Light (if equipped)



#### This warning light illuminates:

- When you place Engine Start/Stop button to the ON position.
  - It illuminates for approximately 3 seconds and then goes off.
- When one or more of your tires are significantly underinflated.

**For more details, refer to "Tire Pressure Monitoring System (TPMS)" in chapter 6.**

This warning light remains ON after blinking for approximately 60 seconds, or repeatedly blinks ON and OFF in 3 second intervals:

- When there is a malfunction with the TPMS.

In this case, have the vehicle inspected by an authorized HYUNDAI dealer as soon as possible.

**For more details, refer to "Tire Pressure Monitoring System (TPMS)" in chapter 6.**

### WARNING

#### Safe Stopping

- The TPMS cannot alert you to severe and sudden tire damage caused by external factors.
- If you notice any vehicle instability, immediately take your foot off the accelerator pedal, apply the brakes gradually with light force, and slowly move to a safe position off the road.

### **Electronic Stability Control (ESC) Indicator Light**



#### **This indicator light illuminates:**

- When you turn the ignition switch or the Engine Start/Stop button to the ON position.
  - It illuminates for approximately 3 seconds and then goes off.
- When there is a malfunction with the ESC system.  
In this case, have the vehicle inspected by an authorized HYUNDAI dealer.

#### **This indicator light blinks:**

- While the ESC is operating.

**For more details, refer to "Electronic Stability Control (ESC)" in chapter 5.**

### **Electronic Stability Control (ESC) OFF Indicator Light**



#### **This indicator light illuminates:**

- When you turn the ignition switch or the Engine Start/Stop button to the ON position.
  - It illuminates for approximately 3 seconds and then goes off.
- When you deactivate the ESC system by pressing the ESC OFF button.

**For more details, refer to "Electronic Stability Control (ESC)" in chapter 5.**

### **Immobilizer Indicator Light (without smart key) (if equipped)**



#### **This indicator light illuminates:**

- When the vehicle detects the immobilizer in the key with the ignition switch in the ON position.
  - At this time, you can start the engine.
  - The indicator light goes off after starting the engine.

#### **This indicator light blinks:**

- When there is a malfunction with the immobilizer system.  
In this case, have the vehicle inspected by an authorized HYUNDAI dealer.

### **Immobilizer Indicator Light (with smart key) (if equipped)**



**This indicator light illuminates for up to 30 seconds:**

- When the vehicle detects the smart key in the vehicle with the Engine Start/Stop button in the ACC or ON position.
  - At this time, you can start the engine.
  - The indicator light goes off after starting the engine.

**This indicator light blinks for a few seconds:**

- When the smart key is not in the vehicle.
  - At this time, you cannot start the engine.

**This indicator light illuminates for 2 seconds and goes off:**

- If the smart key is in the vehicle and the Engine Start/Stop button is ON, but the vehicle cannot detect the smart key.

In this case, have the vehicle inspected by an authorized HYUNDAI dealer.

**This indicator light blinks:**

- When the battery voltage of the smart key is low.
  - At this time, you can not start the engine. However, you can start the engine if you press the Engine Start/Stop button with the smart key. **(For more details, refer to "Starting the Vehicle" in chapter 5).**
- When there is a malfunction with the immobilizer system.

In this case, have the vehicle inspected by an authorized HYUNDAI dealer.

### **Turn Signal Indicator Light**



**This indicator light blinks:**

- When you operate the turn signal indicator light.

If any of the following occurs, there may be a malfunction with the turn signal system.

- The turn signal indicator light illuminates but does not blink
- The turn signal indicator light blinks rapidly
- The turn signal indicator light does not illuminate at all

If either of these conditions occur, have your vehicle inspected by an authorized HYUNDAI dealer.

### **High Beam Indicator Light**



**This indicator light illuminates:**

- When the headlamps are on and in the high beam position.
- When the turn signal lever is pulled into the Flash-to-Pass position.

### **Light ON Indicator Light**

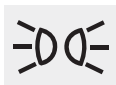

**This indicator light illuminates:**

- When the tail lights or headlamps are on.

### **High Beam Assist indicator light (if equipped)**



**This indicator light illuminates :**

- When the high-beam is on with the light switch in the AUTO light position.
- If your vehicle detects oncoming or preceding vehicles, High Beam Assist system will switch the high beam to low beam automatically.

**For more details, refer to "High Beam Assist (HBA)" in this chapter.**

### **Exterior Light Warning Light (if equipped)**



**This warning light illuminates:**

- When one of the exterior bulbs (headlamp, tail lamp, fog lamp, etc.) is not operating properly. One of the bulbs may need to be replaced.

#### ***i* Information**

**Make sure to replace the burned out bulb with a new one of the same wattage rating.**

### **LED Headlight Warning Light (if equipped)**



#### **This warning light illuminates:**

- When there is a malfunction with the LED headlight.

In this case, have the vehicle inspected by an authorized HYUNDAI dealer.

#### **This warning light blinks:**

- When there is a malfunction with a LED headlight related part.

In this case, have the vehicle inspected by an authorized HYUNDAI dealer.

#### **NOTICE**

**Continuous driving with the LED Headlight Warning Light on or blinking can reduce LED headlight life.**

### **Cruise Indicator Light (if equipped)**



#### **This indicator light illuminates:**

- When the cruise control system is enabled.

**For more details, refer to "Cruise Control System" in chapter 5.**

### **SPORT Mode Indicator Light**



#### **This indicator light illuminates**

- When the driver moves the shift lever to S (Sport).

**For more details, refer to "Dual Clutch Transmission" in chapter 5.**

### **ECO Mode Indicator Light**



#### **This indicator light illuminates:**

- When the driver moves the shift lever to D (Drive).

**For more details, refer to "Dual Clutch Transmission" in chapter 5.**

### **Forward Collision-Avoidance Assist system warning light (if equipped)**



#### **This indicator light illuminates:**

- When you set the ignition switch or Engine Start/Stop button to the ON position.
  - It illuminates for approximately 3 seconds and then goes off.
- When there is a malfunction with the FCA.

In this case, we recommend that you have the vehicle inspected by an authorized HYUNDAI dealer.

**For more information, refer to "Forward Collision-Avoidance Assist (FCA)" in chapter 5.**

### **Lane Keeping Assist system indicator light (if equipped)**



#### **This indicator light illuminates:**

- [Green] When the system operating conditions are satisfied.
- [White] The system operating conditions are not satisfied.
- [Yellow] When there is a malfunction with the lane keeping assist system.

In this case, we recommend that you have your vehicle inspected by an authorized HYUNDAI dealer.

**For more details, refer to "Lane Keeping Assist (LKA)" in chapter 5.**

### **Icy Road Warning Light (if equipped)**



This warning light is to warn the driver the road may be icy.

When the temperature on the outside temperature gauge is approximately below 4°C (40°F), the Icy Road Warning Light and Outside Temperature Gauge blinks and then illuminates. Also, the warning chime sounds 1 time.

The Icy Road Warning function can be activated or deactivated from the User Settings mode in the cluster LCD display.

#### ***i* Information**

**If the icy road warning light appears while driving, you should drive more attentively and safely, refraining from over-speeding, rapid acceleration, sudden braking or sharp turning, etc.**

### LCD Display Messages

#### ***Shift to P (for smart key system)***

This message is displayed if you try to turn off the vehicle with the shift lever in the N (Neutral) position.

At this time, the Engine Start/Stop button turns to the ACC position (If you press the Engine Start/Stop button once more, it will turn to the ON position).

#### ***Low Key Battery (for smart key system)***

This message is displayed if the battery of the smart key is discharged while changing the Engine Start/Stop button to the OFF position.

#### ***Press START button while turning wheel (for smart key system)***

This message is displayed if the steering wheel does not unlock normally when the Engine Start/Stop button is pressed.

You should press the Engine Start/Stop button while turning the steering wheel right and left.

#### ***Check Steering Wheel Lock System (for smart key system)***

This message is displayed if the steering wheel does not lock normally while the Engine Start/Stop button changes to the OFF position.

#### ***Press brake pedal to start vehicle (for smart key system)***

This message is displayed if the Engine Start/Stop button changes to the ACC position twice by pressing the button repeatedly without depressing the brake pedal.

You can start the vehicle by depressing the brake pedal.

#### ***Key not in vehicle (for smart key system)***

This message is displayed if the smart key is not in the vehicle when you press the Engine Start/Stop button.

When attempting to start the vehicle, always have the smart key with you.

#### ***Key not detected (for smart key system)***

This message is displayed if the smart key is not detected when you press the Engine Start/Stop button.

***Press START button again (for smart key system)***

This message is displayed if you were unable to start the vehicle when the Engine Start/Stop button was pressed.

If this occurs, attempt to start the engine by pressing the Engine Start/Stop button again.

If the warning message appears each time you press the Engine Start/Stop button, have your vehicle inspected by an authorized HYUNDAI dealer.

***Press START button with key (for smart key system)***

This message is displayed if you press the Engine Start/Stop button while the warning message "Key not detected" is displayed.

At this time, the immobilizer indicator light blinks.

***Check BRAKE SWITCH fuse (for smart key system)***

This message is displayed if the brake switch fuse is disconnected.

You need to replace the fuse with a new one before starting the engine.

If that is not possible, you can start the engine by pressing the Engine Start/Stop button for 10 seconds in the ACC position.

***Shift to P to start vehicle (for smart key system)***

This message is displayed if you try to start the engine with the shift lever not in the P (Park) position.

***Low Washer Fluid (if equipped)***

This warning message is displayed if the washer fluid level in the reservoir is nearly empty.

Have the washer fluid reservoir refilled.

***Low Fuel***

This warning message is displayed if the fuel tank is almost out of fuel.

When this message is displayed, the low fuel level warning light in the cluster will come on.

It is recommended to look for the nearest fueling station and refuel as soon as possible.

Add fuel as soon as possible.



### ***Icy Road Warning (if equipped)***

This warning message is to warn the driver the road may be icy.

When the temperature on the outside temperature gauge is approximately below 4°C (40°F), the Icy Road Warning message.

### ***i* Information**

If the icy road warning message appears while driving, you should drive more attentively and safely refraining from over-speeding, rapid acceleration, sudden braking or sharp turning, etc.

### ***Engine has overheated/ Engine overheated***

This warning message is displayed when the engine coolant temperature is above 120°C (248°F). This means that the engine is overheated and may be damaged.

If your vehicle is overheated, refer to "Overheating" in chapter 6.

### ***Door, Hood, Tailgate Open***



This warning is displayed indicating which door, or hood, or tailgate is open.

### ***Sunroof Open (if equipped)***



This warning is displayed if you turn off the engine when the sunroof is open.

### ***CAUTION***

**Before driving the vehicle, you should confirm that the door/hood/tailgate is fully closed. Also, check there is no door/hood/tailgate open warning light or message displayed on the instrument cluster.**

## Icy Road Warning Light (if equipped)

■ Type A



OAE046461L

This warning light is to warn the driver the road may be icy.

When the temperature on the outside temperature gauge is approximately below 4°C (40°F), the Icy Road Warning Light and Outside Temperature Gauge blinks and then illuminates. Also, the warning chime sounds 1 time.

## **i** Information

If the icy road warning light appears while driving, you should drive more attentively and safely refraining from over-speeding, rapid acceleration, sudden braking or sharp turning, etc.

## Low Pressure



OAEPH049114L

This message is displayed if the tire pressure is low. The corresponding tire on the vehicle will be illuminated.

**For more details, refer to "Tire Pressure Monitoring System (TPMS)" in chapter 6.**

3

Convenient features of your vehicle

### Turn on FUSE SWITCH/ Turn FUSE SWITCH On

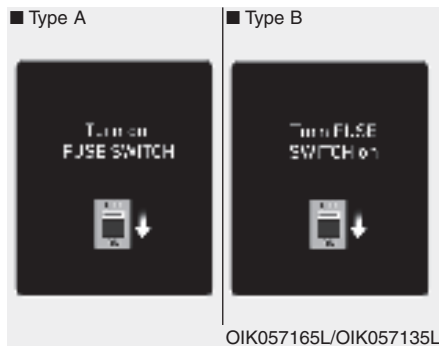

Either message is displayed if the fuse switch located on the fuse box under the steering wheel is OFF. You should turn the fuse switch on.

**For more details, refer to "Fuses" in chapter 7.**

### Check High Beam Assist (HBA) system (if equipped)



This warning message is displayed if there is a problem with High Beam Assist system. Have the vehicle inspected by an authorized HYUNDAI dealer.

**For more details, refer to "High Beam Assist (HBA)" in chapter 3.**

### Lights Mode



This indicator displays which exterior light is selected using the lighting control.

## Wiper mode



This indicator displays which wiper speed is selected using the wiper control.

## Check headlight (High/Low) (if equipped)

This warning message is displayed if the headlamps are not operating properly. A headlamp bulb may need to be replaced.

## Check turn signal (if equipped)

This warning message is displayed if the turn signal lamps are not operating properly. A lamp may need to be replaced.

### **i** Information

**Make sure to replace the burned out bulb with a new one of the same wattage rating.**

## Check headlamp LED (if equipped)

This warning message is displayed if there is a problem with the LED headlamps. We recommend that you have the vehicle inspected by an authorized HYUNDAI dealer.

## Check brake light (if equipped)

This warning message is displayed if the brake lights are not operating properly. A lamp may need to be replaced.

### ***Check Lane Keeping Assist (LKA) system (if equipped)***

This message is displayed if there is a problem with the Lane Keeping Assist (LKA) System. Have the vehicle inspected by an authorized HYUNDAI dealer.

**For more information, refer to "Lane Keeping Assist (LKA)" in chapter 5.**

### ***Check Driver Attention Warning (DAW) system***

This warning message is displayed if there is a problem with the Driver Attention Warning (DAW) system. Have the vehicle inspected by an authorized HYUNDAI dealer.

**For more information, refer to "Driver Attention Warning (DAW)" in chapter 5.**

### ***Parking Distance Warning system malfunction (if equipped)***

This warning is displayed if there is a problem with Parking Distance Warning system. Have the vehicle inspected by an authorized dealer of HYUNDAI.

**For more information, refer to "Reverse Parking Distance Warning (PDW)" in chapter 3.**

### ***Check Active Air Flap System***

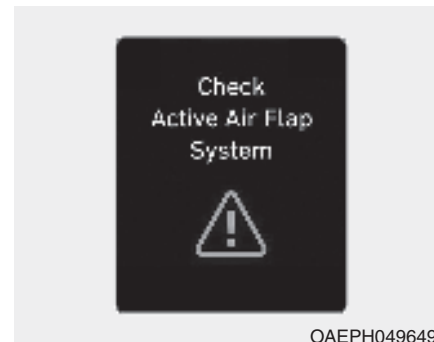

This message is displayed in the following situations:

- There is a malfunction with the actuator flap
- There is a malfunction with the actuator air flap controller
- The air flap does not open

When all of the above conditions are fixed, the warning will disappear.

### **Check Hybrid system**



This message is displayed when there is a problem with the hybrid control system.

Refrain from driving when the warning message is displayed.

In this case, have your vehicle inspected by an authorized HYUNDAI dealer.

### **Check Hybrid system. Turn engine Off**

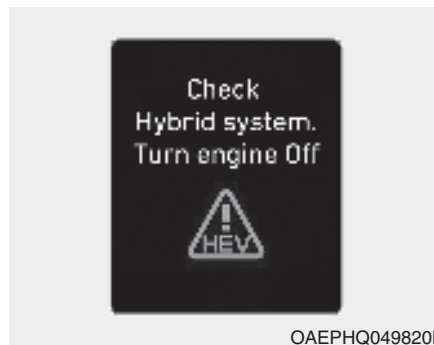

This message is displayed when there is a problem with the hybrid system. The "HEV" indicator will blink and a warning chime will sound until the problem is solved.

In this case, have your vehicle inspected by an authorized HYUNDAI dealer.

### **Check Hybrid system. Do not start engine**



This message is displayed when the hybrid battery power (SOC) level is low. A warning chime will sound until the problem is solved.

In this case have your vehicle inspected by an authorized HYUNDAI dealer.

**Stop vehicle and check power supply**



This message is displayed when a failure occurs in the power supply system.

In this case, park the vehicle in a safe location and tow your vehicle to the nearest authorized HYUNDAI dealer and have the vehicle inspected.

**Park with engine on to charge battery**



This message is displayed when the hybrid battery power (SOC) level is low.

In this case, park the vehicle in a safe location and wait until the hybrid battery is charged.

**Refuel to prevent Hybrid battery damage**



This message is displayed when the fuel tank is nearly empty.

You should refill the fuel tank to prevent hybrid battery damage.

### **Refill inverter coolant**



This message is displayed when the inverter coolant is nearly empty. You should refill the inverter coolant.

### **Check regenerative brakes/ Stop vehicle and check regenerative brakes**

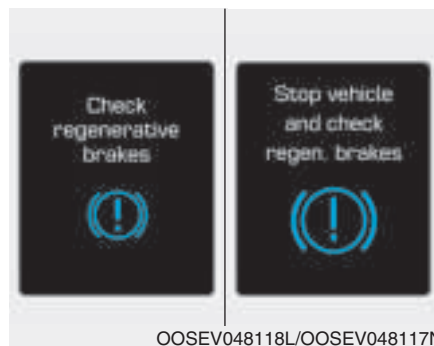

This warning message is displayed when the regenerative brake system does not work properly. If this warning message is displayed, have the vehicle inspected by an authorized HYUNDAI dealer.

### **Check Virtual Engine Sound System**

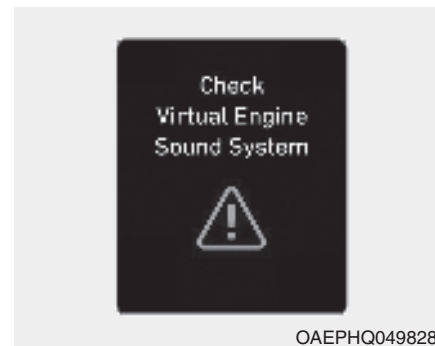

This message is displayed when there is a problem with the Virtual Engine Sound System (VESS). In this case, have your vehicle inspected by an authorized HYUNDAI dealer.



### ***Charging stopped. Check the AC charger***



- This warning message is displayed when charging is stopped for the reasons below:
  - There is a problem with the external AC charger
  - The external AC charger stopped charging
  - The charging cable is damaged

In this case, check whether there is any problem with the external AC and charging cable.

If the same problem occurs when charging the vehicle with a normally operating AC charger or genuine HYUNDAI portable charger, we recommend that you have your vehicle inspected by an authorized HYUNDAI dealer.

### ***Charging stopped. Check the cable connection***



This warning message is displayed when charging is stopped because the charging connector is not correctly connected to the charging inlet.

In this case, separate the charging connector and re-connect it and check whether there is any problem (external damage, foreign substances, etc.) with the charging connector and charging inlet.

If the same problem occurs when charging the vehicle with a replaced charging cable or genuine HYUNDAI portable charger, we recommend that you have your vehicle inspected by an authorized HYUNDAI dealer.

**Unplug vehicle to start  
(Plug-in hybrid vehicle)**



This message is displayed when you start the engine without unplugging the charging cable. Unplug the charging cable, and then start the vehicle.

**Remaining time  
(Plug-in hybrid vehicle)**

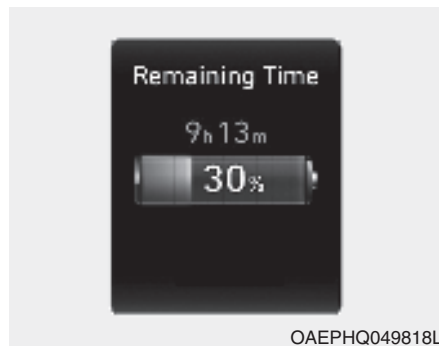

This message is displayed to notify the remaining time to fully charge the battery.

**Wait until fuel door opens  
(Plug-in hybrid vehicle)**



This message is displayed when you attempt to open the fuel filler door with the fuel tank pressurized. Wait until the fuel tank is depressurized.

***i* Information**

**It may take up to 20 seconds to open fuel filler door.**

### **Check fuel door (Plug-in hybrid vehicle)**



This message is displayed when there is a problem with the fuel filler door. Such as, when the fuel filler door does not open after 20 seconds at freezing temperature.

### **Fuel door open (Plug-in hybrid vehicle)**



This message is displayed when the fuel filler door opens after the fuel tank is depressurized. If this message is displayed, you can refuel the fuel tank.

### **Check fuel door (Plug-in hybrid vehicle)**



This message is displayed when the vehicle is driven with the fuel filler door opened. Close the fuel filler door and then start driving.

### ***i* Information**

**When the fuel filler door is frozen and does not open after 20 seconds at freezing temperature, slightly tap the fuel filler door and then attempt to open it. In other cases, have your vehicle inspected by an authorized HYUNDAI dealer.**

**Shift to P to charge  
(Plug-in hybrid vehicle)**

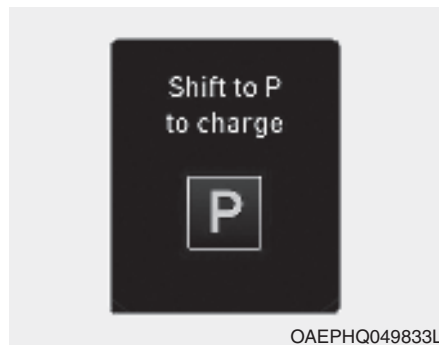

This message is displayed when the charging connector is plugged with the shift lever in R (Reverse), N (Neutral) or D (Drive). Move the shift lever to P (Park) and re-start the charging process.

**Switching to Hybrid mode to  
allow heating or air condition-  
ing (Plug-in hybrid vehicle)**

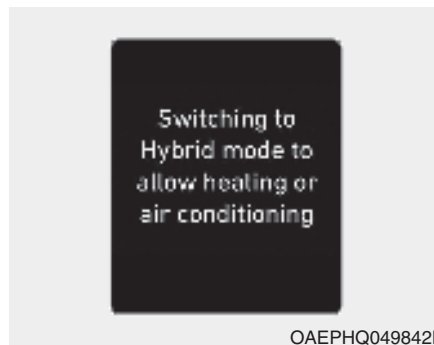

This message is displayed when the vehicle automatically switches to HEV mode to allow heating or air conditioning. It is when the coolant temperature is low (below  $-14^{\circ}\text{C}$  ( $7^{\circ}\text{F}$ )) and the driver turns on the heating or cooling system.

If the coolant temperature gets higher than  $-14^{\circ}\text{C}$  ( $7^{\circ}\text{F}$ ) or the driver turns off the heating or cooling system the vehicle returns to its default (EV) mode.

**Maintaining Hybrid mode to  
continue heating or air condi-  
tioning (Plug-in hybrid vehicle)**

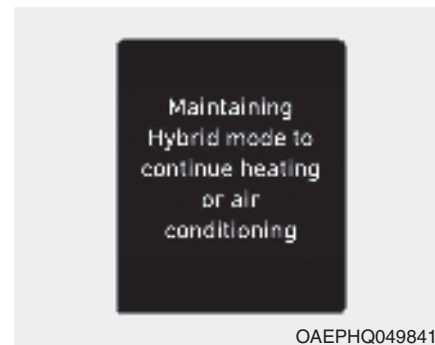

This message is displayed when the vehicle maintains the HEV mode to allow heating or air conditioning. The mode does not change when the driver presses the [HEV] button to switch from the HEV mode to EV mode while the heating and cooling system is on and the coolant temperature is below  $-14^{\circ}\text{C}$  ( $7^{\circ}\text{F}$ ).

**Low/High System Temp.  
Maintaining Hybrid mode  
(Plug-in hybrid vehicle)**

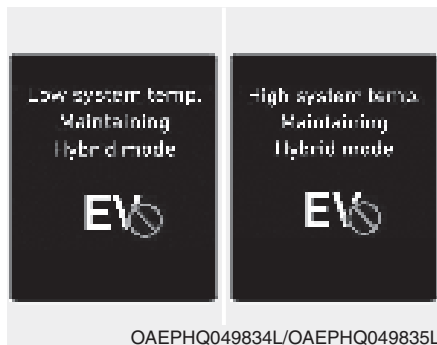

This message is displayed when the temperature of the high-voltage (hybrid) battery is too low or too high. This warning message is to protect the battery and the hybrid system.

**Low/High System Temp.  
Switching to Hybrid mode  
(Plug-in hybrid vehicle)**



This message is displayed when the temperature of the high-voltage (hybrid) battery is too low or high. This warning message is to protect the battery and the hybrid system.

**Switching to Hybrid mode to  
lubricate engine  
(Plug-in hybrid vehicle)**



This message is displayed when the vehicle is automatically switched to the HEV mode to lubricate engine while the Engine Start/Stop button is in the ON position.

**Maintaining Hybrid mode to protect engine  
(Plug-in hybrid vehicle)**



This message is displayed when the [HEV] button is pressed but it is impossible to switch from the HEV mode to EV mode due to engine lubrication.

**Exit SPORT mode to switch to EV  
(Plug-in hybrid vehicle)**





This message is displayed when [HEV] button is pressed but it is impossible to switch from the HEV mode to EV mode because the SPORT mode is engaged.

## LCD DISPLAY

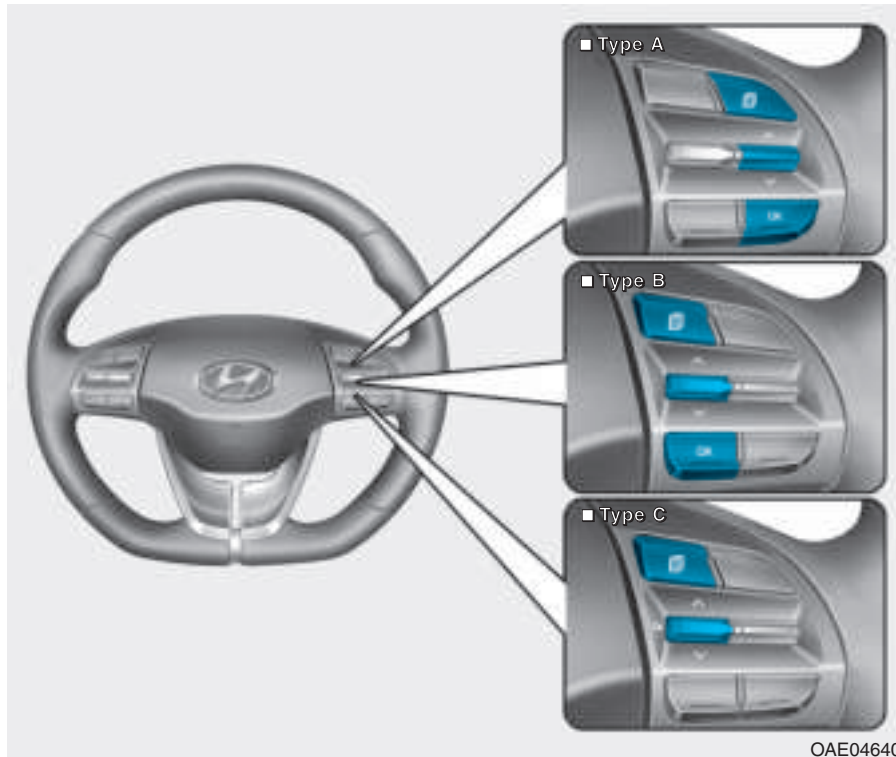







### LCD Display Control



The LCD display modes can be changed by using the control buttons.

- (1)  : MODE button for changing modes
- (2)  ,  : MOVE switch for changing items
- (3) OK : SELECT/RESET button for setting or resetting the selected item

## LCD display modes

	Menu 				
	 Trip Computer	 TBT	 Driving Assist	 User Settings	 Master warning
  <b>Up/Down</b>	Range (Plug-in hybrid vehicle)	Route Guidance	Smart Cruise Control	Driver Assistance	The Master Warning mode displays warning messages related to the vehicle when one or more systems is not operating normally.
	Fuel Economy				
	Accumulated Info	Destination Info	Lane Keeping Assist	Door	
	Drive Info		Lane Following Assist	Lights	
	Driving style		Highway Driving Assist		
	Energy flow		Driver Attention Warning	Sound	
	Engine coolant temperature		Tire Pressure	Convenience	
			Service Interval		
		Other Features			
		Language			
		Reset			

The information provided may differ depending on which functions are applicable to your vehicle.



**Trip computer mode**



The trip computer mode displays information related to vehicle driving parameters including fuel economy, tripmeter information and vehicle speed.

**For more information, refer to "Trip Computer" in this chapter.**

**Turn By Turn (TBT) mode**

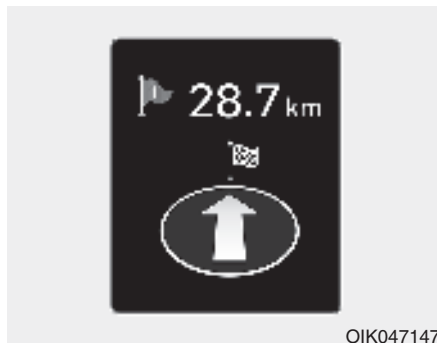

This mode displays the state of the navigation.

**Driving Assist mode**



**SCC/LKA/LFA/HDA, DAW**

This mode displays the state of the Smart Cruise Control (SCC), Lane Keeping Assist (LKA), Lane Following Assist (LFA), Highway Driving Assist (HDA) and Driver Attention Warning (DAW).

**For more details, refer to each system information in chapter 5.**



**Tire Pressure**

This mode displays information related to Tire Pressure.

**For more information, refer to "Tire Pressure Monitoring System (TPMS)" in chapter 6.**

**Master warning mode**



This warning light informs the driver the following situations.

- Forward Collision-Avoidance Assist system malfunction (if equipped)
- Forward Collision-Avoidance Assist radar blocked (if equipped)
- Blind-Spot Collision Warning system malfunction (if equipped)
- Blind-Spot Collision Warning radar blocked (if equipped)
- Smart Cruise Control malfunction (if equipped)
- LED Headlamp malfunction (if equipped)
- High Beam Assist malfunction (if equipped)
- Tire Pressure Monitoring System (TPMS) malfunction (if equipped)

The Master Warning Light illuminates if one or more of the above warning situations occur. At this time, a Master Warning icon (⚠) will appear beside the User Settings icon (⚙), on the LCD display.

If the warning situation is solved, the master warning light will be turned off and the Master Warning icon will disappear.

### User settings mode



In this mode, you can change the settings of the instrument cluster, doors, lamps, etc.

1. Driver Assistance
2. Door
3. Lights
4. Sound
5. Convenience
6. Service interval
7. Other (features)
8. Languages
9. Reset

**The information provided may differ depending on which functions are applicable to your vehicle.**

### Shift to P to edit settings / Engage parking brake to edit settings

This warning message illuminates if you try to select an item from the User Settings mode while driving.

For your safety, change the User Settings after parking the vehicle, applying the parking brake and moving the shift lever to P (Park).

### Quick guide (Help)

This mode provides quick guides for the systems in the User Settings mode.

Select an item, press and hold the OK button.

**For more details about each system, refer to this Owner's Manual**

## 1. Driver Assistance

Items	Explanation
SCC Response	<ul style="list-style-type: none"> <li>• Fast/Normal/Slow</li> </ul> To adjust the sensitivity of Smart Cruise Control system. <b>For more details, refer to "Smart Cruise Control (SCC)" in chapter 5.</b>
Driving Assist	<ul style="list-style-type: none"> <li>• Lane Following Assist</li> </ul> To activate or deactivate Lane Following Assist (LFA) system. <b>For more details, refer to "Lane Following Assist (LFA)" in chapter 5.</b>
	<ul style="list-style-type: none"> <li>• Highway Driving Assist</li> </ul> To activate or deactivate the Highway Driving Assist system. <b>For more details, refer to "Highway Driving Assist (HDA)" in chapter 5.</b>
	<ul style="list-style-type: none"> <li>• Highway Auto Curve Slowdown</li> </ul> To activate or deactivate the Navigation-based Smart Cruise Control system. <b>For more details, refer to "Navigation-based Smart Cruise Control (NSCC)" in chapter 5.</b>
Warning Timing	To adjust the warning timing of the driver assistance system. - Normal / Late
Warning Volume	To adjust the warning volume of the driver assistance system. - High / Medium / Low
Driver Attention Warning	<ul style="list-style-type: none"> <li>• Leading Vehicle Departure Alert</li> </ul> To activate or deactivate Leading Vehicle Departure Alert. <b>For more details, refer to the "Driver Attention Warning (DAW)" in chapter 5.</b>
	To adjust the sensitivity of DAW (Driver Attention Warning). <b>For more details, refer to the "Leading vehicle departure alert" in chapter 5.</b>

※ The information provided may differ depending on which functions are applicable to your vehicle.

### 1. Driver Assistance

Items	Explanation
Forward Safety	<ul style="list-style-type: none"> <li>• Active Assist: If selected, the system controls the vehicle and provides a warning when a collision is detected.</li> <li>• Warning Only: If selected, the system provides a warning when a collision is detected.</li> <li>• Off: Deactivates the system.</li> </ul> <p><b>For more details, refer to "Forward Collision-Avoidance Assist (FCA)" in chapter 5.</b></p>
Lane Safety	<ul style="list-style-type: none"> <li>• Lane Keeping Assist : If selected, the system controls the vehicle and provides a warning when the vehicle leaves the lane.</li> <li>• Lane Departure Warning: If selected, the system provides a warning when the vehicle leaves the lane.</li> <li>• Off: Deactivates LKA system.</li> </ul> <p><b>For more details, refer to "Lane Keeping Assist (LKA) " in chapter 5.</b></p>
Blind-Spot Safety	<ul style="list-style-type: none"> <li>• Warning Only: If selected, the system provides a warning when a collision is detected.</li> <li>• Off: Deactivates the system.</li> </ul> <p><b>For more details, refer to "Blind-Spot Collision Warning (BCW) " in chapter 5.</b></p>
Parking Safety	<ul style="list-style-type: none"> <li>• Rear Cross-Traffic Safety</li> </ul> <p>To activate or deactivate Rear Cross-Traffic Collision Warning function.</p> <p><b>For more details, refer to "Rear Cross-traffic Collision Warning (RCCW)" in chapter 5.</b></p>

※ The information provided may differ depending on which functions are applicable to your vehicle.

## 2. Door

Items	Explanation
Auto Lock	<ul style="list-style-type: none"> <li>• Disable : The auto door lock operation will be deactivated.</li> <li>• Enable on Speed: All doors will be automatically locked when the vehicle speed exceeds 15km/h (9.3mph).</li> <li>• Enable on Shift: All doors will be automatically locked if the automatic transmission shift lever is shifted from the P (Park) position to the R (Reverse), N (Neutral), or D (Drive) position.</li> </ul>
Auto Unlock	<ul style="list-style-type: none"> <li>• Disable : The auto door unlock operation will be canceled.</li> <li>• On key out/On vehicle off : All doors will be automatically unlocked when the ignition key is removed from the ignition switch or the Engine Start/Stop button is set to the OFF position.</li> <li>• On Shift to P: All doors will be automatically unlocked if the automatic transmission/dual clutch transmission shift lever is shifted to the P (Park) position.</li> </ul>
Lock/Unlock sound	<p>To activate or deactivate the lock/unlock sound. If you lock the door with a remote control key again after locking the door, the alarm beeps.</p>
Horn feedback	<p>To activate or deactivate the horn feedback. If the horn feedback is activated, after locking the door by pressing the lock button on the remote key, and pressing it again within 4 seconds, the horn feedback sound will operate once to indicate that all doors are locked (if equipped with remote key).</p>

※ The information provided may differ depending on which functions are applicable to your vehicle.

### 3. Lights

Items	Explanation
One touch turn signal	<ul style="list-style-type: none"><li>• Off: The one touch turn signal function will be deactivated.</li><li>• 3, 5, 7 Flashes: The turn signal indicator will blink 3, 5, or 7 times when the turn signal lever is moved slightly.</li></ul> <p><b>For more details, refer to "Lighting" in this chapter.</b></p>
Headlight Delay	To activate or deactivate the headlight delay function. <b>For more details, refer to "Lighting" in this chapter.</b>
High beam Assist	To activate or deactivate the high beam assist system. <b>For more details, refer to "High Beam Assist (HBA) system" in this chapter.</b>

### 4. Sound

Items	Explanation
Cluster sound	To adjust the cluster volume. - OFF/Level 1/Level 2/Level 3

✳ The information provided may differ depending on which functions are applicable to your vehicle.

## 5. Convenience

Items	Explanation
Seat Easy Access	<ul style="list-style-type: none"> <li>• Off: The seat easy access function is deactivated.</li> <li>• Normal/Extended: When you turn off the engine, the driver's seat will automatically move rearward short (Normal) or long (Extended) for you to enter or exit the vehicle more comfortably.</li> </ul> <p><b>For more details, refer to "Driver Position Memory System" in this chapter.</b></p>
Welcome Mirror/Light	<p>To activate or deactivate the welcome mirror and/or light function.</p> <p><b>For more details, refer to "Welcome System" in this chapter.</b></p>
Wireless Charging System	<p>To activate or deactivate the wireless charging system in the front seat.</p> <p><b>For more details, refer to "Wireless Charging System" in this chapter.</b></p>
Wiper/Lights Display	<p>To activate or deactivate the Wiper/Light mode.</p> <p>When activated, the LCD display shows the selected Wiper/Light mode whenever you changed the mode.</p>
Gear Position Pop-up	<p>To activate or deactivate the gear position pop-up.</p> <p>When activated, the gear position will be displayed on the LCD display.</p>
Coasting Guide	<ul style="list-style-type: none"> <li>• Coasting Guide: To activate or deactivate the Coasting Guide system.</li> <li>• Sound: To activate or deactivate the Coasting Guide system sound.</li> </ul> <p><b>For more details, refer to "Coasting Guide" in chapter 5.</b></p>
Start Coasting	<p>To adjust the sensitivity of the Coasting Guide.</p> <p><b>For more details, refer to "Coasting Guide" in chapter 5.</b></p>
Icy Road Warning	<p>To activate or deactivate the icy road warning.</p>

\* The information provided may differ depending on which functions are applicable to your vehicle.



### 6. Service interval

Items	Explanation
Service Interval	To activate or deactivate the service interval function.
Adjust Interval	If the service interval menu is activated, you may adjust the time and distance.
Reset	To reset the service interval.

#### **i** Information

**To use the service interval menu, consult an authorized HYUNDAI dealer.**

If the service interval is activated and the time and distance is adjusted, messages are displayed in the following situations each time the vehicle is turned on.

- Service in  
: Displayed to inform the driver the remaining mileage and days to service.
- Service required  
: Displayed when the mileage and days to service has been reached or passed.

#### **i** Information

**If any of the following conditions occur, the mileage and number of days to service may be incorrect.**

- **The battery cable is disconnected.**
- **The fuse switch is turned off.**
- **The battery is discharged.**

## 7. Other (features)

Items	Explanation
AUX. BATTERY SAVER+	<p>To activate or deactivate the Aux. Battery Saver+ function. When activated, the high voltage battery is used to keep the 12V battery charged.</p> <p><b>For more details, refer to the "Hybrid System Overview" provided in the front of the owner's manual.</b></p>
Fuel Economy Auto Reset	<ul style="list-style-type: none"> <li>• Off: The average fuel economy will not reset automatically whenever refueling.</li> <li>• After Ignition: When the engine has been OFF for 4 hours or longer the average fuel economy will reset automatically.</li> <li>• After Refueling: The average fuel economy will reset automatically after adding 6 liters (1.6 gallons) of fuel or more and after driving speed exceeds 1 km/h (1 mph).</li> </ul> <p><b>For more details, refer to "Trip Computer" in this chapter.</b></p>
Fuel Economy Unit	To select the fuel economy unit. (km/L, L/100km)
Temperature Unit	To select the temperature unit. (°C, °F)
Tire Pressure Unit	To select the tire pressure unit. (psi, kPa, bar)

※ The information provided may differ depending on which functions are applicable to your vehicle.

### 8. Language (if equipped)

Items	Explanation
Language	Choose the language.

### 9. Reset

Items	Explanation
Reset	You can reset the menus in the User Settings Mode. All menus in the User Settings Mode are reset to factory settings, except language and service interval.

※ The information provided may differ depending on which functions are applicable to your vehicle.

## TRIP COMPUTER (HYBRID VEHICLE)

The trip computer is a microcomputer-controlled driver information system that displays information related to driving.

### **i** Information

Some driving information stored in the trip computer (for example Average Vehicle Speed) resets if the battery is disconnected.

### Trip modes

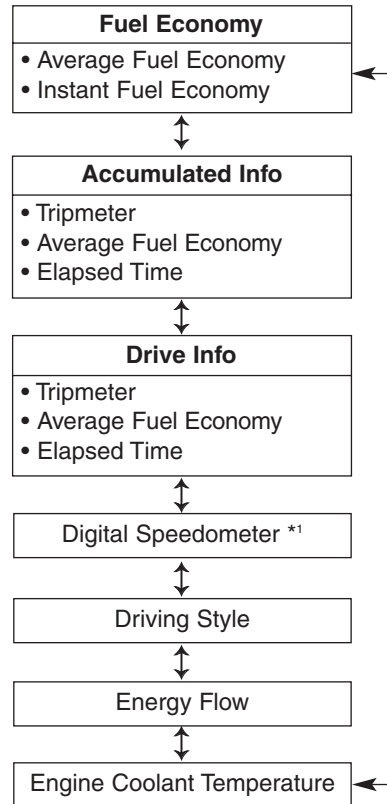

\*1: Type A cluster

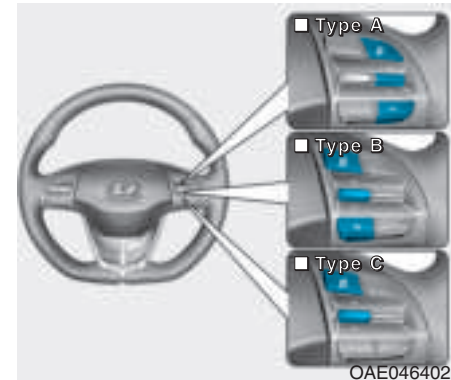

To change the trip mode, toggle the "∧, ∨" switch on the steering wheel.

### Fuel economy

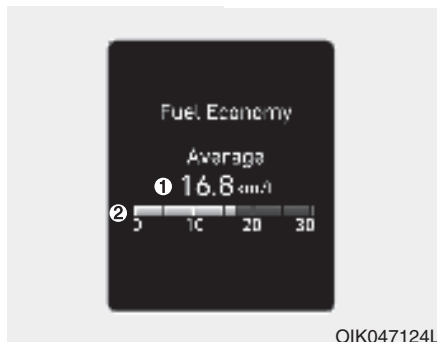

#### Average Fuel Economy (1)

- The average fuel economy is calculated by the total driving distance and fuel consumption since the last average fuel economy reset.
- The average fuel economy can be reset both manually and automatically.

#### Manual reset

To clear the average fuel economy manually, press the [OK] button on the steering wheel for more than 1 second when the average fuel economy is displayed.

#### Automatic reset

To automatically reset the average fuel economy after refueling, select the "Fuel economy Auto Reset" mode in the User Settings menu on the LCD display.

- After Ignition: The average fuel economy will reset automatically whenever it has passed 4 hours after turning OFF the engine.
- After Refueling: The average fuel economy will reset automatically when driving speed exceeds 1 km/h, after adding 6 liters (1.6 gallons) of fuel or more.

#### **i** Information

**The average fuel economy may be inaccurate, when the vehicle drives shorter than 300 meters (0.19 miles) after turning ON the Engine Start/Stop button.**

#### Instant Fuel Economy (2)

- This mode displays the instant fuel economy during the last few seconds when the vehicle speed is more than 10 km/h (6.2 mph).

### Accumulated Info display

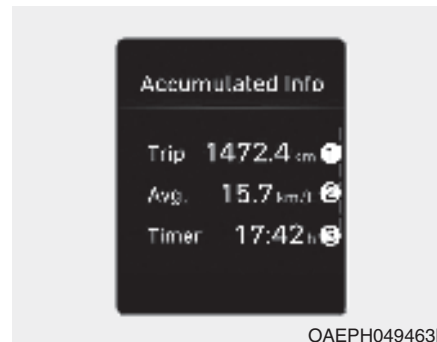

This display shows the accumulated trip distance (1), the average fuel economy (2), and the total driving time (3).

The information is accumulated starting from the last reset.

To manually reset the information, press and hold the OK button when viewing the Accumulated driving info. The trip distance, the average fuel economy, and total driving time will reset simultaneously.

The accumulated driving information will continue to be counted while the engine is still running (for example, when the vehicle is in traffic or stopped at a stop light).

### **i** Information

The vehicle must be driven for a minimum of 300 meters (0.19 miles) since the last ignition key cycle before the average fuel economy will be recalculated.

### **Drive Info display**



This display shows the trip distance (1), the average fuel economy (2), and the total driving time (3).

The information is combined for each ignition cycle. However, when the engine has been OFF for 4 hours or longer the Drive Info screen will reset.

To manually reset the information, press and hold the OK button when viewing the Drive Info. The trip distance, the average fuel economy, and total driving time will reset simultaneously.

The driving information will continue to be counted while the engine is still running (for example, when the vehicle is in traffic or stopped at a stop light.)

### **i** Information

The vehicle must be driven for a minimum of 300 meters (0.19 miles) since the last ignition key cycle before the average fuel economy will be recalculated.

**Digital Speedometer  
(Type A cluster)**



This message shows the speed of the vehicle (km/h, MPH).

**Driving style**

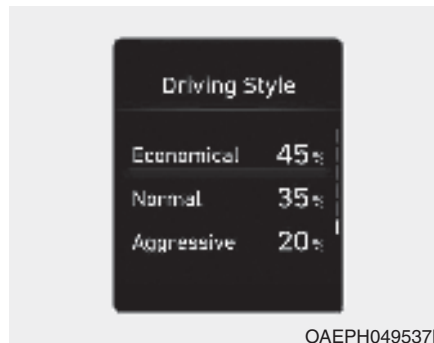

The driving style is displayed when you are driving in ECO mode.

When you drive in SPORT mode, each driving category will be displayed with "--".

**Energy flow**

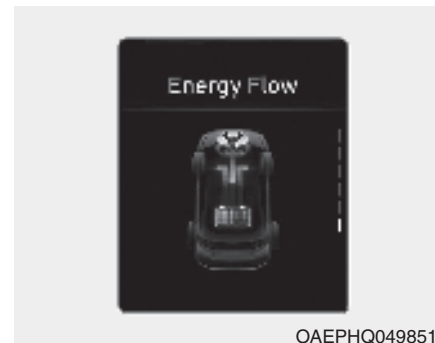

The hybrid system informs the drivers its energy flow in various operating modes. While driving, the current energy flow is specified in 11 modes.

**For more information, refer to HEV Energy Flow in the "Hybrid System Overview" provided in front of the owner's manual.**

## Engine coolant temperature

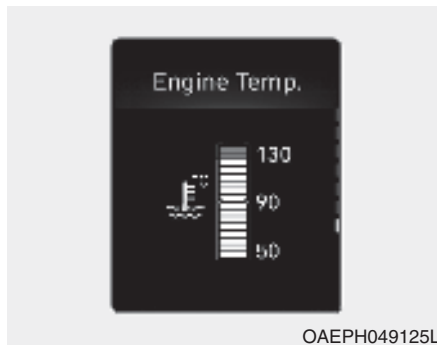

This gauge indicates the temperature of the engine coolant when the engine is running.

### **NOTICE**

**When the gauge indicator gets out of the normal range, toward the "Red" position, it indicates overheating of the engine. It may damage the engine.**

**Do not continue driving with the overheated engine. For further information, refer to "If the Engine Overheats" in the chapter 6.**



## TRIP COMPUTER (PLUG-IN HYBRID VEHICLE)

The trip computer is a microcomputer-controlled driver information system that displays information related to driving.

### **i** Information

Some driving information stored in the trip computer (for example Average Vehicle Speed) resets if the battery is disconnected.

### Trip modes

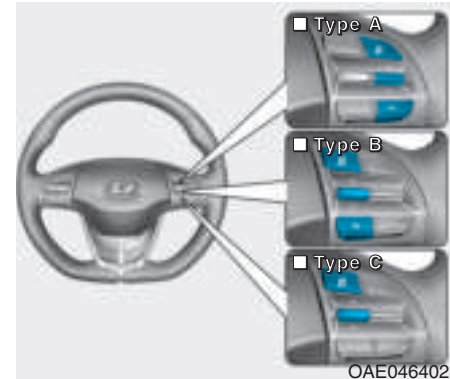
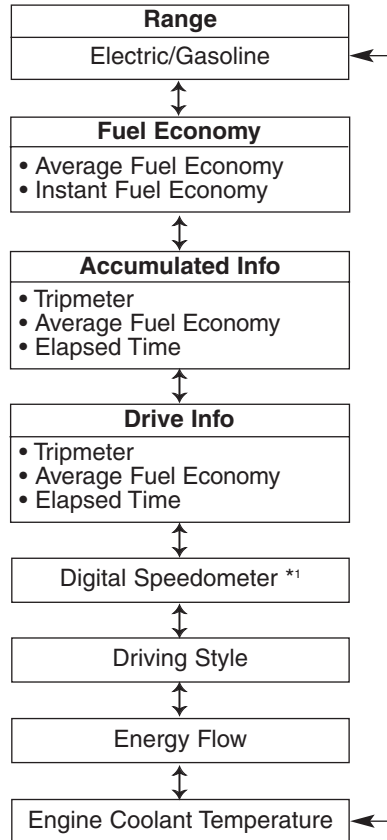

To change the trip mode, toggle the "∧, ∨" switch on the steering wheel.

\*1: Type A cluster

## Range

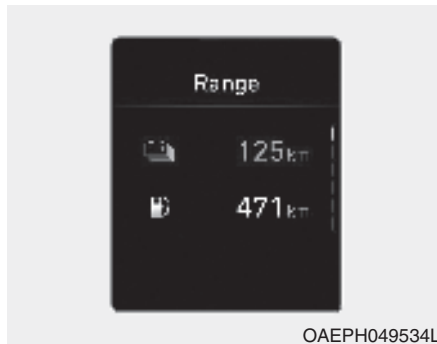

The range is the estimated distance the vehicle can be driven with the remaining fuel in the fuel tank (Gasoline/Petrol) and high-voltage (hybrid) battery (Electric).

If the estimated distance is below 1km (1 mile), the trip computer will display "---" as the range.

## **i** Information

- If the vehicle is not on level ground or the battery power has been interrupted, the range function may not operate correctly.
- The range may differ from the actual driving distance as it is an estimate of the available driving distance.
- The trip computer may not register additional fuel if less than 6 liters (2 gallon) of fuel are added to the vehicle.
- The range may vary significantly based on driving conditions, driving habits, and condition of the vehicle.

## Fuel economy

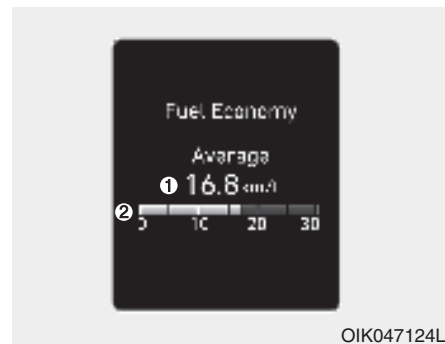

### Average Fuel Economy (1)

- The average fuel economy is calculated by the total driving distance and fuel consumption since the last average fuel economy reset.
- The average fuel economy can be reset both manually and automatically.

### Manual reset

To clear the average fuel economy manually, press the [OK] button on the steering wheel for more than 1 second when the average fuel economy is displayed.

### Automatic reset

To automatically reset the average fuel economy after refueling, select the "Fuel economy Auto Reset" mode in the User Settings menu on the LCD display.

- After Ignition: The average fuel economy will reset automatically whenever it has passed 4 hours after turning OFF the engine.
- After Refueling: The average fuel economy will reset automatically when driving speed exceeds 1 km/h, after adding 6 liters (1.6 gallons) of fuel or more.

### **i** Information

**The average fuel economy may be inaccurate, when the vehicle drives shorter than 300 meters (0.19 miles) after turning ON the Engine Start/Stop button.**

### Instant Fuel Economy (2)

- This mode displays the instant fuel economy during the last few seconds when the vehicle speed is more than 10 km/h (6.2 mph).

### Accumulated Info display

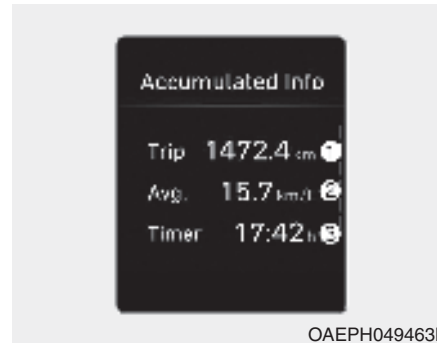

This display shows the accumulated trip distance (1), the average fuel economy (2), and the total driving time (3).

The information is accumulated starting from the last reset.

To manually reset the information, press and hold the OK button when viewing the Accumulated driving info. The trip distance, the average fuel economy, and total driving time will reset simultaneously.

The accumulated driving information will continue to be counted while the engine is still running (for example, when the vehicle is in traffic or stopped at a stop light).

### **i** Information

**The vehicle must be driven for a minimum of 300 meters (0.19 miles) since the last ignition key cycle before the average fuel economy will be recalculated.**

### Drive Info display

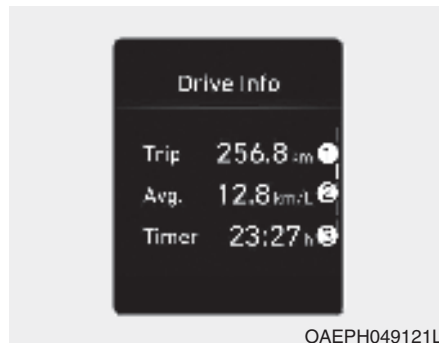

This display shows the trip distance (1), the average fuel economy (2), and the total driving time (3).

The information is combined for each ignition cycle. However, when the engine has been OFF for 4 hours or longer the Drive Info screen will reset.

To manually reset the information, press and hold the OK button when viewing the Drive Info. The trip distance, the average fuel economy, and total driving time will reset simultaneously.

The driving information will continue to be counted while the engine is still running (for example, when the vehicle is in traffic or stopped at a stop light.)

### **i** Information

The vehicle must be driven for a minimum of 300 meters (0.19 miles) since the last ignition key cycle before the average fuel economy will be recalculated.

### Digital Speedometer (Type A cluster)

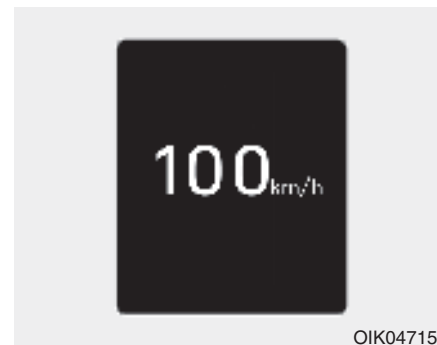

This message shows the speed of the vehicle (km/h, MPH).

### ***Driving style***

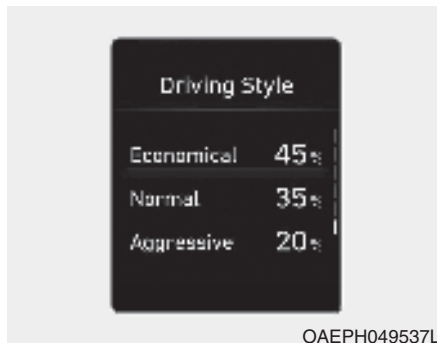

The driving style is displayed when you are driving in ECO mode.

When you drive in SPORT mode, each driving category will be displayed with "--".

### ***Energy flow***

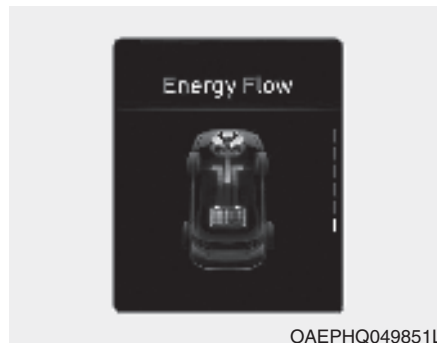

The hybrid system informs the driver its energy flow in various operating modes. While driving, the current energy flow is specified in 11 modes.

**For more information, refer to HEV Energy Flow in the "Hybrid System Overview" provided in front of the owner's manual.**

### ***Engine coolant temperature***



This gauge indicates the temperature of the engine coolant when the engine is running.

#### **NOTICE**

**When the gauge indicator gets out of the normal range, toward the "Red" position, it indicates overheating of the engine. It may damage the engine.**

**Do not continue driving with the overheated engine. For further information, refer to "If the Engine Overheats" in the chapter 6.**

## LIGHTING

### Exterior Lights

#### Lighting control

To operate the lights, turn the knob at the end of the control lever to one of the following positions:

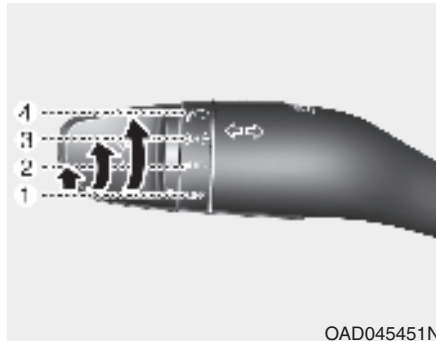

1. OFF position
2. AUTO light position
3. Parking lamp position
4. Headlamp position

#### Daytime running light (DRL) (if equipped)

The Daytime Running Lights (DRL) can make it easier for others to see the front of your vehicle during the day, especially after dawn and before sunset.

The DRL system will turn the dedicated lamp OFF when :

- The headlamps are ON.
- The parking lamps are ON.
- The vehicle is turned off.

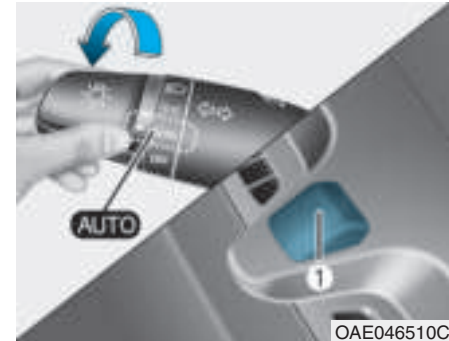

#### AUTO light position (if equipped)

The parking lamp and headlamp will be turned ON or OFF automatically depending on the amount of light outside the vehicle.

Even with the AUTO light feature in operation, it is recommended to manually turn ON the lamps when driving at night or in a fog, driving in the rain, or when you enter dark areas, such as tunnels and parking facilities.

### NOTICE

- Do not cover or spill anything on the sensor (1) located in front of the instrument panel.
- Do not clean the sensor using a window cleaner, the cleanser may leave a light film which could interfere with sensor operation.
- If your vehicle has window tint or other types of metallic coating on the front windshield, the AUTO light system may not work properly.



#### Parking lamp position ( ㊦ )

The parking lamp, license plate lamp and instrument panel lamp are turned ON.



#### Headlamp position ( ㊧ )

The headlamp, parking lamp, license plate lamp and instrument panel lamp are turned ON.

#### **i** Information

The ignition switch must be in the ON position to turn on the headlamp.

### High beam operation



To turn on the high beam headlamp, push the lever away from you. The lever will return to its original position. The high beam indicator will light when the headlamp high beams are switched on.

To turn off the high beam headlamp, pull the lever towards you. The low beams will turn on.

#### WARNING

**Do not use high beam when there are other vehicles approaching you. Using high beam could obstruct the other driver's vision.**

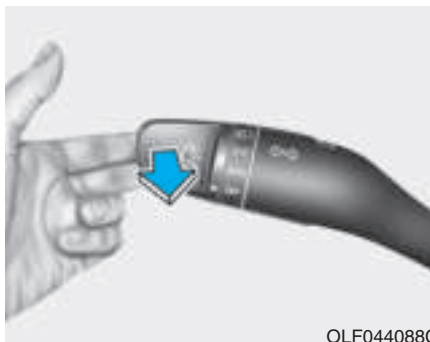

To flash the high beam headlamp, pull the lever towards you, then release the lever. The high beams will remain ON as long as you hold the lever towards you.

### High Beam Assist (HBA) (if equipped)

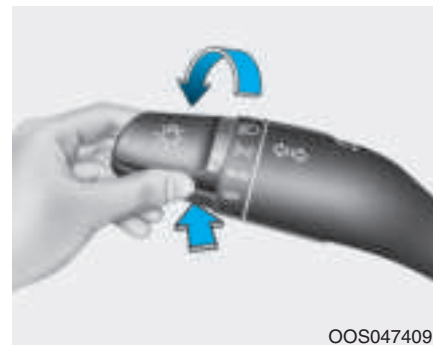

High Beam Assist is a system that automatically adjusts the headlamp range (switches between high beam and low beam) according to the brightness of other vehicles and road conditions.

#### Operating condition

1. Place the headlamp switch in the AUTO position.
2. Turn on the high beam by pushing the lever away from you.

High Beam Assist () indicator will illuminate.



3. High Beam Assist will turn on when vehicle speed is above 40 km/h (25 mph).

- If the headlamp switch is pushed away when High Beam Assist (HBA) is operating, High Beam Assist will turn off and the high beam will be on continuously.
- If the headlamp switch is pulled towards you when the high beam is off, the high beam will turn on without High Beam Assist (HBA) canceled.

When you let go of the light switch, the lever will move to the middle and the high beam will turn off.

- If the headlamp switch is pulled towards you when the high beam is on by High Beam Assist, the low beam will be on and High Beam Assist will turn off.
- If the headlamp switch is placed to the headlamp ON position, High Beam Assist will turn off and the low beam will be on continuously.

When High Beam Assist is operating, the high beam switches to low beam if any of the following conditions occur :

- When the headlamp of an on-coming vehicle is detected.
- When the tail lamp of a vehicle in front is detected.
- When the headlamp or tail lamp of a motorcycle or a bicycle is detected.
- When the surrounding ambient light is bright enough that high beams are not required.
- When streetlights or other lights are detected.
- When the headlamp switch is not in the AUTO position.
- When High Beam Assist is off.
- When vehicle speed is below 24 km/h (15 mph).



### Warning light and message

When High Beam Assist is not working properly, the Check High Beam Assist warning message will come on for a few second.

After the message disappears, the master warning light (▲) will illuminate.

Take your vehicle to an authorized HYUNDAI dealer and have the system checked.

## WARNING

The driver must be cautious in the below situations may not work properly when recognition of light from on-coming or front vehicle is poor or limited:

- ▶ When the light from on-coming or front vehicle is poor
- When the light from the on-coming or front vehicle is not detected because of lamp damage, hidden from sight, etc.
- When the lamp of the on-coming or front vehicle is covered with dust, snow or water.
- When the front vehicle's headlamps are off but the fog lamps on and etc.

(Continued)

(Continued)

- ▶ When external condition is intervened
- When there is a similar shape lamp with the front vehicle's lamps.
- When the headlamp is not repaired or replaced at an authorized dealer.
- When headlamp aiming is not properly adjusted.
- When driving on a narrow curved road, rough road, downhill or uphill.
- When only part of the vehicle in front is visible on a cross-road or curved road.
- When there is a traffic light, reflecting sign, flashing sign or mirror ahead.
- When there is a temporary reflector or flash ahead (construction area).
- When the road conditions are bad such as being wet, iced or covered with snow.

(Continued)

(Continued)

- When a vehicle suddenly appears from a curve.
- When the vehicle is tilted from a flat tire or being towed.
- When LKA (Lane Keeping Assist) system failure indicator (yellow) illuminates (if equipped) and etc.
- ▶ When front visibility is poor
- When the lamp of the on-coming or front vehicle is covered with dust, snow or water.
- When the light from the on-coming or front vehicle is not detected because of exhaust fume, smoke, fog, snow, etc.
- When the front window is covered with foreign matters.
- When it is hard to see because of fog, heavy rain or snow and etc.

(Continued)

### (Continued)

- Do not disassemble a front view camera temporarily for tinted window or attaching any types of coatings and accessories. If you disassemble the camera and assemble it again, take your vehicle to an authorized HYUNDAI dealer and have the system checked to need a calibration.
- When you replace or reinstall the windshield glass, front view camera, take your vehicle to an authorized HYUNDAI dealer and have the system checked.
- Be careful that water doesn't get into the High Beam Assist unit and do not remove or damage related parts of the High Beam Assist system.
- Do not place objects on the crash pad that reflect light such as mirrors, white paper, etc. The system may malfunction if sunlight is reflected.

(Continued)

### (Continued)

- At times, High Beam Assist may not work properly. The system is for your convenience only. It is the responsibility of the driver for safe driving practices and always check the road conditions for your safety.
- When the system does not operate normally, change the lamp position manually between the high beam and low beam.

### Turn signals and lane change signals

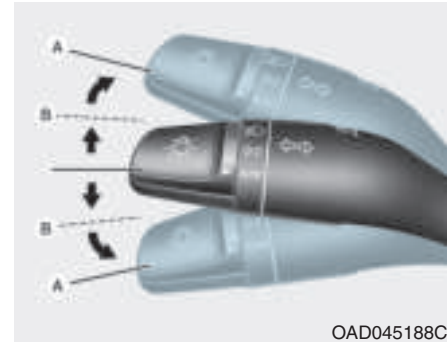

To signal a turn, push down on the lever for a left turn or up for a right turn in position (A).

If an indicator stays on and does not flash or if it flashes abnormally, one of the turn signal bulbs may be burned out and will require replacement.

### **One-touch turn signal function**

To activate the One Touch Turn Signal function, push the turn signal lever up or down to position (B) and then release it.

The lane change signals will blink 3, 5 or 7 times.

You can activate or deactivate the One Touch Turn Signal function or choose the number of blinks (3, 5, or 7) from the User Settings mode (Light) on the LCD display.

**For more information, refer to the "LCD Display" section in this chapter.**

### **Battery saver function**

The purpose of this feature is to prevent the battery from being discharged. The system automatically turns off the parking lamp when the key is removed (remote key) or when the driver turns the vehicle off (smart key) and opens the driver-side door.

With this feature, the parking lamps will turn off automatically if the driver parks on the side of road at night.

If necessary, to keep the lamps on when the vehicle is turned off, perform the following:

- 1) Open the driver-side door.
- 2) Turn the parking lamps OFF and ON again using the light switch on the steering column.

### **Headlamp delay function (if equipped)**

If the key is removed from the ignition switch or placed in the ACC position or the LOCK/OFF position with the headlamps ON, the headlamps (and/or parking lamps) remain on for about 5 minutes. However, if the driver's door is opened and closed, the headlights are turned off after 15 seconds. Also, with the vehicle off if the driver's door is opened and closed, the headlamps (and/or parking lamps) are turned off after 15 seconds.

The headlamps (and/or parking lamps) can be turned off by pressing the lock button on the remote key or smart key twice or turning the light switch to the OFF or AUTO position.

You can activate or deactivate the Headlamp Delay function from the User Settings mode (Light) on the LCD display.

**For more information, refer to the "LCD Display" section in this chapter.**

### NOTICE

If the driver gets out of the vehicle through other doors (except driver's door), the battery saver function does not operate and the headlamp delay function does not turn off automatically. Therefore, it causes the battery to be discharged. In this case, make sure to turn off the lamp before getting out of the vehicle.

### ***AFL (Adaptive Front Lighting) system a.k.a. DBL (Dynamic Bending Light) (if equipped)***

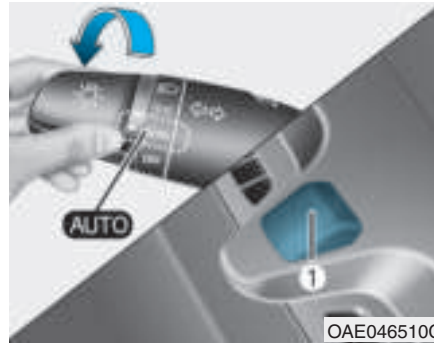

Adaptive front lighting system uses the steering angle and vehicle speed, to keep your field of vision wide by swiveling and leveling the headlamp.

Change the switch to the AUTO position when the vehicle is in the ready (  ) mode. The adaptive front lighting system will operate when the headlamp is ON. To turn off the AFL System, change the switch to other positions. After turning the AFL System off, headlamp swiveling no longer occurs, but leveling operates continuously.

If the AFL System malfunction indicator comes on, the AFL System is not working properly. Drive to the nearest safe location and restart the vehicle (  indicator ON). If the indicator continuously remains on, have the system be checked by an authorized HYUNDAI dealer.

## Interior Lights

### WARNING

**Do not use the interior lights when driving in the dark. The interior lights may obscure your view and cause an accident.**

### NOTICE

**Do not use the interior lights for extended periods when the vehicle is turned off or the battery will discharge.**

### *Interior lamp AUTO cut*

The interior lamps will automatically go off approximately 20 minutes after the vehicle is turned off and the doors are closed. If a door is opened, the lamp will go off 40 minutes after the vehicle is turned off. If the doors are locked by the remote key or smart key and the vehicle enters the armed stage of the theft alarm system, the lamps will go off five seconds later.

## Front lamps



- (1) Front Map Lamp
- (2) Front Door Lamp
- (3) Front Room Lamp ON
- (4) Front Room Lamp OFF



### Front Map Lamp :

Press either lenses to turn the map lamp on or off. This light produces a spot beam for convenient use as a map lamp at night or as a personal lamp for the driver and the front passenger.

### Front Door Lamp ( ):

The front or rear room lamps come on when the front or rear doors are opened. When doors are unlocked by the remote key or smart key, the front and rear lamps come on for approximately 30 seconds as long as any door is not opened. The front and rear room lamps go out gradually after approximately 30 seconds when the door is closed. However, if the Engine Start/Stop button is in the ON position or all doors are locked, the front and rear lamps will turn off. If a door is opened with the ignition switch is in the ACC position or the OFF position, the front and rear lamps stay on for about 20 minutes.

### Front room lamp

-  :  
Press the button to turn ON the room lamp for the front/rear seats.
-  :  
Press the button to turn OFF the room lamp for the front/rear seats regardless of front or rear door open position.

### Rear lamp

■ Type A



■ Type B



Rear Room Lamp (☀):

Press this switch to turn the room lamp on and off.

### Luggage compartment lamp



The luggage compartment lamp comes on when the tailgate is opened.

#### NOTICE

The luggage compartment lamp comes on as long as the tailgate is open. To prevent unnecessary charging system drain, close the tailgate securely after using the luggage compartment.

### Vanity mirror lamp (if equipped)



Push the switch to turn the light on or off.

- ☀ : The lamp will turn on if this button is pressed.
- : The lamp will turn off if this button is pressed.

#### NOTICE

Always have the switch in the off position when the vanity mirror lamp is not in use. If the sunvisor is closed without the lamp off, it may discharge the battery or damage the sunvisor.

## Welcome System (if equipped)

### Welcome light (if equipped)



### Door handle lamp (if equipped)

When all the doors (and tailgate) are closed and locked, the door handle lamp will come on for about 15 seconds if any of the below is performed.

- When the door unlock button is pressed on the remote key or smart key.
- When the button of the outside door handle is pressed with the smart key in possession.
- When the vehicle is approached with the smart key in possession.

### Headlamp and parking lamp

When the headlamp (with the lamp switch in the headlamp or AUTO position) is on and all doors (and trunk) are locked and closed, the parking lamp and headlamp will come on for 15 seconds when the door unlock button is pressed on the remote key or smart key.

At this time, if you press the door lock or unlock button on the remote key or smart key the parking lamp and headlamp will turn off immediately.

You can activate or deactivate the Welcome Light from the User Settings mode on the LCD display. **For more details, refer to "LCD Display" in this chapter.**

### Interior lamp

When the interior lamp switch is in the DOOR position and all doors (and tailgate) are closed and locked, the room lamp will come on for 30 seconds if any of the below is performed.

- When the door unlock button is pressed on the remote key or smart key.
- When the button of the outside door handle is pressed.

At this time, if you press the door lock or unlock button, the room lamp will turn off immediately.



## WIPERS AND WASHERS

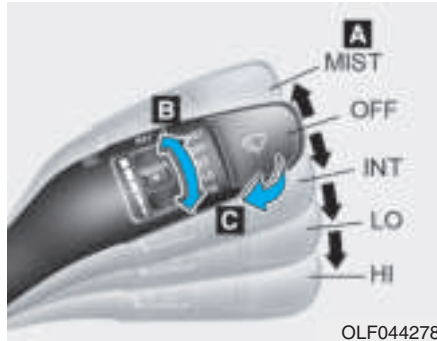

### A : Wiper speed control

- MIST – Single wipe
- OFF – Off
- INT – Intermittent wipe
- LO – Low wiper speed
- HI – High wiper speed

### B : Intermittent control wipe time adjustment

### C : Wash with brief wipes

## Windshield Wipers

Operates as follows when the ignition switch is in the ON position.

**MIST** : For a single wiping cycle, push the lever upward and release. The wipers will operate continuously if the lever is held in this position.

**OFF** : Wiper is not in operation.

**INT** : Wiper operates intermittently at the same wiping intervals. To vary the speed setting, move the speed control lever. The top most setting will run the wipers most frequently (for more rain). The bottom setting will run the wipers the least frequently (for less rain).

**LO** : The wiper runs at a lower speed.

**HI** : The wiper runs at a higher speed.

## **i** Information

**If there is heavy accumulation of snow or ice on the windshield, defrost the windshield for about 10 minutes, or until the snow and/or ice is removed before using the windshield wipers to ensure proper operation.**

**If you do not remove the snow and/or ice before using the wiper and washer, it may damage the wiper and washer system.**

## Windshield Washers

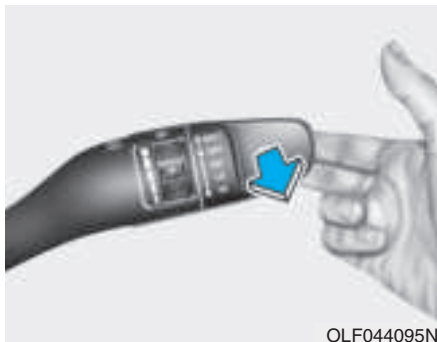

OLF044095N

In the OFF position, pull the lever gently toward you to spray washer fluid on the windshield and to run the wipers 1-3 cycles. The spray and wiper operation will continue until you release the lever. If the washer does not work, you may need to add washer fluid to the washer fluid reservoir.

### **WARNING**

When the outside temperature is below freezing, **ALWAYS** warm the windshield using the defroster to help prevent the washer fluid from freezing on the windshield and obscuring your vision which could result in an accident and serious injury or death.

### **NOTICE**

- To prevent possible damage to the washer pump, do not operate the washer when the fluid reservoir is empty.
- To prevent possible damage to the wipers or windshield, do not operate the wipers when the windshield is dry.
- To prevent damage to the wiper arms and other components, do not attempt to move the wipers manually.
- To prevent possible damage to the wipers and washer system, use anti-freezing washer fluids in the winter season or cold weather.

## REAR VIEW MONITOR (RVM) (IF EQUIPPED)



OAE048640



OAEPH049407N

Rear View Monitor system is a supplemental system that shows the area behind the vehicle on the infotainment system screen to assist you when parking or driving.

- Rear View Monitor with parking guidance will activate when the vehicle is in the ready mode and the shift into R (Reverse) position.
- To assist in parking, the rear view is shown (the parking guide line disappears) on the screen when the shift button is shifted from R (Reverse) to D (Drive) with vehicle speed below 15 km/h (9 mph).

### *Rear View Monitor – Top view*



OAEPHQ049859N

When you touch the icon of infotainment system, the top view is displayed on the screen and shows the distance from the vehicle in the back of your vehicle. Touch the icon again, to switch back to the previous screen.

## CAUTION

- Rear View Monitor is not a safety device. It only serves to assist the driver in identifying objects directly behind the middle of the vehicle. The camera does not cover the complete area behind the vehicle.
- Never rely solely on the rear view monitor. As there are blind spots that do not appear on the camera while backing up and parking, You must always use methods of viewing the area behind you including looking over both shoulders as well as continuously checking all three rear view mirrors.
- Always look around your vehicle to make sure there are no objects or obstacles before moving the vehicle in any direction to prevent a collision.

(Continued)

(Continued)

- Always pay close attention when the vehicle is driven close to objects, particularly pedestrians, and especially children.
- Always keep the camera lens clean. If lens is covered with foreign matter, the camera may not operate normally.
- When stopping for a long time in winter or parking in an indoor parking lot, the image may temporarily be blurry due to the exhaust gas.

## REVERSE PARKING DISTANCE WARNING (PDW) (IF EQUIPPED)

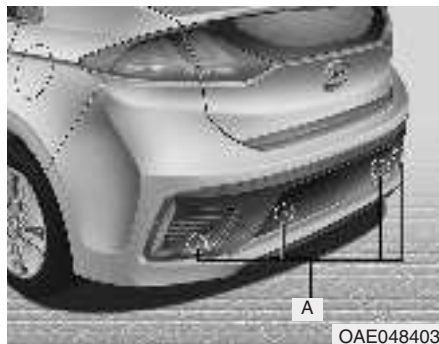

[A] : Rear Sensor

Reverse Parking Distance Warning system assists the driver during reverse movement of the vehicle by chiming if any object is sensed within the distance of 120 cm (48 in) behind the vehicle.

This system is a supplemental system that senses objects within the range and location of the sensors, it cannot detect objects in other areas where sensors are not installed.

### WARNING



- **Always look around your vehicle to make sure there are not any objects or obstacles before moving the vehicle in any direction to prevent a collision.**
- **Always pay close attention when the vehicle is driven close to objects, particularly pedestrians, and especially children.**
- **Be aware that some objects may not be visible on the screen or be detected by the sensors, due to the objects distance, size or material, all of which can limit the effectiveness of the sensor.**

### ***Operation of Reverse Parking Distance Warning system***

#### **Operating condition**

- Reverse Parking Distance Warning system will activate when backing up with the ignition switch in the ON position. However, if vehicle speed exceeds 5 km/h (3 mph), the system may not detect objects.
- If vehicle speed exceeds 10 km/h (6 mph), the system will not warn you even though objects are detected.
- When more than two objects are sensed at the same time, the closest one will be recognized first.

## Types of warning sound and indicator

Types of warning sound	Indicator
When an object is 60 ~ 120 cm (24 ~ 48 in) from the rear bumper : Buzzer beeps intermittently.	
When an object is approximately 30 ~ 60 cm (12 ~ 24 in) from the rear bumper, the warning sound beeps more frequently.	
When an object is within 30 cm (12 in) of the rear bumper : Buzzer beeps continuously.	

### NOTICE

- The indicator may differ from the illustration depending on objects or sensors status. If the indicator blinks, we recommend that you have your vehicle checked by an authorized HYUNDAI dealer.
- If the audible warning does not sound or if the buzzer sounds intermittently when the gear is R (Reverse) position, this may indicate a malfunction with Reverse Parking Distance Warning system. If this occurs, we recommend that you have your vehicle checked by an authorized HYUNDAI dealer as soon as possible.

### ***Non-operational conditions of Reverse Parking Distance Warning system***

Reverse Parking Distance Warning system may not operate normally when:

- Moisture is frozen to the sensor.
- Sensor is covered with foreign matter, such as snow or water, or the sensor cover is blocked.

**There is a possibility of Reverse Parking Distance Warning system malfunction when:**

- Driving on uneven road surfaces such as unpaved roads, gravel, bumps, or gradient.
- Objects generating excessive noise such as vehicle horns, loud motorcycle engines, or truck air brakes can interfere with the sensor.
- Heavy rain or water spray is present.
- Wireless transmitters or mobile phones are present near the sensor.
- The sensor is covered with snow.

- Any non-factory equipment or accessories have been installed, or if the vehicle bumper height or sensor installation has been modified.

### Detecting range may decrease when:

- Outside air temperature is extremely hot or cold.
- Undetectable objects smaller than 100 cm (40 in) and narrower than 14 cm (6 in) in diameter.

### The following objects may not be recognized by the sensor:

- Sharp or slim objects such as ropes, chains or small poles.
- Objects, which tend to absorb sensor frequency such as clothes, spongy material or snow.

### **NOTICE**

- **Reverse Parking Distance Warning system can only sense objects within the range and location of the sensors; It cannot detect objects in other areas where sensors are not installed. Also, small or slim objects, such as poles or objects located between sensors may not be detected by the sensors.**

**Always visually check behind the vehicle when backing up.**

- **Be sure to inform any drivers of the vehicle that may be unfamiliar with the system regarding the systems capabilities and limitations.**

### ***Reverse Parking Distance Warning system precautions***

- Reverse Parking Distance Warning system may not sound consistently depending on the speed and shapes of the objects detected.
- Reverse Parking Distance Warning system may malfunction if the vehicle bumper height or sensor installation has been modified or damaged. Any non-factory installed equipment or accessories may also interfere with the sensor performance.
- The sensor may not recognize objects less than 30 cm (12 in) from the sensor, or it may sense an incorrect distance. Use caution.
- When the sensor is frozen or stained with snow, dirt, or water, the sensor may be inoperative until the stains are removed using a soft cloth.
- Do not push, scratch or strike the sensor with any hard objects that could damage the surface of the sensor. Sensor damage could occur.

- Do not spray the sensors or its surrounding area directly with a high pressure washer. Shock applied from high pressure water may cause the device to not operate normally.

### WARNING

**Your new vehicle warranty does not cover any accidents or damage to the vehicle or injuries to its occupants related to a Reverse Parking Distance Warning system. Always drive safely and cautiously.**

## Self-Diagnosis

When the gear is R (Reverse) position and if one or more of the below occurs you may have a malfunction in the Parking Distance Warning system.

- You don't hear an audible warning sound or if the buzzer sounds intermittently

-  is displayed. (if equipped)  
(blink)

If this occurs, have the system checked by a professional workshop. HYUNDAI recommends to visit an authorized HYUNDAI dealer/service partner.



## FORWARD/REVERSE PARKING DISTANCE WARNING (PDW) (IF EQUIPPED)

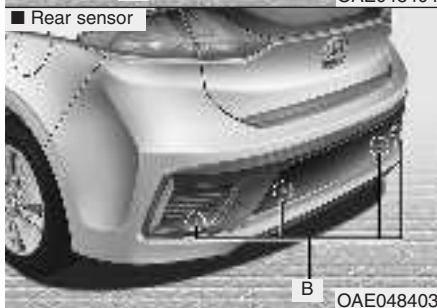
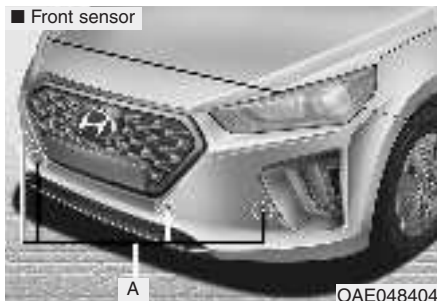

[A] : Front Sensor, [B] : Rear Sensor

Forward/Reverse Parking Distance Warning system assists the driver during movement of the vehicle by chiming if any object is sensed within the distance of 100 cm (40 in) in front and 120 cm (48 in) behind the vehicle.

This system is a supplemental system that senses objects within the range and location of the sensors, it cannot detect objects in other areas where sensors are not installed.

### WARNING

- Always look around your vehicle to make sure there are no objects or obstacles before moving the vehicle in any direction to prevent a collision.
- Always pay close attention when the vehicle is driven close to objects, particularly pedestrians, and especially children.
- Be aware that some objects may not be visible on the screen or be detected by the sensors, due to the objects distance, size or material, all of which can limit the effectiveness of the sensor.

### Operation of Forward/Reverse Parking Distance Warning

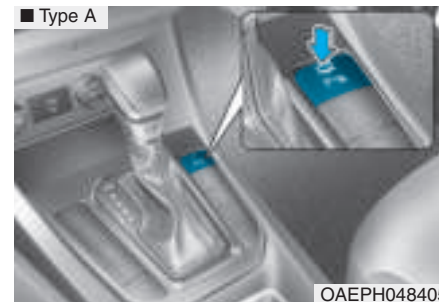







### Operating condition

- Forward/Reverse Parking Distance Warning system will activate when the Parking Distance Warning system button is pressed with the engine running

- Parking Distance Warning system button turns on automatically and activates the system system when the gear is R (Reverse) position. However, if vehicle speed exceeds 10 km/h (6 mph), the system will not warn you even though objects are detected, and if vehicle speed exceeds 20 km/h (12 mph), the system will turn off automatically. To turn on the system, press Parking Distance Warning system button
- When more than two objects are sensed at the same time, the closest one will be recognized first.

### Types of warning sound and indicator

Distance from object in (cm)		Warning indicator		Warning sound
		When driving forward	When driving rearward	
24 ~ 40 (60 ~ 100)	Front		-	Buzzer beeps intermittently
24 ~ 48 (60 ~ 120)	Rear	-		Buzzer beeps intermittently
12 ~ 24 (30 ~ 60)	Front			Buzzer beeps frequently
	Rear	-		Buzzer beeps frequently
12 (30)	Front			Buzzer sounds continuously
	Rear	-		Buzzer sounds continuously

**NOTICE**

- The indicator may differ from the illustration depending on objects or sensors status. If the indicator blinks, we recommend that the system be checked by an authorized HYUNDAI dealer
- If the audible warning does not sound or if the buzzer sounds intermittently when gear is R (Reverse) position, this may indicate a malfunction with Forward/Reverse Parking Distance Warning system. If this occurs, we recommend that vehicle checked by an authorized HYUNDAI dealer.

### ***Non-operational conditions of Forward/Reverse Parking Distance Warning system***

#### **Forward/Reverse Parking Distance Warning may not operate when:**

- Moisture is frozen to the sensor. (It will operate normally when the ice melts.)
- Sensor is covered with foreign matter, such as snow or water, or the sensor cover is blocked. (It will operate normally when the material is removed or the sensor is no longer blocked.)
- Parking Distance Warning button is off.

#### **There is a possibility of Forward/Reverse Parking Distance Warning system malfunction when:**

- Driving on uneven road surfaces such as unpaved roads, gravel, bumps, or gradient.
- Objects generating excessive noise such as vehicle horns, loud motorcycle engines, or truck air brakes can interfere with the sensor.
- Heavy rain or water spray is present.
- Wireless transmitters or mobile phones present near the sensor.
- The sensor is covered with snow
- Any non-factory equipment or accessories have been installed, or if the vehicle bumper height or sensor installation has been modified.

#### **Detecting range may decrease when:**

- Outside air temperature is extremely hot or cold.
- The sensor is covered with foreign matter such as snow or water. (The sensing range will return to normal when removed.)

#### **The following objects may not be recognized by the sensor:**

- Sharp or slim objects such as ropes, chains or small poles.
- Objects, which tend to absorb sensor frequency such as clothes, spongy material or snow.
- Undetectable objects smaller than 100 cm (40 in) and narrower than 14 cm (5.5 in) in diameter.

### ***Forward/Reverse Parking Distance Warning system precautions***

- Forward/Reverse Parking Distance Warning system may not sound consistently depending on the speed and shapes of the objects detected.
- Forward/Reverse Parking Distance Warning system may malfunction if the vehicle bumper height or sensor installation has been modified. Any non-factory installed equipment or accessories may also interfere with the sensor performance.
- Sensor may not recognize objects less than 30 cm (12 in) from the sensor, or it may sense an incorrect distance. Use with caution.
- When the sensor is frozen or stained with snow, dirt, or water, the sensor may be inoperative until the stains are removed using a soft cloth.
- Do not push, scratch or strike the sensor. Sensor damage could occur.

- Do not spray the sensors or its surrounding area directly with a high pressure washer. Shock applied from high pressure water may cause the device to not operate normally.

#### **NOTICE**

- **Forward/Reverse Parking Distance Warning system can only sense objects within the range and location of the sensors; It cannot detect objects in other areas where sensors are not installed. Also, small or slim objects, such as poles or objects located between sensors may not be detected by the sensors.**

**Always visually check behind the vehicle when backing up.**

- **Be sure to inform any drivers of the vehicle that may be unfamiliar with the system regarding the systems capabilities and limitations.**

#### **WARNING**

**Pay close attention when the vehicle is driven close to objects on the road, particularly pedestrians, and especially children. Be aware that some objects may not be detected by the sensors, due to the objects distance, size or material, all of which can limit the effectiveness of the sensor. Always perform a visual inspection to make sure the vehicle is clear of all obstructions before moving the vehicle in any direction.**

### Self-Diagnosis

When the gear is R (Reverse) position and if one or more of the below occurs you may have a malfunction in the Parking Distance Warning system.

- You don't hear an audible warning sound or if the buzzer sounds intermittently.



(blink)

- is displayed. (if equipped)

If this occurs, have the system checked by a professional workshop. We recommend that vehicle be checked by an authorized HYUNDAI dealer.

#### WARNING

**Your new vehicle warranty does not cover any accidents or damage to the vehicle or injuries to its occupants. Always drive safely and cautiously.**

## AUTOMATIC CLIMATE CONTROL SYSTEM



1. Driver's temperature control button
2. Passenger's temperature control button
3. Fan speed control button
4. Mode selection button
5. AUTO (automatic control) button
6. OFF button
7. Front windshield defrost button
8. Rear window defrost button
9. Air conditioning button
10. Air intake control button
11. Driver only button
12. SYNC button
13. Climate control information screen

OAEPH049500N

### Automatic Heating and Air Conditioning



The Automatic Climate Control System is controlled by setting the desired temperature.

1. Press the AUTO button.

The modes, fan speeds, air intake and air-conditioning will be controlled automatically by the temperature setting you select.



2. Press the temperature control knob to the desired temperature. If the temperature is set to the lowest setting (Lo), the air conditioning system will operate continuously. After the interior has cooled sufficiently, adjust the button to a higher temperature set point whenever possible.

To turn the automatic operation off, select any button of the following:

- Mode selection button
- Front windshield defroster button (Press the button one more time to deselect the front windshield defroster function. The 'AUTO' sign will illuminate on the information screen once again.)
- Fan speed control button

The selected function will be controlled manually while other functions operate automatically.

For your convenience and to improve the effectiveness of the climate control, use the AUTO button and set the temperature to 23°C (73°F).



**NOTICE**

**Never place anything near the sensor to ensure better control of the heating and cooling system.**

## Manual Heating and Air Conditioning

The heating and cooling system can be controlled manually by pushing buttons other than the AUTO button. In this case, the system works sequentially according to the order of buttons selected.

When pressing any button except the AUTO button while using automatic operation, the functions not selected will be controlled automatically.

1. Start the vehicle (🚗 indicator ON).
2. Set the mode to the desired position.

To improve the effectiveness of heating and cooling, select:

- Heating: 🌞
- Cooling: ❄️

3. Set the temperature control to the desired position.
4. Set the air intake control to the outside (fresh) air position.
5. Set the fan speed control to the desired speed.
6. If air conditioning is desired, turn the air conditioning system on.
7. Press the AUTO button to convert to full automatic control of the system.



### Mode selection

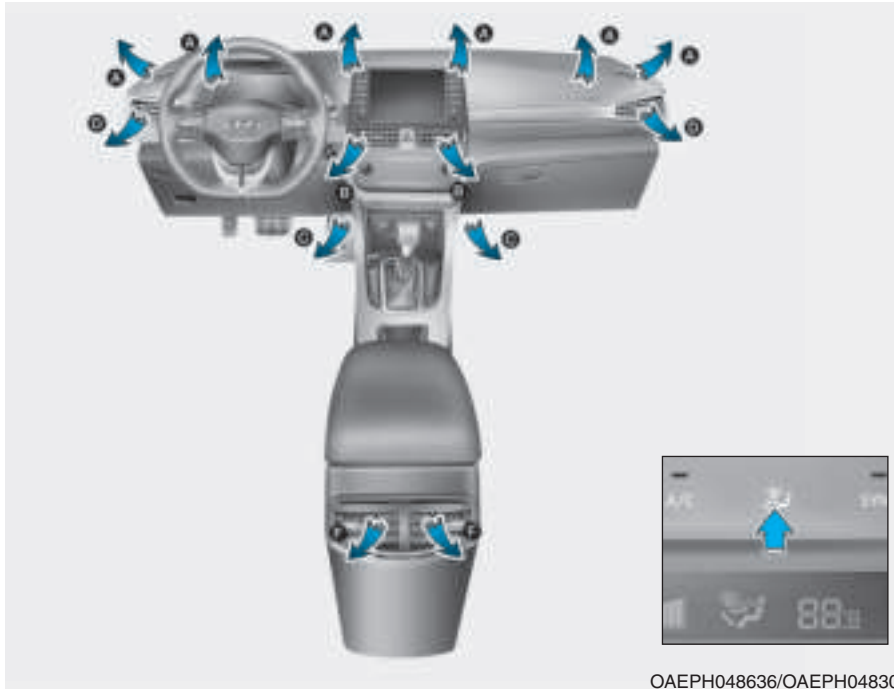

The mode selection button controls the direction of the air flow through the ventilation system.

The air flow outlet direction is cycled as follows:



 Face-Level (B, D, E, F)

Air flow is directed toward the upper body and face. Additionally, each outlet can be controlled to direct the air discharged from the outlet.

 Bi-Level (B, C, D, E, F)

Air flow is directed towards the face and the floor.



### Floor & Defrost (A, C, E, F)

Most of the air flow is directed to the floor and the windshield with a small amount directed to the side window defrosters.



### Floor-Level (A, C, E, F)

Most of the air flow is directed to the floor, with a small amount of the air being directed to the windshield and side window defrosters.



### Defrost-Level

Most of the air flow is directed to the windshield with a small amount of air directed to the side window defrosters.

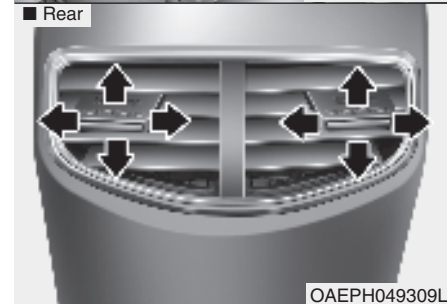
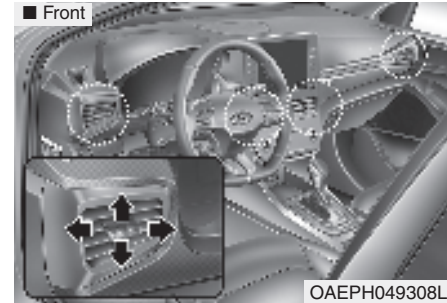

### Interior panel vents

The outlet vents can be opened or closed (☒) using the vent control lever.

Also, you can adjust the direction of air delivered from these vents using the vent control lever as shown.

### Temperature control



Press the button to increase/decrease temperature.  
The temperature will increase or decrease by 0.5°C/1°F.

### Temperature conversion

If the battery has been discharged or disconnected, the temperature mode display will reset to Fahrenheit.

To change the temperature unit from °C to °F or °F to °C:

- On the instrument cluster, go to User Settings Mode → Other (Features) → Temperature Unit.
- Press and hold the AUTO and OFF buttons on the climate control unit for 3 seconds.

The temperature unit on both on the cluster LCD display and climate control information screen will change.

### Sync button



### Adjusting the driver and passenger side temperature equally

- Press the "SYNC" button to operate the driver and passenger side temperature equally.

The passenger side temperature will be set to the same temperature as the driver side temperature.

- Press the left temperature control knob. The driver and passenger side temperature will be adjusted equally.

### Adjusting the driver and passenger side temperature individually

Press the "SYNC" button again to operate the driver and passenger side temperature individually. The button indicator will turn off.

### Air intake control



This button is used to select the outside (fresh) air position or recirculated air position.

### Recirculated air position



With the recirculated air position selected, air from the passenger compartment will be drawn through the heating system and heated or cooled according to the function selected.

### Outside (fresh) air position



With the outside (fresh) air position selected, air enters the vehicle from outside and is heated or cooled according to the function selected.

### **i** Information

Using the system in the fresh air position is recommended.

Prolonged operation of the heater in the recirculated air position (without air conditioning selected) can cause fogging of the windshield and side windows and the air within the passenger compartment will become stale.

In addition, prolonged use of the air conditioning with the recirculated air position selected will result in excessively dry air in the passenger compartment.

**⚠ WARNING**

- Continued use of the climate control system operation in the recirculated air position can cause drowsiness or sleepiness, that may cause loss of vehicle control resulting in an accident. Set the air intake control to the outside (fresh) air position as much as possible while driving.
- Continued use of the climate control system operation in the recirculated air position (without the air conditioning selected) may allow humidity to increase inside the vehicle which may fog the glass and obscure visibility.
- Do not sleep in a vehicle with the air conditioning or heating system on. It may cause serious injury or death due to a drop in the oxygen level and/or body temperature.

**Fan speed control**



The fan speed can be set as desired by pushing the fan speed control button.

More air is delivered with higher fan speeds.

Pressing the OFF button turns off the fan.

**i Information**

For better voice recognition, fan speed may automatically slow down for a couple of minutes when you activate voice recognition or hands free.

**NOTICE**

Operating the fan when the ignition switch is in the ON position could cause the battery to discharge. Operate the fan when the vehicle is in the ready (🚗) mode.

### Driver only



If you press the DRIVER ONLY button (  ) and the indicator light illuminates, air mostly blows in the direction of the driver's seat.

However, some of the air may come out of other seating position ducts to keep indoor air pleasant.

If you use the button with no passenger in the front passenger seat, energy consumption will be reduced.

DRIVER ONLY button will be turned off under the following conditions:

- 1) Defrost on (the DRIVER ONLY button indicator is not turned off)
- 2) DRIVER ONLY button re-push

### Air conditioning



Press the A/C button to manually turn the system on (indicator light will illuminate) and off.

### OFF mode



Press the OFF button to turn the climate control system off.

You can still operate the mode and air intake buttons as long as the ignition switch is in the ON position.

### System Operation

#### Ventilation

1. Select the Face Level  mode.
2. Set the air intake control to the outside (fresh) air position.
3. Set the temperature control to the desired position.
4. Set the fan speed control to the desired speed.

#### Heating

1. Select the Floor Level  mode.
2. Set the air intake control to the outside (fresh) air position.
3. Set the temperature control to the desired position.
4. Set the fan speed control to the desired speed.
5. If dehumidified heating is desired, turn the air conditioning system on.

If the windshield fogs up, select the Floor & Defrost  mode or press the Front Defrost  mode.

#### Operation Tips

- To keep dust or unpleasant fumes from entering the car through the ventilation system, temporarily set the air intake control to the recirculated air position. Return the control to the fresh air position when the irritation has passed. This will help keep the driver alert and comfortable.
- To prevent the inside of the windshield from fogging, set the air intake control to the fresh air position and fan speed to the desired position, turn on the air conditioning system, and adjust the temperature control to the desired temperature.

#### Air conditioning

All HYUNDAI Air Conditioning Systems are filled with environmentally friendly R-134a refrigerant.

1. Start the vehicle.
2. Push the air conditioning button.
3. Set the mode to the Face Level  mode.
4. Set the air intake control to the recirculated air position. However, prolonged operation of the recirculated air position will excessively dry the air. In this case, change the air position.
5. Adjust the fan speed control and temperature control to maintain maximum comfort.

When maximum cooling is desired, set the temperature control to the extreme left position then set the fan speed control to the highest speed.

### Air conditioning system operation tips

- If the vehicle has been parked in direct sunlight during hot weather, open the windows for a short time to let the hot air inside the vehicle escape.
- After sufficient cooling has been achieved, switch back from the recirculated air to the fresh outside air position.
- To help reduce moisture inside of the windows on rainy or humid days, decrease the humidity inside the vehicle by operating the air conditioning system with the windows and sunroof closed.
- Use the air conditioning system every month only for a few minutes to ensure maximum system performance.
- If you operate air conditioner excessively, the difference between the temperature of the outside air and that of the windshield could cause the outer surface of the windshield to fog up, causing loss of visibility. In this case, set the mode selection knob or button to the  position and fan speed control to the lower speed.

## System Maintenance

### Climate control air filter

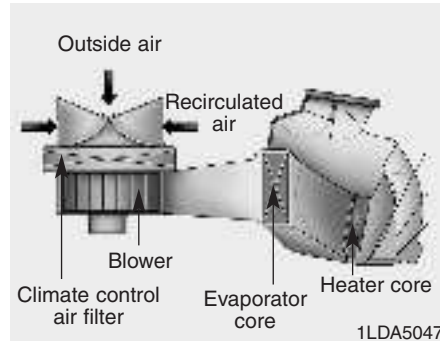

This filter is installed behind the glove box. It filters the dust or other pollutants that enter the vehicle through the heating and air conditioning system.

Have the climate control air filter be replaced by an authorized HYUNDAI dealer according to the maintenance schedule. If the vehicle is being driven in severe conditions such as dusty or rough roads, more frequent air conditioner filter inspections and changes are required.

If the air flow rate suddenly decreases, the system should be checked at an authorized HYUNDAI dealer.

### Checking the amount of air conditioner refrigerant and compressor lubricant

When the amount of refrigerant is low, the performance of the air conditioning is reduced. Overfilling also reduces the performance of the air conditioning system.

Therefore, if abnormal operation is found, have the system inspected by an authorized HYUNDAI dealer.

#### NOTICE

**It is important that the correct type and amount of oil and refrigerant is used. Otherwise, damage to the compressor and abnormal system operation may occur.**



 **WARNING**





**Because the refrigerant is at very high pressure, the air conditioning system should only be serviced by trained and certified technicians. It is important that the correct type and amount of oil and refrigerant is used, otherwise damage to the vehicle and personal injury may occur.**

The air conditioning system should be serviced by an authorized HYUNDAI dealer.

## WINDSHIELD DEFROSTING AND DEFOGGING

### WARNING

#### Windshield heating

Do not use the  or  position during cooling operation in extremely humid weather. The difference between the temperature of the outside air and that of the windshield could cause the outer surface of the windshield to fog up, causing loss of visibility could cause an accident resulting in serious injury or death. In this case, set the mode selection button to the  position and fan speed control knob or button to a lower speed.

- For maximum defrosting, set the temperature control to the extreme right/hot position and the fan speed control to the highest speed.
- If warm air to the floor is desired while defrosting or defogging, set the mode to the floor-defrost position.
- Before driving, clear all snow and ice from the windshield, rear window, side view mirrors, and all side windows.
- Clear all snow and ice from the hood and air inlet in the cowl grill to improve heater and defroster efficiency and to reduce the probability of fogging up the inside of the windshield.

### Information

If the engine temperature is still cold after starting, then a brief engine warm up period may be required for the vented air flow to become warm or hot.

### To Defog Inside Windshield

1. Select the desired fan speed.
2. Select the desired temperature.
3. Press the defroster button ().
4. The outside (fresh) air position will be selected automatically.

If the outside (fresh) air position is not selected automatically, adjust the corresponding button manually.

If the  position is selected, lower fan speed is adjusted to a higher fan speed.



### To Defrost Outside Windshield



1. Set the fan speed to the highest (extreme right) position.
2. Set the temperature to the extreme hot (HI) position.
3. Press the defroster button (  ).
4. The outside (fresh) air position will be selected automatically.

If the  position is selected, lower fan speed is adjusted to a higher fan speed.

### Defogging Logic

To reduce the probability of fogging up the inside of the windshield, the air intake or air conditioning are controlled automatically according to certain conditions such as  or  positions. To cancel or return the defogging logic, do the following.

1. Place the ignition switch to the ON position.
2. Press the defroster button (  ).
3. While pressing the air conditioning button (A/C), press the air intake control button at least 5 times within 3 seconds.

The air intake control button indicator will blink 3 times. It indicates that the defogging logic is canceled or returned to the programmed status.

If the battery has been discharged or disconnected, it resets to the defog status.

### Rear Window Defroster



#### NOTICE

**To prevent damage to the conductors bonded to the inside surface of the rear window, never use sharp instruments or window cleaners containing abrasives to clean the window.**

**If you want to defrost and defog the front windshield, refer to the "Windshield Defrosting and Defogging" section in this chapter.**



OAE049301

The defroster heats the window to remove frost, fog and thin ice from the interior and exterior of the rear window while the vehicle is in the ready (🚗) mode.

- To activate the rear window defroster, press the rear window defroster button located in the center fascia switch panel. The indicator on the rear window defroster button illuminates when the defroster is ON.
- To turn off the defroster, press the rear window defroster button again.

### **i** Information

- If there is heavy accumulation of snow on the rear window, brush it off before operating the rear defroster.
- The rear window defroster automatically turns off after approximately 20 minutes or when the ignition switch is in the LOCK/OFF position.

### **Side view mirror defroster**

If your vehicle is equipped with the side view mirror defrosters, they will operate at the same time you turn on the rear window defroster.

## Auto Defogging System



OAE048320

Auto defogging system reduces the possibility of fogging up the inside of the windshield by automatically sensing the moisture on inside the windshield.

The auto defogging system operates when the heater or air conditioning is on.



When the Auto Defogging System operates, the indicator will illuminate.

If high levels of moisture are sensed in the vehicle, the Auto Defogging System will operate in the following order:

Step 1 : Outside air position

Step 2 : Operating the air conditioning

Step 3 : Blowing air toward the windshield

Step 4 : Increasing air flow toward the windshield

If the air conditioning is off or recirculated air position is manually selected while Auto Defogging System is ON, the Auto Defogging System Indicator will blink 3 times to signal that the manual operation has been canceled.

### To cancel or reset the Auto Defogging System

Press the front windshield defroster button for 3 seconds when the ignition switch is in the ON position. When the Auto Defogging System is canceled, the ADS OFF symbol will blink 3 times and ADS OFF will be displayed on the climate control information screen.

When the Auto Defogging System is reset, the ADS OFF symbol will blink 6 times without a signal.

### **i** Information

- **When the air conditioning is turned on by Auto defogging system, if you try to turn off the air conditioning, the indicator will blink 3 times and the air conditioning will not be turned off.**
- **For efficiency, do not select recirculated air position while the Auto defogging system is operating.**
- **When Auto defogging mode is selected, fan speed, temperature and intake mode which is adjusted manually are canceled for better defogging result.**

### **NOTICE**

**Do not remove the sensor cover located on the upper end of the windshield glass.**

**Damage to system parts could occur and may not be covered by your vehicle warranty.**

---

## CLIMATE CONTROL ADDITIONAL FEATURES

### Automatic Ventilation (if equipped)

When the ignition switch is in the ON position or when the vehicle is in the ready (🚗) mode and temperature is below 15°C (59°F) with the recirculated air position selected more than five minutes, the air intake position will automatically change to the outside (fresh) air position.

#### To cancel or reset the Automatic Ventilation

When the air conditioning system is on, select Face Level 🌀 mode and while pressing the A/C button, press the recirculated air position button five times within three seconds.

### Sunroof inside air recirculation (if equipped)

When the sunroof is opened, outside (fresh) air will be automatically selected. At this time, if you press the air intake control button, recirculated air position will be selected but will change back to outside (fresh) air after 3 minutes. When the sunroof is closed, the air intake position will return to the original position that was selected.

## STORAGE COMPARTMENT

### WARNING

Never store cigarette lighters, propane cylinders, or other flammable/explosive materials in the vehicle. These items may catch fire and/or explode if the vehicle is exposed to hot temperatures for extended periods.

### WARNING

**ALWAYS** keep the storage compartment covers closed securely while driving. Items inside your vehicle are moving as fast as the vehicle. If you have to stop or turn quickly, or if there is a crash, the items may fly out of the compartment and may cause an injury if they strike the driver or a passenger.

### NOTICE

To avoid possible theft, do not leave valuables in the storage compartments.

## Center Console Storage

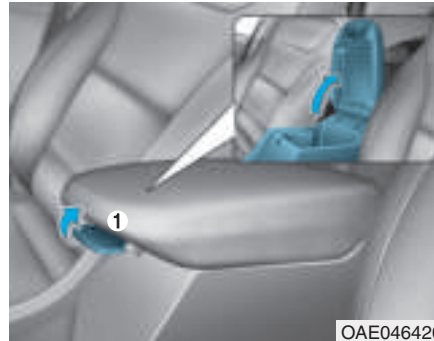

To open :  
Grab and hold the latch (1) on the arm rest then lift the lid.

## Glove Box



To open:  
Pull the lever (1).

### WARNING

**ALWAYS** close the glove box door after use.

An open glove box door can cause serious injury to the passenger in an accident, even if the passenger is wearing a seat belt.

## Sunglass Holder



To open:

Push and release the cover and the holder will slowly open. Place your sunglasses in the compartment door with the lenses facing out.

To close:

Push back into position.

Make sure the sunglass holder is closed while driving.

### WARNING

- Do not keep objects except sunglasses inside the sunglass holder. Such objects can be thrown from the holder in the event of a sudden stop or an accident, possibly injuring the passengers in the vehicle.
- Do not open the sunglass holder while the vehicle is moving. The rear view mirror of the vehicle can be blocked by an open sunglass holder.
- Do not put the glasses forcibly into a sunglass holder. It may cause personal injury if you try to open it forcibly when the glasses are jammed in holder.

## Multi Box



Use the multi box to keep small objects.

### WARNING

Do not keep objects that can be thrown from the multi box and severely injure passengers in the vehicle in the event of a sudden stop or an accident.



## INTERIOR FEATURES

### Cup Holder



Cups or small beverages cups may be placed in the cup holders.

### Rear (if equipped)

Pull the armrest down to use the cup holders.

#### WARNING

- Avoid abrupt starting and braking when the cup holder is in use to prevent spilling your drink. If hot liquid spills, you could be burned. Such a burn to the driver could cause loss of vehicle control resulting in an accident.
- Do not place uncovered or unsecured cups, bottles, cans, etc., in the cup holder containing hot liquid while the vehicle is in motion. Injuries may result in the event of a sudden stop or collision.
- Only use soft cups in the cup holders. Hard objects can injure you in an accident.

#### WARNING

Keep cans or bottles out of direct sun light and do not put them in a hot vehicle. It may explode.

#### NOTICE

- Keep your drinks sealed while driving to prevent spilling your drink. If liquid spills, it may get into the vehicle's electrical/electronic system and damage electrical/electronic parts.
- When cleaning spilled liquids, do not dry the cup holder at high temperature. This may damage the cup holder.

## Sunvisor

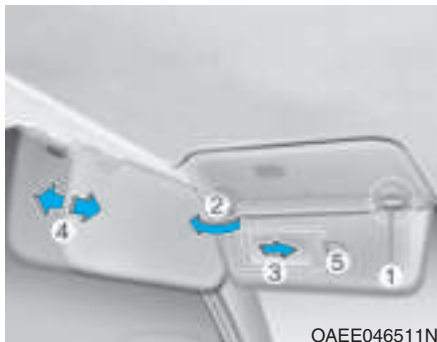

To use a sunvisor, pull it downward.  
To use a sunvisor for a side window, pull it downward, unsnap it from the bracket (1) and swing it to the side (2).  
To use the vanity mirror, pull down the sunvisor and slide the mirror cover (3).  
Adjust the sunvisor forward or backward (4) as needed (if equipped).  
Use the ticket holder (5) to hold tickets (if equipped).

### NOTICE

Close the vanity mirror cover securely and return the sunvisor to its original position after use.

### WARNING

For your safety, do not block your view when using the sunvisor.

### NOTICE

**Do not put several tickets in the ticket holder at one time. This could cause damage to the ticket holder.**

## Power Outlet (if equipped)

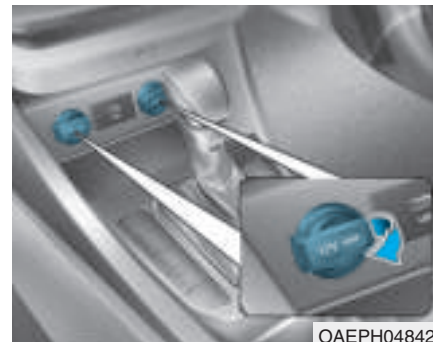

The power outlet is designed to provide power for mobile telephones or other devices designed to operate with vehicle electrical systems. The devices should draw less than 180 W (Watts) with the vehicle in the ready (🚗) mode.

### WARNING

**Avoid electrical shocks. Do not place your fingers or foreign objects (pin, etc.) into a power outlet or touch the power outlet with a wet hand.**

### NOTICE

To prevent damage to the Power Outlets :

- Use the power outlet only when the vehicle is in the ready (  ) mode and remove the accessory plug after use. Using the accessory plug for prolonged periods of time with the vehicle off could cause the battery to discharge.
- Only use 12V electric accessories which are less than 180 W (Watts) in electric capacity.
- Adjust the air-conditioner or heater to the lowest operating level when using the power outlet.
- Close the cover when not in use.

(Continued)

(Continued)

- Some electronic devices can cause electronic interference when plugged into a vehicle's power outlet. These devices may cause excessive audio static and malfunctions in other electronic systems or devices used in your vehicle.
- Push the plug in as far as it will go. If good contact is not made, the plug may overheat and the fuse may open.
- Plug in battery equipped electrical/electronic devices with reverse current protection. The current from the battery may flow into the vehicle's electrical/electronic system and cause system malfunction.

### Wireless Cellular Phone Charging System (if equipped)

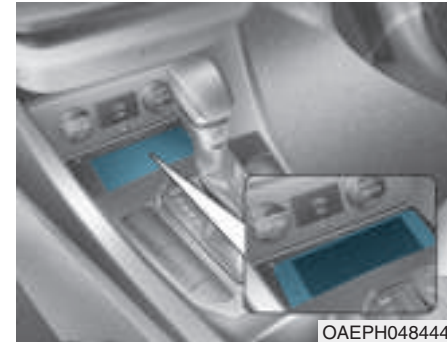

There is a wireless cellular phone charger inside the front console.

The system is available when all doors are closed, and when the ignition switch is in the ACC/ON/START position.

### To charge a cellular phone

The wireless cellular phone charging system charges only the Qi-enabled cellular phones (  ). Read the label on the cellular phone accessory cover or visit your cellular phone manufacturer's website to check whether your cellular phone supports the Qi technology.

The wireless charging process starts when you put a Qi-enabled cellular phone on the wireless charging unit.

1. Remove other items, including the smart key, from the wireless charging unit. If not, the wireless charging process may be interrupted. Place the cellular phone on the center of charging pad.
2. The indicator light is orange when the cellular phone is charging. The indicator light turns green when phone charging is completed.
3. You can turn ON or OFF the wireless charging function in the user settings mode on the instrument cluster. For further information, refer to the "LCD Display Modes" in this chapter.

If your phone is not charging:

- Slightly change the position of the cellular phone on the charging pad.
- Make sure the indicator light is orange.

The indicator light will blink orange for 10 seconds if there is a malfunction in the wireless charging system.

In this case, temporarily stop the charging process, and re-attempt to wirelessly charge your cellular phone again.

The system warns you with a message on the LCD display if the cellular phone is still on the wireless charging unit after the ignition switch is in the OFF position and the front door is opened.

### Information

**For some manufacturers' cellular phones, the system may not warn you even though the cellular phone is left on the wireless charging unit. This is due to the particular characteristic of the cellular phone and not a malfunction of the wireless charging.**

### NOTICE

- **The wireless cellular phone charging system may not support certain cellular phones, which are not verified for the Qi specification (  ).**
- **When placing your cellular phone on the charging mat, position the phone in the middle of the mat for optimal charging performance. If your cell phone is off to the side, the charging rate may be less and in some cases the cell phone may experience higher heat conduction.**
- **In some cases, the wireless charging may stop temporarily when the Smart Key is used, either when starting the vehicle or locking/unlocking the doors, etc.**
- **When charging certain cellular phones, the charging indicator may not change to green when the cell phone is fully charged.**

(Continued)

(Continued)

- The wireless charging process may temporarily stop, when temperature abnormally increases inside the wireless cellular phone charging system. The wireless charging process restarts, when temperature falls to a certain level.
- The wireless charging process may temporarily stop when there is any metallic item, such as a coin, between the wireless cellular phone charging system and a cellular phone.
- For certain cellular phone with their own protection, the wireless charging speed may decrease and the wireless charging may stop.
- If the cellular phone has a thick cover, the wireless charging may not be possible.
- If the cell phone is not completely contacting the charging pad, wireless charging may not operate properly.

(Continued)

(Continued)

- Some magnetic items like credit cards, phone cards or rail tickets may be damaged if left with the cellular phone during the charging process.
- If the cellular phone without the wireless charging function or the metallic items are placed on the charging pad, it may cause slight noise. This noise does not affect the cellular phone and the vehicle, because this noise is an operating sound during determining the item on the charging pad.
- If the ignition switch is in the OFF position, the charging also stops.

## Clock

### WARNING

Do not adjust the clock while driving, you may lose your steering control and cause an accident that results in severe personal injury or death.

#### *Vehicles with Audio system*

Select the [SETUP] button on the audio system → Select [Date/Time].

- Set time: Set the time displayed on the audio screen.
- Time format: Choose between 12-hour and 24-hour time formats.

#### *Vehicles with Navigation system*

Select the Settings menu on the Navigation system → Select [Date/Time].

- GPS time: Displays time according to the received GNSS time.
- 24-hour: Switches to 12 hour or 24 hour.

\* Detailed information for the Infotainment system is described in a separately supplied manual.

## Clothes Hanger (if equipped)

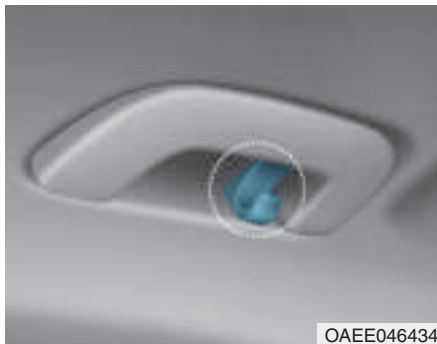

These hangers are not designed to hold large or heavy items.

### WARNING



**Do not hang other objects such as hangers or hard objects except clothes. Also, do not put heavy, sharp or breakable objects in the clothes pockets. In an accident or when the curtain air bag is inflated, it may cause vehicle damage or personal injury.**

## Floor Mat Anchor(s)



ALWAYS use the Floor Mat Anchors to attach the front floor mats to the vehicle. The anchors on the front floor carpet keep the floor mats from sliding forward.

### WARNING

**Do not overlay additional mats or liners over the floor mats. If using All Weather mats, remove the carpeted floor mats before installing them. Only use floor mats designed to connect to the anchors.**

**⚠ WARNING**

The following must be observed when installing ANY floor mat to the vehicle.

- Ensure that the floor mats are securely attached to the vehicle's floor mat anchor(s) before driving the vehicle.
- Do not use ANY floor mat that cannot be firmly attached to the vehicle's floor mat anchors.
- Do not stack floor mats on top of one another (e.g. all-weather rubber mat on top of a carpeted floor mat). Only a single floor mat should be installed in each position.

**IMPORTANT** - Your vehicle was manufactured with driver's side floor mat anchors that are designed to securely hold the floor mat in place. To avoid any interference with pedal operation, HYUNDAI recommends that the HYUNDAI floor mat designed for use in your vehicle be installed.

**Cargo Security Screen  
(if equipped)**



OAE046432N

Use the cargo security screen to hide items stored in the cargo area.

**To use the cargo security screen**

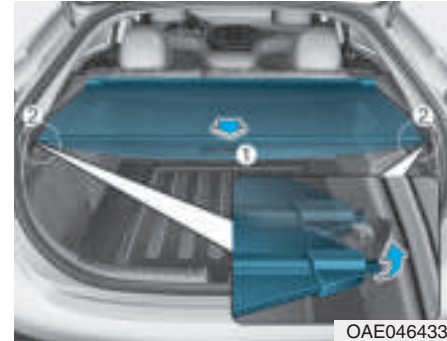

OAE046433

1. Pull the cargo security screen towards the rear of the vehicle by the handle (1).
2. Insert the guide pin into the guide (2).

**NOTICE**

**Pull out the cargo security screen with the handle in the center to prevent the guide pin from falling out of the guide.**

**When the cargo security screen is not in use:**

1. Pull the cargo security screen backward and up to release it from the guides.
2. The cargo security screen will automatically slide back in.

**NOTICE**

**The cargo security screen may not automatically slide back in if the cargo security screen is not fully pulled out. Fully pull it out and then let go.**

**To remove the cargo security screen**

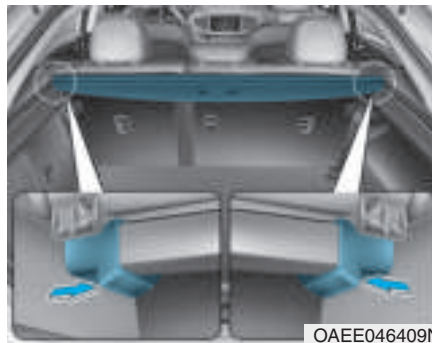

1. Push out the lower part of guide pins in both sides.
2. While pushing in one side of the guide pin, pull out the cargo security screen.



3. Open the luggage tray and keep the cargo security screen in the tray.



# Infotainment System

Infotainment System.....	4-2
USB and iPod® port.....	4-2
Antenna .....	4-2
Steering Wheel Audio Controls.....	4-3
<i>Bluetooth</i> ® Wireless Technology Hands-Free.....	4-4
Audio / Video /Navigation System .....	4-4

## INFOTAINMENT SYSTEM

### NOTICE

- If you install an aftermarket HID head lamp, your vehicle's audio and electronic devices may not function properly.
- Prevent chemicals such as perfume, cosmetic oil, sun cream, hand cleaner, and air freshener from contacting the interior parts because they may cause damage or discoloration.

### USB and iPod® Port



OAEPH048439

You can use the USB port to plug in a USB or iPod® port.

### **i** Information

When using a portable audio device connected to the power outlet, noise may occur during playback. If this happens, use the power source.

※ iPod® is a trademark of Apple Inc.

### Antenna

#### *Shark fin antenna*

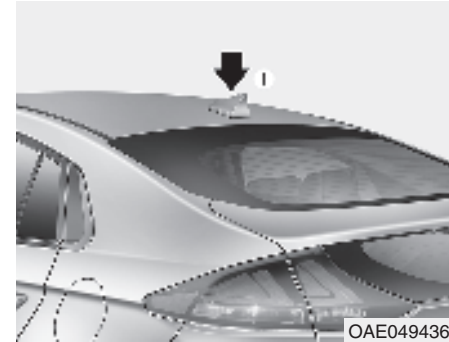

OAE049436

The shark fin antenna will receive the transmit data (example: AM/FM, SXM signal, GPS, LTE).

## Steering Wheel Audio Controls

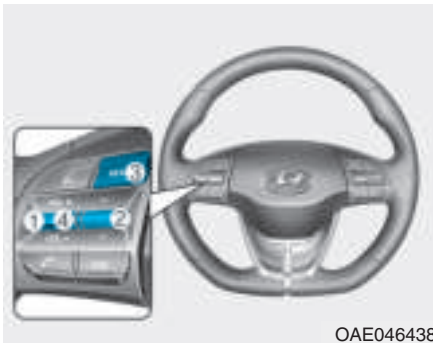

OAE046438

### NOTICE

Do not operate multiple audio remote control buttons simultaneously.

### **VOLUME (VOL +/-) (1)**

- Press the VOLUME switch up to increase volume.
- Press the VOLUME switch down to decrease volume.

### **SEEK/PRESET ( ^ / v ) (2)**

If the SEEK/PRESET switch is pressed up or down and held for 0.8 second or more, it will function in the following modes:

#### **RADIO mode**

It will function as the AUTO SEEK select button. It will SEEK until you release the button.

#### **MEDIA mode**

It will function as the FF/RW button.

If the SEEK/PRESET switch is pressed up or down, it will function in the following modes:

#### **RADIO mode**

It will function as the PRESET STATION UP/DOWN button.

#### **MEDIA mode**

It will function as the TRACK UP/DOWN button.

### **MODE (3)**

Press the MODE button to toggle through Radio, SXM, or AUX modes.

### **MUTE ( ) (4)**

- Press the MUTE button to mute the sound.
- Press the MUTE button again to activate the sound.

### **i Information**

Detailed information for audio control buttons are described in the Car infotainment User's Manual that is supplied with the vehicle.

### **Bluetooth® Wireless Technology Hands-Free**



With the *Bluetooth®* Wireless Technology in the vehicle, you can use the phone wireless.

- (1) Call / Answer button
- (2) Call end button

### (3) Microphone

Detailed information for the *Bluetooth®* Wireless Technology hands-free is described in the Car Multimedia User's Manual.

### **Audio / Video / Navigation system (if equipped)**

Detailed information for the navigation system is described in a separately supplied manual.

## Driving your vehicle

<b>Before driving</b> .....	5-4
Before Entering the Vehicle .....	5-4
Before Starting .....	5-4
<b>Ignition switch</b> .....	5-6
Key Ignition Switch .....	5-6
Engine Start/Stop Button .....	5-8
Turning Off the Vehicle .....	5-14
<b>Dual clutch transmission</b> .....	5-15
Dual Clutch Transmission Operation .....	5-15
LCD display for transmission temperature and warning message .....	5-17
Shift Lever Position .....	5-19
Parking .....	5-22
Good Driving Practices .....	5-23
<b>Paddle shifter</b> .....	5-25
Regen B mode .....	5-25
<b>Coasting guide</b> .....	5-28
<b>Braking system</b> .....	5-29
Power Brakes .....	5-29
Disc Brake Wear Indicator .....	5-30
Parking Brake (foot type) .....	5-30
Electronic Parking Brake (EPB) .....	5-32
AUTO HOLD .....	5-38
Anti-lock Brake System (ABS) .....	5-42
Electronic Stability Control (ESC) .....	5-44
Vehicle Stability Management (VSM) .....	5-47
Hill-Start Assist Control (HAC) .....	5-49
Good Braking Practices .....	5-49
<b>Forward Collision-Avoidance Assist (FCA) (front view camera only)</b> .....	5-50
System setting and activation .....	5-50
FCA warning message and brake control .....	5-52
FCA sensor (Front view camera) .....	5-55
System malfunction .....	5-57
FCA Warning Message and Brake Control .....	5-58
<b>Forward Collision-Avoidance Assist (FCA) - sensor fusion</b> .....	5-64
System setting and activation .....	5-64
FCA warning message and brake control .....	5-66
FCA sensor (Front view camera+ Front radar) .....	5-69
System malfunction .....	5-71
Limitations of the system .....	5-73
<b>Lane Keeping Assist (LKA)</b> .....	5-80
LKA operation .....	5-82
Warning light and message .....	5-85
Limitations of the System .....	5-86
LKA system function change .....	5-88
<b>Blind-spot Collision Warning (BCW)</b> .....	5-89
System description .....	5-89
System setting and operation .....	5-90

Warning message and system control.....	5-92
Declaration of conformity .....	5-99
<b>Driver Attention Warning(DAW) .....</b>	<b>5-101</b>
System setting and operation.....	5-101
Resetting the system .....	5-104
System standby.....	5-104
System malfunction.....	5-104
Leading Vehicle Departure Alert.....	5-107
<b>Cruise Control.....</b>	<b>5-109</b>
Cruise Control Operation .....	5-109
<b>Smart Cruise Control .....</b>	<b>5-114</b>
To adjust the sensitivity of Smart Cruise Control .....	5-116
To convert to Cruise Control mode.....	5-116
Smart Cruise Control speed.....	5-117
Smart Cruise Control Vehicle-to-Vehicle Distance.....	5-122
Sensor to detect distance to the vehicle ahead..	5-125
Limitations of the system.....	5-127
<b>Navigation-based Smart Cruise Control (NSCC) .....</b>	<b>5-133</b>
System Setting and Operation.....	5-134
<b>Lane Following Assist (LFA) .....</b>	<b>5-137</b>
LFA operation .....	5-139
Warning message.....	5-140
Limitations of the system.....	5-142
<b>Highway Driving Assist (HDA) .....</b>	<b>5-144</b>
System Setting and Operation.....	5-144
Warning Message .....	5-147
<b>Rear Cross-traffic Collision Warning (RCCW) .....</b>	<b>5-151</b>
System description .....	5-151
System setting and operation.....	5-151
Warning message and system control .....	5-153
Detecting Sensor.....	5-155
<b>Special driving conditions.....</b>	<b>5-162</b>
Hazardous Driving Conditions.....	5-162
Rocking the Vehicle .....	5-162
Smooth Cornering.....	5-163
Driving at Night .....	5-163
Driving in the Rain.....	5-163
Driving in Flooded Areas.....	5-164
Highway Driving .....	5-164
<b>Winter driving.....</b>	<b>5-165</b>
Snow or Icy Conditions.....	5-165
Winter Precautions.....	5-165
<b>Vehicle load limit.....</b>	<b>5-168</b>
Tire Loading Information Label.....	5-169
<b>Trailer Towing.....</b>	<b>5-173</b>

## WARNING

### **Carbon monoxide (CO) gas is toxic. Breathing CO can cause unconsciousness and death.**

Engine exhaust contains carbon monoxide which cannot be seen or smelled.

### **Do not inhale engine exhaust.**

If at any time you smell engine exhaust inside the vehicle, open the windows immediately. Exposure to CO can cause unconsciousness and death by asphyxiation.

### **Be sure the exhaust system does not leak.**

The exhaust system should be checked whenever the vehicle is raised to change the oil or for any other purpose. If you hear a change in the sound of the exhaust or if you drive over something that strikes the underneath side of the vehicle, have the exhaust system checked as soon as possible by an authorized HYUNDAI dealer.

### **Do not run the engine in an enclosed area.**

Letting the engine idle in your garage, even with the garage door open, is a hazardous practice. Run the engine only long enough to start the engine and to move the vehicle out of the garage.

### **Avoid idling the engine for prolonged periods with people inside the vehicle.**

If it is necessary to idle the engine for a prolonged period with people inside the vehicle, be sure to do so only in an open area with the air intake set at "Fresh" and fan control set to high so fresh air is drawn into the interior.

### **Keep the air intakes clear.**

To assure proper operation of the ventilation system, keep the ventilation air intakes located in front of the windshield clear of snow, ice, leaves, or other obstructions.

### **If you must drive with the tailgate open:**

Close all windows.

Open instrument panel air vents.

Set the air intake control at "Fresh", the air flow control at "Floor" or "Face", and the fan control set to high.

### BEFORE DRIVING

#### Before Entering the Vehicle

- Be sure all windows, outside mirror(s), and outside lights are clean and unobstructed.
- Remove frost, snow, or ice.
- Visually check the tires for uneven wear and damage.
- Check under the vehicle for any sign of leaks.
- Be sure there are no obstacles behind you if you intend to back up.

#### Before Starting

- Make sure the hood, the tailgate, and the doors are securely closed and locked.
- Adjust the position of the seat and steering wheel.
- Adjust the inside and outside rearview mirrors.
- Verify all the lights work.
- Fasten your seatbelt. Check that all passengers have fastened their seatbelts.
- Check the gauges and indicators in the instrument panel and the messages on the instrument display when the ignition switch is in the ON position.
- Check that any items you are carrying are stored properly or fastened down securely.

#### WARNING

**To reduce the risk of SERIOUS INJURY or DEATH, take the following precautions:**

- **ALWAYS wear your seat belt. All passengers must be properly belted whenever the vehicle is moving. For more information, refer to "Seat Belts" in chapter 2.**
- **Always drive defensively. Assume other drivers or pedestrians may be careless and make mistakes.**
- **Stay focused on the task of driving. Driver distraction can cause accidents.**
- **Leave plenty of space between you and the vehicle in front of you.**



**⚠ WARNING**

**NEVER** drink or take drugs and drive.

Drinking or taking drugs and driving is dangerous and may result in an accident and **SERIOUS INJURY** or **DEATH**.

Drunk driving is the number one contributor to the highway death toll each year. Even a small amount of alcohol will affect your reflexes, perceptions and judgment. Just one drink can reduce your ability to respond to changing conditions and emergencies and your reaction time gets worse with each additional drink.

Driving while under the influence of drugs is as dangerous or more dangerous than driving under the influence of alcohol.

(Continued)

(Continued)

You are much more likely to have a serious accident if you drink or take drugs and drive. If you are drinking or taking drugs, don't drive. Do not ride with a driver who has been drinking or taking drugs. Choose a designated driver or call a taxi.

## IGNITION SWITCH

### Key Ignition Switch (if equipped)

#### WARNING

To reduce the risk of **SERIOUS INJURY** or **DEATH**, take the following precautions:

- **NEVER** allow children or any person who is unfamiliar with the vehicle to touch the ignition switch or related parts. Unexpected and sudden vehicle movement can occur.
- **NEVER** reach through the steering wheel for the ignition switch, or any other control, while the vehicle is in motion. The presence of your hand or arm in this area may cause a loss of vehicle control resulting in an accident.



Whenever the front door is opened, the ignition switch will illuminate, provided the ignition switch is not in the ON position. The light will go off immediately when the ignition switch is turned on or go off after about 30 seconds when the door is closed. (if equipped)

#### WARNING

**NEVER** turn the ignition switch to the **LOCK** or **ACC** position while the vehicle is in motion except in an emergency. This will result in the engine turning off and loss of power assist for the steering and brake systems. This may lead to loss of directional control and braking function, which could cause an accident.

**Before leaving the driver's seat, always make sure the shift lever is in P (Park) position, apply the parking brake, and turn ignition switch to the LOCK position.**

**Unexpected vehicle movement may occur if these precautions are not followed.**

#### **NOTICE**

**Never use aftermarket keyhole covers. This may generate start-up failure due to communication failure**

### Key ignition switch positions

Switch Position	Action	Notice
<b>LOCK</b>	To turn the ignition switch to the LOCK position, push the key in at the ACC position and turn the key towards the LOCK position. The ignition key can be removed in the LOCK position. (The shift lever must be in the P (Park) position)	
<b>ACC</b>	Some of the electrical accessories are usable. The steering wheel unlocks.	
<b>ON</b>	This is the normal key position when the vehicle has started. All features and accessories are usable. The warning lights can be checked when you turn the ignition switch from ACC to ON.	Do not leave the ignition switch in the ON position when the vehicle is not in the ready (  ) mode to prevent the battery from discharging.
<b>START</b>	To start the vehicle, turn the ignition switch to the START position. The switch returns to the ON position when you let go of the key.	The engine will crank until you release the key.

### Starting the vehicle

#### WARNING

Always wear appropriate shoes when operating your vehicle.

Unsuitable shoes, such as high heels, ski boots, sandals, flip-flops, etc., may interfere with your ability to use the brake and accelerator pedals.

1. Make sure the parking brake is applied.
2. Make sure the shift lever is in P (Park).
3. Depress the brake pedal.
4. Turn the ignition switch to the START position. Hold the key (maximum of 10 seconds) until the ready () indicator comes on and release it.

#### Information

- Do not wait for the engine to warm up while the vehicle remains stationary. Start driving at moderate engine speeds. (Steep accelerating and decelerating should be avoided.)
- Whether the engine is cold or warm, always start the vehicle with your foot on the brake pedal. Do not depress the accelerator while starting the vehicle. Do not race the engine while warming it up.

#### **NOTICE**

**To prevent damage to the vehicle:**

- Do not hold the ignition key in the START position for more than 10 seconds. Wait 5 to 10 seconds before trying again.
- Do not push or tow your vehicle to start the vehicle.

### Engine Start/Stop Button



Whenever the front door is opened, the Engine Start/Stop button will illuminate and will go off 30 seconds after the door is closed.

#### WARNING

To reduce risk of serious injury or death, NEVER allow children or any person who is unfamiliar with the vehicle to touch the Engine Start/Stop button or related parts. Unexpected and sudden vehicle movement can occur.

## WARNING

To turn the vehicle off in an emergency:

Press and hold the Engine Start/Stop button for more than two seconds OR rapidly press and release the Engine Start/Stop button three times (within three seconds).

If the vehicle is still moving, you can restart the engine without depressing the brake pedal by pressing the Engine Start/Stop button with the shift lever in the N (Neutral) position.

## WARNING

- NEVER press the Engine Start/Stop button while the vehicle is in motion except in an emergency. This will result in the engine turning off and loss of power assist for the steering and brake systems.

This may lead to loss of directional control and braking function, which could cause an accident.



- Before leaving the driver's seat, always make sure the shift lever is in the P (Park) position, set the parking brake, press the Engine Start/Stop button to the OFF position, and take the Smart Key with you. Unexpected vehicle movement may occur if these precautions are not followed.



(Continued)

(Continued)

- NEVER reach through the steering wheel for the Engine Start/Stop button or any other control while the vehicle is in motion. The presence of your hand or arm in this area may cause a loss of vehicle control resulting in an accident.

**Engine Start/Stop Button Positions**

Button Position	Action	Notice
<p style="text-align: center;"><b>OFF</b></p> 	<p>To turn off the vehicle, press the Engine Start/Stop button with shift lever in P (Park). When you press the Engine Start/Stop button without the shift lever in P (Park), the Engine Start/Stop button does not turn to the OFF position, but turns to the ACC position.</p>	
<p style="text-align: center;"><b>ACC</b></p> 	<p>Press the Engine Start/Stop button when the button is in the OFF position without depressing the brake pedal. Some of the electrical accessories are usable.</p>	<p>If you leave the Engine Start/Stop button in the ACC position for more than one hour, the battery power will turn off automatically to prevent the battery from discharging.</p>



Button Position	Action	Notice
<p data-bbox="254 250 299 274"><b>ON</b></p> 	<p data-bbox="417 256 943 340">Press the Engine Start/Stop button while it is in the ACC position without depressing the brake pedal.</p> <p data-bbox="417 350 943 404">The warning lights can be checked before the vehicle is started.</p>	<p data-bbox="959 256 1500 370">Do not leave the Engine Start/Stop button in the ON position when the vehicle is not in the ready (  ) mode to prevent the battery from discharging.</p>
<p data-bbox="232 557 320 581"><b>START</b></p> 	<p data-bbox="417 563 943 647">To start the vehicle, depress the brake pedal and press the Engine Start/Stop button with the shift lever in the P (Park) position.</p>	<p data-bbox="959 563 1500 677">If you press the Engine Start/Stop button without depressing the brake pedal, the vehicle does not start and the Engine Start/Stop button changes as follows:</p> <p data-bbox="959 687 1290 711"><b>OFF → ACC → ON → OFF</b></p> <p data-bbox="959 721 1500 835">However, the vehicle may start if you depress the brake pedal within 0.5 second after pressing the Engine Start/Stop button from the OFF position.</p>

### Starting the Vehicle

#### WARNING

- Always wear appropriate shoes when operating your vehicle. Unsuitable shoes, such as high heels, ski boots, sandals, flip-flops, etc., may interfere with your ability to use the brake and accelerator pedals.
- Do not start the vehicle with the accelerator pedal depressed. The vehicle can move and lead to an accident.
- Wait until the engine rpm is normal. The vehicle may suddenly move if the brake pedal is released when the rpm is high.

#### Information

- The vehicle will start by pressing the Engine Start/Stop button, only when the smart key is in the vehicle.
- Even if the smart key is in the vehicle, if it is far away from the driver, the vehicle may not start.
- When the Engine Start/Stop button is in the ACC or ON position, if any door is open, the system checks for the smart key. If the smart key is not in the vehicle, the " " indicator will blink and the warning "Key not in vehicle" will come on and if all doors are closed, the chime will also sound for about 5 seconds. Keep the smart key in the vehicle when in the ACC position or if the vehicle is in the ready ( ) mode.

1. Always carry the smart key with you.
2. Make sure the parking brake is applied.
3. Make sure the shift lever is in P (Park).
4. Depress the brake pedal.
5. Press the Engine Start/Stop button. If the vehicle starts, the " " indicator will come on.

#### Information

- Do not wait for the engine to warm up while the vehicle remains stationary. Start driving at moderate engine speeds. (Aggressive accelerating and decelerating should be avoided.)
- Always start the vehicle with your foot on the brake pedal. Do not depress the accelerator while starting the vehicle. Do not rev the engine while warming it up.



### NOTICE

To prevent damage to the vehicle:

- If the "  " indicator turns off while you are in motion, do not attempt to shift to the P (Park) position.

If traffic and road conditions permit, you may put the shift lever in the N (Neutral) position while the vehicle is still moving and press the Engine Start/Stop button in an attempt to restart the engine.

- Do not push or tow your vehicle to start the vehicle.

### NOTICE

To prevent damage to the vehicle:

When the stop lamp switch fuse is blown, you can't start the engine normally. Replace the fuse with a new one. If you are not able to replace the fuse, you can start the vehicle by pressing and holding the Engine Start/Stop button for 10 seconds with the Engine Start/Stop button in the ACC position.

Do not press the Engine Start/Stop button for more than 10 seconds except when the stop lamp switch fuse is blown.

For your safety always depress the brake pedal before starting the vehicle.



### Information

If the smart key battery is weak or the smart key does not work correctly, you can start the engine by pressing the Engine Start/Stop button with the smart key in the direction of the picture above.

### Turning Off the Vehicle

1. Depress the brake pedal fully.
2. Shift to P (Park).
3. Apply the parking brake.
4. Press the Engine Start/Stop button to turn the vehicle off.
5. Make sure the " " indicator light on the instrument cluster is turned off.

#### CAUTION

**If the " " indicator light on the instrument cluster is still on, the vehicle is not turned off and can move when the gear is in any position except P (Park).**

## DUAL CLUTCH TRANSMISSION

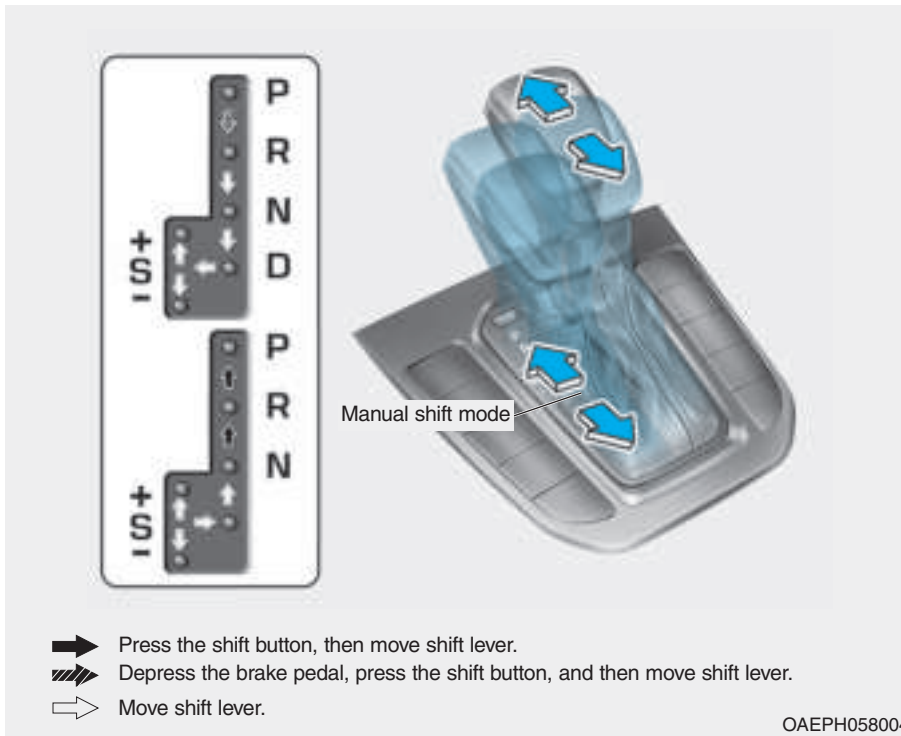

※ To move the shift lever from/to P (Parking) or between R (Reverse) and D (Drive), you must depress the brake pedal for the vehicle to stand still.

### Dual Clutch Transmission Operation

The dual clutch transmission has six forward speeds and one reverse speed.

The individual speeds are selected automatically when the shift lever is in the D (Drive) position.

- The dual clutch transmission can be thought of as an automatically shifting manual transmission. It gives the driving feel of a manual transmission, yet provides the ease of a fully automatic transmission.
- When D (Drive) is selected, the transmission will automatically shift through the gears similar to a conventional automatic transmission. Unlike a traditional automatic transmission, the gear shifting can sometimes be felt and heard as the actuators engage the clutches and the gears are selected.
- The dual clutch transmission incorporates a dry-type dual clutch mechanism, which allows for better acceleration performance and increased fuel efficiency while driving.

But it differs from a conventional automatic transmission because it does not incorporate a torque converter. Instead, the transition from one gear to the next is managed by clutch slip, especially at lower speeds.

As a result, shifts are sometimes more noticeable, and a light vibration can be felt as the transmission shaft speed is matched with the engine shaft speed. This is a normal condition of the dual clutch transmission.

- The dry-type clutch transfers torque more directly and provides a direct-drive feeling which may feel different from a conventional automatic transmission. This may be more noticeable when launching the vehicle from a stop or when traveling at low, stop-and-go vehicle speeds.
- When rapidly accelerating from a lower vehicle speed, the engine rpm may increase dramatically as a result of clutch slip as the dual clutch transmission selects the correct gear. This is a normal condition.
- When accelerating from a stop on an incline, press the accelerator smoothly and gradually to avoid any shudder feeling or jerkiness.
- When traveling at a lower vehicle speed, if you release the accelerator pedal quickly, you may feel engine braking before the transmission changes gears. This engine braking feeling is similar to operating a manual transmission at low speed.
- When driving downhill, you may wish to move the gear shift lever to Manual Shift mode and downshift to a lower gear in order to control your speed without using the brake pedal excessively.
- When you turn the vehicle on and off, you may hear clicking sounds as the system goes through a self-test. This is a normal sound for the dual clutch transmission.
- During the first 1,500 km (1,000 miles), you may feel that the vehicle may not be smooth when accelerating at low speed. During this break-in period, the shift quality and performance of your new vehicle is continuously optimized.

### WARNING

**To reduce the risk of serious injury or death:**

- **ALWAYS check the surrounding areas near your vehicle for people, especially children, before shifting a vehicle into D (Drive) or R (Reverse).**
- **Before leaving the driver's seat, always make sure the shift lever is in the P (Park) position, then set the parking brake, and place the ignition switch in the LOCK/OFF position. Unexpected and sudden vehicle movement can occur if these precautions are not followed.**
- **Do not use aggressive engine braking (shifting from a higher gear to a lower gear) on slippery roads. This could cause the tires to slip and may result in an accident.**

**NOTICE**

- Always come to a complete stop before shifting into D (Drive) or R (Reverse).
- Do not put the shift lever in N (Neutral) while driving.
- To avoid damage to your transmission, do not try to accelerate in R (Reverse) or any forward gear position with the brakes applied.
- When stopped on a slope, do not hold the vehicle with accelerator pedal. Use the brake pedal or the parking brake.

**WARNING**

If the transmission cannot shift into Drive or Reverse, the position indicator D or R) on the cluster will blink. We recommend that you contact an authorized Hyundai dealer to have the system checked.

**LCD display for transmission temperature and warning message**

This warning message is displayed when vehicle is driven slowly on a grade and the vehicle detects that the brake pedal is not applied.

**Steep Grade**

Driving up hills or on steep grades:

- To hold the vehicle on an incline use the foot brake or the parking brake.
- When in stop-and-go traffic on an incline, allow a gap to form ahead of you before moving the vehicle forward. Then hold the vehicle on the incline with the foot brake.

- If the vehicle is held or creeping forward on an incline by applying the accelerator pedal, the clutch and transmission may overheat which can result in damage. At this time, a warning message will appear on the LCD display.
- If the LCD display warning is active, the foot brake must be applied.
- Ignoring the warnings can lead to damage to the transmission.

**NOTICE**

To hold the vehicle on a hill use the foot brake or the parking brake. If the vehicle is held by applying the accelerator pedal on a hill, the clutch and transmission will be overheated resulting in damage.



### Transmission High Temperature

- Under certain conditions, such as repeated stop-and-go launches on steep grades, sudden take off or acceleration, or other harsh driving conditions, the transmission clutch temperatures will increase excessively.
- When the clutch temperatures are too high, the "Transmission temp is high! Stop safely" warning message will appear on the LCD display, a chime will sound, and the transmission shifting may not be smooth.

- If this occurs, pull over to a safe location, stop the vehicle with the engine running, apply the brakes and shift the vehicle to P (Park), and allow the transmission to cool.
- If you ignore this warning, the driving condition may become worse. You may experience abrupt shifts, frequent shifts, or jerkiness.
- When the message "Trans cooled. Resume driving." appears you can continue to drive your vehicle.
- When possible, drive the vehicle smoothly.



### Transmission Overheated

- If the vehicle continues to be driven and the clutch temperatures reach the maximum temperature limit, the "Transmission Hot! Park with engine on" warning will be displayed. When this occurs the clutch is disabled until the clutch cools to normal temperatures.

- The warning will display a time to wait for the transmission to cool.
- If this occurs, pull over to a safe location, stop the vehicle with the engine running, apply the brakes and shift the vehicle to P (Park), and allow the transmission to cool.
- When the message "Trans cooled. Resume driving." appears you can continue to drive your vehicle.
- When possible, drive the vehicle smoothly.

If any of the warning messages in the LCD display continue to blink, for your safety, contact an authorized HYUNDAI dealer and have the system checked.

## Shift Lever Position

### P (Park)

Always come to a complete stop before shifting into P (Park).

To shift from P (Park), you must depress firmly on the brake pedal and make sure your foot is off the accelerator pedal.

**If you have done all of the above and still cannot shift the lever out of P (Park), see "Shift-Lock Release" in this section.**

The shift lever must be in P (Park) before turning the vehicle off.

## WARNING

- **Shifting into P (Park) while the vehicle is in motion may cause you to lose control of the vehicle.**
- **After the vehicle has stopped, always make sure the shift lever is in P (Park), apply the parking brake, and turn the vehicle off.**
- **When parking on an incline, place the shift lever in Park and apply the parking brake to prevent the vehicle from rolling downhill.**
- **Do not use the P (Park) position in place of the parking brake.**

### R (Reverse)

Use this position to drive the vehicle backward.

#### NOTICE

**Always come to a complete stop before shifting into or out of R (Reverse); you may damage the transmission if you shift into R (Reverse) while the vehicle is in motion.**

### N (Neutral)

The wheels and transmission are not engaged.

Always depress the brake pedal when you are shifting from N (Neutral) to another gear.

#### WARNING

**Do not drive with the shift lever in N (Neutral). The engine brake will not work and lead to an accident.**

#### WARNING

**Do not shift into gear unless your foot is firmly on the brake pedal. Shifting into gear when the engine is running at high speed can cause the vehicle to move very rapidly. You could lose control of the vehicle and hit people or objects.**

### D (Drive)

This is the normal driving position. The transmission will automatically shift through a six-gear sequence, providing the best fuel economy and power.

For extra power when passing another vehicle or driving uphill depress the accelerator pedal further until you feel the transmission downshift to a lower gear.

To stop the vehicle during driving, please press brake pedal fully to prevent unintended movement.

If you drive the vehicle with the shift lever in D (Drive), the vehicle will automatically change to ECO mode. The  indicator will illuminate on the instrument cluster.

When driving in ECO mode, the vehicle improves fuel efficiency for eco-friendly driving.

### S (Sport)

If you drive the vehicle with the shift lever in S (Sport), the vehicle will automatically change to SPORT mode. The  indicator will illuminate on the instrument cluster.

When driving in SPORT mode, the vehicle provides sporty but firm riding.

#### Information

**In SPORT mode, the fuel efficiency may decrease.**



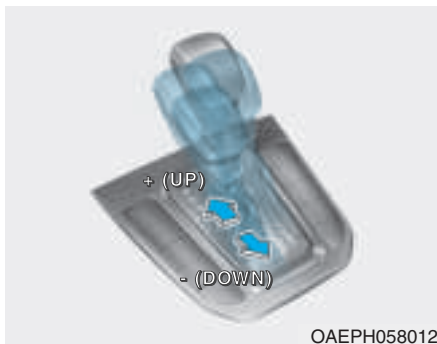

### Manual shift mode

Whether the vehicle is stationary or in motion, manual shift mode is selected by pushing the shift lever from the D (Drive) position into the manual gate. To return to D (Drive) range operation, push the shift lever back into the main gate.

In Manual Shift Mode, moving the shift lever backwards and forwards will allow you to select the desired range of gears for the current driving conditions.

- + (Up) : Push the lever forward once to shift up one gear.
- (Down) : Pull the lever backwards once to shift down one gear.

### **i** Information

- **Only the six forward gears can be selected. To reverse or park the vehicle, move the shift lever to the R (Reverse) or P (Park) position as required.**
- **Downshifts are made automatically when the vehicle slows down. When the vehicle stops, 1<sup>st</sup> gear is automatically selected.**
- **When the engine rpm approaches the red zone the transmission will upshift automatically.**
- **If the driver presses the lever to + (Up) or - (Down) position, the transmission may not make the requested gear change if the next gear is outside of the allowable engine rpm range. The driver must execute upshifts in accordance with road conditions, taking care to keep the engine rpms below the red zone.**

### **Shift-lock system**

For your safety, the dual clutch transmission has a shift-lock system which prevents shifting the transmission from P (Park) into R (Reverse) unless the brake pedal is depressed.

To shift the transmission from P (Park) into R (Reverse):

1. Depress and hold the brake pedal.
2. Start the vehicle or place the ignition switch in the ON position.
3. Move the shift lever.

### Shift-lock release

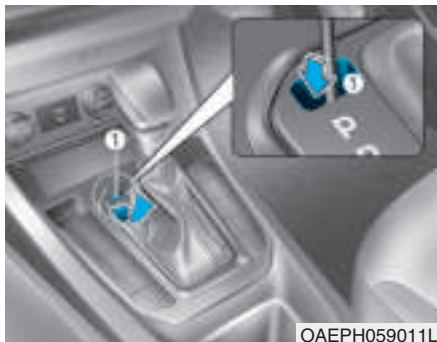

If the shift lever cannot be moved from the P (Park) position into R (Reverse) position with the brake pedal depressed, continue depressing the brake, and then do the following:

1. Place the ignition switch in the LOCK/OFF position.
2. Apply the parking brake.
3. Carefully remove the cap (1) covering the shift-lock release access hole.
4. Insert a tool (e.g. flathead screwdriver) into the access hole and press down on the tool.

5. Move the shift lever.
6. Remove the tool from the shift-lock override access hole then install the cap.

If you need to use the shift-lock release, have your vehicle inspected by an authorized HYUNDAI dealer immediately.

### Parking

Always come to a complete stop and continue to depress the brake pedal. Move the shift lever into the P (Park) position, apply the parking brake, and place the ignition switch in the LOCK/OFF position. Take the key with you when exiting the vehicle.

#### WARNING

**When you stay in the vehicle with the engine running, be careful not to depress the accelerator pedal for a long period of time. The engine or exhaust system may overheat and start a fire.**

**The exhaust gas and the exhaust system are very hot. Keep away from the exhaust system components.**

**Do not stop or park over flammable materials, such as dry grass, paper or leaves. They may ignite and cause a fire.**

---

## Good Driving Practices

- Never move the shift lever from P (Park) or N (Neutral) to any other position with the accelerator pedal depressed.
- Never move the shift lever into P (Park) when the vehicle is in motion.

Be sure the vehicle is completely stopped before you attempt to shift into R (Reverse) or D (Drive).

- Do not move the shift lever to N (Neutral) when driving. If the shift lever is moved to N (Neutral) while driving, the vehicle loses the ability to provide engine braking. Doing so may increase the risk of an accident. Also, moving the shift lever back to D (Drive) while the vehicle is moving may severely damage the transmission.
- Do not drive with your foot resting on the brake pedal. Even light, but consistent pedal pressure can result in the brakes overheating, brake wear and possibly even brake failure.
- Depressing both accelerator and brake pedals at the same time can trigger logic for engine power reduction to assure vehicle deceleration. Vehicle acceleration will resume after the brake pedal is released.
- When driving in Manual Shift Mode, slow down before shifting to a lower gear. Otherwise, the lower gear may not be engaged if the engine rpms are outside of the allowable range.
- Always apply the parking brake when leaving the vehicle. Do not depend on placing the transmission in P (Park) to keep the vehicle from moving.
- Exercise extreme caution when driving on a slippery surface. Be especially careful when braking, accelerating or shifting gears. On a slippery surface, an abrupt change in vehicle speed can cause the drive wheels to lose traction and may cause loss of vehicle control resulting in an accident.

- Optimum vehicle performance and economy is obtained by smoothly depressing and releasing the accelerator.

 **WARNING**

To reduce the risk of **SERIOUS INJURY** or **DEATH**:

- **ALWAYS** wear your seatbelt. In a collision, an unbelted occupant is significantly more likely to be seriously injured or killed than a properly belted occupant.
- Avoid high speeds when cornering or turning.
- Do not make quick steering wheel movements, such as sharp lane changes or fast, sharp turns.
- The risk of rollover is greatly increased if you lose control of your vehicle at highway speeds.
- Loss of control often occurs if two or more wheels drop off the roadway and the driver over steers to reenter the roadway.

(Continued)

(Continued)

- In the event your vehicle leaves the roadway, do not steer sharply. Instead, slow down before pulling back into the travel lanes.
- **HYUNDAI** recommends you follow all posted speed limits.

## PADDLE SHIFTER (IF EQUIPPED)

### Regen B mode



The paddle shifter is used to adjust the regenerative braking level from 0 to 3 when the vehicle is in ECO mode.

- Left side (-): Increases the regenerative braking level and deceleration.
- Right side (+): Decreases the regenerative braking level and deceleration.

### CAUTION

Operating the paddle shifter will not enable the vehicle to come to a complete stop. Depress the brake pedal to stop the vehicle completely.

### Information

- The Regen B function starts from level 0 when starting your vehicle and the system works only in D (Drive).
- The Regen B function is cancelled when the vehicle is shifted to the P (Park), R (Reverse), N(Neutral) and Sport mode.
- The Regen B function is cancelled while ABS (Anti-lock Braking System) and ESC (Electronic Stability Control) is operating.
- Deceleration differences occur even in the same system level according to driving speeds (You may recognize significant deceleration differences during city driving but you may not feel differences while high speed driving.)

### Information

The paddle shifter does not operate when:

- Both paddle shifters are pulled at the same time.
- The vehicle is decelerating by depressing the brake pedal.
- The Cruise Control system or Smart Cruise Control system is activated.

### WARNING

The Regen B function may not operate depending on the motor's chargeable state (over charged, high temperature or low temperature). Always pay attention to road and driving conditions, while driving. If necessary, depress the brake pedal to reduce your driving speed.

■ Type A

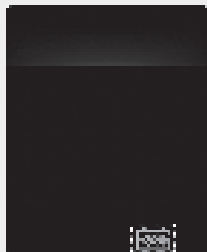

OAEPH058603

■ Type B



OAEPH058602

The selected regenerative braking level is displayed on the instrument cluster.

Initial setting of the regenerative braking level and adjustable range vary according to the selected drive mode.

Drive mode	Adjustable range	Function
ECO	+	Decrease the regenerative braking levels
	-	Increase the regenerative braking levels
SPORT	+	Manual shift [+]
	-	Manual shift [-]



**Regeneration unavailable.  
Battery full**

When the state of charge (SOC) level is too high, the Regen B function will be limited. Drive your vehicle for a while and try to operate the function again.



**Regeneration conditions not met**

The warning messages may appear when:

- The motor or battery temperature is high or low, or there is a problem with the battery or transmission.
- The Regen B function activates while ABS, Cruise Control or Smart Cruise Control is operating.

If the warning message appears, the function operation is limited temporarily. Drive your vehicle for a while and try to operate the system again.

## COASTING GUIDE (IF EQUIPPED)

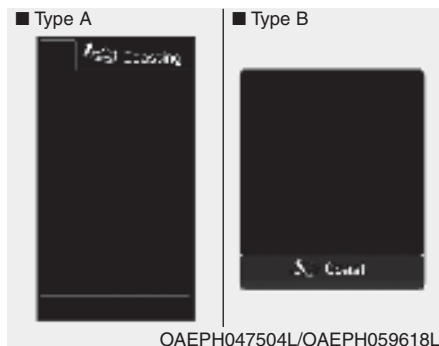

The coasting guide function informs the driver when to take the foot off from the accelerator by anticipating a decelerating event\* based on the analysis of driving routes and road conditions of the navigation. It encourages the driver to remove foot from the pedal and allow coasting down the road with EV motor only. This helps prevent unnecessary fuel consumption and increases fuel efficiency.

### **i** Information

Example of a deceleration event is making a right/left turn, driving through a rotary, entering or exiting a highway (freeway), etc.

The driver can activate the coasting guide by placing the ignition switch in the ON position and by selecting:

- User settings

User Settings → Convenience → Coasting Guide

For the explanation of the system, press and hold the [OK] button.

### **Operation conditions**

To activate the system, take the following procedures. Enter your destination information on the navigation and select the driving route. Have the vehicle in ECO mode by driving the vehicle in D (Drive). Then, satisfy the following.

- The operational speed is above 40 km/h (25 mph).

### **i** Information

The operating speed may vary due to difference between instrument cluster and navigation effected by tire inflation level.

### **i** Information

Coasting guide is only a supplemental system to assist with fuel-efficient driving. Thus, the operating conditions may be different in accordance with traffic/road conditions (i.e. driving in a traffic jam, driving on a slope, driving on a curve). Thus, take the actual driving conditions into consideration, such as distances from the vehicles ahead/behind, while referring to the coasting guide system as guidance.



## BRAKING SYSTEM

### Power Brakes

Your vehicle has power-assisted brakes that adjust automatically through normal usage.

If the vehicle is not in the ready (🚗) mode or the vehicle is turned off while driving, the power assist for the brakes will not work. You can still stop your vehicle by applying greater force to the brake pedal than typical. The stopping distance, however, will be longer than with power brakes.

When the vehicle is not in the ready (🚗) mode, the reserve brake power is partially depleted each time the brake pedal is applied. Do not pump the brake pedal when the power assist has been interrupted.

Pump the brake pedal only when necessary to maintain steering control on slippery surfaces.

### WARNING

Take the following precautions:

- Do not drive with your foot resting on the brake pedal. This will create abnormal high brake temperatures, excessive brake lining and pad wear, and increased stopping distances.
- When descending down a long or steep hill, move the gear shift lever to Manual Shift Mode and manually downshift to a lower gear in order to control your speed without using the brake pedal excessively. Applying the brakes continuously will cause the brakes to overheat and could result in a temporary loss of braking performance.

(Continued)

(Continued)

- Wet brakes may impair the vehicle's ability to safely slow down; the vehicle may also pull to one side when the brakes are applied. Applying the brakes lightly will indicate whether they have been affected in this way. Always test your brakes in this fashion after driving through deep water. To dry the brakes, lightly tap the brake pedal to heat up the brakes while maintaining a safe forward speed until brake performance returns to normal. Avoid driving at high speeds until the brakes function correctly.

### NOTICE

Do not depress the brake pedal continuously without the " " indicator ON. The battery may be discharged.

- Some noise and vibration may occur during braking. This is normal.
- In below cases, some electric brake pump noise and motor vibration may occur temporarily. This is normal operation.
  - When the pedal is depressed very quickly
  - When the pedal is depressed multiple times in short intervals
  - When the ABS function is activated during braking

### Disc Brake Wear Indicator

When your brake pads are worn and new pads are required, you will hear a high pitched warning sound from your front or rear brakes. You may hear this sound come and go or it may occur whenever you depress the brake pedal.

Note that some driving conditions or climates may cause a brake squeal when you first apply (or lightly apply) the brakes. This is normal and does not indicate a problem with your brakes.

### NOTICE

To avoid costly brake repairs, do not continue to drive with worn brake pads.

### **i** Information

Always replace brake pads as complete front or rear axle sets.

### Parking Brake (foot type, if equipped)

Always set the parking brake before leaving the vehicle. To apply the parking brake:



Firmly depress the brake pedal.

Depress the parking brake pedal down as far as possible.

## WARNING

To reduce the risk of **SERIOUS INJURY** or **DEATH**, do not operate the parking brake while the vehicle is moving except in an emergency situation. It could damage the brake system and lead to an accident.

To release:



Firmly depress the brake pedal.

Depress the parking brake pedal down and it will release automatically.

If the parking brake does not release or does not release all the way, have your vehicle checked by an authorized HYUNDAI dealer.

## WARNING

- Whenever leaving the vehicle or parking, always come to a complete stop and continue to depress the brake pedal. Move the shift lever into P (Park) position, then apply the parking brake, and place the ignition switch in the LOCK/OFF position.

Vehicles with the parking brake not fully engaged are at risk for moving inadvertently and causing injury to yourself or others.

- **NEVER** allow anyone who is unfamiliar with the vehicle to touch the parking brake. If the parking brake is released unintentionally, serious injury may occur.
- Only release the parking brake when you are seated inside the vehicle with your foot firmly on the brake pedal.

### NOTICE

- **Do not apply the accelerator pedal while the parking brake is engaged. If you depress the accelerator pedal with the parking brake engaged, warning will sound. Damage to the parking brake may occur.**
- **Driving with the parking brake on can overheat the braking system and cause premature wear or damage to brake parts. Make sure the parking brake is released and the Brake Warning Light is off before driving.**



Check the Parking Brake Warning Light by placing the ignition switch to the ON position (vehicle not in the ready (  ) mode).

This light will be illuminated when the parking brake is applied with the ignition switch in the START or ON position.

Before driving, be sure the parking brake is released and the Brake Warning Light is OFF.

If the Parking Brake Warning Light remains on after the parking brake is released while the vehicle is in the ready (  ) mode, there may be a malfunction in the brake system. Immediate attention is necessary.

If at all possible, cease driving the vehicle immediately. If that is not possible, use extreme caution while operating the vehicle and only continue to drive the vehicle until you can reach a safe location.

## Electronic Parking Brake (EPB) (if equipped)

### Applying the parking brake



### To apply EPB (Electronic Parking Brake):

1. Depress the brake pedal.
2. Pull up the EPB switch.

Make sure the Parking Brake Warning Light (  ) comes on.

## WARNING

To reduce the risk of **SERIOUS INJURY** or **DEATH**, do not operate the EPB while the vehicle is moving except in an emergency situation. It could damage the brake system and lead to an accident.

### Releasing the parking brake



#### To release EPB (Electronic Parking Brake):

- Place the ignition switch in the ON position.
- Depress the brake pedal.
- Press the EPB switch.

Make sure the Parking Brake Warning Light () goes off.

#### To release EPB (Electronic Parking Brake) automatically:

- Shift lever in P (Park)

With the vehicle is in the ready () mode, depress the brake pedal and shift out of P (Park) to R (Rear) or D (Drive).

- Shift lever in N (Neutral)

With the vehicle is in the ready () mode, depress the brake pedal and shift out of N (Neutral) to R (Rear) or D (Drive).

- Satisfy the following conditions

1. Ensure seat belts are fastened and the doors, hood and tailgate are closed.
2. With vehicle in the ready () mode, depress the brake pedal and shift out of P (Park) to R (Reverse), D (Drive) or Manual shift mode.
3. Depress the accelerator pedal.

Make sure the Parking Brake Warning light () goes off.

### **i** Information

- For your safety, you can engage EPB even though the ignition switch is in the OFF position (only if battery power is available), but you cannot release it.
- For your safety, depress the brake pedal and release the parking brake manually with the EPB switch when you drive downhill or when backing up the vehicle.

### **NOTICE**

- If the parking brake warning light is still on even though EPB has been released, we recommend that the system be checked by an authorized HYUNDAI dealer.
- Do not drive your vehicle with the EPB applied. It may cause excessive brake pad and brake rotor wear.

**EPB (Electronic Parking Brake) may be automatically applied when:**

- It is requested by other systems
- The driver turns the vehicle off while Auto Hold is operating.

### **Warning messages**

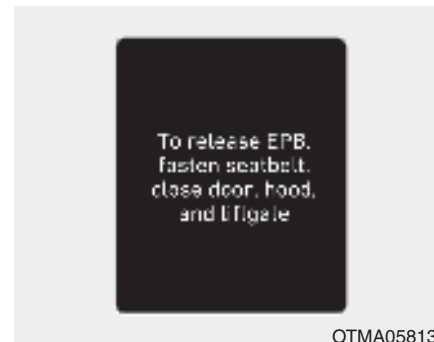

**To release EPB, fasten seatbelt, close door, hood and liftgate**

- When you try to drive with EPB applied, a warning will sound and a message will appear.
- If the driver's seat belt is unfastened and the engine hood or liftgate is opened, a warning will sound and a message will appear.
- When there is a problem with the vehicle, a warning may sound and a message may appear.

If the situation occurs, depress the brake pedal and release EPB by pressing the EPB switch.

## WARNING

- Whenever leaving the vehicle or parking, always come to a complete stop and continue to depress the brake pedal.

Move the shift lever into the P (Park) position, press the EPB switch, and set the ignition switch to the OFF position.

Take the key with you when exiting the vehicle.

Vehicles not fully engaged in P (Park) with the parking brake set are at risk for moving inadvertently and causing injury to yourself or others.

- NEVER allow anyone who is unfamiliar with the vehicle to touch the EPB switch. If EPB is released unintentionally, serious injury may occur.
- Only release EPB when you are seated inside the vehicle with your foot firmly on the brake pedal.

## NOTICE

- Do not apply the accelerator pedal while the parking brake is engaged. If you depress the accelerator pedal with the EPB engaged, a warning will sound and a message will appear. Damage to the parking brake may occur.
- Driving with the parking brake on can overheat the braking system and cause premature wear or damage to brake parts. Make sure EPB is released and the Parking Brake Warning Light is off before driving.

## Information

- A clicking sound may be heard while operating or releasing the EPB. These conditions are normal and indicate that EPB is functioning properly.
- When leaving your keys with a parking attendant or assistant, make sure to inform him/her how to operate the EPB.

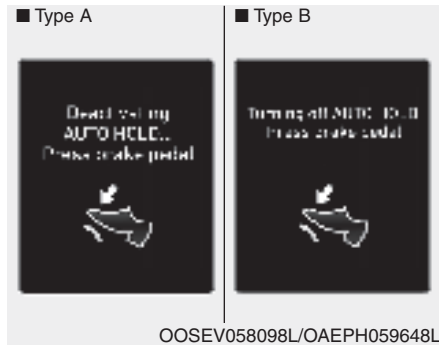

### Deactivating AUTO HOLD... Press brake pedal/Turning off AUTO HOLD. Press brake pedal

When the conversion from Auto Hold to EPB is not working properly a warning will sound and a message will appear.



### Parking brake automatically applied

If the EPB is applied while Auto Hold is activated, a warning will sound and a message will appear.

## EPB malfunction indicator

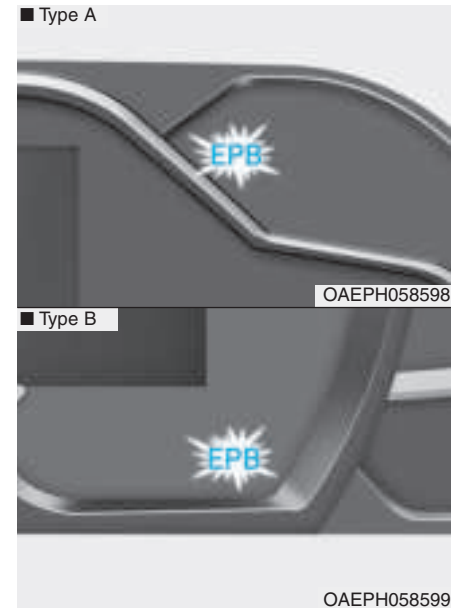

If the EPB malfunction indicator remains on, comes on while driving, or does not come on when the ignition switch is changed to the ON position, this indicates that the EPB may have malfunctioned.



If this occurs, we recommend that the system be checked by an authorized HYUNDAI dealer.

The EPB malfunction indicator may illuminate when the ESC indicator comes on to indicate that ESC is not working properly, but it does not indicate a malfunction of EPB.

#### **NOTICE**

- **If the EPB warning light is still on, we recommend that the system be checked by an authorized HYUNDAI dealer.**
- **If the parking brake warning light does not illuminate or blinks even though the EPB switch was pulled up, EPB may not be applied.**
- **If the parking brake warning light blinks when the EPB warning light is on, press the switch, and then pull it up. Repeat this one more time. If the EPB warning does not go off, we recommend that the system be checked by an authorized HYUNDAI dealer.**

#### **Emergency braking**

If there is a problem with the brake pedal while driving, emergency braking is possible by pulling up and holding the EPB switch. Braking is possible only while you are holding the EPB switch.

#### **⚠ WARNING**

**Do not operate the parking brake while the vehicle is moving except in an emergency situation. It could damage the brake system and lead to a severe accident.**

#### **i Information**

**During emergency braking, the parking brake warning light will illuminate to indicate that the system is operating.**

### NOTICE

If you continuously notice a noise or burning smell when the EPB is used for emergency braking, we recommend that the system be checked by an authorized HYUNDAI dealer.

### When the EPB (Electronic Parking Brake) does not release

If the EPB does not release normally, we recommend that you contact an authorized HYUNDAI dealer by loading the vehicle on a flatbed tow truck and have the system checked.

## AUTO HOLD

The Auto Hold maintains the vehicle in a standstill even though the brake pedal is not depressed after the driver brings the vehicle to a complete stop by depressing the brake pedal.

### To apply:

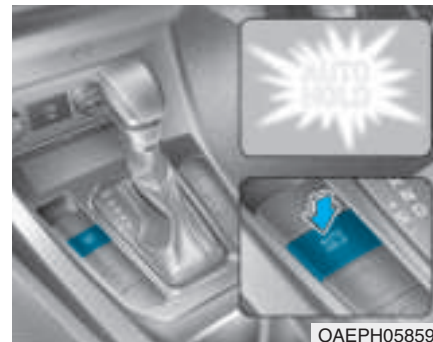

1. With the driver's door and engine hood closed, depress the brake pedal and then press the [AUTO HOLD] switch. The white AUTO HOLD indicator will come on and the system will be in the standby position.



2. When you stop the vehicle completely by depressing the brake pedal, the AUTO HOLD indicator changes from white to green.
3. The vehicle will remain stationary even if you release the brake pedal.
4. If EPB is applied, Auto Hold will be released.

#### **To release:**

- If you depress the accelerator pedal with the shift lever in D (Drive) or Manual shift mode, the Auto Hold will be released automatically and the vehicle will start to move. The indicator changes from green to white.
- If the vehicle is restarted using the cruise control toggle switch (RES+ or SET-) (if equipped) while Auto Hold and cruise control is operating, the Auto Hold will be released regardless of accelerator pedal operation. The AUTO HOLD indicator changes from green to white.

#### **⚠ WARNING**

**When the AUTO HOLD is automatically released by depressing the accelerator pedal, always take a look around your vehicle. Slowly depress the accelerator pedal for a smooth start.**

#### **To cancel :**



1. Depress the brake pedal.
  2. Press the [AUTO HOLD] switch.
- The AUTO HOLD indicator will turn off.

 **WARNING**

To prevent, unexpected and sudden vehicle movement, **ALWAYS** press your foot on the brake pedal to cancel the Auto Hold before you:

- Drive downhill.
- Drive the vehicle in R (Reverse).
- Park the vehicle.

 **Information**

- The Auto Hold does not operate when:
  - The driver's door is opened
  - The engine hood is opened
  - The shift lever is in P (Park)
  - The EPB is applied
- For your safety, the Auto Hold automatically switches to EPB when:
  - The driver's door is opened
  - The engine hood is opened with the shift lever in D (Drive)
  - The vehicle is in a standstill for more than 10 minutes
  - The vehicle is standing on a steep slope
  - The vehicle moved several times

(Continued)

(Continued)

In these cases, the brake warning light comes on, the AUTO HOLD indicator changes from green to white, and a warning sound and a message will appear to inform you that EPB has been automatically engaged. Before driving off again, press depress the pedal, check the surrounding area near your vehicle and release the parking brake manually with the EPB switch.

- While operating Auto Hold, you may hear mechanical noise. However, it is normal operating noise.

## WARNING

- Depress the accelerator pedal slowly when you start the vehicle.
- For your safety, cancel the Auto Hold when you drive downhill, back up the vehicle or park the vehicle.

### NOTICE

If there is a malfunction with the driver's door, engine hood or tailgate open detection system, the Auto Hold may not work properly. We recommend that you contact an authorized HYUNDAI dealer.

### Warning messages



#### Parking brake automatically applied

When the EPB is applied from Auto Hold, a warning will sound and a message will appear.



#### Deactivating AUTO HOLD... Press brake pedal/Turning off AUTO HOLD. Press brake pedal

When the conversion from Auto Hold to EPB is not working properly a warning will sound and a message will appear.

When this message is displayed, the Auto Hold and EPB may not operate. For your safety, depress the brake pedal.



### Press brake pedal to deactivate AUTO HOLD

If you did not apply the brake pedal when you release the Auto Hold by pressing the [AUTO HOLD] switch, a warning will sound and a message will appear.

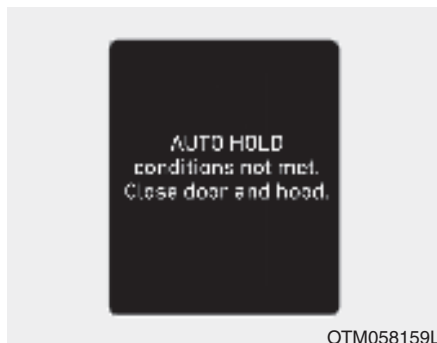

### AUTO HOLD conditions not met. Close door and hood.

When you press the [AUTO HOLD] switch, if the driver's door and engine hood are not closed, a warning will sound and a message will appear on the cluster LCD display.

Press the [AUTO HOLD] switch after closing the driver's door and hood.

## Anti-lock Brake System (ABS)

### WARNING

An Anti-Lock Braking System (ABS) or an Electronic Stability Control (ESC) system will not prevent accidents due to improper or dangerous driving maneuvers. Even though vehicle control is improved during emergency braking, always maintain a safe distance between you and objects ahead of you. Vehicle speeds should always be reduced during extreme road conditions. The braking distance for vehicles equipped with ABS or ESC may be longer than for those without these systems in the following road conditions.

(Continued)

(Continued)

**Drive your vehicle at reduced speeds during the following conditions:**

- **Rough, gravel or snow-covered roads.**
- **On roads where the road surface is pitted or has different surface height.**

**The safety features of an ABS or ESC equipped vehicle should not be tested by high speed driving or cornering. This could endanger the safety of yourself or others.**

ABS is an electronic braking system that helps prevent a braking skid. ABS allows the driver to steer and brake at the same time.

### ***Using ABS***

To obtain the maximum benefit from your ABS in an emergency situation, do not attempt to modulate your brake pressure and do not try to pump your brakes. Depress your brake pedal as hard as possible.

When you apply your brakes under conditions which may lock the wheels, you may hear sounds from the brakes, or feel a corresponding sensation in the brake pedal. This is normal and it means your ABS is active.

ABS does not reduce the time or distance it takes to stop the vehicle.

Always maintain a safe distance from the vehicle in front of you.

ABS will not prevent a skid that results from sudden changes in direction, such as trying to take a corner too fast or making a sudden lane change. Always drive at a safe speed for the road and weather conditions.

ABS cannot prevent a loss of stability. Always steer moderately when braking hard. Severe or sharp steering wheel movement can still cause your vehicle to veer into oncoming traffic or off the road.

On loose or uneven road surfaces, operation of the anti-lock brake system may result in a longer stopping distance than for vehicles equipped with a conventional brake system.

The ABS warning light () will stay on for several seconds after the ignition switch is in the ON position. During that time, the ABS will go through self-diagnosis and the light will go off if everything is normal. If the light stays on, you may have a problem with your ABS. Contact an authorized HYUNDAI dealer as soon as possible.

### WARNING

If the ABS warning light () is on and stays on, you may have a problem with the ABS. Your power brakes will work normally. To reduce the risk of serious injury or death, contact your HYUNDAI dealer as soon as possible.

### CAUTION

When you drive on a road having poor traction, such as an icy road, and apply your brakes continuously, the ABS will be active continuously and the ABS warning light () may illuminate. Pull your car over to a safe place and turn the vehicle off.

Restart the vehicle. If the ABS warning light is off, then your ABS system is normal.

Otherwise, you may have a problem with your ABS system. Contact an authorized HYUNDAI dealer as soon as possible.

### Information

When you jump start your vehicle because of a drained battery, the ABS warning light () may turn on at the same time. This happens because of the low battery voltage. It does not mean your ABS is malfunctioning. Have the battery recharged before driving the vehicle.

## Electronic Stability Control (ESC)



The Electronic Stability Control (ESC) system helps to stabilize the vehicle during cornering maneuvers. ESC checks where you are steering and where the vehicle is actually going. ESC applies braking pressure to any one of the vehicle's brakes and intervenes in the engine management system to assist the driver with keeping the vehicle on the intended path. It is not a substitute for safe driving practices. Always adjust your speed and driving to the road conditions.



## WARNING

Never drive too fast for the road conditions when cornering. The ESC system will not prevent accidents.

Excessive speed in turns, abrupt maneuvers, and hydroplaning on wet surfaces can result in severe accidents.

### **ESC operation**

#### **ESC ON condition**

When the ignition switch is in the ON position, the ESC and the ESC OFF indicator lights illuminate for approximately three seconds. After both lights go off, the ESC is enabled.

### **When operating**



When the ESC is in operation, the ESC indicator light blinks:

- When you apply your brakes under conditions which may lock the wheels, you may hear sounds from the brakes, or feel a corresponding sensation in the brake pedal. This is normal and it means your ESC is active.
- When the ESC activates, the vehicle may not respond to the accelerator as it does under routine conditions.
- If the Cruise Control was in use when the ESC activates, the Cruise Control automatically disengages. The Cruise Control can be reengaged when the road conditions allow. See "Cruise Control System" later in this chapter. (if equipped)
- When moving out of the mud or driving on a slippery road, the engine RPM (revolutions per minute) may not increase even if you press the accelerator pedal deeply. This is to maintain the stability and traction of the vehicle and does not indicate a problem.



### **ESC OFF condition**

To cancel ESC operation :

#### **• State 1**

Press the ESC OFF button briefly. The ESC OFF indicator light and/or message will illuminate. In this state, the traction control function of ESC (engine management) is disabled, but the brake control function of ESC (braking management) still operates.



### • State 2

Press and hold the ESC OFF button continuously for more than 3 seconds. The ESC OFF indicator light and/or message illuminates and a warning chime sounds. In this state, both the traction control function of ESC (engine management) and the brake control function of ESC (braking management) are disabled.

If the ignition switch is placed to the OFF position when ESC is off, ESC remains off. Upon restarting the vehicle, ESC will automatically turn on again.

### Indicator lights

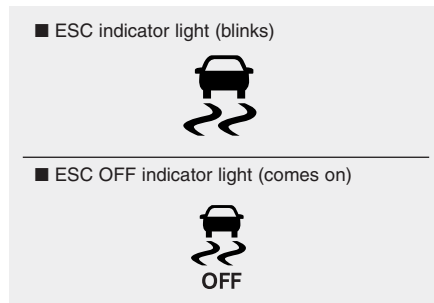

When the ignition switch is placed to the ON position, the ESC indicator light illuminates, then goes off if the ESC system is operating normally.

The ESC indicator light blinks whenever the ESC is operating.

If ESC indicator light stays on, your vehicle may have a malfunction with the ESC system. When this warning light illuminates have your vehicle checked by an authorized HYUNDAI dealer as soon as possible.

The ESC OFF indicator light comes on when ESC is turned off.

### WARNING

**When ESC is blinking, this indicates the ESC is active:**

**Drive slowly and NEVER attempt to accelerate. NEVER turn the ESC off while the ESC indicator light is blinking or you may lose control of the vehicle resulting in an accident.**

### NOTICE

**Driving with wheels and tires with different sizes may cause the ESC system to malfunction. Before replacing tires, make sure all four tires and wheels are the same size. Never drive the vehicle with different sized wheels and tires installed.**

## ESC OFF usage

### When Driving

The ESC OFF mode should only be used briefly to help free the vehicle if stuck in snow or mud by temporarily stopping operation of ESC to maintain wheel torque.

To turn ESC off while driving, press the ESC OFF button while driving on a flat road surface.

### NOTICE

To prevent damage to the transmission:

- **Do not allow wheel(s) of one axle to spin excessively while the ESC, ABS, and parking brake warning lights are displayed. The repairs would not be covered by the vehicle warranty. Reduce engine power and do not spin the wheel(s) excessively while these lights are displayed.**
- **When operating the vehicle on a dynamometer, make sure the ESC is turned off (ESC OFF light illuminated).**

### Information

Turning the ESC off does not affect ABS or standard brake system operation.

## Vehicle Stability Management (VSM)

The Vehicle Stability Management (VSM) is a function of the Electronic Stability Control (ESC) system. It helps the vehicle stay stable when accelerating or braking suddenly on wet, slippery and rough roads where traction over the four tires can suddenly become uneven.

### WARNING

Take the following precautions when using the Vehicle Stability Management (VSM):

- **ALWAYS check the speed and the distance to the vehicle ahead. The VSM is not a substitute for safe driving practices.**
- **Never drive too fast for the road conditions. The VSM system will not prevent accidents. Excessive speed in bad weather, slippery and uneven roads can result in severe accidents.**

### **VSM operation**

#### **VSM ON condition**

The VSM operates when:

- The Electronic Stability Control (ESC) is on.
- Vehicle speed is approximately above 15 km/h (9 mph) on curve roads.
- Vehicle speed is approximately above 20 km/h (12 mph) when the vehicle is braking on rough roads.

#### **When operating**

When you apply your brakes under conditions which may activate the ESC, you may hear sounds from the brakes, or feel a corresponding sensation in the brake pedal. This is normal and it means your VSM is active.

#### **NOTICE**

The VSM does not operate when:

- Driving on a banked road such as gradient or incline.
- Driving rearward.
- ESC OFF indicator light is on.
- EPS (Electric Power Steering) warning light (⊖!) is on or blinks.

#### **⚠ WARNING**

If ESC indicator light (⊖) or EPS warning light (⊖!) stays on or blinks, your vehicle may have a malfunction with the VSM system. When the warning light illuminates, have your vehicle checked by an authorized HYUNDAI dealer as soon as possible.

Driving with wheels and tires with different sizes may cause the ESC system to malfunction. Before replacing tires, make sure all four tires and wheels are the same size. Never drive the vehicle with different sized tires and wheels installed.

## Hill-Start Assist Control (HAC)

The Hill-Start Assist Control (HAC) helps prevent the vehicle from rolling backwards when starting a vehicle from a stop on a hill. The system operates the brakes automatically for approximately 2 seconds and releases the brake after 2 seconds or when the accelerator pedal is depressed.

### WARNING

**Always be ready to depress the accelerator pedal when starting off an incline. The HAC activates only for approximately 2 seconds.**

### Information

- HAC does not operate when the shift lever is in P (Park) or N (Neutral).
- HAC activates even when the ESC (Electronic Stability Control) is off. However, it does not activate, when ESC does not operate normally.

## Good Braking Practices

### WARNING

**Whenever leaving the vehicle or parking, always come to a complete stop and continue to depress the brake pedal. Move the shift lever into P (Park) position, then apply the parking brake, and place the ignition switch in the LOCK/OFF position.**

**Vehicles parked with the parking brake not applied or not fully engaged may roll inadvertently and may cause injury to the driver and others. ALWAYS apply the parking brake before exiting the vehicle.**

Wet brakes can be dangerous! The brakes may get wet if the vehicle is driven through standing water or if it is washed. Your vehicle will not stop as quickly if the brakes are wet. Wet brakes may cause the vehicle to pull to one side.

To dry the brakes, apply the brakes lightly until the braking action returns to normal, taking care to keep the vehicle under control at all times. If the braking action does not return to normal, stop as soon as it is safe to do so and call an authorized HYUNDAI dealer for assistance.

DO NOT drive with your foot resting on the brake pedal. Even light, but constant pedal pressure can result in the brakes overheating, brake wear, and possibly even brake failure.

If a tire goes flat while you are driving, apply the brakes gently and keep the vehicle pointed straight ahead while you slow down. When you are moving slowly enough for it to be safe to do so, pull off the road and stop in a safe location.

Keep your foot firmly on the brake pedal when the vehicle is stopped to prevent the vehicle from rolling forward.

## FORWARD COLLISION-AVOIDANCE ASSIST (FCA) – FRONT VIEW CAMERA ONLY (IF EQUIPPED)

Forward Collision-Avoidance Assist (FCA) system is designed to help detect and monitor the vehicle ahead in the roadway through camera recognition to warn the driver that a collision is imminent, and if necessary, apply emergency braking.

- \* FCA stands for Forward Collision-Avoidance Assist
- \* The camera type FCA system detects the vehicle or pedestrian ahead in the roadway through camera.

### WARNING

**Take the following precautions when using Forward Collision-Avoidance Assist system:**

- **This system is only a supplemental system and it is not intended to, nor does it replace the need for extreme care and attention of the driver. The sensing range and objects detectable by the sensors are limited. Pay attention to the road conditions at all times.**
- **Drive at posted speed limits and accordance to road conditions.**
- **Always drive cautiously to prevent unexpected and sudden situations from occurring. The FCA system may not always stop the vehicle completely and is only intended to help mitigate a collision that is imminent.**

## System setting and activation

### System setting



- Setting Forward Safety function
  - The driver can activate FCA by placing the ignition switch to the ON position and by selecting: 'User settings → Driver assistance → Forward safety'
  - If you select 'Active assist', FCA system activates. FCA produces warning messages and warning alarms in accordance with the collision risk levels. Braking assist will be applied in accordance with the collision risk.

- If you select 'Warning only', FCA system activates and produces only warning alarms in accordance with the collision risk levels. Braking assist will not be applied in this setting.
- If you select 'Off', FCA system deactivates,



The warning light illuminates on the instrument cluster, when you cancel FCA system. The driver can monitor the FCA ON/OFF status on the LCD display. Also, the warning light illuminates when the ESC (Electronic Stability Control) is turned off.

- If the warning light remains ON when FCA is activated, we recommend that you have the system checked by an authorized HYUNDAI dealer.



- Selecting Warning Timing

The driver can select the initial warning activation time from the User Settings in the cluster LCD display by selecting 'User settings → Driver assistance → Warning timing → Normal/Late'.

The options for the initial Forward Collision Warning includes the following:

- Normal:

When this option is selected, the initial Forward Collision Warning is activated sensitively. If you feel the warning activates too early, set the Forward Collision Warning to 'Late'.

Even though, 'Normal' is selected if the front vehicle suddenly stops the initial warning activation time may not seem fast.

- Late:

When this option is selected, the initial Forward Collision Warning is activated later than normal. This setting reduces the amount of distance between the vehicle ahead before the initial warning occurs.

Select 'Late' when traffic is light and when driving speed is slow.

When you accelerate suddenly to the vehicle ahead, the warning may seem to activate earlier even if 'Late' is selected.

### Information

**If you change the warning timing, the warning timing of other systems may change. Always be aware before changing the warning timing.**

### ***Prerequisite for activation***

FCA gets ready to be activated, when 'Active Assist' or 'Warning Only' under Forward Safety is selected in the cluster LCD display, and when the following prerequisites are satisfied.

- ESC (Electronic Stability Control) is on.
- Vehicle speed is over 8 km/h (5 mph). (FCA is only activated within a certain speed range.)
- The system detects a vehicle in front, which may collide with your vehicle. However, FCA may not be activated or may only sound a warning alarm depending on the driving or vehicle conditions.

### **WARNING**

- **To avoid driver distractions, do not attempt to set or cancel FCA while driving the vehicle. Always completely stop the vehicle at a safe place before setting or canceling the system.**
- **FCA automatically activates upon placing the ignition key to the ON position. The driver can deactivate the FCA by canceling the system setting on the cluster LCD display.**
- **FCA automatically deactivates upon canceling the ESC (Electronic Stability Control). When the ESC is canceled, FCA cannot be activated on the LCD display. In this situation, the FCA warning light will illuminate which is normal.**

### **FCA warning message and brake control**

FCA produces warning messages and warning alarms in accordance with the collision risk levels, such as abrupt stopping of the vehicle in front or insufficient braking distance. Also, it controls the brakes in accordance with the collision risk levels.

The driver can select the initial warning activation time in the User Settings on the LCD display. The options for the initial Forward Collision Warning include Late, Normal or Early initial warning time.



### **Collision Warning (First warning)**



This warning message appears on the LCD display with a warning chime. Additionally, some vehicle system intervention occurs to help decelerate the vehicle.

- If FCA detects a vehicle in front, the system operates when your vehicle speed is between 8 km/h (5 mph) and 65 km/h (40 mph). Maximum vehicle speed may decrease depending on the condition of the vehicle ahead and surroundings.
- If FCA detects a pedestrian in front, the system operates when your vehicle speed is between 8 km/h (5 mph) and 65 km/h (40 mph). Maximum vehicle speed may decrease depending on the condition of the pedestrian and surroundings.
- If you select 'Warning only' for the system setting, FCA system activates and produces only warning alarms in accordance with the collision risk levels. You should control the brake directly because FCA system will not control the brake.

### **Emergency braking (Second warning)**



This warning message appears on the LCD display with a warning chime. Additionally, some vehicle system intervention occurs to help decelerate the vehicle.

- If FCA detects a vehicle in front, the system operates when your vehicle speed is above 8 km/h (5 mph) and less than or equal to 65 km/h (40 mph). Maximum vehicle speed may decrease depending on the condition of the vehicle ahead and surroundings.
- If FCA detects a pedestrian in front, the system operates when your vehicle speed is above 8 km/h (5 mph) and less than or equal to 65 km/h (40 mph). Maximum vehicle speed may decrease depending on the condition of the pedestrian and surroundings.
- If you select 'Warning only' for the system setting, FCA system activates and produces only warning alarms in accordance with the collision risk levels. You should control the brake directly because FCA system will not control the brake.

### ***Brake operation***

- In an urgent situation, the braking system enters into the ready status for prompt reaction against the driver's depressing the brake pedal.
- FCA provides additional braking power for optimum braking performance, when the driver depresses the brake pedal.
- The braking control is automatically deactivated, when the driver sharply depresses the accelerator pedal, or when the driver abruptly operates the steering wheel.
- FCA brake control is automatically canceled, when risk factors disappear.

### **CAUTION**

- **The driver should always use extreme caution while operating the vehicle, whether or not there is a warning message or alarm from FCA system.**
- **After the brake control is activated, the driver must immediately depress the brake pedal and check the surroundings. The brake activation by the system lasts for about 2 seconds.**
- **If any other warning sound such as seat belt warning chime is already generated, Forward Collision-Avoidance Assist system warning may not sound.**
- **Playing the vehicle audio system at high volume may prevent occupants from hearing the system warning sounds.**

## WARNING

The braking control cannot completely stop the vehicle nor avoid all collisions. The driver should hold the responsibility to safely drive and control the vehicle.

## WARNING

The FCA system logic operates within certain parameters, such as the distance from the vehicle, the speed of the vehicle ahead, and the driver's vehicle speed. Certain conditions such as inclement weather and road conditions may affect the operation of the FCA system.

## WARNING

Never deliberately drive dangerously to activate the system.

## FCA sensor (Front view camera)

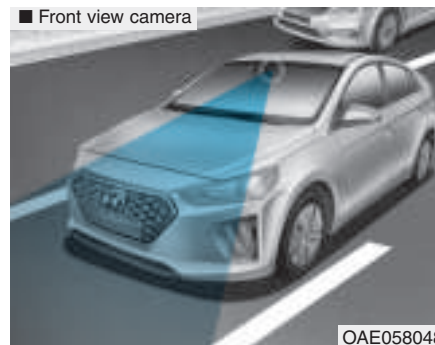

In order for FCA system to operate properly, always make sure the camera is clean and free of dirt, snow, and debris. Dirt, snow, or foreign substances on the surface may adversely affect the sensing performance of the view camera.

## NOTICE

The sensing performance of the sensor may be affected if the following instructions are not followed.

- Always keep the camera sensor clean and free of dirt and debris.
- Use only genuine parts to repair or replace a damaged sensor.

## NOTICE

Be careful not to apply unnecessary force on the camera sensor. If the sensor is forcibly moved out of proper alignment, FCA system may not operate correctly. In this case, a warning message may not be displayed. Have the vehicle inspected by an authorized HYUNDAI dealer.

### NOTICE

- **NEVER** install any accessories or stickers on the front windshield, or tint the front windshield.
- **NEVER** place any reflective objects (i.e. white paper, mirror) over the crash pad. Any light reflection may prevent the system from functioning properly.
- Pay extreme caution to keep the camera dry.
- **NEVER** disassemble the camera assembly, or apply any impact on the camera assembly.

### **i** Information

Have the system checked by an authorized HYUNDAI dealer when:

- The windshield glass is replaced.
- The camera or related parts are repaired or removed.

### **Warning message and warning light**



Forward Collision-Avoidance Assist (FCA) system disabled.  
Camera obscured

When the front camera is blocked with dirt, snow, or debris, FCA system operation may stop temporarily. If this occurs, a warning message will appear on the LCD display. Remove any dirt, snow, or debris and clean the front camera before operating FCA system.

FCA may not properly operate in an area (e.g. open terrain), where any substances are not detected after turning ON the engine.

Also, even though a warning message does not appear on the LCD display, FCA may not properly operate.

### **WARNING**

**FCA system may not activate according to the road conditions, inclement weather, driving conditions or traffic conditions.**

## System malfunction



### Check Forward Collision Avoidance Assist system

- When FCA is not working properly, the FCA warning light (🚗) will illuminate and the warning message will appear for a few seconds. After the message disappears, the master warning light (⚠️) will illuminate. In this case, we recommend that you have the vehicle inspected by an authorized HYUNDAI dealer.

- The FCA warning message may appear along with the illumination of the ESC (Electronic Stability Control) warning light. Both FCA warning light and warning message will disappear once the ESC warning light issue is resolved.

### ⚠️ WARNING

- **FCA is only a supplemental system for the driver's convenience. The driver should hold the responsibility to control the vehicle operation. Do not solely depend on the FCA system. Rather, maintain a safe braking distance, and, if necessary, depress the brake pedal to reduce the driving speed.**

(Continued)

(Continued)

- **In certain instances and under certain driving conditions, FCA system may unintentionally activate. This initial warning message appears on the LCD display with a warning chime.**

Also, in certain instances the front camera recognition system may not detect the vehicle ahead. FCA system may not activate and the warning message will not be displayed.

- **Even if there is any problem with the brake control function of FCA system, the vehicle's basic braking performance will operate normally. However, brake control function for avoiding collision will not activate.**

(Continued)

### (Continued)

- If the vehicle in front stops suddenly, you may have less control of the brake system. Therefore, always keep a safe distance between your vehicle and the vehicle in front of you.
- FCA system may activate during braking and the vehicle may stop suddenly shifting loose objects toward the passengers. Always keep loose objects secured.
- FCA system may not activate if the driver applies the brake pedal to avoid a collision.
- The brake control may be insufficient, possibly causing a collision, if a vehicle in front abruptly stops. Always pay extreme caution.
- Occupants may get injured, if the vehicle abruptly stops by the activated FCA system. Pay extreme caution.
- FCA system operates only to help detect vehicles in front of the vehicle.

### WARNING

- FCA system does not operate when the vehicle is in reverse.
- FCA system is not designed to detect other objects on the road such as animals.
- FCA system does not detect vehicles in the opposite lane.
- FCA system does not detect cross traffic vehicles that are approaching.
- FCA system cannot detect the driver approaching the side view of a parked vehicle (for example on a dead end street.)

In these cases, you must maintain a safe braking distance, and if necessary, depress the brake pedal to reduce the driving speed in order to maintain a safe distance.

## FCA Warning Message and Brake Control

FCA produces warning messages, warning alarms, and emergency braking based on the level of risk of a frontal collision, such as when a vehicle ahead suddenly brakes.

### *Detecting vehicles*

The sensor may be limited when:

- The front view camera is blocked with a foreign object or debris
- The front view camera lens is contaminated due to tinted, filmed or coated windshield, damaged glass, or stuck of foreign matter (sticker, bug, etc.) on the glass
- Inclement weather such as heavy rain or snow obscures the field of view of the camera
- The vehicle is on unpaved or uneven rough surfaces, or road with sudden gradient changes.
- The front view camera sensor recognition is limited
- The vehicle in front is too small to be detected (for example a motorcycle or a bicycle, etc.)

- The camera does not recognize the entire vehicle in front.
- The vehicle in front is an oversized vehicle or trailer that is too big to be detected by the camera recognition system (for example a tractor trailer, etc.)
- The camera's field of view is not well illuminated (either too dark or too much reflection or too much backlight that obscures the field of view)
- The vehicle in front does not have their rear lights properly turned ON
- The outside brightness changes suddenly, for example when entering or exiting a tunnel
- Light coming from a street light or an oncoming vehicle is reflected on a wet road surface such as a puddle in the road
- The field of view in front is obstructed by sun glare
- The vehicle drives inside a building, such as a basement parking lot
- The adverse road conditions cause excessive vehicle vibrations while driving
- The camera is damaged.
- The brightness outside is too low such as when the headlamps are not on at night or the vehicle is going through a tunnel.
- The shadow is on the road by a median strip, trees, etc.
- The vehicle drives through a toll-gate.
- The windshield glass is fogged up; a clear view of the road is obstructed
- The rear part of the vehicle in front is not normally visible (for example, the vehicle is spinning or the vehicle is overturned)
- The sensor recognition changes suddenly when passing over a speed bump
- The vehicle in front is driving erratically
- The vehicle in front is moving vertically to the driving direction
- The vehicle in front is stopped vertically
- The vehicle in front is driving towards your vehicle or reversing
- You are on a roundabout and the vehicle in front circles

### ***Detecting pedestrians***

The sensor may be limited when:

- The pedestrian is not fully detected by the camera recognition system, for example, if the pedestrian is leaning over or is not fully walking upright.
- The pedestrian is moving very quickly or appears abruptly in the camera detection area
- The pedestrian is wearing clothing that easily blends into the background, making it difficult to be detected by the camera recognition system
- The outside lighting is too bright (e.g. when driving in bright sunlight or in sun glare) or too dark (e.g. when driving on a dark rural road at night)
- It is difficult to detect and distinguish the pedestrian from other objects in the surroundings, for example, when there is a group of pedestrians or a large crowd.
- There is an item similar to a person's body structure.

- The pedestrian is small.
- The pedestrian has impaired mobility.
- When the pedestrian suddenly interrupts in front of the vehicle

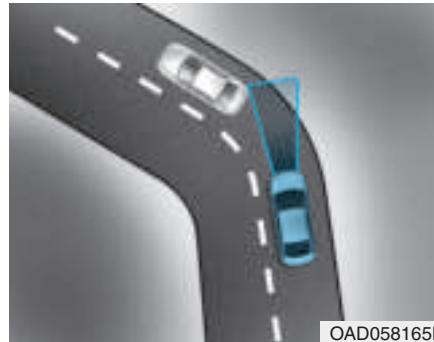

- Driving on a curve

The performance of Forward Collision-Avoidance Assist system may be limited when driving on a curved road.

The front camera recognition system may not detect the vehicle traveling in front on a curved road. This may result in no alarm and braking when necessary.

Always pay attention to road and driving conditions, and if necessary, depress the brake pedal to reduce your driving speed in order to maintain a safe distance.



Forward Collision-Avoidance Assist system may recognize a vehicle in the next lane or outside the lane when driving on a curved road.

If this occurs, the system may unnecessarily alarm the driver and apply the brake. Always pay attention to road and driving conditions, while driving.



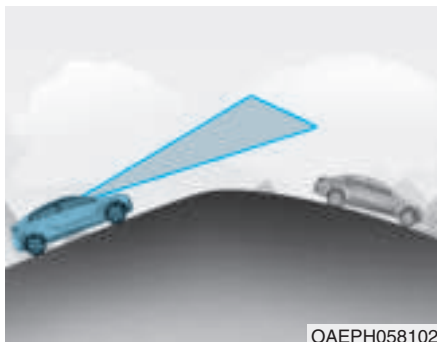

Always keep your eyes forward while driving upward or downward on a slope, and, if necessary, depress the brake pedal to reduce your driving speed in order to maintain distance.

- Driving on a slope

The performance of Forward Collision-Avoidance Assist system may be decreased while driving upward or downward on a slope. The front camera recognition may not detect the vehicle in front. This may result in unnecessary alarm and braking or no alarm and braking when necessary.

When the system suddenly recognizes the vehicle in front while passing over a slope, you may experience sharp deceleration.

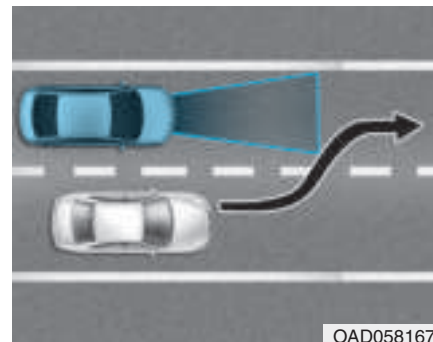

- Changing lanes

When a vehicle changes lanes in front of you, Forward Collision-Avoidance Assist system may not immediately detect the vehicle, especially if the vehicle changes lanes abruptly. In this case, you must maintain a safe braking distance, and if necessary, depress the brake pedal to reduce your driving speed in order to maintain a safe distance.

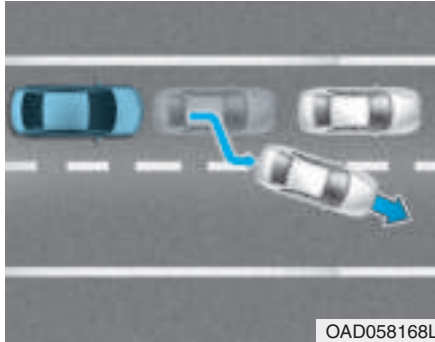

When driving in stop-and-go traffic, and a vehicle in front of you merges out of the lane, Forward Collision-Avoidance Assist system may not immediately detect the new vehicle that is now in front of you. In this case, you must maintain a safe braking distance, and if necessary, depress the brake pedal to reduce your driving speed in order to maintain a safe distance.

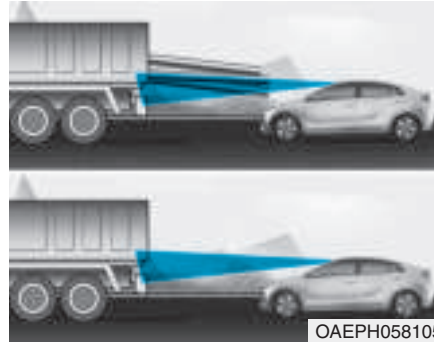

- Detecting the vehicle in front of you  
If the vehicle in front of you has cargo that extends rearward from the cab, or when the vehicle in front of you has higher ground clearance, additional special attention is required. Forward Collision-Avoidance Assist system may not be able to detect the cargo extending from the vehicle. In these instances, you must maintain a safe braking distance from the rearmost object, and if necessary, depress the brake pedal to reduce your driving speed in order to maintain distance.

### WARNING

- Do not use Forward Collision-Avoidance Assist system when towing a vehicle. Application of the FCA system while towing may adversely affect the safety of your vehicle or the towing vehicle.
- Use extreme caution when the vehicle in front of you has cargo that extends rearward from the cab, or when the vehicle in front of you has higher ground clearance.
- FCA system is designed to help detect and monitor the vehicle ahead in the roadway through camera recognition. It is not designed to detect bicycles, motorcycles, or smaller wheeled objects such as luggage bags, shopping carts, or strollers.
- Never try to test the operation of FCA system. Doing so may cause severe injury or death.

---

**i** **Information**

In some instances, FCA system may be canceled when subjected to electromagnetic interference.

**i** **Information**

This device complies with Industry Canada RSS-210 standard.

Operation is subject to the following three conditions:

1. This device may not cause harmful interference, and
2. This device must accept any interference received, including interference that may cause undesired operation.
3. Changes or modifications not expressly approved by the party responsible for compliance could void the user's authority to operate the device.

**i** **Information**

Radio frequency radiation exposure information:

This equipment complies with RSS radiation exposure limits set forth for an uncontrolled environment.

This equipment should be installed and operated with minimum distance of 20 cm (8 in.) between the radiator (antenna) and your body.

This transmitter must not be co-located or operating in conjunction with any other antenna or transmitter.

## FORWARD COLLISION-AVOIDANCE ASSIST (FCA) – SENSOR FUSION (IF EQUIPPED)

Forward Collision-Avoidance Assist system is designed to help detect and monitor the vehicle ahead or detect a pedestrian or cyclists in the roadway through front radar signals and front view camera recognition to warn the driver that a collision is imminent, and if necessary, apply emergency braking.

- ✳ FCA stands for Forward Collision-Avoidance Assist.
- ✳ When Smart Cruise Control is selected, it will be operated for the vehicle ahead, pedestrians and cyclists.

### WARNING

**Take the following precautions when using Forward Collision-Avoidance Assist system:**

- **This system is only a supplemental system and it is not intended to, nor does it replace the need for extreme care and attention of the driver. The sensing range and objects detectable by the sensors are limited. Pay attention to the road conditions at all times.**
- **Drive at posted speed limits and accordance to road conditions.**
- **Always drive cautiously to prevent unexpected and sudden situations from occurring. FCA system may not always stop the vehicle completely and is only intended to help mitigate a collision that is imminent.**

## System setting and activation

### System setting



- Setting Forward Safety function
  - The driver can activate FCA by placing the ignition switch to the ON position and by selecting: 'User settings → Driver assistance → Forward safety'
  - If you select 'Active assist', FCA system activates. FCA produces warning messages and warning alarms in accordance with the collision risk levels. Braking assist will be applied in accordance with the collision risk.

- If you select 'Warning only', FCA system activates and produces only warning alarms in accordance with the collision risk levels. Braking assist will not be applied in this setting.
- If you select 'Off', FCA system deactivates,



The warning light illuminates on the instrument cluster, when you cancel FCA system. The driver can monitor the FCA ON/OFF status on the LCD display. Also, the warning light illuminates when the ESC (Electronic Stability Control) is turned off.

- If the warning light remains ON when the FCA is activated, we recommend that you have the system checked by an authorized HYUNDAI dealer.



OAEPH059648N

- Selecting Warning Timing

The driver can select the initial warning activation time from the User Settings in the cluster LCD display by selecting 'User settings → Driver assistance → Warning timing → Normal/Late'.

The options for the initial Forward Collision Warning includes the following:

- Normal:

When this option is selected, the initial Forward Collision Warning is activated sensitively. If you feel the warning activates too early, set the Forward Collision Warning to 'Late'.

Even though, 'Normal' is selected if the front vehicle suddenly stops the initial warning activation time may not seem fast.

- Late:

When this option is selected, the initial Forward Collision Warning is activated later than normal. This setting reduces the amount of distance between the vehicle, pedestrian or cyclist ahead before the initial warning occurs.

Select 'Late' when traffic is light and when driving speed is slow.

When you accelerate suddenly to the vehicle ahead, the warning may seem to activate earlier even if 'Late' is selected.

### **i** Information

**If you change the warning timing, the warning timing of other systems may change. Always be aware before changing the warning timing.**

### **Prerequisite for activation**

FCA gets ready to be activated, when 'Active Assist' or 'Warning Only' under Forward Safety is selected in the cluster LCD display, and when the following prerequisites are satisfied.

- ESC (Electronic Stability Control) is on.
- Vehicle speed is over 8 km/h (5 mph). (FCA is only activated within a certain speed range.)
- The system detects a pedestrian, cyclist (if equipped) or a vehicle in front, which may collide with your vehicle. However, FCA may not be activated or may only sound a warning alarm depending on the driving or vehicle conditions.

FCA may not operate properly according to the frontal situation, the direction of pedestrian or cyclist (if equipped) and speed.

### **WARNING**

- **To avoid driver distractions, do not attempt to set or cancel FCA while driving the vehicle. Always completely stop the vehicle at a safe place before setting or canceling the system.**
- **FCA automatically activates upon placing the ignition key to the ON position. The driver can deactivate FCA by canceling the system setting on the cluster LCD display.**
- **FCA automatically deactivates upon canceling the ESC (Electronic Stability Control). When the ESC is canceled, the FCA cannot be activated on the LCD display. In this situation, the FCA warning light will illuminate which is normal.**

### **FCA warning message and brake control**

FCA produces warning messages, warning alarms, and emergency braking based on the level of risk of a frontal collision, such as when a vehicle ahead suddenly brakes, or the system detects that a collision with a pedestrian or cyclist (if equipped) is imminent.

### **Collision Warning (First warning)**



This warning message appears on the LCD display with a warning chime. Additionally, some vehicle system intervention occurs to help decelerate the vehicle.

- If FCA detects a vehicle in front, the system operates when your vehicle speed is between 8 km/h (5 mph) and 180 km/h (110 mph). Maximum vehicle speed may decrease depending on the condition of the vehicle ahead and surroundings.
- If FCA detects a pedestrian or cyclist in front, the system operates when your vehicle speed is between 8 km/h (5 mph) and 70 km/h (45 mph). Maximum vehicle speed may decrease depending on the condition of the pedestrian or cyclist ahead and surroundings.
- If you select 'Warning only' for the system setting, FCA system activates and produces only warning alarms in accordance with the collision risk levels. You should control the brake directly because FCA system will not control the brake.

### **Emergency braking (Second warning)**



This warning message appears on the LCD display with a warning chime. Additionally, some vehicle system intervention occurs to help decelerate the engine.

- If FCA detects a vehicle in front, the system operates when your vehicle speed is above 8 km/h (5 mph) and less than or equal to 180 km/h (110 mph). Maximum vehicle speed may decrease depending on the condition of the vehicle ahead and surroundings.
- If FCA detects a pedestrian or cyclist in front, the system operates when your vehicle speed is between 8 km/h (5 mph) or above and under 70 km/h (45 mph). Maximum vehicle speed may decrease depending on the condition of the pedestrian or cyclist ahead and surroundings.
- If you select 'Warning only' for the system setting, FCA system activates and produces only warning alarms in accordance with the collision risk levels. You should control the brake directly because FCA system will not control the brake.

### ***Brake operation***

- In an urgent situation, the braking system enters into the ready status for prompt reaction against the driver's depressing the brake pedal.
- FCA provides additional braking power for optimum braking performance, when the driver depresses the brake pedal.
- The braking control is automatically deactivated, when the driver sharply depresses the accelerator pedal, or when the driver abruptly operates the steering wheel.
- The FCA brake control is automatically canceled, when risk factors disappear.

### **CAUTION**

- **The driver should always use extreme caution while operating the vehicle, whether or not there is a warning message or alarm from FCA system.**
- **After the brake control is activated, the driver must immediately depress the brake pedal and check the surroundings. The brake activation by the system lasts for about 2 seconds.**
- **If any other warning sound such as seat belt warning chime is already generated, Forward Collision-Avoidance Assist system warning may not sound.**
- **Playing the vehicle audio system at high volume may prevent occupants from hearing the system warning sounds.**



## WARNING

The braking control cannot completely stop the vehicle nor avoid all collisions. The driver should hold the responsibility to safely drive and control the vehicle.

## WARNING

The FCA system logic operates within certain parameters, such as the distance from the vehicle, pedestrian or cyclist (if equipped) ahead, the speed of the vehicle ahead, and the driver's vehicle speed. Certain conditions such as inclement weather and road conditions may affect the operation of the FCA system.

## WARNING

Never deliberately drive dangerously to activate the system.

## FCA sensor (Front view camera+ Front radar)

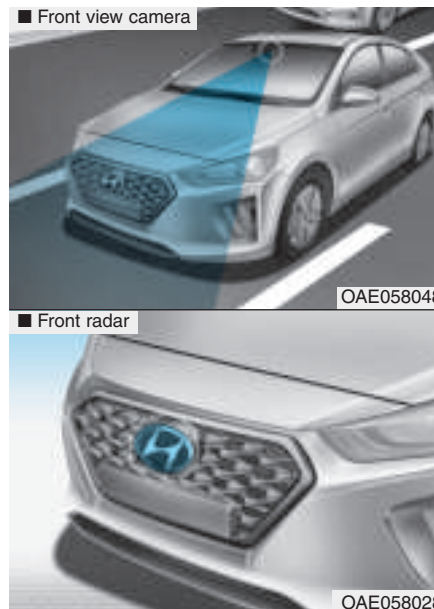

In order for FCA system to operate properly, always make sure the sensor cover or sensor is clean and free of dirt, snow, and debris.

Dirt, snow, or foreign substances on the sensor cover or sensor may adversely affect the sensing performance of the sensor.

## NOTICE

- Do not apply license plate frame or foreign objects such as a bumper sticker or a bumper guard near the front radar sensor. Doing so may adversely affect the sensing performance of the front radar.
- Always keep the front radar sensor and cover clean and free of dirt and debris.
- Use only a soft cloth to wash the vehicle. Do not spray pressurized water directly on the sensor or sensor cover.

(Continued)

(Continued)

- Be careful not to apply unnecessary force on the radar sensor or sensor cover. If the sensor is forcibly moved out of proper alignment, FCA system may not operate correctly. In this case, a warning message may not be displayed. We recommend that you have the vehicle inspected by an authorized HYUNDAI dealer.
- If the front bumper becomes damaged in the area around the front radar sensor, FCA system may not operate properly. We recommend that you have the vehicle inspected by authorized HYUNDAI dealer.
- Use only genuine parts to repair or replace a damaged sensor or sensor cover. Do not apply paint to the sensor cover.

### NOTICE

- NEVER install any accessories or stickers on the front windshield, or tint the front windshield.
- NEVER place any reflective objects (i.e. white paper, mirror) over the crash pad. Any light reflection may prevent the system from functioning properly.
- Pay extreme caution to keep the camera dry.
- NEVER disassemble the camera assembly, or apply any impact on the camera assembly.

### **i** Information

We recommend that you have the system checked by an authorized HYUNDAI dealer when:

- The windshield glass is replaced.
- The front radar sensor or cover gets damaged or replaced.

### *Warning message and warning light*



Forward Collision-Avoidance Assist (FCA) system disabled.  
Radar blocked

When the sensor cover is blocked with dirt, snow, or debris, FCA system may not detect other vehicles. If this occurs, a warning message will appear on the LCD display. Remove any dirt, snow, or debris and clean the radar sensor cover before operating FCA system.

The system will operate normally when such dirt, snow or debris is removed.

FCA may not properly operate in an area (e.g. open terrain), where any substances are not detected after turning ON the vehicle.

Also, even though a warning message does not appear on the LCD display, FCA may not properly operate.



### WARNING

**FCA system may not activate according to the road conditions, inclement weather, driving conditions or traffic conditions.**

## System malfunction



### Check Forward Collision Avoidance Assist system

- When FCA is not working properly, FCA warning light () will illuminate and the warning message will appear for a few seconds. After the message disappears, the master warning light () will illuminate. In this case, we recommend that you have the vehicle inspected by an authorized HYUNDAI dealer.

- The FCA warning message may appear along with the illumination of the ESC (Electronic Stability Control) warning light. Both FCA warning light and warning message will disappear once the ESC warning light issue is resolved.

 **WARNING**

- FCA is only a supplemental system for the driver's convenience. The driver should hold the responsibility to control the vehicle operation. Do not solely depend on FCA system. Rather, maintain a safe braking distance, and, if necessary, depress the brake pedal to reduce the driving speed or to stop the vehicle.
- In certain instances and under certain driving conditions, FCA system may activate unintentionally. This initial warning message appears on the LCD display with a warning chime.

Also due to sensing limitations, in certain situations, the front radar sensor or front view camera recognition system may not detect the vehicle, pedestrian or cyclist ahead.

FCA system may not activate and the warning message may not be displayed.

(Continued)

(Continued)

- Even if there is any problem with the brake control function of FCA system, the vehicle's basic braking performance will operate normally. However, brake control function for avoiding collision will not activate.
- If the vehicle in front stops suddenly, you may have less control of the brake system. Therefore, always keep a safe distance between your vehicle and the vehicle in front of you.
- FCA system may activate during braking and the vehicle may stop suddenly shifting loose objects toward the passengers. Always keep loose objects secured.
- FCA system may not activate if the driver applies the brake pedal to avoid collision.

(Continued)

(Continued)

- If a vehicle in front abruptly stops, the brake control may not work possibly causing a collision.
- Occupants may get injured, if the vehicle abruptly stops by activated FCA system. Pay extreme caution.
- FCA system operates only when the system detects vehicles, pedestrian, or cyclist directly in front of the vehicle.

## WARNING

- **FCA system does not operate when the vehicle is in reverse.**
- **FCA system is not designed to detect other objects on the road such as animals.**
- **FCA system does not detect vehicles in the opposite lane.**
- **FCA system does not detect cross traffic vehicles that are approaching.**
- **FCA system cannot detect vehicles that are stopped vertically to your vehicle at a intersection or dead end street.**
- **FCA system cannot detect the cross traffic cyclist that are approaching.**

**In these cases, you must maintain a safe braking distance, and if necessary, depress the brake pedal to reduce the driving speed in order to maintain a safe distance or to stop the vehicle.**

## Limitations of the system

Forward Collision-Avoidance Assist (FCA) system is designed to monitor the vehicle ahead or a pedestrian or cyclist in the roadway through front view camera and radar signals recognition to warn the driver that a collision is imminent, and if necessary, apply emergency braking.

In certain situations, the front view camera or the front radar sensor may not be able to detect the vehicle, pedestrian or cyclist ahead. In these cases, FCA system may not operate normally. The driver must pay careful attention in the following situations where the FCA operation may be limited.

## *Detecting vehicles*

The sensor may be limited when:

- The system may not operate for 15 seconds after the vehicle is started or the front view camera is initialized
- The front view camera or front radar sensor is covered with a foreign object or debris
- The front view camera lens is contaminated due to tinted, filmed or coated windshield, damaged glass, or stuck of foreign matter (sticker, bug, etc.) on the glass
- Inclement weather such as heavy rain or snow obscures the field of view of the front view camera or front radar sensor
- There is interference by electromagnetic waves
- There is severe irregular reflection from the front radar sensor
- The front view camera/front radar sensor recognition is limited
- The vehicle in front is too small to be detected (for example a motorcycle etc.)

- The vehicle in front is an oversize vehicle or trailer that is too big to be detected by the front view camera recognition system (for example a tractor trailer, etc.)
- The front view camera's field of view is not well illuminated (either too dark or too much reflection or too much backlight that obscures the field of view)
- The vehicle in front does not have their rear lights or their rear lights does not turned ON or their rear lights are located unusually
- The outside brightness changes suddenly, for example when entering or exiting a tunnel
- Light coming from a street light or an oncoming vehicle is reflected on a wet road surface such as a puddle in the road
- The field of view in front is obstructed by sun glare or head light of oncoming vehicle
- The windshield glass is fogged up; a clear view of the road is obstructed
- The vehicle in front is driving erratically
- The vehicle is on unpaved or uneven rough surfaces, or road with sudden gradient changes
- The vehicle is driven near areas containing metal substances as a construction zone, railroad, etc.
- The vehicle drives inside a building, such as a basement parking lot
- The front view camera does not recognize the entire vehicle in front
- The front view camera is damaged
- The brightness outside is too low such as when the headlamps are not on at night or the vehicle is going through a tunnel
- The shadow is on the road by a median strip, trees, etc.
- The vehicle drives through a toll-gate
- The windshield glass is fogged up; a clear view of the road is obstructed
- The rear part of the vehicle in front is not normally visible. (the vehicle turns in other direction or the vehicle is overturned.)
- The adverse road conditions cause excessive vehicle vibrations while driving
- The sensor recognition changes suddenly when passing over a speed bump
- The vehicle in front is moving vertically to the driving direction
- The vehicle in front is stopped vertically
- The vehicle in front is driving towards your vehicle or reversing
- You are on a roundabout and the vehicle in front circles



- Driving on a curve

The performance of Forward Collision-Avoidance Assist system may be limited when driving on a curved road.

The front view camera or front radar sensor recognition system may not detect the vehicle, pedestrian or cyclist traveling in front on a curved road.

This may result in no alarm and braking when necessary.

Always pay attention to road and driving conditions, and if necessary, depress the brake pedal to reduce your driving speed in order to maintain a safe distance.



Forward Collision-Avoidance Assist system may recognize a vehicle or pedestrian or cyclist in the next lane or outside the lane when driving on a curved road.

If this occurs, the system may unnecessarily alarm the driver and apply the brake.

Always pay attention to road and driving conditions, while driving.

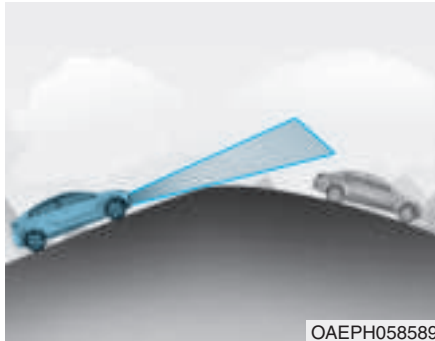

Always keep your eyes forward while driving upward or downward on a slope, and, if necessary, depress the brake pedal to reduce your driving speed in order to maintain distance.

- Driving on a slope

The performance of Forward Collision-Avoidance Assist system may be decreased while driving upward or downward on a slope. The front view camera or front radar sensor recognition may not detect the vehicle, pedestrian or cyclist in front.

This may result in unnecessary alarm and braking or no alarm and braking when necessary.

When the system suddenly recognizes the vehicle, pedestrian or cyclist in front while passing over a slope, you may experience sharp deceleration.

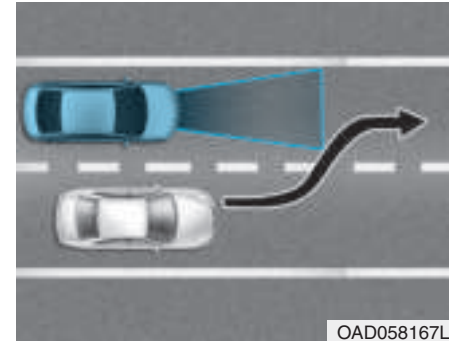

- Changing lanes

When a vehicle changes lanes in front of you, the Forward Collision-Avoidance Assist system may not immediately detect the vehicle, especially if the vehicle changes lanes abruptly. In this case, you must maintain a safe braking distance, and if necessary, depress the brake pedal to reduce your driving speed in order to maintain a safe distance.



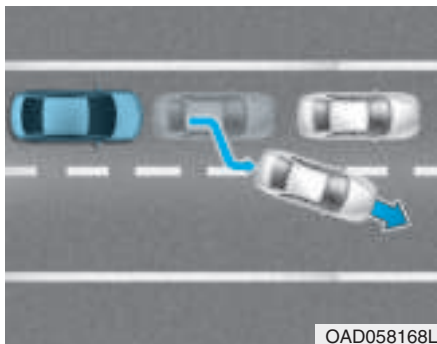

OAD058168L

When driving in stop-and-go traffic, and a vehicle in front of you merges out of the lane, Forward Collision-Avoidance Assist system may not immediately detect the new vehicle that is now in front of you. In this case, you must maintain a safe braking distance, and if necessary, depress the brake pedal to reduce your driving speed in order to maintain a safe distance.



OAE056105

- Detecting the vehicle in front of you If the vehicle in front of you has cargo that extends rearward from the cab, or when the vehicle in front of you has higher ground clearance, additional special attention is required. Forward Collision-Avoidance Assist system may not be able to detect the cargo extending from the vehicle. In these instances, you must maintain a safe braking distance from the rearmost object, and if necessary, depress the brake pedal to reduce your driving speed in order to maintain distance.

### **Detecting pedestrians or cyclists**

The sensor may be limited when:

- The pedestrian or cyclist is not fully detected by the front view camera recognition system, for example, if the pedestrian is leaning over or is not fully walking upright
- The pedestrian or cyclist is moving very quickly or appears abruptly in the front view camera detection area
- The pedestrian or cyclist is wearing clothing that easily blends into the background, making it difficult to be detected by the front view camera recognition system
- The outside lighting is too bright (e.g. when driving in bright sunlight or in sun glare) or too dark (e.g. when driving on a dark rural road at night)
- It is difficult to detect and distinguish the pedestrian or cyclist from other objects in the surroundings, for example, when there is a group of pedestrians, cyclists or a large crowd

- There is an item similar to a person's body structure
- The pedestrian or cyclist is small
- The pedestrian has impaired mobility
- The sensor recognition is limited
- The front radar sensor or front view camera is blocked with a foreign object or debris
- Inclement weather such as heavy rain or snow obscures the field of view of the front radar sensor or front view camera
- When light coming from a street light or an oncoming vehicle is reflected on a wet road surface such as a puddle in the road
- The field of view in front is obstructed by sun glare
- The windshield glass is fogged up; a clear view of the road is obstructed
- The adverse road conditions cause excessive vehicle vibrations while driving
- The sensor recognition changes suddenly when passing over a speed bump
- You are on a roundabout
- The pedestrian or cyclist suddenly interrupts in front of the vehicle
- The cyclist in front is riding intersected with the driving direction
- There is any other electromagnetic interference
- The construction area, rail or other metal object is near the cyclist
- The bicycle material is not reflected well on the front radar

### WARNING

- **Do not use Forward Collision-Avoidance Assist system when towing a vehicle. Application of FCA system while towing may adversely affect the safety of your vehicle or the towing vehicle.**
- **Use extreme caution when the vehicle in front of you has cargo that extends rearward from the cab, or when the vehicle in front of you has higher ground clearance.**
- **Forward Collision-Avoidance Assist system may operate when an object, which has similar shape or characteristic to a vehicle, pedestrian or cyclist, is detected.**

(Continued)

(Continued)

- Never try to test the operation of FCA system. Doing so may cause severe injury or death.
- If the front bumper, front glass, front radar or front view camera have been replaced or repaired, we recommend that you have your vehicle inspected by an authorized HYUNDAI dealer.

### **i** Information

In some instances, FCA system may be canceled when subjected to electromagnetic interference.

### **i** Information

This device complies with Industry Canada RSS-210 standard.

Operation is subject to the following three conditions:

1. This device may not cause harmful interference, and
2. This device must accept any interference received, including interference that may cause undesired operation.
3. Changes or modifications not expressly approved by the party responsible for compliance could void the user's authority to operate the device.

### **i** Information

Radio frequency radiation exposure information:

This equipment complies with RSS radiation exposure limits set forth for an uncontrolled environment.

This equipment should be installed and operated with minimum distance of 20 cm (8 in.) between the radiator (antenna) and your body.

This transmitter must not be co-located or operating in conjunction with any other antenna or transmitter.

## LANE KEEPING ASSIST (LKA) (IF EQUIPPED)

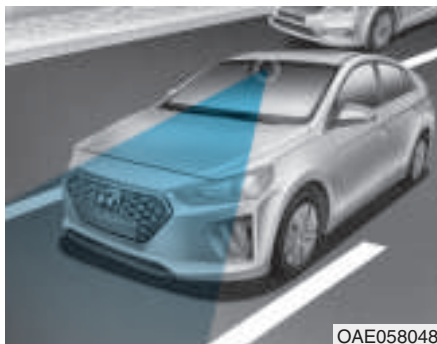

OAE058048

Lane Keeping Assist system helps detect lane markers on the road with a front view camera at the front windshield, and assists the driver's steering to help keep the vehicle between lanes.

When the system detects the vehicle straying from its lane, it alerts the driver with a visual and audible warning, while applying a slight counter-steering torque, trying to help prevent the vehicle from moving out of its lane.

### WARNING

**Lane Keeping Assist system is not a substitute for safe driving practices, but a convenience function only. It is the responsibility of the driver to always be aware of the surroundings and steer the vehicle.**

### WARNING

**Take the following precautions when using Lane Keeping Assist system :**

- **Do not turn the steering wheel suddenly when the steering wheel is being assisted by the system.**
- **LKA system helps to prevent the driver from moving out of the lane unintentionally by assisting the driver's steering. However, the driver should not solely rely on the system but always pay attention on the steering wheel to stay in the lane.**
- **The operation of LKA system can be cancelled or not work properly according to road condition and surroundings. Always be cautious when driving.**

**(Continued)**

(Continued)

- Do not disassemble LKA system camera temporarily to tint the window or attach any types of coatings and accessories. If you disassemble the camera and assemble it again, we recommend that you take your vehicle to an authorized HYUNDAI dealer and have the system checked for calibration.
- When you replace the windshield glass, LKA system camera or related parts of the steering wheel, we recommend that you take your vehicle to an authorized HYUNDAI dealer and have the system checked for calibration.

(Continued)

(Continued)

- The system detects lane markers and controls the steering wheel by a front view camera, therefore, if the lane markers are hard to detect, the system may not work properly.  
Please refer to "Limitations of the System".
- Do not remove or damage the related parts of LKA system.
- You may not hear a warning sound of LKA system if the audio volume is high.
- Do not place objects on the dashboard that reflects light such as mirrors, white paper, etc. This may prevent LKA system from functioning properly.
- When the lane markers are hard to detect, please refer to "Driver's Attention".

(Continued)

(Continued)

- Always have your hands on the steering wheel while LKA system is activated. If you continue to drive with your hands off the steering wheel after the "Keep hands on steering wheel" warning message appears, the system will stop controlling the steering wheel.
- The steering wheel is not continuously controlled so if the vehicle speed is at a higher rate when leaving a lane the vehicle may not be controlled by the system. The driver must always follow the speed limit when using the system.
- If you attach objects to the steering wheel, the system may not assist steering or the hands off alarm may not work properly.
- When you tow a trailer, make sure that you turn off LKA system.

### LKA operation



To activate/deactivate LKA system:

With the ignition switch in the ON position, press LKA system button located on the instrument panel on the left hand side of the steering wheel.

The indicator () in the cluster display will initially illuminate white. This indicates LKA system is in the READY but NOT ENABLED state.

If you press LKA button located on the instrument panel on the lower left hand side of the driver, LKA will be turned off and the indicator on the cluster display will go off.

Note that the vehicle speed must be 5-82



at least approximately 64 km/h (40 mph) to ENABLE the LKA system. The indicator in the cluster display will illuminate green.

- White : Sensor does not detect lane markers or vehicle speed is under 56 km/h (35 mph).
- Green : Sensor detects lane markers and the system is able to control vehicle steering.

### **i** Information

**If the indicator (white) is activated from the previous ignition cycle, the system will turn ON without any additional control. If you press the LKA button again, the indicator on the cluster goes off.**

### LKA system operation

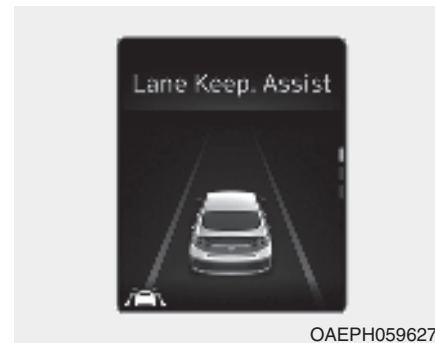

- To see the LKA screen on the LCD display in the cluster, select Driving Assist mode () . For more information, refer to "LCD Display Modes" in chapter 3.

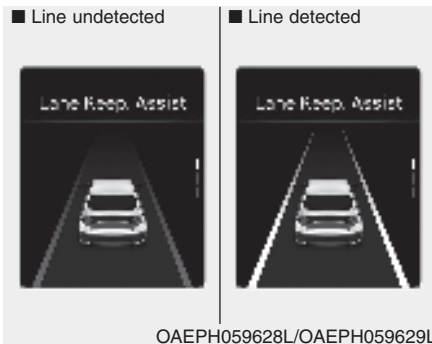

- If vehicle speed is over 64 km/h (40 mph) and the system detects lane markers, the color changes from gray to white.

- If your vehicle speed exceeds 64 km/h (40 mph) and LKA system button is ON, the system is enabled. If your vehicle departs from the projected lane in front of you, LKA system operates as follows:

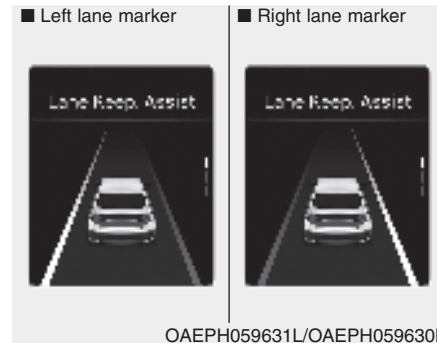

1. A visual warning appears on the cluster LCD display. Either the left lane marker or the right lane marker in the cluster LCD display will blink depending on which direction the vehicle is veering.

2. LKA system will help control the vehicle's steering to prevent the vehicle from crossing the lane marker in below conditions.

- Vehicle speed is over 64 km/h (40 mph)
- The system detects both lane markers
- When driving, the vehicle is located between both lanes normally.
- The steering wheel is not turned suddenly.

When lanes are detected and all the conditions to activate LKA system are satisfied, a LKA system indicator light (🚗) will change from white to green. This indicates that LKA system is in the ENABLED state and the steering wheel will be controlled.



### Keep hands on steering wheel

If the driver takes their hands off the steering wheel for several seconds while LKA system is activated, the system will warn the driver.

### **i** Information

**If the steering wheel is held very lightly the message may still appear because LKA system may not recognize that the driver has their hands on the wheel.**

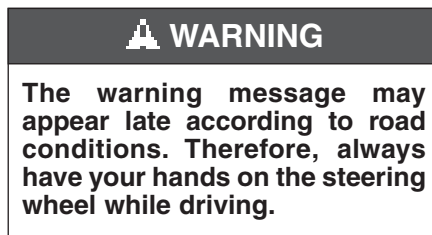

### Driver's hands not detected. LKA system is disabled temporarily

If the driver still does not have their hands on the steering wheel after the message "Keep hands on steering wheel", the system will not control the steering wheel and warn the driver only when the driver crosses the lane markers.

However, if the driver has their hands on the steering wheel again, the system will start controlling the steering wheel.



## WARNING

- The driver is responsible for accurate steering.
- LKA system is a supplemental system only. It is the responsibility of the driver to safely steer the vehicle and to maintain it in its lane.
- Turn off LKA system and drive without using the system in the following situations:
  - In bad weather
  - In bad road conditions
  - When the steering wheel needs to be controlled by the driver frequently.
  - When towing a vehicle or trailer.

## Information

- Even though the steering is assisted by the system, the driver can still steer to control the steering wheel.
- The steering wheel may feel heavier or lighter when the steering wheel is assisted by the system than when it is not.

## Warning light and message



### Check Lane Keeping Assist (LKA) system

If there is a problem with the system a message will appear for a few seconds. If the problem continues LKA system failure indicator will illuminate.

## LKA system indicator



The LKA system indicator (yellow) will illuminate if LKA system is not working properly. We recommend that the system be checked by an authorized HYUNDAI dealer.

When there is a problem with the system do one of the following:

- Turn the system on after turning the vehicle off and on again.
- Check if the ignition switch is in the ON position.
- Check if the system is affected by the weather. (ex: fog, heavy rain, etc.)
- Check if there is foreign matter on the camera lens.

If the problem is not solved, we recommend that the system be checked by an authorized HYUNDAI dealer.

### **LKA system will not be in the ENABLED state and the steering wheel will not be assisted when:**

- The turn signal is turned on before changing a lane. If you change lanes without the turn signal on, the steering wheel might be controlled.
- The vehicle is not driven in the middle of the lane when the system is turned on or right after changing a lane.
- ESC (Electronic Stability Control) or VSM (Vehicle Stability Management) is activated.
- The vehicle is driven on a sharp curve.
- Vehicle speed is below 60 km/h (37 mph) and over 180 km/h (112 mph).
- The vehicle makes sharp lane changes.
- The vehicle brakes suddenly.
- One lane marker is detected.
- The lane is very wide or narrow.
- There are more than two lane markers on the road. (e.g. construction area)
- The vehicle is driven on a steep incline.
- The steering wheel is turned suddenly.
- There are more than two lane markers on the road in front of you.
- The system may not operate for 15 seconds after the vehicle is started or the camera is initialized or rebooting of the front view camera.
- Radius of a curve is too small.

### **Limitations of the System**

LKA system may operate prematurely even if the vehicle does not depart from the intended lane, OR, LKA system may not assist your steering or warn you if the vehicle leaves the intended lane under the following circumstances:

#### **When the lane and road conditions are poor**

- It is difficult to distinguish the lane marking from the road surface or the lane marking is faded or not clearly marked.
- It is difficult to distinguish the color of the lane marker from the road.
- There are markings on the road surface that look like a lane marker that is inadvertently being detected by the camera.
- The lane marker is merged or divided (e.g. tollgate).
- The lane number increases or decreases or the lane marker are crossing complicatedly.
- There are more than two lane markers on the road in front of you.

- The lane marker is very thick or thin.
- The lanes ahead are not visible due to rain, snow, water on the road, damaged or stained road surface, or other factors.
- The shadow is on the lane marker by a median strip, trees, etc.
- The lanes are incomplete or the area is in a construction zone.
- There are crosswalk signs or other symbols on the road.
- The lane marker in a tunnel is stained with oil, etc.
- The lane suddenly disappears such as at the intersection.

#### **When external condition is intervened**

- The brightness outside changes suddenly such as when entering or exiting a tunnel, or when passing under a bridge.
- The brightness outside is too low such as when the headlamps are not on at night or the vehicle is going through a tunnel.
- There is a boundary structure in the roadway such as a concrete barrier, guardrail and reflector post that is inadvertently being detected by the camera.
- When light coming from a street light or an oncoming vehicle is reflected on a wet road surface such as a puddle in the road.
- The field of view in front is obstructed by sun glare.
- There is not enough distance between you and the vehicle in front to be able to detect the lane marker or the vehicle ahead is driving on the lane marker.
- Road surface is not evenness.

- Driving on a steep grade, over a hill, or when driving on a curved road.
- The adverse road conditions cause excessive vehicle vibrations while driving.
- The surrounding of the inside rear view mirror temperature is high due to direct sunlight, etc.

#### **When front visibility is poor**

- The windshield or the front view camera lens is blocked with dirt or debris.
- The windshield glass is fogged up; a clear view of the road is obstructed.
- Placing objects on the dashboard, etc.
- The sensor cannot detect the lane because of fog, heavy rain or snow.

### **LKA system function change**

The driver can change LKA to the Lane Departure Warning (LDW) or change the LKA mode between Standard LKA and Active LKA from the LCD display. Go to the 'User settings → Driver assistance → Lane safety'.

The system is automatically set to Standard LKA if a function is not selected.

### ***Lane Keeping Assist***

This mode guides the driver to help keep the vehicle within the lanes. It rarely controls the steering wheel, when the vehicle drives well inside the lanes. However, it starts to control the steering wheel, when the vehicle is about to deviate out of the lane.

### ***Lane Departure Warning***

Lane Departure Warning alerts the driver with a visual warning and a warning alarm when the system detects the vehicle departing the lane. The steering wheel will not be controlled.

## BLIND-SPOT COLLISION WARNING (BCW) (IF EQUIPPED)

### System description

#### **Blind-Spot Collision Warning (BCW)**

Blind-Spot Collision Warning system uses radar sensors in the rear bumper to monitor and warn the driver when it detects an approaching vehicle in the driver's blind spot area.

#### 1) Blind-Spot Area

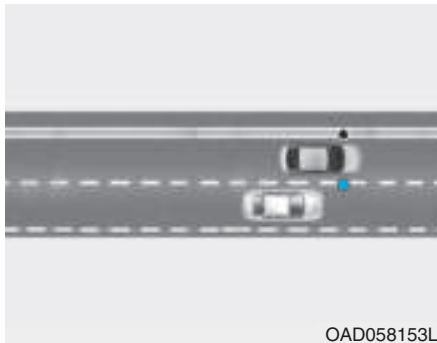

The blind spot detection range varies relative to vehicle speed.

Note that if your vehicle is traveling much faster than the vehicles around you, the warning will not occur.

#### 2) Closing at high speed

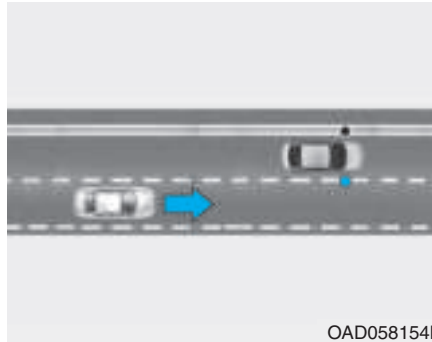

BCW system will alert you when it detects a vehicle is approaching in an adjacent lane at a high rate of speed. If the driver activates the turn signal when the system detects an oncoming vehicle, the system sounds an audible alert.

### WARNING

- Always be aware of road conditions while driving and be alert for unexpected situations even though Blind-Spot Collision Warning system is operating.
- Blind-Spot Collision Warning system is supplemental systems to assist you. Do not entirely rely on the systems. Always pay attention, while driving, for your safety.
- Blind-Spot Collision Warning system is not substitutes for proper and safe driving. Always drive safely and use caution when changing lanes or backing up the vehicle. Blind-Spot Collision Warning system may not detect every object alongside the vehicle.

### System setting and operation

#### System setting



- Setting Blind-Spot Safety function
  - The driver can activate the system by placing the ignition switch to the ON position and by selecting 'User settings → Driver assistance → Blind-spot safety' in the cluster LCD display.
  - BCW turns on and gets ready to be operated when 'Warning only' is selected. Then, if a vehicle approaches the driver's blind spot area a warning sounds.
  - The system is deactivated and the indicator on the BCW button turns off when 'Off' is selected.

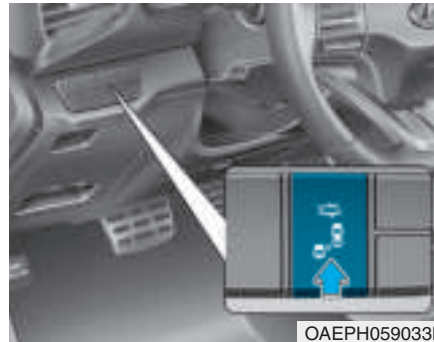

- If you press the BCW button while 'Warning only' is selected, the indicator on the button turns off and the system deactivates.
- If you press the BCW button while the system is cancelled, the indicator on the button illuminates and the system activates.

When the system is initially turned on and when the vehicle is turned off then on again while the system is in activation, the warning light will illuminate for 3 seconds on the outside rearview mirror.

- If the vehicle is turned off then on again, the system maintains the last setting.



- Selecting Warning Timing  
The driver can select the initial warning activation time from the User Settings in the cluster LCD display by selecting 'User settings → Driver assistance → Warning timing → Normal/Late'.

The options for the initial Blind-Spot Collision Warning includes the following:

- Normal:

When this option is selected, the initial Blind-Spot Collision Warning is activated normally. If this setting feels too sensitive change the option to 'Late'.

The warning activation time may feel late if the side/rear vehicle abruptly accelerates.

- Late:

Select this warning activation time when the traffic is light and you are driving in at low speeds.

### **i** Information

If you change the warning timing, the warning time of other systems may change.



- Setting Warning Volume

The driver can select the warning volume from the User Settings in the LCD display by selecting 'User settings → Driver assistance → Warning volume → High/Medium/Low'.

### **i** Information

If you change the warning volume, the warning volume of other systems may change.

For more information refer to "LCD Display Modes" in chapter 3.

### **Operating Conditions**

The system enters the ready status, when 'Warning Only' is selected in the cluster LCD display and vehicle speed is above approximately 30 km/h (20 mph).

### Warning message and system control

#### Blind-Spot Collision Warning system

■ Left side



■ Right side



OAE056035

#### First stage alert

If a vehicle is detected within the boundary of the system, a warning light will illuminate on the outside rearview mirror.

If the detected vehicle is no longer within the blind spot area, the warning will turn off according to the driving conditions of the vehicle.



[A] : Warning sound

#### Second stage alert

A warning chime to alert the driver will activate when:

1. A vehicle has been detected in the blind spot area by the radar system AND.
2. The turn signal is applied (same side as where the vehicle is being detected).

When this alert is activated, the warning light on the outside rearview mirror will also blink. And a warning chime will sound.

If you turn off the turn signal indicator, the second stage alert will be deactivated.

If the detected vehicle is no longer within the blind spot area, the warning will turn off according to the driving conditions of the vehicle.



## WARNING

- The warning light on the outside rearview mirror will illuminate whenever a vehicle is detected at the rear side by the system.

To avoid accidents, do not focus only on the warning light and neglect to see the surroundings of the vehicle.

- Drive safely even though the vehicle is equipped with a Blind-Spot Collision Warning system. Do not solely rely on the system but check your surroundings before changing lanes or backing the vehicle up.
- The system may not alert the driver in some situations due to system limitations so always check your surroundings while driving.

## CAUTION

- Always pay attention to road and traffic conditions while driving, whether or not the warning light on the outside rearview mirror illuminates or there is a warning alarm.
- Playing the vehicle audio system at high volume may offset Blind-Spot Collision Warning system warning sounds.
- The warning of Blind-Spot Collision Warning system may not sound while other system's warning sounds.

## Detecting Sensor



The rear corner radars are located inside the rear bumper for detecting the side and rear areas. Always keep the rear bumper clean for proper operation of the system.

## NOTICE

- The system may not work properly when the bumper has been damaged, or if the rear bumper has been replaced or repaired.

(Continued)

### (Continued)

- The sensing range differs somewhat according to the width of the road. When the road is narrow, the system may detect other vehicles in the next lane.
- The system may turn off if interfered by strong electromagnetic waves.
- Always keep the sensors clean.
- NEVER disassemble the sensor component or apply any impact on the sensor component.
- Be careful not to apply unnecessary force on the radar sensor or sensor cover. If the sensor is forcibly moved out of proper alignment, the system may not operate correctly. In this case, a warning message may not be displayed. We recommend that the vehicle be inspected by an authorized HYUNDAI dealer.
- Do not apply foreign objects such as a bumper sticker or a bumper guard near the radar sensor or apply paint to the sensor area. Doing so may adversely affect the performance of the sensor.

### Warning message

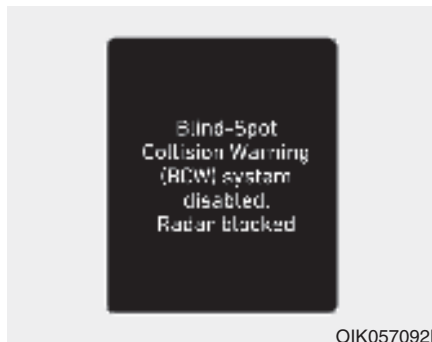

### Blind-Spot Collision Warning (BCW) system disabled. Radar blocked

- This warning message may appear when:
  - One or both of the sensors on the rear bumper is blocked by dirt or snow or a foreign object.
  - Driving in rural areas where the sensor does not detect another vehicle for an extended period of time.
  - When there is inclement weather such as heavy snow or rain.

- When a trailer or carrier is installed.

If any of these conditions occur, the light on the BCW button and the system will turn off automatically.

### **i** Information

Turn off BCW and RCCW system (if equipped) when a trailer or carrier is installed.

- Press BCW button (the indicator on the button will turn off)
- Deactivate RCCW system by deselecting

'User settings → Driver assistance → Parking safety → Rear cross-traffic safety'

When the BCW canceled warning message is displayed in the cluster, check to make sure that the rear bumper is free from any dirt or snow in the areas where the sensor is located. Remove any dirt, snow, or foreign material that could interfere with the radar sensors.

After any dirt or debris is removed, the system should operate normally after about 10 minutes of driving the vehicle.

If the system still does not operate normally, we recommend that the vehicle be inspected by an authorized HYUNDAI dealer.



### Check Blind-Spot Collision Warning (BCW) system

If there is a problem with BCW system, a warning message will appear and the light on the button will turn off. The system will turn off automatically. We recommend that you have your vehicle inspected by an authorized HYUNDAI dealer.

### **Limitations of the system**

The driver must be cautious in the below situations because the system may not detect other vehicles or objects in certain circumstances:

- When a trailer or carrier is installed.
- The vehicle drives in inclement weather such as heavy rain or snow.
- The sensor is covered with rain, snow, mud, etc.
- The rear bumper where the sensor is located is covered with a foreign object such as a bumper sticker, a bumper guard, a bike rack, etc.
- The rear bumper is damaged, or the sensor is out of the original default position.
- The vehicle height gets lower or higher due to heavy loading in a tailgate, abnormal tire pressure, etc.
- When the temperature of the rear bumper is high.
- When the sensors are blocked by other vehicles, walls or parking-lot pillars.

## Driving your vehicle

---

- The vehicle is driven on a curved road.
- The vehicle is driven through a toll-gate.
- The road pavement (or the peripheral ground) abnormally contains metallic components (i.e. possibly due to subway construction).
- There is a fixed object near the vehicle, such as a guardrail.
- While going down or up a steep road where the height of the lane is different.
- Driving on a narrow road where trees or grass or overgrown.
- Driving in rural areas where the sensor does not detect another vehicle or structure for an extended period of time.
- Driving on a wet road.
- Driving on a road where the guardrail or wall is in double structure.
- A big vehicle is near such as a bus or truck.
- When the other vehicle approaches very close.
- When the other vehicle passes at a very fast speed.
- While changing lanes.
- If the vehicle has started at the same time as the vehicle next to you and has accelerated.
- When the vehicle in the next lane moves two lanes away from you OR when the vehicle two lanes away moves to the next lane from you.
- A motorcycle or bicycle is near.
- A flat trailer is near.
- If there are small objects in the detecting area such as a shopping cart or a baby stroller.
- If there is a low height vehicle such as a sports car.
- The vehicle abruptly changes driving direction.
- The vehicle makes sharp lane changes.
- The vehicle sharply stops.
- Temperature is extremely low around the vehicle.
- The vehicle severely vibrates while driving over a bumpy road, uneven/bumpy road, or concrete patch.
- The vehicle drives on a slippery surface due to snow, water puddle, or ice.



- Driving on a curve

BCW system may not operate properly when driving on a curved road. In certain instances the system may not detect the vehicle in the next lane.

Always pay attention to road and driving conditions, while driving.



BCW system may not operate properly when driving on a curved road. In certain instances the system may recognize a vehicle in the same lane.

Always pay attention to road and driving conditions, while driving.

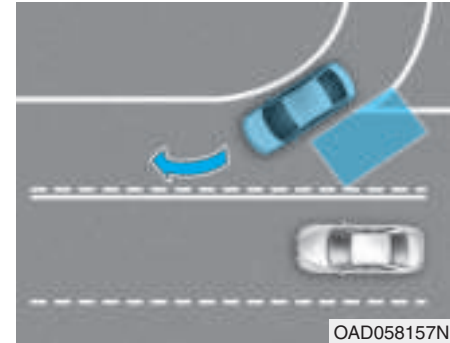

- Driving where the road is merging/dividing

BCW system may not operate properly when driving where the road is merging/dividing. In certain instances the system may not detect the vehicle in the next lane.

Always pay attention to road and driving conditions, while driving.

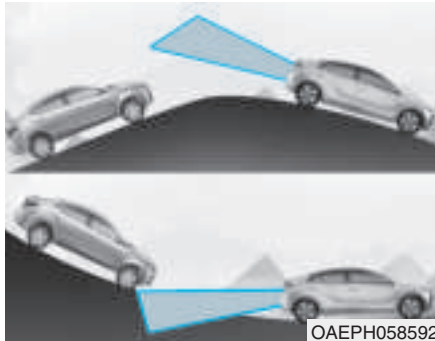

- Driving on a slope

BCW system may not operate properly when driving on a slope. In certain instances the system may not detect the vehicle in the next lane.

Also, in certain instances the system may wrongly recognize the ground or structures.

Always pay attention to road and driving conditions, while driving.

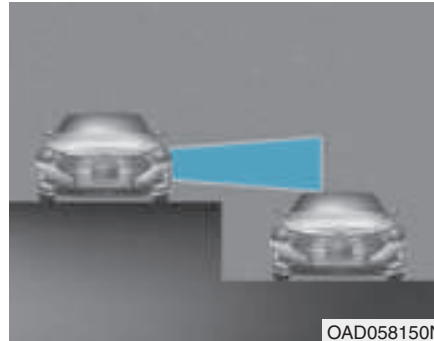

- Driving where the heights of the lanes are different

BCW system may not operate properly when driving where the heights of the lanes are different.

In certain instances, the system may not detect the vehicle on a road with different lane heights (underpass joining section, grade separated intersections, etc.).

Always pay attention to road and driving conditions, while driving.



[A] : noise barrier, [B] : guardrail

- Driving where there is a structure beside the road

BCW system may not operate properly when driving where there is structure beside the road.

In certain instances, the system may wrongly recognize the structures (noise barriers, guardrail, double guardrail, median strip, bollard, street light, road sign, tunnel wall, etc.) beside the road.

Always pay attention to road and driving conditions, while driving.

## **i** Information

This device complies with Industry Canada RSS-210 standard.

Operation is subject to the following three conditions:

1. This device may not cause harmful interference, and
2. This device must accept any interference received, including interference that may cause undesired operation.
3. Changes or modifications not expressly approved by the party responsible for compliance could void the user's authority to operate the device.

## **i** Information

Radio frequency radiation exposure information:

This equipment complies with RSS radiation exposure limits set forth for an uncontrolled environment.

This equipment should be installed and operated with minimum distance of 20 cm (8 in.) between the radiator (antenna) and your body.

This transmitter must not be co-located or operating in conjunction with any other antenna or transmitter.

## Declaration of conformity (if equipped)

The radio frequency components (Rear Corner Radar) comply with requirements and other relevant provisions.

- For Taiwan



- For Singapore



- For Mexico



- For Brazil

Anatael: 00772-13-04942  
OAEPH069061L

- For South Africa (TA-2012/779)



OAEPH069051L

- For Oman

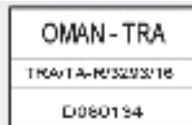

OAEPH069052L

- For Moldova



OAEPH069053L

- For Russia



OAEPH069054L

- For UAE

TRA  
REGISTERED No:  
XXXXXXXXXX  
DEALER No:  
XXXXXXXXXX

OAEPH069055L

- For Vietnam



OAEPH069056L

- For Serbia



OAEPH069057L

- For Ukraine



OAEPH069058L

- For Argentina

CNE COMISIÓN NACIONAL  
DE COMUNICACIONES

OAEPH069059L

- For Paraguay (2017-08-I-0000279 )



OAEPH069060L



## DRIVER ATTENTION WARNING (DAW) (IF EQUIPPED)

Driver Attention Warning system displays the level of the driver's fatigue and inattention, considering the driving pattern, etc.

### System setting and operation

#### System setting

- Driver Attention Warning can be activated from the Users Settings mode in the cluster LCD display by following the procedure below.
  1. Set the ignition switch to the ON position.
  2. Select 'User settings → Driver assistance → Driver Attention Warning' in the cluster LCD display. Deselect the setting to turn off the system.
- If the vehicle is turned off then on again, the system maintains the last setting.



- Selecting Warning Timing  
The driver can select the initial warning activation time from the User Settings in the cluster LCD display by selecting 'User settings → Driver assistance → Warning timing → Normal/Late'.

The options for the initial Driver Attention Warning includes the following:

- Normal:

When this option is selected, the initial Driver Attention Warning is activated normally. If this setting feels sensitive, change the option to 'Late'.

The warning activation time may feel late if a vehicle at the side or rear abruptly accelerates.

- Late:

Select this warning activation time when the traffic is light and you are driving at low speeds.

#### **i** Information

**Other driver assistance systems like Forward Collision-Avoidance Assist system, etc. can be changed when warning time setting is changed.**



- **Setting Warning Volume**

The driver can select the warning volume from the User Settings in the LCD display by selecting 'User settings → Driver assistance → Warning volume → High/Medium/Low'.

### **i** Information

If you change the warning volume, the warning volume of other systems may change.

For more details, refer to "LCD Display Modes" in chapter 3.

### **Display of the driver's attention level**

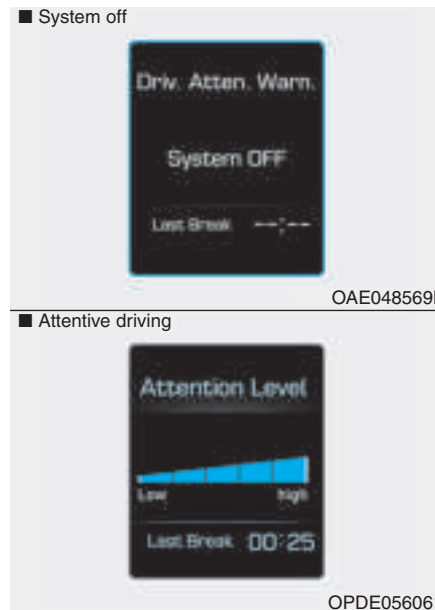

- The driver can monitor his/her driving conditions on the cluster LCD display.

The DAW screen will appear when you select the Driving Assist mode (DA) on the LCD display if the system is activated. **(For more details, refer to "LCD Display Modes" in chapter 3.)**

- The driver's attention level is displayed on the scale of 1 to 5. The lower the level is, the more inattentive the driver is.

- The level decreases when the driver does not take a break for a certain period of time.
- The level increases when the driver attentively drives for a certain period of time.
- When the driver turns on the system while driving, it displays 'Last Break time' and level.

### **Take a break**



- The "Consider taking a break" message appears on the cluster LCD display and a warning sounds to suggest that the driver take a break, when the driver's attention level is below 1.
- Driver Attention Warning system will not suggest a break, when the total driving time is shorter than 10 minutes and also doesn't recommend an additional break within 10 minutes after a break.

### **CAUTION**

**If any other warning sound such as seat belt warning chime is already generated, Driver Attention Warning system warning may not sound.**

### Resetting the system

- The last break time is set to 00:00 and the driver's attention level is set to 5 (very attentive) when the driver resets Driver Attention Warning system.
- Driver Attention Warning system resets the last break time to 00:00 and the driver's attention level to 5 in the following situations.
  - The vehicle is turned OFF.
  - The driver unfastens the seat belt and then opens the driver's door.
  - The vehicle is stopped for more than 10 minutes.
- Driver Attention Warning system operates again, when the driver restarts driving.

### System standby



Driver Attention Warning system enters the ready status and displays the 'Standby' screen in the following situations.

- The front view camera does not detect the lane.
- Driving speed over 180 km/h (110 mph).

### System malfunction



#### Check Driver Attention Warning (DAW) system

When the "Check Driver Attention Warning (DAW) system" warning message appears, the system is not working properly. In this case, we recommend that you have the vehicle inspected by an authorized HYUNDAI dealer.

## WARNING

- Driver Attention Warning system is not a substitute for safe driving practices, but a convenience function only. It is the responsibility of the driver to always drive cautiously to prevent unexpected and sudden situations from occurring. Pay attention to the road conditions at all times.
- The driver who feels fatigued should take a break, even though there is no break suggestion by Driver Attention Warning system.
- The driver has a responsibility of safe driving himself/herself at all times.

## Information

The system may suggest a break according to the driver's driving pattern or habits even if the driver doesn't feel fatigue.

## NOTICE

Driver Attention Warning system utilizes the front view camera on the front windshield for its operation. To keep the front view camera sensor in the best condition, you should observe the followings:

- Never install any accessories or stickers on the front windshield, or tint the front windshield.
- NEVER place any reflective objects (i.e. white paper, mirror) over the dashboard. Any light reflection may cause a malfunction of Driver Attention Warning system.
- Pay extreme caution to keep the front view camera sensor dry.
- NEVER disassemble the front view camera assembly, nor apply any impact on the front view camera assembly.

(Continued)

(Continued)

- If the sensor is forcibly moved out of proper alignment, the system may not operate correctly. We recommend that you take your vehicle to an authorized HYUNDAI dealer and have the system checked for calibration.

 **CAUTION**

Driver Attention Warning system may not provide alerts in the following situations:

- The system may not work around 15 seconds after starting the vehicle or the initialization or rebooting of the front view camera.
- The lane detection performance is limited. (For more information, refer to "Lane Keeping Assist (LKA)" in this chapter.)
- The vehicle is erratically driven or is abruptly turned for obstacle avoidance (e.g. construction area, other vehicles, fallen objects, bumpy road).

(Continued)

(Continued)

- Forward drivability of the vehicle is severely undermined (possibly due to wide variation in tire pressures, uneven tire wear-out, toe-in/toe-out alignment).
- The vehicle is driven on a curvy road.
- The vehicle is driven through a windy area.
- The vehicle is driven on a bumpy road.
- The vehicle is controlled by the following driving assist systems:
  - Forward Collision-Avoidance Assist system
  - Smart Cruise Control system
  - Lane Keeping Assist system
  - Lane Following Assist system

 **CAUTION**

Playing the vehicle audio system at high volume may prevent occupants from hearing Driver Attention Warning system warning sounds.

## Leading Vehicle Departure Alert (if equipped)

Leading Vehicle Departure Alert function provides the alert whether the leading vehicle drives away or not, while at a stop.

### **Function setting and operating conditions**

#### System setting

- Selecting Driver Attention Warning function

The Leading Vehicle Departure Alert can be activated from Users Settings mode in the cluster LCD display by following the procedure below.

1. Set the ignition switch to the ON position.
  2. Select 'User Settings → Driving Assistance → Driver Attention Warning → Leading Vehicle Departure Alert' in cluster LCD display. Deselect the setting to turn off the system.
- If the vehicle is turned off then on again, the system maintains the last setting.

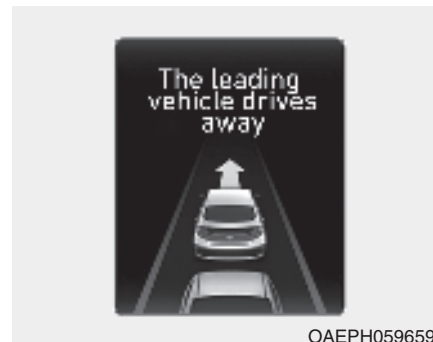

#### **Alert announcement**

The system notifies the driver with the alert message and a warning sound when the leading vehicle drives away while a stop.

 **WARNING**

- **Leading Vehicle Departure Alert function is only a convenient auxiliary for the driver. The system can't announce the alarm when a leading vehicle departs in real time.**
- **The driver must check and determine real conditions and then start to drive even if the system notified the leading vehicle departure.**

 **CAUTION**

- **It may not provide Vehicle Departure Alert or may not properly operate in the following situations:**
  - **Leading pedestrian(s) or bicycle(s) in front of vehicle**
  - **Leading cut-in vehicle(s)**
  - **Leading vehicle's quick departure**
  - **Stop on speed bump or steep hill**
  - **Stop on a right-turn junction or a curved road**
  - **Stop on shoulder road, rest area, parking lot**



## CRUISE CONTROL

### Cruise Control Operation





1. Cruise indicator
2. SET indicator

The Cruise Control system allows you to drive at speeds above 30 km/h (20 mph) without depressing the accelerator pedal.

### WARNING

Take the following precautions:

- Always set the vehicle speed under the speed limit.
- If the Cruise Control is left on, (cruise (  CRUISE) indicator light is illuminated) the Cruise Control can be activated unintentionally. Keep the Cruise Control system off (cruise (  CRUISE) indicator light OFF) when the Cruise Control is not in use, to avoid inadvertently setting a speed.
- Use the Cruise Control system only when traveling on open highways in good weather.
- Do not use the Cruise Control when it may be unsafe to keep the vehicle at a constant speed:

(Continued)

(Continued)

- When driving in heavy traffic or when traffic conditions make it difficult to drive at a constant speed
- When driving on rainy, icy, or snow-covered roads
- When driving on hilly or windy roads
- When driving in windy areas
- When driving with limited view (possibly due to bad weather such as fog, snow, rain and sandstorm)

### **i** Information

- During normal cruise control operation, when the SET switch is activated or reactivated after applying the brakes, the cruise control will energize after approximately 3 seconds. This delay is normal.
- Before activating the cruise control function, the system will check to verify that the brake switch is operating normally. Depress the brake pedal at least once after turning ON the ignition or starting the engine.

### **To set Cruise Control speed**



1. Press the CRUISE button on the steering wheel to turn the system on. The cruise (  CRUISE ) indicator will illuminate.
2. Accelerate to the desired speed, which must be more than 30 km/h (20 mph).

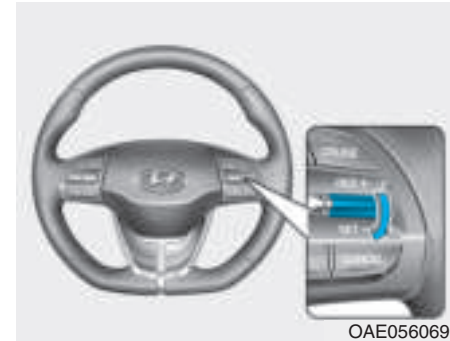

3. Push the toggle switch down (SET-), and release it. The SET indicator light will illuminate.
4. Release the accelerator pedal.

### **i** Information

**On a steep slope, the vehicle may slightly slow down or speed up, while driving uphill or downhill.**

### **To increase Cruise Control speed**

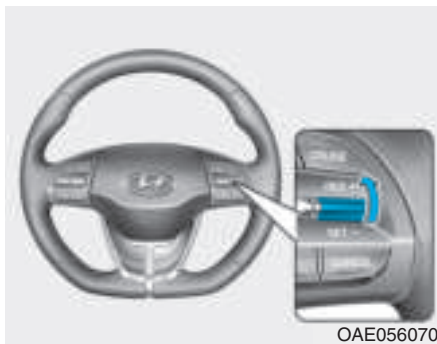

OAE056070

- Push the toggle switch up (RES+) and release it immediately. The cruising speed will increase 1.6 km/h (1.0 mph) each time the toggle switch is operated in this manner.
- Push the toggle switch up (RES+) and hold it, while monitoring the SET speed on the instrument cluster.

Release the toggle switch when the desired speed is shown and the vehicle will accelerate to that speed.

- Depress the accelerator pedal. When the vehicle attains the desired speed, push the toggle switch down (SET-).

### **To decrease Cruise Control speed**

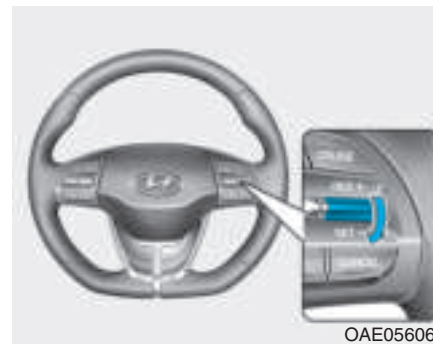

OAE056069

- Push the toggle switch down (SET-) and release it immediately. The cruising speed will decrease 1.6 km/h (1.0 mph) each time the toggle switch is operated in this manner.
- Push the toggle switch down (SET-) and hold it. Your vehicle will gradually slow down. Release the toggle switch at the speed you want to maintain.
- Lightly tap the brake pedal. When the vehicle attains the desired speed, push the toggle switch down (SET-).

### **To temporarily accelerate with the Cruise Control ON**

Depress the accelerator pedal. When you take your foot off the accelerator, the vehicle will return to the previously set speed.

If you push the toggle switch down (SET-) at the increased speed, the Cruise Control will maintain the increased speed.

### **Cruise Control will be canceled when:**



- Depressing the brake pedal.
- Pressing the CANCEL button located on the steering wheel.
- Pressing the CRUISE button. Both the "Ⓢ CRUISE" indicator and the "SET" indicator will turn OFF.
- Moving the shift lever into N (Neutral).
- Decreasing the vehicle speed to less than approximately 30 km/h (20 mph).

- The ESC (Electronic Stability Control) is operating.
- Downshifting to 2<sup>nd</sup> gear when in Manual Shift mode.

### ***i* Information**

Each of the above actions will cancel Cruise Control operation (the "SET" indicator in the instrument cluster will go off), but only pressing the CRUISE button will turn the system off. If you wish to resume Cruise Control operation, push the toggle switch up (RES+) located on your steering wheel. You will return to your previously preset speed, unless the system was turned off using the CRUISE button.

### **To resume preset Cruising speed**

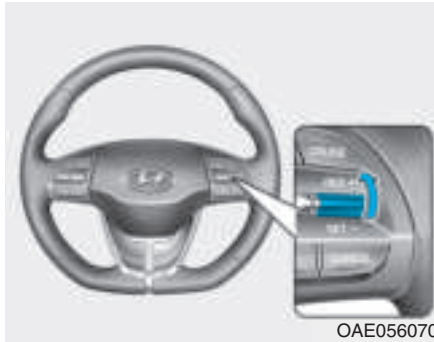

Push the toggle switch up (RES+). If the vehicle speed is over 30 km/h (20 mph), the vehicle will resume the preset speed.

### **To turn Cruise Control off**



- Press the CRUISE button (the cruise (CRUISE) indicator light will go off).
- Turn the vehicle OFF.

## SMART CRUISE CONTROL (IF EQUIPPED)



- (1) Cruise indicator
- (2) Set speed
- (3) Vehicle-to-vehicle distance

To see the SCC screen on the LCD display in the cluster, select Driving Assist mode ( ). For more information, refer to "LCD Display Modes" in chapter 3.

Smart Cruise Control system allows you to program the vehicle to help maintain the desired speed and minimum distance between the vehicle ahead.

Smart Cruise Control system will automatically adjust your vehicle speed to help maintain your programmed speed and following distance without requiring you to depress the accelerator or brake pedals.

### WARNING



**For your safety, please read the owner's manual before using the Smart Cruise Control system.**

### WARNING

- **Smart Cruise Control system is not a substitute for safe driving practices, but a convenience function only. It is the responsibility of the driver to always check the speed and distance to the vehicle ahead.**
- **Always be aware of road conditions while driving and be alert for unexpected situations even though Smart Cruise Control system is operating.**
- **Smart Cruise Control is supplemental systems to assist you. Do not entirely rely on the systems. Always pay attention, while driving, for your safety.**

## **WARNING**

Take the following precautions :

- Always set the vehicle speed under the speed limit on the road that you are driving.
- If Smart Cruise Control is left on, (cruise (  CRUISE) indicator light in the instrument cluster is illuminated) Smart Cruise Control can be activated unintentionally. Keep Smart Cruise Control system off (cruise (  CRUISE) indicator light OFF) when the Smart Cruise Control is not in use, to avoid inadvertently setting a speed.
- Use Smart Cruise Control system only when traveling on open highways in good weather.

(Continued)

(Continued)

- Smart Cruise Control is not a collision avoidance or warning device.

Smart Cruise Control is designed to only detect vehicles as it cannot detect motorcycles, bicycles, or pedestrians.

- Do not use Smart Cruise Control when it may not be safe to keep the vehicle at a constant speed:
  - When driving in heavy traffic or when traffic conditions make it difficult to drive at a constant speed
  - When driving on rainy, icy, or snow-covered roads
  - When driving on a steep downhill or uphill
  - When driving in windy areas
  - When driving in parking lots
  - When driving near crash barriers

(Continued)

(Continued)

- When driving on a sharp curve
- When driving with limited view (possibly due to bad weather, such as fog, snow, rain or sandstorm)
- When the vehicle sensing ability decreases due to vehicle modification resulting level difference of the vehicle's front and rear

### To adjust the sensitivity of Smart Cruise Control



OOSEV058091L

The sensitivity of vehicle speed when following the front vehicle to maintain the set distance can be adjusted. Select 'User settings → Driver assistance → SCC response → Slow/Normal/Fast' in the cluster LCD display.

You may select one of the three stages you prefer.

- Slow:  
Vehicle speed following the front vehicle to maintain the set distance is slower than normal speed.
- Normal:  
Vehicle speed following the front vehicle to maintain the set distance is normal.
- Fast:  
Vehicle speed following the front vehicle to maintain the set distance is faster than normal speed.

#### **i** Information

**The last selected speed sensitivity of the smart cruise control is remained in the system.**

### To convert to Cruise Control mode

The driver may choose to only use the conventional Cruise Control mode (speed control function) by doing as follows:

1. Turn Smart Cruise Control system on (the cruise indicator light will be on but the system will not be activated).
2. Push and hold the Vehicle-to-Vehicle Distance button for more than 2 seconds.
3. Choose between "Smart Cruise Control" and "Cruise Control".

When the system is cancelled using the CRUISE button or the CRUISE button is used after the vehicle is in the ready (  ) mode, the Smart Cruise Control mode will turn on.



## WARNING

When using the Cruise Control mode, you must manually adjust the distance to other vehicles by depressing the accelerator or brake pedal. The system does not automatically adjust the distance to vehicles in front of you.

### Smart Cruise Control speed

#### To set Smart Cruise Control speed



1. Push the CRUISE button on the steering wheel to turn the system on. The cruise (  CRUISE ) indicator will illuminate.
2. Accelerate to the desired speed.  
Smart Cruise Control speed can be set when vehicle speed is between as follows.
  - 10 ~ 180 km/h ( 5 ~ 110 mph ) :  
when there is no vehicle in front
  - 0 ~ 180 km/h ( 0 ~ 110 mph ) :  
when there is a vehicle in front

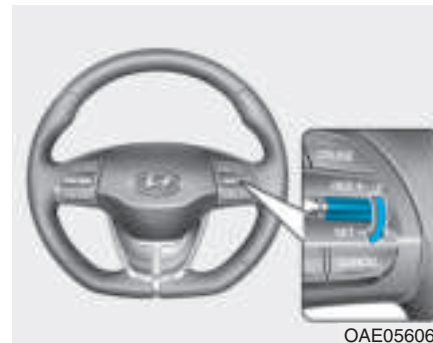

3. Push the toggle switch down (SET-). The Set Speed and Vehicle-to-Vehicle Distance on the LCD display will illuminate.
4. Release the accelerator pedal. The desired speed will automatically be maintained.

If there is a vehicle in front of you, the speed may decrease to maintain the distance to the vehicle ahead.

On a steep grade, the vehicle may slow down or speed up slightly while going uphill or downhill.

### **i** Information

- Vehicle speed may decrease on an upward slope and increase on a downward slope.
- When you are setting the cruise control speed with a vehicle in front and your vehicle speed is between 0-30 km/h (0-20 mph), the speed will set to 30 km/h (20 mph).

### **To increase Smart Cruise Control set speed**

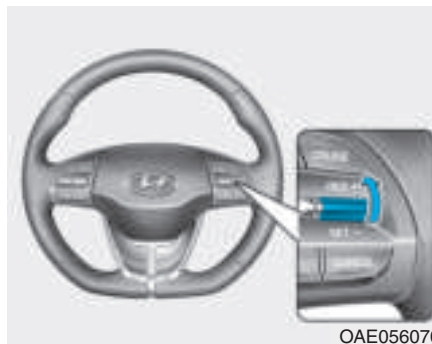

Follow either of these procedures:

- Push the toggle switch up (RES+), and release it immediately. The cruising speed will increase by 1 km/h (1 mph) each time you move the toggle switch up in this manner.
- Push the toggle switch up (RES+), and hold it. Your vehicle set speed will increase by 10 km/h (5 mph). Release the toggle switch at the speed you want.
- You can set the speed to 180 km/h (110 mph).

### **CAUTION**

**Check the driving condition before using the toggle switch. Driving speed sharply increases, when you push up and hold the toggle switch.**

### To decrease the Smart Cruise Control set speed

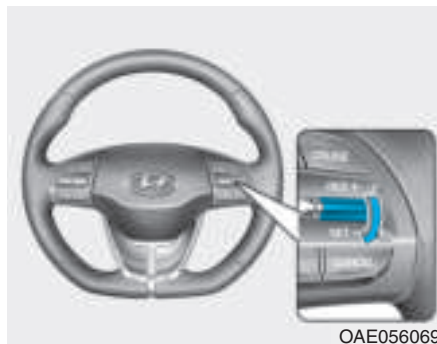

Follow either of these procedures:

- Push the toggle switch down (SET-), and release it immediately. The cruising speed will decrease by 1 km/h (1 mph) each time you move the toggle switch down in this manner.
- Push the toggle switch down (SET-), and hold it. Your vehicle set speed will decrease by 10 km/h (5 mph). Release the toggle switch at the speed you want.
- You can set the speed to 30 km/h (20 mph).

### To temporarily accelerate with Smart Cruise Control on

If you want to speed up temporarily when Smart Cruise Control is on, depress the accelerator pedal. Increased speed will not interfere with Smart Cruise Control operation or change the set speed.

To return to the set speed, take your foot off the accelerator pedal.

If you push the toggle switch down (SET-) at increased speed, the set speed is updated.

#### **i** Information

**Be careful when accelerating temporarily, because the speed is not controlled automatically at this time even if there is a vehicle in front of you.**

### Smart Cruise Control will be temporarily cancelled when:



#### Canceled manually

- Depressing the brake pedal.
- Pressing the CANCEL button located on the steering wheel.
- Depress the brake pedal and press the CANCEL button at the same time, when the vehicle is at a standstill.

Smart Cruise Control turns off temporarily when the Set Speed and Vehicle-to-Vehicle Distance indicator on the LCD display turns off.

The cruise (  CRUISE ) indicator is illuminated continuously.

### Cancelled automatically

- The driver's door is opened.
- The shift lever is shifted to N (Neutral), R (Reverse) or P (Park).
- The parking brake is applied.
- The vehicle speed is over 190 km/h (120 mph).
- ESC (Electronic Stability Control), TCS (Traction Control System) or ABS is operating.
- ESC is turned off.
- The sensor or the cover is dirty or blocked with foreign matter.
- The vehicle is stopped for more than 5 minutes.
- The vehicle stops and goes repeatedly for a long period of time.
- The accelerator pedal is continuously depressed for a long period of time.
- SCC system has malfunctioned.
- The motor performance is abnormal.

- The braking control is operated for FCA (Forward Collision-Avoidance Assist)
- The driver starts driving by pushing the toggle switch up (RES+)/down (SET-) or depressing the accelerator pedal, after the vehicle is stopped by the Smart Cruise Control system with no other vehicle ahead.
- The driver starts driving by pushing the toggle switch up (RES+)/down (SET-) or depressing the accelerator pedal, after stopping the vehicle with a vehicle stopped far away in front.

Each of these actions will cancel the Smart Cruise Control operation. The Set Speed and Vehicle-to-Vehicle Distance on the LCD display will go off.

In a condition the Smart Cruise Control is cancelled automatically, the Smart Cruise Control will not resume even though the RES+ or SET- toggle switch is pushed.

Also, if Smart Cruise Control is cancelled automatically while the vehicle is at a standstill, the EPB (Electronic Parking Brake) will be applied.

### Information

**If the Smart Cruise Control is cancelled by other than the reasons mentioned, we recommend that the system be checked by an authorized HYUNDAI dealer.**



### Smart Cruise Control canceled

If the system is cancelled, the warning chime will sound and a message will appear for a few seconds.

You must adjust the vehicle speed by depressing the accelerator or brake pedal according to the road condition ahead and driving condition.

Always check the road conditions. Do not rely on the warning chime.

### To resume Smart Cruise Control set speed

If any method other than the cruise toggle switch was used to cancel cruising speed and the system is still activated, the cruising speed will automatically resume when you push the toggle switch up (RES+) or down (SET-).

If you push the toggle switch up (RES+), the speed will resume to the recently set speed. However, if vehicle speed drops under 10 km/h (5 mph), it will resume when there is a vehicle in front of your vehicle.

### **i** Information

**Always check the road conditions when you push the toggle switch up (RES+) to resume speed.**

### To turn Cruise Control off



- Press the CRUISE button (the cruise (  CRUISE ) indicator light will go off).

### Smart Cruise Control Vehicle-to-Vehicle Distance

#### To set Vehicle-to-Vehicle Distance

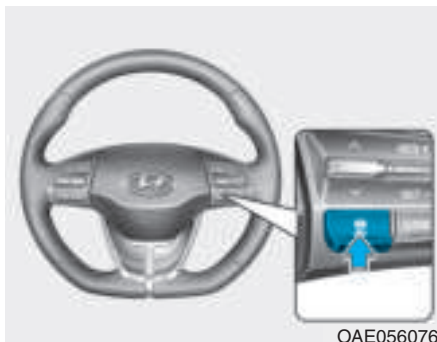

When Smart Cruise Control system is ON, you can set and maintain the distance from the vehicle ahead of you without pressing the accelerator or brake pedal.

Each time the button is pressed, the vehicle to vehicle distance changes as follows:

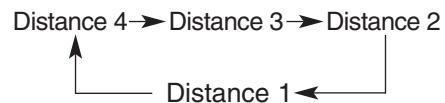

For example, if you drive at 90 km/h (56 mph), the distance is maintained as follows:

- Distance 4 - approximately 52.5 m
- Distance 3 - approximately 40 m
- Distance 2 - approximately 32.5 m
- Distance 1 - approximately 25 m

### **i** Information

The distance is set to the last set distance when the system is used for the first time after starting the engine.

*When the lane ahead is clear:*



OPD056084

The vehicle speed will maintain the set speed.

*When there is a vehicle ahead of you in your lane:*

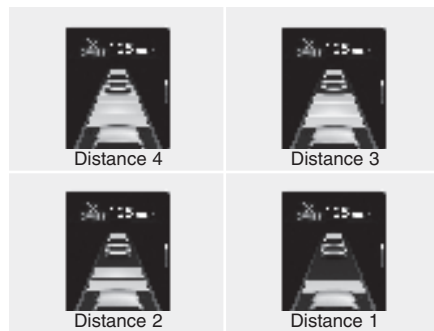

OAEPH058615/OAEPH058614/OAEPH058613/OAEPH058612

- Your vehicle speed will slow down or speed up to maintain the selected distance.
- If the vehicle ahead speeds up, your vehicle will travel at a steady cruising speed after accelerating to the set speed.
- If distance from the front vehicle has been changed due to accelerating or decelerating of the front vehicle, the distance on the LCD display may change. (Only when there is a vehicle in front, the front vehicle appears in the LCD display.)

**WARNING**

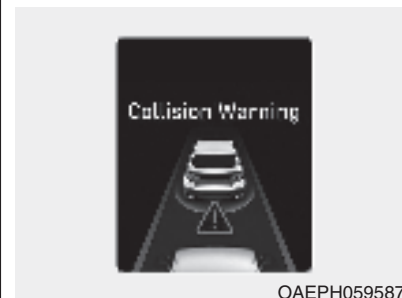

OAEPH059587L

**When using Smart Cruise Control system:**

- The warning message appears and warning chime sounds if the vehicle is unable to maintain the selected distance from the vehicle ahead.
- If the warning message appears and warning chime sounds, depress the brake pedal to actively adjust the vehicle speed, and the distance to the vehicle ahead.

**(Continued)**

### (Continued)

- Even if the warning message does not appear and warning chime does not sound, always pay attention to the driving conditions to prevent dangerous situations from occurring.
- Playing the vehicle audio system at high volume may prevent occupants from hearing the system warning sounds.

### CAUTION



OAEPH059168L

If the vehicle ahead (vehicle speed: less than 30 km/h (20 mph)) disappears to the next lane, the warning chime will sound and a message "Watch for surrounding vehicles" will appear. Adjust your vehicle speed for vehicles or objects that can suddenly appear in front of you by depressing the brake pedal.

Always pay attention to the road condition ahead.

### *In traffic situation*



OIK057107L

### Use switch or pedal to accelerate

- In traffic, your vehicle will stop if the vehicle ahead of you stops. Also, if the vehicle ahead of you starts moving, your vehicle will start as well. However, if the vehicle stops for more than 3 seconds, you must depress the accelerator pedal or push up the toggle switch (RES+) to start driving.



- If you push the smart cruise control toggle switch (RES+ or SET-) while Auto Hold and smart cruise control is operating the Auto Hold will be released regardless of accelerator pedal operation and the vehicle will start to move. The AUTO HOLD indicator changes from green to white.

### Sensor to detect distance to the vehicle ahead



Smart Cruise Control uses a sensor to detect distance to the vehicle ahead.

If the sensor is covered with dirt or other foreign matter, the vehicle to vehicle distance control may not operate correctly. Always keep the sensor clean.

### Warning message



### Smart Cruise Control disabled. Radar blocked

When the sensor lens cover is blocked with dirt, snow, or debris, Smart Cruise Control system operation may stop temporarily. If this occurs, a warning message will appear on the cluster LCD display. Remove any dirt, snow, or debris and clean the radar sensor lens cover before operating Smart Cruise Control system. The Smart Cruise Control system may not properly activate, if the radar is totally covered, or if any substance is not detected after the vehicle is in the ready (  ) mode (e.g. in an open terrain).

5-125

### **i** Information

For the SCC operation is temporarily stopped if the radar is blocked, but you wish to use cruise control mode (speed control function), you must convert to the cruise control mode (refer to "To convert to Cruise Control mode" in the following page.

#### **CAUTION**

- Do not apply license plate frame or foreign objects such as a bumper sticker or a bumper guard near the radar sensor. Doing so may adversely affect the sensing performance of the radar.
- Always keep the radar sensor and lens cover clean and free of dirt and debris.
- Use only a soft cloth to wash the vehicle. Do not spray pressurized water directly on the sensor or sensor cover.

(Continued)

(Continued)

- Be careful not to apply unnecessary force on the radar sensor or sensor cover. If the sensor is forcibly moved out of proper alignment, Smart Cruise Control system may not operate correctly. In this case, a warning message may not be displayed. Have the vehicle inspected by an authorized HYUNDAI dealer.
- If the front bumper becomes damaged in the area around the radar sensor, Smart Cruise Control system may not operate properly. We recommend you to have the vehicle inspected by an authorized HYUNDAI dealer.
- Use only genuine HYUNDAI parts to repair or replace a damaged sensor or sensor cover. Do not apply paint to the sensor cover.



#### Check Smart Cruise Control System

The message will appear when the vehicle to vehicle distance control system is not functioning normally.

We recommend that you take your vehicle to an authorized HYUNDAI dealer and have the system checked.

## Limitations of the system

The Smart Cruise Control System may have limits to its ability to detect distance to the vehicle ahead due to road and traffic conditions.

### On curves

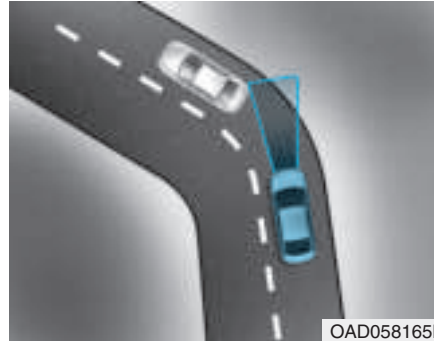

- Smart Cruise Control system may not detect a moving vehicle in your lane, and then your vehicle could accelerate to the set speed. Also, the vehicle speed will decrease when the vehicle ahead is recognized suddenly.
- Select the appropriate set speed on curves and apply the brakes or accelerator pedal if necessary.



Your vehicle speed can be reduced due to a vehicle in the adjacent lane. Apply the accelerator pedal and select the appropriate set speed. Check to be sure that the road conditions permit safe operation of Smart Cruise Control.

### ***On inclines***

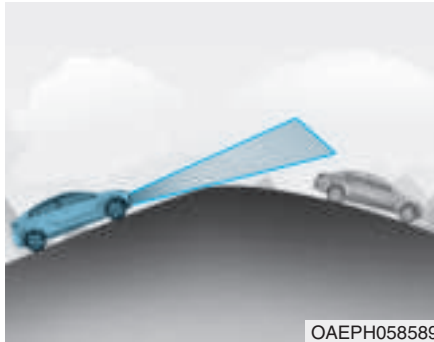

- During uphill or downhill driving, Smart Cruise Control system may not detect a moving vehicle in your lane, and cause your vehicle to accelerate to the set speed. Also, the vehicle speed will rapidly decrease when the vehicle ahead is recognized suddenly.
- Select the appropriate set speed on inclines and apply the brake or accelerator pedal if necessary.

### ***Lane changing***

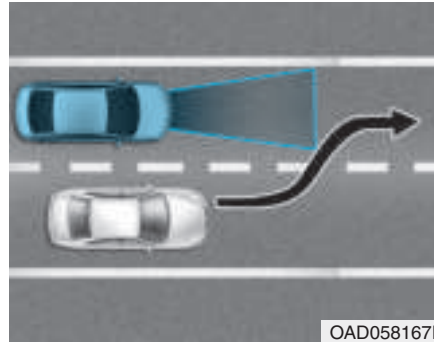

- A vehicle which moves into your lane from an adjacent lane cannot be recognized by the sensor until it is in the sensor's detection range.
- The radar may not detect immediately when a vehicle cuts in suddenly. Always pay attention to the traffic, road and driving conditions.
- If a slower vehicle moves into your lane, your speed may decrease to maintain the distance to the vehicle ahead.
- If a faster vehicle which moves into your lane, your vehicle will accelerate to the set speed.

### ***Vehicle recognition***

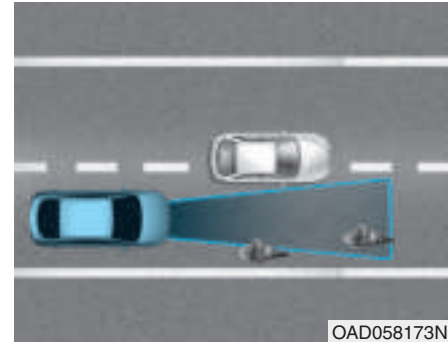

Some vehicles in your lane cannot be recognized by the sensor:

- Vehicles offset to one side
- Slow-moving vehicles or sudden-decelerating vehicles
- Stopped vehicles
- Vehicles with small rear profile such as trailers with no loads

A vehicle ahead cannot be recognized correctly by the sensor if any of the following occurs:

- When the vehicle is pointing upwards due to overloading in the luggage compartment
- While the steering wheel is operating
- When driving to one side of the lane
- When driving on narrow lanes or on curves

Apply the brake or accelerator pedal if necessary.

### WARNING

**Smart Cruise Control is basically designed to set vehicles as a target. Always look ahead cautiously to cope with unexpected situations such as a collision when the system sets an object as a target, not vehicles.**

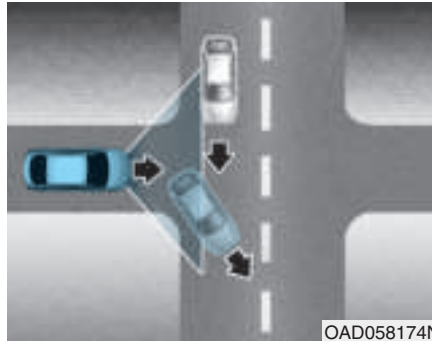

- Your vehicle may accelerate when a vehicle ahead of you disappears.
- When you are warned that the vehicle ahead of you is not detected, drive with caution.

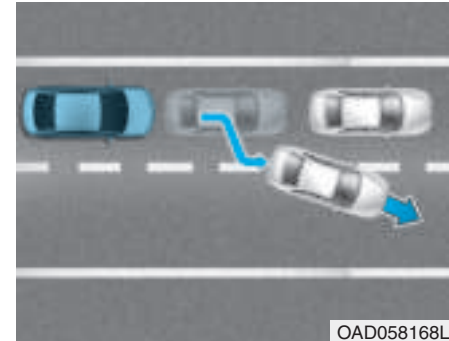

- When driving in stop-and-go traffic, and a vehicle in front of you merges out of the lane, the system may not immediately detect the new vehicle that is now in front of you. In this case, you must maintain a safe braking distance, and if necessary, depress the brake pedal to reduce your driving speed in order to maintain a safe distance.

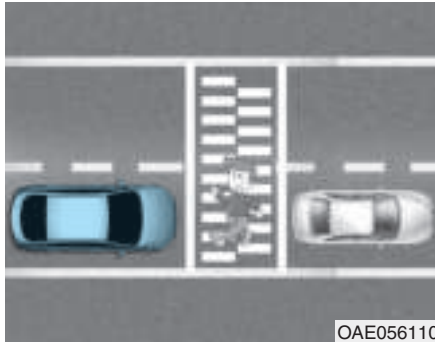

OAE056110

- Always look out for pedestrians when your vehicle is maintaining a distance with the vehicle ahead.

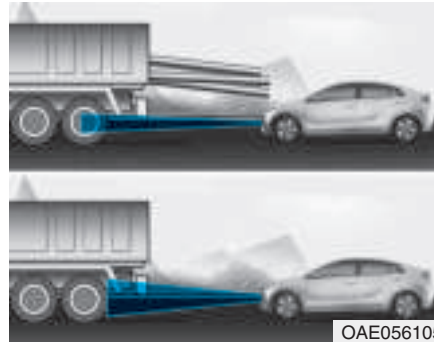

OAE056105

- Always be cautious for vehicles with higher height or vehicles carrying loads that sticks out from the back of the vehicle.

### WARNING

When using Smart Cruise Control take the following precautions:

- If an emergency stop is necessary, you must apply the brakes. The vehicle cannot be stopped at every emergency situation by using Smart Cruise Control system.
- Keep a safe distance according to road conditions and vehicle speed. If the vehicle to vehicle distance is too close during a high-speed driving, a serious collision may result.
- Always maintain sufficient braking distance and decelerate your vehicle by applying the brakes if necessary.

(Continued)

(Continued)

- Smart Cruise Control System cannot recognize a stopped vehicle, pedestrians or an oncoming vehicle. Always look ahead cautiously to prevent unexpected and sudden situations from occurring.
- Vehicles moving in front of you with a frequent lane change may cause a delay in the system's reaction or may cause the system to react to a vehicle actually in an adjacent lane. Always drive cautiously to prevent unexpected and sudden situations from occurring.
- Always be aware of the selected speed and vehicle to vehicle distance. The driver should not solely rely on the system but always pay attention to driving conditions and control your vehicle speed.

(Continued)

(Continued)

- Smart Cruise Control System may not recognize complex driving situations so always pay attention to driving conditions and control your vehicle speed.
- Turn off Smart Cruise Control system when the vehicle is being towed.
- Do not activate Smart Cruise Control when towing a trailer or vehicle.

Safety of the vehicle may be deteriorated when braking control is applied in the towing condition.

**NOTICE**

Smart Cruise Control system may not operate temporarily due to:

- Electrical interference
- Modifying the suspension
- Differences of tire abrasion or tire pressure
- Installing different type of tires

### **i** Information

This device complies with Industry Canada RSS-210 standard.

Operation is subject to the following three conditions:

1. This device may not cause harmful interference, and
2. This device must accept any interference received, including interference that may cause undesired operation.
3. Changes or modifications not expressly approved by the party responsible for compliance could void the user's authority to operate the device.

### **i** Information

Radio frequency radiation exposure information:

This equipment complies with RSS radiation exposure limits set forth for an uncontrolled environment.

This equipment should be installed and operated with minimum distance of 20 cm (8 in.) between the radiator (antenna) and your body.

This transmitter must not be co-located or operating in conjunction with any other antenna or transmitter.



## NAVIGATION-BASED SMART CRUISE CONTROL (NSCC) (IF EQUIPPED)

Navigation-based Smart Cruise Control system will help automatically adjust your speed when a curved road is ahead by receiving road information from the navigation while Smart Cruise Control is operating.

### WARNING

- **Navigation-based Smart Cruise Control system is not a substitute for safe driving practices, but a convenience function. It is the responsibility of the driver to always be aware of the surroundings and drive safely.**
- **Navigation-based Smart Cruise Control system relies entirely on the road information provided by the navigation system and may accelerate above speed limit. It is the responsibility of the driver to follow traffic laws and avoid accidents.**

(Continued)

### (Continued)

- **Turn off the Navigation-based smart cruise control system when the vehicle is being towed.**
- **For your safety, please read the owner's manual before using the system.**

### Information

- **Navigation-based Smart Cruise Control system is available only on controlled access road of certain highways.**
- **\* Controlled access road indicates roads with limited entrances and exits that allow uninterrupted high speed traffic flow. Only passenger cars and motorcycles are allowed on controlled access roads.**

Available highway (Controlled access road)	
USA	Select Interstate Highway and U.S. (Federal) and State Highways
Canada	Select Provincial and Territorial Highways

- **Additional highways may be expanded by navigation updates.**

### System Setting and Operation

#### System setting

- With the Engine Start/Stop button in the ON or START position, the Navigation-based Smart Cruise Control can be activated by selecting 'User setting → Driver Assistance → Driver Assist → Highway Auto Curve Slowdown' from the Settings menu in the infotainment system screen. Deselect the setting to turn off the system.
- If the engine is turned off then on again, the system maintains the last setting.

#### Operating conditions

Select 'Highway Auto Curve Slowdown' from the Settings menu in the infotainment system screen and satisfy the following conditions for the system to operate.

- Driving on the highway main line
- Smart Cruise Control is operating

If all the mentioned conditions are satisfied, the system is ENABLED and the 'AUTO' symbol on the cluster will illuminate white.

#### System operation

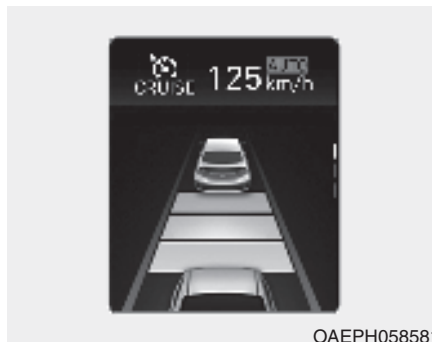

#### System standby

If the system is ENABLED, the **AUTO** symbol on the cluster will illuminate white.

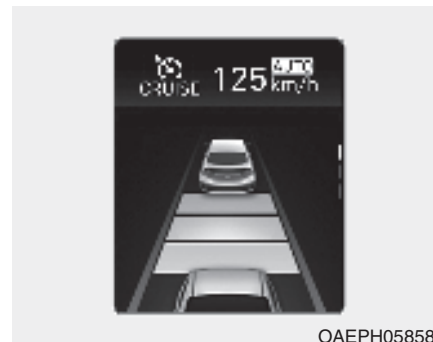

#### System in operation

If the vehicle decelerates in a curve, the **AUTO** symbol on the cluster will illuminate green.

- This system works only for curved sections located on highway main lines.
- Depending on the curve ahead on the road, the vehicle will decelerate, and after passing the curve, the vehicle will accelerate to the Smart Cruise Control set speed.
- The higher the driving speed, the faster the vehicle is decelerated.

- The system responds to curves located on the destination set in the navigation. If the destination is not set, the system will respond to road information of the expected route.

### **i** Information

- Navigation-based Smart Cruise Control is limited in other countries.
- The system may not operate due to the existence of leading vehicles and the driving situations of the vehicle.
- The system operates regardless of whether the sharp curve warning appears on the navigation, but the time gap could occur between the warning and system operation.
- The navigation only provides curve information within permitted speed ranges so that the system may not decrease its speed during extreme over-speed driving.
- The system is not designed to work on highways other than mentioned as a controlled access road.
- The system automatically cancels when you leave the highway.

(Continued)

(Continued)

- Highway Driving Assist and Navigation-based Smart Cruise Control uses the same **AUTO** symbol that indicates the status of the system. Therefore, even if the Navigation-based Cruise Control is off, the **AUTO** symbol may be displayed.
- If there is a problem with Navigation-based Smart Cruise Control, the system cannot be activated in the infotainment system screen, and the **AUTO** symbol will turn off. However, if Highway Driving Assist is activated, the **AUTO** symbol will be displayed.
- After you pass through a tollgate on a highway, the system operates based on the first lane. If you enter one of the other lanes, the system might not properly decelerate.
- If you over speed, the system may not decelerate the vehicle in a curve.
- Deceleration by the system may not be sufficient if the driver accelerates while the system is operating.

(Continued)

(Continued)

- If the driver releases the accelerator after stepping on it while the system is operating, sudden deceleration might occur for safety.
- Deceleration by the system may not be sufficient due to road conditions such as uneven road surfaces, narrow lanes, etc.
- If the road is controlled, due to construction or holiday events, the system might not work properly.

### **CAUTION**

Navigation-based Cruise Control system may not function properly in the following situations:

- The navigation is not working properly.
- The navigation is not updated.
- The real-time GPS or map information provided has errors.

(Continued)

(Continued)

- The navigation is overloaded by performing functions such as route search, video playback, voice recognition, etc. are performing simultaneously.
- GPS signals are blocked in areas such as a tunnel.
- The driver goes off course or the route to the destination is changed or canceled by resetting the navigation.
- The vehicle enters a service station or rest area.
- A section of the highway's shape has changed.
- Android Auto or Car Play is operating.
- The navigation cannot detect the current vehicle position (ex: elevated roads including overpass adjacent to general roads or nearby roads exist in a parallel way).

(Continued)

(Continued)

- The navigation is being updated while driving.
- The navigation is being reset while driving.
- The road is slippery due to bad weather such as rain or snow.

### Information

This device complies with Industry Canada RSS-210 standard.

Operation is subject to the following three conditions:

1. This device may not cause harmful interference, and
2. This device must accept any interference received, including interference that may cause undesired operation.
3. Changes or modifications not expressly approved by the party responsible for compliance could void the user's authority to operate the device.

### Information

Radio frequency radiation exposure information:

This equipment complies with RSS radiation exposure limits set forth for an uncontrolled environment.

This equipment should be installed and operated with minimum distance of 20 cm (8 in.) between the radiator (antenna) and your body.

This transmitter must not be co-located or operating in conjunction with any other antenna or transmitter.

## LANE FOLLOWING ASSIST (LFA) (IF EQUIPPED)

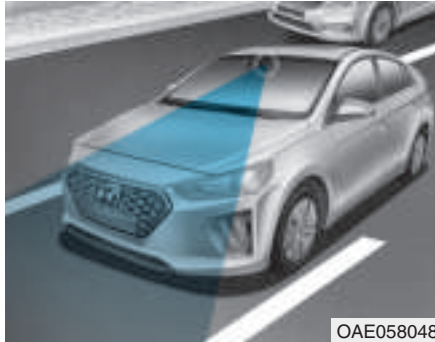

Lane Following Assist system helps detect lane markers on the road with a front view camera at the front windshield, and assists the driver's steering to help keep the vehicle between lanes.

### WARNING

Lane Following Assist system is not a substitute for safe driving practices, but a convenience function. It is the responsibility of the driver to always be aware of the surroundings and steer the vehicle.

### WARNING

Take the following precautions when using Lane Following Assist system:

- Do not turn the steering wheel suddenly when the steering wheel is being assisted by the system.
- LFA system helps the driver to keep the vehicle in the center of the lane by assisting the driver's steering. However, the driver should not solely rely on the system but always pay attention on the steering wheel to stay in the lane.
- The operation of LFA system can be canceled or not work properly according to road condition and surroundings. Always be cautious when driving.

(Continued)

**(Continued)**

- Do not disassemble the front view camera temporarily to tint the window or attach any types of coatings and accessories. If you disassemble the camera and assemble it again, we recommend that you take your vehicle to an authorized HYUNDAI dealer and have the system checked for calibration.
- When you replace the windshield glass, front view camera or related parts of the steering wheel, we recommend that you take your vehicle to an authorized HYUNDAI dealer and have the system checked for calibration.
- The system helps detect lane markers and controls the steering wheel by a camera, therefore, if the lane markers are hard to detect, the system may not work properly.

**(Continued)**

**(Continued)**

Please refer to "Limitations of the System".

- Do not remove or damage the related parts of LFA system.
- You may not hear a warning sound of LFA system if the audio volume is high.
- Do not place objects on the dashboard that reflects light such as mirrors, white paper, etc. This may prevent LFA system from functioning properly.
- Always have your hands on the steering wheel while LFA system is activated. If you continue to drive with your hands off the steering wheel after the "Keep hands on steering wheel" warning message appears, the system will turn off automatically.

However, if the driver has their hands on the steering wheel again, the system will start controlling the steering wheel.

**(Continued)**

**(Continued)**

- The steering wheel is not continuously controlled so if the vehicle speed is at a higher rate when leaving a lane the vehicle may not be controlled by the system. The driver must always follow the speed limit when using the system.
- If you attach objects to the steering wheel, the system may not assist steering or the hands off alarm may not work properly.
- When you tow a trailer, make sure that you turn off LFA system.

## LFA operation

### System setting

- With the ignition switch is in the ON position, Lane Following Assist can be activated by selecting 'User settings → Driver assistance → Driving assist → Lane following assist' in the cluster LCD display. Deselect the setting to turn off the system.
- If the vehicle is turned off then on again, the system maintains the last setting.

### Operating conditions

Select 'Lane following assist' from the User settings mode in the cluster LCD display and meet the following conditions for the system to operate.

- Smart Cruise Control is operating
- Vehicle speed is below 180 km/h (110 mph)

When the system is activated, the indicator (⊕) on the cluster will illuminate. The color of the indicator will change depending on the condition of the LFA system.

- Green : Steering assist mode is ON
- White : Steering assist mode is OFF

### LFA system operation

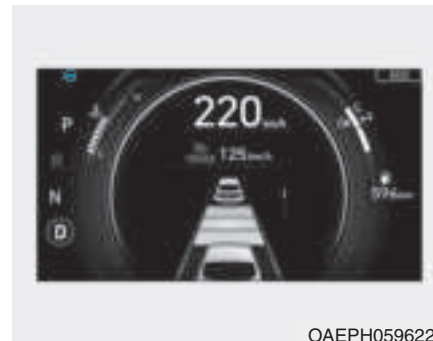

OAEPH059622L

If the vehicle is inside the lane with both lanes detected by the system (lane color changes from gray to white), and there is no abrupt steering made by the driver, LFA system changes to steering assist mode. The ⊕ indicator light will come on green, and the system helps the vehicle stay in line by controlling the steering wheel. If the lane markers are hard to detect, steering wheel will be able to be controlled depending on front vehicle and front vehicle driving conditions. When the steering wheel is not controlled temporarily, the ⊕ indicator light will flash green and change to white.

### Warning message



#### Keep hands on steering wheel

If the driver takes their hands off the steering wheel for several seconds while LFA system is activated, the system will warn the driver.

#### **i** Information

**Hold the steering wheel tight. Otherwise, LFA system could misjudge that the driver's hands are off the steering wheel, and the above warning may occur.**

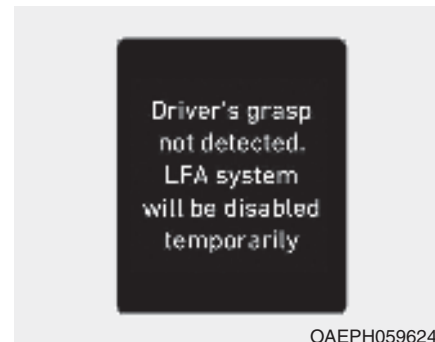
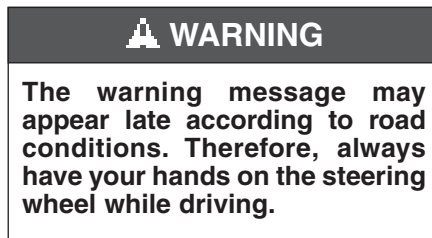

#### Driver's hands not detected. LFA system will be disabled temporarily

If the driver still does not have their hands on the steering wheel after the message "Keep hands on steering wheel", the system will not control the steering wheel and warn the driver only when the driver crosses the lane markers.

However, if the driver has their hands on the steering wheel again, the system will start controlling the steering wheel.



## WARNING

- LFA system is a supplemental system only. It is the responsibility of the driver to safely steer the vehicle and to maintain it in its lane.
- Turn off LFA system and drive without using the system in the following situations:
  - In bad weather
  - In bad road conditions
  - When the steering wheel needs to be controlled by the driver frequently.

## Information

- Even though the steering is assisted by the system, the driver may control the steering wheel.
- The steering wheel may feel heavier when the steering wheel is assisted by the system than when it is not.

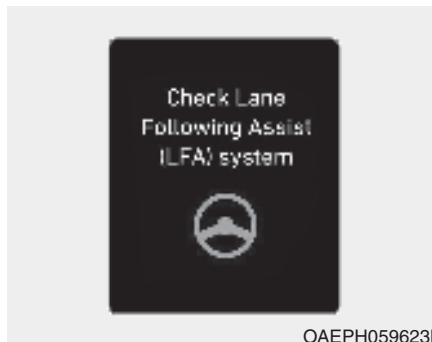

### Check Lane Following Assist (LFA) system

If there is a problem with the system a message will appear for a few seconds. If the problem continues the LFA system failure indicator will illuminate.

The LFA system will not be in the **ENABLED** state and/or the steering wheel will not be assisted when:

- The turn signal is turned on before changing a lane. If you change lanes without the turn signal on, the steering wheel might be controlled.
- The vehicle is not driven in the middle of the lane when the system is turned on or right after changing a lane.
- ESC (Electronic Stability Control) or VSM (Vehicle Stability Management) is activated.
- The vehicle is driven on a sharp curve.
- Vehicle speed is over 180 km/h (110 mph).
- The vehicle makes sharp lane changes.
- The vehicle brakes suddenly.
- Only one lane marker is detected.
- The lane is very wide or narrow.
- There are more than two lane markers on the road (e.g. construction area).

- Radius of a curve is too small.
- The vehicle is driven on a steep incline.
- The steering wheel is turned suddenly.
- The system may not operate for 15 seconds after the vehicle is started or the camera is initialized or rebooting of the front view camera.

### Limitations of the system

LFA system may operate prematurely even if the vehicle does not depart from the intended lane, OR, LFA system may not assist your steering or warn you if the vehicle leaves the intended lane under the following circumstances:

### When the lane and road conditions are poor

- It is difficult to distinguish the lane marking from the road surface or the lane marking is faded or not clearly marked.
- It is difficult to distinguish the color of the lane marker from the road.
- There are markings on the road surface that look like a lane marker that is inadvertently being detected by the camera.
- The lane marker is indistinct or damaged.
- The lane marker is merged or divided. (e.g. tollgate)
- The lane number increases or decreases or the lane marker are crossing complicatedly.
- There are more than two lane markers on the road in front of you.

- The lane marker is very thick or thin.
- The lane is very wide or narrow.
- The lane marker ahead is not visible due to rain, snow, water on the road, damaged or stained road surface, or other factors.
- The shadow is on the lane marker by a median strip, trees, guardrail, noise barriers, etc.
- The lane markers are complicated or a structure substitutes for the lines such as a construction area.
- There are crosswalk signs or other symbols on the road.
- The lane marker in a tunnel is stained with oil, etc.
- The lane suddenly disappears such as at the intersection.

#### **When external condition is intervened**

- The brightness outside changes suddenly such as when entering or exiting a tunnel, or when passing under a bridge.
- The brightness outside is too low such as when the headlamps are not on at night or the vehicle is going through a tunnel.
- There is a boundary structure in the roadway such as a concrete barrier, guardrail and reflector post that is inadvertently being detected by the camera.
- When light coming from a street light or an oncoming vehicle is reflected on a wet road surface such as a puddle in the road.
- The field of view in front is obstructed by sun glare.
- There is not enough distance between you and the vehicle in front to be able to detect the lane marker or the vehicle ahead is driving on the lane marker.

- Driving on a steep grade, over a hill, or when driving on a curved road.
- The adverse road conditions cause excessive vehicle vibrations while driving.
- The surrounding of the inside rear view mirror temperature is high due to direct sunlight, etc.

#### **When front visibility is poor**

- The windshield or the camera lens is blocked with dirt or debris.
- The windshield glass is fogged up; a clear view of the road is obstructed.
- Placing objects on the dashboard, etc.
- The sensor cannot detect the lane because of fog, heavy rain or snow.

## HIGHWAY DRIVING ASSIST (HDA) (IF EQUIPPED)

Highway Driving Assist system helps keep the vehicle between lanes, maintain a distance with the vehicle ahead, and automatically adjusts the vehicle speed to the speed limit while driving on the highway.

### WARNING

- Highway Driving Assist system is not a substitute for safe driving practices, but a convenience function. It is the responsibility of the driver to always be aware of the surroundings and drive safely.
- Highway Driving Assist system relies entirely on the road information provided by the navigation system. It is the responsibility of the driver to follow traffic laws and avoid accidents.
- Turn off the Highway driving assist system when the vehicle is being towed.
- For your safety, please read the owner's manual before using the system.

### Information

- Highway Driving Assist system is available only on controlled access road of certain highways.
- \* Controlled access road indicates roads with limited entrances and exits that allow uninterrupted high speed traffic flow. Only passenger cars and motorcycles are allowed on controlled access roads.

Available highway (Controlled access road)	
USA	Select Interstate Highway and U.S. (Federal) and State Highways
Canada	Select Provincial and Territorial Highways

USA	Select Interstate Highway and U.S. (Federal) and State Highways
Canada	Select Provincial and Territorial Highways

- Additional highways may be expanded by navigation updates.

## System Setting and Operation

### System setting

- With the Engine Start/Stop button in the ON or START position, the Highway Driving Assist can be activated by selecting 'User setting → Driver Assistance → Driver Assist → Highway Driving Assist' from the Settings menu in the infotainment system screen. Deselect the setting to turn off the system.
- If the engine is turned off then on again, the system maintains the last setting.

## Operating conditions

Select 'Highway Driving Assist' from the Settings menu in the infotainment system screen and satisfy the following conditions for the system to operate.

- Driving on the highway main line
- Smart Cruise Control is operating
  - If Smart Cruise Control is in the READY state the Highway Driving Assist will be in the READY state. The  indicator on the cluster will illuminate white.
- Vehicle speed is under 145 km/h (90 mph)

If all the mentioned conditions are satisfied, the system is ENABLED and the  indicator on the cluster will illuminate green.

## Steering wheel control

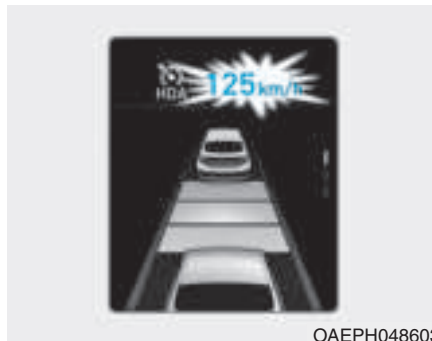

### Steering control

If the vehicle detects both lane markers (lane color white), the  indicator light will change from white to green. This indicates that the steering wheel is being controlled.



### Temporary deactivation

The  indicator light changes from green to white when the steering wheel control is temporarily deactivated. Even if the steering wheel is not controlled, the distance between the vehicle ahead will be maintained. (For more information of steering wheel control, refer to "Lane Following Assist (LFA) system" in this chapter.)

### Speed setting



#### Automatic speed setting mode

The system enters the automatic speed setting mode when:

1. The operating conditions are satisfied
  -  indicator will illuminate green
2. The Smart Cruise Control set speed and the highway speed limit matches

If the system changes to the automatic speed mode, the **AUTO** symbol will turn green and a chime will sound.

When the highway speed limit changes, the set speed automatically changes to the changed speed limit.



#### Manual speed setting mode

If the speed is set manually using the RES+ or SET- toggle switch on the steering wheel, the set speed on the cluster will turn white and the 'AUTO' symbol will disappear.

## Warning Message

### Hands-off warning



#### Keep hands on steering wheel

If the driver takes their hands off the steering wheel for several seconds while the HDA system is activated, the system will warn the driver.

#### **i** Information

If the steering wheel is held with a light grip, the message may appear because HDA system may not recognize that the driver has their hands on the steering wheel.



The warning message may appear late according to road conditions. Therefore, always have your hands on the steering wheel while driving.

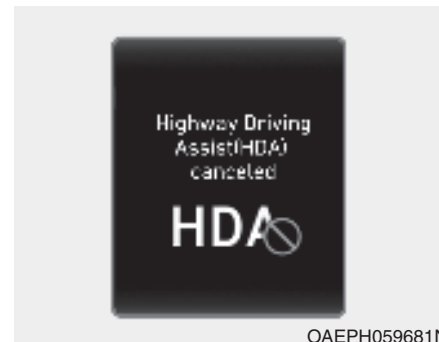

#### Highway Driving Assist (HDA) system canceled

If the driver still does not have their hands on the steering wheel after the message "Keep hands on steering wheel", HDA system will be canceled. However, if the Smart Cruise Control is reactivated manually by the driver, Highway Driving Assist system will reactivate.

**To activate Smart Cruise control, refer to "Smart Cruise Control (SCC)" in chapter 5.**

### **HDA system will not be in the ENABLED state and/or the steering wheel will not be assisted when:**

- The turn signal is turned on before changing a lane. If you change lanes without the turn signal on, the steering wheel might be controlled.
  - The vehicle is not driven in the middle of the lane when the system is turned on or right after changing a lane.
  - ESC (Electronic Stability Control) or VSM (Vehicle Stability Management) is activated.
  - The vehicle is driven on a sharp curve.
  - Vehicle speed is over 153 km/h (95 mph).
  - The vehicle makes sharp lane changes.
  - The vehicle brakes suddenly.
  - Only one lane marker is detected.
  - The lane is very wide or narrow.
- There are more than two lane markers on the road (e.g. construction area).
  - Radius of a curve is too small.
  - The vehicle is driven on a steep incline.
  - The steering wheel is turned suddenly.

### **System malfunction**



### **Check Highway Driving Assist (HDA) system**

If there is a problem with the system, a message will appear for a few seconds. If the problem continues, have the vehicle inspected by an authorized HYUNDAI dealer.



### **i** Information

- High Driving Assist is limited in other countries.
- High Driving Assist only operates based on the speed limits of the highway but it does not work with the speed cameras.
- The time gap could occur between the navigation speed warning and system operation.
- The system is not designed to work on highways other than mentioned as a controlled access road. The system automatically cancels when you leave the highway.
- If there is a problem with Highway Driving Assist, the system cannot be activated in the Cluster.
- If your vehicle is 500 m (1640 ft.) ahead and behind of an open toll-gate, the system is automatically canceled. Also, it is converted to Smart Cruise Control automatically with a pop-up message on the navigation.

(Continued)

(Continued)

- In the automatic speed setting mode, the vehicle automatically accelerates or decelerates when the highway speed limit changes.
- If your vehicle speed exceeds 150 km/h (93 mph), Highway Driving Assist is automatically canceled. Also, it is converted to Smart Cruise Control automatically with a pop-up message on the navigation.
- If you enter a rest area on the highway or a IC/JC (intersection/junction) without a destination set, the system is canceled later than when the vehicle actually leaves the highway.

### **⚠ CAUTION**

Highway Driving Assist system may not function properly in the following situations:

- The navigation is not working properly.
- The navigation is not updated.
- The real-time GPS or map information provided has errors.
- The navigation is overloaded by performing functions such as route search, video playback, voice recognition, etc. are performing simultaneously.
- The navigation is recalculating the route while driving.
- GPS signals are blocked in areas such as a tunnel.
- The driver goes off course or the route to the destination is changed or canceled by resetting the navigation.

(Continued)

(Continued)

- The vehicle enters a service station or rest area
- The speed limit of selected highway section is changed due to road conditions.
- Android Auto or Car Play is operating.
- The navigation cannot detect the current vehicle position (ex: elevated roads including overpass adjacent to general roads or nearby roads exist in a parallel way).
- The navigation is being updated while driving.
- The navigation is being reset while driving.
- The road is slippery due to bad weather such as rain or snow.
- If your vehicle tows a trailer or another vehicle, you should release Highway Driving Assist (HDA) system. Operating the brake system or steering system while towing may adversely affect the safety.

### **i** Information

- For information's on vehicle to vehicle distance control and the front radar, refer to "Smart Cruise Control (SCC)" in this chapter.
- For information's on steering control and distance control and the front camera, refer to "Lane Following Assist (LFA)" in this chapter.

### **i** Information

This device complies with Industry Canada RSS-210 standard.

Operation is subject to the following three conditions:

1. This device may not cause harmful interference, and
2. This device must accept any interference received, including interference that may cause undesired operation.
3. Changes or modifications not expressly approved by the party responsible for compliance could void the user's authority to operate the device.

### **i** Information

Radio frequency radiation exposure information:

This equipment complies with RSS radiation exposure limits set forth for an uncontrolled environment.

This equipment should be installed and operated with minimum distance of 20 cm (8 in.) between the radiator (antenna) and your body.

This transmitter must not be co-located or operating in conjunction with any other antenna or transmitter.

## REAR CROSS-TRAFFIC COLLISION WARNING (RCCW) (IF EQUIPPED)

### System description

#### **Rear Cross-Traffic Collision Warning System**

Rear Cross-Traffic Collision Warning system uses radar sensors to monitor the approaching cross traffic from the left and right side of the vehicle when your vehicle is in reverse.

The blind spot detection range varies relative to the approaching vehicle speed.

**⚠ WARNING**

- **Always be aware of road and traffic conditions while driving and be alert for unexpected situations even though Rear Cross-Traffic Collision Warning system is operating.**
- **Rear Cross-Traffic Collision Warning system is supplemental systems to assist you. Do not entirely rely on the systems. Always pay attention, while driving, for your safety.**
- **Rear Cross-Traffic Collision Warning system is not substitutes for proper and safe driving. Always drive safely and use caution when backing up the vehicle.**

### System setting and operation

#### System setting



- **Setting Parking Safety function**  
The driver can activate the systems by placing the ignition switch to the ON position and by selecting 'User settings → Driver assistance → Parking safety'. The system turns on and is ready to be operated when 'Rear cross-traffic safety' is selected.
- When the vehicle is turned off then on again, the system will be ready to be operated.

- When the system is initially turned on and when the vehicle is turned off then on again, the warning light will illuminate for 3 seconds on the outside rearview mirror.



- **Selecting Warning Timing**

The driver can select the initial warning activation time from the User Settings in the cluster LCD display by selecting 'User settings → Driver assistance → Warning timing → Normal/Late'.

The options for the initial Rear Cross-Traffic Collision Warning includes the following:

- **Normal:**

When this option is selected, the initial Rear Cross-Traffic Collision Warning is activated normally. If this setting feels too sensitive change the option to 'Late'.

The warning activation time may feel late if the side/rear vehicle abruptly accelerates.

- **Late:**

Select this warning activation time when the traffic is light and you are driving at low speeds.

### **i** Information

**If you change the warning timing, the warning time of other systems may change.**

**Always be aware before changing the warning timing.**



- **Setting Warning Volume**

The driver can select the warning volume from the User Settings in the LCD display by selecting 'User settings → Driver assistance → Warning volume → High/Medium/Low'.

**i Information**

**If you change the warning volume, the warning volume of other systems may change.**

**Always be aware before changing the warning volume.**

**For more information refer to "LCD Display Modes" in chapter 3.**

### Operating conditions

To operate:

1. Go to the 'User settings → Driver assistance → Parking safety → Rear Cross-Traffic Safety' on the LCD display. The system will turn on and standby to operate.
2. The system will operate when vehicle speed is below 10 km/h (7 mph) and with the shift lever in R (Reverse).

\* The system will not operate when the vehicle speed exceeds 10 km/h (7 mph). The system will activate again when the speed is below 10 km/h (7 mph).

The system's detecting range is approximately 0.5 m ~ 20 m (1 ft ~ 65 ft). An approaching vehicle will be detected if their vehicle speed is within 8 km/h ~ 36 km/h (5 ~ 22.5 mph).

Note that the detecting range and operating speed may vary under certain conditions. As always, use caution and pay close attention to your surroundings when backing up your vehicle.

### Warning message and system control

#### Rear Cross-Traffic Collision Warning System



If the vehicle detected by the sensors approaches from the rear left/right side of your vehicle, the warning chime will sound, the warning light on the outside rearview mirror will blink and a message will appear on the LCD display. If the rear view monitor system is in activation, a message will also appear on the audio or infotainment system screen.

The warning will stop when:

- The detected vehicle moves out of the sensing area or
- When the vehicle is right behind your vehicle or
- When the vehicle is not approaching your vehicle or
- When the other vehicle slows down.
- The vehicle's approaching speed is decreased.

### CAUTION

- **When the operating condition of Rear Cross-Traffic Collision Warning system is satisfied the warning will occur when a vehicle approaches the side/rear of your stopped (0 km/h vehicle speed) vehicle.**
- **The system's warning may not operate properly if the left/right of your vehicle's rear bumper is blocked by a vehicle or obstacle.**
- **Always pay attention to road and traffic conditions while driving, whether or not the warning light on the outside rearview mirror illuminates or there is a warning alarm.**
- **Playing the vehicle audio system at high volume may prevent occupants from hearing the system's warning sounds.**

(Continued)

(Continued)

- **The warning of Rear Cross-Traffic Collision Warning system may not sound while other system's warning sounds.**

### WARNING

- **If any other warning sound such as seat belt warning chime is already generated, Rear Cross-Traffic Collision Warning system warning may not sound.**
- **Drive safely even though the vehicle is equipped with a Rear Cross-Traffic Collision Warning system. Do not solely rely on the system but check your surrounding when backing the vehicle up.**
- **The driver is responsible for accurate brake control.**

(Continued)

(Continued)

- Always pay extreme caution while driving. Rear Cross-Traffic Collision Warning system may not operate properly or unnecessarily operate depending on traffic and driving conditions.
- Rear Cross-Traffic Collision Warning system is not a substitute for safe driving practices, but a convenience function only. It is the responsibility of the driver to always drive cautiously to prevent unexpected and sudden situations from occurring. Pay attention to the road conditions at all times.

## Detecting Sensor



The rear radars are located inside the rear bumper for detecting the side and rear. Always keep the rear bumper clean for proper operation of the system.

### NOTICE

- The system may not work properly when the bumper has been damaged, or if the rear bumper has been replaced or repaired.
- The system may turn off if interfered by strong electromagnetic waves.
- Always keep the sensors clean.
- NEVER disassemble the sensor component or apply any impact on the sensor component.
- Be careful not to apply unnecessary force on the radar sensor or sensor cover. If the sensor is forcibly moved out of proper alignment, the system may not operate correctly. In this case, a warning message may not be displayed. We recommend that you have the vehicle inspected by an authorized HYUNDAI dealer.

(Continued)

(Continued)

- Do not apply foreign objects such as a bumper sticker or a bumper guard near the radar sensor or apply paint to the sensor area. Doing so may adversely affect the performance of the sensor.

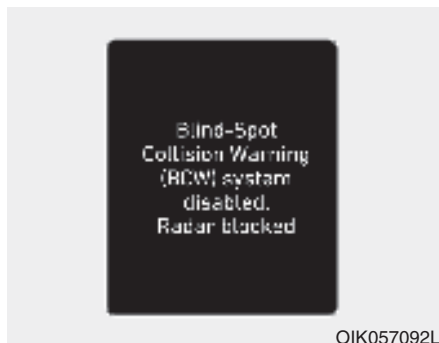

**Blind-Spot Collision Warning (BCW) system disabled. Radar blocked**

- This warning message may appear when:
  - One or both of the sensors on the rear bumper is blocked by dirt or snow or a foreign object.
  - Driving in rural areas where the sensor does not detect another vehicle for an extended period of time.
  - When there is inclement weather such as heavy snow or rain.

If any of these conditions occur, the light on the BCW switch and the system will turn off automatically.

### **i** Information

Turn off the BCW and RCCW system (if equipped) when a trailer or carrier is installed.

- Press BCW button (the indicator on the button will turn off)
- Deactivate RCCW system by deselecting

'User settings → Driver assistance → Parking safety → Rear cross-traffic safety'



When the BCW canceled warning message is displayed in the cluster, check to make sure that the rear bumper is free from any dirt or snow in the areas where the sensor is located. Remove any dirt, snow, or foreign material that could interfere with the radar sensors.

After any dirt or debris is removed, the RCCW system should operate normally after about 10 minutes of driving the vehicle.

If the system still does not operate normally, we recommend that the vehicle be inspected by an authorized HYUNDAI dealer.



### Check Blind-Spot Collision Warning (BCW) system

If there is a problem with BCW system, a warning message will appear and the light on the button will turn off. The system will turn off automatically. RCCW will not operate also if BCW system turns off due to malfunction. We recommend that you have your vehicle inspected by an authorized HYUNDAI dealer.

### Limitations of the system

The driver must be cautious in the below situations because the system may not detect other vehicles or objects in certain circumstances:

- The vehicle drives in inclement weather such as heavy rain or snow.
- The sensor is polluted with rain, snow, mud, etc.
- The rear bumper where the sensor is located is covered with a foreign object such as a bumper sticker, a bumper guard, a bike rack, etc.
- The rear bumper is damaged, or the sensor is out of the original default position.
- The vehicle height gets lower or higher due to heavy loading in a tailgate, abnormal tire pressure, etc.
- When the temperature of the rear bumper is high.
- When the sensors are blocked by other vehicles, walls or parking-lot pillars.

## Driving your vehicle

- The vehicle is driven on a curved road.
- The road pavement (or the peripheral ground) abnormally contains metallic components (i.e. possibly due to subway construction).
- There is a fixed object near the vehicle, such as a guardrail.
- While going down or up a steep road where the height of the lane is different.
- Driving on a narrow road where trees or grass or overgrown.
- Driving in rural areas where the sensor does not detect another vehicle for an extended period of time.
- Driving on a wet road.
- Driving on a road where the guardrail or wall is in double structure.
- A big vehicle is near such as a bus or truck.
- When the other vehicle approaches very close.
- When the other vehicle passes at a very fast speed.
- While changing lanes.
- If the vehicle has started at the same time as the vehicle next to you and has accelerated.
- When the vehicle in the next lane moves two lanes away from you OR when the vehicle two lanes away moves to the next lane from you.
- A motorcycle or bicycle is near.
- A flat trailer is near.
- If there are small objects in the detecting area such as a shopping cart or a baby stroller.
- If there is a low height vehicle such as a sports car.
- Temperature is extremely low around the vehicle.
- The vehicle severely vibrates while driving over a bumpy road, uneven/bumpy road, or concrete patch.
- The vehicle is driven on a slippery surface due to snow, water puddle, or ice.



[A] : Structure

- Driving where there is a vehicle or structure near

The system may not operate properly when driving where there is a vehicle or structure near.

In certain instances, the system may not detect the vehicle approaching from behind and the warning may not operate properly.

Always pay attention to your surrounding while driving.

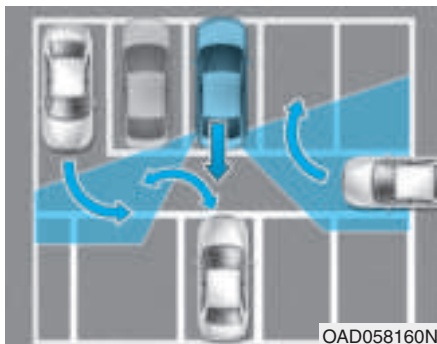

OAD058160N

- When the vehicle is in a complex parking environment

The system may not operate properly when the vehicle is in a complex parking environment.

In certain instances, the system may not be able to exactly determine the risk of collision for the vehicles which are parking or pulling out near your vehicle (e.g. a vehicle escaping beside your vehicle, a vehicle parking or pulling out in the rear area, a vehicle approaching your vehicle making a turn, etc.).

In this case, the warning may not operate properly.

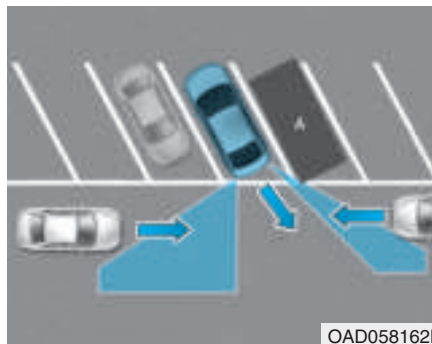

OAD058162L

[A] : Vehicle

- When the vehicle is parked diagonally

The system may not operate properly when the vehicle is parked diagonally.

In certain instances, when the diagonally parked vehicle is pulled out of the parking space, the system may not detect the vehicle approaching from the rear left/right of your vehicle. In this case, the warning may not operate properly.

Always pay attention to your surrounding while driving.

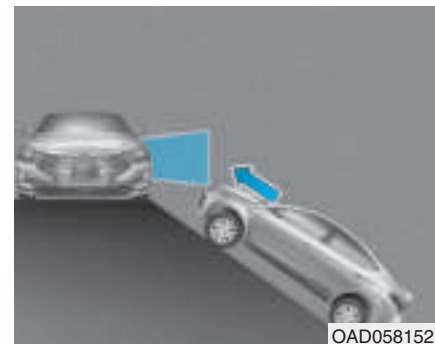

OAD058152N

- When the vehicle is on/near a slope

The system may not operate properly when the vehicle is on/near a slope.

In certain instances, the system may not detect the vehicle approaching from the rear left/right and the warning may not operate properly.

Always pay attention to your surrounding while driving.

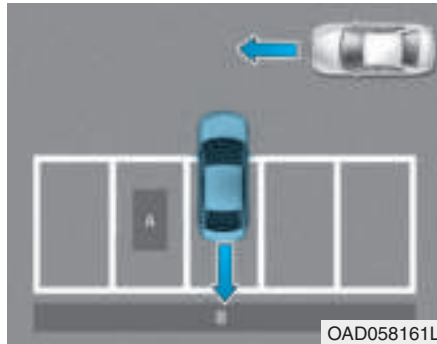

[A] : Structure, [B] : Wall

- Pulling into the parking space where there is a structure

The system may not operate properly when pulling in the vehicle to the parking space where there is a structure at the back or side of your vehicle.

In certain instances, when backing into the parking space, the system may falsely detect the vehicle moving in front of your vehicle. In this case, the warning may operate.

Always pay attention to the parking space while driving.



- When the vehicle is parked rearward

If the vehicle is parked rearward and the sensor detects another vehicle in the rear area of the parking space, warning may operate. Always pay attention to the parking space while driving.

### **i** Information

This device complies with Industry Canada RSS-210 standard.

Operation is subject to the following three conditions:

1. This device may not cause harmful interference, and
2. This device must accept any interference received, including interference that may cause undesired operation.
3. **Changes or modifications not expressly approved by the party responsible for compliance could void the user's authority to operate the device.**

---

**i** **Information**

**Radio frequency radiation exposure information:**

**This equipment complies with RSS radiation exposure limits set forth for an uncontrolled environment.**

**This equipment should be installed and operated with minimum distance of 20 cm (8 in.) between the radiator (antenna) and your body.**

**This transmitter must not be co-located or operating in conjunction with any other antenna or transmitter.**

## SPECIAL DRIVING CONDITIONS

### Hazardous Driving Conditions

When hazardous driving elements are encountered such as water, snow, ice, mud and sand, take the below suggestions:

- Drive cautiously and keep a longer braking distance.
- Avoid abrupt braking or steering.
- When your vehicle is stuck in snow, mud, or sand, use second gear. Accelerate slowly to avoid unnecessary wheel spin.
- Put sand, rock salt, or other non-slip materials under the wheels to provide additional traction while the vehicle becomes stuck in ice, snow, or mud.

#### WARNING

**Downshifting with an dual clutch transmission while driving on slippery surfaces can cause an accident. The sudden change in tire speed could cause the tires to skid. Be careful when downshifting on slippery surfaces.**

### Rocking the Vehicle

If it is necessary to rock the vehicle to free it from snow, sand, or mud, first turn the steering wheel right and left to clear the area around your front wheels. Then, shift back and forth between R (Reverse) and a forward gear.

Try to avoid spinning the wheels, and do not race the engine.

To prevent transmission wear, wait until the wheels stop spinning before shifting gears. Release the accelerator pedal while shifting, and press lightly on the accelerator pedal while the transmission is in gear. Slowly spinning the wheels in forward and reverse directions causes a rocking motion that may free the vehicle.

#### WARNING

**If the vehicle is stuck and excessive wheel spin occurs, the temperature in the tires can increase very quickly. If the tires become damaged, a tire blow out or tire explosion can occur. This condition is dangerous - you and others may be injured. Do not attempt this procedure if people or objects are anywhere near the vehicle.**

**If you attempt to free the vehicle, the vehicle can overheat quickly, possibly causing an engine compartment fire or other damage. Try to avoid spinning the wheels as much as possible to prevent overheating of either the tires or the engine. DO NOT allow the vehicle to spin the wheels above 56 km/h (35 mph).**

## **i** Information

The ESC system must be turned OFF before rocking the vehicle.

### **NOTICE**

**If you are still stuck after rocking the vehicle a few times, have the vehicle pulled out by a tow vehicle to avoid engine overheating, possible damage to the transmission, and tire damage. See "Towing" in chapter 6.**

## Smooth Cornering

Avoid braking or gear changing in corners, especially when roads are wet. Ideally, corners should always be taken under gentle acceleration.

## Driving at Night

Night driving presents more hazards than driving in the daylight. Here are some important tips to remember:

- Slow down and keep more distance between you and other vehicles, as it may be more difficult to see at night, especially in areas where there may not be any street lights.
- Adjust your mirrors to reduce the glare from other driver's headlamps.
- Keep your headlamps clean and properly aimed. Dirty or improperly aimed headlamps will make it much more difficult to see at night.
- Avoid staring directly at the headlamps of oncoming vehicles. You could be temporarily blinded, and it will take several seconds for your eyes to readjust to the darkness.

## Driving in the Rain

Rain and wet roads can make driving dangerous. Here are a few things to consider when driving in the rain or on slick pavement:

- Slow down and allow extra following distance. A heavy rainfall makes it harder to see and increases the distance needed to stop your vehicle.
- Turn OFF your Cruise Control. (if equipped)
- Replace your windshield wiper blades when they show signs of streaking or missing areas on the windshield.
- Tires should be properly maintained with at least 1.6 mm (2/32 inch) of tread depth. If your tires do not have enough tread, making a quick stop on wet pavement can cause a skid and possibly lead to an accident. **See "Tire Tread" in chapter 7.**
- Turn on your headlamps to make it easier for others to see you.

- Driving too fast through large puddles can affect your brakes. If you must go through puddles, try to drive through them slowly.
- If you believe your brakes may be wet, apply them lightly while driving until normal braking operation returns.

### **Hydroplaning**

If the road is wet enough and you are going fast enough, your vehicle may have little or no contact with the road surface and actually ride on the water. The best advice is SLOW DOWN when the road is wet.

**The risk of hydroplaning increases as the depth of tire tread decreases, refer to "Tire Tread" in chapter 7.**

### **Driving in Flooded Areas**

Avoid driving through flooded areas unless you are sure the water is no higher than the bottom of the wheel hub. Drive through any water slowly. Allow adequate stopping distance because brake performance may be reduced.

After driving through water, dry the brakes by gently applying them several times while the vehicle is moving slowly.

### **Highway Driving**

#### **Tires**

Adjust the tire inflation, as specified. Under-inflation may overheat or damage the tires.

Do not install worn-out or damaged tires, which may reduce traction or adversely affect vehicle handling. This could lead to sudden tire failure that may cause loss of vehicle control resulting in an accident.

#### ***i* Information**

**Never over-inflate your tires above the maximum inflation pressure, as specified on your tires.**

### ***Fuel, engine coolant and engine oil***

Driving at higher speeds on the highway consumes more fuel and is less efficient than driving at a slower, more moderate speed. Maintain a moderate speed in order to conserve fuel when driving on the highway.

Be sure to check both the engine coolant level and the engine oil before driving.

### ***Drive belt***

A loose or damaged drive belt may overheat the engine.

#### **WARNING**

**In a rollover crash, an unbelted person is significantly more likely to die than a person wearing a seat belt. Make sure all passengers are wearing their seat belts.**



## WINTER DRIVING

The severe weather conditions of winter quickly wear out tires and cause other problems. To minimize winter driving problems, you should take the following suggestions:

### Snow or Icy Conditions

You need to keep sufficient distance between your vehicle and the vehicle in front of you.

Apply the brakes gently. Speeding, rapid acceleration, sudden brake applications, and sharp turns are potentially very hazardous practices. During deceleration, use engine braking to the fullest extent. Sudden brake applications on snowy or icy roads may cause the vehicle to skid.

To drive your vehicle in deep snow, it may be necessary to use snow tires.

Always carry emergency equipment. Some of the items you may want to carry include, tow straps or chains, a flashlight, emergency flares, sand, a shovel, jumper cables, a window scraper, gloves, ground cloth, coveralls, a blanket, etc.

### Snow tires

#### WARNING

**Snow tires should be equivalent in size and type to the vehicle's standard tires. Otherwise, the safety and handling of your vehicle may be adversely affected.**

If you mount snow tires on your vehicle, make sure to use radial tires of the same size and load range as the original tires. Mount snow tires on all four wheels to balance your vehicle's handling in all weather conditions. The traction provided by snow tires on dry roads may not be as high as your vehicle's original equipment tires. Check with the tire dealer for maximum speed recommendations.

#### Information

**Do not install studded tires without first checking local, country and municipal regulations for possible restrictions against their use.**

### Winter Precautions

#### ***Use high quality ethylene glycol coolant***

Your vehicle is delivered with high quality ethylene glycol coolant in the cooling system. It is the only type of coolant that should be used because it helps prevent corrosion in the cooling system, lubricates the water pump and prevents freezing. Be sure to replace or replenish your coolant in accordance with the maintenance schedule in chapter 7. Before winter, have your coolant tested to assure that its freezing point is sufficient for the temperatures anticipated during the winter.

### ***Change to "winter weight" oil if necessary***

In some climates it is recommended that a lower viscosity "winter weight" oil be used during cold weather. See chapter 8 for recommendations. If you aren't sure what weight oil you should use, consult an authorized HYUNDAI dealer.

### ***Check battery and cables***

Winter puts additional burdens on the battery system. Visually inspect the battery and cables as described in chapter 7. The level of charge in your battery can be checked by an authorized HYUNDAI dealer or a service station.

### ***Check spark plugs and ignition system***

Inspect your spark plugs as described in chapter 7 and replace them if necessary. Also check all ignition wiring and components to be sure they are not cracked, worn or damaged in any way.

### ***Use approved window washer anti-freeze in system***

To keep the water in the window washer system from freezing, add an approved window washer anti-freeze solution in accordance with instructions on the container. Window washer anti-freeze is available from an authorized HYUNDAI dealer and most auto parts outlets. Do not use engine coolant or other types of anti-freeze as these may damage the paint finish.

### ***Do not let your parking brake freeze***

Under some conditions your parking brake can freeze in the engaged position. This is most likely to happen when there is an accumulation of snow or ice around or near the rear brakes or if the brakes are wet. If there is a risk the parking brake may freeze, apply it only temporarily while you put the gear selector lever in P and block the rear wheels so the car cannot roll. Then release the parking brake.

### ***Do not let ice and snow accumulate underneath***

Under some conditions, snow and ice can build up under the fenders and interfere with the steering. When driving in severe winter conditions where this may happen, you should periodically check underneath the car to be sure the movement of the front wheels and the steering components is not obstructed.

---

***Don't place foreign objects or materials in the engine compartment***

Placement of foreign object or materials which prevent cooling of the engine, in the engine compartment, may cause a failure or combustion. The manufacturer is not responsible for the damage caused by such placement.

***To keep locks from freezing***

To keep the locks from freezing, squirt an approved de-icer fluid or glycerine into the key opening. If a lock is covered with ice, squirt it with an approved de-icing fluid to remove the ice. If the lock is frozen internally, you may be able to thaw it out by using a heated key. Handle the heated key with care to avoid injury.

### VEHICLE LOAD LIMIT

Two labels on your driver's door sill show how much weight your vehicle was designed to carry: the Tire and Loading Information Label and the Certification Label.

Before loading your vehicle, familiarize yourself with the following terms for determining your vehicle's weight ratings, from the vehicle's specifications and the Certification Label:

#### **Base Curb Weight**

This is the weight of the vehicle including a full tank of fuel and all standard equipment. It does not include passengers, cargo, or optional equipment.

#### **Vehicle Curb Weight**

This is the weight of your new vehicle when you picked it up from your dealer plus any aftermarket equipment.

#### **Cargo Weight**

This figure includes all weight added to the Base Curb Weight, including cargo and optional equipment.

#### **GAW (Gross Axle Weight)**

This is the total weight placed on each axle (front and rear) - including vehicle curb weight and all payload.

#### **GAWR (Gross Axle Weight Rating)**

This is the maximum allowable weight that can be carried by a single axle (front or rear). These numbers are shown on the Certification Label. The total load on each axle must never exceed its GAWR.

#### **GVW (Gross Vehicle Weight)**

This is the Base Curb Weight plus actual Cargo Weight plus passengers.

#### **GVWR (Gross Vehicle Weight Rating)**

This is the maximum allowable weight of the fully loaded vehicle (including all options, equipment, passengers and cargo). The GVWR is shown on the Certification Label located on the driver's door sill.

## Tire Loading Information Label

- 15 inch tire  
- Type A

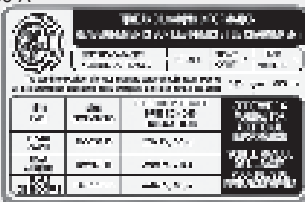

OAE067034N

- Type B

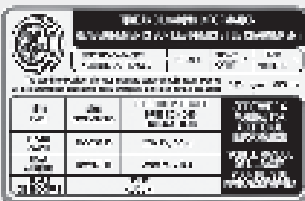

OAE066035N

- 16 inch tire

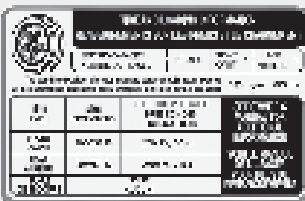

OAEPH067035

- 17 inch tire  
- Type A



OAEPH069032N

- Type B

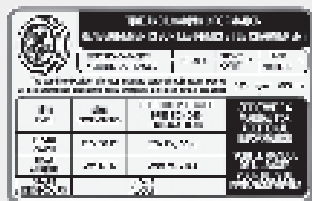

OAE066036N

The label located on the driver's door sill gives the original tire size, cold tire pressures recommended for your vehicle, the number of people that can be in your vehicle and vehicle capacity weight.

## Vehicle capacity weight

385 kg (849 lbs.)

Vehicle capacity weight is the maximum combined weight of occupants and cargo. If your vehicle is equipped with a trailer, the combined weight includes the tongue load.

## Seating capacity

Total : 5 persons

(Front seat : 2 persons,  
Rear seat : 3 persons)

Seating capacity is the maximum number of occupants including a driver, your vehicle may carry. However, the seating capacity may be reduced based upon the weight of all of the occupants, and the weight of the cargo being carried or towed. Do not overload the vehicle as there is a limit to the total weight, or load limit including occupants and cargo, the vehicle can carry.

### ***Towing capacity***

We do not recommend using this vehicle for trailer towing.

### ***Cargo capacity***

The cargo capacity of your vehicle will increase or decrease depending on the weight and the number of occupants and the tongue load, if your vehicle is equipped with a trailer.

### ***Steps for determining correct load limit***









1. Locate the statement "The combined weight of occupants and cargo should never exceed XXX kg or XXX lbs." on your vehicle's placard.
2. Determine the combined weight of the driver and passengers that will be riding in your vehicle.
3. Subtract the combined weight of the driver and passengers from XXX kg or XXX lbs.

4. The resulting figure equals the available amount of cargo and luggage load capacity. For example, if the "XXX" amount equals 635 kg (1400 lbs.) and there will be five 68 kg (150 lb) passengers in your vehicle, the amount of available cargo and luggage load capacity is 295 kg (650 lbs.) ( $635 - 340 (5 \times 68) = 295 \text{ kg}$  or  $(1400 - 750 (5 \times 150) = 650 \text{ lbs.})$ )
5. Determine the combined weight of luggage and cargo being loaded on the vehicle. That weight may not safely exceed the available cargo and luggage load capacity calculated in Step 4.

### **WARNING**

**Do not overload the vehicle as there is a limit to the total weight, or load limit, including occupants and cargo, the vehicle can carry. Overloading can shorten the life of the vehicle. If the GVWR or the GAWR is exceeded, parts on the vehicle can break, and it can change the handling of your vehicle. These could cause you to lose control and result in an accident.**

6. If your vehicle will be towing a trailer, load from your trailer will be transferred to your vehicle. Consult this manual to determine how this reduces the available cargo and luggage load capacity of your vehicle.

<p><b>Example 1</b></p>	<div style="display: flex; align-items: center; justify-content: center;"> <div style="text-align: center;">  <p>Vehicle Capacity</p> <p>Maximum Load (635 kg) (1400 lbs.)</p> </div> <div style="margin: 0 10px;">≥</div> <div style="text-align: center;">  <p>Passenger Weight (68 kg × 2 = 136 kg) (150 lbs. × 2 = 300 lbs.)</p> </div> <div style="margin: 0 10px;">+</div> <div style="text-align: center;">  <p>Cargo Weight (499 kg) (1100 lbs.)</p> </div> </div>
<p><b>Example 2</b></p>	<div style="display: flex; align-items: center; justify-content: center;"> <div style="text-align: center;">  <p>Vehicle Capacity</p> <p>Maximum Load (635 kg) (1400 lbs.)</p> </div> <div style="margin: 0 10px;">≥</div> <div style="text-align: center;">  <p>Passenger Weight (68 kg × 5 = 340 kg) (150 lbs. × 5 = 750 lbs.)</p> </div> <div style="margin: 0 10px;">+</div> <div style="text-align: center;">  <p>Cargo Weight (295 kg) (650 lbs.)</p> </div> </div>
<p><b>Example 3</b></p>	<div style="display: flex; align-items: center; justify-content: center;"> <div style="text-align: center;">  <p>Vehicle Capacity</p> <p>Maximum Load (635 kg) (1400 lbs.)</p> </div> <div style="margin: 0 10px;">≥</div> <div style="text-align: center;">  <p>Passenger Weight (78 kg × 5 = 390 kg) (172 lbs. × 5 = 860 lbs.)</p> </div> <div style="margin: 0 10px;">+</div> <div style="text-align: center;">  <p>Cargo Weight (245 kg) (540 lbs.)</p> </div> </div>

### **Certification label**

The certification label is located on the driver's door sill at the center pillar and shows the maximum allowable weight of the fully loaded vehicle. This is called the GVWR (Gross Vehicle Weight Rating). The GVWR includes the weight of the vehicle, all occupants, fuel and cargo.

This label also tells you the maximum weight that can be supported by the front and rear axles, called Gross Axle Weight Rating (GAWR).

The total weight of the vehicle, including all occupants, accessories, cargo, and trailer tongue load must not exceed the Gross Vehicle Weight Rating (GVWR) or the Gross Axle Weight Rating (GAWR). To find out the actual loads on your front and rear axles, you need to go to a weigh station and weigh your vehicle. Be sure to spread out your load equally on both sides of the centerline.

### **WARNING**

#### **Overloading**

- **Never exceed the GVWR for your vehicle, the GAWR for either the front or rear axle and vehicle capacity weight. Exceeding these ratings can affect your vehicle's handling and braking ability, and cause an accident.**
- **Do not overload your vehicle. Overloading your vehicle can cause heat buildup in your vehicle's tires and possible tire failure, increased stopping distances and poor vehicle handling—all of which may result in a crash.**

### **NOTICE**

**Overloading your vehicle may cause damage. Repairs would not be covered by your warranty. Do not overload your vehicle.**

### **WARNING**

**If you carry items inside your vehicle (e.g., suitcases, tools, packages, or anything else), they are moving as fast as the vehicle. If you have to stop or turn quickly, or if there is a crash, the items will keep going and can cause an injury if they strike the driver or a passenger.**

- **Put items in the cargo area of your vehicle. Try to spread the weight evenly.**
- **Do not stack items, like suitcases, inside the vehicle above the tops of the seats.**
- **Do not leave an unsecured child restraint in your vehicle.**
- **When you carry something inside the vehicle, secure it.**



---

## TRAILER TOWING

We do not recommend using this vehicle for trailer towing.

## What to do in an emergency

Hazard warning flasher .....	6-2	If you have a flat tire .....	6-20
In case of an emergency while driving .....	6-2	With Spare Tire.....	6-20
If the Engine Stalls While Driving .....	6-2	With Tire Mobility Kit (TMK)- Type A.....	6-25
If the Vehicle Stalls at a Crossroad or Crossing .....	6-2	With Tire Mobility Kit (TMK)- Type B.....	6-33
If You Have a Flat Tire While Driving .....	6-3	<b>Towing .....</b>	<b>6-40</b>
<b>If the vehicle will not start .....</b>	<b>6-3</b>	Towing Service.....	6-40
<b>If the 12 volt battery is discharged .....</b>	<b>6-5</b>	Removable Towing Hook.....	6-41
Before Jump Starting .....	6-5	Emergency Towing .....	6-42
Jump Starting.....	6-6	<b>If An Accident Occurs .....</b>	<b>6-44</b>
<b>If the 12 volt battery is discharged</b>			
<b>(plug-in hybrid vehicle) .....</b>	<b>6-9</b>		
Jump Starting.....	6-9		
<b>If the engine overheats .....</b>	<b>6-12</b>		
<b>Tire Pressure Monitoring System (TPMS).....</b>	<b>6-14</b>		
Check Tire Pressure .....	6-14		
Tire Pressure Monitoring System.....	6-15		
Low Tire Pressure Telltale .....	6-16		
Low Tire Pressure LCD Display with Position			
Indicator.....	6-16		
TPMS Malfunction Indicator .....	6-17		
Changing a Tire with TPMS.....	6-18		

## HAZARD WARNING FLASHER

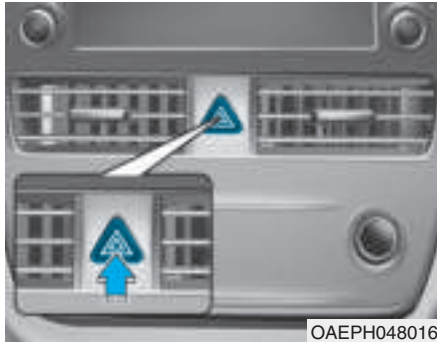

The hazard warning flasher serves as a warning to other drivers to exercise extreme caution when approaching, overtaking, or passing your vehicle.

It should be used whenever emergency repairs are being made or when the vehicle is stopped near the edge of a roadway.

To turn the hazard warning flasher on or off, press the hazard warning flasher button both the left and right. The button is located in the center fascia panel. All turn signal lights will flash simultaneously.

- The hazard warning flasher operates whether your vehicle is running or not.
- The turn signals do not work when the hazard flasher is on.

## IN CASE OF AN EMERGENCY WHILE DRIVING

### If the Engine Stalls While Driving

- Reduce your speed gradually, keeping a straight line. Move cautiously off the road to a safe place.
- Turn on your hazard warning flasher.
- Try to start the hybrid system again. If your vehicle will not start, contact an authorized HYUNDAI dealer or seek other qualified assistance.

### If the Vehicle Stalls at a Crossroad or Crossing

If the vehicle stalls at a crossroad or crossing, if safe to do so, move the shift lever to the N (Neutral) position and then push the vehicle to a safe location.

## If You Have a Flat Tire While Driving

If a tire goes flat while you are driving:

- Take your foot off the accelerator pedal and let the vehicle slow down while driving straight ahead. Do not apply the brakes immediately or attempt to pull off the road as this may cause loss of vehicle control resulting in an accident. When the vehicle has slowed to such a speed that it is safe to do so, brake carefully and pull off the road. Drive off the road as far as possible and park on firm, level ground. If you are on a divided highway, do not park in the median area between the two traffic lanes.
- When the vehicle is stopped, press the hazard warning flasher button, move the shift lever into P (Park), and apply the parking brake, and place the ignition switch in the LOCK/OFF position.
- Have all passengers get out of the vehicle. Be sure they all get out on the side of the vehicle that is away from traffic.
- When changing a flat tire, follow the instructions provided later in this chapter.

## IF THE VEHICLE WILL NOT START

### Hybrid vehicle

- Be sure the shift lever is in P (Park). The vehicle starts only when the shift lever is in P (Park).
- This vehicle does not have a regular 12V battery that needs periodic replacement. It is lithium ion polymer type integrated into the HEV high voltage battery. The vehicle has a 12V battery protection system that cuts 12V battery from vehicle draw to prevent full discharge. If vehicle will not start, first try pressing the 12V Battery Reset switch (left side of the steering wheel near the fuel door open switch) to reconnect the 12V battery, but you must start vehicle within 15 seconds of pressing the 12V Battery Reset switch. After starting vehicle, operate the vehicle safely outdoors in ready mode stopped and/or drive it for 30 minutes total to charge the 12V battery fully.

### NOTICE

**Push or pull starting the vehicle may cause the catalytic converter to overload which can lead to damage to the emission control system.**

- Check the fuel level and add fuel if necessary.

If the vehicle still does not start, have your vehicle checked by an authorized HYUNDAI dealer.

### ***Plug-in hybrid vehicle***

- Be sure the shift lever is in P (Park). The engine starts only when the shift lever is in P (Park).
- Check the battery connections to be sure they are clean and tight.
- Turn on the interior light. If the light dims or goes out when you operate the starter, the battery is drained.

Do not push or pull the vehicle to start it. This could cause damage to your vehicle. See instructions for "Jump Starting" provided in this chapter.

- Check the fuel level and add fuel if necessary.

If the engine still does not start, have your vehicle checked by an authorized HYUNDAI dealer.

#### **CAUTION**

**Push or pull starting the vehicle may cause the catalytic converter to overload which can lead to damage to the emission control system.**

## IF THE 12 VOLT BATTERY IS DISCHARGED

### Before Jump Starting

This vehicle does not have a regular 12V battery that needs periodic replacement. It is lithium ion polymer type integrated into the HEV high voltage battery. The vehicle has a 12V battery protection system that cuts 12V battery from vehicle draw to prevent full discharge.

### Using the 12V Battery Reset Switch

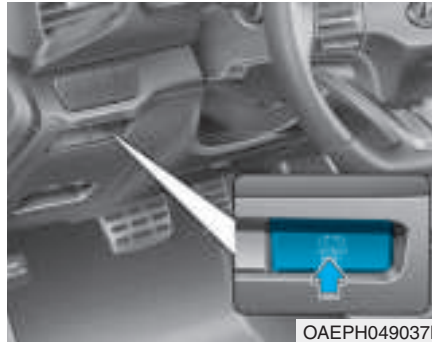

1. Press the 12V Battery Reset switch to reconnect the 12V battery.
2. Start the vehicle within 15 seconds of pressing the 12V Battery Reset switch.
3. After starting the vehicle (🚗 indicator on), operate the vehicle safely outdoors in ready mode stopped and/or drive it for 30 minutes total to charge the 12V battery fully.

If you do not start the vehicle immediately after pressing the 12V Battery Reset switch, the power of 12V battery is automatically disconnected after few seconds to save the 12V battery from additional discharge. If the 12V battery is disconnected prior to starting the vehicle, press the 12V Battery Reset switch again and then immediately start the vehicle as explained.

Repeated use of the 12V Battery Reset switch without a sufficient engine ON cycle (30 Min+) may cause over discharge of the 12V battery, which will prevent the vehicle from starting. If the 12V battery is over discharged to a point that the reset does not work, try to jump-start the vehicle.

### **i** Information

After starting the vehicle (🚗 indicator on), the 12V battery is being charged whether the engine is running or not. Although there is no engine-sound, it is unnecessary to depress the accelerator pedal.

The following items may need to be reset after the battery has been discharged or the battery has been disconnected. See chapter 3 or 4 for:

- Power Windows
- Trip Computer
- Climate Control System
- Clock
- Audio System
- Sunroof
- Driver Position Memory System

### **NOTICE**

#### **External power source using 12V battery**

The use of external power accessories may reduce performance and function of the vehicle. Especially, the use of dash cameras may shut off the power of the vehicle prior to the dash camera's automatic shut-down.

If the power of the vehicle is shut off, start the vehicle as explained. (refer to "Using the 12V Battery Switch")

## **Jump Starting**

In the event vehicle still does not have a functional 12V battery (check if interior lights will not turn on) then you can try a jump start to the engine compartment jumper terminals using a 12V booster pack or jumper cables from another vehicle's 12V battery according to the following instructions.

### **CAUTION**

**Jump starting can be dangerous if done incorrectly. Follow the jump starting procedure in this section to avoid serious injury or damage to your vehicle. If in doubt about how to properly jump start your vehicle, we strongly recommend that you have a service technician or towing service do it for you.**

1. Position the vehicles close enough that the jumper cables will reach, but do not allow the vehicles to touch.
2. Avoid fans or any moving parts in the engine compartment at all times, even when the vehicles are turned off.
3. Turn off all electrical devices such as radios, lights, air conditioning, etc. Put the vehicles in P (Park) and set the parking brake. Turn both vehicles OFF.

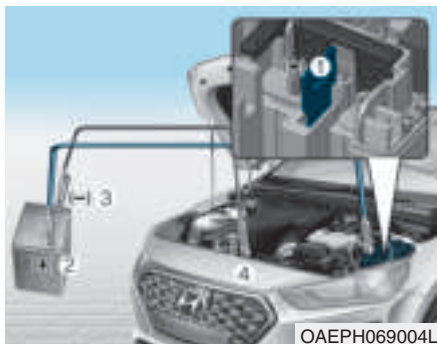

4. Connect the jumper cables in the exact sequence shown in the illustration. First connect one jumper cable to the red, positive (+) jumper terminal of your vehicle (1).
5. Connect the other end of the jumper cable to the red, positive (+) battery/jumper terminal of the assisting vehicle (2).
6. Connect the second jumper cable to the black, negative (-) battery/chassis ground of the assisting vehicle (3).

7. Connect the other end of the second jumper cable to the black, negative (-) chassis ground of your vehicle (4).

Do not allow the jumper cables to contact anything except the correct battery or jumper terminals or the correct ground. Do not lean over the battery when making connections.



8. Press the 12V Battery Reset switch.
9. Start the engine of the assisting vehicle and let it run for a few minutes.
10. Start your vehicle as soon as possible. After starting vehicle (  indicator on), operate the vehicle safely outdoors in ready mode stopped and/or drive it for 30 minutes total to charge the 12V battery fully.



If your vehicle will not start after a few attempts, it probably requires servicing. In this event please seek qualified assistance. If the cause of your battery discharging is not apparent, have your vehicle checked by an authorized HYUNDAI dealer.

Disconnect the jumper cables in the exact reverse order you connected them:

1. Disconnect the jumper cable from the black, negative (-) chassis ground of your vehicle (4).
2. Disconnect the other end of the jumper cable from the black, negative (-) battery/chassis ground of the assisting vehicle (3).
3. Disconnect the second jumper cable from the red, positive (+) battery/jumper terminal of the assisting vehicle (2).
4. Disconnect the other end of the jumper cable from the red, positive (+) jumper terminal of your vehicle (1).

### Information

The voltage range of the charger should be 13.3~14V and its current range should be less than 60A. (13.8V is recommended).

### CAUTION

- The use of an improper charger with a voltage and current range higher than specified may cause overheating and damage to the 12V battery.
- The use of an incorrect charger will lead to a power shut-off to save the 12V battery. Stop using the incorrect charger once the power of the vehicle is shut off.

### Information



An inappropriately disposed battery can be harmful to the environment and human health. Dispose of the battery according to your local law(s) or regulations.

### NOTICE

To prevent damage to your vehicle:

- Only use a 12-volt power supply (battery or jumper system) to jump start your vehicle.
- Do not attempt to jump start your vehicle by push-starting.

## IF THE 12 VOLT BATTERY IS DISCHARGED (PLUG-IN HYBRID VEHICLE)

### Jump Starting

Jump starting can be dangerous if done incorrectly. Follow the jump starting procedure in this section to avoid serious injury or damage to your vehicle. If in doubt about how to properly jump start your vehicle, we strongly recommend that you have a service technician or towing service do it for you.

#### WARNING

To prevent **SERIOUS INJURY** or **DEATH** to you or bystanders, always follow these precautions when working near or handling the battery:



Always read and follow instructions carefully when handling a battery.



Wear eye protection designed to protect the eyes from acid splashes.



Keep all flames, sparks, or smoking materials away from the battery.



Hydrogen is always present in battery cells, is highly combustible, and may explode if ignited.



Keep batteries out of reach of children.

(Continued)

(Continued)



Batteries contain sulfuric acid which is highly corrosive. Do not allow acid to contact your eyes, skin or clothing.

If acid gets into your eyes, flush your eyes with clean water for at least 15 minutes and get immediate medical attention. If acid gets on your skin, thoroughly wash the area. If you feel pain or a burning sensation, get medical attention immediately.

- When lifting a plastic-cased battery, excessive pressure on the case may cause battery acid to leak. Lift with a battery carrier or with your hands on opposite corners.
- Do not attempt to jump start your vehicle if your battery is frozen.

(Continued)

### (Continued)

- **NEVER attempt to recharge the battery when the vehicle's battery cables are connected to the battery.**
- **The electrical ignition system works with high voltage. NEVER touch these components with the engine running or when the Engine Start/Stop button is in the ON position.**

### Information



An inappropriately disposed battery can be harmful to the environment and human health. Dispose of the battery according to your local law(s) or regulations.

### **NOTICE**

**To prevent damage to your vehicle:**

- **Only use a 12-volt power supply (battery or jumper system) to jump start your vehicle.**
- **Do not attempt to jump start your vehicle by push-starting.**

### ***Jump starting procedure***

1. Position the vehicles close enough that the jumper cables will reach, but do not allow the vehicles to touch.
2. Avoid fans or any moving parts in the engine compartment at all times, even when the vehicles are turned off.
3. Turn off all electrical devices such as radios, lights, air conditioning, etc. Put the vehicles in P (Park) and set the parking brake. Turn both vehicles OFF.

### Information

Your vehicle has a battery in the luggage compartment, but when you jump start your vehicle, use the jumper terminal in the engine compartment.

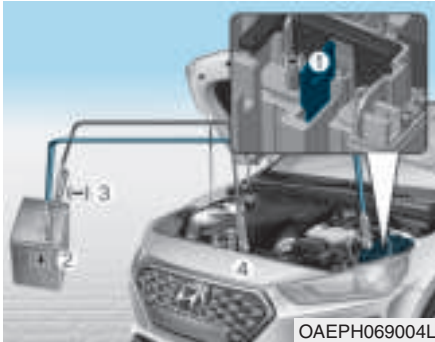

4. Connect the jumper cables in the exact sequence shown in the illustration. First connect one jumper cable to the red, positive (+) jumper terminal of your vehicle (1).
5. Connect the other end of the jumper cable to the red, positive (+) battery/jumper terminal of the assisting vehicle (2).
6. Connect the second jumper cable to the black, negative (-) battery/chassis ground of the assisting vehicle (3).

7. Connect the other end of the second jumper cable to the black, negative (-) chassis ground of your vehicle (4).

Do not allow the jumper cables to contact anything except the correct battery or jumper terminals or the correct ground. Do not lean over the battery when making connections.

8. Start the engine of the assisting vehicle and let it run at approximately 2,000 rpm for a few minutes. Then start your vehicle.



If your vehicle will not start after a few attempts, it probably requires servicing. In this event please seek qualified assistance. If the cause of your battery discharging is not apparent, have your vehicle checked by an authorized HYUNDAI dealer.

Disconnect the jumper cables in the exact reverse order you connected them:

1. Disconnect the jumper cable from the black, negative (-) chassis ground of your vehicle (4).
2. Disconnect the other end of the jumper cable from the black, negative (-) battery/chassis ground of the assisting vehicle (3).
3. Disconnect the second jumper cable from the red, positive (+) battery/jumper terminal of the assisting vehicle (2).
4. Disconnect the other end of the jumper cable from the red, positive (+) jumper terminal of your vehicle (1).

### IF THE ENGINE OVERHEATS

If your engine coolant temperature gauge indicates overheating, you experience a loss of power, or hear loud pinging or knocking, the engine may be overheating. If this happens, you should:

1. Turn ON the hazard warning flasher, pull off the road and stop as soon as it is safe to do so.
2. Place the shift lever in P (Park) and set the parking brake.
3. Make sure that there is no hot steam gushing out of the engine compartment. When it is safe to do so, open the engine compartment, and check the water-pump connector. When the water-pump connector is disconnected, stop the engine, re-connect the water-pump connector, and then re-start the engine.
4. Set the temperature and the air flow to the maximum, and turn ON the air conditioner.
5. When the Service warning light (  ) illuminates on the instrument cluster, immediately stop the engine, and contact an authorized HYUNDAI dealer. When the engine warning light (  ) illuminates, or when the coolant or hot steams gush out of the engine compartment, leave the engine compartment opened, while running the engine. This is to ventilate the engine compartment and to cool down the engine.
6. Check the coolant temperature gauge on the instrument cluster to make sure the coolant temperature is sufficiently cooled down. Check the coolant level. When it is insufficient, check its connection with the radiator, the heater hose, and the water pump for any leakage. When there is no leakage, add the coolant. However, if the problems persists, such as the illumination of the warning lights, leakages, or the cooling-fan malfunction, which may overheat the engine, immediately stop the engine, and have your vehicle checked by an authorized HYUNDAI dealer.

#### WARNING



**The electric motor for the cooling fan may continue to operate or start up when the engine is not running and can cause serious injury. Keep hands, clothing and tools away from the rotating fan blades of the cooling fan.**

**⚠ WARNING**

Your vehicle is equipped with a pressurized coolant reserve tank. **NEVER** remove the coolant reserve tank cap or the radiator drain plug while the engine and radiator are **HOT**. Hot coolant and steam may blow out under pressure, causing serious injury.

Turn the engine off and wait until the engine cools down. Use extreme care when removing the coolant reserve tank cap. Wrap a towel or thick rag around it, and turn it counterclockwise slowly to release some of the pressure from the system. Step back while the pressure is released.

When you are sure all the pressure has been released, continue turning the cap counterclockwise to remove it.

7. If you cannot find the cause of the overheating, wait until the engine temperature has returned to normal. Then, if coolant has been lost, carefully add coolant to the reservoir to bring the fluid level in the reservoir up to the halfway mark.
8. Proceed with caution, keeping alert for further signs of overheating. If overheating happens again, call an authorized HYUNDAI dealer for assistance.

**⚠ CAUTION**

Serious loss of coolant indicates a leak in the cooling system and should be checked as soon as possible by an authorized HYUNDAI dealer.



## TIRE PRESSURE MONITORING SYSTEM (TPMS)



- (1) Low Tire Pressure / TPMS Malfunction Indicator Lamp
- (2) Low Tire Pressure / Tire Pressure Monitor / TPMS Malfunction Display (shown on the cluster LCD display)

### Check Tire Pressure



- You can check the tire pressure in the Information Mode (for cluster type A) or Assist Mode (  ) on the cluster.  
 to the "LCD Display Modes" in chapter 3.
- Tire pressure is displayed after a few minutes of driving after initial engine start up.
- If tire pressure is not displayed when the vehicle is stopped, "Drive to display" message will appear. After driving, check the tire pressure.

- The displayed tire pressure values may differ from those measured with a tire pressure gauge.
- You can change the tire pressure unit in the User Settings mode on the cluster.
  - psi, kpa, bar (**Refer to the "User Settings Mode" section in chapter 3**).

## Tire Pressure Monitoring System

### WARNING

**Over-inflation or under-inflation can reduce tire life, adversely affect vehicle handling, and lead to sudden tire failure that may cause loss of vehicle control resulting in an accident.**

Each tire, including the spare (if provided), should be checked monthly when cold and inflated to the inflation pressure recommended by the vehicle manufacturer on the vehicle placard or tire inflation pressure label. (If your vehicle has tires of a different size than the size indicated on the vehicle placard or tire inflation pressure label, you should determine the proper tire inflation pressure for those tires.)

As an added safety feature, your vehicle has been equipped with a tire pressure monitoring system (TPMS) that illuminates a low tire pressure telltale when one or more of your tires is significantly under-inflated. Accordingly, when the low tire pressure telltale illuminates, you should stop and check your tires as soon as possible, and inflate them to the proper pressure. Driving on a significantly underinflated tire causes the tire to overheat and can lead to tire failure.

Under-inflation also reduces fuel efficiency and tire tread life, and may affect the vehicle's handling and stopping ability.

Please note that the TPMS is not a substitute for proper tire maintenance, and it is the driver's responsibility to maintain correct tire pressure, even if under-inflation has not reached the level to trigger illumination of the TPMS low tire pressure telltale.

Your vehicle has also been equipped with a TPMS malfunction indicator to indicate when the system is not operating properly.

The TPMS malfunction indicator is combined with the low tire pressure telltale. When the system detects a malfunction, the telltale will flash for approximately one minute and then remain continuously illuminated. This sequence will continue upon subsequent vehicle start-ups as long as the malfunction exists.

When the malfunction indicator is illuminated, the system may not be able to detect or signal low tire pressure as intended. TPMS malfunctions may occur for a variety of reasons, including the installation of replacement or alternate tires or wheels on the vehicle that prevent the TPMS from functioning properly. Always check the TPMS malfunction telltale after replacing one or more tires or wheels on your vehicle to ensure that the replacement or alternate tires and wheels allow the TPMS to continue to function properly.



Always check the TPMS malfunction LCD display after replacing one or more tires or wheels on your vehicle to ensure that the replacement or alternate tires and wheels allow the TPMS to continue to function properly.

### NOTICE

**If any of the below happens, have the system checked by an authorized HYUNDAI dealer.**

- 1. The Low Tire Pressure TPMS Malfunction Indicator does not illuminate for 3 seconds when the Engine Start/Stop button is placed to the ON position or the vehicle is in the ready (🚗) mode.**
- 2. The TPMS Malfunction Indicator remains illuminated after blinking for approximately 1 minute.**
- 3. The Low Tire Pressure LCD display remains illuminated**



### Low Tire Pressure Telltale



OAEPH059643L

### Low Tire Pressure LCD Display with Position Indicator

When the tire pressure monitoring system warning indicators are illuminated and the warning message is displayed on the cluster LCD display, one or more of your tires is significantly under-inflated. The LCD position indicator will indicate which tire is significantly under-inflated by illuminating the corresponding position light.

If any of your tire pressures are indicated as being low, immediately reduce your speed, avoid hard cornering, and anticipate increased stopping distances. You should stop and check your tires as soon as possible. Inflate the tires to the proper pressure as indicated on the vehicle's placard or tire inflation pressure label located on the driver's side center pillar outer panel.

If you cannot reach a service station or if the tire cannot hold the newly added air, replace the low pressure tire with the spare tire.

The Low Tire Pressure LCD position indicator will remain on and the TPMS Malfunction Indicator may blink for one minute and then remain illuminated until you have the low pressure tire repaired and replaced on the vehicle.

### NOTICE

**The spare tire is not equipped with a tire pressure sensor.**

**CAUTION**

During winter or cold weather, the TPMS indicator may illuminate if the tire pressures were set when the outside temperature was warm. As the outside air becomes colder, the pressure in the tires will decrease. Similarly, if the outside air becomes warmer, the pressure in the tires will increase. As you drive your vehicle, the temperature of the tires will heat up, therefore the tire pressures will increase. Check and adjust your tire pressures regularly before driving to make sure your vehicle is operating at the correct pressures as designed.

**WARNING****Low pressure damage**

**Significantly low tire pressure makes the vehicle unstable and can contribute to loss of vehicle control and increased braking distances.**

**Continued driving on low pressure tires can cause the tires to overheat and fail.**

**TPMS Malfunction Indicator**

The TPMS Malfunction Indicator will illuminate after it blinks for approximately one minute when there is a problem with the Tire Pressure Monitoring System.

Have the system checked by an authorized HYUNDAI dealer as soon as possible.

**NOTICE**

**If there is a malfunction with the TPMS, the individual tire pressures in the cluster LCD display will not be available. Have the system checked by an authorized HYUNDAI dealer as soon as possible.**

### **NOTICE**

**The TPMS Malfunction Indicator may illuminate after blinking for one minute if the vehicle is near electric power supply cables or radio transmitters such as police stations, government and public offices, broadcasting stations, military installations, airports, transmitting towers, etc.**

**Additionally, the TPMS Malfunction Indicator may illuminate if snow chains are used or electronic devices such as computers, chargers, remote starters, navigation, etc. This may interfere with normal operation of the TPMS.**

### Changing a Tire with TPMS

If you have a flat tire, the Low Tire Pressure and LCD position indicator will come on. Have the flat tire repaired by an authorized HYUNDAI dealer as soon as possible or replace the flat tire with the spare tire.

### **NOTICE**

**Never use a puncture-repairing agent not approved by HYUNDAI dealer to repair and/or inflate a low pressure tire. Tire sealant not approved by HYUNDAI dealer may damage the tire pressure sensor.**

The spare tire does not come with a tire pressure monitoring sensor. When the low pressure tire or the flat tire is replaced with the spare tire, the Low Tire Pressure LCD position indicator will remain on. Also, the TPMS Malfunction Indicator will illuminate after blinking for one minute if the vehicle is driven at speed above 15.5 mph (25 km/h) for approximately 20 minutes.

Once the original tire equipped with a tire pressure monitoring sensor is reinflated to the recommended pressure and reinstalled on the vehicle, the Low Tire Pressure LCD position indicator and TPMS Malfunction Indicator will go off within a few minutes of driving.

If the indicators do not disappear after a few minutes, please visit an authorized HYUNDAI dealer.

Each wheel is equipped with a tire pressure sensor mounted inside the tire behind the valve stem (except for the spare tire). You must use TPMS specific wheels. It is recommended that you always have your tires serviced by an authorized HYUNDAI dealer.

## **WARNING**

Tampering with, modifying, or disabling the Tire Pressure Monitoring System (TPMS) components may interfere with the system's ability to warn the driver of low tire pressure conditions and/or TPMS malfunctions. Tampering with, modifying, or disabling the Tire Pressure Monitoring System (TPMS) components may void the warranty for that portion of the vehicle.

## **Information**

This device complies with Industry Canada RSS-210 standard.

Operation is subject to the following three conditions:

1. This device may not cause harmful interference, and
2. This device must accept any interference received, including interference that may cause undesired operation.
3. Changes or modifications not expressly approved by the party responsible for compliance could void the user's authority to operate the device.

## IF YOU HAVE A FLAT TIRE With Spare Tire (if equipped)

### WARNING

Changing a tire can be dangerous. Follow the instructions in this section when changing a tire to reduce the risk of serious injury or death.

### CAUTION

Be careful as you use the jack handle to stay clear of the flat end. The flat end has sharp edges that could cause cuts.

### Jack and tools

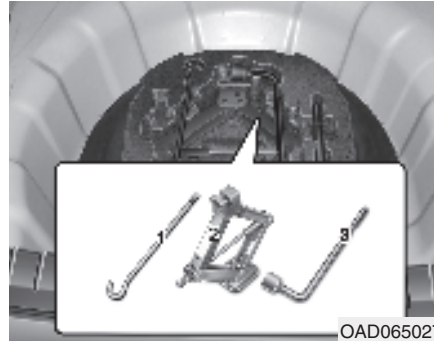

- ① Jack handle
- ② Jack
- ③ Wheel lug nut wrench

The jack, jack handle, and wheel lug nut wrench are stored in the luggage compartment under the luggage box cover.

The jack is provided for emergency tire changing only.

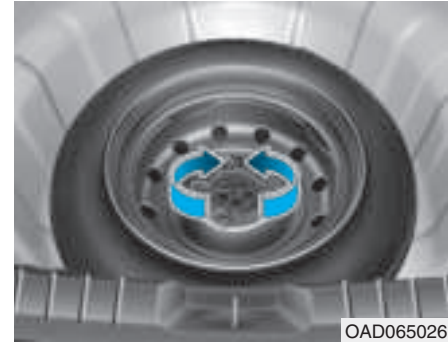

Turn the winged hold down bolt counterclockwise to remove the spare tire.

Store the spare tire in the same compartment by turning the winged hold down bolt clockwise.

To prevent the spare tire and tools from "rattling", store them in their proper location.



If it is hard to loosen the tire hold-down wing bolt by hand, you can loosen it easily using the jack handle.

1. Put the jack handle (1) inside of the tire hold-down wing bolt.
2. Turn the tire hold-down wing bolt counterclockwise with the jack handle.

## Changing tires

### WARNING

A vehicle can slip or roll off of a jack causing serious injury or death to you or those nearby. Take the following safety precautions:

- Never place any portion of your body under a vehicle that is supported by a jack.
- **NEVER attempt to change a tire in the lane of traffic. ALWAYS move the vehicle completely off the road on level, firm ground away from traffic before trying to change a tire. If you cannot find a level, firm place off the road, call a towing service for assistance.**
- **Be sure to use the jack provided with the vehicle.**
- **ALWAYS place the jack on the designated jacking positions on the vehicle and NEVER on the bumpers or any other part of the vehicle for jacking support.**

(Continued)

(Continued)

- Do not start or run the engine while the vehicle is on the jack.
- Do not allow anyone to remain in the vehicle while it is on the jack.
- Keep children away from the road and the vehicle.

Follow these steps to change your vehicle's tire:

1. Park on a level, firm surface.
2. Move the shift lever into P (Park), apply the parking brake, and place the ignition switch in the LOCK/OFF position.
3. Press the hazard warning flasher button.
4. Remove the wheel lug nut wrench, jack, jack handle, and spare tire from the vehicle.
5. Block both the front and rear of the tire diagonally opposite of the tire you are changing.



6. Loosen the wheel lug nuts counterclockwise one turn each in the order shown above, but do not remove any lug nuts until the tire has been raised off of the ground.



7. Place the jack at the designated jacking position under the frame closest to the tire you are changing. The jacking positions are plates welded to the frame with two notches. Never jack at any other position or part of the vehicle. Doing so may damage the side seal molding or other parts of the vehicle.

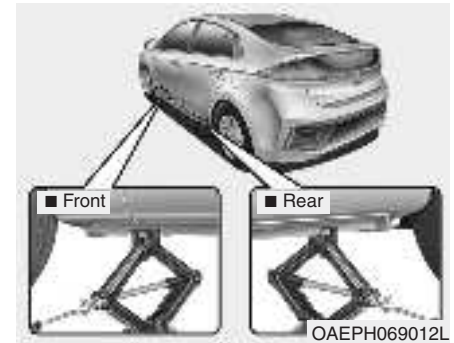

8. Insert the jack handle into the jack and turn it clockwise, raising the vehicle until the tire clears the ground. Make sure the vehicle is stable on the jack.



OAEPH069013L

9. Loosen the lug nuts with the wheel lug nut wrench and remove them with your fingers. Remove the wheel from the studs and lay it flat on the ground out of the way. Remove any dirt or debris from the studs, mounting surfaces, and wheel.
10. Install the spare tire onto the studs of the hub.

11. Tighten the lug nuts with your fingers onto the studs with the smaller end of the lug nuts closest to the wheel.
12. Lower the vehicle to the ground by turning the jack handle counterclockwise.
13. Use the wheel lug nut wrench to tighten the lug nuts in the order shown. Double-check each lug nut until they are tight. After changing tires, have an authorized HYUNDAI dealer tighten the lug nuts to their proper torque as soon as possible. **The wheel lug nut should be tightened to 11~13 kgf·m (79~94 lbf·ft).**



OLF064013

If you have a tire gauge, check the tire pressure (see "Tires and Wheels" in chapter 8 for tire pressure instructions.). If the pressure is lower or higher than recommended, drive slowly to the nearest service station and adjust it to the recommended pressure. Always reinstall the valve cap after checking or adjusting tire pressure. If the cap is not replaced, air may leak from the tire. If you lose a valve cap, buy another and install it as soon as possible. After changing tires, secure the flat tire and return the jack and tools to their proper storage locations.



### NOTICE

**Check the tire pressure as soon as possible after installing a spare tire. Adjust it to the recommended pressure.**

### CAUTION

**Your vehicle has metric threads on the studs and lug nuts. Make certain during tire changing that the same nuts that were removed are reinstalled. If you have to replace your lug nuts make sure they have metric threads to avoid damaging the studs and ensure the wheel is properly secured to the hub. Consult an authorized HYUNDAI dealer for assistance.**

If any of the equipment such as the jack, lug nuts, studs, or other equipment is damaged or in poor condition, do not attempt to change the tire and call for assistance.

### Use of compact spare tires (if equipped)

Compact spare tires are designed for emergency use only. Drive carefully on the compact spare tire and always follow the safety precautions.

### WARNING

**To prevent compact spare tire failure and loss of control possibly resulting in an accident:**

- **Use the compact spare tire only in an emergency.**
- **NEVER operate your vehicle over 80 km/h (50 mph).**
- **Do not exceed the vehicle's maximum load rating or the load carrying capacity shown on the sidewall of the compact spare tire.**
- **Do not use the compact spare tire continuously. Repair or replace the original tire as soon as possible to avoid failure of the compact spare tire.**

When driving with the compact spare tire mounted to your vehicle:

- Check the tire pressure after installing the compact spare tire. The compact spare tire should be inflated to 420 kPa (60 psi).
- Do not take this vehicle through an automatic car wash while the compact spare tire is installed.
- Do not use the compact spare tire on any other vehicle because this tire has been designed especially for your vehicle.
- The compact spare tire's tread life is shorter than a regular tire. Inspect your compact spare tire regularly and replace worn compact spare tires with the same size and design, mounted on the same wheel.
- Do not use more than one compact spare tire at a time.

### NOTICE

When the original tire and wheel are repaired and reinstalled on the vehicle, the lug nut torque must be set correctly. The correct lug nut tightening torque is 11~13 kgf·m (79~94 lbf·ft).

### CAUTION

To prevent damaging the compact spare tire and your vehicle:

- Drive slowly enough for the road conditions to avoid all hazards, such as a potholes or debris.
- Avoid driving over obstacles. The compact spare tire diameter is smaller than the diameter of a conventional tire and reduces the ground clearance approximately 25 mm (1 inch).
- Do not use the compact spare tire on any other wheels, nor should standard tires, snow tires, wheel covers or trim rings be used with the compact spare wheel.

### With Tire Mobility Kit (TMK) - Type A



For safe operation, carefully read and follow the instructions in this manual before use.

- (1) Compressor
- (2) Sealant bottle

The Tire Mobility Kit is a temporary fix to the tire and the tire should be inspected by an authorized HYUNDAI dealer as soon as possible.

### CAUTION

#### One sealant bottle for one tire

**When two or more tires are flat, do not use the tire mobility kit because the supported one sealant of Tire Mobility Kit is only used for one flat tire.**

### WARNING

#### Tire wall

**Do not use the Tire Mobility Kit to repair punctures in the tire walls. This can result in an accident due to tire failure.**

### WARNING

#### Temporary fix

**Have your tire repaired as soon as possible. The tire may lose air pressure at any time after inflating with the Tire Mobility Kit.**

### **Introduction**

With the Tire Mobility Kit you stay mobile even after experiencing a tire puncture.

The compressor and sealing compound system effectively and comfortably seals most punctures in a passenger car tire caused by nails or similar objects and reinflates the tire.

After you ensure that the tire is properly sealed you can drive cautiously on the tire (distance up to 200 km (120 miles)) at a max. speed of (80 km/h (50 mph)) in order to reach a service station or tire dealer for the tire replacement.

It is possible that some tires, especially with larger punctures or damage to the sidewall, cannot be sealed completely.

Air pressure loss in the tire may adversely affect tire performance.

For this reason, you should avoid abrupt steering or other driving maneuvers, especially if the vehicle is heavily loaded or if a trailer is in use.

The Tire Mobility Kit is not designed or intended as a permanent tire repair method and is to be used for one tire only.

This instruction shows you step by step how to temporarily seal the puncture simply and reliably.

Read the section "Notes on the safe use of the Tire Mobility Kit".

### ***Notes on the safe use of the Tire Mobility Kit***

- Park your car at the side of the road so that you can work with the Tire Mobility Kit away from moving traffic.
- To be sure your vehicle will not move, even when you're on fairly level ground, always set your parking brake.
- Only use the Tire Mobility Kit for sealing/inflation passenger car tires. Only punctured areas located within the tread region of the tire can be sealed using the tire mobility kit.
- Do not use on motorcycles, bicycles or any other type of tires.
- When the tire and wheel are damaged, do not use Tire Mobility Kit for your safety.
- Use of the Tire Mobility Kit may not be effective for tire damage larger than approximately 4 mm (0.15 inch).  
Please contact the nearest HYUNDAI dealership if the tire cannot be made roadworthy with the Tire Mobility Kit.
- Do not use the Tire Mobility Kit if a tire is severely damaged by driving run flat or with insufficient air pressure.
- Do not remove any foreign objects such as nails or screws that have penetrated the tire.
- Provided the car is outdoors, leave the engine running. Otherwise operating the compressor may eventually drain the car battery.
- Never leave the Tire Mobility Kit unattended while it is being used.
- Do not leave the compressor running for more than 10 minutes at a time or it may overheat.
- Do not use the Tire Mobility Kit if the ambient temperature is below -30°C (-22°F) or over 70°C (158°F).
- In case of skin contact with the sealant, wash the area thoroughly with plenty of water. If the irritation persists, seek medical attention.
- In case of eye contact with the sealant, flush your eyes for at least 15 minutes. If the irritation persists, seek medical attention.
- In case of swallowing the sealant, rinse the mouth and drink plenty of water. However, never give anything to an unconscious person and seek medical attention immediately.
- Long time exposure to the sealant may cause damage to bodily tissues such as kidney, etc.

**Components of the Tire Mobility Kit**

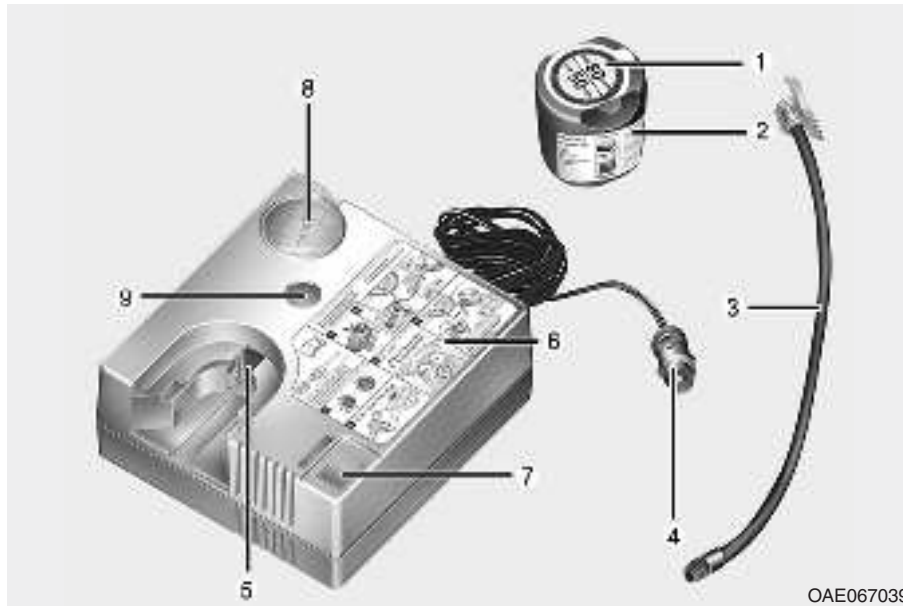

1. Speed restriction label
2. Sealant bottle and label with speed restriction
3. Filling hose from sealant bottle to wheel
4. Connectors and cable for power outlet direct connection
5. Holder for the sealant bottle
6. Compressor
7. ON/OFF switch
8. Pressure gauge for displaying the tire inflation pressure
9. Button for reducing tire inflation pressure

Connectors, cable and connection hose are stored in the compressor housing.

Strictly follow the specified sequence, otherwise the sealant may escape under high pressure.

### WARNING

**Do not use the tire sealant after the sealant has expired (i.e. past the expiration date on the sealant container). This can increase the risk of tire failure.**

### WARNING

- Keep out of reach of children.
- Avoid contact with eyes.
- Do not swallow.

## Using the Tire Mobility Kit

### CAUTION

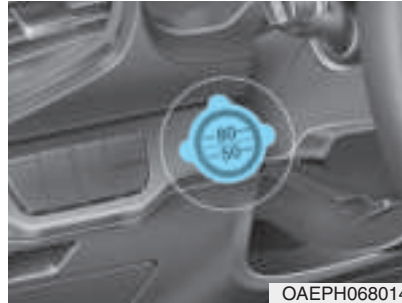

**Detach the speed restriction label (1) from the sealant bottle (2), and place it in a highly visible place inside the vehicle such as on the steering wheel to remind the driver not to drive too fast.**

1. Shake the sealant bottle (2).

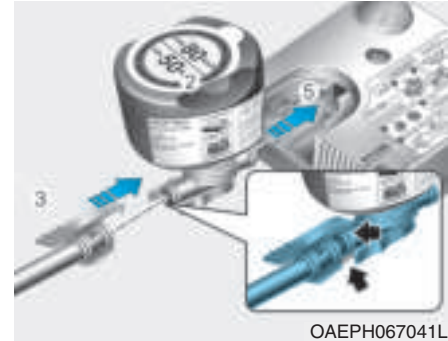

2. Screw the filling hose (3) onto the connector of the sealant bottle (2).
3. Insert the sealant bottle into the housing of the compressor (5) so that the bottle is upright.
4. Ensure that the button (9) on the compressor is not pressed.



5. Unscrew the valve cap from the valve of the defective wheel and screw the filling hose (3) of the sealant bottle onto the valve.
6. Ensure that the compressor is switched OFF.

**CAUTION**

Securely install the sealant filling hose to the valve. If not, sealant may flow backward, possibly clogging the filling hose.

OAEPH068027



7. Plug the compressor power cord (4) into the vehicle power outlet.
8. With the vehicle ON (  indicator ON), switch on the compressor and let it run for approximately 5~7 minutes to fill the sealant up to proper pressure. (refer to the Tire and Wheels, chapter 8). The inflation pressure of the tire after filling is unimportant and will be checked/corrected later.

Be careful not to overinflate the tire and stay away from the tire when filling it.

**CAUTION**

Do not attempt to drive your vehicle if the tire pressure is below 200 kpa (29 psi). This could result in an accident due to sudden tire failure.

9. Switch off the compressor.
10. Detach the hoses from the sealant bottle connector and from the tire valve.

Return the Tire Mobility Kit to its storage location in the vehicle.

**WARNING**

Do not the filling leave your vehicle running in a poorly ventilated area for extended periods of time. Carbon monoxide poisoning and suffocation can occur.

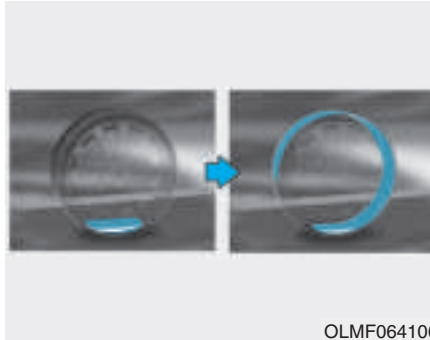

OLMF064106

**Distributing the sealant**

11. Immediately drive approximately 7~10 km (4~6 miles or about 10 minutes) to evenly distribute the sealant in the tire.

Do not exceed a speed of 80 km/h (50 mph). If possible, do not fall below a speed of 20 km/h (12 mph).

While driving, if you experience any unusual vibration, ride disturbance or noise, reduce your speed and drive with caution until you can safely pull off of the side of the road.

**Checking the tire inflation pressure**

1. After driving approximately 7~10 km (4~6 miles or about 10 minutes), stop at a safe location.

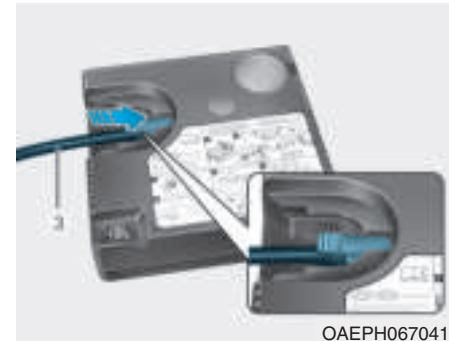

OAEPH067041

2. Connect the filling hose (3) directly into the compressor.





3. Connect the other end of the filling hose (3) directly into the tire valve.
4. Plug the compressor power cord (4) into the vehicle power outlet.

5. Adjust the tire inflation pressure to the recommended tire inflation.

With the ignition switched on, proceed as follows.

- **To increase the inflation pressure:**

Switch on the compressor. To check the current inflation pressure setting, briefly switch off the compressor.

- **To reduce the inflation pressure:**

Press the button (9) on the compressor.

### **i** Information

The pressure gauge may show higher than actual reading when the compressor is running. To get an accurate tire pressure, the compressor needs to be turned off.

### **⚠ CAUTION**

**When you use the Tire Mobility Kit including sealant not approved by HYUNDAI, the tire pressure sensors may be damaged by sealant.**

**The sealant on the tire pressure sensor and wheel should be removed when you replace the tire with a new one and inspect the tire pressure sensors at an authorized dealer.**

### **⚠ WARNING**

**The tire inflation pressure must be at least 220 kPa (32 psi). If it is not, do not continue driving. Call for road side service or towing.**

### **i** Information

When reinstalling the repaired or replaced tire and wheel on the vehicle, tighten the wheel lug nut to 11~13 kgf·m (79~94 lbf·ft).

## With Tire Mobility Kit (TMK) - Type B



For safe operation, carefully read and follow the instructions in this manual before use.

- (1) Compressor
- (2) Sealant bottle

The Tire Mobility Kit is a temporary fix to the tire and the tire should be inspected by an authorized HYUNDAI dealer as soon as possible.

### CAUTION

**One sealant bottle for one tire**

**When two or more tires are flat, do not use the tire mobility kit because the supported one sealant of Tire Mobility Kit is only used for one flat tire.**

### WARNING

**Tire wall**

**Do not use the Tire Mobility Kit to repair punctures in the tire walls. This can result in an accident due to tire failure.**

### WARNING

**Temporary fix**

**Have your tire repaired as soon as possible. The tire may lose air pressure at any time after inflating with the Tire Mobility Kit.**

### **Introduction**

With the Tire Mobility Kit you stay mobile even after experiencing a tire puncture.

The compressor and sealing compound system effectively and comfortably seals most punctures in a passenger car tire caused by nails or similar objects and reinflates the tire.

After you ensure that the tire is properly sealed you can drive cautiously on the tire (distance up to 200 km (120 miles)) at a max. speed of (80 km/h (50 mph)) in order to reach a service station or tire dealer for the tire replacement.

It is possible that some tires, especially with larger punctures or damage to the sidewall, cannot be sealed completely.

Air pressure loss in the tire may adversely affect tire performance.

For this reason, you should avoid abrupt steering or other driving maneuvers, especially if the vehicle is heavily loaded or if a trailer is in use.

The Tire Mobility Kit is not designed or intended as a permanent tire repair method and is to be used for one tire only.

This instruction shows you step by step how to temporarily seal the puncture simply and reliably.

Read the section "Notes on the safe use of the Tire Mobility Kit".

### **Notes on the safe use of the Tire Mobility Kit**

- Park your car at the side of the road so that you can work with the Tire Mobility Kit away from moving traffic.
- To be sure your vehicle will not move, even when you're on fairly level ground, always set your parking brake.
- Only use the Tire Mobility Kit for sealing/inflation passenger car tires. Only punctured areas located within the tread region of the tire can be sealed using the tire mobility kit.
- Do not use on motorcycles, bicycles or any other type of tires.

- When the tire and wheel are damaged, do not use Tire Mobility Kit for your safety.
- Use of the Tire Mobility Kit may not be effective for tire damage larger than approximately 4 mm (0.15 inch).

Please contact the nearest HYUNDAI dealership if the tire cannot be made roadworthy with the Tire Mobility Kit.

- Do not use the Tire Mobility Kit if a tire is severely damaged by driving run flat or with insufficient air pressure.
- Do not remove any foreign objects such as nails or screws that have penetrated the tire.
- Provided the car is outdoors, leave the vehicle in the ready () mode. Otherwise operating the compressor may eventually drain the car battery.
- Never leave the Tire Mobility Kit unattended while it is being used.
- Do not leave the compressor running for more than 10 minutes at a time or it may overheat.

- Do not use the Tire Mobility Kit if the ambient temperature is below  $-30^{\circ}\text{C}$  ( $-22^{\circ}\text{F}$ ) or over  $70^{\circ}\text{C}$  ( $158^{\circ}\text{F}$ ).
- In case of skin contact with the sealant, wash the area thoroughly with plenty of water. If the irritation persists, seek medical attention.
- In case of eye contact with the sealant, flush your eyes for at least 15 minutes. If the irritation persists, seek medical attention.
- In case of swallowing the sealant, rinse the mouth and drink plenty of water. However, never give anything to an unconscious person and seek medical attention immediately.
- Long time exposure to the sealant may cause damage to bodily tissues such as kidney, etc.

### Components of the Tire Mobility Kit

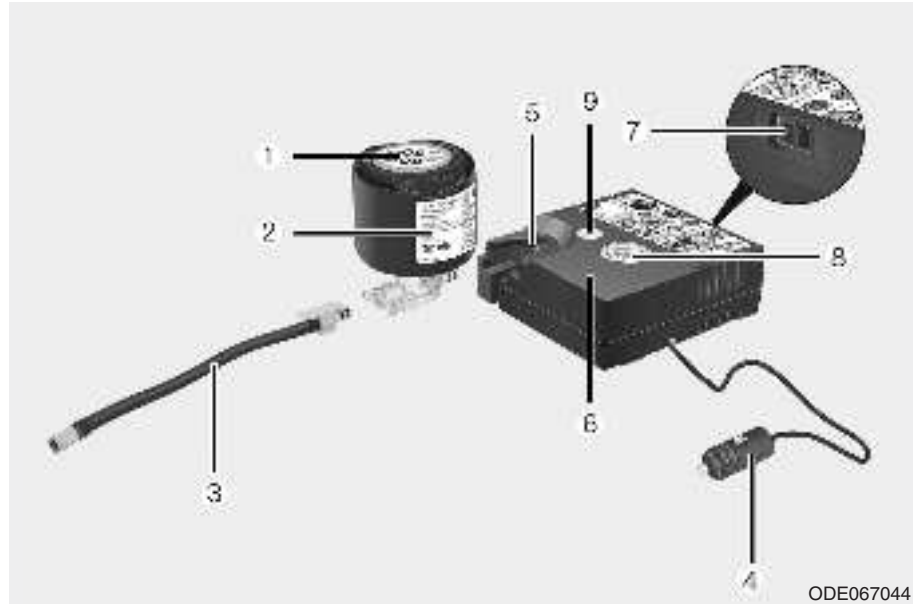

ODE067044

- |                                                            |                                                              |
|------------------------------------------------------------|--------------------------------------------------------------|
| 1. Speed restriction label                                 | 5. Holder for the sealant bottle                             |
| 2. Sealant bottle and label with speed restriction         | 6. Compressor                                                |
| 3. Filling hose from sealant bottle to wheel               | 7. ON/OFF switch                                             |
| 4. Connectors and cable for power outlet direct connection | 8. Pressure gauge for displaying the tire inflation pressure |
|                                                            | 9. Button for reducing tire inflation pressure               |

Connectors, cable and connection hose are stored in the compressor housing.

Strictly follow the specified sequence, otherwise the sealant may escape under high pressure.

### WARNING

**Do not use the tire sealant after the sealant has expired (i.e. past the expiration date on the sealant container). This can increase the risk of tire failure.**

### WARNING

- Keep out of reach of children.
- Avoid contact with eyes.
- Do not swallow.

## Using the Tire Mobility Kit

### CAUTION

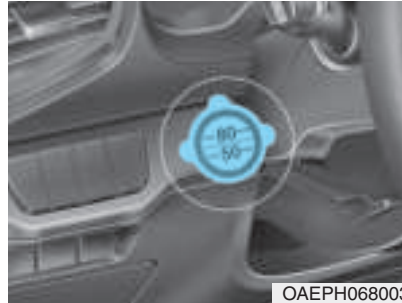

**Detach the speed restriction label (1) from the sealant bottle (2), and place it in a highly visible place inside the vehicle such as on the steering wheel to remind the driver not to drive too fast.**

1. Shake the sealant bottle (2).



2. Connect the filling hose (3) to the sealant bottle (2) in the direction of (A) and connect the sealant bottle to the compressor (5) in the direction of (B).
3. Ensure that the compressor is switched OFF.



OAE068040

4. Unscrew the valve cap from the valve of the defective wheel and screw the filling hose (3) of the sealant bottle onto the valve.

#### NOTICE

Securely install the sealant filling hose to the valve. If not, sealant may flow backward, possibly clogging the filling hose.



OAEPH068027



OAEPH069016L

5. Plug the compressor power cord (4) into the vehicle power outlet.
6. With the vehicle ON (  indicator ON), switch on the compressor and let it run for approximately 5~7 minutes to fill the sealant up to proper pressure. (refer to the Tire and Wheels, chapter 8). The inflation pressure of the tire after filling is unimportant and will be checked/corrected later.

Be careful not to overinflate the tire and stay away from the tire when filling it.

**CAUTION**

Do not attempt to drive your vehicle if the tire pressure is below 200 kpa (29 psi). This could result in an accident due to sudden tire failure.

7. Switch off the compressor.
8. Detach the hoses from the sealant bottle connector and from the tire valve.

Return the Tire Mobility Kit to its storage location in the vehicle.

**WARNING**

Do not the filling leave your vehicle running in a poorly ventilated area for extended periods of time. Carbon monoxide poisoning and suffocation can occur.

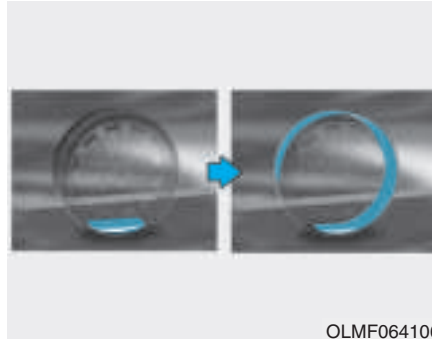

OLMF064106

**Distributing the sealant**

9. Immediately drive approximately 7~10 km (4~6 miles or about 10 minutes) to evenly distribute the sealant in the tire.

Do not exceed a speed of 80 km/h (50 mph). If possible, do not fall below a speed of 20 km/h (12 mph).

While driving, if you experience any unusual vibration, ride disturbance or noise, reduce your speed and drive with caution until you can safely pull off of the side of the road.

**Checking the tire inflation pressure**

1. After driving approximately 7~10 km (4~6 miles or about 10 minutes), stop at a safe location.



OAEPH067042

2. Connect the filling hose (3) directly into the compressor.



3. Connect the other end of the filling hose (3) directly into the tire valve.
4. Plug the compressor power cord (4) into the vehicle power outlet.

5. Adjust the tire inflation pressure to the recommended tire inflation.

With the ignition switched on, proceed as follows.

- **To increase the inflation pressure:**

Switch on the compressor. To check the current inflation pressure setting, briefly switch off the compressor.

- **To reduce the inflation pressure:**

Press the button (9) on the compressor.

### **i** Information

The pressure gauge may show higher than actual reading when the compressor is running. To get an accurate tire pressure, the compressor needs to be turned off.

### **⚠ CAUTION**

**When you use the Tire Mobility Kit including sealant not approved by HYUNDAI, the tire pressure sensors may be damaged by sealant.**

**The sealant on the tire pressure sensor and wheel should be removed when you replace the tire with a new one and inspect the tire pressure sensors at an authorized dealer.**

### **⚠ WARNING**

**The tire inflation pressure must be at least 220 kPa (32 psi). If it is not, do not continue driving. Call for road side service or towing.**

### **i** Information

When reinstalling the repaired or replaced tire and wheel on the vehicle, tighten the wheel lug nut to 11~13 kgf·m (79~94 lbf·ft).



## TOWING

### Towing Service

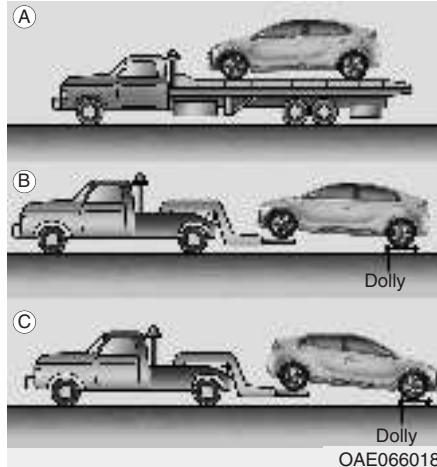

If emergency towing is necessary, we recommend having it done by an authorized HYUNDAI dealer or a commercial tow-truck service.

Proper lifting and towing procedures are necessary to prevent damage to the vehicle. The use of wheel dollies or flatbed is recommended.

It is acceptable to tow the vehicle with the rear wheels on the ground (without dollies) and the front wheels off the ground.

If any of the loaded wheels or suspension components are damaged or the vehicle is being towed with the front wheels on the ground, use a towing dolly under the front wheels.

When being towed by a commercial tow truck and wheel dollies are not used, the front of the vehicle should always be lifted, not the rear.

### CAUTION

- Do not tow the vehicle with the front wheels on the ground as this may cause damage to the vehicle.



- Do not tow with sling-type equipment. Use wheel lift or flatbed equipment.



When towing your vehicle in an emergency without wheel dollies :

1. Place the ignition switch in the ACC position.
2. Place the shift lever in N (Neutral).
3. Release the parking brake.

### CAUTION

**Failure to place the transmission shift lever in N (Neutral) may cause internal damage to the transmission.**

## Removable Towing Hook



1. Open the tailgate, and take the towing hooks out from the tool case.

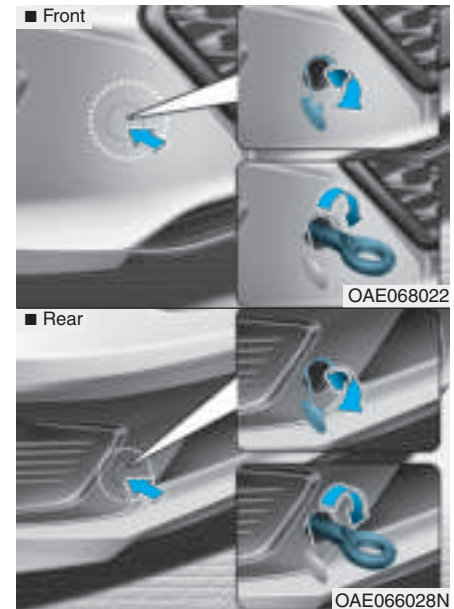

2. Remove the hole cover by pressing the lower part of the cover on the front or rear bumper.
3. Install the towing hook by turning it clockwise into the hole until it is fully secured.
4. Remove the towing hook and install the cover after use.

### Emergency Towing (if equipped)

■ Front



■ Rear

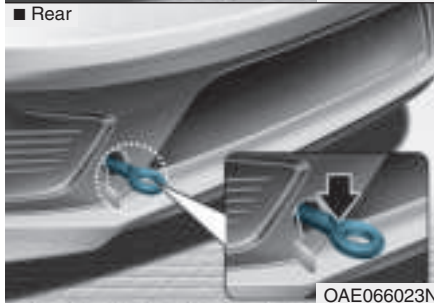

If towing is necessary, we recommend you to have it done by an authorized HYUNDAI dealer or a commercial tow truck service.

If a towing service is not available in an emergency, your vehicle may be temporarily towed using a cable or chain secured to the emergency towing hook at the rear of the vehicle.

Use extreme caution when towing the vehicle with a cable or chain. A driver must be in the vehicle to steer it and operate the brakes.

Towing should be done only on a solid ground for a short distance and at a low speed.

Also, the wheels, axles, power train, steering and brakes must all be in good condition.

#### **CAUTION**

**The driver must be in the vehicle for steering and braking operations when the vehicle is being towed. Passengers other than the driver must not be in the vehicle.**

Always follow these emergency towing precautions:

- Place the ignition switch in the ACC position so the steering wheel is not locked.
- Place the shift lever in N (Neutral).
- Release the parking brake.
- Depress the brake pedal with more force than normal since you will have reduced braking performance.
- More steering effort will be required because the power steering system will be disabled.
- Use a vehicle heavier than your own to tow your vehicle.
- The drivers of both vehicles should communicate with each other frequently.
- Before emergency towing, check that the hook is not broken or damaged.
- Fasten the towing cable or chain securely to the hook.
- Do not jerk the hook. Apply steady and even force.

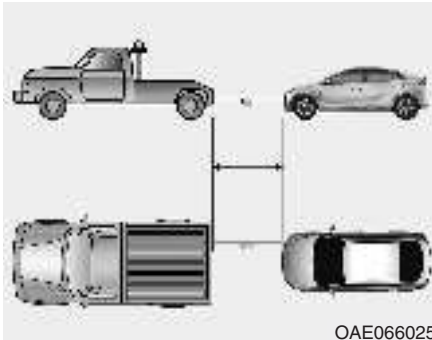

OAE066025

- Use a towing cable or chain less than 5 m (16 feet) long. Attach a white or red cloth (about 30 cm (12 inches) wide) in the middle of the cable or chain for easy visibility.
- Drive carefully so the towing cable or chain remains tight during towing.
- Before towing, check the dual clutch transmission for fluid leaks under your vehicle. If the dual clutch transmission fluid is leaking, flatbed equipment or a towing dolly must be used.

**NOTICE**

Accelerate or decelerate the vehicle in a slow and gradual manner while maintaining tension on the tow rope or chain to start or drive the vehicle, otherwise tow hooks and the vehicle may be damaged.

**NOTICE**

To avoid damage to your vehicle and vehicle components when towing:

- Always pull straight ahead when using the towing hooks. Do not pull from the side or at a vertical angle.
- Do not use the towing hooks to pull a vehicle out of mud, sand or other conditions from which the vehicle cannot be driven out under its own power.
- The vehicle should be towed at a speed of 25 km/h (15 mph) or less within the distance of 20 km (12 mph).

## IF AN ACCIDENT OCCURS

### WARNING

- For your safety, do not touch high voltage cables, connectors and package modules. High voltage components are orange in color.
- Exposed cables or wires may be visible inside or outside of the vehicle. Never touch the wires or cables, because an electrical shock, an injury, or a death may occur.
- Any gas or electrolyte leakage from your vehicle is not only poisonous but also flammable. Upon witnessing one of those, open the windows, and remain a safe distance from the vehicle out of the road. Immediately contact an authorized Hyundai dealer and advise them that a hybrid vehicle is involved.
- If you need towing, refer to "Towing" in the previous pages.

(Continued)

(Continued)

- When the vehicle is severely damaged, remain a safe distance of 15 meter (50 feet) or more between your vehicle and other vehicles/flammas.

### WARNING

If a fire occurs :

Upon witnessing any sparks, gases, flames, or fuel leakage of your vehicle, immediately call the fire department or contact an authorized HYUNDAI dealer. Also, advise them that a hybrid vehicle is involved.

### WARNING

When a submersion in water occurs:

When your vehicle is flooded in water, a high-voltage battery may cause shock or may catch on fire. Thus, turn the hybrid system OFF, take the key in your possession and move to a safe place. Never attempt physical contact with your flooded vehicle. Immediately contact an authorized HYUNDAI dealer and advise them that a hybrid vehicle is involved.

# Maintenance

Engine Compartment .....	7-3	Brake Fluid .....	7-23
Maintenance Services .....	7-5	Checking the Brake Fluid Level .....	7-23
Owner's Responsibility .....	7-5	Washer Fluid .....	7-24
Owner Maintenance Precautions .....	7-5	Checking the Washer Fluid Level .....	7-24
Owner Maintenance .....	7-6	Parking Brake .....	7-24
How to Disconnect the (-) Cable for		Checking the Parking Brake .....	7-24
Regular Maintenance (Hybrid vehicle) .....	7-7	Air Cleaner .....	7-25
Owner Maintenance Schedule .....	7-7	Filter Replacement .....	7-25
Scheduled Maintenance Services .....	7-8	Climate Control Air Filter .....	7-27
Normal Maintenance Schedule .....	7-9	Filter Inspection .....	7-27
Maintenance Under Severe Usage Conditions .....	7-13	Wiper Blades .....	7-29
Severe driving conditions .....	7-14	Blade Inspection .....	7-29
Explanation of Scheduled Maintenance		Blade Replacement .....	7-29
Items .....	7-15	Battery (12 Volt, Plug-In Hybrid Vehicle) .....	7-32
Engine Oil .....	7-17	For Best Battery Service .....	7-33
Checking the Engine Oil Level .....	7-17	Battery Recharging .....	7-33
Checking the Engine Oil and Filter .....	7-18	Reset Features .....	7-34
Engine Coolant/Inverter Coolant .....	7-19	Tires and wheels .....	7-35
Checking the Coolant Level .....	7-19	Tire Care .....	7-35
Changing Coolant .....	7-22	Recommended Cold Tire Inflation Pressures .....	7-36
Hybrid Starter & Generator (HSG) Belt .....	7-22	Check Tire Inflation Pressure .....	7-37
Checking the Hybrid Starter &		Tire Rotation .....	7-38
Generator (HSG) Belt .....	7-22	Wheel Alignment and Tire Balance .....	7-39
		Tire Replacement .....	7-39

Wheel Replacement .....	7-40	<b>Appearance Care.....</b>	<b>7-67</b>
Tire Traction .....	7-40	Exterior Care .....	7-67
Tire Maintenance .....	7-41	Interior Care .....	7-73
Tire Sidewall Labeling .....	7-41	<b>Emission Control System .....</b>	<b>7-76</b>
Tire Terminology and Definitions.....	7-45	Crankcase Emission Control System .....	7-76
All Season Tires.....	7-48	Evaporative Emission Control System Including	
Summer Tires .....	7-48	Onboard Refueling Vapor Recovery (ORVR).....	7-76
Snow Tires .....	7-48	Exhaust Emission Control System .....	7-77
Radial-Ply Tires .....	7-48		
Low Aspect Ratio Tires.....	7-49		
<b>Fuses.....</b>	<b>7-50</b>		
Instrument Panel Fuse Replacement.....	7-51		
Engine Compartment Panel Fuse Replacement.....	7-52		
Fuse/Relay Panel Description.....	7-54		
<b>Light Bulbs .....</b>	<b>7-56</b>		
Headlamp, Parking Lamp, Turn Signal Lamp			
and Side Marker .....	7-56		
Daytime Running Light (DRL).....	7-61		
Side Repeater Lamp Replacement.....	7-61		
Rear Combination Light Bulb Replacement.....	7-61		
High Mounted Stop Lamp Replacement.....	7-64		
License Plate Light Bulb Replacement .....	7-65		
Interior Light Bulb Replacement .....	7-65		

## ENGINE COMPARTMENT

### ■ Hybrid vehicle



1. Engine coolant reservoir
2. Engine coolant cap
3. Inverter coolant reservoir
4. Brake fluid reservoir
5. Air cleaner
6. Engine oil dipstick
7. Engine oil filler cap
8. Windshield washer fluid reservoir
9. Fuse box

The actual engine compartment in the vehicle may differ from the illustration.

OAE078001



### ■ Plug-in hybrid vehicle



1. Engine coolant reservoir
2. Engine coolant cap
3. Inverter coolant reservoir
4. Brake fluid reservoir
5. Air cleaner
6. Engine oil dipstick
7. Engine oil filler cap
8. Windshield washer fluid reservoir
9. Fuse box

**The actual engine compartment in the vehicle may differ from the illustration.**

OAEPH078001

## MAINTENANCE SERVICES

You should exercise the utmost care to prevent damage to your vehicle and injury to yourself whenever performing any maintenance or inspection procedures.

We recommend you have your vehicle maintained and repaired by an authorized HYUNDAI dealer. An authorized HYUNDAI dealer meets HYUNDAI's high service quality standards and receives technical support from HYUNDAI in order to provide you with a high level of service satisfaction.

### Owner's Responsibility

Maintenance service and record retention are the owner's responsibility.

You should retain documents that show proper maintenance has been performed on your vehicle in accordance with the scheduled maintenance service charts shown on the following pages. You need this information to establish your compliance with the servicing and maintenance requirements of your vehicle warranties.

Detailed warranty information is provided in your Service Passport.

Repairs and adjustments required as a result of improper maintenance or a lack of required maintenance are not covered.

### Owner Maintenance Precautions

Inadequate, incomplete or insufficient servicing may result in operational problems with your vehicle that could lead to vehicle damage, an accident, or personal injury. This chapter provides instructions only for the maintenance items that are easy to perform. Several procedures can be done only by an authorized HYUNDAI dealer with special tools.

Your vehicle should not be modified in any way. Such modifications may adversely affect the performance, safety or durability of your vehicle and may, in addition, violate conditions of the limited warranties covering the vehicle.

### NOTICE

**Improper owner maintenance during the warranty period may affect warranty coverage. For details, read the separate Service Passport provided with the vehicle. If you're unsure about any service or maintenance procedure, have it done by an authorized HYUNDAI dealer.**

## OWNER MAINTENANCE

### **WARNING**

Performing maintenance work on a vehicle can be dangerous. If you lack sufficient knowledge and experience or the proper tools and equipment to do the work, have it done by an authorized HYUNDAI dealer.

**ALWAYS** follow these precautions for performing maintenance work:

- Park your vehicle on level ground, move the shift lever into the P (Park), apply the parking brake, and place the ignition switch in the LOCK/OFF position.

(Continued)

(Continued)

- **Block the tires (front and back) to prevent the vehicle from moving.**

**Remove loose clothing or jewelry that can become entangled in moving parts.**

- **If you must run the engine during maintenance, do so out doors or in an area with plenty of ventilation.**
- **Keep flames, sparks, or smoking materials away from the battery and fuel-related parts.**

The following lists are vehicle checks and inspections that should be performed by the owner or an authorized HYUNDAI dealer at the frequencies indicated to help ensure safe, dependable operation of your vehicle.

Any adverse conditions should be brought to the attention of your dealer as soon as possible.

These Owner Maintenance vehicle checks are generally not covered by warranties and you may be charged for labor, parts and lubricants used.

## How to Disconnect the (-) Cable for Regular Maintenance (Hybrid vehicle)



When the vehicle is under regular maintenance, make sure to separate the (-) cable before maintenance.

Separate the (-) cable following the below instructions.

1. Fold the rear left side seat.
2. Remove the service cover (A) on the luggage trim.
3. Separate the (-) cable (B).

Reassemble in the reverse order.

## Owner Maintenance Schedule

### *When you stop for fuel:*

- Check the engine oil level.
- Check the coolant level in the engine coolant reservoir.
- Check the windshield washer fluid level.
- Check for low or under-inflated tires.

### **WARNING**

**Be careful when checking your engine coolant/inverter coolant level when the engine is hot. This may result in coolant being blown out of the opening and cause serious burns and other injuries.**

### *While operating your vehicle:*

- Note any changes in the sound of the exhaust or any smell of exhaust fumes in the vehicle.
- Check for vibrations in the steering wheel. Notice if there is any increased steering effort or looseness in the steering wheel, or change in its straight-ahead position.
- Notice if your vehicle constantly turns slightly or "pulls" to one side when traveling on smooth, level road.
- When stopping, listen and check for unusual sounds, pulling to one side, increased brake pedal travel or "hard-to-push" brake pedal.
- If any slipping or changes in the operation of your transmission occurs, check the transmission fluid level.
- Check the dual clutch transmission P (Park) function.
- Check the parking brake.
- Check for fluid leaks under your vehicle (water dripping from the air conditioning system during or after use is normal).

### ***At least monthly:***

- Check coolant level in the engine coolant reservoir.
- Check the operation of all exterior lights, including the brake lights, turn signals and hazard warning flashers.
- Check the inflation pressures of all tires including the spare for tires that are worn, show uneven wear, or are damaged.
- Check for loose wheel lug nuts.

### ***At least twice a year: (i.e., every Spring and Fall)***

- Check radiator, heater and air conditioning hoses for leaks or damage.
- Check windshield washer spray and wiper operation. Clean wiper blades with a clean cloth dampened with washer fluid.
- Check headlamp alignment.
- Check muffler, exhaust pipes, shields and clamps.
- Check the seat belts for wear and function.

### ***At least once a year:***

- Clean body and door drain holes.
- Lubricate door hinges and hood hinges.
- Lubricate door and hood locks and latches.
- Lubricate door rubber weather strips.
- Lubricate door checker.
- Check the air conditioning system.
- Inspect and lubricate transmission linkage and controls.
- Clean the battery and terminals.
- Check the brake fluid level.

## **SCHEDULED MAINTENANCE SERVICES**

Follow Normal Maintenance Schedule if the vehicle is usually operated where none of the following conditions apply. If any of the following conditions apply, you must follow the Maintenance Under Severe Usage Conditions.

- Repeated short distance driving.
- Driving in dusty conditions or sandy areas.
- Extensive use of brakes.
- Driving in areas where salt or other corrosive materials are used.
- Driving on rough or muddy roads.
- Driving in mountainous areas.
- Extended periods of idling or low speed operation.
- Driving for a prolonged period in cold temperatures and/or extremely humid climates.
- More than 50% driving in heavy city traffic during hot weather above 32°C (90°F).

For additional information or assistance see your authorized HYUNDAI dealer.

## Normal Maintenance Schedule

The following maintenance services must be performed to ensure good emission control and performance.

Keep receipts for all vehicle emission services to protect your warranty. Where both mileage and time are shown, the frequency of service is determined by whichever occurs first.

R : Replace or change.

I : Inspect and if necessary, adjust, correct, clean or replace.

No.	MAINTENANCE INTERVALS MAINTENANCE ITEM	Km×1,000	12	24	36	48	60	72	84	96	108	120	132	144	156	168	180	192	204	216	228	240
		Months	6	12	18	24	30	36	42	48	54	60	66	72	78	84	90	96	102	108	114	120
1	HSG belts *1	Inspect every 12,000 km or 12 months Replace every 96,000 km or 48 months																				
2	Engine oil and filter	Replace every 12,000 km or 12 months																				
3	Fuel additives *2	Add every 12,000 km or 12 months																				
4	Air cleaner filter	I	I	I	R	I	I	I	R	I	I	I	R	I	I	I	R	I	I	I	R	
5	Spark plugs	Replace every 168,000 km or 84 months																				
6	Rotate tires	Rotate every 12,000 km or 6 months																				
7	Climate control air filter (for evaporator and blower unit)		R		R		R		R		R		R		R		R		R		R	
8	Engine clutch actuator fluid			R		R			R			R			R			R			R	

\*1 : Inspect HSG belt for evidence of cuts, crocks, excessive wear or oil saturation and replace if necessary. If drive belt noise occurred, readjust drive belt tension before replace.

\*2 : If TOP TIER Detergent Gasoline is not available, one bottle of additive is recommended. Additives are available from your authorized HYUNDAI dealer along with information on how to use them. Do not mix other additives.

## Normal Maintenance Schedule (CONT.)

R : Replace or change.

I : Inspect and if necessary, adjust, correct, clean or replace.

No.	MAINTENANCE INTERVALS	Km×1,000	12	24	36	48	60	72	84	96	108	120	132	144	156	168	180	192	204	216	228	240	
			Months	6	12	18	24	30	36	42	48	54	60	66	72	78	84	90	96	102	108	114	120
9	Vacuum hose		I	I	I	I	I	I	I	I	I	I	I	I	I	I	I	I	I	I	I	I	I
10	Engine Coolant/Inverter coolant		At first, replace at 192,000 km or 120 months; after that, replace every 48,000 km or 24 months																				
11	Battery condition		I	I	I	I	I	I	I	I	I	I	I	I	I	I	I	I	I	I	I	I	I
12	All latch, hinges and locks			I		I		I		I		I		I		I		I		I		I	
13	Clutch (if equipped) and brake pedal free play		I	I	I	I	I	I	I	I	I	I	I	I	I	I	I	I	I	I	I	I	I
14	Engine clutch actuator hoses and lines			I		I		I		I		I		I		I		I		I		I	
15	Brake hose/Lines and Connections (including booster)			I		I		I		I		I		I		I		I		I		I	

## Normal Maintenance Schedule (CONT.)

R : Replace or change.

I : Inspect and if necessary, adjust, correct, clean or replace.

No.	MAINTENANCE INTERVALS	Km×1,000	12	24	36	48	60	72	84	96	108	120	132	144	156	168	180	192	204	216	228	240	
			Months	6	12	18	24	30	36	42	48	54	60	66	72	78	84	90	96	102	108	114	120
16	Front disc brake/pads, calipers			I		I		I		I		I		I		I		I		I		I	
17	Rear brake disc/pads			I		I		I		I		I		I		I		I		I		I	
18	Steering gear box, linkage & boots/ lower arm ball joint, upper arm ball joint			I		I		I		I		I		I		I		I		I		I	
19	Drive shafts and boots			I		I		I		I		I		I		I		I		I		I	
20	Suspension mounting bolts			I		I		I		I		I		I		I		I		I		I	
21	Cooling system hoses and connections		I	I	I	I	I	I	I	I	I	I	I	I	I	I	I	I	I	I	I	I	I
22	Air conditioning refrigerant			I		I		I		I		I		I		I		I		I		I	
23	Exhaust pipe and muffler			I		I		I		I		I		I		I		I		I		I	



### Normal Maintenance Schedule (CONT.)

R : Replace or change.

I : Inspect and if necessary, adjust, correct, clean or replace.

No.	MAINTENANCE INTERVALS	Km×1,000	12	24	36	48	60	72	84	96	108	120	132	144	156	168	180	192	204	216	228	240	
		Months	6	12	18	24	30	36	42	48	54	60	66	72	78	84	90	96	102	108	114	120	
24	Dual clutch transmission fluid						I					I					I						I
25	Fuel tank air filter * <sup>3</sup>					I				I				I				I					I
26	Fuel filter * <sup>3</sup>					I				I				I				I					I
27	Fuel tank, fuel filler cap, canister, vapor hose, fuel line, fuel hoses and connections of each part					I				I				I				I					I
28	Parking brake					I				I				I				I					I
29	Brake fluid					I				I				I				I					I

\*<sup>3</sup> : Fuel filter & Fuel tank air filter are considered to be maintenance free but periodic inspection is recommended for this maintenance schedule depends on fuel quality. If there are some important safety matters like fuel flow restriction, surging, loss of power, hard starting problem etc, replace the fuel filter immediately regardless of maintenance schedule and consult an authorized HYUNDAI dealer for details.

#### NOTICE

**After 120 months or 240,000 km (150,000 miles) continue to follow the prescribed maintenance intervals.**

## Maintenance Under Severe Usage Conditions

The following items must be serviced more frequently on cars normally used under severe driving conditions. Refer to the chart below for the appropriate maintenance intervals.

R : Replace or change. I : Inspect and if necessary, adjust, correct, clean or replace.

Maintenance item	Maintenance operation	Maintenance intervals	Driving condition
HSG (Hybrid Starter&Generator) belt	R	Every 48,000 km or 24 months	C, D, E, L
	I	Every 6,000 km or 6 months	
Engine oil and filter	R	Every 6,000 km or 6 months	A, B, C, D, E, F, G, H, I, K
Air cleaner filter	R	More frequently	C, E
Spark plugs	R	More frequently	B, H
Dual clutch transmission fluid	R	Every 120,000 km	C, D, E, F, G, H, I, J
Front brake disc/pads, calipers	I	More frequently	C, D, G, H
Rear brake disc/pads	I	More frequently	C, D, G, F
Parking brake	I	More frequently	C, D, G, H

Maintenance item	Maintenance operation	Maintenance intervals	Driving condition
Steering gear box, linkage & boots/lower arm ball joint, upper arm ball joint	I	More frequently	C, D, E, F, G, H, I
Drive shafts and boots	I	Every 12,000 km or 6 months	C, D, E, F, G, H, I, J
Climate control air filter (for evaporator and blower unit)	R	More frequently	C, E

### Severe Driving Conditions

- A - Repeatedly driving short distance of less than 8 km in normal temperature or less than 16 km in freezing temperature
- B - Extensive engine idling or low speed driving for long distances
- C - Driving on rough, dusty, muddy, unpaved, graveled or salt-spread roads
- D - Driving in areas using salt or other corrosive materials or in very cold weather
- E - Driving in sandy areas
- F - Driving in heavy traffic area over 32°C (90°F)
- G - Driving on uphill, downhill, or mountain road
- H - Towing a trailer, or using a camper, or roof rack
- I - Driving as a patrol car, taxi, other commercial use or vehicle towing
- J - Driving over 170 km/h (106 mph)
- K - Frequently driving in stop-and-go conditions

## EXPLANATION OF SCHEDULED MAINTENANCE ITEMS

### Engine Oil and Filter

The engine oil and filter should be changed at the intervals specified in the maintenance schedule. If the vehicle is being driven in severe conditions, more frequent oil and filter changes are required.

### Fuel Filter

A clogged-up fuel filter may limit the vehicle driving speed, damage the emission system, and cause the hard starting. When a considerable amount of foreign substances are accumulated in the fuel tank, the fuel filter should be replaced.

Upon installing a new fuel filter, operate the engine for several minutes, and check the connections for any leakages. Fuel filters should be installed by an authorized HYUNDAI dealer.

### Fuel Lines, Fuel Hoses and Connections

Check the fuel lines, fuel hoses and connections for leakage and damage. Have an authorized HYUNDAI dealer replace any damaged or leaking parts immediately.

### Vapor Hose and Fuel Filler Cap

The vapor hose and fuel filler cap should be inspected at those intervals specified in the maintenance schedule. Make sure a new vapor hose or fuel filler cap is correctly replaced.

### HSG (Hybrid Starter & Generator) Belt

The HSG belt should be changed at the intervals specified in the maintenance schedule.

### Air Cleaner Filter

A genuine HYUNDAI air cleaner filter is recommended when the filter is replaced.

### Spark Plugs

Make sure to install new spark plugs of the correct heat range.

### Cooling System

Check cooling system components, such as radiator, coolant reservoir, hoses and connections for leakage and damage. Replace any damaged parts.

### Engine Coolant / Inverter Coolant

The coolant should be changed at the intervals specified in the maintenance schedule.

### Dual Clutch Transmission Fluid

The dual clutch transmission fluid should be inspected according to the intervals specified in the maintenance schedule.

### Engine Clutch Actuator Fluid

The engine clutch actuator fluid level should be inspected or replaced to the intervals specified in the maintenance schedule.

### Brake Hoses and Lines

Visually check for proper installation, chafing, cracks, deterioration and any leakage. Replace any deteriorated or damaged parts immediately.

### Brake Fluid

Check the brake fluid level in the brake the fluid reservoir. The level should be between the MIN and the MAX marks on the side of the reservoir. Use only hydraulic brake fluid conforming to DOT 4 specification.

### Parking Brake

Inspect the parking brake system including the parking brake pedal and cables.

### Brake Discs, Pads, Calipers and Rotors

Check the pads for excessive wear, discs for run out and wear, and calipers for fluid leakage.

### Exhaust Pipe and Muffler

Visually inspect the exhaust pipes, muffler and hangers for cracks, deterioration, or damage. Start the engine and listen carefully for any exhaust gas leakage. Tighten connections or replace parts as necessary.

### Suspension Mounting Bolts

Check the suspension connections for looseness or damage. Retighten to the specified torque.

### Steering Gear Box, Linkage & Boots / Lower Arm Ball Joint

With the vehicle stopped and the engine off, check for excessive free-play in the steering wheel. Check the linkage for bends or damage. Check the dust boots and ball joints for deterioration, cracks, or damage.

Replace any damaged parts.

### Drive Shafts and Boots

Check the drive shafts, boots and clamps for cracks, deterioration, or damage. Replace any damaged parts and, if necessary, repack the grease.

### Air Conditioning Refrigerant

Check the air conditioning lines and connections for leakage and damage.

## ENGINE OIL

### Checking the Engine Oil Level

1. Follow all of the oil manufacturer's precautions.
2. Be sure the vehicle is on the level ground in P (Park) with the parking brake set. If possible, block the wheels.
3. Turn the engine on and allow the engine to reach normal operating temperature.
4. Turn the engine off and wait about five minutes for the oil to return to the oil pan.
5. Pull the dipstick out, wipe it clean, and re-insert it fully.

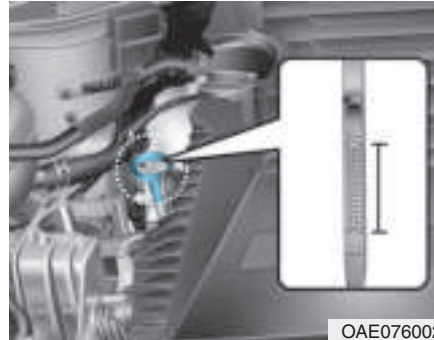

6. Pull the dipstick out again and check the level. The level should be between F (Full) and L (Low).
7. If it is near or at L, add enough oil to bring the level to F.



#### **NOTICE**

**To prevent damage to your engine:**

- **Do not overfill with engine oil. Add oil in small quantities and recheck level to ensure engine is not overfilled.**
- **Do not spill engine oil when adding or changing engine oil. Use a funnel to help prevent oil from being spilled on engine components. Wipe off spilled oil immediately.**

### **i** Information

Use only the specified engine oil (refer to "Recommended Lubricants and Capacities" in chapter 8).

#### **⚠** WARNING



The electric motor for the cooling fan may continue to operate or start up when the engine is not running and can cause serious injury. Keep hands, clothing and tools away from the rotating fan blades of the cooling fan.

### Checking the Engine Oil and Filter



Have engine oil and filter changed by an authorized HYUNDAI dealer according to the Maintenance Schedule at the beginning of this chapter.

## ENGINE COOLANT/INVERTER COOLANT

The high-pressure cooling system has a reservoir filled with year-round antifreeze coolant. The reservoir is filled at the factory.

Check the antifreeze protection and coolant level at least once a year, at the beginning of the winter season and before traveling to a colder climate.

### Checking the Coolant Level

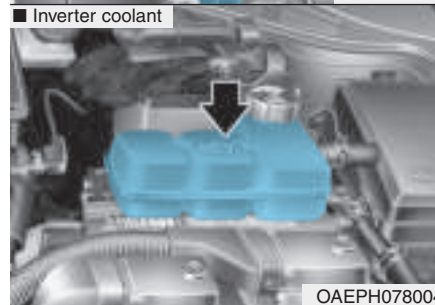
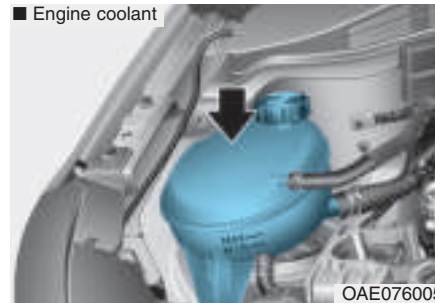

Check the condition and connections of all cooling system hoses and heater hoses. Replace any swollen or deteriorated hoses.

The coolant level should be filled between the MAX and the MIN marks on the side of the coolant reservoir when the engine is cool.

If the coolant level is low, add enough distilled (deionized) water to bring the level to the MAX mark, but do not overfill. If frequent additions are required, see an authorized HYUNDAI dealer for a cooling system inspection.



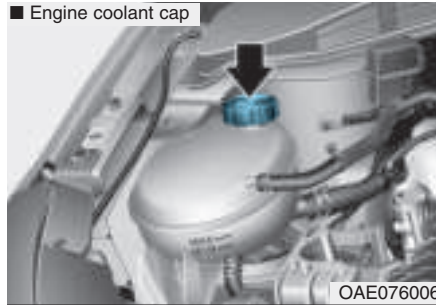

### WARNING



Never remove the engine coolant cap and/or inverter coolant cap or the drain plug while the engine and radiator are hot. Hot coolant and steam may blow out under pressure, causing serious injury.

Turn the hybrid system off and wait until the engine cools down. Use extreme care when removing the engine coolant cap and/or inverter coolant cap. Wrap a thick towel around it, and turn it counterclockwise slowly to the first stop. Step back while the pressure is released from the cooling system. When you are sure all the pressure has been released, press down on the cap, using a thick towel, and continue turning counterclockwise to remove it.

### Information

The engine coolant and/or inverter coolant level is influenced by the hybrid system temperature. Before checking or refilling the engine coolant and/or inverter coolant, turn the hybrid vehicle off.

### WARNING



The electric motor for the cooling fan may continue to operate or start up when the engine is not running and can cause serious injury. Keep hands, clothing and tools away from the rotating fan blades of the cooling fan.

Always turn off the engine unless the vehicle has to be inspected with the engine on. Be cautious as the cooling fan may operate if the negative (-) battery terminal is not disconnected.

## WARNING

Make sure the coolant cap is properly closed after refilling coolant. Otherwise the engine could be overheated while driving.

■ Engine room front view

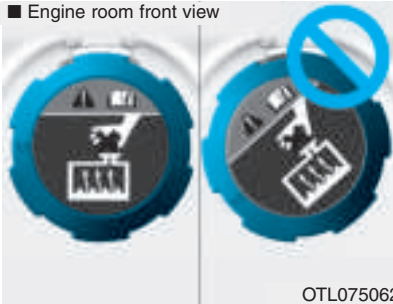

OTL075062

1. Check if the coolant cap label is straight in front.

(Continued)

(Continued)

■ Engine compartment rear view

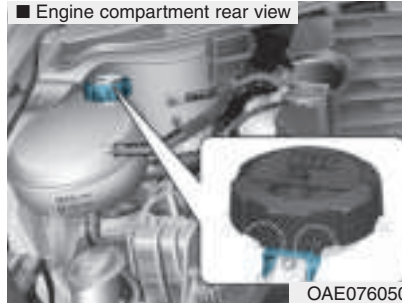

OAE076050

2. Make sure that the tiny protrusions inside the coolant cap is securely interlocked.

### **Recommended coolant**

- When adding coolant, use only distilled (deionized) water for your vehicle and never mix hard water in the coolant filled at the factory.
- An improper coolant mixture can result in severe malfunction or engine/ hybrid system damage.
- The engine in your vehicle has aluminum engine parts and must be protected by a phosphate-based ethylene glycol coolant to prevent corrosion and freezing.
- Do not use alcohol or methanol coolant or mix them with the specified coolant.
- Do not use a solution that contains more than 60% antifreeze or less than 35% antifreeze, which would reduce the effectiveness of the solution.

For mixing percentage, refer to the following table:

Ambient Temperature	Mixture Percentage (volume)	
	Antifreeze	Water
-15°C (5°F)	35	65
-25°C (-13°F)	40	60
-35°C (-31°F)	50	50
-45°C (-49°F)	60	40

### **i** Information

If in doubt about the mix ratio, a 50% water and 50% antifreeze mix is the easiest to mix together as it will be the same quantity of each. It is suitable to use for most temperature ranges of -35 °C (-31°F) and higher.

### Changing Coolant

Have coolant changed by an authorized HYUNDAI dealer according to the Maintenance Schedule at the beginning of this chapter.

#### WARNING

**Do not use engine coolant or antifreeze in the washer fluid reservoir.**

**Engine coolant can severely obscure visibility when sprayed on the windshield and may cause loss of vehicle control resulting in an accident.**

**Engine coolant may also cause damage to paint and body trim.**

#### **NOTICE**

To prevent damage to engine parts, put a thick towel around the radiator cap before refilling the coolant to prevent the coolant from overflowing into engine parts, such as the alternator.

## HYBRID STARTER & GENERATOR (HSG) BELT

### Checking the Hybrid Starter & Generator (HSG) Belt

Have the hybrid starter & generator (HSG) belt inspected or replaced according to the Maintenance Schedule in this chapter by an authorized HYUNDAI dealer.

#### CAUTION

**When the HSG belt is worn out or damaged, replace the belt. Otherwise, it may cause engine overheating or battery discharge.**

#### WARNING

- Turn the vehicle off while you inspect the engine or hybrid starter & generator (HSG) belt. Otherwise it may result in serious injury.
- Keep hands, clothing etc. away from the hybrid starter & generator (HSG) belt.

## BRAKE FLUID

### Checking the Brake Fluid Level

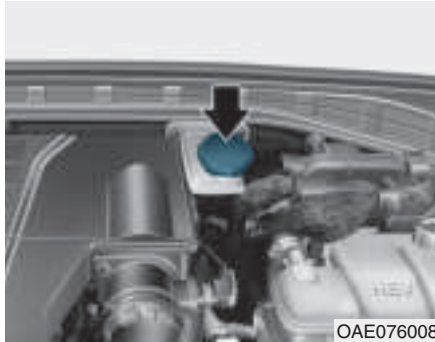

Check the fluid level in the reservoir periodically. The fluid level should be between MAX and MIN marks on the side of the reservoir.

Before removing the reservoir cap and adding brake fluid, clean the area around the reservoir cap thoroughly to prevent brake fluid contamination.

If the level is low, add the specified brake fluid to the MAX level. The level will fall with accumulated mileage. This is a normal condition associated with the wear of the brake linings. If the fluid level is excessively low, have the brake system checked by an authorized HYUNDAI dealer.

#### WARNING

**If the brake system requires frequent additions of fluid this could indicate a leak in the brake system. Have the vehicle inspected by an authorized HYUNDAI dealer.**

#### WARNING

**Do not allow brake fluid to come in contact with your eyes. If brake fluid comes in contact with your eyes, flush your eyes with clean water for at least 15 minutes and get immediate medical attention.**

#### NOTICE

- **Do not allow brake fluid to contact the vehicle's body paint, as paint damage will result.**
- **Brake fluid, which has been exposed to open air for an extended time should NEVER be used as its quality cannot be guaranteed. It should be disposed of properly.**
- **Do not use the wrong kind of brake fluid. A few drops of mineral based oil, such as engine oil, in your brake system can damage brake system parts.**

#### Information

Use only the specified brake fluid (refer to "Recommended Lubricants and Capacities" in chapter 8).

## WASHER FLUID

### Checking the Washer Fluid Level



Check the fluid level in the washer fluid reservoir and add fluid if necessary. Plain water may be used if washer fluid is not available. However, use washer solvent with antifreeze characteristics in cold climates to prevent freezing.

### WARNING

To prevent serious injury or death, take the following safety precautions when using washer fluid:

- Do not use engine coolant or antifreeze in the washer fluid reservoir.  
Engine coolant can severely obscure visibility when sprayed on the windshield and may cause loss of vehicle control resulting in an accident or damage to paint and body trim.
- Do not allow sparks or flames to contact the washer fluid or the washer fluid reservoir. Washer fluid may contain alcohol and can be flammable.
- Do not drink washer fluid and avoid contact with skin. Washer fluid is harmful to humans and animals.
- Keep washer fluid away from children and animals.

## PARKING BRAKE

### Checking the Parking Brake



Check whether the stroke is within specification when the parking brake pedal is depressed with 20 kg (44 lb, 196 N) of force. Also, the parking brake alone should securely hold the vehicle on a fairly steep grade. If the stroke is more or less than specified, have the parking brake adjusted by an authorized HYUNDAI dealer.

**Stroke : 4~5 notch**

## AIR CLEANER

### Filter Replacement

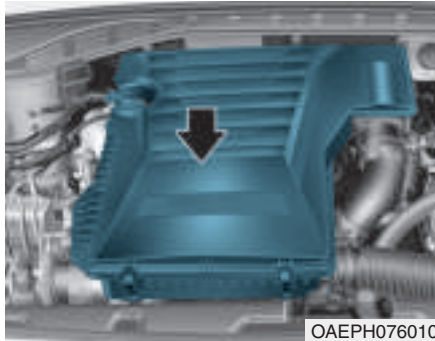

Do not attempt to wash or to rinse it, as water will damage the filter.

If soiled, the air cleaner filter must be replaced.

Replace the filter according to the Maintenance Schedule.



1. Loosen the air cleaner cover attaching clips and open the cover.

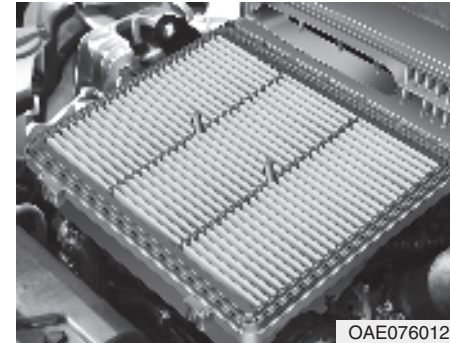

2. Wipe the inside of the air cleaner.
3. Replace the air cleaner filter.
4. Lock the cover with the cover attaching clips.
5. Check that the cover is firmly installed.

### **i** Information

If the vehicle is operated in extremely dusty or sandy areas, replace the element more often than the usual recommended intervals (refer to "Maintenance Under Severe Usage Conditions" in this chapter).

#### **NOTICE**

- Do not drive with the air cleaner filter removed. This will result in excessive engine wear.
- When removing the air cleaner filter, be careful that dust or dirt does not enter the air intake, or damage may result.
- Use HYUNDAI genuine parts. Use of non-genuine parts could damage the air flow sensor.

## CLIMATE CONTROL AIR FILTER

### Filter inspection

The climate control air filter should be replaced according to the Maintenance Schedule. If the vehicle is operated in severely air-polluted cities or on dusty rough roads for a long period, it should be inspected more frequently and replaced sooner. Replace the climate control air filter by following the procedure below and be careful to avoid damaging other components.



1. With the glove box open, remove the stoppers on both sides to allow the glove box to hang freely on the hinges.



2. Remove the support rod (1).





3. Press and hold the lock (1) on both sides of the cover.
4. Pull out (2) the cover.

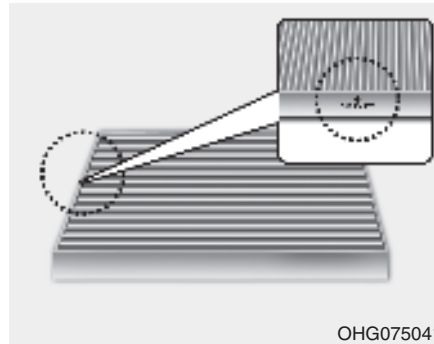

5. Replace the climate control air filter.
6. Reassemble in the reverse order of disassembly.

### **NOTICE**

**Install a new climate control air filter in the correct direction with the arrow symbol (↓) facing downwards to prevent noise and reduced effectiveness.**

## WIPER BLADES

### Blade inspection

Contamination of either the windshield or the wiper blades with foreign matter can reduce the effectiveness of the windshield wipers.

Common sources of contamination are insects, tree sap, and hot wax treatments used by some commercial car washes. If the blades are not wiping properly, clean both the window and the blades with a good cleaner or mild detergent, and rinse thoroughly with clean water.

#### NOTICE

**To prevent damage to the wiper blades, arms or other components, do not:**

- Use gasoline, kerosene, paint thinner, or other solvents on or near them.
- Attempt to move the wipers manually.
- Use non-specified wiper blades.

#### **i** Information

Commercial hot waxes applied by automatic car washes have been known to make the windshield difficult to clean.

### Blade Replacement

When the wipers no longer clean adequately, the blades may be worn or cracked, and require replacement.

#### NOTICE

- In order to prevent damage to the hood and the wiper arms, the wiper arms should only be lifted when in the top wiping position.
- Always return the wiper arms to the windshield before driving.

**Type A**



1. Raise the wiper arm and slightly rotate the wiper blade assembly to expose the plastic locking clip.

**NOTICE**

**Do not allow the wiper arm to fall against the windshield, since it may chip or crack the windshield.**

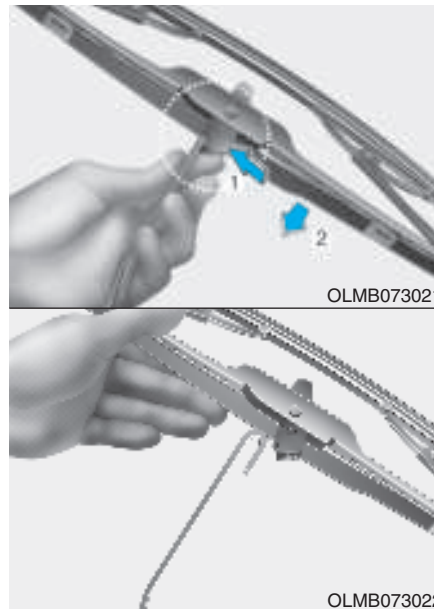

2. Press the clip (1) and slide the blade assembly downward (2).
3. Lift it off the arm.
4. Install the blade assembly in the reverse order of removal.
5. Return the wiper arm on the windshield.

**Type B**



1. Raise the wiper arm.

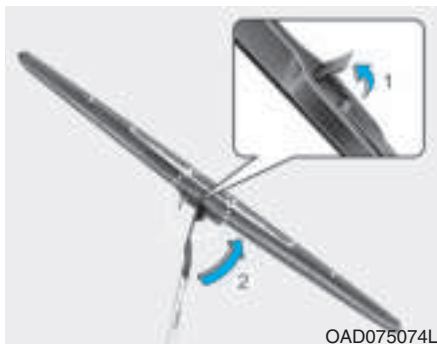

2. Lift up the wiper blade clip (1). Then lift up the wiper blade (2).



3. While pushing the lock (3), pull down the wiper blade (4).



4. Remove the wiper blade from the wiper arm (5).  
5. Install a new wiper blade assembly in the reverse order of removal.  
6. Return the wiper arm on the windshield.

## BATTERY (12 VOLT, PLUG-IN HYBRID VEHICLE)

### WARNING

To prevent **SERIOUS INJURY** or **DEATH** to you or bystanders, always follow these precautions when working near or handling the battery:



Always read and follow instructions carefully when handling a battery.



Wear eye protection designed to protect the eyes from acid splashes.



Keep all flames, sparks, or smoking materials away from the battery.



Hydrogen is always present in battery cells, is highly combustible, and may explode if ignited.



Keep batteries out of reach of children.

(Continued)

(Continued)



Batteries contain sulfuric acid which is highly corrosive. Do not allow acid to contact your eyes, skin or clothing.

If acid gets into your eyes, flush your eyes with clean water for at least 15 minutes and get immediate medical attention. If acid gets on your skin, thoroughly wash the area. If you feel pain or a burning sensation, get medical attention immediately.

- When lifting a plastic-cased battery, excessive pressure on the case may cause battery acid to leak. Lift with a battery carrier or with your hands on opposite corners.
- Do not attempt to jump start your vehicle if your battery is frozen.

(Continued)

(Continued)

- **NEVER** attempt to recharge the battery when the vehicle's battery cables are connected to the battery.
- The electrical ignition system works with high voltage. **NEVER** touch these components with the engine running or when the Engine Start/Stop button is in the ON position.

### NOTICE

- When you do not use the vehicle for a long time in a low temperature area, disconnect the battery and keep it indoors.
- Always charge the battery fully to prevent battery case damage in low temperature areas.

## For Best Battery Service



- Keep the battery securely mounted.
- Keep the battery top clean and dry.
- Keep the terminals and connections clean, tight, and coated with petroleum jelly or terminal grease.
- Rinse any spilled acid from the battery immediately with a solution of water and baking soda.

## Battery Recharging

### **WARNING**

Always follow these instructions when recharging your vehicle's battery to avoid the risk of **SERIOUS INJURY** or **DEATH** from explosions or acid burns:

- Before performing maintenance or recharging the battery, turn off all accessories and place the Engine Start/Stop button in the OFF position.
- Keep all flames, sparks, or smoking materials away from the battery.
- Always work outdoors or in an area with plenty of ventilation.
- Wear eye protection when checking the battery during charging.
- The battery must be removed from the vehicle and placed in a well ventilated area.

(Continued)

(Continued)

- Watch the battery during charging, and stop or reduce the charging rate if the battery cells begin boiling violently.
- The negative battery cable must be removed first and installed last when the battery is disconnected. Disconnect the battery charger in the following order:
  - (1) Turn off the battery charger main switch.
  - (2) Unhook the negative clamp from the negative battery terminal.
  - (3) Unhook the positive clamp from the positive battery terminal.
- Always use a genuine HYUNDAI approved battery when you replace the battery.

### ***By jump starting***

After a jump start from a good battery, drive the vehicle for 20-30 minutes before it is shutoff. The vehicle may not restart if you shut it off before the battery had a chance to adequately recharge. See "Jump Starting" in chapter 6 for more information on jump starting procedures.

### ***i* Information**



**An inappropriately disposed battery can be harmful to the environment and human health. Dispose of the battery according to your local law(s) or regulations.**

### **Reset Features**

The following items may need to be reset after the battery has been discharged or the battery has been disconnected. See chapter 3 or 4 for:

- Power Windows
- Trip Computer
- Climate Control System
- Clock
- Audio System
- Sunroof
- Driver Position Memory System

## TIRES AND WHEELS

### WARNING

Tire failure may cause loss of vehicle control resulting in an accident. To reduce risk of **SERIOUS INJURY** or **DEATH**, take the following precautions:

- Inspect your tires monthly for proper inflation as well as wear and damage.
- The recommended cold tire pressure for your vehicle can be found in this manual and on the tire label located on the driver's side center pillar. Always use a tire pressure gauge to measure tire pressure. Tires with too much or too little pressure wear unevenly causing poor handling.
- Check the pressure of the spare every time you check the pressure of the other tires on your vehicle.

(Continued)

(Continued)

- Replace tires that are worn, show uneven wear, or are damaged. Worn tires can cause loss of braking effectiveness, steering control, or traction.
- **ALWAYS** replace tires with the same size as each tire that was originally supplied with this vehicle. Using tires and wheels other than the recommended sizes could cause unusual handling characteristics, poor vehicle control, or negatively affect your vehicle's Anti-Lock Brake System (ABS) resulting in a serious accident.

### Tire Care

For proper maintenance, safety, and maximum fuel economy, you must always maintain recommended tire inflation pressures and stay within the load limits and weight distribution recommended for your vehicle.





All specifications (sizes and pressures) can be found on a label attached to the driver's side center pillar.

### Recommended Cold Tire Inflation Pressures

All tire pressures (including the spare) should be checked when the tires are cold. "Cold tires" means the vehicle has not been driven for at least three hours or has been driven less than 1.6 km (one mile).

Warm tires normally exceed recommended cold tire pressures by 28 to 41 kPa (4 to 6 psi). Do not release air from warm tires to adjust the pressure or the tires will be under-inflated. For recommended inflation pressure, refer to "Tire and Wheels" in chapter 8.

### WARNING

**Recommended pressures must be maintained for the best ride, vehicle handling, and minimum tire wear.**

**Over-inflation or under-inflation can reduce tire life, adversely affect vehicle handling, and lead to sudden tire failure that could result in loss of vehicle control resulting in an accident.**

**Severe under-inflation can lead to severe heat build-up, causing blowouts, tread separation and other tire failures that can result in the loss of vehicle control resulting in an accident. This risk is much higher on hot days and when driving for long periods at high speeds.**

## CAUTION

- **Under-inflation results in excessive wear, poor handling and reduced fuel economy. Wheel deformation is also possible. Keep your tire pressures at the proper levels. If a tire frequently needs refilling, have it checked by an authorized HYUNDAI dealer.**
- **Over-inflation produces a harsh ride, excessive wear at the center of the tire tread, and a greater possibility of damage from road hazards.**

## Check Tire Inflation Pressure

Check your tires, including the spare tire, once a month or more.

### *How to check*

Use a good quality tire pressure gauge to check tire pressure. You can not tell if your tires are properly inflated simply by looking at them. Radial tires may look properly inflated when they are under-inflated.

Remove the valve cap from the tire valve stem. Press the tire gauge firmly onto the valve to get a pressure measurement. If the cold tire inflation pressure matches the recommended pressure on the tire label located on the driver's side center pillar or in this manual. No further adjustment is necessary. If the pressure is low, add air until you reach the recommended pressure. Make sure to put the valve caps back on the valve stems. Without the valve cap, dirt or moisture could get into the valve core and cause air leakage. If a valve cap is missing, install a new one as soon as possible.

If you overfill the tire, release air by pushing on the metal stem in the center of the tire valve. Recheck the tire pressure with the tire gauge. Be sure to put the valve caps back on the valve stems. Without the valve cap, dirt or moisture could get into the valve core and cause air leakage. If a valve cap is missing, install a new one as soon as possible.

A cold tire means the vehicle has been sitting for 3 hours and driven for less than 1.6 km (1 mile) in that 3 hour period.

Allow the tire to cool before measuring the inflation pressure. Always be sure the tire is cold before inflating to the recommended pressure.

### Tire Rotation

To equalize tread wear, HYUNDAI recommends that the tires be rotated every 12,000 km (7,500 miles) or sooner if irregular wear develops.

During rotation, check the tires for correct balance.

When rotating tires, check for uneven wear and damage. Abnormal wear is usually caused by incorrect tire pressure, improper wheel alignment, out-of-balance wheels, severe braking or severe cornering. Look for bumps or bulges in the tread or side of the tire. Replace the tire if you find any of these conditions. Replace the tire if fabric or cord is visible. After rotation, be sure to bring the front and rear tire pressures to specification and check lug nut tightness (proper torque is 11~13 kgf·m [79~94 lbf·ft]).

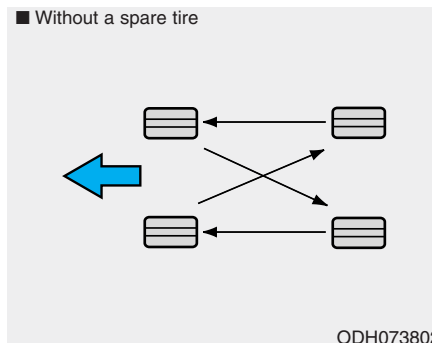

Disc brake pads should be inspected for wear whenever tires are rotated.

### Information

Tires that are asymmetrical or directional can only be installed on the wheel in one direction. The outside and inside of an asymmetrical tire is not easily distinguishable. Pay careful attention to the markings on the sidewalls of the tires, noting the "outside" marking and also the rotating direction before installing them on the vehicle.

### WARNING

- Do not use the compact spare tire for tire rotation.
- Do not mix bias ply and radial ply tires under any circumstances. This may cause unusual handling characteristics that may cause loss of vehicle control resulting in an accident.

## Wheel Alignment and Tire Balance

The wheels on your vehicle were aligned and balanced carefully at the factory to give you the longest tire life and best overall performance.

In most cases, you will not need to have your wheels aligned again. However, if you notice unusual tire wear or your vehicle pulling one way or the other, the alignment may need to be reset.

If you notice your vehicle vibrating when driving on a smooth road, your wheels may need to be rebalanced.

### NOTICE

**Improper wheel weights can damage your vehicle's aluminum wheels. Use only approved wheel weights.**

## Tire Replacement



If the tire is worn evenly, a tread wear indicator will appear as a solid band across the tread. This shows there is less than 1.6 mm (1/16 inch) of tread left on the tire. Replace the tire when this happens.

Do not wait for the tread surface to become level with the tread wear indicators before replacing the tire.

## ⚠ WARNING

**To reduce the risk of DEATH or SERIOUS INJURY:**

- Replace tires that are worn, show uneven wear, or are damaged. Worn tires can cause loss of braking effectiveness, steering control, and traction.
- Always use tires of the same type, size, brand, construction and tread pattern all four wheels. Using tires and wheels other than the recommended sizes could cause unusual handling characteristics, poor vehicle control, or negatively affect your vehicle's Anti-Lock Brake System (ABS) resulting in a serious accident.

**(Continued)**

### (Continued)

- **Tires degrade over time, even when they are not being used. Regardless of the remaining tread, HYUNDAI recommends that tires be replaced after six (6) years of normal service.**
- **When replacing tires (or wheels), it is recommended to replace the two front or two rear tires (or wheels) as a pair. Replacing just one tire can seriously affect your vehicle's handling. If only replacing one pair of tires, it is recommended to install the pair of new tires on the rear axle.**
- **Heat caused by hot climates or frequent high loading conditions can accelerate the aging process. Failure to follow this warning may cause sudden tire failure, which could lead to a loss of vehicle control resulting in an accident.**

### ***Compact spare tire replacement (if equipped)***

A compact spare tire has a shorter tread life than a regular size tire. Replace it when you can see the tread wear indicator bars on the tire. The replacement compact spare tire should be the same size and design tire as the one provided with your new vehicle and should be mounted on the same compact spare tire wheel. The compact spare tire is not designed to be mounted on a regular size wheel, and the compact spare tire wheel is not designed for mounting a regular size tire.

### **WARNING**

**The original tire should be repaired or replaced as soon as possible to avoid failure of the spare and loss of vehicle control resulting in an accident. The compact spare tire is for emergency use only. Do not operate your vehicle over 80 km/h (50 mph) when using the compact spare tire.**

### **Wheel Replacement**

When replacing the metal wheels for any reason, make sure the new wheels are equivalent to the original factory units in diameter, rim width and offset.

### **Tire Traction**

Tire traction can be reduced if you drive on worn tires, tires that are improperly inflated or on slippery road surfaces. Tires should be replaced when the tread depth is at least 1.6 mm (1/16 inch). To reduce the possibility of losing control, slow down whenever there is rain, snow or ice on the road.

## Tire Maintenance

In addition to proper inflation, correct wheel alignment helps to decrease tire wear. If you find a tire is worn unevenly, have your dealer check the wheel alignment.

When you have new tires installed, make sure they are balanced. This will increase vehicle ride comfort and tire life. Additionally, a tire should always be rebalanced if it is removed from the wheel.

## Tire Sidewall Labeling

This information identifies and describes the fundamental characteristics of the tire and also provides the tire identification number (TIN) for safety standard certification. The TIN can be used to identify the tire in case of a recall.

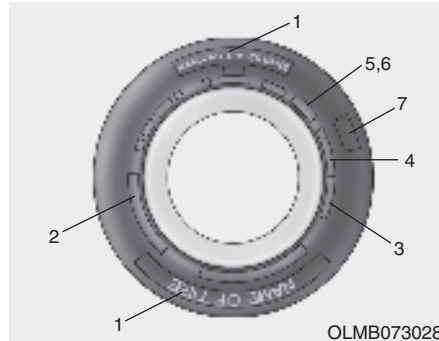

### 1. Manufacturer or brand name

Manufacturer or brand name is shown.

### 2. Tire size designation

A tire's sidewall is marked with a tire size designation. You will need this information when selecting replacement tires for your car. The following explains what the letters and numbers in the tire size designation mean.

Example tire size designation:

(These numbers are provided as an example only; your tire size designator could vary depending on your vehicle.)

**195/65R15 91H**

195 - Tire width in millimeters.

65 - Aspect ratio. The tire's section height as a percentage of its width.

R - Tire construction code (Radial).

15 - Rim diameter in inches.

91 - Load Index, a numerical code associated with the maximum load the tire can carry.

H - Speed Rating Symbol. See the speed rating chart in this section for additional information.

### Wheel size designation

Wheels are also marked with important information that you need if you ever have to replace one. The following explains what the letters and numbers in the wheel size designation mean.

Example wheel size designation:

#### **6.5J X 15**

6.5 - Rim width in inches.

J - Rim contour designation.

15 - Rim diameter in inches.

### Tire speed ratings

The chart below lists many of the different speed ratings currently being used for passenger vehicle tires. The speed rating is part of the tire size designation on the sidewall of the tire. This symbol corresponds to that tire's designed maximum safe operating speed.

Speed Rating Symbol	Maximum Speed
S	180 km/h (112 mph)
T	190 km/h (118 mph)
H	210 km/h (130 mph)
V	240 km/h (149 mph)
W	270 km/h (168 mph)
Y	300 km/h (186 mph)

### **3. Checking tire life (TIN : Tire Identification Number)**

Any tires that are over six years old, based on the manufacturing date, (including the spare tire) should be replaced by new ones. You can find the manufacturing date on the tire sidewall (possibly on the inside of the wheel), displaying the DOT Code. The DOT Code is a series of numbers on a tire consisting of numbers and English letters. The manufacturing date is designated by the last four digits (characters) of the DOT code.

**DOT : XXXX XXXX OOOO**

The front part of the DOT shows a plant code number, tire size and tread pattern and the last four numbers indicate week and year manufactured.

For example:

DOT XXXX XXXX 1419 represents that the tire was produced in the 14th week of 2019.

#### **4. Tire ply composition and material**

The number of layers or plies of rubber-coated fabric in the tire. Tire manufacturers also must indicate the materials in the tire, which include steel, nylon, polyester, and others. The letter "R" means radial ply construction; the letter "D" means diagonal or bias ply construction; and the letter "B" means belted-bias ply construction.

#### **5. Maximum permissible inflation pressure**

This number is the greatest amount of air pressure that should be put in the tire. Do not exceed the maximum permissible inflation pressure. Refer to the Tire and Loading Information label for recommended inflation pressure.

#### **6. Maximum load rating**

This number indicates the maximum load in kilograms and pounds that can be carried by the tire. When replacing the tires on the vehicle, always use a tire that has the same load rating as the factory installed tire.

#### **7. Uniform tire quality grading**

Quality grades can be found where applicable on the tire sidewall between tread shoulder and maximum section width.

For example:

TREADWEAR 200  
TRACTION AA  
TEMPERATURE A

#### **Tread wear**

The tread wear grade is a comparative rating based on the wear rate of the tire when tested under controlled conditions on a specified government test course. For example, a tire graded 150 would wear one-and-a-half times ( $1\frac{1}{2}$ ) as well on the government course as a tire graded 100.

The relative performance of tires depends upon the actual conditions of their use, however, and may depart significantly from the norm due to variations in driving habits, service practices and differences in road characteristics and climate.

These grades are molded on the sidewalls of passenger vehicle tires. The tires available as standard or optional equipment on your vehicle may vary with respect to grade.



### Traction - AA, A, B & C

The traction grades, from highest to lowest, are AA, A, B and C. Those grades represent the tire's ability to stop on wet pavement as measured under controlled conditions on specified government test surfaces of asphalt and concrete. A tire marked C may have poor traction performance.

#### WARNING

**The traction grade assigned to this tire is based on straight-ahead braking traction tests, and does not include acceleration, cornering, hydroplaning, or peak traction characteristics.**

### Temperature - A, B & C

The temperature grades are A (the highest), B and C representing the tire's resistance to the generation of heat and its ability to dissipate heat when tested under controlled conditions on a specified indoor laboratory test wheel.

Sustained high temperature can cause the material of the tire to degenerate and reduce tire life, and excessive temperature can lead to sudden tire failure. Grades B and A represent higher levels of performance on the laboratory test wheel than the minimum required by law.

#### WARNING

**The temperature grade for this tire is established for a tire that is properly inflated and not overloaded. Excessive speed, under-inflation, over-inflation, or excessive loading, either separately or in combination, can cause heat build-up and possible sudden tire failure. This may cause loss of vehicle control resulting in an accident.**

## Tire Terminology and Definitions

### **Air Pressure**

The amount of air inside the tire pressing outward on the tire. Air pressure is expressed in pounds per square inch (psi) or kilopascal (kPa).

### **Accessory Weight**

This means the combined weight of optional accessories. Some examples of optional accessories are automatic transmission, power seats, and air conditioning.

### **Aspect Ratio**

The relationship of a tire's height to its width.

### **Belt**

A rubber coated layer of cords that is located between the plies and the tread. Cords may be made from steel or other reinforcing materials.

### **Bead**

The tire bead contains steel wires wrapped by steel cords that hold the tire onto the rim.

### **Bias Ply Tire**

A pneumatic tire in which the plies are laid at alternate angles less than 90 degrees to the centerline of the tread.

### **Cold Tire Pressure**

The amount of air pressure in a tire, measured in pounds per square inch (psi) or kilopascals (kPa) before a tire has built up heat from driving.

### **Curb Weight**

This means the weight of a motor vehicle with standard and optional equipment including the maximum capacity of fuel, oil and coolant, but without passengers and cargo.

### **DOT Markings**

The DOT code includes the Tire Identification Number (TIN), an alphanumeric designator which can also identify the tire manufacturer, production plant, brand and date of production.

### **GVWR**

Gross Vehicle Weight Rating

### **GAWR FRT**

Gross Axle Weight Rating for the Front Axle.

### **GAWR RR**

Gross Axle Weight Rating for the Rear axle.

### **Intended Outboard Sidewall**

The side of an asymmetrical tire, that must always face outward when mounted on a vehicle.

### ***Kilopascal (kPa)***

The metric unit for air pressure.

### ***Light truck (LT) tire***

A tire designated by its manufacturer as primarily intended for use on light-weight trucks or multipurpose passenger vehicles.

### ***Load ratings***

The maximum load that a tire is rated to carry for a given inflation pressure.

### ***Load Index***

An assigned number ranging from 1 to 279 that corresponds to the load carrying capacity of a tire.

### ***Maximum Inflation Pressure***

The maximum air pressure to which a cold tire may be inflated. The maximum air pressure is molded onto the sidewall.

### ***Maximum Load Rating***

The load rating for a tire at the maximum permissible inflation pressure for that tire.

### ***Maximum Loaded Vehicle Weight***

The sum of curb weight; accessory weight; vehicle capacity weight; and production options weight.

### ***Normal Occupant Weight***

The number of occupants a vehicle is designed to seat multiplied by 68 kg (150 pounds).

### ***Occupant Distribution***

Designated seating positions.

### ***Outward Facing Sidewall***

An asymmetrical tire has a particular side that faces outward when mounted on a vehicle. The outward facing sidewall bears white lettering or bears manufacturer, brand, and/or model name molding that is higher or deeper than the same moldings on the inner facing sidewall.

### ***Passenger (P-Metric) tire***

A tire used on passenger cars and some light duty trucks and multipurpose vehicles.

### ***Ply***

A layer of rubber-coated parallel cords.

### ***Pneumatic tire***

A mechanical device made of rubber, chemicals, fabric and steel or other materials, that, when mounted on an automotive wheel provides the traction and contains the gas or fluid that sustains the load.

### ***Pneumatic options weight***

The combined weight of installed regular production options weighing over 2.3 kg (5 lb.) in excess of the standard items which they replace, not previously considered in curb weight or accessory weight, including heavy duty breaks, ride levelers, roof rack, heavy duty battery, and special trim.

### **Recommended Inflation Pressure**

Vehicle manufacturer's recommended tire inflation pressure as shown on the tire placard.

### **Radial Ply Tire**

A pneumatic tire in which the ply cords that extend to the beads are laid at 90 degrees to the centerline of the tread.

### **Rim**

A metal support for a tire and upon which the tire beads are seated.

### **Sidewall**

The portion of a tire between the tread and the bead.

### **Speed Rating**

An alphanumeric code assigned to a tire indicating the maximum speed at which a tire can operate.

### **Traction**

The friction between the tire and the road surface. The amount of grip provided.

### **Tread**

The portion of a tire that comes into contact with the road.

### **Treadwear Indicators**

Narrow bands, sometimes called "wear bars", that show across the tread of a tire when only 1/16 inch of tread remains.

### **UTQGS**

Uniform Tire Quality Grading Standards is a tire information system that provides consumers with ratings for a tire's traction, temperature and treadwear. Ratings are determined by tire manufacturers using government testing procedures. The ratings are molded into the sidewall of the tire.

### **Vehicle Capacity Weight**

The number of designated seating positions multiplied by 68 kg (150 lbs.) plus the rated cargo and luggage load.

### **Vehicle Maximum Load on the Tire**

Load on an individual tire due to curb and accessory weight plus maximum occupant and cargo weight.

### **Vehicle Normal Load on the Tire**

Load on an individual tire that is determined by distributing to each axle its share of the curb weight, accessory weight, and normal occupant weight and dividing by 2.

### **Vehicle Placard**

A label permanently attached to a vehicle showing the original equipment tire size and recommended inflation pressure.

### All Season Tires

HYUNDAI specifies all season tires on some models to provide good performance for use all year round, including snowy and icy road conditions. All season tires are identified by ALL SEASON and/or M+S (Mud and Snow) on the tire sidewall. Snow tires have better snow traction than all season tires and may be more appropriate in some areas.

### Summer Tires

HYUNDAI specifies summer tires on some models to provide superior performance on dry roads. Summer tire performance is substantially reduced in snow and ice. Summer tires do not have the tire traction rating M+S (Mud and Snow) on the tire side wall. If you plan to operate your vehicle in snowy or icy conditions, HYUNDAI recommends the use of snow tires or all season tires on all four wheels.

### Snow Tires

If you equip your car with snow tires, they should be the same size and have the same load capacity as the original tires. Snow tires should be installed on all four wheels; otherwise, poor handling may result. Snow tires should carry 28 kPa (4 psi) more air pressure than the pressure recommended for the standard tires on the tire label on the driver's side of the center pillar, or up to the maximum pressure shown on the tire sidewall, whichever is less. Do not drive faster than 120 km/h (75 mph) when your vehicle is equipped with snow tires.

### Radial-Ply Tires

Radial-ply tires provide improved tread life, road hazard resistance and smoother high speed ride. The radial-ply tires used on this vehicle are of belted construction, and are selected to complement the ride and handling characteristics of your vehicle.

Radial-ply tires have the same load carrying capacity, as bias-ply or bias belted tires of the same size, and use the same recommended inflation pressure. Mixing of radial-ply tires with bias-ply or bias belted tires is not recommended. Any combinations of radial-ply and bias-ply or bias belted tires when used on the same vehicle will seriously deteriorate vehicle handling. The best rule to follow is: Identical pairs of radial-ply tires should always be used as a set for the front tires and a set for the rear tires.

Longer wearing tires can be more susceptible to irregular tread wear. It is very important to follow the tire rotation interval in this chapter to achieve the tread life potential of these tires. Cuts and punctures in radial-ply tires are repairable only in the tread area, because of sidewall flexing. Consult your tire dealer for radial-ply tire repairs.

## WARNING

**Do not mix bias ply and radial ply tires under any circumstances. This may cause unusual handling characteristics that may cause loss of vehicle control resulting in an accident.**

### Low Aspect Ratio Tires (if equipped)

The aspect ratio is lower than 50 on low aspect ratio tires.

Because low aspect ratio tires are optimized for handling and braking, their sidewall is a little stiffer than a standard tire. Also low aspect ratio tires tend to be wider and consequently have a greater contact patch with the road surface. In some instances they may generate more road noise compared with standard tires.

## CAUTION

Because the sidewall of a low aspect ratio tire is shorter than a standard tire, the rim of the wheel and the tire itself is more easily susceptible to damage. Use caution when driving and follow the guidelines below to help minimize damage to the wheel and tire:

- When driving on a rough road or off road, drive cautiously because tires and wheels may be damaged. And after driving, inspect tires and wheels.
- When passing over a pothole, speed bump, manhole, or curb stone, drive slowly so that the tires and wheels are not damaged.
- If the tire is subjected to a severe impact, have the tire and wheel inspected by an authorized HYUNDAI dealer.
- Inspect the tire condition and pressure every 3,000km (1,800 miles).

## CAUTION

- It is not easy to recognize tire damage with your own eyes. But if there is the slightest hint of tire damage, have the tire checked or replaced because the tire damage may cause air leakage from the tire.
- If the tire is damaged by driving on a rough road, off road, pothole, manhole, or curb stone, it will not be covered by the warranty.

## FUSES

■ Blade type



Normal



Blown

■ Cartridge type



Normal



Blown

■ Multi fuse



Normal

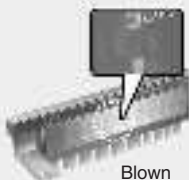

Blown

■ Battery fuse terminal



Normal



Blown

OLF074075

A vehicle's electrical system is protected from electrical overload damage by fuses.

This vehicle has 2 (or 3) fuse panels, one located in the driver's side panel bolster, the other in the engine compartment near the battery.

If any of your vehicle's lights, accessories, or controls do not work, check the appropriate circuit fuse. If a fuse has blown, the element inside the fuse will be melted or broken.

If the electrical system does not work, first check the driver's side fuse panel. Before replacing a blown fuse, turn the engine and all switches off, and then disconnect the negative battery cable. Always replace a blown fuse with one of the same rating.

If the replacement fuse blows, this indicates an electrical problem. Avoid using the system involved and immediately consult an authorized HYUNDAI dealer.

### WARNING

**NEVER** replace a fuse with anything but another fuse of the same rating.

- A higher capacity fuse could cause damage and possibly cause a fire.
- Do not install a wire or aluminum foil instead of the proper fuse - even as a temporary repair. It may cause extensive wiring damage and possibly a fire.

### NOTICE

**Do not use a screwdriver or any other metal object to remove fuses because it may cause a short circuit and damage the system.**

## Instrument Panel Fuse Replacement



1. Turn the vehicle off.
2. Turn all other switches OFF.
3. Open the fuse panel cover.
4. Refer to the label on the inside of the fuse panel cover to locate the suspected fuse location.



5. Pull the suspected fuse straight out. Use the removal tool provided in the engine compartment fuse panel.
6. Check the removed fuse; replace it if it is blown. Spare fuses are provided in the instrument panel fuse panels (or in the engine compartment fuse panel).
7. Push in a new fuse of the same rating, and make sure it fits tightly in the clips. If it fits loosely, consult an authorized HYUNDAI dealer.

In an emergency, if you do not have a spare fuse, use a fuse of the same rating from a circuit you may not need for operating the vehicle.

If the headlamps or other electrical components do not work and the fuses are undamaged, check the fuse panel in the engine compartment. If a fuse is blown, it must be replaced with the same rating.



### Fuse switch

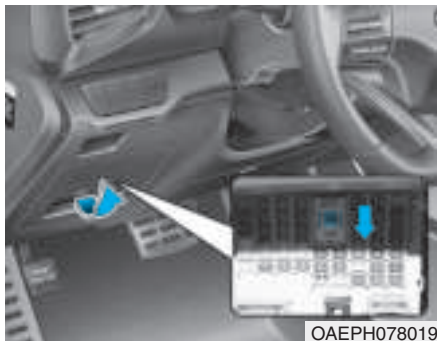

Always, place the fuse switch to the ON position.

If you move the switch to the OFF position, some items such as the audio system and digital clock must be reset and the smart key may not work properly.

### **i** Information



If the fuse switch is OFF, "Turn on FUSE SWITCH" or "Turn FUSE SWITCH On" message will appear.

### **NOTICE**

- Always place the fuse switch in the ON position while driving the vehicle.
- Do not move the fuse switch repeatedly. The fuse switch may be damaged.

### Engine Compartment Panel Fuse Replacement

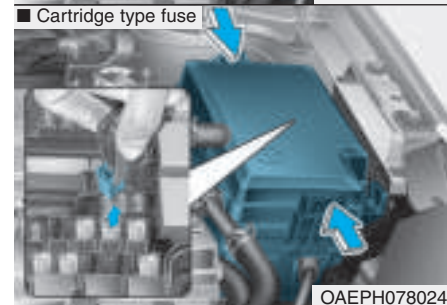
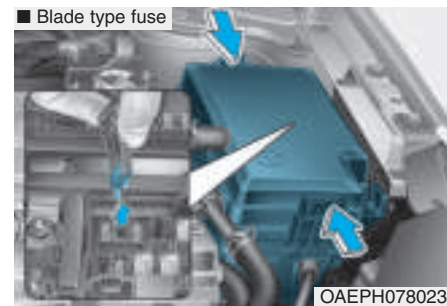

1. Turn the vehicle off.
2. Turn all other switches OFF.
3. Remove the fuse panel cover by pressing the tap and pulling up.

4. Check the removed fuse; replace it if it is blown. To remove or insert the fuse, use the fuse puller in the engine compartment fuse panel.
5. Push in a new fuse of the same rating, and make sure it fits tightly in the clips. If it fits loosely, consult an authorized HYUNDAI dealer.

### ***Multi fuse***

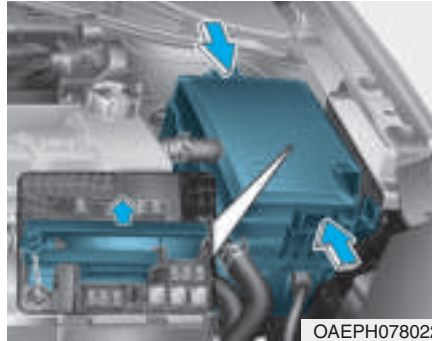

If the multi fuse is blown, we recommend that you consult an authorized HYUNDAI dealer.



## Engine compartment fuse panel



Inside the fuse/relay box cover, you can find the fuse/relay label describing fuse/relay names and ratings.

### **i** Information

Not all fuse panel descriptions in this manual may be applicable to your vehicle; the information is accurate at the time of printing. When you inspect the fuse panel in your vehicle, refer to the fuse panel label.

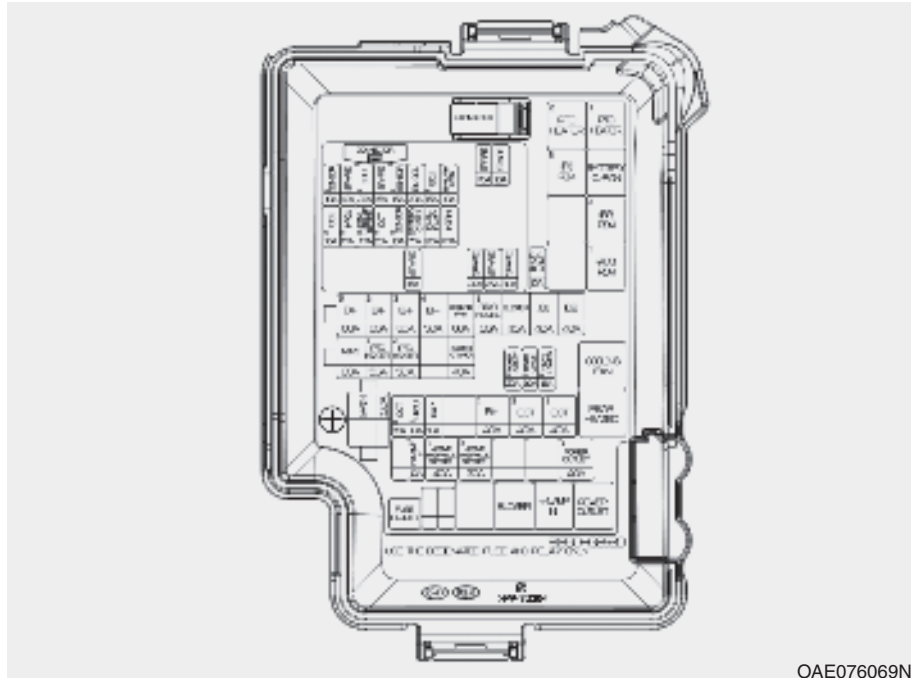

## LIGHT BULBS

Consult an authorized HYUNDAI dealer to replace most vehicle light bulbs. It is difficult to replace vehicle light bulbs because other parts of the vehicle must be removed before you can get to the bulb. This is especially true for removing the headlamp assembly to get to the bulb(s).

Removing/installing the headlamp assembly can result in damage to the vehicle.

### **i** Information

The headlamp and tail lamp lenses could appear frosty if the vehicle is washed after driving or the vehicle is driven at night in wet weather. This condition is caused by temperature difference between the lamp inside and outside and, it does not indicate a problem with your vehicle. When moisture condenses in the lamp, it will be removed after driving with the headlamp on. The removable level may differ depending on lamp size, lamp position and environmental condition. However, if moisture is not removed, we recommend that your vehicle is inspected by an authorized HYUNDAI dealer.

### **⚠** WARNING

- Prior to replacing a lamp, depress the foot brake, move the shift lever into P (Park) apply the parking brake, place the ignition switch to the LOCK/OFF position, and take the key with you when leaving the vehicle to avoid sudden movement of the vehicle and to prevent possible electric shock.
- Be aware the bulbs may be hot and may burn your fingers.

## Headlamp, Parking Lamp, Turn Signal Lamp and Side Marker

### *Type A – Standard type*

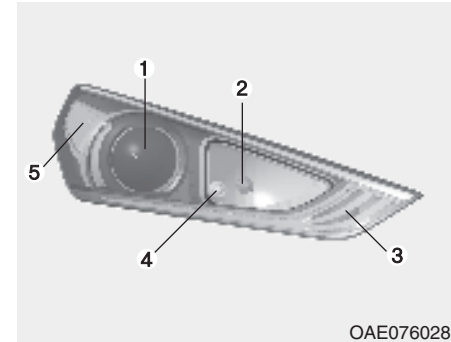

- (1) Headlamp (Low)
- (2) Headlamp (High)
- (3) Turn signal lamp
- (4) Parking lamp
- (5) Side marker

## WARNING

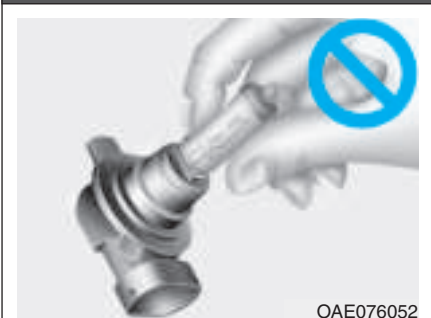

### Halogen bulb

- Handle halogen bulbs with care. Halogen bulbs contain pressurized gas that will produce flying pieces of glass that could cause injuries if broken.
- Wear eye protection when changing a bulb. Allow the bulb to cool down before handling it.

- Always handle them carefully, and avoid scratches and abrasions. If the bulbs are lit, avoid contact with liquids.
- Never touch the glass with bare hands. Residual oil may cause the bulb to overheat and burst when lit.
- A bulb should be operated only when installed in a headlamp.
- If a bulb becomes damaged or cracked, replace it immediately and carefully dispose of it.

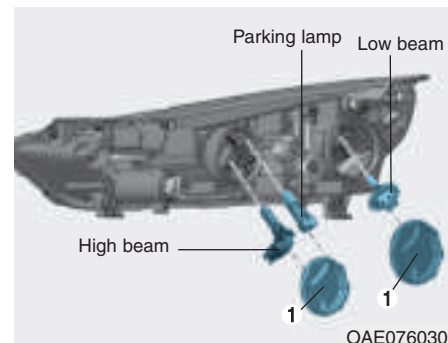

### Headlamp and parking lamp

1. Open the hood.
2. Disconnect the negative battery cable.
3. Remove the headlamp bulb cover (1) by turning it counterclockwise.
4. Disconnect the headlamp bulb socket-connector. (for low beam and high beam)
5. Remove the bulb from the headlamp assembly.
6. Install a new bulb.

7. Connect the headlamp bulb socket-connector. (for low beam and high beam)
8. Install the bulb cover (1) by turning it clockwise.

### **i** Information

**The headlamp aiming should be adjusted after an accident or after the headlamp assembly is reinstalled at an authorized HYUNDAI dealer.**

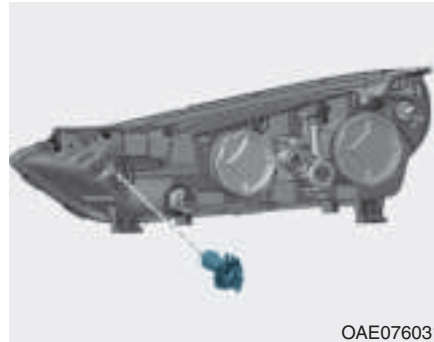

### Turn signal

1. Open the hood.
2. Disconnect the negative battery cable.
3. Remove the socket from the assembly by turning the socket counterclockwise until the tabs on the socket align with the slots on the assembly.
4. Remove the bulb from the socket by pressing it in and rotating it counterclockwise until the tabs on the bulb align with the slots in the socket. Pull the bulb out of the socket.

5. Install a new bulb by inserting it into the socket and rotating it until it locks into place.
6. Install the socket into the assembly by aligning the tabs on the socket with the slots in the assembly.
7. Push the socket into the assembly and turn the socket clockwise.

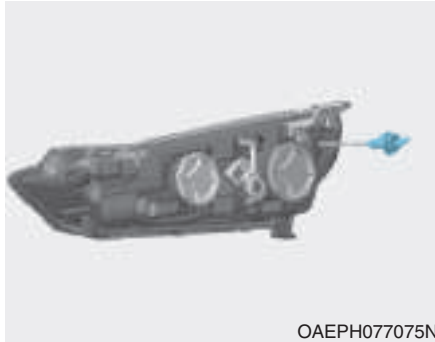

### Side marker

1. Open the hood.
2. Disconnect the negative battery cable.
3. Remove the socket from the assembly by turning the socket counterclockwise until the tabs on the socket align with the slots on the assembly.
4. Remove the bulb from the socket by pulling out the bulb.
5. Insert a new bulb.

### Type B

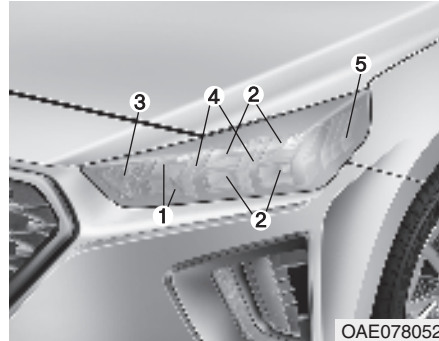

- (1) Headlamp (high)
- (2) Headlamp (low)
- (3) Turn signal lamp
- (4) Parking lamp
- (5) Side marker lamp

### Headlamp, parking lamp and side marker lamp

If the light bulb does not operate, we recommend that you have the vehicle checked by an authorized HYUNDAI dealer.

### WARNING

#### HID headlamp

Do not attempt to replace or inspect the low beam (XENON bulb) due to electric shock danger. If the low beam (XENON bulb) is not working, have your vehicle checked by an authorized HYUNDAI Dealer.

### Information

If your vehicle is equipped with High Intensity Discharge (HID) headlamps, these headlamps contain mercury. So if you need to have your vehicle disposed, you should remove the HID Headlamps before disposal. The removed HID headlamps should be recycled, re-used or disposed as hazardous waste.



### **i** Information

**HID lamps have superior performance vs. halogen bulbs.**

HID lamps are estimated by the manufacturer to last twice as long or longer than halogen bulbs depending on their frequency of use. They will probably require replacement at some point in the life of the vehicle. Cycling the headlamps on and off more than typical use will shorten HID lamps life. HID lamps do not fail in the same manner as halogen incandescent lamps. If a headlamp goes out after a period of operation but will immediately relight when the headlamp switch is cycled it is likely the HID lamp needs to be replaced. HID lighting components are more complex than conventional halogen bulbs thus have higher replacement cost.

### **i** Information

The headlamp aiming should be adjusted after an accident or after the headlamp assembly is reinstalled at an authorized HYUNDAI dealer.

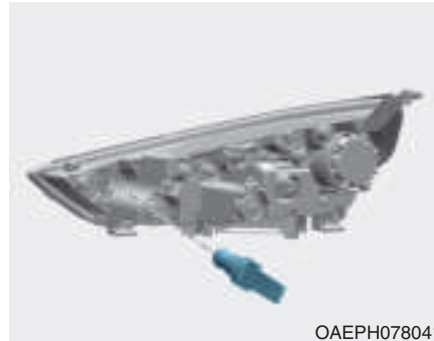

#### Turn signal lamp

1. Open the hood.
2. Disconnect the negative battery cable.
3. Remove the socket from the assembly by turning the socket counterclockwise until the tabs on the socket align with the slots on the assembly.
4. Remove the bulb from the socket by pressing it in and rotating it counterclockwise until the tabs on the bulb align with the slots in the socket. Pull the bulb out of the socket.

5. Insert a new bulb by inserting it into the socket and rotating it until it locks into place.
6. Install the socket into the assembly by aligning the tabs on the socket with the slots in the assembly.
7. Push the socket into the assembly and turn the socket clockwise.

## Daytime Running Light (DRL)

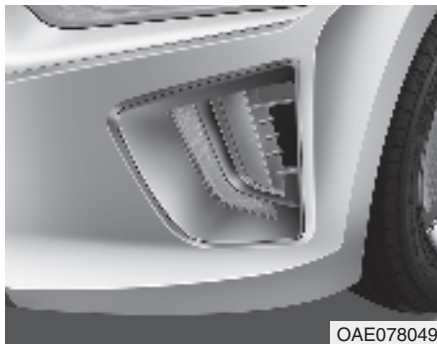

Your vehicle is equipped with LED lamps. LED lamps do not have replaceable bulbs. If the LED lamp does not operate, have the vehicle checked by an authorized HYUNDAI dealer.

## Side Repeater Lamp Replacement

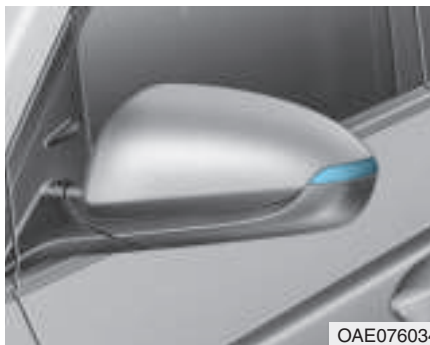

Your vehicle is equipped with LED lamps. LED lamps do not have replaceable bulbs. If the LED lamp does not operate, have the vehicle checked by an authorized HYUNDAI dealer.

## Rear combination lamp bulb replacement

### Type A

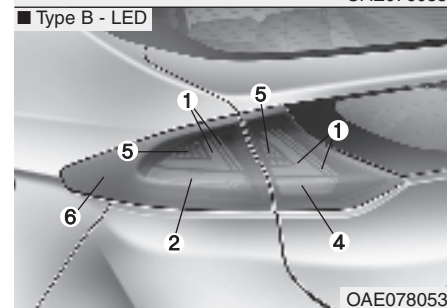
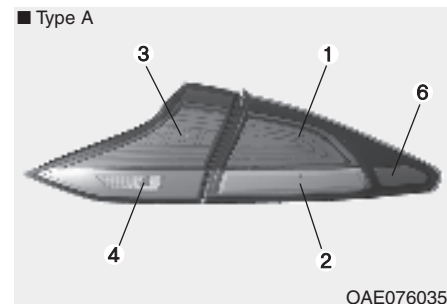

- (1) Tail/Stop lamp
- (2) Turn signal lamp
- (3) Tail lamp
- (4) Backup lamp
- (5) Stop lamp
- (6) Side marker lamp

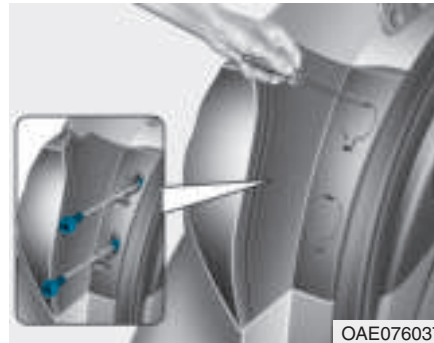

**Tail/Stop lamp (Type A), turn signal lamp (Type A, B) and side marker lamp (Type A)**

1. Open the tailgate.
2. Open the lamp assembly retaining screw covers.
3. Loosen the lamp assembly retaining screws with a cross-tip screwdriver.

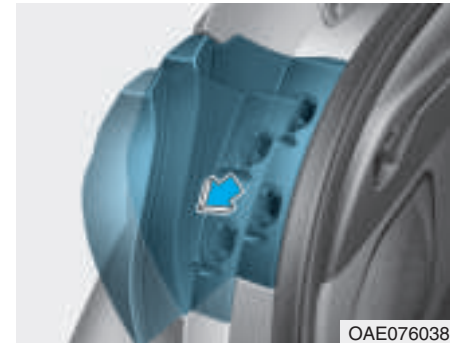

4. Remove the rear combination lamp assembly from the body of the vehicle.

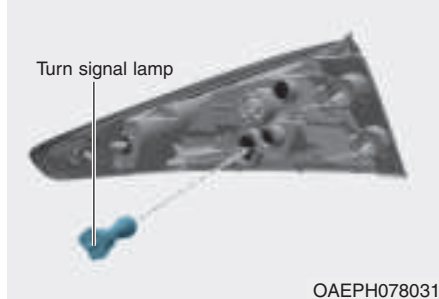
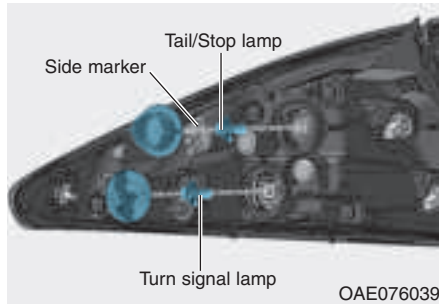

5. Remove the socket from the assembly by turning the socket counterclockwise until the tabs on the socket align with the slots on the assembly.

6. Remove the bulb from the socket by pressing it in and rotating it counterclockwise until the tabs on the bulb align with the slots in the socket. Pull the bulb out of the socket.
7. Insert a new bulb by inserting it into the socket and rotating it until it locks into place.
8. Install the socket into the assembly by aligning the tabs on the socket with the slots in the assembly. Push the socket into the assembly and turn the socket clockwise.
9. Reinstall the lamp assembly to the body of the vehicle.

### Stop lamp, tail lamp and side marker (Type B)

Your vehicle is equipped with LED lamps. LED lamps do not have replaceable bulbs. If the LED lamp does not operate, have the vehicle checked by an authorized HYUNDAI dealer.



### Tail lamp (Type A) and back-up lamp

1. Open the liftgate.
2. Remove the service cover using a flat-blade screwdriver.

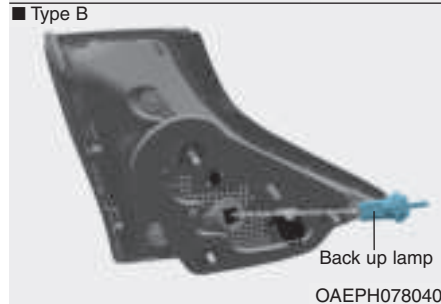
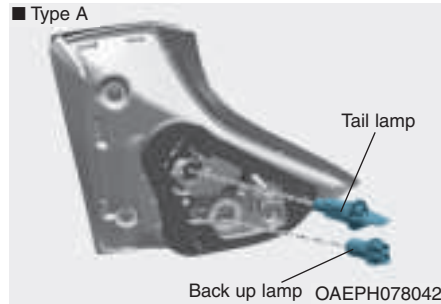

3. Remove the socket from the assembly by turning the socket counterclockwise until the tabs on the socket align with the slots on the assembly.
4. Pull the bulb out of the socket.
5. Insert a new bulb into the socket.

### High Mounted Stop Lamp Replacement



1. Open the tailgate.
2. Gently remove the cover of the tailgate trim.
3. Remove the spoiler plug hole.
4. Disconnect the electrical connector.
5. Loosen the mounting bolts and remove the spoiler.
6. Remove the high mounted stop light assembly after disconnecting the connector.
7. Reinstall a new light assembly in the reverse order of removal.

## License Plate Light Bulb Replacement

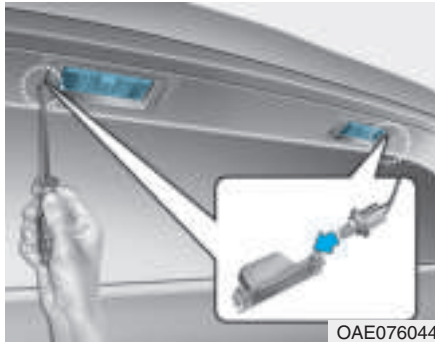

1. Using a flat-blade screwdriver, gently pry the lens cover from the lamp housing.
2. Remove the bulb by pulling it straight out.
3. Install a new bulb.
4. Reinstall in the reverse order.

## Interior Light Bulb Replacement

### Map lamp and room lamp

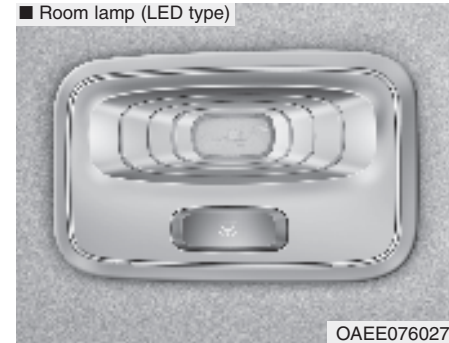

Your vehicle is equipped with LED lamps. LED lamps do not have replaceable bulbs. If the LED lamp does not operate, have the vehicle checked by an authorized HYUNDAI dealer.

### Map lamp, room lamp, vanity mirror lamp and luggage compartment lamp

■ Map lamp (Bulb type)



■ Room lamp (Bulb type)

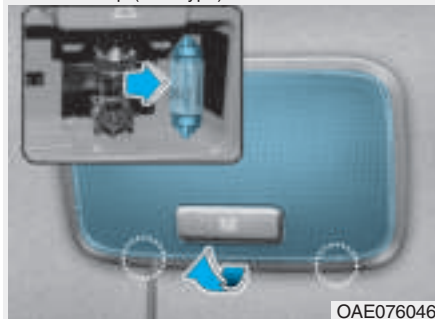

■ Vanity mirror lamp



■ Luggage compartment lamp



1. Using a flat-blade screwdriver, gently pry the lens from the interior lamp housing.
2. Remove the bulb by pulling it straight out.

#### **WARNING**

**Prior to working on the Interior Lights, ensure that the lamp is off to avoid burning your fingers or receiving an electric shock.**

3. Install a new bulb into the socket.
4. Align the lens tabs with the interior lamp housing notches and snap the lens into place.

#### **NOTICE**

**Use care not to dirty or damage lens, lens tab, and plastic housings.**

## APPEARANCE CARE

### Exterior Care

#### *Exterior general caution*

It is very important to follow the label directions when using any chemical cleaner or polish. Read all warning and caution statements that appear on the label.

#### *Protecting your vehicle's finish*

##### *Washing*

To help protect your vehicle's finish from rust and deterioration, wash it thoroughly and frequently at least once a month with lukewarm or cold water.

If you use your vehicle for off-road driving, you should wash it after each off-road trip. Pay special attention to the removal of any accumulation of salt, dirt, mud, and other foreign materials. Make sure the drain holes in the lower edges of the doors and rocker panels are kept clear and clean.

Insects, tar, tree sap, bird droppings, industrial pollution and similar deposits can damage your vehicle's finish if not removed immediately.

Even prompt washing with plain water may not completely remove all these deposits. A mild soap, safe for use on painted surfaces, should be used.

After washing, rinse the vehicle thoroughly with lukewarm or cold water. Do not allow soap to dry on the finish.

#### WARNING

**After washing the vehicle, test the brakes while driving slowly to see if they have been affected by water before getting on the road. If braking performance is impaired, dry the brakes by applying them lightly while maintaining a slow forward speed.**



### NOTICE

- **Do not use strong soap, chemical detergents or hot water, and do not wash the vehicle in direct sunlight or when the body of the vehicle is warm.**
- **Be careful when washing the side windows of your vehicle. Especially, with high-pressure water, water may leak through the windows and wet the interior.**
- **To prevent damage to the plastic parts, do not clean with chemical solvents or strong detergents.**
- **To prevent damage to the charging door, make sure to close and lock the vehicle doors when washing (high-pressure washing, automatic car washing, etc.) the vehicle.**

### High-pressure washing

- When using high-pressure washers, make sure to maintain sufficient distance from the vehicle. Insufficient clearance or excessive pressure can lead to component damage or water penetration.
- Do not spray the camera, sensors or its surrounding area directly with a high pressure washer. Shock applied from high pressure water may cause the device to not operate normally.
- Do not bring the nozzle tip close to boots (rubber or plastic covers) or connectors as they may be damaged if they come into contact with high pressure water.



### NOTICE

- **Water washing in the engine compartment including high pressure water washing may cause the failure of electrical circuits located in the engine compartment.**
- **Never allow water or other liquids to come in contact with electrical/electronic components inside the vehicle as this may damage them.**

**NOTICE****Matte paint finish vehicle  
(if equipped)**

Automatic car wash which uses rotating brushes should not be used as this can damage the surface of your vehicle. A steam cleaner which washes the vehicle surface at high temperature may result the oil to adhere and leave stains that is difficult to remove.

Use a soft cloth (e.g. microfiber towel or sponge) when washing your vehicle and dry with a microfiber towel. When you hand wash your vehicle, you should not use a cleaner that finishes with wax. If the vehicle surface is too dirty (sand, dirt, dust, contaminant, etc.), clean the surface with water before washing the vehicle.

**Waxing**

A good coat of wax provides a barrier between your paint and environmental contamination.

Keeping a good coat of wax on your vehicle will help protect it.

Wax the vehicle when water will no longer bead on the paint.

Always wash and dry the vehicle before waxing. Use a good quality liquid or paste wax, and follow the manufacturer's instructions. Wax all metal trim to protect it and to maintain its luster.

Removing oil, tar, and similar materials with a spot remover will usually strip the wax from the finish. Be sure to re-wax these areas even if the rest of the vehicle does not yet need waxing.

**NOTICE**

- Wiping dust or dirt off the body with a dry cloth will scratch the finish.
- Do not use steel wool, abrasive cleaners, or strong detergents containing highly alkaline or caustic agents on chrome-plated or anodized aluminum parts. This may result in damage to the protective coating and cause discoloration or paint deterioration.

**NOTICE****Matte paint finish vehicle  
(if equipped)**

Do not use any polish protector such as a detergent, an abrasive and a polish. In case wax is applied, remove the wax immediately using a silicon remover and if any tar or tar contaminant is on the surface use a tar remover to clean. However, be careful not to apply too much pressure on the painted area.

### ***Repairing your vehicle's finish***

Deep scratches or stone chips in the painted surface must be repaired promptly. Exposed metal will quickly rust and may develop into a major repair expense.

#### **NOTICE**

**If your vehicle is damaged and requires any metal repair or replacement, be sure the body shop applies anti-corrosion materials to the parts repaired or replaced.**

#### **NOTICE**

**Matte paint finish vehicle (if equipped)**

**In case of matte paint finish vehicles, it is impossible to modify only the damaged area and repair of the whole part is necessary. If the vehicle is damaged and painting is required, we recommend that you have your vehicle maintained and repaired by an authorized HYUNDAI dealer. Take extreme care, as it is difficult to restore the quality after the repair.**

### ***Bright-metal maintenance***

- To remove road tar and insects, use a tar remover, not a scraper or other sharp object.
- To protect the surfaces of bright-metal parts from corrosion, apply a coating of wax or chrome preservative and rub to a high luster.
- During winter weather or in coastal areas, cover the bright metal parts with a heavier coating of wax or preservative. If necessary, coat the parts with non-corrosive petroleum jelly or other protective compound.

### ***Underbody maintenance***

Corrosive materials used for ice and snow removal and dust control may collect on the underbody. If these materials are not removed, accelerated rusting can occur on underbody parts such as the fuel lines, frame, floor pan and exhaust system, even though they have been treated with rust protection.

Thoroughly flush the vehicle underbody and wheel openings with luke-warm or cold water once a month, after off-road driving and at the end of each winter. Pay special attention to these areas because it is difficult to see all the mud and dirt. It will do more harm than good to wet down the road grime without removing it. The lower edges of doors, rocker panels, and frame members have drain holes that should not be allowed to clog with dirt; trapped water in these areas can cause rusting.

#### **WARNING**

**After washing the vehicle, test the brakes while driving slowly to see if they have been affected by water. If braking performance is impaired, dry the brakes by applying them lightly while maintaining a slow forward speed.**

### **Aluminum wheel maintenance**

The aluminum wheels are coated with a clear protective finish.

#### **NOTICE**

- **Do not use abrasive cleaner, polishing compound, solvent, or wire brushes on aluminum wheels.**
- **Clean the wheel when it has cooled.**
- **Use only a mild soap or neutral detergent, and rinse thoroughly with water. Also, clean the wheels after driving on salted roads.**
- **Do not wash the wheels with high-speed car wash brushes.**
- **Do not use any cleaners containing acid or alkaline detergents.**

### **Corrosion protection**

#### **Protecting your vehicle from corrosion**

By using the most advanced design and construction practices to combat corrosion, HYUNDAI produces vehicles of the highest quality. However, this is only part of the job. To achieve the long-term corrosion resistance your vehicle can deliver, the owner's cooperation and assistance is also required.

#### **Common causes of corrosion**

The most common causes of corrosion on your vehicle are:

- Road salt, dirt and moisture that is allowed to accumulate underneath the vehicle.
- Removal of paint or protective coatings by stones, gravel, abrasion or minor scrapes and dents which leave unprotected metal exposed to corrosion.

### **High-corrosion areas**

If you live in an area where your vehicle is regularly exposed to corrosive materials, corrosion protection is particularly important. Some of the common causes of accelerated corrosion are road salts, dust control chemicals, ocean air and industrial pollution.

#### **Moisture breeds corrosion**

Moisture creates the conditions in which corrosion is most likely to occur. For example, corrosion is accelerated by high humidity, particularly when temperatures are just above freezing. In such conditions, the corrosive material is kept in contact with the vehicle surfaces by moisture that is slow to evaporate.

Mud is particularly corrosive because it is slow to dry and holds moisture in contact with the vehicle. Although the mud appears to be dry, it can still retain moisture and promote corrosion.

High temperatures can also accelerate corrosion of parts that are not properly ventilated so the moisture can be dispersed. For all these reasons, it is particularly important to keep your vehicle clean and free of mud or accumulations of other materials. This applies not only to the visible surfaces but particularly to the underside of the vehicle.

### To help prevent corrosion

#### *Keep your vehicle clean*

The best way to prevent corrosion is to keep your vehicle clean and free of corrosive materials. Attention to the underside of the vehicle is particularly important.

- If you live in a high-corrosion area — where road salts are used, near the ocean, areas with industrial pollution, acid rain, etc.—, you should take extra care to prevent corrosion. In winter, hose off the underside of your vehicle at least once a month and be sure to clean the underside thoroughly when winter is over.

- When cleaning underneath the vehicle, pay particular attention to the components under the fenders and other areas that are hidden from view. Do a thorough job; just dampening the accumulated mud rather than washing it away will accelerate corrosion rather than prevent it. Water under high pressure and steam are particularly effective in removing accumulated mud and corrosive materials.
- When cleaning lower door panels, rocker panels and frame members, be sure that drain holes are kept open so that moisture can escape and not be trapped inside to accelerate corrosion.

#### *Keep your garage dry*

Don't park your vehicle in a damp, poorly ventilated garage. This creates a favorable environment for corrosion. This is particularly true if you wash your vehicle in the garage or drive it into the garage when it is still wet or covered with snow, ice or mud. Even a heated garage can contribute to corrosion unless it is well ventilated so moisture is dispersed.

#### *Keep paint and trim in good condition*

Scratches or chips in the finish should be covered with "touch-up" paint as soon as possible to reduce the possibility of corrosion. If bare metal is showing through, the attention of a qualified body and paint shop is recommended.

Bird droppings are highly corrosive and may damage painted surfaces in just a few hours. Always remove bird droppings as soon as possible.

## Interior Care

### *Interior general precautions*

Prevent caustic solutions such as perfume and cosmetic oil, from contacting the interior parts because they may cause damage or discoloration. If they do contact the interior parts, wipe them off immediately. See the instructions for the proper way to clean vinyl.

#### **NOTICE**

- **Never allow water or other liquids to come in contact with electrical/electronic components inside the vehicle as this may damage them.**
- **When cleaning leather products (steering wheel, seats etc.), use neutral detergents or low alcohol content solutions. If you use high alcohol content solutions or acid/alkaline detergents, the color of the leather may fade or the surface may get stripped off.**

### *Cleaning the upholstery and interior trim*

#### **Vinyl (if equipped)**

Remove dust and loose dirt from vinyl with a whisk broom or vacuum cleaner. Clean vinyl surfaces with a vinyl cleaner.

#### **Fabric (if equipped)**

Remove dust and loose dirt from fabric with a whisk broom or vacuum cleaner. Clean with a mild soap solution recommended for upholstery or carpets. Remove fresh spots immediately with a fabric spot cleaner. If fresh spots do not receive immediate attention, the fabric can be stained and its color can be affected. Also, its fire-resistant properties can be reduced if the material is not properly maintained.

#### **NOTICE**

**Using anything but recommended cleaners and procedures may affect the fabric's appearance and fire-resistant properties.**

#### **Leather (if equipped)**

- Features of seat leather
  - Leather is made from the outer skin of an animal, which goes through a special process to be available for use. Since it is a natural product, each part differs in thickness or density.
  - Wrinkles may appear as a natural result of stretching and shrinking depending on the temperature and humidity.
  - The seat is made of stretchable fabric to improve comfort.
  - The parts contacting the body are curved and the side supporting area is high which provides driving comfort and stability.
  - Wrinkles may appear naturally from usage. It is not a fault of the products.

### **NOTICE**

- **Wrinkles or abrasions which appear naturally from usage are not covered by warranty.**
  - **Belts with metallic accessories, zippers or keys inside the back pocket may damage the seat fabric.**
  - **Make sure not to wet the seat. It may change the nature of natural leather.**
  - **Jeans or clothes which could bleach may contaminate the surface of the seat covering fabric.**
- **Caring for the leather seats**
    - Vacuum the seat periodically to remove dust and sand on the seat. It will prevent abrasion or damage of the leather and maintain its quality.
    - Wipe the natural leather seat cover often with dry or soft cloth.
    - Use of proper leather protector may prevent abrasion of the cover and helps maintain the color. Be sure to read the instructions and consult a specialist when using leather coating or protective agent.
    - Light colored (beige, cream beige) leather is easily contaminated and the stain is noticeable. Clean the seats frequently.
    - Avoid wiping with wet cloth. It may cause the surface to crack.
  - **Cleaning the leather seats**
    - Remove all contaminations instantly. Refer to instructions below for removal of each contaminant.
    - Cosmetic products (sunscreen, foundation, etc.)  
Apply cleansing cream on a cloth and wipe the contaminated spot. Wipe off the cream with a wet cloth and remove water with a dry cloth.
    - Beverages (coffee, soft drink, etc.)  
Apply a small amount of neutral detergent and wipe until contaminations do not smear.
    - Oil  
Remove oil instantly with absorbable cloth and wipe with stain remover used only for natural leather.
    - Chewing gum  
Harden the gum with ice and remove gradually.

### ***Cleaning the seat belt webbing***

Clean the belt webbing with any mild soap solution recommended for cleaning upholstery or carpet. Follow the instructions provided with the soap. Do not bleach or re-dye the webbing because this may weaken the seat belt.

### ***Cleaning the interior window glass***

If the interior glass surfaces of the vehicle become fogged (that is, covered with an oily, greasy or waxy film), they should be cleaned with glass cleaner. Follow the directions on the glass cleaner container.

#### **NOTICE**

**Do not scrape or scratch the inside of the rear window. This may result in damage to the rear window defroster grid.**



### EMISSION CONTROL SYSTEM

The emission control system of your vehicle is covered by a written limited warranty. Please see the warranty information contained in the Service Passport in your vehicle.

Your vehicle is equipped with an emission control system to meet all applicable emission regulations. There are three emission control systems, as follows.

- (1) Crankcase emission control system
- (2) Evaporative emission control system
- (3) Exhaust emission control system

In order to ensure the proper function of the emission control systems, it is recommended that you have your vehicle inspected and maintained by an authorized HYUNDAI dealer in accordance with the maintenance schedule in this manual.

#### NOTICE

**For the Inspection and Maintenance Test (with Electronic Stability Control (ESC) system)**

- **To prevent the vehicle from misfiring during dynamometer testing, turn the Electronic Stability Control (ESC) system off by pressing the ESC switch (ESC OFF light illuminated).**
- **After dynamometer testing is completed, turn the ESC system back on by pressing the ESC switch again.**

#### 1. Crankcase Emission Control System

The positive crankcase ventilation system is employed to prevent air pollution caused by blow-by gases being emitted from the crankcase. This system supplies fresh filtered air to the crankcase through the air intake hose. Inside the crankcase, the fresh air mixes with blow-by gases, which then pass through the PCV valve into the induction system.

#### 2. Evaporative Emission Control System Including Onboard Refueling Vapor Recovery (ORVR)

The Evaporative Emission Control System is designed to prevent fuel vapors from escaping into the atmosphere. The ORVR system is designed to allow the vapors from the fuel tank to be loaded into a canister while refueling at the gas station, preventing the escape of fuel vapors into the atmosphere.

### **Canister**

Fuel vapors generated inside the fuel tank are absorbed and stored in the onboard canister. When the engine is running, the fuel vapors absorbed in the canister are drawn into the surge tank through the purge control solenoid valve.

### **Purge Control Solenoid Valve (PCSV)**

The purge control solenoid valve is controlled by the Engine Control Module (ECM); when the engine coolant temperature is low during idling, the PCSV closes so that evaporated fuel is not taken into the engine. After the engine warms-up during ordinary driving, the PCSV opens to introduce evaporated fuel to the engine.

## **3. Exhaust Emission Control System**

The Exhaust Emission Control System is a highly effective system which controls exhaust emissions while maintaining good vehicle performance.

When the engine starts or fails to start, excessive attempts to restart the engine may cause damage to the emission system.

### **Engine exhaust (carbon monoxide) precautions**

- Carbon monoxide can be present with other exhaust fumes. If you smell exhaust fumes of any kind in your vehicle, drive with all the windows fully open. Have your vehicle checked and repaired immediately.

#### **WARNING**

**Engine exhaust gases contain carbon monoxide (CO). Though colorless and odorless, it is dangerous and could be lethal if inhaled. Follow the instructions on this page to avoid CO poisoning.**

- Do not operate the engine in confined or closed areas (such as garages) any more than what is necessary to move the vehicle in or out of the area.
- When the vehicle is stopped in an open area for more than a short time with the engine running, adjust the ventilation system (as needed) to draw outside air into the vehicle.
- Never sit in a parked or stopped vehicle for any extended time with the engine running.
- When the engine stalls or fails to start, excessive attempts to restart the engine may cause damage to the emission control system.

### ***Operating precautions for catalytic converters (if equipped)***

#### **WARNING**

**The exhaust system and catalytic converter are very hot during and immediately after the engine has been running. To avoid SERIOUS INJURY or DEATH:**

- **Do not park, idle, or drive the vehicle over or near flammable objects, such as grass, vegetation, paper, leaves, etc. A hot exhaust system can ignite flammable items under your vehicle.**
- **Keep away from the exhaust system and catalytic converter or you may get burned.**

**Also, Do not remove the heat sink around the exhaust system, do not seal the bottom of the vehicle, and do not coat the vehicle for corrosion control. It may present a fire risk under certain conditions.**

Your vehicle is equipped with a catalytic converter emission control device.

To prevent damage to the catalytic converter and to your vehicle, take the following precautions:

- Use only UNLEADED FUEL for gasoline engines.
- Do not operate the vehicle when there are signs of engine malfunction, such as misfire or a noticeable loss of performance.
- Do not misuse or abuse the engine. Examples of misuse are coasting with the engine off and descending steep grades in gear with the engine off.
- Do not operate the engine at high idle speed for extended periods (5 minutes or more).
- Do not modify or tamper with any part of the engine or emission control system. All inspections and adjustments must be made by an authorized HYUNDAI dealer.
- Avoid driving with extremely low fuel level. If you run out of gasoline, it could cause the engine to misfire and result in excessive loading of the catalytic converter.

# Specifications

Dimensions .....	8-2
Engine .....	8-2
Bulb Wattage .....	8-3
Tires and Wheels .....	8-5
Volume and Weight.....	8-6
Air Conditioning System.....	8-6
Recommended Lubricants and Capacities .....	8-7
Recommended SAE Viscosity Number .....	8-8
Vehicle Identification Number (VIN) .....	8-9
Vehicle Certification Label.....	8-9
Tire Specification and Pressure Label .....	8-10
Engine Number .....	8-10

### DIMENSIONS

Items		mm (in)
Overall length		4,470 (175.9)
Overall width		1,820 (71.6)
Overall height		1,445 (56.8)
Front tread	195/65 R15 *1	1,563 (61.5)
	205/55 R16 *2	1,555 (61.2)
	225/45 R17 *1	1,549 (60.0)
Rear tread	195/65 R15 *1	1,577 (62.0)
	205/55 R16 *2	1,569 (61.8)
	225/45 R17 *1	1,563 (61.5)
Wheelbase		2,700 (106.3)

\*1: Hybrid vehicle

\*2: Plug-in hybrid vehicle

### ENGINE

Engine	Displacement cu cc (in.)	Bore X Stroke mm (in.)	Firing Order	No. of Cylinders
1.6 GDI	1,580 (96.4)	72 X 97 (2.8 X 3.8)	1-3-4-2	In-line 4 cylinder

## BULB WATTAGE

		Light Bulb	Bulb Type	Wattage		
Front	Type A	Headlamp	Low	H7LL	55	
			High	9005HL+	60	
		Parking lamp		W5W	5	
		Turn signal lamp		28/8W	28/8	
		Side marker		W5W	5	
	Type B	Headlamp	Low/High		LED	LED
			Parking lamp		LED	LED
		Turn signal lamp		28/8W	28/8	
		Side marker		LED	LED	
		Daytime running light (DRL)		LED	LED	
Side repeater lamp		LED	LED			
Rear	Type A	Tail/Stop lamp		P21/5W	21/5	
		Turn signal lamp		PY27W	27	
		Tail lamp		W5W	5	
		Backup lamp		W16W	16	
		Side marker		W5W	5	
	Type B	Tail/Stop lamp		LED	LED	
		Turn signal lamp		LED	LED	
		Tail lamp		LED	LED	
		Backup lamp		W16W	16	
		Side marker		LED	LED	
	High mounted stop lamp		LED	LED		
License plate lamp		W5W	10			

## Specifications

---

Light Bulb		Bulb Type	Wattage	
Interior	Map lamp	Type A	W10W	
		Type B	LED	
	Room lamp	Type A	FESTOON	
		Type B	LED	
	Vanity mirror lamp		FESTOON	5
	Luggage compartment lamp		FESTOON	5

## TIRES AND WHEELS

Items	Tire Size	Wheel Size	Inflation Pressure kPa (psi)				WheelLug Nut Torque kgf·m (lbf·ft, N·m)
			Normal Load		Maximum Load		
			Front	Rear	Front	Rear	
Full size tire	195/65 R15 *1	6.0J X 15	250 (36)	250 (36)	250 (36)	250 (36)	11~13 (79~94, 107~127)
	205/55 R16 *2	6.5J X 16	250 (36)	250 (36)	250 (36)	250 (36)	
	225/45 R17 *1	7.0J X 17	250 (36)	250 (36)	250 (36)	250 (36)	
Compact spare tire (if equipped)	T125/80 D15	4.0T X 15	420 (60)	420 (60)	420 (60)	420 (60)	
	T125/80 D16	4.0T X 16	420 (60)	420 (60)	420 (60)	420 (60)	

If your vehicle is not equipped with a compact spare tire, your vehicle will be equipped with a Tire Mobility Kit.

\*1: Hybrid vehicle

\*2: Plug-in hybrid vehicle

### NOTICE

- It is permissible to add 20 kPa (3 psi) to the standard tire pressure specification if colder temperatures are expected soon. Tires typically loose 7 kPa (1 psi) for every 7°C (12°F) temperature drop. If extreme temperature variations are expected, recheck your tire pressure as necessary to keep them properly inflated.
- An air pressure generally decreases, as you drive up to a high-altitude area above sea level. Thus, if you plan to drive a high-altitude area, check the tire pressures in advance. If necessary, inflate them to a proper level (Air inflation per altitude: +10 kPa/1 km (+2.4 psi/1 mile)).

### NOTICE

When replacing tires, use the same size originally supplied with the vehicle.  
Using tires of a different size can damage the related parts or not work properly.



## VOLUME AND WEIGHT

Gross Vehicle Weight    kg (lbs.)		Luggage Volume    / (cu ft)	
Hybrid vehicle	Plug-in hybrid vehicle	Hybrid vehicle	Plug-in hybrid vehicle
1,785 (3,935)* <sup>1</sup> / 1,850 (4,079)	1,970 (4,343)	750 (26.5)	650 (23.0)

\*<sup>1</sup>: For echo pack vehicles

## AIR CONDITIONING SYSTEM

Items	Weight of Volume	Classification
Refrigerant g (oz.)	600±25 (21.16±0.88)	R-134a
Compressor lubricant cc (oz.)	130±10 (4.58±0.35±0.88)	POE

Contact an authorized HYUNDAI dealer for more details.

## RECOMMENDED LUBRICANTS AND CAPACITIES

To help achieve proper engine and powertrain performance and durability, use only lubricants of the proper quality. The correct lubricants also help promote engine efficiency that results in improved fuel economy.

Lubricant		Volume	Classification
Engine oil *1 *2 (drain and refill)		3.8 l (4.0 US qt.)	0W-20 (SAE Viscosity Number), API SN (or above) or ACEA C2 *3
Recommends			
			
Dual clutch transmission fluid		1.6 ~ 1.7 l (1.69 ~ 1.79 US qt.)	HK D DCTF TGO-10 (SK) SPIRAX S6 GHDE 70W DCTF (H.K.SHELL) 7 DCTF HKM (S-OIL) (API GL-4, SAE 70W)
Engine clutch actuator fluid		80 ~ 120 cc (0.08 ~ 0.13 US qt.)	FMVSS116 DOT3
Engine coolant		6.7 l (7.07 US qt.)	Mixture of antifreeze and water (Phosphate-based Ethylene glycol coolant for aluminum radiator)
Inverter coolant		3.2 l (3.38 US qt.)	
Brake fluid		0.7 ~ 0.8 l (0.74~0.85 US qt.)	SAE J1704 DOT-4LV, FMVSS 116 DOT-4, ISO4925 CLASS-6
Fuel	Hybrid vehicle	45 l (11.9 US gal.)	Refer to "Fuel requirements" in the Foreword chapter.
	Plug-in hybrid vehicle	43 l (11.4 US gal.)	

\*1 : Refer to the recommended SAE viscosity numbers on the next page.

\*2 : Engine oils labeled Energy Conserving Oil are now available. Along with other additional benefits, they contribute to fuel economy by reducing the amount of fuel necessary to overcome engine friction. Often, these improvements are difficult to measure in everyday driving, but in a year's time, they can offer significant cost and energy savings.

\*3 : If the ACEA C2 engine oil is not available in your country, you are able to use ILSAC GF-3 (or above) or ACEA A3 (or above).

## Recommended SAE Viscosity Number

### CAUTION

**Always be sure to clean the area around any filler plug, drain plug, or dipstick before checking or draining any lubricant. This is especially important in dusty or sandy areas and when the vehicle is used on unpaved roads. Cleaning the plug and dipstick areas will prevent dirt and grit from entering the engine and other mechanisms that could be damaged.**

Engine oil viscosity (thickness) has an effect on fuel economy and cold weather operating (engine start and engine oil flowability). Lower viscosity engine oils can provide better fuel economy and cold weather performance, however, higher viscosity engine oils are required for satisfactory lubrication in hot weather.

Using oils of any viscosity other than those recommended could result in engine damage.

When choosing an oil, consider the range of temperature your vehicle will be operated in before the next oil change. Proceed to select the recommended oil viscosity from the chart.

Temperature Range for SAE Viscosity Numbers										
Temperature	°C	-30	-20	-10	0	10	20	30	40	50
	(°F)	-10	0	20	40	60	80	100	120	
Engine Oil *1						10W-30				
						0/5W-20, 0/5W-30				

\*1 : For better fuel economy, it is recommended to use the engine oil of a viscosity grade SAE 0W-20 (API SN (or above) or ACEA C2). However, if the engine oil is not available in your country, select the proper engine oil using the engine oil viscosity chart.



## VEHICLE IDENTIFICATION NUMBER (VIN)

■ Frame number

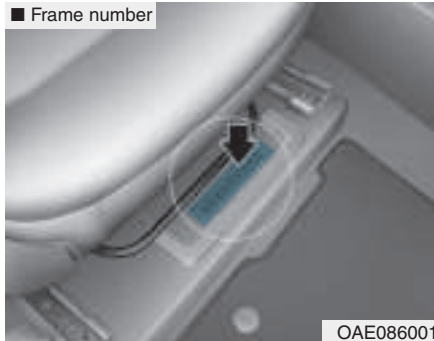

The vehicle identification number (VIN) is the number used in registering your car and in all legal matters pertaining to its ownership, etc.

The number is punched on the floor under the passenger seat. To check the number, open the cover.

■ VIN label



The VIN is also on a plate attached to the top of the dashboard. The number on the plate can easily be seen through the windshield from outside.

## VEHICLE CERTIFICATION LABEL



The vehicle certification label attached on the driver's side center pillar gives the Vehicle Identification Number (VIN).

## TIRE SPECIFICATION AND PRESSURE LABEL



The tires supplied on your new vehicle are chosen to provide the best performance for normal driving.

The tire label located on the driver's side center pillar gives the tire pressures recommended for your car.

## ENGINE NUMBER

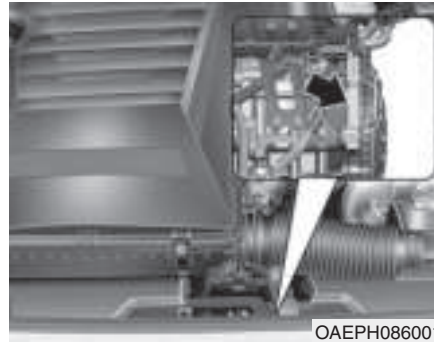

The engine number is stamped on the engine block as shown in the drawing.

# Index

**A**

Accessing your vehicle .....	3-3
Immobilizer System .....	3-12
Remote Key .....	3-3
Smart Key.....	3-7
Air bag - advanced supplemental restraint system.....	2-47
Additional Safety Precautions.....	2-69
Air Bag Warning Labels.....	2-70
How Does the Air Bag System Operate?.....	2-52
Occupant Classification System (OCS) .....	2-58
SRS Care .....	2-68
What to Expect After an Air Bag Inflates.....	2-57
Where Are the Air Bags? .....	2-49
Why Didn't My Air Bag Go Off in a Collision?.....	2-63
Air cleaner.....	7-25
Filter Replacement .....	7-25
Air conditioning system.....	8-6
Appearance care.....	7-67
Exterior Care .....	7-67
Interior Care .....	7-73
Automatic climate control system .....	3-139
Automatic Heating and Air Conditioning .....	3-140
Manual Heating and Air Conditioning.....	3-141
System Maintenance .....	3-149
System Operation .....	3-148

**B**

Battery (12 volt, plug-in hybrid vehicle).....	7-32
Battery Recharging.....	7-33
For Best Battery Service .....	7-33
Reset Features .....	7-34
Before driving .....	5-4
Before Entering the Vehicle .....	5-4
Before Starting .....	5-4
Blind-spot Collision Warning (BCW) .....	5-89
Declaration of conformity .....	5-99
System description .....	5-89
System setting and operation .....	5-90
Warning message and system control .....	5-92
Brake fluid .....	7-23
Checking the Brake Fluid Level .....	7-23
Braking system .....	5-29
Anti-lock Brake System (ABS).....	5-42
AUTO HOLD.....	5-38
Disc Brake Wear Indicator .....	5-30
Electronic Parking Brake (EPB) .....	5-32
Electronic Stability Control (ESC).....	5-44
Good Braking Practices .....	5-49
Hill-Start Assist Control (HAC).....	5-49
Parking Brake (foot type).....	5-30
Power Brakes.....	5-29
Vehicle Stability Management (VSM).....	5-47
Bulb wattage .....	8-3

## C

Child Restraint System (CRS).....	2-36
Children Always in the Rear.....	2-36
Installing a Child Restraint System (CRS).....	2-39
Selecting a Child Restraint System (CRS).....	2-37
Climate control additional features.....	3-155
Automatic Ventilation.....	3-155
Sunroof inside air recirculation.....	3-155
Climate control air filter.....	7-27
Filter Inspection.....	7-27
Coasting guide.....	5-28
Cruise control.....	5-109
Cruise Control Operation.....	5-109

## D

Dimensions.....	8-2
Distance.....	5-122
Door locks.....	3-14
Auto Door Lock/Unlock Features.....	3-18
Child-Protector Rear Door Locks.....	3-18
Operating Door Locks from Inside the Vehicle.....	3-16
Operating Door Locks from Outside the Vehicle.....	3-14
Driver Attention Warning(DAW).....	5-101
Leading Vehicle Departure Alert.....	5-107
Resetting the system.....	5-104
System malfunction.....	5-104

System setting and operation.....	5-101
System standby.....	5-104
Driver position memory system.....	3-20
Easy Access Function.....	3-21
Recalling Positions from Memory.....	3-21
Storing Positions into Memory.....	3-20
Dual clutch transmission.....	5-15
Dual Clutch Transmission Operation.....	5-15
Good Driving Practices.....	5-23
LCD display for transmission temperature and warning message.....	5-17
Parking.....	5-22
Shift Lever Position.....	5-19

## E

Emission control system.....	7-76
Crankcase Emission Control System.....	7-76
Evaporative Emission Control System Including Onboard Refueling Vapor Recovery (ORVR).....	7-76
Exhaust Emission Control System.....	7-77
Engine.....	8-2
Engine compartment.....	7-3
Engine coolant/Inverter coolant.....	7-19
Changing Coolant.....	7-22
Checking the Coolant Level.....	7-19
Engine number.....	8-10
Engine oil.....	7-17
Checking the Engine Oil and Filter.....	7-18



Checking the Engine Oil Level.....	7-17
Explanation of scheduled maintenance items.....	7-15
Exterior features.....	3-45
Fuel Filler Door (Hybrid vehicle).....	3-48
Fuel Filler Door (Plug-in hybrid vehicle).....	3-51
Hood.....	3-45
Tailgate.....	3-46

## F

Forward Collision-Avoidance Assist (FCA)	
- sensor fusion .....	5-64
FCA sensor (Front view camera+ Front radar).....	5-69
FCA warning message and brake control .....	5-66
Limitations of the system.....	5-73
System malfunction.....	5-71
System setting and activation.....	5-64
Forward Collision-Avoidance Assist (FCA)	
(front view camera only).....	5-50
FCA sensor (Front view camera).....	5-55
FCA warning message and brake control .....	5-52
FCA Warning Message and Brake Control.....	5-58
System malfunction.....	5-57
System setting and activation.....	5-50
Forward/Reverse Parking Distance Warning (PDW) ...	3-134
Self-Diagnosis .....	3-138
Fuses .....	7-50
Engine Compartment Panel Fuse Replacement.....	7-52
Fuse/Relay Panel Description .....	7-54
Instrument Panel Fuse Replacement.....	7-51

## H

Hazard warning flasher .....	6-2
Highway Driving Assist (HDA) .....	5-144
System Setting and Operation.....	5-144
Warning Message .....	5-147
Hybrid Starter & Generator (HSG) Belt.....	7-22
Checking the Hybrid Starter & Generator	
(HSG) Belt .....	7-22
Hybrid Vehicle	
Engine Compartment.....	1-6
Exterior Overview .....	1-2
Instrument Panel Overview.....	1-5
Interior Overview .....	1-4

## I

If an accident occurs .....	6-44
If the 12 volt battery is discharged .....	6-5
Before Jump Starting.....	6-5
Jump Starting.....	6-6
If the 12 volt battery is discharged	
(plug-in hybrid vehicle).....	6-9
Jump Starting.....	6-9
If the engine overheats.....	6-12
If the vehicle will not start .....	6-3
If you have a flat tire .....	6-20
With Spare Tire .....	6-20
With Tire Mobility Kit (TMK)- Type A.....	6-25

With Tire Mobility Kit (TMK)- Type B.....	6-33
Ignition switch .....	5-6
Engine Start/Stop Button.....	5-8
Key Ignition Switch .....	5-6
Turning Off the Vehicle.....	5-14
Important safety precautions.....	2-2
Air Bag Hazards .....	2-2
Always Wear Your Seat Belt.....	2-2
Control Your Speed .....	2-3
Driver Distraction.....	2-2
Keep Your Vehicle in Safe Condition .....	2-3
Restrain All Children.....	2-2
In case of an emergency while driving .....	6-2
If the Engine Stalls While Driving.....	6-2
If the Vehicle Stalls at a Crossroad or Crossing .....	6-2
If You Have a Flat Tire While Driving .....	6-3
Infotainment system.....	4-2
Antenna .....	4-2
Audio / Video /Navigation System .....	4-4
Bluetooth® Wireless Technology Hands-Free.....	4-4
Steering Wheel Audio Controls.....	4-3
USB and iPod® port .....	4-2
Instrument cluster .....	3-54
Gauges and Meters.....	3-56
Instrument Cluster Control.....	3-56
LCD Display Messages.....	3-76
Warning and Indicator Lights.....	3-63

Interior features .....	3-158
Cargo Security Screen.....	3-164
Clock .....	3-162
Clothes Hanger .....	3-163
Cup Holder .....	3-158
Floor Mat Anchor(s).....	3-163
Power Outlet .....	3-159
Sunvisor.....	3-159
Wireless Cellular Phone Charging System .....	3-160

## L

Lane Following Assist (LFA) .....	5-137
LFA operation.....	5-139
Limitations of the system.....	5-142
Warning message.....	5-140
Lane Keeping Assist (LKA) .....	5-80
Limitations of the System .....	5-86
LKA operation.....	5-82
LKA system function change.....	5-88
Warning light and message .....	5-85
LCD display .....	3-92
LCD Display Control .....	3-92
LCD display modes.....	3-93
Light bulbs .....	7-56
Daytime Running Light (DRL).....	7-61
Headlamp, Parking Lamp, Turn Signal Lamp and Side Marker.....	7-56
High Mounted Stop Lamp Replacement.....	7-64

Interior Light Bulb Replacement .....	7-65
License Plate Light Bulb Replacement.....	7-65
Rear Combination Light Bulb Replacement.....	7-61
Side Repeater Lamp Replacement .....	7-61
Lighting .....	3-115
Exterior Lights.....	3-115
Interior Lights.....	3-123
Welcome System .....	3-125

## M

Maintenance services .....	7-5
Owner Maintenance Precautions.....	7-5
Owner's Responsibility.....	7-5
Mirrors .....	3-25
Inside Rearview Mirror .....	3-25
Reverse Parking Aid Function .....	3-36
Side View Mirrors .....	3-33

## N

Navigation-based Smart Cruise Control (NSCC).....	5-133
System Setting and Operation.....	5-134

## O

Owner maintenance .....	7-6
How to Disconnect the (-) Cable for Regular Maintenance (Hybrid vehicle) .....	7-7
Owner Maintenance Schedule.....	7-7

## P

Paddle shifter .....	5-25
Regen B mode .....	5-25
Parking brake .....	7-24
Checking the Parking Brake .....	7-24
Plug-in hybrid vehicle	
Engine Compartment.....	1-11
Exterior Overview .....	1-7
Instrument Panel Overview.....	1-10
Interior Overview .....	1-9

## R

Rear Cross-traffic Collision Warning (RCCW) .....	5-151
Detecting Sensor .....	5-155
System description .....	5-151
System setting and operation .....	5-151
Warning message and system control .....	5-153
Rear View Monitor (RVM) .....	3-128
Recommended lubricants and capacities .....	8-7
Recommended SAE Viscosity Number .....	8-8
Regular maintenance (hybrid vehicle).....	7-7
Reverse Parking Distance Warning (PDW) .....	3-130
Self-Diagnosis .....	3-133

**S**

Scheduled maintenance services.....	7-8
Maintenance Under Severe Usage Conditions.....	7-13
Normal Maintenance Schedule .....	7-9
Severe driving conditions.....	7-14
Seat belts.....	2-23
Additional Seat Belt Safety Precautions .....	2-32
Care of Seat Belts.....	2-35
Seat Belt Restraint System.....	2-25
Seat Belt Safety Precautions .....	2-23
Seat Belt Warning Light.....	2-24
Seats .....	2-4
Battery Cooling Duct .....	2-22
Front Seats.....	2-6
Head Restraints .....	2-16
Rear Seats.....	2-12
Safety Precautions .....	2-5
Seat warmers .....	2-20
Smart cruise control .....	5-114
Limitations of the system.....	5-127
Sensor to detect distance to the vehicle ahead.....	5-125
Smart Cruise Control speed.....	5-117
Smart Cruise Control Vehicle-to-Vehicle Distance.....	5-122
To adjust the sensitivity of Smart Cruise Control....	5-116
To convert to Cruise Control mode.....	5-116
Special driving conditions .....	5-162
Driving at Night .....	5-163
Driving in Flooded Areas .....	5-164
Driving in the Rain.....	5-163
Hazardous Driving Conditions.....	5-162
Highway Driving .....	5-164
Rocking the Vehicle .....	5-162
Smooth Cornering .....	5-163
Steering wheel.....	3-22
Electric Power Steering (EPS) .....	3-22
Heated Steering Wheel .....	3-24
Horn.....	3-23
Tilt Steering / Telescope Steering .....	3-22
Storage compartment .....	3-156
Center Console Storage.....	3-156
Glove Box .....	3-156
Multi Box .....	3-157
Sunglass Holder.....	3-157
Sunroof.....	3-41
Resetting the Sunroof.....	3-44
Sliding the Sunroof .....	3-42
Sunroof Opening and Closing.....	3-42
Sunshade.....	3-43
Tilting the Sunroof .....	3-43

**T**

Theft-alarm system .....	3-19
Tire Pressure Monitoring System (TPMS) .....	6-14
Changing a Tire with TPMS .....	6-18
Check Tire Pressure.....	6-14
Low Tire Pressure LCD Display with Position Indicator .....	6-16
Low Tire Pressure Telltale.....	6-16
Tire Pressure Monitoring System.....	6-15
TPMS Malfunction Indicator .....	6-17
Tire specification and pressure label .....	8-10
Tires and wheels .....	7-35, 8-5
All Season Tires .....	7-48
Check Tire Inflation Pressure.....	7-37
Low Aspect Ratio Tires.....	7-49
Radial-Ply Tires.....	7-48
Recommended Cold Tire Inflation Pressures.....	7-36
Snow Tires.....	7-48
Summer Tires .....	7-48
Tire Care.....	7-35
Tire Maintenance.....	7-41
Tire Replacement.....	7-39
Tire Rotation.....	7-38
Tire Sidewall Labeling .....	7-41
Tire Terminology and Definitions.....	7-45
Tire Traction .....	7-40
Wheel Alignment and Tire Balance .....	7-39
Wheel Replacement.....	7-40

Towing .....	6-40
Emergency Towing .....	6-42
Removable Towing Hook.....	6-41
Towing Service.....	6-40
Trailer towing.....	5-173
Trip computer (hybrid vehicle).....	3-105
Trip modes.....	3-105
Trip computer (plug-in hybrid vehicle) .....	3-110
Trip modes .....	3-110

**V**

Vehicle certification label .....	8-9
Vehicle Identification Number (VIN).....	8-9
Vehicle load limit.....	5-168
Tire Loading Information Label.....	5-169
Volume and weight .....	8-6

## W

Washer fluid .....	7-24
Checking the Washer Fluid Level .....	7-24
Windows .....	3-37
Power Windows.....	3-38
Windshield defrosting and defogging.....	3-151
Auto Defogging System .....	3-153
Defogging Logic .....	3-152
Rear Window Defroster.....	3-152
To Defog Inside Windshield.....	3-151
To Defrost Outside Windshield.....	3-152
Winter driving.....	5-165
Snow or Icy Conditions.....	5-165
Winter Precautions .....	5-165
Wiper Blades.....	7-29
Blade Inspection .....	7-29
Blade Replacement.....	7-29
Wipers and washers .....	3-126
Windshield Washers .....	3-127
Windshield Wipers .....	3-126