



**BUREAU  
VERITAS**



## TEST REPORT

# Engineering recommendation G98

**Requirements for the connection of Fully Type Tested Micro-generators (up to and including 16 A per phase) in parallel with public Low Voltage Distribution Networks.**

<b>Report reference number</b> .....	<b>PVUK180906N022</b>
Date of issue .....	2019-02-20
Total number of pages .....	189
<b>Testing laboratory name</b> .....	<b>Bureau Veritas Shenzhen Co., Ltd. Dongguan Branch</b>
Address .....	No. 34, Chenwulu Section, Guantai Rd., Houjie Town, Dongguan City, Guangdong 523942, China
<b>Applicant's name</b> .....	<b>Huawei Technologies Co., Ltd.</b>
Address .....	Administration Building, Headquarters of Huawei Technologies Co., Ltd., Bantian, Longgang District, Shenzhen, 518129, P.R. China
<b>Test specification</b>	
Standard.....	G98-1/1
<b>Certificate</b> .....	<b>Certificate of compliance</b>
Test report form number .....	TEST REPORT G98-1 VER.0
Master TRF .....	Bureau Veritas Shenzhen Co., Ltd. Dongguan Branch
<b>Test item description</b> .....	<b>SOLAR INVERTER</b>
Trademark .....	 <b>HUAWEI</b>
Model / Type .....	SUN2000-3KTL-M0, SUN2000-4KTL-M0, SUN2000-5KTL-M0, SUN2000-6KTL-M0, SUN2000-8KTL-M0, SUN2000-10KTL-M0, SUN2000-3KTL-M1, SUN2000-4KTL-M1, SUN2000-5KTL-M1, SUN2000-6KTL-M1, SUN2000-8KTL-M1, SUN2000-10KTL-M1
<small>This report is governed by, and incorporates by reference, CPS Conditions of Service as posted at the date of issuance of this report at <a href="http://www.bureauveritas.com/home/about-us/our-business/cps/about-us/terms-conditions">http://www.bureauveritas.com/home/about-us/our-business/cps/about-us/terms-conditions</a> and is intended for your exclusive use. Any copying or replication of this report to or for any other person or entity, or use of our name or trademark, is permitted only with our prior written permission. This report sets forth our findings solely with respect to the test samples identified herein. The results set forth in this report are not indicative or representative of the quality or characteristics of the lot from which a test sample was taken or any similar or identical product unless specifically and expressly noted. Our report includes all of the tests requested by you and the results thereof based upon the information that you provided to us. Measurement uncertainty is only provided upon request for accredited tests. You have 60 days from date of issuance of this report to notify us of any material error or omission caused by our negligence or if you require measurement uncertainty; provided, however, that such notice shall be in writing and shall specifically address the issue you wish to raise. A failure to raise such issue within the prescribed time shall constitute your unqualified acceptance of the completeness of this report, the tests conducted and the correctness of the report contents.</small>	

<b>Ratings</b> ..... :	SUN2000-3KTL-M0, SUN2000-3KTL-M1	SUN2000-4KTL-M0, SUN2000-4KTL-M1	SUN2000-5KTL-M0, SUN2000-5KTL-M1
MPP DC voltage range [V]..... :	140-980		
Input DC voltage range [V]..... :	140-1100, max. 1100		
Input DC current [A]..... :	Max. 11 x 2 strings		
Battery side DC voltage range [V].... :	max.1100		
Battery side DC current [A]..... :	Max. 16		
Output AC voltage [V]..... :	230/400, 3(N)~ + PE, 50Hz		
Output AC current [A]..... :	Max. 5,1	Max. 6,8	Max. 8,5
Nominal Output power [kVA]..... :	3,0	4,0	5,0
Maximum Output power [kVA]..... :	3,3	4,4	5,5
<b>Ratings</b> ..... :	SUN2000-6KTL-M0, SUN2000-6KTL-M1	SUN2000-8KTL-M0, SUN2000-8KTL-M1	SUN2000-10KTL-M0, SUN2000-10KTL-M1
MPP DC voltage range [V]..... :	140-980		
Input DC voltage range [V]..... :	140-1100, max. 1100		
Input DC current [A]..... :	Max. 11 x 2 strings		
Battery side DC voltage range [V].... :	max.1100		
Battery side DC current [A]..... :	Max. 16		
Output AC voltage [V]..... :	230/400, 3(N)~ + PE, 50Hz		
Output AC current [A]..... :	Max. 10,1	Max. 13,5	Max. 16,9
Nominal Output power [kVA]..... :	6,0	8,0	10,0
Maximum Output power [kVA]..... :	6,6	8,8	11,0

<b>Testing Location</b> .....	<b>Bureau Veritas Shenzhen Co., Ltd. Dongguan Branch</b>
Address .....	No. 34, Chenwulu Section, Guantai Rd., Houjie Town, Dongguan City, Guangdong 523942, China
Tested by (name and signature) .....	James Huang 
Approved by (name and signature) .....	Ted Wu 
<b>Manufacturer's name</b> .....	<b>Huawei Technologies Co., Ltd.</b>
Manufacturer address .....	Administration Building, Headquarters of Huawei Technologies Co., Ltd., Bantian, Longgang District, Shenzhen, 518129, P.R. China
<b>Factory's name 1</b> .....	<b>Huawei Machine Co., Ltd.</b>
Factory address 1 .....	No. 2 New City Avenue, Songshan Lake Sci. & Tech. Industry Park, 523808, Dongguan, P.R. China
<b>Factory's name 2</b> .....	<b>Huazhi Machine Co., Ltd.</b>
Factory address 2 .....	A District, Yingzhan Industrial Park, Kengzi Sub-district office, Pingshan District, Shenzhen, 518122

Document History			
Date	Internal reference	Modification / Change / Status	Revision
2019-02-20	James Huang	Initial report was written	--
Supplementary information:			

<b>Test items particulars</b>	
Equipment mobility.....	: Permanent connection
Operating condition.....	: Continuous
Class of equipment .....	: Class I
Protection against ingress of water..	: IP65 according to EN 60529
Mass of equipment [kg].....	: 18
<b>Test case verdicts</b>	
Test case does not apply to the test object.....	: N/A
Test item does meet the requirement.....	: P(ass)
Test item does not meet the requirement.....	: F(ail)
<b>Testing</b>	
Date of receipt of test item .....	: 2018-09-06
Date(s) of performance of test.....	: 2018-09-06 to 2018-12-16
<b>General remarks:</b>	
<p>The test result presented in this report relate only to the object(s) tested. The report shall state compliance of the tested objects with the requirements of G98-1. This report must not be reproduced in part or in full without the written approval of the issuing testing laboratory.</p> <p>"(see Annex #)" refers to additional information appended to the report.          "(see appended table)" refers to a table appended to the report.</p> <p>Throughout this report a comma is used as the decimal separator.</p>	
<b>This Test Report consists of the following documents:</b>	
<ol style="list-style-type: none"> <li>1. Test Results</li> <li>2. Annex No. 1 – EMC Test Report</li> <li>3. Annex No. 2 – Pictures of the unit</li> <li>4. Annex No. 3 – Test equipment list</li> </ol>	

Copy of marking plate

 型号 Model: SUN2000-3KTL-M0  
名称 Name: 太阳能光伏逆变器  
SOLAR INVERTER

最大输入电压 d.c. Max. Input Voltage: 1100 Vd.c.  
最大输入电流 d.c. Max. Input Current: 11 A/11 A  
输入短路电流 Isc: 15 A/15 A  
MPPT电压范围 d.c. MPPT Range: 140 - 980Vd.c.  
输出电压 a.c. Output Nominal Voltage:  
220/380Va.c., 230/400Va.c., 3(N)~+⊕  
输出频率 a.c. Nominal Operating Frequency: 50/60 Hz  
额定输出功率 a.c. Output Rated Power: 3kVA \*  
最大视在功率 a.c. Max. Output Apparent Power: 3.3kVA  
最大输出电流 a.c. Max. Output Current: 5.1A  
功率因数 Power Factor: 0.8(lagging)-0.8(leading)  
温度范围 Operating Temperature Range: - 25 - +60 °C  
海拔Altitude: 4000m (>3000m refer to user manual)  
过电压类别 Overvoltage Category: II(DC)/III(AC)  
通讯方式 Communication: RS485/WLAN/PLC  
逆变器拓扑 Inverter Topology: Non-Isolation  
防护等级 Enclosure: IP65  
保护等级 Protection Class: I  
\*: CEI 0-16 & CEI 0-21 : 3kW

华为技术有限公司 HUAWEI TECHNOLOGIES CO., LTD. 中国制造 MADE IN CHINA  
HQ of Huawei, Bantian, Longgang District, Shenzhen, 518129, P.R.C.

 型号 Model: SUN2000-3KTL-M0  
名称 Name: 太阳能光伏逆变器  
SOLAR INVERTER

最大输入电压 d.c. Max. Input Voltage: 1100 Vd.c.  
最大输入电流 d.c. Max. Input Current: 11 A/11 A  
输入短路电流 Isc: 15 A/15 A  
MPPT电压范围 d.c. MPPT Range: 140 - 980Vd.c.  
输出电压 a.c. Output Nominal Voltage:  
220/380Va.c., 230/400Va.c., 3(N)~+⊕  
输出频率 a.c. Nominal Operating Frequency: 50/60 Hz  
额定输出功率 a.c. Output Rated Power: 3kVA \*  
最大视在功率 a.c. Max. Output Apparent Power: 3.3kVA  
最大输出电流 a.c. Max. Output Current: 5.1A  
功率因数 Power Factor: 0.8(lagging)-0.8(leading)  
温度范围 Operating Temperature Range: - 25 - +60 °C  
海拔Altitude: 4000m (>3000m refer to user manual)  
过电压类别 Overvoltage Category: II(DC)/III(AC)  
通讯方式 Communication: RS485/WLAN/PLC  
逆变器拓扑 Inverter Topology: Non-Isolation  
防护等级 Enclosure: IP65  
保护等级 Protection Class: I  
电弧故障保护 AFCI: TYPE I  
\*: CEI 0-16 & CEI 0-21: 3kW

华为技术有限公司 HUAWEI TECHNOLOGIES CO., LTD. 中国制造 MADE IN CHINA  
HQ of Huawei, Bantian, Longgang District, Shenzhen, 518129, P.R.C.

 型号 Model: SUN2000-3KTL-M0  
名称 Name: 太阳能光伏逆变器  
SOLAR INVERTER

最大输入电压 d.c. Max. Input Voltage: 1100 Vd.c.  
最大输入电流 d.c. Max. Input Current: 11 A/11 A  
输入短路电流 Isc: 15 A/15 A  
MPPT电压范围 d.c. MPPT Range: 140 - 980Vd.c.  
输出电压 a.c. Output Nominal Voltage:  
220/380Va.c., 230/400Va.c., 3(N)~+⊕  
输出频率 a.c. Nominal Operating Frequency: 50/60 Hz  
额定输出功率 a.c. Output Rated Power: 3kVA \*  
最大视在功率 a.c. Max. Output Apparent Power: 3.3kVA  
最大输出电流 a.c. Max. Output Current: 5.1A  
功率因数 Power Factor: 0.8(lagging)-0.8(leading)  
温度范围 Operating Temperature Range: - 25 - +60 °C  
海拔Altitude: 4000m (>3000m refer to user manual)  
过电压类别 Overvoltage Category: II(DC)/III(AC)  
通讯方式 Communication: RS485/WLAN/PLC  
逆变器拓扑 Inverter Topology: Non-Isolation  
防护等级 Enclosure: IP65  
保护等级 Protection Class: I  
\*: CEI 0-16 & CEI 0-21: 3kW

华为技术有限公司 HUAWEI TECHNOLOGIES CO., LTD. 中国制造 MADE IN CHINA  
HQ of Huawei, Bantian, Longgang District, Shenzhen, 518129, P.R.C.

 型号 Model: SUN2000-3KTL-M0  
名称 Name: 太阳能光伏逆变器  
SOLAR INVERTER

最大输入电压 d.c. Max. Input Voltage: 1100 Vd.c.  
最大输入电流 d.c. Max. Input Current: 11 A/11 A  
输入短路电流 Isc: 15 A/15 A  
MPPT电压范围 d.c. MPPT Range: 140 - 980Vd.c.  
输出电压 a.c. Output Nominal Voltage:  
220/380Va.c., 230/400Va.c., 3(N)~+⊕  
输出频率 a.c. Nominal Operating Frequency: 50/60 Hz  
额定输出功率 a.c. Output Rated Power: 3kVA \*  
最大视在功率 a.c. Max. Output Apparent Power: 3.3kVA  
最大输出电流 a.c. Max. Output Current: 5.1A  
功率因数 Power Factor: 0.8(lagging)-0.8(leading)  
温度范围 Operating Temperature Range: - 25 - +60 °C  
海拔Altitude: 4000m (>3000m refer to user manual)  
过电压类别 Overvoltage Category: II(DC)/III(AC)  
通讯方式 Communication: RS485/WLAN/PLC  
逆变器拓扑 Inverter Topology: Non-Isolation  
防护等级 Enclosure: IP65  
保护等级 Protection Class: I  
\*: CEI 0-16 & CEI 0-21: 3kW

华为技术有限公司 HUAWEI TECHNOLOGIES CO., LTD. 中国制造 MADE IN CHINA  
HQ of Huawei, Bantian, Longgang District, Shenzhen, 518129, P.R.C.

 型号 Model: SUN2000-4KTL-M0  
名称 Name: 太阳能光伏逆变器  
SOLAR INVERTER

最大输入电压 d.c. Max. Input Voltage: 1100 Vd.c.  
最大输入电流 d.c. Max. Input Current: 11 A/11 A  
输入短路电流 Isc: 15 A/15 A  
MPPT电压范围 d.c. MPPT Range: 140 - 980Vd.c.  
输出电压 a.c. Output Nominal Voltage:  
220/380Va.c., 230/400Va.c., 3(N)~+⊕  
输出频率 a.c. Nominal Operating Frequency: 50/60 Hz  
额定输出功率 a.c. Output Rated Power: 4kVA \*  
最大视在功率 a.c. Max. Output Apparent Power: 4.4kVA  
最大输出电流 a.c. Max. Output Current: 6.8A  
功率因数 Power Factor: 0.8(lagging)-0.8(leading)  
温度范围 Operating Temperature Range: - 25 - +60 °C  
海拔Altitude: 4000m (>3000m refer to user manual)  
过电压类别 Overvoltage Category: II(DC)/III(AC)  
通讯方式 Communication: RS485/WLAN/PLC  
逆变器拓扑 Inverter Topology: Non-Isolation  
防护等级 Enclosure: IP65  
保护等级 Protection Class: I  
\*: CEI 0-16 & CEI 0-21 : 4kW

华为技术有限公司 HUAWEI TECHNOLOGIES CO., LTD. 中国制造 MADE IN CHINA  
HQ of Huawei, Bantian, Longgang District, Shenzhen, 518129, P.R.C.

 型号 Model: SUN2000-4KTL-M0  
名称 Name: 太阳能光伏逆变器  
SOLAR INVERTER

最大输入电压 d.c. Max. Input Voltage: 1100 Vd.c.  
最大输入电流 d.c. Max. Input Current: 11 A/11 A  
输入短路电流 Isc: 15 A/15 A  
MPPT电压范围 d.c. MPPT Range: 140 - 980Vd.c.  
输出电压 a.c. Output Nominal Voltage:  
220/380Va.c., 230/400Va.c., 3(N)~+⊕  
输出频率 a.c. Nominal Operating Frequency: 50/60 Hz  
额定输出功率 a.c. Output Rated Power: 4kVA \*  
最大视在功率 a.c. Max. Output Apparent Power: 4.4kVA  
最大输出电流 a.c. Max. Output Current: 6.8A  
功率因数 Power Factor: 0.8(lagging)-0.8(leading)  
温度范围 Operating Temperature Range: - 25 - +60 °C  
海拔Altitude: 4000m (>3000m refer to user manual)  
过电压类别 Overvoltage Category: II(DC)/III(AC)  
通讯方式 Communication: RS485/WLAN/PLC  
逆变器拓扑 Inverter Topology: Non-Isolation  
防护等级 Enclosure: IP65  
保护等级 Protection Class: I  
\*: CEI 0-16 & CEI 0-21: 4kW

华为技术有限公司 HUAWEI TECHNOLOGIES CO., LTD. 中国制造 MADE IN CHINA  
HQ of Huawei, Bantian, Longgang District, Shenzhen, 518129, P.R.C.

Copy of marking plate

 型号 Model: SUN2000-4KTL-M0  
名称 Name: 太阳能光伏逆变器  
SOLAR INVERTER

最大输入电压 d.c. Max. Input Voltage: 1100 Vd.c.  
最大输入电流 d.c. Max. Input Current: 11 A/11 A  
输入短路电流 Isc: 15 A/15 A  
MPPT电压范围 d.c. MPPT Range: 140-980Vd.c.  
输出电压 a.c. Output Nominal Voltage:  
220/380Va.c., 230/400Va.c., 3(N)→+⊕  
输出频率 a.c. Nominal Operating Frequency: 50/60 Hz  
额定输出功率 a.c. Output Rated Power: 4kVA \*  
最大视在功率 a.c. Max. Output Apparent Power: 4.4kVA  
最大输出电流 a.c. Max. Output Current: 6.8A  
功率因数 Power Factor: 0.8(lagging)-0.8(leading)  
温度范围 Operating Temperature Range: -25 + +60 °C  
海拔Altitude: 4000m (>3000m refer to user manual)  
过电压类别 Overvoltage Category: II(DC)/III(AC)  
通讯方式 Communication: RS485/WLAN/PLC  
逆变器拓扑 Inverter Topology: Non-Isolation  
电池 Battery: 1100VDC Max; 16A Max  
防护等级 Enclosure: IP65  
保护等级 Protection Class: I  
\*: CEI 0-16 & CEI 0-21:4kW

华为技术有限公司 中国制造  
HUAWEI TECHNOLOGIES CO., LTD. MADE IN CHINA  
HQ of Huawei, Bantian, Longgang District, Shenzhen, 518129, P.R.C.

 型号 Model: SUN2000-4KTL-M0  
名称 Name: 太阳能光伏逆变器  
SOLAR INVERTER

最大输入电压 d.c. Max. Input Voltage: 1100 Vd.c.  
最大输入电流 d.c. Max. Input Current: 11 A/11 A  
输入短路电流 Isc: 15 A/15 A  
MPPT电压范围 d.c. MPPT Range: 140-980Vd.c.  
输出电压 a.c. Output Nominal Voltage:  
220/380Va.c., 230/400Va.c., 3(N)→+⊕  
输出频率 a.c. Nominal Operating Frequency: 50/60 Hz  
额定输出功率 a.c. Output Rated Power: 4kVA \*  
最大视在功率 a.c. Max. Output Apparent Power: 4.4kVA  
最大输出电流 a.c. Max. Output Current: 6.8A  
功率因数 Power Factor: 0.8(lagging)-0.8(leading)  
温度范围 Operating Temperature Range: -25 + +60 °C  
海拔Altitude: 4000m (>3000m refer to user manual)  
过电压类别 Overvoltage Category: II(DC)/III(AC)  
通讯方式 Communication: RS485/WLAN/PLC  
逆变器拓扑 Inverter Topology: Non-Isolation  
电池 Battery: 1100VDC Max; 16A Max  
防护等级 Enclosure: IP65  
保护等级 Protection Class: I  
\*: CEI 0-16 & CEI 0-21:4kW

华为技术有限公司 中国制造  
HUAWEI TECHNOLOGIES CO., LTD. MADE IN CHINA  
HQ of Huawei, Bantian, Longgang District, Shenzhen, 518129, P.R.C.

 型号 Model: SUN2000-5KTL-M0  
名称 Name: 太阳能光伏逆变器  
SOLAR INVERTER

最大输入电压 d.c. Max. Input Voltage: 1100 Vd.c.  
最大输入电流 d.c. Max. Input Current: 11 A/11 A  
输入短路电流 Isc: 15 A/15 A  
MPPT电压范围 d.c. MPPT Range: 140-980Vd.c.  
输出电压 a.c. Output Nominal Voltage:  
220/380Va.c., 230/400Va.c., 3(N)→+⊕  
输出频率 a.c. Nominal Operating Frequency: 50/60 Hz  
额定输出功率 a.c. Output Rated Power: 5kVA \*  
最大视在功率 a.c. Max. Output Apparent Power: 5.5kVA  
最大输出电流 a.c. Max. Output Current: 8.5A  
功率因数 Power Factor: 0.8(lagging)-0.8(leading)  
温度范围 Operating Temperature Range: -25 + +60 °C  
海拔Altitude: 4000m (>3000m refer to user manual)  
过电压类别 Overvoltage Category: II(DC)/III(AC)  
通讯方式 Communication: RS485/WLAN/PLC  
逆变器拓扑 Inverter Topology: Non-Isolation  
防护等级 Enclosure: IP65  
保护等级 Protection Class: I  
\*: CEI 0-16 & CEI 0-21: 5kW

华为技术有限公司 中国制造  
HUAWEI TECHNOLOGIES CO., LTD. MADE IN CHINA  
HQ of Huawei, Bantian, Longgang District, Shenzhen, 518129, P.R.C.

 型号 Model: SUN2000-5KTL-M0  
名称 Name: 太阳能光伏逆变器  
SOLAR INVERTER

最大输入电压 d.c. Max. Input Voltage: 1100 Vd.c.  
最大输入电流 d.c. Max. Input Current: 11 A/11 A  
输入短路电流 Isc: 15 A/15 A  
MPPT电压范围 d.c. MPPT Range: 140-980Vd.c.  
输出电压 a.c. Output Nominal Voltage:  
220/380Va.c., 230/400Va.c., 3(N)→+⊕  
输出频率 a.c. Nominal Operating Frequency: 50/60 Hz  
额定输出功率 a.c. Output Rated Power: 5kVA \*  
最大视在功率 a.c. Max. Output Apparent Power: 5.5kVA  
最大输出电流 a.c. Max. Output Current: 8.5A  
功率因数 Power Factor: 0.8(lagging)-0.8(leading)  
温度范围 Operating Temperature Range: -25 + +60 °C  
海拔Altitude: 4000m (>3000m refer to user manual)  
过电压类别 Overvoltage Category: II(DC)/III(AC)  
通讯方式 Communication: RS485/WLAN/PLC  
逆变器拓扑 Inverter Topology: Non-Isolation  
防护等级 Enclosure: IP65  
保护等级 Protection Class: I  
\*: CEI 0-16 & CEI 0-21:5kW

华为技术有限公司 中国制造  
HUAWEI TECHNOLOGIES CO., LTD. MADE IN CHINA  
HQ of Huawei, Bantian, Longgang District, Shenzhen, 518129, P.R.C.

 型号 Model: SUN2000-5KTL-M0  
名称 Name: 太阳能光伏逆变器  
SOLAR INVERTER

最大输入电压 d.c. Max. Input Voltage: 1100 Vd.c.  
最大输入电流 d.c. Max. Input Current: 11 A/11 A  
输入短路电流 Isc: 15 A/15 A  
MPPT电压范围 d.c. MPPT Range: 140-980Vd.c.  
输出电压 a.c. Output Nominal Voltage:  
220/380Va.c., 230/400Va.c., 3(N)→+⊕  
输出频率 a.c. Nominal Operating Frequency: 50/60 Hz  
额定输出功率 a.c. Output Rated Power: 5kVA \*  
最大视在功率 a.c. Max. Output Apparent Power: 5.5kVA  
最大输出电流 a.c. Max. Output Current: 8.5A  
功率因数 Power Factor: 0.8(lagging)-0.8(leading)  
温度范围 Operating Temperature Range: -25 + +60 °C  
海拔Altitude: 4000m (>3000m refer to user manual)  
过电压类别 Overvoltage Category: II(DC)/III(AC)  
通讯方式 Communication: RS485/WLAN/PLC  
逆变器拓扑 Inverter Topology: Non-Isolation  
电池 Battery: 1100VDC Max; 16A Max  
防护等级 Enclosure: IP65  
保护等级 Protection Class: I  
\*: CEI 0-16 & CEI 0-21:5kW

华为技术有限公司 中国制造  
HUAWEI TECHNOLOGIES CO., LTD. MADE IN CHINA  
HQ of Huawei, Bantian, Longgang District, Shenzhen, 518129, P.R.C.

 型号 Model: SUN2000-5KTL-M0  
名称 Name: 太阳能光伏逆变器  
SOLAR INVERTER

最大输入电压 d.c. Max. Input Voltage: 1100 Vd.c.  
最大输入电流 d.c. Max. Input Current: 11 A/11 A  
输入短路电流 Isc: 15 A/15 A  
MPPT电压范围 d.c. MPPT Range: 140-980Vd.c.  
输出电压 a.c. Output Nominal Voltage:  
220/380Va.c., 230/400Va.c., 3(N)→+⊕  
输出频率 a.c. Nominal Operating Frequency: 50/60 Hz  
额定输出功率 a.c. Output Rated Power: 5kVA \*  
最大视在功率 a.c. Max. Output Apparent Power: 5.5kVA  
最大输出电流 a.c. Max. Output Current: 8.5A  
功率因数 Power Factor: 0.8(lagging)-0.8(leading)  
温度范围 Operating Temperature Range: -25 + +60 °C  
海拔Altitude: 4000m (>3000m refer to user manual)  
过电压类别 Overvoltage Category: II(DC)/III(AC)  
通讯方式 Communication: RS485/WLAN/PLC  
逆变器拓扑 Inverter Topology: Non-Isolation  
电池 Battery: 1100VDC Max; 16A Max  
防护等级 Enclosure: IP65  
保护等级 Protection Class: I  
\*: CEI 0-16 & CEI 0-21:5kW

华为技术有限公司 中国制造  
HUAWEI TECHNOLOGIES CO., LTD. MADE IN CHINA  
HQ of Huawei, Bantian, Longgang District, Shenzhen, 518129, P.R.C.

Copy of marking plate

 型号 Model: SUN2000-6KTL-M0  
名称 Name: 太阳能光伏逆变器  
SOLAR INVERTER

最大输入电压 d.c. Max. Input Voltage: 1100 Vd.c.  
最大输入电流 d.c. Max. Input Current: 11 A/11 A  
输入短路电流 Isc: 15 A/15 A  
MPPT电压范围 d.c. MPPT Range: 140-980Vd.c.  
输出电压 a.c. Output Nominal Voltage:  
220/380Va.c., 230/400Va.c., 3(N)~+⊕  
输出频率 a.c. Nominal Operating Frequency: 50/60 Hz  
额定输出功率 a.c. Output Rated Power: 6kVA \*  
最大视在功率 a.c. Max. Output Apparent Power: 6.6kVA  
最大输出电流 a.c. Max. Output Current: 10.1A  
功率因数 Power Factor: 0.8(lagging)-0.8(leading)  
温度范围 Operating Temperature Range: -25 ~ +60 °C  
海拔Altitude: 4000m (>3000m refer to user manual)  
过电压类别 Overvoltage Category: II(DC)/III(AC)  
通讯方式 Communication: RS485/WLAN/PLC  
逆变器拓扑 Inverter Topology: Non-isolation  
防护等级 Enclosure: IP65  
保护等级 Protection Class: I  
\*: CEI 0-16 & CEI 0-21: 6kW

华为技术有限公司 HUAWEI TECHNOLOGIES CO., LTD. 中国制造 MADE IN CHINA  
HQ of Huawei, Bantian, Longgang District, Shenzhen, 518129, P.R.C

 型号 Model: SUN2000-6KTL-M0  
名称 Name: 太阳能光伏逆变器  
SOLAR INVERTER

最大输入电压 d.c. Max. Input Voltage: 1100 Vd.c.  
最大输入电流 d.c. Max. Input Current: 11 A/11 A  
输入短路电流 Isc: 15 A/15 A  
MPPT电压范围 d.c. MPPT Range: 140-980Vd.c.  
输出电压 a.c. Output Nominal Voltage:  
220/380Va.c., 230/400Va.c., 3(N)~+⊕  
输出频率 a.c. Nominal Operating Frequency: 50/60 Hz  
额定输出功率 a.c. Output Rated Power: 6kVA \*  
最大视在功率 a.c. Max. Output Apparent Power: 6.6kVA  
最大输出电流 a.c. Max. Output Current: 10.1A  
功率因数 Power Factor: 0.8(lagging)-0.8(leading)  
温度范围 Operating Temperature Range: -25 ~ +60 °C  
海拔Altitude: 4000m (>3000m refer to user manual)  
过电压类别 Overvoltage Category: II(DC)/III(AC)  
通讯方式 Communication: RS485/WLAN/PLC  
逆变器拓扑 Inverter Topology: Non-isolation  
防护等级 Enclosure: IP65  
保护等级 Protection Class: I  
电弧故障保护 AFCI: TYPE I  
\*: CEI 0-16 & CEI 0-21: 6kW

华为技术有限公司 HUAWEI TECHNOLOGIES CO., LTD. 中国制造 MADE IN CHINA  
HQ of Huawei, Bantian, Longgang District, Shenzhen, 518129, P.R.C

 型号 Model: SUN2000-6KTL-M0  
名称 Name: 太阳能光伏逆变器  
SOLAR INVERTER

最大输入电压 d.c. Max. Input Voltage: 1100 Vd.c.  
最大输入电流 d.c. Max. Input Current: 11 A/11 A  
输入短路电流 Isc: 15 A/15 A  
MPPT电压范围 d.c. MPPT Range: 140-980Vd.c.  
输出电压 a.c. Output Nominal Voltage:  
220/380Va.c., 230/400Va.c., 3(N)~+⊕  
输出频率 a.c. Nominal Operating Frequency: 50/60 Hz  
额定输出功率 a.c. Output Rated Power: 6kVA \*  
最大视在功率 a.c. Max. Output Apparent Power: 6.6kVA  
最大输出电流 a.c. Max. Output Current: 10.1A  
功率因数 Power Factor: 0.8(lagging)-0.8(leading)  
温度范围 Operating Temperature Range: -25 ~ +60 °C  
海拔Altitude: 4000m (>3000m refer to user manual)  
过电压类别 Overvoltage Category: II(DC)/III(AC)  
通讯方式 Communication: RS485/WLAN/PLC  
逆变器拓扑 Inverter Topology: Non-isolation  
防护等级 Enclosure: IP65  
保护等级 Protection Class: I  
\*: CEI 0-16 & CEI 0-21: 6kW

华为技术有限公司 HUAWEI TECHNOLOGIES CO., LTD. 中国制造 MADE IN CHINA  
HQ of Huawei, Bantian, Longgang District, Shenzhen, 518129, P.R.C

 型号 Model: SUN2000-6KTL-M0  
名称 Name: 太阳能光伏逆变器  
SOLAR INVERTER

最大输入电压 d.c. Max. Input Voltage: 1100 Vd.c.  
最大输入电流 d.c. Max. Input Current: 11 A/11 A  
输入短路电流 Isc: 15 A/15 A  
MPPT电压范围 d.c. MPPT Range: 140-980Vd.c.  
输出电压 a.c. Output Nominal Voltage:  
220/380Va.c., 230/400Va.c., 3(N)~+⊕  
输出频率 a.c. Nominal Operating Frequency: 50/60 Hz  
额定输出功率 a.c. Output Rated Power: 6kVA \*  
最大视在功率 a.c. Max. Output Apparent Power: 6.6kVA  
最大输出电流 a.c. Max. Output Current: 10.1A  
功率因数 Power Factor: 0.8(lagging)-0.8(leading)  
温度范围 Operating Temperature Range: -25 ~ +60 °C  
海拔Altitude: 4000m (>3000m refer to user manual)  
过电压类别 Overvoltage Category: II(DC)/III(AC)  
通讯方式 Communication: RS485/WLAN/PLC  
逆变器拓扑 Inverter Topology: Non-isolation  
防护等级 Enclosure: IP65  
保护等级 Protection Class: I  
电弧故障保护 AFCI: TYPE I  
\*: CEI 0-16 & CEI 0-21: 6kW

华为技术有限公司 HUAWEI TECHNOLOGIES CO., LTD. 中国制造 MADE IN CHINA  
HQ of Huawei, Bantian, Longgang District, Shenzhen, 518129, P.R.C

 型号 Model: SUN2000-6KTL-M0  
名称 Name: 太阳能光伏逆变器  
SOLAR INVERTER

最大输入电压 d.c. Max. Input Voltage: 1100 Vd.c.  
最大输入电流 d.c. Max. Input Current: 11 A/11 A  
输入短路电流 Isc: 15 A/15 A  
MPPT电压范围 d.c. MPPT Range: 140-980Vd.c.  
输出电压 a.c. Output Nominal Voltage:  
220/380Va.c., 230/400Va.c., 3(N)~+⊕  
输出频率 a.c. Nominal Operating Frequency: 50/60 Hz  
额定输出功率 a.c. Output Rated Power: 6kVA \*  
最大视在功率 a.c. Max. Output Apparent Power: 6.6kVA  
最大输出电流 a.c. Max. Output Current: 13.5A  
功率因数 Power Factor: 0.8(lagging)-0.8(leading)  
温度范围 Operating Temperature Range: -25 ~ +60 °C  
海拔Altitude: 4000m (>3000m refer to user manual)  
过电压类别 Overvoltage Category: II(DC)/III(AC)  
通讯方式 Communication: RS485/WLAN/PLC  
逆变器拓扑 Inverter Topology: Non-isolation  
防护等级 Enclosure: IP65  
保护等级 Protection Class: I  
\*: CEI 0-16 & CEI 0-21: 8kW

华为技术有限公司 HUAWEI TECHNOLOGIES CO., LTD. 中国制造 MADE IN CHINA  
HQ of Huawei, Bantian, Longgang District, Shenzhen, 518129, P.R.C

 型号 Model: SUN2000-6KTL-M0  
名称 Name: 太阳能光伏逆变器  
SOLAR INVERTER

最大输入电压 d.c. Max. Input Voltage: 1100 Vd.c.  
最大输入电流 d.c. Max. Input Current: 11 A/11 A  
输入短路电流 Isc: 15 A/15 A  
MPPT电压范围 d.c. MPPT Range: 140-980Vd.c.  
输出电压 a.c. Output Nominal Voltage:  
220/380Va.c., 230/400Va.c., 3(N)~+⊕  
输出频率 a.c. Nominal Operating Frequency: 50/60 Hz  
额定输出功率 a.c. Output Rated Power: 6kVA \*  
最大视在功率 a.c. Max. Output Apparent Power: 6.8kVA  
最大输出电流 a.c. Max. Output Current: 13.5A  
功率因数 Power Factor: 0.8(lagging)-0.8(leading)  
温度范围 Operating Temperature Range: -25 ~ +60 °C  
海拔Altitude: 4000m (>3000m refer to user manual)  
过电压类别 Overvoltage Category: II(DC)/III(AC)  
通讯方式 Communication: RS485/WLAN/PLC  
逆变器拓扑 Inverter Topology: Non-isolation  
防护等级 Enclosure: IP65  
保护等级 Protection Class: I  
电弧故障保护 AFCI: TYPE I  
\*: CEI 0-16 & CEI 0-21: 8kW

华为技术有限公司 HUAWEI TECHNOLOGIES CO., LTD. 中国制造 MADE IN CHINA  
HQ of Huawei, Bantian, Longgang District, Shenzhen, 518129, P.R.C

Copy of marking plate

 型号 Model: SUN2000-8KTL-M0  
名称 Name: 太阳能光伏逆变器  
SOLAR INVERTER

最大输入电压 d.c. Max. Input Voltage: 1100 Vd.c.  
最大输入电流 d.c. Max. Input Current: 11 A/11 A  
输入短路电流 Isc: 15 A/15 A  
MPPT电压范围 d.c. MPPT Range: 140-980Vd.c.  
输出电压 a.c. Output Nominal Voltage:  
220/380Va.c., 230/400Va.c., 3(N)~+⊕  
输出频率 a.c. Nominal Operating Frequency: 50/60 Hz  
额定输出功率 a.c. Output Rated Power: 8kVA\*  
最大视在功率 a.c. Max. Output Apparent Power: 8.8kVA  
最大输出电流 a.c. Max. Output Current: 13.5A  
功率因数 Power Factor: 0.8(lagging)-0.8(leading)  
温度范围 Operating Temperature Range: -25 ~ +60 °C  
海拔Altitude: 4000m (>3000m refer to user manual)  
过电压类别 Overvoltage Category: II(DC)/III(AC)  
通讯方式 Communication: RS485/WLAN/PLC  
逆变器拓扑 Inverter Topology: Non-Isolation  
电池 Battery: 1100VDC Max; 16A Max  
防护等级 Enclosure: IP65  
保护等级 Protection Class: I  
\*: CEI 0-16 & CEI 0-21:8kW

华为技术有限公司 HUAWEI TECHNOLOGIES CO., LTD. 中国制造 MADE IN CHINA  
HQ of Huawei, Bantian, Longgang District, Shenzhen, 518129, P.R.C

 型号 Model: SUN2000-8KTL-M0  
名称 Name: 太阳能光伏逆变器  
SOLAR INVERTER

最大输入电压 d.c. Max. Input Voltage: 1100 Vd.c.  
最大输入电流 d.c. Max. Input Current: 11 A/11 A  
输入短路电流 Isc: 15 A/15 A  
MPPT电压范围 d.c. MPPT Range: 140-980Vd.c.  
输出电压 a.c. Output Nominal Voltage:  
220/380Va.c., 230/400Va.c., 3(N)~+⊕  
输出频率 a.c. Nominal Operating Frequency: 50/60 Hz  
额定输出功率 a.c. Output Rated Power: 8kVA\*  
最大视在功率 a.c. Max. Output Apparent Power: 8.8kVA  
最大输出电流 a.c. Max. Output Current: 13.5A  
功率因数 Power Factor: 0.8(lagging)-0.8(leading)  
温度范围 Operating Temperature Range: -25 ~ +60 °C  
海拔Altitude: 4000m (>3000m refer to user manual)  
过电压类别 Overvoltage Category: II(DC)/III(AC)  
通讯方式 Communication: RS485/WLAN/PLC  
逆变器拓扑 Inverter Topology: Non-Isolation  
电池 Battery: 1100VDC Max; 16A Max  
防护等级 Enclosure: IP65  
保护等级 Protection Class: I  
电弧故障保护 AFCI: TYPE I  
\*: CEI 0-16 & CEI 0-21:8kW

华为技术有限公司 HUAWEI TECHNOLOGIES CO., LTD. 中国制造 MADE IN CHINA  
HQ of Huawei, Bantian, Longgang District, Shenzhen, 518129, P.R.C

 型号 Model: SUN2000-10KTL-M0  
名称 Name: 太阳能光伏逆变器  
SOLAR INVERTER

最大输入电压 d.c. Max. Input Voltage: 1100 Vd.c.  
最大输入电流 d.c. Max. Input Current: 11 A/11 A  
输入短路电流 Isc: 15 A/15 A  
MPPT电压范围 d.c. MPPT Range: 140-980Vd.c.  
输出电压 a.c. Output Nominal Voltage:  
220/380Va.c., 230/400Va.c., 3(N)~+⊕  
输出频率 a.c. Nominal Operating Frequency: 50/60 Hz  
额定输出功率 a.c. Output Rated Power: 10kVA\*  
最大视在功率 a.c. Max. Output Apparent Power: 11 kVA  
最大输出电流 a.c. Max. Output Current: 16.9A  
功率因数 Power Factor: 0.8(lagging)-0.8(leading)  
温度范围 Operating Temperature Range: -25 ~ +60 °C  
海拔Altitude: 4000m (>3000m refer to user manual)  
过电压类别 Overvoltage Category: II(DC)/III(AC)  
通讯方式 Communication: RS485/WLAN/PLC  
逆变器拓扑 Inverter Topology: Non-Isolation  
防护等级 Enclosure: IP65  
保护等级 Protection Class: I  
\*: CEI 0-16 & CEI 0-21: 10kW

华为技术有限公司 HUAWEI TECHNOLOGIES CO., LTD. 中国制造 MADE IN CHINA  
HQ of Huawei, Bantian, Longgang District, Shenzhen, 518129, P.R.C

 型号 Model: SUN2000-10KTL-M0  
名称 Name: 太阳能光伏逆变器  
SOLAR INVERTER

最大输入电压 d.c. Max. Input Voltage: 1100 Vd.c.  
最大输入电流 d.c. Max. Input Current: 11 A/11 A  
输入短路电流 Isc: 15 A/15 A  
MPPT电压范围 d.c. MPPT Range: 140-980Vd.c.  
输出电压 a.c. Output Nominal Voltage:  
220/380Va.c., 230/400Va.c., 3(N)~+⊕  
输出频率 a.c. Nominal Operating Frequency: 50/60 Hz  
额定输出功率 a.c. Output Rated Power: 10kVA\*  
最大视在功率 a.c. Max. Output Apparent Power: 11kVA  
最大输出电流 a.c. Max. Output Current: 16.9A  
功率因数 Power Factor: 0.8(lagging)-0.8(leading)  
温度范围 Operating Temperature Range: -25 ~ +60 °C  
海拔Altitude: 4000m (>3000m refer to user manual)  
过电压类别 Overvoltage Category: II(DC)/III(AC)  
通讯方式 Communication: RS485/WLAN/PLC  
逆变器拓扑 Inverter Topology: Non-Isolation  
防护等级 Enclosure: IP65  
保护等级 Protection Class: I  
电弧故障保护 AFCI: TYPE I  
\*: CEI 0-16 & CEI 0-21:10KW

华为技术有限公司 HUAWEI TECHNOLOGIES CO., LTD. 中国制造 MADE IN CHINA  
HQ of Huawei, Bantian, Longgang District, Shenzhen, 518129, P.R.C

 型号 Model: SUN2000-10KTL-M0  
名称 Name: 太阳能光伏逆变器  
SOLAR INVERTER

最大输入电压 d.c. Max. Input Voltage: 1100 Vd.c.  
最大输入电流 d.c. Max. Input Current: 11 A/11 A  
输入短路电流 Isc: 15 A/15 A  
MPPT电压范围 d.c. MPPT Range: 140-980Vd.c.  
输出电压 a.c. Output Nominal Voltage:  
220/380Va.c., 230/400Va.c., 3(N)~+⊕  
输出频率 a.c. Nominal Operating Frequency: 50/60 Hz  
额定输出功率 a.c. Output Rated Power: 10kVA\*  
最大视在功率 a.c. Max. Output Apparent Power: 11kVA  
最大输出电流 a.c. Max. Output Current: 16.9A  
功率因数 Power Factor: 0.8(lagging)-0.8(leading)  
温度范围 Operating Temperature Range: -25 ~ +60 °C  
海拔Altitude: 4000m (>3000m refer to user manual)  
过电压类别 Overvoltage Category: II(DC)/III(AC)  
通讯方式 Communication: RS485/WLAN/PLC  
逆变器拓扑 Inverter Topology: Non-Isolation  
电池 Battery: 1100VDC Max; 16A Max  
防护等级 Enclosure: IP65  
保护等级 Protection Class: I  
\*: CEI 0-16 & CEI 0-21:10kW

华为技术有限公司 HUAWEI TECHNOLOGIES CO., LTD. 中国制造 MADE IN CHINA  
HQ of Huawei, Bantian, Longgang District, Shenzhen, 518129, P.R.C

 型号 Model: SUN2000-10KTL-M0  
名称 Name: 太阳能光伏逆变器  
SOLAR INVERTER

最大输入电压 d.c. Max. Input Voltage: 1100 Vd.c.  
最大输入电流 d.c. Max. Input Current: 11 A/11 A  
输入短路电流 Isc: 15 A/15 A  
MPPT电压范围 d.c. MPPT Range: 140-980Vd.c.  
输出电压 a.c. Output Nominal Voltage:  
220/380Va.c., 230/400Va.c., 3(N)~+⊕  
输出频率 a.c. Nominal Operating Frequency: 50/60 Hz  
额定输出功率 a.c. Output Rated Power: 10kVA\*  
最大视在功率 a.c. Max. Output Apparent Power: 11kVA  
最大输出电流 a.c. Max. Output Current: 16.9A  
功率因数 Power Factor: 0.8(lagging)-0.8(leading)  
温度范围 Operating Temperature Range: -25 ~ +60 °C  
海拔Altitude: 4000m (>3000m refer to user manual)  
过电压类别 Overvoltage Category: II(DC)/III(AC)  
通讯方式 Communication: RS485/WLAN/PLC  
逆变器拓扑 Inverter Topology: Non-Isolation  
电池 Battery: 1100VDC Max; 16A Max  
防护等级 Enclosure: IP65  
保护等级 Protection Class: I  
电弧故障保护 AFCI: TYPE I  
\*: CEI 0-16 & CEI 0-21:10kW

华为技术有限公司 HUAWEI TECHNOLOGIES CO., LTD. 中国制造 MADE IN CHINA  
HQ of Huawei, Bantian, Longgang District, Shenzhen, 518129, P.R.C



Copy of marking plate

 型号 Model: SUN2000-3KTL-M1  
名称 Name: 太阳能光伏逆变器  
SOLAR INVERTER

最大输入电压 d.c. Max. Input Voltage: 1100 Vd.c.  
最大输入电流 d.c. Max. Input Current: 11 A/11 A  
输入短路电流 Isc: 16 A/15 A  
MPPT电压范围 d.c. MPPT Range: 140-980Vd.c.  
输出电压 a.c. Output Nominal Voltage:  
220/380Va.c., 230/400Va.c., 3(N)-→⊕  
输出频率 a.c. Nominal Operating Frequency: 50/60 Hz  
额定输出功率 a.c. Output Rated Power: 3kVA \*  
最大视在功率 a.c. Max. Output Apparent Power: 3.3kVA  
最大输出电流 a.c. Max. Output Current: 5.1A  
功率因数 Power Factor: 0.8(lagging)-0.8(leading)  
温度范围 Operating Temperature Range: -25 - +60 °C  
海拔Altitude: 4000m (>3000m refer to user manual)  
过电压类别 Overvoltage Category: II(DC)/III(AC)  
通讯方式 Communication: RS485/WLAN/PLC  
逆变器拓扑 Inverter Topology: Non-Isolation  
防护等级 Enclosure: IP65  
保护等级 Protection Class: I  
\*: CEI 0-16 & CEI 0-21 : 3kW

华为技术有限公司 中国制造  
HUAWEI TECHNOLOGIES CO., LTD. MADE IN CHINA  
HQ of Huawei, Bantian, Longgang District, Shenzhen, 518129, P.R.C

 型号 Model: SUN2000-3KTL-M1  
名称 Name: 太阳能光伏逆变器  
SOLAR INVERTER

最大输入电压 d.c. Max. Input Voltage: 1100 Vd.c.  
最大输入电流 d.c. Max. Input Current: 11 A/11 A  
输入短路电流 Isc: 16 A/15 A  
MPPT电压范围 d.c. MPPT Range: 140-980Vd.c.  
输出电压 a.c. Output Nominal Voltage:  
220/380Va.c., 230/400Va.c., 3(N)-→⊕  
输出频率 a.c. Nominal Operating Frequency: 50/60 Hz  
额定输出功率 a.c. Output Rated Power: 3kVA \*  
最大视在功率 a.c. Max. Output Apparent Power: 3.3kVA  
最大输出电流 a.c. Max. Output Current: 5.1A  
功率因数 Power Factor: 0.8(lagging)-0.8(leading)  
温度范围 Operating Temperature Range: -25 - +60 °C  
海拔Altitude: 4000m (>3000m refer to user manual)  
过电压类别 Overvoltage Category: II(DC)/III(AC)  
通讯方式 Communication: RS485/WLAN/PLC  
逆变器拓扑 Inverter Topology: Non-Isolation  
防护等级 Enclosure: IP65  
保护等级 Protection Class: I  
电弧故障保护 AFCI: TYPE I  
\*: CEI 0-16 & CEI 0-21: 3kW

华为技术有限公司 中国制造  
HUAWEI TECHNOLOGIES CO., LTD. MADE IN CHINA  
HQ of Huawei, Bantian, Longgang District, Shenzhen, 518129, P.R.C

 型号 Model: SUN2000-3KTL-M1  
名称 Name: 太阳能光伏逆变器  
SOLAR INVERTER

最大输入电压 d.c. Max. Input Voltage: 1100 Vd.c.  
最大输入电流 d.c. Max. Input Current: 11 A/11 A  
输入短路电流 Isc: 16 A/15 A  
MPPT电压范围 d.c. MPPT Range: 140-980Vd.c.  
输出电压 a.c. Output Nominal Voltage:  
220/380Va.c., 230/400Va.c., 3(N)-→⊕  
输出频率 a.c. Nominal Operating Frequency: 50/60 Hz  
额定输出功率 a.c. Output Rated Power: 3kVA \*  
最大视在功率 a.c. Max. Output Apparent Power: 3.3kVA  
最大输出电流 a.c. Max. Output Current: 5.1A  
功率因数 Power Factor: 0.8(lagging)-0.8(leading)  
温度范围 Operating Temperature Range: -25 - +60 °C  
海拔Altitude: 4000m (>3000m refer to user manual)  
过电压类别 Overvoltage Category: II(DC)/III(AC)  
通讯方式 Communication: RS485/WLAN/PLC  
逆变器拓扑 Inverter Topology: Non-Isolation  
电池 Battery: 1100VDC Max; 16A Max  
防护等级 Enclosure: IP65  
保护等级 Protection Class: I  
\*: CEI 0-16 & CEI 0-21: 3kW

华为技术有限公司 中国制造  
HUAWEI TECHNOLOGIES CO., LTD. MADE IN CHINA  
HQ of Huawei, Bantian, Longgang District, Shenzhen, 518129, P.R.C

 型号 Model: SUN2000-3KTL-M1  
名称 Name: 太阳能光伏逆变器  
SOLAR INVERTER

最大输入电压 d.c. Max. Input Voltage: 1100 Vd.c.  
最大输入电流 d.c. Max. Input Current: 11 A/11 A  
输入短路电流 Isc: 16 A/15 A  
MPPT电压范围 d.c. MPPT Range: 140-980Vd.c.  
输出电压 a.c. Output Nominal Voltage:  
220/380Va.c., 230/400Va.c., 3(N)-→⊕  
输出频率 a.c. Nominal Operating Frequency: 50/60 Hz  
额定输出功率 a.c. Output Rated Power: 3kVA \*  
最大视在功率 a.c. Max. Output Apparent Power: 3.3kVA  
最大输出电流 a.c. Max. Output Current: 5.1A  
功率因数 Power Factor: 0.8(lagging)-0.8(leading)  
温度范围 Operating Temperature Range: -25 - +60 °C  
海拔Altitude: 4000m (>3000m refer to user manual)  
过电压类别 Overvoltage Category: II(DC)/III(AC)  
通讯方式 Communication: RS485/WLAN/PLC  
逆变器拓扑 Inverter Topology: Non-Isolation  
电池 Battery: 1100VDC Max; 16A Max  
防护等级 Enclosure: IP65  
保护等级 Protection Class: I  
电弧故障保护 AFCI: TYPE I  
\*: CEI 0-16 & CEI 0-21: 3kW

华为技术有限公司 中国制造  
HUAWEI TECHNOLOGIES CO., LTD. MADE IN CHINA  
HQ of Huawei, Bantian, Longgang District, Shenzhen, 518129, P.R.C

 型号 Model: SUN2000-4KTL-M1  
名称 Name: 太阳能光伏逆变器  
SOLAR INVERTER

最大输入电压 d.c. Max. Input Voltage: 1100 Vd.c.  
最大输入电流 d.c. Max. Input Current: 11 A/11 A  
输入短路电流 Isc: 16 A/15 A  
MPPT电压范围 d.c. MPPT Range: 140-980Vd.c.  
输出电压 a.c. Output Nominal Voltage:  
220/380Va.c., 230/400Va.c., 3(N)-→⊕  
输出频率 a.c. Nominal Operating Frequency: 50/60 Hz  
额定输出功率 a.c. Output Rated Power: 4kVA \*  
最大视在功率 a.c. Max. Output Apparent Power : 4.4kVA  
最大输出电流 a.c. Max. Output Current: 6.8A  
功率因数 Power Factor: 0.8(lagging)-0.8(leading)  
温度范围 Operating Temperature Range: -25 - +60 °C  
海拔Altitude: 4000m (>3000m refer to user manual)  
过电压类别 Overvoltage Category: II(DC)/III(AC)  
通讯方式 Communication: RS485/WLAN/PLC  
逆变器拓扑 Inverter Topology: Non-Isolation  
防护等级 Enclosure: IP65  
保护等级 Protection Class: I  
\*: CEI 0-16 & CEI 0-21 : 4kW

华为技术有限公司 中国制造  
HUAWEI TECHNOLOGIES CO., LTD. MADE IN CHINA  
HQ of Huawei, Bantian, Longgang District, Shenzhen, 518129, P.R.C

 型号 Model: SUN2000-4KTL-M1  
名称 Name: 太阳能光伏逆变器  
SOLAR INVERTER

最大输入电压 d.c. Max. Input Voltage: 1100 Vd.c.  
最大输入电流 d.c. Max. Input Current: 11 A/11 A  
输入短路电流 Isc: 16 A/15 A  
MPPT电压范围 d.c. MPPT Range: 140-980Vd.c.  
输出电压 a.c. Output Nominal Voltage:  
220/380Va.c., 230/400Va.c., 3(N)-→⊕  
输出频率 a.c. Nominal Operating Frequency: 50/60 Hz  
额定输出功率 a.c. Output Rated Power: 4kVA \*  
最大视在功率 a.c. Max. Output Apparent Power: 4.4kVA  
最大输出电流 a.c. Max. Output Current: 6.8A  
功率因数 Power Factor: 0.8(lagging)-0.8(leading)  
温度范围 Operating Temperature Range: -25 - +60 °C  
海拔Altitude: 4000m (>3000m refer to user manual)  
过电压类别 Overvoltage Category: II(DC)/III(AC)  
通讯方式 Communication: RS485/WLAN/PLC  
逆变器拓扑 Inverter Topology: Non-Isolation  
防护等级 Enclosure: IP65  
保护等级 Protection Class: I  
电弧故障保护 AFCI: TYPE I  
\*: CEI 0-16 & CEI 0-21: 4kW

华为技术有限公司 中国制造  
HUAWEI TECHNOLOGIES CO., LTD. MADE IN CHINA  
HQ of Huawei, Bantian, Longgang District, Shenzhen, 518129, P.R.C

Copy of marking plate

 型号 Model: SUN2000-4KTL-M1  
名称 Name: 太阳能光伏逆变器  
SOLAR INVERTER

最大输入电压 d.c. Max. Input Voltage: 1100 Vd.c.  
最大输入电流 d.c. Max. Input Current: 11 A/11 A  
输入短路电流 Isc: 15 A/15 A  
MPPT电压范围 d.c. MPPT Range: 140 - 980Vd.c.  
输出电压 a.c. Output Nominal Voltage:  
220/380Va.c., 230/400Va.c., 3(N)~+⊕  
输出频率 a.c. Nominal Operating Frequency: 50/60 Hz  
额定输出功率 a.c. Output Rated Power: 4kVA \*  
最大视在功率 a.c. Max. Output Apparent Power: 4.4kVA  
最大输出电流 a.c. Max. Output Current: 8.8A  
功率因数 Power Factor: 0.8(lagging)-0.8(leading)  
温度范围 Operating Temperature Range: - 25 - +60 °C  
海拔Altitude: 4000m (>3000m refer to user manual)  
过电压类别 Overvoltage Category: II(DC)/III(AC)  
通讯方式 Communication: RS485/WLAN/PLC  
逆变器拓扑 Inverter Topology: Non-Isolation  
电池 Battery: 1100VDC Max; 16A Max  
防护等级 Enclosure: IP65  
保护等级 Protection Class: I  
\* : CEI 0-16 & CEI 0-21:4kW

华为技术有限公司 中国制造  
HUAWEI TECHNOLOGIES CO., LTD. MADE IN CHINA  
HQ of Huawei, Bantian, Longgang District, Shenzhen, 518129, P.R.C

 型号 Model: SUN2000-4KTL-M1  
名称 Name: 太阳能光伏逆变器  
SOLAR INVERTER

最大输入电压 d.c. Max. Input Voltage: 1100 Vd.c.  
最大输入电流 d.c. Max. Input Current: 11 A/11 A  
输入短路电流 Isc: 15 A/15 A  
MPPT电压范围 d.c. MPPT Range: 140 - 980Vd.c.  
输出电压 a.c. Output Nominal Voltage:  
220/380Va.c., 230/400Va.c., 3(N)~+⊕  
输出频率 a.c. Nominal Operating Frequency: 50/60 Hz  
额定输出功率 a.c. Output Rated Power: 4kVA \*  
最大视在功率 a.c. Max. Output Apparent Power: 4.4kVA  
最大输出电流 a.c. Max. Output Current: 8.8A  
功率因数 Power Factor: 0.8(lagging)-0.8(leading)  
温度范围 Operating Temperature Range: - 25 - +60 °C  
海拔Altitude: 4000m (>3000m refer to user manual)  
过电压类别 Overvoltage Category: II(DC)/III(AC)  
通讯方式 Communication: RS485/WLAN/PLC  
逆变器拓扑 Inverter Topology: Non-Isolation  
电池 Battery: 1100VDC Max; 16A Max  
防护等级 Enclosure: IP65  
保护等级 Protection Class: I  
\* : CEI 0-16 & CEI 0-21:4kW

华为技术有限公司 中国制造  
HUAWEI TECHNOLOGIES CO., LTD. MADE IN CHINA  
HQ of Huawei, Bantian, Longgang District, Shenzhen, 518129, P.R.C

 型号 Model: SUN2000-5KTL-M1  
名称 Name: 太阳能光伏逆变器  
SOLAR INVERTER

最大输入电压 d.c. Max. Input Voltage: 1100 Vd.c.  
最大输入电流 d.c. Max. Input Current: 11 A/11 A  
输入短路电流 Isc: 15 A/15 A  
MPPT电压范围 d.c. MPPT Range: 140 - 980Vd.c.  
输出电压 a.c. Output Nominal Voltage:  
220/380Va.c., 230/400Va.c., 3(N)~+⊕  
输出频率 a.c. Nominal Operating Frequency: 50/60 Hz  
额定输出功率 a.c. Output Rated Power: 5kVA \*  
最大视在功率 a.c. Max. Output Apparent Power: 5.5kVA  
最大输出电流 a.c. Max. Output Current: 8.5A  
功率因数 Power Factor: 0.8(lagging)-0.8(leading)  
温度范围 Operating Temperature Range: - 25 - +60 °C  
海拔Altitude: 4000m (>3000m refer to user manual)  
过电压类别 Overvoltage Category: II(DC)/III(AC)  
通讯方式 Communication: RS485/WLAN/PLC  
逆变器拓扑 Inverter Topology: Non-Isolation  
防护等级 Enclosure: IP65  
保护等级 Protection Class: I  
\* : CEI 0-16 & CEI 0-21: 5kW

华为技术有限公司 中国制造  
HUAWEI TECHNOLOGIES CO., LTD. MADE IN CHINA  
HQ of Huawei, Bantian, Longgang District, Shenzhen, 518129, P.R.C

 型号 Model: SUN2000-5KTL-M1  
名称 Name: 太阳能光伏逆变器  
SOLAR INVERTER

最大输入电压 d.c. Max. Input Voltage: 1100 Vd.c.  
最大输入电流 d.c. Max. Input Current: 11 A/11 A  
输入短路电流 Isc: 15 A/15 A  
MPPT电压范围 d.c. MPPT Range: 140 - 980Vd.c.  
输出电压 a.c. Output Nominal Voltage:  
220/380Va.c., 230/400Va.c., 3(N)~+⊕  
输出频率 a.c. Nominal Operating Frequency: 50/60 Hz  
额定输出功率 a.c. Output Rated Power: 5kVA \*  
最大视在功率 a.c. Max. Output Apparent Power: 5.5kVA  
最大输出电流 a.c. Max. Output Current: 8.5A  
功率因数 Power Factor: 0.8(lagging)-0.8(leading)  
温度范围 Operating Temperature Range: - 25 - +60 °C  
海拔Altitude: 4000m (>3000m refer to user manual)  
过电压类别 Overvoltage Category: II(DC)/III(AC)  
通讯方式 Communication: RS485/WLAN/PLC  
逆变器拓扑 Inverter Topology: Non-Isolation  
防护等级 Enclosure: IP65  
保护等级 Protection Class: I  
电击故障保护 AFCI: TYPE I  
\* : CEI 0-16 & CEI 0-21:5kW

华为技术有限公司 中国制造  
HUAWEI TECHNOLOGIES CO., LTD. MADE IN CHINA  
HQ of Huawei, Bantian, Longgang District, Shenzhen, 518129, P.R.C

 型号 Model: SUN2000-5KTL-M1  
名称 Name: 太阳能光伏逆变器  
SOLAR INVERTER

最大输入电压 d.c. Max. Input Voltage: 1100 Vd.c.  
最大输入电流 d.c. Max. Input Current: 11 A/11 A  
输入短路电流 Isc: 15 A/15 A  
MPPT电压范围 d.c. MPPT Range: 140 - 980Vd.c.  
输出电压 a.c. Output Nominal Voltage:  
220/380Va.c., 230/400Va.c., 3(N)~+⊕  
输出频率 a.c. Nominal Operating Frequency: 50/60 Hz  
额定输出功率 a.c. Output Rated Power: 5kVA \*  
最大视在功率 a.c. Max. Output Apparent Power: 5.5kVA  
最大输出电流 a.c. Max. Output Current: 8.5A  
功率因数 Power Factor: 0.8(lagging)-0.8(leading)  
温度范围 Operating Temperature Range: - 25 - +60 °C  
海拔Altitude: 4000m (>3000m refer to user manual)  
过电压类别 Overvoltage Category: II(DC)/III(AC)  
通讯方式 Communication: RS485/WLAN/PLC  
逆变器拓扑 Inverter Topology: Non-Isolation  
电池 Battery: 1100VDC Max; 16A Max  
防护等级 Enclosure: IP65  
保护等级 Protection Class: I  
\* : CEI 0-16 & CEI 0-21:5kW

华为技术有限公司 中国制造  
HUAWEI TECHNOLOGIES CO., LTD. MADE IN CHINA  
HQ of Huawei, Bantian, Longgang District, Shenzhen, 518129, P.R.C

 型号 Model: SUN2000-5KTL-M1  
名称 Name: 太阳能光伏逆变器  
SOLAR INVERTER

最大输入电压 d.c. Max. Input Voltage: 1100 Vd.c.  
最大输入电流 d.c. Max. Input Current: 11 A/11 A  
输入短路电流 Isc: 15 A/15 A  
MPPT电压范围 d.c. MPPT Range: 140 - 980Vd.c.  
输出电压 a.c. Output Nominal Voltage:  
220/380Va.c., 230/400Va.c., 3(N)~+⊕  
输出频率 a.c. Nominal Operating Frequency: 50/60 Hz  
额定输出功率 a.c. Output Rated Power: 5kVA \*  
最大视在功率 a.c. Max. Output Apparent Power: 5.5kVA  
最大输出电流 a.c. Max. Output Current: 8.5A  
功率因数 Power Factor: 0.8(lagging)-0.8(leading)  
温度范围 Operating Temperature Range: - 25 - +60 °C  
海拔Altitude: 4000m (>3000m refer to user manual)  
过电压类别 Overvoltage Category: II(DC)/III(AC)  
通讯方式 Communication: RS485/WLAN/PLC  
逆变器拓扑 Inverter Topology: Non-Isolation  
电池 Battery: 1100VDC Max; 16A Max  
防护等级 Enclosure: IP65  
保护等级 Protection Class: I  
电击故障保护 AFCI: TYPE I  
\* : CEI 0-16 & CEI 0-21:5kW

华为技术有限公司 中国制造  
HUAWEI TECHNOLOGIES CO., LTD. MADE IN CHINA  
HQ of Huawei, Bantian, Longgang District, Shenzhen, 518129, P.R.C

Copy of marking plate

 型号 Model: SUN2000-6KTL-M1  
名称 Name: 太阳能光伏逆变器  
SOLAR INVERTER

最大输入电压 d.c. Max. Input Voltage: 1100 Vd.c.  
最大输入电流 d.c. Max. Input Current: 11 A/11 A  
输入短路电流 Isc: 15 A/15 A  
MPPT电压范围 d.c. MPPT Range: 140~980Vd.c.  
输出电压 a.c. Output Nominal Voltage:  
220/380Va.c., 230/400Va.c., 3(N)~+⊕  
输出频率 a.c. Nominal Operating Frequency: 50/60 Hz  
额定输出功率 a.c. Output Rated Power: 6kVA \*  
最大视在功率 a.c. Max. Output Apparent Power: 6.6kVA  
最大输出电流 a.c. Max. Output Current: 10.1A  
功率因数 Power Factor: 0.8(lagging)-0.8(leading)  
温度范围 Operating Temperature Range: -25~+60 °C  
海拔Altitude: 4000m (>3000m refer to user manual)  
过电压类别 Overvoltage Category: II(DC)/III(AC)  
通讯方式 Communication: RS485/WLAN/PLC  
逆变器拓扑 Inverter Topology: Non-Isolation  
防护等级 Enclosure: IP65  
保护等级 Protection Class: I  
\*: CEI 0-16 & CEI 0-21 : 6kW

华为技术有限公司 中国制造  
HUAWEI TECHNOLOGIES CO., LTD. MADE IN CHINA  
HQ of Huawei, Bantian, Longgang District, Shenzhen, 518129, P.R.C

 型号 Model: SUN2000-6KTL-M1  
名称 Name: 太阳能光伏逆变器  
SOLAR INVERTER

最大输入电压 d.c. Max. Input Voltage: 1100 Vd.c.  
最大输入电流 d.c. Max. Input Current: 11 A/11 A  
输入短路电流 Isc: 15 A/15 A  
MPPT电压范围 d.c. MPPT Range: 140~980Vd.c.  
输出电压 a.c. Output Nominal Voltage:  
220/380Va.c., 230/400Va.c., 3(N)~+⊕  
输出频率 a.c. Nominal Operating Frequency: 50/60 Hz  
额定输出功率 a.c. Output Rated Power: 6kVA \*  
最大视在功率 a.c. Max. Output Apparent Power: 6.6kVA  
最大输出电流 a.c. Max. Output Current: 10.1A  
功率因数 Power Factor: 0.8(lagging)-0.8(leading)  
温度范围 Operating Temperature Range: -25~+60 °C  
海拔Altitude: 4000m (>3000m refer to user manual)  
过电压类别 Overvoltage Category: II(DC)/III(AC)  
通讯方式 Communication: RS485/WLAN/PLC  
逆变器拓扑 Inverter Topology: Non-Isolation  
防护等级 Enclosure: IP65  
保护等级 Protection Class: I  
\*: CEI 0-16 & CEI 0-21:6kW

华为技术有限公司 中国制造  
HUAWEI TECHNOLOGIES CO., LTD. MADE IN CHINA  
HQ of Huawei, Bantian, Longgang District, Shenzhen, 518129, P.R.C

 型号 Model: SUN2000-6KTL-M1  
名称 Name: 太阳能光伏逆变器  
SOLAR INVERTER

最大输入电压 d.c. Max. Input Voltage: 1100 Vd.c.  
最大输入电流 d.c. Max. Input Current: 11 A/11 A  
输入短路电流 Isc: 15 A/15 A  
MPPT电压范围 d.c. MPPT Range: 140~980Vd.c.  
输出电压 a.c. Output Nominal Voltage:  
220/380Va.c., 230/400Va.c., 3(N)~+⊕  
输出频率 a.c. Nominal Operating Frequency: 50/60 Hz  
额定输出功率 a.c. Output Rated Power: 6kVA \*  
最大视在功率 a.c. Max. Output Apparent Power: 6.6kVA  
最大输出电流 a.c. Max. Output Current: 10.1A  
功率因数 Power Factor: 0.8(lagging)-0.8(leading)  
温度范围 Operating Temperature Range: -25~+60 °C  
海拔Altitude: 4000m (>3000m refer to user manual)  
过电压类别 Overvoltage Category: II(DC)/III(AC)  
通讯方式 Communication: RS485/WLAN/PLC  
逆变器拓扑 Inverter Topology: Non-Isolation  
电池 Battery: 1100VDC Max; 16A Max  
防护等级 Enclosure: IP65  
保护等级 Protection Class: I  
\*: CEI 0-16 & CEI 0-21:6kW

华为技术有限公司 中国制造  
HUAWEI TECHNOLOGIES CO., LTD. MADE IN CHINA  
HQ of Huawei, Bantian, Longgang District, Shenzhen, 518129, P.R.C

 型号 Model: SUN2000-8KTL-M1  
名称 Name: 太阳能光伏逆变器  
SOLAR INVERTER

最大输入电压 d.c. Max. Input Voltage: 1100 Vd.c.  
最大输入电流 d.c. Max. Input Current: 11 A/11 A  
输入短路电流 Isc: 15 A/15 A  
MPPT电压范围 d.c. MPPT Range: 140~980Vd.c.  
输出电压 a.c. Output Nominal Voltage:  
220/380Va.c., 230/400Va.c., 3(N)~+⊕  
输出频率 a.c. Nominal Operating Frequency: 50/60 Hz  
额定输出功率 a.c. Output Rated Power: 6kVA \*  
最大视在功率 a.c. Max. Output Apparent Power: 6.6kVA  
最大输出电流 a.c. Max. Output Current: 10.1A  
功率因数 Power Factor: 0.8(lagging)-0.8(leading)  
温度范围 Operating Temperature Range: -25~+60 °C  
海拔Altitude: 4000m (>3000m refer to user manual)  
过电压类别 Overvoltage Category: II(DC)/III(AC)  
通讯方式 Communication: RS485/WLAN/PLC  
逆变器拓扑 Inverter Topology: Non-Isolation  
电池 Battery: 1100VDC Max; 16A Max  
防护等级 Enclosure: IP65  
保护等级 Protection Class: I  
\*: CEI 0-16 & CEI 0-21:6kW

华为技术有限公司 中国制造  
HUAWEI TECHNOLOGIES CO., LTD. MADE IN CHINA  
HQ of Huawei, Bantian, Longgang District, Shenzhen, 518129, P.R.C

 型号 Model: SUN2000-8KTL-M1  
名称 Name: 太阳能光伏逆变器  
SOLAR INVERTER

最大输入电压 d.c. Max. Input Voltage: 1100 Vd.c.  
最大输入电流 d.c. Max. Input Current: 11 A/11 A  
输入短路电流 Isc: 15 A/15 A  
MPPT电压范围 d.c. MPPT Range: 140~980Vd.c.  
输出电压 a.c. Output Nominal Voltage:  
220/380Va.c., 230/400Va.c., 3(N)~+⊕  
输出频率 a.c. Nominal Operating Frequency: 50/60 Hz  
额定输出功率 a.c. Output Rated Power: 8kVA \*  
最大视在功率 a.c. Max. Output Apparent Power: 8.8kVA  
最大输出电流 a.c. Max. Output Current: 13.5A  
功率因数 Power Factor: 0.8(lagging)-0.8(leading)  
温度范围 Operating Temperature Range: -25~+60 °C  
海拔Altitude: 4000m (>3000m refer to user manual)  
过电压类别 Overvoltage Category: II(DC)/III(AC)  
通讯方式 Communication: RS485/WLAN/PLC  
逆变器拓扑 Inverter Topology: Non-Isolation  
防护等级 Enclosure: IP65  
保护等级 Protection Class: I  
\*: CEI 0-16 & CEI 0-21 : 8kW

华为技术有限公司 中国制造  
HUAWEI TECHNOLOGIES CO., LTD. MADE IN CHINA  
HQ of Huawei, Bantian, Longgang District, Shenzhen, 518129, P.R.C

 型号 Model: SUN2000-8KTL-M1  
名称 Name: 太阳能光伏逆变器  
SOLAR INVERTER

最大输入电压 d.c. Max. Input Voltage: 1100 Vd.c.  
最大输入电流 d.c. Max. Input Current: 11 A/11 A  
输入短路电流 Isc: 15 A/15 A  
MPPT电压范围 d.c. MPPT Range: 140~980Vd.c.  
输出电压 a.c. Output Nominal Voltage:  
220/380Va.c., 230/400Va.c., 3(N)~+⊕  
输出频率 a.c. Nominal Operating Frequency: 50/60 Hz  
额定输出功率 a.c. Output Rated Power: 8kVA \*  
最大视在功率 a.c. Max. Output Apparent Power: 8.8kVA  
最大输出电流 a.c. Max. Output Current: 13.5A  
功率因数 Power Factor: 0.8(lagging)-0.8(leading)  
温度范围 Operating Temperature Range: -25~+60 °C  
海拔Altitude: 4000m (>3000m refer to user manual)  
过电压类别 Overvoltage Category: II(DC)/III(AC)  
通讯方式 Communication: RS485/WLAN/PLC  
逆变器拓扑 Inverter Topology: Non-Isolation  
防护等级 Enclosure: IP65  
保护等级 Protection Class: I  
\*: CEI 0-16 & CEI 0-21:8kW

华为技术有限公司 中国制造  
HUAWEI TECHNOLOGIES CO., LTD. MADE IN CHINA  
HQ of Huawei, Bantian, Longgang District, Shenzhen, 518129, P.R.C

Copy of marking plate

 型号 Model: SUN2000-8KTL-M1  
名称 Name: 太阳能光伏逆变器  
SOLAR INVERTER

最大输入电压 d.c. Max. Input Voltage: 1100 Vd.c.  
最大输入电流 d.c. Max. Input Current: 11 A/11 A  
输入短路电流 Isc: 15 A/15 A  
MPPT电压范围 d.c. MPPT Range: 140-980Vd.c.  
输出电压 a.c. Output Nominal Voltage:  
220/380Va.c., 230/400Va.c., 3(N)~+⊕  
输出频率 a.c. Nominal Operating Frequency: 50/60 Hz  
额定输出功率 a.c. Output Rated Power: 8kVA \*  
最大视在功率 a.c. Max. Output Apparent Power: 8.8kVA  
最大输出电流 a.c. Max. Output Current: 13.5A  
功率因数 Power Factor: 0.8(lagging)-0.8(leading)  
温度范围 Operating Temperature Range: -25 ~ +60 °C  
海拔Altitude: 4000m (>3000m refer to user manual)  
过电压类别 Overvoltage Category: II(DC)/III(AC)  
通讯方式 Communication: RS485/WLAN/PLC  
逆变器拓扑 Inverter Topology: Non-Isolation  
电池 Battery: 1100VDC Max; 16A Max  
防护等级 Enclosure: IP65  
保护等级 Protection Class: I  
电击故障保护 AFCI: TYPE I  
\*: CEI 0-16 & CEI 0-21: 8kW

华为技术有限公司 HUAWEI TECHNOLOGIES CO., LTD. 中国制造 MADE IN CHINA  
HQ of Huawei, Bantian, Longgang District, Shenzhen, 518129, P.R.C

 型号 Model: SUN2000-8KTL-M1  
名称 Name: 太阳能光伏逆变器  
SOLAR INVERTER

最大输入电压 d.c. Max. Input Voltage: 1100 Vd.c.  
最大输入电流 d.c. Max. Input Current: 11 A/11 A  
输入短路电流 Isc: 15 A/15 A  
MPPT电压范围 d.c. MPPT Range: 140-980Vd.c.  
输出电压 a.c. Output Nominal Voltage:  
220/380Va.c., 230/400Va.c., 3(N)~+⊕  
输出频率 a.c. Nominal Operating Frequency: 50/60 Hz  
额定输出功率 a.c. Output Rated Power: 8kVA \*  
最大视在功率 a.c. Max. Output Apparent Power: 8.8kVA  
最大输出电流 a.c. Max. Output Current: 13.5A  
功率因数 Power Factor: 0.8(lagging)-0.8(leading)  
温度范围 Operating Temperature Range: -25 ~ +60 °C  
海拔Altitude: 4000m (>3000m refer to user manual)  
过电压类别 Overvoltage Category: II(DC)/III(AC)  
通讯方式 Communication: RS485/WLAN/PLC  
逆变器拓扑 Inverter Topology: Non-Isolation  
电池 Battery: 1100VDC Max; 16A Max  
防护等级 Enclosure: IP65  
保护等级 Protection Class: I  
电击故障保护 AFCI: TYPE I  
\*: CEI 0-16 & CEI 0-21: 8kW

华为技术有限公司 HUAWEI TECHNOLOGIES CO., LTD. 中国制造 MADE IN CHINA  
HQ of Huawei, Bantian, Longgang District, Shenzhen, 518129, P.R.C

 型号 Model: SUN2000-10KTL-M1  
名称 Name: 太阳能光伏逆变器  
SOLAR INVERTER

最大输入电压 d.c. Max. Input Voltage: 1100 Vd.c.  
最大输入电流 d.c. Max. Input Current: 11 A/11 A  
输入短路电流 Isc: 15 A/15 A  
MPPT电压范围 d.c. MPPT Range: 140-980Vd.c.  
输出电压 a.c. Output Nominal Voltage:  
220/380Va.c., 230/400Va.c., 3(N)~+⊕  
输出频率 a.c. Nominal Operating Frequency: 50/60 Hz  
额定输出功率 a.c. Output Rated Power: 10kVA \*  
最大视在功率 a.c. Max. Output Apparent Power: 11 kVA  
最大输出电流 a.c. Max. Output Current: 16.9A  
功率因数 Power Factor: 0.8(lagging)-0.8(leading)  
温度范围 Operating Temperature Range: -25 ~ +60 °C  
海拔Altitude: 4000m (>3000m refer to user manual)  
过电压类别 Overvoltage Category: II(DC)/III(AC)  
通讯方式 Communication: RS485/WLAN/PLC  
逆变器拓扑 Inverter Topology: Non-Isolation  
防护等级 Enclosure: IP65  
保护等级 Protection Class: I  
\*: CEI 0-16 & CEI 0-21 : 10kW

华为技术有限公司 HUAWEI TECHNOLOGIES CO., LTD. 中国制造 MADE IN CHINA  
HQ of Huawei, Bantian, Longgang District, Shenzhen, 518129, P.R.C

 型号 Model: SUN2000-10KTL-M1  
名称 Name: 太阳能光伏逆变器  
SOLAR INVERTER

最大输入电压 d.c. Max. Input Voltage: 1100 Vd.c.  
最大输入电流 d.c. Max. Input Current: 11 A/11 A  
输入短路电流 Isc: 15 A/15 A  
MPPT电压范围 d.c. MPPT Range: 140-980Vd.c.  
输出电压 a.c. Output Nominal Voltage:  
220/380Va.c., 230/400Va.c., 3(N)~+⊕  
输出频率 a.c. Nominal Operating Frequency: 50/60 Hz  
额定输出功率 a.c. Output Rated Power: 10kVA \*  
最大视在功率 a.c. Max. Output Apparent Power: 11kVA  
最大输出电流 a.c. Max. Output Current: 16.9A  
功率因数 Power Factor: 0.8(lagging)-0.8(leading)  
温度范围 Operating Temperature Range: -25 ~ +60 °C  
海拔Altitude: 4000m (>3000m refer to user manual)  
过电压类别 Overvoltage Category: II(DC)/III(AC)  
通讯方式 Communication: RS485/WLAN/PLC  
逆变器拓扑 Inverter Topology: Non-Isolation  
防护等级 Enclosure: IP65  
保护等级 Protection Class: I  
电击故障保护 AFCI: TYPE I  
\*: CEI 0-16 & CEI 0-21: 10KW

华为技术有限公司 HUAWEI TECHNOLOGIES CO., LTD. 中国制造 MADE IN CHINA  
HQ of Huawei, Bantian, Longgang District, Shenzhen, 518129, P.R.C

 型号 Model: SUN2000-10KTL-M1  
名称 Name: 太阳能光伏逆变器  
SOLAR INVERTER

最大输入电压 d.c. Max. Input Voltage: 1100 Vd.c.  
最大输入电流 d.c. Max. Input Current: 11 A/11 A  
输入短路电流 Isc: 15 A/15 A  
MPPT电压范围 d.c. MPPT Range: 140-980Vd.c.  
输出电压 a.c. Output Nominal Voltage:  
220/380Va.c., 230/400Va.c., 3(N)~+⊕  
输出频率 a.c. Nominal Operating Frequency: 50/60 Hz  
额定输出功率 a.c. Output Rated Power: 10kVA \*  
最大视在功率 a.c. Max. Output Apparent Power: 11kVA  
最大输出电流 a.c. Max. Output Current: 16.9A  
功率因数 Power Factor: 0.8(lagging)-0.8(leading)  
温度范围 Operating Temperature Range: -25 ~ +60 °C  
海拔Altitude: 4000m (>3000m refer to user manual)  
过电压类别 Overvoltage Category: II(DC)/III(AC)  
通讯方式 Communication: RS485/WLAN/PLC  
逆变器拓扑 Inverter Topology: Non-Isolation  
电池 Battery: 1100VDC Max; 16A Max  
防护等级 Enclosure: IP65  
保护等级 Protection Class: I  
电击故障保护 AFCI: TYPE I  
\*: CEI 0-16 & CEI 0-21: 10kW

华为技术有限公司 HUAWEI TECHNOLOGIES CO., LTD. 中国制造 MADE IN CHINA  
HQ of Huawei, Bantian, Longgang District, Shenzhen, 518129, P.R.C

 型号 Model: SUN2000-10KTL-M1  
名称 Name: 太阳能光伏逆变器  
SOLAR INVERTER

最大输入电压 d.c. Max. Input Voltage: 1100 Vd.c.  
最大输入电流 d.c. Max. Input Current: 11 A/11 A  
输入短路电流 Isc: 15 A/15 A  
MPPT电压范围 d.c. MPPT Range: 140-980Vd.c.  
输出电压 a.c. Output Nominal Voltage:  
220/380Va.c., 230/400Va.c., 3(N)~+⊕  
输出频率 a.c. Nominal Operating Frequency: 50/60 Hz  
额定输出功率 a.c. Output Rated Power: 10kVA \*  
最大视在功率 a.c. Max. Output Apparent Power : 11kVA  
最大输出电流 a.c. Max. Output Current: 16.9A  
功率因数 Power Factor: 0.8(lagging)-0.8(leading)  
温度范围 Operating Temperature Range: -25 ~ +60 °C  
海拔Altitude: 4000m (>3000m refer to user manual)  
过电压类别 Overvoltage Category: II(DC)/III(AC)  
通讯方式 Communication: RS485/WLAN/PLC  
逆变器拓扑 Inverter Topology: Non-Isolation  
电池 Battery: 1100VDC Max; 16A Max  
防护等级 Enclosure: IP65  
保护等级 Protection Class: I  
电击故障保护 AFCI: TYPE I  
\*: CEI 0-16 & CEI 0-21: 10kW

华为技术有限公司 HUAWEI TECHNOLOGIES CO., LTD. 中国制造 MADE IN CHINA  
HQ of Huawei, Bantian, Longgang District, Shenzhen, 518129, P.R.C

### General product information:

The Solar converter converts DC voltage into AC voltage.  
The DC input of Solar converter can be supplied from PV array and Batteries.  
The charging current to batteries from PV array, battery management unit is integrated in External Energy storage.

The input and output are protected by Varistors to Earth. The unit is providing EMC filtering at the output toward mains. The unit does not provide galvanic separation from input to output (transformerless). The output is switched off redundant by the high power switching bridge and a two relays. This assures that the opening of the output circuit will also operate in case of one error.

### Description of the electrical circuit: (Figure 1):

The internal control is redundant built. It consists of Microcontroller DSP (U3) and MCU (U33).

The DSP (U3) control the relays by switching signals; measures the PV voltage, PV current, Bus voltage, grid voltage, frequency, AC current with injected DC and the array insulation resistance to ground. In addition it tests the current sensors and the RCMU circuit before each start up.

The MCU (U33) is measures the grid voltage, grid frequency, DCI and residual current, also can switch off the relays independently, and communicate with the DSP (U3) each other.

The current is measured by a current sensor. The AC current signal and the injected DC current signal are sent to the DSP (U3). The DSP (U3) tests and calibrates before each start up all current sensors.

The unit provides two relays in series in all output conductors. When single fault applied to one relay, alarm an error code in display panel, another redundant relay provides basic insulation maintained between the PV array and the mains. All the relays are tested before each start up.

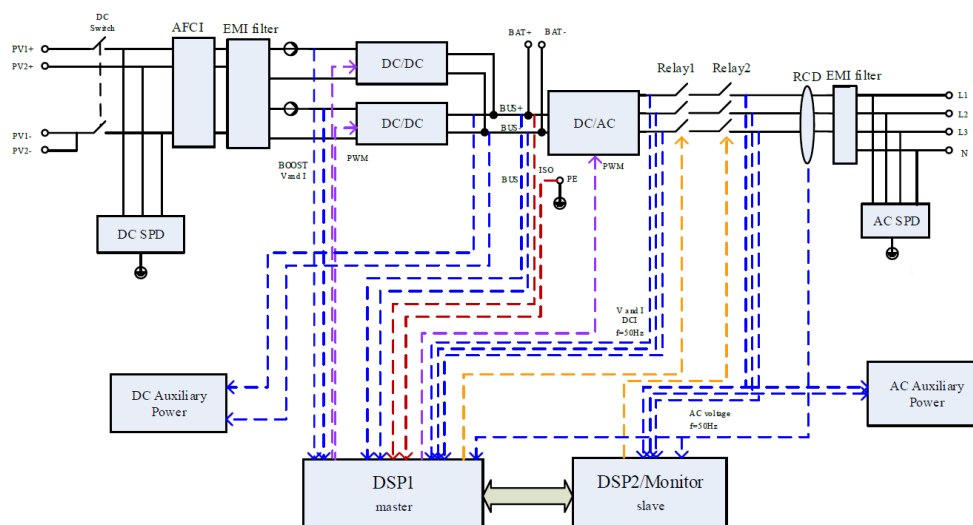

Figure 1 – Block diagram

### Differences of the models:

The models SUN2000-3KTL-M0, SUN2000-4KTL-M0, SUN2000-5KTL-M0, SUN2000-6KTL-M0, SUN2000-8KTL-M0 and SUN2000-10KTL-M0 are almost identical in hardware except current sampling circuit and the output power derated by software.

The models SUN2000-3KTL-M1, SUN2000-4KTL-M1, SUN2000-5KTL-M1, SUN2000-6KTL-M1, SUN2000-8KTL-M1 and SUN2000-10KTL-M1 are almost identical in hardware except current sampling circuit and the output power derated by software.

The models SUN2000-3KTL-M1, SUN2000-4KTL-M1, SUN2000-5KTL-M1, SUN2000-6KTL-M1, SUN2000-8KTL-M1 and SUN2000-10KTL-M1 are almost identical in hardware with SUN2000-3KTL-M0, SUN2000-4KTL-M0, SUN2000-5KTL-M0, SUN2000-6KTL-M0, SUN2000-8KTL-M0, and SUN2000-10KTL-M0

except the PLC communication circuit. (J6 port and a Hi3911V200 chip)

**The product was tested on:**

Hardware: V100R001  
Software: V100R001

All tests were performed on EUT of SUN2000-10KTL-M0. Tests of the EUT of SUN2000-10KTL-M0 applicable for the models SUN2000-3KTL-M0, SUN2000-4KTL-M0, SUN2000-5KTL-M0, SUN2000-6KTL-M0, SUN2000-8KTL-M0, SUN2000-3KTL-M1, SUN2000-4KTL-M1, SUN2000-5KTL-M1, SUN2000-6KTL-M1, SUN2000-8KTL-M1 and SUN2000-10KTL-M1 were performed on the concerned models and a statement is given at the relevant test.

<b>Engineering recommendation G98-1</b>			
<b>Clause</b>	<b>Requirement – Test</b>	<b>Result – Remark</b>	<b>Verdict</b>
<b>5</b>	<b>Connection Procedure</b>		
<b>5.1</b>	<b>Single Premises Connection Procedure</b>		
<b>5.1.1</b>	In most instances the installation of Micro-generating Plant, the aggregate Registered Capacity of which is no greater than 16 A per phase, connected in parallel with the public Low Voltage Distribution Network, will have negligible impact on the operation of the public Low Voltage Distribution Network; as such there will be no need for the DNO to carry out detailed network studies to assess the impact of the connection. As required by the ESQCR Certificate of Exemption (2008) the Installer shall provide the DNO with all necessary information on the installation no later than 28 days after the Micro-generating Plant has been commissioned; the format and content shall be as shown in Appendix 3 Form B Installation Document.	Rely in the responsibility of the installer.	<b>N/A</b>
<b>5.1.2</b>	This procedure will not apply where an Installer plans (within the next 28 days) or has already installed (in the previous 28 days) other Micro-generating Plants in a Close Geographic Region; in this case the procedure in 5.2 shall be followed. Failure to comply with this requirement may lead to the disconnection of the Micro-generating Plant under ESQCR (26) or failure of the Micro-generating Plant to operate as intended.	Rely in the responsibility of the installer.	<b>N/A</b>
<b>5.2</b>	<b>Multiple Premises Connection Procedure</b>		
<b>5.2.1</b>	In the case of projects where the proposal is to install single or multiple Micro-generators in a number of Customer Installations in a Close Geographic Region, the Installer shall discuss the installation project with the local DNO at the earliest opportunity. The DNO will need to assess the impact that these connections may have on the Distribution Network and specify conditions for connection. The initial application will need to be in a format similar to that shown in Appendix 3 Form A. Connection of the Micro-generator is only allowed after the application for connection has been approved by the DNO and any DNO works facilitating the connection have been completed. Confirmation of the commissioning of each Micro-generator will	Rely in the responsibility of the installer.	<b>N/A</b>

Engineering recommendation G98-1			
Clause	Requirement – Test	Result – Remark	Verdict
	need to be made no later than 28 days after commissioning; the format and content shall be as shown in Appendix 3 Form B Installation Document.		
<b>6</b>	<b>Certification Requirements</b>		
<b>6.1</b>	<b>Type Test Certification</b>		<b>P</b>
<b>6.1.1</b>	Type Tested certification is the responsibility of the Manufacturer. The Manufacturer shall make available upon request a Type Test Verification Report confirming that the Micro-generator has been tested to satisfy the requirements of this EREC G98. The report shall detail the type and model of Micro-generator tested, the test conditions and results recorded. All of these details shall be included in a Type Test Verification Report. The required verification report and declaration are shown in Appendix 3 Form C. It is intended that Manufacturers of Micro-generators will use the requirements of this EREC G98 to develop type verification certification for each of their Micro-generator models.	Considered	<b>P</b>
<b>6.1.2</b>	Manufacturers of a Fully Type Tested Micro-generator should allocate a Manufacturer's reference number with the required details of the Micro-generator with the Energy Networks Association Type Test Verification Report Register.	Considered	<b>P</b>
<b>6.2</b>	<b>Compliance</b>		<b>P</b>
<b>6.2.1</b>	Compliance with the requirements detailed in this EREC G98 will ensure that the Micro-generator(s) is considered to be approved for connection to the DNO's Distribution Network.	Considered	<b>P</b>
<b>6.2.2</b>	The Micro-generator(s) shall conform to all relevant European Directives and should be labelled with a CE marking.	Considered	<b>P</b>
<b>7</b>	<b>Operation and Safety</b>		
<b>7.1</b>	<b>Operational Requirements</b>		<b>P</b>
<b>7.1.1</b>	Compliance with this EREC G98 in respect of the design, installation, operation and maintenance of a Micro-generating Plant, will ensure that the Customer is discharging their legal obligations under ESQCR 22(1)(a) and the EU Network Code on Requirements for Grid Connection of	The inverter is tested according the relevant requirements.  The operational requirements in all cases rely in the responsibility of	<b>P</b>

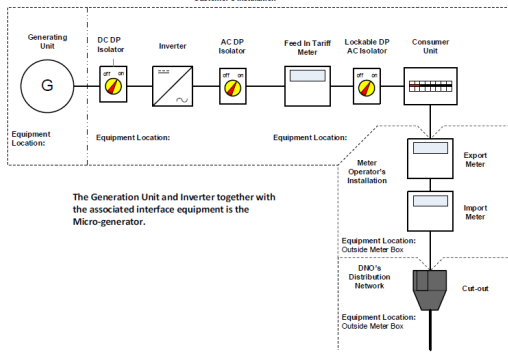

Engineering recommendation G98-1			
Clause	Requirement – Test	Result – Remark	Verdict
	Generators.	the user.	
<b>7.2</b>	<b>Isolation</b>		<b>P</b>
<b>7.2.1</b>	The Micro-generator(s) shall be connected via an accessible isolation switch that is capable of isolating all phases and neutral. The isolation switch shall be capable of being secured in the 'off' (isolated) position.		<b>P</b>
<b>7.3</b>	<b>Labelling</b>		<b>P</b>
<b>7.3.1</b>	Labelling shall be placed in accordance with EN 50438. It should be noted that the warning label does not imply a right on the Customer, Installer or maintainer to operate (remove / replace) the DNO's cut-out fuse and a note to this effect should be included on the warning label.	The required labelling is stated in the manual of the SSEG.  The installation relies in the responsibility of the installer.	<b>P</b>
<b>7.3.2</b>	In addition to the warning label, this EREC G98 requires the following, up to date, information to be displayed at the Connection Point with the DNO's Distribution Network.  a) A circuit diagram relevant to the installation showing the circuit wiring, including all protective devices, between the Micro-generator and the DNO's fused cut-out. This diagram should also show by whom all apparatus is owned and maintained; and  b) A summary of the Interface Protection settings incorporated within the Micro-generator.	The required labelling is stated in the manual of the SSEG.  The installation relies in the responsibility of the installer.	<b>P</b>
<b>7.3.3</b>	Figure 1 shows an outline example of the type of circuit diagram that will need to be displayed. Figure 1 is non-prescriptive and is for illustrative purposes only.   <p>Figure 1 – Example of the type of circuit diagram</p>	The required labelling is stated in the manual of the SSEG.  The installation relies in the responsibility of the installer.	<b>P</b>
<b>7.3.4</b>	The Installer shall advise the Customer that it is the Customer's responsibility to ensure that this safety information is kept up to	See user manual	<b>P</b>

Engineering recommendation G98-1			
Clause	Requirement – Test	Result – Remark	Verdict
	date. The installation operating instructions shall contain the Manufacturer's contact details eg name, telephone number and web address.		
<b>7.4</b>	<b>Maintenance &amp; Routine Testing</b>		<b>P</b>
<b>7.4.1</b>	Periodic testing of the Micro-generator is recommended at intervals prescribed by the Manufacturer. This information shall be included in the installation and user instructions. The method of testing and/or servicing should be included in the servicing instructions.	See user manual	<b>P</b>
<b>7.5</b>	<b>Phase Unbalance</b>		<b>P</b>
<b>7.5.1</b>	There is no requirement to balance phases on installations below or equal to 16 A per phase.	Less than 16A per phase	<b>N/A</b>
<b>7.5.2</b>	For multiple installations of Micro-generators (eg new housing developments), balancing the Micro-generators evenly against the load on the three phases will need to be considered by the DNO. The DNO will advise the Installer of any phase balancing requirements.	See user manual	<b>P</b>
<b>8</b>	<b>Commissioning, Notification and Decommissioning</b>		
<b>8.1</b>	<b>General</b>		<b>N/A</b>
<b>8.1.1</b>	The installation shall be carried out by Installers who are competent and have sufficient skills and training (complete with recognised and approved qualifications relating to the fuels used and general electrical installations) to apply safe methods of work to install a Micro-generator in compliance with this EREC G98.	Rely in the responsibility of the installer.	<b>N/A</b>
<b>8.1.2</b>	Notwithstanding the requirements of this EREC G98, the installation will be carried out to no lower a standard than that required in the Manufacturer's installation instructions.	Rely in the responsibility of the installer.	<b>N/A</b>
<b>8.1.3</b>	The information required by a DNO under an Application for Connection is shown in Appendix 3 Form A. The information required by a DNO to confirm commissioning is shown in Appendix 3 Form B.	Rely in the responsibility of the installer.	<b>N/A</b>
<b>8.1.4</b>	It is the responsibility of the Installer to ensure that the relevant information as specified in sections 5 and 6 is forwarded	Rely in the responsibility of the installer.	<b>N/A</b>

<b>Engineering recommendation G98-1</b>			
<b>Clause</b>	<b>Requirement – Test</b>	<b>Result – Remark</b>	<b>Verdict</b>
	to the local DNO as appropriate. The pro forma in Appendix 3 are designed to: a) simplify the connection procedure for both DNO and Micro-generator Installer; b) provide the DNO with all the information required to assess the potential impact of the Micro-generator connection on the operation of the Distribution Network; c) inform the DNO that the Micro-generator installation complies with the requirements of this EREC G98; and d) allow the DNO to accurately record the location of all Micro-generators connected to the Distribution Network.		
<b>8.1.5</b>	Upon receipt of a multiple premises connection application the DNO's response will be in accordance with the electricity generation standards set by the Authority for applications connecting to the Distribution Network.	Rely in the responsibility of the installer.	<b>N/A</b>
<b>8.2</b>	<b>Commissioning</b>		<b>N/A</b>
<b>8.2.1</b>	No parameter relating to the electrical connection and subject to type verification certification shall be modified unless previously agreed in writing between the DNO and the Customer or their agent. Customer access to such parameters shall be prevented.	Rely in the responsibility of the installer.	<b>N/A</b>
<b>8.2.2</b>	As part of the on-site commissioning tests the Installer shall carry out a functional check of the loss of mains protection, for example by removing the supply to the Micro-generator during operation and checking that the Interface Protection operates to disconnect the Micro-generator from the DNO's Distribution Network. For three phase installations this test can be achieved by opening a three phase circuit breaker or isolator and confirming that the Micro-generator has shut down. Testing for the loss of a single phase is covered in the type testing of Inverters, see section 10.2.	Rely in the responsibility of the installer.	<b>N/A</b>
<b>8.3</b>	<b>Notification of Commissioning</b>		<b>N/A</b>
<b>8.3.1</b>	In accordance with ESQCR and the HSE Certificate of Exemption (2008) (see Appendix 4) the Installer shall ensure that the DNO is advised of the intention to use the Micro-generator in parallel with the Distribution Network no later than 28 days (inclusive of the day of commissioning)	Rely in the responsibility of the installer.	<b>N/A</b>

<b>Engineering recommendation G98-1</b>			
<b>Clause</b>	<b>Requirement – Test</b>	<b>Result – Remark</b>	<b>Verdict</b>
	after commissioning the Micro-generator. Notification that the Micro-generator has been commissioned is achieved by completing an Installation Document as per Appendix 3 Form B (Installation Document), which also includes the relevant details on the Micro-generator installation required by the DNO.		
<b>8.3.2</b>	The Installer shall supply separate Installation Documents for each premises in which Micro-generators are installed under EREC G98. Documentation may be submitted via an agent acting on behalf of the Installer and may be submitted electronically.	Rely in the responsibility of the installer.	<b>N/A</b>
<b>8.4</b>	<b>Notification of Changes</b>		<b>N/A</b>
<b>8.4.1</b>	If a Micro-generator requires modification the Manufacturer must re-submit the Type Test Verification Report prior to the modification being made and the Micro-generator being recommissioned.	Rely in the responsibility of the installer.	<b>N/A</b>
<b>8.4.2</b>	The DNO shall be notified of any operational incidents or failures of a Micro-generator that affect its compliance with this EREC G98, without undue delay, after the occurrence of those incidents.	Rely in the responsibility of the installer.	<b>N/A</b>
<b>8.4.3</b>	The DNO shall have the right to request that the Customer arrange to have compliance tests undertaken after any failure, modification or replacement of any equipment that may have an impact on the Micro-generator's compliance with this EREC G98.	Rely in the responsibility of the installer.	<b>N/A</b>
<b>8.5</b>	<b>Notification of Decommissioning</b>		<b>N/A</b>
<b>8.5.1</b>	The Customer shall notify the DNO about the permanent decommissioning of a Micro-generator by providing the information as detailed under Appendix 3 Form D. Documentation may be submitted by an agent acting on behalf of the Customer and may be submitted electronically.	Rely in the responsibility of the installer.	<b>N/A</b>
<b>9</b>	<b>General Technical Requirements</b>		
<b>9.1</b>	<b>Frequency withstand</b>		<b>P</b>
<b>9.1.1</b>	The Micro-generator shall be capable of remaining connected to the Distribution Network and operating within the frequency ranges and time periods specified in Table	Considered	<b>P</b>

Engineering recommendation G98-1															
Clause	Requirement – Test	Result – Remark	Verdict												
	<p>1 unless disconnection was triggered by rate-of-change-of-frequency-type loss of mains protection.</p> <p>Table 1 – Minimum time periods for which a Micro-generator has to be capable of operating within different frequency ranges without disconnecting from the Distribution Network</p> <table border="1"> <tr> <td>47.0 Hz – 47.5 Hz</td> <td>20 seconds</td> </tr> <tr> <td>47.5 Hz – 48.5 Hz</td> <td>90 minutes</td> </tr> <tr> <td>48.5 Hz -49.0 Hz</td> <td>90 minutes</td> </tr> <tr> <td>49.0 Hz – 51.0 Hz</td> <td>Unlimited</td> </tr> <tr> <td>51.0 Hz – 51.5 Hz</td> <td>90 minutes</td> </tr> <tr> <td>51.5 Hz – 52.0 Hz</td> <td>15 minutes</td> </tr> </table>	47.0 Hz – 47.5 Hz	20 seconds	47.5 Hz – 48.5 Hz	90 minutes	48.5 Hz -49.0 Hz	90 minutes	49.0 Hz – 51.0 Hz	Unlimited	51.0 Hz – 51.5 Hz	90 minutes	51.5 Hz – 52.0 Hz	15 minutes		
47.0 Hz – 47.5 Hz	20 seconds														
47.5 Hz – 48.5 Hz	90 minutes														
48.5 Hz -49.0 Hz	90 minutes														
49.0 Hz – 51.0 Hz	Unlimited														
51.0 Hz – 51.5 Hz	90 minutes														
51.5 Hz – 52.0 Hz	15 minutes														
<b>9.2</b>	<b>Rate of Change of Frequency</b>		<b>P</b>												
<b>9.2.1</b>	With regard to the rate of change of frequency withstand capability, a Micro-generator shall be capable of staying connected to the Distribution Network and operate at rates of change of frequency up to 1.0 Hzs-1 measured over 500 ms.	Considered	<b>P</b>												
<b>9.3</b>	<b>Limited Frequency Sensitive Mode – Overfrequency</b>		<b>P</b>												
<b>9.3.1</b>	With regard to the Limited Frequency Sensitive Mode — Overfrequency (LFSM-O), the Micro-generator shall be capable of activating the provision of Active Power Frequency Response according to EN 50438. The GB specific standard frequency threshold shall be 50.4 Hz; the Droop setting shall be 10%. No intentional delay should be programmed to ensure that the initial delay is as short as possible with a maximum of 2 s.	Considered	<b>P</b>												
<b>9.3.2</b>	The Micro-generator will continue to reduce power with rising frequency with a Droop of 10% until 52.0 Hz, at which point the Micro-generator should disconnect.	Considered	<b>P</b>												
<b>9.4</b>	<b>Active Power Output</b>		<b>P</b>												
<b>9.4.1</b>	The Micro-generator shall be capable of maintaining constant output at its Registered Capacity regardless of changes in frequency, except where the output follows the changes defined in the context of paragraphs 9.3.1 and 9.4.2.	Considered	<b>P</b>												
<b>9.4.2</b>	The Micro-generator shall be capable of maintaining constant output at its	Considered	<b>P</b>												

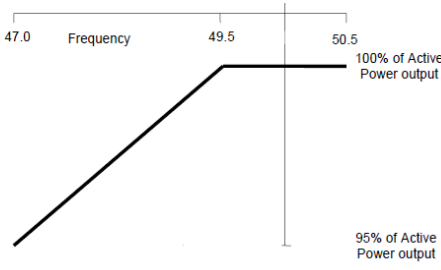
Engineering recommendation G98-1			
Clause	Requirement – Test	Result – Remark	Verdict
	<p>Registered Capacity regardless of changes in frequency in the range 49.5 – 50.4 Hz. Below 49.5 Hz, the power output should not drop by more than pro-rata with frequency, ie the maximum permitted requirement is 100% power at 49.5 Hz falling linearly to 95% power at 47.0 Hz as illustrated in Figure 2.</p>  <p>Figure 2 – Change in output power with falling frequency</p>		
9.4.3	<p>The Micro-generator shall be equipped with a logic interface (input port) in order to cease Active Power output within 5 s following an instruction being received from the DNO at the input port. By default the logic interface will take the form of a simple binary output that can be operated by a simple switch or contactor. When the switch is closed the Micro-generator can operate normally. When the switch is opened the Micro-generator will reduce its Active Power to zero within 5 s. The signal from the Micro-generator that is being switched can be either AC (maximum value 240 V) or DC (maximum value 110 V). The DNO may specify any additional requirements particularly regarding remote operation of this facility.</p>	Considered	P
9.5	<b>Power Factor</b>		P
9.5.1	<p>The power factor capability of the Micro-generator shall conform to EN 50438. When operating at Registered Capacity the Micro-generator shall operate at a power factor within the range 0.95 lagging to 0.95 leading relative to the voltage waveform unless otherwise agreed with the DNO eg for power factor improvement.</p>	Considered	P
9.6	<b>Automatic Connection</b>		P
9.6.1	<p>Micro-generators shall conform to EN 50438 in respect of connection and starting to generate electric power. This includes automatic reconnection where the minimum observation time shall be as</p>	Considered	P

Engineering recommendation G98-1																											
Clause	Requirement – Test	Result – Remark	Verdict																								
	stated in Annex A12 of EN 50438.																										
<b>10</b>	<b>Interface Protection</b>																										
<b>10.1</b>	<b>General</b>		<b>P</b>																								
<b>10.1.1</b>	The Micro-generator shall conform to the Interface Protection settings set out below (Table 2). Means shall be provided to protect the settings from unpermitted interference (eg via a password or seal).	Considered	<b>P</b>																								
<b>10.1.2</b>	The DNO is responsible under the Distribution Code for ensuring, by design, that the voltage and frequency at the Connection Point remains within statutory limits. The Interface Protection settings have been chosen to allow for voltage rise or drop within the Customer's Installation and to allow the Micro-generator to continue to operate outside of the statutory frequency range as required by the EU Network Code on Requirements for Grid Connection of Generators.	Considered	<b>P</b>																								
<b>10.1.3</b>	Interface Protection shall be installed which disconnects the Micro-generator from the DNO's Distribution Network when any parameter is outside of the settings shown in Table 2.  Table 2 – Interface Protection settings  <table border="1" data-bbox="300 1310 817 1552"> <thead> <tr> <th>Protection Function</th> <th>Trip Setting</th> <th>Time Delay Setting</th> </tr> </thead> <tbody> <tr> <td>U/V</td> <td><math>V_{\varphi-n}^{\dagger} - 20\% = 184 \text{ V}</math></td> <td>2.5 s</td> </tr> <tr> <td>O/V stage 1</td> <td><math>V_{\varphi-n}^{\dagger} + 14\% = 262.2 \text{ V}</math></td> <td>1.0 s</td> </tr> <tr> <td>O/V stage 2</td> <td><math>V_{\varphi-n}^{\dagger} + 19\% = 273.7 \sqrt{3}</math></td> <td>0.5 s</td> </tr> <tr> <td>U/F stage 1</td> <td>47.5 Hz</td> <td>20 s</td> </tr> <tr> <td>U/F stage 2</td> <td>47 Hz</td> <td>0.5 s</td> </tr> <tr> <td>O/F</td> <td>52 Hz</td> <td>0.5 s</td> </tr> <tr> <td>LoM (RoCoF)</td> <td><math>1.0 \text{ Hzs}^{-1}</math></td> <td></td> </tr> </tbody> </table>	Protection Function	Trip Setting	Time Delay Setting	U/V	$V_{\varphi-n}^{\dagger} - 20\% = 184 \text{ V}$	2.5 s	O/V stage 1	$V_{\varphi-n}^{\dagger} + 14\% = 262.2 \text{ V}$	1.0 s	O/V stage 2	$V_{\varphi-n}^{\dagger} + 19\% = 273.7 \sqrt{3}$	0.5 s	U/F stage 1	47.5 Hz	20 s	U/F stage 2	47 Hz	0.5 s	O/F	52 Hz	0.5 s	LoM (RoCoF)	$1.0 \text{ Hzs}^{-1}$		Test results see appended table.	<b>P</b>
Protection Function	Trip Setting	Time Delay Setting																									
U/V	$V_{\varphi-n}^{\dagger} - 20\% = 184 \text{ V}$	2.5 s																									
O/V stage 1	$V_{\varphi-n}^{\dagger} + 14\% = 262.2 \text{ V}$	1.0 s																									
O/V stage 2	$V_{\varphi-n}^{\dagger} + 19\% = 273.7 \sqrt{3}$	0.5 s																									
U/F stage 1	47.5 Hz	20 s																									
U/F stage 2	47 Hz	0.5 s																									
O/F	52 Hz	0.5 s																									
LoM (RoCoF)	$1.0 \text{ Hzs}^{-1}$																										
<b>10.1.4</b>	The total disconnection time for voltage and frequency protection, including the operating time of the disconnection device, shall be the time delay setting with a tolerance of, -0s + 0.5 s.	Test results see appended table.	<b>P</b>																								
<b>10.1.5</b>	For the avoidance of doubt, where the Distribution Network voltage or frequency exceed the trip settings in Table 2, for less than the time delay setting, the Micro-generator should not disconnect from the Distribution Network.	Test results see appended table.	<b>P</b>																								
<b>10.1.6</b>	Fully Type Tested Micro-generators shall have protection settings set during	Considered	<b>P</b>																								

Engineering recommendation G98-1			
Clause	Requirement – Test	Result – Remark	Verdict
	manufacture.		
10.1.7	<p>The Manufacturer shall establish a secure way of displaying the Interface Protection setting information in one of the following ways:</p> <ul style="list-style-type: none"> <li>• A display on a screen;</li> <li>• A display on a PC which can communicate with the Micro-generator and confirm that it is the correct Micro-generator by means of a serial number permanently fixed to the Micro-generator and visible on the PC screen at the same time as the settings; or</li> <li>• Display of all Interface Protection settings and nominal voltage and current outputs, alongside the serial number of the Micro-generator, permanently fixed to the Micro-generator.</li> </ul>	Considered	P
10.1.8	The provision of loose documents, documents attached to the Micro-generator by cable ties etc, or provision of data on adhesive paper based products which are not likely to survive due to fading, or failure of the adhesive, for at least 20 years is not acceptable.	Considered	P
10.1.9	In response to a protection operation the Micro-generator shall be automatically disconnected from the DNO's Distribution Network. This disconnection must be achieved preferably by the separation of mechanical contacts or alternatively by the operation of a suitably rated solid state switching device. Where a solid state switching device is used to afford disconnection of the Micro-generator, the switching device shall incorporate fail safe monitoring to check the voltage level at its output stage. In the event that the solid state switching device fails to disconnect the Micro-generator, the voltage on the output side of the switching device shall be reduced to a value below 50 V within 0.5 s of the protection and trip delay timer operation.	Considered	P
10.1.10	Where a common protection system is used to provide the protection function for multiple Micro-generators the complete installation cannot be considered to comprise Fully Type Tested Micro-generators if the protection and	Test results see appended table.	P



Engineering recommendation G98-1			
Clause	Requirement – Test	Result – Remark	Verdict
	connections are made up on site and so cannot be factory tested or Fully Type Tested. In accordance with Annex A1 or Annex A2 if the units or Micro-generators are specifically designed with plugs and sockets to be interconnected on site, then provided the assembly passes the function tests required in Appendix 3 Form C, the Micro-generator(s) can retain Fully Type Tested status.		
10.1.11	Once the Micro-generator has been installed and commissioned the protection settings shall only be altered following written agreement between the DNO and the Customer or their agent.	Considered	P
10.2	<b>Loss of Mains Protection</b>		P
10.2.1	Loss of mains protection shall be incorporated and tested as defined in the compliance type testing annex of EN 50438. Active methods which use impedance measuring techniques by drawing current pulses from or injecting AC currents into the DNO's Distribution Network are not considered to be suitable. For Micro-generators which generate on more than one phase, the loss of mains protection should be able to detect the loss of a single phase of the supply network. This should be tested during type testing and recorded in the Type Test Verification Report as per Appendix 3 Form C.	Test results see appended table.	P
10.3	<b>Frequency Drift and Step Change Stability Test</b>		P
10.3.1	Under normal operation of the Distribution Network, the frequency changes over time due to continuous unbalance of load and generation or can experience a step change due to the loss of a Distribution Network component which does not cause a loss of supply.	Considered	P
10.3.2	In order to ensure that such phenomena do not cause unnecessary tripping of Micro-generators, stability type tests shall be carried out.	Considered	P
10.3.3	The Rate of Change of Frequency (RoCoF) and Vector Shift values required for these tests are marginally less than the corresponding protection settings for RoCoF in Table 2 and vector shifts of up to 50°. Both stability tests shall be carried out in all cases.	Test results see appended table.	P
10.3.4	The stability tests are to be carried out as	Test results see appended	P

Engineering recommendation G98-1			
Clause	Requirement – Test	Result – Remark	Verdict
	per the table in Appendix 3 Form C of this document and the Micro-generator should remain connected during each and every test. The tests shall check that the Micro-generator remains stable and connected during the following scenarios: <ul style="list-style-type: none"> <li>• RoCoF: 0.95 Hzs-1 from 49.0 Hz to 51.0 Hz on both rising and falling frequency; and</li> <li>• Vector shift: 50° plus from 49.5 Hz and 50° minus from 50.5 Hz.</li> </ul>	table.	
<b>11</b>	<b>Quality of Supply</b>		
<b>11.1</b>	The power quality requirements set out in EN 50438 should be met along with the 11.1 requirements described in this section of EREC G98.	Considered	<b>P</b>
<b>11.2</b>	Micro-generators are likely to be installed in large numbers on LV Distribution 11.2 Networks. They are likely to operate for long periods with no diversity between them, and adjacent Micro-generators are likely to be of the same technology. Therefore, in order to accommodate a high number of Micro-generators on a Distribution Network, procedures are specified in Annex A1 and Annex A2, which need to be applied when testing for harmonic current emissions and flicker.	Considered	<b>P</b>
<b>11.3</b>	The requirements of EN 50438 shall be met for DC injection.	Considered	<b>P</b>
<b>12</b>	<b>Short Circuit Current Contribution</b>		
<b>12.1</b>	<b>Directly Coupled Micro-generators</b>		<b>P</b>
<b>12.1.1</b>	The short-circuit parameters of synchronous Micro-generators shall be determined by means of a short-circuit test in accordance with EN 50438.	Considered	<b>P</b>
<b>12.2</b>	<b>Inverter Connected Micro-generators</b>		<b>P</b>
<b>12.2.1</b>	In addition to EN 50438 Manufacturers of Inverters shall take account of the following: <ul style="list-style-type: none"> <li>• DNOs need to understand the contribution that Inverters make to system fault levels in order to determine that they can continue to safely operate their Distribution Networks without exceeding design fault levels for switchgear and other circuit components; and</li> </ul>	Considered	<b>P</b>

Engineering recommendation G98-1			
Clause	Requirement – Test	Result – Remark	Verdict
	<ul style="list-style-type: none"> <li>As the output from an Inverter reduces to zero when a short circuit is applied to its terminals, a short circuit test does not represent the worst case scenario; in most cases the voltage will not collapse to zero for a Distribution Network fault.</li> </ul>		
12.2.2	To address this issue a test, which ensures that at least 10% of nominal voltage remains and which allows the Micro-generator to feed into a load with an X to R ratio of 2.5, is specified as detailed in Annex A1.	Considered	P
<b>Annex A1 Requirements for Type Testing of Inverter Connected Micro-generators</b>			
A 1.1	<p><b>General</b></p> <p>This Annex describes a methodology for obtaining type certification or type verification for Micro-generators which are connected to the Distribution Network via an Inverter.</p> <p>The compliance testing annex of EN 50438 should be complied with except where alternative requirements are detailed in this Annex.</p>	Considered	P
A 1.2	<p><b>Type Verification Functional Testing of the Interface Protection</b></p> <p>Type testing is the responsibility of the Manufacturer.</p> <p>The type testing can be done by the Manufacturer of an individual component or by an external test house or by the supplier of the complete system, or any combination of them as appropriate.</p> <p>The type testing will verify that the operation of the Interface Protection shall result:</p> <p>a) in the safe disconnection of the Micro-generator from the DNO's Distribution Network in the event that the protection settings specified in Table 2 are exceeded; and</p> <p>b) in the Micro-generator remaining connected to the DNO's Distribution Network while Distribution Network conditions are:</p> <p>1) within the envelope specified by the settings plus and minus the tolerances specified for equipment operation in Table</p>	<p>Considered</p> <p>Test results see appended table.</p>	P

<b>Engineering recommendation G98-1</b>			
<b>Clause</b>	<b>Requirement – Test</b>	<b>Result – Remark</b>	<b>Verdict</b>
	<p>2; and</p> <p>2) within the time delay settings specified in Table 2.</p> <p>Wherever possible the type testing of a Micro-generator designed for a particular type of prime mover should be proved under normal conditions of operation for that technology (unless otherwise noted).</p>		
<b>A 1.2.1</b>	<p><b>Disconnection times</b></p> <p>The minimum trip time delay settings, for over / under voltage, over / under frequency and loss of mains tests below, are presented in Table 2.</p> <p>For over / under voltage, over / under frequency and loss of mains tests, reconnection shall be checked as detailed below.</p>	Test results see appended table.	<b>P</b>
<b>A 1.2.2</b>	<p><b>Over / Under Voltage</b></p> <p>In addition to the EN 50438 over / under voltage tests the tests in this paragraph shall be undertaken.</p> <p>The Interface Protection shall be tested by operating the Controller in parallel with a variable AC test supply, as an example see Figure A1.1. Correct protection and ride-through operation shall be confirmed. The set points for over and under voltage at which the Interface Protection disconnects from the supply will be established by varying the AC supply voltage. The disconnect sequence should be initiated when the network conditions mean the protection should trip in accordance with the settings in Table 2, otherwise normal operation should continue.</p>	Test results see appended table.	<b>P</b>
<b>A 1.2.3</b>	<p><b>Over / Under Frequency</b></p> <p>In addition to the EN 50438 over / under frequency tests the tests in this paragraph shall be undertaken into account.</p> <p>The Micro-generator shall be tested by operating in parallel with a low impedance, variable frequency test supply system, see figure A1.2. Correct protection and ride-through operation should be confirmed during operation of the Micro-generator. The set points for over and under frequency at which the Micro-generator disconnects from the supply will be established by varying the test supply frequency.</p>	Test results see appended table.	<b>P</b>

<b>Engineering recommendation G98-1</b>			
<b>Clause</b>	<b>Requirement – Test</b>	<b>Result – Remark</b>	<b>Verdict</b>
<b>A 1.2.4</b>	<p><b>Loss of Mains Protection</b></p> <p>The tests should be carried out in accordance with BS EN 62116 and a subset of results should be recorded as indicated in the Protection – Loss of Mains test section of the Type Test Verification Report, Appendix 3 Form C.</p>	Test results see appended table.	<b>P</b>
<b>A 1.2.5</b>	<p><b>Reconnection</b></p> <p>Further tests will confirm that once the AC supply voltage and frequency have returned to be within the stage 1 settings specified in Table 2 following an automatic protection trip operation there is a minimum time delay of 20 s before the Micro-generator output is restored (ie before the Micro-generator automatically reconnects to the Distribution Network).</p>	Test results see appended table.	<b>P</b>
<b>A 1.2.6</b>	<p><b>Frequency Drift and Step Change Stability test</b></p> <p>The tests will be carried out using the same circuit as specified in A1.2.3 above and following confirmation that the Micro-generator has passed the under and over frequency trip tests and the under and over frequency stability tests.</p>	Test results see appended table.	<b>P</b>
<b>A 1.2.7</b>	<p><b>Active power feed-in at under-frequency</b></p> <p>EN 50438 shall be complied with in respect of active power feed-in at under-frequency.</p>	Test results see appended table.	<b>P</b>
<b>A 1.2.8</b>	<p><b>Power response to over-frequency</b></p> <p>EN 50438 shall be complied with in respect of power response to over-frequency using a specific standard frequency threshold of 50.4 Hz and a Droop setting of 10%.</p>	Test results see appended table.	<b>P</b>
<b>A 1.3</b>	<b>POWER QUALITY</b>	Test results see appended table.	<b>P</b>
<b>A 1.3.1</b>	<p><b>Harmonics</b></p> <p>The tests should be carried out as specified in BS EN 61000-3-2 and can be undertaken with a fixed source of energy at two power levels firstly between 45 and 55% and at 100% of Registered Capacity. The test must be carried out with a minimum of 2 kW of rated Micro-generators. Where an individual Micro-generator is smaller than 2 kW it should be tested as a group. However, where a Micro-generator is designed to be installed singly in an installation then this can be tested alone, for example a domestic CHP</p>	Test results see appended table.	<b>P</b>

<b>Engineering recommendation G98-1</b>			
<b>Clause</b>	<b>Requirement – Test</b>	<b>Result – Remark</b>	<b>Verdict</b>
	<p>unit. The maximum group size for the test is 3.68 kW.</p> <p>The results for all Micro-generators should be normalised to a rating of 3.68 kW. The Micro-generator or group shall meet the harmonic emissions of Table 1 in BS EN 61000-3-2 with a scaling factor applied as follows for each harmonic current:</p> <p>BS EN 61000-3-2 Table 1 current limit × rating of Micro-generator being tested (kW) per phase / 3.68</p>		
<b>A 1.3.2</b>	<p><b>Power Factor</b></p> <p>The test should be undertaken as laid out in EN 50438 with the following three test voltages 230 V –6%, 230V and 230 V +10%.</p>	Test results see appended table.	<b>P</b>
<b>A 1.3.3</b>	<p><b>Voltage Flicker</b></p> <p>The test must be carried out with a minimum of 2 kW of rated Micro-generators. Where an individual Micro-generator is smaller than 2 kW it should be tested as a group. However, where a Micro-generator is designed to be installed singly in an installation then this can be tested alone, for example a domestic CHP unit. The maximum group size for the test is 3.68 kW.</p> <p>The Micro-generator or group shall meet the required <math>d_{max}</math>, <math>d_c</math>, <math>d(t)</math>, <math>P_{st}</math>, <math>P_{lt}</math> requirements of BS EN 61000-3-3 with a scaling factor applied as follows for each voltage change component.</p> <p><math>d_{max}</math>, <math>d_c</math>, <math>d(t)</math>, <math>P_{st}</math>, <math>P_{lt}</math> × rating of Micro-generator being tested (kW) per phase / 3.68</p> <p>The results for groups of Micro-generators should be normalised to a rating of 3.68 kW and to the standard source impedance. Single Micro-generators need to be normalised to the standard source impedance, these normalised results need to conform to the limits set out in the Type Test Verification Report, Appendix 3 Form C.</p> <p>For voltage change and flicker measurements the following simplified formula is to be used to convert the measured values to the normalised values where the power factor of the Micro-generator output is 0.98 or above. Where it is less than 0.98 then compliance with the</p>	Test results see appended table.	<b>P</b>

Engineering recommendation G98-1			
Clause	Requirement – Test	Result – Remark	Verdict
	full requirements of BS EN 61000-3-3 is required.		
<b>A 1.3.4</b>	<b>DC Injection for Inverters</b> DC injection compliance testing in EN 50438 shall be applicable to all Inverter connected Micro-generators regardless of connection configuration.	Test results see appended table.	<b>P</b>
<b>A 1.3.5</b>	<b>Short Circuit Current Contribution for Inverters</b> Inverter connected Micro-generators generally have small short circuit fault contributions, however, DNOs need to understand the contribution that they make to system fault levels in order to determine that they can continue to safely operate without exceeding design fault levels for switchgear and other circuit components. The following type tests shall be carried out and the results noted in the Type Test Verification Report, Appendix 3 Form C.	Test results see appended table.	<b>P</b>
<b>A 1.3.6</b>	<b>Self-Monitoring - Solid State Disconnection</b> Some Micro-generators include solid state switching devices to disconnect from the DNO's Distribution Network. In this case 10.1.9 requires the control equipment to monitor the output stage of the Micro-generator to ensure that in the event of a protection initiated trip the output voltage is either disconnected completely or reduced to a value below 50 V AC. This shall be verified either by self-certification by the Manufacturer, or additional material shall be presented to the tester sufficient to allow an assessment to be made.	A Disconnection device with mechanical separation in the use of two relays in series in line and neutral are provided in the SSEG.	<b>P</b>
<b>A 1.3.7</b>	<b>Electromagnetic Compatibility (EMC)</b> All equipment shall conform to the generic EMC standards: BS EN61000-6-3: Electromagnetic Compatibility, Generic Emission Standard; and BS EN61000-6-1: Electromagnetic Compatibility, Generic Immunity Standard.	See Annex 1 EMC test report.	<b>P</b>
<b>Annex A2 Requirements for Type Testing of Synchronous Micro-generators</b>			
<b>A 2.1</b>	<b>General</b> The compliance testing annex of EN 50438 should be complied with except where alternative requirements are detailed in this	The SSEG is a photovoltaic inverter.	<b>N/A</b>

Engineering recommendation G98-1			
Clause	Requirement – Test	Result – Remark	Verdict
	Annex.		
<b>A 2.2</b>	<p><b>Type Verification Functional Testing of the Interface Protection</b></p> <p>Type testing is the responsibility of the Manufacturer.</p> <p>The type testing can be done by the Manufacturer of an individual component, by an external test house or by the supplier of the complete system, or any combination of them as appropriate.</p> <p>The type testing will verify that the operation of the Interface Protection shall result:</p> <p>a) in the safe disconnection of the Micro-generator from the DNO's Distribution Network in the event that the protection settings specified in Table 2 are exceeded; and</p> <p>b) in the Micro-generator remaining connected to the DNO's Distribution Network while Distribution Network conditions are: 1) within the envelope specified by the settings plus and minus the tolerances specified for equipment operation in Table 2; and</p> <p>2) within the time delay settings specified in Table 2.</p>	The SSEG is a photovoltaic inverter.	<b>N/A</b>
<b>A 2.2.1</b>	<p><b>Disconnection times</b></p> <p>The minimum trip time delay settings, for over / under voltage, over / under frequency and loss of mains tests below, are presented in Table 2.</p> <p>For over / under voltage, over / under frequency and loss of mains tests, reconnection shall be checked as detailed below.</p>	The SSEG is a photovoltaic inverter.	<b>N/A</b>
<b>A 2.2.2</b>	<p><b>Over / Under Voltage</b></p> <p>In addition to the EN 50438 over / under voltage tests the tests in this paragraph shall be undertaken.</p> <p>The Interface Protection shall be tested by operating the Controller in parallel with a variable AC test supply, as an example see Figure A2.1. Correct protection and ride-through operation shall be confirmed. The set points for over and under voltage at which the Interface Protection disconnects from the supply will be established by varying the AC supply voltage. The</p>	The SSEG is a photovoltaic inverter.	<b>N/A</b>



Engineering recommendation G98-1			
Clause	Requirement – Test	Result – Remark	Verdict
	disconnect sequence should be initiated when the network conditions of Table 2 are met, otherwise normal operation should continue.		
<b>A 2.2.3</b>	<p><b>Over / Under Frequency</b></p> <p>In addition to the EN 50438 over / under frequency tests the tests in this paragraph shall be undertaken into account.</p> <p>The Interface Protection shall be tested by operating the Controller in parallel with a low impedance, variable frequency test supply system, as an example see Figure A2.2. Correct protection and ride-through operation should be confirmed during the test. The set points for over and under frequency at which the Interface Protection disconnects from the supply will be established by varying the test supply frequency.</p>	The SSEG is a photovoltaic inverter.	<b>N/A</b>
<b>A 2.2.4</b>	<p><b>Loss of Mains Protection</b></p> <p>The test described in EN 50438 should be completed at 10%, 55%, and 100% of the Registered Capacity. In both cases a subset of results should be recorded as indicated in the Protection – Loss of Mains test section of the Type Test Verification Report, Appendix 3 Form C.</p>	The SSEG is a photovoltaic inverter.	<b>N/A</b>
<b>A 2.2.5</b>	<p><b>Reconnection</b></p> <p>Further tests will confirm that once the AC supply voltage and frequency have returned to be within the stage 1 settings specified in Table 2 following an automatic protection trip operation there is a minimum time delay of 20 s before the Micro-generator output is restored (ie before the Micro-generator automatically reconnects to the Distribution Network).</p>	The SSEG is a photovoltaic inverter.	<b>N/A</b>
<b>A 2.2.6</b>	<p><b>Frequency Drift and Step Change Stability test</b></p> <p>The tests will be carried out using the same circuit as specified in A.2.2.3 above and following confirmation that the Micro-generator has passed the under and over frequency trip tests and the under and over frequency stability tests.</p>	The SSEG is a photovoltaic inverter.	<b>N/A</b>
<b>A 2.2.7</b>	<p><b>Active power feed-in at under-frequency</b></p> <p>EN 50438 shall be complied with in respect of active power feed-in at under-frequency.</p>	The SSEG is a photovoltaic inverter.	<b>N/A</b>
<b>A 2.2.8</b>	<b>Power response to over-frequency</b>	The SSEG is a	<b>N/A</b>

<b>Engineering recommendation G98-1</b>			
<b>Clause</b>	<b>Requirement – Test</b>	<b>Result – Remark</b>	<b>Verdict</b>
	EN 50438 shall be complied with in respect of power response to over-frequency using a specific standard frequency threshold of 50.4 Hz and a Droop setting of 10%.	photovoltaic inverter.	
<b>A 2.3</b>	<b>POWER QUALITY</b>	The SSEG is a photovoltaic inverter.	<b>N/A</b>
<b>A 2.3.1</b>	<p><b>Harmonics</b></p> <p>The tests should be carried out as specified in BS EN 61000-3-2 and can be undertaken with a fixed source of energy at two power levels firstly between 45 and 55% and at 100% of Registered Capacity.</p> <p>The test must be carried out with a minimum of 2 kW of rated Micro-generators. Where an individual Micro-generator is smaller than 2 kW it should be tested as a group. However, where a Micro-generator is designed to be installed singly in an installation then this can be tested alone, for example a domestic CHP unit. The maximum group size for the test is 3.68 kW.</p>	The SSEG is a photovoltaic inverter.	<b>N/A</b>
<b>A 2.3.2</b>	<p><b>Power Factor</b></p> <p>The test should be undertaken as laid out in EN 50438 with the following three test voltages 230 V –6%, 230V and 230 V +10%.</p>	The SSEG is a photovoltaic inverter.	<b>N/A</b>
<b>A 2.3.3</b>	<p><b>Voltage Flicker</b></p> <p>The test must be carried out with a minimum of 2 kW of rated Micro-generators. Where an individual Micro-generator is smaller than 2 kW it should be tested as a group. However, where a Micro-generator is designed to be installed singly in an installation then this can be tested alone, for example a domestic CHP unit. The maximum group size for the test is 3.68 kW.</p> <p>The Micro-generator or group shall meet the required <math>d_{max}</math>, <math>d_c</math>, <math>d(t)</math>, <math>P_{st}</math>, <math>P_{lt}</math> requirements of BS EN 61000-3-3 with a scaling factor applied as follows for each voltage change component.</p> <p><math>d_{max}</math>, <math>d_c</math>, <math>d(t)</math>, <math>P_{st}</math>, <math>P_{lt} \times</math> rating of Micro-generator being tested (kW) per phase / 3.68</p> <p>The results for groups of Micro-generators should be normalised to a rating of 3.68 kW and to the standard source impedance. Single Micro-generators need to be</p>	The SSEG is a photovoltaic inverter.	<b>N/A</b>

Engineering recommendation G98-1			
Clause	Requirement – Test	Result – Remark	Verdict
	<p>normalised to the standard source impedance, these normalised results need to conform to the limits set out in the Type Test Verification Report, Appendix 3 Form C.</p> <p>For voltage change and flicker measurements the following simplified formula is to be used to convert the measured values to the normalised values where the power factor of the Micro-generator output is 0.98 or above. Where it is less than 0.98 then compliance with the full requirements of BS EN 61000-3-3 is required.</p>		
<b>A 2.3.4</b>	<p><b>Short Circuit Current Contribution for Directly Coupled technology</b></p> <p>DNOs need to understand the contribution a Micro-generator makes to system fault levels in order to determine that they can continue to safely operate without exceeding design fault levels for switchgear and other circuit components.</p> <p>The tests in EN 50438 shall apply.</p> <p>For rotating machines and linear piston machines the test should produce a 0 – 2 s plot of the short circuit current as seen at the Micro-generator terminals.</p>	The SSEG is a photovoltaic inverter.	<b>N/A</b>
<b>A 2.3.5</b>	<p><b>Electromagnetic Compatibility (EMC)</b></p> <p>All equipment shall conform to the generic EMC standards: BS EN61000-6-3: Electromagnetic Compatibility, Generic Emission Standard; and BS EN61000-6-1: Electromagnetic Compatibility, Generic Immunity Standard.</p>	The SSEG is a photovoltaic inverter.	<b>N/A</b>

## G98-1/1 Test Results:

### A1 Common Directly Coupled Connected SSEG Requirements

A1.2 Type Verification Functional Testing of the Interface Protection Functional safety - fault condition tests according DIN V VDE V 0126-1-1								P
ambient temperature [°C] :		23,2						
model/type of power supply :		Chroma						
manufacturer of power supply :		AC: 61512 DC: 62150h-1000s						
rated markings of power supply :		AC: 0-300V, 15kVA DC: 0-1000V,15A						
component No.	fault	test condition		test time	fuse No.	fault condition		result
		AC	DC			AC	DC	
Relay defect K1506 Pin 3-pin 4	s-c*	230V <0,1A	850V <0,1 A	10 min.	--	230V <0,1A	850V <0,1A	PCE can't start up. Error message: alarm grid relay abnormal No hazard, no damage, no reconnection.
Relay defect K1507 Pin 3-pin 4	s-c*	230V <0,1A	850V <0,1 A	10 min.	--	230V <0,1A	850V <0,1A	PCE can't start up. Error message: alarm grid relay abnormal No hazard, no damage, no reconnection.
Relay defect K1508 Pin 3-pin 4	s-c*	230V <0,1A	850V <0,1 A	10 min.	--	230V <0,1A	850V <0,1A	PCE can't start up. Error message: alarm grid relay abnormal No hazard, no damage, no reconnection.
Relay defect K1509 Pin 3-pin 4	s-c*	230V <0,1A	850V <0,1 A	10 min.	--	230V <0,1A	850V <0,1A	PCE can't start up. Error message: alarm grid relay abnormal No hazard, no damage, no reconnection.
Relay defect K6 Pin 3-pin 4	s-c*	230V <0,1A	850V <0,1 A	10 min.	--	230V <0,1A	850V <0,1A	PCE can't start up. Error message: alarm grid relay abnormal No hazard, no damage, no reconnection.
Relay defect K7 Pin 3-pin 4	s-c*	230V <0,1A	850V <0,1 A	10 min.	--	230V <0,1A	850V <0,1A	PCE can't start up. Error message: alarm grid relay abnormal No hazard, no damage, no reconnection.
Relay defect C4063	s-c	230V 14,7A	850V 12,2A	10 min.	--	230V <0,1A	850V <0,1A	PCE shutdown immediately. Error message: alarm grid relay abnormal No hazard, no damage, no reconnection.

component No.	fault	test condition		test time	fuse No.	fault condition		result
		AC	DC			AC	DC	
Relay defect Q230	s-c	230V 14,7A	850V 12,2A	10 min.	--	230V <0,1A	850V <0,1A	PCE shutdown immediately. Error message: alarm grid relay abnormal No hazard, no damage, no reconnection.
Monitoring grid voltage phase defect D13 pin3 to pin2	s-c	230V 14,7A	850V 12,2A	10 min.	--	230V <0,1A	850V <0,1A	PCE shutdown immediately. Error message: alarm ABC phase over voltage No hazard, no damage, no reconnection.
Monitoring grid voltage phase defect D21 pin3 to pin2	s-c	230V 14,7A	850V 12,2A	10 min.	--	230V <0,1A	850V <0,1A	PCE shutdown immediately. Error message: alarm grid over voltage,unballance No hazard, no damage, no reconnection.
Monitoring grid voltage phase defect D15 pin3 to pin2	s-c	230V 14,7A	850V 12,2A	10 min.	--	230V <0,1A	850V <0,1A	PCE shutdown immediately. Error message: alarm PE wire connection abnormal No hazard, no damage, no reconnection.
Monitoring grid voltage phase defect R305	s-c	230V 14,7A	850V 12,2A	10 min.	--	230V <0,1A	850V <0,1A	PCE shutdown immediately. Error message: alarm grid over voltage No hazard, no damage, no reconnection.
Monitoring grid voltage phase defect R308	s-c	230V 14,7A	850V 12,2A	10 min.	--	230V <0,1A	850V <0,1A	PCE shutdown immediately. Error message: alarm 3 phase voltage unballance No hazard, no damage, no reconnection.
Monitoring grid voltage phase defect D55 pin3 to pin2	s-c	230V 14,7A	850V 12,2A	10 min.	--	230V <0,1A	850V <0,1A	PCE shutdown immediately. Error message: alarm ABC phase over voltage No hazard, no damage, no reconnection.
Monitoring grid voltage phase defect D55 pin3 to pin1	s-c	230V 14,7A	850V 12,2A	10 min.	--	230V <0,1A	850V <0,1A	PCE shutdown immediately. Error message: alarm ABC phase over voltage No hazard, no damage, no reconnection.
Monitoring grid voltage phase defect D54 pin3 to pin1	s-c	230V 14,7A	850V 12,2A	10 min.	--	230V <0,1A	850V <0,1A	PCE shutdown immediately. Error message: alarm ABC phase over voltage No hazard, no damage, no reconnection.

component No.	fault	test condition		test time	fuse No.	fault condition		result
		AC	DC			AC	DC	
Monitoring grid voltage phase defect D54 pin3 to pin2	s-c	230V 14,7A	850V 12,2A	10 min.	--	230V <0,1A	850V <0,1A	PCE shutdown immediately. Error message: alarm ABC phase over voltage No hazard, no damage, no reconnection.
Monitoring grid voltage phase defect D57 pin3 to pin2	s-c	230V 14,7A	850V 12,2A	10 min.	--	230V <0,1A	850V <0,1A	PCE shutdown immediately. Error message: alarm ABC phase over voltage No hazard, no damage, no reconnection.
Monitoring grid voltage phase defect D57 pin3 to pin1	s-c	230V 14,7A	850V 12,2A	10 min.	--	230V <0,1A	850V <0,1A	PCE shutdown immediately. Error message: alarm ABC phase over voltage No hazard, no damage, no reconnection.
Monitoring grid voltage phase defect D56 pin3 to pin2	s-c	230V 14,7A	850V 12,2A	10 min.	--	230V <0,1A	850V <0,1A	PCE shutdown immediately. Error message: alarm ABC phase over voltage No hazard, no damage, no reconnection.
Monitoring grid voltage phase defect D56 pin3 to pin1	s-c	230V 14,7A	850V 12,2A	10 min.	--	230V <0,1A	850V <0,1A	PCE shutdown immediately. Error message: alarm ABC phase over voltage No hazard, no damage, no reconnection.
Monitoring grid voltage phase defect D59 pin3 to pin2	s-c	230V 14,7A	850V 12,2A	10 min.	--	230V <0,1A	850V <0,1A	PCE shutdown immediately. Error message: alarm ABC phase over voltage No hazard, no damage, no reconnection.
Monitoring grid voltage phase defect D59 pin3 to pin1	s-c	230V 14,7A	850V 12,2A	10 min.	--	230V <0,1A	850V <0,1A	PCE shutdown immediately. Error message: alarm ABC phase over voltage No hazard, no damage, no reconnection.
Monitoring grid voltage phase defect D14 pin3 to pin2	s-c	230V 14,7A	850V 12,2A	10 min.	--	230V <0,1A	850V <0,1A	PCE shutdown immediately. Error message: alarm ABC phase over voltage No hazard, no damage, no reconnection.

component No.	fault	test condition		test time	fuse No.	fault condition		result
		AC	DC			AC	DC	
Monitoring grid voltage phase defect D14 pin3 to pin1	s-c	230V 14,7A	850V 12,2A	10 min.	--	230V <0,1A	850V <0,1A	PCE shutdown immediately. Error message: alarm ABC phase over voltage No hazard, no damage, no reconnection.
Monitoring grid voltage phase defect D13 pin3 to pin1	s-c	230V 14,7A	850V 12,2A	10 min.	--	230V <0,1A	850V <0,1A	PCE shutdown immediately. Error message: alarm ABC phase over voltage No hazard, no damage, no reconnection.
Monitoring grid voltage phase defect D12 pin3 to pin1	s-c	230V 14,7A	850V 12,2A	10 min.	--	230V <0,1A	850V <0,1A	PCE shutdown immediately. Error message: alarm ABC phase over voltage No hazard, no damage, no reconnection.
Monitoring grid voltage phase defect R109	o-c	230V 14,7A	850V 12,2A	10 min.	--	230V <0,1A	850V <0,1A	PCE shutdown immediately. Error message: alarm ABC phase over voltage No hazard, no damage, no reconnection.
Monitoring grid voltage phase defect R363	o-c	230V 14,7A	850V 12,2A	10 min.	--	230V <0,1A	850V <0,1A	PCE shutdown immediately. Error message: alarm ABC phase over voltage No hazard, no damage, no reconnection.
Monitoring grid voltage phase defect R110	o-c	230V 14,7A	850V 12,2A	10 min.	--	230V <0,1A	850V <0,1A	PCE shutdown immediately. Error message: alarm ABC phase over voltage No hazard, no damage, no reconnection.
Monitoring PV voltage defect D26 pin2 to pin3	s-c	230V 14,7A	850V 12,2A	10 min.	--	230V <0,1A	850V <0,1A	PCE shutdown immediately. Error message: alarm BOOSTA input voltage over voltage No hazard, no damage, no reconnection.
Monitoring PV voltage defect R134	o-c	230V 14,7A	850V 12,2A	10 min.	--	230V <0,1A	850V <0,1A	PCE shutdown immediately. Error message: alarm BOOSTA input voltage over voltage No hazard, no damage, no reconnection.
Monitoring PV voltage defect R136	o-c	230V 14,7A	850V 12,2A	10 min.	--	230V <0,1A	850V <0,1A	PCE shutdown immediately. Error message: alarm BOOSTA input voltage over voltage No hazard, no damage, no reconnection.

component No.	fault	test condition		test time	fuse No.	fault condition		result
		AC	DC			AC	DC	
Monitoring PV voltage defect R369	o-c	230V 14,7A	850V 12,2A	10 min.	--	230V <0,1A	850V <0,1A	PCE shutdown immediately. Error message: alarm BOOSTA input voltage over voltage  No hazard, no damage, no reconnection.
Monitoring PV voltage defect R176	o-c	230V 14,7A	850V 12,2A	10 min.	--	230V <0,1A	850V <0,1A	PCE shutdown immediately. Error message: alarm BOOSTA input voltage over voltage  No hazard, no damage, no reconnection.
Monitoring BUS voltage defect C432	s-c	230V 14,7A	850V 12,2A	10 min.	--	230V <0,1A	850V <0,1A	PCE shutdown immediately. Error message: alarm bus over voltage  No hazard, no damage, no reconnection.
Monitoring BUS voltage defect C429	s-c	230V 14,7A	850V 12,2A	10 min.	--	230V <0,1A	850V <0,1A	PCE shutdown immediately. Error message: alarm bus over voltage  No hazard, no damage, no reconnection.
Monitoring BUS voltage defect D5 pin3 to pin2	s-c	230V 14,7A	850V 12,2A	10 min.	--	230V <0,1A	850V <0,1A	PCE shutdown immediately. Error message: alarm bus over voltage, bus voltage unballance  No hazard, no damage, no reconnection.
Monitoring BUS voltage defect D5 pin3 to pin1	s-c	230V 14,7A	850V 12,2A	10 min.	--	230V <0,1A	850V <0,1A	PCE shutdown immediately. Error message: alarm bus over voltage, bus voltage unballance  No hazard, no damage, no reconnection.
Monitoring BUS voltage defect D6 pin3 to pin2	s-c	230V 14,7A	850V 12,2A	10 min.	--	230V <0,1A	850V <0,1A	PCE shutdown immediately. Error message: alarm bus over voltage  No hazard, no damage, no reconnection.
Frequency measurement defect C396	s-c	230V 14,7A	850V 12,2A	10 min.	--	230V <0,1A	850V <0,1A	PCE shutdown immediately. Error message: alarm under frequency, grid fault.  No hazard, no damage, no reconnection.
Frequency measurement defect C393	s-c	230V 14,7A	850V 12,2A	10 min.	--	230V <0,1A	850V <0,1A	PCE shutdown immediately. Error message: alarm under frequency, grid fault.  No hazard, no damage, no reconnection.



component No.	fault	test condition		test time	fuse No.	fault condition		result
		AC	DC			AC	DC	
Frequency measurement defect C389	s-c	230V 14,7A	850V 12,2A	10 min.	--	230V <0,1A	850V <0,1A	PCE shutdown immediately. Error message: alarm under frequency, grid fault.  No hazard, no damage, no reconnection.
Grid current measurement defect D19 pin3 to pin2	s-c	230V 14,7A	850V 12,2A	10 min.	--	230V <0,1A	850V <0,1A	PCE shutdown immediately. Error message: alarm inverter over current  No hazard, no damage, no reconnection.
Grid current measurement defect U23 pin7 to agnd	o-c	230V 14,7A	850V 12,2A	10 min.	--	230V <0,1A	850V <0,1A	PCE shutdown immediately. Error message: alarm positive bus voltage over voltage  No hazard, no damage, no reconnection.
Grid current measurement defect C352	s-c	230V 14,7A	850V 12,2A	10 min.	--	230V <0,1A	850V <0,1A	PCE shutdown immediately. Error message: alarm inverter circuit abnormal  No hazard, no damage, no reconnection.
Grid current measurement defect C353	s-c	230V 14,7A	850V 12,2A	10 min.	--	230V <0,1A	850V <0,1A	PCE shutdown immediately. Error message: alarm inverter circuit abnormal  No hazard, no damage, no reconnection.
Grid current measurement defect C354	s-c	230V 14,7A	850V 12,2A	10 min.	--	230V <0,1A	850V <0,1A	PCE shutdown immediately. Error message: alarm inverter circuit abnormal  No hazard, no damage, no reconnection.
Grid current measurement defect C355	s-c	230V 14,7 A	850V 12,2 A	10 min.	--	230V <0,1A	850V <0,1A	PCE shutdown immediately. Error message: alarm inverter over current  No hazard, no damage, no reconnection.
PV Current measurement defect R517	s-c	230V 14,7 A	850V 12,2 A	10 min.	--	230V <0,1A	850V <0,1A	PCE shutdown immediately. Error message: alarm boost input over current  No hazard, no damage, no reconnection.
PV Current measurement defect R518	s-c	230V 14,7 A	850V 12,2 A	10 min.	--	230V <0,1A	850V <0,1A	PCE shutdown immediately. Error message: alarm boost input over current  No hazard, no damage, no reconnection.

component No.	fault	test condition		test time	fuse No.	fault condition		result
		AC	DC			AC	DC	
RCMU measurement defect D9	o-c	230V 14,7 A	850V 12,2 A	10 min.	--	230V <0,1A	850V <0,1A	PCE shutdown immediately. Error message: alarm RCD fault  No hazard, no damage, no reconnection.
RCMU measurement defect R402	o-c	230V 14,7 A	850V 12,2 A	10 min.	--	230V <0,1A	850V <0,1A	PCE shutdown immediately. Error message: alarm RCD fault  No hazard, no damage, no reconnection.
RCMU measurement defect R4549	o-c	230V 14,7 A	850V 12,2 A	10 min.	--	230V <0,1A	850V <0,1A	PCE shutdown immediately. Error message: alarm RCD fault  No hazard, no damage, no reconnection.
RCMU measurement defect D10	o-c	230V 14,7 A	850V 12,2 A	10 min.	--	230V <0,1A	850V <0,1A	PCE shutdown immediately. Error message: alarm RCD fault  No hazard, no damage, no reconnection.
PV insulation measurement defect D28 pin2 to pin3	s-c*	230V <0,1 A	850V <0,1 A	10 min.	--	230V <0,1A	850V <0,1A	PCE can't start up. Error message: Unit can't power on, alarm, ISO fault. No hazard, no damage, no reconnection.
PV insulation measurement defect R589	s-c*	230V <0,1 A	850V <0,1 A	10 min.	--	230V <0,1A	850V <0,1A	PCE can't start up. Error message: Unit can't power on, alarm, ISO fault. No hazard, no damage, no reconnection.
PV insulation measurement defect D70 pin2 to pin3	s-c*	230V <0,1 A	850V <0,1 A	10 min.	--	230V <0,1A	850V <0,1A	PCE can't start up. Error message: Unit can't power on, alarm, ISO fault. No hazard, no damage, no reconnection.
Loss of control DSP failure +1,2V	s-c	230V 14,7 A	850V 12,2 A	10 min.	--	230V <0,1A	850V <0,1A	PCE shutdown immediately. No hazard, no damage, no reconnection.
Loss of control DSP failure +3,3V	s-c	230V 14,7 A	850V 12,2 A	10 min.	--	230V <0,1A	850V <0,1A	PCE shutdown immediately. No hazard, no damage, no reconnection.
Loss of control DSP failure +5V	s-c	230V 14,7 A	850V 12,2 A	10 min.	--	230V <0,1A	850V <0,1A	PCE shutdown immediately. No hazard, no damage, no reconnection.

component No.	fault	test condition		test time	fuse No.	fault condition		result
		AC	DC			AC	DC	
Loss of control Inverter voltage detector X1	s-c	230V 14,7 A	850V 12,2 A	10 min.	--	230V <0,1A	850V <0,1A	PCE shutdown immediately. No hazard, no damage, no reconnection.
Communication microcontroller defect C285	s-c	230V 43,4 A	700V 44,1 A	10 min.	--	230V <0,1A	820V <0,1A	PCE shutdown immediately. Error message: alarm control circuit fault No hazard, no damage, no reconnection.
Communication microcontroller defect DSP pin 93 to GND	s-c	230V 43,4 A	700V 44,1 A	10 min.	--	230V <0,1A	820V <0,1A	PCE shutdown immediately. Error message: alarm control circuit fault No hazard, no damage, no reconnection.

Note:

The errors in the control circuit simulate that the safety is even under one error ensured.

s-c: short circuit; o-c: open circuit

\* Before start-up.

The conditions and testing is performed according to VDE V 0124-100, 5.4.5.2

The test had been performed on the model SUN2000-10KTL-M0, the test results are valid for the SUN2000-3KTL-M0, SUN2000-4KTL-M0, SUN2000-5KTL-M0, SUN2000-6KTL-M0, SUN2000-8KTL-M0, SUN2000-3KTL-M1, SUN2000-4KTL-M1, SUN2000-5KTL-M1, SUN2000-6KTL-M1, SUN2000-8KTL-M1 and SUN2000-10KTL-M1 since it is almost identical in hardware and just the output power derated by software.

<b>Operating Range:</b> This test should be carried out as specified in EN 50438 D.3.1.				<b>P</b>
Setting values	Over-voltage [V]:		253,0	
	Under-voltage [V]:		195,5	
	Over-frequency [Hz]:		52,00	
	Under-frequency [Hz]:		47,50	
<ul style="list-style-type: none"> <li>- Test 1: U = 195,5 V; f = 47,5 Hz; P = 1,00 Sn; <math>\cos\phi = 1</math>; at least 90 mins</li> <li>- Test 2: U = 253,0 V; f = 51,5 Hz; P = 1,00 Sn; <math>\cos\phi = 1</math>; at least 90 mins</li> <li>- Test 2: U = 253,0 V; f = 52,0 Hz; P = 1,00 Sn; <math>\cos\phi = 1</math>; at least 15 mins</li> </ul>				
Test sequence	Voltage [V]	Frequency [Hz]	Output power [W]	Cos $\phi$ [1]
1	196,0	47,50	9984	0,999
2	253,1	51,50	10000	0,999
3	253,1	52,00	10000	0,999
<p><b>Note:</b></p> <p>During the tests the interface protection was disabled.</p> <p>Operation at reduced power is allowed during test 1, equal to the maximum power that can be supplied on reaching the maximum output current limit (<math>P \geq 0,85 S_n</math>).</p> <p>During the sequence of test 2, automatic adjustment to reduce power in the case of over-frequency was disabled.</p>				

<b>A1.2.2 Over / Under Voltage</b>						
The test procedure in Annex A.1.2.2 (Inverter connected) or Annex A2 A.2.2.2 (Synchronous).						
<b>Single Phase / Phase 1</b>						
Function	Setting		Trip test		No trip test	
	Voltage	Time delay	Voltage	Time delay	Voltage / time	Confirm no trip
U/V	184,0V	2,5s	182,9V	2,572s	188V / 3,5s	No trip
					180V / 2,48s	No trip
O/V stage 1	262,2V	1,0s	261,0V	1,062s	258,2V / 2,0s	No trip
O/V stage 2	273,7V	0,5s	272,2V	0,563s	269,7V / 0,98s	No trip
					277,7V / 0,48s	No trip
<b>Phase 2</b>						
Function	Setting		Trip test		No trip test	
	Voltage	Time delay	Voltage	Time delay	Voltage / time	Confirm no trip
U/V	184,0V	2,5s	184,9V	2,552s	188V / 3,5s	No trip
					180V / 2,48s	No trip
O/V stage 1	262,2V	1,0s	263,2V	1,077s	258,2V / 2,0s	No trip
O/V stage 2	273,7V	0,5s	275,0V	0,583s	269,7V / 0,98s	No trip
					277,7V / 0,48s	No trip
<b>Phase 3</b>						
Function	Setting		Trip test		No trip test	
	Voltage	Time delay	Voltage	Time delay	Voltage / time	Confirm no trip
U/V	184,0V	2,5s	184,8V	2,556s	188V / 3,5s	No trip
					180V / 2,48s	No trip
O/V stage 1	262,2V	1,0s	262,1V	1,074s	258,2V / 2,0s	No trip
O/V stage 2	273,7V	0,5s	274,1V	0,558s	269,7V / 0,98s	No trip
					277,7V / 0,48s	No trip

**Note:**

The total disconnection time for voltage and frequency protection, including the operating time of the disconnection device, shall be the time delay setting with a tolerance of,  $-0s + 0.5s$ .

The Voltage required to trip is the setting  $\pm 3.45V$ . The time delay can be measured at a larger deviation than the minimum required to operate the protection. The No trip tests need to be carried out at the setting  $\pm 4V$  and for the relevant times as shown in the table above to ensure that the protection will not trip in error.

The test had been performed on the model SUN2000-10KTL-M0, the test results are valid for the SUN2000-3KTL-M0, SUN2000-4KTL-M0, SUN2000-5KTL-M0, SUN2000-6KTL-M0, SUN2000-8KTL-M0, SUN2000-3KTL-M1, SUN2000-4KTL-M1, SUN2000-5KTL-M1, SUN2000-6KTL-M1, SUN2000-8KTL-M1 and SUN2000-10KTL-M1 since it is almost identical in hardware and just the output power derated by software.

### U/V, Phase 1



### O/V stage 1, Phase 1

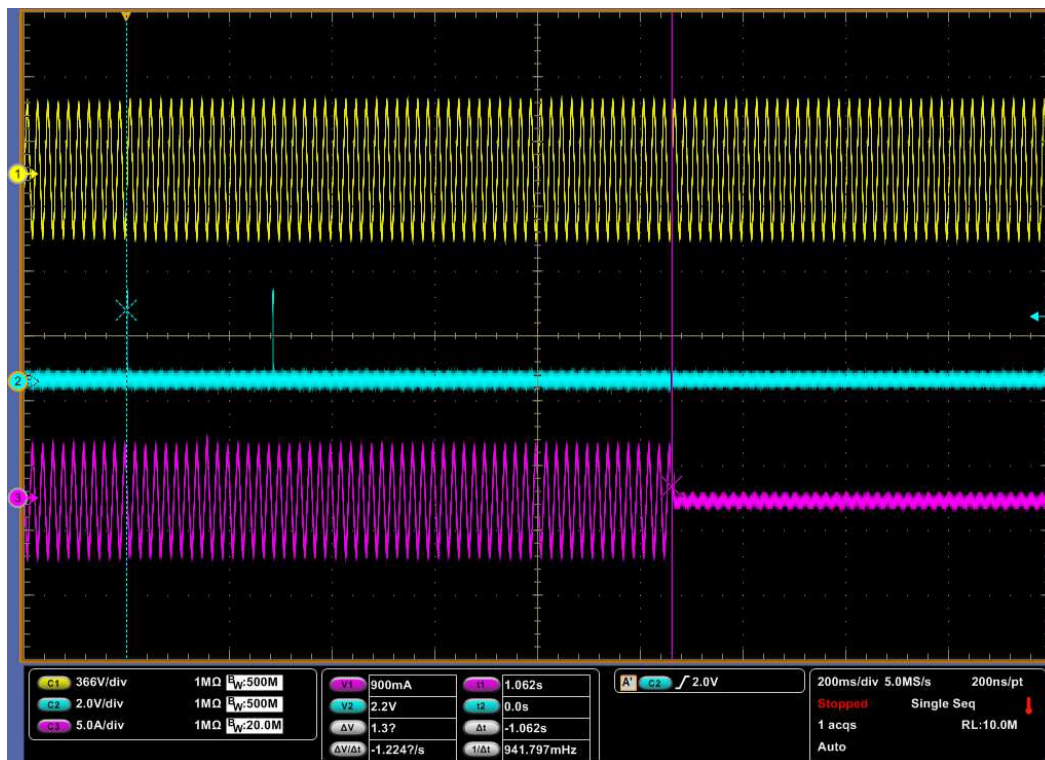

### O/V stage 2, Phase 1



### U/V, Phase 2

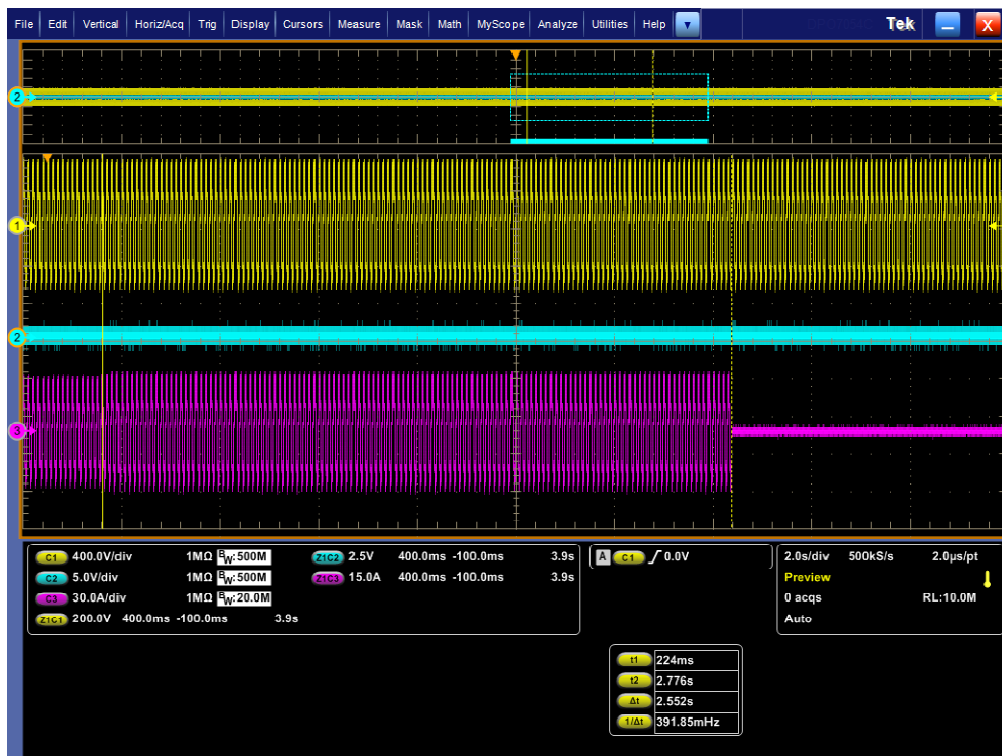



O/V stage 1, Phase 2

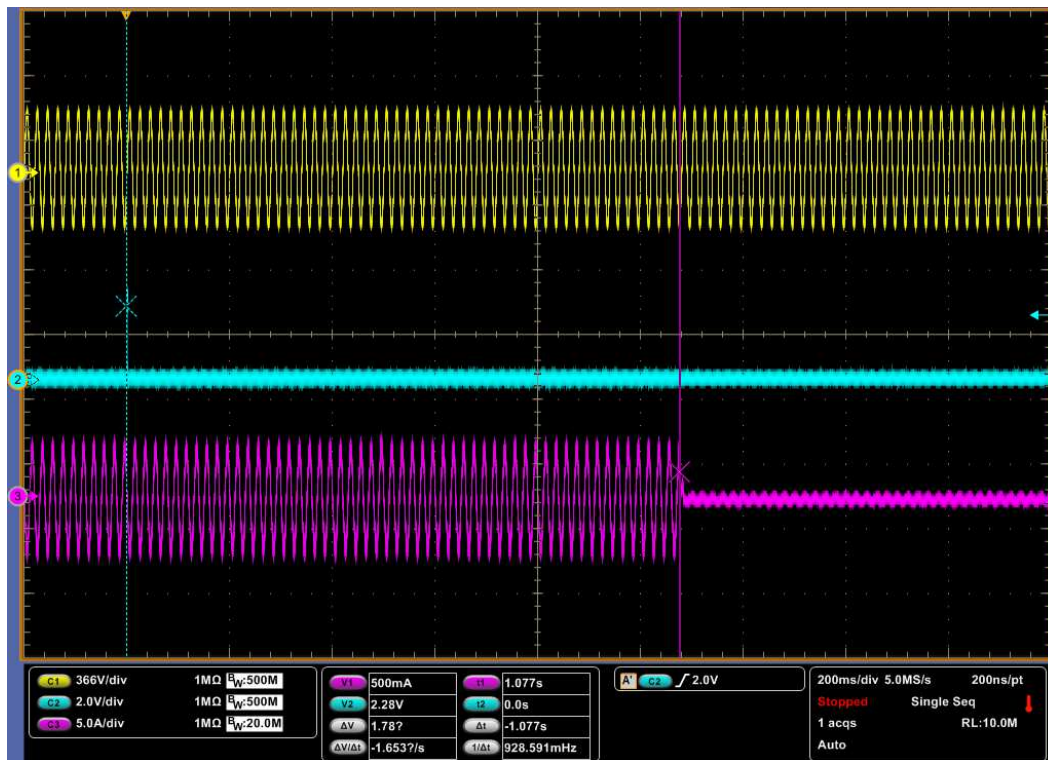

O/V stage 2, Phase 2

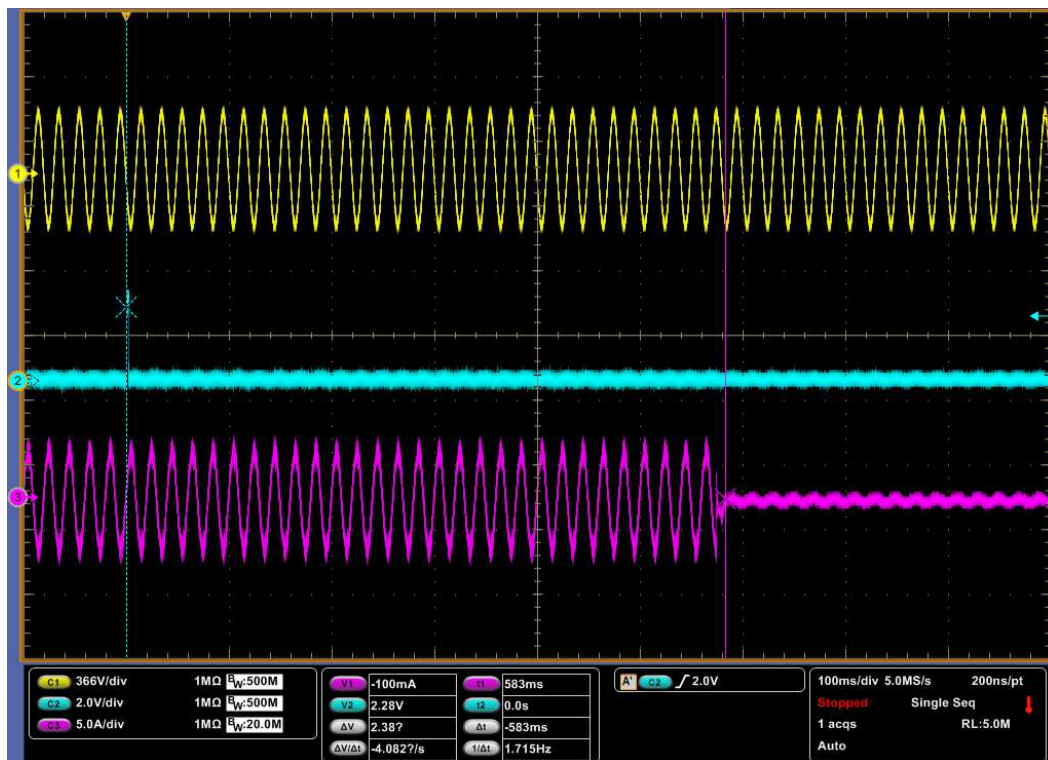

### U/V, Phase 3



### O/V stage 1, Phase 3

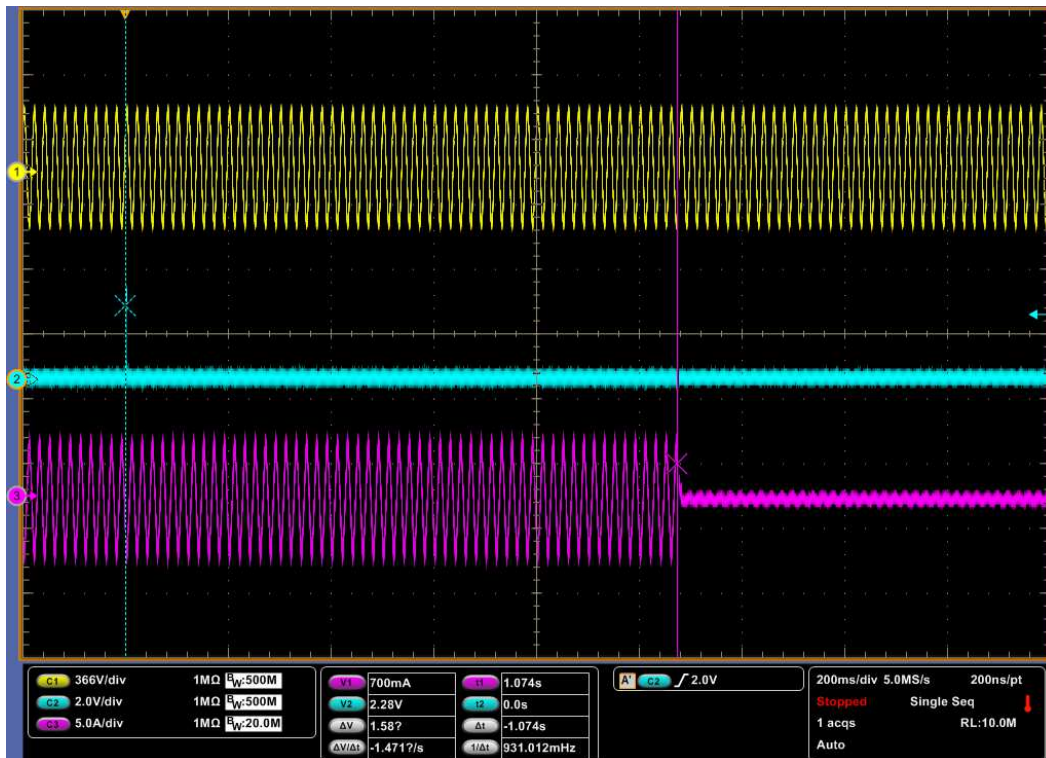

O/V stage 2, Phase 3

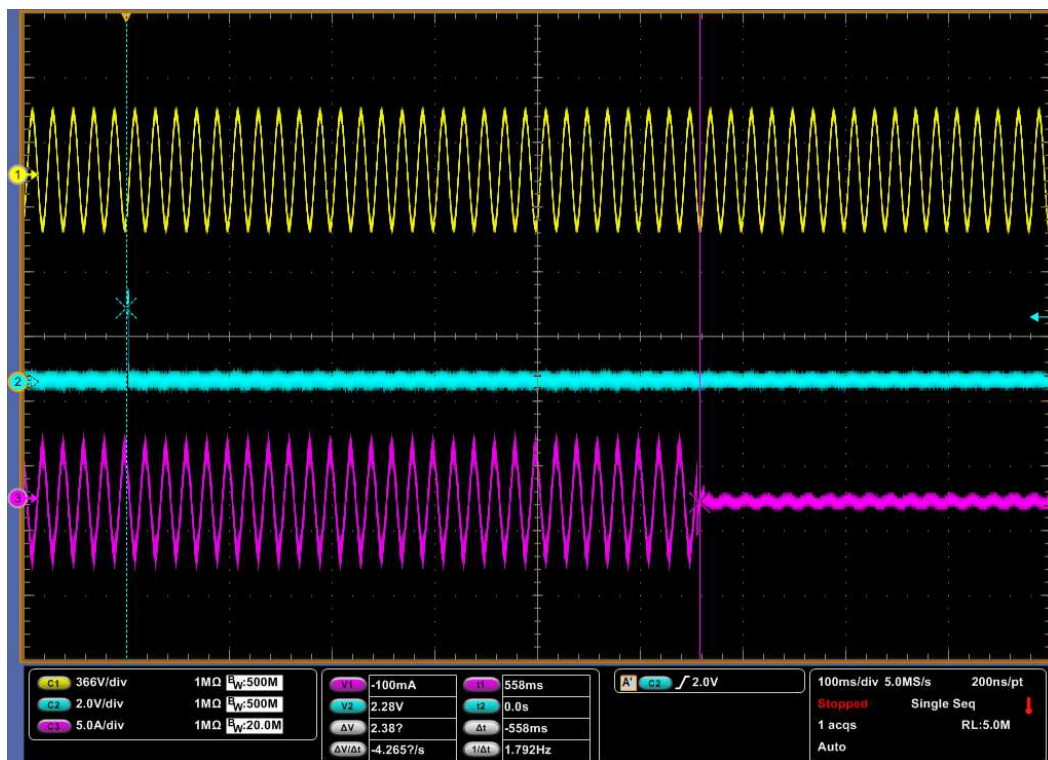

<b>A1.2.3 Over / Under Frequency</b> The test procedure in Annex A.1.2.3 (Inverter connected) or Annex A2 A.2.2.3 (Synchronous).						<b>P</b>	
Function		Setting		Trip test		No trip test	
		Frequency	Time delay	Frequency	Time delay	Frequency / time	Confirm no trip
U/F stage 1		47,5Hz	20s	47,5Hz	20,065s	47,7Hz / 25s	No trip
U/F stage 2		47Hz	0,5s	47Hz	0,567s	47,2Hz / 19,98s	No trip
						46,8 Hz / 0,48s	No trip
O/F	52Hz	0,5s	52Hz	0,560s		51,8Hz / 89,98s	No trip
						52,2 Hz / 0,48s	No trip

**Note:**

The total disconnection time for voltage and frequency protection, including the operating time of the disconnection device, shall be the time delay setting with a tolerance of, -0s + 0.5 s.

For frequency trip tests the frequency required to trip is the setting  $\pm 0.1$  Hz. In order to measure the time delay a larger deviation than the minimum required to operate the protection can be used. The "No trip tests" need to be carried out at the setting  $\pm 0.2$  Hz and for the relevant times as shown in the table above to ensure that the protection will not trip in error.

The test had been performed on the model SUN2000-10KTL-M0, the test results are valid for the SUN2000-3KTL-M0, SUN2000-4KTL-M0, SUN2000-5KTL-M0, SUN2000-6KTL-M0, SUN2000-8KTL-M0, SUN2000-3KTL-M1, SUN2000-4KTL-M1, SUN2000-5KTL-M1, SUN2000-6KTL-M1, SUN2000-8KTL-M1 and SUN2000-10KTL-M1 since it is almost identical in hardware and just the output power derated by software.

### U/F stage 1

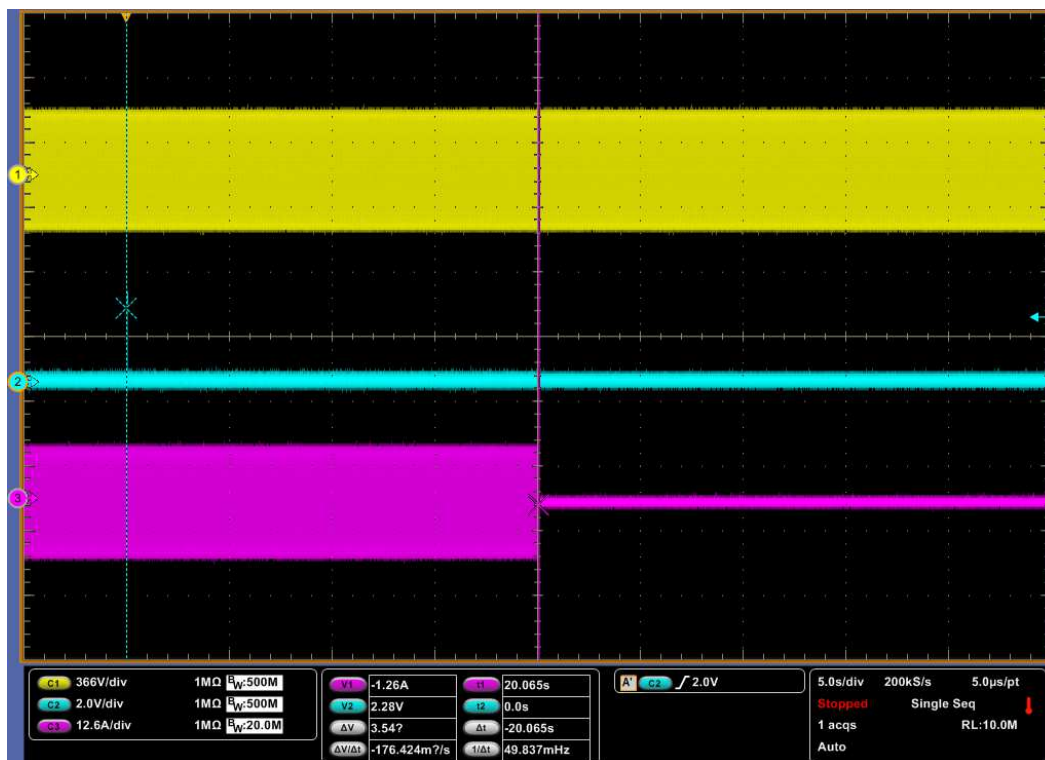

### U/F stage 2



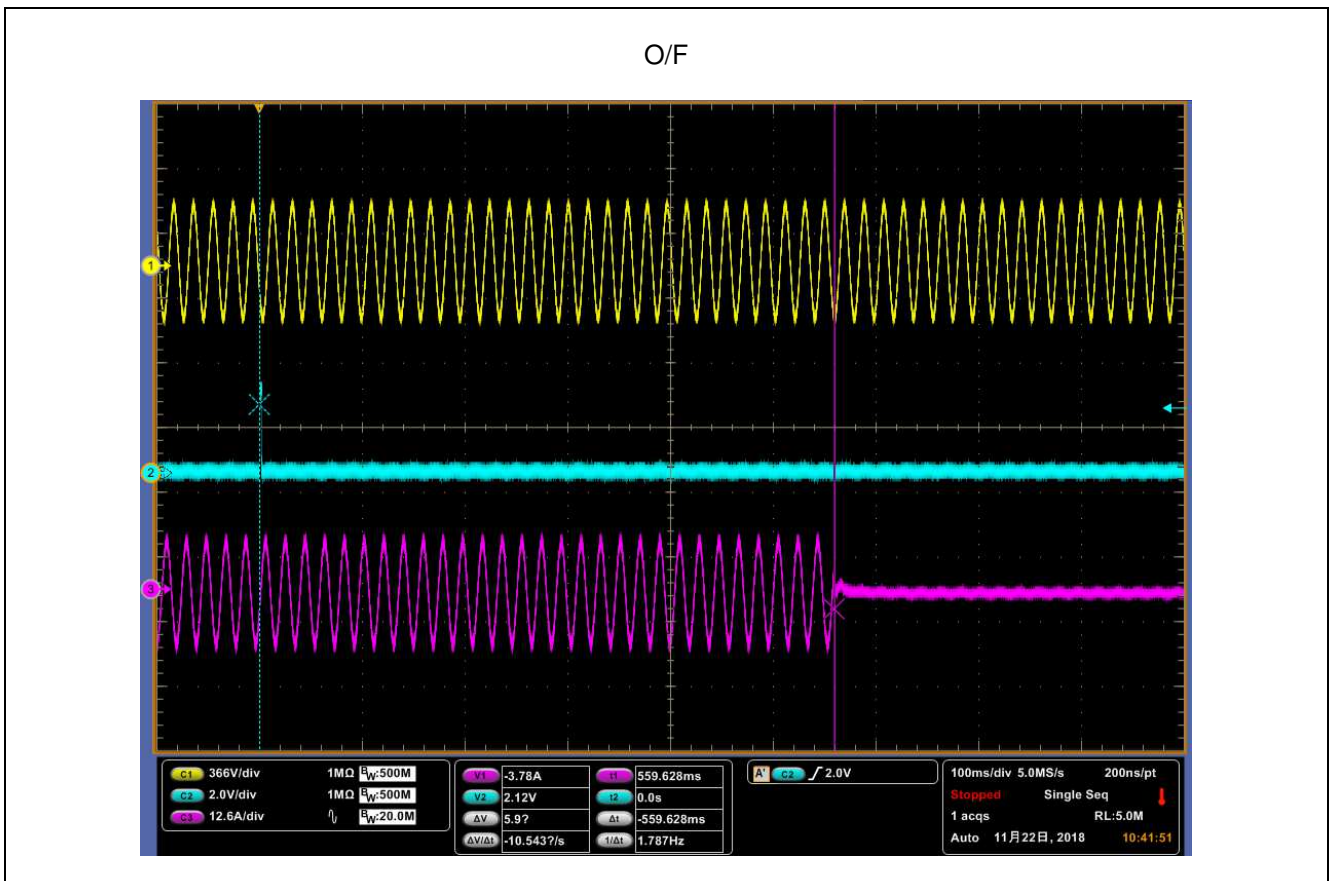

<b>A1.2.4 Loss of mains protection according BS EN 62116</b> The requirement is specified in section 10.2, test procedure in Annex A.2.2.4 Load imbalance (real, reactive load) for test condition A (EUT output = 100%)									P
Test conditions		Frequency: 50+/-0,1Hz $U_N=230\pm 3V_{ac}$ Distortion factor of chokes < 2% Quality =1							
Disconnection limit		1s							
No	$P_{EUT}^{1)}$ (% of EUT rating)	Reactive load (% of $Q_L$ in 6.1.d 1)	$P_{AC}^{2)}$ (% of nominal)	$Q_{AC}^{3)}$ (% of nominal)	$P_{EUT}$ [W per phase]	$V_{DC}$ [V]	$Q_f$ [1]	Run on Time [ms]	Remarks <sup>4)</sup>
1	100	100	0	0	3300	700	1,010	563	Test A at BL
2	100	100	-5	-5	3300	700	1,037	174	Test A at IB
3	100	100	-5	0	3300	700	1,064	291	Test A at IB
4	100	100	-5	+5	3300	700	1,090	184	Test A at IB
5	100	100	0	-5	3300	700	0,985	164	Test A at IB
6	100	100	0	+5	3300	700	1,035	232	Test A at IB
7	100	100	+5	-5	3300	700	0,938	172	Test A at IB
8	100	100	+5	0	3300	700	0,962	270	Test A at IB
9	100	100	+5	+5	3300	700	0,986	179	Test A at IB
Parameter at 0%			L= 50,07 mH		R= 15,89 $\Omega$		C= 202,38 $\mu F$		
Indicate additional shut down time included in above results. (Disconnection device operation time)								20 ms	

**Note:**

Note for technologies which have a substantial shut down time this can be added to the 0.5 seconds in establishing that the trip occurred in less than 0.5s. Maximum shut down time could therefore be up to 1.0 seconds for these technologies.

RLC is adjusted to min. +/-1% of the inverter rated output power

1)  $P_{EUT}$ : EUT output power

2)  $P_{AC}$ : Real power flow at S1 in Figure 1. Positive means power from EUT to utility. Nominal is the 0 % test condition value.

3)  $Q_{AC}$ : Reactive power flow at S1 in Figure 1. Positive means power from EUT to utility. Nominal is the 0 % test condition value.

4) BL: Balance condition, IB: Imbalance condition.

Condition A:

EUT output power  $P_{EUT}$  = Maximum <sup>5)</sup>

EUT input voltage <sup>6)</sup> = >90% of rated input voltage range

<sup>5)</sup> Maximum EUT output power condition should be achieved using the maximum allowable input power.

Actual output power may exceed nominal rated output.

<sup>6)</sup> Based on EUT rated input operating range. For example, If range is between X volts and Y volts, 90 % of range =  $X + 0,9 \times (Y - X)$ . Y shall not exceed  $0,8 \times$  EUT maximum system voltage (i.e., maximum allowable array open circuit voltage). In any case, the EUT should not be operated outside of its allowable input voltage range.

The test had been performed on the model SUN2000-10KTL-M0, the test results are valid for the SUN2000-3KTL-M0, SUN2000-4KTL-M0, SUN2000-5KTL-M0, SUN2000-6KTL-M0, SUN2000-8KTL-M0, SUN2000-3KTL-M1, SUN2000-4KTL-M1, SUN2000-5KTL-M1, SUN2000-6KTL-M1, SUN2000-8KTL-M1 and SUN2000-10KTL-M1 since it is almost identical in hardware and just the output power derated by software.

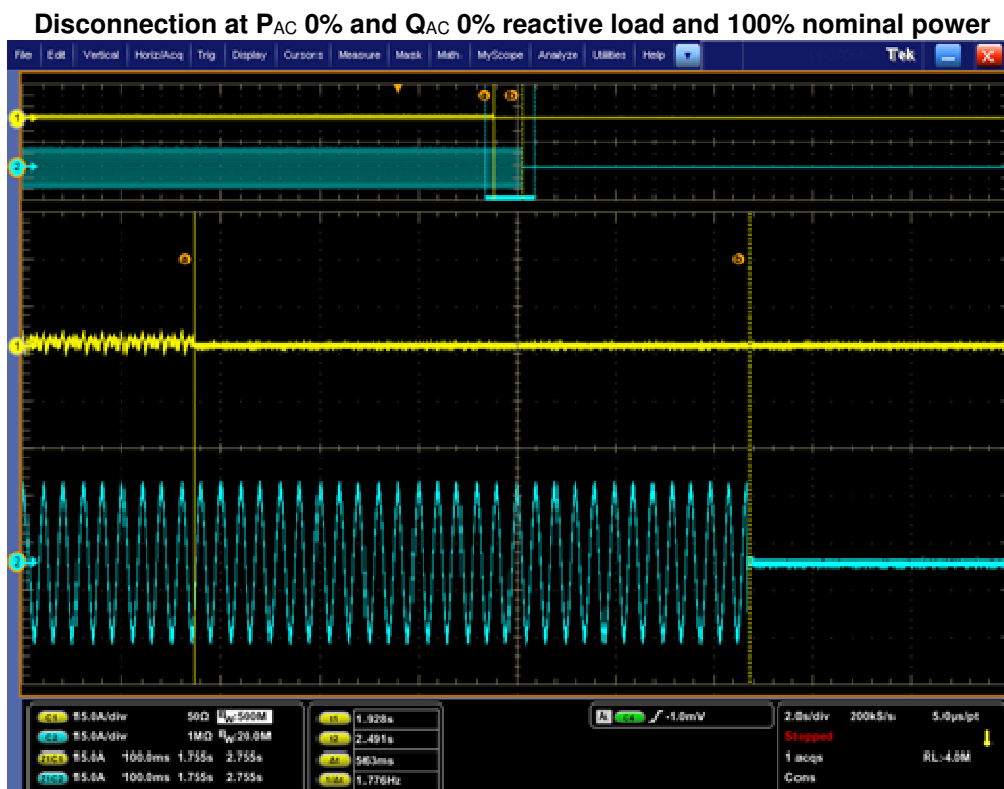

Fundamental of  $I_{AC}$  at balance condition = 0,056A

**Note:**

C1: Fundamental of  $I_{AC}$

C2: EUT Current



<b>A1.3.4 Loss of mains protection according BS EN 62116</b> The requirement is specified in section 10.2, test procedure in Annex A.2.2.4 Load imbalance (real, reactive load) for test condition A (EUT output = 50 % – 66 %)									P
Test conditions		Frequency: 50+/-0,1Hz $U_N=230\pm 3V_{ac}$ Distortion factor of chokes < 2% Quality =1							
Disconnection limit		1s							
No	$P_{EUT}^{1)}$ (% of EUT rating)	Reactive load (% of $Q_L$ in 6.1.d) 1)	$P_{AC}^{2)}$ (% of nominal)	$Q_{AC}^{3)}$ (% of nominal)	$P_{EUT}$ [W per phase]	$V_{DC}$ [V]	$Q_f$ [1]	Run on Time [ms]	Remarks <sup>4)</sup>
11	66	66	0	-5	2200	520	0,980	173	Test B at IB
10	66	66	0	-4	2200	520	0,985	174	Test B at IB
9	66	66	0	-3	2200	520	0,991	176	Test B at IB
8	66	66	0	-2	2200	520	0,996	195	Test B at IB
7	66	66	0	-1	2200	520	1,001	247	Test B at IB
1	66	66	0	0	<b>2200</b>	<b>520</b>	<b>1,006</b>	<b>591</b>	Test B at BL
2	66	66	0	1	2200	520	1,011	347	Test B at IB
3	66	66	0	2	2200	520	1,016	300	Test B at IB
4	66	66	0	3	2200	520	1,021	271	Test B at IB
5	66	66	0	4	2200	520	1,026	260	Test B at IB
6	66	66	0	5	2200	520	1,031	248	Test B at IB
Parameter at 0%			L= 77,13 mH		R= 24,38 $\Omega$		C= 131,36 $\mu$ F		
Indicate additional shut down time included in above results. (Disconnection device operation time)								20 ms	

**Note:**

RLC is adjusted to min. +/-1% of the inverter rated output power

1)  $P_{EUT}$ : EUT output power

2)  $P_{AC}$ : Real power flow at S1 in Figure 1. Positive means power from EUT to utility. Nominal is the 0 % test condition value.

3)  $Q_{AC}$ : Reactive power flow at S1 in Figure 1. Positive means power from EUT to utility. Nominal is the 0 % test condition value.

4) BL: Balance condition, IB: Imbalance condition.

Condition B:

EUT output power  $P_{EUT}$  = 50 % – 66 % of maximum

EUT input voltage <sup>5)</sup> = 50 % of rated input voltage range,  $\pm 10$  %

<sup>5)</sup> Based on EUT rated input operating range. For example, If range is between X volts and Y volts, 90 % of range =  $X + 0,5 \times (Y - X)$ . Y shall not exceed  $0,8 \times$  EUT maximum system voltage (i.e., maximum allowable array open circuit voltage). In any case, the EUT should not be operated outside of its allowable input voltage range.

The test had been performed on the model SUN2000-10KTL-M0, the test results are valid for the SUN2000-3KTL-M0, SUN2000-4KTL-M0, SUN2000-5KTL-M0, SUN2000-6KTL-M0, SUN2000-8KTL-M0, SUN2000-3KTL-M1, SUN2000-4KTL-M1, SUN2000-5KTL-M1, SUN2000-6KTL-M1, SUN2000-8KTL-M1 and SUN2000-10KTL-M1 since it is almost identical in hardware and just the output power derated by software.

**Disconnection at  $P_{AC}$  0% and  $Q_{AC}$  -1% reactive load and 66% nominal power**

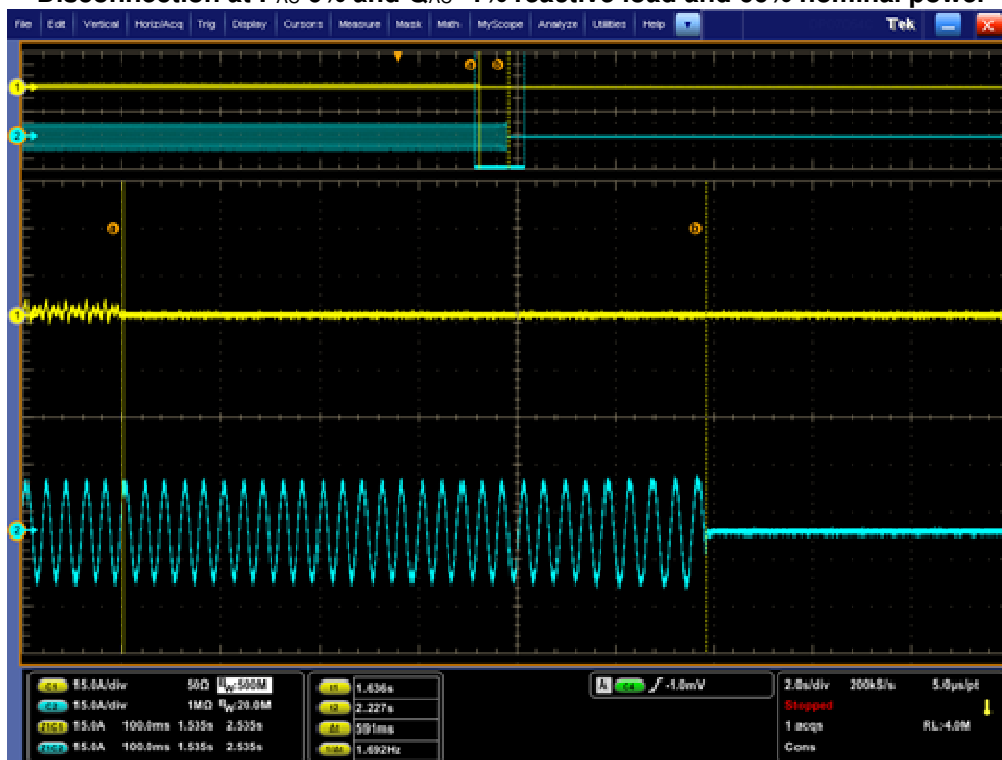

Fundamental of IAC at balance condition = 0,082A

**Note:**

C1: Fundamental of  $I_{AC}$

C2: EUT Current

<b>A1.3.4 Loss of mains protection according BS EN 62116</b> The requirement is specified in section 10.2, test procedure in Annex A.2.2.4 Load imbalance (real, reactive load) for test condition A (EUT output = 25 % – 33 %)									<b>P</b>
Test conditions		Frequency: 50+/-0,1Hz $U_N=230\pm 3V_{ac}$ Distortion factor of chokes < 2% Quality =1							
Disconnection limit		1s							
No	$P_{EUT}^{1)}$ (% of EUT rating)	Reactive load (% of $Q_L$ in 6.1.d) 1)	$P_{AC}^{2)}$ (% of nominal)	$Q_{AC}^{3)}$ (% of nominal)	$P_{EUT}$ [W per phase]	$V_{DC}$ [V]	$Q_f$ [1]	Run on Time [ms]	Remarks <sup>4)</sup>
11	33	33	0	-5	1100	304	0,984	169	Test B at IB
10	33	33	0	-4	1100	304	0,990	174	Test B at IB
9	33	33	0	-3	1100	304	0,995	179	Test B at IB
8	33	33	0	-2	1100	304	1,000	226	Test B at IB
7	33	33	0	-1	1100	304	1,005	289	Test B at IB
1	33	33	0	0	<b>1100</b>	<b>304</b>	<b>1,010</b>	<b>384</b>	Test B at BL
2	33	33	0	1	1100	304	1,015	347	Test B at IB
3	33	33	0	2	1100	304	1,020	298	Test B at IB
4	33	33	0	3	1100	304	1,025	295	Test B at IB
5	33	33	0	4	1100	304	1,030	268	Test B at IB
6	33	33	0	5	1100	304	1,035	255	Test B at IB
Parameter at 0%			L= 151,56 mH		R= 48,09 $\Omega$		C= 66,85 $\mu F$		
Indicate additional shut down time included in above results. (Disconnection device operation time)								20 ms	

**Note:**

RLC is adjusted to min. +/-1% of the inverter rated output power

1)  $P_{EUT}$ : EUT output power

2)  $P_{AC}$ : Real power flow at S1 in Figure 1. Positive means power from EUT to utility. Nominal is the 0 % test condition value.

3)  $Q_{AC}$ : Reactive power flow at S1 in Figure 1. Positive means power from EUT to utility. Nominal is the 0 % test condition value.

4) BL: Balance condition, IB: Imbalance condition.

Condition C:

EUT output power  $P_{EUT} = 25\% - 33\%$  <sup>5)</sup> of maximum

EUT input voltage <sup>6)</sup> = <10 % of rated input voltage range

<sup>5)</sup> Or minimum allowable EUT output level if greater than 33 %.

<sup>6)</sup> Based on EUT rated input operating range. For example, If range is between X volts and Y volts, 90 % of range =  $X + 0,1 \times (Y - X)$ . Y shall not exceed  $0,8 \times$  EUT maximum system voltage (i.e., maximum allowable array open circuit voltage). In any case, the EUT should not be operated outside of its allowable input voltage range.

The test had been performed on the model SUN2000-10KTL-M0, the test results are valid for the SUN2000-3KTL-M0, SUN2000-4KTL-M0, SUN2000-5KTL-M0, SUN2000-6KTL-M0, SUN2000-8KTL-M0, SUN2000-3KTL-M1, SUN2000-4KTL-M1, SUN2000-5KTL-M1, SUN2000-6KTL-M1, SUN2000-8KTL-M1 and SUN2000-10KTL-M1 since it is almost identical in hardware and just the output power derated by software.

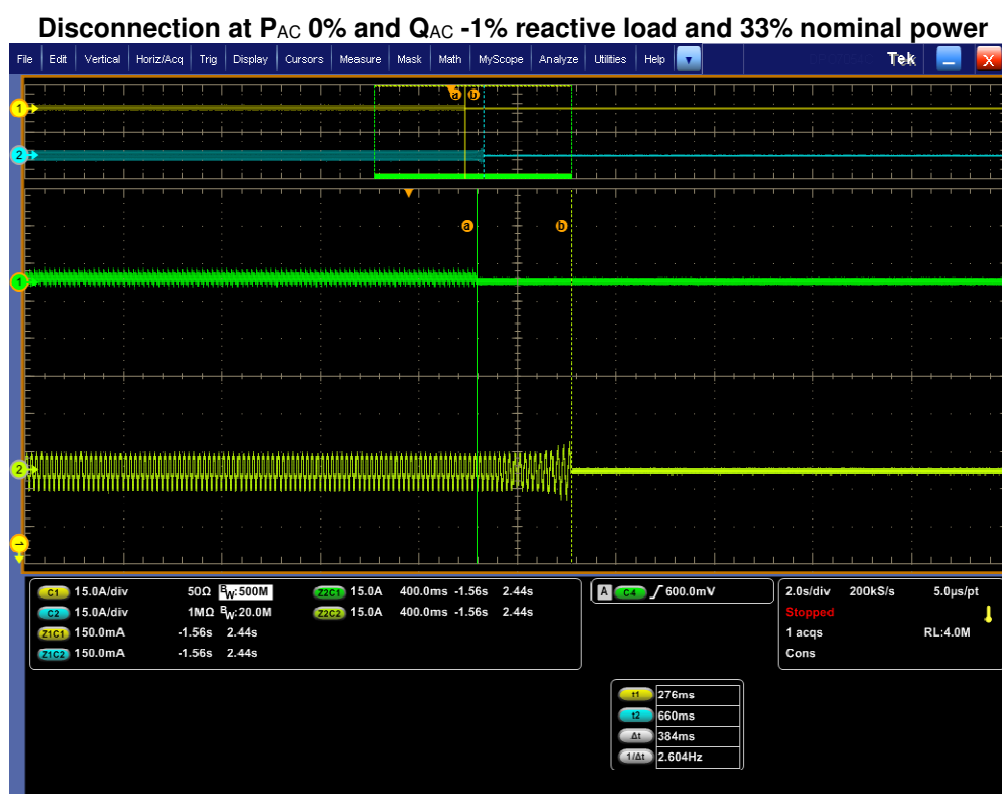

Fundamental of  $I_{AC}$  at balance condition = 0,102A

**Note:**

C1: Fundamental of  $I_{AC}$

C2: EUT Current

<b>A 1.2.5 Reconnection</b> The test procedure in Annex A 1.2.5 (Inverter connected) or Annex A2 A 2.2.5 (Synchronous).			<b>P</b>	
Test should prove that the reconnection sequence starts after a minimum delay of 20 seconds for restoration of voltage and frequency to within the stage 1 settings of table 1.				
Under Voltage(182V)				
Time delay setting		Measured delay		
20s		121,0s		
Over Voltage(266,2V)				
Time delay setting		Measured delay		
20s		125,4s		
Under Frequency(47,4Hz)				
Time delay setting		Measured delay		
20s		125,2s		
Over Frequency(52,1Hz)				
Time delay setting		Measured delay		
20s		124,8s		
Checks on no reconnection when voltage or frequency is brought to just outside stage 1 limits of table 1.				
	At 266,2V	At 182V	At 47,4Hz	At 52,1Hz
Confirmation that the SSEG does not re-connect.	No reconnection	No reconnection	No reconnection	No reconnection
<b>Note:</b> The test had been performed on the model SUN2000-10KTL-M0, the test results are valid for the SUN2000-3KTL-M0, SUN2000-4KTL-M0, SUN2000-5KTL-M0, SUN2000-6KTL-M0, SUN2000-8KTL-M0, SUN2000-3KTL-M1, SUN2000-4KTL-M1, SUN2000-5KTL-M1, SUN2000-6KTL-M1, SUN2000-8KTL-M1 and SUN2000-10KTL-M1 since it is almost identical in hardware and just the output power derated by software.				

<b>A1.2.6 Frequency Drift and Step change Stability test</b>				<b>P</b>
The requirement is specified in section 11.3, test procedure in Annex A.1.2.6 (Inverter connected) or Annex A2 A.2.2.6 (Synchronous).				
	Start Frequency	Change	End Frequency	Confirm no trip
Positive Vector Shift	49,0Hz	+50 degrees		No trip
Negative Vector Shift	50,0Hz	-50 degrees		No trip
Positive Frequency drift	49,0Hz	+0,95Hz/sec	51,0Hz	No trip
Negative Frequency drift	51,0Hz	-0,95Hz/sec	49,0Hz	No trip

**Note:**  
Manufacturers considering new designs should allow for the RoCoF where stability is required to be increased to, up to 2Hz per second, as proposed in the new European network codes, which are expected to come into force over the period 2014/2015. Under these conditions RoCoF will cease to be an effective loss of mains protection and is unlikely to be permitted in future revisions of this document.

For the step change test the SSEG should be operated with a measureable output at the start frequency and then a vector shift should be applied by extending or reducing the time of a single cycle with subsequent cycles returning to the start frequency. The start frequency should then be maintained for a period of at least 10 seconds to complete the test. The SSEG should not trip during this test.

For frequency drift tests the SSEG should be operated with a measureable output at the start frequency and then the frequency changed in a ramp function at 0,95Hz per second to the end frequency. On reaching the end frequency it should be maintained for a period of at least 10 seconds. The SSEG should not trip during this test.

The test had been performed on the model SUN2000-10KTL-M0, the test results are valid for the SUN2000-3KTL-M0, SUN2000-4KTL-M0, SUN2000-5KTL-M0, SUN2000-6KTL-M0, SUN2000-8KTL-M0, SUN2000-3KTL-M1, SUN2000-4KTL-M1, SUN2000-5KTL-M1, SUN2000-6KTL-M1, SUN2000-8KTL-M1 and SUN2000-10KTL-M1 since it is almost identical in hardware and just the output power derated by software.

### A 1.2.7 Active power feed-in at under-frequency

This test should be carried out in accordance with EN 50438 Annex D.3.2 active power feed-in at under-frequency.

**P**

#### Graph of frequency a) to b) to c):

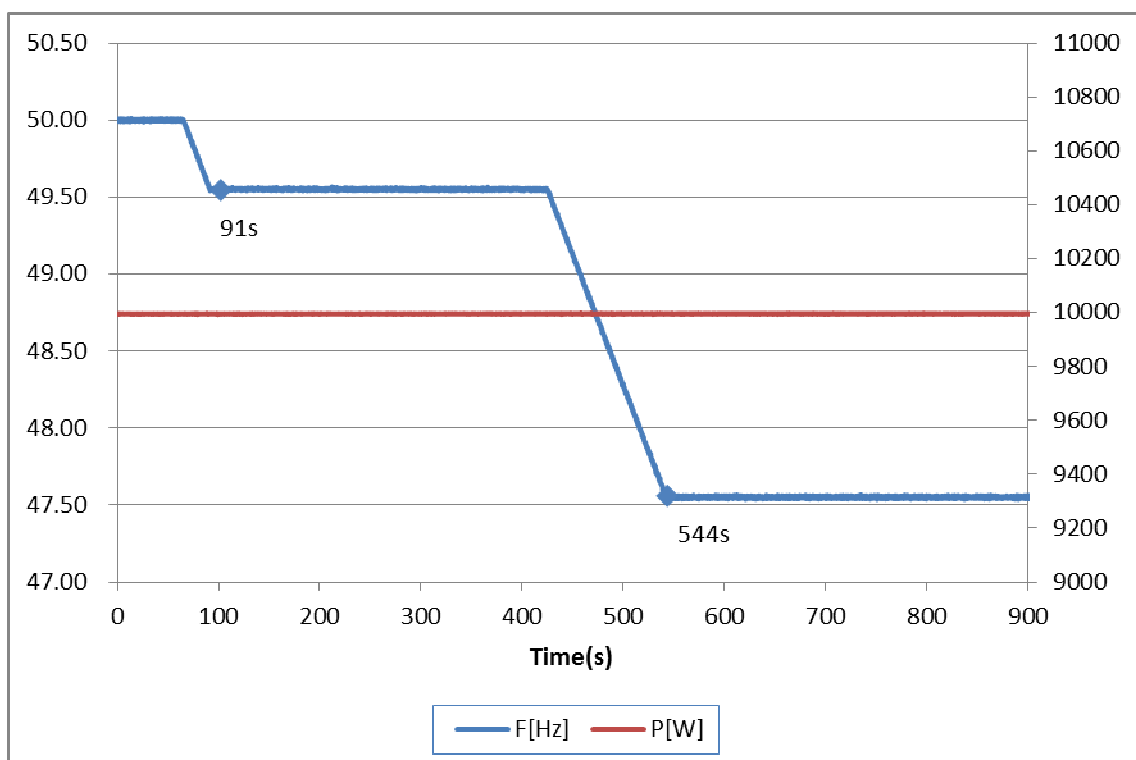

#### Test:

	Switch to:		
5-min mean value (each)	a) $50 \pm 0,01$ [Hz]	b) - 0,4 to - 0,5 [Hz]	c) - 2,4 to - 2,5 [Hz]
Frequency [Hz]:	50,00	49,55	47,55
Active power [W]:	9995	9995	9996
$\Delta P/P_M$ [%] per 1 Hz:			0

#### Test:

Operating points b) and c) must be kept for at least 5 minutes.

The test must be carried out at 100%  $P_n$ .

With a programmable AC source, the PGU is operated at 100%  $P_n$  and  $50 \pm 0,01$  Hz, thereafter the frequency is reduced by 1 Hz/min. to - 0,4 to - 0,5 Hz and in addition to - 2,4 to - 2,5 Hz. A 5-min mean value is recorded both before and after the frequency change.

**Assessment criterion:**

The test is passed when the micro-generator

- does not disconnect from the network on a network frequency change at the operating points a) to c),
- continues to feed in 100%  $P_n$  in b) and
- the power reduction in point c) is less or equal to the power reduction of 10 %  $P_M$  per 1 Hz drop.

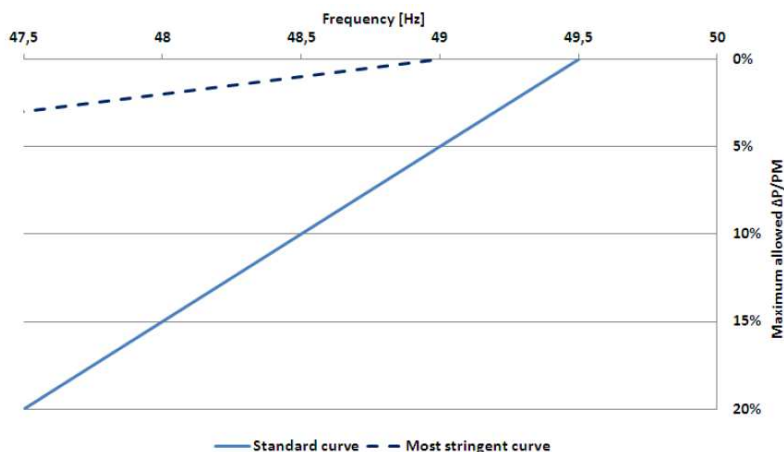

Maximum allowable power reduction in case of under-frequency

**Note:**

The test had been performed on the model SUN2000-10KTL-M0, the test results are valid for the SUN2000-3KTL-M0, SUN2000-4KTL-M0, SUN2000-5KTL-M0, SUN2000-6KTL-M0, SUN2000-8KTL-M0, SUN2000-3KTL-M1, SUN2000-4KTL-M1, SUN2000-5KTL-M1, SUN2000-6KTL-M1, SUN2000-8KTL-M1 and SUN2000-10KTL-M1 since it is almost identical in hardware and just the output power derated by software.



### A 1.2.8 Power response to over-frequency

This test should be carried out in accordance with EN 50438 Annex D.3.3 Power response to over-frequency. The test should be carried out using the specific threshold frequency of 50.4 Hz and Droop of 10%.

**P**

#### Test:

1-min mean value [Hz]: a) 50,00 b) 50,45 c) 50,70 d) 51,15 e) 50,70 f) 50,45 g) 50,00

1. Measurement a) to g): Active power output > 80%  $P_n$

Frequency [Hz]:	50,00	50,45	50,70	51,15	50,70	50,45	50,00
$P_M$ [kW]:	N/A	9,880	9,390	8,480	9,390	9,880	N/A
$P_{E60}$ [kW]:	10,000	9,884	9,384	8,483	9,384	9,884	10,000
$\Delta P_{E60}/P_M$ [%]:	N/A	0,06	0,06	0,07	0,06	0,04	N/A

2. Measurement a) to g): Active power output 40% and 60% after freezing > 80%  $P_n$

Frequency [Hz]:	50,00	50,45	50,70	51,15	50,70	50,45	50,00
$P_M$ [kW]:	N/A	5,001	4,751	4,295	4,748	5,003	N/A
$P_{E60}$ [kW]:	5,070	5,003	4,750	4,293	4,750	5,003	5,558
$\Delta P_{E60}/P_M$ [%]:	N/A	0,02	0,01	0,02	0,02	0,01	N/A

Limit  $\Delta P/P_{1min}$ : + 10 % of  $P_M$

#### Graph of Measurement 1.: Active power output > 80% $P_n$

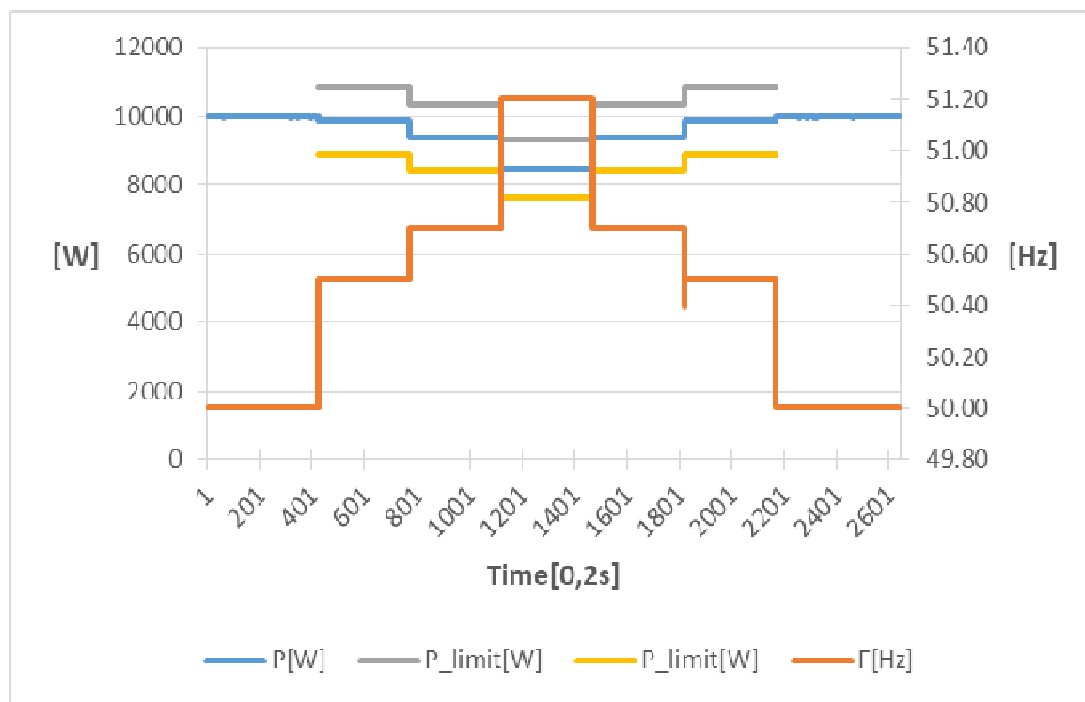

**Graph of Measurement 2.:Active power output 40% and 60% after freezing > 80% P<sub>n</sub>**

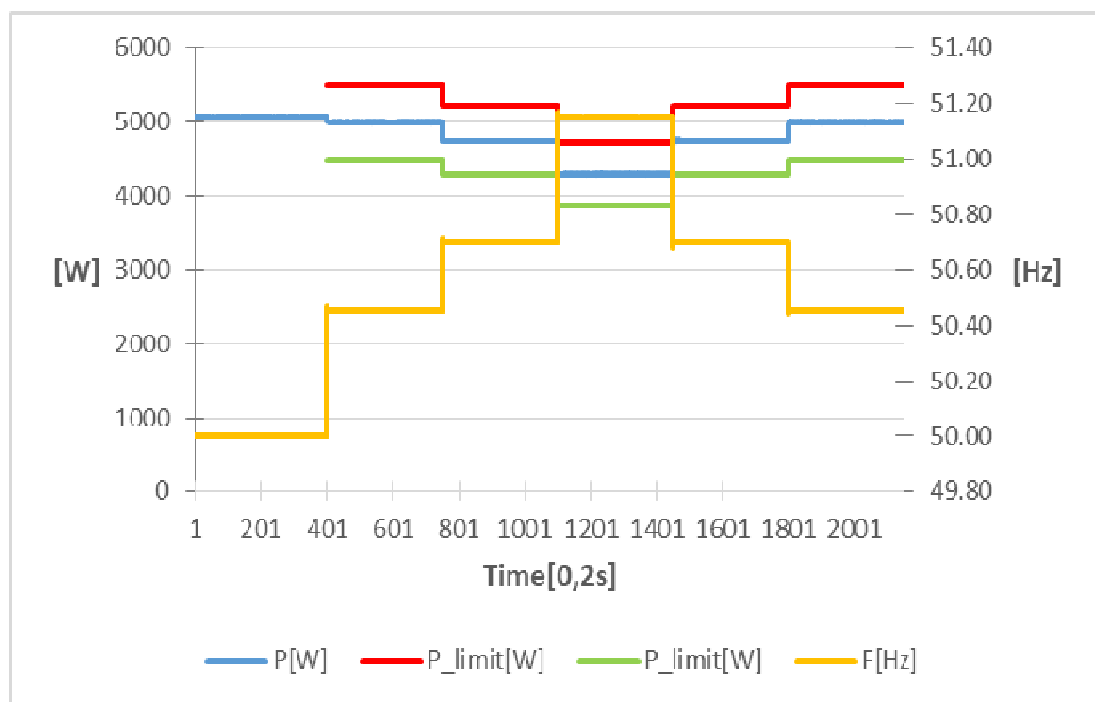

**Graph of power gradient:**



**Test:**

The test is conducted for two powers. First, the test must start at a power  $> 80\% P_n$  ("Measurement 1"), and in a second test, for a power between  $40\%$  to  $60\% P_n$  ("Measurement 2"). In the second test, after freezing of the  $P_M$ , the available active power output must be increased to a value  $> 80\% P_n$ , and after the network frequency of  $50,2$  Hz is fallen below, the rise of the active power gradient must be recorded.

Point g) must be held until the micro-generator is again feeding in with the active power output available.

**Assessment criterion:**

For  $f = 50,2$  Hz, the value of the  $P_M$  active power currently being generated is "frozen".

a) For adjustable micro-generators when:

1) the active power reduces between measuring points b) and f) given above with the set gradient  $P_M$  per Hz for a increasing frequency (or rises for a frequency decreasing again).

2) the maximum active power gradient occurring in point is less than the configured maximum active power per minute

3) the reaction value of the setpoint determined by the gradient characteristic curve does not differ from  $P_n$  by more than  $\pm 10\%$ .

4) the settling time is equal or below  $2$  s with an intentional delay set to zero

b) For partly adjustable micro-generators

1) when they behave as in a) within their adjustment range, and

2) when, outside the adjustable range, the power fed in on leaving the adjustment range remains constant until shutdown. Shutdown must be no later than at  $51,5$  Hz.

**Note:**

The test had been performed on the model SUN2000-10KTL-M0, the test results are valid for the SUN2000-3KTL-M0, SUN2000-4KTL-M0, SUN2000-5KTL-M0, SUN2000-6KTL-M0, SUN2000-8KTL-M0, SUN2000-3KTL-M1, SUN2000-4KTL-M1, SUN2000-5KTL-M1, SUN2000-6KTL-M1, SUN2000-8KTL-M1 and SUN2000-10KTL-M1 since it is almost identical in hardware and just the output power derated by software.

<b>A1.3.1 Harmonic Current Emissions</b>							<b>P</b>
The test requirements are specified in Annex A1 A.1.3.1 (Inverter connected) or Annex A2 A.2.3.1 (Synchronous).							
<b>SUN2000-3KTL-M0</b>							
Harmonic order	55% rated output power						Harmonic current limit EN 61000-3-2, Class A [A]
	Measured Value (MV) in Amps			Measured Value (MV) in %			
Phase	Phase L1	Phase L2	Phase L3	Phase L1	Phase L2	Phase L3	--
1st	2,677	2,660	2,659	55,974	55,618	55,597	-
2nd	0,032	0,041	0,031	0,669	0,857	0,648	1,080
3rd	0,030	0,034	0,038	0,627	0,711	0,795	2,300
4th	0,022	0,019	0,022	0,460	0,397	0,460	0,430
5th	0,015	0,013	0,018	0,314	0,272	0,376	1,140
6th	0,012	0,011	0,013	0,251	0,230	0,272	0,300
7th	0,013	0,010	0,013	0,272	0,209	0,272	0,770
8th	0,011	0,010	0,011	0,230	0,209	0,230	0,230
9th	0,013	0,013	0,013	0,272	0,272	0,272	0,400
10th	0,012	0,010	0,010	0,251	0,209	0,209	0,184
11th	0,011	0,010	0,011	0,230	0,209	0,230	0,330
12th	0,012	0,010	0,012	0,251	0,209	0,251	0,153
13th	0,012	0,012	0,011	0,251	0,251	0,230	0,210
14th	0,010	0,011	0,011	0,209	0,230	0,230	0,131
15th	0,012	0,017	0,013	0,251	0,355	0,272	0,150
16th	0,009	0,009	0,010	0,188	0,188	0,209	0,115
17th	0,009	0,009	0,010	0,188	0,188	0,209	0,132
18th	0,008	0,009	0,009	0,167	0,188	0,188	0,102
19th	0,008	0,008	0,009	0,167	0,167	0,188	0,118
20th	0,007	0,008	0,008	0,146	0,167	0,167	0,092
21th	0,008	0,010	0,007	0,167	0,209	0,146	0,107
22th	0,006	0,006	0,006	0,125	0,125	0,125	0,084
23th	0,006	0,006	0,007	0,125	0,125	0,146	0,098
24th	0,006	0,005	0,005	0,125	0,105	0,105	0,077
25th	0,006	0,005	0,005	0,125	0,105	0,105	0,090
26th	0,004	0,004	0,005	0,084	0,084	0,105	0,071
27th	0,005	0,005	0,005	0,105	0,105	0,105	0,083
28th	0,003	0,003	0,004	0,063	0,063	0,084	0,066
29th	0,005	0,004	0,006	0,105	0,084	0,125	0,078
30th	0,004	0,004	0,004	0,084	0,084	0,084	0,061
31th	0,004	0,004	0,004	0,084	0,084	0,084	0,073
32th	0,003	0,003	0,004	0,063	0,063	0,084	0,058
33th	0,013	0,015	0,010	0,272	0,314	0,209	0,068
34th	0,003	0,003	0,003	0,063	0,063	0,063	0,054
35th	0,012	0,012	0,012	0,251	0,251	0,251	0,064
36th	0,004	0,004	0,004	0,084	0,084	0,084	0,051
37th	0,017	0,018	0,018	0,355	0,376	0,376	0,061
38th	0,004	0,004	0,004	0,084	0,084	0,084	0,048
39th	0,016	0,020	0,015	0,335	0,418	0,314	0,058
40th	0,004	0,004	0,004	0,084	0,084	0,084	0,046
41th	0,019	0,018	0,019	0,397	0,376	0,397	--
42th	0,004	0,004	0,004	0,084	0,084	0,084	--
43th	0,014	0,016	0,015	0,293	0,335	0,314	--
44th	0,003	0,003	0,003	0,063	0,063	0,063	--
45th	0,007	0,007	0,007	0,146	0,146	0,146	--
46th	0,003	0,003	0,003	0,063	0,063	0,063	--
47th	0,009	0,008	0,008	0,188	0,167	0,167	--
48th	0,003	0,003	0,003	0,063	0,063	0,063	--

49th	0,018	0,018	0,017	0,376	0,376	0,355	--
50th	0,003	0,003	0,003	0,063	0,063	0,063	--

**Note:**

The test had been performed on the model SUN2000-3KTL-M0, and the test results are valid for the SUN2000-3KTL-M1 since it is identical in rated output power.

**A1.3.1 Harmonic Current Emissions**

The test requirements are specified in Annex A1 A.1.3.1 (Inverter connected) or Annex A2 A.2.3.1 (Synchronous).

**P**

**SUN2000-3KTL-M0**

Harmonic order	100% rated output power						Harmonic current limit EN 61000-3-2, Class A [A]
	Measured Value (MV) in Amps			Measured Value (MV) in %			
Phase	Phase L1	Phase L2	Phase L3	Phase L1	Phase L2	Phase L3	--
1st	4,357	4,385	4,360	99,980	99,977	99,976	-
2nd	0,008	0,009	0,006	0,189	0,204	0,144	1,080
3rd	0,012	0,025	0,014	0,278	0,576	0,319	2,300
4th	0,006	0,007	0,007	0,140	0,156	0,160	0,430
5th	0,009	0,009	0,006	0,207	0,210	0,128	1,140
6th	0,005	0,005	0,005	0,117	0,125	0,116	0,300
7th	0,007	0,008	0,006	0,157	0,177	0,141	0,770
8th	0,004	0,005	0,006	0,102	0,123	0,128	0,230
9th	0,009	0,007	0,008	0,196	0,165	0,173	0,400
10th	0,005	0,006	0,006	0,117	0,135	0,130	0,184
11th	0,007	0,007	0,005	0,152	0,153	0,120	0,330
12th	0,005	0,005	0,005	0,113	0,110	0,114	0,153
13th	0,006	0,006	0,006	0,141	0,145	0,141	0,210
14th	0,005	0,005	0,005	0,115	0,119	0,114	0,131
15th	0,007	0,007	0,009	0,153	0,161	0,217	0,150
16th	0,004	0,005	0,005	0,098	0,121	0,122	0,115
17th	0,007	0,007	0,007	0,160	0,165	0,156	0,132
18th	0,005	0,006	0,006	0,122	0,129	0,135	0,102
19th	0,006	0,006	0,005	0,139	0,144	0,124	0,118
20th	0,005	0,005	0,006	0,111	0,115	0,135	0,092
21th	0,006	0,008	0,007	0,131	0,171	0,160	0,107
22th	0,005	0,005	0,006	0,113	0,113	0,149	0,084
23th	0,007	0,007	0,006	0,170	0,161	0,148	0,098
24th	0,006	0,007	0,007	0,144	0,159	0,156	0,077
25th	0,007	0,008	0,007	0,167	0,174	0,156	0,090
26th	0,006	0,006	0,007	0,136	0,145	0,163	0,071
27th	0,006	0,009	0,010	0,135	0,195	0,218	0,083
28th	0,006	0,005	0,006	0,131	0,124	0,142	0,066
29th	0,006	0,006	0,005	0,141	0,142	0,126	0,078
30th	0,006	0,006	0,005	0,132	0,139	0,122	0,061
31th	0,005	0,006	0,005	0,126	0,129	0,114	0,073
32th	0,007	0,006	0,005	0,152	0,144	0,118	0,058
33th	0,007	0,007	0,013	0,150	0,148	0,289	0,068
34th	0,004	0,005	0,005	0,092	0,105	0,108	0,054
35th	0,005	0,005	0,005	0,111	0,111	0,123	0,064
36th	0,005	0,006	0,006	0,106	0,126	0,137	0,051
37th	0,005	0,005	0,005	0,104	0,104	0,113	0,061
38th	0,004	0,004	0,005	0,095	0,101	0,107	0,048
39th	0,004	0,007	0,007	0,097	0,168	0,159	0,058
40th	0,004	0,004	0,005	0,086	0,089	0,107	0,046
41th	0,038	0,036	0,036	0,879	0,810	0,834	--
42th	0,004	0,005	0,005	0,101	0,108	0,105	--

43th	0,027	0,024	0,026	0,616	0,542	0,596	--
44th	0,003	0,005	0,005	0,075	0,109	0,106	--
45th	0,005	0,005	0,006	0,104	0,123	0,146	--
46th	0,004	0,004	0,004	0,085	0,082	0,101	--
47th	0,022	0,023	0,023	0,498	0,514	0,525	--
48th	0,004	0,004	0,003	0,086	0,102	0,076	--
49th	0,021	0,018	0,021	0,471	0,420	0,490	--
50th	0,004	0,005	0,004	0,092	0,119	0,090	--

**Note:**

The test had been performed on the model SUN2000-3KTL-M0, and the test results are valid for the SUN2000-3KTL-M1 since it is identical in rated output power.

**A1.3.1 Harmonic Current Emissions**

The test requirements are specified in Annex A1 A.1.3.1 (Inverter connected) or Annex A2 A.2.3.1 (Synchronous).

**P**

**SUN2000-4KTL-M0**

Harmonic order	55% rated output power						Harmonic current limit EN 61000-3-2, Class A [A]
	Measured Value (MV) in Amps			Measured Value (MV) in %			
Phase	Phase L1	Phase L2	Phase L3	Phase L1	Phase L2	Phase L3	--
1st	3,203	3,179	3,181	50,229	49,853	49,884	-
2nd	0,028	0,040	0,029	0,439	0,627	0,455	1,080
3rd	0,024	0,028	0,036	0,376	0,439	0,565	2,300
4th	0,024	0,022	0,024	0,376	0,345	0,376	0,430
5th	0,014	0,010	0,014	0,220	0,157	0,220	1,140
6th	0,013	0,010	0,013	0,204	0,157	0,204	0,300
7th	0,012	0,008	0,010	0,188	0,125	0,157	0,770
8th	0,011	0,010	0,010	0,173	0,157	0,157	0,230
9th	0,009	0,008	0,011	0,141	0,125	0,173	0,400
10th	0,011	0,010	0,010	0,173	0,157	0,157	0,184
11th	0,010	0,007	0,010	0,157	0,110	0,157	0,330
12th	0,013	0,011	0,013	0,204	0,173	0,204	0,153
13th	0,010	0,009	0,009	0,157	0,141	0,141	0,210
14th	0,011	0,011	0,010	0,173	0,173	0,157	0,131
15th	0,008	0,014	0,009	0,125	0,220	0,141	0,150
16th	0,010	0,011	0,010	0,157	0,173	0,157	0,115
17th	0,008	0,007	0,007	0,125	0,110	0,110	0,132
18th	0,009	0,009	0,010	0,141	0,141	0,157	0,102
19th	0,007	0,006	0,007	0,110	0,094	0,110	0,118
20th	0,007	0,008	0,007	0,110	0,125	0,110	0,092
21th	0,007	0,007	0,005	0,110	0,110	0,078	0,107
22th	0,008	0,007	0,007	0,125	0,110	0,110	0,084
23th	0,005	0,006	0,005	0,078	0,094	0,078	0,098
24th	0,006	0,006	0,006	0,094	0,094	0,094	0,077
25th	0,005	0,005	0,004	0,078	0,078	0,063	0,090
26th	0,005	0,004	0,005	0,078	0,063	0,078	0,071
27th	0,005	0,007	0,004	0,078	0,110	0,063	0,083
28th	0,005	0,005	0,004	0,078	0,078	0,063	0,066
29th	0,005	0,005	0,005	0,078	0,078	0,078	0,078
30th	0,004	0,004	0,005	0,063	0,063	0,078	0,061
31th	0,004	0,004	0,004	0,063	0,063	0,063	0,073
32th	0,003	0,003	0,004	0,047	0,047	0,063	0,058
33th	0,011	0,013	0,009	0,173	0,204	0,141	0,068
34th	0,003	0,004	0,003	0,047	0,063	0,047	0,054
35th	0,013	0,013	0,013	0,204	0,204	0,204	0,064
36th	0,004	0,004	0,004	0,063	0,063	0,063	0,051

37th	0,019	0,018	0,018	0,298	0,282	0,282	0,061
38th	0,004	0,004	0,004	0,063	0,063	0,063	0,048
39th	0,013	0,015	0,012	0,204	0,235	0,188	0,058
40th	0,004	0,004	0,004	0,063	0,063	0,063	0,046
41th	0,013	0,012	0,013	0,204	0,188	0,204	--
42th	0,004	0,004	0,004	0,063	0,063	0,063	--
43th	0,014	0,015	0,013	0,220	0,235	0,204	--
44th	0,004	0,003	0,004	0,063	0,047	0,063	--
45th	0,008	0,009	0,008	0,125	0,141	0,125	--
46th	0,004	0,004	0,004	0,063	0,063	0,063	--
47th	0,010	0,010	0,010	0,157	0,157	0,157	--
48th	0,004	0,004	0,004	0,063	0,063	0,063	--
49th	0,013	0,013	0,013	0,204	0,204	0,204	--
50th	0,004	0,004	0,004	0,063	0,063	0,063	--

**Note:**

The test had been performed on the model SUN2000-4KTL-M0, and the test results are valid for the SUN2000-4KTL-M1 since it is identical in rated output power.

**A1.3.1 Harmonic Current Emissions**

The test requirements are specified in Annex A1 A.1.3.1 (Inverter connected) or Annex A2 A.2.3.1 (Synchronous).

**P**

**SUN2000-4KTL-M0**

Harmonic order	100% rated output power						Harmonic current limit EN 61000-3-2, Class A [A]
	Measured Value (MV) in Amps			Measured Value (MV) in %			
Phase	Phase L1	Phase L2	Phase L3	Phase L1	Phase L2	Phase L3	--
1st	5,870	5,902	5,872	99,969	99,972	99,972	-
2nd	0,038	0,023	0,031	0,645	0,391	0,525	1,080
3rd	0,017	0,010	0,012	0,290	0,162	0,213	2,300
4th	0,016	0,016	0,014	0,268	0,268	0,234	0,430
5th	0,026	0,027	0,035	0,447	0,458	0,598	1,140
6th	0,005	0,005	0,006	0,084	0,090	0,095	0,300
7th	0,033	0,029	0,033	0,564	0,496	0,554	0,770
8th	0,012	0,016	0,013	0,203	0,266	0,220	0,230
9th	0,007	0,016	0,007	0,124	0,274	0,122	0,400
10th	0,017	0,018	0,018	0,292	0,302	0,301	0,184
11th	0,014	0,014	0,011	0,247	0,232	0,181	0,330
12th	0,007	0,008	0,005	0,124	0,131	0,093	0,153
13th	0,023	0,022	0,025	0,388	0,372	0,433	0,210
14th	0,004	0,007	0,006	0,076	0,121	0,106	0,131
15th	0,007	0,006	0,008	0,122	0,095	0,141	0,150
16th	0,007	0,007	0,006	0,120	0,111	0,108	0,115
17th	0,069	0,069	0,070	1,169	1,176	1,198	0,132
18th	0,007	0,006	0,006	0,118	0,106	0,105	0,102
19th	0,045	0,045	0,046	0,761	0,764	0,786	0,118
20th	0,006	0,007	0,007	0,103	0,124	0,123	0,092
21th	0,006	0,008	0,006	0,107	0,130	0,094	0,107
22th	0,007	0,007	0,007	0,111	0,114	0,119	0,084
23th	0,009	0,010	0,011	0,158	0,166	0,179	0,098
24th	0,007	0,008	0,007	0,120	0,138	0,118	0,077
25th	0,015	0,014	0,014	0,247	0,245	0,231	0,090
26th	0,011	0,012	0,009	0,188	0,198	0,159	0,071
27th	0,007	0,008	0,008	0,127	0,136	0,128	0,083
28th	0,011	0,013	0,010	0,183	0,220	0,171	0,066
29th	0,012	0,009	0,010	0,210	0,152	0,176	0,078
30th	0,009	0,007	0,007	0,146	0,123	0,122	0,061

31th	0,010	0,008	0,007	0,163	0,134	0,119	0,073
32th	0,020	0,010	0,014	0,333	0,172	0,239	0,058
33th	0,008	0,009	0,006	0,134	0,147	0,099	0,068
34th	0,014	0,010	0,013	0,234	0,174	0,216	0,054
35th	0,009	0,007	0,008	0,156	0,122	0,141	0,064
36th	0,007	0,008	0,007	0,121	0,143	0,116	0,051
37th	0,012	0,012	0,010	0,196	0,206	0,174	0,061
38th	0,012	0,014	0,011	0,208	0,236	0,195	0,048
39th	0,011	0,008	0,009	0,187	0,141	0,154	0,058
40th	0,012	0,013	0,009	0,198	0,216	0,149	0,046
41th	0,029	0,025	0,027	0,498	0,425	0,462	--
42th	0,008	0,007	0,005	0,138	0,112	0,092	--
43th	0,014	0,016	0,012	0,233	0,268	0,209	--
44th	0,012	0,010	0,006	0,206	0,167	0,099	--
45th	0,005	0,005	0,005	0,090	0,091	0,084	--
46th	0,010	0,011	0,012	0,169	0,192	0,196	--
47th	0,021	0,017	0,021	0,354	0,296	0,358	--
48th	0,005	0,007	0,005	0,091	0,124	0,088	--
49th	0,008	0,007	0,009	0,135	0,124	0,147	--
50th	0,009	0,006	0,009	0,158	0,108	0,153	--

**Note:**

The test had been performed on the model SUN2000-4KTL-M0, and the test results are valid for the SUN2000-4KTL-M1 since it is identical in rated output power.

**A1.3.1 Harmonic Current Emissions**

The test requirements are specified in Annex A1 A.1.3.1 (Inverter connected) or Annex A2 A.2.3.1 (Synchronous).

**P**

**SUN2000-5KTL-M0**

Harmonic order	55% rated output power						Harmonic current limit EN 61000-3-2, Class A [A]
	Measured Value (MV) in Amps			Measured Value (MV) in %			
Phase	Phase L1	Phase L2	Phase L3	Phase L1	Phase L2	Phase L3	--
1st	4,301	4,275	4,269	53,958	53,632	53,557	-
2nd	0,015	0,022	0,014	0,188	0,276	0,176	1,080
3rd	0,008	0,008	0,024	0,100	0,100	0,301	2,300
4th	0,010	0,010	0,008	0,125	0,125	0,100	0,430
5th	0,007	0,007	0,007	0,088	0,088	0,088	1,140
6th	0,009	0,008	0,009	0,113	0,100	0,113	0,300
7th	0,009	0,006	0,007	0,113	0,075	0,088	0,770
8th	0,007	0,007	0,007	0,088	0,088	0,088	0,230
9th	0,007	0,005	0,008	0,088	0,063	0,100	0,400
10th	0,010	0,009	0,009	0,125	0,113	0,113	0,184
11th	0,008	0,005	0,008	0,100	0,063	0,100	0,330
12th	0,012	0,010	0,012	0,151	0,125	0,151	0,153
13th	0,006	0,007	0,008	0,075	0,088	0,100	0,210
14th	0,010	0,009	0,008	0,125	0,113	0,100	0,131
15th	0,006	0,009	0,008	0,075	0,113	0,100	0,150
16th	0,011	0,010	0,009	0,138	0,125	0,113	0,115
17th	0,008	0,005	0,007	0,100	0,063	0,088	0,132
18th	0,009	0,009	0,010	0,113	0,113	0,125	0,102
19th	0,005	0,006	0,006	0,063	0,075	0,075	0,118
20th	0,007	0,007	0,007	0,088	0,088	0,088	0,092
21th	0,005	0,010	0,005	0,063	0,125	0,063	0,107
22th	0,008	0,007	0,007	0,100	0,088	0,088	0,084
23th	0,004	0,004	0,004	0,050	0,050	0,050	0,098
24th	0,006	0,006	0,006	0,075	0,075	0,075	0,077



25th	0,004	0,004	0,004	0,050	0,050	0,050	0,090
26th	0,004	0,004	0,004	0,050	0,050	0,050	0,071
27th	0,004	0,005	0,004	0,050	0,063	0,050	0,083
28th	0,005	0,005	0,004	0,063	0,063	0,050	0,066
29th	0,004	0,004	0,005	0,050	0,050	0,063	0,078
30th	0,005	0,004	0,005	0,063	0,050	0,063	0,061
31th	0,005	0,006	0,005	0,063	0,075	0,063	0,073
32th	0,003	0,003	0,003	0,038	0,038	0,038	0,058
33th	0,013	0,013	0,010	0,163	0,163	0,125	0,068
34th	0,003	0,004	0,003	0,038	0,050	0,038	0,054
35th	0,017	0,017	0,018	0,213	0,213	0,226	0,064
36th	0,004	0,004	0,004	0,050	0,050	0,050	0,051
37th	0,015	0,015	0,015	0,188	0,188	0,188	0,061
38th	0,003	0,004	0,003	0,038	0,050	0,038	0,048
39th	0,017	0,022	0,016	0,213	0,276	0,201	0,058
40th	0,003	0,004	0,004	0,038	0,050	0,050	0,046
41th	0,014	0,015	0,014	0,176	0,188	0,176	--
42th	0,004	0,004	0,004	0,050	0,050	0,050	--
43th	0,017	0,017	0,017	0,213	0,213	0,213	--
44th	0,003	0,003	0,003	0,038	0,038	0,038	--
45th	0,008	0,009	0,008	0,100	0,113	0,100	--
46th	0,004	0,004	0,004	0,050	0,050	0,050	--
47th	0,011	0,011	0,011	0,138	0,138	0,138	--
48th	0,004	0,004	0,004	0,050	0,050	0,050	--
49th	0,014	0,016	0,014	0,176	0,201	0,176	--
50th	0,004	0,004	0,004	0,050	0,050	0,050	--

**Note:**

The test had been performed on the model SUN2000-5KTL-M0, and the test results are valid for the SUN2000-5KTL-M1 since it is identical in rated output power.

**A1.3.1 Harmonic Current Emissions**

The test requirements are specified in Annex A1 A.1.3.1 (Inverter connected) or Annex A2 A.2.3.1 (Synchronous).

**P**

**SUN2000-5KTL-M0**

Harmonic order	100% rated output power						Harmonic current limit EN 61000-3-2, Class A [A]
	Measured Value (MV) in Amps			Measured Value (MV) in %			
Phase	Phase L1	Phase L2	Phase L3	Phase L1	Phase L2	Phase L3	--
1st	7,340	7,335	7,297	99,982	99,981	99,983	-
2nd	0,015	0,010	0,015	0,203	0,140	0,200	1,080
3rd	0,017	0,025	0,009	0,233	0,345	0,126	2,300
4th	0,007	0,007	0,007	0,097	0,101	0,095	0,430
5th	0,041	0,036	0,048	0,552	0,492	0,654	1,140
6th	0,007	0,007	0,005	0,102	0,093	0,070	0,300
7th	0,031	0,030	0,035	0,420	0,413	0,482	0,770
8th	0,005	0,006	0,006	0,069	0,078	0,079	0,230
9th	0,008	0,007	0,006	0,111	0,091	0,079	0,400
10th	0,006	0,006	0,005	0,076	0,081	0,069	0,184
11th	0,032	0,030	0,029	0,432	0,405	0,398	0,330
12th	0,006	0,006	0,005	0,084	0,087	0,075	0,153
13th	0,013	0,014	0,010	0,173	0,194	0,137	0,210
14th	0,007	0,007	0,006	0,094	0,089	0,083	0,131
15th	0,009	0,009	0,007	0,122	0,118	0,103	0,150
16th	0,006	0,007	0,007	0,086	0,097	0,096	0,115
17th	0,032	0,029	0,023	0,443	0,392	0,310	0,132
18th	0,006	0,009	0,008	0,079	0,123	0,109	0,102

19th	0,048	0,045	0,044	0,655	0,607	0,601	0,118
20th	0,008	0,010	0,007	0,112	0,134	0,097	0,092
21th	0,011	0,008	0,008	0,144	0,103	0,116	0,107
22th	0,006	0,007	0,006	0,085	0,098	0,088	0,084
23th	0,012	0,011	0,011	0,165	0,143	0,146	0,098
24th	0,007	0,007	0,007	0,092	0,092	0,091	0,077
25th	0,012	0,012	0,009	0,160	0,164	0,128	0,090
26th	0,009	0,007	0,007	0,118	0,102	0,100	0,071
27th	0,009	0,008	0,010	0,119	0,109	0,141	0,083
28th	0,008	0,008	0,008	0,103	0,102	0,108	0,066
29th	0,010	0,007	0,010	0,130	0,100	0,138	0,078
30th	0,010	0,011	0,008	0,142	0,148	0,106	0,061
31th	0,009	0,007	0,008	0,120	0,096	0,112	0,073
32th	0,010	0,010	0,010	0,132	0,130	0,130	0,058
33th	0,009	0,009	0,010	0,125	0,117	0,139	0,068
34th	0,008	0,009	0,008	0,108	0,118	0,103	0,054
35th	0,009	0,008	0,008	0,121	0,112	0,116	0,064
36th	0,009	0,009	0,009	0,128	0,118	0,121	0,051
37th	0,007	0,010	0,010	0,102	0,134	0,139	0,061
38th	0,010	0,010	0,008	0,141	0,133	0,114	0,048
39th	0,009	0,008	0,011	0,127	0,112	0,144	0,058
40th	0,008	0,010	0,009	0,103	0,135	0,118	0,046
41th	0,009	0,017	0,017	0,123	0,237	0,239	--
42th	0,008	0,013	0,010	0,114	0,182	0,140	--
43th	0,025	0,018	0,018	0,334	0,247	0,246	--
44th	0,008	0,009	0,008	0,106	0,128	0,115	--
45th	0,009	0,010	0,008	0,129	0,138	0,105	--
46th	0,006	0,008	0,007	0,087	0,108	0,102	--
47th	0,027	0,026	0,027	0,372	0,353	0,365	--
48th	0,007	0,007	0,008	0,091	0,100	0,115	--
49th	0,008	0,012	0,010	0,111	0,165	0,140	--
50th	0,007	0,007	0,006	0,098	0,095	0,087	--

**Note:**

The test had been performed on the model SUN2000-5KTL-M0, and the test results are valid for the SUN2000-5KTL-M1 since it is identical in rated output power.

**A1.3.1 Harmonic Current Emissions**

The test requirements are specified in Annex A1 A.1.3.1 (Inverter connected) or Annex A2 A.2.3.1 (Synchronous).

**P**

**SUN2000-6KTL-M0**

Harmonic order	55% rated output power						Harmonic current limit EN 61000-3-2, Class A [A]
	Measured Value (MV) in Amps			Measured Value (MV) in %			
Phase	Phase L1	Phase L2	Phase L3	Phase L1	Phase L2	Phase L3	
1st	4,357	4,385	4,360	54,661	55,012	54,698	--
2nd	0,008	0,009	0,006	0,100	0,113	0,075	1,080
3rd	0,012	0,025	0,014	0,151	0,314	0,176	2,300
4th	0,006	0,007	0,007	0,075	0,088	0,088	0,430
5th	0,009	0,009	0,006	0,113	0,113	0,075	1,140
6th	0,005	0,005	0,005	0,063	0,063	0,063	0,300
7th	0,007	0,008	0,006	0,088	0,100	0,075	0,770
8th	0,004	0,005	0,006	0,050	0,063	0,075	0,230
9th	0,009	0,007	0,008	0,113	0,088	0,100	0,400
10th	0,005	0,006	0,006	0,063	0,075	0,075	0,184
11th	0,007	0,007	0,005	0,088	0,088	0,063	0,330
12th	0,005	0,005	0,005	0,063	0,063	0,063	0,153

13th	0,006	0,006	0,006	0,075	0,075	0,075	0,210
14th	0,005	0,005	0,005	0,063	0,063	0,063	0,131
15th	0,007	0,007	0,009	0,088	0,088	0,113	0,150
16th	0,004	0,005	0,005	0,050	0,063	0,063	0,115
17th	0,007	0,007	0,007	0,088	0,088	0,088	0,132
18th	0,005	0,006	0,006	0,063	0,075	0,075	0,102
19th	0,006	0,006	0,005	0,075	0,075	0,063	0,118
20th	0,005	0,005	0,006	0,063	0,063	0,075	0,092
21th	0,006	0,008	0,007	0,075	0,100	0,088	0,107
22th	0,005	0,005	0,006	0,063	0,063	0,075	0,084
23th	0,007	0,007	0,006	0,088	0,088	0,075	0,098
24th	0,006	0,007	0,007	0,075	0,088	0,088	0,077
25th	0,007	0,008	0,007	0,088	0,100	0,088	0,090
26th	0,006	0,006	0,007	0,075	0,075	0,088	0,071
27th	0,006	0,009	0,010	0,075	0,113	0,125	0,083
28th	0,006	0,005	0,006	0,075	0,063	0,075	0,066
29th	0,006	0,006	0,005	0,075	0,075	0,063	0,078
30th	0,006	0,006	0,005	0,075	0,075	0,063	0,061
31th	0,005	0,006	0,005	0,063	0,075	0,063	0,073
32th	0,007	0,006	0,005	0,088	0,075	0,063	0,058
33th	0,007	0,007	0,013	0,088	0,088	0,163	0,068
34th	0,004	0,005	0,005	0,050	0,063	0,063	0,054
35th	0,005	0,005	0,005	0,063	0,063	0,063	0,064
36th	0,005	0,006	0,006	0,063	0,075	0,075	0,051
37th	0,005	0,005	0,005	0,063	0,063	0,063	0,061
38th	0,004	0,004	0,005	0,050	0,050	0,063	0,048
39th	0,004	0,007	0,007	0,050	0,088	0,088	0,058
40th	0,004	0,004	0,005	0,050	0,050	0,063	0,046
41th	0,038	0,036	0,036	0,477	0,452	0,452	--
42th	0,004	0,005	0,005	0,050	0,063	0,063	--
43th	0,027	0,024	0,026	0,339	0,301	0,326	--
44th	0,003	0,005	0,005	0,038	0,063	0,063	--
45th	0,005	0,005	0,006	0,063	0,063	0,075	--
46th	0,004	0,004	0,004	0,050	0,050	0,050	--
47th	0,022	0,023	0,023	0,276	0,289	0,289	--
48th	0,004	0,004	0,003	0,050	0,050	0,038	--
49th	0,021	0,018	0,021	0,263	0,226	0,263	--
50th	0,004	0,005	0,004	0,050	0,063	0,050	--

**Note:**

The test had been performed on the model SUN2000-6KTL-M0, and the test results are valid for the SUN2000-6KTL-M1 since it is identical in rated output power.

<b>A1.3.1 Harmonic Current Emissions</b>							<b>P</b>
The test requirements are specified in Annex A1 A.1.3.1 (Inverter connected) or Annex A2 A.2.3.1 (Synchronous).							
<b>SUN2000-6KTL-M0</b>							
Harmonic order	100% rated output power						Harmonic current limit EN 61000-3-2, Class A [A]
	Measured Value (MV) in Amps			Measured Value (MV) in %			
Phase	Phase L1	Phase L2	Phase L3	Phase L1	Phase L2	Phase L3	--
1st	8,756	8,750	8,706	99,987	99,985	99,986	-
2nd	0,012	0,010	0,009	0,136	0,110	0,105	1,080
3rd	0,018	0,024	0,013	0,211	0,273	0,154	2,300
4th	0,007	0,008	0,007	0,081	0,090	0,079	0,430
5th	0,037	0,035	0,048	0,424	0,400	0,553	1,140
6th	0,008	0,007	0,007	0,090	0,081	0,080	0,300

7th	0,030	0,033	0,034	0,342	0,378	0,390	0,770
8th	0,006	0,008	0,007	0,068	0,090	0,079	0,230
9th	0,011	0,006	0,005	0,128	0,066	0,060	0,400
10th	0,006	0,006	0,007	0,073	0,070	0,081	0,184
11th	0,005	0,009	0,007	0,062	0,100	0,086	0,330
12th	0,007	0,007	0,006	0,085	0,082	0,071	0,153
13th	0,024	0,021	0,027	0,278	0,240	0,313	0,210
14th	0,007	0,007	0,007	0,082	0,080	0,084	0,131
15th	0,006	0,009	0,008	0,072	0,098	0,091	0,150
16th	0,006	0,006	0,007	0,069	0,073	0,081	0,115
17th	0,052	0,049	0,049	0,592	0,562	0,567	0,132
18th	0,009	0,009	0,007	0,098	0,105	0,077	0,102
19th	0,055	0,055	0,055	0,632	0,629	0,630	0,118
20th	0,009	0,008	0,009	0,106	0,095	0,099	0,092
21th	0,006	0,007	0,006	0,071	0,082	0,064	0,107
22th	0,006	0,008	0,008	0,070	0,094	0,089	0,084
23th	0,008	0,010	0,008	0,088	0,117	0,095	0,098
24th	0,010	0,010	0,008	0,110	0,114	0,089	0,077
25th	0,020	0,015	0,016	0,226	0,170	0,186	0,090
26th	0,009	0,010	0,008	0,098	0,109	0,093	0,071
27th	0,006	0,011	0,007	0,072	0,129	0,086	0,083
28th	0,007	0,009	0,008	0,078	0,101	0,095	0,066
29th	0,008	0,014	0,017	0,097	0,163	0,191	0,078
30th	0,010	0,011	0,010	0,118	0,124	0,112	0,061
31th	0,008	0,012	0,012	0,097	0,138	0,133	0,073
32th	0,010	0,011	0,008	0,109	0,128	0,093	0,058
33th	0,010	0,009	0,008	0,109	0,098	0,092	0,068
34th	0,008	0,010	0,009	0,088	0,112	0,107	0,054
35th	0,007	0,009	0,009	0,085	0,104	0,100	0,064
36th	0,009	0,011	0,008	0,098	0,123	0,097	0,051
37th	0,017	0,010	0,015	0,189	0,110	0,174	0,061
38th	0,008	0,009	0,007	0,095	0,104	0,086	0,048
39th	0,007	0,015	0,008	0,085	0,170	0,090	0,058
40th	0,007	0,009	0,007	0,075	0,097	0,086	0,046
41th	0,039	0,044	0,043	0,440	0,504	0,491	--
42th	0,009	0,010	0,007	0,099	0,119	0,079	--
43th	0,021	0,020	0,018	0,238	0,225	0,208	--
44th	0,008	0,009	0,006	0,095	0,100	0,071	--
45th	0,006	0,007	0,006	0,073	0,082	0,067	--
46th	0,005	0,008	0,006	0,059	0,089	0,071	--
47th	0,033	0,037	0,038	0,376	0,427	0,436	--
48th	0,008	0,007	0,006	0,087	0,082	0,073	--
49th	0,013	0,011	0,008	0,148	0,128	0,095	--
50th	0,006	0,007	0,005	0,068	0,077	0,057	--

**Note:**

The test had been performed on the model SUN2000-6KTL-M0, and the test results are valid for the SUN2000-6KTL-M1 since it is identical in rated output power.

**A1.3.1 Harmonic Current Emissions**

The test requirements are specified in Annex A1 A.1.3.1 (Inverter connected) or Annex A2 A.2.3.1 (Synchronous).

**P**

**SUN2000-8KTL-M0**

Harmonic order	55% rated output power						Harmonic current limit EN 61000-3-2, Class A [A]
	Measured Value (MV) in Amps			Measured Value (MV) in %			
Phase	Phase L1	Phase L2	Phase L3	Phase L1	Phase L2	Phase L3	--

1st	5,870	5,902	5,872	50,629	50,905	50,646	-
2nd	0,038	0,023	0,031	0,328	0,198	0,267	1,080
3rd	0,017	0,010	0,012	0,147	0,086	0,104	2,300
4th	0,016	0,016	0,014	0,138	0,138	0,121	0,430
5th	0,026	0,027	0,035	0,224	0,233	0,302	1,140
6th	0,005	0,005	0,006	0,043	0,043	0,052	0,300
7th	0,033	0,029	0,033	0,285	0,250	0,285	0,770
8th	0,012	0,016	0,013	0,104	0,138	0,112	0,230
9th	0,007	0,016	0,007	0,060	0,138	0,060	0,400
10th	0,017	0,018	0,018	0,147	0,155	0,155	0,184
11th	0,014	0,014	0,011	0,121	0,121	0,095	0,330
12th	0,007	0,008	0,005	0,060	0,069	0,043	0,153
13th	0,023	0,022	0,025	0,198	0,190	0,216	0,210
14th	0,004	0,007	0,006	0,035	0,060	0,052	0,131
15th	0,007	0,006	0,008	0,060	0,052	0,069	0,150
16th	0,007	0,007	0,006	0,060	0,060	0,052	0,115
17th	0,069	0,069	0,070	0,595	0,595	0,604	0,132
18th	0,007	0,006	0,006	0,060	0,052	0,052	0,102
19th	0,045	0,045	0,046	0,388	0,388	0,397	0,118
20th	0,006	0,007	0,007	0,052	0,060	0,060	0,092
21th	0,006	0,008	0,006	0,052	0,069	0,052	0,107
22th	0,007	0,007	0,007	0,060	0,060	0,060	0,084
23th	0,009	0,010	0,011	0,078	0,086	0,095	0,098
24th	0,007	0,008	0,007	0,060	0,069	0,060	0,077
25th	0,015	0,014	0,014	0,129	0,121	0,121	0,090
26th	0,011	0,012	0,009	0,095	0,104	0,078	0,071
27th	0,007	0,008	0,008	0,060	0,069	0,069	0,083
28th	0,011	0,013	0,010	0,095	0,112	0,086	0,066
29th	0,012	0,009	0,010	0,104	0,078	0,086	0,078
30th	0,009	0,007	0,007	0,078	0,060	0,060	0,061
31th	0,010	0,008	0,007	0,086	0,069	0,060	0,073
32th	0,020	0,010	0,014	0,173	0,086	0,121	0,058
33th	0,008	0,009	0,006	0,069	0,078	0,052	0,068
34th	0,014	0,010	0,013	0,121	0,086	0,112	0,054
35th	0,009	0,007	0,008	0,078	0,060	0,069	0,064
36th	0,007	0,008	0,007	0,060	0,069	0,060	0,051
37th	0,012	0,012	0,010	0,104	0,104	0,086	0,061
38th	0,012	0,014	0,011	0,104	0,121	0,095	0,048
39th	0,011	0,008	0,009	0,095	0,069	0,078	0,058
40th	0,012	0,013	0,009	0,104	0,112	0,078	0,046
41th	0,029	0,025	0,027	0,250	0,216	0,233	--
42th	0,008	0,007	0,005	0,069	0,060	0,043	--
43th	0,014	0,016	0,012	0,121	0,138	0,104	--
44th	0,012	0,010	0,006	0,104	0,086	0,052	--
45th	0,005	0,005	0,005	0,043	0,043	0,043	--
46th	0,010	0,011	0,012	0,086	0,095	0,104	--
47th	0,021	0,017	0,021	0,181	0,147	0,181	--
48th	0,005	0,007	0,005	0,043	0,060	0,043	--
49th	0,008	0,007	0,009	0,069	0,060	0,078	--
50th	0,009	0,006	0,009	0,078	0,052	0,078	--

**Note:**

The test had been performed on the model SUN2000-8KTL-M0, and the test results are valid for the SUN2000-8KTL-M1 since it is identical in rated output power.

<b>A1.3.1 Harmonic Current Emissions</b>							<b>P</b>
The test requirements are specified in Annex A1 A.1.3.1 (Inverter connected) or Annex A2 A.2.3.1 (Synchronous).							
<b>SUN2000-8KTL-M0</b>							
Harmonic order	100% rated output power						Harmonic current limit EN 61000-3-2, Class A [A]
	Measured Value (MV) in Amps			Measured Value (MV) in %			
Phase	Phase L1	Phase L2	Phase L3	Phase L1	Phase L2	Phase L3	--
1st	11,646	11,640	11,583	99,991	99,991	99,991	-
2nd	0,017	0,015	0,007	0,145	0,129	0,065	1,080
3rd	0,023	0,027	0,018	0,198	0,232	0,159	2,300
4th	0,009	0,010	0,008	0,077	0,082	0,066	0,430
5th	0,058	0,053	0,074	0,502	0,459	0,636	1,140
6th	0,006	0,007	0,007	0,048	0,059	0,063	0,300
7th	0,031	0,033	0,035	0,264	0,283	0,300	0,770
8th	0,006	0,006	0,006	0,052	0,055	0,048	0,230
9th	0,016	0,007	0,007	0,134	0,060	0,058	0,400
10th	0,007	0,007	0,006	0,063	0,058	0,055	0,184
11th	0,007	0,006	0,007	0,060	0,049	0,063	0,330
12th	0,006	0,006	0,006	0,050	0,051	0,053	0,153
13th	0,030	0,029	0,032	0,261	0,252	0,276	0,210
14th	0,006	0,008	0,006	0,056	0,066	0,054	0,131
15th	0,005	0,009	0,008	0,046	0,075	0,071	0,150
16th	0,007	0,007	0,008	0,060	0,064	0,069	0,115
17th	0,026	0,020	0,025	0,219	0,175	0,218	0,132
18th	0,009	0,007	0,007	0,073	0,061	0,061	0,102
19th	0,034	0,036	0,034	0,293	0,308	0,296	0,118
20th	0,010	0,009	0,008	0,083	0,075	0,070	0,092
21th	0,008	0,011	0,007	0,069	0,094	0,060	0,107
22th	0,008	0,008	0,008	0,067	0,065	0,072	0,084
23th	0,009	0,009	0,008	0,077	0,075	0,067	0,098
24th	0,011	0,009	0,007	0,096	0,074	0,064	0,077
25th	0,015	0,017	0,017	0,131	0,148	0,145	0,090
26th	0,010	0,009	0,010	0,085	0,076	0,084	0,071
27th	0,009	0,008	0,010	0,075	0,072	0,083	0,083
28th	0,010	0,011	0,010	0,083	0,093	0,086	0,066
29th	0,009	0,012	0,014	0,073	0,106	0,123	0,078
30th	0,014	0,013	0,012	0,124	0,108	0,103	0,061
31th	0,016	0,016	0,014	0,138	0,138	0,117	0,073
32th	0,014	0,015	0,011	0,120	0,128	0,098	0,058
33th	0,011	0,012	0,011	0,091	0,104	0,099	0,068
34th	0,011	0,011	0,013	0,097	0,098	0,116	0,054
35th	0,012	0,017	0,015	0,099	0,146	0,134	0,064
36th	0,014	0,015	0,013	0,120	0,125	0,116	0,051
37th	0,010	0,012	0,010	0,084	0,100	0,083	0,061
38th	0,014	0,015	0,015	0,118	0,132	0,131	0,048
39th	0,014	0,014	0,013	0,121	0,122	0,115	0,058
40th	0,010	0,011	0,010	0,090	0,092	0,084	0,046
41th	0,034	0,032	0,031	0,294	0,277	0,269	--
42th	0,015	0,013	0,011	0,131	0,113	0,093	--
43th	0,037	0,036	0,038	0,317	0,313	0,326	--
44th	0,009	0,010	0,007	0,080	0,083	0,061	--
45th	0,010	0,010	0,010	0,082	0,084	0,087	--
46th	0,008	0,009	0,009	0,066	0,077	0,078	--
47th	0,017	0,014	0,018	0,143	0,122	0,156	--

48th	0,010	0,011	0,011	0,085	0,099	0,096	--
49th	0,027	0,023	0,022	0,235	0,201	0,189	--
50th	0,009	0,008	0,008	0,079	0,073	0,072	--

**Note:**

The test had been performed on the model SUN2000-8KTL-M0, and the test results are valid for the SUN2000-8KTL-M1 since it is identical in rated output power.

**A1.3.1 Harmonic Current Emissions**

The test requirements are specified in Annex A1 A.1.3.1 (Inverter connected) or Annex A2 A.2.3.1 (Synchronous).

**P**

**SUN2000-10KTL-M0**

Harmonic order	55% rated output power						Harmonic current limit EN 61000-3-2, Class A [A]
	Measured Value (MV) in Amps			Measured Value (MV) in %			
Phase	Phase L1	Phase L2	Phase L3	Phase L1	Phase L2	Phase L3	--
1st	7,340	7,335	7,297	50,646	50,612	50,349	-
2nd	0,015	0,010	0,015	0,104	0,069	0,104	1,080
3rd	0,017	0,025	0,009	0,117	0,173	0,062	2,300
4th	0,007	0,007	0,007	0,048	0,048	0,048	0,430
5th	0,041	0,036	0,048	0,283	0,248	0,331	1,140
6th	0,007	0,007	0,005	0,048	0,048	0,035	0,300
7th	0,031	0,030	0,035	0,214	0,207	0,242	0,770
8th	0,005	0,006	0,006	0,035	0,041	0,041	0,230
9th	0,008	0,007	0,006	0,055	0,048	0,041	0,400
10th	0,006	0,006	0,005	0,041	0,041	0,035	0,184
11th	0,032	0,030	0,029	0,221	0,207	0,200	0,330
12th	0,006	0,006	0,005	0,041	0,041	0,035	0,153
13th	0,013	0,014	0,010	0,090	0,097	0,069	0,210
14th	0,007	0,007	0,006	0,048	0,048	0,041	0,131
15th	0,009	0,009	0,007	0,062	0,062	0,048	0,150
16th	0,006	0,007	0,007	0,041	0,048	0,048	0,115
17th	0,032	0,029	0,023	0,221	0,200	0,159	0,132
18th	0,006	0,009	0,008	0,041	0,062	0,055	0,102
19th	0,048	0,045	0,044	0,331	0,311	0,304	0,118
20th	0,008	0,010	0,007	0,055	0,069	0,048	0,092
21th	0,011	0,008	0,008	0,076	0,055	0,055	0,107
22th	0,006	0,007	0,006	0,041	0,048	0,041	0,084
23th	0,012	0,011	0,011	0,083	0,076	0,076	0,098
24th	0,007	0,007	0,007	0,048	0,048	0,048	0,077
25th	0,012	0,012	0,009	0,083	0,083	0,062	0,090
26th	0,009	0,007	0,007	0,062	0,048	0,048	0,071
27th	0,009	0,008	0,010	0,062	0,055	0,069	0,083
28th	0,008	0,008	0,008	0,055	0,055	0,055	0,066
29th	0,010	0,007	0,010	0,069	0,048	0,069	0,078
30th	0,010	0,011	0,008	0,069	0,076	0,055	0,061
31th	0,009	0,007	0,008	0,062	0,048	0,055	0,073
32th	0,010	0,010	0,010	0,069	0,069	0,069	0,058
33th	0,009	0,009	0,010	0,062	0,062	0,069	0,068
34th	0,008	0,009	0,008	0,055	0,062	0,055	0,054
35th	0,009	0,008	0,008	0,062	0,055	0,055	0,064
36th	0,009	0,009	0,009	0,062	0,062	0,062	0,051
37th	0,007	0,010	0,010	0,048	0,069	0,069	0,061
38th	0,010	0,010	0,008	0,069	0,069	0,055	0,048
39th	0,009	0,008	0,011	0,062	0,055	0,076	0,058
40th	0,008	0,010	0,009	0,055	0,069	0,062	0,046
41th	0,009	0,017	0,017	0,062	0,117	0,117	--

42th	0,008	0,013	0,010	0,055	0,090	0,069	--
43th	0,025	0,018	0,018	0,173	0,124	0,124	--
44th	0,008	0,009	0,008	0,055	0,062	0,055	--
45th	0,009	0,010	0,008	0,062	0,069	0,055	--
46th	0,006	0,008	0,007	0,041	0,055	0,048	--
47th	0,027	0,026	0,027	0,186	0,179	0,186	--
48th	0,007	0,007	0,008	0,048	0,048	0,055	--
49th	0,008	0,012	0,010	0,055	0,083	0,069	--
50th	0,007	0,007	0,006	0,048	0,048	0,041	--

**Note:**

The test had been performed on the model SUN2000-10KTL-M0, and the test results are valid for the SUN2000-10KTL-M1 since it is identical in rated output power.

**A1.3.1 Harmonic Current Emissions**

The test requirements are specified in Annex A1 A.1.3.1 (Inverter connected) or Annex A2 A.2.3.1 (Synchronous).

**P**

**SUN2000-10KTL-M0**

Harmonic order	100% rated output power						Harmonic current limit EN 61000-3-2, Class A [A]
	Measured Value (MV) in Amps			Measured Value (MV) in %			
Phase	Phase L1	Phase L2	Phase L3	Phase L1	Phase L2	Phase L3	--
1st	14,408	14,521	14,423	99,993	99,992	99,992	-
2nd	0,030	0,016	0,025	0,207	0,113	0,173	1,080
3rd	0,043	0,016	0,036	0,299	0,110	0,246	2,300
4th	0,010	0,012	0,015	0,070	0,084	0,102	0,430
5th	0,017	0,018	0,016	0,117	0,124	0,110	1,140
6th	0,008	0,009	0,008	0,054	0,060	0,053	0,300
7th	0,011	0,009	0,012	0,074	0,063	0,080	0,770
8th	0,007	0,009	0,009	0,048	0,062	0,063	0,230
9th	0,010	0,014	0,008	0,069	0,096	0,055	0,400
10th	0,007	0,008	0,008	0,050	0,057	0,055	0,184
11th	0,010	0,010	0,011	0,071	0,069	0,076	0,330
12th	0,007	0,007	0,007	0,047	0,049	0,050	0,153
13th	0,009	0,012	0,012	0,064	0,085	0,081	0,210
14th	0,006	0,008	0,008	0,044	0,058	0,057	0,131
15th	0,006	0,007	0,009	0,044	0,047	0,059	0,150
16th	0,008	0,008	0,007	0,057	0,058	0,051	0,115
17th	0,009	0,009	0,008	0,062	0,060	0,053	0,132
18th	0,007	0,007	0,008	0,048	0,048	0,054	0,102
19th	0,008	0,009	0,009	0,055	0,063	0,061	0,118
20th	0,006	0,007	0,007	0,043	0,045	0,046	0,092
21th	0,006	0,007	0,009	0,043	0,045	0,061	0,107
22th	0,007	0,007	0,007	0,047	0,049	0,050	0,084
23th	0,009	0,009	0,009	0,063	0,059	0,065	0,098
24th	0,008	0,008	0,007	0,053	0,052	0,050	0,077
25th	0,008	0,009	0,009	0,059	0,064	0,065	0,090
26th	0,006	0,007	0,007	0,043	0,050	0,048	0,071
27th	0,009	0,010	0,008	0,061	0,069	0,059	0,083
28th	0,008	0,010	0,010	0,056	0,071	0,070	0,066
29th	0,008	0,008	0,009	0,055	0,057	0,062	0,078
30th	0,009	0,011	0,011	0,064	0,074	0,077	0,061
31th	0,009	0,010	0,010	0,060	0,070	0,071	0,073
32th	0,009	0,018	0,017	0,062	0,126	0,119	0,058
33th	0,013	0,014	0,013	0,089	0,096	0,088	0,068
34th	0,013	0,018	0,015	0,090	0,121	0,105	0,054
35th	0,048	0,048	0,036	0,330	0,331	0,248	0,064



36th	0,017	0,020	0,016	0,121	0,141	0,110	0,051
37th	0,026	0,042	0,037	0,178	0,290	0,255	0,061
38th	0,011	0,025	0,026	0,075	0,174	0,180	0,048
39th	0,025	0,015	0,016	0,171	0,102	0,110	0,058
40th	0,016	0,025	0,019	0,108	0,172	0,135	0,046
41th	0,022	0,024	0,034	0,154	0,163	0,239	--
42th	0,016	0,023	0,018	0,108	0,158	0,123	--
43th	0,031	0,032	0,037	0,217	0,220	0,257	--
44th	0,013	0,022	0,020	0,088	0,149	0,141	--
45th	0,018	0,015	0,016	0,124	0,103	0,110	--
46th	0,012	0,019	0,017	0,083	0,132	0,118	--
47th	0,034	0,045	0,039	0,235	0,308	0,267	--
48th	0,014	0,015	0,015	0,099	0,102	0,105	--
49th	0,032	0,020	0,028	0,221	0,138	0,192	--
50th	0,010	0,023	0,020	0,071	0,158	0,136	--

**Note:**

The test had been performed on the model SUN2000-10KTL-M0, and the test results are valid for the SUN2000-10KTL-M1 since it is identical in rated output power.

<b>A1.3.2 Power factor</b>				<b>P</b>
The requirement is specified in section 9.5, test procedure in Annex A1 A.1.3.2 (Inverter connected) or Annex A2 A.2.3.2 (Synchronous).				
<b>SUN2000-3KTL-M0</b>				
Output power	216,2 V	230 V	253 20 V	Measured at three voltage levels and at full output. Voltage to be maintained within $\pm 1.5\%$ of the stated level during the test.
20%	0,9955	0,9962	0,9951	
50%	0,9991	0,9992	0,9991	
75%	0,9996	0,9996	0,9996	
100%	0,9998	0,9998	0,9998	
Limit	>0,95	>0,95	>0,95	
<b>SUN2000-10KTL-M0</b>				
Output power	216,2 V	230 V	253 20 V	Measured at three voltage levels and at full output. Voltage to be maintained within $\pm 1.5\%$ of the stated level during the test.
20%	0,9996	0,9996	0,9995	
50%	0,9999	0,9993	0,9999	
75%	0,9999	0,9997	0,9999	
100%	0,9999	0,9998	0,9999	
Limit	>0,95	>0,95	>0,95	
<p>Note:</p> <p>The power factor capability of the SSEG shall conform to EN 50438. When operating at Registered Capacity the SSEG shall operate at a power factor within the range 0.95 lagging to 0.95 leading relative to the voltage waveform unless otherwise agreed with the DNO eg for power factor improvement.</p> <p>The test set up shall be such that the Inverter supplies full load to the DNO's Distribution System via the power factor (pf) meter and the variac as shown below in figure A5. The Inverter pf should be within the limits given in 5.6, for three test voltages 230 V -6%, 230V and 230 V +10%.</p> <p>The test had been performed on the model SUN2000-3KTL-M0 and SUN2000-10KTL-M0, the test results are valid for the SUN2000-4KTL-M0, SUN2000-5KTL-M0, SUN2000-6KTL-M0, SUN2000-8KTL-M0, SUN2000-3KTL-M1, SUN2000-4KTL-M1, SUN2000-5KTL-M1, SUN2000-6KTL-M1, SUN2000-8KTL-M1 and SUN2000-10KTL-M1 since it is almost identical in hardware and just the output power derated by software.</p>				

A 1.3.3 Voltage Flicker				P					
The requirement is specified in section 5.4.2, test procedure in Annex A or B 1.4.3									
Test conditions:		Maximum permissible voltage fluctuation (expressed as a percentage of nominal voltage at 100 % power) and flicker as per EN 61000-3-3							
		Starting	Stopping	Running					
Limit		3,3%	3,3%	P <sub>st</sub> =1,0	P <sub>It</sub> =0,65				
Test value		See below							
No.	dc[%]	dmax[%]	d(t)[ms]	Pst	No.	dc[%]	dmax[%]	d(t)[ms]	Pst
1	0.00	0.00	0.00	0.07	1	0.00	0.00	0.00	0.07
2	0.09	0.10	0.00	0.08	2	0.02	0.07	0.00	0.08
3	0.12	0.12	0.00	0.08	3	0.01	0.06	0.00	0.08
4	0.20	0.22	0.00	0.08	4	0.06	0.06	0.00	0.08
5	0.04	0.05	0.00	0.10	5	0.25	0.28	0.00	0.08
6	0.24	0.29	0.00	0.10	6	0.31	0.34	0.00	0.08
7	0.00	0.00	0.00	0.08	7	0.00	0.00	0.00	0.07
8	0.23	0.24	0.00	0.08	8	0.10	0.18	0.00	0.08
9	0.10	0.12	0.00	0.08	9	0.19	0.29	0.00	0.08
10	0.19	0.26	0.00	0.08	10	0.06	0.23	0.00	0.08
11	0.00	0.00	0.00	0.07	11	0.00	0.00	0.00	0.07
12	0.00	0.00	0.00	0.07	12	0.00	0.00	0.00	0.07
				PIt					PIt
				0.08					0.08
<b>SUN2000-10KTL-M0: L1 Phase</b>					<b>SUN2000-10KTL-M0: L2 Phase</b>				
No.	dc[%]	dmax[%]	d(t)[ms]	Pst	No.	dc[%]	dmax[%]	d(t)[ms]	Pst
1	0.00	0.00	0.00	0.07	1	0.00	0.00	0.00	0.07
2	0.24	0.26	0.00	0.08	2	0.00	0.00	0.00	0.07
3	0.20	0.28	0.00	0.08	3	0.00	0.00	0.00	0.07
4	0.07	0.09	0.00	0.08	4	0.00	0.00	0.00	0.07
5	0.03	0.04	0.00	0.07	5	0.00	0.00	0.00	0.07
6	0.15	0.18	0.00	0.08	6	0.00	0.00	0.00	0.07
7	0.00	0.00	0.00	0.07	7	0.00	0.00	0.00	0.07
8	0.32	0.34	0.00	0.08	8	0.00	0.00	0.00	0.07
9	0.06	0.07	0.00	0.08	9	0.00	0.00	0.00	0.07
10	0.03	0.16	0.00	0.08	10	0.00	0.00	0.00	0.07
11	0.00	0.00	0.00	0.07	11	0.00	0.00	0.00	0.07
12	0.00	0.00	0.00	0.07	12	0.00	0.00	0.00	0.07
				PIt					PIt
				0.08					0.07
<b>SUN2000-10KTL-M0: L3 Phase</b>					<b>SUN2000-8KTL-M0: L1 Phase</b>				
No.	dc[%]	dmax[%]	d(t)[ms]	Pst	No.	dc[%]	dmax[%]	d(t)[ms]	Pst
1	0.00	0.00	0.00	0.07	1	0.00	0.00	0.00	0.07
2	0.00	0.00	0.00	0.07	2	0.00	0.00	0.00	0.07
3	0.00	0.00	0.00	0.07	3	0.00	0.00	0.00	0.07
4	0.00	0.00	0.00	0.07	4	0.00	0.00	0.00	0.07
5	0.00	0.00	0.00	0.07	5	0.00	0.00	0.00	0.07
6	0.00	0.00	0.00	0.07	6	0.00	0.00	0.00	0.07
7	0.00	0.00	0.00	0.07	7	0.00	0.00	0.00	0.07
8	0.00	0.00	0.00	0.07	8	0.00	0.00	0.00	0.07
9	0.00	0.00	0.00	0.07	9	0.00	0.00	0.00	0.07
10	0.00	0.00	0.00	0.07	10	0.00	0.00	0.00	0.07
11	0.00	0.00	0.00	0.07	11	0.00	0.00	0.00	0.07
12	0.00	0.00	0.00	0.07	12	0.00	0.00	0.00	0.07
				PIt					PIt
				0.07					0.07
<b>SUN2000-8KTL-M0: L2 Phase</b>					<b>SUN2000-8KTL-M0: L3 Phase</b>				

No.	dc[%]	dmax[%]	d(t)[ms]	Pst	No.	dc[%]	dmax[%]	d(t)[ms]	Pst
1	0.00	0.00	0.00	0.07	1	0.00	0.00	0.00	0.07
2	0.00	0.00	0.00	0.07	2	0.00	0.00	0.00	0.07
3	0.00	0.00	0.00	0.07	3	0.00	0.00	0.00	0.07
4	0.00	0.00	0.00	0.07	4	0.00	0.00	0.00	0.07
5	0.00	0.00	0.00	0.07	5	0.00	0.00	0.00	0.07
6	0.00	0.00	0.00	0.07	6	0.00	0.00	0.00	0.07
7	0.00	0.00	0.00	0.07	7	0.00	0.00	0.00	0.07
8	0.00	0.00	0.00	0.07	8	0.00	0.00	0.00	0.07
9	0.00	0.00	0.00	0.07	9	0.00	0.00	0.00	0.07
10	0.00	0.00	0.00	0.07	10	0.00	0.00	0.00	0.07
11	0.00	0.00	0.00	0.07	11	0.00	0.00	0.00	0.07
12	0.00	0.00	0.00	0.07	12	0.00	0.00	0.00	0.07
				Plt					Plt
				0.07					0.07

**SUN2000-6KTL-M0: L1 Phase**

**SUN2000-6KTL-M0: L2 Phase**

No.	dc[%]	dmax[%]	d(t)[ms]	Pst	No.	dc[%]	dmax[%]	d(t)[ms]	Pst
1	0.00	0.00	0.00	0.07	1	0.00	0.00	0.00	0.07
2	0.00	0.00	0.00	0.07	2	0.00	0.00	0.00	0.07
3	0.00	0.00	0.00	0.07	3	0.00	0.00	0.00	0.07
4	0.00	0.00	0.00	0.07	4	0.00	0.00	0.00	0.07
5	0.00	0.00	0.00	0.07	5	0.00	0.00	0.00	0.07
6	0.00	0.00	0.00	0.07	6	0.00	0.00	0.00	0.07
7	0.00	0.00	0.00	0.07	7	0.00	0.00	0.00	0.07
8	0.00	0.00	0.00	0.07	8	0.00	0.00	0.00	0.07
9	0.00	0.00	0.00	0.07	9	0.00	0.00	0.00	0.07
10	0.00	0.00	0.00	0.07	10	0.00	0.00	0.00	0.07
11	0.00	0.00	0.00	0.07	11	0.00	0.00	0.00	0.07
12	0.00	0.00	0.00	0.07	12	0.00	0.00	0.00	0.07
				Plt					Plt
				0.07					0.07

**SUN2000-6KTL-M0: L3 Phase**

**SUN2000-5KTL-M0: L1 Phase**

No.	dc[%]	dmax[%]	d(t)[ms]	Pst	No.	dc[%]	dmax[%]	d(t)[ms]	Pst
1	0.00	0.00	0.00	0.07	1	0.00	0.00	0.00	0.07
2	0.00	0.00	0.00	0.07	2	0.00	0.00	0.00	0.07
3	0.00	0.00	0.00	0.07	3	0.00	0.00	0.00	0.07
4	0.00	0.00	0.00	0.07	4	0.00	0.00	0.00	0.07
5	0.00	0.00	0.00	0.07	5	0.00	0.00	0.00	0.07
6	0.00	0.00	0.00	0.07	6	0.00	0.00	0.00	0.07
7	0.00	0.00	0.00	0.07	7	0.00	0.00	0.00	0.07
8	0.00	0.00	0.00	0.07	8	0.00	0.00	0.00	0.07
9	0.00	0.00	0.00	0.07	9	0.00	0.00	0.00	0.07
10	0.00	0.00	0.00	0.07	10	0.00	0.00	0.00	0.07
11	0.00	0.00	0.00	0.07	11	0.00	0.00	0.00	0.07
12	0.00	0.00	0.00	0.07	12	0.00	0.00	0.00	0.07
				Plt					Plt
				0.07					0.07

**SUN2000-5KTL-M0: L2 Phase**

**SUN2000-5KTL-M0: L3 Phase**

No.	dc[%]	dmax[%]	d(t)[ms]	Pst	No.	dc[%]	dmax[%]	d(t)[ms]	Pst
1	0.00	0.00	0.00	0.07	1	0.00	0.00	0.00	0.07
2	0.00	0.00	0.00	0.07	2	0.00	0.00	0.00	0.07
3	0.00	0.00	0.00	0.07	3	0.00	0.00	0.00	0.07
4	0.00	0.00	0.00	0.07	4	0.00	0.00	0.00	0.07
5	0.00	0.00	0.00	0.07	5	0.00	0.00	0.00	0.07
6	0.00	0.00	0.00	0.07	6	0.00	0.00	0.00	0.07
7	0.00	0.00	0.00	0.07	7	0.00	0.00	0.00	0.07
8	0.00	0.00	0.00	0.07	8	0.00	0.00	0.00	0.07
9	0.00	0.00	0.00	0.07	9	0.00	0.00	0.00	0.07
10	0.00	0.00	0.00	0.07	10	0.00	0.00	0.00	0.07
11	0.00	0.00	0.00	0.07	11	0.00	0.00	0.00	0.07
12	0.00	0.00	0.00	0.07	12	0.00	0.00	0.00	0.07
				Plt					Plt
				0.07					0.07

**SUN2000-4KTL-M0: L1 Phase**

**SUN2000-4KTL-M0: L2 Phase**

No.	dc[%]	dmax[%]	d(t)[ms]	Pst	No.	dc[%]	dmax[%]	d(t)[ms]	Pst
1	0.00	0.00	0.00	0.07	1	0.00	0.00	0.00	0.07
2	0.00	0.00	0.00	0.07	2	0.00	0.00	0.00	0.07
3	0.00	0.00	0.00	0.07	3	0.00	0.00	0.00	0.07
4	0.00	0.00	0.00	0.07	4	0.00	0.00	0.00	0.07
5	0.00	0.00	0.00	0.07	5	0.00	0.00	0.00	0.07
6	0.00	0.00	0.00	0.07	6	0.00	0.00	0.00	0.07
7	0.00	0.00	0.00	0.08	7	0.00	0.00	0.00	0.07
8	0.00	0.00	0.00	0.07	8	0.00	0.00	0.00	0.07
9	0.00	0.00	0.00	0.07	9	0.00	0.00	0.00	0.07
10	0.00	0.00	0.00	0.07	10	0.00	0.00	0.00	0.07
11	0.00	0.00	0.00	0.07	11	0.00	0.00	0.00	0.07
12	0.00	0.00	0.00	0.07	12	0.00	0.00	0.00	0.07
				Pst					Pst
				0.07					0.07

SUN2000-4KTL-M0: L3 Phase					SUN2000-4KTL-M0: L1 Phase				
No.	dc[%]	dmax[%]	d(t)[ms]	Pst	No.	dc[%]	dmax[%]	d(t)[ms]	Pst
1	0.00	0.00	0.00	0.07	1	0.00	0.00	0.00	0.07
2	0.00	0.00	0.00	0.07	2	0.00	0.00	0.00	0.07
3	0.00	0.00	0.00	0.07	3	0.00	0.00	0.00	0.07
4	0.00	0.00	0.00	0.07	4	0.00	0.00	0.00	0.07
5	0.00	0.00	0.00	0.07	5	0.00	0.00	0.00	0.07
6	0.00	0.00	0.00	0.07	6	0.00	0.00	0.00	0.07
7	0.00	0.00	0.00	0.07	7	0.00	0.00	0.00	0.07
8	0.00	0.00	0.00	0.07	8	0.00	0.00	0.00	0.07
9	0.00	0.00	0.00	0.07	9	0.00	0.00	0.00	0.07
10	0.00	0.00	0.00	0.07	10	0.00	0.00	0.00	0.07
11	0.00	0.00	0.00	0.07	11	0.00	0.00	0.00	0.07
12	0.00	0.00	0.00	0.07	12	0.00	0.00	0.00	0.07
				Pst					Pst
				0.07					0.07

SUN2000-3KTL-M0: L2 Phase					SUN2000-3KTL-M0: L3 Phase				
No.	dc[%]	dmax[%]	d(t)[ms]	Pst	No.	dc[%]	dmax[%]	d(t)[ms]	Pst
1	0.00	0.00	0.00	0.07	1	0.00	0.00	0.00	0.07
2	0.00	0.00	0.00	0.07	2	0.00	0.00	0.00	0.07
3	0.00	0.00	0.00	0.07	3	0.00	0.00	0.00	0.07
4	0.00	0.00	0.00	0.07	4	0.00	0.00	0.00	0.07
5	0.00	0.00	0.00	0.07	5	0.00	0.00	0.00	0.07
6	0.00	0.00	0.00	0.07	6	0.00	0.00	0.00	0.07
7	0.00	0.00	0.00	0.07	7	0.00	0.00	0.00	0.07
8	0.00	0.00	0.00	0.07	8	0.00	0.00	0.00	0.07
9	0.00	0.00	0.00	0.07	9	0.00	0.00	0.00	0.07
10	0.00	0.00	0.00	0.07	10	0.00	0.00	0.00	0.07
11	0.00	0.00	0.00	0.07	11	0.00	0.00	0.00	0.07
12	0.00	0.00	0.00	0.07	12	0.00	0.00	0.00	0.07
				Pst					Pst
				0.07					0.07

Note:

\*The stationary deviance of dc% is more relevant than the dynamic deviance of d<sub>max</sub> at starting and stopping.

Mains Impedance according EN61000-3-3: **R<sub>max</sub> = 0,24Ω; jX<sub>max</sub> = 0,15Ω @50Hz (|Z<sub>max</sub>| = 0,283 / 0,472 Ω)**  
 For single phase inverter Z<sub>max</sub> + R<sub>n</sub> and jx<sub>n</sub> **R<sub>n</sub> = 0,16Ω; jX<sub>n</sub> = 0,1Ω**

Calculation of the maximum permissible grid impedance at the point of common coupling based on d<sub>c</sub>:  
 $Z_{max} = Z_{ref} * 3,3\% / d_c(P_n)$

The tests should be based on the limits of the EN61000-3-3 for less than 16A.

The test had been performed on the models SUN2000-3KTL-M0, SUN2000-4KTL-M0, SUN2000-5KTL-M0, SUN2000-6KTL-M0, SUN2000-8KTL-M0, and SUN2000-10KTL-M0, and the test results are valid for the SUN2000-3KTL-M1, SUN2000-4KTL-M1, SUN2000-5KTL-M1, SUN2000-6KTL-M1, SUN2000-8KTL-M1, and SUN2000-10KTL-M1 since it is identical in rated output power.

<b>A.1.3.4 DC injection</b> The test procedure in Annex A1 A.1.3.4 (Inverter connected) or Annex A2 A.2.3.4 (Synchronous).	<b>P</b>
---	----------

<b>SUN2000-10KTL-M0</b>					
Test level power		20%	50%	75%	100%
<b>L1</b>	Recorded value in Amps	3,4 mA	3,7 mA	3,8 mA	5,8 mA
	As % of rated AC current	0,02	0,02	0,02	0,03
<b>L2</b>	Recorded value in Amps	3,9 mA	3,1 mA	3,5 mA	5,3 mA
	As % of rated AC current	0,02	0,02 %	0,02	0,03
<b>L3</b>	Recorded value in Amps	1,4 mA	1,7 mA	3,1 mA	4,7 mA
	As % of rated AC current	0,01	0,01	0,02	0,03
Limit		0,25%	0,25%	0,25%	0,25%

**Diagram of Permanent DC-injection**

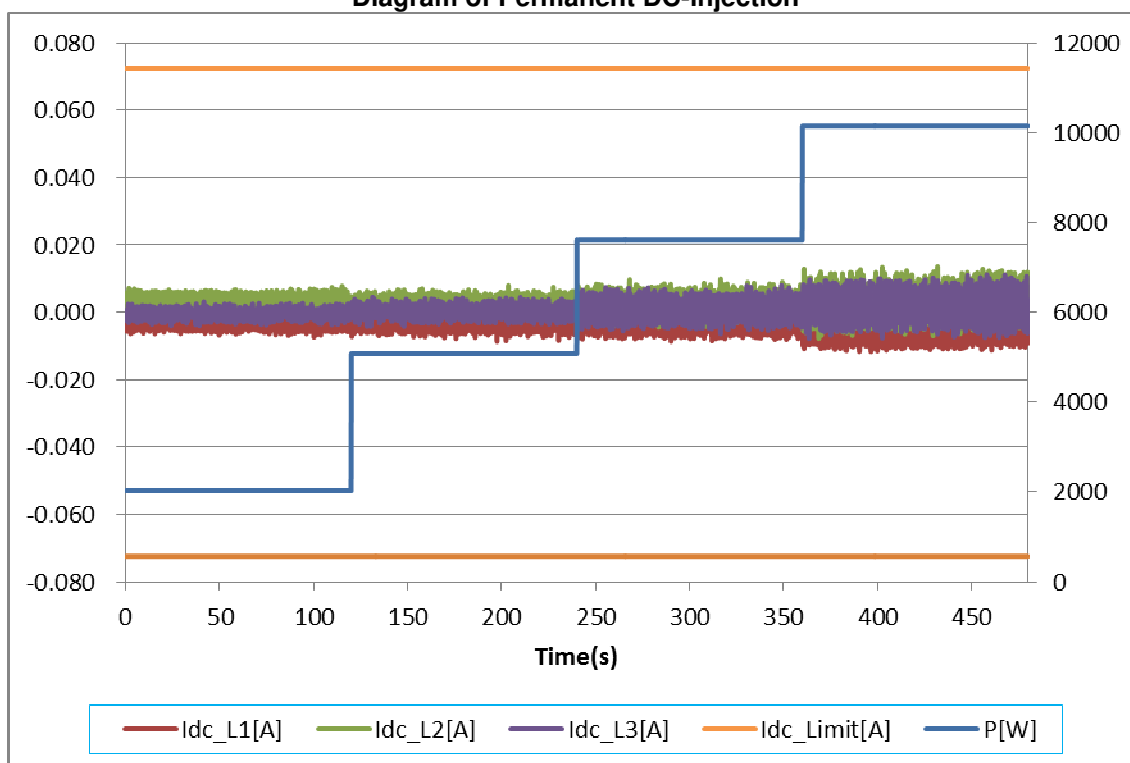

SUN2000-3KTL-M0					
Test level power		20%	50%	75%	100%
L1	Recorded value in Amps	4,5	4,2	4,2	4,0
	As % of rated AC current	0,08%	0,08%	0,08%	0,08%
L2	Recorded value in Amps	4,2	4,1	4,3	4,1
	As % of rated AC current	0,08%	0,08%	0,08%	0,08%
L3	Recorded value in Amps	1,2	1,2	0,7	0,8
	As % of rated AC current	0,02%	0,02%	0,01 %	0,02%
Limit		0,25%	0,25%	0,25%	0,25%

Diagram of Permanent DC-injection

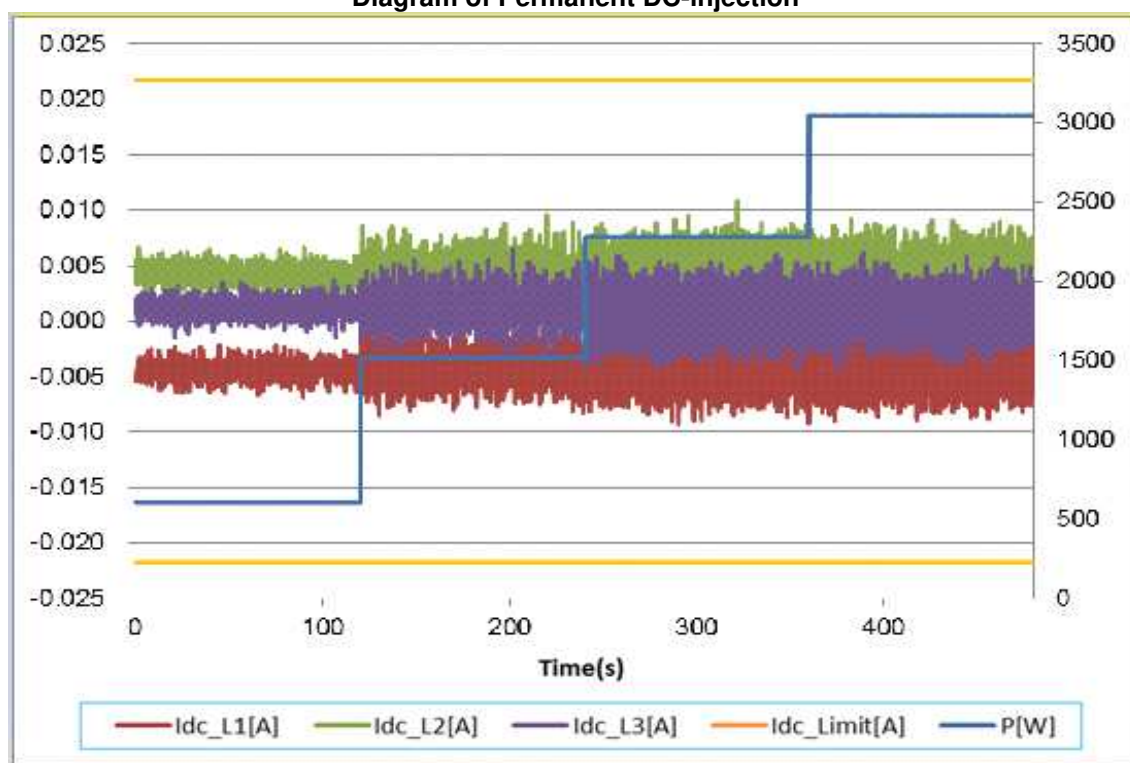

**Note:**

The level of DC injection from the Inverter-connected PV generator in to the DNO's Distribution System shall not exceed the levels specified in 5.5 when measured during operation at three levels, 20%, 50%, 75% and 100% of rating with a tolerance of plus or minus 5%.

The test had been performed on the model SUN2000-10KTL-M0 and SUN2000-3KTL-M0, the test results are valid for the SUN2000-4KTL-M0, SUN2000-5KTL-M0, SUN2000-6KTL-M0, SUN2000-8KTL-M0, SUN2000-3KTL-M1, SUN2000-4KTL-M1, SUN2000-5KTL-M1, SUN2000-6KTL-M1, SUN2000-8KTL-M1 and SUN2000-10KTL-M1 since it is almost identical in hardware and just the output power derated by software.

<b>A 1.3.5 Short Circuit Current Contribution for Inverters</b>					<b>P</b>
The test procedure in Annex A1 A.1.3.5 (Inverter connected) or Annex A2 A.2.3.5 (Synchronous).					
L1 phase					
For a directly coupled SSEG			For a Inverter SSEG		
Parameter	Symbol	Value	Time after fault	Volts	Amps
Peak Short Circuit current	$i_p$	N/A	20ms	54	12,9
Initial Value of aperiodic current	$A$	N/A	100ms	39	7,7
Initial symmetrical short-circuit current*	$I_k$	N/A	250ms	N/A	N/A
Decaying (aperiodic) component of short circuit current*	$i_{DC}$	N/A	500ms	N/A	N/A
Reactance/Resistance Ratio of source*	$X/R$	N/A	Time to trip	0,074	In seconds
L2 phase					
For a directly coupled SSEG			For a Inverter SSEG		
Parameter	Symbol	Value	Time after fault	Volts	Amps
Peak Short Circuit current	$i_p$	N/A	20ms	49	13,1
Initial Value of aperiodic current	$A$	N/A	100ms	38	8,2
Initial symmetrical short-circuit current*	$I_k$	N/A	250ms	N/A	N/A
Decaying (aperiodic) component of short circuit current*	$i_{DC}$	N/A	500ms	N/A	N/A
Reactance/Resistance Ratio of source*	$X/R$	N/A	Time to trip	0,074	In seconds
L3 phase					
For a directly coupled SSEG			For a Inverter SSEG		
Parameter	Symbol	Value	Time after fault	Volts	Amps
Peak Short Circuit current	$i_p$	N/A	20ms	37	13,3
Initial Value of aperiodic current	$A$	N/A	100ms	35	7,7
Initial symmetrical short-circuit current*	$I_k$	N/A	250ms	N/A	N/A
Decaying (aperiodic) component of short circuit current*	$i_{DC}$	N/A	500ms	N/A	N/A
Reactance/Resistance Ratio of source*	$X/R$	N/A	Time to trip	0,074	In seconds
<b>Testing:</b>					
Testing procedure: LVRT 10 – 15 % $U_{NOM}$ with > 500 ms shall be recorded					



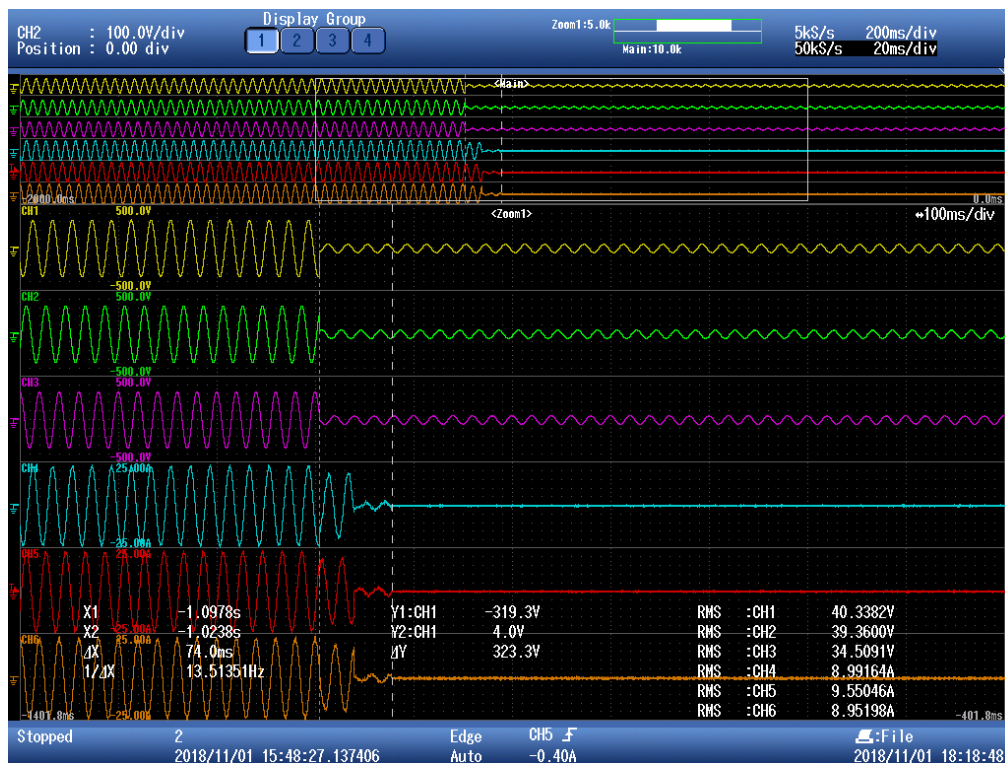

**Note:**

The test had been performed on the model SUN2000-10KTL-M0, the test results are valid for the SUN2000-3KTL-M0, SUN2000-4KTL-M0, SUN2000-5KTL-M0, SUN2000-6KTL-M0, SUN2000-8KTL-M0, SUN2000-3KTL-M1, SUN2000-4KTL-M1, SUN2000-5KTL-M1, SUN2000-6KTL-M1, SUN2000-8KTL-M1 and SUN2000-10KTL-M1 since it is almost identical in hardware and just the output power derated by software.

<p><b>A1.3.6 Self Monitoring – Solid state Disconnection</b> The test procedure in Annex A1 A.1.3.6 (Inverter connected) or Annex A2 A.2.3.6 (Synchronous).</p>	<b>N/A</b>
<p>It has been verified that in the event of the solid state switching device failing to disconnect the SSEG, the voltage on the output side of the switching device is reduced to a value below 50 volts within 0.5 seconds.</p>	

<p><b>A 1.3.7 Electromagnetic Compatibility (EMC)</b></p>	<b>P</b>
<p>All equipment shall comply with the generic EMC standards: BS EN61000-6-3: 2007 Electromagnetic Compatibility, Generic Emission Standard; and BS EN61000-6-1: 2007 Electromagnetic Compatibility, Generic Immunity Standard.</p>	
<p><b>Note:</b> The whole EMC test reports see Annex 1 EMC test report.</p>	

## Annex No. 1

### EMC test report



Test Report No.: CE181019N024



# TEST REPORT

Applicant	Huawei Technologies Co., Ltd.
Address	Administration Building, Headquarters of Huawei Technologies Co., Ltd., Bantian, Longgang District, Shenzhen, 518129, P.R.C

Manufacturer or Supplier	Huawei Technologies Co., Ltd.	
Address	Administration Building, Headquarters of Huawei Technologies Co., Ltd., Bantian, Longgang District, Shenzhen, 518129, P.R.C	
Product	SOLAR INVERTER	
Brand Name	Huawei	
Model	SUN2000-10KTL-M0	
Additional Model & Model Difference	SUN2000-3KTL-M0, SUN2000-4KTL-M0, SUN2000-5KTL-M0, SUN2000-6KTL-M0, SUN2000-8KTL-M0; See item 2.1	
Date of tests	Oct. 09, 2018 ~ Oct. 23, 2018	

The submitted sample of the above equipment has been tested for according to the requirements of the following standards:

- |   |  |   |
|---|--|---|
| <input checked="" type="checkbox"/> EN 61000-6-3:2007 + A1:2011 | <input checked="" type="checkbox"/> IEC 61000-6-3:2006 + A1:2010 | <input checked="" type="checkbox"/> EN 61000-6-1:2007                   |
| <input checked="" type="checkbox"/> EN 61000-6-4:2007 + A1:2011 | <input checked="" type="checkbox"/> IEC 61000-6-4:2006 + A1:2010 | <input checked="" type="checkbox"/> IEC 61000-6-1:2005                  |
| <input checked="" type="checkbox"/> EN 61000-3-2:2014           | <input checked="" type="checkbox"/> IEC 61000-3-2:2014           | <input checked="" type="checkbox"/> Draft EN 301 489-1 V2.2.0 (2017-03) |
| <input checked="" type="checkbox"/> EN 61000-3-3:2013           | <input checked="" type="checkbox"/> IEC 61000-3-3:2013           | <input checked="" type="checkbox"/> Draft EN 301489-17 V3.2.0(2017-03)  |
| <input checked="" type="checkbox"/> EN 61000-6-2:2005           | <input checked="" type="checkbox"/> IEC 61000-6-2:2005           |   |

**CONCLUSION: The submitted sample was found to COMPLY with the test requirement**

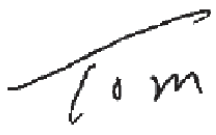
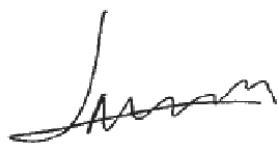
Tested by Tom Chen Project Engineer / EMC Department	Approved by Madison Luo Supervisor / EMC Department
	 Date: Nov. 06, 2018

This report is governed by, and incorporates by reference, CPS Conditions of Service as posted at the date of issuance of this report at <http://www.bureauveritas.com/home/about-us/our-business/cps/about-us/terms-conditions/> and is intended for your exclusive use. Any copying or replication of this report to or for any other person or entity, or use of our name or trademark, is permitted only with our prior written permission. This report sets forth our findings solely with respect to the test samples identified herein. The results set forth in this report are not indicative or representative of the quality or characteristics of the lot from which a test sample was taken or any similar or identical product unless specifically and expressly noted. Our report includes all of the tests requested by you and the results thereof based upon the information that you provided to us. Measurement uncertainty is only provided upon request for accredited tests. You have 60 days from date of issuance of this report to notify us of any material error or omission caused by our negligence or if you require measurement uncertainty; provided, however, that such notice shall be in writing and shall specifically address the issue you wish to raise. A failure to raise such issue within the prescribed time shall constitute your unqualified acceptance of the completeness of this report, the tests conducted and the correctness of the report contents.

Bureau Veritas Shenzhen Co., Ltd.  
Dongguan Branch

No. 34, Chenwulu Section, Guantai Rd., Houjie  
Town, Dongguan City,  
Guangdong 523942, China

Tel: +86 769 8593 5656  
Fax: +86 769 8593 1080  
Email: [customerservice.dg@cn.bureauveritas.com](mailto:customerservice.dg@cn.bureauveritas.com)



**BUREAU  
VERITAS** Test Report No.: CE181019N024

## Table of Contents

RELEASE CONTROL RECORD .....	5
1 SUMMARY OF TEST RESULTS .....	6
1.1 MEASUREMENT UNCERTAINTY .....	9
2 GENERAL INFORMATION .....	10
2.1 GENERAL DESCRIPTION OF EUT .....	10
2.2 DESCRIPTION OF TEST MODES .....	12
2.3 GENERAL DESCRIPTION OF APPLIED STANDARDS .....	16
2.4 DESCRIPTION OF SUPPORT UNITS .....	17
3 EMISSION TEST .....	18
3.1 CONDUCTED EMISSION MEASUREMENT .....	18
3.1.1 LIMITS OF CONDUCTED EMISSION MEASUREMENT .....	18
3.1.2 TEST INSTRUMENTS .....	18
3.1.3 TEST PROCEDURE .....	19
3.1.4 DEVIATION FROM TEST STANDARD .....	19
3.1.5 TEST SETUP .....	19
3.1.6 EUT OPERATING CONDITIONS .....	19
3.1.7 TEST RESULTS .....	20
3.2 CONDUCTED EMISSION MEASUREMENT AT TELECOMMUNICATION PORTS .....	24
3.2.1 LIMIT OF CONDUCTED COMMON MODE DISTURBANCE AT TELECOMMUNICATION PORTS .....	24
3.2.2 TEST INSTRUMENTS .....	24
3.2.3 TEST PROCEDURE .....	25
3.2.4 DEVIATION FROM TEST STANDARD .....	26
3.2.5 TEST SETUP .....	27
3.2.6 EUT OPERATING CONDITIONS .....	28
3.2.7 TEST RESULTS .....	29
3.3 RADIATED EMISSION MEASUREMENT .....	30
3.3.1 LIMITS OF RADIATED EMISSION MEASUREMENT .....	30
3.3.2 TEST INSTRUMENTS .....	31
3.3.3 TEST PROCEDURE .....	32
3.3.4 DEVIATION FROM TEST STANDARD .....	33
3.3.5 TEST SETUP .....	34
3.3.6 EUT OPERATING CONDITIONS .....	34
3.3.7 TEST RESULTS .....	35
3.4 HARMONICS CURRENT MEASUREMENT (<16A) .....	37
3.4.1 LIMITS OF HARMONICS CURRENT MEASUREMENT .....	37
3.4.2 TEST INSTRUMENTS .....	38
3.4.3 TEST PROCEDURE .....	38
3.4.4 DEVIATION FROM TEST STANDARD .....	39
3.4.5 TEST SETUP .....	39
3.4.6 EUT OPERATING CONDITIONS .....	39
3.4.7 TEST RESULTS .....	40

Bureau Veritas Shenzhen Co., Ltd.  
Dongguan Branch

No. 34, Chenwulu Section, Guantai Rd., Houjie  
Town, Dongguan City,  
Guangdong 523942, China

Tel: +86 769 8593 5656  
Fax: +86 769 8593 1080  
Email: [customerservice.dg@cn.bureauveritas.com](mailto:customerservice.dg@cn.bureauveritas.com)



**BUREAU  
VERITAS** Test Report No.: CE181019N024

3.5	VOLTAGE FLUCTUATION AND FLICKS MEASUREMENT .....	46
3.5.1	LIMITS OF VOLTAGE FLUCTUATION AND FLICKS MEASUREMENT .....	46
3.5.2	TEST INSTRUMENTS.....	46
3.5.3	TEST PROCEDURE.....	47
3.5.4	DEVIATION FROM TEST STANDARD.....	47
3.5.5	TEST SETUP.....	47
3.5.6	EUT OPERATING CONDITIONS .....	47
3.5.7	TEST RESULTS .....	48
4	IMMUNITY TEST .....	49
4.1	GENERAL DESCRIPTION .....	49
4.1.1	GENERAL DESCRIPTION .....	49
4.1.2	PERFORMANCE CRITERIA .....	51
4.1.3	EUT OPERATING CONDITION.....	52
4.2	ELECTROSTATIC DISCHARGE IMMUNITY TEST (ESD) (EN 61000-6-2, EN 301 489) .....	53
4.2.1	TEST SPECIFICATION .....	53
4.2.2	TEST INSTRUMENTS.....	53
4.2.3	TEST PROCEDURE.....	54
4.2.4	DEVIATION FROM TEST STANDARD.....	54
4.2.5	TEST SETUP.....	55
4.2.6	TEST RESULTS .....	56
4.3	RADIATED, RADIO-FREQUENCY, ELECTROMAGNETIC FIELD.....	57
	IMMUNITY TEST (RS) (EN 61000-6-2) .....	57
4.3.1	TEST SPECIFICATION .....	57
4.3.2	TEST INSTRUMENTS.....	57
4.3.3	TEST PROCEDURE.....	58
4.3.4	DEVIATION FROM TEST STANDARD.....	58
4.3.5	TEST SETUP.....	58
4.3.6	TEST RESULTS .....	59
4.4	RADIATED, RADIO-FREQUENCY, ELECTROMAGNETIC FIELD.....	60
	IMMUNITY TEST (RS) (EN 310 489) .....	60
4.4.1	TEST SPECIFICATION .....	60
4.4.2	TEST INSTRUMENTS.....	60
4.4.3	TEST PROCEDURE.....	61
4.4.4	DEVIATION FROM TEST STANDARD.....	61
4.4.5	TEST SETUP.....	61
4.4.6	TEST RESULTS .....	62
4.5	ELECTRICAL FAST TRANSIENT/BURST IMMUNITY TEST (EFT) (EN 61000-6-2, EN 301 489) .....	63
4.5.1	TEST SPECIFICATION .....	63
4.5.2	TEST INSTRUMENTS.....	63
4.5.3	TEST PROCEDURE.....	63
4.5.4	DEVIATION FROM TEST STANDARD.....	64
4.5.5	TEST SETUP.....	64
4.5.6	TEST RESULTS .....	65
4.6	SURGE IMMUNITY TEST (EN 61000-6-2).....	66
4.6.1	TEST SPECIFICATION .....	66

Bureau Veritas Shenzhen Co., Ltd.  
Dongguan Branch

No. 34, Chenwulu Section, Guantai Rd., Houjie  
Town, Dongguan City,  
Guangdong 523942, China

Tel: +86 769 8593 5656  
Fax: +86 769 8593 1080  
Email: [customerservice.dg@cn.bureauveritas.com](mailto:customerservice.dg@cn.bureauveritas.com)



**BUREAU  
VERITAS** Test Report No.: CE181019N024

4.6.2	TEST INSTRUMENTS.....	66
4.6.3	TEST PROCEDURE.....	67
4.6.4	DEVIATION FROM TEST STANDARD.....	67
4.6.5	TEST SETUP.....	67
4.6.6	TEST RESULTS.....	68
4.7	SURGE IMMUNITY TEST (EN 301489).....	70
4.7.1	TEST SPECIFICATION.....	70
4.7.2	TEST INSTRUMENTS.....	70
4.7.3	TEST PROCEDURE.....	71
4.7.4	DEVIATION FROM TEST STANDARD.....	71
4.7.5	TEST SETUP.....	71
4.7.6	TEST RESULTS.....	72
4.8	IMMUNITY TO CONDUCTED DISTURBANCES INDUCED BY RF.....	74
	FIELDS (CS) (EN 61000-6-2, EN 301 489).....	74
4.8.1	TEST SPECIFICATION.....	74
4.8.2	TEST INSTRUMENTS.....	74
4.8.3	TEST PROCEDURE.....	75
4.8.4	DEVIATION FROM TEST STANDARD.....	75
4.8.5	TEST SETUP.....	76
4.8.6	TEST RESULTS.....	77
4.9	POWER FREQUENCY MAGNETIC FIELD IMMUNITY TEST (EN 61000-6-2).....	78
4.9.1	TEST SPECIFICATION.....	78
4.9.2	TEST INSTRUMENTS.....	78
4.9.3	TEST PROCEDURE.....	78
4.9.4	DEVIATION FROM TEST STANDARD.....	78
4.9.5	TEST SETUP.....	79
4.9.6	TEST RESULTS.....	80
5	PHOTOGRAPHS OF THE TEST CONFIGURATION.....	81
6	APPENDIX A – MODIFICATIONS RECORDERS FOR ENGINEERING CHANGES TO THE EUT BY THE LAB.....	92



**BUREAU** Test Report No.: CE181019N024  
**VERITAS**

## RELEASE CONTROL RECORD

ISSUE NO.	REASON FOR CHANGE	DATE ISSUED
CE181019N024	Original release	Nov. 06, 2018

Bureau Veritas Shenzhen Co., Ltd.  
Dongguan Branch

No. 34, Chenwulu Section, Guantai Rd., Houjie  
Town, Dongguan City,  
Guangdong 523942, China

Tel: +86 769 8593 5656  
Fax: +86 769 8593 1080  
Email: [customerservice.dg@cn.bureauveritas.com](mailto:customerservice.dg@cn.bureauveritas.com)

Page 5 of 92

Report Version 1

Bureau Veritas Shenzhen Co., Ltd.  
Dongguan Branch

No. 34, Chenwulu Section, Guantai Rd.,  
Houjie Town, Dongguan City, Guangdong  
523942, China

Page 96 of 189

Tel: +86 769 8593 5656  
Fax: +86 769 8599 1080  
Email: [customerservice.dg@cn.bureauveritas.com](mailto:customerservice.dg@cn.bureauveritas.com)  
TEST REPORT G98-1 VER.0





**BUREAU  
VERITAS** Test Report No.: CE181019N024

## 1 SUMMARY OF TEST RESULTS

The EUT has been tested according to the following specifications:

EMISSION			
Standard	Test Type	Result	Remarks
EN61000-6-3:2007 + A1:2011 EN 61000-6-4:2007 + A1:2011 IEC 61000-6-3:2006 + A1:2010 IEC 61000-6-4:2006 + A1:2010 EN 55032:2015+ AC:2016, Class B	Conducted Test	PASS	Meets Requirement Limit Minimum passing margin is 5.3dB at 3.439527MHz
	Conducted Test (Telecom port)	PASS	Meets Requirement Limit Minimum passing margin is 16.4dB at 0.343500MHz
	Radiated Test (30MHz~1GHz)	PASS	Meets Limits Minimum passing margin is 5.2dB at 50.060MHz
	Radiated Test (1GHz~6GHz)	PASS	Meets Limits Minimum passing margin is 26.4dB at 4176.145667MHz
EN 61000-3-2:2014 IEC 61000-3-2:2014	Harmonic current emissions	PASS	Meets the requirements.
EN 61000-3-3:2013 IEC 61000-3-3:2013	Voltage fluctuations & flicker	PASS	Meets the requirements.

IMMUNITY (EN 61000-6-2:2005, IEC 61000-6-2:2005, IEC 61000-6-1:2005, EN 61000-6-1:2007)			
Standard	Test Type	Result	Remarks
IEC 61000-4-2:2008	Electrostatic discharge immunity test	PASS	Electrostatic Discharge – ESD: 8kV Air discharge, 6kV Contact discharge, Performance Criterion A
IEC 61000-4-3:2006 + A1:2007 +A2:2010	Radiated, radio-frequency, electromagnetic field immunity test	PASS	Radio-Frequency Electromagnetic Field Susceptibility Test – RS: 80-1000 MHz, 10V/m, 80% AM (1kHz), 1400-2000 MHz, 10V/m, 80% AM (1kHz) 2000-2700 MHz, 10V/m, 80% AM (1kHz), Performance Criterion A
IEC 61000-4-4:2012	Electrical fast transient / burst immunity test.	PASS	Electrical Fast Transient/Burst - EFT AC Power line: 2kV, DC Power line: 2kV, Signal line: 1kV Performance Criterion A

Bureau Veritas Shenzhen Co., Ltd.  
Dongguan Branch

No. 34, Chenwulu Section, Guantai Rd., Houjie  
Town, Dongguan City,  
Guangdong 523942, China

Tel: +86 769 8593 5656  
Fax: +86 769 8593 1080  
Email: [customerservice.dg@cn.bureauveritas.com](mailto:customerservice.dg@cn.bureauveritas.com)



**BUREAU  
VERITAS** Test Report No.: CE181019N024

IEC 61000-4-5:2014	Surge immunity test	PASS	Surge Immunity Test: 1.2/50 us Open Circuit Voltage, 8 /20 us Short Circuit Current, AC Power Line: line to line 1 kV, line to earth 2kV , DC Power Line: line to line 0.5 kV line to earth 0.5kV Signal Line: 1kV Performance Criterion A
IEC 61000-4-6:2013	Immunity to conducted disturbances, induced by radio-frequency fields	PASS	Conducted Radio Frequency Disturbances Test – CS: 0.15-80 MHz, 10Vrms, 80% AM, 1kHz, Performance Criterion A
IEC 61000-4-8:2009	Power frequency magnetic field immunity test.	PASS	Power Frequency Magnetic Field Test, 50 Hz , 30A/m, Performance Criterion A

**Remark:** The Emission Requirements Of IEC 61000-6-3:2006 + A1:2010, EN 61000-6-3:2007+A1:2011 And Immunity Requirements Of IEC 61000-6-2:2005, EN 61000-6-2:2005 Are Stricter Than That Of IEC 61000-6-4:2006 + A1:2010, EN 61000-6-4:2007 + A1:2011 And Of IEC 61000-6-1:2005, EN 61000-6-1:2007 Respectively, So The EMI Tests Were Performed According To IEC 61000-6-3:2006 + A1:2010, EN 61000-6-3:2007 + A1:2011 And EMS Tests Were Performed According To IEC 61000-6-2:2005, EN 61000-6-2:2005.

**Bureau Veritas Shenzhen Co., Ltd.  
Dongguan Branch**

No. 34, Chenwulu Section, Guantai Rd., Houjie  
Town, Dongguan City,  
Guangdong 523942, China

Tel: +86 769 8593 5656  
Fax: +86 769 8593 1080  
Email: [customerservice.dg@cn.bureauveritas.com](mailto:customerservice.dg@cn.bureauveritas.com)

Page 7 of 92

Report Version 1



**BUREAU VERITAS** Test Report No.: CE181019N024

IMMUNITY(Draft EN 301 489-1 V2.2.0 (2017-03), Draft EN 301489-17 V3.2.0(2017-03))			
Standard	Test Type	Result	Remarks
EN 61000-4-2:2009	Electrostatic discharge immunity test	PASS	Meets the requirements of Performance Criterion A
EN 61000-4-3:2006 + A1:2008 + A2:2010	Radiated, radio-frequency, electromagnetic field immunity test	PASS	Meets the requirements of Performance Criterion A
EN 61000-4-4:2012	Electrical fast transient / burst immunity test.	PASS	Meets the requirements of Performance Criterion A
EN 61000-4-5:2014	Surge immunity test	PASS	Meets the requirements of Performance Criterion A
EN 61000-4-6:2014	Immunity to conducted disturbances, induced by radio-frequency fields	PASS	Meets the requirements of Performance Criterion A

Bureau Veritas Shenzhen Co., Ltd.  
Dongguan Branch

No. 34, Chenwulu Section, Guantai Rd., Houjie  
Town, Dongguan City,  
Guangdong 523942, China

Tel: +86 769 8593 5656  
Fax: +86 769 8593 1080  
Email: [customerservice.dg@cn.bureauveritas.com](mailto:customerservice.dg@cn.bureauveritas.com)

Page 8 of 92

Report Version 1

Bureau Veritas Shenzhen Co., Ltd.  
Dongguan Branch

No. 34, Chenwulu Section, Guantai Rd.,  
Houjie Town, Dongguan City, Guangdong  
523942, China

Page 99 of 189

Tel: +86 769 8593 5656  
Fax: +86 769 8599 1080  
Email: [customerservice.dg@cn.bureauveritas.com](mailto:customerservice.dg@cn.bureauveritas.com)  
TEST REPORT G98-1 VER.0



**BUREAU  
VERITAS** Test Report No.: CE181019N024

## 1.1 MEASUREMENT UNCERTAINTY

Where relevant, the following measurement uncertainty levels have been estimated for tests performed on the EUT as specified in CISPR 16-4-2:

This uncertainty represents an expanded uncertainty expressed at approximately the 95% confidence level using a coverage factor of k=2.

MEASUREMENT	FREQUENCY	UNCERTAINTY
Conducted emissions(Shanghai Huawei)	0.15MHz ~ 30MHz	+ /-2.55 dB
Radiated emissions(Shanghai Huawei)	30MHz ~ 1000MHz	+ /-4.59 dB
Radiated emissions(Shanghai Huawei)	1GHz ~ 6GHz	+ /-4.20 dB

**Bureau Veritas Shenzhen Co., Ltd.  
Dongguan Branch**

No. 34, Chenwulu Section, Guantai Rd., Houjie  
Town, Dongguan City,  
Guangdong 523942, China

Tel: +86 769 8593 5656  
Fax: +86 769 8593 1080  
Email: [customerservice.dg@cn.bureauveritas.com](mailto:customerservice.dg@cn.bureauveritas.com)

Page 9 of 92

Report Version 1

Bureau Veritas Shenzhen Co., Ltd.  
Dongguan Branch

No. 34, Chenwulu Section, Guantai Rd.,  
Houjie Town, Dongguan City, Guangdong  
523942, China

Page 100 of 189

Tel: +86 769 8593 5656  
Fax: +86 769 8599 1080  
Email: [customerservice.dg@cn.bureauveritas.com](mailto:customerservice.dg@cn.bureauveritas.com)  
TEST REPORT G98-1 VER.0



**BUREAU  
VERITAS** Test Report No.: CE181019N024

## 2 GENERAL INFORMATION

### 2.1 GENERAL DESCRIPTION OF EUT

<b>PRODUCT</b>	SOLAR INVERTER
<b>MODEL NO.</b>	SUN2000-10KTL-M0
<b>ADDITIONAL MODEL</b>	SUN2000-3KTL-M0, SUN2000-4KTL-M0, SUN2000-5KTL-M0, SUN2000-6KTL-M0, SUN2000-8KTL-M0;
<b>POWER SUPPLY</b>	Input: DC 140-980V, Output: 220Vac/380Vac, 230Vac/400Vac, 3W+(N)+PE;
<b>SOFTWARE VERSION</b>	V100R001
<b>HARDWARE VERSION</b>	V100R001
<b>THE HIGHEST OPERATING FREQUENCY</b>	2.4GHz
<b>DATA CABLE SUPPLIED</b>	N/A

**Note:**

1. For the test results, the EUT had been tested with all conditions. But only the worst case was showed in test report.
2. For a more detailed features description, please refer to the manufacturer's specifications or the User's Manual.
3. Additional models SUN2000-3KTL-M0, SUN2000-4KTL-M0, SUN2000-5KTL-M0, SUN2000-6KTL-M0, SUN2000-8KTL-M0 are identical with the test model SUN2000-10KTL-M0 except model number and Max. output power for marketing purpose. the difference has been considered during this test, full test was performed for the model SUN2000-10KTL-M0.
4. Please refer to the EUT photo document (Reference No.:181019N024) for detailed product photo.

Bureau Veritas Shenzhen Co., Ltd.  
Dongguan Branch

No. 34, Chenwulu Section, Guantai Rd., Houjie  
Town, Dongguan City,  
Guangdong 523942, China

Tel: +86 769 8593 5656  
Fax: +86 769 8593 1080  
Email: [customerservice.dg@cn.bureauveritas.com](mailto:customerservice.dg@cn.bureauveritas.com)

Page 10 of 92

Report Version 1

Bureau Veritas Shenzhen Co., Ltd.  
Dongguan Branch

No. 34, Chenwulu Section, Guantai Rd.,  
Houjie Town, Dongguan City, Guangdong  
523942, China

Page 101 of 189

Tel: +86 769 8593 5656  
Fax: +86 769 8599 1080  
Email: [customerservice.dg@cn.bureauveritas.com](mailto:customerservice.dg@cn.bureauveritas.com)  
TEST REPORT G98-1 VER.0



**BUREAU  
VERITAS** Test Report No.: CE181019N024

5. Model List:

Parameter	SUN2000-3KTL-M0	SUN2000-4KTL- M0	SUN2000-5KTL- M0	SUN2000-6KTL- M0	SUN2000-8KTL- M0	SUN2000-10KTL- M0
MPPT Input	DC 140-980V, 11A*2	DC 140-980V, 11A*2	DC 140-980V, 11A*2	DC 140-980V, 11A*2	DC 140-980V, 11A*2	DC 140-980V, 11A*2
Output	220Vac/380Vac, 230Vac/400Vac. 3W+(N)+PE 50/60Hz, 3kW	220Vac/380Vac, 230Vac/400Vac. 3W+(N)+PE 50/60Hz, 4kW	220Vac/380Vac, 230Vac/400Vac. 3W+(N)+PE 50/60Hz, 5kW	220Vac/380Vac, 230Vac/400Vac. 3W+(N)+PE 50/60Hz, 6kW	220Vac/380Vac, 230Vac/400Vac. 3W+(N)+PE 50/60Hz, 8kW	220Vac/380Vac, 230Vac/400Vac. 3W+(N)+PE 50/60Hz, 10kW
Max.	3300VA	4400VA	5500VA	6600VA	8800VA	11000VA
Rated output current	4.6A for 380Vac, 4.4A for 400Vac.	6.1A for 380Vac, 5.8A for 400Vac.	7.6A for 380Vac, 7.3A for 400Vac.	9.1A for 380Vac, 8.7A for 400Vac.	12.2A for 380Vac, 11.6A for 400Vac.	15.2A for 380Vac, 14.5A for 400Vac.
Maximum output current	5.1A	6.8A	8.5A	10.1A	13.5A(400Vac)	16.9A(400Vac)
Power	3kW	4kW	5kW	6kW	8kW	10kW
RS485	Support	Support	Support	Support	Support	Support
Remote ripple control	Support	Support	Support	Support	Support	Support
PID	Support	Support	Support	Support	Support	Support
USB Smart Dongle	Support	Support	Support	Support	Support	Support
Communication (WLAN + APP)	Support	Support	Support	Support	Support	Support

**Bureau Veritas Shenzhen Co., Ltd.  
Dongguan Branch**

No. 34, Chenwulu Section, Guantai Rd., Houjie  
Town, Dongguan City,  
Guangdong 523942, China

Tel: +86 769 8593 5656  
Fax: +86 769 8593 1080  
Email: [customerservice.dg@cn.bureauveritas.com](mailto:customerservice.dg@cn.bureauveritas.com)



**BUREAU VERITAS** Test Report No.: CE181019N024

## 2.2 DESCRIPTION OF TEST MODES

The EUT was tested under the following modes' the final worst mode were marked in boldface and recorded in this report.

- ◆ For Conducted Emission Test

Test Mode	TEST VOLTAGE	Model
<b>Grid Mode(Full Load) + RS485 Data Acquisition + Wifi Data Acquisition</b>	<b>DC 480V; AC 400V</b>	<b>SUN2000-10KTL-M0</b>
Grid Mode(Full Load) + RS485 Data Acquisition + Wifi Data Acquisition	DC 600V; AC 400V	
Grid Mode(Full Load) + RS485 Data Acquisition + Wifi Data Acquisition	DC 850V; AC 400V	
Grid Mode(10% Load) + RS485 Data Acquisition + Wifi Data Acquisition	DC 140V; AC 400V	
Grid Mode(10% Load) + RS485 Data Acquisition + Wifi Data Acquisition	DC 600V; AC 400V	
Grid Mode(10% Load) + RS485 Data Acquisition + Wifi Data Acquisition	DC 980V; AC 400V	
Grid Mode(Full Load) + RS485 Data Acquisition + Wifi Data Acquisition + USB Smart Dongle	DC 480V; AC 400V	
Standby+ PID OFF + RS485 Data Acquisition + Wifi Data Acquisition	DC 0V; AC 400V	
Standby + PID ON + RS485 Data Acquisition + Wifi Data Acquisition	DC 0V; AC 400V	

Bureau Veritas Shenzhen Co., Ltd.  
Dongguan Branch

No. 34, Chenwulu Section, Guantai Rd., Houjie  
Town, Dongguan City,  
Guangdong 523942, China

Tel: +86 769 8593 5656  
Fax: +86 769 8593 1080  
Email: [customerservice.dg@cn.bureauveritas.com](mailto:customerservice.dg@cn.bureauveritas.com)

Page 12 of 92

Report Version 1



**BUREAU  
VERITAS** Test Report No.: CE181019N024

◆ Conducted Emissions At Telecom Port Test

Test Mode	TEST VOLTAGE	Model
<b>Grid Mode(Full Load) + RS485 Data Acquisition + Wifi Data Acquisition</b>	<b>DC 480V; AC 400V</b>	<b>SUN2000-10KTL-M0</b>
Grid Mode(Full Load) + RS485 Data Acquisition + Wifi Data Acquisition	DC 600V; AC 400V	
Grid Mode(Full Load) + RS485 Data Acquisition + Wifi Data Acquisition	DC 850V; AC 400V	
Standby + PID OFF+ RS485 Data Acquisition + Wifi Data Acquisition	DC 0V; AC 400V	
Standby + PID ON + RS485 Data Acquisition + Wifi Data Acquisition	DC 0V; AC 400V	
Grid Mode(10% Load) + RS485 Data Acquisition + Wifi Data Acquisition	DC 140V; AC 400V	
Grid Mode(10% Load) + RS485 Data Acquisition + Wifi Data Acquisition	DC 600V; AC 400V	
Grid Mode(10% Load) + RS485 Data Acquisition + Wifi Data Acquisition	DC 980V; AC 400V	
Grid Mode(10% Load) + RS485 Data Acquisition + Wifi Data Acquisition	DC 980V; AC 400V	

**Bureau Veritas Shenzhen Co., Ltd.  
Dongguan Branch**

No. 34, Chenwulu Section, Guantai Rd., Houjie  
Town, Dongguan City,  
Guangdong 523942, China

Tel: +86 769 8593 5656  
Fax: +86 769 8593 1080  
Email: [customerservice.dg@cn.bureauveritas.com](mailto:customerservice.dg@cn.bureauveritas.com)

Page 13 of 92

Report Version 1





**BUREAU  
VERITAS** Test Report No.: CE181019N024

◆ For Radiated Emission Test (30~1000MHz)

Test Mode	TEST VOLTAGE	Model
<b>Grid Mode(Full Load) + RS485 Data Acquisition + Wifi Data Acquisition</b>	<b>DC 480V; AC 400V</b>	<b>SUN2000-10KTL-M0</b>
Grid Mode(Full Load) + RS485 Data Acquisition + Wifi Data Acquisition	DC 600V; AC 400V	
Grid Mode(Full Load) + RS485 Data Acquisition + Wifi Data Acquisition	DC 850V; AC 400V	
Grid Mode(10% Load) + RS485 Data Acquisition + Wifi Data Acquisition	DC 140V; AC 400V	
Grid Mode(10% Load) + RS485 Data Acquisition + Wifi Data Acquisition	DC 600V; AC 400V	
Grid Mode(10% Load) + RS485 Data Acquisition + Wifi Data Acquisition	DC 980V; AC 400V	
Grid Mode(Full Load) + RS485 Data Acquisition + Wifi Data Acquisition + USB Smart Dongle	DC 480V; AC 400V	
Grid Mode(Full Load) + RS485 Data Acquisition + Wifi Data Acquisition + USB Smart Dongle	DC 600V; AC 400V	
Grid Mode(Full Load) + RS485 Data Acquisition + Wifi Data Acquisition + USB Smart Dongle	DC 850V; AC 400V	
Standby + PID OFF + RS485 Data Acquisition + Wifi Data Acquisition	DC 0V; AC 400V	
Standby + PID ON + RS485 Data Acquisition + Wifi Data Acquisition	DC 0V; AC 400V	

**Bureau Veritas Shenzhen Co., Ltd.  
Dongguan Branch**

No. 34, Chenwulu Section, Guantai Rd., Houjie  
Town, Dongguan City,  
Guangdong 523942, China

Tel: +86 769 8593 5656  
Fax: +86 769 8593 1080  
Email: [customerservice.dg@cn.bureauveritas.com](mailto:customerservice.dg@cn.bureauveritas.com)



**BUREAU  
VERITAS** Test Report No.: CE181019N024

◆ For Radiated Emission Test (1000~6000MHz)

Test Mode	TEST VOLTAGE	Model
Grid Mode(Full Load) + RS485 Data Acquisition + Wifi Data Acquisition + USB Smart Dongle	DC 480V; AC 400V	SUN2000-10KTL-M0

◆ For H/F Emission Test

Test Mode	TEST VOLTAGE	Model
Grid Mode(Full Load) + RS485 Data Acquisition + Wifi Data Acquisition	DC 480V; AC 400V	SUN2000-10KTL-M0

◆ For Immunity Tests

Mode No.	Test Mode	TEST VOLTAGE	Model
A	Grid Mode(10% Load) + RS485 Data Acquisition + Wifi Data Acquisition	DC 400V; AC 400V	SUN2000-10KTL-M0
B	Grid Mode(10% Load) + RS485 Data Acquisition + Wifi Data Acquisition + USB Smart Dongle	DC 400V; AC 400V	
C	Standby + PID ON + RS485 Data Acquisition + Wifi Data Acquisition	DC 0V; AC 400V	

Bureau Veritas Shenzhen Co., Ltd.  
Dongguan Branch

No. 34, Chenwulu Section, Guantai Rd., Houjie  
Town, Dongguan City,  
Guangdong 523942, China

Tel: +86 769 8593 5656  
Fax: +86 769 8593 1080  
Email: [customerservice.dg@cn.bureauveritas.com](mailto:customerservice.dg@cn.bureauveritas.com)

Page 15 of 92

Report Version 1



**BUREAU** Test Report No.: CE181019N024  
**VERITAS**

## 2.3 GENERAL DESCRIPTION OF APPLIED STANDARDS

The EUT has been tested and complied with the requirements of the following standards:

**EN 61000-6-3:2007 + A1:2011**  
**EN 61000-6-4:2007 + A1:2011**  
**IEC 61000-6-3:2006 + A1:2010**  
**IEC 61000-6-4:2006 + A1:2010**  
**EN 61000-3-2:2014**  
**IEC 61000-3-2:2014**  
**EN 61000-3-3:2013**  
**IEC 61000-3-3:2013**  
**EN 61000-6-1:2007**  
**EN 61000-6-2:2005**  
**IEC 61000-6-1:2005**  
**IEC 61000-6-2:2005**  
IEC 61000-4-2:2008  
IEC 61000-4-3:2006 + A1:2007 + A2:2010  
IEC 61000-4-4:2012  
IEC 61000-4-5:2014  
IEC 61000-4-6:2013  
IEC 61000-4-8:2009  
**Draft EN 301 489-1 V2.2.0 (2017-03)**  
**Draft EN 301 489-17 V3.2.0(2017-03)**  
**EN 55032:2015, CLASS B**  
EN 61000-4-2:2009  
EN 61000-4-3:2006 + A1:2008 + A2:2010  
EN 61000-4-4:2012  
EN 61000-4-5:2014  
EN 61000-4-6:2014

**Notes:** 1. All applicable tests have been performed and recorded as per the above standards.

Bureau Veritas Shenzhen Co., Ltd.  
Dongguan Branch

No. 34, Chenwulu Section, Guantai Rd., Houjie  
Town, Dongguan City,  
Guangdong 523942, China

Tel: +86 769 8593 5656  
Fax: +86 769 8593 1080  
Email: [customerservice.dg@cn.bureauveritas.com](mailto:customerservice.dg@cn.bureauveritas.com)

Page 16 of 92

Report Version 1



**BUREAU  
VERITAS** Test Report No.: CE181019N024

## 2.4 DESCRIPTION OF SUPPORT UNITS

The EUT has been tested as an dependent unit together with other necessary accessories or support units. The following support units or accessories were used to form a representative test configuration during the tests.

NO.	PRODUCT	BRAND	MODEL NO.	SERIAL NO.	FCC ID
1	Personal Computer	HP	HP8200	4C1345N8L	N/A
2	Smart Logger	HUAWEI	SmartLogger1000-10	2102311FRT10H5 000018	N/A
3	Programmable DC Power Supply	KEYSIGHT	N8957APV	DE17072175	N/A
4	Smart Dongle-4G	HUAWEI	SDongleA-03	2102312DHE10J 5000002	N/A

NO.	DESCRIPTION OF THE ABOVE SUPPORT UNITS
1	AC Line: Unshielded, Detachable 1.8m; DC Line: Unshielded, Undetachable 1.5m.
2	RJ45 Cable: Shielded or Unshielded, Detachable 10m; RS485 Cable: Shielded, Detachable 10m.
3	AC Line: Unshielded, Detachable 1.8m; DC Line: Unshielded, Detachable 1.5m
4	N/A

**Remarks:** Personal Computer, Smart Logger Unit and Programmable DC Power Supply is distal support units.

Bureau Veritas Shenzhen Co., Ltd.  
Dongguan Branch

No. 34, Chenwulu Section, Guantai Rd., Houjie  
Town, Dongguan City,  
Guangdong 523942, China

Tel: +86 769 8593 5656  
Fax: +86 769 8593 1080  
Email: [customerservice.dg@cn.bureauveritas.com](mailto:customerservice.dg@cn.bureauveritas.com)

Page 17 of 92

Report Version 1



BUREAU VERITAS Test Report No.: CE181019N024

### 3 EMISSION TEST

#### 3.1 CONDUCTED EMISSION MEASUREMENT

##### 3.1.1 LIMITS OF CONDUCTED EMISSION MEASUREMENT

FREQUENCY (MHz)	Class A (dBuV)		Class B (dBuV)	
	Quasi-peak	Average	Quasi-peak	Average
0.15 - 0.5	79	66	66 - 56	56 - 46
0.50 - 5.0	73	60	56	46
5.0 - 30.0	73	60	60	50

- Note:**
- (1) The lower limit shall apply at the transition frequencies.
  - (2) The limit decreases in line with the logarithm of the frequency in the range of 0.15 to 0.50 MHz.
  - (3) All emanations from a class A/B digital device or system, including any network of conductors and apparatus connected thereto, shall not exceed the level of field strengths specified above.

##### 3.1.2 TEST INSTRUMENTS

Equipment	Manufacturer	Model No.	Serial No.	Last Cal.	Next Cal.
100Ω Resistance	LUTHI	100Ω Resistance	370	2018/08/01	2019/07/31
Artificial Mains Network	SCHWARZBECK	NNLK8129	5184	2018/07/23	2019/07/22
Current probe	FCC	F-52	111659	2018/07/23	2019/07/22

- NOTE:**
1. The test was performed by witness in conducted shielding room of ShangHai Huawei Technology Co., Ltd.
  2. The test was performed in Conducted shielding room.

Bureau Veritas Shenzhen Co., Ltd.  
Dongguan Branch

No. 34, Chenwulu Section, Guantai Rd., Houjie  
Town, Dongguan City,  
Guangdong 523942, China

Tel: +86 769 8593 5656  
Fax: +86 769 8593 1080  
Email: [customerservice.dg@cn.bureauveritas.com](mailto:customerservice.dg@cn.bureauveritas.com)

Page 18 of 92

Report Version 1



BUREAU VERITAS Test Report No.: CE181019N024

### 3.1.3 TEST PROCEDURE

- The EUT was placed 0.4 meters from the conducting wall of the shielded room with EUT being connected to the power mains through a line impedance stabilization network (LISN). Other support units were connected to the power mains through another LISN. The two LISNs provide 50 Ohm/ 50uH of coupling impedance for the measuring instrument.
- Both lines of the power mains connected to the EUT were checked for maximum conducted interference.
- The frequency range from 150 kHz to 30 MHz was searched. Emission levels under (Limit – 20dB) were not recorded.

### 3.1.4 DEVIATION FROM TEST STANDARD

No deviation

### 3.1.5 TEST SETUP

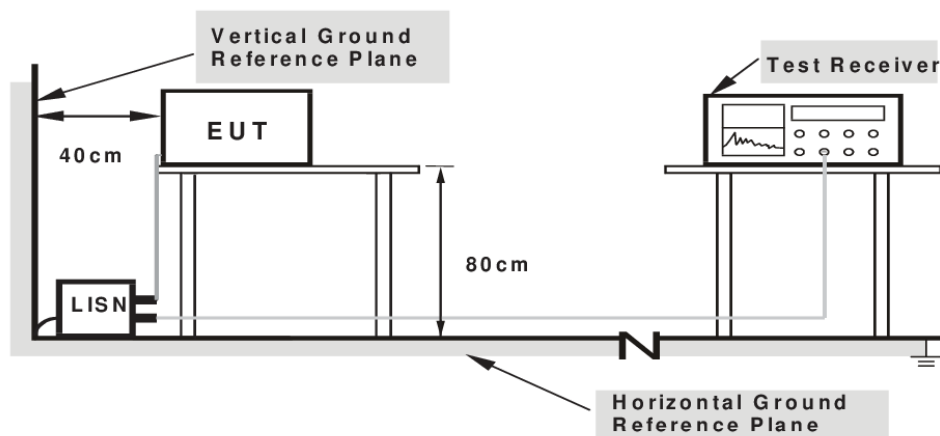

- Note: 1. Support units were connected to second LISN.  
2. Both of LISNs (AMN) are 80cm from EUT and at least 80cm from other units and other metal planes support units.

### 3.1.6 EUT OPERATING CONDITIONS

- Turned on the power of all equipment.
- EUT was operated according to the type used was description in manufacturer's specifications or the User's Manual.

Bureau Veritas Shenzhen Co., Ltd.  
Dongguan Branch

No. 34, Chenwulu Section, Guantai Rd., Houjie  
Town, Dongguan City,  
Guangdong 523942, China

Tel: +86 769 8593 5656  
Fax: +86 769 8593 1080  
Email: [customerservice.dg@cn.bureauveritas.com](mailto:customerservice.dg@cn.bureauveritas.com)

Page 19 of 92

Report Version 1



**BUREAU VERITAS** Test Report No.: CE181019N024

### 3.1.7 TEST RESULTS

<b>TEST MODE</b>	SUN2000-10KTL-M0 Grid Mode(Full Load) + RS485 Data Acquisition + Wifi Data Acquisition	<b>6dB BANDWIDTH</b>	9 kHz
<b>TEST VOLTAGE</b>	DC 480V AC 400V	<b>PHASE</b>	Line (L1)
<b>ENVIRONMENTAL CONDITIONS</b>	25 deg. C, 50% RH	<b>TESTED BY:</b> Zhou Weijie	

Frequency (MHz)	QuasiPeak (dBμ V)	Meas. Time (ms)	Bandwidth (kHz)	PE	Line	Corr. (dB)	Margin (dB)	Limit (dBμ V)	Comment
0.411000	44.1	1000.0	9.000	GND	L1	0.2	13.1	57.1	
2.055494	43.3	1000.0	9.000	GND	L1	0.2	12.8	56.0	
2.394105	45.6	1000.0	9.000	GND	L1	0.2	10.4	56.0	
3.124422	48.8	1000.0	9.000	GND	L1	0.2	7.2	56.0	
3.445422	48.6	1000.0	9.000	GND	L1	0.2	7.4	56.0	
3.578519	41.5	1000.0	9.000	GND	L1	0.2	14.5	56.0	
Frequency (MHz)	Average (dBμ V)	Meas. Time (ms)	Bandwidth (kHz)	PE	Line	Corr. (dB)	Margin (dB)	Limit (dBμ V)	Comment
0.204000	41.1	1000.0	9.000	GND	L1	0.2	10.2	51.3	
1.229970	35.3	1000.0	9.000	GND	L1	0.2	10.7	46.0	
1.547409	29.2	1000.0	9.000	GND	L1	0.2	16.8	46.0	
2.327144	27.0	1000.0	9.000	GND	L1	0.2	19.0	46.0	
2.768245	28.6	1000.0	9.000	GND	L1	0.2	17.4	46.0	
3.302970	28.9	1000.0	9.000	GND	L1	0.2	17.1	46.0	

Level in dBuV

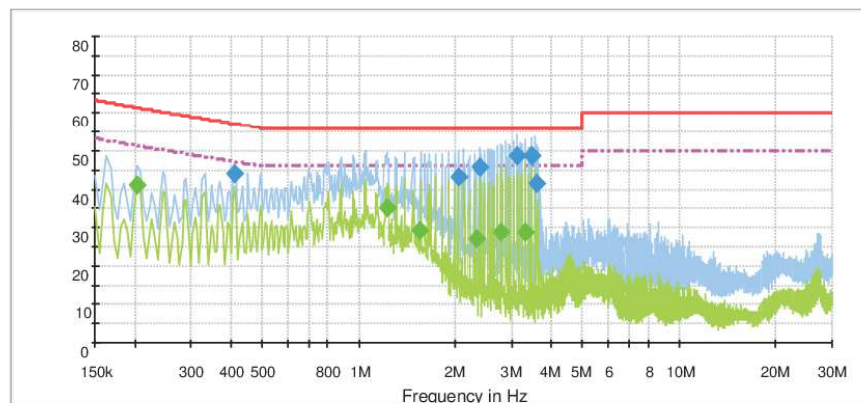

Bureau Veritas Shenzhen Co., Ltd.  
Dongguan Branch

No. 34, Chenwulu Section, Guantai Rd., Houjie  
Town, Dongguan City,  
Guangdong 523942, China

Tel: +86 769 8593 5656  
Fax: +86 769 8593 1080  
Email: [customerservice.dg@cn.bureauveritas.com](mailto:customerservice.dg@cn.bureauveritas.com)



**BUREAU VERITAS** Test Report No.: CE181019N024

<b>TEST MODE</b>	SUN2000-10KTL-M0 Grid Mode(Full Load) + RS485 Data Acquisition + Wifi Data Acquisition	<b>6dB BANDWIDTH</b>	9 kHz
<b>TEST VOLTAGE</b>	DC 480V AC 400V	<b>PHASE</b>	Line (L2)
<b>ENVIRONMENTAL CONDITIONS</b>	25 deg. C, 50% RH	<b>TESTED BY:</b> Zhou Weijie	

Frequency (MHz)	QuasiPeak (dBμ V)	Meas. Time (ms)	Bandwidth (kHz)	PE	Line	Corr. (dB)	Margin (dB)	Limit (dBμ V)	Comment
1.101943	43.4	1000.0	9.000	GND	L2	0.1	12.6	56.0	
1.612460	45.3	1000.0	9.000	GND	L2	0.1	10.7	56.0	
2.201967	44.1	1000.0	9.000	GND	L2	0.1	11.9	56.0	
3.026776	49.1	1000.0	9.000	GND	L2	0.2	6.9	56.0	
3.124423	48.7	1000.0	9.000	GND	L2	0.2	7.3	56.0	
3.493413	49.5	1000.0	9.000	GND	L2	0.2	6.5	56.0	
Frequency (MHz)	Average (dBμ V)	Meas. Time (ms)	Bandwidth (kHz)	PE	Line	Corr. (dB)	Margin (dB)	Limit (dBμ V)	Comment
0.411000	38.1	1000.0	9.000	GND	L2	0.1	9.0	47.1	
0.775500	33.5	1000.0	9.000	GND	L2	0.1	12.5	46.0	
1.131017	32.8	1000.0	9.000	GND	L2	0.1	13.2	46.0	
1.648459	27.1	1000.0	9.000	GND	L2	0.1	18.9	46.0	
2.292056	30.6	1000.0	9.000	GND	L2	0.1	15.4	46.0	
2.782431	30.1	1000.0	9.000	GND	L2	0.2	15.9	46.0	
3.047946	29.3	1000.0	9.000	GND	L2	0.2	16.7	46.0	
3.387707	29.5	1000.0	9.000	GND	L2	0.2	16.5	46.0	
3.463310	31.2	1000.0	9.000	GND	L2	0.2	14.8	46.0	

Level in dBuV

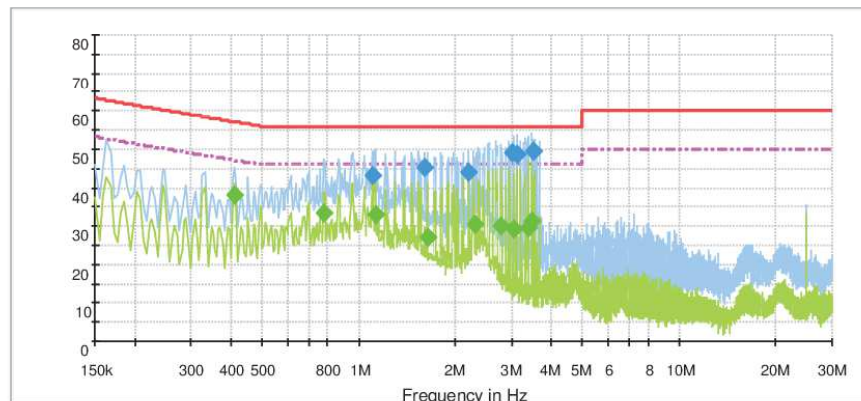

Bureau Veritas Shenzhen Co., Ltd.  
Dongguan Branch

No. 34, Chenwulu Section, Guantai Rd., Houjie  
Town, Dongguan City,  
Guangdong 523942, China

Tel: +86 769 8593 5656  
Fax: +86 769 8593 1080  
Email: [customerservice.dg@cn.bureauveritas.com](mailto:customerservice.dg@cn.bureauveritas.com)

Page 21 of 92

Report Version 1





**BUREAU VERITAS** Test Report No.: CE181019N024

<b>TEST MODE</b>	SUN2000-10KTL-M0 Grid Mode(Full Load) + RS485 Data Acquisition + Wifi Data Acquisition	<b>6dB BANDWIDTH</b>	9 kHz
<b>TEST VOLTAGE</b>	DC 480V AC 400V	<b>PHASE</b>	Line (L3)
<b>ENVIRONMENTAL CONDITIONS</b>	25 deg. C, 50% RH	<b>TESTED BY:</b> Zhou Weijie	

Frequency (MHz)	QuasiPeak (dB $\mu$ V)	Meas. Time (ms)	Bandwidth (kHz)	PE	Line	Corr. (dB)	Margin (dB)	Limit (dB $\mu$ V)	Comment
0.451500	38.7	1000.0	9.000	GND	L3	0.1	17.9	56.6	
1.031997	42.9	1000.0	9.000	GND	L3	0.1	13.1	56.0	
1.418323	45.4	1000.0	9.000	GND	L3	0.1	10.6	56.0	
3.439527	50.3	1000.0	9.000	GND	L3	0.2	5.7	56.0	
3.506913	47.6	1000.0	9.000	GND	L3	0.2	8.4	56.0	
3.623670	42.5	1000.0	9.000	GND	L3	0.2	13.5	56.0	
Frequency (MHz)	Average (dB $\mu$ V)	Meas. Time (ms)	Bandwidth (kHz)	PE	Line	Corr. (dB)	Margin (dB)	Limit (dB $\mu$ V)	Comment
0.451500	32.6	1000.0	9.000	GND	L3	0.1	14.0	46.6	
1.026273	35.2	1000.0	9.000	GND	L3	0.1	10.8	46.0	
1.747912	31.7	1000.0	9.000	GND	L3	0.1	14.3	46.0	
2.892988	30.4	1000.0	9.000	GND	L3	0.2	15.6	46.0	
3.338768	32.4	1000.0	9.000	GND	L3	0.2	13.6	46.0	
3.506913	31.4	1000.0	9.000	GND	L3	0.2	14.6	46.0	

Level in dB $\mu$ V

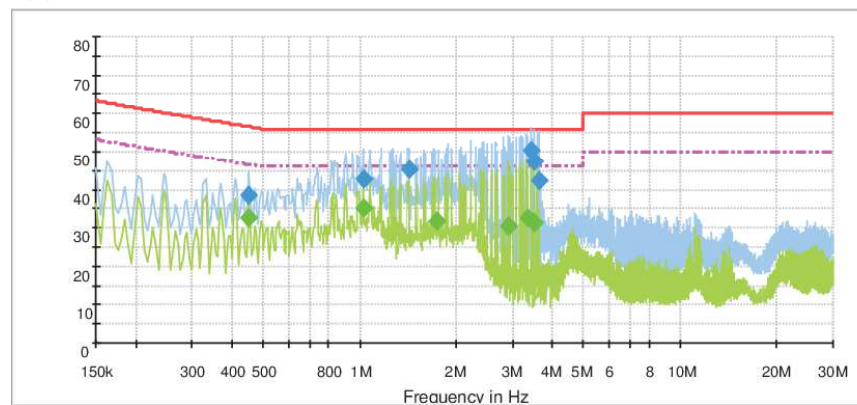

Bureau Veritas Shenzhen Co., Ltd.  
Dongguan Branch

No. 34, Chenwulu Section, Guantai Rd., Houjie  
Town, Dongguan City,  
Guangdong 523942, China

Tel: +86 769 8593 5656  
Fax: +86 769 8593 1080  
Email: [customerservice.dg@cn.bureauveritas.com](mailto:customerservice.dg@cn.bureauveritas.com)

Page 22 of 92

Report Version 1

Bureau Veritas Shenzhen Co., Ltd.  
Dongguan Branch

No. 34, Chenwulu Section, Guantai Rd.,  
Houjie Town, Dongguan City, Guangdong  
523942, China

Page 113 of 189

Tel: +86 769 8593 5656  
Fax: +86 769 8599 1080  
Email: [customerservice.dg@cn.bureauveritas.com](mailto:customerservice.dg@cn.bureauveritas.com)  
TEST REPORT G98-1 VER.0



**BUREAU VERITAS** Test Report No.: CE181019N024

<b>TEST MODE</b>	SUN2000-10KTL-M0 Grid Mode(Full Load) + RS485 Data Acquisition + Wifi Data Acquisition	<b>6dB BANDWIDTH</b>	9 kHz
<b>TEST VOLTAGE</b>	DC 480V AC 400V	<b>PHASE</b>	Line (N)
<b>ENVIRONMENTAL CONDITIONS</b>	25 deg. C, 50% RH	<b>TESTED BY:</b> Zhou Weijie	

Frequency (MHz)	QuasiPeak (dBμ V)	Meas. Time (ms)	Bandwidth (kHz)	PE	Line	Corr. (dB)	Margin (dB)	Limit (dBμ V)	Comment
1.636692	31.7	1000.0	9.000	GND	N	0.1	24.3	56.0	
2.008473	32.3	1000.0	9.000	GND	N	0.1	23.7	56.0	
2.527668	33.3	1000.0	9.000	GND	N	0.2	22.7	56.0	
2.944494	35.1	1000.0	9.000	GND	N	0.2	20.9	56.0	
3.353962	37.8	1000.0	9.000	GND	N	0.2	18.2	56.0	
3.512382	42.0	1000.0	9.000	GND	N	0.2	14.0	56.0	
Frequency (MHz)	Average (dBμ V)	Meas. Time (ms)	Bandwidth (kHz)	PE	Line	Corr. (dB)	Margin (dB)	Limit (dBμ V)	Comment
1.289058	19.2	1000.0	9.000	GND	N	0.1	26.8	46.0	
1.752434	20.7	1000.0	9.000	GND	N	0.1	25.4	46.0	
2.359442	25.2	1000.0	9.000	GND	N	0.2	20.8	46.0	
3.017864	22.2	1000.0	9.000	GND	N	0.2	23.8	46.0	
3.378534	22.5	1000.0	9.000	GND	N	0.2	23.5	46.0	
3.414326	25.3	1000.0	9.000	GND	N	0.2	20.7	46.0	

Level in dBuV

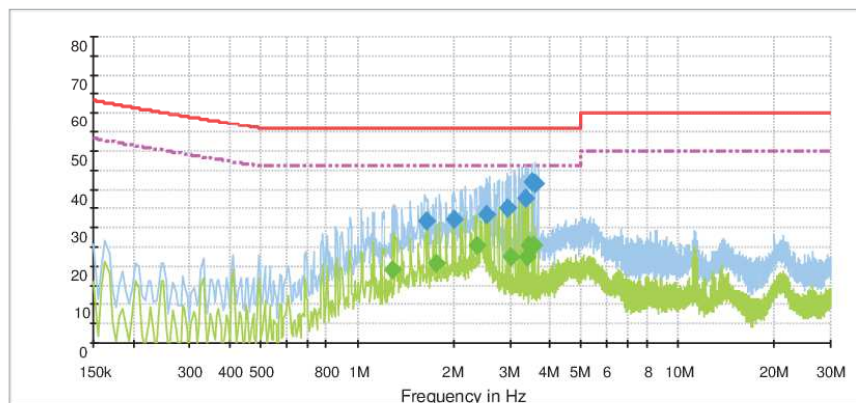

Bureau Veritas Shenzhen Co., Ltd.  
Dongguan Branch

No. 34, Chenwulu Section, Guantai Rd., Houjie  
Town, Dongguan City,  
Guangdong 523942, China

Tel: +86 769 8593 5656  
Fax: +86 769 8593 1080  
Email: [customerservice.dg@cn.bureauveritas.com](mailto:customerservice.dg@cn.bureauveritas.com)

Page 23 of 92

Report Version 1



**BUREAU  
VERITAS** Test Report No.: CE181019N024

## 3.2 CONDUCTED EMISSION MEASUREMENT AT TELECOMMUNICATION PORTS

### 3.2.1 LIMIT OF CONDUCTED COMMON MODE DISTURBANCE AT TELECOMMUNICATION PORTS

#### FOR CLASS A EQUIPMENT

FREQUENCY (MHz)	Voltage Limit (dBuV)		Current Limit (dBuA)	
	Quasi-peak	Average	Quasi-peak	Average
0.15 - 0.5	97 – 87	84 - 74	53 – 43	40 – 30
0.5 - 30.0	87	74	43	30

#### FOR CLASS B EQUIPMENT

FREQUENCY (MHz)	Voltage Limit (dBuV)		Current Limit (dBuA)	
	Quasi-peak	Average	Quasi-peak	Average
0.15 - 0.5	84 - 74	74 - 64	40 – 30	30 – 20
0.5 - 30.0	74	64	30	20

**NOTE:** (1) The limits decrease linearly with the logarithm of the frequency in the range 0.15 MHz to 0.5 MHz.

### 3.2.2 TEST INSTRUMENTS

Equipment	Manufacturer	Model No.	Serial No.	Last Cal.	Next Cal.
100Ω Resistance	LUTHI	100Ω Resistance	370	2018/08/01	2019/07/31
Artificial Mains Network	SCHWARZBECK	NNLK8129	5184	2018/07/23	2019/07/22
Current probe	FCC	F-52	111659	2018/07/23	2019/07/22

**NOTE:** 1. The test was performed by witness in conducted shielding room of ShangHai Huawei Technology Co., Ltd.  
2. The test was performed in Conducted shielding room.

Bureau Veritas Shenzhen Co., Ltd.  
Dongguan Branch

No. 34, Chenwulu Section, Guantai Rd., Houjie  
Town, Dongguan City,  
Guangdong 523942, China

Tel: +86 769 8593 5656  
Fax: +86 769 8593 1080  
Email: [customerservice.dg@cn.bureauveritas.com](mailto:customerservice.dg@cn.bureauveritas.com)

Page 24 of 92

Report Version 1



BUREAU VERITAS Test Report No.: CE181019N024

### 3.2.3 TEST PROCEDURE

#### For using ISN:

- a. The EUT is placed 0.4 meters from the conducting wall of the shielded room and connected to ISN directly to reference ground plane.
- b. If voltage measurement is used, measure voltage at the measurement port of the ISN, correct the reading by adding the ISN voltage division factor, and compare to the voltage limit.
- c. If current measurement is used, measure current with the current probe and compare to the current limit.
- d. It is not necessary to apply the voltage and the current limit if the ISN is used. A  $50\ \Omega$  load has to be connected to the measurement port of the ISN during the current measurement.
- e. The disturbance levels and the frequencies of at least six highest disturbances are recorded from be measured each telecommunication port, which comprises the EUT.

#### For using a $150\ \Omega$ load to the outside surface of the shield cable:

- a. Break the insulation and connect a  $150\ \Omega$  resistor from the outside surface of the shield cable to ground, and apply a ferrite tube or clamp between  $150\ \Omega$  connection and AE.
- b. The EUT is placed 0.4 meters from the conducting wall of the shielded room and connected to AE with the shield cable.
- c. Measure current with a current probe and compare to the current limit. The common mode impedance towards the right of the  $150\ \Omega$  resistor.
- d. The disturbance levels and the frequencies of at least six highest disturbances are recorded from be measured each telecommunication port, which comprises the EUT.

Bureau Veritas Shenzhen Co., Ltd.  
Dongguan Branch

No. 34, Chenwulu Section, Guantai Rd., Houjie  
Town, Dongguan City,  
Guangdong 523942, China

Tel: +86 769 8593 5656  
Fax: +86 769 8593 1080  
Email: [customerservice.dg@cn.bureauveritas.com](mailto:customerservice.dg@cn.bureauveritas.com)

Page 25 of 92

Report Version 1



**BUREAU** Test Report No.: CE181019N024  
**VERITAS**

**For using a combination of current probe and capacitive voltage probe:**

- a. The EUT is placed 0.4 meters from the conducting wall of the shielded room and connected to AE with a cable. The cable contains more than four balanced pairs or to unbalanced cable.
- b. Measure current with a current probe and compare to the current limit.
- c. Measure voltage with a capacitive probe and adjust the measured voltage as follows:
  - d. – current margin  $\leq 6$  dB – subtract the actual current margin from measured voltage;
  - e. – current margin  $> 6$  dB – subtract 6 dB from measured voltage.
- f. Compare adjusted voltage with the applicable voltage limit.
- g. Both the measured current and the adjusted voltage shall be below the applicable current and voltage limits.
- h. The disturbance levels and the frequencies of at least six highest disturbances are recorded from be measured each telecommunication port, which comprises the EUT.

**3.2.4 DEVIATION FROM TEST STANDARD**

No deviation

Bureau Veritas Shenzhen Co., Ltd.  
Dongguan Branch

No. 34, Chenwulu Section, Guantai Rd., Houjie  
Town, Dongguan City,  
Guangdong 523942, China

Tel: +86 769 8593 5656  
Fax: +86 769 8593 1080  
Email: [customerservice.dg@cn.bureauveritas.com](mailto:customerservice.dg@cn.bureauveritas.com)

Page 26 of 92

Report Version 1



BUREAU VERITAS Test Report No.: CE181019N024

### 3.2.5 TEST SETUP

For using ISN:

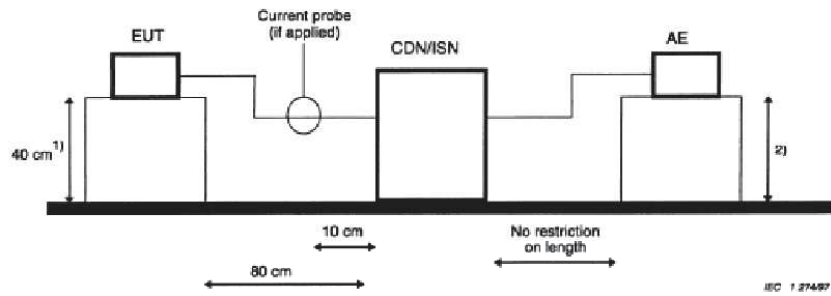

AE = Associated equipment  
EUT = Equipment under test

- <sup>1)</sup> Distance to the reference groundplane (vertical or horizontal).  
<sup>2)</sup> Distance to the reference groundplane is not critical.

For using a 150 Ω load to the outside surface of the shield cable:

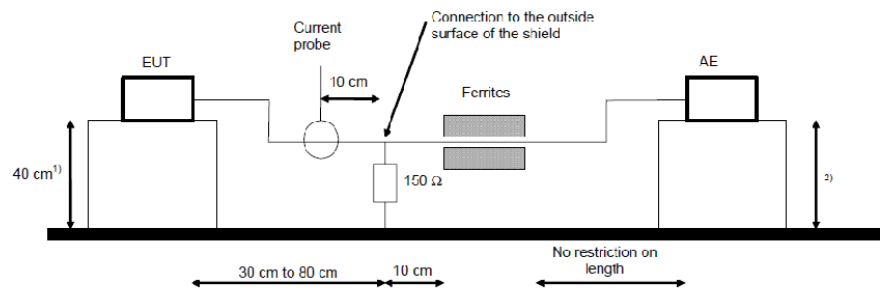

AE = Associated equipment  
EUT = Equipment under test

- <sup>1)</sup> Distance to the reference groundplane (vertical or horizontal).  
<sup>2)</sup> Distance to the reference groundplane is not critical.

Bureau Veritas Shenzhen Co., Ltd.  
Dongguan Branch

No. 34, Chenwulu Section, Guantai Rd., Houjie  
Town, Dongguan City,  
Guangdong 523942, China

Tel: +86 769 8593 5656  
Fax: +86 769 8593 1080  
Email: [customerservice.dg@cn.bureauveritas.com](mailto:customerservice.dg@cn.bureauveritas.com)

Page 27 of 92

Report Version 1



BUREAU  
VERITAS Test Report No.: CE181019N024

For using a combination of current probe and capacitive voltage probe:

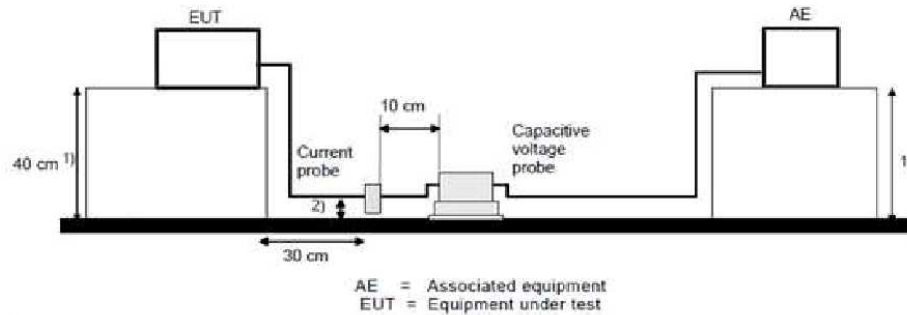

<sup>1)</sup> Distance to the reference groundplane (vertical or horizontal)

<sup>2)</sup> Distance  $4 \pm 1$  cm from the reference groundplane.

For the actual test configuration, please refer to the related item – Photographs of the Test Configuration.

### 3.2.6 EUT OPERATING CONDITIONS

Same as item 3.1.6

Bureau Veritas Shenzhen Co., Ltd.  
Dongguan Branch

No. 34, Chenwulu Section, Guantai Rd., Houjie  
Town, Dongguan City,  
Guangdong 523942, China

Tel: +86 769 8593 5656  
Fax: +86 769 8593 1080  
Email: [customerservice.dg@cn.bureauveritas.com](mailto:customerservice.dg@cn.bureauveritas.com)

Page 28 of 92

Report Version 1



BUREAU VERITAS Test Report No.: CE181019N024

### 3.2.7 TEST RESULTS

<b>TEST MODE</b>	SUN2000-10KTL-M0 Grid Mode(Full Load) + RS485 Data Acquisition + Wifi Data Acquisition	<b>6dB BANDWIDTH</b>	9kHz
<b>TEST VOLTAGE</b>	DC 480V AC 400V	<b>PHASE</b>	RS485 PORT (RJ45 Cable)
<b>ENVIRONMENTAL CONDITIONS</b>	25 deg. C, 50% RH	<b>TEST BY</b>	Zhou Weijie

Frequency (MHz)	Quasi-Peak (dB $\mu$ A)	Meas. Time (ms)	Bandwidth (kHz)	Corr. (dB)	Margin (dB)	Limit (dB $\mu$ A)	Comment
0.249000	13.5	1000.0	9.000	-2.6	22.0	35.4	
0.361500	11.6	1000.0	9.000	-3.7	20.8	32.4	
0.609000	4.9	1000.0	9.000	-7.2	25.1	30.0	
1.249718	3.1	1000.0	9.000	-12.5	26.9	30.0	
2.262698	4.1	1000.0	9.000	-13.4	25.9	30.0	
3.498420	-2.8	1000.0	9.000	-13.4	32.8	30.0	
Frequency (MHz)	Average (dB $\mu$ A)	Meas. Time (ms)	Bandwidth (kHz)	Corr. (dB)	Margin (dB)	Limit (dB $\mu$ A)	Comment
0.172500	6.6	1000.0	9.000	-1.3	22.1	28.6	
0.258000	7.9	1000.0	9.000	-2.7	17.1	25.0	
0.343500	6.3	1000.0	9.000	-3.5	16.4	22.7	
1.249718	-2.2	1000.0	9.000	-12.5	22.2	20.0	
2.298518	-1.9	1000.0	9.000	-13.4	21.9	20.0	
3.507532	-12.8	1000.0	9.000	-13.4	32.8	20.0	

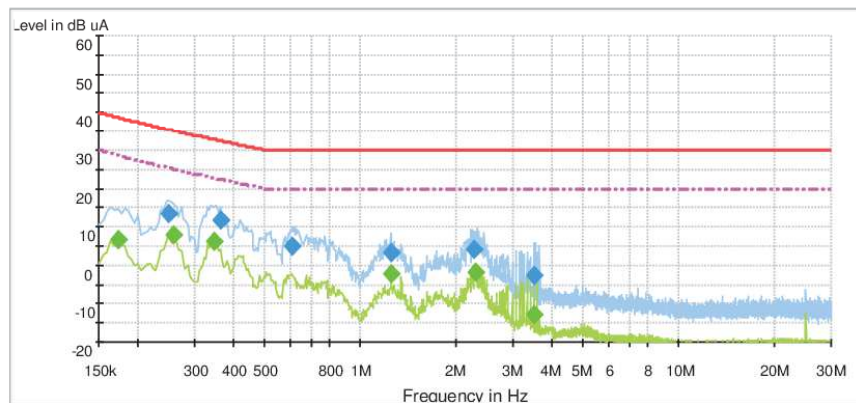

Bureau Veritas Shenzhen Co., Ltd.  
Dongguan Branch

No. 34, Chenwulu Section, Guantai Rd., Houjie  
Town, Dongguan City,  
Guangdong 523942, China

Tel: +86 769 8593 5656  
Fax: +86 769 8593 1080  
Email: [customerservice.dg@cn.bureauveritas.com](mailto:customerservice.dg@cn.bureauveritas.com)

Page 29 of 92

Report Version 1





**BUREAU  
VERITAS** Test Report No.: CE181019N024

### 3.3 RADIATED EMISSION MEASUREMENT

#### 3.3.1 LIMITS OF RADIATED EMISSION MEASUREMENT FOR FREQUENCY BELOW 1000 MHz

FREQUENCY (MHz)	Class A (at 10m)	Class B (at 10m)
	Quasi-Peak (dBuV/m)	Quasi-Peak (dBuV/m)
30 – 230	40	30
230 – 1000	47	37

#### FREQUENCY RANGE OF RADIATED MEASUREMENT (For unintentional radiators)

Highest frequency generated or Upper frequency of measurement used in the device or on which the device operates or tunes (MHz)	Range (MHz)
Below 108	1000
108 – 500	2000
500 – 1000	5000
Above 1000	Up to 5 times of the highest frequency or 6 GHz, whichever is less

#### FOR FREQUENCY ABOVE 1000 MHz

FREQUENCY (GHz)	Class A (dBuV/m) (at 3m)		Class B (dBuV/m) (at 3m)	
	PEAK	AVERAGE	PEAK	AVERAGE
1 to 3	76	56	70	50
3 to 6	80	60	74	54

**NOTE:** (1) The lower limit shall apply at the transition frequencies.  
 (2) Emission level (dBuV/m) = 20 log Emission level (uV/m).  
 (3) All emanation from a class A/B digital device or system, including any network of conductors and apparatus connected thereto, shall not exceed the level of field strengths specified above.

Bureau Veritas Shenzhen Co., Ltd.  
Dongguan Branch

No. 34, Chenwulu Section, Guantai Rd., Houjie  
Town, Dongguan City,  
Guangdong 523942, China

Tel: +86 769 8593 5656  
Fax: +86 769 8593 1080  
Email: [customerservice.dg@cn.bureauveritas.com](mailto:customerservice.dg@cn.bureauveritas.com)

Page 30 of 92

Report Version 1



**BUREAU VERITAS** Test Report No.: CE181019N024

### 3.3.2 TEST INSTRUMENTS

Equipment	Manufacturer	Model No.	Serial No.	Last Cal.	Next Cal.
EMI Receiver	Agilent	N9038A	MY51210233	2017/12/13	2018/12/12
Spectrum Analyzer	Agilent	E4447A	MY52090002	2018/07/23	2019/07/22
Bilog antenna(30M-1G)	SCHWARZBECK	VULB 9163	548	2018/5/5	2019/5/04
Bilog antenna(30M-1G)	SCHWARZBECK	VULB 9163	549	2016/12/2	2018/12/01
Preamplifier(30M-1G)	SONOMA INSTRUMENT	317	321043	2018/5/2	2019/5/01
Preamplifier(30M-1G)	Agilent	8447D	2944A10175	2018/07/23	2019/07/22

**NOTE:** 1.The test was performed by witness in 10m chamber of ShangHai Huawei Technology Co., Ltd.

2.The test was performed in 10m Chamber.

Equipment	Manufacturer	Model No.	Serial No.	Last Cal.	Next Cal.
EMI Test receiver	R&S	ESU40	100303	2018/5/2	2019/5/1
Horn antenna	SCHWARZBECK	BBHA9120D	878	2017/5/20	2019/5/19
MICROWAVE POWER AMPLIFIER	RongXiang	PAP-1G18G	7616	2018/7/23	2019/7/22
switch	R&S	OSP120	100306	N/A	N/A

**NOTE:** 1.The test was performed by witness in 3m chamber of ShangHai Huawei Technology Co., Ltd.

2. The test was performed in 3m Chamber.

Bureau Veritas Shenzhen Co., Ltd.  
Dongguan Branch

No. 34, Chenwulu Section, Guantai Rd., Houjie  
Town, Dongguan City,  
Guangdong 523942, China

Tel: +86 769 8593 5656  
Fax: +86 769 8593 1080  
Email: [customerservice.dg@cn.bureauveritas.com](mailto:customerservice.dg@cn.bureauveritas.com)

Page 31 of 92

Report Version 1



### 3.3.3 TEST PROCEDURE

#### <Frequency Range below 1GHz>

- a. The EUT was placed on the top of a rotating table 0.8 meters above the ground at a 10 meters Semi-anechoic chamber room. The table was rotated 360 degrees to determine the position of the highest radiation.
- b. The EUT was set 10 meters away from the interference-receiving antenna, which was mounted on the top of a variable-height antenna tower.
- c. The height of antenna is varied from one meter to four meters above the ground to determine the maximum value of the field strength. Both horizontal and vertical polarizations of the antenna are set to make the measurement.
- d. For each suspected emission, the EUT was arranged to its worst case and then the antenna was tuned to heights from 1 meter to 4 meters and the turn table was turned from 0 degrees to 360 degrees to find the maximum reading.
- e. The test-receiver system was set to quasi-peak detect function and specified bandwidth with maximum hold mode when the test frequency is below 1 GHz.

#### NOTE:

1. The resolution bandwidth of test receiver/spectrum analyzer is 120kHz for Quasi-peak detection (QP) at frequency below 1GHz.
2. Emission level(dBuV/m)=Raw Value(dBuV) + Correction Factor(dB/m)
3. Correction Factor(dB/m) = Antenna Factor (dB/m) + Cable Factor (dB) (if the raw value not contains the amplifier)
4. Correction Factor (dB/m) = Antenna Factor (dB/m) + Cable Factor (dB) – Amplifier Gain(dB) (if the raw value contains the amplifier)
5. Margin value = Emission level – Limit value.



BUREAU  
VERITAS Test Report No.: CE181019N024

#### <Frequency Range above 1GHz>

- a. The EUT was placed on the top of a rotating table 0.8 meters above the ground at a 3 meter chamber room. The table was rotated 360 degrees to determine the position of the highest radiation.
- b. The EUT was set 3 meters away from the interference-receiving antenna, which was mounted on the top of a variable-height antenna tower.
- c. The height of antenna can be varied from one meter-to four meters, the height of adjustment depends on the EUT height and the antenna 3dB beamwidth both, to detect the maximum value of the field strength. Both horizontal and vertical polarizations of the antenna are set to make the measurement. The bore sight should be used during the test above 1GHz.
- d. For each suspected emission, the EUT was arranged to its worst case and then the antenna was tuned to heights and the rotatable table was turned from 0 degrees to 360 degrees to find the maximum reading.
- e. The test receiver/spectrum was set to peak and average detect function and specified bandwidth with maximum hold mode when the test frequency is above 1 GHz.

#### NOTE:

1. The resolution bandwidth is 1MHz and video bandwidth of test receiver/spectrum analyzer is 3MHz for Peak detection at frequency above 1GHz. The resolution bandwidth of test receiver/spectrum analyzer is 1 MHz for Average detection (AV) at frequency above 1GHz.
2. For measurement of frequency above 1000 MHz, the EUT was set 3 meters away from the receiver antenna.
3. Emission level(dBuV/m)=Raw Value(dBuV) + Correction Factor(dB/m)
4. Correction Factor(dB/m) = Antenna Factor (dB/m) + Cable Factor (dB) (if the raw value not contains the amplifier)
5. Correction Factor (dB/m) = Antenna Factor (dB/m) + Cable Factor (dB) – Amplifier Gain(dB) (if the raw value contains the amplifier)
6. Margin value = Emission level – Limit value.

### 3.3.4 DEVIATION FROM TEST STANDARD

No deviation

Bureau Veritas Shenzhen Co., Ltd.  
Dongguan Branch

No. 34, Chenwulu Section, Guantai Rd., Houjie  
Town, Dongguan City,  
Guangdong 523942, China

Tel: +86 769 8593 5656  
Fax: +86 769 8593 1080  
Email: [customerservice.dg@cn.bureauveritas.com](mailto:customerservice.dg@cn.bureauveritas.com)

Page 33 of 92

Report Version 1



BUREAU VERITAS Test Report No.: CE181019N024

### 3.3.5 TEST SETUP

<Frequency Range below 1GHz>

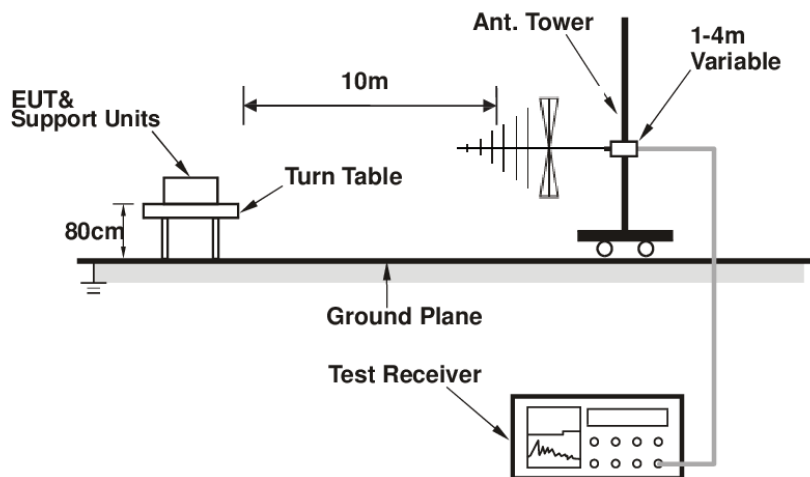

<Frequency Range above 1GHz>

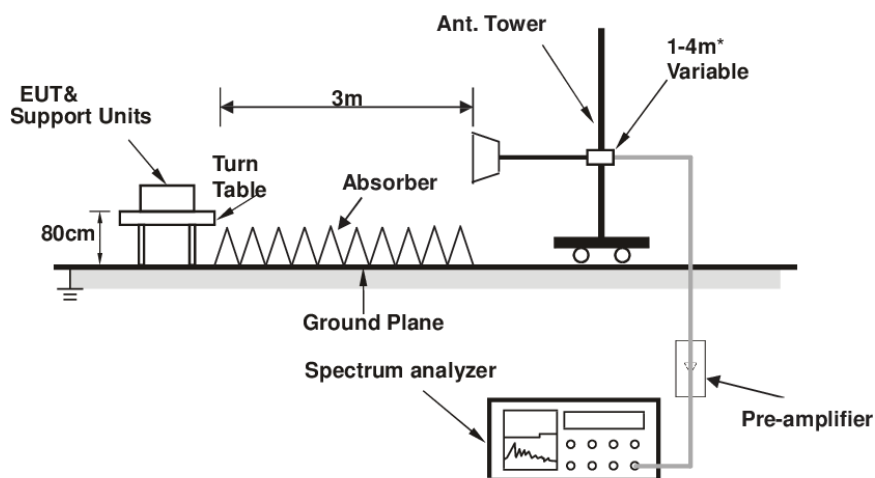

\* : depends on the EUT height and the antenna 3dB beamwidth both, refer to section 7.3 of CISPR 16-2-3.

### 3.3.6 EUT OPERATING CONDITIONS

Same as item 3.1.6

Bureau Veritas Shenzhen Co., Ltd.  
Dongguan Branch

No. 34, Chenwulu Section, Guantai Rd., Houjie  
Town, Dongguan City,  
Guangdong 523942, China

Tel: +86 769 8593 5656  
Fax: +86 769 8593 1080  
Email: [customerservice.dg@cn.bureauveritas.com](mailto:customerservice.dg@cn.bureauveritas.com)

Page 34 of 92

Report Version 1



BUREAU VERITAS Test Report No.: CE181019N024

### 3.3.7 TEST RESULTS

<b>TEST MODE</b>	SUN2000-10KTL-M0 Grid Mode(Full Load) + RS485 Data Acquisition + Wifi Data Acquisition	<b>FREQUENCY RANGE</b>	30-1000 MHz
<b>TEST VOLTAGE</b>	DC 480V AC 400V	<b>DETECTOR FUNCTION &amp; BANDWIDTH</b>	Quasi-Peak, 120kHz
<b>ENVIRONMENTAL CONDITIONS</b>	25 deg. C, 48% RH	<b>TESTED BY:</b> Zhou Weijie	

Frequency MHz	Level (dBuV/m) QP	Transd (dB)	Limit (dBuV/m) QP	Margin (dB) QP	Height cm	Angle deg	Polarization
50.060	24.8	-21.9	30.0	5.2	101.0	0.0	V
39.911	22.1	-22.3	30.0	7.9	102.0	44.0	V
30.247	19.4	-25.2	30.0	10.6	101.0	92.0	V
73.569	21.5	-26.9	30.0	8.5	217.0	357.0	V
71.654	20.2	-26.7	30.0	9.8	215.0	103.0	V
107.233	14.7	-23.8	30.0	15.3	100.0	63.0	V
243.497	12.6	-21.6	37.0	24.4	216.0	194.0	H
49.854	9.9	-22.0	30.0	20.1	194.0	230.0	H
156.802	5.3	-25.9	30.0	24.7	187.0	302.0	H
99.353	7.3	-23.9	30.0	22.7	168.0	183.0	H
40.802	9.4	-22.3	30.0	20.6	216.0	333.0	H
40.030	9.7	-22.3	30.0	20.3	215.0	269.0	H

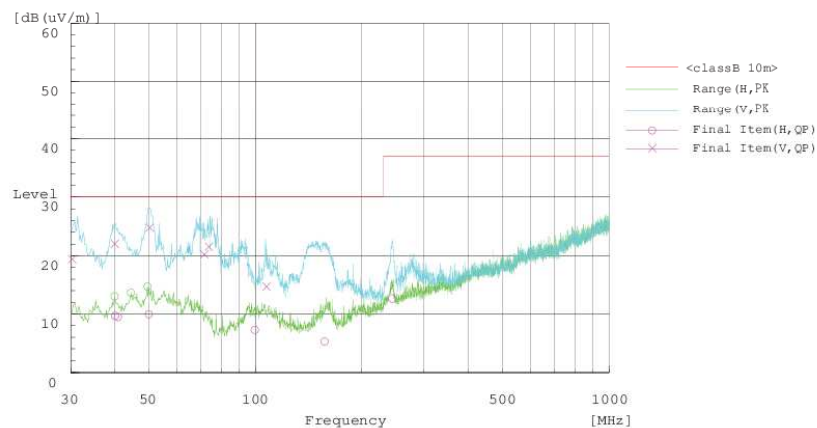

Bureau Veritas Shenzhen Co., Ltd.  
Dongguan Branch

No. 34, Chenwulu Section, Guantai Rd., Houjie  
Town, Dongguan City,  
Guangdong 523942, China

Tel: +86 769 8593 5656  
Fax: +86 769 8593 1080  
Email: [customerservice.dg@cn.bureauveritas.com](mailto:customerservice.dg@cn.bureauveritas.com)



**BUREAU VERITAS** Test Report No.: CE181019N024

<b>TEST MODE</b>	SUN2000-10KTL-M0 Grid Mode(Full Load) + RS485 Data Acquisition + Wifi Data Acquisition + USB Smart Dongle (4G Module)		
<b>TEST VOLTAGE</b>	DC 480V AC 400V	<b>FREQUENCY RANGE</b>	1000-6000 MHz
<b>ENVIRONMENTAL CONDITIONS</b>	25 deg. C, 48% RH		<b>TESTED BY:</b> Zhou Weijie

Frequency (MHz)	Average (dBuV/m)	Meas. Time (ms)	Bandwidth (kHz)	Height (cm)	Polarization	Azimuth (deg)	Corr. (dB)	Margin (dB)	Limit (dBμV/m)
4176.145667	27.6	1000.0	1000.000	100.0	H	273.0	-2.4	26.4	54.0

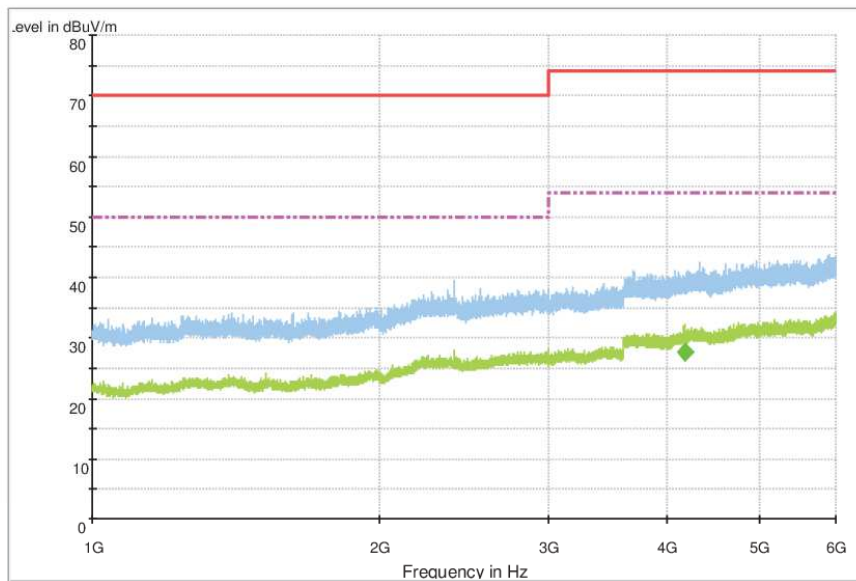

Bureau Veritas Shenzhen Co., Ltd.  
Dongguan Branch

No. 34, Chenwulu Section, Guantai Rd., Houjie  
Town, Dongguan City,  
Guangdong 523942, China

Tel: +86 769 8593 5656  
Fax: +86 769 8593 1080  
Email: [customerservice.dg@cn.bureauveritas.com](mailto:customerservice.dg@cn.bureauveritas.com)

Page 36 of 92

Report Version 1



**BUREAU VERITAS** Test Report No.: CE181019N024

### 3.4 HARMONICS CURRENT MEASUREMENT (<16A)

#### 3.4.1 LIMITS OF HARMONICS CURRENT MEASUREMENT

TEST STANDARD: EN 61000-3-2

Limits for Class A equipment		Limits for Class D equipment		
Harmonic Order n	Max. permissible harmonics current A	Harmonic Order n	Max. permissible harmonics current per watt mA/W	Max. permissible harmonics current A
Odd harmonics		Odd Harmonics only		
3	2.30	3	3.4	2.30
5	1.14	5	1.9	1.14
7	0.77	7	1.0	0.77
9	0.40	9	0.5	0.40
11	0.33	11	0.35	0.33
13	0.21	13	0.30	0.21
15<=n<=39	0.15x15/n	15<=n<=39	3.85/n	0.15x15/n
Even harmonics				
2	1.08			
4	0.43			
6	0.30			
8<=n<=40	0.23x8/n			

**NOTE:** 1. Class A and Class D are classified according to section 5 of EN 61000-3-2.

2. According to section 7 of EN 61000-3-2, the above limits for all equipment except for lighting equipment having an active input power > 75 W and no limits apply for equipment with an active input power up to and including 75 W.

◆ **Limits for Class B equipment:**

For class B equipment, the harmonics of the input current shall not exceed the maximum permissible values given for class A equipment multiplied by a factor of 1.5.

Limits for Class C equipment	
Harmonic Order n	Max. permissible harmonics current expressed as a percentage of the input current at the fundamental frequency %
2	2
3	30·λ *
5	10
7	7
9	5
11<=n<=39 (odd harmonics only)	3

\*λ is the circuit power factor

**NOTE:** Discharge lighting equipment having an active input power smaller than or equal to 25W, the harmonic currents shall not exceed the power related limits of Class D.

Bureau Veritas Shenzhen Co., Ltd.  
Dongguan Branch

No. 34, Chenwulu Section, Guantai Rd., Houjie Town, Dongguan City, Guangdong 523942, China

Tel: +86 769 8593 5656  
Fax: +86 769 8593 1080  
Email: [customerservice.dg@cn.bureauveritas.com](mailto:customerservice.dg@cn.bureauveritas.com)





**BUREAU  
VERITAS** Test Report No.: CE181019N024

### 3.4.2 TEST INSTRUMENTS

Description	Manufacturer	Model no.	Serial No.	Last Cal.	Next Cal.
Power Analyzer	YOKOGAWA	WT3000	91J902079	2018/02/13	2019/02/12
Programmable DC source	Keysight	N8957APV	DE16391780	2018/03/14	2019/03/13
AC Source	Ametek	RS90-3PI-LAN-400-150 /300-HV-LF-SNK	1515A00638	2018/05/15	2019/05/14
Oscillographic recorder	YOKOGAWA	DL850	91LA25621	2018/05/15	2019/05/14

**NOTE:** 1. The test was performed by witness in H/F Room of ShangHai Huawei Technology Co., Ltd.  
2. The test was performed in Harmonics Room.

### 3.4.3 TEST PROCEDURE

- a. The EUT was placed on the top of a wooden table 0.8 meters above the ground and operated to produce the maximum harmonic components under normal operating conditions for each successive harmonic component in turn.
- b. The classification of EUT is according to section 5 of EN 61000-3-2  
The EUT is classified as follows:
  - Class A: Balanced three-phase equipment, Household appliances excluding equipment as Class D, Tools excluding portable tools, Dimmers for incandescent lamps, audio equipment, equipment not specified in one of the three other classes.
  - Class B: Portable tools. ; Arc welding equipment which is not professional equipment
  - Class C: Lighting equipment.
  - Class D: Equipment having a specified power less than or equal to 600 W of the following types: Personal computers and personal computer monitors and television receivers.
- c. The correspondent test program of test instrument to measure the current harmonics emanated from EUT is chosen. The measure time shall be not less than the time necessary for the EUT to be exercised.

Bureau Veritas Shenzhen Co., Ltd.  
Dongguan Branch

No. 34, Chenwulu Section, Guantai Rd., Houjie  
Town, Dongguan City,  
Guangdong 523942, China

Tel: +86 769 8593 5656  
Fax: +86 769 8593 1080  
Email: [customerservice.dg@cn.bureauveritas.com](mailto:customerservice.dg@cn.bureauveritas.com)

Page 38 of 92

Report Version 1



**BUREAU  
VERITAS** Test Report No.: CE181019N024

### 3.4.4 DEVIATION FROM TEST STANDARD

No deviation

### 3.4.5 TEST SETUP

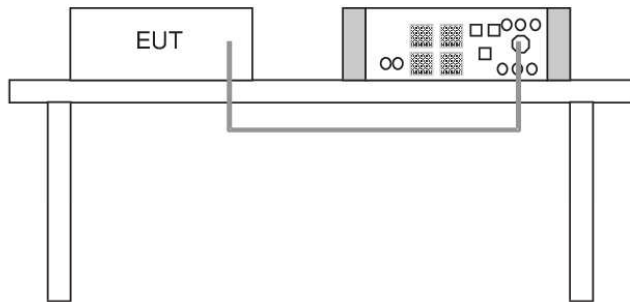

### 3.4.6 EUT OPERATING CONDITIONS

Same as item 3.1.6



**BUREAU VERITAS** Test Report No.: CE181019N024

### 3.4.7 TEST RESULTS

SUN2000-10KTL-M0

Regulation : IEC61000-3-2 Cd3.0 am2  
 IEC61000-4-7 Fr2 D A1  
 Class : CLASS A  
 MeasureTime : 150.00sec  
 Model : YOKOGAWA WT3000  
 Rating Voltage : 230.00 V  
 Wiring : 3P4W  
 Element : 1(U)  
 Range : 300V/30A  
 Current(mA) : 15.7900 A  
 Voltage(mV) : 230.77 V  
 Frequency : 50.001 Hz  
 Power Factor : 1.0000  
 PCHC limit : 0.2514 A  
 PCHC Max : 0.0295 A  
 THC : 0.0800 A

**PASS**

Set Fundamental I : -----  
 Set Power Factor : -----  
 Set P : -----  
 Sigma W Max : 10044.15 W  
 Sigma PF : 1.0000  
 Distortion factor(V) : 0.12 %  
 V THDS : 0.12 %  
 V THDG : 0.12 %  
 Distortion factor(A) : 0.08 %  
 A THDS : 0.50 %  
 A THDG : 0.67 %  
 P THD : 0.00 %  
 Power Limit : 75 W

Order	Measure[A]	Limit[A]	Margin[%]	Order	Measure[A]	Limit[A]	Margin[%]
1	15.7958			2	0.0262	1.0300	97.3
3	0.0375	2.3000	90.4	4	0.0139	0.4300	96.0
5	0.0477	1.1400	96.3	6	0.0147	0.3000	95.1
7	0.0240	0.7700	90.8	8	0.0081	0.2300	90.5
9	0.0099	0.4000	97.0	10	0.0009	0.1040	95.1
11	0.0111	0.3300	90.0	12	0.0111	0.1083	90.8
13	0.0101	0.2100	95.2	14	0.0082	0.1314	93.7
15	0.0059	0.1500	98.1	16	0.0081	0.1160	82.7
17	0.0091	0.1324	93.1	18	0.0142	0.1022	06.1
19	0.0089	0.1184	94.2	20	0.0081	0.0920	91.2
21	0.0099	0.1071	93.9	22	0.0085	0.0890	89.8
23	0.0100	0.0970	89.0	24	0.0139	0.0767	01.9
25	0.0067	0.0900	92.6	26	0.0089	0.0704	87.6
27	0.0050	0.0800	91.0	28	0.0007	0.0657	06.0
29	0.0060	0.0776	88.4	30	0.0180	0.0613	78.5
31	0.0070	0.0726	90.4	32	0.0101	0.0575	02.5
33	0.0070	0.0682	89.8	34	0.0084	0.0541	84.4
35	0.0075	0.0643	88.3	36	0.0139	0.0511	72.9
37	0.0003	0.0600	06.4	38	0.0101	0.0404	75.2
39	0.0099	0.0577	81.6	40	0.0076	0.0410	83.1

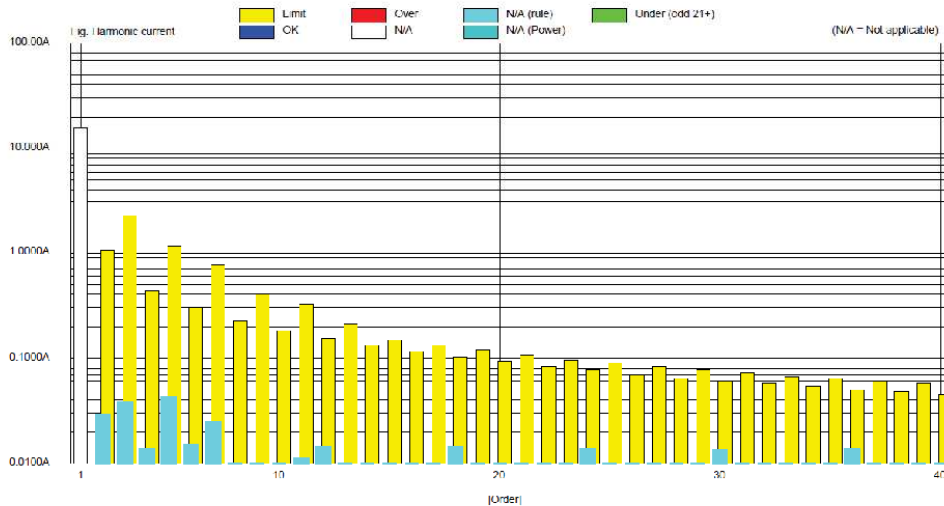

Bureau Veritas Shenzhen Co., Ltd.  
 Dongguan Branch

No. 34, Chenwulu Section, Guantai Rd., Houjie  
 Town, Dongguan City,  
 Guangdong 523942, China

Tel: +86 769 8593 5656  
 Fax: +86 769 8593 1080  
 Email: [customerservice.dg@cn.bureauveritas.com](mailto:customerservice.dg@cn.bureauveritas.com)



**Test Report No.: CE181019N024**

Regulation : IEC61000-3-2 Ed3.0 am2  
 IEC61000 4.7 Ed2.0 A1  
 Class : CLASS A  
 MeasureTime : 150.00sec  
 Model : YOKOGAWA W19000  
 Rating Voltage : 230.00 V  
 Wiring : 3P4W  
 Filament : 1(L)  
 Range : 300V/30A  
 Current(rms) : 15.8090 A  
 Voltage(rms) : 230.78 V  
 Frequency : 50.032 Hz  
 Power Factor : 1.0000  
 Beyond Limit Time : 14.8898 s  
 Beyond Total Time : 0.0000 s  
 THC : 0.0576 A

**PASS**

Set Fundamental I : -----  
 Set Power Factor : -----  
 Set P : -----  
 Sigma W Max : 10044.15 W  
 Sigma PF : 1.0000  
 Distortion factor(V) : 0.12 %  
 V I HD5 : 0.12 %  
 V THDG : 0.12 %  
 Distortion factor(A) : 0.59 %  
 A THDS : 0.65 %  
 A THDG : 0.73 %  
 P THD : 0.00 %  
 Power Limit : 75 W

Order	Measure[A]	Limit[A]	Margin[%]	Order	Measure[A]	Limit[A]	Margin[%]
1	15.8093			2	0.0432	1.6200	97.3
3	0.0427	3.4500	98.8	4	0.0245	0.6450	96.2
5	0.0451	1.7100	97.4	6	0.0166	0.4500	96.3
7	0.0263	1.1550	97.7	8	0.0102	0.3400	97.0
9	0.0110	0.6000	98.2	10	0.0112	0.2760	96.0
11	0.0128	0.4950	97.4	12	0.0150	0.2300	93.5
13	0.0118	0.3150	96.3	14	0.0101	0.1671	94.0
15	0.0071	0.2250	96.8	16	0.0093	0.1725	94.6
17	0.0105	0.1985	94.7	18	0.0101	0.1533	90.2
19	0.0086	0.1776	95.5	20	0.0092	0.1380	93.3
21	0.0077	0.1607	95.2	22	0.0097	0.1255	92.2
23	0.0111	0.1467	92.4	24	0.0150	0.1100	86.9
25	0.0082	0.1350	93.9	26	0.0107	0.1062	89.9
27	0.0079	0.1250	93.7	28	0.0109	0.0966	89.8
29	0.0102	0.1164	91.2	30	0.0146	0.0920	84.2
31	0.0095	0.1089	91.3	32	0.0134	0.0862	84.5
33	0.0088	0.1023	91.3	34	0.0104	0.0812	87.1
35	0.0088	0.0964	89.8	36	0.0158	0.0767	79.7
37	0.0111	0.0912	87.0	38	0.0127	0.0726	82.6
39	0.0121	0.0865	86.0	40	0.0104	0.0690	85.0

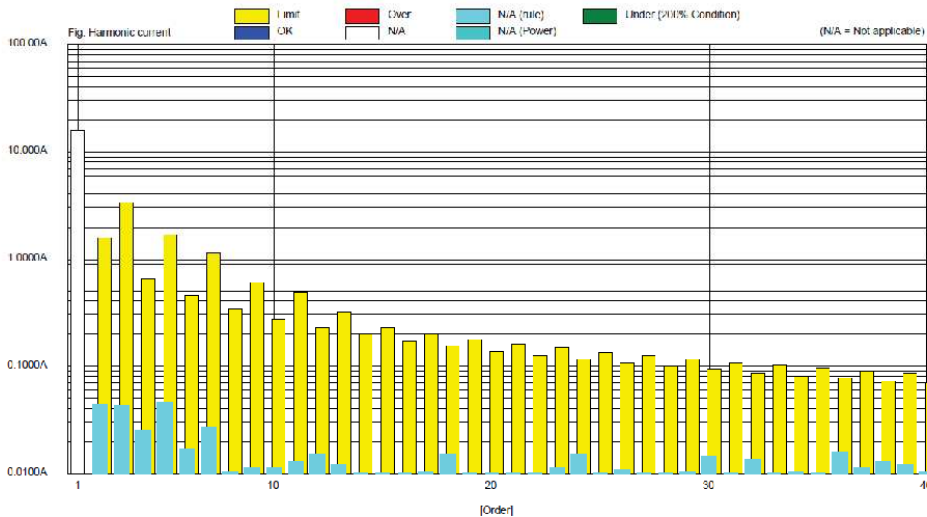

Bureau Veritas Shenzhen Co., Ltd.  
 Dongguan Branch

No. 34, Chenwulu Section, Guantai Rd., Houjie  
 Town, Dongguan City,  
 Guangdong 523942, China

Tel: +86 769 8593 5656  
 Fax: +86 769 8593 1080  
 Email: [customerservice.dg@cn.bureauveritas.com](mailto:customerservice.dg@cn.bureauveritas.com)



**Test Report No.: CE181019N024**

Regulation : IEC61000-3-2 F13.0 AmD  
 IEC61000-4-7 Ed2.0 A1  
 Class : CLASS A  
 MeasureTime : 150.00sec  
 Model : YOKOGAWA WT3000  
 Rating Voltage : 230.00 V  
 Wiring : 3P+N  
 Filament : 2(V)  
 Range : 300V/30A  
 Current(rms) : 15.7756 A  
 Voltage(rms) : 230.46 V  
 Frequency : 50.001 Hz  
 Power Factor : 1.0000  
 POHC Limit : 0.2614 A  
 POHC Max : 0.0355 A  
 THC : 0.0780 A

**PASS**

Set Fundamental I : -----  
 Set Power Factor : -----  
 Set P : -----  
 Sigma W Max : 10944.15 W  
 Sigma PF : 1.0000  
 Distortion factor(V) : 0.12 %  
 VTHDS : 0.12 %  
 VTHDG : 0.12 %  
 Distortion factor(A) : 0.36 %  
 ATHDS : 0.44 %  
 ATHDG : 0.50 %  
 FTID : 0.00 %  
 Power Limit : 75 W

Order	Measure[A]	Limit[A]	Margin[%]	Order	Measure[A]	Limit[A]	Margin[%]
1	16.7756	2.5000	98.1	2	0.0278	1.0000	97.4
3	0.0002	2.5000	98.1	4	0.0165	0.4300	96.2
5	0.0107	1.1400	98.5	6	0.0104	0.3000	96.5
7	0.0280	0.7700	96.2	8	0.0101	0.2300	95.6
9	0.0079	0.4000	98.0	10	0.0110	0.1640	93.7
11	0.0080	0.3300	97.4	12	0.0113	0.1533	92.7
13	0.0074	0.2100	96.5	14	0.0104	0.1314	92.1
15	0.0110	0.1500	92.7	16	0.0114	0.1150	90.1
17	0.0080	0.1324	93.0	18	0.0098	0.1022	90.4
19	0.0086	0.1131	91.5	20	0.0111	0.0920	87.9
21	0.0081	0.1071	92.4	22	0.0110	0.0836	86.0
23	0.0103	0.0973	88.5	24	0.0100	0.0787	87.0
25	0.0064	0.0900	92.0	26	0.0105	0.0708	84.6
27	0.0091	0.0833	89.0	28	0.0107	0.0657	83.7
29	0.0117	0.0775	84.0	30	0.0118	0.0613	80.7
31	0.0076	0.0723	88.5	32	0.0114	0.0575	80.2
33	0.0111	0.0682	83.6	34	0.0107	0.0541	80.2
35	0.0077	0.0643	80.0	36	0.0111	0.0511	70.3
37	0.0088	0.0608	85.5	38	0.0114	0.0484	76.1
39	0.0135	0.0577	76.6	40	0.0097	0.0460	70.9

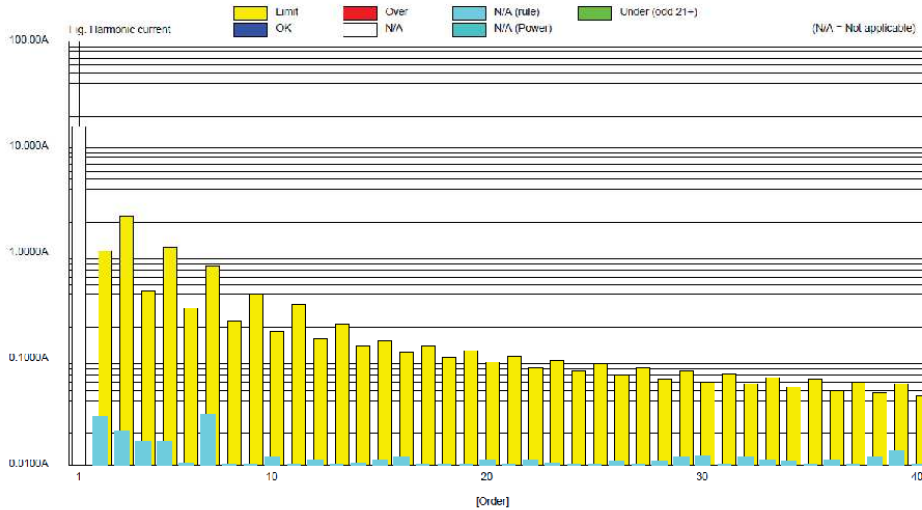

Bureau Veritas Shenzhen Co., Ltd.  
 Dongguan Branch

No. 34, Chenwulu Section, Guantai Rd., Houjie  
 Town, Dongguan City,  
 Guangdong 523942, China

Tel: +86 769 8593 5656  
 Fax: +86 769 8593 1080  
 Email: [customerservice.dg@cn.bureauveritas.com](mailto:customerservice.dg@cn.bureauveritas.com)



**BUREAU VERITAS** Test Report No.: CE181019N024

Regulation : IEC61000-3-2 E33.0 am2  
 IEC61000-4-7 E42.0 A1  
 Class : CLASS A  
 MeasureTime : 160.00sec  
 Model : YOKOGAWA WT3000  
 Rating Voltage : 230.00 V  
 Wiring : 3P4W  
 Element : 2(V)  
 Range : 300V/30A  
 Current(rms) : 16.7885 A  
 Voltage(rms) : 230.50 V  
 Frequency : 50.032 Hz  
 Power Factor : 1.0000  
 Beyond Limit Time : 14.9998 s  
 Beyond Total Time : 0.0000 s  
 IHC : 0.0920 A

**PASS**

Std Fundamental I : -----  
 Std Power Factor : -----  
 Std P : -----  
 Sigma W Max : 10944.15 W  
 Sigma PF : 1.0000  
 Distortion factor(V) : 0.13 %  
 VTHDS : 0.13 %  
 VTHDG : 0.13 %  
 Distortion factor(A) : 0.62 %  
 ATHDS : 0.67 %  
 ATHDG : 0.72 %  
 PTHD : 0.06 %  
 Power Limit : 75 W

Order	Measure[A]	Limit[A]	Margin[%]	Order	Measure[A]	Limit[A]	Margin[%]
1	15.7885			2	0.0470	1.0200	97.1
3	0.0317	3.4500	99.1	4	0.0286	0.6150	95.9
5	0.0213	1.7100	98.8	5	0.0127	0.4500	97.2
7	0.0301	1.1550	97.4	8	0.0130	0.3450	96.2
9	0.0099	0.6000	90.4	10	0.0136	0.2750	95.1
11	0.0107	0.4950	97.8	12	0.0127	0.2300	94.5
13	0.0098	0.3150	96.9	14	0.0123	0.1971	93.8
15	0.0123	0.2250	91.5	15	0.0133	0.1725	92.3
17	0.0092	0.1985	95.4	16	0.0106	0.1533	93.1
19	0.0079	0.1776	95.5	20	0.0129	0.1389	90.6
21	0.0100	0.1607	93.8	22	0.0131	0.1255	89.6
23	0.0113	0.1467	92.3	24	0.0113	0.1150	90.2
25	0.0077	0.1350	94.3	25	0.0136	0.1082	87.2
27	0.0115	0.1250	90.8	26	0.0122	0.0985	87.7
29	0.0140	0.1161	88.0	27	0.0145	0.0920	84.3
31	0.0097	0.1009	91.1	28	0.0131	0.0852	84.0
33	0.0140	0.1023	88.3	29	0.0130	0.0812	84.0
35	0.0095	0.0964	89.8	30	0.0142	0.0757	81.5
37	0.0125	0.0912	88.3	31	0.0137	0.0728	81.1
39	0.0155	0.0865	82.1	32	0.0136	0.0690	80.3

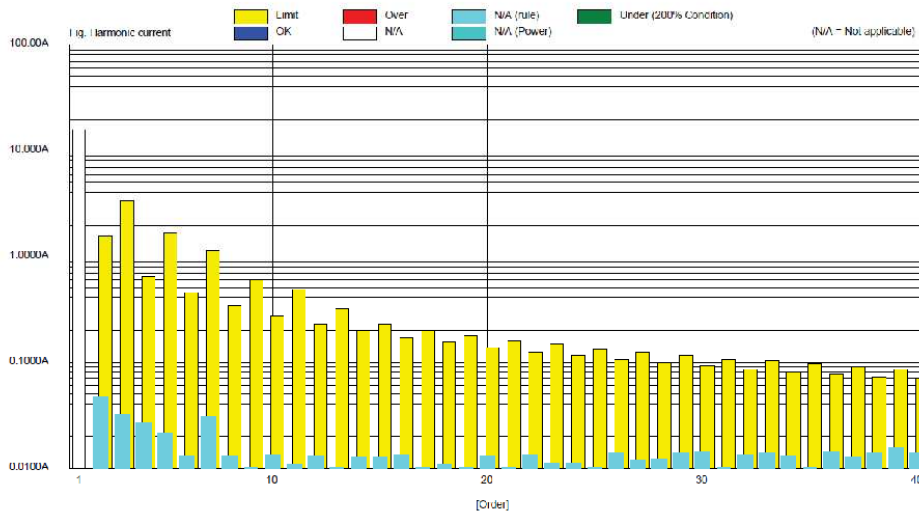

Bureau Veritas Shenzhen Co., Ltd.  
 Dongguan Branch

No. 34, Chenwulu Section, Guantai Rd., Houjie  
 Town, Dongguan City,  
 Guangdong 523942, China

Tel: +86 769 8593 5656  
 Fax: +86 769 8593 1080  
 Email: [customerservice.dg@cn.bureauveritas.com](mailto:customerservice.dg@cn.bureauveritas.com)



**BUREAU VERITAS** Test Report No.: CE181019N024

Regulation : IEC61000-3-2 Ed3.0 am2  
 IEC61000 4.7 Ed2.0 A1  
 Class : CLASS A  
 MeasureTime : 150.00sec  
 Model : YOKOGAWA W13000  
 Rating Voltage : 230.00 V  
 Wiring : 2P4W  
 Element : 3(W)  
 Range : 300V/30A  
 Current(rms) : 15.8645 A  
 Voltage(rms) : 230.52 V  
 Frequency : 50.001 Hz  
 Power Factor : 1.0000  
 POHC Limit : 0.2514 A  
 POHC Max : 0.0287 A  
 THIC : 0.0029 A

**PASS**

Set Fundamental I : -----  
 Set Power Factor : -----  
 Set P : -----  
 Sigma W Max : 10944.15 W  
 Sigma PT : 1.0000  
 Distortion factor(V) : 0.12 %  
 V THDS : 0.12 %  
 V THDG : 0.12 %  
 Distortion factor(A) : 0.41 %  
 A THDS : 0.40 %  
 A THDG : 0.63 %  
 P THD : 0.00 %  
 Power Limit : 75 W

Order	Measure[A]	Limit[A]	Margin[%]	Order	Measure[A]	Limit[A]	Margin[%]
1	15.8643			2	0.0274	1.0800	97.6
3	0.0242	2.3000	98.9	4	0.0117	0.4300	97.3
5	0.0365	1.1400	96.8	6	0.0131	0.3000	96.6
7	0.0289	0.7700	96.3	8	0.0099	0.2300	96.7
9	0.0118	0.4000	97.0	10	0.0066	0.1840	94.8
11	0.0110	0.3300	96.4	12	0.0132	0.1533	91.4
13	0.0107	0.2100	94.9	14	0.0109	0.1314	91.7
15	0.0082	0.1500	95.9	16	0.0083	0.1150	91.8
17	0.0087	0.1324	91.9	18	0.0124	0.1022	87.8
19	0.0069	0.1104	94.2	20	0.0109	0.0920	90.1
21	0.0101	0.1071	90.8	22	0.0091	0.0838	89.1
23	0.0071	0.0978	92.8	24	0.0112	0.0787	85.1
25	0.0068	0.0900	92.5	26	0.0106	0.0708	85.0
27	0.0066	0.0833	92.1	28	0.0092	0.0657	85.9
29	0.0094	0.0776	87.9	30	0.0099	0.0613	83.8
31	0.0075	0.0726	89.7	32	0.0104	0.0575	81.9
33	0.0080	0.0682	88.3	34	0.0083	0.0541	82.7
35	0.0075	0.0643	88.4	36	0.0117	0.0511	77.1
37	0.0081	0.0598	86.7	38	0.0105	0.0484	78.3
39	0.0075	0.0577	87.0	40	0.0089	0.0460	80.6

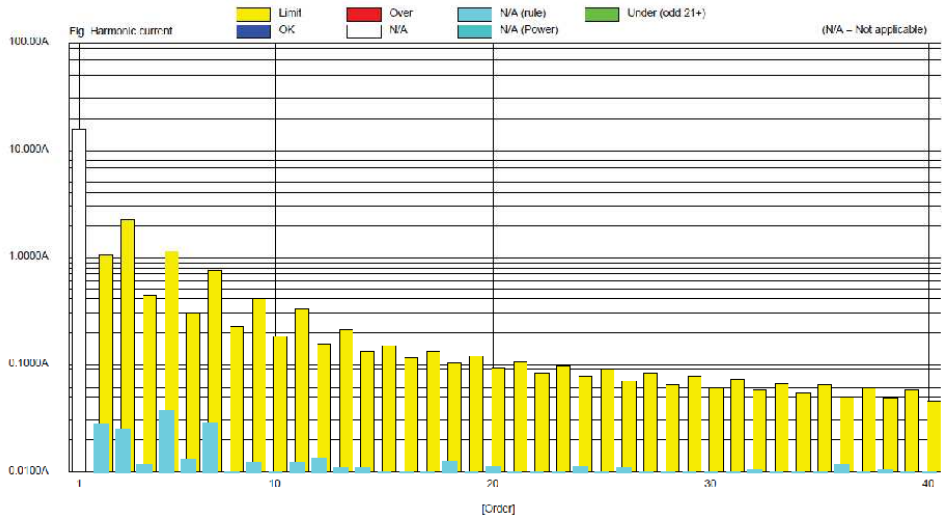

Bureau Veritas Shenzhen Co., Ltd.  
 Dongguan Branch

No. 34, Chenwulu Section, Guantai Rd., Houjie  
 Town, Dongguan City,  
 Guangdong 523942, China

Tel: +86 769 8593 5656  
 Fax: +86 769 8593 1080  
 Email: [customerservice.dg@cn.bureauveritas.com](mailto:customerservice.dg@cn.bureauveritas.com)



**BUREAU VERITAS** Test Report No.: CE181019N024

Regulation : IEC61000-3-2 Ed3.0 am2  
 IEC61000-4-7 Ed2.0 A1  
 Class : CLASS A  
 MeasureTime : 150.00sec  
 Model : YOKOGAWA W13000  
 Rating Voltage : 230.00 V  
 Wiring : 3P+N  
 Element : 3(W)  
 Range : 300V/30A  
 Current(rms) : 15.8678 A  
 Voltage(rms) : 230.63 V  
 Frequency : 50.632 Hz  
 Power Factor : 1.0000  
 Beyond Limit Time : 14.9998 s  
 Beyond Total Time : 0.0000 s  
 THC : 0.0662 A

**PASS**

Set Fundamental I : -----  
 Set Power Factor : -----  
 Set P : -----  
 Sigma W Max : 10944.15 W  
 Sigma PF : 1.0000  
 Distortion factor(V) : 0.12 %  
 V THDS : 0.13 %  
 V THDG : 0.13 %  
 Distortion factor(A) : 0.61 %  
 A THDS : 0.68 %  
 A THDG : 0.71 %  
 P THD : 0.00 %  
 Power Limit : 75 W

Order	Measure[A]	Limit[A]	Margin[%]	Order	Measure[A]	Limit[A]	Margin[%]
1	15.8678	3.4500	99.1	2	0.0498	1.6200	97.1
3	0.0310	1.1500	97.4	4	0.0200	0.6450	95.9
5	0.0421	1.7100	97.5	6	0.0144	0.4500	96.8
7	0.0301	1.1500	97.4	8	0.0127	0.3450	96.3
9	0.0110	0.6000	97.7	10	0.0117	0.2780	95.8
11	0.0141	0.4950	97.2	12	0.0142	0.2300	93.8
13	0.0122	0.3150	90.0	14	0.0126	0.1971	93.6
16	0.0070	0.2260	98.0	18	0.0115	0.1725	93.3
17	0.0081	0.1985	95.9	18	0.0132	0.1533	91.1
19	0.0080	0.1776	95.6	20	0.0126	0.1380	90.0
21	0.0118	0.1607	92.7	22	0.0113	0.1255	91.0
23	0.0082	0.1467	94.4	24	0.0122	0.1150	89.4
26	0.0083	0.1350	93.8	26	0.0121	0.1062	88.6
27	0.0064	0.1250	93.3	28	0.0109	0.0966	88.9
28	0.0105	0.1164	90.9	30	0.0116	0.0920	87.4
31	0.0095	0.1080	91.2	32	0.0115	0.0862	86.7
33	0.0090	0.1023	91.2	34	0.0114	0.0912	85.9
35	0.0090	0.0964	90.7	38	0.0141	0.0767	81.6
37	0.0105	0.0912	88.5	38	0.0120	0.0726	83.5
39	0.0109	0.0865	87.4	40	0.0128	0.0690	81.4

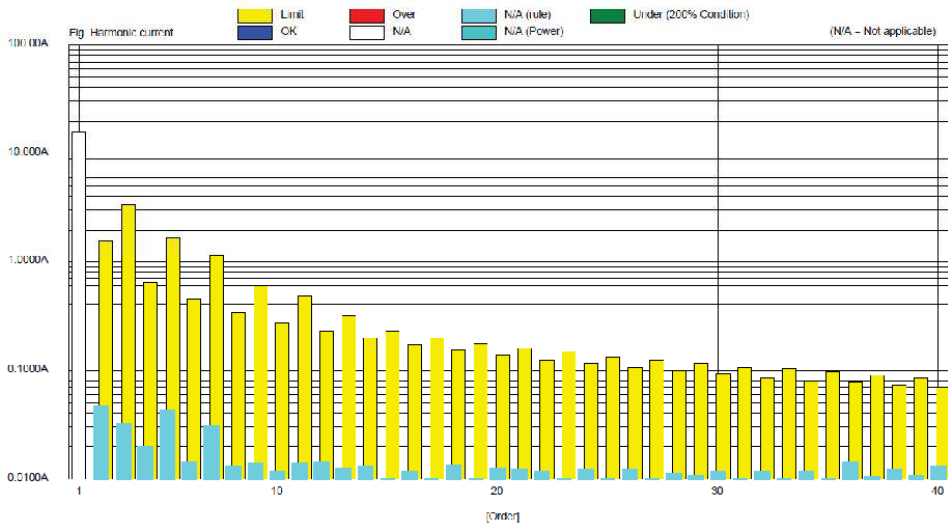

Bureau Veritas Shenzhen Co., Ltd.  
 Dongguan Branch

No. 34, Chenwulu Section, Guantai Rd., Houjie  
 Town, Dongguan City,  
 Guangdong 523942, China

Tel: +86 769 8593 5656  
 Fax: +86 769 8593 1080  
 Email: [customerservice.dg@cn.bureauveritas.com](mailto:customerservice.dg@cn.bureauveritas.com)





**BUREAU  
VERITAS** Test Report No.: CE181019N024

### 3.5 VOLTAGE FLUCTUATION AND FLICKS MEASUREMENT

#### 3.5.1 LIMITS OF VOLTAGE FLUCTUATION AND FLICKS MEASUREMENT

TEST STANDARD: EN 61000-3-3

TEST ITEM	LIMIT	NOTE
$P_{st}$	1.0	$P_{st}$ means short-term flicker indicator.
$P_{lt}$	0.65	$P_{lt}$ means long-term flicker indicator.
$T_{d(t)}$ (ms)	500	$T_{d(t)}$ means maximum time that $d(t)$ exceeds 3.3%.
$d_{max}$ (%)	4	$d_{max}$ means maximum relative voltage change.
dc (%)	3.3	dc means relative steady-state voltage change

#### 3.5.2 TEST INSTRUMENTS

Description	Manufacturer	Model no.	Serial No.	Last Cal.	Next Cal.
Power Analyzer	YOKOGAWA	WT3000	91J902079	2018/01/29	2019/01/28
Programmable DC source	Keysight	N8957APV	DE16391780	2018/08/13	2019/08/12
AC Source	Ametek	RS90-3PI-LAN-400-150 /300-HV-LF-SNK	1515A00638	2018/05/14	2019/05/13
Oscillographic recorder	YOKOGAWA	DL850	91LA25621	2018/05/15	2019/05/14

**NOTE:** 1. The test was performed by witness in H/F Room of ShangHai Huawei Technology Co., Ltd.  
2. The test was performed in Harmonics Room.

Bureau Veritas Shenzhen Co., Ltd.  
Dongguan Branch

No. 34, Chenwulu Section, Guantai Rd., Houjie  
Town, Dongguan City,  
Guangdong 523942, China

Tel: +86 769 8593 5656  
Fax: +86 769 8593 1080  
Email: [customerservice.dg@cn.bureauveritas.com](mailto:customerservice.dg@cn.bureauveritas.com)

Page 46 of 92

Report Version 1



**BUREAU VERITAS** Test Report No.: CE181019N024

### 3.5.3 TEST PROCEDURE

- a. The EUT was placed on the top of a wooden table 0.8 meters above the ground and operated to produce the most unfavorable sequence of voltage changes under Normal Operating conditions.
- b. During the flick measurement, the measure time shall include that part of whole operation cycle in which the EUT produce the most unfavorable sequence of voltage changes. The observation period for short-term flicker indicator is 120 minutes

### 3.5.4 .DEVIATION FROM TEST STANDARD

No deviation

### 3.5.5 TEST SETUP

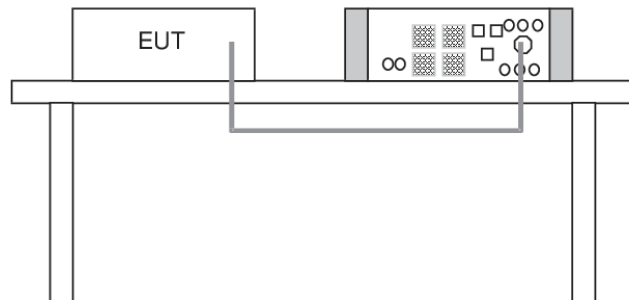

### 3.5.6 EUT OPERATING CONDITIONS

Same as item 3.1.6.



BUREAU VERITAS Test Report No.: CE181019N024

### 3.5.7 TEST RESULTS

SUN2000-10KTL-M0

Regulation : IEC61000-3-3 Ed2.0  
IEC61000-4-15 Ed2.0  
Interval : 10Min0Sec  
Model : YOKOGAWA WT3000  
Wiring : three-phase 4wire  
Voltage Range : 300.00V  
Set Voltage : 230V  
Set Frequency : 50Hz  
Voltage U1 : 230.33V  
Frequency U1 : 50.000Hz  
Element : 1  
dmin : 0.20%

**PASS**  
(Under dmin)

Element1 : Pass  
dc (3.30%) : Pass  
dmax (6.00%) : Pass  
d(t) (500ms) : Pass  
Pst (1.00) : Pass  
Pit (0.65) : Pass

No.	dc[%]	dmax[%]	d(t)[ms]	Pst
1	0.11	0.25	0.00	0.10

Pit  
0.04

Regulation : IEC61000-3-3 Ed2.0  
IEC61000-4-15 Ed2.0  
Interval : 10Min0Sec  
Model : YOKOGAWA WT3000  
Wiring : three-phase 4wire  
Voltage Range : 300.00V  
Set Voltage : 230V  
Set Frequency : 50Hz  
Voltage U2 : 230.32V  
Frequency U2 : 50.000Hz  
Element : 2  
dmin : 0.20%

**PASS**  
(Under dmin)

Element2 : Pass(Under dmin)  
dc (3.30%) : Pass  
dmax (6.00%) : Pass  
d(t) (500ms) : Pass  
Pst (1.00) : Pass  
Pit (0.65) : Pass

No.	dc[%]	dmax[%]	d(t)[ms]	Pst
1	0.00	0.00	0.00	0.03

Pit  
0.03

Regulation : IEC61000-3-3 Ed2.0  
IEC61000-4-15 Ed2.0  
Interval : 10Min0Sec  
Model : YOKOGAWA WT3000  
Wiring : three-phase 4wire  
Voltage Range : 300.00V  
Set Voltage : 230V  
Set Frequency : 50Hz  
Voltage U3 : 230.32V  
Frequency U3 : Error  
Element : 3  
dmin : 0.20%

**PASS**  
(Under dmin)

Element3 : Pass(Under dmin)  
dc (3.30%) : Pass  
dmax (0.00%) : Pass  
d(t) (500ms) : Pass  
Pst (1.00) : Pass  
Pit (0.65) : Pass

No.	dc[%]	dmax[%]	d(t)[ms]	Pst
1	0.00	0.00	0.00	0.03

Pit  
0.04

Bureau Veritas Shenzhen Co., Ltd.  
Dongguan Branch

No. 34, Chenwulu Section, Guantai Rd., Houjie  
Town, Dongguan City,  
Guangdong 523942, China

Tel: +86 769 8593 5656  
Fax: +86 769 8593 1080  
Email: [customerservice.dg@cn.bureauveritas.com](mailto:customerservice.dg@cn.bureauveritas.com)



BUREAU VERITAS Test Report No.: CE181019N024

## 4 IMMUNITY TEST

### 4.1 GENERAL DESCRIPTION

#### 4.1.1 GENERAL DESCRIPTION

<b>Product Standard:</b>	<b>EN 61000-6-2:2005, EN 61000-6-1:2007</b>	
<b>Basic Standard, specification requirement, and Performance Criteria:</b>	IEC 61000-4-2	Electrostatic Discharge – ESD: 6kV Contact discharge, 8kV air discharge, Performance Criterion B
	IEC 61000-4-3	Radio-Frequency Electromagnetic Field Susceptibility Test – RS: 80-1000 MHz, 10V/m, 80% AM (1kHz), 1400-2000 MHz, 10V/m, 80% AM (1kHz) 2000-2700 MHz, 10V/m, 80% AM (1kHz) Performance Criterion A
	IEC 61000-4-4	Electrical Fast Transient/Burst - EFT AC Power line: 2kV, DC Power line: 2kV Signal line: 1kV Performance Criterion B
	IEC 61000-4-5	Surge Immunity Test: 1.2/50 us Open Circuit Voltage, 8 /20 us Short Circuit Current, AC Power Line: line to line 1 kV, line to earth 2kV DC Power Line: line to line 0.5kV line to earth 0.5kV Signal line: 1kV Performance Criterion B
	IEC 61000-4-6	Conducted Radio Frequency Disturbances Test – CS: 0.15-80 MHz, 10Vrms, 80% AM, 1kHz, Performance Criterion A
	IEC 61000-4-8	Power Frequency Magnetic Field Test, 50 Hz, 30A/m, Performance Criterion A

Bureau Veritas Shenzhen Co., Ltd.  
Dongguan Branch

No. 34, Chenwulu Section, Guantai Rd., Houjie  
Town, Dongguan City,  
Guangdong 523942, China

Tel: +86 769 8593 5656  
Fax: +86 769 8593 1080  
Email: [customerservice.dg@cn.bureauveritas.com](mailto:customerservice.dg@cn.bureauveritas.com)

Page 49 of 92

Report Version 1



**BUREAU  
VERITAS** Test Report No.: CE181019N024

Product Standard	Draft EN 301 489-1 V2.2.0 (2017-03) Draft EN 301489-17 V3.2.0(2017-03)	
<b>Basic Standard, Specification, and Performance Criterion required</b>	EN 61000-4-2	Electrostatic Discharge – ESD: 8 kV air discharge, 6 kV contact discharge(client request), Performance Criterion B
	EN 61000-4-3	Radio-Frequency Electromagnetic Field Susceptibility Test – RS: 80 ~ 6000 MHz, 3 V/m, 80% AM (1 kHz), Performance Criterion A
	EN 61000-4-4	Electrical Fast Transient/Burst - EFT, AC power line: 1 kV Signal Line:0.5 kV Performance Criterion B
	EN 61000-4-5	Surge Immunity Test: 1.2/50 us Open Circuit Voltage, 8 /20 us Short Circuit Current, 10/700 us Open Circuit Voltage. 5 /320 us Short Circuit Current AC Power Line: Line to Line:1kV, Line to PE:2kV DC Power Line: Line to Line:0.5kV, Line to PE:1kV Signal Line: 1kV Performance Criterion B
	EN 61000-4-6	Conducted Radio Frequency Disturbances Test – CS: 0.15 ~ 80 MHz, 3 Vrms, 80% AM, 1 kHz, Performance Criterion A

Bureau Veritas Shenzhen Co., Ltd.  
Dongguan Branch

No. 34, Chenwulu Section, Guantai Rd., Houjie  
Town, Dongguan City,  
Guangdong 523942, China

Tel: +86 769 8593 5656  
Fax: +86 769 8593 1080  
Email: [customerservice.dg@cn.bureauveritas.com](mailto:customerservice.dg@cn.bureauveritas.com)

Page 50 of 92

Report Version 1



**BUREAU  
VERITAS** Test Report No.: CE181019N024

#### 4.1.2 PERFORMANCE CRITERIA

According to Clause 4 of EN 61000-6-2:2005, EN 61000-6-1:2007 standard, the following describes the general performance criteria.

<b>CRITERION A</b>	The apparatus shall continue to operate as intended during and after the test. No degradation of performance or loss of function is allowed below a performance level specified by the manufacturer, when the apparatus is used as intended. The performance level may be replaced by a permissible loss of performance. If the minimum performance level or the permissible performance loss is not specified by the manufacturer, either of these may be derived from the product description and documentation and what the user may reasonably expect from the apparatus if used as intended.
<b>CRITERION B</b>	The apparatus shall continue to operate as intended after the test. No degradation of performance or loss of function is allowed below a performance level specified by the manufacturer, when the apparatus is used as intended. The performance level may be replaced by a permissible loss of performance. During the test, degradation of performance is however allowed. No change of operating state or stored data is allowed. If the minimum performance level or the permissible performance loss is not specified by the manufacturer, either of these may be derived from the product description and documentation and what the user may reasonably expect from the apparatus if used as intended.
<b>CRITERION C</b>	Temporary loss of function is allowed, provided the function is self-recoverable or can be restored by the operation of the controls.

#### FOR EN301489-17

The phenomena allowed during and after test in each criterion are clearly stated in the following table.

<b>The Requirement of Performance Criteria</b>		
1	Performance criteria for continuous phenomena applied to transmitters (CT)	Criterion A of the applicable class shall apply
2	Performance criteria for transient phenomena applied to transmitters (TT)	Criterion B of the applicable class shall apply
3	Performance criteria for continuous phenomena applied to receivers (CR)	Criterion A of the applicable class shall apply
4	Performance criteria for transient phenomena applied to receivers (TR)	Criterion B of the applicable class shall apply

Bureau Veritas Shenzhen Co., Ltd.  
Dongguan Branch

No. 34, Chenwulu Section, Guantai Rd., Houjie  
Town, Dongguan City,  
Guangdong 523942, China

Tel: +86 769 8593 5656  
Fax: +86 769 8593 1080  
Email: [customerservice.dg@cn.bureauveritas.com](mailto:customerservice.dg@cn.bureauveritas.com)

Page 51 of 92

Report Version 1



**BUREAU  
VERITAS** Test Report No.: CE181019N024

The phenomena allowed during and after test in each criterion are clearly stated in the following table.

Performance criteria		
Criteria	During test	After test
A	Shall operate as intended. (see note 1). Shall be no loss of function. Shall be no unintentional transmissions.	Shall operate as intended. Shall be no degradation of performance (see note 3). Shall be no loss of function. Shall be no loss of stored data or user programmable functions.
B	May show loss of function (one or more). May show degradation of performance (see note 2). Shall be no unintentional transmissions.	Functions shall be self-recoverable. Shall operate as intended after recovering. Shall be no degradation of performance (see note 3). Shall be no loss of stored data or user programmable functions.
C	May be loss of function (one or more).	Functions shall be recoverable by the operator. Shall operate as intended after recovering. Shall be no degradation of performance (see note 3).
<p><b>NOTE 1:</b> Operate as intended during the test allows a level of degradation not below a minimum performance level specified by the manufacturer for the use of the apparatus as intended. In some cases the specified minimum performance level may be replaced by a permissible degradation of performance. If the minimum performance level or the permissible performance degradation is not specified by the manufacturer then either of these may be derived from the product description and documentation (including leaflets and advertising) and what the user may reasonably expect from the apparatus if used as intended..</p> <p><b>NOTE 2:</b> Degradation of performance during the test is understood as a degradation to a level not below a minimum performance level specified by the manufacturer for the use of the apparatus as intended. In some cases the specified minimum performance level may be replaced by a permissible degradation of performance. If the minimum performance level or the permissible performance degradation is not specified by the manufacturer then either of these may be derived from the product description and documentation (including leaflets and advertising) and what the user may reasonably expect from the apparatus if used as intended.</p> <p><b>NOTE 3:</b> No degradation of performance after the test is understood as no degradation below a minimum performance level specified by the manufacturer for the use of the apparatus as intended. In some cases the specified minimum performance level may be replaced by a permissible degradation of performance. After the test no change of actual operating data or user retrievable data is allowed. If the minimum performance level or the permissible performance degradation is not specified by the manufacturer then either of these may be derived from the product description and documentation (including leaflets and advertising) and what the user may reasonably expect from the apparatus if used as intended.</p>		

#### 4.1.3 EUT OPERATING CONDITION

Same as item 3.1.6

Bureau Veritas Shenzhen Co., Ltd.  
Dongguan Branch

No. 34, Chenwulu Section, Guantai Rd., Houjie  
Town, Dongguan City,  
Guangdong 523942, China

Tel: +86 769 8593 5656  
Fax: +86 769 8593 1080  
Email: [customerservice.dg@cn.bureauveritas.com](mailto:customerservice.dg@cn.bureauveritas.com)

Page 52 of 92

Report Version 1



**BUREAU** Test Report No.: CE181019N024  
**VERITAS**

## 4.2 ELECTROSTATIC DISCHARGE IMMUNITY TEST (ESD) (EN 61000-6-2, EN 301 489)

### 4.2.1 TEST SPECIFICATION

<b>Basic Standard:</b>	IEC 61000-4-2
<b>Discharge Impedance:</b>	330 ohm / 150 pF
<b>Discharge Voltage:</b>	Air Discharge: 8 kV (Direct) Contact Discharge: 6 kV (Indirect & Direct)
<b>Polarity:</b>	Positive & Negative
<b>Number of Discharge:</b>	20 times at each test point
<b>Discharge Mode:</b>	Single Discharge
<b>Discharge Period:</b>	1 second

### 4.2.2 TEST INSTRUMENTS

Equipment	Manufacturer	Model No.	Serial No.	Last Cal.	Next Cal.
ESD simulator	Teseq	NSG 437	398	2018/5/8	2019/5/7

**NOTE:** 1.The test was performed by witness in BF-61 room of ShangHai Huawei Technology Co., Ltd.  
2.The test was performed in BF-61 Room.

Bureau Veritas Shenzhen Co., Ltd.  
Dongguan Branch

No. 34, Chenwulu Section, Guantai Rd., Houjie  
Town, Dongguan City,  
Guangdong 523942, China

Tel: +86 769 8593 5656  
Fax: +86 769 8593 1080  
Email: [customerservice.dg@cn.bureauveritas.com](mailto:customerservice.dg@cn.bureauveritas.com)

Page 53 of 92

Report Version 1





BUREAU  
VERITAS Test Report No.: CE181019N024

#### 4.2.3 TEST PROCEDURE

The basic test procedure was in accordance with IEC 61000-4-2:

- a. Electrostatic discharges were applied only to those points and surfaces of the EUT that are accessible to users during normal operation.
- b. The test was performed with at least ten single discharges on the pre-selected points in the most sensitive polarity.
- c. The time interval between two successive single discharges was at least 1 second.
- d. The discharge return cable of the generator shall be kept at a distance of at least 0.2 m from the EUT whilst the discharge is being applied and should not be held by the operator.
- e. Contact discharges were applied to the non-insulating coating, with the pointed tip of the generator penetrating the coating and contacting the conducting substrate.
- f. Air discharges were applied with the round discharge tip of the discharge electrode approaching the EUT as fast as possible (without causing mechanical damage) to touch the EUT. After each discharge, the ESD generator was removed from the EUT and re-triggered for a new single discharge. The test was repeated until all discharges were complete.
- g. At least ten single discharges (in the most sensitive polarity) were applied to the **Horizontal Coupling Plane** at points on each side of the EUT. The ESD generator was positioned horizontal at a distance of 0.1 meters from the EUT with the discharge electrode touching the **HCP**.
- h. At least ten single discharges (in the most sensitive polarity) were applied to the center of one vertical edge of the **Vertical Coupling Plane** in sufficiently different positions that the four faces of the EUT were completely illuminated. The **VCP** (dimensions 0.5m x 0.5m) was placed vertically to and 0.1 meters from the EUT.

#### 4.2.4 DEVIATION FROM TEST STANDARD

No Deviation

Bureau Veritas Shenzhen Co., Ltd.  
Dongguan Branch

No. 34, Chenwulu Section, Guantai Rd., Houjie  
Town, Dongguan City,  
Guangdong 523942, China

Tel: +86 769 8593 5656  
Fax: +86 769 8593 1080  
Email: [customerservice.dg@cn.bureauveritas.com](mailto:customerservice.dg@cn.bureauveritas.com)

Page 54 of 92

Report Version 1

Bureau Veritas Shenzhen Co., Ltd.  
Dongguan Branch

No. 34, Chenwulu Section, Guantai Rd.,  
Houjie Town, Dongguan City, Guangdong  
523942, China

Page 145 of 189

Tel: +86 769 8593 5656  
Fax: +86 769 8599 1080  
Email: [customerservice.dg@cn.bureauveritas.com](mailto:customerservice.dg@cn.bureauveritas.com)  
TEST REPORT G98-1 VER.0



## 4.2.5 TEST SETUP

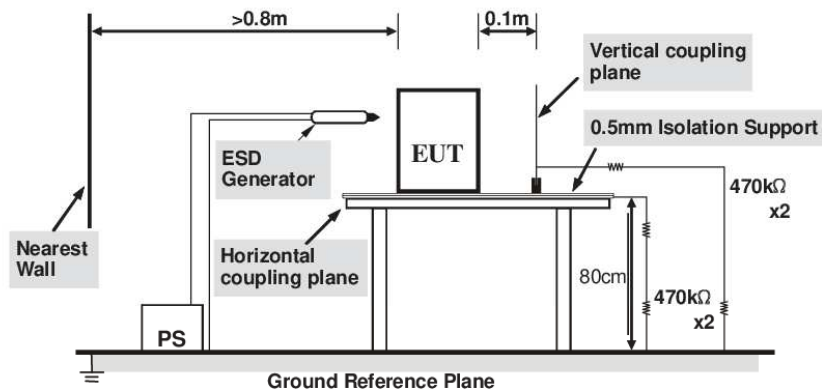

### NOTE:

#### TABLE-TOP EQUIPMENT

The configuration consisted of a wooden table 0.8 meters high standing on the **Ground Reference Plane**. The **GRP** consisted of a sheet of aluminum at least 0.25mm thick, and 2.5 meters square connected to the protective grounding system. A **Horizontal Coupling Plane** (1.6m x 0.8m) was placed on the table and attached to the **GRP** by means of a cable with 940kΩ total impedance. The equipment under test, was installed in a representative system as described in section 7 of IEC 61000-4-2, and its cables were placed on the **HCP** and isolated by an insulating support of 0.5mm thickness. A distance of 0.8-meter minimum was provided between the EUT and the walls of the laboratory and any other metallic structure.

#### FLOOR-STANDING EQUIPMENT

The equipment under test was installed in a representative system as described in section 7 of IEC 61000-4-2, and its cables were isolated from the Ground Reference Plane by an insulating support of 0.1-meter thickness. The GRP consisted of a sheet of aluminum that is at least 0.25mm thick, and 2.5 meters square connected to the protective grounding system and extended at least 0.5 meters from the EUT on all sides.



**BUREAU  
VERITAS** Test Report No.: CE181019N024

#### 4.2.6 TEST RESULTS

<b>TEST MODE</b>	Mode A&B	<b>TEST VOLTAGE</b>	DC 400V AC 400V;
<b>ENVIRONMENTAL CONDITIONS</b>	21deg. C, 50% RH 101.00kPa	<b>TESTED BY:</b> Zhou Weijie	

Direct Discharge Application				
Test Level (kV)	Polarity	Test Point	Test Result of Contact Discharge	Test Result of Air Discharge
6	+/-	All Metal Part	A	N/A
8	+/-	All Non-metal Part	N/A	A

Indirect Discharge Application				
Discharge Level (kV)	Polarity	Test Point	Test Result of HCP	Test Result of VCP
6	+/-	HCP&VCP	A	A

<b>TEST MODE</b>	Mode C	<b>TEST VOLTAGE</b>	DC 0V AC 400V;
<b>ENVIRONMENTAL CONDITIONS</b>	21deg. C, 50% RH 101.00kPa	<b>TESTED BY:</b> Zhou Weijie	

Direct Discharge Application				
Test Level (kV)	Polarity	Test Point	Test Result of Contact Discharge	Test Result of Air Discharge
6	+/-	All Metal Part	A	N/A
8	+/-	All Non-metal Part	N/A	A

Indirect Discharge Application				
Discharge Level (kV)	Polarity	Test Point	Test Result of HCP	Test Result of VCP
6	+/-	HCP&VCP	A	A

**NOTE:** A: There was no change compared with initial operation during the test.

Bureau Veritas Shenzhen Co., Ltd.  
Dongguan Branch

No. 34, Chenwulu Section, Guantai Rd., Houjie  
Town, Dongguan City,  
Guangdong 523942, China

Tel: +86 769 8593 5656  
Fax: +86 769 8593 1080  
Email: [customerservice.dg@cn.bureauveritas.com](mailto:customerservice.dg@cn.bureauveritas.com)

Page 56 of 92

Report Version 1



**BUREAU  
VERITAS** Test Report No.: CE181019N024

### 4.3 RADIATED, RADIO-FREQUENCY, ELECTROMAGNETIC FIELD IMMUNITY TEST (RS) (EN 61000-6-2)

#### 4.3.1 TEST SPECIFICATION

<b>Basic Standard:</b>	IEC 61000-4-3
<b>Frequency Range:</b>	80-1000MHz, 1400-2000MHz, 2000-2700MHz
<b>Field Strength:</b>	10V/m
<b>Modulation:</b>	1kHz Sine Wave, 80%, AM Modulation
<b>Frequency Step:</b>	1 % of fundamental
<b>Polarity of Antenna:</b>	Horizontal and Vertical
<b>Antenna Height:</b>	1.5m
<b>Dwell Time:</b>	at least 3 seconds

#### 4.3.2 TEST INSTRUMENTS

Equipment	Manufacturer	Model No.	Serial No.	Last Cal.	Next Cal.
Signal generator	AR	SG6000	327339	2018/7/23	2019/7/22
Power Meter	AR	PM2003	339736	2018/7/23	2019/7/22
Amplifier	AR	500W1000A	337312	2018/7/23	2019/7/22
Amplifier	AR	175S1G4M3	340318	2018/7/23	2019/7/22
Directional Coupler	AR	DC6180A	311186	2018/7/23	2019/7/22
Directional Coupler	AR	DC7144A	336840	2018/7/23	2019/7/22
Log-periodic antenna	SCHWARZBECK	STLP 9128D	9128D036	N/A	N/A

**NOTE:** 1.The test was performed by witness in 3m Chamber of ShangHai Huawei Technology Co., Ltd.  
2.The test was performed in 3m Chamber.

Bureau Veritas Shenzhen Co., Ltd.  
Dongguan Branch

No. 34, Chenwulu Section, Guantai Rd., Houjie  
Town, Dongguan City,  
Guangdong 523942, China

Tel: +86 769 8593 5656  
Fax: +86 769 8593 1080  
Email: [customerservice.dg@cn.bureauveritas.com](mailto:customerservice.dg@cn.bureauveritas.com)

Page 57 of 92

Report Version 1



BUREAU VERITAS Test Report No.: CE181019N024

### 4.3.3 TEST PROCEDURE

The test procedure was in accordance with IEC 61000-4-3

- The testing was performed in a fully-anechoic chamber.
- The frequency range is swept from 80 MHz to 1000 MHz, 1400MHz to 2000MHz, 2000MHz to 2700MHz with the signal 80% amplitude modulated with a 1kHz sine wave.
- The dwell time at each frequency shall not be less than the time necessary for the EUT to be exercised and to respond, but shall in no case be less than 0,5s.
- The field strength levels were 10V/m.
- The test was performed with the EUT exposed to both vertically and horizontally polarized fields on each of the four sides.

### 4.3.4 DEVIATION FROM TEST STANDARD

No Deviation

### 4.3.5 TEST SETUP

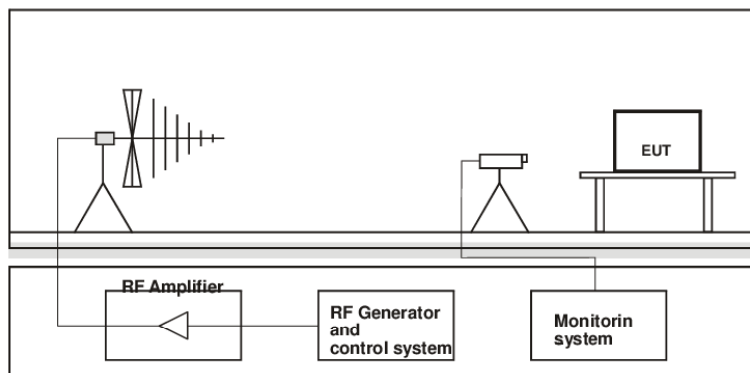

#### NOTE:

##### TABLETOP EQUIPMENT

The EUT installed in a representative system as described in section 7 of IEC 61000-4-3 was placed on a non-conductive table 0.8 meters in height. The system under test was connected to the power and signal wire according to relevant installation instructions.

##### FLOOR STANDING EQUIPMENT

The EUT installed in a representative system as described in section 7 of IEC 61000-4-3 was placed on a non-conductive wood support 0.1 meters in height. The system under test was connected to the power and signal wire according to relevant installation instructions.

Bureau Veritas Shenzhen Co., Ltd.  
Dongguan Branch

No. 34, Chenwulu Section, Guantai Rd., Houjie  
Town, Dongguan City,  
Guangdong 523942, China

Tel: +86 769 8593 5656  
Fax: +86 769 8593 1080  
Email: [customerservice.dg@cn.bureauveritas.com](mailto:customerservice.dg@cn.bureauveritas.com)

Page 58 of 92

Report Version 1



BUREAU VERITAS Test Report No.: CE181019N024

#### 4.3.6 TEST RESULTS

<b>TEST MODE</b>	Mode A&B	<b>TEST VOLTAGE</b>	DC 400V AC 400V;
<b>ENVIRONMENTAL CONDITIONS</b>	21deg. C, 58% RH	<b>TESTED BY:</b> Zhou Weijie	

Field Strength (V/m)	Test Frequency Note#1 (MHz)	Polarization of antenna (Horizontal / Vertical)	Test Distance (m)	Test Result	Remark
10	80 - 1000	H&V	3	A	N/A
10	1400 - 2000	H&V	3	A	N/A
10	2000 - 2700	H&V	3	A	N/A

<b>TEST MODE</b>	Mode C	<b>TEST VOLTAGE</b>	DC 0V AC 400V;
<b>ENVIRONMENTAL CONDITIONS</b>	21deg. C, 58% RH	<b>TESTED BY:</b> Zhou Weijie	

Field Strength (V/m)	Test Frequency Note#1 (MHz)	Polarization of antenna (Horizontal / Vertical)	Test Distance (m)	Test Result	Remark
10	80 - 1000	H&V	3	A	N/A
10	1400 - 2000	H&V	3	A	N/A
10	2000 - 2700	H&V	3	A	N/A

Note#1: Tested Israel SII Frequencies 89,100,107,144,163,196,244,315,434,460,600,825,845,880 MHz

**NOTE:** A: There was no change compared with initial operation during the test.

Bureau Veritas Shenzhen Co., Ltd.  
Dongguan Branch

No. 34, Chenwulu Section, Guantai Rd., Houjie  
Town, Dongguan City,  
Guangdong 523942, China

Tel: +86 769 8593 5656  
Fax: +86 769 8593 1080  
Email: [customerservice.dg@cn.bureauveritas.com](mailto:customerservice.dg@cn.bureauveritas.com)



**BUREAU VERITAS** Test Report No.: CE181019N024

## 4.4 RADIATED, RADIO-FREQUENCY, ELECTROMAGNETIC FIELD IMMUNITY TEST (RS) (EN 310 489)

### 4.4.1 TEST SPECIFICATION

<b>Basic Standard:</b>	IEC 61000-4-3
<b>Frequency Range:</b>	80-6000MHz
<b>Field Strength:</b>	10V/m
<b>Modulation:</b>	1kHz Sine Wave, 80%, AM Modulation
<b>Frequency Step:</b>	1 % of fundamental
<b>Polarity of Antenna:</b>	Horizontal and Vertical
<b>Antenna Height:</b>	1.5m
<b>Dwell Time:</b>	at least 3 seconds

### 4.4.2 TEST INSTRUMENTS

Equipment	Manufacturer	Model No.	Serial No.	Last Cal.	Next Cal.
Signal generator	AR	SG6000	327339	2018/7/23	2019/7/22
Power Meter	AR	PM2003	339736	2018/7/23	2019/7/22
Amplifier	AR	500W1000A	337312	2018/7/23	2019/7/22
Amplifier	AR	175S1G4M3	340318	2018/7/23	2019/7/22
Directional Coupler	AR	DC6180A	311186	2018/7/23	2019/7/22
Directional Coupler	AR	DC7144A	336840	2018/7/23	2019/7/22
Log-periodic antenna	SCHWARZBECK	STLP 9128D	9128D036	N/A	N/A

**NOTE:** 1.The test was performed by witness in 3m Chamber of ShangHai Huawei Technology Co., Ltd.  
2.The test was performed in 3m Chamber.

Bureau Veritas Shenzhen Co., Ltd.  
Dongguan Branch

No. 34, Chenwulu Section, Guantai Rd., Houjie  
Town, Dongguan City,  
Guangdong 523942, China

Tel: +86 769 8593 5656  
Fax: +86 769 8593 1080  
Email: [customerservice.dg@cn.bureauveritas.com](mailto:customerservice.dg@cn.bureauveritas.com)

Page 60 of 92

Report Version 1



**BUREAU VERITAS** Test Report No.: CE181019N024

#### 4.4.3 TEST PROCEDURE

The test procedure was in accordance with IEC 61000-4-3

- f. The testing was performed in a fully-anechoic chamber.
- g. The frequency range is swept from 80 MHz to 6000 MHz with the signal 80% amplitude modulated with a 1kHz sine wave.
- h. The dwell time at each frequency shall not be less than the time necessary for the EUT to be exercised and to respond, but shall in no case be less than 0,5s.
- i. The field strength levels were 10V/m.
- j. The test was performed with the EUT exposed to both vertically and horizontally polarized fields on each of the four sides.

#### 4.4.4 DEVIATION FROM TEST STANDARD

No Deviation

#### 4.4.5 TEST SETUP

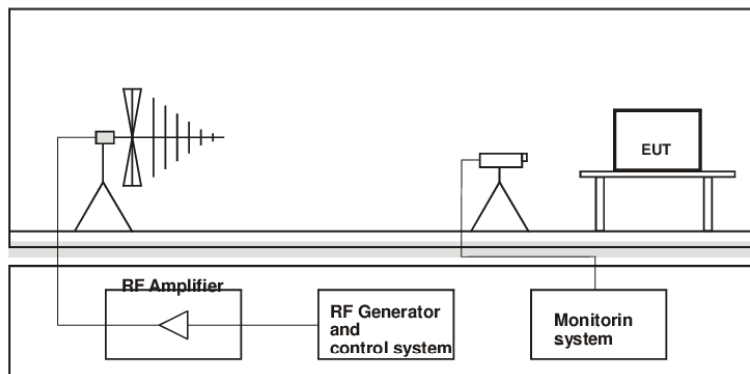

#### NOTE:

##### TABLETOP EQUIPMENT

The EUT installed in a representative system as described in section 7 of IEC 61000-4-3 was placed on a non-conductive table 0.8 meters in height. The system under test was connected to the power and signal wire according to relevant installation instructions.

##### FLOOR STANDING EQUIPMENT

The EUT installed in a representative system as described in section 7 of IEC 61000-4-3 was placed on a non-conductive wood support 0.1 meters in height. The system under test was connected to the power and signal wire according to relevant installation instructions.

Bureau Veritas Shenzhen Co., Ltd.  
Dongguan Branch

No. 34, Chenwulu Section, Guantai Rd., Houjie  
Town, Dongguan City,  
Guangdong 523942, China

Tel: +86 769 8593 5656  
Fax: +86 769 8593 1080  
Email: [customerservice.dg@cn.bureauveritas.com](mailto:customerservice.dg@cn.bureauveritas.com)

Page 61 of 92

Report Version 1





BUREAU VERITAS Test Report No.: CE181019N024

#### 4.4.6 TEST RESULTS

<b>TEST MODE</b>	Mode A&B	<b>TEST VOLTAGE</b>	DC 400V AC 400V;
<b>ENVIRONMENTAL CONDITIONS</b>	21deg. C, 58% RH	<b>TESTED BY:</b> Zhou Weijie	

Field Strength (V/m)	Test Frequency Note#1 (MHz)	Polarization of antenna (Horizontal / Vertical)	Test Distance (m)	Test Result	Remark
10	80 - 6000	H&V	3	A	N/A

<b>TEST MODE</b>	Mode C	<b>TEST VOLTAGE</b>	DC 0V AC 400V;
<b>ENVIRONMENTAL CONDITIONS</b>	21deg. C, 58% RH	<b>TESTED BY:</b> Zhou Weijie	

Field Strength (V/m)	Test Frequency Note#1 (MHz)	Polarization of antenna (Horizontal / Vertical)	Test Distance (m)	Test Result	Remark
10	80 - 6000	H&V	3	A	N/A

Note#1: Tested Israel SII Frequencies 89,100,107,144,163,196,244,315,434,460,600,825,845, 880 MHz

**NOTE:** A: There was no change compared with initial operation during the test.

Bureau Veritas Shenzhen Co., Ltd.  
Dongguan Branch

No. 34, Chenwulu Section, Guantai Rd., Houjie  
Town, Dongguan City,  
Guangdong 523942, China

Tel: +86 769 8593 5656  
Fax: +86 769 8593 1080  
Email: [customerservice.dg@cn.bureauveritas.com](mailto:customerservice.dg@cn.bureauveritas.com)

Page 62 of 92

Report Version 1



**BUREAU  
VERITAS** Test Report No.: CE181019N024

## 4.5 ELECTRICAL FAST TRANSIENT/BURST IMMUNITY TEST (EFT) (EN 61000-6-2, EN 301 489)

### 4.5.1 TEST SPECIFICATION

<b>Basic Standard:</b>	IEC 61000-4-4
<b>Test Voltage:</b>	Power Line: 2kV Signal Line: 2kV
<b>Polarity:</b>	Positive & Negative
<b>Impulse Frequency:</b>	5 kHz
<b>Impulse Waveshape :</b>	5/50 ns
<b>Burst Duration:</b>	15 ms
<b>Burst Period:</b>	300 ms
<b>Test Duration:</b>	1 min.

### 4.5.2 TEST INSTRUMENTS

Equipment	Manufacturer	Model No.	Serial No.	Last Cal.	Next Cal.
Fast Transient Burt Simulator	Teseq	NSG2025	32075	2018/7/23	2019/7/22
Coupling clamp	Teseq	CDN8014	31839	2018/7/23	2019/7/22
Coupling Decoupling Network	Teseq	CDN163	160	2018/7/23	2019/7/22

**NOTE:** 1. The test was performed by witness in BF-65 room of ShangHai Huawei Technology Co., Ltd.  
2. The test was performed in BF-65 Room.

### 4.5.3 TEST PROCEDURE

- Both positive and negative polarity discharges were applied.
- The distance between any coupling devices and the EUT should be (0.5 – 0/+0.1) m for table-top equipment testing, and (1.0 ± 0.1) m for floor standing equipment.
- The duration time of each test sequential was 1 minute.
- The transient/burst waveform was in accordance with IEC 61000-4-4, 5/50ns.

Bureau Veritas Shenzhen Co., Ltd.  
Dongguan Branch

No. 34, Chenwulu Section, Guantai Rd., Houjie  
Town, Dongguan City,  
Guangdong 523942, China

Tel: +86 769 8593 5656  
Fax: +86 769 8593 1080  
Email: [customerservice.dg@cn.bureauveritas.com](mailto:customerservice.dg@cn.bureauveritas.com)

Page 63 of 92

Report Version 1



BUREAU VERITAS Test Report No.: CE181019N024

#### 4.5.4 DEVIATION FROM TEST STANDARD

No deviation.

#### 4.5.5 TEST SETUP

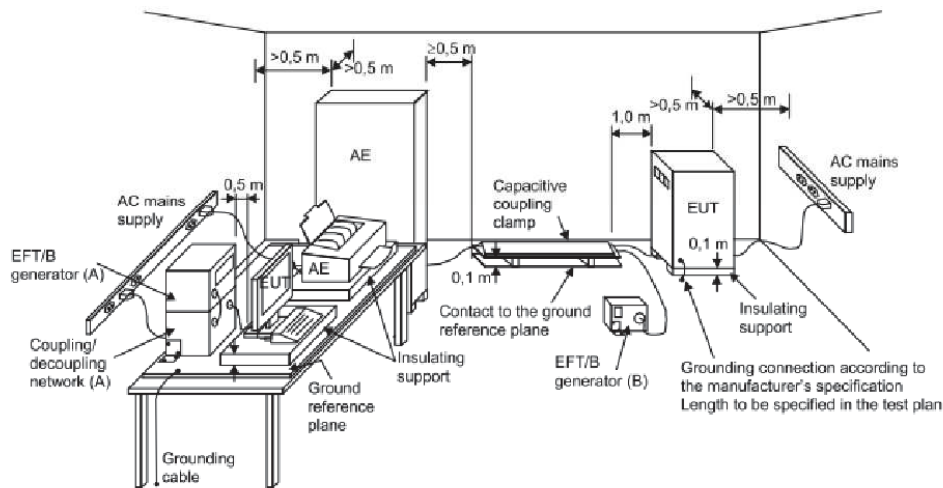

IEC 645/12

#### NOTE:

- (A) location for supply line coupling
- (B) location for signal lines coupling

For the actual test configuration, please refer to the related item – Photographs of the Test Configuration

Bureau Veritas Shenzhen Co., Ltd.  
Dongguan Branch

No. 34, Chenwulu Section, Guantai Rd., Houjie  
Town, Dongguan City,  
Guangdong 523942, China

Tel: +86 769 8593 5656  
Fax: +86 769 8593 1080  
Email: [customerservice.dg@cn.bureauveritas.com](mailto:customerservice.dg@cn.bureauveritas.com)

Page 64 of 92

Report Version 1



BUREAU VERITAS Test Report No.: CE181019N024

#### 4.5.6 TEST RESULTS

<b>TEST MODE</b>	Mode A&B	<b>TEST VOLTAGE</b>	DC 400V AC 400V
<b>ENVIRONMENTAL CONDITIONS</b>	21 deg. C, 55% RH	<b>TESTED BY:</b> Zhou Weijie	

Pulse Voltage	1 kV		2 kV		kV		kV	
	+	-	+	-	+	-	+	-
L1+L2+L3 + PE	/	/	A	A	/	/	/	/
L1+L2+L3	/	/	A	A	/	/	/	/
N	/	/	A	A	/	/	/	/
PE	/	/	A	A	/	/	/	/
N+PE	/	/	A	A	/	/	/	/
PV+, PV-, PE	/	/	A	A	/	/	/	/
485 Port	A	A	/	/	/	/	/	/
DI Port	A	A	/	/	/	/	/	/
Emergency Stop signal	A	A	/	/	/	/	/	/
Energy storage signal	A	A	/	/	/	/	/	/

<b>TEST MODE</b>	Mode C	<b>TEST VOLTAGE</b>	DC 0V AC 400V
<b>ENVIRONMENTAL CONDITIONS</b>	21 deg. C, 55% RH	<b>TESTED BY:</b> Zhou Weijie	

Pulse Voltage	1 kV		2 kV		kV		kV	
	+	-	+	-	+	-	+	-
L1+L2+L3 + PE	/	/	A	A	/	/	/	/
L1+L2+L3	/	/	A	A	/	/	/	/
N	/	/	A	A	/	/	/	/
PE	/	/	A	A	/	/	/	/
N+PE	/	/	A	A	/	/	/	/
PV+, PV-, PE	/	/	A	A	/	/	/	/
485 Port	A	A	/	/	/	/	/	/
DI Port	A	A	/	/	/	/	/	/
Emergency Stop signal	A	A	/	/	/	/	/	/
Energy storage signal	A	A	/	/	/	/	/	/

**NOTE:** A: There was no change compared with initial operation during the test

Bureau Veritas Shenzhen Co., Ltd.  
Dongguan Branch

No. 34, Chenwulu Section, Guantai Rd., Houjie  
Town, Dongguan City,  
Guangdong 523942, China

Tel: +86 769 8593 5656  
Fax: +86 769 8593 1080  
Email: [customerservice.dg@cn.bureauveritas.com](mailto:customerservice.dg@cn.bureauveritas.com)

Page 65 of 92

Report Version 1



**BUREAU  
VERITAS** Test Report No.: CE181019N024

## 4.6 SURGE IMMUNITY TEST (EN 61000-6-2)

### 4.6.1 TEST SPECIFICATION

<b>Basic Standard:</b>	IEC 61000-4-5
<b>Wave-Shape:</b>	Combination Wave 1.2/50 us Open Circuit Voltage 8 /20 us Short Circuit Current
<b>Test Voltage:</b>	AC Power Line: Line to Line:1kV, Line to PE:2kV DC Power Line: Line to Line:0.5kV, Line to PE:1kV Signal Line: 1kV
<b>Surge Input/Output:</b>	L1-L2-L3-N&L-PE, N-PE, RS485, All Signal Port
<b>Polarity:</b>	Positive/Negative
<b>Phase Angle:</b>	0° /90°/180°/270°
<b>Pulse Repetition Rate:</b>	1 time / 60 sec.
<b>Number of Tests:</b>	5 positive and 5 negative at selected points

### 4.6.2 TEST INSTRUMENTS

Equipment	Manufacturer	Model No.	Serial No.	Last Cal.	Next Cal.
High Energy Pulse Generator	3cTEST	CWS 1000G	ES3521701	2018/3/28	2019/3/27
Coupling Decoupling Network	3cTEST	SPN1550T	ES4221701	2018/5/2	2019/5/1
Coupling Decoupling Network	3cTEST	SPN1550T	ES4221702	2018/5/2	2019/5/1
High energy pulse generator	3cTEST	CWS 1000CT	ES3531801	2018/7/23	2019/7/22

- NOTE:** 1. The test was performed by witness in BF-65 room of ShangHai Huawei Technology Co., Ltd.  
2. The test was performed in BF-65 Room.

Bureau Veritas Shenzhen Co., Ltd.  
Dongguan Branch

No. 34, Chenwulu Section, Guantai Rd., Houjie  
Town, Dongguan City,  
Guangdong 523942, China

Tel: +86 769 8593 5656  
Fax: +86 769 8593 1080  
Email: [customerservice.dg@cn.bureauveritas.com](mailto:customerservice.dg@cn.bureauveritas.com)

Page 66 of 92

Report Version 1



**BUREAU  
VERITAS** Test Report No.: CE181019N024

### 4.6.3 TEST PROCEDURE

a. For EUT power supply:

The surge is to be applied to the EUT power supply terminals via the capacitive coupling network. Decoupling networks are required in order to avoid possible adverse effects on equipment not under test that may be powered by the same lines, and to provide sufficient decoupling impedance to the surge wave. The power cord between the EUT and the coupling/decoupling networks shall be 2 meters in length (or shorter).

b. For test applied to unshielded unsymmetrically operated interconnection lines of EUT:

The surge is applied to the lines via the capacitive coupling. The coupling / decoupling networks shall not influence the specified functional conditions of the EUT. The interconnection line between the EUT and the coupling/decoupling networks shall be 2 meters in length (or shorter).

c. For test applied to unshielded symmetrically operated interconnection / telecommunication lines of EUT:

The surge is applied to the lines via gas arrestors coupling. Test levels below the ignition point of the coupling arrestor cannot be specified. The interconnection line between the EUT and the coupling/decoupling networks shall be 2 meters in length (or shorter).

### 4.6.4 DEVIATION FROM TEST STANDARD

No deviation.

### 4.6.5 TEST SETUP

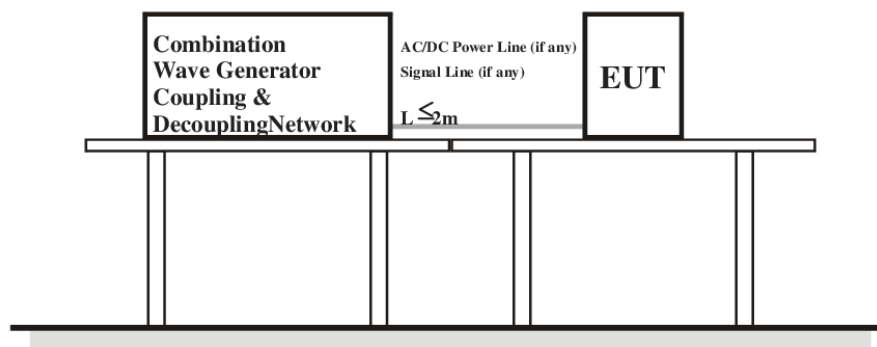

Bureau Veritas Shenzhen Co., Ltd.  
Dongguan Branch

No. 34, Chenwulu Section, Guantai Rd., Houjie  
Town, Dongguan City,  
Guangdong 523942, China

Tel: +86 769 8593 5656  
Fax: +86 769 8593 1080  
Email: [customerservice.dg@cn.bureauveritas.com](mailto:customerservice.dg@cn.bureauveritas.com)

Page 67 of 92

Report Version 1



**BUREAU VERITAS** Test Report No.: CE181019N024

### 4.6.6 TEST RESULTS

<b>TEST MODE</b>	Mode A&B	<b>TEST VOLTAGE</b>	DC 400V AC 400V
<b>ENVIRONMENTAL CONDITIONS</b>	21deg. C, 55% RH	<b>TESTED BY:</b> Zhou Weijie	

**AC/DC Power port:**

Voltage (kV)	\Phase angle \ Test point	\ Test result \ Polarity	Test point				DC Power Port & Energy storage port	
			0°	90°	180°	270°		
0.5	/	+	/	/	/	/	PV+ - PV-	A
		-	/	/	/	/		A
1	L1-L2	+	A	A	A	A	PV+ - PE	A
		-	A	A	A	A		A
1	L1-L3	+	A	A	A	A	PV- - PE	A
		-	A	A	A	A		A
1	L2-L3	+	A	A	A	A	/	/
		-	A	A	A	A	/	/
1	L1-N	+	A	A	A	A	/	/
		-	A	A	A	A	/	/
2	L1-PE	+	A	A	A	A	/	/
		-	A	A	A	A	/	/
2	L2-PE	+	A	A	A	A	/	/
		-	A	A	A	A	/	/
2	L3-PE	+	A	A	A	A	/	/
		-	A	A	A	A	/	/
2	N-PE	+	A	A	A	A	/	/
		-	A	A	A	A	/	/

**Signal ports and telecommunication ports:**

Voltage (kV)	Test Point	Polarity	Test result	Voltage (kV)	Test Point	Polarity	Test result
1	485 Port	+/-	A	1	DI Port	+/-	A
1	Emergency Stop signal	+/-	A	1	Energy storage signal	+/-	A

**NOTE:** A: There was no change compared with initial operation during the test.

Bureau Veritas Shenzhen Co., Ltd.  
Dongguan Branch

No. 34, Chenwulu Section, Guantai Rd., Houjie Town, Dongguan City, Guangdong 523942, China

Tel: +86 769 8593 5656  
Fax: +86 769 8593 1080  
Email: [customerservice.dg@cn.bureauveritas.com](mailto:customerservice.dg@cn.bureauveritas.com)



**BUREAU VERITAS** Test Report No.: CE181019N024

<b>TEST MODE</b>	Mode C	<b>TEST VOLTAGE</b>	DC 0V AC 400V
<b>ENVIRONMENTAL CONDITIONS</b>	21deg. C, 55% RH	<b>TESTED BY:</b> Zhou Weijie	

**AC/DC Power port:**

Voltage (kV)	Phase angle \ Test point	Test result \ Polarity	Test point				DC Power Port & Energy storage port	
			0°	90°	180°	270°		
0.5	/	+	/	/	/	/	PV+ - PV-	A
		-	/	/	/	/		A
1	L1-L2	+	A	A	A	A	PV+ - PE	A
		-	A	A	A	A		A
1	L1-L3	+	A	A	A	A	PV- - PE	A
		-	A	A	A	A		A
1	L2-L3	+	A	A	A	A	/	/
		-	A	A	A	A	/	/
1	L1-N	+	A	A	A	A	/	/
		-	A	A	A	A	/	/
2	L1-PE	+	A	A	A	A	/	/
		-	A	A	A	A	/	/
2	L2-PE	+	A	A	A	A	/	/
		-	A	A	A	A	/	/
2	L3-PE	+	A	A	A	A	/	/
		-	A	A	A	A	/	/
2	N-PE	+	A	A	A	A	/	/
		-	A	A	A	A	/	/

**NOTE:** A: There was no change compared with initial operation during the test.

Bureau Veritas Shenzhen Co., Ltd.  
Dongguan Branch

No. 34, Chenwulu Section, Guantai Rd., Houjie  
Town, Dongguan City,  
Guangdong 523942, China

Tel: +86 769 8593 5656  
Fax: +86 769 8593 1080  
Email: [customerservice.dg@cn.bureauveritas.com](mailto:customerservice.dg@cn.bureauveritas.com)





BUREAU  
VERITAS Test Report No.: CE181019N024

## 4.7 SURGE IMMUNITY TEST (EN 301489)

### 4.7.1 TEST SPECIFICATION

<b>Basic Standard:</b>	IEC 61000-4-5
<b>Wave-Shape:</b>	Signal/telecommunication port(direct to outdoor cables*) 10/700 us Open Circuit Voltage, 5/320 us Short Circuit Current. Combination Wave, Input AC power port: 1.2/50 us Open Circuit Voltage 8 /20 us Short Circuit Current
<b>Test Voltage:</b>	AC Power Line: Line to Line:1kV, Line to PE:2kV DC Power Line: Line to Line:0.5kV, Line to PE:1kV Signal Line: 1kV
<b>Surge Input/Output:</b>	L1-L2-L3-N&L-PE, N-PE, RS485, All Signal Port
<b>Polarity:</b>	Positive/Negative
<b>Phase Angle:</b>	0° /90°/180°/270°
<b>Pulse Repetition Rate:</b>	1 time / 60 sec.
<b>Number of Tests:</b>	5 positive and 5 negative at selected points

\* This test are applicable to RS485 port and all signal ports, which according to the manufacturer's specification, may connect directly to outdoor cables.

### 4.7.2 TEST INSTRUMENTS

Equipment	Manufacturer	Model No.	Serial No.	Last Cal.	Next Cal.
High Energy Pulse Generator	3cTEST	CWS 1000G	ES3521701	2018/3/28	2019/3/27
Coupling Decoupling Network	3cTEST	SPN1550T	ES4221701	2018/5/2	2019/5/1
Coupling Decoupling Network	3cTEST	SPN1550T	ES4221702	2018/5/2	2019/5/1
High energy pulse generator	3cTEST	CWS 1000CT	ES3531801	2018/7/23	2019/7/22

**NOTE:** 1. The test was performed by witness in BF-65 room of ShangHai Huawei Technology Co., Ltd.  
2. The test was performed in BF-65 Room.

Bureau Veritas Shenzhen Co., Ltd.  
Dongguan Branch

No. 34, Chenwulu Section, Guantai Rd., Houjie  
Town, Dongguan City,  
Guangdong 523942, China

Tel: +86 769 8593 5656  
Fax: +86 769 8593 1080  
Email: [customerservice.dg@cn.bureauveritas.com](mailto:customerservice.dg@cn.bureauveritas.com)

Page 70 of 92

Report Version 1



**BUREAU  
VERITAS** Test Report No.: CE181019N024

### 4.7.3 TEST PROCEDURE

a. For EUT power supply:

The surge is to be applied to the EUT power supply terminals via the capacitive coupling network. Decoupling networks are required in order to avoid possible adverse effects on equipment not under test that may be powered by the same lines, and to provide sufficient decoupling impedance to the surge wave. The power cord between the EUT and the coupling/decoupling networks shall be 2 meters in length (or shorter).

b. For test applied to unshielded unsymmetrically operated interconnection lines of EUT:

The surge is applied to the lines via the capacitive coupling. The coupling / decoupling networks shall not influence the specified functional conditions of the EUT. The interconnection line between the EUT and the coupling/decoupling networks shall be 2 meters in length (or shorter).

c. For test applied to unshielded symmetrically operated interconnection / telecommunication lines of EUT:

The surge is applied to the lines via gas arrestors coupling. Test levels below the ignition point of the coupling arrestor cannot be specified. The interconnection line between the EUT and the coupling/decoupling networks shall be 2 meters in length (or shorter).

### 4.7.4 DEVIATION FROM TEST STANDARD

No deviation.

### 4.7.5 TEST SETUP

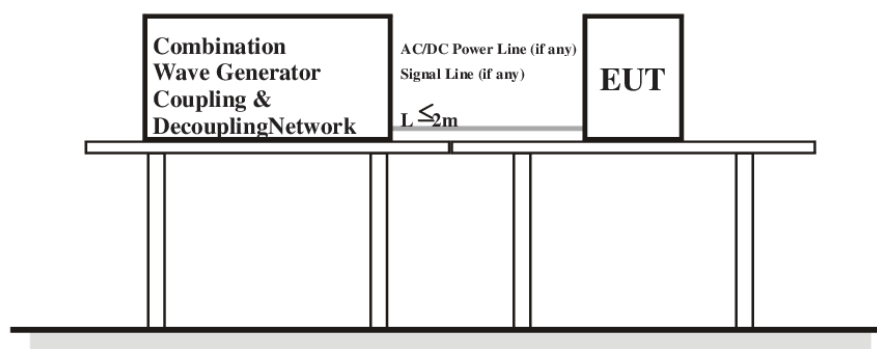

Bureau Veritas Shenzhen Co., Ltd.  
Dongguan Branch

No. 34, Chenwulu Section, Guantai Rd., Houjie  
Town, Dongguan City,  
Guangdong 523942, China

Tel: +86 769 8593 5656  
Fax: +86 769 8593 1080  
Email: [customerservice.dg@cn.bureauveritas.com](mailto:customerservice.dg@cn.bureauveritas.com)

Page 71 of 92

Report Version 1



**BUREAU VERITAS** Test Report No.: CE181019N024

### 4.7.6 TEST RESULTS

<b>TEST MODE</b>	Mode A&B	<b>TEST VOLTAGE</b>	DC 400V AC 400V
<b>ENVIRONMENTAL CONDITIONS</b>	21deg. C, 55% RH	<b>TESTED BY:</b> Zhou Weijie	

**AC/DC Power port:**

Voltage (kV)	\Phase angle \ Test point	\ Test result \ Polarity	Test point				DC Power Port & Energy storage port	
			0°	90°	180°	270°		
0.5	/	+	/	/	/	/	PV+ - PV-	A
		-	/	/	/	/		A
1	L1-L2	+	A	A	A	A	PV+ - PE	A
		-	A	A	A	A		A
1	L1-L3	+	A	A	A	A	PV- - PE	A
		-	A	A	A	A		A
1	L2-L3	+	A	A	A	A	/	/
		-	A	A	A	A	/	/
1	L1-N	+	A	A	A	A	/	/
		-	A	A	A	A	/	/
2	L1-PE	+	A	A	A	A	/	/
		-	A	A	A	A	/	/
2	L2-PE	+	A	A	A	A	/	/
		-	A	A	A	A	/	/
2	L3-PE	+	A	A	A	A	/	/
		-	A	A	A	A	/	/
2	N-PE	+	A	A	A	A	/	/
		-	A	A	A	A	/	/

**Signal ports and telecommunication ports:**

Voltage (kV)	Test Point	Polarity	Test result	Voltage (kV)	Test Point	Polarity	Test result
1	485 Port	+/-	A	1	DI Port	+/-	A
1	Emergency Stop signal	+/-	A	1	Energy storage signal	+/-	A

**NOTE:** A: There was no change compared with initial operation during the test.

Bureau Veritas Shenzhen Co., Ltd.  
Dongguan Branch

No. 34, Chenwulu Section, Guantai Rd., Houjie Town, Dongguan City, Guangdong 523942, China

Tel: +86 769 8593 5656  
Fax: +86 769 8593 1080  
Email: [customerservice.dg@cn.bureauveritas.com](mailto:customerservice.dg@cn.bureauveritas.com)



**BUREAU VERITAS** Test Report No.: CE181019N024

<b>TEST MODE</b>	Mode C	<b>TEST VOLTAGE</b>	DC 0V AC 400V
<b>ENVIRONMENTAL CONDITIONS</b>	21deg. C, 55% RH	<b>TESTED BY:</b> Zhou Weijie	

**AC/DC Power port:**

Voltage (kV)	Phase angle \ Test point	Test result \ Polarity	Test point				DC Power Port & Energy storage port	
			0°	90°	180°	270°		
0.5	/	+	/	/	/	/	PV+ - PV-	A
		-	/	/	/	/		A
1	L1-L2	+	A	A	A	A	PV+ - PE	A
		-	A	A	A	A		A
1	L1-L3	+	A	A	A	A	PV- - PE	A
		-	A	A	A	A		A
1	L2-L3	+	A	A	A	A	/	/
		-	A	A	A	A	/	/
1	L1-N	+	A	A	A	A	/	/
		-	A	A	A	A	/	/
2	L1-PE	+	A	A	A	A	/	/
		-	A	A	A	A	/	/
2	L2-PE	+	A	A	A	A	/	/
		-	A	A	A	A	/	/
2	L3-PE	+	A	A	A	A	/	/
		-	A	A	A	A	/	/
2	N-PE	+	A	A	A	A	/	/
		-	A	A	A	A	/	/

**NOTE:** A: There was no change compared with initial operation during the test.

Bureau Veritas Shenzhen Co., Ltd.  
Dongguan Branch

No. 34, Chenwulu Section, Guantai Rd., Houjie  
Town, Dongguan City,  
Guangdong 523942, China

Tel: +86 769 8593 5656  
Fax: +86 769 8593 1080  
Email: [customerservice.dg@cn.bureauveritas.com](mailto:customerservice.dg@cn.bureauveritas.com)



**BUREAU  
VERITAS** Test Report No.: CE181019N024

## 4.8 IMMUNITY TO CONDUCTED DISTURBANCES INDUCED BY RF FIELDS (CS) (EN 61000-6-2, EN 301 489)

### 4.8.1 TEST SPECIFICATION

<b>Basic Standard:</b>	IEC 61000-4-6
<b>Frequency Range:</b>	0.15 MHz - 80 MHz
<b>Field Strength:</b>	10V <sub>r.m.s</sub>
<b>Modulation:</b>	1kHz Sine Wave, 80%, AM Modulation
<b>Frequency Step:</b>	1 % of fundamental
<b>Coupled Cable:</b>	Power Mains & DC Power Line & Signal Line
<b>Coupling Device:</b>	CDN-M1 & Current Probe & Direct injection

### 4.8.2 TEST INSTRUMENTS

Equipment	Manufacturer	Model No.	Serial No.	Last Cal.	Next Cal.
Signal generator	R&S	SMC100A	1411.4002k02-102618-Yb	2018/7/23	2019/7/22
Amplifier	R&S	BBA100	5354.9000k50-100984-Ut	2018/7/23	2019/7/22
6dB Attenuator	Bird	75-A-FFN-06	1136	2018/7/23	2019/7/22
Power Meter	R&S	NRVD	857.8008.02	2018/7/23	2019/7/22
Coupling Decoupling Network	FCC	FCC-801-M1-50A	111651	2018/7/23	2019/7/22
RF Inject Clamp	FCC	F-120-9A	111657	2018/7/23	2019/7/22
100Ω Resistance	Luthi	CR100A	370	2018/7/23	2019/7/22

- NOTE:** 1. The test was performed by witness in CS Shielding room of ShangHai Huawei Technology Co., Ltd.  
2. The test was performed in CS Shielding Room.

Bureau Veritas Shenzhen Co., Ltd.  
Dongguan Branch

No. 34, Chenwulu Section, Guantai Rd., Houjie  
Town, Dongguan City,  
Guangdong 523942, China

Tel: +86 769 8593 5656  
Fax: +86 769 8593 1080  
Email: [customerservice.dg@cn.bureauveritas.com](mailto:customerservice.dg@cn.bureauveritas.com)

Page 74 of 92

Report Version 1



BUREAU  
VERITAS Test Report No.: CE181019N024

### 4.8.3 TEST PROCEDURE

- a. The EUT shall be tested within its intended operating and climatic conditions.
- b. An artificial hand was placed on the hand-held accessory and connected to the ground reference plane.
- c. The test shall be performed with the test generator connected to each of the coupling and decoupling devices in turn, while the other non-excited RF input ports of the coupling devices are terminated by a 50-ohm load resistor.
- d. The frequency range is swept from 150 kHz to 80 MHz, using the signal level established during the setting process and with a disturbance signal of 80 % amplitude. The signal is modulated with a 1 kHz sine wave, pausing to adjust the RF signal level or the switch coupling devices as necessary. Where the frequency is swept incrementally, the step size shall not exceed 1 % of the preceding frequency value.
- e. The dwell time of the amplitude modulated carrier at each frequency shall not be less than the time necessary for the EUT to be exercised and to respond, but shall in no case be less than 0,5 s. The sensitive frequencies (e.g. clock frequencies) shall be analyzed separately.
- f. Attempts should be made to fully exercise the EUT during testing, and to fully interrogate all exercise modes selected for susceptibility.

### 4.8.4 DEVIATION FROM TEST STANDARD

No deviation.

Bureau Veritas Shenzhen Co., Ltd.  
Dongguan Branch

No. 34, Chenwulu Section, Guantai Rd., Houjie  
Town, Dongguan City,  
Guangdong 523942, China

Tel: +86 769 8593 5656  
Fax: +86 769 8593 1080  
Email: [customerservice.dg@cn.bureauveritas.com](mailto:customerservice.dg@cn.bureauveritas.com)

Page 75 of 92

Report Version 1

Bureau Veritas Shenzhen Co., Ltd.  
Dongguan Branch

No. 34, Chenwulu Section, Guantai Rd.,  
Houjie Town, Dongguan City, Guangdong  
523942, China

Page 166 of 189

Tel: +86 769 8593 5656  
Fax: +86 769 8599 1080  
Email: [customerservice.dg@cn.bureauveritas.com](mailto:customerservice.dg@cn.bureauveritas.com)  
TEST REPORT G98-1 VER.0



BUREAU  
VERITAS Test Report No.: CE181019N024

#### 4.8.5 TEST SETUP

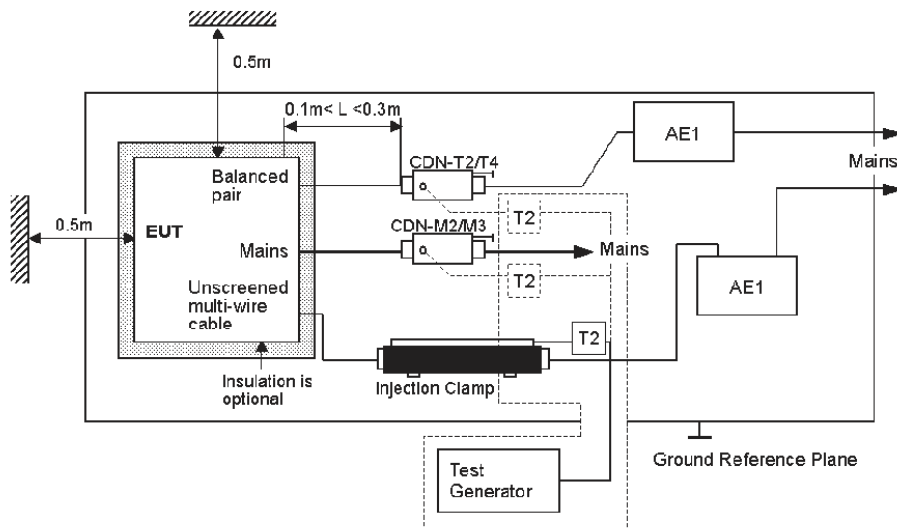

NOTE: The EUT clearance from any metallic obstacles shall be at least 0.5m.  
All non-excited input ports of the CDNs shall be terminated by 50Ω loads.

#### NOTE:

##### FLOOR-STANDING EQUIPMENT

The equipment to be tested is placed on an insulating support of 0.1 meters height above a ground reference plane. All relevant cables shall be provided with the appropriate coupling and decoupling devices at a distance between 0.1 meters and 0.3 meters from the projected geometry of the EUT on the ground reference plane.

Bureau Veritas Shenzhen Co., Ltd.  
Dongguan Branch

No. 34, Chenwulu Section, Guantai Rd., Houjie  
Town, Dongguan City,  
Guangdong 523942, China

Tel: +86 769 8593 5656  
Fax: +86 769 8593 1080  
Email: [customerservice.dg@cn.bureauveritas.com](mailto:customerservice.dg@cn.bureauveritas.com)

Page 76 of 92

Report Version 1



BUREAU VERITAS Test Report No.: CE181019N024

#### 4.8.6 TEST RESULTS

<b>TEST MODE</b>	Mode A&B	<b>TEST VOLTAGE</b>	DC 400V AC 400V;
<b>ENVIRONMENTAL CONDITIONS</b>	21deg. C, 54% RH	<b>TESTED BY:</b> Zhou Weijie	

Voltage (V)	Test Frequency Note#1 (MHz)	Tested Line	Injection Method.	Test Result	Remark
10	0.15 – 80	AC line	Current Probe	A	/
10	0.15 – 80	DC line	Current Probe	A	/
10	0.15 – 80	RS485 Cable	Direct injection	A	/
10	0.15 – 80	Energy storage line	Current Probe	A	/
10	0.15 – 80	Energy storage Signal	Clamp injection	A	/
10	0.15 – 80	Emergency Stop signal	Clamp injection	A	/
10	0.15 – 80	DI signal Line	Clamp injection	A	/

<b>TEST MODE</b>	Mode C	<b>TEST VOLTAGE</b>	DC 0V AC 400V;
<b>ENVIRONMENTAL CONDITIONS</b>	21deg. C, 54% RH	<b>TESTED BY:</b> Zhou Weijie	

Voltage (V)	Test Frequency Note#1 (MHz)	Tested Line	Injection Method.	Test Result	Remark
10	0.15 – 80	AC line	Current Probe	A	/
10	0.15 – 80	DC line	Current Probe	A	/
10	0.15 – 80	RS485 Cable	Direct injection	A	/
10	0.15 – 80	Energy storage line	Current Probe	A	/
10	0.15 – 80	Energy storage Signal	Clamp injection	A	/
10	0.15 – 80	Emergency Stop signal	Clamp injection	A	/
10	0.15 – 80	DI signal Line	Clamp injection	A	/

Note#1: Tested Israel SII Frequencies 0.2,0.53,1,1.5,7.1,13.56,21,27.12,40.68,65,68 MHz

**NOTE:** A: There was no change compared with initial operation during the test.

Bureau Veritas Shenzhen Co., Ltd.  
Dongguan Branch

No. 34, Chenwulu Section, Guantai Rd., Houjie  
Town, Dongguan City,  
Guangdong 523942, China

Tel: +86 769 8593 5656  
Fax: +86 769 8593 1080  
Email: [customerservice.dg@cn.bureauveritas.com](mailto:customerservice.dg@cn.bureauveritas.com)

Page 77 of 92

Report Version 1





**BUREAU  
VERITAS** Test Report No.: CE181019N024

## 4.9 POWER FREQUENCY MAGNETIC FIELD IMMUNITY TEST (EN 61000-6-2)

### 4.9.1 TEST SPECIFICATION

<b>Basic Standard:</b>	IEC 61000-4-8
<b>Frequency Range:</b>	50Hz
<b>Field Strength:</b>	30A/m
<b>Observation Time:</b>	1 minute
<b>Inductance Coil:</b>	Rectangular type, 1.5mx1.5m

### 4.9.2 TEST INSTRUMENTS

Equipment	Manufacturer	Model No.	Serial No.	Last Cal.	Next Cal.
Power source	EMTEST	NET Wave 7	V1129110285	2018/7/23	2019/7/22
Helmholtz coil	EMTEST	HHS 5215-100	5215-100 102	2018/7/23	2019/7/22

**NOTE:** 1. The test was performed by witness in BF-59 room of ShangHai Huawei Technology Co., Ltd.  
2. The test was performed in BF-59 Room.

### 4.9.3 TEST PROCEDURE

- The equipment is configured and connected to satisfy its functional requirements.
- The power supply, input and output circuits shall be connected to the sources of power supply, control and signal.
- The cables supplied or recommended by the equipment manufacturer shall be used. 1 meter of all cables used shall be exposed to the magnetic field.

### 4.9.4 DEVIATION FROM TEST STANDARD

No Deviation

Bureau Veritas Shenzhen Co., Ltd.  
Dongguan Branch

No. 34, Chenwulu Section, Guantai Rd., Houjie  
Town, Dongguan City,  
Guangdong 523942, China

Tel: +86 769 8593 5656  
Fax: +86 769 8593 1080  
Email: [customerservice.dg@cn.bureauveritas.com](mailto:customerservice.dg@cn.bureauveritas.com)

Page 78 of 92

Report Version 1



#### 4.9.5 TEST SETUP

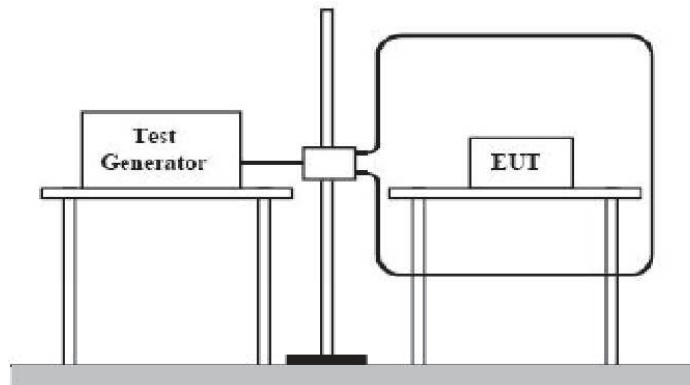

#### NOTE:

##### TABLETOP EQUIPMENT

The equipment shall be subjected to the test magnetic field by using the induction coil of standard dimension (1 m x 1 m). The induction coil shall then be rotated by 90 degrees in order to expose the EUT to the test field with different orientations.

##### FLOOR-STANDING EQUIPMENT

The equipment shall be subjected to the test magnetic field by using induction coils of suitable dimensions. The test shall be repeated by moving and shifting the induction coils, in order to test the whole volume of the EUT for each orthogonal direction. The test shall be repeated with the coil shifted to different positions along the side of the EUT, in steps corresponding to 50 % of the shortest side of the coil. The induction coil shall then be rotated by 90 degrees in order to expose the EUT to the test field with different orientations.



BUREAU VERITAS Test Report No.: CE181019N024

#### 4.9.6 TEST RESULTS

<b>TEST MODE</b>	Mode A&B	<b>TEST VOLTAGE</b>	DC 400V AC 400V;
<b>ENVIRONMENTAL CONDITIONS</b>	21deg. C, 55% RH	<b>TESTED BY:</b> Zhou Weijie	

MAGNETIC FIELD DIRECTION	TESTING RESULT	REMARK
X - Axis	A	30A/ m
Y - Axis	A	30A/ m
Z - Axis	A	30A/ m

<b>TEST MODE</b>	Mode C	<b>TEST VOLTAGE</b>	DC 0V AC 400V;
<b>ENVIRONMENTAL CONDITIONS</b>	21deg. C, 55% RH	<b>TESTED BY:</b> Zhou Weijie	

MAGNETIC FIELD DIRECTION	TESTING RESULT	REMARK
X - Axis	A	30A/ m
Y - Axis	A	30A/ m
Z - Axis	A	30A/ m

**NOTE:** A: There is no change compared with the initial operation during the test.

Bureau Veritas Shenzhen Co., Ltd.  
Dongguan Branch

No. 34, Chenwulu Section, Guantai Rd., Houjie  
Town, Dongguan City,  
Guangdong 523942, China

Tel: +86 769 8593 5656  
Fax: +86 769 8593 1080  
Email: [customerservice.dg@cn.bureauveritas.com](mailto:customerservice.dg@cn.bureauveritas.com)

Page 80 of 92

Report Version 1



**BUREAU** Test Report No.: CE181019N024  
**VERITAS**

## 5 PHOTOGRAPHS OF THE TEST CONFIGURATION

CONDUCTED EMISSION TEST (AC Power)



CONDUCTED EMISSION TEST (Telecom port-RS485)



Bureau Veritas Shenzhen Co., Ltd.  
Dongguan Branch

No. 34, Chenwulu Section, Guantai Rd., Houjie  
Town, Dongguan City,  
Guangdong 523942, China

Tel: +86 769 8593 5656  
Fax: +86 769 8593 1080  
Email: [customerservice.dg@cn.bureauveritas.com](mailto:customerservice.dg@cn.bureauveritas.com)

Page 81 of 92

Report Version 1



RADIATED EMISSION TEST (30~1000MHz)



RADIATED EMISSION TEST (1000~6000MHz)





HARMONICS EMISSION TEST &  
VOLTAGE FLUCTUATIONS AND FLICKER TEST



ESD TEST





RS TEST





EFT TEST (AC Main-AC Power)

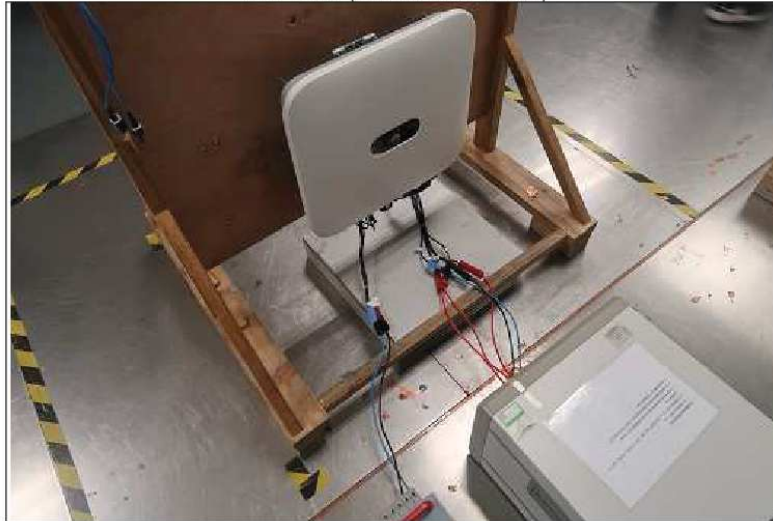

EFT TEST (DC Main)







EFT TEST (Signal)



SURGE TEST (AC Main)

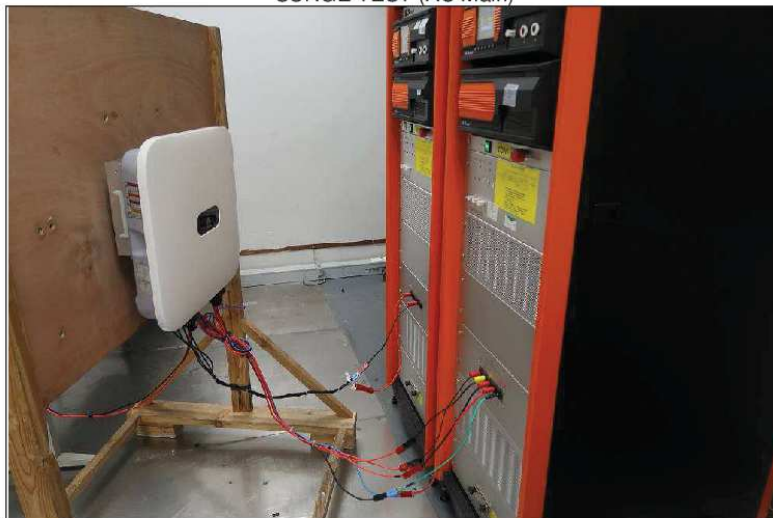



SURGE TEST (DC Main)



SURGE TEST (485)

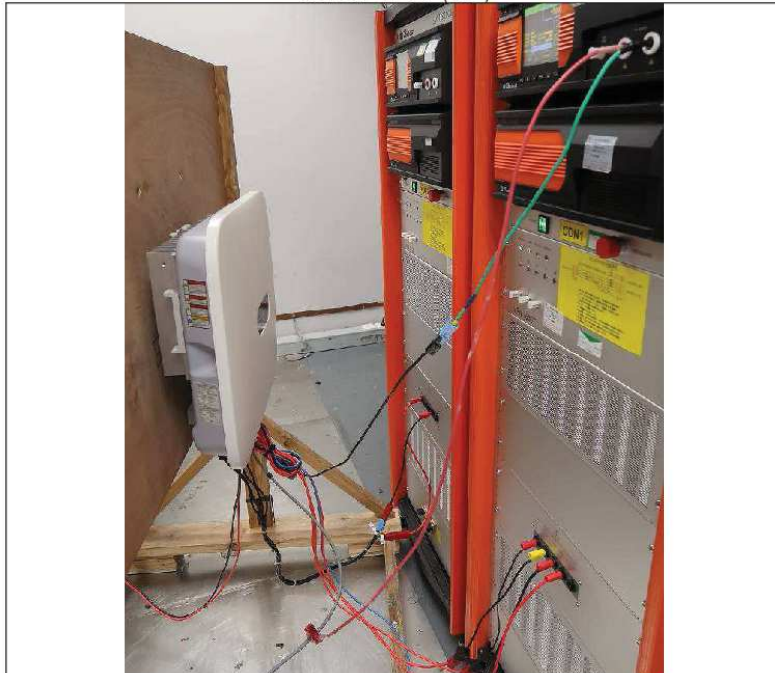



CONDUCTED SUSCEPTIBILITY TEST (AC Main)

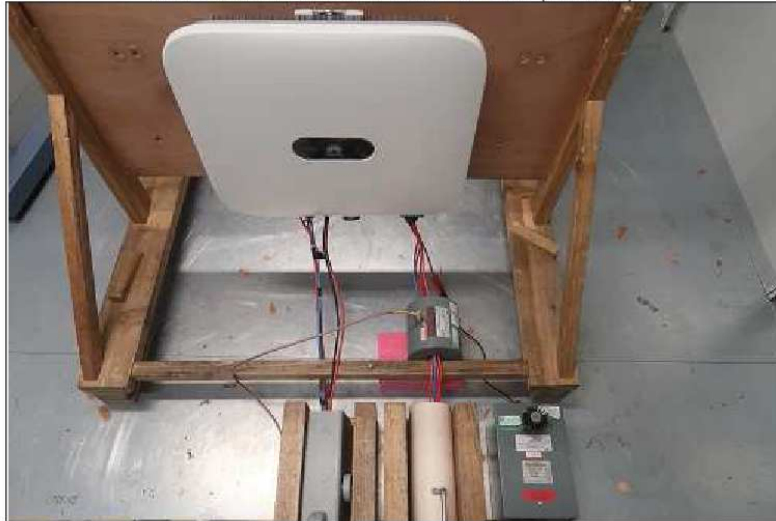

CONDUCTED SUSCEPTIBILITY TEST (DC Main)





CONDUCTED SUSCEPTIBILITY TEST (Shielded Signal)



CONDUCTED SUSCEPTIBILITY TEST (PE)





CONDUCTED SUSCEPTIBILITY TEST (Energy storage)



CONDUCTED SUSCEPTIBILITY TEST (Non-Shielded Signal)





POWER-FREQUENCY MAGNETIC FIELDS TEST



Bureau Veritas Shenzhen Co., Ltd.  
Dongguan Branch

No. 34, Chenwulu Section, Guantai Rd., Houjie  
Town, Dongguan City,  
Guangdong 523942, China

Tel: +86 769 8593 5656  
Fax: +86 769 8593 1080  
Email: [customerservice.dg@cn.bureauveritas.com](mailto:customerservice.dg@cn.bureauveritas.com)

Page 91 of 92

Report Version 1

Bureau Veritas Shenzhen Co., Ltd.  
Dongguan Branch

No. 34, Chenwulu Section, Guantai Rd.,  
Houjie Town, Dongguan City, Guangdong  
523942, China  
Page 182 of 189

Tel: +86 769 8593 5656  
Fax: +86 769 8599 1080  
Email: [customerservice.dg@cn.bureauveritas.com](mailto:customerservice.dg@cn.bureauveritas.com)  
TEST REPORT G98-1 VER.0



**BUREAU  
VERITAS** Test Report No.: CE181019N024

## 6 APPENDIX A – MODIFICATIONS RECORDERS FOR ENGINEERING CHANGES TO THE EUT BY THE LAB

No any modifications were made to the EUT by the lab during the test.

---END---

**Bureau Veritas Shenzhen Co., Ltd.  
Dongguan Branch**

No. 34, Chenwulu Section, Guantai Rd., Houjie  
Town, Dongguan City,  
Guangdong 523942, China

Tel: +86 769 8593 5656  
Fax: +86 769 8593 1080  
Email: [customerservice.dg@cn.bureauveritas.com](mailto:customerservice.dg@cn.bureauveritas.com)

Page 92 of 92

Report Version 1

Bureau Veritas Shenzhen Co., Ltd.  
Dongguan Branch

No. 34, Chenwulu Section, Guantai Rd.,  
Houjie Town, Dongguan City, Guangdong  
523942, China  
Page 183 of 189

Tel: +86 769 8593 5656  
Fax: +86 769 8599 1080  
Email: [customerservice.dg@cn.bureauveritas.com](mailto:customerservice.dg@cn.bureauveritas.com)  
TEST REPORT G98-1 VER.0

**Annex No. 2**  
**Pictures of the unit**  
**The full pictures refer to PHOTO DOCUMENT**  
**Project No.: 180906N022**  
**Date: 20181015**



Enclosure front view



Enclosure side view



Enclosure side view



Enclosure top view

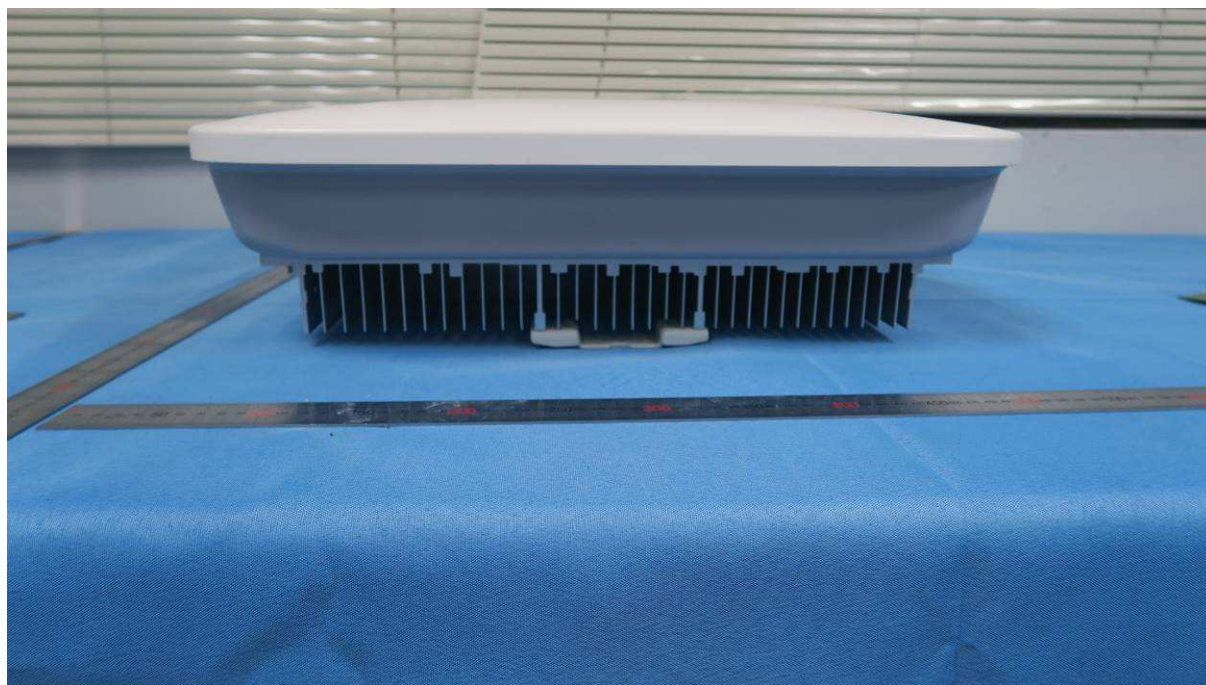

Enclosure bottom view



Enclosure rear view

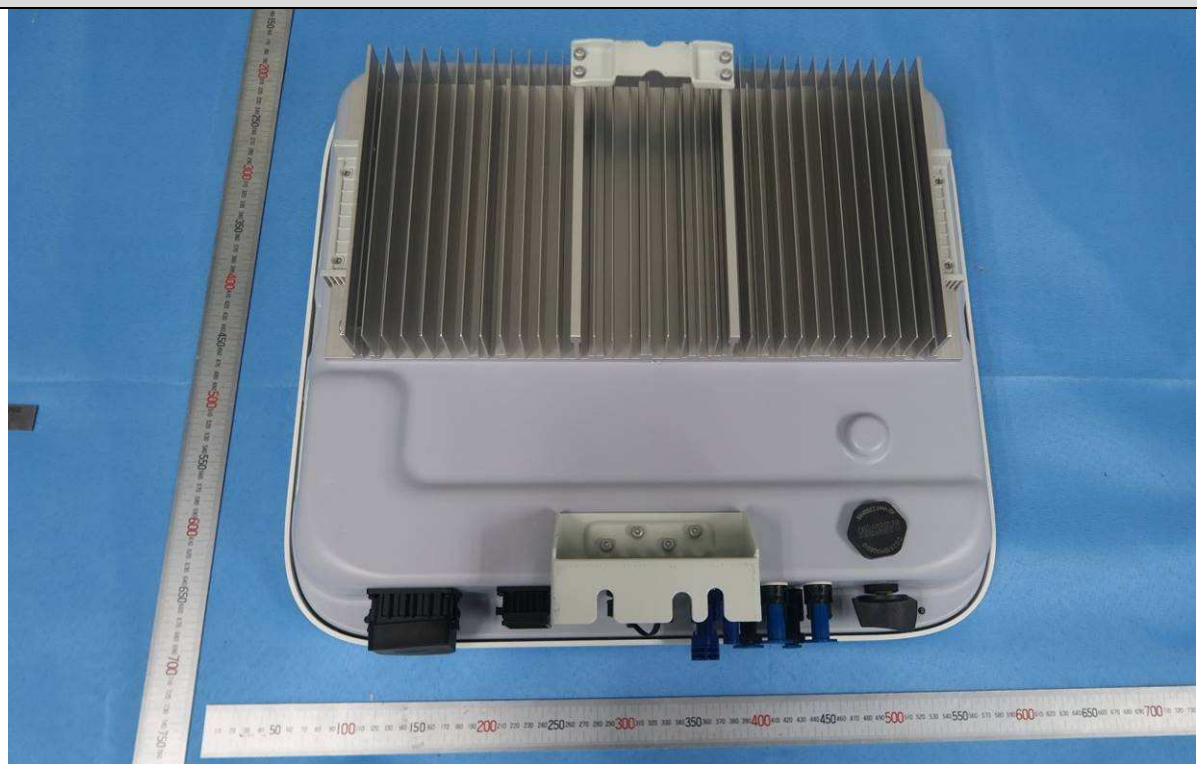



Report No.: PVUK180906N022

## **Annex No. 3**

### **Test Equipment list**

**Test location: Bureau Veritas Shenzhen Co., Ltd. Dongguan Branch**  
**Performed dates of test: 2018-09-06 to 2018-12-16**

Equipment	Internal no.:	Manufacturer:	Type:	Serial no.:	Last calibration
Power Analyzer	A4080002DG	YOKOGAWA	WT3000	91M210852	Jan. 12, 2018
AC Source	A7040019DG	Chroma	61512	61512000439	Monitored by Power Analyzer
AC Source	A7040020DG	Chroma	61512	61512000438	
DC Simulation Power Supply	A7040016DG	Chroma	62150H- 1000S	62150EF00490	
DC Simulation Power Supply	A7040021DG	Chroma	62150H- 1000S	62150EF00609	
RLC Load	A7150027DG	Qunling	ACLT-3803H	93VOO2869	
Eight Channel Digital Phosphor Oscilloscope	A4089017DG	YOKOGAWA	DL850	91N726247	Sep. 14, 2018
Four Channel Digital Phosphor Oscilloscope	A4089003DG	Tektronix	DPO4104B	C010624	Oct. 25, 2018
Isolation voltage probe	A1490009DG	YOKOGAWA	701901	//	Nov. 01, 2018
	A1490010DG	YOKOGAWA	701901	//	Nov. 01, 2018
	A1490011DG	YOKOGAWA	701901	//	Nov. 01, 2018
Current transducer	A1060008DG	YOKOGAWA	CT200	1130700017	Nov. 17, 2018
	A1060009DG	YOKOGAWA	CT200	1130700019	Nov. 17, 2018
	A1060009DG	YOKOGAWA	CT200	1130700019	Nov. 17, 2018