

Service and Troubleshooting

AVZC18 INVERTER HEAT PUMP CONDENSER UNITS WITH R-410A REFRIGERANT BLOWERS, COILS, & ACCESSORIES

Pride and workmanship go into every product to provide our customers with quality products. It is possible, however, that during its lifetime a product may require service. Products should be serviced only by a qualified service technician who is familiar with the safety procedures required in the repair and who is equipped with the proper tools, parts, testing instruments and the appropriate service manual. **REVIEW ALL SERVICE INFORMATION IN THE APPROPRIATE SERVICE MANUAL BEFORE BEGINNING REPAIRS.**

For service information related to the Bluetooth® Shared Data Loader BTSDL01 referenced in this manual, please refer to the installation instructions for the BTSDL01 at www.coolcloudhvac.com/loaderuserguide

TABLE OF CONTENTS

IMPORTANT INFORMATION	2
PRODUCT IDENTIFICATION	4
SYSTEM OPERATION	5
SERVICING	9
CHECKING VOLTAGE	9
CHECKING WIRING	9
CHECKNG THERMOSTAT, WIRING	9
THERMOSTAT AND WIRING	9
CHECKING TRANSFORMER AND CONTROL CIRCUIT	9
CHECKING HIGH PRESSURE SWITCH	10
CHECKING INDOOR AND OUTDOOR HI/LOW PRESSURE SENSOR.....	10
CHECKING COMPRESSOR.....	10
COMPRESSOR WINDING INSULATION TEST	11
GROUND TEST	11
TESTING TEMPERATURE SENSORS AND EEV COIL RESISTANCE.....	12
TESTING EEV COIL RESISTANCE	12
TESTING REVERSING VALVE.....	12
AVPEC* HEATER CONTROL.....	13
REFRIGERATION REPAIR PRACTICE	14
LEAK TESTING (NITROGEN OR NITROGEN-TRACED).....	14
STANDING PRESSURE TEST (RECOMMENDED).....	14
EVACUATION	15
CHARGING	16
FINAL CHARGE ADJUSTMENT	16
CHECKING COMPRESSOR EFFICIENCY	16
CHECKING SUBCOOLING	16
NON-CONDENSABLES.....	17
COMPRESSOR BURNOUT	17



WARNING

ONLY PERSONNEL THAT HAVE BEEN TRAINED TO INSTALL, ADJUST, SERVICE OR REPAIR (HEREINAFTER, "SERVICE") THE EQUIPMENT SPECIFIED IN THIS MANUAL SHOULD SERVICE THE EQUIPMENT. THE MANUFACTURER WILL NOT BE RESPONSIBLE FOR ANY INJURY OR PROPERTY DAMAGE ARISING FROM IMPROPER SERVICE OR SERVICE PROCEDURES. IF YOU SERVICE THIS UNIT, YOU ASSUME RESPONSIBILITY FOR ANY INJURY OR PROPERTY DAMAGE WHICH MAY RESULT. IN ADDITION, IN JURISDICTIONS THAT REQUIRE ONE OR MORE LICENSES TO SERVICE THE EQUIPMENT SPECIFIED IN THIS MANUAL, ONLY LICENSED PERSONNEL SHOULD SERVICE THE EQUIPMENT. IMPROPER INSTALLATION, ADJUSTMENT, SERVICING OR REPAIR OF THE EQUIPMENT SPECIFIED IN THIS MANUAL, OR ATTEMPTING TO INSTALL, ADJUST, SERVICE OR REPAIR THE EQUIPMENT SPECIFIED IN THIS MANUAL WITHOUT PROPER TRAINING MAY RESULT IN PRODUCT DAMAGE, PROPERTY DAMAGE, PERSONAL INJURY OR DEATH.

PROP 65 WARNING FOR CALIFORNIA CONSUMERS



WARNING

Cancer and Reproductive Harm - www.P65Warnings.ca.gov

0140M00517-A

RS6215001r5
January 2021



Copyright © 2015-2017, 2019, 2021 Goodman Manufacturing Company, L.P.

Amana is a registered trademark of Maytag Corporation or its related companies and is used under license. All rights reserved.

IMPORTANT INFORMATION

REFRIGERANT PIPING	18
DUCT STATIC PRESSURES AND/OR STATIC PRES- SURE DROP ACROSS COILS	22
AIR HANDLER EXTERNAL STATIC	22
COIL STATIC PRESSURE DROP	22
INDOOR UNIT TROUBLESHOOTING	23
DIAGNOSTIC CODES	25
SETTING THE MODE DISPLAY	28
INDOOR UNIT ERROR CODES	30
CTK04 ADDENDUM	49
TROUBLESHOOTING	69
WIRING DIAGRAMS	81
ACCESSORIES	83
CHECKING HEATER LIMIT CONTROL(S) (OPTION- AL ELECTRIC HEATERS)	84
ELECTRIC HEATER OPTIONAL ITEM	84
CHECKING HEATER FUSE LINK (OPTIONAL ELEC- TRIC HEATERS)	85

IMPORTANT NOTICES FOR CONSUMERS AND SERVICERS RECOGNIZE SAFETY SYMBOLS, WORDS AND LABELS

Pride and workmanship go into every product to provide our customers with quality products. It is possible, however, that during its lifetime a product may require service. Products should be serviced only by a qualified service technician who is familiar with the safety procedures required in the repair and who is equipped with the proper tools, parts, testing instruments and the appropriate service manual. **REVIEW ALL SERVICE INFORMATION IN THE APPROPRIATE SERVICE MANUAL BEFORE BEGINNING REPAIRS.**

 **WARNING**

HIGH VOLTAGE !

DISCONNECT ALL POWER BEFORE SERVICING.
MULTIPLE POWER SOURCES MAY BE PRESENT. FAILURE TO DO SO MAY CAUSE PROPERTY DAMAGE, PERSONAL INJURY OR DEATH.



 **WARNING**

DO NOT CONNECT TO OR USE ANY DEVICE THAT IS NOT DESIGN CERTIFIED BY THE MANUFACTURER FOR USE WITH THIS UNIT. SERIOUS PROPERTY DAMAGE, PERSONAL INJURY, REDUCED UNIT PERFORMANCE AND/OR HAZARDOUS CONDITIONS MAY RESULT FROM THE USE OF SUCH NON-APPROVED DEVICES.

 **WARNING**

TO PREVENT THE RISK OF PROPERTY DAMAGE, PERSONAL INJURY, OR DEATH, DO NOT STORE COMBUSTIBLE MATERIALS OR USE GASOLINE OR OTHER FLAMMABLE LIQUIDS OR VAPORS IN THE VICINITY OF THIS APPLIANCE.

NOTICE

INVERTER H/P MODELS CAN ONLY BE MATCHED WITH AN AVPEC* AIR HANDLER OR TXV-V** EXPANSION VALVE KIT. DAMAGE RESULTING FROM OPERATION WITH ANY OTHER COMBINATION IS NOT COVERED BY OUR WARRANTIES.

SAFE REFRIGERANT HANDLING

While these items will not cover every conceivable situation, they should serve as a useful guide.

 **WARNING**

REFRIGERANTS ARE HEAVIER THAN AIR. THEY CAN "PUSH OUT" THE OXYGEN IN YOUR LUNGS OR IN ANY ENCLOSED SPACE. TO AVOID POSSIBLE DIFFICULTY IN BREATHING OR DEATH:

- NEVER PURGE REFRIGERANT INTO AN ENCLOSED ROOM OR SPACE. BY LAW, ALL REFRIGERANTS MUST BE RECLAIMED.
- IF AN INDOOR LEAK IS SUSPECTED, THOROUGHLY VENTILATE THE AREA BEFORE BEGINNING WORK.
- LIQUID REFRIGERANT CAN BE VERY COLD. TO AVOID POSSIBLE FROST BITE OR BLINDNESS, AVOID CONTACT AND WEAR GLOVES AND GOGGLES. IF LIQUID REFRIGERANT DOES CONTACT YOUR SKIN OR EYES, SEEK MEDICAL HELP IMMEDIATELY.
- ALWAYS FOLLOW EPA REGULATIONS. NEVER BURN REFRIGERANT, AS POISONOUS GAS WILL BE PRODUCED.

 **WARNING**

THE UNITED STATES ENVIRONMENTAL PROTECTION AGENCY ("EPA") HAS ISSUED VARIOUS REGULATIONS REGARDING THE INTRODUCTION AND DISPOSAL OF REFRIGERANTS INTRODUCED INTO THIS UNIT. FAILURE TO FOLLOW THESE REGULATIONS MAY HARM THE ENVIRONMENT AND CAN LEAD TO THE IMPOSITION OF SUBSTANTIAL FINES. THESE REGULATIONS MAY VARY BY JURISDICTION. SHOULD QUESTIONS ARISE, CONTACT YOUR LOCAL EPA OFFICE.

 **WARNING**

TO AVOID POSSIBLE EXPLOSION:

- NEVER APPLY FLAME OR STEAM TO A REFRIGERANT CYLINDER. IF YOU MUST HEAT A CYLINDER FOR FASTER CHARGING, PARTIALLY IMMERSE IT IN WARM WATER.
- NEVER FILL A CYLINDER MORE THAN 80% FULL OF LIQUID REFRIGERANT.
- NEVER ADD ANYTHING OTHER THAN R-410A TO A RETURNABLE R-410A CYLINDER. THE SERVICE EQUIPMENT USED MUST BE LISTED OR CERTIFIED FOR THE TYPE OF REFRIGERANT USE.
- STORE CYLINDERS IN A COOL, DRY PLACE. NEVER USE A CYLINDER AS A PLATFORM OR A ROLLER.

OUTSIDE THE U.S., call 1-713-861-2500.

(Not a technical assistance line for dealers.) Your telephone company will bill you for the call.

IMPORTANT INFORMATION



WARNING

TO AVOID POSSIBLE EXPLOSION:

- USE ONLY RETURNABLE (NOT DISPOSABLE) SERVICE CYLINDERS WHEN REMOVING REFRIGERANT FROM A SYSTEM.
- ENSURE THE CYLINDER IS FREE OF DAMAGE WHICH COULD LEAD TO A LEAK OR EXPLOSION.
- ENSURE THE HYDROSTATIC TEST DATE DOES NOT EXCEED 5 YEARS.
- ENSURE THE PRESSURE RATING MEETS OR EXCEEDS 400 LBS.

WHEN IN DOUBT, DO NOT USE THE CYLINDER.



WARNING

TO AVOID POSSIBLE INJURY, EXPLOSION OR DEATH, PRACTICE SAFE HANDLING OF REFRIGERANTS.



CAUTION

THE COMPRESSOR PVE OIL FOR R-410A UNITS IS EXTREMELY SUSCEPTIBLE TO MOISTURE ABSORPTION AND COULD CAUSE COMPRESSOR FAILURE. DO NOT LEAVE SYSTEM OPEN TO ATMOSPHERE ANY LONGER THAN NECESSARY FOR INSTALLATION.

NOTICE

THE ENTIRE SYSTEM (COMBINATION OF INDOOR AND OUTDOOR SECTIONS) MUST BE MANUFACTURER APPROVED AND AIR-CONDITIONING, HEATING, AND REFRIGERATION INSTITUTE (AHRI) LISTED.

NOTE: INSTALLATION OF UNMATCHED SYSTEMS IS NOT PERMITTED. DAMAGE OR REPAIRS DUE TO INSTALLATION OF UNMATCHED SYSTEMS IS NOT COVERED UNDER THE WARRANTY.



WARNING

SYSTEM CONTAMINANTS, IMPROPER SERVICE PROCEDURE AND/OR PHYSICAL ABUSE AFFECTING HERMETIC COMPRESSOR ELECTRICAL TERMINALS MAY CAUSE DANGEROUS SYSTEM VENTING.

Notice:

When the outdoor unit is connected to main power, the inverter board has a small current flowing into it to be prepared for operation when needed. Due to this, the Control Board components have to be cooled even when the unit is not running. For this cooling operation, the condenser fan may come on at any time, including in the winter months. Any obstruction to the outdoor fan should be avoided at all times when the unit is powered to prevent damage.

The successful development of hermetically sealed refrigeration compressors has completely sealed the compressor's moving parts and electric motor inside a common housing, minimizing refrigerant leaks and the hazards sometimes associated with moving belts, pulleys or couplings.

Fundamental to the design of hermetic compressors is a method whereby electrical current is transmitted to the compressor motor through terminal conductors which pass through the compressor housing wall. These terminals are sealed in a dielectric material which insulates them from the housing and maintains the pressure tight integrity of the hermetic compressor. The terminals and their dielectric embedment are strongly constructed, but are vulnerable to careless compressor installation or maintenance procedures and equally vulnerable to internal electrical short circuits caused by excessive system contaminants.

In either of these instances, an electrical short between the terminal and the compressor housing may result in the loss of integrity between the terminal and its dielectric embedment. This loss may cause the terminals to be expelled, thereby venting the vaporous and liquid contents of the compressor housing and system.

A venting compressor terminal normally presents no danger to anyone, providing the terminal protective cover is properly in place.

If, however, the terminal protective cover is not properly in place, a venting terminal may discharge a combination of

- hot lubricating oil and refrigerant
- flammable mixture (if system is contaminated with air)

in a stream of spray which may be dangerous to anyone in the vicinity. Death or serious bodily injury could occur.

Under no circumstances is a hermetic compressor to be electrically energized and/or operated without having the terminal protective cover properly in place. See Service Section for proper servicing.

PRODUCT IDENTIFICATION

NOMENCLATURES

	A	V	Z	C	18
Brand	A - Amana® Brand				
Compressor	V - Variable Capacity				
Type	X - AC R-410A Z - HP R-410A				
Feature Set	C - ComfortNet 4 wire ready				
SEER	18 - SEER 20 - SEER				

	024	1	A	A
	Engineering Minor Revision			
	Engineering Major Revision			
	Voltage 1 - 208/230 V single phase 60 Hz 2 - 208/240 V single phase 50 Hz			
	Tonnage Nominal 024 - 2.0-ton 036 - 3.0-ton 048 - 4.0-ton 060 - 5.0-ton			

	A	V	P	E	C	25
Brand	A - Amana® Brand					
Unit Application	V - Multi Position Variable-Speed Motor-Communicating					
Cabinet Finish	P - Painted					
Expansion Device	T - Expansion Valve V - Inverter Tuned Expansion Valve E - Electronic Expansion Valve					
Communication	C - ComfortNet™ Compatible					

	25	B	1	4	AA
	Engineering Major/Minor Revision				
	Refrigerant Charged= 4 - R410A				
	Voltage 1 - 208/230 V				
	Cabinet Width B: 17.5" C: 21" D: 24.5"				
	Tonnage Nominal 25 - 2.0-ton 37 - 3.0-ton 59 - 4.0-ton 61 - 5.0-ton				

SYSTEM OPERATION

This section gives a basic description of heat pump condenser unit operation, its various components and their basic operation. Ensure your system is properly sized for heat gain and loss according to methods of the Air Conditioning Contractors Association (ACCA) or equivalent.

CONDENSING UNIT

The ambient air is pulled through the heat pump condenser coil by a direct drive propeller fan. This air is then discharged out of the top of the cabinet. These units are designed for free air discharge, so no additional resistance, like duct work, shall be attached.

The gas and liquid line connections on present models are of the sweat type for field piping with refrigerant type copper. Front seating valves are factory installed to accept the field run copper. The total refrigerant charge for a normal installation is factory installed in the heat pump condenser unit.

AVZC18 models are available in 2 through 5 ton sizes and use R-410A refrigerant. They are designed for 208/230 volt single phase applications.

All AVZC18 models use a Daikin rotary compressor specifically designed for R-410A refrigerant. These models are ComfortNet™ ready.

AVZC18 models use “FVC50K” which is NOT compatible with mineral oil based lubricants like 3GS. “FVC50K” oil (required by the manufacturer) must be used if additional oil is required.

COOLING

The refrigerant used in the system is R-410A. It is a clear, colorless, non-toxic and non-irritating liquid. R-410A is a 50:50 blend of R-32 and R-125. The boiling point at atmospheric pressure is -62.9°F.

A few of the important principles that make the refrigeration cycle possible are: heat always flows from a warmer to a cooler body. Under lower pressure, a refrigerant will absorb heat and vaporize at a low temperature. The vapors may be drawn off and condensed at a higher pressure and temperature to be used again.

The indoor evaporator coil functions to cool and dehumidify the air conditioned spaces through the evaporative process taking place within the coil tubes.

NOTE: The pressures and temperatures shown in the refrigerant cycle illustrations on the following pages are for demonstration purposes only. Actual temperatures and pressures are to be obtained from the “Expanded Performance Chart”.

Liquid refrigerant at condensing pressure and temperatures leaves the outdoor condensing coil through the drier and is metered into the indoor coil through indoor electronic expansion valve. As the cool, low pressure, saturated refrigerant enters the tubes of the indoor coil, a portion of the liquid immediately vaporizes. It continues to soak up heat and vaporizes as it proceeds through the coil, cooling the indoor coil down to about 48°F.

Heat is continually being transferred to the cool fins and tubes of the indoor evaporator coil by the warm system air. This warming process causes the refrigerant to boil. The heat removed from the air is carried off by the vapor.

As the vapor passes through the last tubes of the coil, it becomes superheated. That is, it absorbs more heat than is necessary to vaporize it. This is assurance that only dry gas will reach the compressor. Liquid reaching the compressor can weaken or break compressor valves.

The compressor increases the pressure of the gas, thus adding more heat, and discharges hot, high pressure superheated gas into the outdoor condenser coil.

In the condenser coil, the hot refrigerant gas, being warmer than the outdoor air, first loses its superheat by heat transferred from the gas through the tubes and fins of the coil. The refrigerant now becomes saturated, part liquid, part vapor and then continues to give up heat until it condenses to a liquid alone. Once the vapor is fully liquefied, it continues to give up heat which subcools the liquid, and it is ready to repeat the cycle.

The inverter system can stop the compressor or outdoor fan to protect the unit. The inverter system can run higher compressor speed than required from thermostat to recover compressor oil that flows.

HEATING

The heating portion of the refrigeration cycle is similar to the cooling cycle. By de-energizing the reversing valve solenoid coil, the flow of the refrigerant is reversed. The indoor coil now becomes the heat pump condenser coil, and the outdoor coil becomes the evaporator coil. The check valve at the outdoor coil will be forced closed by the refrigerant flow, thereby utilizing the outdoor expansion device. An electronic expansion valve meters the condensed refrigerant to the outdoor coil.

DEFROST CYCLE

The defrosting of the outdoor coil is controlled by the PCB and the outdoor coil temperature thermistor and defrost sensor. The outdoor coil temperature thermistor (T_m) sensor is clamped to a return bend entering the outdoor coil and the defrost sensor at bottom flowrator leg at outdoor coil outlet. Defrost timing periods of 30, 60, 90 or 120 minutes may be selected via the thermostat setting. PCB will initiate time defrost at the interval selected from the thermostat. During operation, the microprocessor on the PCB checks the coil and defrost temperature (T_m and T_b) via sensors every 5 seconds in heating mode. When the PCB detects the coil temperature to be high enough (approximately 54 °F) and defrost sensor more than 43 °F for 30 seconds, the defrost cycle is terminated and the timing period is reset. The field service personnel can also advance a heat pump to the defrost cycle by selecting “force defrost” option from thermostat.

SYSTEM OPERATION

SYSTEM STARTUP TEST

A system verification test is now required to check the equipment settings and functionality.

18 SEER Inverter units are tested by any of the following methods:

- Setting the “SUT” menu (System verification test) to ON through the indoor unit control board push buttons.
- Setting the System verification test menu of mode display screen-4 to ON through the outdoor unit control board push buttons.

Once selected, it checks the equipment for approximately 5 - 15 minutes. System test may exceed 15 minutes if there is an error. Refer to the Troubleshooting section, if error code appears.

Before starting the SYSTEM TEST, turn off the electric heater (if applicable)

NOTE: If the unit is attempting to run SYSTEM TEST in under 20°F ambient temperature, the unit may not be able to complete the test due to low suction pressure. In such a case, re-run the SYSTEM TEST when the ambient temperature exceeds 20° F.

CHARGE MODE

CHARGE mode allows for charging of the system. System operates for a duration of approximately one hour while the equipment runs at full capacity. After one hour, the CHARGE MODE ends and the system resumes normal operation.

Before starting the CHARGE MODE, turn off the Cool or Heat mode and electric heat (if applicable).

- 18 SEER Inverter units are charged by any of the following methods:
 - setting the “CR9” menu (Charge Mode) to ON through the indoor unit control board push buttons.
 - setting the Charge mode menu of mode display screen-4 to ON through the outdoor unit control board push buttons.
 - Through the CoolCloud HVAC phone application.
- The System will remain in charge mode (high speed) for 60 minutes before timing out.
- Manually shut off.

BOOST MODE

BOOST MODE enables the system to operate at a higher compressor speed than rated maximum compressor speed and satisfy the structural load more effectively during higher ambient outdoor conditions. BOOST MODE is initiated by an outdoor temperature sensor located in the outdoor unit. Please note that outdoor equipment operational sound levels may increase while the equipment is running in BOOST MODE. Disabling BOOST MODE will provide the quietest and most efficient operation.

NOTE: BOOST MODE performance is most effective when paired with an electronic expansion valve enabled indoor unit.

BOOST MODE is ON by default and is activated when the outdoor temperature reaches 105°F. BOOST MODE can be disabled and enabled and the activation temperature adjusted in BOOST TEMP menu using the following procedure:

1. On the HOME screen, select MENU
2. From the MENU screen, select COMFORTNET™ USER MENU
3. Enter Installer password if known.
 - a. The password is the thermostat date code and can be obtained by selecting the red Cancel button and selecting the Dealer Information button.
 - b. Once recorded, click the green OK button and return to the previous step.
4. Select YES to continue.
5. Select HEAT PUMP.
6. Select SYS SETUP
7. BOOST MD turns BOOST MODE OFF or ON. BOOST MODE is ON by default.
8. BOOST TEMP adjusts the activation temperature from 70°F to 105°F. “Always ON” option is also available to permanently engage BOOST MODE. Factory default is 105°.
9. Once satisfied with BOOST MODE adjustments, navigate to the HOME screen by selecting the Previous Menu button three times and then selecting HOME.

DEHUMIDIFICATION

The thermostat reads the indoor humidity level from the CTK04 and allows the user to set a dehumidification target based on these settings. The thermostat controls the humidity level of the conditioned space using the cooling system. Dehumidification is engaged whenever a cooling demand is present and structural humidity levels are above the target level. When this condition exists the circulating fan output is reduced, increasing system run time, over cooling the evaporator coil and ultimately removing more humidity from the structure than if only in cooling mode. The CTK04 also allows for an additional overcooling limit setting from 0 °F to 3 °F setup through the Installer Option menu (direction below). This allows the cooling system to further reduce humidity by lowering the temperature up to 3° F below the cooling setpoint in an attempt to better achieve desired humidity levels.

By default dehumidification needs to be turned ON at the thermostat via the Dehumidification Equipment menu. Dehumidification can be activated at the original equipment setup by selecting the A/C with Low Speed Fan button in the Dehumidification Menu. Availability can be verified by pressing MENU on the home screen. Scroll down and if a Dehumidification button is present dehumidification is activated.

If Dehumidification is not available in the menu then it must be enabled through the Installer Options menu. Use the following procedure to enable and disable dehumidification:

SYSTEM OPERATION

1. On the CTK04 HOME screen, select MENU.
2. From the MENU screen, scroll down and select Installer Options.
3. Enter installer password if known.
 - a. The password is the thermostat date code and can be obtained by selecting the red Cancel button and selecting the Dealer Information button.
 - b. Once recorded click the green OK button and return to the previous step.
4. Select YES to continue.
5. Select View / Edit Current Setup.
6. Scroll down and select Dehumidification.
7. Once open select Dehumidification Equipment: None.
8. From the Dehumidification Menu select A/C with Low Speed Fan and click the green Done button.
9. Additional Dehumidification operational options can be selected in the resulting window.
10. Once satisfied with the selection navigate to the HOME screen by selecting the Done button and selecting Yes to verify the changes.
11. Select Previous Menu, then the HOME to return to the main menu.

DEHUMIDIFICATION TIPS

For effective dehumidification operation:

- Ensure “Dehum” is ON through the Installer Options menu and/or in the ComfortNet User Menu (COOL SETUP)
 - If ON, the Dehumidification menu should be visible in the main menu.
- Verify the cooling airflow profile is set to “Profile D”.
 - See the Cool Set-up section of the Installation Manual for complete airflow profile details.
 - By default “Dehum” is ON and the cooling airflow profile is set to “Profile D”.
- For additional dehumidification control, airflow settings are field adjustable and can be fine-tuned to a value that is comfortable for the application from a range of +15% to -15%.
 - See the Heat Pump Advanced Feature Menu section of the installation manual for more detail.

FAULT CODE HISTORY

The heat pump’s diagnostics menu provides access to the most recent faults. The six most recent faults can be accessed through the control board seven segment displays. Any consecutively repeated fault is stored a maximum of three times.

Example: A leak in the system, low refrigerant charge or an incompletely open stop valve can cause the unit to flash error code E15. This error code suggests that the unit is experiencing operation at low pressure. The control will only store this fault the first three consecutive times the fault occurs.

NOTE: The fault list can be cleared after performing maintenance or servicing the system to assist in the troubleshooting process.

SYSTEM OPERATION

COOLING CYCLE

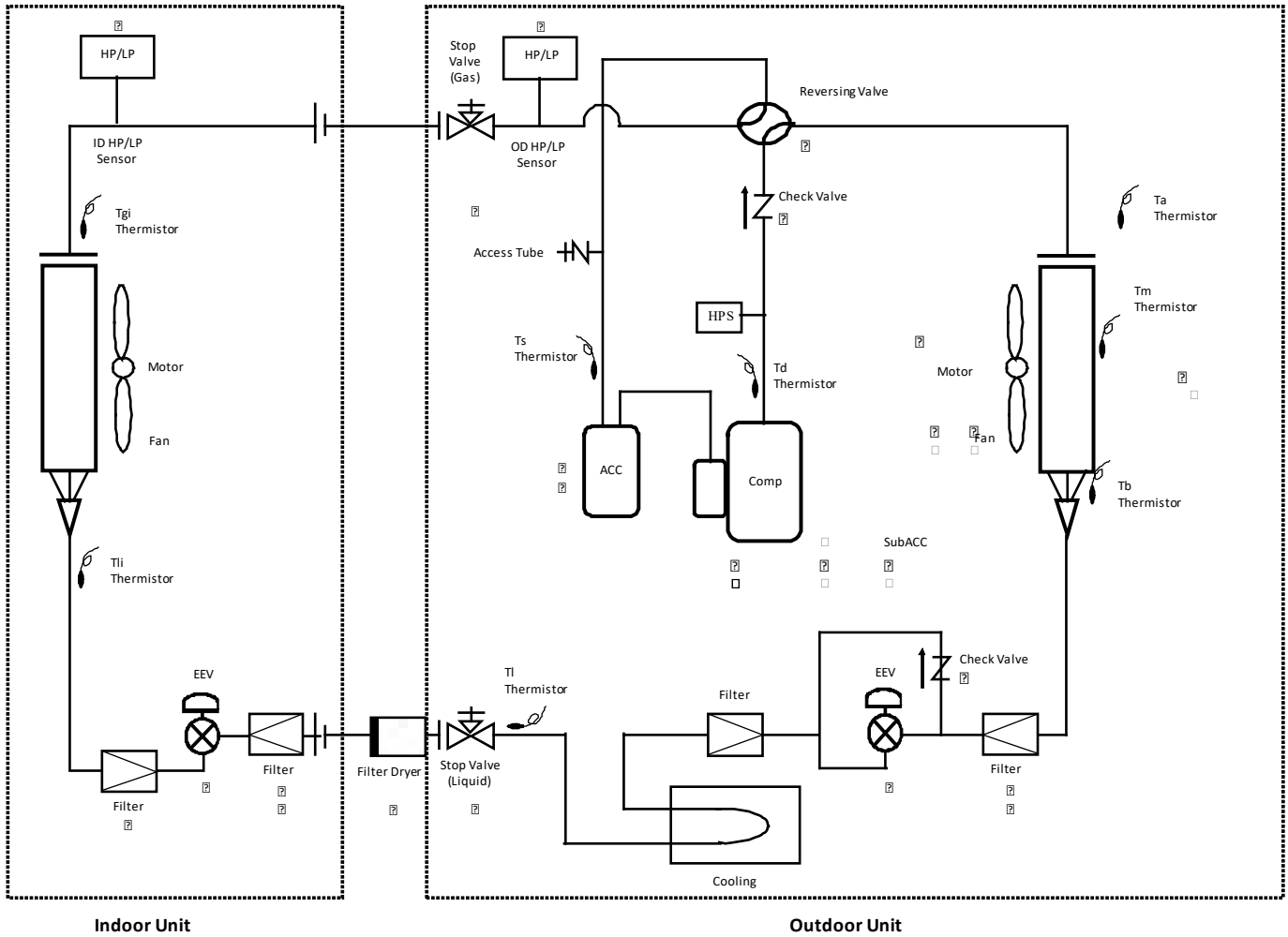

LEGEND:

TI = Thermistor (Outdoor Liquid Temperature)
 Td = Thermistor (Discharge Temperature)
 Tb = Thermistor (Defrost Sensor)
 Tm = Thermistor (Outdoor Coil Temperature)
 Ta = Thermistor (Outdoor Air Temperature)
 Tgi = Thermistor (Indoor Gas Temperature)

Tli = Thermistor (Indoor Liquid Temperature)
 Ts = Thermistor (Suction Temperature)
 OD HP/LP sensor = Outdoor High/Low Pressure Sensor
 ID HP/LP sensor = Indoor High/Low Pressure Sensor
 HPS = High Pressure Switch

SERVICING

CHECKING VOLTAGE

1. Remove outer case, control panel cover, etc., from unit being tested.
With power ON:

 **WARNING**

LINE VOLTAGE NOW PRESENT.

2. Using a voltmeter, measure the voltage across terminals L1 and L2 of the contactor for the heat pump condenser unit or at the field connections for the air handler or heaters.
ComfortNet™ Ready Heat Pump Condenser Units: Measure the voltage across the L1 and L2 lugs on the unitary (UC) control.
3. No reading - indicates open wiring, open fuse(s) no power or etc., from unit to fused disconnect service. Repair as needed.
4. With ample voltage at line voltage connectors, energize the unit.

Unit Supply Voltage		
Voltage	Min.	Max
208/230	197	253

NOTE: When operating electric heaters on voltages other than 240 volt, refer to the System Operation section on electric heaters to calculate temperature rise and air flow. Low voltage may cause insufficient heating.

CHECKING WIRING

 **WARNING**

HIGH VOLTAGE !

DISCONNECT ALL POWER BEFORE SERVICING OR INSTALLING. MULTIPLE POWER SOURCES MAY BE PRESENT. FAILURE TO DO SO MAY CAUSE PROPERTY DAMAGE, PERSONAL INJURY OR DEATH.



1. Check wiring visually for signs of overheating, damaged insulation and loose connections.
2. Use an ohmmeter to check continuity of any suspected open wires.
3. If any wires must be replaced, replace with comparable gauge and insulation thickness.

CHECKING THERMOSTAT AND WIRING

ComfortNet™ Ready Models

Communicating Thermostat Wiring: The maximum wire length for 18 AWG thermostat wire is 250 feet.

THERMOSTAT AND WIRING

 **WARNING**

LINE VOLTAGE NOW PRESENT.

With power ON, thermostat calling for cooling/heating.

1. Use a voltmeter to check for 24 volt at thermostat wires C and R in the indoor unit control panel.
2. No voltage indicates trouble in the thermostat, wiring or transformer source.
3. Check the continuity of the thermostat and wiring. Repair or replace as necessary.

 **WARNING**

LINE VOLTAGE NOW PRESENT.

Resistance Heaters

With power ON:

1. Set room thermostat to a higher setting than room temperature so both stages call for heat.
2. With voltmeter, check for 24 volt at each heater relay.
3. No voltage indicates the trouble is in the thermostat or wiring.
4. Check the continuity of the thermostat and wiring. Repair or replace as necessary.

NOTE: Consideration must be given to how the heaters are wired (O.D.T. and etc.). Also safety devices must be checked for continuity.

CHECKING TRANSFORMER AND CONTROL CIRCUIT

 **WARNING**

HIGH VOLTAGE !

DISCONNECT ALL POWER BEFORE SERVICING OR INSTALLING. MULTIPLE POWER SOURCES MAY BE PRESENT. FAILURE TO DO SO MAY CAUSE PROPERTY DAMAGE, PERSONAL INJURY OR DEATH.



A step-down transformer (208/230 volt primary to 24 volt secondary) is provided with each indoor unit. This allows ample capacity for use with resistance heaters. The outdoor sections do not contain a transformer (see note below). (see indoor unit WIRING DIAGRAM)

 **WARNING**

DISCONNECT ALL POWER BEFORE SERVICING.

1. Remove control panel cover, or etc., to gain access to transformer.

With power ON:

 **WARNING**

LINE VOLTAGE NOW PRESENT.

SERVICING

- Using a voltmeter, check voltage across secondary voltage side of transformer (R to C).
- No voltage indicates faulty transformer, bad wiring, or bad splices.
- Check transformer primary voltage at incoming line voltage connections and/or splices.
- If line voltage available at primary voltage side of transformer and wiring and splices good, transformer is inoperative. Replace.

CHECKING HIGH PRESSURE SWITCH

⚠ WARNING

HIGH VOLTAGE !

DISCONNECT ALL POWER BEFORE SERVICING OR INSTALLING. MULTIPLE POWER SOURCES MAY BE PRESENT. FAILURE TO DO SO MAY CAUSE PROPERTY DAMAGE, PERSONAL INJURY OR DEATH.



The high pressure switch senses the pressure in the compressor discharge line. If abnormally high condensing pressures develop, the contacts of the control open, breaking the control circuit before the compressor motor overloads. This control is automatically reset.

- Using an ohmmeter, check across the X32A connection on the outdoor unit PCB terminals of high pressure control, with wire removed. If not continuous, the contacts are open.
- Attach a gauge to the dill valve port on the base valve. With power ON:

⚠ WARNING

LINE VOLTAGE NOW PRESENT.

- Start the system in charge mode and place a piece of cardboard in front of the outdoor coil, raising the condensing pressure.
- Check pressure at which the high pressure control cuts-out. If it cuts-out at 605 PSIG to -17 PSIG, it is operating normally (See causes for high head pressure in Service Problem Analysis Guide). If it cuts out below this pressure range, replace the control.

CHECKING INDOOR AND OUTDOOR HI/LOW PRESSURE SENSOR

The HI/LOW pressure sensor senses the suction pressure in cooling mode, and the discharge pressure in heating mode. Follow the following sequence to check the pressure sensor.

With Power ON:

⚠ WARNING

LINE VOLTAGE NOW PRESENT.

- Connect manifold gauge to the air conditioner unit
- Connect a pair of extended Molex probe tips to your voltmeter test leads.
- Find the suction pressure in the cool mode, or discharge pressure in the heat mode (terminals) Locate (X17A) connection and connect a DC voltmeter across sensor terminals 1 and 3, (black and white wires) and record the DC voltage.
- Compare your readings to the detected pressure vs output voltage in the following table. Replace the sensor if the sensor is open, shorted, or outside of the voltage range.

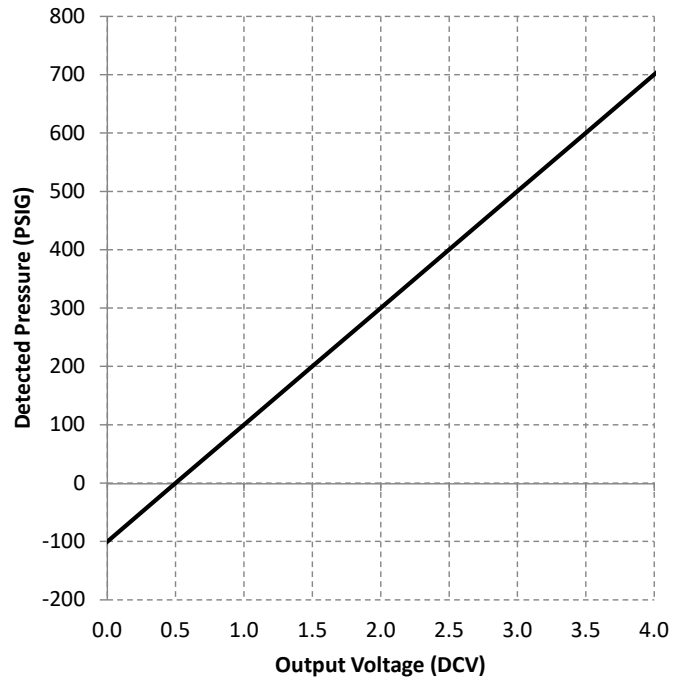

VOLTAGE AND PRESSURE CHARACTERISTICS

CHECKING COMPRESSOR

⚠ WARNING

Hermetic compressor electrical terminal venting can be dangerous. When insulating material which supports a hermetic compressor or electrical terminal suddenly disintegrates due to physical abuse or as a result of an electrical short between the terminal and the compressor housing, the terminal may be expelled, venting the vapor and liquid contents of the compressor housing and system.

If the compressor terminal PROTECTIVE COVER and gasket (if required) are not properly in place and secured, there is a remote possibility if a terminal vents, that the vaporous and liquid discharge can be ignited, spouting flames several feet, causing potentially severe or fatal injury to anyone in its path.

This discharge can be ignited external to the compressor if the terminal cover is not properly in place and if the discharge impinges on a sufficient heat source.

SERVICING

Ignition of the discharge can also occur at the venting terminal or inside the compressor, if there is sufficient contaminant air present in the system and an electrical arc occurs as the terminal vents.

Ignition cannot occur at the venting terminal without the presence of contaminant air, and cannot occur externally from the venting terminal without the presence of an external ignition source.

Therefore, proper evacuation of a hermetic system is essential at the time of manufacture and during servicing. To reduce the possibility of external ignition, all open flame, electrical power, and other heat sources should be extinguished or turned off prior to servicing a system.

COMPRESSOR WINDING INSULATION TEST

The Inverter on the outdoor control board takes the position signal from the UVW line, connected with the compressor. If the system detects a malfunction on the compressor, check the insulation resistance in accordance with the following procedure.

⚠ WARNING
HIGH VOLTAGE!
Disconnect ALL power before servicing or installing. Multiple power sources may be present. Failure to do so may cause property damage, personal injury or death.



1. Remove the leads from the compressor terminals.

⚠ WARNING
See warnings before removing compressor terminal cover.

2. Using a Megometer, attach one lead to ground.
3. Using the other lead of the Megometer, check the insulation between U to ground, V to ground, W to ground.

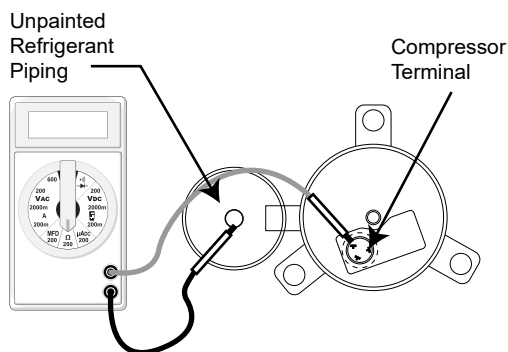

TESTING COMPRESSOR WINDINGS INSULATION

NOTE: The 2, 3, and 4 ton compressor has a terminal on the top. The 5 ton compressor has the terminals on the side. If the insulation resistance of the compressor is less than 100k Ohms between U to ground, V to ground, W to ground, replace the compressor.

GROUND TEST

If fuse, circuit breaker, ground fault protective device, etc., has tripped, this is a strong indication that an electrical problem exists and must be found and corrected. The circuit protective device rating must be checked, and its maximum rating should coincide with that marked on the equipment nameplate.

With the terminal protective cover in place, it is acceptable to replace the fuse or reset the circuit breaker ONE TIME ONLY to see if it was just a nuisance opening. If it opens again, DO NOT continue to reset.

Disconnect all power to unit, making sure that **all** power legs are open.

1. DO NOT remove protective terminal cover. Disconnect the three leads going to the compressor terminals at the nearest point to the compressor.
2. Identify the leads and using an ohmmeter on the R x 10,000 scale or the highest resistance scale on your ohmmeter check the resistance between each of the three leads separately to ground (such as an unpainted tube on the compressor).
3. If a ground is indicated, then carefully remove the compressor terminal protective cover and inspect for loose leads or insulation breaks in the lead wires.
4. If no visual problems indicated, carefully remove the leads at the compressor terminals.
5. Carefully retest for ground, directly between compressor terminals and ground.
6. If ground is indicated, replace the compressor. The resistance reading should be infinity. If there is any reading on meter, there is some continuity to ground and compressor should be considered defective.

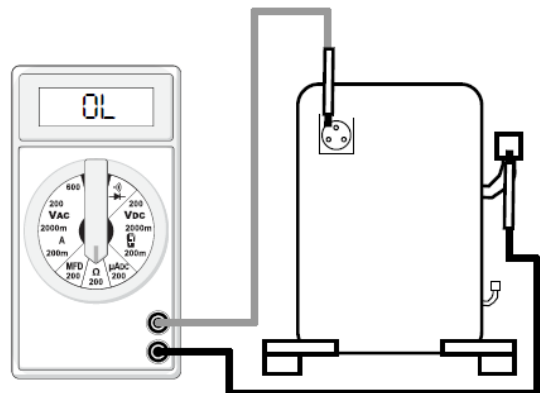

SERVICING

WARNING
 Damage can occur to the glass embedded terminals if the leads are not properly removed. This can result in terminal and hot oil discharging.

WARNING
 Disconnect ALL power before servicing.

TESTING TEMPERATURE SENSORS AND EEV COIL RESISTANCE

The AVZC ComfortNet ready heat pump models and AVPEC indoor units are factory equipped with:

- (Ta) an outdoor air temperature sensor
- (Tm) an outdoor coil temperature sensor
- (TI) an outdoor liquid temperature sensor
- (Td) a discharge temperature sensor
- (Tb) a defrost temperature sensor
- (Tgi) an indoor gas temperature sensor
- (Tli) an indoor liquid temperature sensor

To check above sensors:

WARNING
HIGH VOLTAGE!
 Disconnect ALL power before servicing or installing. Multiple power sources may be present. Failure to do so may cause property damage, personal injury or death.



1. Disconnect power to the heat pump condenser.
2. Disconnect the sensor from the electric board.
3. Connect an ohmmeter across the sensor terminals. The ohmmeter should read be the resistance shown in the table THERMISTOR RESISTANCE AND TEMPERATURE CHARACTERISTICS. Replace the sensor if the sensor is open, shorted, or outside the valid resistance range.

TESTING EEV COIL RESISTANCE

To check the resistance of the EEV coil, first disconnect EEV cable from the Control board. Make measurements of resistance between the connector pins, and then make sure the resistance falls in the range of 40 to 50Ω.

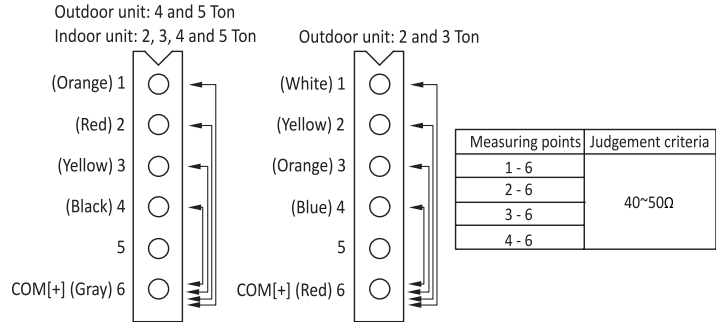

TESTING REVERSING VALVE

CHECKING REVERSING VALVE AND SOLENOID

Reversing valve used in heat pumps could potentially leak internally. Discharge gases can leak into the suction inside the valve. Compound gages will give the same symptoms as bad compressor valves or broken scroll flanks. The temperature between true suction and the suction line after the valve should not be greater than 4 degrees. Note: The center tube is always the suction line and should be cold.

TROUBLESHOOTING THE REVERSING VALVE FOR ELECTRICAL FAILURE

Place unit into the cooling mode. Test for 24 volts at the solenoid. If there is no voltage present at coil, check the control voltage. If voltage is present, loosen the nut on the top of the coil. Remove the coil, there should be slight resistance. If the slight resistance is felt, remove the coil. As you remove the coil listen carefully, an audible click should be detected. The clicking is due to the movement of the pilot valve plunger. The absence of a clicking sound indicates the plunger is stuck.

TROUBLESHOOTING MECHANICAL FAILURES ON A REVERSING VALVE BY PRESSURE

Troubleshooting the reversing valve can be done by pressure and touch. Raise the head pressure. In the cooling mode block the fan exhaust. Once head pressure has been raised, cycle between cooling and heating and see if the piston can be freed.

TROUBLESHOOTING MECHANICAL FAILURES ON A REVERSING VALVE BY TEMPERATURE

When operating properly the valve contains refrigerant gases at certain temperatures. The discharge line should be the same temperature after the valves discharge line. The true suction should be the same as the suction line after the valve. If there is a 4-degree difference, valve is leaking. When stuck in the mid-position, part of the discharge gas from the compressor is directed back to the suction side, resulting in excessively high suction pressure. An increase in the suction line temperature through the reversing valve can also be measured. Check operation of the valve by starting the system and switching the opera-

SERVICING

tion from COOLING to HEATING cycle. If the valve fails to change its position, test the voltage (24V) at the valve coil terminals (X25A) on outdoor unit PCB while the system is on the COOLING cycle. If voltage is registered at the coil, tap the valve body lightly while switching the system from HEATING to COOLING, etc. If this fails to cause the valve to switch positions, remove the coil connector cap and test the continuity of the reversing valve solenoid coil. If the coil does not test continuous - replace it. If the coil test continuous and 24 volts is present at the coil terminals, the valve is inoperative - replace it.

AVPEC* HEATER CONTROL (OPTIONAL) DESCRIPTION

The AVPEC* models utilize an electronic control that provides ECM blower motor control and control of up to two electric heat sequencers. The control has thermostat inputs for variable stage of cooling/heating, two stages of electric heat, reversing valve, and dehumidification. Control input is 24 VAC.

FEATURES



The new air handler control includes advanced diagnostic features with fault recall, estimated CFM display via 7 segment display of control board, CoolCloud™ and ComfortNet™ ready. Diagnostics includes heater kit selection diagnostics, open fuse, internal control fault, data errors, and blower motor faults. Data errors are not included in the fault recall list. Diagnostic error codes are displayed on a single red LED. The estimated CFM is displayed on an on-board 7 segment display. For example, if the CFM is 1240CFM, 7 segment display shows “FC...A...12...40...”.

The AVPEC* air handlers may be used in a fully communicating system when matched with a compatible outdoor unit and the thermostat. A fully communicating system offers advanced setup and diagnostic features.

BASIC OPERATION

The air handler control receives operation demand inputs from the thermostat. The control operates the variable speed blower motor at the demand as determined from the thermostat input(s). If a demand for electric heat is received, the control will provide a 24VAC output for up to two electric heat sequencers.

TROUBLESHOOTING MOTOR CONTROL CIRCUITS



**WARNING**
HIGH VOLTAGE!
Disconnect ALL power before servicing or installing. Multiple power sources may be present. Failure to do so may cause property damage, personal injury or death.

1. Turn on power to air handler or modular.

**WARNING**
Line Voltage now present.

2. Check voltage between pins 1 and 4 at the 4-wire motor connector on the control board. Voltage should be between 9 and 15 VDC. Replace control if voltage is not as specified.

ELECTRIC HEAT SEQUENCER OUTPUTS

**WARNING**
HIGH VOLTAGE!
Disconnect ALL power before servicing or installing. Multiple power sources may be present. Failure to do so may cause property damage, personal injury or death.

1. Turn on power to air handler or modular blower.

**WARNING**
Line Voltage now present.

2. Disconnect the 3-circuit harness connecting the control to the electric heater kit.
3. Provide a thermostat demand for low stage auxiliary heat (W1). Measure the voltage between pins 1 and 3 at the on-board electric heat connector. Voltage should measure 24VAC. Replace control if no voltage is present.

NOTE: Allow for any built-in time delays before making voltage measurements. Any electric heater faults that are present may prevent the heater output from energizing. Verify that no heater faults are present before making voltage measurements.

COMMUNICATIONS (APPLIES ONLY TO SYSTEMS WITH COMPATIBLE COMFORTNET™ OUTDOOR UNIT AND CTK04** THERMOSTAT)

The integrated air handler control has some on-board tools that may be used to troubleshoot the network. These tools are: red communications LED, green receive (Rx) LED, and learn button. These are described below

- a. Red communications LED – Indicates the status of the network. Refer to the Network Troubleshooting Chart for the LED status and the corresponding potential problem.
- b. Green receive LED – Indicates network traffic. Refer to the Network Troubleshooting Chart for the LED status and the corresponding potential problem.
- c. Learn button – Used to reset the network. Depress the button for approximately 2 seconds to reset the network.

SERVICING

Voltages between the two data lines and between each data line and common may be used to determine if the network is operating properly.

Do the following to measure the voltages on the communications data lines.



WARNING
Line Voltage now present.

1. With power on to the unit, measure voltage between terminal "1" and terminal "C" on control board's thermostat connector. Voltage should be as noted in the table below.
2. Measure voltage between terminals "2" and "C".
3. Measure voltage between terminals "1" and "2".
4. If voltages are different than stated in the table below, check thermostat wiring for opens/shorts.
5. The network troubleshooting chart provides additional communications troubleshooting information.

Terminals	Normal dc Voltages
1 to C	> 2.5 Vdc
2 to C	< 2.5 Vdc
1 to 2	> 0.2 Vdc

REFRIGERATION REPAIR PRACTICE



DANGER
Always remove the refrigerant charge in a proper manner before applying heat to the system.

When repairing the refrigeration system:



WARNING
HIGH VOLTAGE!
Disconnect ALL power before servicing or installing. Multiple power sources may be present. Failure to do so may cause property damage, personal injury or death.



1. Never open a system that is under vacuum. Air and moisture will be drawn in.
2. Plug or cap all openings.
3. Remove all burrs and clean the brazing surfaces of the tubing with sand cloth or paper. Brazing materials do not flow well on oxidized or oily surfaces.
4. Clean the inside of all new tubing to remove oils and pipe chips.
5. When brazing, sweep the tubing with dry nitrogen to prevent the formation of oxides on the inside surfaces.
6. Complete any repair by replacing the liquid line drier in the system, evacuate and charge.

BRAZING MATERIALS

IMPORTANT NOTE: Torch heat required to braze tubes of various sizes is proportional to the size of the tube. Tubes of smaller size require less heat to bring the tube to brazing temperature before adding brazing alloy. Applying too much heat to any tube can melt the tube. Service personnel must use the appropriate heat level for the size of the tube being brazed.

NOTE: The use of a heat shield when brazing is recommended to avoid burning the serial plate or the finish on the unit. Heat trap or wet rags should be used to protect heat sensitive components such as stop valves, EEV, TXV and filters.

Copper to Copper Joints - Sil-Fos used without flux (alloy of 15% silver, 80% copper, and 5% phosphorous). Recommended heat 1400°F.

Copper to Steel Joints - Silver Solder used without a flux (alloy of 30% silver, 38% copper, 32% zinc). Recommended heat - 1200°F.

LEAK TESTING (NITROGEN OR NITROGEN-TRACED)



WARNING
To avoid the risk of fire or explosion, never use oxygen, high pressure air or flammable gases for leak testing of a refrigeration system.



WARNING
To avoid possible explosion, the line from the nitrogen cylinder must include a pressure regulator and a pressure relief valve. The pressure relief valve must be set to open at no more than 450 psig.

Pressure test the system using dry nitrogen and soapy water to locate leaks. If you wish to use a leak detector, charge the system to 10 PSIG using the appropriate refrigerant then use nitrogen to finish charging the system to working pressure, then apply the detector to suspect areas. If leaks are found, repair them. After repair, repeat the pressure test. If no leaks exist, proceed to system evacuation.

STANDING PRESSURE TEST (RECOMMENDED)

Best practices dictate system should be pressure tested at 450 PSIG with nitrogen for a minimum 4 hours. Follow the procedure outlined below to test system. If leaks are found, repair them. After repair, repeat the leak pressure test described above. If no leaks exist, proceed to system evacuation and charging.

SERVICING

SYSTEM PRESSURE TESTING

Once all of the refrigerant line connections are completed. Perform a 3-step nitrogen pressure test.

1. Pressurize the system with nitrogen to 150 PSIG and hold for 3 minutes. If any pressure drops occur, locate and repair leaks and repeat step 1.
2. Pressurize the system with nitrogen to 325 PSIG and hold for 5 minutes. If any pressure drops occur, locate and repair leaks and repeat step 1.
3. Pressurize the system with nitrogen to 450 PSIG and hold for 4 hours. If any pressure drops occur, locate and repair leaks and repeat step 1.

EVACUATION



WARNING

REFRIGERANT UNDER PRESSURE!

Failure to follow proper procedures may cause property damage, personal injury or death.

IMPORTANT NOTE: Because of the potential damage to compressors, do not allow suction pressure at service valve to drop below 5 PSIG when pumping unit system down for repair. Outdoor section, depending on line set length and amount of charge in system, may not be able to hold the entire system charge.

This is the most important part of the entire service procedure. The life and efficiency of the equipment is dependent upon the thoroughness exercised by the serviceman when evacuating air (non-condensables) and moisture from the system.

Air in a system causes high condensing temperature and pressure, resulting in increased power input and reduced performance.

Moisture chemically reacts with the refrigerant oil to form corrosive acids. These acids attack motor windings and parts, causing breakdown.

The equipment required to thoroughly evacuate the system is a vacuum pump, capable of producing a vacuum equivalent to 500 microns absolute and a micron gauge to give a true reading of the vacuum in the system

NOTE: Never use the system compressor as a vacuum pump or run when under a high vacuum. Motor damage could occur.

The triple evacuation method is recommended.

1. Evacuate the system to 4000 microns and hold for 15 minutes. Then, break the vacuum with dry nitrogen, bring the system pressure up to 2-3 PSIG, and hold for 20 minutes. Release the nitrogen.
2. Evacuate to 1500 microns and hold for 20 minutes.

Break the vacuum with dry nitrogen again, bring the system pressure back up to 2-3 PSIG, and hold for 20 minutes.

3. Then, evacuate the system until it is below 500 microns and hold for 60 minutes.



WARNING

Do not front seat the service valve(s) with the compressor open, with the suction line of the compressor closed or severely restricted.

1. Connect the vacuum pump, vacuum tight manifold set with high vacuum hoses, micron gauge and charging cylinder as shown.
2. Start the vacuum pump and open the shut off valve to the high vacuum gauge manifold only. After the compound gauge (low side) has dropped to approximately 29 inches of vacuum, open the valve to the vacuum micron gauge. See that the vacuum pump will blank-off to a maximum of 500 microns. A vacuum pump can only produce a good vacuum if its oil is non-contaminated.

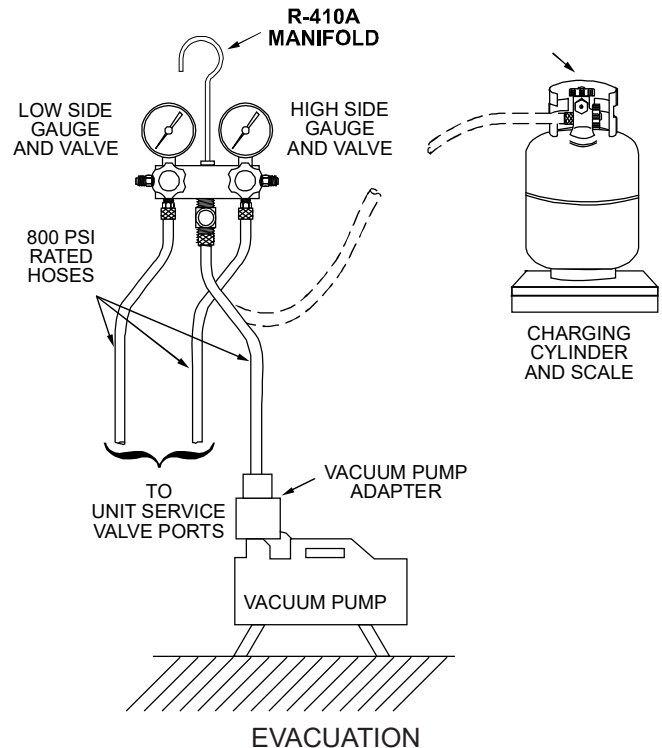

3. If the vacuum pump is working properly, close the valve to the micron gauge and open the high and low side valves to the high vacuum manifold set. With the valve on the charging cylinder closed, open the manifold valve to the cylinder.
4. Evacuate the system to at least 29 inches gauge before opening valve to micron gauge.
5. Continue to evacuate to a maximum of 500 microns. Close valve to vacuum pump and watch rate of rise. If vacuum does not rise above 500 microns in three to five minutes, system can be considered properly evacuated.
6. If micron gauge continues to rise and levels off at about

SERVICING

2000 microns, moisture and non-condensables are still present. If gauge continues to rise a leak is present. Repair and re-evacuate.

7. Close valve to micron gauge and vacuum pump. Shut off pump and prepare to charge.

CHARGING



WARNING

REFRIGERANT UNDER PRESSURE!

- * Do not overcharge system with refrigerant.
 - * Do not operate unit in a vacuum or at negative pressure.
- Failure to follow proper procedures may cause property damage, personal injury or death.



CAUTION

Use refrigerant certified to AHRI standards. Used refrigerant may cause compressor damage and is not covered by the warranty. Most portable machines cannot clean used refrigerant to meet AHRI Standards.



CAUTION

Damage to the unit caused by operating the compressor with the suction valve closed is not covered under the warranty and may cause serious compressor damage.

Charge the system with the exact amount of refrigerant. See the Installation Manual for the correct refrigerant charge.

An inaccurately charged system will cause future problems.

1. When using an ambient compensated calibrated charging cylinder, allow liquid refrigerant only to enter the high side.
2. Once the system stops taking refrigerant, close the valve on the high side of the charging manifold.
3. Start the system and charge the balance of the refrigerant through the low side.

NOTE: R410A should be drawn out of the storage container or drum in liquid form due to its fractionation properties, but should be "Flashed" to its gas state before entering the system. There are commercially available restriction devices that fit into the system charging hose set to accomplish this. **DO NOT** charge liquid R410A into the compressor.

4. With the system still running, close the valve on the charging cylinder. At this time, you may still have some liquid refrigerant in the charging cylinder hose and will definitely have liquid in the liquid hose. Reseat the liquid line core. Slowly open the high side manifold valve and transfer the liquid refrigerant from the liquid line hose and charging cylinder hose into the suction service valve port. **CAREFUL:** Watch so that liquid refrigerant does not enter the compressor.

FINAL CHARGE ADJUSTMENT

The outdoor temperature must be 65°F to 105°F. If outdoor ambient temperature is out of range, charge defined amount and don't adjust subcooling. Set the room thermostat to CHARGE mode.

After system has stabilized per startup instructions, check subcooling as detailed in the following section.

In the event of system overcharge or undercharge, refrigerant in the system must be adjusted to the appropriate subcooling and superheat as specified in the following sections. Refrigerant amount should be adjusted within +/- 0.5 lb. if the outdoor ambient temperature is greater than 65°F and less than 105°F. Manufacturer recommends that the system should be evacuated and should be charged the initial refrigerant for given line length when the ambient temperature is less than 65°F and more than 105°F. Refer to the Installation Manual to calculate refrigerant amount.

5. With the system still running, remove hose and reinstall both valve caps.
6. Check system for leaks.

NOTE: Subcooling information is valid only while the unit is operating at 100% capacity or 100% of compressor speed in CHARGE MODE. Compressor speed is displayed under STATUS menu in the thermostat.

CHECKING COMPRESSOR EFFICIENCY

The reason for compressor inefficiency is that the compressor is broken or damaged, reducing the ability of the compressor to pump refrigerant vapor.

The condition of the compressor is checked in the following manner.

1. Attach gauges to the high and low side of the system.
2. Start the system and run CHARGE MODE.

If the test shows:

- a. Below normal high side pressure.
- b. Above normal low side pressure.
- c. Low temperature difference across coil.
- d. Low amp draw at compressor.

And the charge is correct. The compressor is faulty - replace the compressor.

CHECKING SUBCOOLING

Refrigerant liquid is considered subcooled when its temperature is lower than the saturation temperature corresponding to its pressure. The degree of subcooling equals the degrees of temperature decrease below the saturation temperature at the existing pressure.

1. Attach an accurate thermometer or preferably a thermocouple type temperature tester to the liquid service valve as it leaves the condensing unit.

SERVICING

2. Install a high side pressure gauge on the high side (liquid) service valve at the front of the unit.
3. Record the gauge pressure and the temperature of the line.
4. Review the technical information manual or specification sheet for the model being serviced to obtain the design subcooling.
5. Compare the hi-pressure reading to the "Required Liquid Line Temperature" chart. Find the hi-pressure value on the left column. Follow that line right to the column under the design subcooling value. Where the two intersect is the required liquid line temperature.
Alternately you can convert the liquid line pressure gauge reading to temperature by finding the gauge reading in the R-410A Pressure vs. Temperature Chart, find the temperature in the °F. Column.
6. The difference between the thermometer reading and pressure to temperature conversion is the amount of subcooling.

Add charge to raise subcooling. Recover charge to lower subcooling.
Subcooling Formula = Sat. Liquid Temp. - Liquid Line Temp.

EXAMPLE:

- a. Liquid Line Pressure = 417 PSIG
- b. Corresponding Temp. = 120°F.
- c. Thermometer on Liquid line = 109°F.

To obtain the amount of subcooling subtract 109°F from 120°F.

The difference is 11° subcooling. See the specification sheet or technical information manual for the design subcooling range for your unit.

2 TON	10-12°F
3 TON	13-15°F
4 TON	8-10°F
5 TON	11-13°F

There are other causes for high head pressure which may be found in the "Cooling / Heating Analysis Chart." If other causes check out normal, an overcharge or a system containing non-condensables would be indicated. If this system is observed:

1. Start the system.
2. Remove and capture small quantities of gas from the suction line dill valve until the head pressure is reduced to normal.
3. Observe the system while running a cooling performance test. If a shortage of refrigerant is indicated, then the system contains non-condensables.

SUBCOOLING ADJUSTMENT ON EEV APPLICATIONS

NOTE: Subcooling information is valid only while the unit is operating at 100% capacity or 100% compressor speed in CHARGE MODE.

Compressor speed is displayed under STATUS menu in the thermostat.

1. Run system at least 20 minutes to allow pressure to stabilize. During the adjustment of subcooling, ambient temperature should be greater than 65°F and less than 105°F. If ambient temperature is out of range, don't adjust subcooling.
2. For best results, temporarily install a thermometer on the liquid line at the liquid line service valve. Ensure the thermometer makes adequate contact and is insulated for best possible readings. Use liquid line temperature to determine sub-cooling.
3. The system subcooling should fall in the range shown in following table. If not in that range, adjust subcooling according to the following procedure.
 - a. If subcooling is low, add charge to adjust the subcooling as specified in the following table.

2 TON	10-12°F
3 TON	13-15°F
4 TON	8-10°F
5 TON	11-13°F

- b. If subcooling is high, remove charge to lower the subcooling to specified range.

NOTE: Not more than 0.8 lb. (13 oz.) of refrigerant be added to the system at a time to achieve the target subcooling. It is recommended adding 4 oz. refrigerant each time, then wait 20 minutes to stabilize the system.

4. Disconnect manifold set. Installation is complete.

NON-CONDENSABLES

If non-condensables are suspected, shut down the system and allow the pressures to equalize. Wait at least 15 minutes. Compare the pressure to the temperature of the coldest coil since this is where most of the refrigerant will be. If the pressure indicates a higher temperature than that of the coil temperature, non-condensables are present.

Non-condensables are removed from the system by first removing the refrigerant charge, replacing and/or installing liquid line drier, evacuating and recharging.

COMPRESSOR BURNOUT

When a compressor burns out, high temperature develops causing the refrigerant, oil and motor insulation to decompose forming acids and sludge.

If a compressor is suspected of being burned-out, attach a refrigerant hose to the liquid line dill valve and properly remove and dispose of the refrigerant.



NOTICE

Violation of EPA regulations may result in fines or other penalties.

SERVICING

Now determine if a burn out has actually occurred. Confirm by analyzing an oil sample using a Sporlan Acid Test Kit, AK-3 or its equivalent.

Remove the compressor and obtain an oil sample from the suction stub. If the oil is not acidic, either a burnout has not occurred or the burnout is so mild that a complete clean-up is not necessary.

If acid level is unacceptable, the system must be cleaned by using the clean-up drier method.



CAUTION

**Do not allow the sludge or oil to contact the skin.
Severe burns may result.**

NOTE: The Flushing Method using R-11 refrigerant is no longer approved by the Manufacturer.

REFRIGERANT PIPING

The piping of a refrigeration system is very important in relation to system capacity, proper oil return to compressor, pumping rate of compressor and cooling performance of the evaporator. A bi-flow filter drier must be brazed on by the installer onsite. Ensure the bi-flow filter drier paint finish is intact after brazing. If the paint of the steel filter drier has been burned or chipped, repaint or treat with a rust preventative. The recommended location of the filter drier is before the electronic expansion valve at the indoor unit. The liquid line must be insulated if more than 50 ft. of liquid line will pass through an area that may reach temperatures of 30° F of higher than ambient in cooling mode and/or if the temperature inside the conditioned space may reach a temperature lower than ambient in heating mode.

FVC50K oils maintain a consistent viscosity over a large temperature range which aids in the oil return to the compressor; however, there will be some installations which require oil return traps. These installations should be avoided whenever possible, as adding oil traps to the refrigerant lines also increases the opportunity for debris and moisture to be introduced into the system.

Avoid long running traps in horizontal suction line.

SERVICING

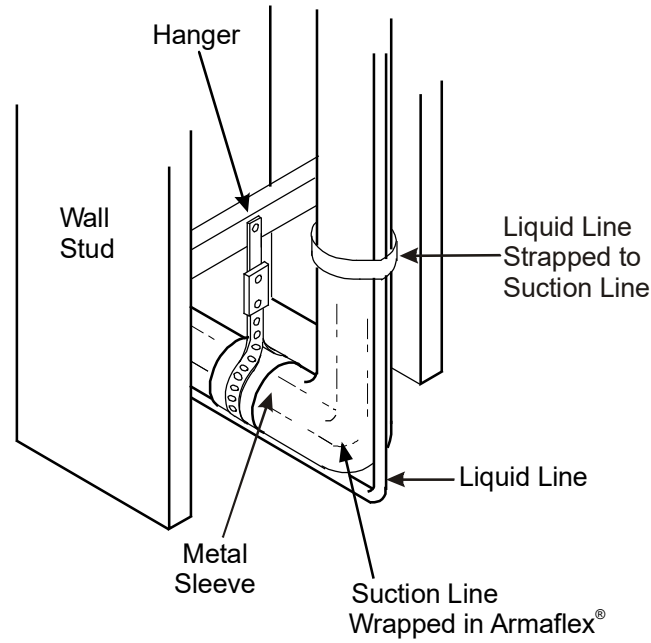

FIGURE 1-1.
INSTALLATION OF REFRIGERATION PIPING FROM VERTICAL TO HORIZONTAL

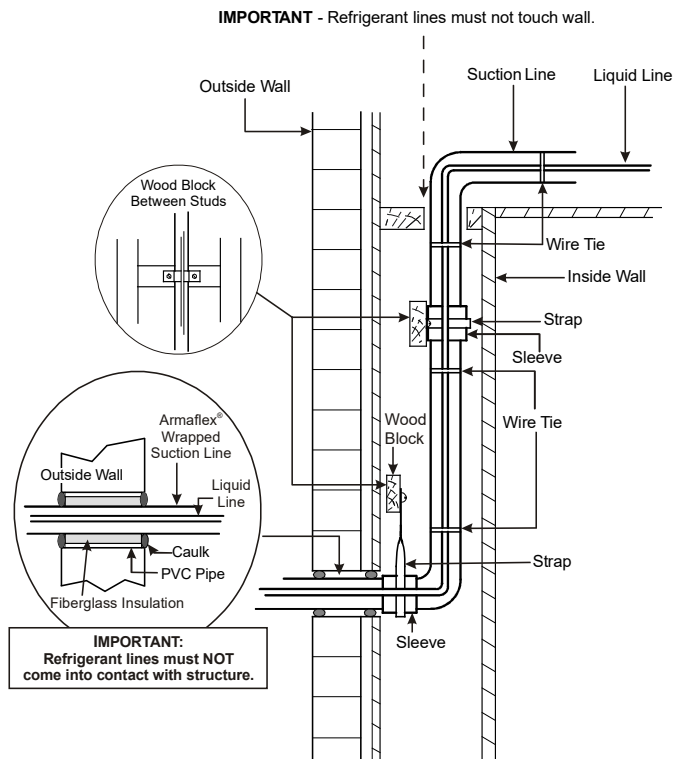
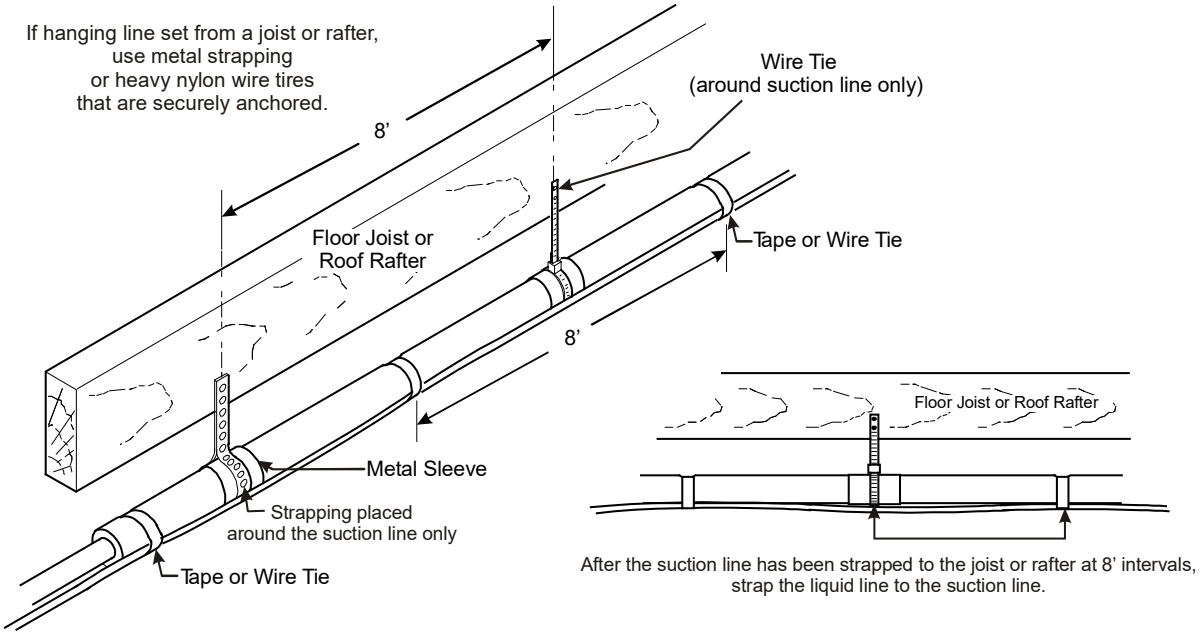

FIGURE 1-2. INSTALLATION OF REFRIGERANT PIPING (VERTICAL)
NEW CONSTRUCTION SHOWN

NOTE: If line set is installed on the exterior of an outside wall, similar installation practices are to be used.

SERVICING



SECTION 3. OUTDOOR UNIT IS ABOVE THE INDOOR UNIT



Condenser ABOVE Evaporator

Mounting the condensing unit above the evaporator coil will require an oil trap that is vertically centered between the condensing unit and air handler IF the vertical separation exceeds 80 ft. The trap can be constructed from standard refrigerant fittings as shown in the figure (bottom left).

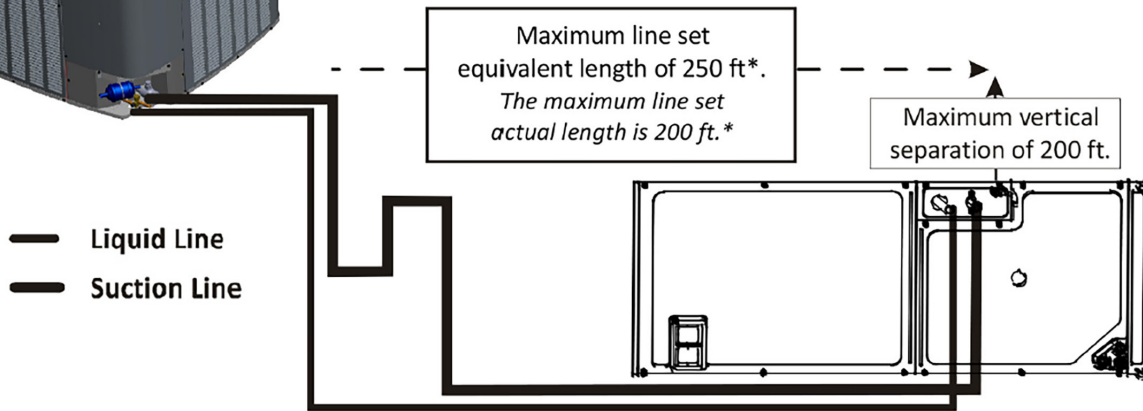

**Accounts for pressure losses of any elbows, bends, etc.*

1. Gas line must be sloped continuously towards the indoor unit.
2. The maximum elevation (vertical) difference between the outdoor unit and indoor unit is 200 feet.
3. The maximum line set equivalent length is 250 feet, which includes pressure losses of any elbow, bends, etc. The maximum line set actual length is 200 feet.
4. Inverted suction loop is not required at either unit.
5. An accumulator is not required for outdoor unit (accumulators are factory installed).

SERVICING

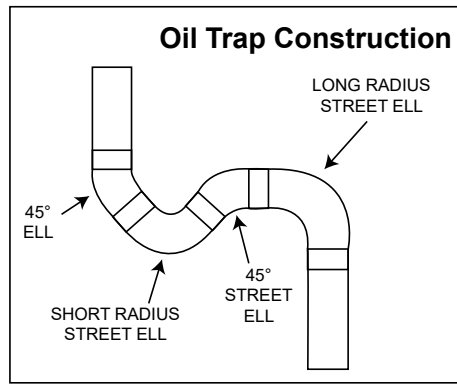

SECTION 4. OUTDOOR UNIT IS BELOW THE INDOOR UNIT

Heat Pump BELOW Indoor Coil

Mounting the indoor coil above the heat pump unit will require an inverted loop in the gas line adjacent or near the connection to the indoor coil, for the purpose of creating an oil trap. The top of the loop must be slightly higher than the top of the coil.

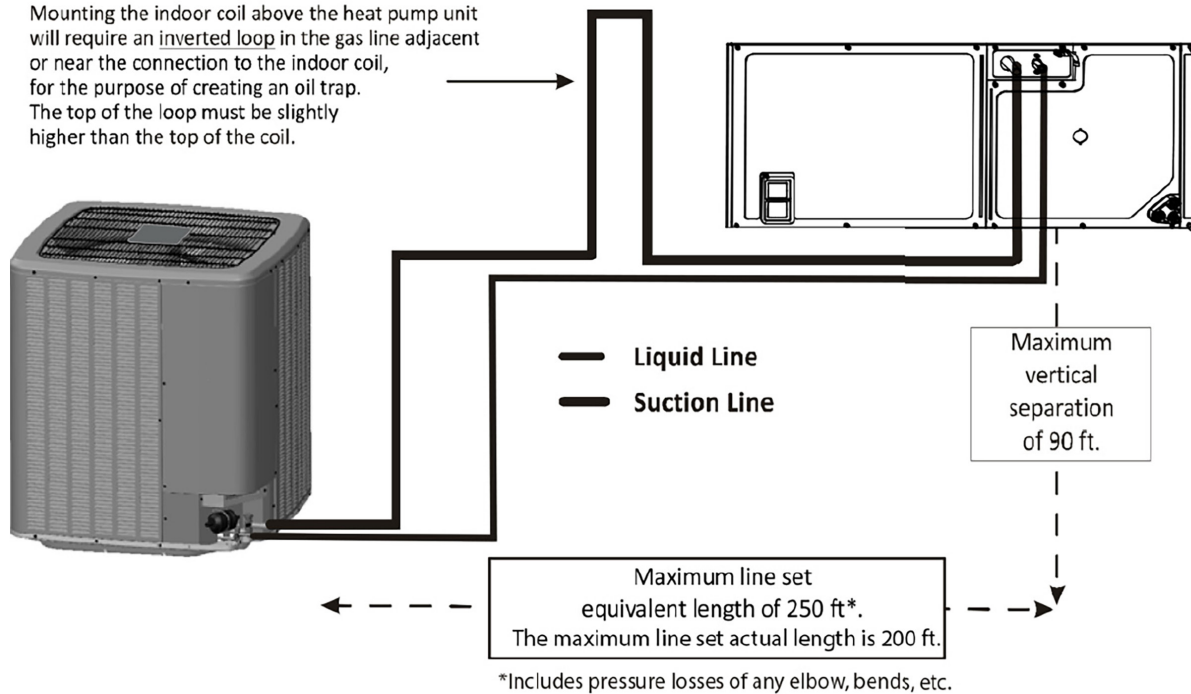

1. The maximum elevation (vertical) difference between the outdoor unit and the indoor unit is 90 feet.
2. Suction line must be installed in a manner to prevent liquid migration to the outdoor unit from the indoor unit. The heat pump condenser unit is shipped with a predetermined factory charge level as shown in the following chart. For longer line sets greater than 15 feet, add 0.6 ounces of refrigerant per foot.

NOTICE

TOTAL REFRIGERANT =
 FACTORY CHARGE + (0.6 oz./ft. * ADDITIONAL FEET
 OF ACTUAL LINE SET).

SERVICING

DUCT STATIC PRESSURES AND/OR STATIC PRESSURE DROP ACROSS COILS

This minimum and maximum allowable duct static pressure for the indoor sections are found in the specifications section.

Tables are also provided for each coil, listing quantity of air (CFM) versus static pressure drop across the coil.

Too great an external static pressure will result in insufficient air that can cause icing of the coil. Too much air can cause poor humidity control and condensate to be pulled off the indoor coil causing condensate leakage. Too much air can also cause motor overloading and in many cases this constitutes a poorly designed system.

AIR HANDLER EXTERNAL STATIC

To determine proper air movement, proceed as follows:

1. Using a draft gauge (inclined manometer), measure the static pressure of the return duct at the inlet of the unit, (Negative Pressure).
2. Measure the static pressure of the supply duct, (Positive Pressure).
3. Add the two (2) readings together.
4. Consult unit nameplate for quantity of air.

COIL STATIC PRESSURE DROP

1. Using a draft gauge (inclined manometer), connect the positive probe underneath the coil and the negative probe above the coil.
2. A direct reading can be taken of the static pressure drop across the coil.
3. Consult unit nameplate for quantity of air.

If the total external static pressure and/or static pressure drop exceeds the maximum or minimum allowable statics, check for closed dampers, dirty filters, undersized or poorly laid out duct work.

Checking Static Pressure Single Piece Air Handler

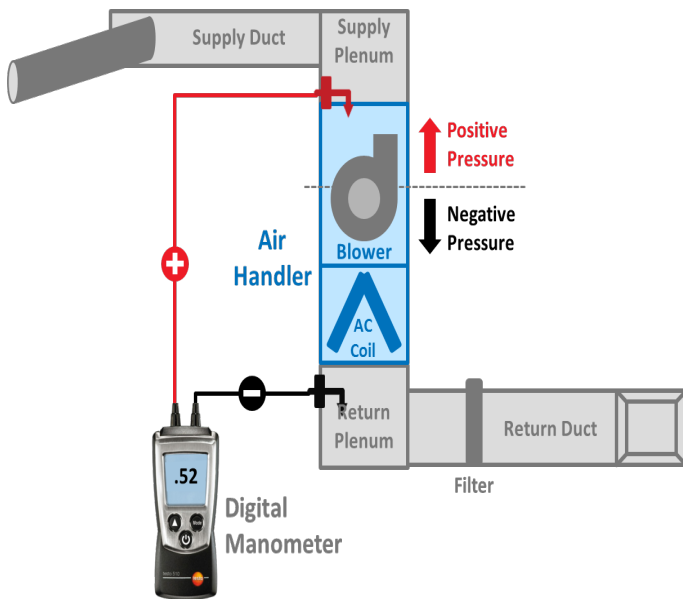

- Measure static pressure of the supply duct at the outlet of the air handler.
- Measure the static pressure of the return duct at the inlet of the air handler
- Single piece air handler evaporator coil is already considered in airflow calculation
- **NOTE:** Both readings may be taken simultaneously and read if so desired.

SERVICING

INDOOR UNIT TROUBLESHOOTING

⚠ WARNING

HIGH VOLTAGE !

DISCONNECT ALL POWER BEFORE SERVICING.

MULTIPLE POWER SOURCES MAY BE PRESENT. FAILURE TO DO SO MAY CAUSE PROPERTY DAMAGE, PERSONAL INJURY OR DEATH.



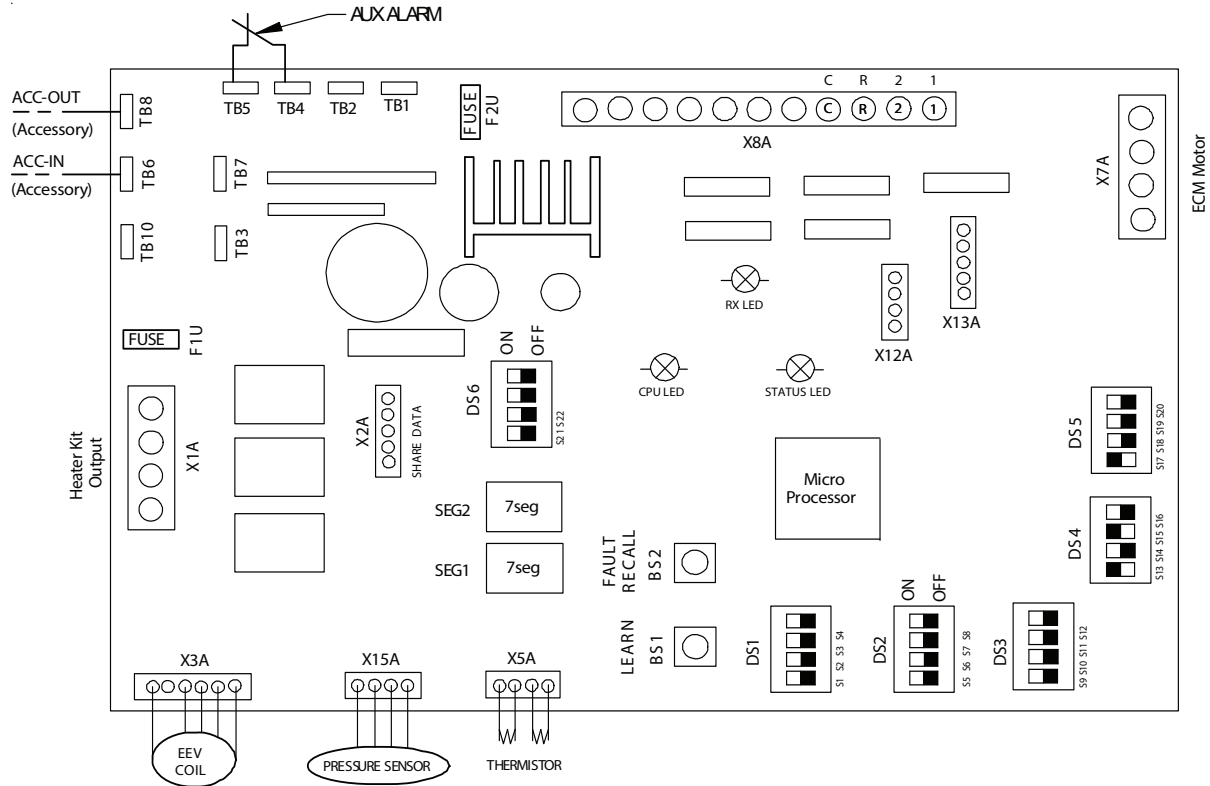

INDOOR UNIT PCB

AUXILIARY ALARM SWITCH

The control is equipped with two Auxiliary Alarm terminals, labeled TB4 and TB5, which are typically utilized in series with a condensate switch but could also be used with compatible CO2 sensors or fire alarms.

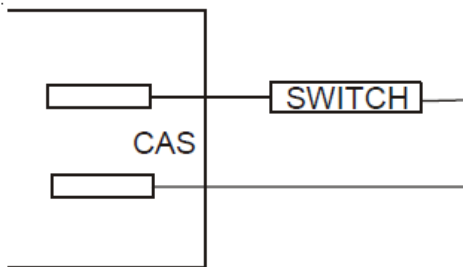

The auxiliary alarm switch must be normally closed and open when the alarm occurs. For example, a normally closed condensate switch will open when the base pan's water level reaches a particular level. The control will respond by turning off the blower motor and displaying the

proper fault codes. If the switch is later detected closed for 30 seconds, normal operation resumes and the error message is removed. The switch is closed as part of the default factory setting. The error will be maintained in the equipment's fault history.

CIRCULATOR BLOWER

This air handler is equipped with a variable speed circulator blower. This blower provides several automatically-adjusted blower speeds. The Specification Sheet applicable to your model provides an airflow table, showing the relationship between airflow (CFM) and external static pressure (E.S.P.).

NOTE: Upon start up in communicating mode the circuit board may display an "Ed" error. This is an indication that the dip switches on the control board need to be configured in accordance with the Electric Heating Airflow Table. Configuring the dip switches and resetting power to the unit will clear the error code.

SERVICING

TROUBLESHOOTING

ELECTROSTATIC DISCHARGE (ESD) PRECAUTIONS

NOTE: Discharge body's static electricity before touching unit. An electrstaic can adversely affect electrical components.

Use the following precautions during air handler installation and servicing to protect the integrated control module from damage. By putting the air handler, the control, and ther person at the same electrostatic potential, these steps will help avoid exposing the integrated control module to electrostatic discharge. This procedure is applicable to both installed and uninstalled (ungrounded) blowers.

1. Disconnect all power to the blower. Do not touch the integrated control module or any wire connected to the control prior to discharging your body's electrostatic charge to ground.
2. Firmly touch a clean, unpainted, metal surface of the air handler blower near the control. Any tools held in a person's hand during grounding will be discharged.
3. Service integrated control module or connecting wiring following the discharge process in step 2. Use caution not to recharge your body with static electricity; (i.e., do not move or shuffle your feet, do not touch ungrounded objects, etc.). If you come in contact with an ungrounded object, repeat step 2 before touching control or wires.
4. Discharge your body to ground before removing a new control from its container. Follow steps 1 through 3 if installing the control on a blower. Return any old or new controls to their containers before touching any ungrounded object.

DIAGNOSTIC CHART

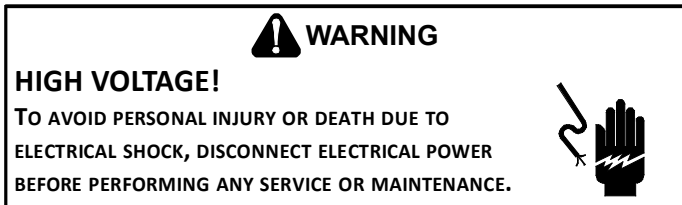

Refer to the Troubleshooting Chart at the end of this manual for assistance in determining the source of unit operational problems. The 7 segment LED display will provide any active fault codes. An arrow printed next to the display indicates proper orientation (arrow points to top of display). See following image.

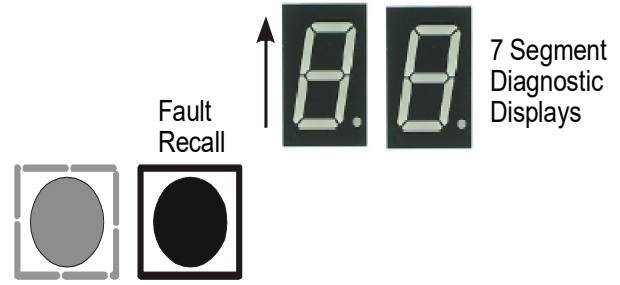

FAULT RECALL

The integrated control module is equipped with a momentary push-button switch that can be used to display the last six faults on the 7 segment LED display. To display the faults, follow the steps below.

NOTE: The integrated control module must be in Standby Mode (no thermostat inputs).

1. Press FAULT RECALL button (for 2 to 5 seconds). The 7 segment LED display will blink "--".

NOTE: If FAULT RECALL button is not pressed long enough (for 2 to 5 seconds, the control goes back to Standby Mode. If the button is pressed for 5 to 10 seconds, control goes back to Standby Mode.

2. Release the FAULT RECALL button. The 7 segment LED display will show the most recent fault.
3. Subsequent pressing of the FAULT RECALL button will recall a previous fault. At the end of the faults, the 7 segment LED display will show "--" and go back to Standby Mode.

NOTE: Consecutively repeated faults are displayed a maximum of three times. If the FAULT RECALL button is left untouched longer than 3 minutes, the control goes back to Standby Mode.

To clear the error code history:

1. Press FAULT RECALL button until the 7 segment LED display blinks "--".
2. Release the FAULT RECALL button. The 7 segment LED display will show "88" and clear the faults.

NOTE: If FAULT RECALL button is help pressed for longer than 15 seconds, control goes back to Standby Mode.

SERVICING

DIAGNOSTIC CODES

7 SEGMENT LED DISPLAY	DESCRIPTION OF CONDITION	ERROR MESSAGE
On	Normal Operation	--
Eb	NO HTR KIT INSTALLED - SYSTEM CALLING FOR AUXILIARY HEAT (Minor Error Code)	(No Display)
Ed	HEATER KIT DIP SWITCHES NOT SET PROPERLY	Check Heater Kit Dip Switches
E5	FUSE OPEN	BLOWN FUSE
EF	AUXILIARY SWITCH OPEN	Auxiliary Contacts Open
d0	DATA NOT ON NETWORK	Data Not Yet On Network
d1	INVALID DATA ON NETWORK	Invalid Data On Network
d4	INVALID BLUETOOTH® SHARED DATA LOADER BTSDL01 DATA	Invalid BTSDL01 data
b0	BLOWER MOTOR NOT RUNNING	Blower Motor Not Running
b1	BLOWER MOTOR COMMUNICATION ERROR	Blower Communication Error
b2	BLOWER MOTOR HP (Horse power) MISMATCH	Blower Motor HP Mismatch
b3	BLOWER MOTOR OPERATING IN POWER, TEMP., OR SPEED LIMIT	(No Display)
b4	BLOWER MOTOR CURRENT TRIP OR LOST ROTOR	Blower Trip or Lost Rotor
b6	OVER/UNDER VOLTAGE TRIP OR OVER TEMPERATURE TRIP	Voltage or Temperature Trip
b7	INCOMPLETE PARAMETER SENT TO MOTOR	Incomplete Parameters Sent to Motor
b9	LOW INDOOR AIRFLOW (Minor Error Code) (without EH mode)	(No Display)
9b	LOW INDOOR AIRFLOW (Major Error Code) (EH mode only)	LOW ID AIR EH MODE
70	EEV DISCONNECTION DETECTED	EEV OPEN CKT
73	LIQUID SIDE THERMISTOR ABNORMALITY	LIQ TEMP FLT
74	GAS SIDE THERMISTOR ABNORMALITY	GAS TEMP FLT
75	PRESSURE SENSOR ABNORMALITY	PRESSURE FLT
77	INDOOR UNIT - THERMOSTAT COMMUNICATION ERROR (STARTUP OPERATION & DURING OPERATION)	TSTAT ID NO COM
Hu	HUMIDIFICATION DEMAND (Running without heating)	--
FC	FAN COOL - COMMUNICATING MODE ONLY (Fan Demand-Cool)	--
FH	FAN HEAT - COMMUNICATING MODE ONLY (Fan Demand-Heat)	--
F	FAN ONLY (Fan Demand-Manual)	--
H1	ELECTRIC HEAT LOW (Heat Demand, Back-up Heat Demand)	--
H2	ELECTRIC HEAT HIGH (Heat Demand, Back-up Heat Demand)	--
dF	DEFROST - COMMUNICATING MODE ONLY (note: defrost is displayed as H1 in a legacy setup)	--

SERVICING

2-digit 7 segment displays

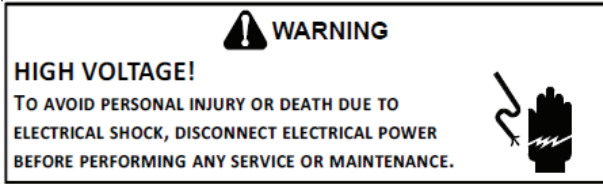

When the indoor units energized power supply, 2-digit 7 segment displays on indoor control board show current status of state, error code and airflow.

1. State shows current operation status of indoor unit described in right table.

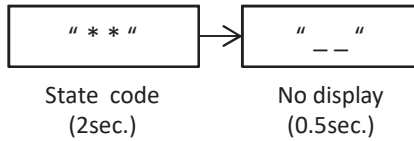

7 Segment LED Display (State)	Description of Condition
(No Display)	INTERNAL CONTROL FAULT/NO POWER
On	STANDBY, WAITING FOR INPUTS
FC	FAN COOL-COMMUNICATING MODE ONLY (Aux Heat Demand)
FH	FAN HEAT-COMMUNICATING MODE ONLY (Aux Heat Demand)
_F	FAN ONLY (Fan Demand-Manual)
H1	ELECTRIC HEAT LOW (Heat Demand, Back-up Heat Demand)
H2	ELECTRIC HEAT HIGH (Heat Demand, Back-up Heat Demand)
dF	DEFROST COMMUNICATING MODE ONLY
Hu	HUMIDITY RUNNING WITHOUT HEATING (Humidification Demand)

2. Error code shows current error indoor units have. To see the previous error code, please follow the instruction of fault recall. For more information of error code, please see the table of indoor unit error code.

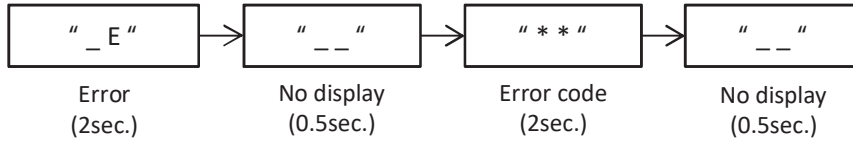

3. Airflow shows estimated CFM of indoor unit. For example, if the CFM is 1240CFM, 7 segment display shows "A...12...40...".

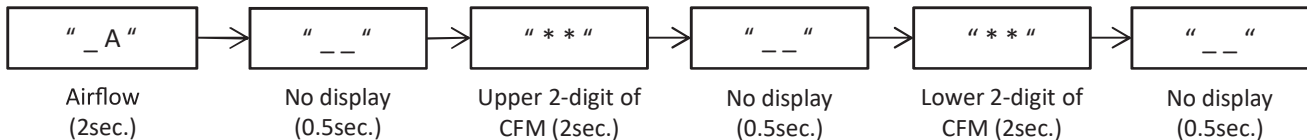

The contents indicated at 7 segment display vary from operation mode and status of indoor unit. In the event of showing some error code, please follow the instruction in the table of indoor unit error code to solve the error.

1. When the unit is running in normal mode, 2-digit 7 segment displays show state and airflow status.

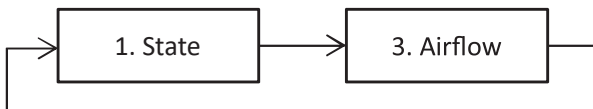

2. When the unit is having some major error code in normal mode, 2-digit 7 segment displays keep showing error code.



SERVICING

2-digit 7 segment displays

3. When the unit is having some minor error code in normal mode, 2-digit 7 segment displays show error code and airflow status.

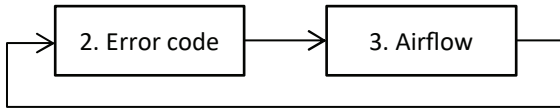

4. When the unit is having some minor error code during defrost operation in normal mode, 2-digit 7 segment displays show state "dF", error code and airflow status.

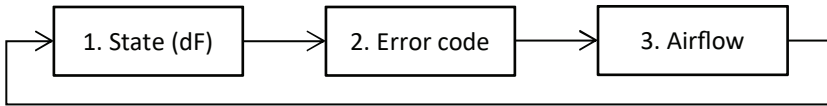

5. When the unit is having some minor error code in emergency mode, 2-digit 7 segment displays show state (EE) and error code.

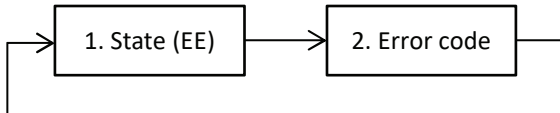

MODE DISPLAY INTRODUCTION

A 2-digit display is provided on the printed circuit board (PCB) as a backup tool to the thermostat for accessing error codes and erasing error code history of the indoor unit. Follow the information provided in this section to learn how to use the mode display.

DISPLAY

The display consists of 2 digits.

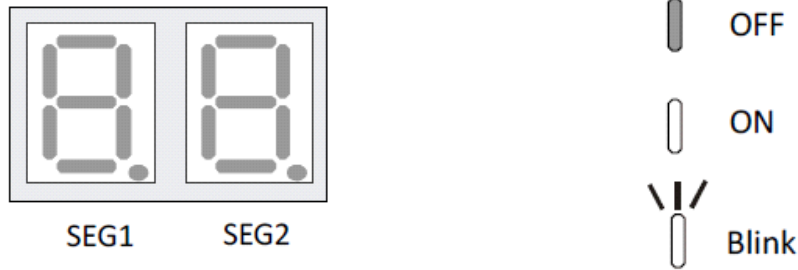

DISPLAY BUTTON LAYOUT

The display buttons shown can be used to navigate and select items:

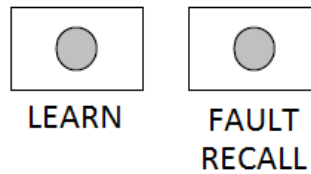

Example of button layout is shown above

FAULT CODE HISTORY NAVIGATION

This mode will allow the user to see the six most recent system faults. Please follow the flow chart to navigate to error codes from screen zero.

For a list of the fault codes, please see the TROUBLESHOOTING tables in this document.

It is also possible to erase all the diagnostics codes from this menu.

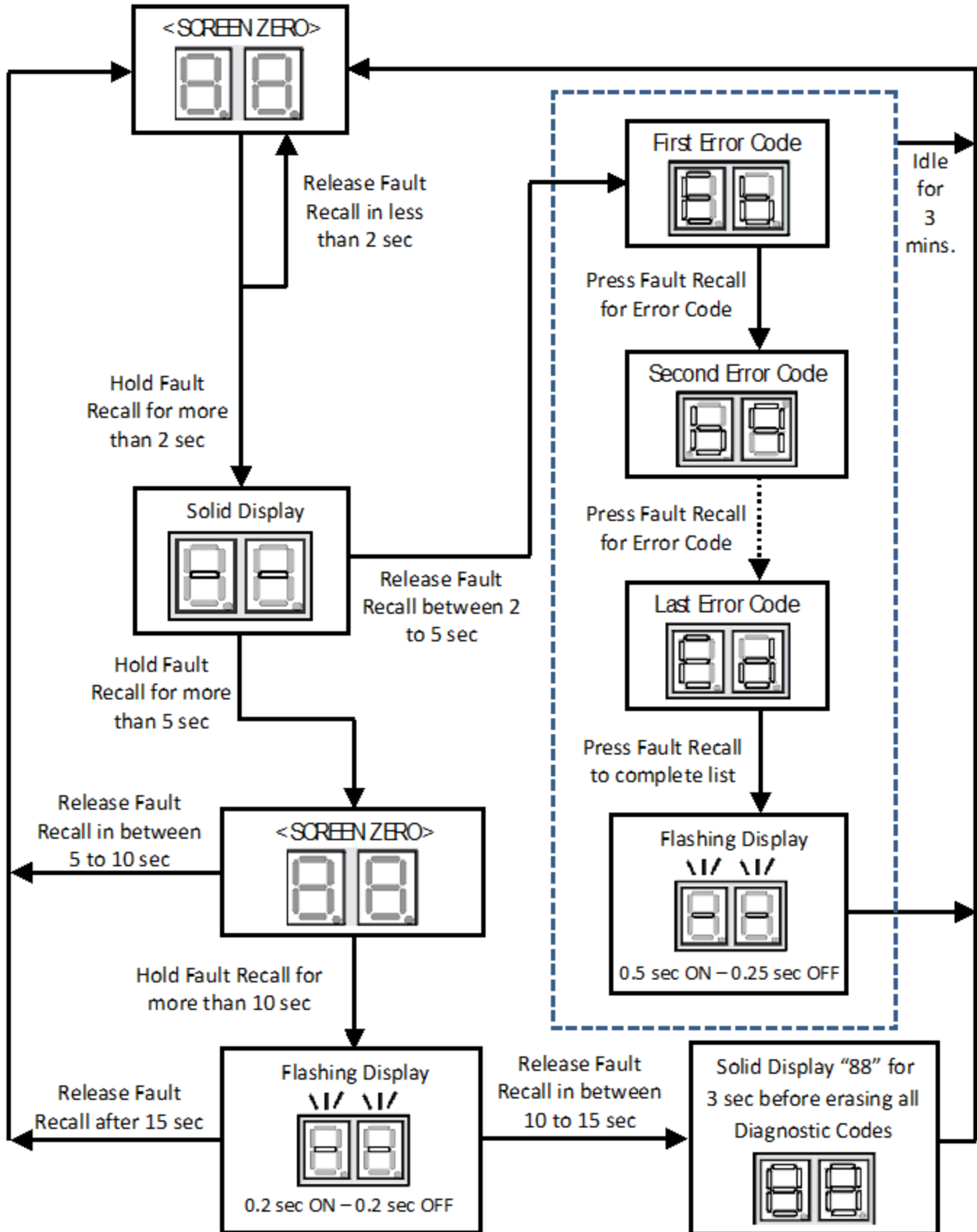

Error Code	PCB LED Display	ClimateTalk Message	Description	Possible Causes	Corrective Actions
EE	No display (EE display is EMG mode)	INTERNAL FAULT	<ul style="list-style-type: none"> No power supply to ID blower / no 24 volt power to PCB Blown fuse or circuit breaker PCB has an internal fault 	<ul style="list-style-type: none"> Manual disconnect switch OFF No power supply to ID blower / no 24 volt power to PCB Blown fuse or faulty circuit breaker Control board has internal fault 	<ul style="list-style-type: none"> Assure 208/230 volt and 24 volt power to blower and control board. Check fuse F2U on control board Check for possible short in 208/230 volt and 24 volt circuits. Repair as necessary. Replace the control board.
Eb	E_Eb	No Display	Selecting "no heater kit" and receiving electric heat demand	<ul style="list-style-type: none"> No heater kit selected 	<ul style="list-style-type: none"> Select the valid heater kit on thermostat Valid dip switch selection (heater kit selection out of range of the unit configuration)
Ed	E_Ed	Check Heater Kit Dip Switches (CHECK HTR DIPSW)	Heater Kit dip switches not set properly	<ul style="list-style-type: none"> Invalid heater kit selected 	<ul style="list-style-type: none"> Set correct dip switches
E5	E_E5	BLOWN FUSE	Fuse Open	<ul style="list-style-type: none"> Fuse (F1U) is blown Connector TB10 is open 	<ul style="list-style-type: none"> Replace fuse Check wiring to AUX alarm, heater kit, communication connection. Replace the control board
EF	E_EF	Auxiliary Contacts Open (AUX-ALARM FAULT)	Auxiliary Switch Open	<ul style="list-style-type: none"> High water level in the evaporation coil The connected alarm device is activated Auxiliary Alarm terminals (TB4, TB5) are open 	<ul style="list-style-type: none"> Check water level in drain pan Check alarm device. Close Auxiliary terminals TB4 and TB5 if not used
d0	E_d0	Data Not Yet On Network (NO NET DATA)	Data not on Network	<ul style="list-style-type: none"> No shared data on the network 	<ul style="list-style-type: none"> Populate shared data set using Bluetooth® Shared Data Loader BTSDDL01.
d1	E_d1	Invalid Data On Network (INVALID DATA)	Invalid Data on Network	<ul style="list-style-type: none"> Wrong shared data on the network 	<ul style="list-style-type: none"> Populate shared data set using Bluetooth® Shared Data Loader BTSDDL01.
d4	E_d4	Invalid Bluetooth® Shared Data Loader BTSDDL01 (INVALID MC DATA)	Invalid BTSDDL01 Data	<ul style="list-style-type: none"> Wrong BTSDDL01 data 	<ul style="list-style-type: none"> Replace circuit board Rewrite data using the correct Bluetooth® Shared Data Loader BTSDDL01.
b0	E_b0	Blower Motor Not Running (MOTOR NOT RUN)	Blower Motor not running	<ul style="list-style-type: none"> Fan/motor obstruction Power interruption (low voltage) Incorrect / loose wiring 	<ul style="list-style-type: none"> Check for obstruction on the fan/motor Verify the input voltage at the motor Check wiring or tighten wiring connections if needed Replace circuit board or motor
b1	E_b1	Blower Communication Error (MOTOR COMM)	Blower Motor Communication error	<ul style="list-style-type: none"> Incorrect / loose wiring Power interruption (low voltage) 	<ul style="list-style-type: none"> Check wiring or tighten wiring connections if needed Verify the input voltage at the motor Replace circuit board or motor
b2	E_b2	Blower Motor HP Mismatch (MOTOR MISMATCH)	Blower Motor HP Mismatch	<ul style="list-style-type: none"> Incorrect size motor Invalid shared data 	<ul style="list-style-type: none"> Correct motor installation Populate shared data set using Bluetooth® Shared Data Loader BTSDDL01.
b3	E_b3	No Display	Blower Motor operating in Power, Temp or Speed Limiting conditions	<ul style="list-style-type: none"> Fan/motor obstruction or blocked filters Power interruption (low voltage) Incorrect wiring Blockage in the airflow (ductwork) or ductwork undersized 	<ul style="list-style-type: none"> Check for obstruction on the fan/motor/ductwork, clean filters Verify the input voltage at the motor Check wiring Replace motor

Error Code	PCB LED Display	ClimateTalk Message	Description	Possible Causes	Corrective Actions
b4	E_b4	Blower Trip or Lost Rotor (MOTOR TRIPS)	Blower Motor - Current Trip (or) Lost Rotor	<ul style="list-style-type: none"> Fan/motor obstruction or abnormal motor loading Power interruption (low voltage) High loading conditions, blocked filters Blockage in the airflow (ductwork) or ductwork undersized 	<ul style="list-style-type: none"> Check for obstruction on the fan/motor/ductwork Verify the input voltage at the motor Check filters, grills, duct system, coil air inlet/outlet for blockages. Replace motor
b6	E_b6	Voltage or Temperature Trip (MOTOR VOLTS)	<ul style="list-style-type: none"> Blower motor stops for over/under voltage Blower motor stops due to PCB over heating 	<ul style="list-style-type: none"> High AC line voltage to ID blower Low AC line voltage to ID blower High ambient temperatures Fan/motor obstruction or blockage in the airflow 	<ul style="list-style-type: none"> Verify line voltage to blower is within the range specified on the ID blower rating plate See "Installation Instructions" for installation requirements Check power to air handler blower Check for obstruction on the fan/motor/ductwork Check wiring Replace motor
b7	E_b7	Incomplete Parameters Send to Motor (MOTOR PARAMS)	ID blower motor does not have required parameters to function. Motor fails to start 40 consecutive times.	<ul style="list-style-type: none"> Wrong / no shared data on the network Locked motor rotor condition 	<ul style="list-style-type: none"> Check for locked rotor condition (see above error code for details) Replace circuit board or motor
b9	E_b9	No Display	Low Indoor Airflow (without Electric Heat mode)	<ul style="list-style-type: none"> Fan/motor obstruction or blocked filters Restrictive ductwork or ductwork undersized ID motor failure 	<ul style="list-style-type: none"> Check for obstruction on the fan/motor Check ductwork/filter for blockage, clean filters Remove obstruction. Verify all registers are fully open Check the connections and the rotation of the motor Verify the input voltage at the motor Verify ductwork is appropriately sized for system. Resize/replace ductwork if needed Replace motor
9b	E_9b	LOW ID AIR EH MODE	Low Indoor Airflow (with Electric Heat mode)	<ul style="list-style-type: none"> Fan/motor obstruction or blocked filters Restrictive ductwork or ductwork undersized ID motor failure Combination mistake of outdoor unit and indoor unit 	<ul style="list-style-type: none"> Check for obstruction on the fan/motor Check ductwork/filter for blockage, clean filters Remove obstruction. Verify all registers are fully open Check the connections and the rotation of the motor Verify the input voltage at the motor Verify ductwork is appropriately sized for system. Resize/replace ductwork if needed Replace motor
70	E_70	EEV OPEN CKT	EEV disconnection detected	<ul style="list-style-type: none"> Indoor EEV coil not connected Incorrect wiring to EEV 	<ul style="list-style-type: none"> Check Indoor EEV coil connection (PCB and junction connector) Replace EEV coil Check the resistance value of EEV coil (refer service manual) Replace the control board
73	E_73	LIQ TEMP FLT	Liquid side thermistor abnormality	<ul style="list-style-type: none"> Open (or) short circuit of the liquid thermistor (X5A) Liquid thermistor reading incorrect or values outside the normal range 	<ul style="list-style-type: none"> Check the connection to liquid thermistor (PCB and junction connector) Check the resistance value of the thermistor (refer service manual) Replace thermistor Replace the control board
74	E_74	GAS TEMP FLT	Gas side thermistor abnormality	<ul style="list-style-type: none"> Open (or) short circuit of the gas thermistor (X5A) Gas thermistor reading incorrect or values outside the normal range 	<ul style="list-style-type: none"> Check the connection to gas thermistor (PCB and junction connector) Check the resistance value of the thermistor (refer service manual) Replace thermistor Replace the control board
75	E_75	PRESSURE FLT	Pressure sensor abnormality	<ul style="list-style-type: none"> Open (or) short circuit of the Pressure sensor (X15A) Pressure sensor reading incorrect or values outside the normal range 	<ul style="list-style-type: none"> Check the connection to pressure sensor (PCB and junction connector) Check the output voltage of the pressure sensor (refer service manual) Replace pressure sensor Replace the control board
77	E_77	No Display	Indoor Unit - Thermostat communication error (start-up & during operation)	<ul style="list-style-type: none"> Incorrect wiring between ID unit and thermostat Thermostat failure Power interruption (low voltage) 	<ul style="list-style-type: none"> Check for thermostat and indoor unit wiring Verify the input voltage at the ID unit and thermostat Replace control board or thermostat Press "LEARN" button on PCB for more than 5 seconds to reestablish network

SERVICING

ADVANCED USER MENU

DIAGNOSTICS		
<i>SUBMENU ITEM</i>	<i>INDICATION/USER MODIFIABLE OPTIONS</i>	<i>COMMENTS</i>
Clear Faults	NO or YES	Selecting "YES" clears the fault history.
Fault 1	Most recent HP fault	
Fault 2	2nd most recent HP fault	
Fault 3	3rd most recent HP fault	
Fault 4	4th most recent HP fault	
Fault 5	5th most recent HP fault	
Fault 6	6th most recent HP fault	

STATUS	
<i>SUBMENU ITEM</i>	<i>COMMENTS</i>
Time Stamp (TS)	Provides compressor run time in hours.
Mode (MD)	Current system operation mode (COOLING, COOLING STARTUP, HEATING, HEATING STARTUP, DEFROST, OIL RETURN, STOP).
Compressor Reduction Mode (CRM)	Displays ON or OFF status. ON indicates that the reduction mode is operating and the compressor is running at a lower speed than the cooling/heating load would normally require.
Requested and Actual % Demand (RAD)	Displays a 0-100% value, based on a ratio of the requested cooling demand to what the system is actually providing.
Requested and Reported ID CFM (RAF)	Compares the requested indoor airflow to what the indoor equipment has reported.
Outdoor Air Temperature and Outdoor Fan Status (ATOF)	Displays the outdoor air temperature and outdoor coil temperature as well as outdoor fan speed(TAP). 0:Off; 1:Low Tap; 2:Medium Tap; 3:High Tap
Discharge Temperature and Outdoor Coil Temperature (DCT)	Displays the discharge temperature and outdoor coil temperature sensor readings.
Defrost sensor and Outdoor Liquid Temperature (DLT)	Displays the defrost temperature sensor and outdoor liquid temperature sensor reading.
Pressure Sensor and Suction Temperature (PSDST)	Displays the low pressure sensor reading which is taken slightly upstream of the suction accumulator and outdoor suction temperature sensor reading.

SERVICING

ADVANCED USER MENU

SYSTEM SETUP (SYS SETUP)		
SUBMENU ITEM	USER MODIFIABLE OPTIONS	COMMENTS
Reset System Setup Options to Factory Defaults (SYS SETUP RESET)	NO or YES	Selecting "YES" resets this menu to factory default settings.
SET MAX CURRENT	N/A	Future use.
VERTICAL RISE	Same Level, Outdoor Lower, or Indoor Lower	If the outdoor & indoor units are within +/- 15 ft. vertical distance, select SAME LEVEL. If the outdoor unit is more than 15 ft. below the indoor unit, select OUTDOOR LOWER. If the outdoor unit is more than 15 ft. above the indoor unit, select INDOOR L
BOOST MODE (BOOST MD)	ON or OFF	BOOST MD turns BOOST MODE OFF or ON. See BOOST MODE section of this manual for more details.
BOOST MODE TEMPERATURE (BOOST TEMP)	Always ON, 70, 75, 80, 85, 90, 95, 100, 105°F	BOOST TEMP adjusts the activation temperature from 70°F to 105°F. An "Always ON" option is also available to permanently engage BOOST MODE.

EQUIPMENT TEST (EQUIP TEST)		
SUBMENU ITEM	INDICATION/USER MODIFIABLE OPTIONS	COMMENTS
System Verification Test (SYSTEM TEST)	ON or OFF	System Verification Test must be run after installation. This is approximately a 5-15 minute test. If the thermostat is set to COOL mode, the system will enter CHARGE mode upon completion, otherwise it will stop.
Force Defrost Cycle (FORCE DF CYCLE)	ON or OFF	This will make the unit run in defrost mode.

SYSTEM MAINTENANCE		
SUBMENU ITEM	USER MODIFIABLE OPTIONS	COMMENTS
PUMP DOWN	ON or OFF	Enter PUMP DOWN Mode. This procedure runs the equipment for approximately 15 minutes and allows accumulation of refrigerant at the outdoor unit for purposes of removing & replacing the indoor unit or outdoor unit.
CHARGE MODE	ON or OFF	Enter Charging Mode. This allows for a steady system operation for a duration of approximately 1 hour to allow for refrigerant charging of the system via the suction charge port. The system will stop after completion.

SERVICING

ADVANCED USER MENU

COOL SETUP		
SUBMENU ITEM	USER MODIFIABLE OPTIONS	COMMENTS
CL Reset	YES or NO	Selecting to default factory setting.
Cool Airflow Trim Hi (C TR H)	-15% to +15% in 3% increments	Selects the cooling airflow trim amount.
Cool Airflow Trim Int (C TR I)	-15% to +15% in 3% increments	Selects the cooling airflow trim amount.
Cool Airflow Trim Low (C TR L)	-15% to +15% in 3% increments	Selects the cooling airflow trim amount.
Cool Airflow Profile	A, B, C, or D	Selects the cooling airflow profile.
Cool ON Delay	5, 10, 20, 30 seconds	Selects the indoor blower ON delay.
Cool OFF Delay	30, 60, 90, 120 seconds	Selects the indoor blower OFF delay.
Dehumidification Select	ON or OFF	Selecting OFF disables dehumidification; selecting ON enables dehumidification.

SET COOLING RUN VALUES (CL RUN VALUES)		
SUBMENU ITEM	USER MODIFIABLE OPTIONS	COMMENTS
Maximum Compressor RPS Range for Cooling (COOL RPS RANGE)	Five different compressor RPS ranges will be provided.	Select the appropriate range for the installed system configuration.
Maximum Compressor RPS Selection for Cooling (COOL RPS SELECT)	Ten compressor RPS values will be provided within the range selected in the COOL RPS RANGE menu	Select the appropriate compressor RPS for the installed system configuration.

HEAT SETUP		
SUBMENU ITEM	USER MODIFIABLE OPTIONS	COMMENTS
HT Reset	YES or NO	Selecting to default factory setting.
Heat Airflow Trim Hi (H TR H)	-15% to +15% in 3% increments	Selects the Heating airflow trim amount.
Heat Airflow Trim Int (H TR I)	-15% to +15% in 3% increments	Selects the Heating airflow trim amount.
Heat Airflow Trim Low (H TR L)	-15% to +15% in 3% increments	Selects the Heating airflow trim amount.
Heat ON Delay	5, 10, 15 seconds	Selects the indoor blower ON delay.
Heat OFF Delay	30, 50, 70, 90 seconds	Selects the indoor blower OFF delay.
Maximum Defrost Interval	30 min., 1hr., 1.5hrs. and 2hrs.	Selects time defrost interval

SET HEATING RUN VALUES (HT RUN VALUES)		
SUBMENU ITEM	USER MODIFIABLE OPTIONS	COMMENTS
Maximum Compressor RPS Range for Heating (HEAT RPS RANGE)	Five different compressor RPS ranges will be provided.	Select the appropriate range for the installed system configuration.
Maximum Compressor RPS Selection for Heating (HEAT RPS SELECT)	Ten compressor RPS values will be provided within the range selected in the HEAT RPS RANGE menu	Select the appropriate compressor RPS for the installed system configuration.

SERVICING

EMERGENCY MODE FOR EEV APPLICABLE INDOOR UNIT



Emergency mode is to only be used in a situation where communication between equipment (broken wires) or a failed thermostat cannot be immediately corrected or replaced. This mode will allow for cooling or heating to be activated without the need of communication wires or a thermostat. Once corrections have been made to wiring or the thermostat, emergency mode must be turned off and the system returned to normal operation (this applies to both the indoor and outdoor units). Note: Emergency mode does not control to a specific room temperature set point. Exact room temperature achieved is related to the building load at the time emergency mode is activated. This is only a temporary solution.

At first inspection, if the outdoor unit is displaying one of the following error codes: E51 (outdoor communication error), Eb0 (no indoor airflow), Eb9 (low indoor airflow), Ed2 (Indoor unit is too small and cannot provide airflow of outdoor unit) or the indoor unit is displaying error code E77 (no thermostat communications) it is acceptable to use emergency mode if the equipment cannot be immediately fixed. Cycling power to the equipment may temporarily clear error codes, but doing so may not fix the underlying problem. Note: If after initial power up communication issues occur due to faulty wires or a thermostat these error codes may not be displayed.

In emergency mode, the unit will function according to the mode selected on the appropriate dip switches. Operation in emergency mode must be limited to a minimum and should be viewed as a temporary solution before the issue with the unit is resolved and system operates in normal mode.

NOTE: In the emergency operation, the operating status will not be shown in the thermostat status menu or on the outdoor 7-segment displays. The 7-segment displays on indoor control board will display “EE”.

1. HEATING EMERGENCY MODE

Emergency Heating mode is to be used when communication between the indoor unit and thermostat is not functioning properly. This mode will run the electric heat strips independently of any thermostat in one of two modes: High Heat Level or Low Heat Level. Dip Switch Bank DS-6 (specifically dip switches S-21 and S-22) on the indoor control is used to engage emergency heating mode. Default setting for these two dip switches are in the OFF position (S21 set to ON and S22 set to ON will enable Low Heat Level Emergency Mode. S21 set to OFF and S22 set to ON will enable High Heat Level Emergency Mode). Note: once equipment has been fixed, these dip switches must be placed back in the OFF position. During operation, the indoor fan and electric heater kit will be turned on and off at following intervals based on the Heat Level selected. 2 stage electric heater kits will be energized in stage 2.

	Heating On	Heating Off
High Heat Level	8 minutes	8 minutes
Low Heat Level	7 minutes	15 minutes

Emergency Heat Mode Airflow: DIP switches S-9, S-10, S-11 and S-12 must be set to the correct size electric heat kit that has been installed. These are located on dip switch bank DS-3 of the indoor control. See the Switch Bank DS-3 Indoor Control Board Settings table to properly select heater kit size.

To activate heating emergency mode, appropriately select switches S-21 and S-22 from dip switch bank DS-6 on the indoor control board depending on the heat level required in accordance with the Switch Bank DS-6 Indoor Control Board Settings table.

NOTE: During the heating emergency mode, outdoor unit must stop operation. Once the communication is established, heating emergency mode must be terminated so that the system resumes operation in normal mode. To eliminate the heating emergency mode, dip switches S-21 and S-22 from dip switch bank DS-6 on the indoor control board must be set back to default factory settings (normal operating mode).

SERVICING

Upon start up in emergency mode the circuit board may display an “Ed” error. This is an indication that the DIP switches on the control board need to be configured in accordance with the Electric Heating Airflow Table. Configuring the DIP switches to the unit will clear the error code.

Switch Bank DS-3 Indoor Control Board Settings								
Heater Kit Selection	Heater kW				Dip Switch Setting			
	AVPEC25B14A*	AVPEC37C14A*	AVPEC59D14A*	AVPEC61D14A*	S-9	S-10	S-11	S-12
No Heater	-	-	-	-	OFF*	OFF*	OFF*	OFF*
First	3	5	5	5	ON	ON	ON	ON
Second	5	6	6	6	ON	ON	ON	OFF
Third	6	8	8	8	ON	ON	OFF	ON
Fourth	8	10	10	10	ON	ON	OFF	OFF
Fifth	10	15	15	15	ON	OFF	ON	ON
Sixth	X	19	20	20	ON	OFF	ON	OFF
Seventh	X	X	X	25	ON	OFF	OFF	ON

Switch Bank DS-6 Indoor Control Board Settings			
Function		S-21	S-22
Normal operation		OFF*	OFF*
Emergency Mode	Cooling Emergency mode/Fan only Emergency mode	ON	OFF
	Heating Emergency mode (High heat level)	OFF	ON
	Heating Emergency mode (Low heat level)	ON	ON

Switch Bank DS-2 Outdoor Control Board Settings			
Function		S-1	S-2
Normal operation		OFF*	OFF*
Emergency Mode	Cooling Emergency mode (Low cool Level)	ON	OFF
	Cooling Emergency mode (Medium cool Level)	OFF	ON
	Cooling Emergency mode (High cool level)	OFF	OFF

NOTE: Default factory settings are marked with *.

SERVICING

2. COOLING EMERGENCY MODE

Cooling emergency mode is to be used when communication between the indoor and outdoor units is not functioning properly and temporary cooling operation is required. This mode enables the outdoor unit and indoor unit to run independently of each other. There are two key steps to setup Cooling Emergency Mode.

- a) Select the appropriate airflow on the indoor unit and enable emergency indoor airflow operation (using Dip switches S-13 and S-14 of Switch Bank DS-4 on the indoor unit to select desired 25%, 50%, 75% or 100% airflow. In addition, set switch bank DS-6 dip switches S-21 to ON and S-22 to OFF enabling emergency indoor fan).
- b) Select the desired cooling level at the outdoor unit (there are 3 levels available: Low Cool Level, Medium Cool Level, High Cool Level selectable by dip switch bank DS-2 on the outdoor unit). See Dip Switch Position DS2-1 and DS2-2 Table for cooling level selection.

	ON time	OFF time	Avg. Run Time
Low Cool Level	7 minutes	15 minutes	30%
Medium Cool Level	8 minutes	10 minutes	50%
High Cool Level	15 minutes	6 minutes	70%

Note: This mode does not require a thermostat. Any thermostat requests will be ignored while in emergency operation.

NOTE: Set indoor DS-4 (Indoor fan setting) and DS-6 (Indoor emergency mode enable) before setting outdoor DS-2 dip switch settings. Otherwise, the compressor may be damaged in operation.

Note: When proper communication is established, these switches must be returned to default settings

Switch Bank DS-4 Indoor Fan Settings					
Function	Value	SW13	SW14	SW15	SW16
Fan Only Speed %	25	OFF	OFF	-	-
	50	ON*	OFF*	-	-
	75	OFF	ON	ON*	-
	100	ON	ON	OFF	-

During operation the indoor unit will provide constant airflow as selected (even if the compressor has stopped). The indoor unit will continue to operate the electronic expansion valve for refrigerant super heat control and the compressor will cycle at the interval selected by dip switch bank DS-2

The compressor speed will automatically adjust based on the outdoor ambient temperature. If ambient temperature is higher than 95 ° F, the outdoor unit can operate at 100% compressor speed. If ambient temperature is lower than 70° F, the unit will run at 50% compressor speed. Between 95 ° F and 70 ° F, the compressor speed will adjust linearly as shown.

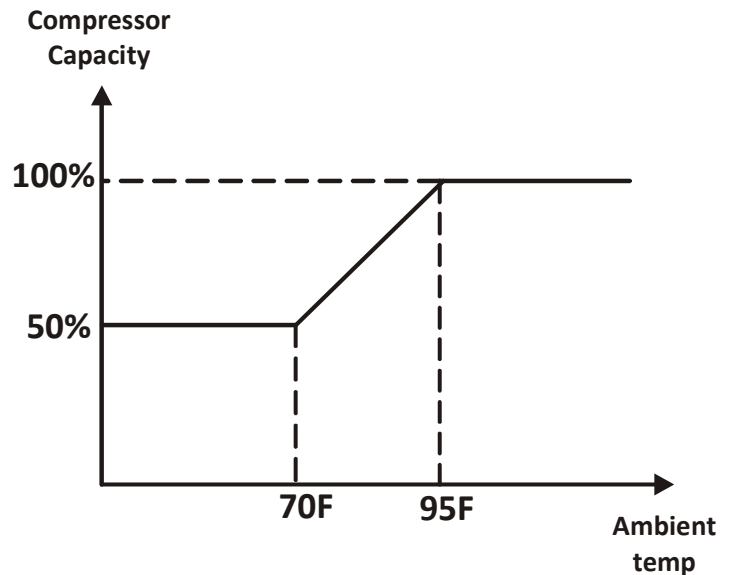

SERVICING

Dipswitch Default Factory Settings			
Switch #	Setting	Function	
ID DS-1	1	OFF	No Use
	2	OFF	No Use
	3	OFF	No Use
	4	OFF	No Use
ID DS-2	5	OFF	No Use
	6	OFF	No Use
	7	OFF	No Use
	8	OFF	No Use
ID DS-3	9	OFF	Heater Kit Selection in Emergency Mode
	10	OFF	Heater Kit Selection in Emergency Mode
	11	OFF	Heater Kit Selection in Emergency Mode
	12	OFF	Heater Kit Selection in Emergency Mode
ID DS-4	13	ON	Allow in Emergency Mode (Fan Emergency Mode)
	14	OFF	Allow in Emergency Mode (Fan Emergency Mode)
	15	ON	EEV Enable**
	16	OFF	No Use
ID DS-5	17	ON	Emergency EEV Opening
	18	OFF	Emergency EEV Opening
	19	OFF	EEV Emergency Mode**
	20	OFF	No Use
ID DS-6	21	OFF	Emergency mode (Cooling and Heating Emergency Mode)
	22	OFF	Emergency mode (Cooling and Heating Emergency Mode)
	23	OFF	No Use
	24	OFF	No Use
OD DS-1	1	ON	CT Communication Enable*
	2	ON	CT Communication Enable*
OD DS-2	1	OFF	Cooling Emergency mode*
	2	OFF	Cooling Emergency mode*

* Must be set at factory setting to operate the normal mode.

** Must be set at factory setting indoor unit with EEV. It's prohibited to change setting.

SERVICING

COOLING EMERGENCY MODE WIRING FOR TXV APPLICABLE INDOOR UNIT

Cooling emergency mode is available when using a TXV applicable indoor unit. To energize the blower at the appropriate speed, standard Legacy wiring is required. The image below shows how the thermostat input terminals are to be wired when selecting a cooling airflow. Note: the blower will run continuously with this wiring which is required. The outdoor unit will cycle as described in the Cooling Emergency Mode section when appropriate dip switch modes are set.

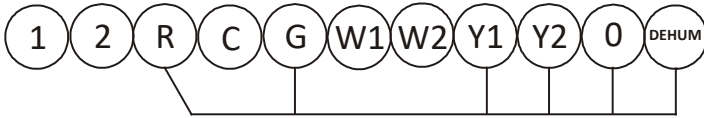

INDOOR UNIT INTEGRATED CONTROL MODULE

Note: Emergency heating mode is not available with TXV applicable indoor units. If communications still exist between the indoor unit and thermostat, the thermostat should be used to provide heating calls.

MODE DISPLAY INTRODUCTION

A 3-digit display is provided on the Control board as a backup tool to the thermostat for reading faults, fault history, monitoring and setting up the unit. Follow the information provided in this section to learn how to use the mode display.

DISPLAY

The display consists of 3 digits.

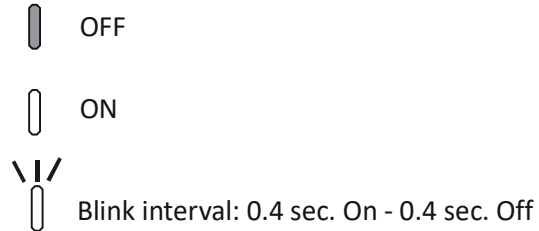
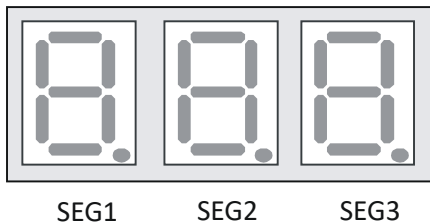

DISPLAY BUTTON LAYOUT

The display buttons shown can be used to navigate and select items:

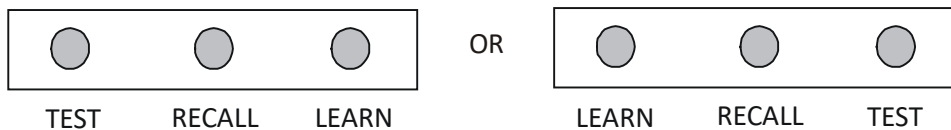

*Examples of button layout are shown above.
 Identify correct display buttons on your unit Control board.*

MODES

There are 5 modes which can be accessed using the setting display: FAULT CODE, FAULT HISTORY, MONITORING, SETTING MODE 1 and SETTING MODE 2.

To enter any of these modes, use the schemes shown in this section. Each mode has its own corresponding "Screen #" within the display itself which allows the user to navigate and use the features. (Example: The Fault Code is accessed and displayed from "Screen 0" of the 7-segment display. The Fault History is accessed and display using "Screen 1" of the display, etc.)

<u>MODE</u>	<u>FUNCTION</u>	<u>DISPLAY SCREEN #</u>
<i>Fault Code Display</i>	Present fault (if any).	0 (Default)
<i>Fault Code History</i>	6 Recent faults stored.	1
<i>Monitoring Mode</i>	*Monitors system values.	2
<i>Setting Mode 1</i>	*Can change system settings	3
<i>Setting Mode 2</i>	*Can change system settings.	4

**See tables at the end of this section.*

NAVIGATING THROUGH THE DISPLAY SCREENS

- SCREEN 0** The home or default screen on the display. This shows the most recent fault.
- SCREEN 1** To access, hold the RECALL button for 5 seconds at screen 0.
- SCREEN 2** To access, hold the RECALL button for 5 seconds at screen 1.
- SCREEN 3** To access, hold the RECALL button for 5 seconds at screen 2.
- SCREEN 4** To access, hold the RECALL and TEST buttons simultaneously for 5 seconds at screen 2.
To return to SCREEN 0 of the display, press the LEARN button.

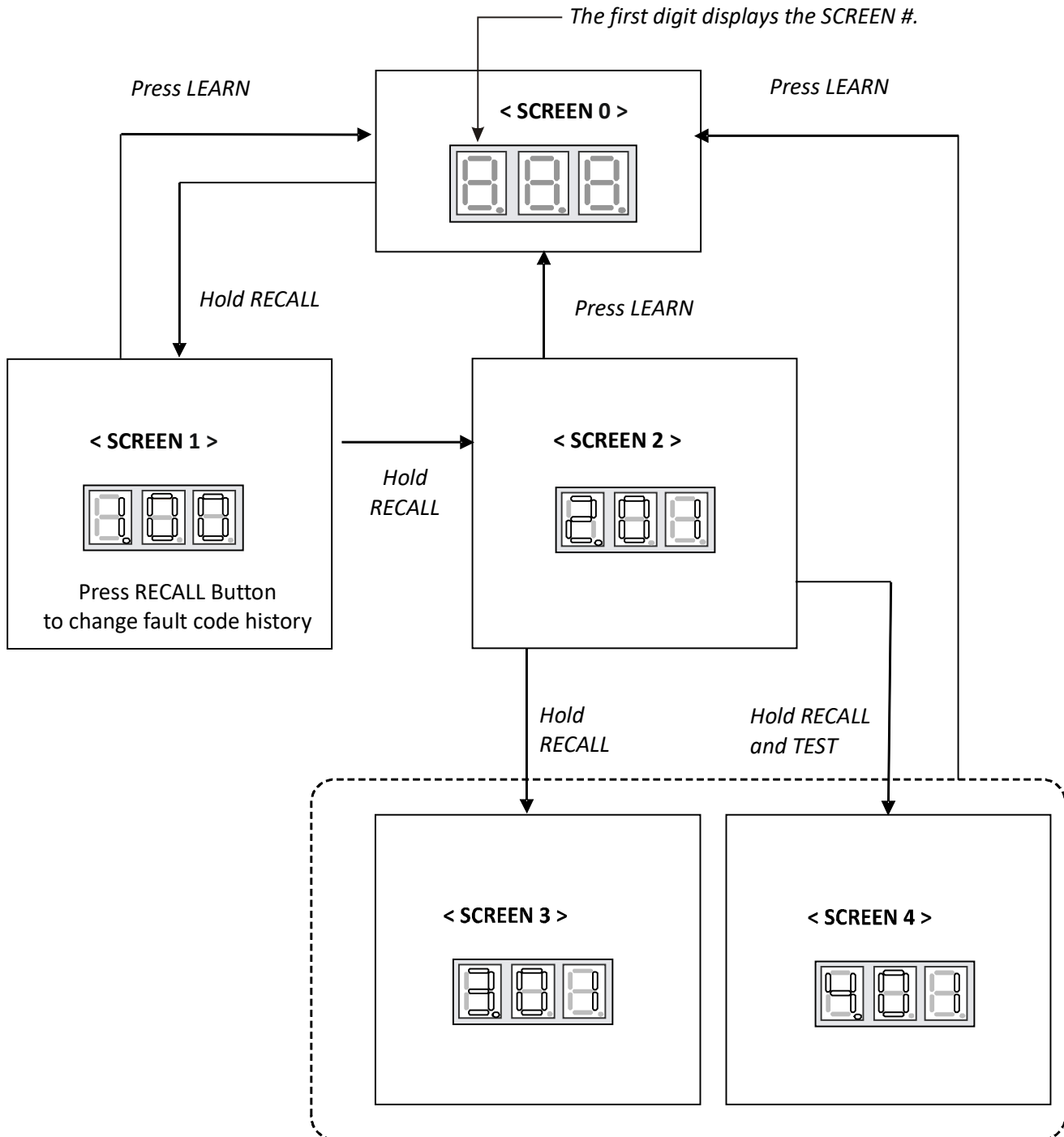

FAULT CODE HISTORY NAVIGATION

< SCREEN 1 >

This mode will allow the user to see the six most recent system faults.
For a list of the fault codes, please see the TROUBLESHOOTING tables in this document.

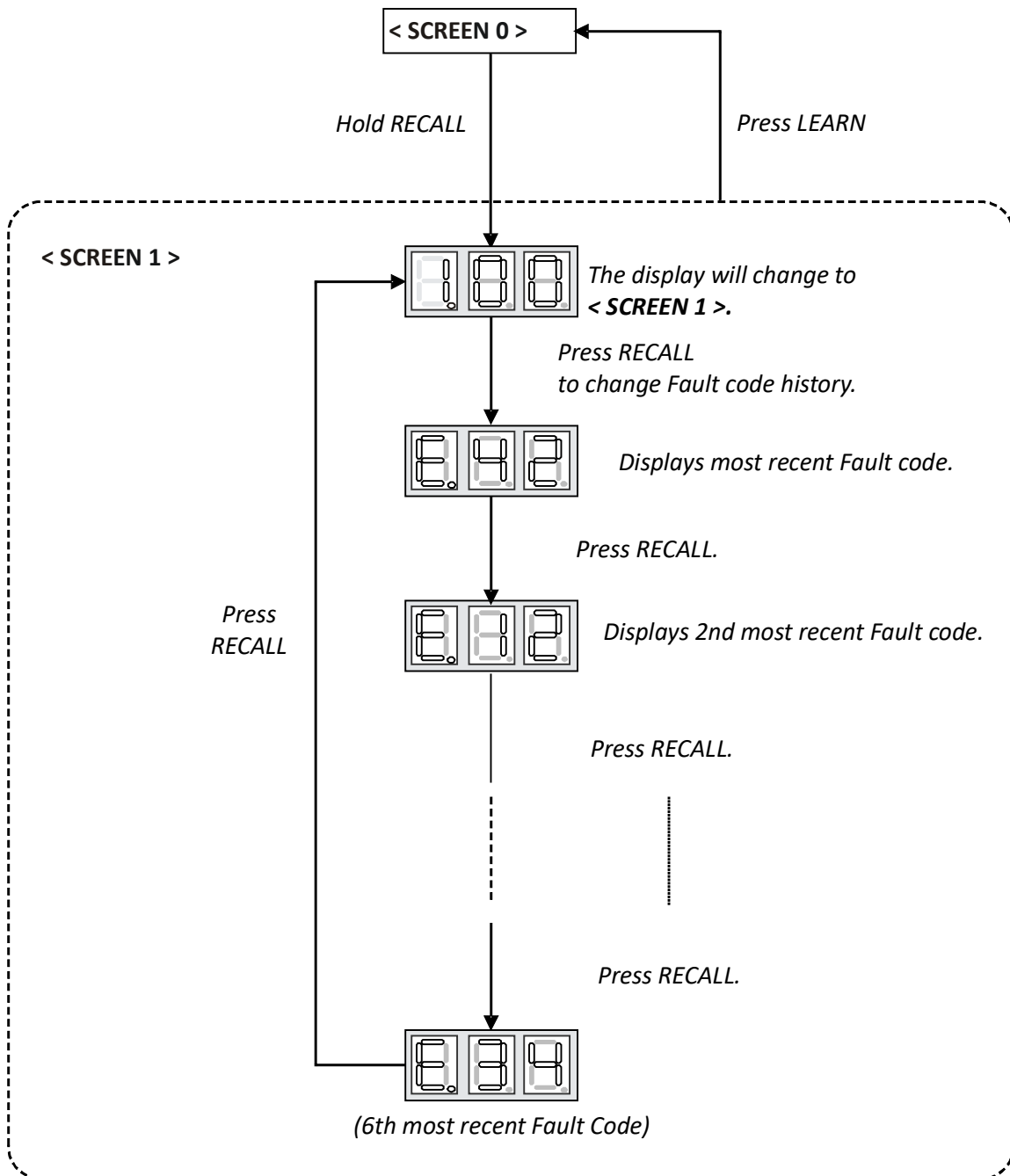

MONITORING MODE NAVIGATION

< SCREEN 2 >

This screen allows the user to monitor system variables as shown in the tables at the end of this section.

< SCREEN 0 >

< SCREEN 1 >

Hold *RECALL*

Press *LEARN*

OFF

ON

Blink interval:
0.4 sec. On - 0.4 sec. Off

< SCREEN 2 >

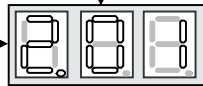

Press *RECALL*
to increase the value.

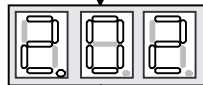

Press *RECALL*.



Press *RECALL*.

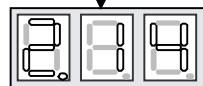

Press *TEST*
to confirm the setting.

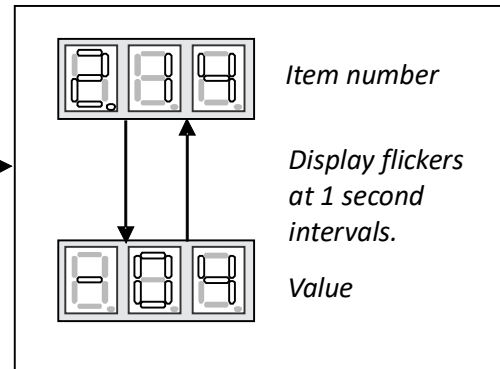

Press *RECALL*.

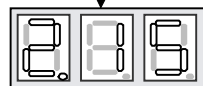

Press *RECALL*.



Press
RECALL

SETTINGS MODE 1 NAVIGATION

< SCREEN 3 >

Setting Mode 1 allows the user to adjust system settings as shown in the tables at the end of this section.

< SCREEN 0 >

-  OFF
-  ON
-  Blink interval:
0.4 sec. On - 0.4 sec. Off

< SCREEN 2 >

Hold RECALL.

Press LEARN.

< SCREEN 3 >

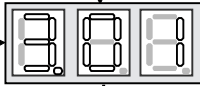

Press RECALL to increase the value.

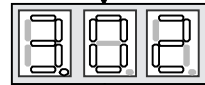

Press RECALL.

.....

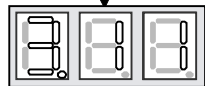

Press RECALL.

Press TEST to change setting.

Press RECALL.

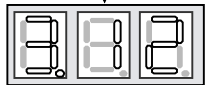

Press RECALL.

< Changing Setting Display >

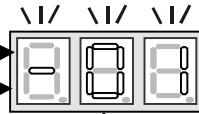

Press RECALL to increase the value.

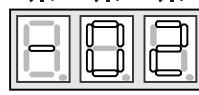

Press TEST.

Press RECALL.

Press RECALL.

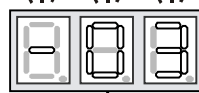

Press RECALL.

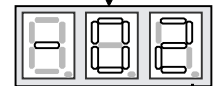



Press TEST to complete setting and return to setting mode.

SETTINGS MODE 2

< SCREEN 4 >

Setting Mode 2 allows the user to change system settings. See table in back of this section.

< SCREEN 0 >

-  OFF
-  ON
-  Blink interval:
0.4 sec. On - 0.4 sec. Off

< SCREEN 2 >

Hold **RECALL** and **TEST**.

Press **LEARN**.

< SCREEN 4 >

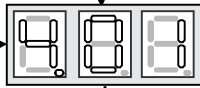

Press **RECALL**
to increase the number.

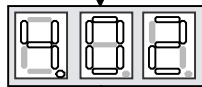

Press **RECALL**.

Press **RECALL**.

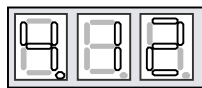

Press **TEST**
to change setting.

Press **RECALL**.

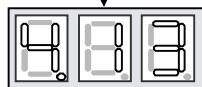

Press **TEST** to complete setting and return to setting mode.

Press
RECALL

< Changing setting display >

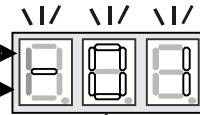

Press **RECALL**.

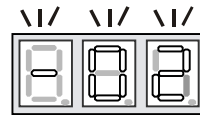

Press **TEST**.

Press
RECALL.

Press **RECALL**.

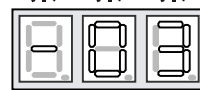

Press **RECALL**.

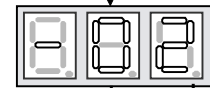

SERVICING

7-SEGMENT DISPLAY

SCREEN 0 (Display FAULT CODE)

Setting No.	Contents	Notes
1	Fault code (present)	

SCREEN 1 (Display FAULT CODES)

Setting No.	Contents	Notes
1	Fault code (latest)	Latest
2	Fault code (2nd)	2nd
3	Fault code (3rd)	3rd
4	Fault code (4th)	4th
5	Fault code (5th)	5th
6	Fault code (6th)	6th

SCREEN 2 (MONITOR MODE)

Setting No.	Contents	Notes
1	Compressor operation time	unit : hr (Multiply by 200,)
2	Operation code	0: Stop 1: Cooling Start-up 2: Heating Start-up 3: Oil Return Operation 4: Heating Operation 5: Defrost Operation 6: Cooling Operation
3	Compressor Reduction Mode	0:OFF,1:ON
4	% demand	unit : % (Cut off the decimal first place.)
5	act % demand	unit : % (Cut off the decimal first place.)
6	Requested ID CFM	unit : CFM (Multiply by 10)
7	Reported ID CFM	unit : CFM (Multiply by 10)
8	Outdoor FAN TAP	0: Off; 1: Low Tap; 2: Medium Tap; 3: High Tap
9	Ta (Outdoor Air Temperature)	unit : F
10	Td (Discharge Temperature)	unit : F
11	Tm (Outdoor Coil Temperature)	unit : F
12	Tb (Defrost Sensor Temperature)	unit : F
13	Tl (Liquid Temperature)	unit : F
14	Pressure Sensor	unit : PSI
15	Ts (Suction Temperature)	unit : F

SCREEN 3 (SETTING MODE 1)

Setting No.	Contents	Setting	Notes
1	Cool Airflow Trim High	0:-15% 6:3% 1:-12% 7:6% 2:-9% 8:9% 3:-6% 9:12% 4:-3% 10:15% 5:0%	
2	Cool Airflow Trim Int	0:-15% 6:3% 1:-12% 7:6% 2:-9% 8:9% 3:-6% 9:12% 4:-3% 10:15% 5:0%	
3	Cool Airflow Trim Low	0:-15% 6:3% 1:-12% 7:6% 2:-9% 8:9% 3:-6% 9:12% 4:-3% 10:15% 5:0%	
4	Cool Profile	0:A 2:C 1:B 3:D	
5	Cool ON Delay	0:5sec. 2:20sec. 1:10sec. 3:30sec.	
6	Cool OFF Delay	0:30sec. 2:90sec. 1:60sec. 3:120sec.	
7	Dehumidification Select	0:ON 1:OFF	
8	Heat Airflow Trim High	0:-15% 6:3% 1:-12% 7:6% 2:-9% 8:9% 3:-6% 9:12% 4:-3% 10:15% 5:0%	
9	Heat Airflow Trim Int	0:-15% 6:3% 1:-12% 7:6% 2:-9% 8:9% 3:-6% 9:12% 4:-3% 10:15% 5:0%	
10	Heat Airflow Trim Low	0:-15% 6:3% 1:-12% 7:6% 2:-9% 8:9% 3:-6% 9:12% 4:-3% 10:15% 5:0%	
11	Heat ON Delay	0:5sec. 2:15sec. 1:10sec.	
12	Heat OFF Delay	0:30sec. 2:70sec. 1:50sec. 3:90sec.	

SERVICING

7-SEGMENT DISPLAY

SCREEN 4 (SETTING MODE 2)

Setting No.	Contents	Setting	Notes
1	Maximum Defrost Interval	<u>0: 30min.</u> 1: 60min. 2: 90min. 3: 120min.	
2	Set Maximum Current	N/A	Future Use
3	Vertical Rise	0:Same Level <u>1:Outdoor Lower</u> 2:Indoor Lower	
4	System Verification Test	0:ON <u>1:OFF</u>	
7	Force Defrost Cycle	0:ON <u>1:OFF</u>	
8	Pump Down	0:ON <u>1:OFF</u>	
9	Charge Mode	0:ON <u>1:OFF</u>	
10	Maximum Compressor RPS for Cooling	*	
11	Maximum Compressor RPS for Heating	*	
12	BOOST MODE Selection	<u>0:ON,</u> 1:OFF	
13	BOOST MODE Temperature	<u>0:105F,</u> 1:100F, 2:95F, 3:90F, 4:85F, 5:80F, 6:75F, 7:70F, 8:Always ON	

NOTE: Parameters as per factory setting are highlighted in bold and underlined.

SERVICING

CTK04** COMFORTNET™ THERMOSTAT OVERVIEW

The ComfortNet™ system (or CT system) is a system that includes a ComfortNet compatible modular blower heat pump condenser with a CTK04** thermostat. The table below compares the valid CT systems.

<i>CT compatible Air Handler or Modular Blower</i>	<i>CT compatible Heat Pump Unit</i>	<i>Full CT system benefits & features</i>
--	-------------------------------------	---

A ComfortNet heating/air conditioning system differs from a legacy/traditional system in the manner in which the indoor unit, outdoor unit and thermostat interact with one another. In a traditional system, the thermostat sends commands to the indoor and outdoor units via analog 24 VAC signals. It is a one-way communication path in that the indoor and outdoor units typically do not return information to the thermostat.

On the other hand, the indoor unit, outdoor unit, and thermostat comprising a ComfortNet system “communicate” digitally with one another. It is now a two-way communications path. The thermostat still sends commands to the indoor and outdoor units. However, the thermostat may also request and receive information from both the indoor and outdoor units. This information may be displayed on the CT thermostat. The indoor and outdoor units also interact with one another. The outdoor unit may send commands to or request information from the indoor unit. This two-way digital communications between the thermostat and subsystems (indoor/outdoor unit) and between subsystems is the key to unlocking the benefits and features of the ComfortNet system.

Two-way digital communications is accomplished using only two wires. The thermostat and subsystem controls are powered with 24 VAC. Thus, a maximum of 4 wires between the equipment and thermostat is all that is required to operate the system.

CTK04 WIRING

NOTE: A removable plug connector is provided with the control to make thermostat wire connections. This plug may be removed, wire connections made to the plug, and replaced. It is strongly recommended that you do not connect more than two wires into a single terminal in the field because there is a risk of the wires becoming loose. Failure to do so may result in intermittent operation.

Typical 18 AWG thermostat wire may be used to wire the system components. However, communications reliability may be improved by using a high quality, shielded, twisted pair cable for the data transmission lines. In either case, 250 feet is the maximum length of wire between indoor unit and outdoor unit, or between indoor unit and thermostat. Please use a thermostat model later than CTK04AE.

CTK04 ADDENDUM

TWO-WIRE OUTDOOR, FOUR-WIRE INDOOR WIRING

Low voltage wiring consists of two wires between the indoor unit and outdoor unit and four wires between the indoor unit and the thermostat. The required wires are: (a) data lines, 1 and 2; (b) thermostat “R” (24 VAC hot) and “C” (24 VAC common).

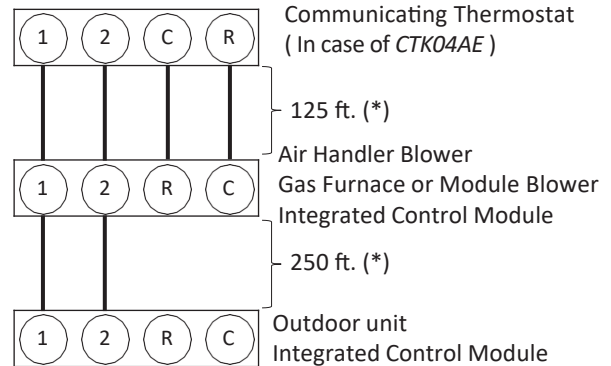

(*) Allowable Maximum Length

SYSTEM WIRING SYSTEM WIRING USING FOUR-WIRES

Two wires only may be utilized between the indoor and outdoor units. For this wiring scheme, only the data lines, 1 and 2, are required between the indoor and outdoor units.

SERVICING

THERMOSTAT MENU SCREEN SYSTEM START-UP TEST

NOTICE

ON INITIAL POWER START-UP, THE OUTDOOR UNIT WILL DISPLAY CODE E11, SIGNALING THAT INITIAL SYSTEM TEST MUST BE RUN. FOLLOW THE COMFORTNET™ SETUP SCREEN TO ENTER APPLICATION-UNIQUE INFORMATION. SEE COMFORTNET THERMOSTAT MANUAL FOR DETAILED INFORMATION.

A system test is now required to check the equipment settings and functionality. Once selected, it checks the equipment for approximately 5 - 15 minutes. System test may exceed 15 minutes if there is an error. Refer to the Troubleshooting section, if error code appears. Before starting the SYSTEM TEST, turn off the electric heater and gas furnace.

NOTE: If the unit is attempting to run SYSTEM TEST in under 20° F ambient temperature, the unit may not be able to complete the test due to low suction pressure. In such a case, re-run the SYSTEM TEST when the ambient temperature exceeds 20° F.

1. Ensure the thermostat is installed.
2. Apply power to outdoor and indoor units.
3. Start-up.
After the application information is entered, the initial system test must be run.

NOTICE

FOR INVERTER HEAT PUMP CONDENSER SYSTEM USING COMFORTNET, DO NOT INSTALL A TRANSFORMER.

The HOME screen will be displayed showing information similar to one of the adjacent screens. Select MENU. Make sure the thermostat is in OFF mode and select SYSTEM MENU. Choose OFF before SYSTEM VERIFICATION test.

NOTE: Either screen may be displayed. SYSTEM TEST must be run for all installations. System will not operate without a completed initial SYSTEM TEST.

NOTE: The thermostat screen may indicate to run a SYSTEM VERIFICATION test.

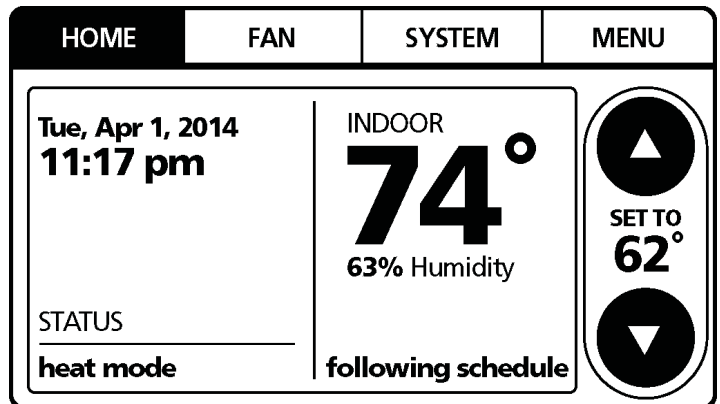
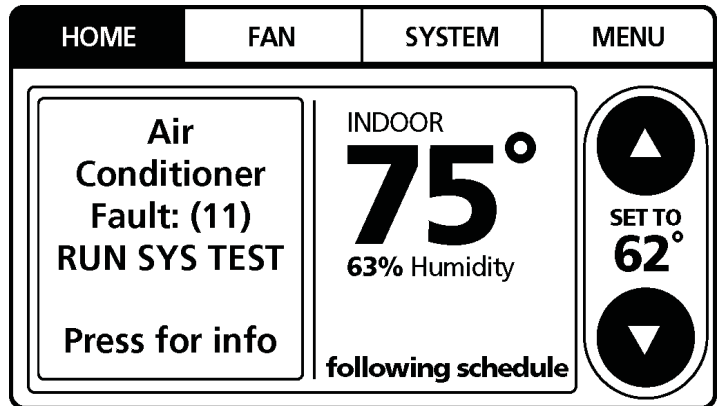

- From the MENU screen, scroll down and select Comfort-Net™ USER MENU.

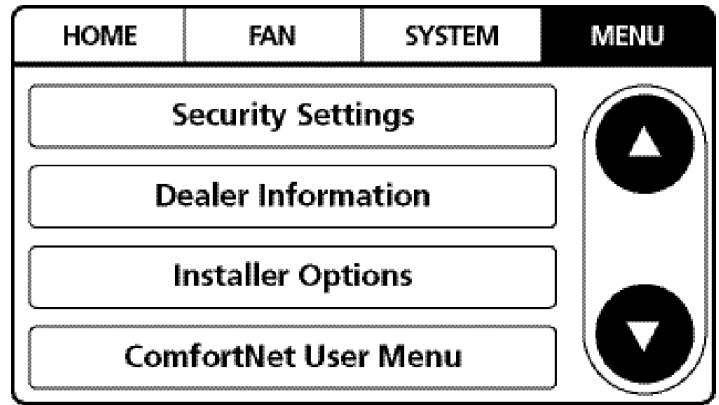

- Enter Installer password. (The password is the Date Code located on the thermostat and is available by entering the EQUIPMENT STATUS menu and scrolling to the bottom.)

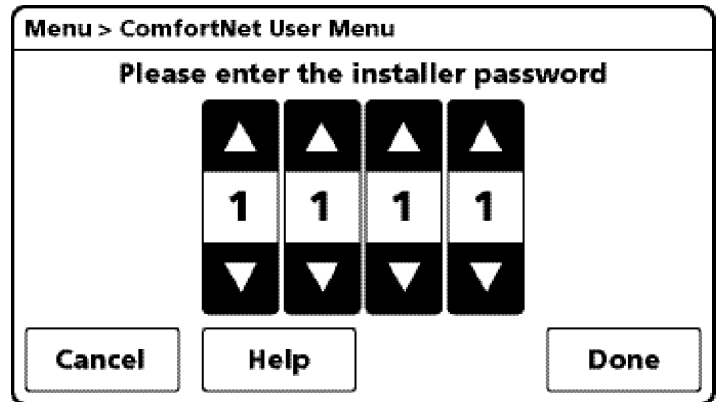

- Select YES to continue.

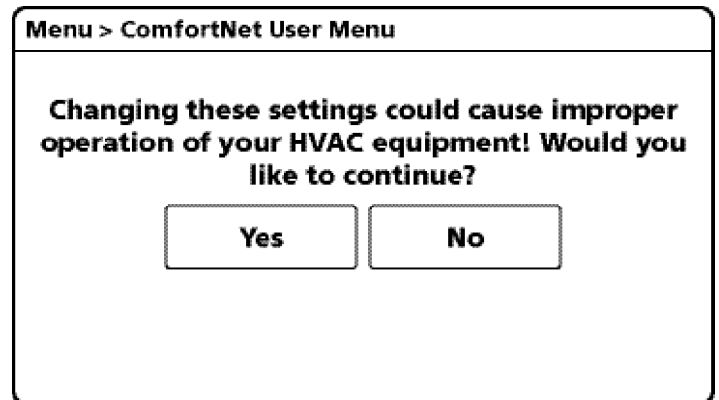

- From the ComfortNet USER MENU, select HEAT PUMP. Note: Screen may show air handler or furnace depending on the type of system installed.

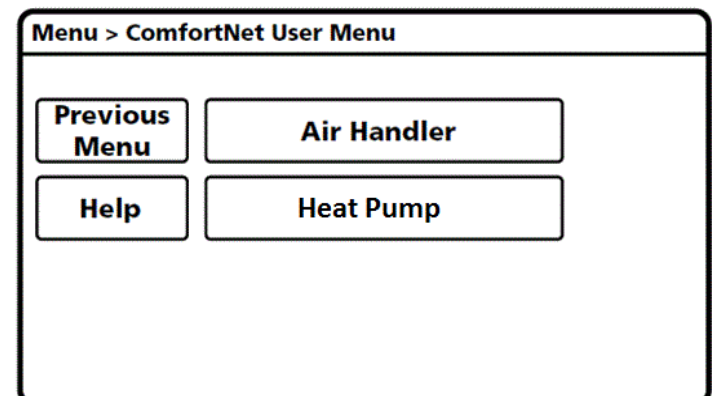

SERVICING

8. Next, scroll down and select EQUIP TEST.

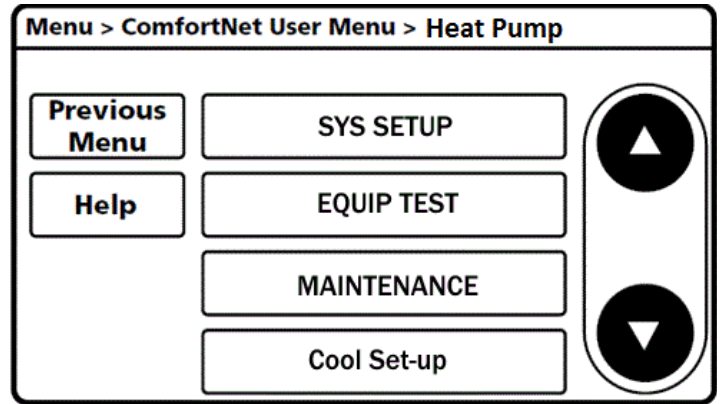

9. Select SYSTEM TEST.

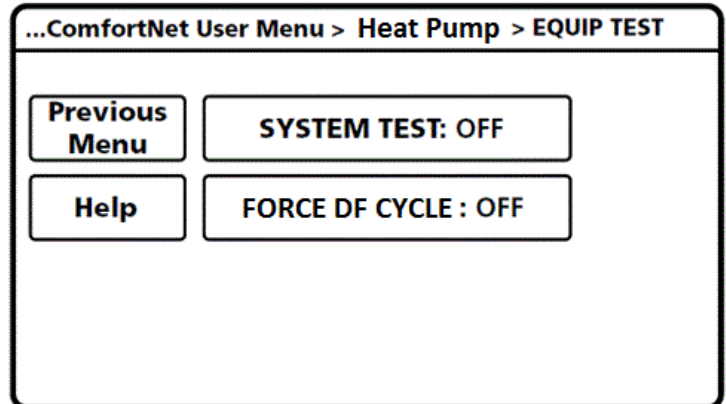

10. Select ON to run the SYSTEM TEST.
Press DONE to initiate test.

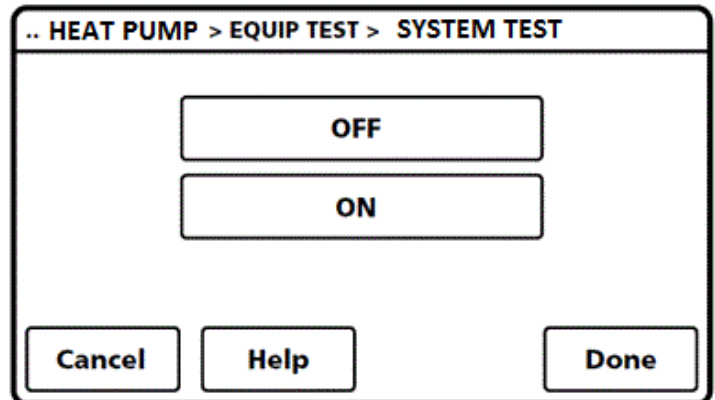

11. Allow the system test to run for its duration (5-15 minutes). EQUIP TEST SCREEN will show the system test is ON once selected. System test will operate the outdoor unit and the indoor unit through a series of startup tests. Please proceed to the next step and allow for startup tests to complete. Do not interrupt power to outdoor unit, indoor unit, or thermostat during system test.

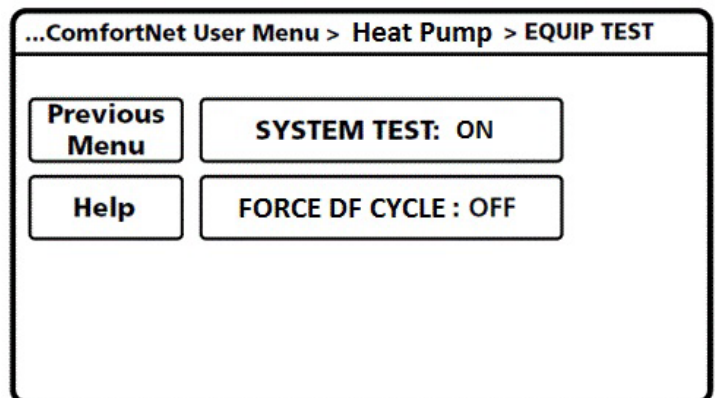

SERVICING

12. Press Previous Menu button and navigate to HOME screen and allow test to finish. The display similar to the one at the right will be displayed after SYSTEM TEST completes. Test is complete only when CODE 11 notice clears from BOTH the thermostat display AND the seven segment LED display on the outdoor unit. Please wait for test to complete and for both codes to clear.

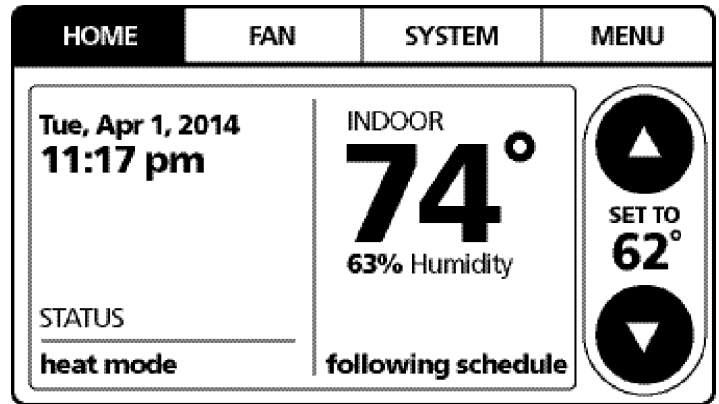

SET THERMOSTAT TO CHARGE MODE

Please follow the following sequence to enter CHARGE Mode.

CHARGE mode allows for charging of the system. System operates for a duration of approximately one hour while the equipment runs at full capacity. After one hour, the charge mode ends and the system resumes normal thermostat operation.

Before starting the charge mode, turn off the electric heater and gas furnace.

1. On the HOME screen, select MENU.
NOTE: Ensure the thermostat is in the OFF mode.
Select SYSTEM menu. Choose OFF before CHARGE MODE.

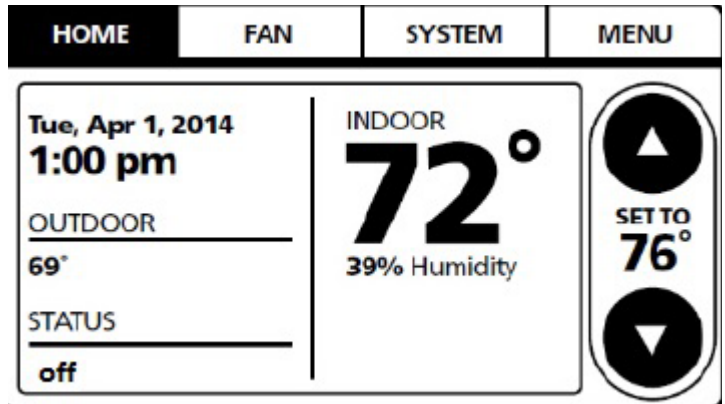

2. From the MENU screen, scroll down and select COMFORTNET™ USER MENU.

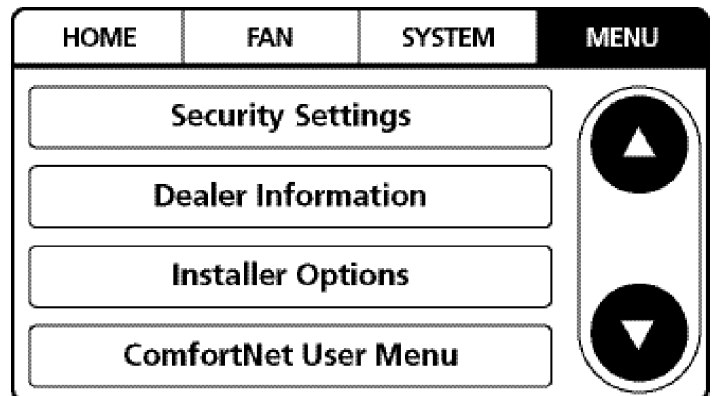

SERVICING

3. Enter Installer password. (The password is the Date Code located on the thermostat and is available by entering the EQUIPMENT STATUS menu and scrolling to the bottom).

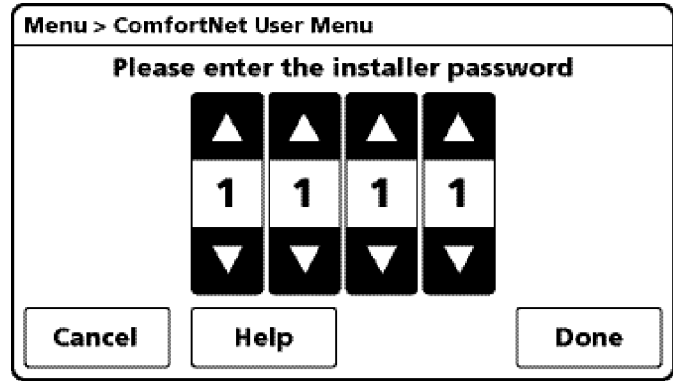

4. Select YES to continue.

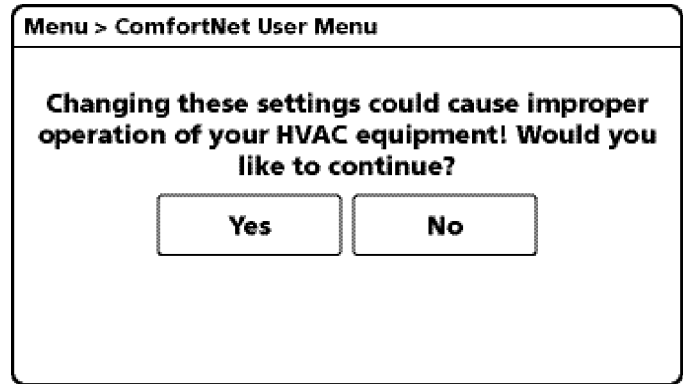

5. Select HEAT PUMP.

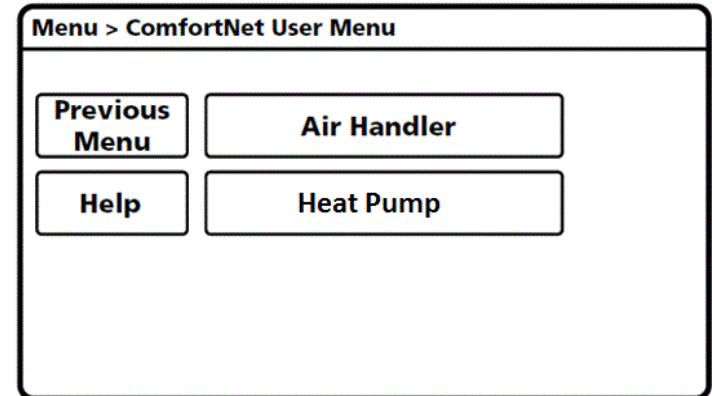

6. Select MAINTENANCE.

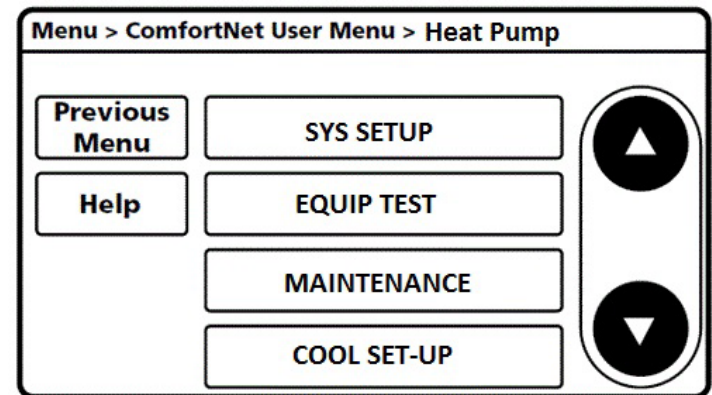

SERVICING

7. Select CHARGE Mode.

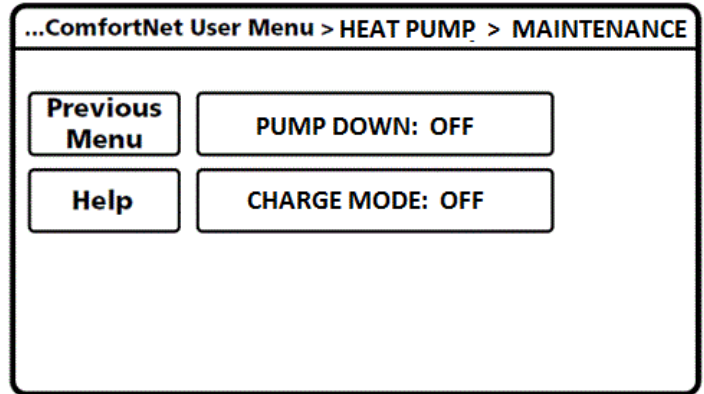

8. Select ON. Press DONE to initiate CHARGE Mode. (System will then run for 1 hour and either return to cooling or heating mode depending on if the mode thermostat is set at COOL or HEAT MODE from the SYSTEM menu on the main screen. If charging is not complete after 1 hour, repeat 7. and 8. Refer to S-103 for refrigerant charge level adjustment.

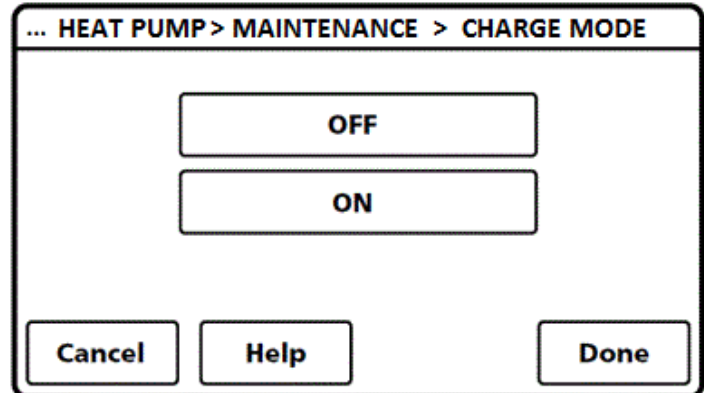

9. To terminate CHARGE MODE, select CHARGE Mode screen again. Press OFF. Press DONE to terminate CHARGE MODE.

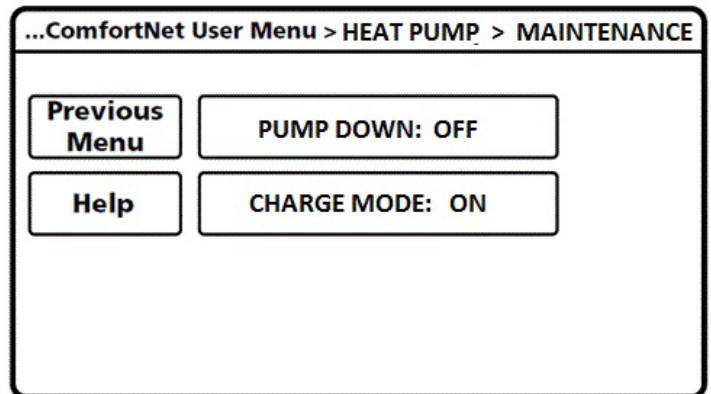

10. Once CHARGE MODE is complete and has been terminated, navigate to HOME screen. Enter normal operation with temperature offset or thermostat schedule, as desired.

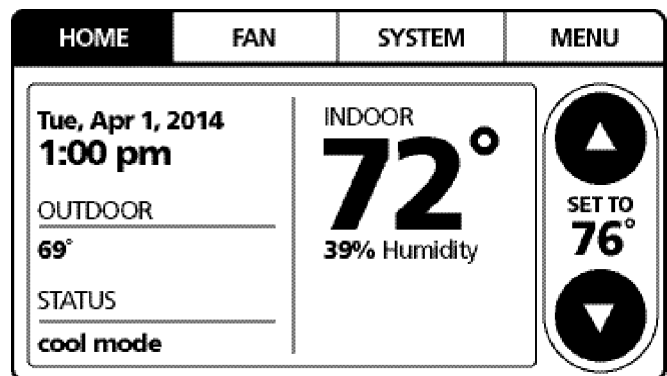

SERVICING

SET THERMOSTAT TO ADJUST MAXIMUM COMPRESSOR SPEED

Please follow the following sequence to enter MAXIMUM compressor speed.

Maximum compressor speed at which the outdoor unit will operate in cooling or heating mode can be changed using thermostat. Maximum compressor speed can be changed to get the required capacity or efficiency. Once the maximum speed is set, the system operates between the set maximum speed and default low speed.

1. On the HOME screen, select MENU

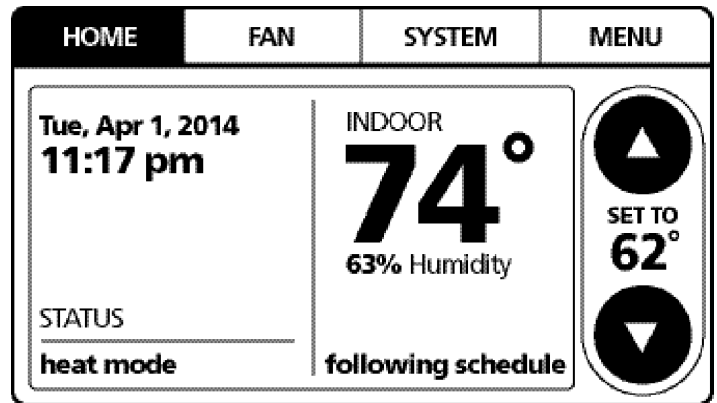

2. From the MENU screen, select COMFORTNET™ USER MENU.

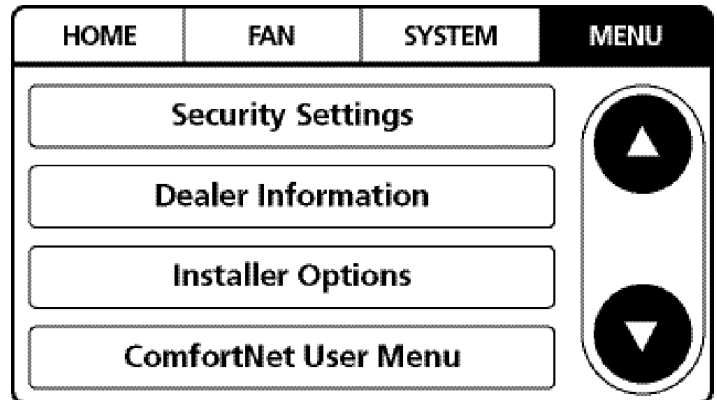

3. Enter Installer password. (The password is the Date Code located on the thermostat and is available by entering the EQUIPMENT STATUS menu and scrolling to the bottom).

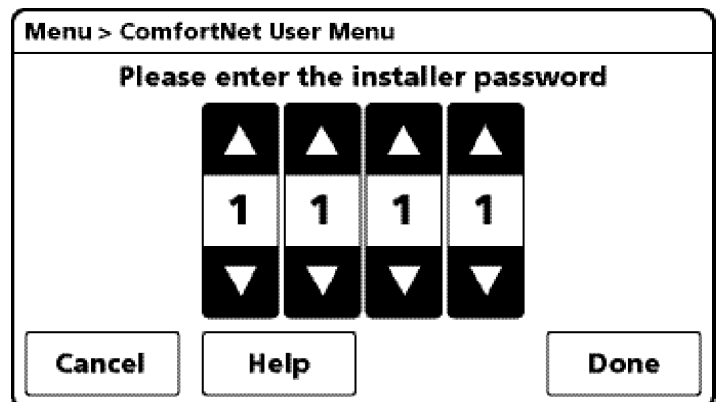

SERVICING

4. Select YES to continue.

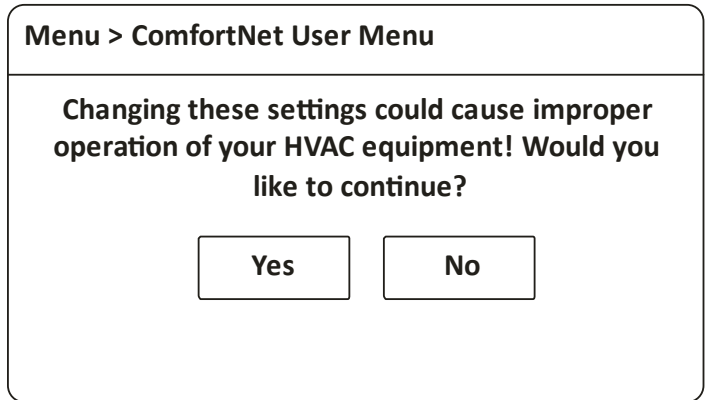

5. Select HEAT PUMP.

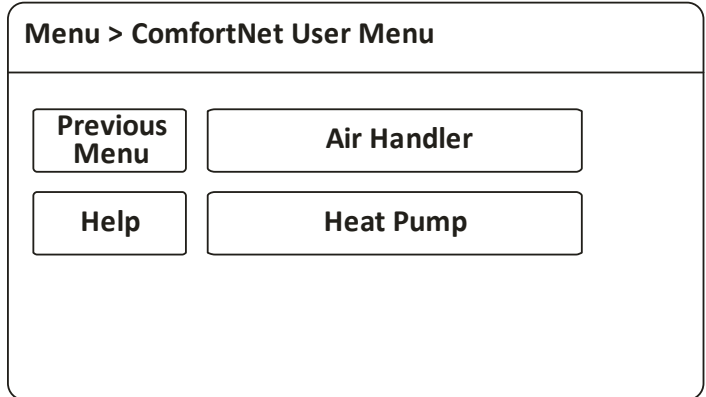

6. Select
CL RUN VALUES: for cooling mode
HT RUN VALUES: for heating mode

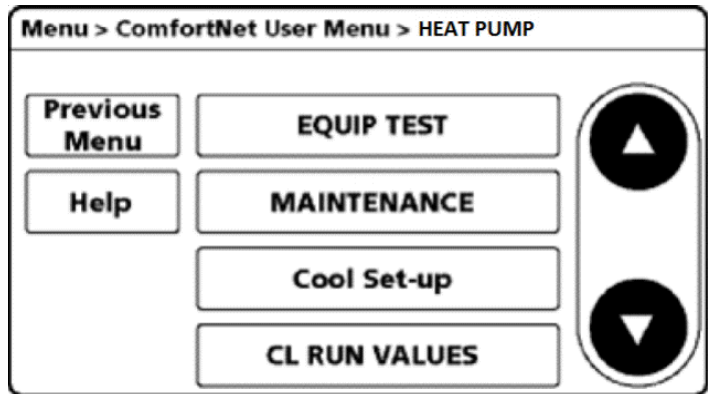

7. Select Cool/HEAT RPS RANGE.
Press Cool RPS Range (for cooling mode) or HEAT RPS RANGE (heating mode) to select the range in which the desired Maximum compressor speed falls.

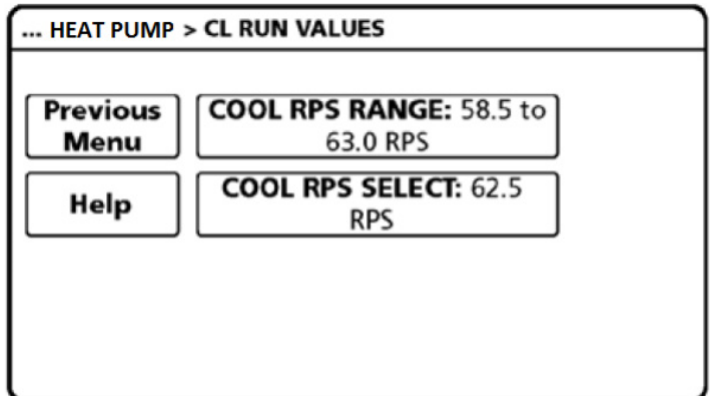

SERVICING

- Select Cool RPS SELECT (cooling mode) or HEAT RPS SELECT (heating mode).
Select the desired Maximum compressor speed

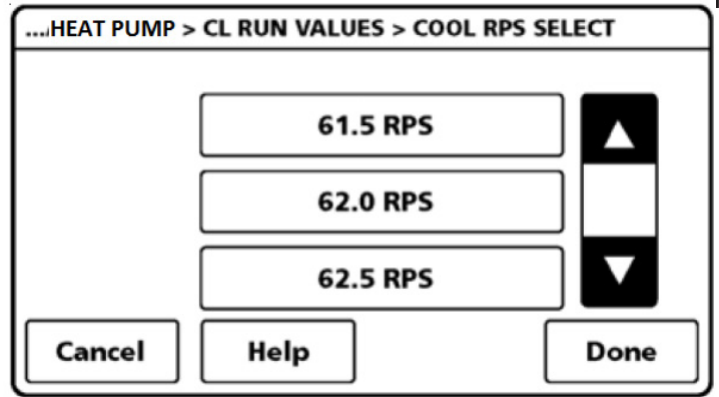

- Once Maximum compressor speed is set, navigate to HOME screen. Enter normal operation with temperature offset or thermostat schedule, as desired.

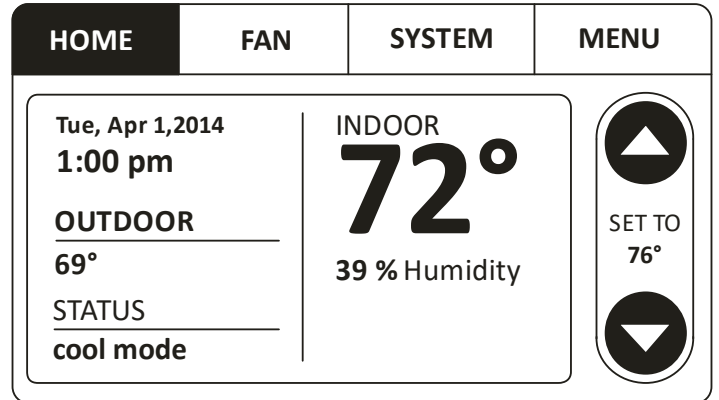

Set Thermostat to Adjust Indoor Air CFM trim

- On the HOME screen, select MENU

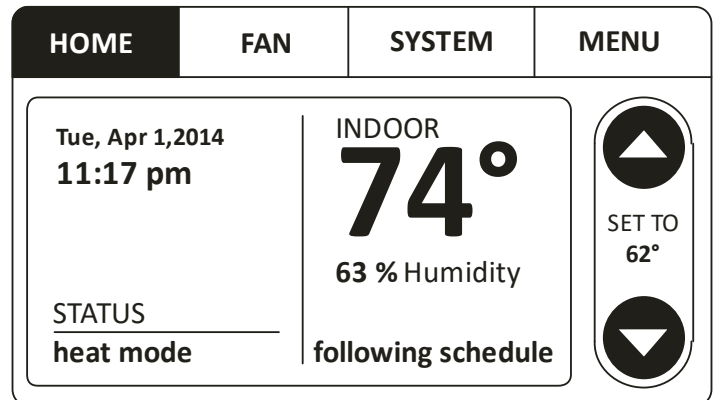

- From the MENU screen, select COMFORTNET™ USER MENU

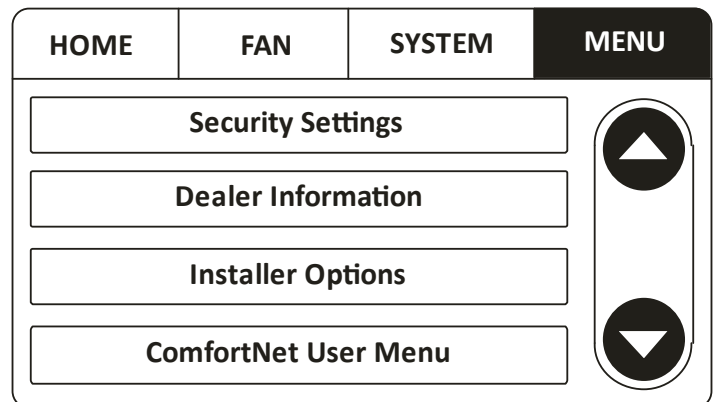

SERVICING

- 3. Enter Installer password. (The password is the Date Code located on the thermostat and is available by entering the EQUIPMENT STATUS menu and scrolling to the bottom).

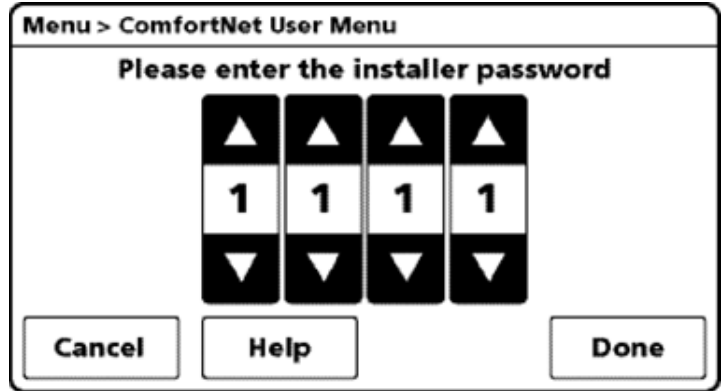

- 4. Select YES to continue.

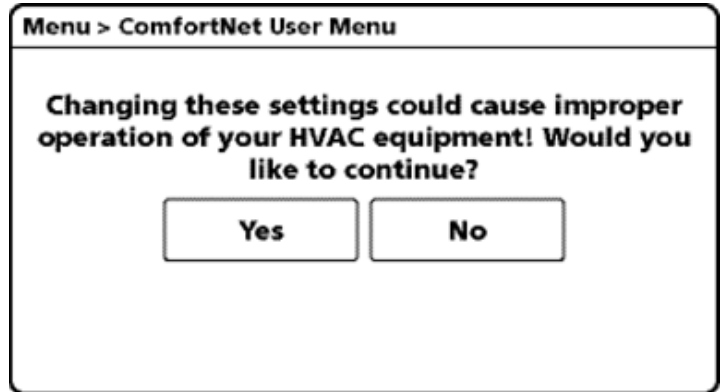

- 5. Select HEAT PUMP.

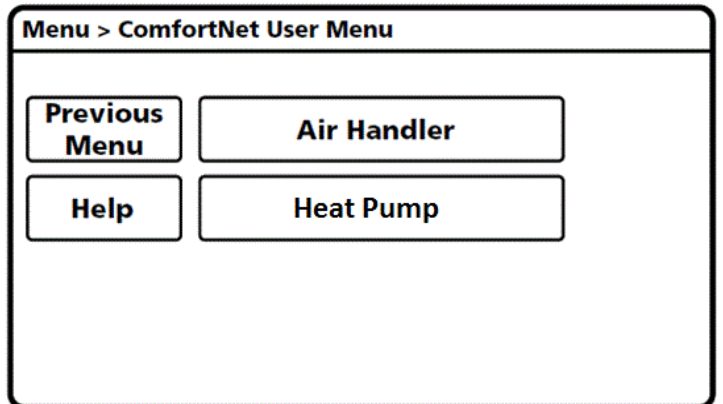

- 6. Select
Cool Setup: Cooling Mode
HEAT SETUP: Heating Mode

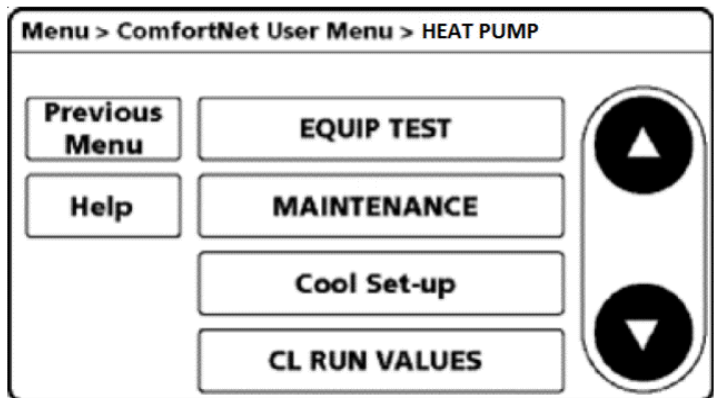

SERVICING

7. User can change the airflow trim at high, intermediate and low compressor for cooling and heating mode.

Select:

Cool Airflow Trim Hi: high speed cooling

Cool Airflow Trim Int: intermediate speed cooling

Cool Airflow Trim Low: low speed cooling

Heat Airflow Trim Hi: high speed heating

Heat Airflow Trim Int: intermediate speed heating

Heat Airflow Trim Low: low speed heating

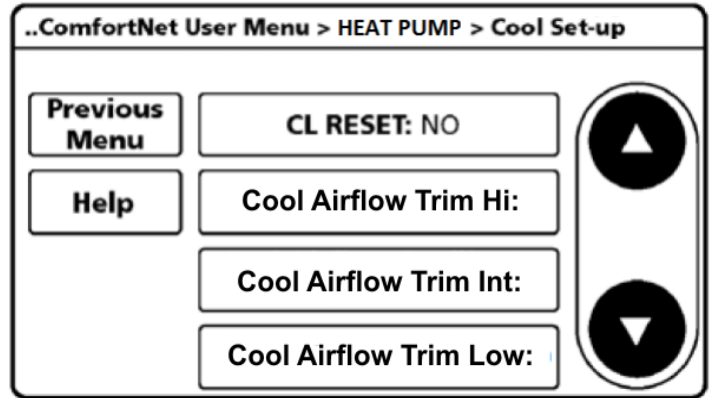

Under each trim setting, the airflow can be increased or decreased by a certain percentage. The increment that can be changed depends on the production date.

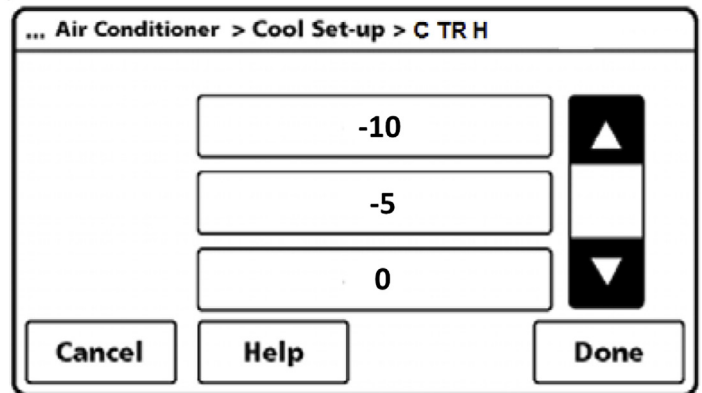

8. Once Cool Airflow Trim is set, navigate to HOME screen. Enter normal operation with temperature offset or thermostat schedule, as desired.

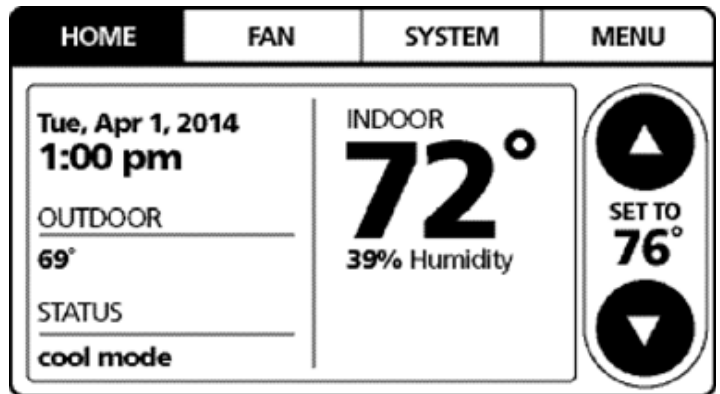

SERVICING

SET THERMOSTAT TO ADJUST INDOOR AIRFLOW PROFILE, COOL/HEAT ON DELAY AND COOL/HEAT OFF DELAY DEFROST

1. Please follow the sequence 1. to .6 of Set Thermostat To Adjust Indoor Air CFM trim

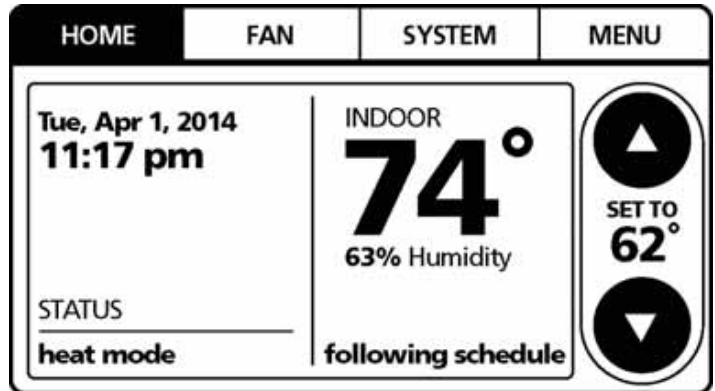

2. Select
Cool Set-up for Cool Airflow Profile, Cool ON Delay or Cool OFF Delay
Heat Set-up for Heat ON Delay or Heat OFF Delay
Heat Airflow Profile, DEFROST

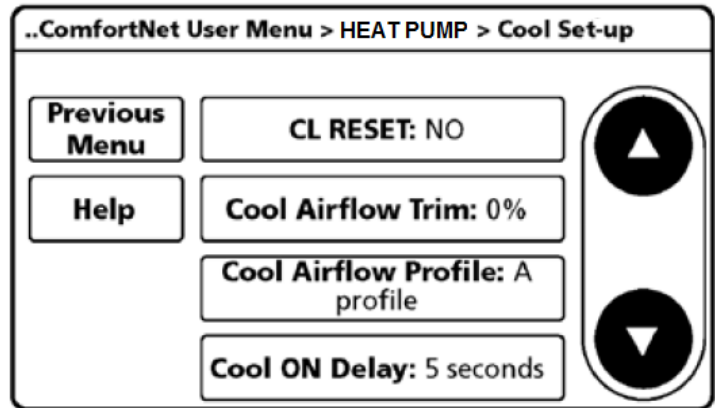

3. Once Cool Set-up / Heat Set-up settings are complete, navigate to HOME screen.

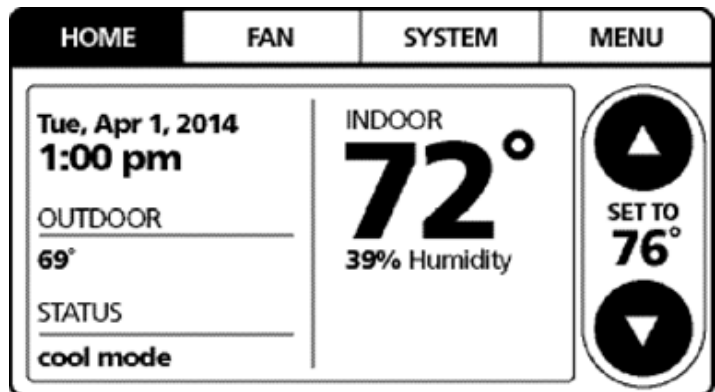

SERVICING

SET THERMOSTAT TO FORCE DEFROST CYCLE

Follow the following sequence to Force a defrost cycle.

NOTE: Unit will need to wait another 6 minutes before starting another force defrost cycle.

1. On the HOME screen, select MENU.

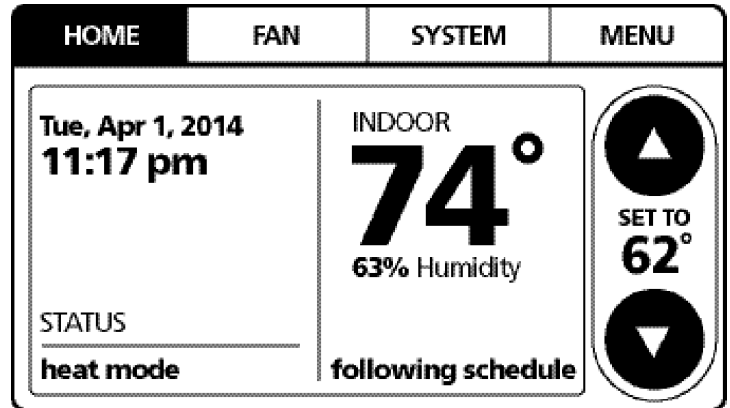

2. From the MENU screen, select COMFORTNET™ USER MENU.

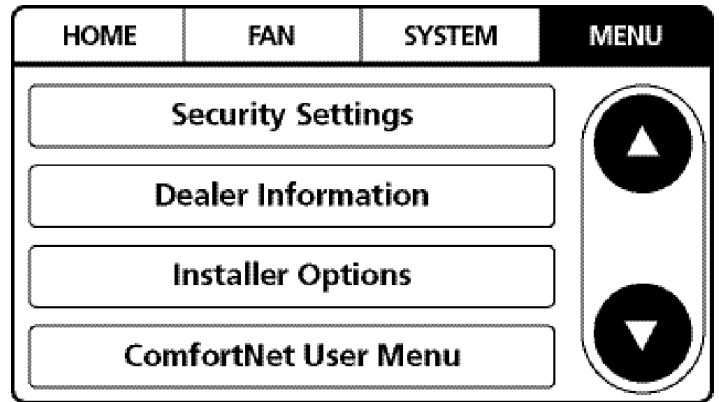

3. Enter Installer password. (The password is the Date Code located on the thermostat and is available by entering the EQUIPMENT STATUS menu and scrolling to the bottom).

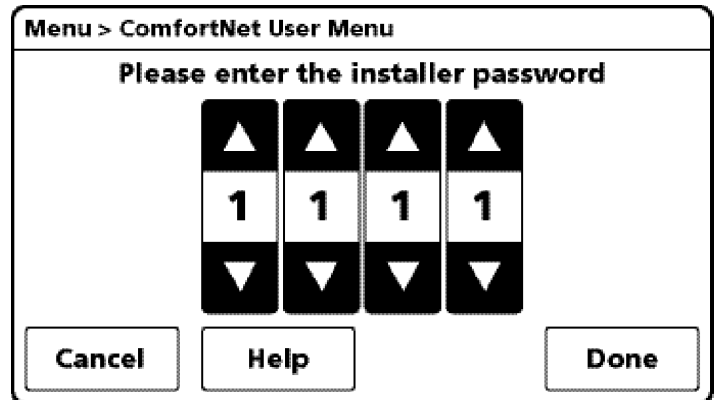

4. Select YES to continue.

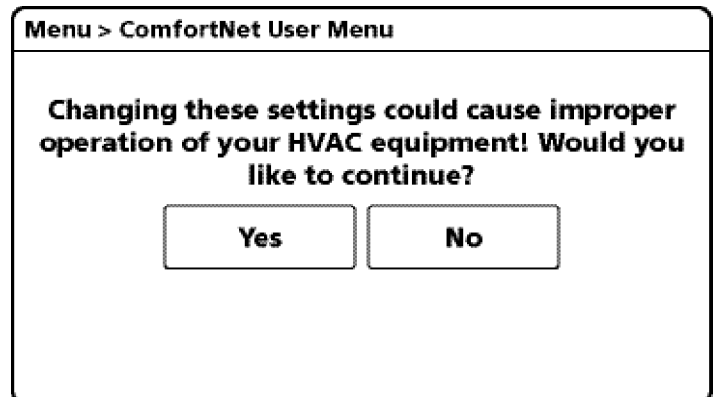

SERVICING

5. Select HEAT PUMP.

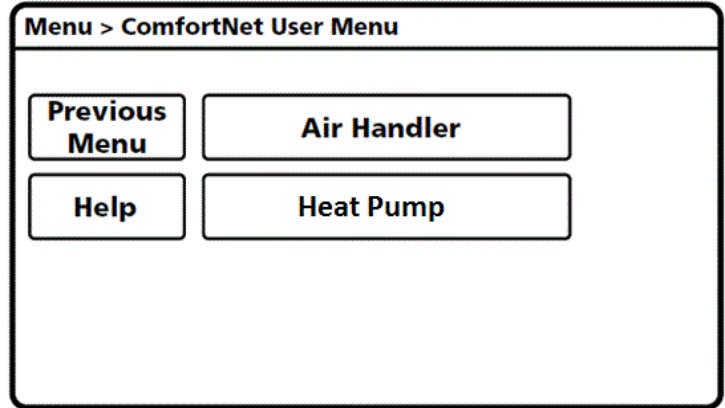

6. Select EQUIP TEST.

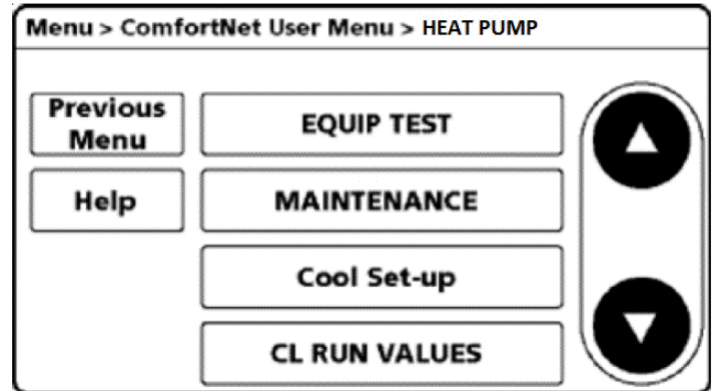

7. Select FORCE DF CYCLE.

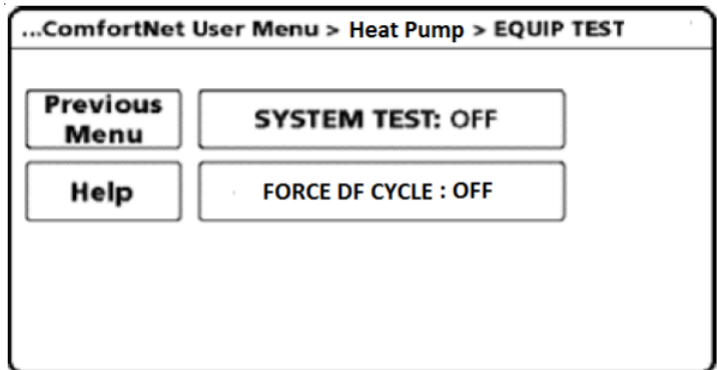

8. Select ON. Press DONE to initiate FORCE DEFROST CYCLE.

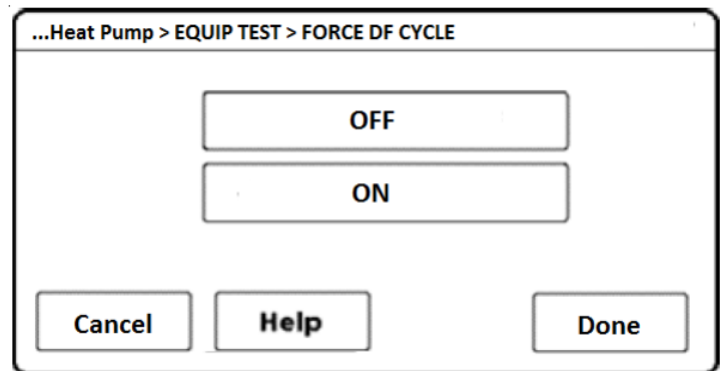

SERVICING

SET THERMOSTAT TO PUMP DOWN

Please follow the following sequence to enter PUMP DOWN to accumulate the refrigerant to outdoor unit. Do not operate Cool ON or Heat ON mode to enter PUMP DOWN. Before starting the PUMP DOWN operation, change indoor fan trim, delay and profile back to default and stop electric heater and gas furnace. Remove if no trim feature. In this operation, the gas valve and liquid service valve should be opened.

NOTE: Manufacturer recommends to set PUMP DOWN using 7-segment display. For more information, see section Set 7-segment mode display to PUMP DOWN. If difficulty is encountered using 7-segment display, use the thermostat as an alternative method. See section SET 7-SEGMENT MODE DISPLAY TO PUMP DOWN.

1. On the HOME screen, select MENU.

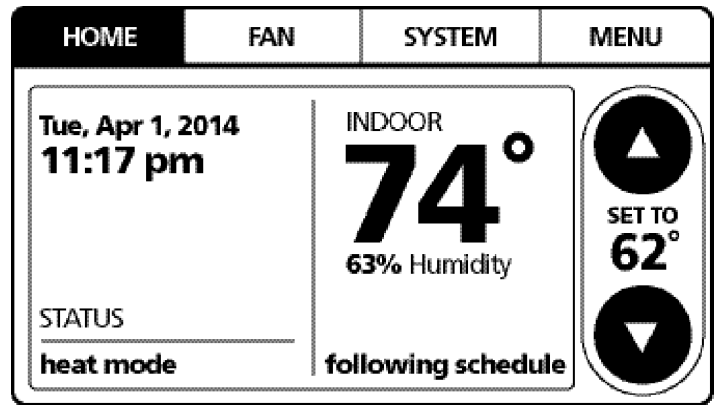

2. From the MENU screen, select COMFORTNET™ USER MENU.

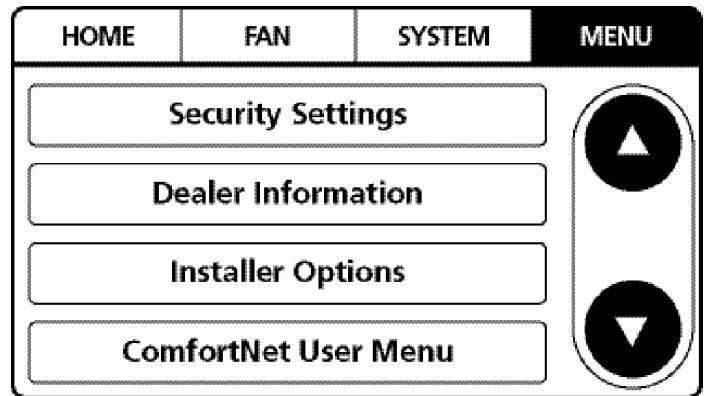

3. Enter installer password. (The password is the Date Code located on the thermostat and is available by entering the equipment status menu and scrolling to the bottom.)

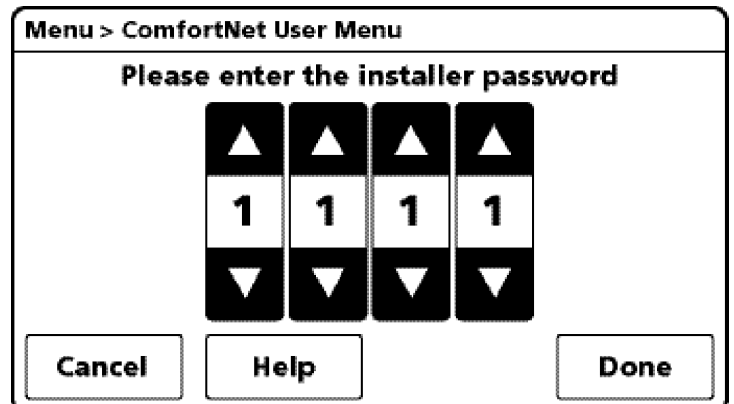

SERVICING

4. Select YES to continue.

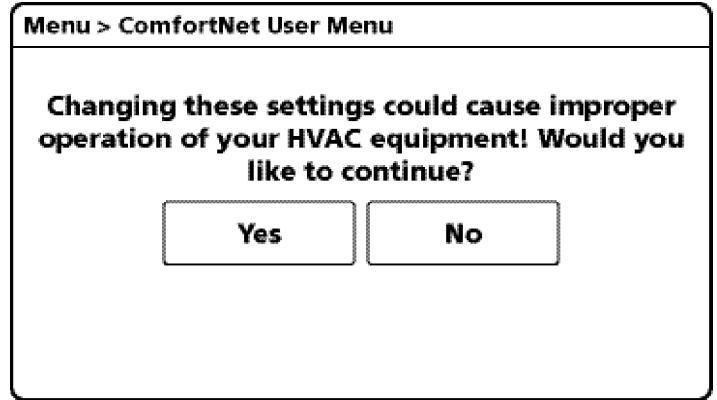

5. Select HEAT PUMP .

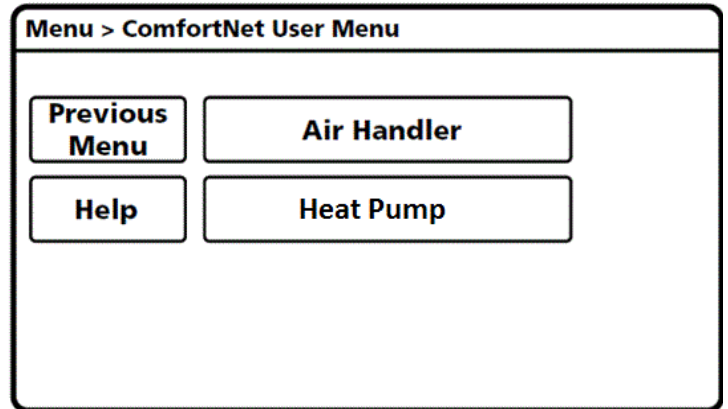

6. Select MAINTENANCE.

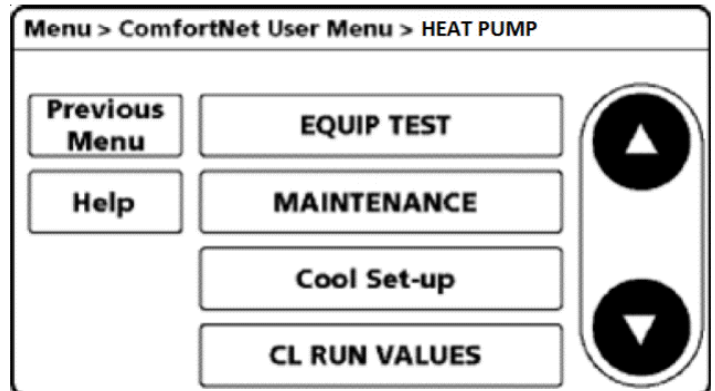

7. Select PUMP DOWN.

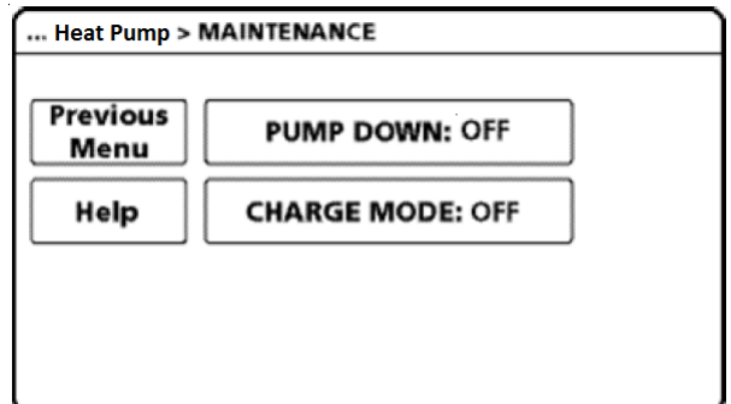

SERVICING

8. Select ON. Press DONE to initiate PUMP DOWN. Approximately one minute later, the compressor should start operating. Check the amperage at the compressor wiring to see the compressor operation status. Close liquid service valve approximately two minutes after compressor has come on. Compressor will stop automatically then close the gas service valve immediately.

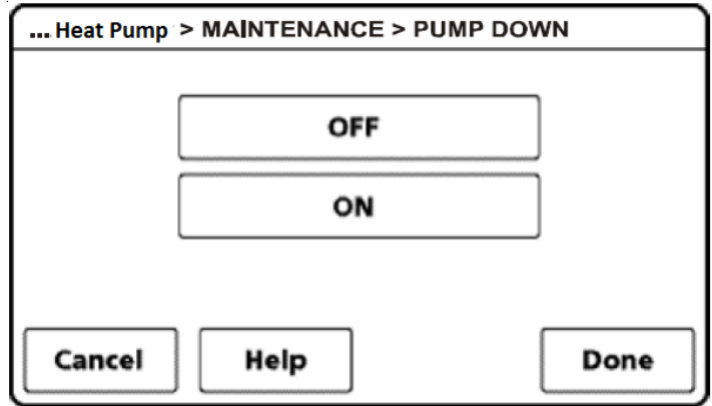

9. To terminate PUMP DOWN, select PUMP DOWN screen again. Press OFF. Press DONE to terminate PUMP DOWN.

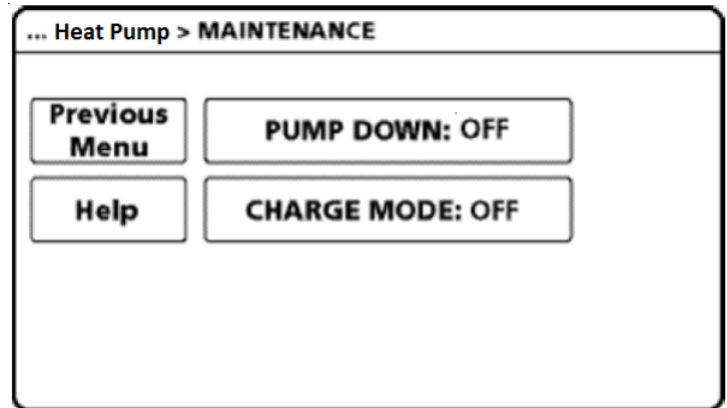

10. Once PUMP DOWN is set, navigate to HOME screen. After finishing PUMP DOWN operation, unit will stop automatically. Unit will show error code "E11" after the PUMP DOWN operation starts.

NOTE: Refrigerant cannot be collected to the outdoor unit completely if the system is overcharged or if there is a delay in closing the liquid service valve and gas service valve. Evacuate the leftover refrigerant from the system using a recovery machine.

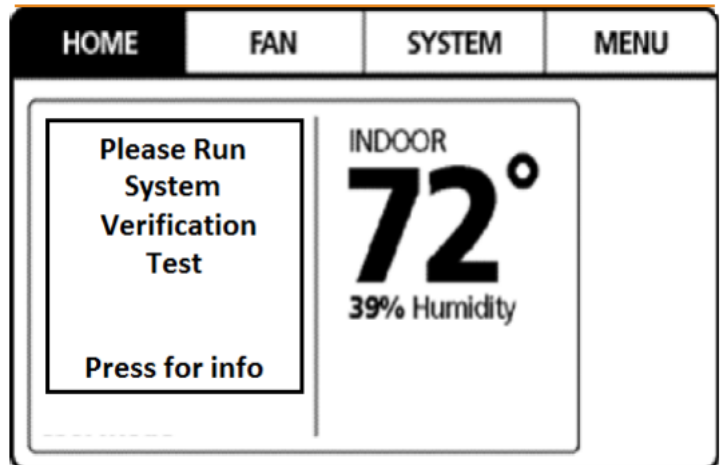

SERVICING

SET 7-SEGMENT MODE DISPLAY TO PUMP DOWN



WARNING

PUMP DOWN operation is designed for line set less than 80 feet in length. Do not start PUMP DOWN operation if line set length is 80 feet or more. Piping may burst as a result.

Please follow the following sequence to enter PUMP DOWN to accumulate the refrigerant to outdoor unit.

Do not operate COOL ON or HEAT ON mode to enter PUMP DOWN. Before starting the PUMP DOWN operation, change indoor fan trim, delay and profile back to default and stop electric heater and gas furnace. Remove if no trim feature. In this operation, the gas and liquid service valve should be opened.

1. Set 7-segment display to SCREEN 4 (SETTING MODE 2) Setting No. 8 and change the display from “-01” to “-00”. System will then automatically start PUMP DOWN operation.
For information on how to set 7-segment display, see the section SETTING THE MODE DISPLAY in this manual.
2. Approximately one minute later, the compressor should start operating. Check the amperage at the compressor wiring to see the compressor operation status. Unit display error code E11 (System verification Test) once the PUMP DOWN operations starts.
3. Close liquid service valve approximately two minutes after compressor has come on.
4. Compressor will come to a stop automatically. Close the suction service valve immediately after the compressor stops. After completion of PUMP DOWN, unit shows error code “E11”.

NOTE: Refrigerant cannot be collected to the outdoor unit completely if the system is overcharged or if there is a delay in closing the liquid service valve and suction service valve. Evacuate the left over refrigerant from the system using a recovery machine.

SET THERMOSTAT TO CHECK SYSTEM STATUS

1. Follow the sequence 1. to 5. of Set Thermostat to Adjust Indoor Air CFM trim.
2. Select STATUS.

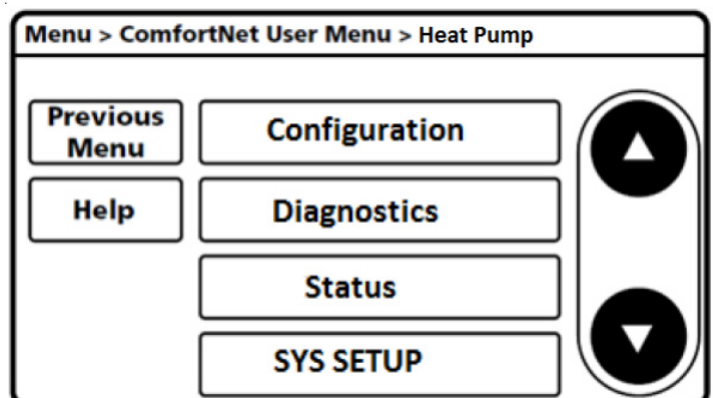

SERVICING

3. Follow screen for System Status.

TS	Time Stamp (Compressor run time)
MD	Current system operational Mode (cooling, cooling startup, heating, heating startup, oil return, defrost, stop)
CRM	Compressor Reduction Mode
RAD	Requested and Actual percentage Demand (Requested Demand, Actual cooling/heating provided)
RAF	Requested and Reported ID airflow (Requested CFM, Actual CFM)
ATOF	Outdoor Air Temperature and Outdoor Fan STATUS
DCT	Discharge Temperature, Outdoor Coil Temperature
DLT	Defrost sensor temperature, Outdoor Liquid Temperature
PSDST	Pressure Sensor and Outdoor Suction Temperature

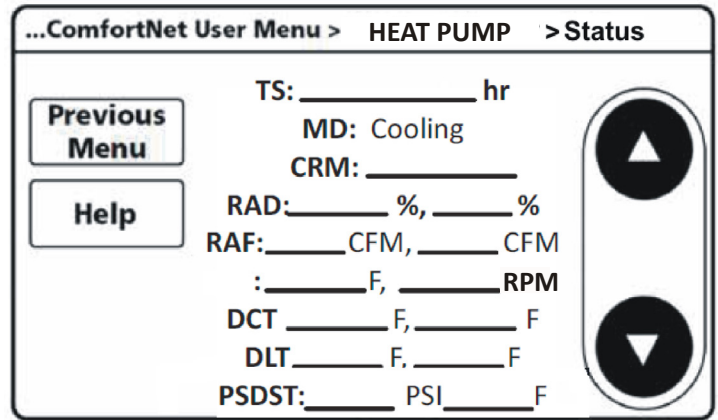

HEAT PUMP WITH OUTDOOR TEMPERATURE LOCKOUTS

It is recommended to set the outdoor temperature lockouts during the initial thermostat set up. This will enable the compressor to be turned off and switch heating source from refrigeration to auxiliary/secondary heating under low ambient conditions.

Backup heat lockout temperature will enable auxiliary/secondary heating to be turned on when outdoor temperature is much higher than indoor temperature, compressor might stop operating under this circumstance.

Backup Heat Lockout Temperature (-)	Compressor Lockout Temperature (F°)
OFF	15

In order to access the compressor lockout temperature, Press **MENU** and scroll down to press **INSTALLER OPTIONS**. Enter the date code (password) when prompted. Choose **VIEW / EDIT CURRENT SETUP** and **COMPRESSOR LOCKOUT / BALANCE POINT** will be under **HEAT / COOL CONTROL OPTIONS**. For more information please refer to COMFORTNET™ CTK04 Communicating Thermostat SYSTEM INSTALLATION GUIDE.SYSTEM INSTALLATION GUIDE.

TROUBLESHOOTING

HEATING ANALYSIS CHART

POSSIBLE CAUSE X IN ANALYSIS GUIDE INDICATE "POSSIBLE CAUSE"	Comp discharge temp > 200F	Comp discharge temp < 105F	Comp discharge SH > 70F	Comp discharge SH < 20F	High pressure > 490psi	High pressure SSV < 270psi	High pressure LSV < 270psi	LSV SC > 12F	LSV SC < 4F	Low pressure < 40psi	Requested % demand < Actual %	Requested % demand > Actual %	Repeated stop/start	Weak heating	No switch heating	Noise	Incomplete defrost operation	Stop operation	Sweating liquid line
	Liquid stop valve does not fully open	X		X		X			X		X		X	X	X			X	
Gas stop valve does not fully open	X		X		X				X	X		X	X	X			X		
Line set restriction	X		X		X				X	X		X	X	X			X		X
Line set length is too long					X		X												X
Blocked filter-dryer	X		X		X				X	X		X	X	X			X		X
OD EEV coil failure	X	X	X	X	X	X	X	X	X	X	X	X	X	X			X	X	
OD EEV failure	X	X	X	X	X	X	X	X	X	X	X	X	X	X			X	X	
ID EEV coil failure	X		X		X		X		X	X	X	X	X	X			X	X	X
ID EEV failure	X		X		X		X		X	X	X	X	X	X			X	X	X
Check valve failure – Leakage		X		X					X		X		X	X					X
High Pressure switch failure																			X
Pressure sensor failure			X	X	X	X	X	X	X		X	X	X	X					X
Suction temp sensor failure	X	X	X	X				X	X	X	X	X	X	X					X
Discharge temp sensor failure	X	X	X	X							X	X	X	X					X
Coil temp sensor failure										X		X	X	X			X	X	
Defrost sensor failure										X		X	X	X			X	X	
Liquid temp sensor failure								X	X										X
Ambient temp sensor failure					X					X			X	X	X				X
OD recirculation	X		X			X	X			X		X	X	X					
ID recirculation	X		X		X							X	X	X					
Dirty OD Heat-exchanger	X		X			X	X			X		X	X	X					X
Dirty ID Heat-exchanger	X		X		X							X	X	X					
Outdoor Ambient temp is too high					X							X	X	X					X
Outdoor Ambient temp is too low	X	X	X			X	X		X	X		X	X	X					
ID suction temp is too high	X				X							X	X	X					
ID suction temp is too low						X	X												X
Mixture of non-condensable gas	X		X		X				X	X		X	X	X					
OD fan motor failure	X		X			X	X			X		X	X	X					X
RV failure			X			X	X					X	X	X	X		X	X	
RV coil failure			X			X	X					X	X	X			X		
Over charge			X	X	X			X			X	X	X	X					X
Under charge	X	X	X			X	X		X	X			X	X					X
Leak	X	X	X			X	X		X	X			X	X					X
ID failure	X	X	X	X	X	X	X	X	X	X	X	X	X	X			X	X	X
OD Control Board failure																			X
Compressor failure	X	X	X	X		X	X					X	X	X		X	X	X	
Cooling loop is not attached												X	X	X					
Cooling loop grease is not enough												X	X	X					
Low ID CFM	X				X				X			X	X	X					X

Outdoor Normal Temperature Operating Range: 17-62°F

Indoor Normal Temperature Operating Range: 65-85°F

Outdoor Normal Temperature Operating Range: 67-115°F / Indoor Normal Temperature Operating Range: 65 - 85°F

WARNING

AVOID CONTACT WITH THE CHARGED AREA.

•NEVER TOUCH THE CHARGED AREA BEFORE CONFIRMING THAT THE RESIDUAL VOLTAGE IS 50 VOLTS OR LESS.

1. SHUT DOWN THE POWER AND LEAVE THE CONTROL BOX FOR 10 MINUTES.
2. MAKE SURE TO TOUCH THE EARTH GROUND TERMINAL TO RELEASE THE STATIC ELECTRICITY FROM YOUR BODY (TO PREVENT FAILURE OF THE PC BOARD).
3. MEASURE THE RESIDUAL VOLTAGE IN THE SPECIFIED MEASUREMENT POSITION USING A VOM WHILE PAYING ATTENTION NOT TO TOUCH THE CHARGED AREA.
4. IMMEDIATELY AFTER MEASURING THE RESIDUAL VOLTAGE, DISCONNECT THE CONNECTORS OF THE OUTDOOR UNIT'S FAN MOTOR. (IF THE FAN BLADE ROTATES BY STRONG WIND BLOWING AGAINST IT, THE CAPACITOR WILL BE CHARGED, CAUSING THE DANGER OF ELECTRICAL SHOCK.)

TROUBLESHOOTING

COOLING ANALYSIS CHART

POSSIBLE CAUSE X IN ANALYSIS GUIDE INDICATE "POSSIBLE CAUSE"	Comp discharge temp > 200F	Comp discharge temp < 105F	Comp discharge SH > 70F	Comp discharge SH < 20F	High pressure > 490psi	High pressure < 255psi	LSV SC > 12F	LSV SC < 4F	OD SSV SH > 20F	OD SSV SH < 4F	Low pressure > 185psi	Low pressure < 100psi	Requested % demand < Actual	Requested % demand > Actual	Repeated stop/start	Weak cooling	No switch cooling	Noise	Stop operation
	Liquid stop valve does not fully open	X		X		X		X		X		X		X	X	X	X		X
Gas stop valve does not fully open	X	X									X		X	X	X				
Line set restriction	X	X	X		X		X		X		X		X	X	X	X		X	
Line set length is too long								X			X			X	X			X	
Blocked filter-dryer	X	X	X	X	X	X	X	X	X		X		X	X	X	X		X	
OD EEV coil failure														X	X	X			X
OD EEV failure														X	X	X			
ID EEV coil failure	X	X	X	X	X	X	X	X	X	X	X	X	X	X	X	X			X
ID EEV failure	X	X	X	X	X	X	X	X	X	X	X	X	X	X	X	X			
Check valve failure – Blocked	X		X	X				X	X			X		X	X	X			
High Pressure switch failure																			X
Pressure sensor failure	X										X	X		X	X	X			X
Suction temp sensor failure													X	X		X			
Discharge temp sensor failure	X	X	X	X									X	X	X	X			X
Coil temp sensor failure				X	X	X							X	X	X	X			X
Defrost sensor failure																			
Liquid temp sensor failure																			
Ambient temp sensor failure				X	X	X							X	X	X	X			
OD recirculation	X		X	X										X	X	X			X
ID recirculation		X		X					X		X	X	X	X	X	X			
Dirty OD Heat-exchanger	X		X	X										X	X	X			X
Dirty ID Heat-exchanger		X		X				X		X		X	X	X	X	X			
Outdoor Ambient temp is too high	X		X	X					X					X	X	X			X
Outdoor Ambient temp is too low		X		X		X	X				X	X	X	X	X	X			
ID suction temp is too high								X		X									
ID suction temp is too low		X		X				X	X		X	X	X	X	X	X			
Mixture of non-condensable gas	X		X	X				X	X			X		X	X	X			X
OD fan motor failure	X		X	X				X						X	X	X			X
RV failure	X		X		X						X			X	X	X	X		X
RV coil failure	X		X		X						X			X	X	X	X		X
Over charge	X	X	X	X	X		X		X			X			X				X
Under charge	X	X	X		X		X	X			X				X				X
Leak	X	X	X		X		X	X			X			X	X	X			X
OD Control Board Failure																			X
ID Failure	X	X	X	X	X	X	X	X	X	X	X	X	X	X	X	X	X		X
Compressor failure	X	X	X		X						X			X	X	X			X
Cooling loop is not attached														X	X	X			
Cooling loop grease is not enough														X	X	X			
Low ID CFM		X		X					X		X	X	X	X	X	X			X

Outdoor Normal Temperature Operating Range: 67-115°F

Indoor Normal Temperature Operating Range: 65 - 85°F

Outdoor Normal Temperature Operating Range: 17-62°F / Indoor Normal Temperature Operating Range: 65 - 85°F

WARNING

AVOID CONTACT WITH THE CHARGED AREA.

•NEVER TOUCH THE CHARGED AREA BEFORE CONFIRMING THAT THE RESIDUAL VOLTAGE IS 50 VOLTS OR LESS.

1. SHUT DOWN THE POWER AND LEAVE THE CONTROL BOX FOR 10 MINUTES.
2. MAKE SURE TO TOUCH THE EARTH GROUND TERMINAL TO RELEASE THE STATIC ELECTRICITY FROM YOUR BODY (TO PREVENT FAILURE OF THE PC BOARD).
3. MEASURE THE RESIDUAL VOLTAGE IN THE SPECIFIED MEASUREMENT POSITION USING A VOM WHILE PAYING ATTENTION NOT TO TOUCH THE CHARGED AREA.
4. IMMEDIATELY AFTER MEASURING THE RESIDUAL VOLTAGE, DISCONNECT THE CONNECTORS OF THE OUTDOOR UNIT'S FAN MOTOR. (IF THE FAN BLADE ROTATES BY STRONG WIND BLOWING AGAINST IT, THE CAPACITOR WILL BE CHARGED, CAUSING THE DANGER OF ELECTRICAL SHOCK.)

TROUBLESHOOTING

OUTDOOR UNIT- ERROR CODES

ClimateTalk Fault Code	PCB LED Display	Transmitted ClimateTalk Message	Thermostat Fault	Probable Causes	Corrective Actions
22	E22	HI DISCH TEMP	This error indicates the equipment is experiencing frequent high discharge temperature faults. Discharge thermistor is not put on correct position.	<ul style="list-style-type: none"> Discharge thermistor inoperable or improperly connected Discharge thermistor is put on incorrect position or off Low refrigerant charge Overcharge Faulty compressor 	<ul style="list-style-type: none"> Check discharge thermistor resistance and connections; Repair/replace as needed Check discharge thermistor position Check refrigerant charge level; Adjust if needed Check the compressor; Repair/replace if needed
23	E23	DISCH TEMP FAIL	The control has detected that the Discharge Temperature Sensor is out of range.	<ul style="list-style-type: none"> Discharge thermistor inoperable or improperly connected 	<ul style="list-style-type: none"> Check discharge thermistor resistance and connections; Repair/replace as needed
24	E24	HPS OPEN	The high pressure switch is open.	<ul style="list-style-type: none"> High pressure switch (HPS) inoperable 	<ul style="list-style-type: none"> Check resistance on HPS to verify operation; Replace if needed
25	E25	AIR SENSOR FLT	The outdoor air temperature sensor is open or shorted.	<ul style="list-style-type: none"> Faulty outdoor thermistor sensor or disconnect 	<ul style="list-style-type: none"> Inspect and test sensor; Replace sensor if needed
26	E26	PRESSURE SENSOR	The control determines that the pressure sensor is not reacting properly.	<ul style="list-style-type: none"> Low pressure sensor inoperable or not properly connected 	<ul style="list-style-type: none"> Check the connection to low pressure sensor; Repair/replace if needed
27	E27	COIL TEMP FAIL1	The control has detected that the Outdoor Defrost Sensor is out of range.	<ul style="list-style-type: none"> Outdoor defrost thermistor inoperable or not properly connected 	<ul style="list-style-type: none"> Check the connection to OD defrost thermistor; Repair/replace if needed
28	E28	COIL TEMP FAIL2	The control has detected that the Outdoor Coil Temperature Sensor is out of range.	<ul style="list-style-type: none"> Outdoor coil thermistor inoperable or not properly connected 	<ul style="list-style-type: none"> Check the connection to OD coil thermistor; Repair if needed
29	E29	LIQ TEMP FAIL	The control has detected that the Liquid Temperature Sensor is out of range.	<ul style="list-style-type: none"> Liquid thermistor inoperable or not properly connected 	<ul style="list-style-type: none"> Check the connection to liquid thermistor; Repair/replace if needed
30	E30	OD CTRL FAIL3	Indicates the control board may need to be replaced.	<ul style="list-style-type: none"> Wiring to control board disconnected Faulty control board Noise 	<ul style="list-style-type: none"> Check wiring to control board; Repair as needed Replace control board if necessary
32	E32	HI TEMP CTRL1	This error indicates the equipment is experiencing high temperature faults on the outdoor control board.	<ul style="list-style-type: none"> Ambient air conditions too high Cooling bracket screw(s) missing or not properly fastened No or poor thermal grease coating between cooling plumbing and cooling bracket on control board No flow or limited flow through control board cooling circuit (potential restriction in line or low refrigerant) Stop valve not completely open 	<ul style="list-style-type: none"> Cycle power; re-try during usable ambient temperature range Verify cooling bracket screws in place and secure; Secure fasteners as needed Check thermal grease inside cooling bracket on control board; Apply additional grease as needed Check for restriction in line Check refrigerant charge level; Adjust if needed Check the opening of stop valve, should be full open; Repair/replace if needed
33	-	HI TEMP CTRL2	This error indicates the equipment is experiencing high temperature faults on the outdoor control board. Control has determined continued operation is acceptable. This indicates they may be a problem with the equipment.	<ul style="list-style-type: none"> Ambient air conditions too high Cooling bracket screw(s) missing or not properly fastened No or poor thermal grease coating between cooling plumbing and cooling bracket on control board No flow or limited flow through control board cooling circuit (potential restriction in line or low refrigerant) Stop valve not completely open 	<ul style="list-style-type: none"> Cycle power; re-try during usable ambient temperature range Verify cooling bracket screws in place and secure; Secure fasteners as needed Check thermal grease inside cooling bracket on control board; Apply additional grease as needed Check for restriction in line Check refrigerant charge level; Adjust if needed Check the opening of stop valve, should be full open; Repair/replace if needed
34	E34	CURRENT SPIKE	Board detected a high current condition. This indicates the potential for a short circuit.	<ul style="list-style-type: none"> Current spike in supply Stop valve not completely open The compressor wire is lost phase Faulty control board Faulty compressor 	<ul style="list-style-type: none"> Check power supply for in-rush current during start-up or steady state operation Check the opening of stop valve, should be full open; Repair/replace if needed Check the wire between control board and compressor Replace control board if necessary Check the compressor; Repair/replace if needed

TROUBLESHOOTING

OUTDOOR UNIT- ERROR CODES

ClimateTalk Fault Code	PCB LED Display	Transmitted ClimateTalk Message	Thermostat Fault	Probable Causes	Corrective Actions
35	E35	HIGH CURRENT	Board detected a high current condition.	<ul style="list-style-type: none"> Short circuit condition Stop valve not completely open Overcharge Faulty control board Faulty compressor 	<ul style="list-style-type: none"> Check installation clearances. Check the opening of stop valve, should be full open; Repair/replace if needed Check refrigerant charge level; Adjust if needed Replace control board if necessary Check the compressor; Repair/replace if needed.
36	E36	STARTUP ERROR	The control encountered an abnormal condition during the startup procedure.	<ul style="list-style-type: none"> Blocked/restricted condenser coil and/or lines The compressor wire is lost phase Inconsistent compressor load Faulty control board 	<ul style="list-style-type: none"> Check and clean condenser coil and/or lines Check the wire between control board and compressor Replace control board if necessary
37	E37	OD CTRL FAIL4	Indicates the control board may need to be replaced.	<ul style="list-style-type: none"> Faulty control board 	<ul style="list-style-type: none"> Replace control board if necessary
38	E38	COMP VOLTAGE	The control has detected a voltage related issue with the compressor.	<ul style="list-style-type: none"> High or low voltage from supply The compressor wire is lost phase Faulty control board 	<ul style="list-style-type: none"> Correct low/high line voltage condition; Contact local utility if needed Check the wire between control board and compressor Replace control board if necessary
39	E39	OD CTRL FAIL5	Indicates the control board may need to be replaced.	<ul style="list-style-type: none"> Thermistors inoperable or improperly connected Faulty control board 	<ul style="list-style-type: none"> Check the connection to thermistors; Repair/replace if needed Replace control board if necessary
40	E40	COMP MISMATCH	Control determines that its compressor requirement is different than the compressor capability.	<ul style="list-style-type: none"> Bluetooth Shared Data Loader BTSDL01 not correct Control board mismatch 	<ul style="list-style-type: none"> Check Bluetooth Shared Data Loader BTSDL01 data vs. Heat Pump model Verify control board size vs. Heat Pump model; Replace control board if necessary
41	E41	LOW REFRIGERANT	The control has detected a low refrigerant condition.	<ul style="list-style-type: none"> Refrigerant leak Low refrigerant charge Thermistors inoperable or not properly connected 	<ul style="list-style-type: none"> Test for system leaks using leak test procedure Check refrigerant charge level; Adjust if needed Check the connection to thermistor; Repair/replace if needed
42	E42	LOW LINE VOLT	Control detects a low power supply voltage condition.	<ul style="list-style-type: none"> Low line voltage supply 	<ul style="list-style-type: none"> Check circuit breakers and fuses; Replace if needed Verify unit is connected to power supply as specified on rating plate Correct low line voltage condition; Contact local utility if needed
43	E43	HIGH LINE VOLT	Control detects a high power supply voltage condition.	<ul style="list-style-type: none"> High line voltage supply 	<ul style="list-style-type: none"> Verify unit is connected to power supply as specified on rating plate Correct high line voltage condition; Contact local utility if needed
44	E44	OP TEMP RANGE	The control detects the outdoor temperature outside recommended operational range. Unit may continue to operate normally.	<ul style="list-style-type: none"> Ambient air conditions too high or low 	<ul style="list-style-type: none"> Cycle power; re-try during usable ambient temperature range
45	E45	NO COOLING TEST	The control is unable to start the Cooling mode test because indoor heat has been turned on by thermostat. Please set thermostat to off position.	<ul style="list-style-type: none"> Heat provided by secondary heating source 	<ul style="list-style-type: none"> Turn off heater using thermostat before running AHRI mode
47	E47	NO SYS VER TEST	The control is unable to start the System Verification test because indoor heat has been turned on by thermostat. Please set thermostat to off position.	<ul style="list-style-type: none"> Heat provided by secondary heating source 	<ul style="list-style-type: none"> Turn off heater using thermostat before operation
48	E48	NO PUMP DOWN	The control is unable to enter the Pump Down Mode because indoor heat has been turned on by thermostat. Please set thermostat to off position.	<ul style="list-style-type: none"> Heat provided by secondary heating source 	<ul style="list-style-type: none"> Turn off heater using thermostat before operation
49	E49	NO CHARGE MODE	The control is unable to enter Charging Mode because indoor heat has been turned on by thermostat. Please set thermostat to off position.	<ul style="list-style-type: none"> Heat provided by secondary heating source 	<ul style="list-style-type: none"> Turn off heater using thermostat before operation
50	E50	LINE VOLT CTRL	This indicates there is a voltage issue on the control board. See service manual for troubleshooting information.	<ul style="list-style-type: none"> High or low voltage from supply Faulty control board 	<ul style="list-style-type: none"> Correct low/high line voltage condition; Contact local utility if needed Replace control board if necessary
51	E51	OD COMM ERROR	This indicates potential communication issues have been detected by the outdoor control board.	<ul style="list-style-type: none"> Communication wiring disconnected 	<ul style="list-style-type: none"> Check communication wiring; Repair as needed
52	-	COMP FAIL MINOR	This error indicates the equipment is experiencing frequent compressor faults. Control has determined continued operation is acceptable. This indicates they may be a problem with the equipment.	<ul style="list-style-type: none"> Stop valve not completely open The compressor wire is lost phase Compressor motor failure 	<ul style="list-style-type: none"> Check the opening of stop valve, should be full open; Repair/replace if needed Check the wire between control board and compressor Inspect compressor motor for proper function; Replace if necessary

TROUBLESHOOTING

OUTDOOR UNIT- ERROR CODES

ClimateTalk Fault Code	PCB LED Display	Transmitted ClimateTalk Message	Thermostat Fault	Probable Causes	Corrective Actions
54	-	EEV MINOR	This error indicates the equipment is experiencing frequent low discharge superheat faults. Control has determined continued operation is acceptable. This indicates they may be a problem with the equipment.	<ul style="list-style-type: none"> Thermistors inoperable or improperly connected Faulty indoor EEV or indoor EEV coil Faulty control board 	<ul style="list-style-type: none"> Check the connection to thermistors; Repair/replace if needed Check indoor EEV; Replace if needed Check indoor EEV coil; Replace if needed Replace control board if necessary
55	-	HI DIS TEMP MIN	This error indicates the equipment is experiencing frequent high discharge temperature faults. Control has determined continued operation is acceptable. This indicates they may be a problem with the equipment.	<ul style="list-style-type: none"> Discharge thermistor inoperable or improperly connected Discharge thermistor is put on incorrect position or off Low refrigerant charge Overcharge Faulty compressor 	<ul style="list-style-type: none"> Check discharge thermistor resistance and connections; Repair/replace as needed Check discharge thermistor position Check refrigerant charge level; Adjust if needed Check refrigerant charge level; Adjust if needed Check the compressor; Repair/replace if needed
56	E56	SUCT TEMP FAIL	The control has detected if the Outdoor Suction Temperature Sensor is out of range.	<ul style="list-style-type: none"> Suction thermistor inoperable or not properly connected 	<ul style="list-style-type: none"> Check the connection to suction thermistor; Repair/replace if needed
57	-	CL LOOP SWEAT	This indicates the control is sensing sweating on the cooling loop.	<ul style="list-style-type: none"> Refrigerant Leak Low refrigerant charge Faulty indoor EEV or indoor EEV coil Thermistors inoperable or improperly connection 	<ul style="list-style-type: none"> Test for system leaks using leak test procedure Check refrigerant charge level; Adjust if needed Check indoor EEV; Replace if needed Check indoor EEV coil; Replace if needed Check the connection to thermistors; Repair/replace if needed
B0	Eb0	NO ID AIRFLOW	The estimated airflow from indoor subsystem is near to 0 CFM.	<ul style="list-style-type: none"> Failed indoor blower motor Indoor fan motor not properly connected Too much static pressure 	<ul style="list-style-type: none"> Check ID fan motor wiring and connectors; Repair/replace if needed Check ID fan motor; Replace if needed
B9	Eb9	LOW ID AIRFLOW	Estimated airflow from motor is lower than the airflow requirement.	<ul style="list-style-type: none"> Failed indoor blower motor Indoor fan motor not properly connected Too much static pressure 	<ul style="list-style-type: none"> Check ID fan motor wiring and connectors; Repair/replace if needed Check ID fan motor; Replace if needed
D0	Ed0	NO NET DATA	Control board does not have the necessary data for it to properly perform its functions.	<ul style="list-style-type: none"> Heat Pump is wired as part of a communicating system and integrated control module does not contain any shared data. 	<ul style="list-style-type: none"> Replace control board if necessary
D1	Ed1	INVALID DATA	Control board does not the appropriate data needed to properly perform its functions.	<ul style="list-style-type: none"> Heat Pump is wired as part of a communicating system and integrated control module contains invalid shared data or network data is invalid for the integrated control module. 	<ul style="list-style-type: none"> Replace control board if necessary
D2	Ed2	SYSTEM MISMATCH	The airflow requirement is greater than the airflow capability of the indoor subsystem.	<ul style="list-style-type: none"> Heat Pump is wired as part of a communicating system and outdoor unit requires airflow greater than indoor unit's airflow capability Shared data is incompatible the system or missing parameters Communication wiring has loose connection. Indoor unit without EEV. 	<ul style="list-style-type: none"> Verify shared data is correct for your specific model; Repopulate data if required Check communication wiring. Repair as needed.
Items below are messages only displayed on the thermostat screen.					
11	E11	RUN SYS TEST	This test is required at startup. Installer should navigate to the ComfortNet User Menu, choose Heat Pump, then EQUIP TEST and SYSEYEM TEST. Selecting ON will run the required test. Display will clear once testing is complete.	<ul style="list-style-type: none"> Incomplete SYSTEM TEST SYSTEM TEST is running 	MESSAGE ONLY

NETWORK TROUBLESHOOTING

Communications is achieved by taking the difference between a positive dc signal and a negative dc signal.

The positive dc signal is termed “data 1” or “1”. Data 1 is positive with respect to ground (or common). The negative dc signal is termed “data 2” or “2”. Data 2 is negative with respect to ground (or common).

Verify that the bus DS1 dip switches are in the ON position. Data 1 should be approximately 2.8 volt dc. Data 2 should be approximately 2.2 volt dc. The voltage difference between data 1 and data 2 should be approximately 0.6 volt dc.

If the voltage difference is not .6 VDC, turn OFF DS1 switches Data 1 and Data 2. Reset Power and check for .6 DCV.



The ComfortNet™ system is a fully communicating system, constituting a network. Occasionally the need to troubleshoot the network may arise. The integrated control module has some on-board tools that can be used to troubleshoot the network. These tools are: red communications LED, green receive (Rx) LED, and the learn button.

- Red communications LED – Indicates the status of the network. The table below indicates the LED status and the corresponding potential problem.
- Green receive LED – Indicates network traffic. The table below indicates the LED status and the corresponding potential problem.
- LEARN button – Used to reset the network. Press the button for approximately 5 seconds to reset the network.

LED COLOR	LED Status	Indication	Probable Causes	Corrective Actions
Red Communications LED (H1P)	Off	Nominal condition	• None	• none
	1 Flash	Communications Failure	• Unknown packet is received	• Depress learn button
	2 Flash	Out-of-box reset	• Control power up • Learn button depressed	• None
Green Receive LED (H2P)	Off	No power Communications error	• No power to Outdoor unit • Open fuse • Communication error	• Check circuit breakers and fuses; Replace if needed • Reset network by depressing learn button • Check communication wires (data 1/ data 2 wires); Replace if needed
	1 Steady Flash	No network found	• Broken/ disconnected communication wire(s) • AC is installed as a legacy/ traditional system	• Check communication wires (data 1/ data 2 wires); Replace if needed • Check installation type (legacy/ traditional or communicating) • Check data 1/ data 2 voltages
	Rapid Flashing	Nominal network traffic	• Control is "talking" on network as expected	• none
	On Solid	Data 1/Data 2 miss-wire	• Data 1 and data 2 wires reversed at indoor unit, thermostat, or outdoor unit • Short between data 1 and data 2 wires • Short between data 1 or data 2 wires	• Check communication wires (data 1/ data 2 wires); Replace if needed • Check data 1/ data 2 voltages

TROUBLESHOOTING

THERMISTOR RESISTANCE VALUE

		Tm : Coil Tl : Liquid Tb : Defrost Tgi: Indoor Gas Tli: Indoor Liquid		Tl : Liquid		Td : Discharge		Ta : Ambient	
TEMP	TEMP	Thermistor Resistance	Volts	Thermistor Resistance	Volts	Thermistor Resistance	Volts	Thermistor Resistance	Volts
(°C)	(F)	R (kΩ)	DC (V)	R (kΩ)	DC (V)	R (kΩ)	DC (V)	R (kΩ)	DC (V)
-30	-22	364.43	4.58	364.43	4.58	4759.15	4.96	362.48	4.58
-25	-13	267.00	4.45	267.00	4.45	3454.24	4.94	265.99	4.45
-20	-4	197.81	4.29	197.81	4.29	2533.62	4.92	197.31	4.28
-15	5	148.10	4.09	148.10	4.09	1877.01	4.90	147.86	4.09
-10	14	111.99	3.86	111.99	3.86	1403.82	4.86	111.88	3.86
-5	23	85.49	3.61	85.49	3.61	1059.45	4.82	85.43	3.61
0	32	65.84	3.33	65.84	3.33	806.47	4.77	65.80	3.33
5	41	51.09	3.04	51.09	3.04	618.95	4.70	51.10	3.04
10	50	39.96	2.74	39.96	2.74	478.76	4.62	39.99	2.74
15	59	31.50	2.44	31.50	2.44	373.11	4.53	31.54	2.44
20	68	25.01	2.16	25.01	2.16	292.86	4.41	25.06	2.16
25	77	20.00	1.89	20.00	1.89	231.44	4.28	20.04	1.89
30	86	16.10	1.64	16.10	1.64	184.11	4.13	16.13	1.64
35	95	13.04	1.42	13.04	1.42	147.37	3.95	13.07	1.42
40	104	10.63	1.22	10.63	1.22	118.68	3.76	10.65	1.22
45	113	8.71	1.04	8.71	1.04	96.13	3.56	8.73	1.05
50	122	7.18	0.89	7.18	0.89	78.29	3.34	7.18	0.89
55	131	5.95	0.76	5.95	0.76	64.10	3.11	-	-
60	140	4.96	0.65	4.96	0.65	52.76	2.87	-	-
65	149	4.16	0.56	4.16	0.56	43.63	2.64	-	-
70	158	3.50	0.48	3.50	0.48	36.26	2.41	-	-
75	167	2.96	0.41	2.96	0.41	30.27	2.18	-	-
80	176	2.51	0.35	2.51	0.35	25.38	1.97	-	-
85	185	2.14	0.30	2.14	0.30	21.37	1.77	-	-
90	194	1.83	0.26	1.83	0.26	18.06	1.58	-	-
95	203	1.58	0.23	1.58	0.23	15.33	1.41	-	-
100	212	1.36	0.20	1.36	0.20	13.06	1.25	-	-
105	221	1.18	0.17	1.18	0.17	11.17	1.11	-	-
110	230	1.02	0.15	1.02	0.15	9.59	0.99	-	-
115	239	0.89	0.13	0.89	0.13	8.25	0.87	-	-
120	248	0.78	0.12	0.78	0.12	7.13	0.77	-	-
125	257	0.68	0.10	0.68	0.10	6.18	0.68	-	-
130	266	0.60	0.09	0.60	0.09	5.37	0.61	-	-
135	275	0.53	0.08	0.53	0.08	4.69	0.54	-	-
140	284	0.47	0.07	0.47	0.07	4.10	0.48	-	-
145	293	0.42	0.06	0.42	0.06	3.59	0.42	-	-
150	302	0.37	0.06	0.37	0.06	3.16	0.37	-	-

R-410A Pressure vs. Temperature Chart											
PSIG	°F	PSIG	°F	PSIG	°F	PSIG	°F	PSIG	°F	PSIG	°F
12	-37.7	114	37.8	216	74.3	318	100.2	420.0	120.7	522	137.6
14	-34.7	116	38.7	218	74.9	320	100.7	422.0	121.0	524	137.9
16	-32.0	118	39.5	220	75.5	322	101.1	424.0	121.4	526	138.3
18	-29.4	120	40.5	222	76.1	324	101.6	426.0	121.7	528	138.6
20	-36.9	122	41.3	224	76.7	326	102.0	428.0	122.1	530	138.9
22	-24.5	124	42.2	226	77.2	328	102.4	430.0	122.5	532	139.2
24	-22.2	126	43.0	228	77.8	330	102.9	432.0	122.8	534	139.5
26	-20.0	128	43.8	230	78.4	332	103.3	434.0	123.2	536	139.8
28	-17.9	130	44.7	232	78.9	334	103.7	436.0	123.5	538	140.1
30	-15.8	132	45.5	234	79.5	336	104.2	438.0	123.9	540	140.4
32	-13.8	134	46.3	236	80.0	338	104.6	440.0	124.2	544	141.0
34	-11.9	136	47.1	238	80.6	340	105.1	442.0	124.6	548	141.6
36	-10.1	138	47.9	240	81.1	342	105.4	444.0	124.9	552	142.1
38	-8.3	140	48.7	242	81.6	344	105.8	446.0	125.3	556	142.7
40	-6.5	142	49.5	244	82.2	346	106.3	448.0	125.6	560	143.3
42	-4.5	144	50.3	246	82.7	348	106.6	450.0	126.0	564	143.9
44	-3.2	146	51.1	248	83.3	350	107.1	452.0	126.3	568	144.5
46	-1.6	148	51.8	250	83.8	352	107.5	454.0	126.6	572	145.0
48	0.0	150	52.5	252	84.3	354	107.9	456.0	127.0	576	145.6
50	1.5	152	53.3	254	84.8	356	108.3	458.0	127.3	580	146.2
52	3.0	154	54.0	256	85.4	358	108.8	460.0	127.7	584	146.7
54	4.5	156	54.8	258	85.9	360	109.2	462.0	128.0	588	147.3
56	5.9	158	55.5	260	86.4	362	109.6	464.0	128.3	592	147.9
58	7.3	160	56.2	262	86.9	364	110.0	466.0	128.7	596	148.4
60	8.6	162	57.0	264	87.4	366	110.4	468.0	129.0	600	149.0
62	10.0	164	57.7	266	87.9	368	110.8	470.0	129.3	604	149.5
64	11.3	166	58.4	268	88.4	370	111.2	472.0	129.7	608	150.1
66	12.6	168	59.0	270	88.9	372	111.6	474.0	130.0	612	150.6
68	13.8	170	59.8	272	89.4	374	112.0	476.0	130.3	616	151.2
70	15.1	172	60.5	274	89.9	376	112.4	478.0	130.7	620	151.7
72	16.3	174	61.1	276	90.4	378	112.6	480.0	131.0	624	152.3
74	17.5	176	61.8	278	90.9	380	113.1	482.0	131.3	628	152.8
76	18.7	178	62.5	280	91.4	382	113.5	484.0	131.6	632	153.4
78	19.8	180	63.1	282	91.9	384	113.9	486.0	132.0	636	153.9
80	21.0	182	63.8	284	92.4	386	114.3	488.0	132.3	640	154.5
82	22.1	184	64.5	286	92.8	388	114.7	490.0	132.6	644	155.0
84	23.2	186	65.1	288	93.3	390	115.0	492.0	132.9	648	155.5
86	24.3	188	65.8	290	93.8	392	115.5	494.0	133.3	652	156.1
88	25.4	190	66.4	292	94.3	394	115.8	496.0	133.6	656	156.6
90	26.4	192	67.0	294	94.8	396	116.2	498.0	133.9	660	157.1
92	27.4	194	67.7	296	95.2	398	116.6	500.0	134.0	664	157.7
94	28.5	196	68.3	298	95.7	400	117.0	502.0	134.5	668	158.2
96	29.5	198	68.9	300	96.2	402	117.3	504.0	134.8	672	158.7
98	30.5	200	69.5	302	96.6	404	117.7	506.0	135.2	676	159.2
100	31.2	202	70.1	304	97.1	406	118.1	508.0	135.5	680	159.8
102	32.2	204	70.7	306	97.5	408	118.5	510.0	135.8	684	160.3
104	33.2	206	71.4	308	98.0	410	118.8	512.0	136.1	688	160.8
106	34.1	208	72.0	310	98.4	412	119.2	514.0	136.4	692	161.3
108	35.1	210	72.6	312	98.9	414	119.6	516.0	136.7	696	161.8
110	35.5	212	73.2	314	99.3	416	119.9	518.0	137.0		
112	36.9	214	73.8	316	99.7	418	120.3	520.0	137.3		

TROUBLESHOOTING

Required Liquid Line Temperature						
LIQUID PRESSURE AT SERVICE VALVE (PSIG)	REQUIRED SUBCOOLING TEMPERATURE (°F)					
	8	10	12	14	16	18
189	58	56	54	52	50	48
195	60	58	56	54	52	50
202	62	60	58	56	54	52
208	64	62	60	58	56	54
215	66	64	62	60	58	56
222	68	66	64	62	60	58
229	70	68	66	64	62	60
236	72	70	68	66	64	62
243	74	72	70	68	66	64
251	76	74	72	70	68	66
259	78	76	74	72	70	68
266	80	78	76	74	72	70
274	82	80	78	76	74	72
283	84	82	80	78	76	74
291	86	84	82	80	78	76
299	88	86	84	82	80	78
308	90	88	86	84	82	80
317	92	90	88	86	84	82
326	94	92	90	88	86	84
335	96	94	92	90	88	86
345	98	96	94	92	90	88
354	100	98	96	94	92	90
364	102	100	98	96	94	92
374	104	102	100	98	96	94
384	106	104	102	100	98	96
395	108	106	104	102	100	98
406	110	108	106	104	102	100
416	112	110	108	106	104	102
427	114	112	110	108	106	104
439	116	114	112	110	108	106
450	118	116	114	112	110	108
462	120	118	116	114	112	110
474	122	120	118	116	114	112
486	124	122	120	118	116	114
499	126	124	122	120	118	116
511	128	126	124	122	120	118

TROUBLESHOOTING

⚠ WARNING

HIGH VOLTAGE !

DISCONNECT ALL POWER BEFORE SERVICING OR INSTALLING. MULTIPLE POWER SOURCES MAY BE PRESENT. FAILURE TO DO SO MAY CAUSE PROPERTY DAMAGE, PERSONAL INJURY OR DEATH.



⚠ CAUTION

WHEN REPLACING THE ELECTRICAL BOARD, DO NOT TOUCH THE HATCHED AREAS. BEFORE INSTALLING THE NEW ELECTRICAL BOARD, BE SURE TO WIPE THE GREASE OFF THE REFRIGERANT TUBING. EXERCISE CAUTION TO NOT DAMAGE THE ELECTRICAL CONNECTIONS. DISCONNECT AS NEEDED.

UNINSTALL THE ELECTRICAL BOARD

When uninstalling the main electrical board, remove the screws holding the cover in place. If board replacement is attempted without following proper uninstallation procedure, the refrigerant piping might be damaged. Always replace the grease with new grease on heat sink used for cooling. Not replacing grease may result in insufficient cooling and may damage the electrical board.

1. Remove the fixing screw A.
2. Lift the cover and open it in the direction shown in the figure.

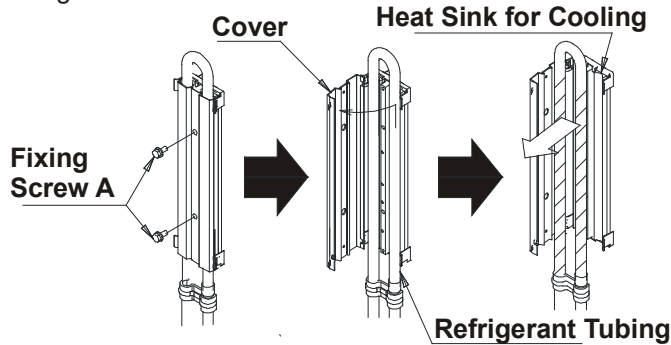

3. Remove fixing screws B affixing the sheet metal plate.
4. Carefully slide the sheet metal plate with the electrical board behind the refrigerant tubing as shown.

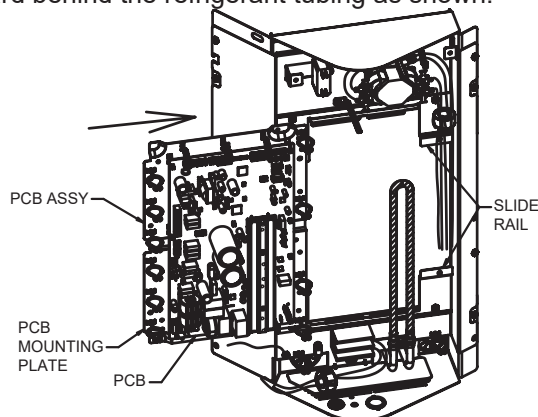

INSTALL THE ELECTRICAL BOARD

When working on a service port, ensure that no refrigerant and/or compressor oil is sprayed onto the electrical board. This could damage the board's functionality.

1. Wipe the stale grease completely from the installed piping. If you reinstall the control board, make sure to wipe clean the heat sink on the board. Coat the surface with the standard quantity of the specified new grease.
2. Carefully slide the sheet metal plate back in and fix the screws B.
3. Do not apply force to the parts on the control board. Hold the control board plate NOT the control board.
4. Ensure that the liquid tube does not come in contact with any part of the PCB assembly.
5. Gently fit the tube in the heat sink troughs. Ensure good contact.
6. Close the cover, slide it downwards, fix it with the nails (two nails) and tighten fixing screws A so that the piping is tightly connected.

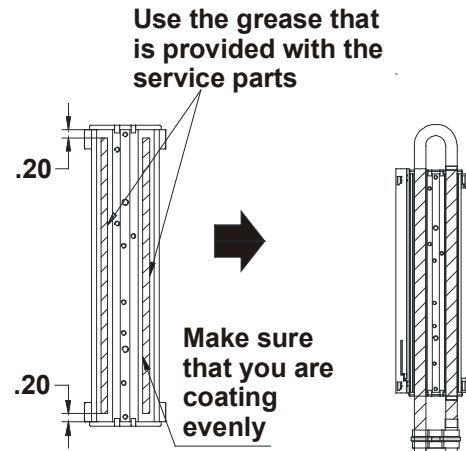

Tightening Torque:
14.1±1.7 lbf-in

Tighten with a driver until the position where a tightening torque increases suddenly. Then extra-tighten by 30° to 40°.

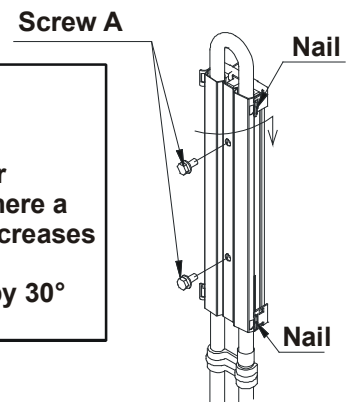

TROUBLESHOOTING

⚠ WARNING

AVOID CONTACT WITH THE CHARGED AREA.

• NEVER TOUCH THE CHARGED AREA BEFORE CONFIRMING THAT THE RESIDUAL VOLTAGE IS 50 VOLTS OR LESS.

1. SHUT DOWN THE POWER AND LEAVE THE CONTROL BOX FOR 10 MINUTES.
2. MAKE SURE TO TOUCH THE EARTH GROUND TERMINAL TO RELEASE THE STATIC ELECTRICITY FROM YOUR BODY (TO PREVENT FAILURE OF THE PC BOARD).
3. MEASURE THE RESIDUAL VOLTAGE IN THE SPECIFIED MEASUREMENT POSITION USING A VOM WHILE PAYING ATTENTION NOT TO TOUCH THE CHARGED AREA.
4. IMMEDIATELY AFTER MEASURING THE RESIDUAL VOLTAGE, DISCONNECT THE CONNECTORS OF THE OUTDOOR UNIT'S FAN MOTOR. (IF THE FAN BLADE ROTATES BY STRONG WIND BLOWING AGAINST IT, THE CAPACITOR WILL BE CHARGED, CAUSING THE DANGER OF ELECTRICAL SHOCK.)

2-3 TON

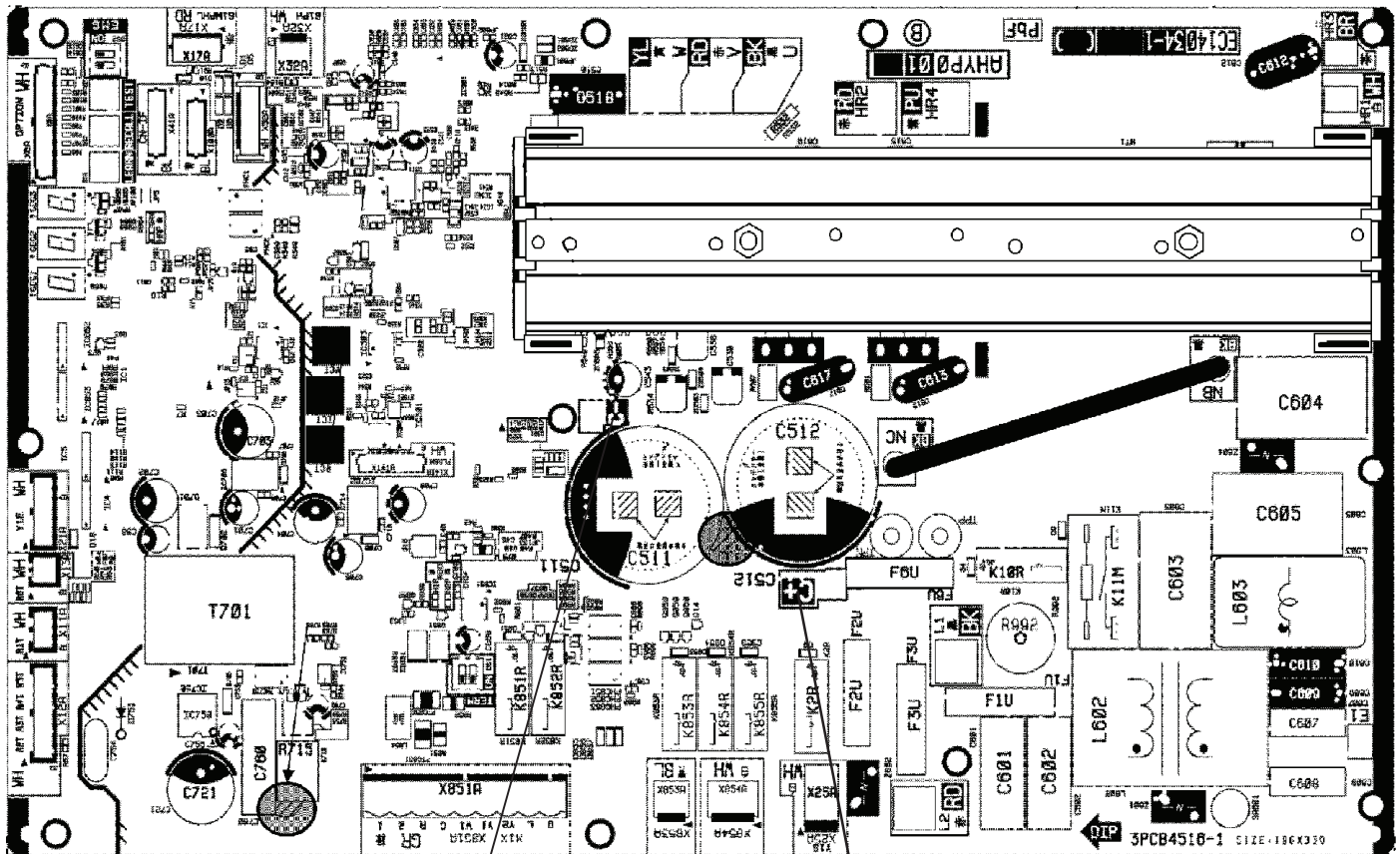

C- Capacitor Voltage C+

TROUBLESHOOTING

WARNING

AVOID CONTACT WITH THE CHARGED AREA.

• NEVER TOUCH THE CHARGED AREA BEFORE CONFIRMING THAT THE RESIDUAL VOLTAGE IS 50 VOLTS OR LESS.

1. SHUT DOWN THE POWER AND LEAVE THE CONTROL BOX FOR 10 MINUTES.
2. MAKE SURE TO TOUCH THE EARTH GROUND TERMINAL TO RELEASE THE STATIC ELECTRICITY FROM YOUR BODY (TO PREVENT FAILURE OF THE PC BOARD).
3. MEASURE THE RESIDUAL VOLTAGE IN THE SPECIFIED MEASUREMENT POSITION USING A VOM WHILE PAYING ATTENTION NOT TO TOUCH THE CHARGED AREA.
4. IMMEDIATELY AFTER MEASURING THE RESIDUAL VOLTAGE, DISCONNECT THE CONNECTORS OF THE OUTDOOR UNIT'S FAN MOTOR. (IF THE FAN BLADE ROTATES BY STRONG WIND BLOWING AGAINST IT, THE CAPACITOR WILL BE CHARGED, CAUSING THE DANGER OF ELECTRICAL SHOCK.)

4-5 TON

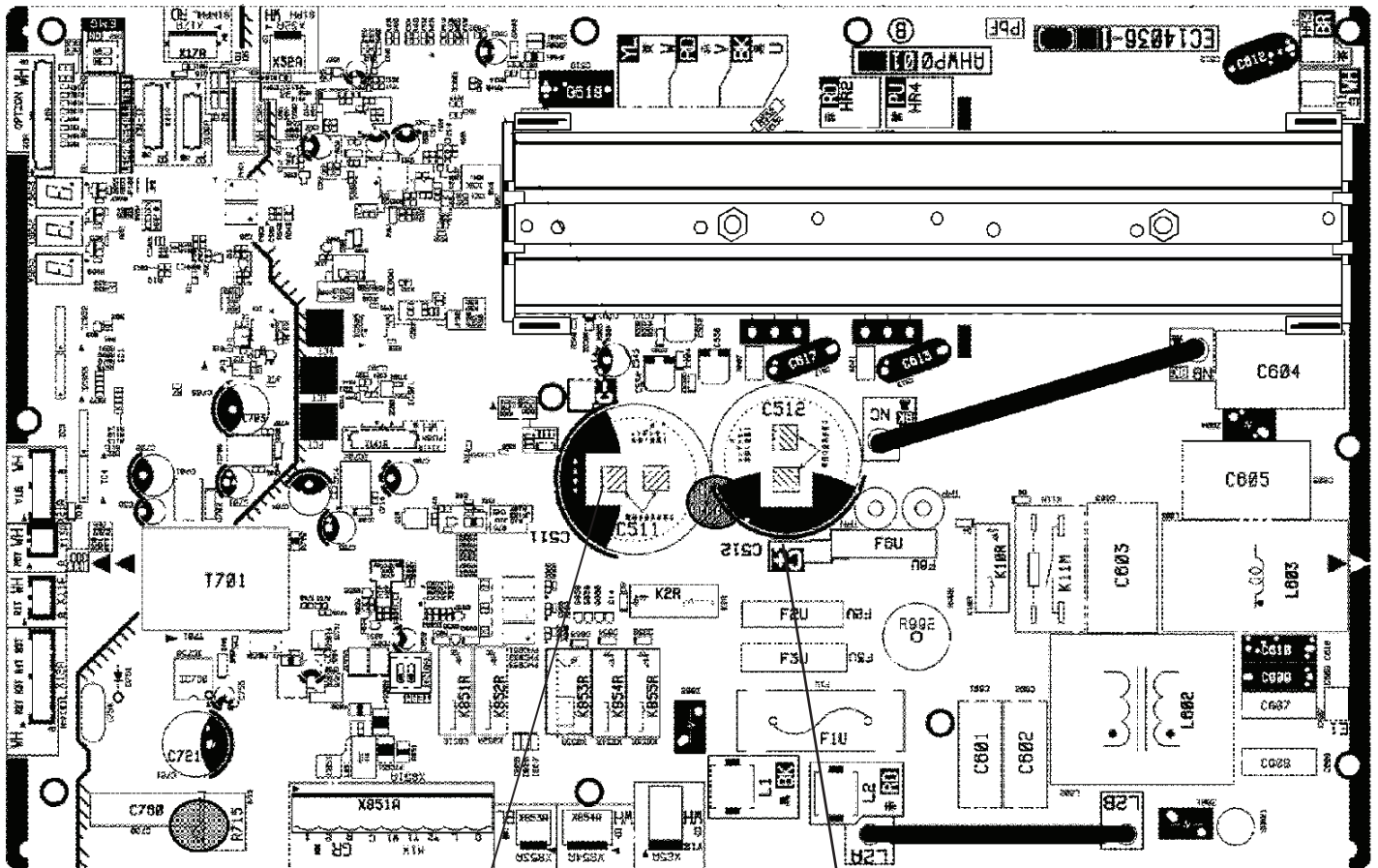

C- Capacitor Voltage C+

WIRING DIAGRAM

AVZC180241**, AVZC180361**, AVZC180481**, AVZC180601**

WARNING

HIGH VOLTAGE!

DISCONNECT ALL POWER BEFORE SERVICING OR INSTALLING THIS UNIT.
MULTIPLE POWER SOURCES MAY BE PRESENT. FAILURE TO DO SO MAY
CAUSE PROPERTY DAMAGE, PERSONAL INJURY OR DEATH.

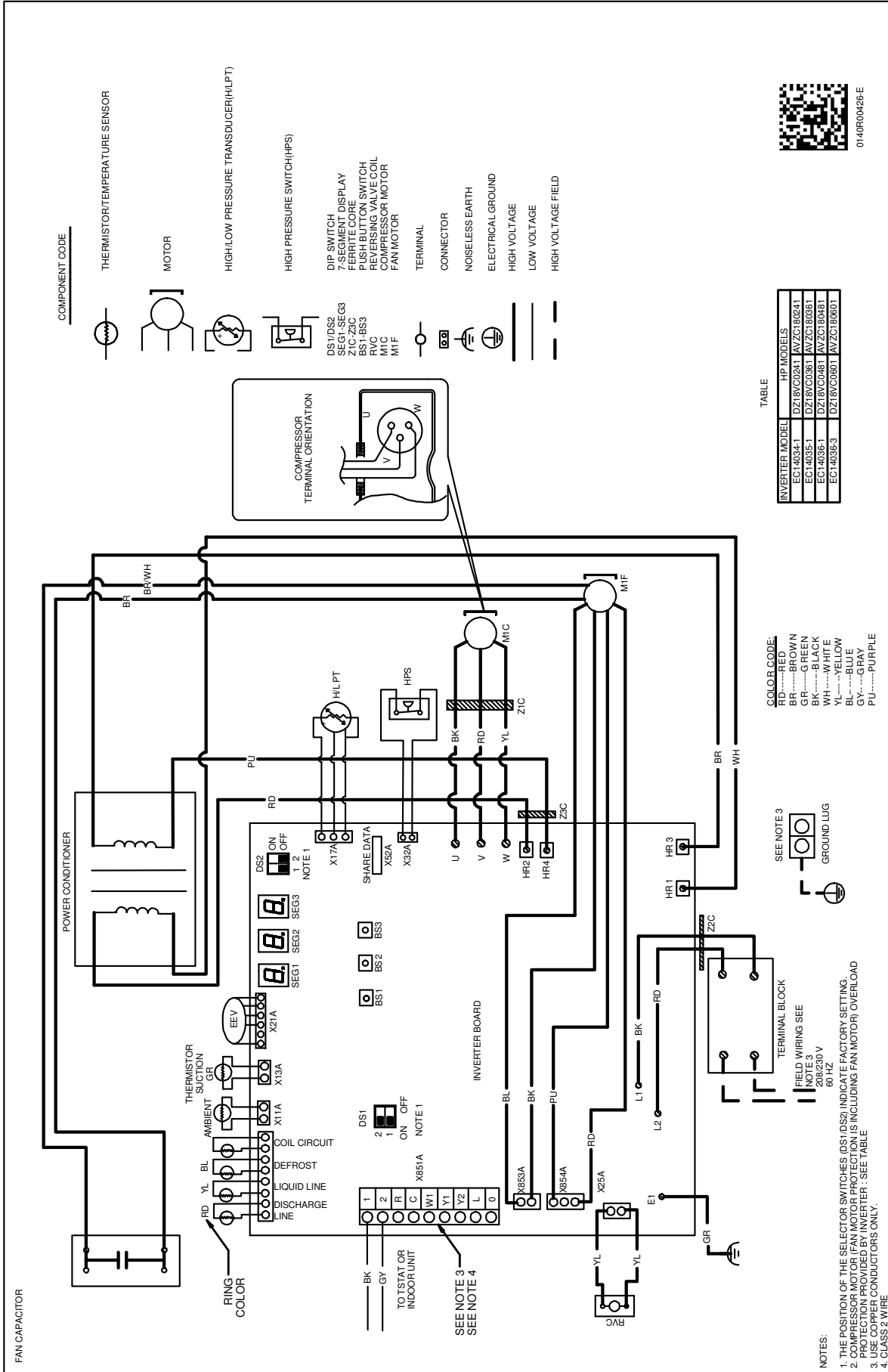

COMPONENT CODE

- THERMISTOR/TEMPERATURE SENSOR
- MOTOR
- HIGH/LOW PRESSURE TRANSDUCER(H/LPT)
- HIGH PRESSURE SWITCH(HPS)
- DS1/DS2 ZFC1/SEG3
- ZFC1/SEG2
- BS1/BS3
- RVC
- M1C
- M1F
- DIP SWITCH
- SEGMENT DISPLAY
- PUSH BUTTON SWITCH
- REVERSING VALVE COIL
- COMPRESSOR MOTOR
- FAN MOTOR
- TERMINAL
- CONNECTOR
- NOISELESS EARTH
- ELECTRICAL GROUND
- HIGH VOLTAGE
- LOW VOLTAGE
- HIGH VOLTAGE FIELD



0140R00426 E

TABLE

INVERTER MODEL	HP MODELS
EC14034-1	DZ18VC0241 AVZC180241
EC14035-1	DZ18VC0361 AVZC180361
EC14036-1	DZ18VC0481 AVZC180481
EC14036-3	DZ18VC0601 AVZC180601

COLOR CODE:

RD	RED
BR	BROWN
GR	GREEN
BK	BLACK
WH	WHITE
YL	YELLOW
BL	BLUE
PU	PURPLE

- NOTES:
1. THE POSITION OF THE SELECTOR SWITCHES (DS1/DS2) INDICATE FACTORY SETTING.
 2. COMPRESSOR MOTOR (FAN MOTOR) PROTECTION IS INCLUDING FAN MOTOR OVERLOAD PROTECTION PROVIDED BY INVERTER. SEE TABLE.
 3. USE COPPER CONDUCTORS ONLY.
 4. CLASS 2 WIRE.

Wiring is subject to change. Always refer to wiring diagram on the unit for the most up to date wiring.

WIRING DIAGRAM



WARNING
HIGH VOLTAGE!
 DISCONNECT ALL POWER BEFORE SERVICING OR INSTALLING THIS UNIT.
 MULTIPLE POWER SOURCES MAY BE PRESENT. FAILURE TO DO SO MAY
 CAUSE PROPERTY DAMAGE, PERSONAL INJURY OR DEATH.

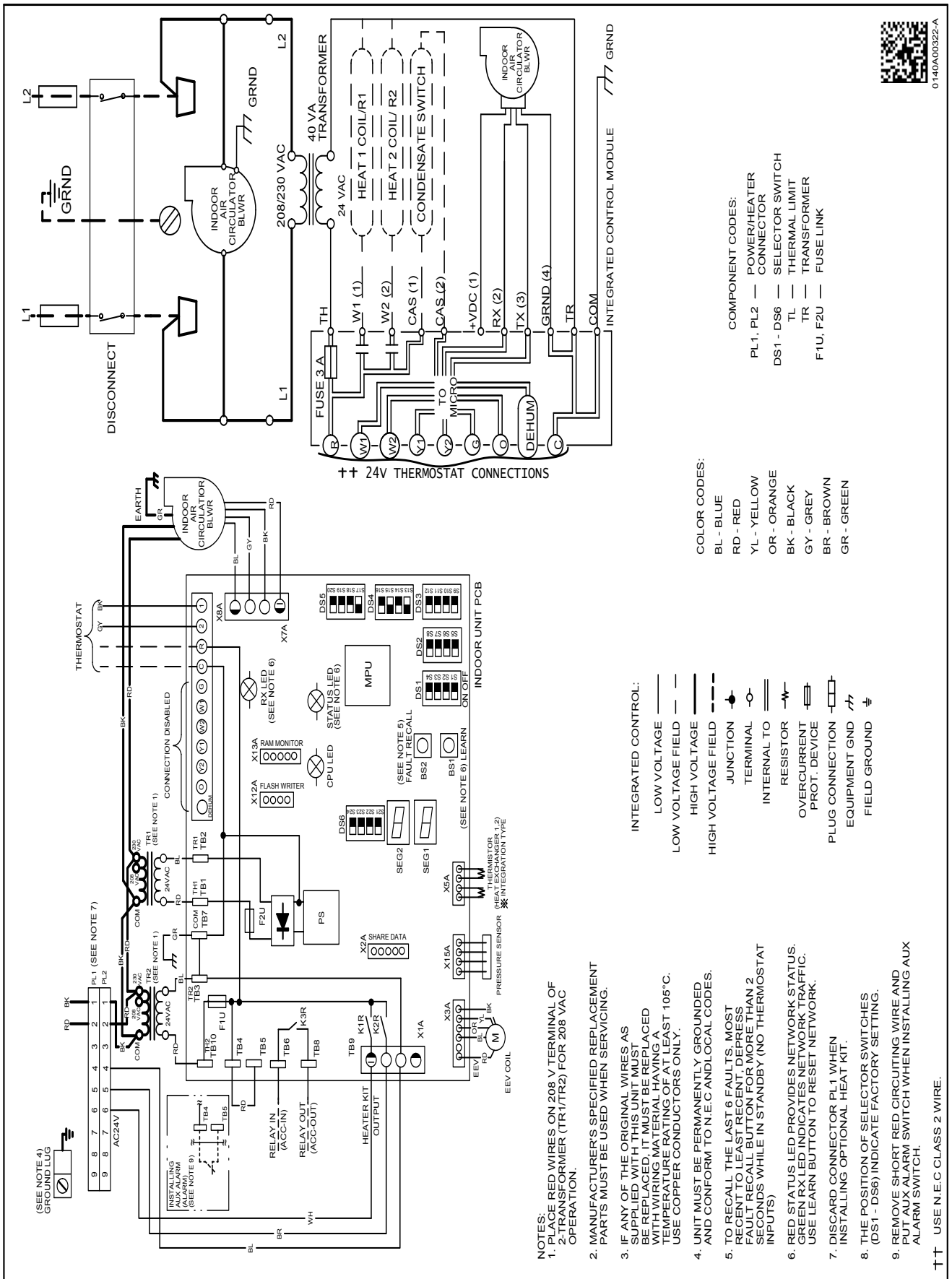

0140A00322-A

ACCESSORIES

AV**PEC

HEATER KIT

MODELS	HKX03XC	HKX05XC	HKX06XC	HKX08XC	HKX10XC	HKSC05XC	HKSC08XC	HKSC10XC	HKSC15XA	HKSC15XB	HKSC15XF	HKSC19CA	HKSC19CB	HKSC20DA	HKSC20DB	HKSC20XF	HKSC25DC
AVPEC25B14A*	X	X	X	X	X	X	X	X									
AVPEC37C14A*		X	X	X	X	X	X	X	X	X	X	X	X				
AVPEC59D14A*		X	X	X	X	X	X	X	X	X	X			X	X	X	
AVPEC61D14A*		X	X	X	X	X	X	X	X	X	X			X	X	X	X

*Revision level taht may or may not be designated.

NOTE: Airflow selection should meet the minimum requirements as mentioned in the air handler Installation instructions.

For heater kit installation, it is important to set the capacity of the electric heater at Set-up menu on the thermostat and DIP switch on indoor unit control board. For more information, please see indoor unit I/O manual.

VALID SWITCH SETTINGS								
Heater Kit	Heater kW				Dip Switch Setting Indoor PCB DS Bank 3			
Selection	AVPEC25B14A*	AVPEC37C14A* +	AVPEC59D14A* ++	AVPEC61D14A*	S-9	S-10	S-11	S-12
No heater	-	-	-	-	OFF	OFF	OFF	OFF
First	3	5	5	5	ON	ON	ON	ON
Second	5	6	6	6	ON	ON	ON	OFF
Third	6	8	8	8	ON	ON	OFF	ON
Fourth	8	10	10	10	ON	ON	OFF	OFF
Fifth	10	15	15	15	ON	OFF	ON	ON
Sixth	X	19	20	20	ON	OFF	ON	OFF
Seventh	X	X	X	25	ON	OFF	OFF	ON

+For match up with a 2 ton outdoor unit: Heater kit application shall not exceed 10 kW.

++For match up with a 3 ton outdoor unit: Heater kit application shall not exceed 15 kW.

NOTE: For emergency mode heating, set the dipswitch on PCB. For heating mode, use the thermostta user menu.

ACCESSORIES

CHECKING HEATER LIMIT CONTROL(S) (OPTIONAL ELECTRIC HEATERS)

Each individual heater element is protected with an automatic rest limit control connected in series with each element to prevent overheating of components in case of low airflow. This limit control will open its circuit at approximately 150°F. to 160°F and close at approximately 110°F.



WARNING
Disconnect ALL power before servicing.

1. Remove the wiring from the control terminals.
2. Using an ohmmeter test for continuity across the normally closed contacts. No reading indicates the control is open - replace if necessary. Make sure the limits are cool before testing.

IF FOUND OPEN - REPLACE - DO NOT WIRE AROUND.

CHECKING HEATER ELEMENTS

Optional electric heaters may be added, in the quantities shown in the spec sheet for each model unit, to provide electric resistance heating. Under no condition shall more heaters than the quantity shown be installed.



WARNING
HIGH VOLTAGE!
Disconnect ALL power before servicing or installing. Multiple power sources may be present. Failure to do so may cause property damage, personal injury or death.



1. Disassemble and remove the heating element(s).
2. Visually inspect the heater assembly for any breaks in the wire or broken insulators.
3. Using an ohmmeter, test the element for continuity - no reading indicates the element is open. Replace as necessary.

ELECTRIC HEATER (OPTIONAL ITEM)

Optional electric heaters may be added, in the quantities shown in the specifications section, to provide electric resistance heating. Under no condition shall more heaters than the quantity shown be installed.

The low voltage circuit in the air handler is factory wired and terminates at the location provided for the electric heater(s). A minimum of field wiring is required to complete the installation.

Other components such as a Heating/Cooling Thermostat and Outdoor Thermostats are available to complete the installation.

The system CFM can be determined by measuring the

static pressure external to the unit. The installation manual supplied with the blower coil, or the blower performance table in the service manual, shows the CFM for the static measured.

Alternately, the system CFM can be determined by operating the electric heaters and indoor blower WITHOUT having the compressor in operation. Measure the temperature rise as close to the blower inlet and outlet as possible.

If other than a 240V power supply is used, refer to the BTUH CAPACITY CORRECTION FACTOR in the following chart.

BTUH CAPACITY CORRECTION FACTOR				
SUPPLY VOLTAGE	250	230	220	208
MULTIPLICATION FACTOR	1.08	.92	.84	.75

EXAMPLE: Five (5) heaters provide 24.0 KW at the rated 240V. Our actual measured voltage is 220V, and our measured temperature rise is 42°F. Find the actual CFM:

Answer: 24.0KW, 42°F Rise, 240 V = 1800 CFM from the **TEMPERATURE RISE** chart on the right.

Heating output at 220 V = 24.0KW x 3.413 x .84 = 68.8 MBH.

Actual CFM = 1800 x .84 Corr. Factor = 1400 CFM.

NOTE: The temperature rise table is for sea level installations. The temperature rise at a particular KW and CFM will be greater at high altitudes, while the external static pressure at a particular CFM will be less.

CFM	HEAT KIT NOMINAL kW								
	3	5	6	8	10	15	19/20	25	
800	12	19	23	31	37				
1000	9	15	19	25	30	44			
1200	8	12	15	21	25	37	49	62	
1400	7	11	13	18	21	32	42	53	
1600	6	9	12	15	19	28	37	46	
1800	5	8	10	14	16	25	33	41	
2000	5	7	9	12	15	22	30	37	

230/1/60 SUPPLY VOLTAGE - TEMP. RISE °F

CFM	HEAT KIT NOMINAL kW								
	3	5	6	8	10	15	19/20	25	
800	11	18	22	30	35				
1000	9	14	18	24	28	42			
1200	7	12	15	20	24	35	47	59	
1400	6	10	13	17	20	30	40	51	
1600	6	9	11	15	18	27	35	44	
1800	5	8	10	13	16	24	31	39	
2000	4	7	9	12	14	21	28	35	

220/1/60 SUPPLY VOLTAGE - TEMP. RISE °F

ACCESSORIES

CFM	HEAT KIT NOMINAL KW							
	3	5	6	8	10	15	19/20	25
800	10	17	21	28	33			
1000	8	13	17	22	27	40		
1200	7	11	14	19	22	33	45	56
1400	6	10	12	16	19	29	38	48
1600	5	8	10	14	17	25	33	42
1800	5	7	9	12	15	22	30	37
2000	4	7	8	11	13	20	27	33

208/1/60 SUPPLY VOLTAGE - TEMP. RISE °F

NOTE: The link is designed to open at approximately 333°F. DO NOT WIRE AROUND - determine reason for failure.

Model	HEATER (kW)								
	3	5	6	8	10	15	19	20	25
AVPEC25B14*	550	650	700	715	875				
AVPEC37C14*		850	900	1000	1120	1220	1250		
AVPEC59D14*		990	1110	1200	1240	1520		1520	
AVPEC61D14*		1030	1150	1250	1320	1650		1690	1715

MINIMUM CFM REQUIRED FOR HEATER KITS

ELECTRIC HEATER CAPACITY BTUH								
HTR KW	3.0 KW	4.7 KW	6.0 KW	7.0 KW	9.5 KW	14.2 KW	19.5 KW	21.0 KW
BTUH	10200	16200	20400	23800	32400	48600	66500	71600

FORMULAS:

Heating Output = KW x 3.413 x Corr. Factor

Actual CFM = CFM (from table) x Corr. Factor

BTUH = KW x 3.413

BTUH = CFM x 1.08 x Temperature Rise (T)

$$CFM = \frac{KW \times 3.413}{1.08 \times T}$$

$$T = \frac{BTUH}{CFM \times 1.08}$$

CHECKING HEATER FUSE LINK (OPTIONAL ELECTRIC HEATERS)

Each individual heater element is protected with a one time fuse link which is connected in series with the element. The fuse link will open at approximately 333°.



WARNING
Disconnect ALL power before servicing.

1. Remove heater element assembly so as to expose fuse link.
2. Using an ohmmeter, test across the fuse link for continuity - no reading indicates the link is open. Replace as necessary.

CUSTOMER FEEDBACK

We are very interested in all product comments.

Please fill out the feedback form on one of the following links:

Goodman® Brand Products: (<http://www.goodmanmfg.com/about/contact-us>).

Amana® Brand Products: (<http://www.amana-hac.com/about-us/contact-us>).

You can also scan the QR code on the right for the product brand you purchased to be directed to the feedback page.



GOODMAN® BRAND



AMANA® BRAND

Amana is a registered trademark of Maytag Corporation or its related companies and is used under license.

All rights reserved.

Copyright © 2015-2017, 2019, 2021 Goodman Manufacturing Company, L.P.