

EN

TECHNICAL
MANUAL

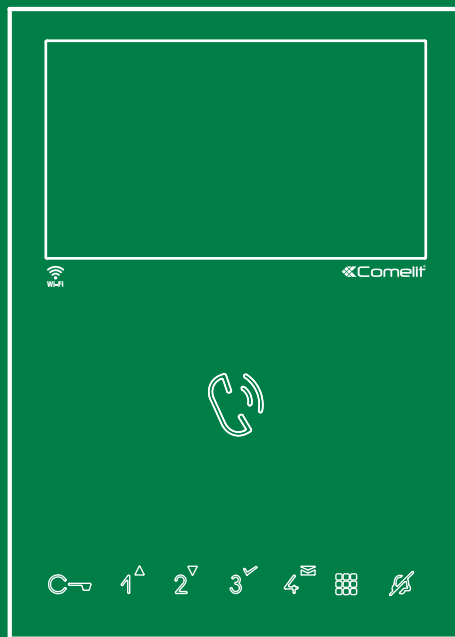

Amazon, Alexa and all related logos are trademarks of Amazon.com, Inc. or its affiliates.



Mini Hands-free Door Entry Monitor
Art. 6741W - Art. 6741W/BM

 **Comelit**[®]
Passion. Technology. Design.

Warning

Intended use

This Comelit product has been designed and manufactured for use in the creation of audio and video communication systems in residential, commercial, industrial and public buildings.

Installation

All activities connected to the installation of Comelit products must be carried out by qualified technical personnel, with careful observation of the indications provided in the Manuals / Instruction sheets supplied with those products.

Wires

Disconnect the power supply before carrying out any operations on the wiring.

Use wires with a cross-section suited to the distances involved, observing the instructions provided in the system manual.

We advise against running the system wires through the same duct as power cables (230V or higher).

Safe usage

To ensure Comelit products are used safely:

- carefully observe the indications provided in the Manuals / Instruction sheets,
- make sure the system created using Comelit products has not been tampered with / damaged.

Service

Comelit products do not require maintenance aside from routine cleaning, which should be carried out in accordance with the indications provided in the Manuals / Instruction sheets.

Any repairs must be carried out:

- for the products themselves, exclusively by **Comelit Group S.p.A.**,
- for the systems, by qualified technical personnel.

Disclaimer

Comelit Group S.p.A. does not assume any responsibility for

- any purpose other than the intended use,
- failure to observe the indications and warnings contained in this Manual / Instruction sheet.

Comelit Group S.p.A. reserves the right to change the information provided in this Manual / Instruction Sheet at any time and without prior notice.

The manufacturer, **Comelit Group S.p.A.**, hereby declares that the radio equipment art. 6741W conforms to directive 2014/53/EU. The full EU conformity declaration is available at the following web address: <https://pro.comelitgroup.com/products?s=6741W>

Table of contents

Warning	2
Description.....	4
Touch-sensitive buttons	5
Description	5
Indicator LED.....	5
Operation.....	6
Answering an incoming call	6
Enabling/disabling Automatic answer (hands-free) mode.....	6
Technical specifications	7
Installation.....	9
Removing the door entry monitor	10
Removing / fitting the terminal	10
Connections.....	11
Door entry monitor setup	12
Building mode, Kit mode.....	12
Power Management.....	12
Main and secondary door entry monitors	13
Addressing table.....	14
Button configuration	15
Basic configuration.....	15
Legend	15
Press and hold buttons (disabled by default)	16
Advanced configuration	17
Intercom call	17
Introduction	17
Internal general intercom call and external general intercom call: button programming.....	17
Intercom call to selective address: button programming	18
Selective intercom address	18
Assigning a selective address to the door entry monitor	18
Deleting the selective address for the door entry monitor	18
Generic actuator, coded actuator.....	19
Generic actuator : button programming.....	19
Coded actuator : button programming.....	19
Remote camera module.....	20
<i>Remote camera module with generic address</i> : button programming	20
<i>Remote camera module with address 220 [or 221]</i> : button programming	20
Other functions: button programming	21
Programming range	21
Changing door entry monitor ringtones.....	22
Programming reset	22
Art. 6741W (/BM) in systems powered by Art. 4888C/4888CU ..	23
Installation rules.....	23
New coding from rev. 53.....	23
Operating distances.....	24
Art. 6741W (/BM) in systems powered by Art. 1210/1210A	25
Operating distances.....	25
Art. 6741W (/BM) in Kit systems Art. 8451V	26
Operating distances.....	26
Wiring diagrams.....	27
System with Art. 4888C / 4888CU.....	27
System with Art. 1210/1210A	28
Kit Art. 8461V: basic single-family system with Art. 1209	28
Art. 6741W (/BM) and a secondary door entry monitor in branch connection	29
Art. 6741W (/BM) and a secondary door entry monitor 6721W (/BM) in cascade connection.....	29
System performance and layouts	30

Description

Hands-free Mini Wi-Fi door entry monitor for Simplebus 2 system. When used in conjunction with the Comelit app, available to download free of charge from the Google and Apple stores, and/or the Alexa/Ecoshow/Google voice assistants, it can be used to answer calls directly from your smartphone/tablet/assistant device, both locally and remotely. It can be used to enable the "Face recognition" function directly from the app, to automatically - once a person has been recognised - send a lock-release command (enabled by default), trigger an actuator to control a light or additional opening and receive notification when a known individual makes a call. Replacing an old door entry monitor to benefit from all the advantages offered by Wi-Fi technology is no longer problematic: Mini Wi-Fi is actually compatible with all types of Comelit Simplebus 2 video entry phone system and does not require any additional masonry work. Supplied with mounting backplate and riser distribution terminal art. 1214/2C.

The 6741W/BM door entry monitor includes a magnetic induction amplification system as standard. Backplate Art. 6710 is not supplied, and is available to purchase separately.

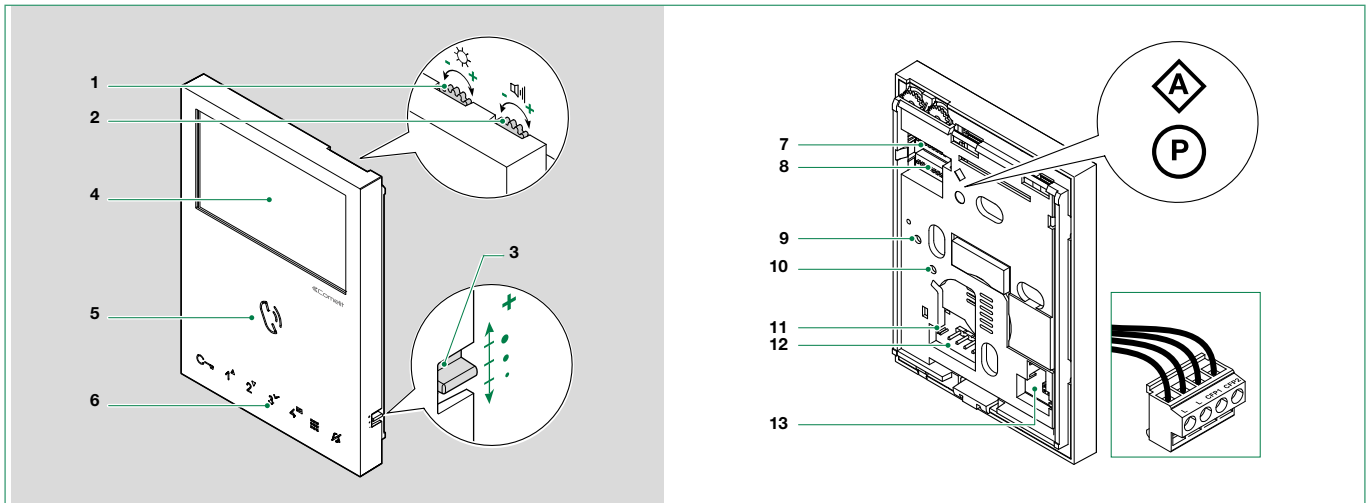

1. Brightness control
 - ▶ To increase the value, turn clockwise
2. Loudspeaker volume control
 - ▶ To increase the value, turn clockwise
3. Call volume adjustment (high - medium - low)
4. 4.3" / 16:9 LCD screen
5. Speaker and audio activation button
6. Touch-sensitive buttons
7. **S1** ⬠ Microswitches for user code programming (see table A "[Addressing table](#)")
8. **S2** ⊕ Microswitches for programming buttons and functions
 - DIP 1-2-3-4** for button function programming
 - DIP 5-6** access to programming
 - DIP 7** for power supply voltage management (Paragraph "[Power Management](#)"). Default = ON



S2 DIP 7 must always be set to ON, even in systems with 4888C and 4888CU (as in the factory settings).

DIP 8 (not used)

9.10. Factory setting - DO NOT CHANGE!

11. CV 5 Jumper for video closure. In systems with more than one door entry monitor connected in cascade, only the door entry monitor furthest away must have CV5 closed.

12. Pin for securing terminal block

13. S3 Microswitches:

DIP 1 to set the correct operating mode (Paragraph "[Building mode, Kit mode](#)")

DIP 2 (not used)

Terminal block for system connection:

LL BUS line connection terminals

CFP1 CFP2 Floor door call input

Touch-sensitive buttons

Description

► Press and release the desired button once to activate the associated function.

Wait for approx. 1 sec. before pressing the same button again; rapidly pressing the same button repeatedly will cancel the command which has just been sent.

	Audio activation	
	Lock-release control	[programmable]
1	Actuator control	[programmable]
2	** Self Activation	[programmable]
3	Secondary switchboard call	[programmable]
4	** Door opening upon call (Doctor) Automatic door opening on receipt of call from external entrance panel.	[programmable]
	Menu	[not programmable]
	Silent mode (Privacy). Ringtone in silence mode on receipt of a call from the external entrance panel and from the switchboard.	[not programmable]
	Arrow keys	
	Confirm selection	
	Message menu	

**Pressing and holding enables / disables the function, see [“Press and hold buttons \(disabled by default\)”](#)

Indicator LED

	Audio	FLASHING LED	<i>Incoming call.</i>
		STEADY LED in call	<i>In communication.</i>
		STEADY LED in standby	<i>Automatic answer (hands-free) mode enabled.</i>
	Lock-release	FLASHING LED	<i>Incoming call.</i>
		FLASHING LED (slow)	<i>Door open indication.</i>
		1 FLASH	<i>Door opening confirmation.</i>
	Silent mode (Privacy)	STEADY LED	<i>Silent (Privacy) mode enabled.</i>
		STEADY AND FLASHING LED (3 flashes every 5 sec.)	<i>Door opening upon call (Doctor) function and Silent (Privacy) mode enabled.</i>
		OFF AND FLASHING LED (3 flashes every 5 sec.)	<i>Door opening upon call (Doctor) enabled.</i>
		4 FLASHES	<i>The called device is busy.</i>
	Menu	FLASHING LED	<i>User notification present.</i>

Operation



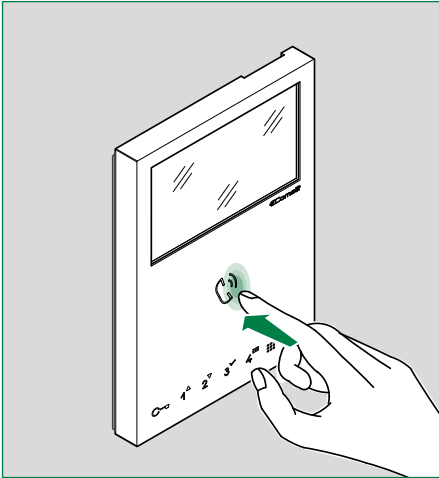

When Art. 6741W (/BM) is connected to the power supply, the LEDs will flash: wait for them to switch off (approx. 40 sec) before starting to use the device.

Answering an incoming call



Press the touch-sensitive audio activation button  to answer the incoming call.

Enabling/disabling Automatic answer (hands-free) mode

- ▶ Press and hold (5 sec) the button 
 - » ENABLING:  +  LED STEADY ON
 - » DISABLING:  +  LED OFF

Technical specifications

	6741W	6741W/BM
GENERAL DATA		
Product height (mm)	160	160
Product width (mm)	115	115
Product depth (mm)	22	22
Product weight (g)	400	400
Product colour	White RAL9003	White RAL9003
Material	ABS	ABS
Surface mounting	Yes	Yes
Desk base mounting	Yes, with specific accessory	Yes, with specific accessory
COMPATIBLE SYSTEMS		
Simplebus 2 audio/video with power supply unit Art. 4888C	Yes	Yes
Simplebus 2 audio/video with power supply unit Art. 1210/1210A	Yes	Yes
Simplebus 2 audio/video kit with power supply unit Art. 1209	Yes	Yes
DISPLAY SPECIFICATIONS		
Size (inches) (")	4.3	4.3
Aspect ratio	16:9	16:9
Resolution (pixels)	480x272	480x272
On-screen menu (OSD)	Yes	Yes
AUDIO SPECIFICATIONS		
Type	Hands-free	Hands-free
Magnetic induction module	No	Yes
Microphone	6 mm (Ø), Omnidirectional	6 mm (Ø), Omnidirectional
Loudspeaker	36 mm (Ø), 40 Ohm, 1W	36 mm (Ø), 40 Ohm, 1W
ELECTRICAL SPECIFICATIONS		
Type of power supply	Power supply via video entry bus	Power supply via video entry bus
Power supply voltage	22 to 34 VDC (Bus)	22 to 34 VDC (Bus)
Absorption in standby (W)	0.1	0.1
Absorption in standby in kit mode (W)	1.9	1.9
Maximum absorption (W)	8.1	8.1
HARDWARE CHARACTERISTICS		
Type of buttons	Capacitive	Capacitive
Service buttons	Lock-release, Answer, Silent (Privacy), Menu, Messages	Lock-release, Answer, Silent (Privacy), Menu, Messages
No. of programmable buttons for additional functions	4	4
Terminals	L L CFP1 CFP2	L L CFP1 CFP2
Removable terminals	Yes	Yes
Number of inputs (no.)	1	1
SETTINGS		
Loudspeaker volume	Yes	Yes
Ringtone volume	Yes	Yes
Screen brightness	Yes	Yes

	6741W	6741W/BM
NETWORK AND COMMUNICATION PROTOCOL		
Type of Wi-Fi connection	IEEE 802.11 b/g/n, 2.4 Ghz, 13 channels	IEEE 802.11 b/g/n, 2.4 Ghz, 13 channels
Encryption method and supported authentication	Networks OPEN WPA-PSK, TKIP WPA2-PSK, AES WEP 64-bit (codes with 5 ASCII digits or 10 hexadecimal), WEP 128-bit (codes with 13 ASCII digits or 26 hexadecimal)	Networks OPEN WPA-PSK, TKIP WPA2-PSK, AES WEP 64-bit (codes with 5 ASCII digits or 10 hexadecimal), WEP 128-bit (codes with 13 ASCII digits or 26 hexadecimal)
IP address assignment	DHCP	DHCP
IoT connection to Comelit Cloud	Yes	Yes
Firmware updating via Comelit Cloud	Yes	Yes

ENVIRONMENTAL AND CONFORMITY SPECIFICATIONS		
IP protection rating	IP30	IP30
Operating temperature (°C)	5 to 40	5 to 40
Operating humidity (max RH - %)	25 to 75	25 to 75
Environmental class	I	I
Conformity and Certifications	RoHS II - 2011/65/EU (EN 50581:2012), RED 2014/53/EU (EN 60950-1:2006+A11:2009+A1:2010+A12:2011, +A2:2013, EN 62311:2008, EN 61000-6-1:2007, EN 61000-6-3:2007 + A1:2011, ETSI EN 301 489-1 V2.2.0, ETSI EN 301 489-17 V3.2.0, ETSI EN 300 328 V2.1.1)	RoHS II - 2011/65/EU (EN 50581:2012), RED 2014/53/EU (EN 60950-1:2006+A11:2009+A1:2010+A12:2011, +A2:2013, EN 62311:2008, EN 61000-6-1:2007, EN 61000-6-3:2007 + A1:2011, ETSI EN 301 489-1 V2.2.0, ETSI EN 301 489-17 V3.2.0, ETSI EN 300 328 V2.1.1)

MAIN FUNCTIONS		
Compatible with Comelit app	Yes	Yes
Lock-release	Yes	Yes
Self Activation	Yes	Yes
Intercom calls	Yes	Yes
Actuator control	Yes	Yes
Switchboard call	Yes	Yes
Input for floor door call	Yes	Yes
Silent mode (Privacy)	Yes	Yes
Video memory	Yes	Yes
Door opening upon call (Doctor)	Yes	Yes
Automatic answer (hands-free)	Yes	Yes
Door open indication	Yes	Yes
Multiple address	Yes	Yes
Customisable ringtone	Yes	Yes
Alarm call transmission	Yes	Yes
Date/time display	Yes	Yes
Integration with voice assistants	Yes	Yes
Face recognition	Yes	Yes

Installation

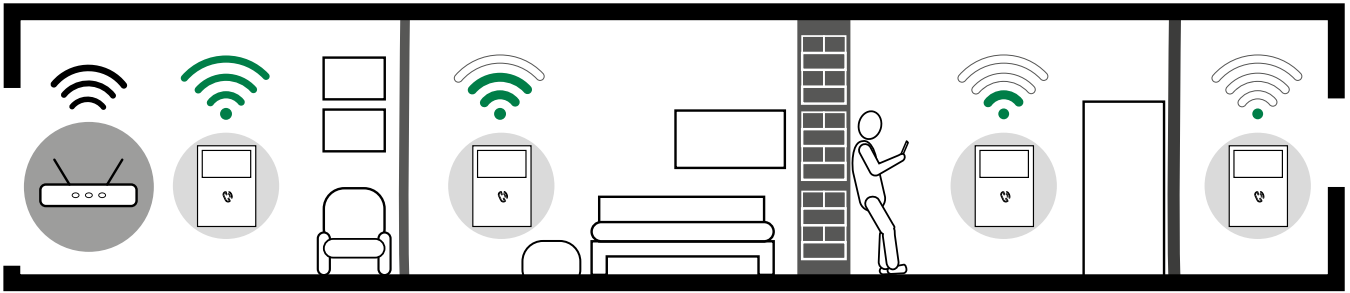

Before definitive installation of the door entry monitor, make sure the device has good Wi-Fi signal reception; the distance between the router and door entry monitor, and the construction materials used in the walls are factors that can affect signal quality.

If the Wi-Fi signal is not strong enough to guarantee correct operation, a Wi-Fi repeater must be installed between the router and door entry monitor in order to boost the Wi-Fi signal received by the door entry monitor.

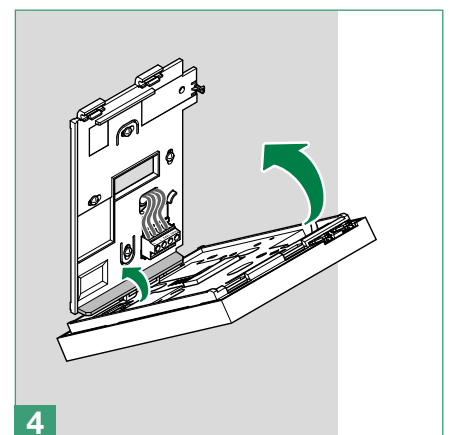
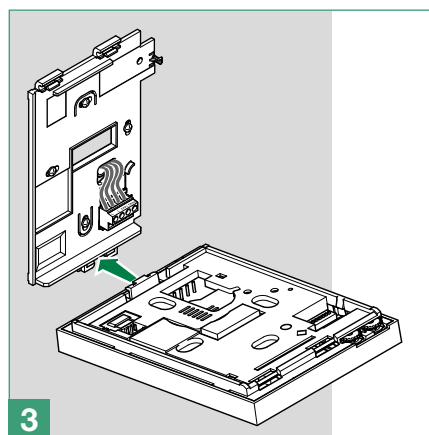
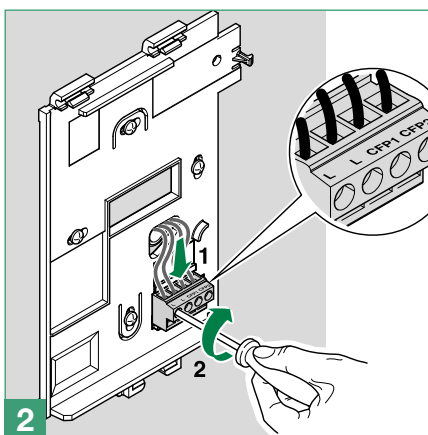
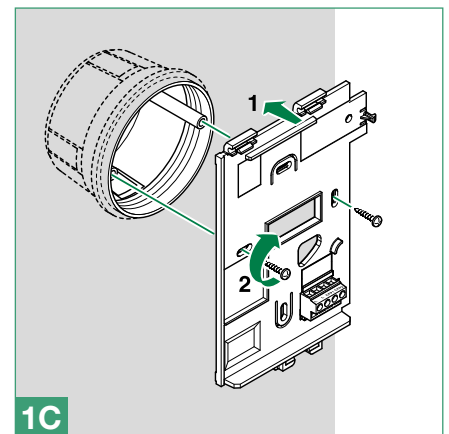
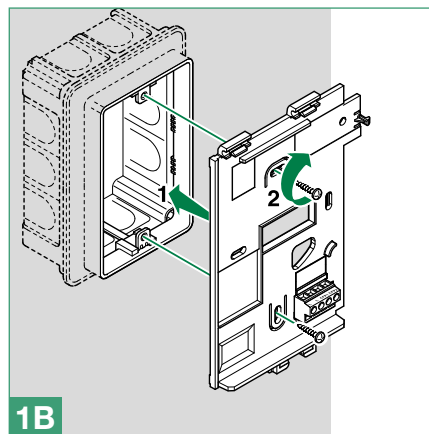
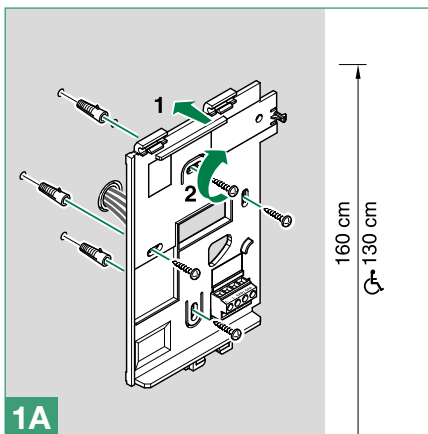
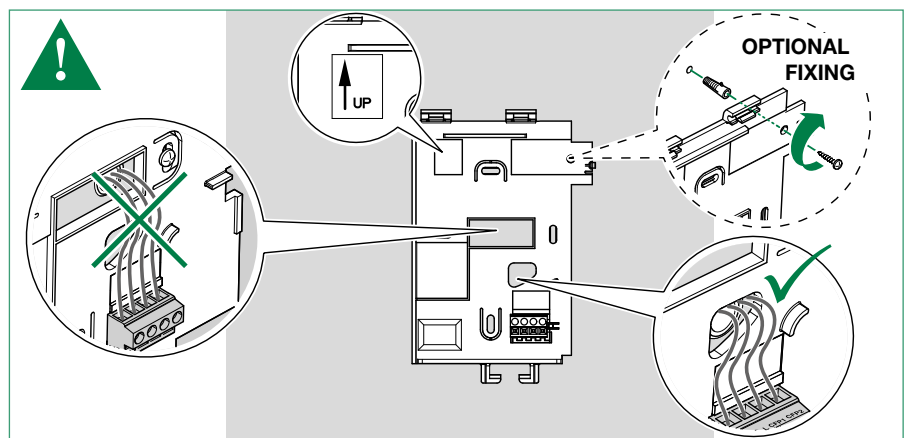
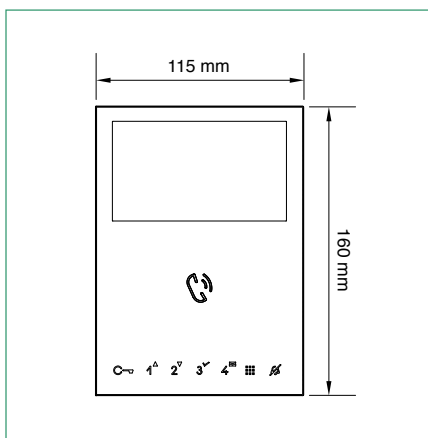

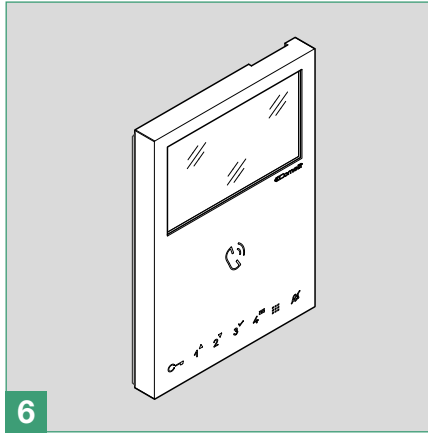
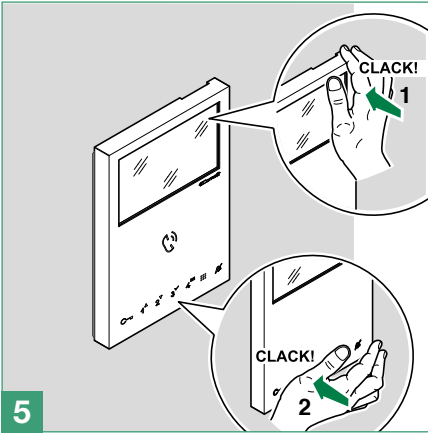

Removing the door entry monitor

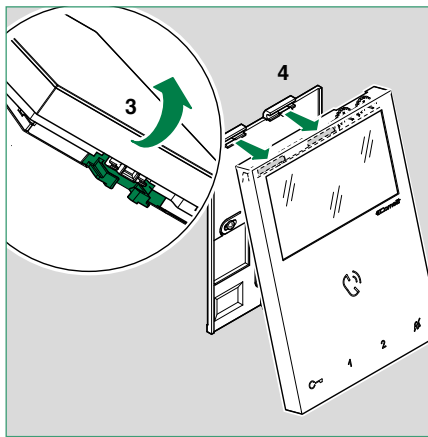
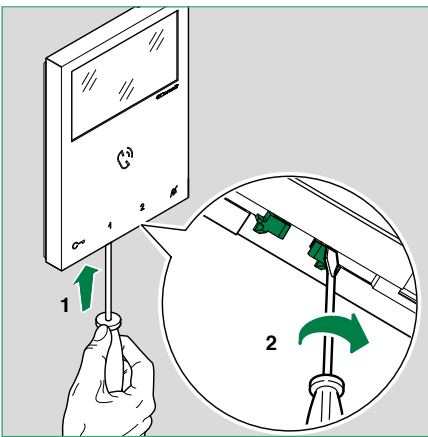

Removing / fitting the terminal

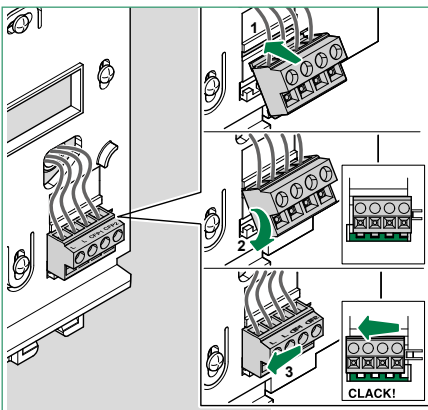
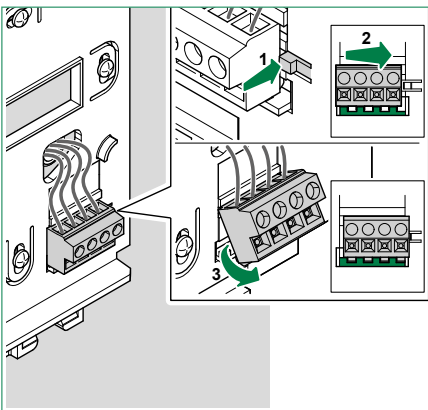

Connections

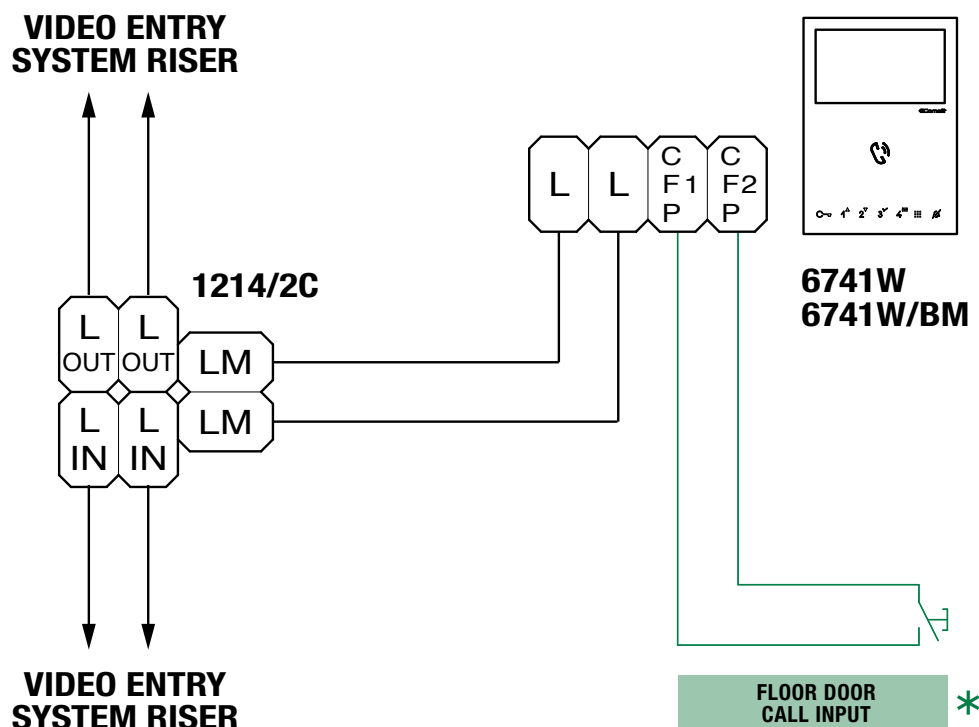

* **20 m MAX** - Use shielded cable for the connection and do not route the cables in the vicinity of heavy inductive loads or power supply cables (230 V/400 V).

Where multiple door-entry phones or door entry monitors have the same user code, connect the CFP button on one only; all the devices will ring simultaneously.

Door entry monitor setup

Building mode, Kit mode





For correct configuration, set DIP 1 of **S3** (on/off) as follows:

- BUILDING mode: (S3) DIP 1= **OFF**
- ✓ BUILDING mode must be set in systems powered by 4888C / 4888CU, while for systems powered by 1210/1210A, set BUILDING mode when the number of 6741W/(BM) door entry monitors is greater than 10.

In this mode you can answer video entry phone calls at home and away from your smartphone/tablet/voice assistants.

- KIT mode: (S3) DIP 1= **ON**
- ✓ KIT mode is permitted in systems powered by 1210/1210A with 10 or fewer 6741W / (BM) devices, and in systems powered by 1209 with 4 or fewer 6741W / (BM) devices.

In this mode you can answer video entry phone calls at home and away from your smartphone/tablet/voice assistants, but also implement self activation and control actuators.

Art. 6741W (/BM) QTY	Art. 4888C / 4888CU	Art. 1210/1210A	Art. 1209
< 10	S3  OFF	S3  ON	S3  ON (Art. 6741W (/BM) MAX 4)
> 10	S3  OFF	S3  OFF	-

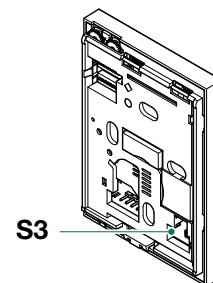

Power Management

For correct power supply management, set **DIP 7 (S2)** according to the table.

With Art. 6741W with a revision index [RR] greater than or equal to 12 and with Art. 6741W/BM with a revision index [RR] greater than or equal to 10: DIP 7 of S2 should always be left in ON (default), even in systems with 4888C and 4888CU.

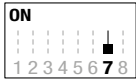
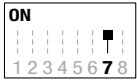
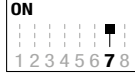
		with power supply unit Art. 4888C 4888CU	with power supply unit Art. 1210/1210A	with power supply unit Art. 1209
6741W	RR < 12	 S2	 S2	 S2
6741W/BM	RR < 10			
6741W	RR >= 12			
6741W/BM	RR >= 10			

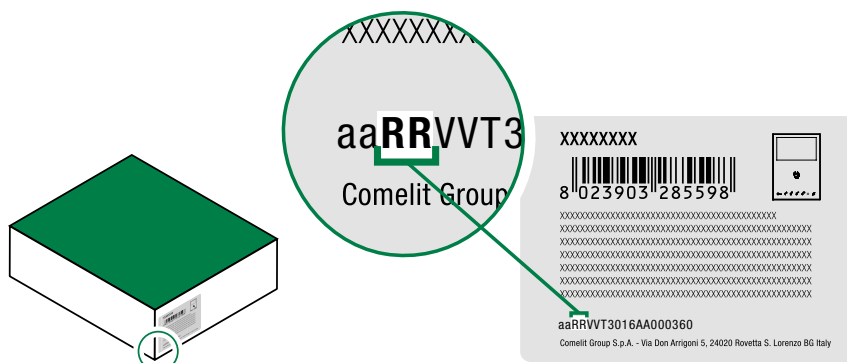

Main and secondary door entry monitors

A single 6741W (/BM) door entry monitor can be installed for each user code; this will also be the only main door entry monitor (P)

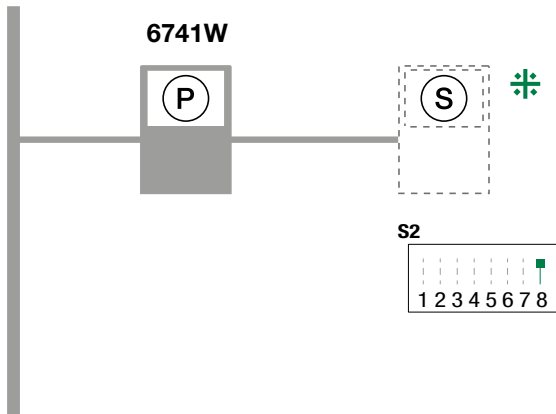

4888C / 4888CU / 1210 / 1210A / 1209

✦ Compatible secondary door entry monitors			
6601W 6601W/BM	6701W 6701W/8 6701W/BM	6721W 6721W/BM	6801W 6801W/BM

Addressing table

Code	Dip switch ON														
1	1	31	1,2,3,4,5	61	1,3,4,5,6	91	1,2,4,5,7	121	1,4,5,6,7	151	1,2,3,5,8	181	1,3,5,6,8	211	1,2,5,7,8
2	2	32	6	62	2,3,4,5,6	92	3,4,5,7	122	2,4,5,6,7	152	4,5,8	182	2,3,5,6,8	212	3,5,7,8
3	1.2	33	1.6	63	1,2,3,4,5,6	93	1,3,4,5,7	123	1,2,4,5,6,7	153	1,4,5,8	183	1,2,3,5,6,8	213	1,3,5,7,8
4	3	34	2.6	64	7	94	2,3,4,5,7	124	3,4,5,6,7	154	2,4,5,8	184	4,5,6,8	214	2,3,5,7,8
5	1.3	35	1,2,6	65	1.7	95	1,2,3,4,5,7	125	1,3,4,5,6,7	155	1,2,4,5,8	185	1,4,5,6,8	215	1,2,3,5,7,8
6	2.3	36	3.6	66	2.7	96	6.7	126	2,3,4,5,6,7	156	3,4,5,8	186	2,4,5,6,8	216	4,5,7,8
7	1,2,3	37	1,3,6	67	1,2,7	97	1,6,7	127	1,2,3,4,5,6,7	157	1,3,4,5,8	187	1,2,4,5,6,8	217	1,4,5,7,8
8	4	38	2,3,6	68	3.7	98	2,6,7	128	8	158	2,3,4,5,8	188	3,4,5,6,8	218	2,4,5,7,8
9	1.4	39	1,2,3,6	69	1,3,7	99	1,2,6,7	129	1.8	159	1,2,3,4,5,8	189	1,3,4,5,6,8	219	1,2,4,5,7,8
10	2.4	40	4.6	70	2,3,7	100	3,6,7	130	2.8	160	6.8	190	2,3,4,5,6,8	220	3,4,5,7,8
11	1,2,4	41	1,4,6	71	1,2,3,7	101	1,3,6,7	131	1,2,8	161	1,6,8	191	1,2,3,4,5,6,8	221	1,3,4,5,7,8
12	3.4	42	2,4,6	72	4.7	102	2,3,6,7	132	3.8	162	2,6,8	192	7.8	222	2,3,4,5,7,8
13	1,3,4	43	1,2,4,6	73	1,4,7	103	1,2,3,6,7	133	1,3,8	163	1,2,6,8	193	1,7,8	223	1,2,3,4,5,7,8
14	2,3,4	44	3,4,6	74	2,4,7	104	4,6,7	134	2,3,8	164	3,6,8	194	2,7,8	224	6,7,8
15	1,2,3,4	45	1,3,4,6	75	1,2,4,7	105	1,4,6,7	135	1,2,3,8	165	1,3,6,8	195	1,2,7,8	225	1,6,7,8
16	5	46	2,3,4,6	76	3,4,7	106	2,4,6,7	136	4.8	166	2,3,6,8	196	3,7,8	226	2,6,7,8
17	1.5	47	1,2,3,4,6	77	1,3,4,7	107	1,2,4,6,7	137	1,4,8	167	1,2,3,6,8	197	1,3,7,8	227	1,2,6,7,8
18	2.5	48	5.6	78	2,3,4,7	108	3,4,6,7	138	2,4,8	168	4,6,8	198	2,3,7,8	228	3,6,7,8
19	1,2,5	49	1,5,6	79	1,2,3,4,7	109	1,3,4,6,7	139	1,2,4,8	169	1,4,6,8	199	1,2,3,7,8	229	1,3,6,7,8
20	3.5	50	2,5,6	80	5.7	110	2,3,4,6,7	140	3,4,8	170	2,4,6,8	200	4,7,8	230	2,3,6,7,8
21	1,3,5	51	1,2,5,6	81	1,5,7	111	1,2,3,4,6,7	141	1,3,4,8	171	1,2,4,6,8	201	1,4,7,8	231	1,2,3,6,7,8
22	2,3,5	52	3,5,6	82	2,5,7	112	5.6,7	142	2,3,4,8	172	3,4,6,8	202	2,4,7,8	232	4,6,7,8
23	1,2,3,5	53	1,3,5,6	83	1,2,5,7	113	1,5,6,7	143	1,2,3,4,8	173	1,3,4,6,8	203	1,2,4,7,8	233	1,4,6,7,8
24	4.5	54	2,3,5,6	84	3,5,7	114	2,5,6,7	144	5.8	174	2,3,4,6,8	204	3,4,7,8	234	2,4,6,7,8
25	1,4,5	55	1,2,3,5,6	85	1,3,5,7	115	1,2,5,6,7	145	1,5,8	175	1,2,3,4,6,8	205	1,3,4,7,8	235	1,2,4,6,7,8
26	2,4,5	56	4,5,6	86	2,3,5,7	116	3,5,6,7	146	2,5,8	176	5,6,8	206	2,3,4,7,8	236	3,4,6,7,8
27	1,2,4,5	57	1,4,5,6	87	1,2,3,5,7	117	1,3,5,6,7	147	1,2,5,8	177	1,5,6,8	207	1,2,3,4,7,8	237	1,3,4,6,7,8
28	3,4,5	58	2,4,5,6	88	4,5,7	118	2,3,5,6,7	148	3,5,8	178	2,5,6,8	208	5,7,8	238	2,3,4,6,7,8
29	1,3,4,5	59	1,2,4,5,6	89	1,4,5,7	119	1,2,3,5,6,7	149	1,3,5,8	179	1,2,5,6,8	209	1,5,7,8	239	1,2,3,4,6,7,8
30	2,3,4,5	60	3,4,5,6	90	2,4,5,7	120	4,5,6,7	150	2,3,5,8	180	3,5,6,8	210	2,5,7,8	*240	5,6,7,8

NOTES

- In BUILDING mode we recommend choosing user codes with the lowest available values.
- Code *240 is reserved for the porter switchboard.

Button configuration

By default the buttons control the functions in row **A** (“Standard configuration” table).

It is possible to change the default configuration of the buttons by changing the positions of the S2 DIP 1-2-3-4 on the rear of the door entry monitor to one of the combinations (B-P) proposed in the table. All the buttons will change function.

Basic configuration

		S2 Dip-switches				Mini 6741W / 6741W/BM				
		DIP 1	DIP 2	DIP 3	DIP 4	C→	1	2	3	4
default ▶	A	OFF	OFF	OFF	OFF	AP	ACT	AI	CCS	D
	B	ON	OFF	OFF	OFF	AP	CCS	AI	INT	INTb
	C	OFF	ON	OFF	OFF	AP	INT	AI	INTb	ACT
	D	ON	ON	OFF	OFF	AP	ACT	CCS	CCP	PAN
	E	OFF	OFF	ON	OFF	ACT	ACT	ACT	ACT	ACT
	F	ON	OFF	ON	OFF	AP	INT	ACT	CCS	CCP
	G	OFF	ON	ON	OFF	AP	AI	D	K	CCS
	H	ON	ON	ON	OFF	AP	INTb	INT	AI	INT
	I	OFF	OFF	OFF	ON	AP	CCS	PAN	D	AI
	J	ON	OFF	OFF	ON	AP	K	CCS	PAN	CCP
	K	OFF	ON	OFF	ON	AP	CCP	K	PAN	ACT
	L	ON	ON	OFF	ON	AP	AI	CAMG	CAM1	CAM2
	M	OFF	OFF	ON	ON	AP	INTb	AI	INT	ACT
	N	ON	OFF	ON	ON	AP	INT	INT	INT	INT
	P	OFF	ON	ON	ON	NULL	NULL	NULL	NULL	NULL
			ON	ON	ON	ON	PROG			

Legend

AP	Lock-release	<i>Press and release key</i>
ACT	Actuator	
AI **	Self Activation	
CAMG	Remote camera module with generic address	
CAM1	Remote camera module with address 220	
CAM2	Remote camera module with address 221	
CCP*	Call to main switchboard	
CCS*	Call to secondary switchboard	
K	Caretaker door-entry phone call	
PAN*	Panic	
INT	General or selective programmable intercom. <i>Default: single-family call</i>	
INTb	Two-family intercom call - <i>for Kit only</i>	
NULL	No function	
D **	Door opening upon call (Doctor) mode	
PROG	Programmed functions, see “Advanced configuration”. In this DIP setting, the buttons control the programmed functions; the NON-programmed buttons control the functions referred to on line A (default).	

* Cannot be used in Kit systems



** Pressing and holding enables / disables the function, see [“Press and hold buttons \(disabled by default\)”](#)

Press and hold buttons (disabled by default)

Pressing and holding keys adds further functions to the door entry monitor.

Carry out the procedure described below to enable - or disable, depending on the factory setting - the press and hold feature:

✓ *Door entry monitor in standby.*

1. Take note of the S2 DIP-switch settings.
2. Enter programming mode by setting S2 DIP-switches 1, 3, 5 to ON.
 - » *The LED  flashes*
3. Press 1 to enable (or press 2 to disable).
4. Make sure the  key flashes 4 times and the confirmation tone is emitted.
5. Restore the initial configuration of the S2 DIP-switches.
 - » *LED  switches off*

Advanced configuration

If the standard configuration settings do not reflect requirements, the buttons can be programmed differently by carrying out the steps below.

After programming, set **S2 DIP 1-2-3-4 (PROG)** to ON. With these DIP settings, the buttons manage the programmed functions.

i The buttons that are NOT programmed control the functions in row A (table [“Basic configuration”](#)).

Intercom call

Introduction

From an internal unit you can send an intercom call to:

- **all devices of the same apartment** (internal general intercom call)
- **all devices of another apartment** (external general intercom call)
- **a single internal unit** of an apartment identified by a dedicated intercom address different to the address that identifies the apartment (intercom call to selective address).
- **a group of internal units** of the same apartment or another apartment identified by a dedicated intercom address different to the address that identifies the apartment (selective group intercom call).

i General and selective intercoms CANNOT be used together on the same riser.

Internal **general** intercom call and external general intercom call: button programming

1. Take note of the S1 DIP-switch settings.

2. To enter programming mode, set S2 **DIP 6** to ON.

» the LED flashes

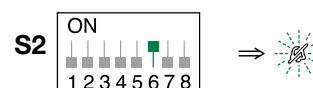

3. Refer to the table [“Basic configuration”](#) and select a combination in which the intercom function is listed for the buttons you wish to program.

Example:

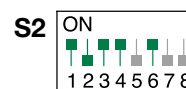

4. Set the S1 DIP according to the call address of the desired apartment. See [“Addressing table”](#)

5. Press and release the button to be associated with the function.

- » *Correct procedure indication:* the *Lock release* LED flashes for a few seconds and a confirmation tone sounds.
- » *Procedure error indication:* the *Audio* LED flashes for few seconds and an error tone sounds.

6. Exit programming mode by setting S2 **DIP 6** to OFF.

» LED switches off

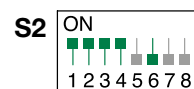

7. Set S2 **DIP 1-2-3-4** to ON.

8. Return S1 DIP to the original combination.

Intercom call to selective address: button programming

✓ *It is necessary to carry out the 3 steps described in the paragraph "Assigning a selective address to the door entry monitor".*

1. Take note of the S1 DIP-switch settings.

2. To enter programming mode, set S2 **DIP 6** to ON.

» *the LED  flashes*

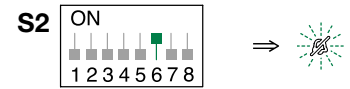

3. Refer to the table "**Basic configuration**" and set on S2 a combination in which the intercom function associated with the buttons you wish to program appears.

Example:

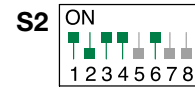

4. Set the S1 DIP according to the **selective** address of the internal unit you wish to call. Table B.

5. Press and release the button to be associated with the function.

» *Correct procedure indication: the Lock release LED flashes for a few seconds and a confirmation tone sounds.*

» *Procedure error indication: the Audio LED flashes for few seconds and an error tone sounds.*

6. Exit programming mode by setting S2 **DIP 6** to OFF.

» *LED  switches off*

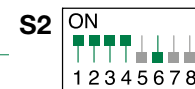









7. Set S2 **DIP 1-2-3-4** to ON.

8. Return S1 DIP to the original combination.

Selective intercom address

You must set the intercom address on all the internal units of the riser.
You can assign the same intercom address to a maximum of 3 internal units.
For group calls, select the desired intercom codes simultaneously (max. 3).

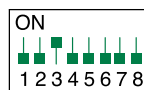
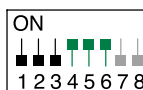

TABLE B

Code	S1 DIP-switch ON	Code	S1 DIP-switch ON
1	1 	5	5 
2	2 	6	6 
3	3 	7	7 
4	4 	8	8 



Assigning a selective address to the door entry monitor

Assign one of the 8 available intercom codes in TABLE B to the door entry monitor.

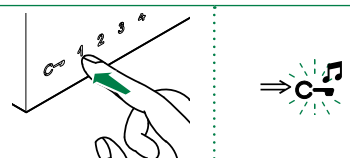
 *Take note of the S2, S1 settings and restore on completion of programming*

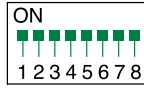
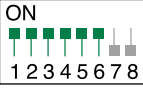

<p>1.</p> <p>Example address 3. <i>Follow the steps as illustrated.</i></p> <div style="display: flex; align-items: center;"> <div style="margin-right: 20px;"> <p>S1 </p> </div> <div style="margin-right: 20px;"> <p>S2 </p> </div> <div>  </div> </div>	<p>2.</p> 
---	---

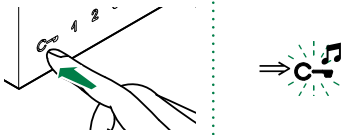
Deleting the selective address for the door entry monitor

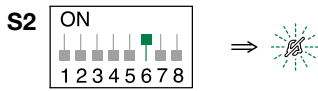
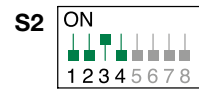
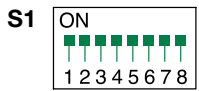

<p>1.</p> <p>Carry out the operations as shown in the figure.</p> <div style="display: flex; align-items: center;"> <div style="margin-right: 20px;"> <p>S1 </p> </div> <div style="margin-right: 20px;"> <p>S2 </p> </div> <div>  </div> </div>	<p>2.</p> 
---	---

Generic actuator, coded actuator

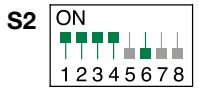
Generic actuator: button programming



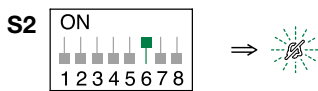
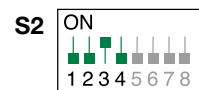

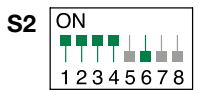
1. Take note of the S1 DIP-switch settings.	
2. To enter programming mode, set S2 DIP 6 to ON. » the LED  flashes	
3. Refer to the table “Basic configuration” and set on S2 a combination in which the actuator function (ACT) associated with the buttons you wish to program appears.	<p>Example:</p> 
4. Set all the S1 DIP-switches to the ON position.	
5. Press and release the button to be associated with the function. » <i>Correct procedure indication</i> : the <i>Lock release</i> LED flashes for a few seconds and a confirmation tone sounds » <i>Procedure error indication</i> : the <i>Audio</i> LED flashes for few seconds and an error tone sounds	
6. Exit programming mode by setting S2 DIP 6 to OFF. » LED  switches off	
7. Set S2 DIP 1-2-3-4 to ON.	
8. Return S1 DIP-switches to the original combination.	

Coded actuator: button programming



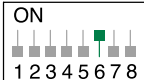

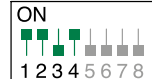
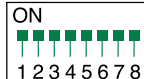
1. Take note of the S1 DIP-switch settings.	
2. To enter programming mode, set S2 DIP 6 to ON. » the LED  flashes	
3. Refer to the table “Basic configuration” and set on S2 a combination in which the actuator function (ACT) associated with the buttons you wish to program appears.	<p>Example:</p> 
4. The S1 DIP switches with the desired code, according to “Addressing table”	
5. Press and release the button to be associated with the function. » <i>Correct procedure indication</i> : the <i>Lock release</i> LED flashes for a few seconds and a confirmation tone sounds » <i>Procedure error indication</i> : the <i>Audio</i> LED flashes for few seconds and an error tone sounds	
6. Exit programming mode by setting S2 DIP 6 to OFF. » LED  switches off	
7. Set S2 DIP 1-2-3-4 to ON.	
8. Return S1 DIP-switches to the original combination.	

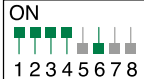
Remote camera module



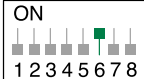

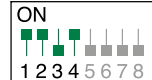
Remote camera module with generic address: button programming

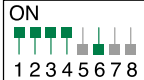
1. Take note of the S1 DIP-switch settings.	
2. To enter programming mode, set S2 DIP 6 to ON. » the LED  flashes	S2  ⇒ 
3. Refer to the table “Basic configuration” and on S2 set the combination in which the Remote camera module with generic address (cAMG) appears.	Example: S2 
4. Set all the S1 DIP to the ON position.	S1 
5. Press and release button 2. » <i>Correct procedure indication</i> : the Lock release LED flashes for a few seconds and a confirmation tone sounds » <i>Procedure error indication</i> : the Audio LED flashes for few seconds and an error tone sounds	
6. Exit programming mode by setting S2 DIP 6 to OFF. » LED  switches off	S2 
7. Set S2 DIP 1-2-3-4 to ON.	
8. Return S1 DIP-switches to the original combination.	

Remote camera module with address 220 [or 221]: button programming

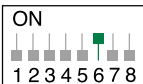
1. Take note of the S1 DIP-switch settings.	
2. To enter programming mode, set S2 DIP 6 to ON. » the LED  flashes	S2  ⇒ 
3. Refer to the table “Basic configuration” and on S2 set the combination in which the Remote camera module with address 220 (CAM1) [or Remote camera module with address 221 (CAM2)] appears.	Example: S2 
4. Set S1 with address 220 [or 221] in accordance with the “Addressing table” .	
5. Press and release button 3 (for address 220) [or 4 (for address 221)]. » <i>Correct procedure indication</i> : the Lock release LED flashes for a few seconds and a confirmation tone sounds » <i>Procedure error indication</i> : the Audio LED flashes for few seconds and an error tone sounds	
6. Exit programming mode by setting S2 DIP 6 to OFF. » LED  switches off	S2 
7. Set S2 DIP 1-2-3-4 to ON.	
8. Return S1 DIP-switches to the original combination.	

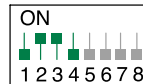

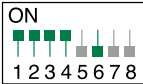







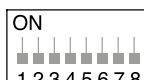
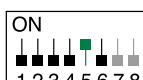

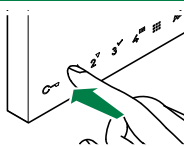
Other functions: button programming

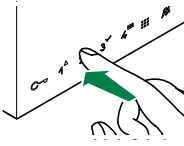
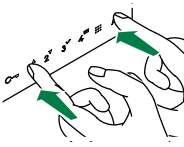
<p>1. To enter programming mode, set S2 DIP 6 to ON. » the LED  flashes</p>	<p>S2  ⇒ </p>
<p>2. Refer to the table “Basic configuration” and set on S2 a combination in which the function associated with the buttons you wish to program appears.</p>	<p>Example: S2 </p>
<p>3. Press and release the button to be associated with the function. » <i>Correct procedure indication:</i> the Lock release LED flashes for a few seconds and a confirmation tone sounds » <i>Procedure error indication:</i> the Audio LED flashes for few seconds and an error tone sounds</p>	
<p>4. Exit programming mode by setting S2 DIP 6 to OFF. » LED  switches off</p>	<p>S2 </p>
<p>5. Set S2 DIP 1-2-3-4 to ON.</p>	

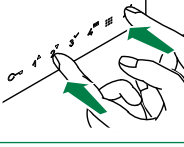

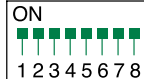
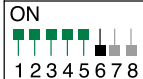
Programming range

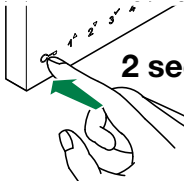
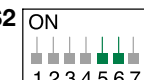
 Take note of the S2, S1 settings and restore on completion of programming

Carry out steps 1 to 4

	1.	2.	3.	4.
<p>Range minimum address</p>	<p>S1  setting a code</p>	<p>S2  </p>		
<p>Range maximum address</p>	<p><u>“Addressing table”</u></p>			
<p>Enable range</p>				
<p>Disable range</p>				
<p>Deleting the range</p>	<p>S1 </p>	<p>S2  </p>	 <p>2 sec</p>	<p>S2  </p>

Changing door entry monitor ringtones

1. Press and hold C→ for 6 sec.
 - » a confirmation tone will sound
 - » the LED  will flash to indicate "programming" mode.
- ✓ the procedure can only take place while the system is in standby; otherwise the LED  will flash 4 times to inform the user that the system is busy
2. Press and release C→
 - Once** (1 confirmation tone is emitted) to change the ringtone for calls from the external entrance panel.
 - Twice** (2 confirmation tones emitted) to change the switchboard ringtone.
 - 3 times** (3 confirmation tones are emitted) to change the ringtone for intercom calls made from the internal unit.
 - 4 times** (4 confirmation tones are emitted) to change the floor door call ringtone.

Any further pressing of the C→ button repeats the sequence described above.
 3. Press and release 1 to scroll through the various available ringtones in sequence.
 4. Press 2 to confirm selection of the last ringtone heard and to exit (at any time) change door entry monitor ringtone mode.
 - » a confirmation tone is emitted
 - » LED  switches off
 5. Repeat steps 1 to 4 to change the other ringtones.

Programming reset

Factory settings:

- Button functions for the S2 DIP 1-2-3-4 combination
- Intercom address absent
- Range function and min./max. addresses absent
- Ringtone reset



Take note of the S2, S1 settings and restore on completion of programming

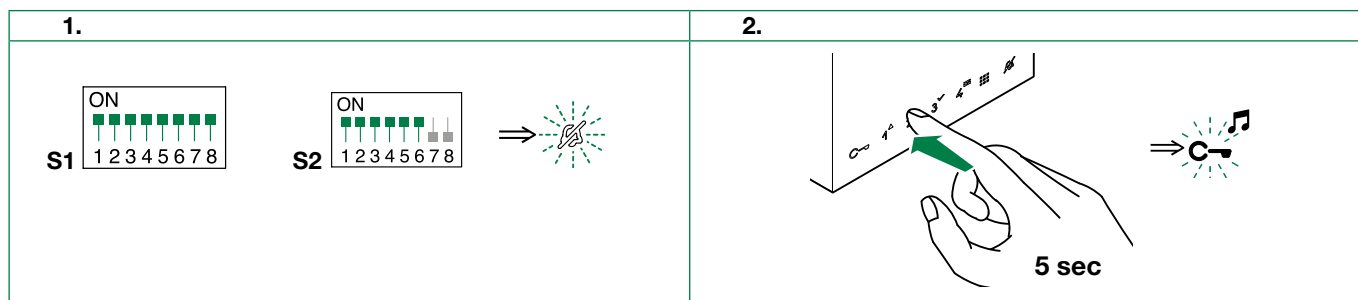

Art. 6741W (/BM) in systems powered by Art. 4888C/4888CU

Max. number of riser-powered 6741W (/BM) with the same user code	1
Call repetition devices that can be used	1229A
Maximum number of internal units (including call repetition devices) with the same user code	4
Maximum number of internal units that can be powered by Art. 4888C / 4888CU	100

Installation rules

- In systems powered by 4888C (4888CU) with a revision index greater than or equal to **053 (014)**, up to 100 door entry monitors can be installed.
- In systems powered by 4888C with a revision index between **021 and 052**, up to 50 door entry monitors can be installed.
- Power supply units 4888C (4888CU) with a revision index prior to **021 (014)** are not compatible for use with 6741W (/BM), and should therefore be replaced.

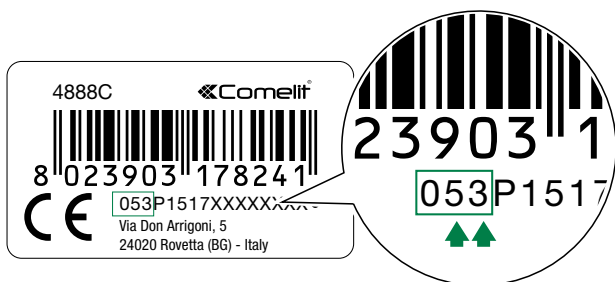

Serial code.

The first 3 digits correspond to the revision index.

New coding from rev. 53

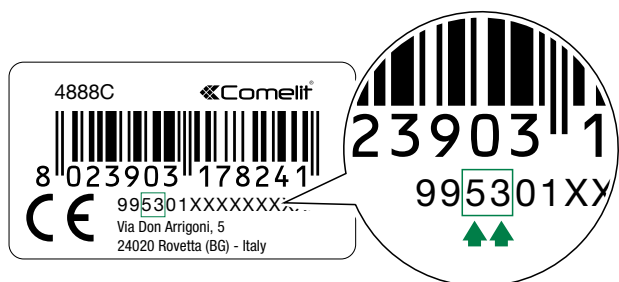





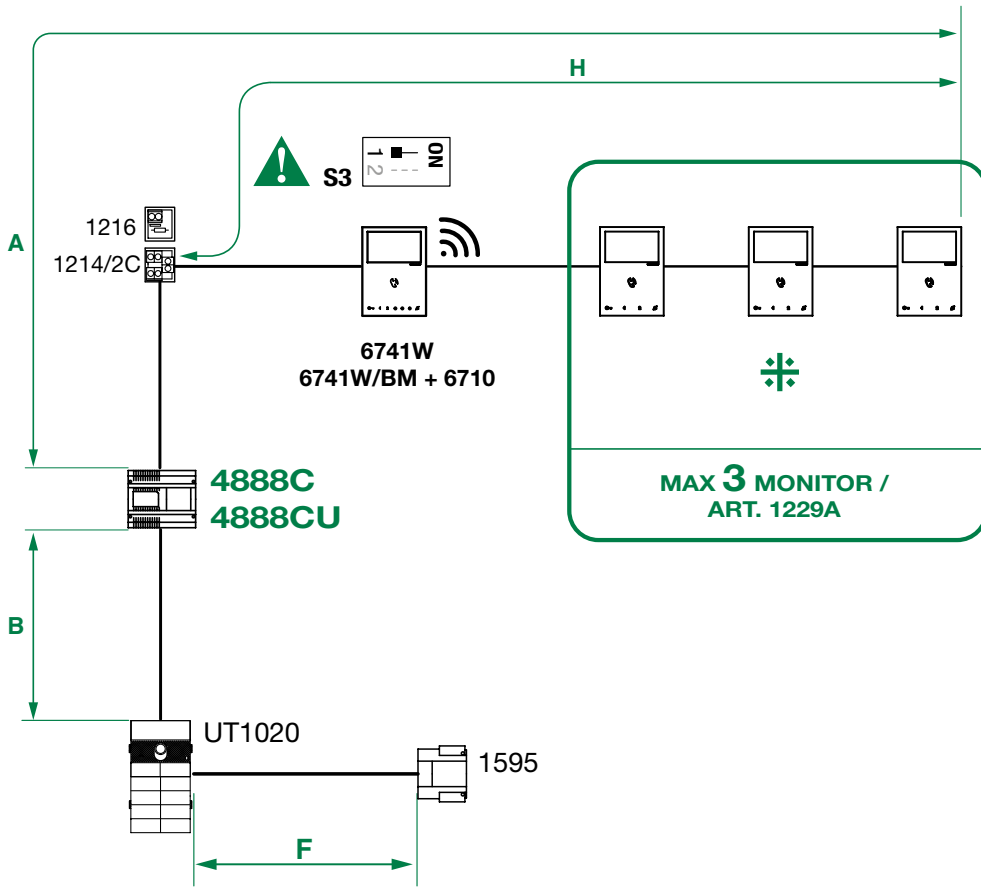

New coding.

The third and fourth digits correspond to the revision index.

Operating distances

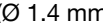
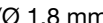

	A max	B max	F max	H max
Comelit Art. 4577/4579 1 mm ² (Ø 1.2 mm AWG 17) 	200 m (655 feet)	200 m (655 feet)	50 m (165 feet)	100 m (330 feet)
UTP5 cat. 5 0.2 mm ² (Ø 0.5 mm AWG 24) 	80 m (260 feet)	150 m (490 feet)		60 m (195 feet)
0.28 mm ² (Ø 0.6 mm AWG 23) 	100 m (330 feet)	150 m (490 feet)	5 m (15 feet)	60 m (195 feet)
0.5 mm ² (Ø 0.8 mm AWG 20) 	120 m (395 feet)	100 m (330 feet)	25 m (85 feet)	60 m (195 feet)
1 mm ² (Ø 1.2 mm AWG 17) 	120 m (395 feet)	150 m (490 feet)	50 m (165 feet)	60 m (195 feet)
1 mm ² (Ø 1.2 mm AWG 17) 	120 m (395 feet)	80 m (260 feet)	50 m (165 feet)	40 m (130 feet)
1.5 mm ² (Ø 1.4 mm AWG 15) 	150 m (490 feet)	100 m (330 feet)	75 m (245 feet)	60 m (195 feet)
2.5 mm ² (Ø 1.8 mm AWG 13) 	150 m (490 feet)	100 m (330 feet)	100 m (330 feet)	60 m (195 feet)

Art. 6741W (/BM) in systems powered by Art. 1210/1210A

Max. number of riser-powered 6741W (/BM) with the same user code	1
Call repetition devices that can be used	1229A
Maximum number of internal units (including call repetition devices) with the same user code	2 in kit mode 4 in building mode
Maximum number of internal units that can be powered by Art. 1210/1210A	100

Operating distances

KIT MODE: MAX 10 MONITORS / ART. 1229A

BUILDING MODE: MAX 100 MONITORS / ART. 1229A

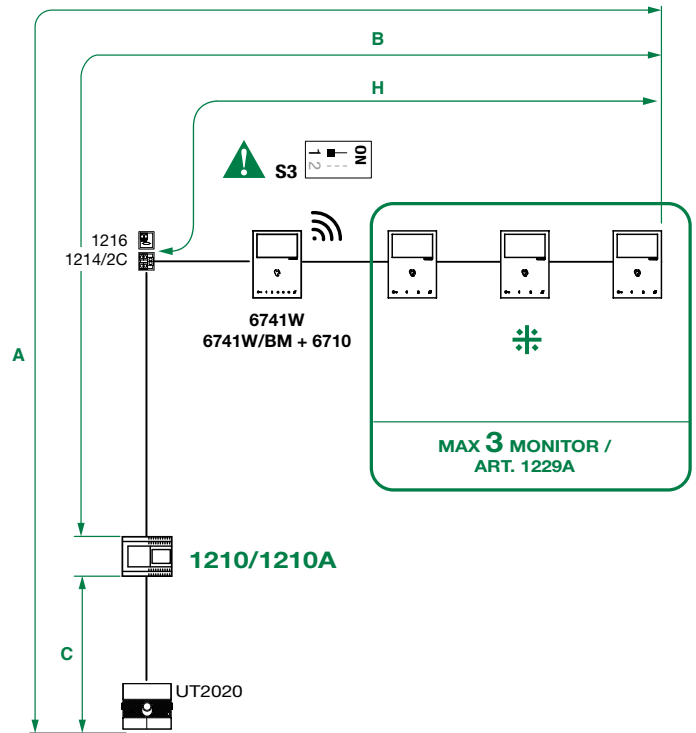
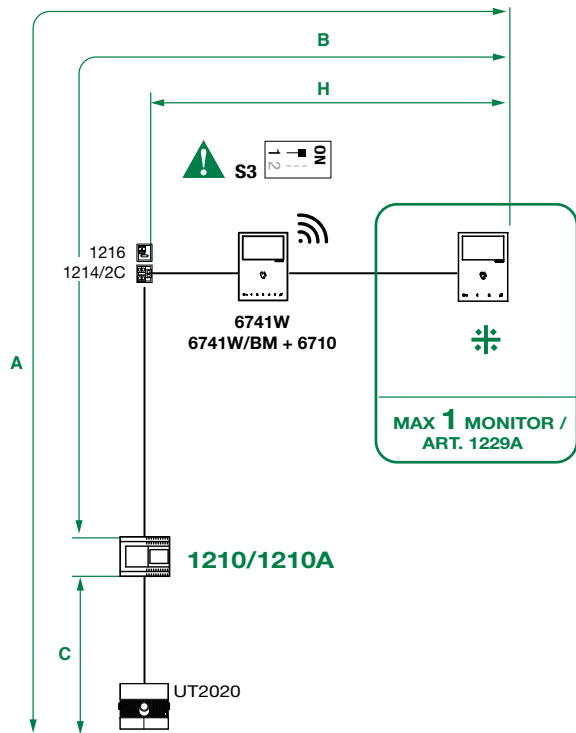

	A max	B max	C max	H max
Comelit Art. 4577/4579 1 mm ² (Ø 1.2 mm AWG 17) 	260 (850 feet)	130 (425 feet)	130 (425 feet)	50 (164 feet)
UTP5 cat. 5 0.2 mm ² (Ø 0.5 mm AWG 24) 	80 (260 feet)	40 (130 feet)	40 (130 feet)	30 (98 feet)
0.28 mm ² (Ø 0.6 mm AWG 23) 	100 (328 feet)	50 (164 feet)	50 (164 feet)	30 (98 feet)
0,5 mm ² (Ø 0,8 mm AWG 20) 	140 (460 feet)	70 (230 feet)	70 (230 feet)	30 (98 feet)
1 mm ² (Ø 1.2 mm AWG 17) 	200 (656 feet)	100 (328 feet)	100 (328 feet)	40 (130 feet)
1.5 mm ² (Ø 1.4 mm AWG 15) 	80 (260 feet)	40 (130 feet)	40 (130 feet)	30 (98 feet)
UTP5 cat. 5 0.2 mm ² (Ø 0.5 mm AWG 24) MULTI PAIR CABLE 	260 (850 feet)	130 (425 feet)	130 (425 feet)	50 (164 feet)









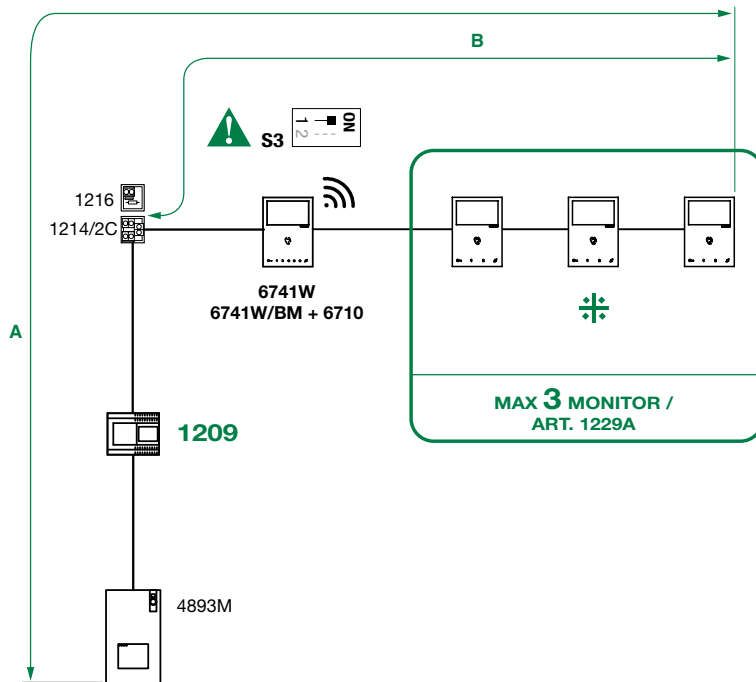

UTP cable with multi-cable connection: FOLLOW THE COLOURS SHOWN IN THE DIAGRAM!

Art. 6741W (/BM) in Kit systems Art. 8451V

Max. number of riser-powered 6741W (/BM) with the same user code	1
Call repetition devices that can be used	1229A
Maximum number of internal units (including call repetition devices) with the same user code	4
Maximum number of internal units that can be powered by Art. 1209	16

Operating distances

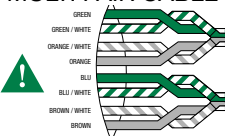

	A max	B max
Cornelit Art. 4577/4579 1 mm ² (Ø 1.2 mm AWG 17) 	200 m (655 feet)	100 m (330 feet)
UTP5 cat. 5 0.2 mm ² (Ø 0.5 mm AWG 24) 	100 m (330 feet)	60 m (195 feet)
0.28 mm ² (Ø 0.6 mm AWG 23) 	100 m (330 feet)	60 m (195 feet)
0.5 mm ² (Ø 0.8 mm AWG 20) 	100 m (330 feet)	60 m (195 feet)
1 mm ² (Ø 1.2 mm AWG 17) 	100 m (330 feet)	60 m (195 feet)
1 mm ² (Ø 1.2 mm AWG 17) 	80 m (260 feet)	40 m (130 feet)
1.5 mm ² (Ø 1.4 mm AWG 15) 	100 m (330 feet)	60 m (195 feet)
UTP5 cat. 5 0.2 mm ² (Ø 0.5 mm AWG 24) MULTI PAIR CABLE 	200 m (655 feet)	70 m (230 feet)



UTP cable with multi-cable connection: FOLLOW THE COLOURS SHOWN IN THE DIAGRAM!

Wiring diagrams

System with Art. 4888C / 4888CU

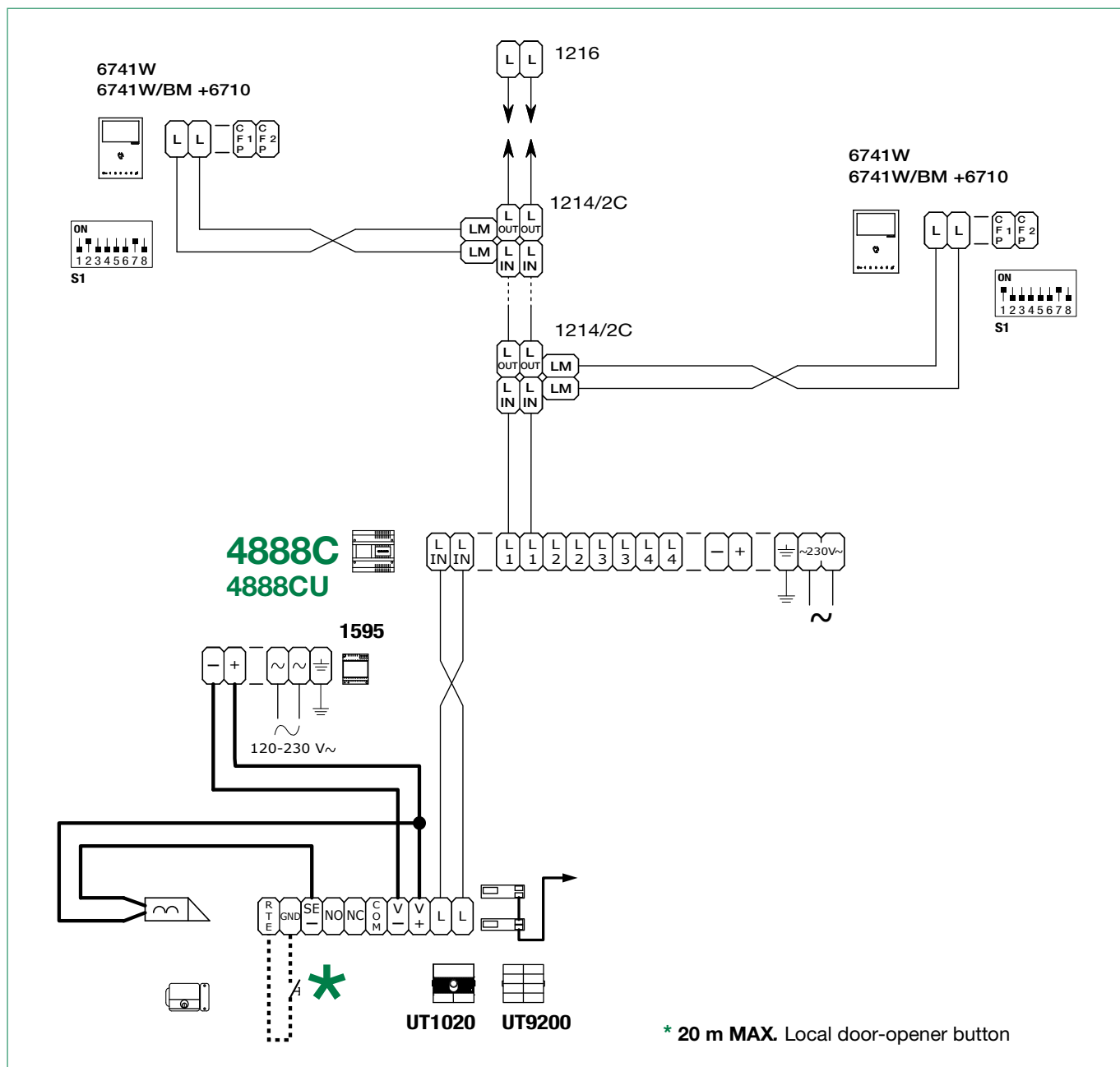

System with Art. 1210/1210A

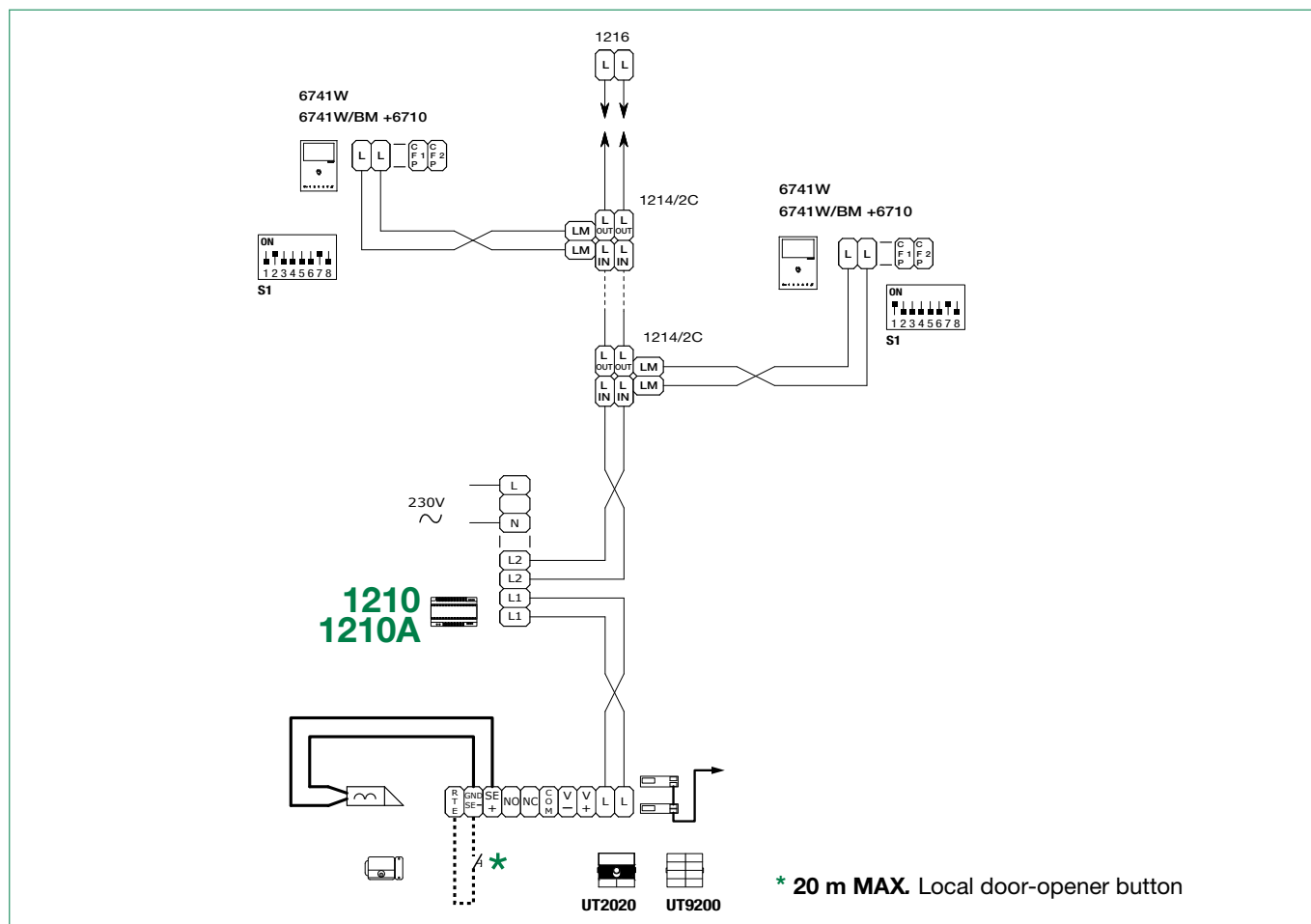

Kit Art. 8461V: basic single-family system with Art. 1209

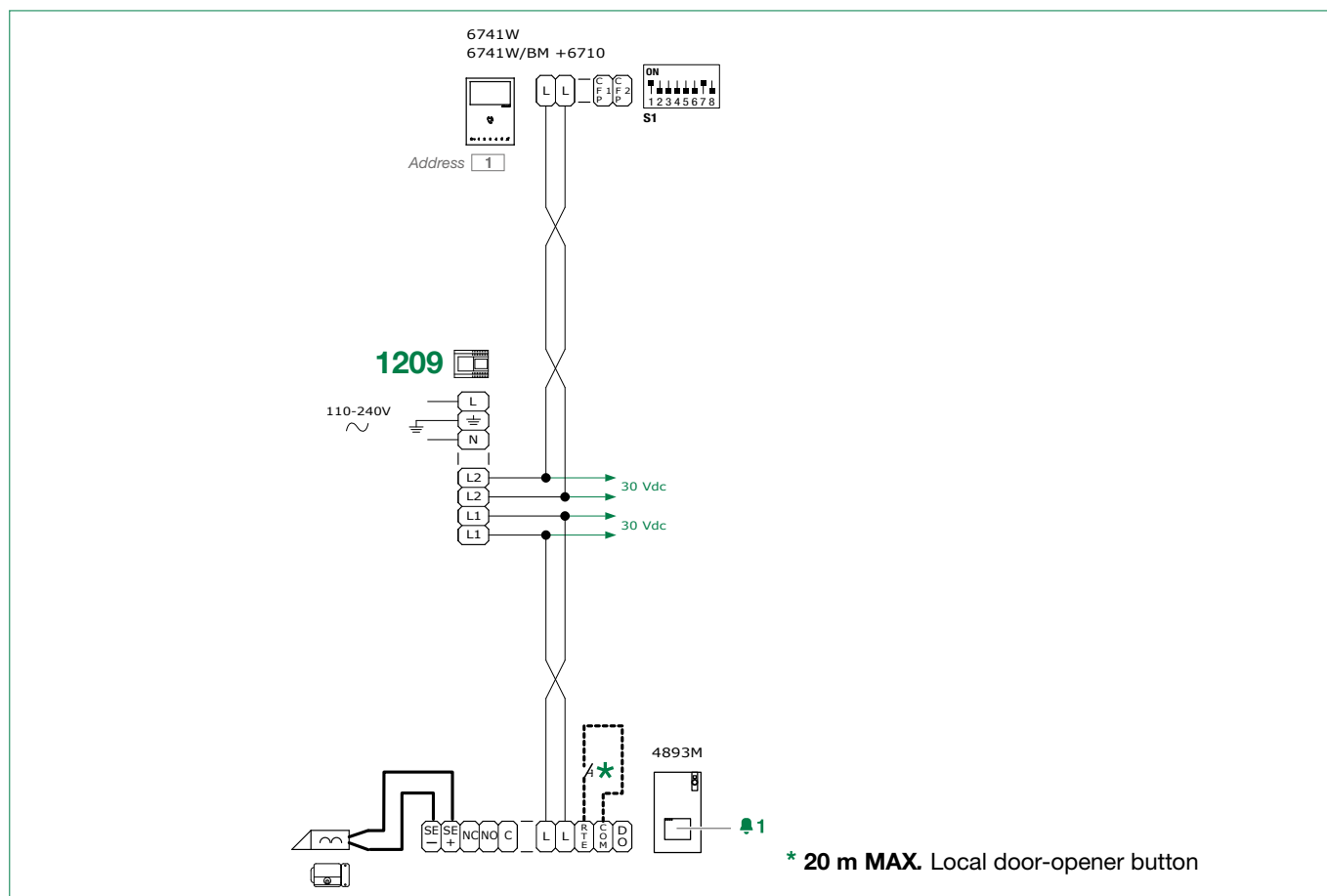

Art. 6741W (/BM) and a secondary door entry monitor in branch connection

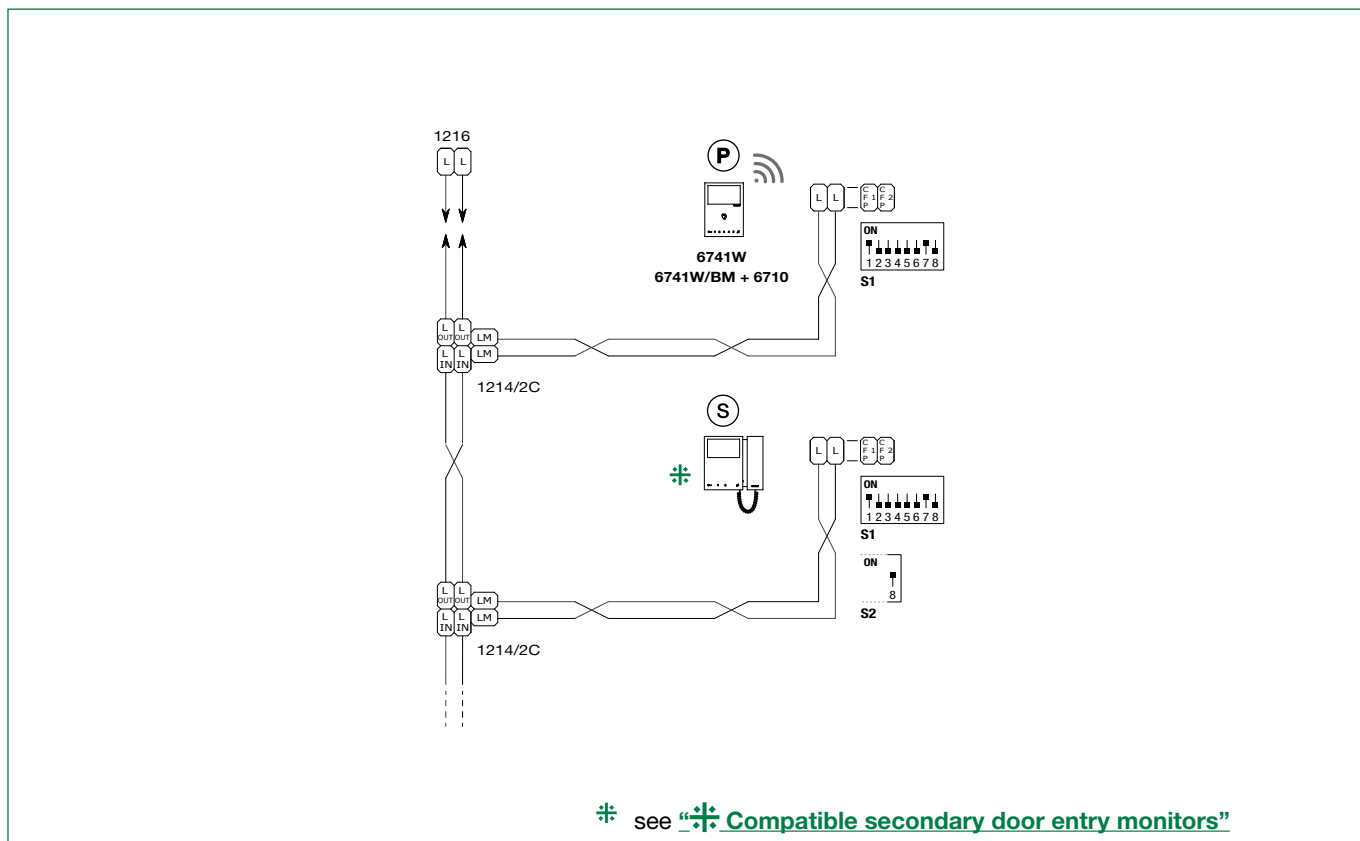

Art. 6741W (/BM) and a secondary door entry monitor 6721W (/BM) in cascade connection

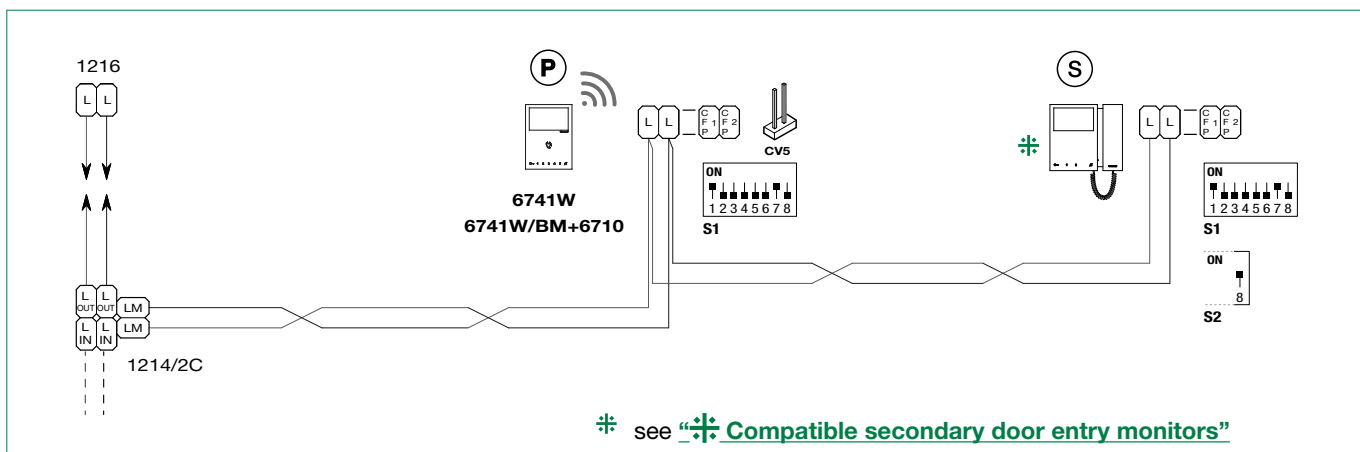

System performance and layouts

For further information of system performance and to view installation layouts, click on the system type that best meets your requirements:

- [Simplebus2 audio/video with 1210/1210A](#)
- [Simplebus2 audio/video with 4888C](#)
- [Audio/Video kit](#)

CERTIFIED MANAGEMENT SYSTEMS



www.comelitgroup.com

Via Don Arrigoni, 5 - 24020 Rovetta (BG) - Italy

