

VARDUS

Loudspeaker Systems



Instruction Manual



Wharfedale

BRITAIN'S MOST FAMOUS LOUDSPEAKERS

IMPORTANT SAFETY INFORMATION

	CAUTION! RISK OF ELECTRIC SHOCK DO NOT OPEN	
TO REDUCE THE RISK OF ELECTRIC SHOCK DO NOT REMOVE COVER (OR BACK) NO USER-REMOVABLE PARTS INSIDE REFER SERVICING TO QUALIFIED PERSONNEL		
ADVERTISSEMENT: RISQUE DE CHOC ELECTRIQUE- NE PAS OUVRIR		



This symbol indicates that there are important operating and maintenance instructions in the literature accompanying this unit.



This symbol indicates that dangerous voltage constituting a risk of electric shock is present within this unit.

Read these instructions.

Keep these instructions.

Heed all warnings.

Follow all instructions.

Do not use this apparatus near water.

Clean only with dry cloth.

Do not block any ventilation openings.

Install in accordance with the manufacturer's instructions.

Do not install near any heat sources such as radiators, heat registers, stoves, or other apparatus (including amplifiers) that produce heat.

Do not defeat the safety purpose of the polarized or grounding type plug. A polarized plug has two blades with one wider than the other. A grounding type plug has two blades and a third grounding prong. The wider blade or the third prong are provided for your safety. If the provided plug does not fit into your outlet, consult an electrician for replacement of the obsolete outlet.

Protect the power cord from being walked on or pinched, particularly at plugs, convenience receptacles, and the point where they exit from the apparatus.

Use only attachments/accessories specified by the manufacturer.



Use only with a cart, stand, tripod, bracket, or table specified by the manufacturer, or sold with the apparatus. When a cart is used, use caution when moving the cart/ apparatus combination to avoid injury from tip-over.

Unplug this apparatus during lightning storms or when unused for long periods of time.

Refer all servicing to qualified service personnel. Servicing is required when the apparatus has been damaged in any way, such as power-supply cord or plug is damaged, liquid has been spilled or objects have fallen into the apparatus, the apparatus has been exposed to rain or moisture, does not operate normally, or has been dropped.

Warning: To reduce the risk of fire or electrical shock, do not expose this product to rain or moisture. The product must not be exposed to dripping and splashing and no object filled with liquids such as a vase of flowers should be placed on the product.

No naked flame sources such as candles should be placed on the product.

Caution: Changes or modifications not expressly approved by the manufacturer could void the user's authority to operate this device.

Warning: The mains power switch for this appliance is located on the rear panel. To permit free access to this switch, the apparatus must be located in an open area without any obstructions.

ESSENTIAL INFORMATION FOR UK USERS

The power cord on your subwoofer may be supplied with a plug incorporating a fuse, the value of which is indicated on the pin face of the plug. Should the fuse need to be replaced, an ASTA or BSI approved BS1362 fuse must be used of the same rating. If the plug is cut off it must NOT be re-used. Dispose of any such plug safely. There is a danger of electric shock if a cut-off plug is inserted into a mains socket.

The wires in the mains lead are coloured in accordance with the following code: Blue - Neutral: Brown - Live.

As the colours of the wires in the mains lead may not correspond with the markings identifying the terminals in the replacement mains plug, proceed as follows:

The wire coloured Blue must be connected to the terminal marked with the letter 'N' or coloured Black. The wire coloured Brown must be connected to the terminal marked with the letter 'L' or coloured Red.

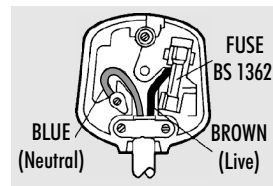

Class II construction double insulated.

This product must not be connected to earth.

PRELIMINARIES

UNPACKING YOUR LOUDSPEAKERS

After taking out the top packing piece, lift the loudspeakers and accessories from the carton. Remove all the protective bags. Do NOT lift the loudspeakers out using the bags.

Accessories provided with each loudspeaker are as follows:

VR-200, 300, 400

- One set of spikes with mounting hardware.
- One set of rubber feet

VR-50, 100

- One set of rubber feet

VR-CEN 1, CEN 2

- No accessories needed

VR-SURR 1, SURR 2

- No accessories needed

VR-10 SUB

- Four floor spikes (attached to the subwoofer)
- IEC power cord suitable for your location

Check all items after unpacking. If any item is missing or damaged, immediately contact your Wharfedale dealer. Retain the packaging. If you dispose of the packing, follow all recycling regulations in your area.



Before installing this product read all these instructions!

Before making any connections, switch all the units in your system off at the mains.

Set the volume control at minimum when you switch on your system or change sources, and turn the level up gradually.

DO NOT use your amplifier at full volume.

Ensure that all loudspeakers in the system are correctly wired.

DO NOT subject your loudspeakers to excessive cold, heat, humidity or sunlight.

DO NOT place heavy objects on top of loudspeakers

DO NOT connect speaker terminals to the mains supply.

DO NOT dismantle the loudspeaker. There are no user serviceable parts inside it and you will void the warranty.

PREPARATION FOR INSTALLATION

Before connecting your system consider where you will place the speakers in the room. This is particularly important if you are wall mounting the centre or surround loudspeakers.

VR-50, 100: These loudspeakers are designed to be mounted on a rigid floor stand. The loudspeaker may also be placed on a sturdy shelf or wall mounted on a suitable wall bracket. Consult your dealer for advice if you are in any doubt.

VR-200, 300, 400: These are floorstanding models. For improved performance the loudspeakers are spike coupled to the floor. Rubber feet are provided as an alternative.

VR-CEN, CEN 2; VR-SURR 1, SURR 2: The centre and surround loudspeakers are intended to be operated attached to the wall via keyhole mounts in the rear of the loudspeaker (see Page 6). Fixings for attaching the loudspeakers to the wall are not supplied.

CONNECTORS AND CABLES

Stereo systems require two lengths of two core cable. 5.1 and 7.1 installations require 5 and 7 lengths respectively. The cables connecting the Front loudspeakers should be the same length and the cables connecting the Surround (and Rear) speakers should also be of equal length. We suggest you use audio cable and not general purpose 'bell' or 'zip' wire.

VR-10 SUBWOOFER:

Ensure there is a mains point within easy reach of the unit.

You will need to purchase a suitable RCA interconnect cable to connect the subwoofer to your pre-amplifier or A/V amplifier (see page 11). This cable must be a high quality fully screened cable. Poorly screened cable is liable to pick up stray hum and interference fields and should be avoided.

CAUTION: When running cables to loudspeakers, do not trail them across open floors where they can be a source of danger. Route them safely, around room boundaries if necessary.

PREPARING FLOORSTANDING LOUDSPEAKERS

ATTACHING THE SPIKES

CAUTION: SPIKES ARE SHARP.

Make sure that there are no wires or hidden obstacles that could be damaged by the spikes in the immediate operational area of the speakers.

NEVER drag a loudspeaker on its spikes. Always lift it. If the item is heavy get assistance.

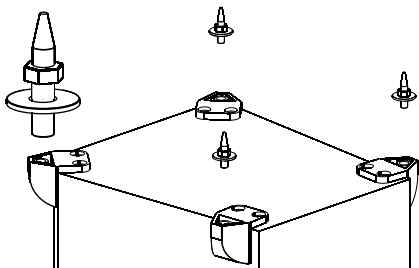

Place a soft cloth on the floor to protect the speaker. Invert the loudspeaker and place it on the cloth.

Thread a locking nut two-thirds of the way up the spike. Place a washer over the spike and insert each spike assembly into a spike mount on the loudspeaker. Tighten the nut finger tight so that the spike is secure but not locked in place.

LEVELLING THE LOUDSPEAKER

After all the spikes are attached, invert the loudspeaker and place it carefully on the floor. Place a spirit level on the speaker

Loosen the nut on each spike one turn. If the floor is not perfectly level you will find that one spike is off the ground. Starting with this spike, unscrew it so that it touches the floor. Move the other spikes in and out so the speaker does not wobble and is level front and back and sideways. Now tighten the nuts to lock the spikes firmly in position

A set of rubber feet is provided as an alternative to spikes.

POSITIONING STEREO LOUDSPEAKERS

The VR-200, 300, and 400 are floor standing. We suggest that they are positioned at least 200 mm from the rear walls and 700 mm from the side walls, facing slightly inwards. The VR-50 and 100 should be stand or wall mounted or placed on a rigid shelf.

The bass extension will improve if smaller speakers are operated closer to the rear walls. If the loudspeakers are placed too close to the walls the bass will increase but may be boomy and indistinct. If the loudspeakers are placed away from the

walls, the inward angle may be increased by up to 40%, but this may restrict the width of the optimum listening position.

A rule of thumb is that the listener should be as far from the loudspeakers as they are from each other. The speakers should ideally be positioned so that the treble units are roughly at ear level to a seated listener. As personal taste plays a large role, experiment with different configurations and play a wide range of programme before finalising the position of your speakers.

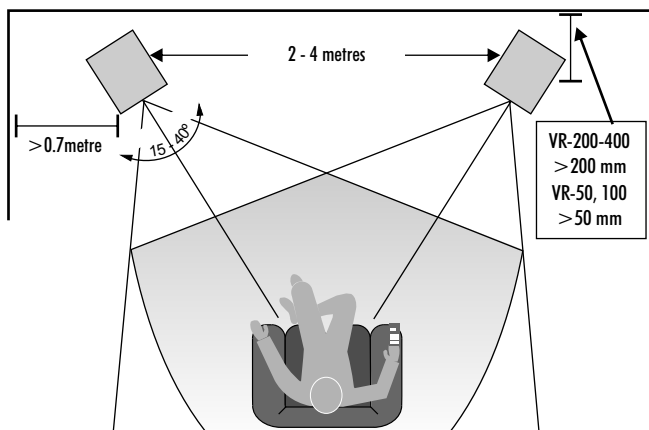

POSITIONING HOME CINEMA LOUDSPEAKERS

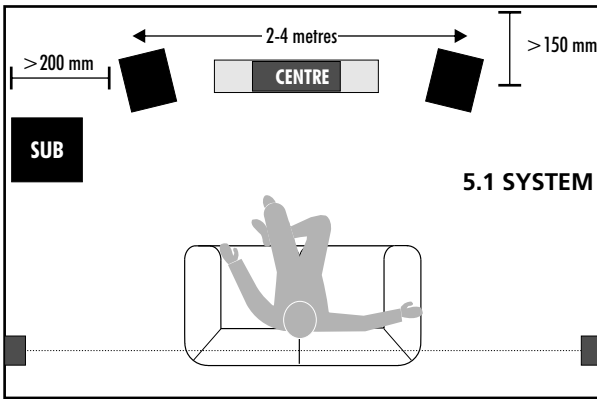

5.1 POSITIONING

Place the front speakers as shown. Front loudspeakers should be placed away from walls for best results. Angling the speakers inward slightly will improve stereo images but too extreme an angle will impair movie sound.

The VR-100 200 and 300 loudspeakers must be placed at least 450mm from a TV screen. The VR-50 may be operated close to a TV screen.

The VR-CEN 1 and CEN 2 centre speakers can be placed above or below the TV screen.

Place the VR-10 SUB subwoofer as close to the wall as you can, leaving just enough space to operate the controls and mains switch. Room positioning is not critical but we recommend that it is placed in front of the listening seat. Never operate the subwoofer within 450mm of a conventional TV screen.

The surround speakers should be placed above and behind the listening seat. They may be mounted on the side walls or on the rear walls but always behind the listener. Do not operate them within 450mm of a TV screen.

If the distance between the side walls is too great, you could use a second pair of stand mounted or floorstanding loudspeakers as the surround loudspeakers, placed as shown in the drawing opposite.

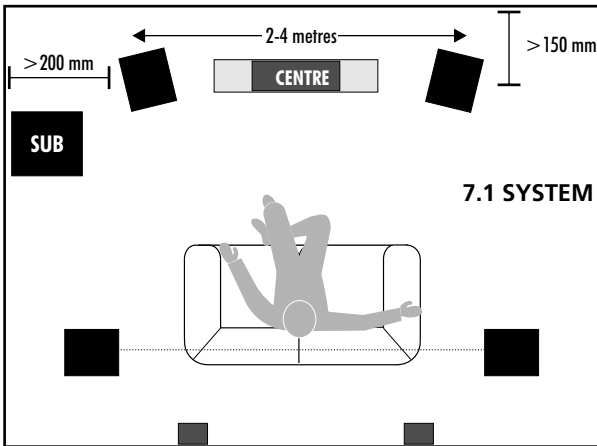

7.1 POSITIONING

If you are using a 7.1 system, the back loudspeakers must be at least 1 metre behind the listening seat.

WALL MOUNTING POSITIONS

If you are wall mounting the centre and effects loudspeakers we recommend that they be mounted as shown.

Wall mounting the centre channel loudspeaker below the screen is not recommended for fixed installations.

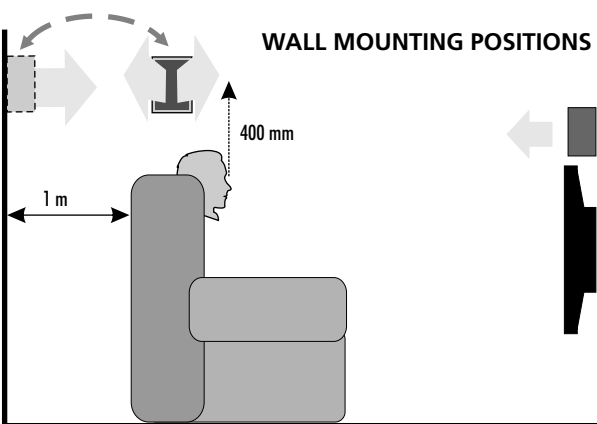



WALL MOUNTING

The Satellite and Centre loudspeakers are provided with integral keyhole mounts for wall mounting.

Wall mounting should be carried out by licensed sound contractors or technicians with appropriate qualifications and experience. All installation and wiring should comply with the relevant standards laid down by the competent authority in the country and place of installation.

Before you attempt wall or ceiling mounting, ensure the surface is stable and strong enough to support the weight of the speaker and mounting hardware.

Determine the location of the loudspeakers. Identify your loudspeaker from the drawings on this page.

VR-CEN 1; VR-CEN 2

You will need 2 No.8 screws and matching wall plugs to attach each loudspeaker to the wall. These are the responsibility of the installer who should supply suitable fixings for this purpose.

Mark off a horizontal line on the wall. Use a spirit level to ensure that the line is accurately drawn. Mark off two points on this line at the mounting centres indicated in the drawings.

Drill two 6mm holes in the wall at the points marked. Fix a suitable No 8 round head screw firmly into each hole using appropriate wall plugs. Leave a stub of 5mm protruding from the wall. Align the holes in the mounting brackets over the screw

heads and carefully lower the unit onto the screws.

Remove the loudspeakers from the wall ready for connection. After connection they can be re-installed on the wall.

VR-SURR 1; VR-SURR 2

You will need one No.8 screw and a matching wall plug per speaker. Proceed as outlined above and attach each loudspeaker to the wall via the single keyhole slot integrated into the crossover connection panel.

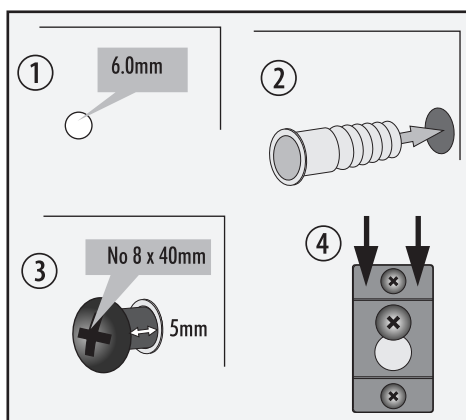

VR-SURR 1

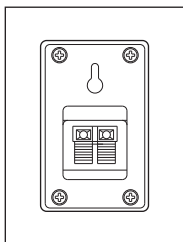

VR-SURR 2

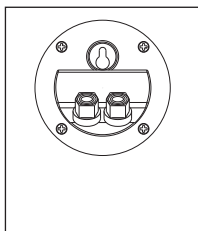

VR-CEN 1

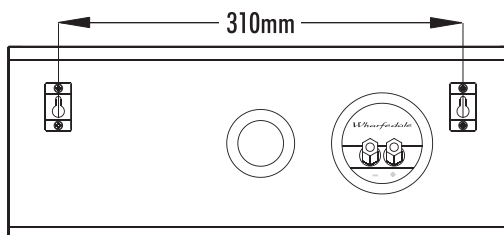

VR-CEN 2

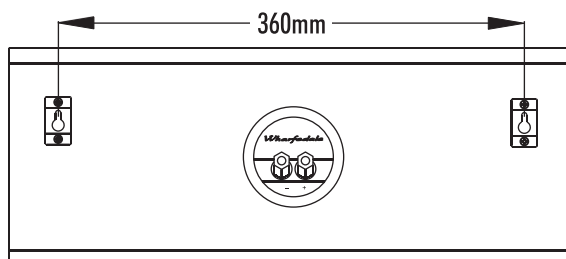

CONNECTING YOUR LOUDSPEAKERS - 1

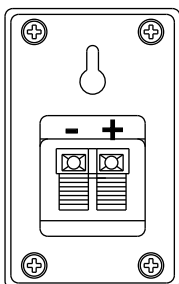

VR-SURR 1

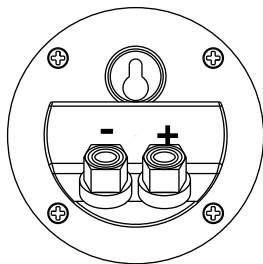

VR-SURR 2

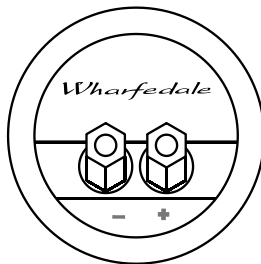

ALL OTHER MODELS

TERMINAL PANELS

All the loudspeakers connect to the amplifier via a twin terminal connecting panel. The positive terminal is located at the right of the panel and is coded Red, The Negative terminal is coded Black.

The VR-SURR 1 uses spring loaded push terminals. All the other models use screw terminals.

CABLE PREPARATION

Prepare a suitable length of loudspeaker cable for each unit. Split the twin cores to a depth of about 40mm. Carefully strip the insulation from each end, leaving about 8mm of bare wire. If the cable is stranded, lightly twist to gather any loose strands.

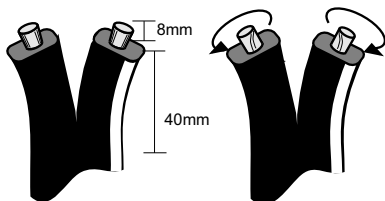

Audio cable is polarised, with two cores of different colours, or often a coloured tracer or identification rib. We suggest that you connect the coloured/striped wire to the RED, Positive terminals of your AV amplifier. This will ensure that all the loudspeakers are connected the correct way round and avoid set-up problems.

CONNECTING THE VR-SURR 1

Press down on a terminal lever. Insert the wire into the terminal. Release the lever. Ensure that the terminal grips the bare wire at the end of the cable, not the insulation.

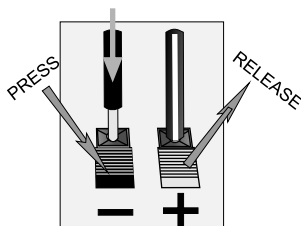

ALL OTHER MODELS

Unscrew a terminal. Thread the bared end of each cable through the hole in the bottom of the terminal post. Ensure that there are no loose strands which may touch adjacent terminals. Retighten the terminal securely.

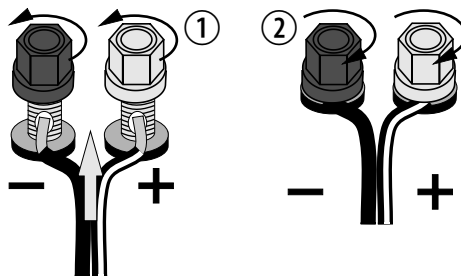

AMPLIFIER - SPEAKER CONNECTIONS

Connect each loudspeaker to the correct channel of your amplifier or AV processor taking care to connect the Red, Positive (+) terminal of the speaker to the Red, Positive (+) terminal of the speaker output terminal of the amplifier, and similarly with the Black, Negative (-) terminal. Use the connection diagrams on the next page to help you.

WALL MOUNTING

If you are wall mounting speakers please follow this procedure.

- 1: Run the cable from the amplifier to the speaker location.
- 2: Connect the cable to the loudspeaker.
- 3: Hang the loudspeaker on the wall.
- 4: Connect the loudspeaker cable to the amplifier.

CONNECTING YOUR LOUDSPEAKERS - 2

STEREO CONNECTIONS

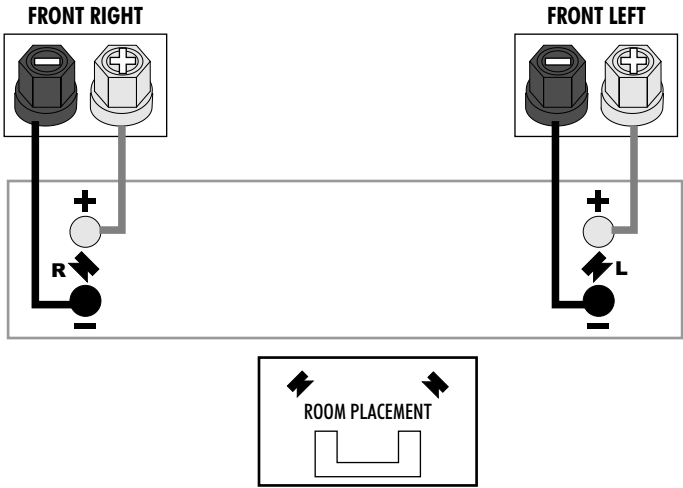

5 CHANNEL CONNECTIONS

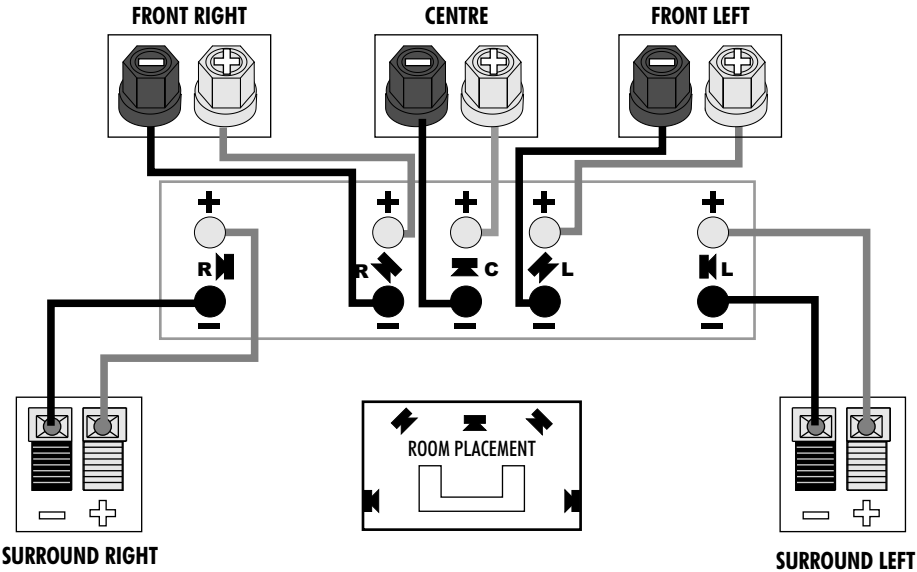

7 CHANNEL CONNECTIONS & PLACEMENTS

7 CHANNEL CONNECTIONS

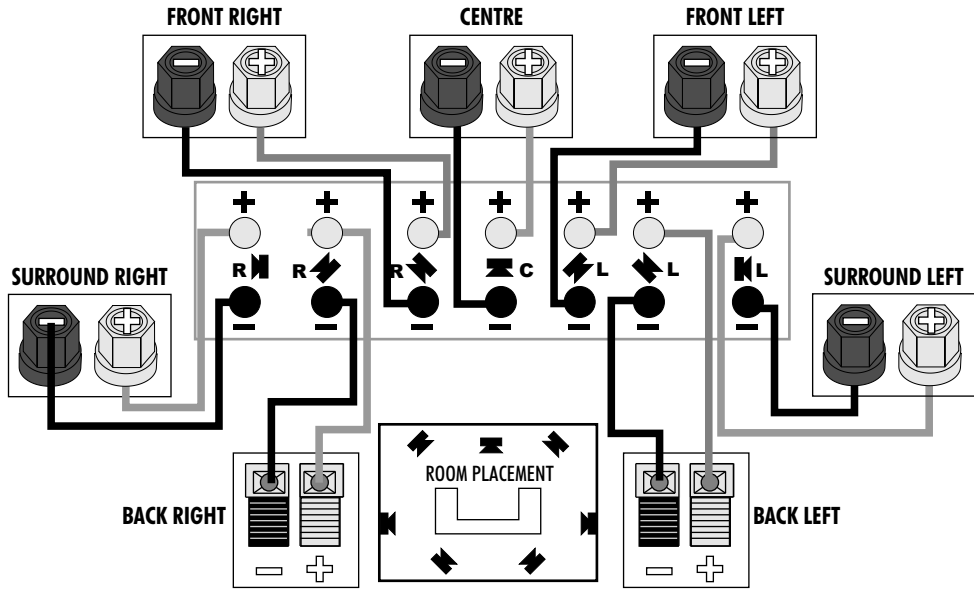

Dolby Labs Recommended 7.1 Placement (Single Back channel for 6.1 shown dotted)

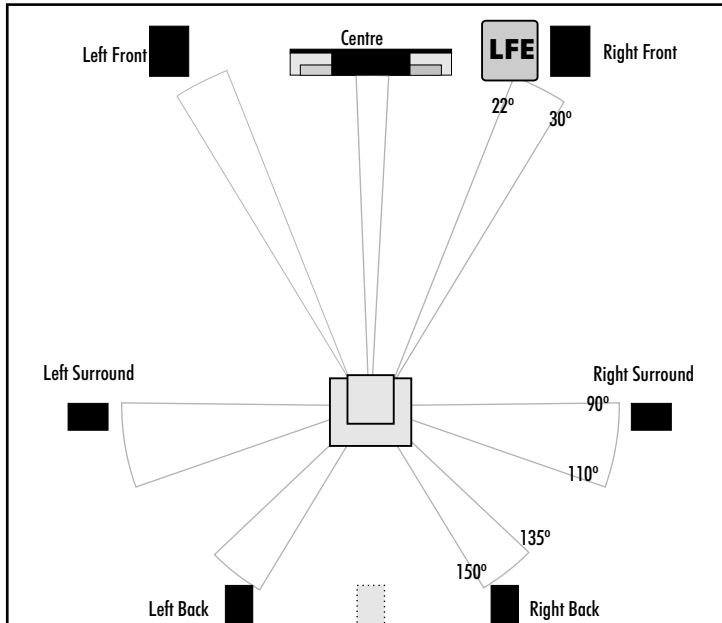

INSTALLING THE VR 10 SUBWOOFER

PRELIMINARIES

Open the carton and remove all the top packing pieces. Lift the subwoofer out taking care not to damage the cabinet. DO NOT lift the subwoofer out of the carton using the protective bag. The unit is heavy; if you cannot manage it easily, get assistance.

Retain the packing materials. If you decide not to keep the packing, please dispose of it having regard to any recycling regulations in your area. Please retain the user manual. If you transfer this equipment to a third party, please ensure all the instructions are passed on with the product.

REAR PANEL CONNECTIONS

- ① Volume Control
- ② Crossover Frequency Control
- ③ Phase Control
- ④ Auto Power Switch
- ⑤ Power ON/OFF Switch
- ⑥ Mains Power Fuse
- ⑦ IEC Mains Input Socket
- ⑧ Speaker Level Inputs
- ⑨ Line Level Inputs
- ⑩ Line Level Outputs

PLACEMENT

Although the unit may be placed almost anywhere in the room, we recommend that it is placed in front of the listener central to the listening position. There should be a mains outlet within easy reach.

The bass port is mounted under the subwoofer firing downward and moves a lot of air at high volume, so make sure the floor is sound. The subwoofer is front-firing so do not place it behind surfaces or objects that may rattle.

POWER CONNECTIONS

This subwoofer is factory set to operate from the mains voltage marked on the amplifier panel. Before connecting check this voltage is correct for your mains supply.

- 230 volt products - 220 volts to 240 volts
- 115 volt products - 110 volts to 120 volts

If you move to an area with a different mains supply, consult your Wharfedale dealer for advice.

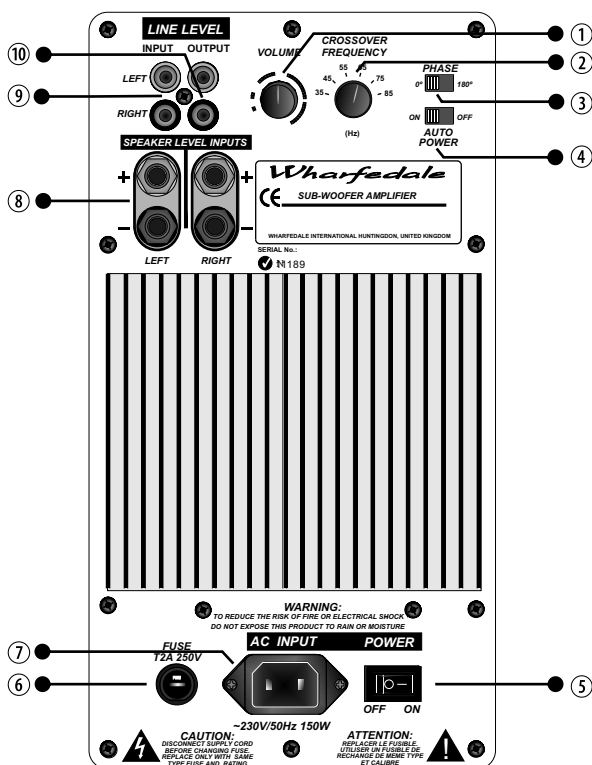

INSTALLING THE VR 10 SUBWOOFER - 2

A/V PROCESSOR CONNECTIONS

Your subwoofer has been designed for optimum performance with a Digital processor. If your AV processor has a line level or LFE subwoofer output you should use this connection. You will need to purchase a single screened RCA phono lead from your dealer. Connect this lead to the Left line input of the Subwoofer as shown below

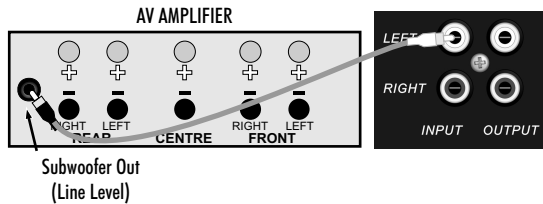

Alternatively, you may use a split mono lead from the processor to both inputs of the subwoofer. In this case the input level at the subwoofer will be slightly higher.

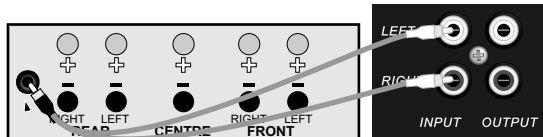

STEREO LINE CONNECTIONS

If your amplifier has a spare preamplifier output or a stereo sub-woofer output, connect the sub-woofer as shown. You will need a stereo screened RCA phono cable.

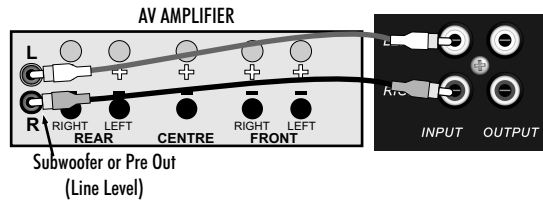

PRE OUT - MAIN IN CONNECTIONS

If you use a stereo pre and power amplifier, or a stereo amplifier where the pre and main amplifier can be separated, connect the sub-woofer as shown. There are two alternative methods.

A: You will need two screened RCA 'Y' adaptors and two single RCA phono cables.

Remove the Pre-Main links on your amplifier. Connect the socket (common) of an RCA 'Y' adaptor to one of the mono cables. Connect one leg of the 'Y' adaptor to the Left Channel Pre Out socket on the amplifier and the other leg to the Left Channel Main In socket. Connect the remaining plug to the Left Channel Line Level Input on the subwoofer. Repeat for the Right Channel.

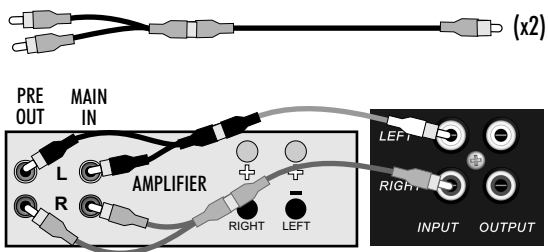

B: You will need two stereo screened RCA cables.

Connect a Stereo cable from the Line Level Inputs of the sub-woofer to the Pre Out sockets of the amplifier. Now connect a second Stereo cable from the Line Level Outputs of the sub-woofer to the Main In sockets of the amplifier. The sub-woofer is now inserted in the system loop.

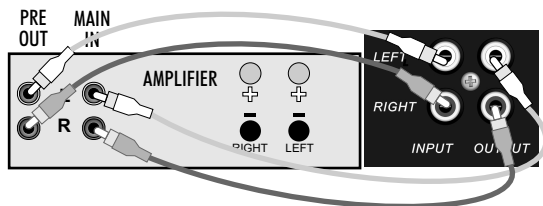

INSTALLING THE VR 10 SUBWOOFER - 3

SPEAKER LEVEL CONNECTIONS

The high level Speaker connections should be used only if your amplifier does not have a line level subwoofer output. In this connection the subwoofer is fed together with the Front loudspeakers. For this you will need two extra twin core cables.

Measure out two loudspeaker cables of the appropriate length. Prepare the cables as described on Page 7.

Connect the Left Speaker Terminals on the sub bass unit to the Front Left speaker terminals on the amplifier. Connect the Red (+) speaker terminal on the amplifier to the Red (+) terminal on the subwoofer. Connect the Black (-) speaker terminal on the amplifier to the Black (-) terminal on the subwoofer. Now connect the Right Speaker terminals on the subwoofer to the Front Right speaker terminals of the amplifier.

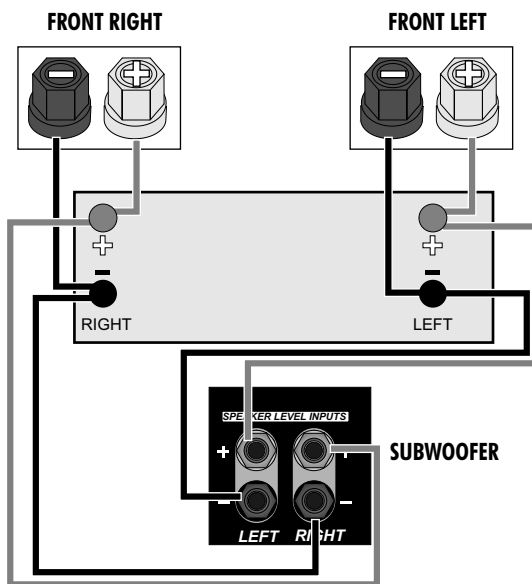

POSITIONING THE VR-10 SUBWOOFER

Although the unit may be placed almost anywhere in the room, even behind the sofa or the TV set, we recommend that it be placed in front of the listener and as central to the listening position as possible. The subwoofer should not be operated within 450mm of a television set as the drive unit magnet may distort the picture.

Place the VR-SUB subwoofer as close to the wall as you can, leaving just enough space to operate the controls and mains switch. A position close to the wall will enhance the bass; If the bass is excessive you can move the subwoofer out from the wall

to a distance of about 200mm from the wall. Placing the subwoofer across a room corner will increase the bass further, possibly at the expense of clarity. Experiment with a variety of locations and sources before making a final decision.

Your system will perform best if there is a clear line of sight between the subwoofer and the listening position.

NOTE: When running signal cables to the subwoofer, keep them clear of obstructions. Do not run a long signal cable close to mains cables or cables carrying heavy digital traffic.

VR 10 SUBWOOFER - OPERATION

SETTING UP

- Set the subwoofer power switch to OFF.
- Turn the system Volume Control to minimum.
- Re-check all system connections.
- Connect the supplied subwoofer power lead to the IEC power socket on the subwoofer and connect the mains plug into the wall socket.
- Set the subwoofer volume control midway (12 o'clock)
- Switch on the mains power.

FINE TUNING

Switch on the subwoofer power switch. Check that the power indicator on the front of the cabinet glows. Now switch on the system. Play a programme with extended bass and set the system volume to a reasonable level. Adjust the subwoofer volume control to produce the desired level of bass.

PHASE SWITCH: If the bass is indistinct or lacks depth, the Phase switch may need adjustment. Set the switch to 0° and listen carefully to some music with extended bass. If there is insufficient bass output from the sub-woofer set the Phase switch to 180°. Select the position which produces the most natural, extended bass.

LOW PASS FILTER. This adjusts the blend between the subwoofer and the main speakers, and enables the system to be set up for optimum bass performance. The higher settings are for use with bookshelf loudspeakers, the lower settings for large floorstanding models. If you choose too low a setting with small speakers, there will be a 'hole' in the bass response; too high a setting with large speakers will result in the upper bass becoming bloated.

AUTO SWITCH. In normal mode the subwoofer is permanently on. This may result in low level hum or noise if the rest of the system is switched off and the subwoofer is left switched on. Setting the AUTO switch to ON automatically turns the subwoofer on when a signal is detected at any of the inputs and turns it off (Standby Mode) after a period of inactivity. We recommend the AUTO switch be set to ON for normal operation.

In AUTO mode the indicator on the front of the subwoofer will glow RED when the unit is in Standby and GREEN when operational. If your subwoofer is disconnected from the mains or the Power switch is "Off", the indicator will be extinguished.

When the system is not in use for extended periods, we suggest you switch off the subwoofer to protect it from switching noises caused by domestic appliances, etc.

HOME THEATRE TOPICS

As the ear is unable to detect the direction from which deep bass originates, this allows freedom in positioning the subwoofer. Varying the distance from the wall alters the amount of bass. Some prefer to place the subwoofer against a room corner. This arrangement gives more bass at the possible expense of clarity.

LOUDSPEAKER SIZES

Many digital AV processors require you to specify the size of speakers in the various channels. These are usually 'Large' or 'Small'. We recommend that you set the centre and surround speakers to 'Small'. This will direct all the bass in the system to the subwoofer and provide clean, deep and louder bass.

Set the VR-50, 100 and 200 to "Small" The VR-400 should be set to "Large". We recommend the VR-300 be set to "Large" though if the bass is excessive, you may wish to set it to "Small".

Set the 'Subwoofer' option on the processor to 'On' or 'Yes'.

SETTING LEVELS

Once the loudspeaker settings have been finalised, put the AV amplifier into its "Test" mode (see your processor instructions), Adjust the levels until all channels are equally loud.

You may need to adjust the subwoofer output level. Avoid setting too high a level or you will swamp the sound with bass which be tiring to listen to and may limit the subwoofer's ability to respond to large bass transients. Set a sensible level going into the subwoofer. The subwoofer volume control should be between 12 o'clock and 3 o'clock .

LFE

The Low Frequency Effects channel was designed as an additional bass channel with its own dedicated subwoofer. In practice however, if all the speakers are set to Small, the LFE channel will be combined with the bass from other channels and all this feeds into the subwoofer. When you set the LFE level from your AV processor, use care with this setting as the LFE channel may contain powerful low frequencies which, although normal in a cinema, may overload a domestic subwoofer.

If, during a programme, you hear popping or thumping noises coming from the subwoofer, immediately turn the AV Processor's volume level down and then back off the LFE level. If this does not cure the problem, back off the volume level at the subwoofer.

Please read the relevant sections of your AV amplifier manual and familiarise yourself with the various issues. If you are unsure, consult your dealer for help.



FURTHER INFORMATION

TROUBLESHOOTING - *Before investigating a problem, always switch off the system at the mains.*

If your system is not working properly please work through this checklist before returning a unit to your dealer.

Symptom	Possible Cause
No Sound	System not switched on; Speaker cables shorting terminals out; Wrong source selected
Sound lacks bass content Bass reproduction indistinct	Front loudspeakers out of phase. Check all system connections and rectify. Subwoofer not switched on; Subwoofer phase incorrect; Subwoofer crossover control too low
Excessive bass distortion at low volumes	Subwoofer level set too high; LFE level set too high; Subwoofer incorrectly wired
Excessive or distorted bass at high levels	System level set too high; Bass control set too high; Speakers too close to room corners
Distorted / rattling sounds at high levels	System level too high; Objects on speakers/subwoofer; Objects too close to subwoofer
Popping or thumping from the subwoofer	System level set high; Subwoofer level set too high; LFE level set too high
Indistinct sound; Poor localisation of effects. Poor localisation of dialogue	One or more loudspeakers is out of phase. Check all system connections and rectify. (Read the manual for correct connection procedure)
Television picture colour is distorted	Subwoofer too close to TV. (Switch off system and TV. Move units away. Leave 15 mins. Switch on.

SPECIFICATIONS

Stand/Bookshelf

Loudspeakers	VR-50	VR-100
Format	Stand: Ported	Stand: Ported
Bass unit	100 mm	150mm
Tweeter	25 mm	25mm
Rec. Amplifier Power	10 -100 W	10 -100 W
Nominal Impedance	6 Ohms	6 Ohms
A/V shielding	Yes	No
Sensitivity (1W @ 1M)	86 dB	87 dB
Freq. Response (-6dB)	65 Hz-20kHz	60 Hz-20kHz
Cabinet Volume	6.2 Litres	10 Litres
Size (H x W x D)	296 x 194 x 200 mm	365 x 224 x 255 mm





SPECIFICATIONS

Front Loudspeakers	VR-200	VR-300	VR-400
Format	Tower: Ported	Tower: Ported	Tower: Ported
ABR/Bass Unit			150mm
Bass unit	150mm	150mm	150mm
Bass mid unit		150mm	150mm
Tweeter	25mm	25mm	25mm
Rec. Amplifier Power	10 -100 W	10 -120 W	10 -150 W
Nominal Impedance	6 Ohms	6 Ohms	6 Ohms
A/V shielding	No	No	No
Sensitivity (1W @ 1M)	88 dB	88 dB	90 dB
Freq. Response (-6dB)	55 Hz-20kHz	50 Hz-20kHz	40 Hz-20kHz
Cabinet Volume	25.8 Litre	27.8 Litres	29.8 Litres
Size (H x W x D)	800 x 223 x 255 mm	860 x 223 x 255 mm	920 x 223 x 255 mm
Size with feet (H x W)	840 x 267 mm	900 x 267 mm	960 x 267 mm

Effects Loudspeakers	VR-CEN 1	VR-CEN 2	VR-SURR 1	VR-SURR 2
Format	Centre; Ported	Centre	Surround; Ported	Surround
Bass/Bass mid unit	2 x 100 mm	4 x 100 mm	75 mm	100 mm
Tweeter	25 mm	25 mm	22 mm	25 mm
Rec. Amplifier Power	10 -100 W	10 -150 W	10 -100 W	10 -100 W
Nominal Impedance	6 Ohms	6 Ohms	6 Ohms	6 Ohms
A/V shielding	Yes	Yes	No	Yes
Sensitivity (1W @ 1M)	89 dB	90 dB	87 dB	86 dB
Freq. Response (-6dB)	80 Hz - 20 kHz	70 Hz - 20 kHz	110 Hz - 20 kHz	80 Hz - 20 kHz
Cabinet Volume	4.6 Litres	5.5 Litres	1.25 Litres	3.2 Litres
Size (H x W x D)	148 x 385 x 130 mm	168 x 436 x 150 mm	150 x 115 x 110 mm	240 x 164 x 115 mm

Subwoofer	VR- 8 SUB	VR-10 SUB
Format	Reflex	Reflex
Bass Woofer	200mm	250 mm
A/V shielding	No	No
Amplifier Power	100 Watts	150 Watts
Input Sensitivity	250mV at 75 W output	300mV at 100W output
Avg. Max Output at 1 metre	107dB	110dB
Freq. Response (boundary pos)	38 Hz - 110 Hz	35 Hz - 110 Hz
Crossover Range	35- 85Hz	35- 85Hz
Cabinet Volume	17.4 Litres	31 Litres
Size inc feet (H x W x D)	350 x 300 x 325mm	400 x 350 x 380 mm



SERVICE AND WARRANTY

CARE AND MAINTENANCE

If you play the speakers with the grilles off exercise great care. NEVER touch the drive units which are easily damaged.

The loudspeaker cabinets can be cleaned with a damp cloth or with a spray furniture polish and a soft cloth. Apply the spray sparingly to the cloth and then polish the cabinet. Never apply spray directly to the cabinet.

GUARANTEE & SERVICE

In the unlikely event that your unit develops a fault you should return it to your Wharfedale dealer using the original packing to ensure safe shipping.

The terms of your guarantee may vary in different countries but in all cases the guarantee excludes:

All damage caused through accident, misuse, wear and tear, neglect, incorrect installation, adjustment or repair by unauthorised personnel. Liability for damage or loss occurring in transit to or from the purchaser.

Wharfedale will not be liable for any consequential damage, loss or injury, arising from or in conjunction with this equipment.

AUTHORISED SERVICE CENTRES

UK

Wharfedale International Ltd. IAG House, Sovereign Court, Ermine Business Park, Huntingdon, Cambs PE29 6XU, England.
Tel: +44 (0)1480 447700 Fax: +44 (0)1480 43176

ASIA

IAG. Room 2310 - 2311, Press Building, Shennan Road C, Shenzhen, China.
Tel: +86-755-82091200 Fax: +86-755-82091205

USA

IAG America, Inc. 8440 154th Avenue NE, Redmond, Washington 98052 USA
Tel: +1 425 861 3909 Fax: +1 425 861 390

For information on other authorised service centres worldwide contact Wharfedale International in the U.K.

A worldwide distributor list is available on the Wharfedale website: www.wharfedale.co.uk

Wharfedale has a policy of continuous product development and reserves the right to change specification without notice.

The name 'WHARFEDALE' is a registered trademark of Wharfedale International Ltd. Wharfedale is a member of the International Audio Group

Wharfedale

Wharfedale International Ltd., IAG House, Sovereign Court, Ermine Business Park, Huntingdon, Cambs PE29 6XU, England.

Tel: +44 (0)1480 447700 www.wharfedale.co.uk

Wharfedale is a member of the International Audio Group.