

# ClearOne®

**DIALOG® 20 and DIALOG® 10 USB  
Wireless Microphone Systems**

## **Antenna Installation Guide**



# **ClearOne® DIALOG® 20 and DIALOG® 10 USB**

---

The ClearOne DIALOG 20 and DIALOG 10 USB Wireless Microphone System Receivers include two, built-in, passive antennas. When using a ClearOne DIALOG 20 or DIALOG 10 USB Antenna Cable Kit, the antennas can be extended to either 10' or 25' lengths in each direction easily accommodating most conferencing requirements and room types. These Plenum rated antennas adhere to most municipal fire codes, and therefore, they can be extended inside ceiling crawl spaces for discreet installation. The available transmitters include: Boundary tabletop, Gooseneck podium, Handheld and Beltpack.

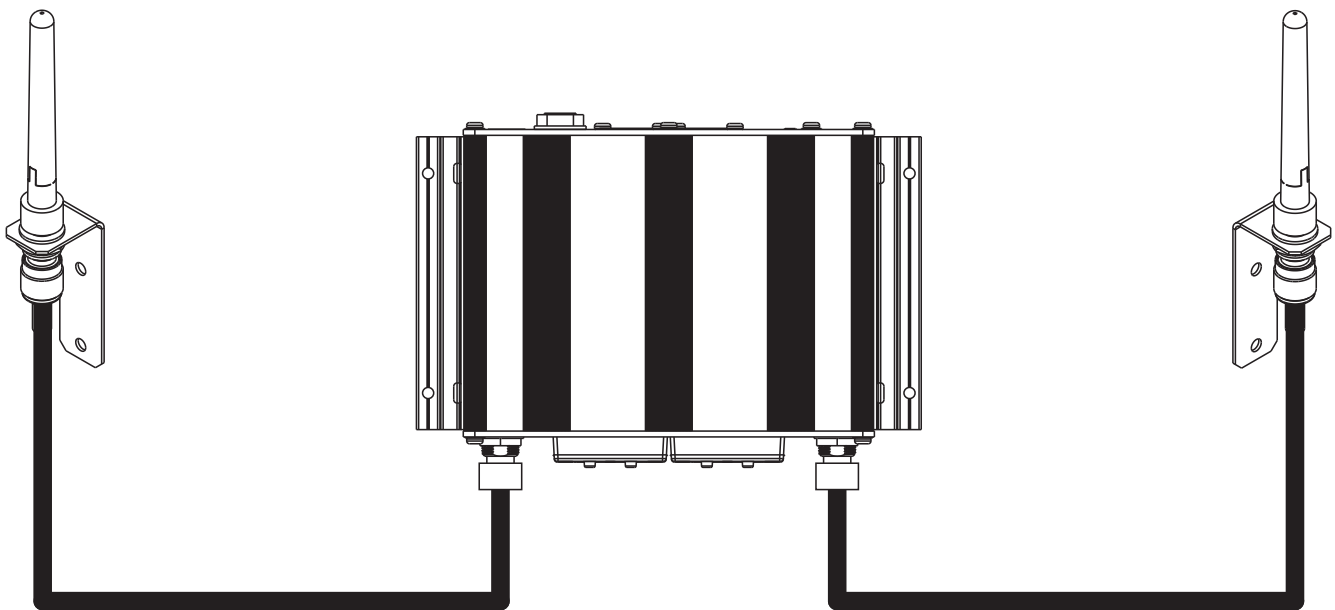

Example of “A” and “B” antennas with antenna kit configuration.

# ClearOne® DIALOG® 20 and DIALOG® 10 USB

## Receiver Mounted Antennas:

DIALOG 20 and DIALOG 10 USB Receivers come with two, Plenum rated, dipole antennas.

- Mount the antennas on the front of the receiver using a non-conductive adhesive on the threads of the Female TNC Connector.
- Tilt the antennas slightly outward.

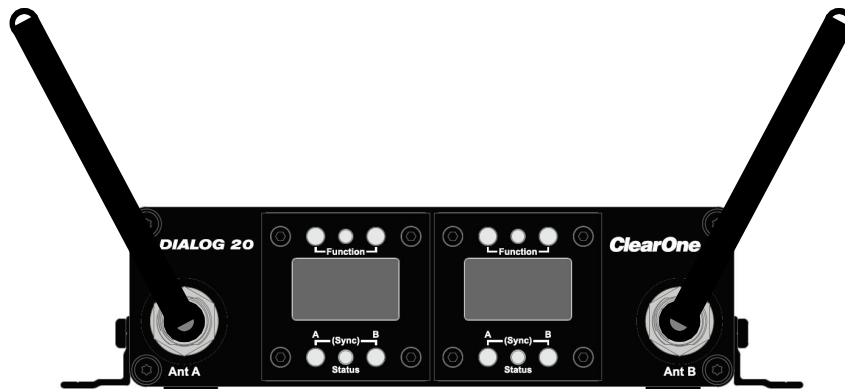

## Antenna Cable Kits:

DIALOG 20 and DIALOG 10 USB Antenna Cable Kits are available in two lengths.

The DIALOG Antenna Cable kit can be used to extend the passive, Plenum rated, dipole antennas that are included with the DIALOG 20 and DIALOG 10 USB Receivers.

Choose either a 10' (ft) or 25' (ft) Antenna Cable Kit.

Includes required hardware. Does not include antennas or adhesive.

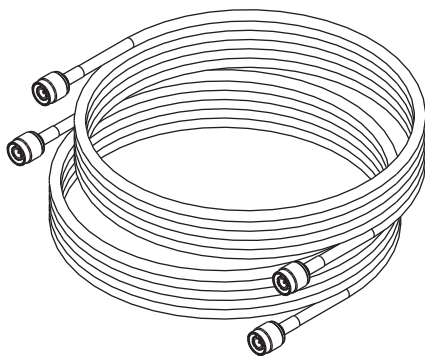

10' (ft) length for small rooms  
(RG58 Plenum Cable)  
SKU: 910-6105-011

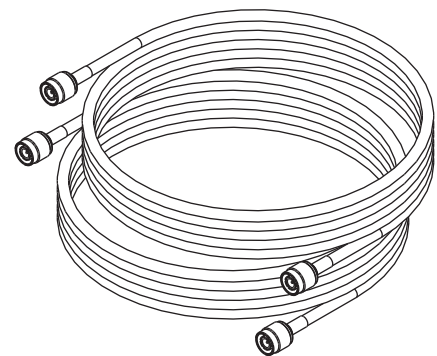

25' (ft) length for large rooms  
(RG8 Plenum Cable)  
SKU: 910-6105-021

# ClearOne® DIALOG® 20 and DIALOG® 10 USB

Confirm the Box Contains the Following:

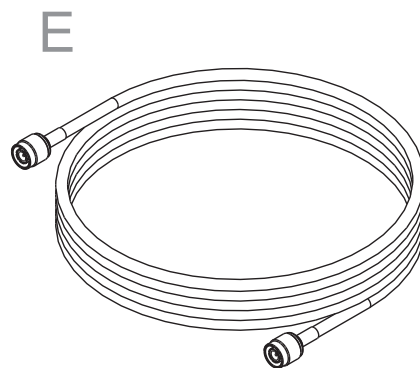
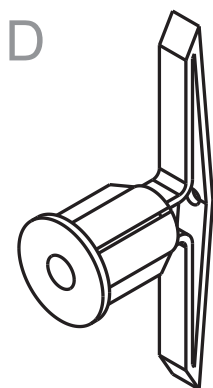
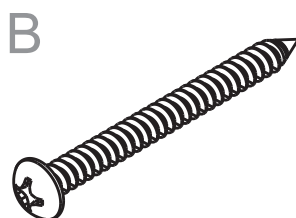
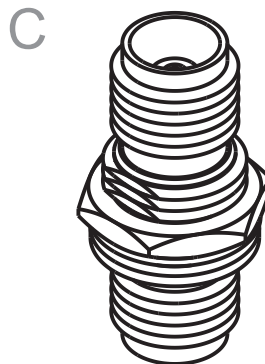
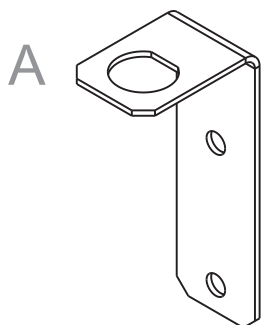
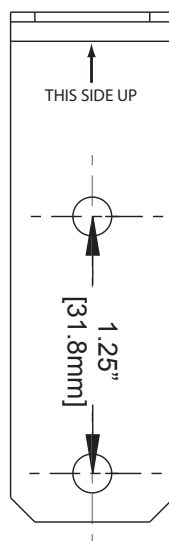
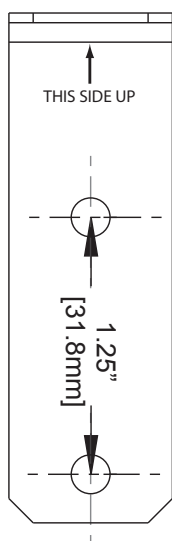

Fig. 1  
Bracket  
Hole  
Templates  
(Actual Size)



Use these cable extension bracket templates to mark the pilot holes.

# ClearOne® DIALOG® 20 and DIALOG® 10 USB

## Hollow Wall Antenna Installation:

1 Determine required mounting location.

2 Using the antenna extension brackets or the templates (fig. 1; Pg. 2), mark the two (2) mounting hole locations.

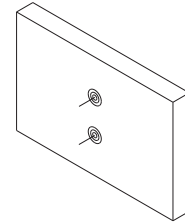

Fig. 2  
Wall  
Anchor

3 Drill two 5/16" (8mm) pilot holes (Fig 2).

4 Fold the anchor (D) in the middle by pressing in middle with finger (Fig. 3).

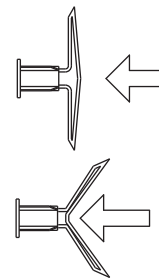

Fig. 3  
Wall  
Anchor

5 Insert anchor in hole and tap flush with a hammer (Fig. 4).

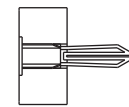

Fig. 4  
Wall  
Anchor  
Flush

6 Use nail or small screwdriver to pop anchor open behind hollow wall (Fig. 5; not necessary for thick or solid walls).

**Do not hammer nail or screwdriver.**

7 Remove the nail or screwdriver.

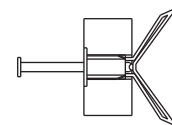

Fig. 5  
Wall Anchor  
open in wall

8 Repeat steps 4 - 7 for the second anchor.

**To avoid interference, only one anchor should be installed vertically.**

9 Secure antenna extension bracket (A) using two (2) wood screws (B) (Fig 6). Do not overtighten screws.

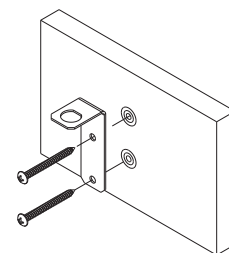

Fig. 6  
Secure  
Bracket to  
Wall

**Hollow wall anchors (D) may be used as wedge anchors in walls thicker than 3/4" or as expansion anchors in solid walls.**

# ClearOne® DIALOG® 20 and DIALOG® 10 USB

---

## Wood Stud Antenna Installation:

- 1 Determine required mounting location.
- 2 Using the antenna extension bracket or the template (fig. 1; pg. 2), mark two (2) mounting hole locations.
- 3 Drill two 7/64" (2.5mm) pilot holes to a depth of 1-3/4" (45mm).
- 4 Secure the antenna extension bracket (A) to the structure using two (2) wood screws (B) (Fig. 7).

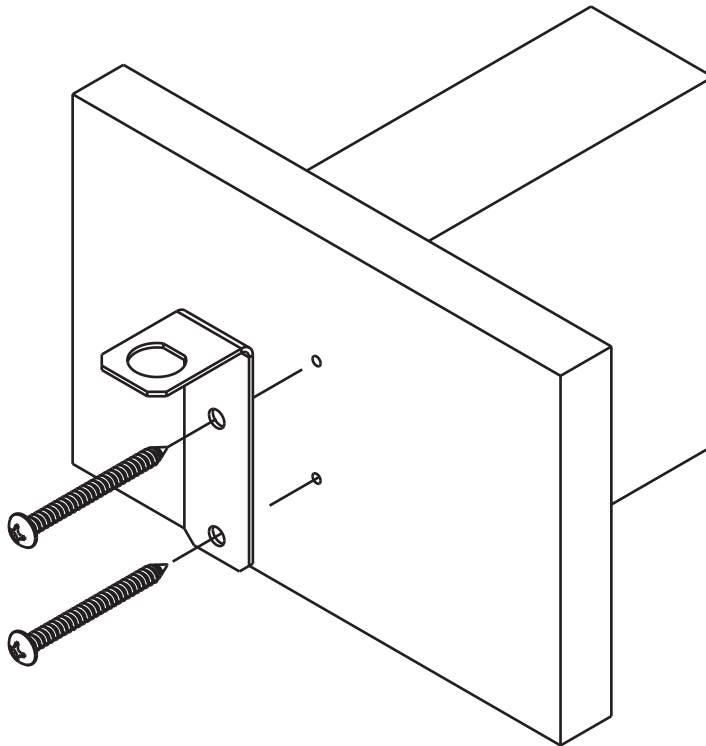

Fig. 7  
Wood Stud  
Wall Mount  
Installation

# ClearOne® DIALOG® 20 and DIALOG® 10 USB

## Mounting Antennas to Wall, Ceiling or AV Rack:

1 Mount antenna over-head and within line of site to transmitters. The dipole antenna's reception is strongest at the sides of the antenna with a null point at the tip. Therefore, it is best to tilt the antenna so that the side faces the transmitters.

- Wall Mount (Fig. 8).
- Ceiling Mount (Fig. 9, 10, 11).
- Ceiling Mount RX with PoE to CONVERGE Pro 2 or Beamforming Mic Array 2 (Fig. 11).
- AV Rack Mount (Fig. 12).

2 Separation distance of antennas should be a minimum of 2' (ft.) and maximum of 30' (ft.).

3 Attach TNC panel mount connector (C) and permanently secure both the antenna and the extension cable (E) to the antenna extension bracket (A) by using a non-conductive adhesive on the threads of both sides of the TNC Panel Mount Connector (Fig. 8).

4 Attach the other end of the extension cable to the Dialog 20 Receiver and secure by using a non-conductive adhesive on the threads of the Female TNC Connector.

5 Repeat steps 1 to 4 for the second antenna and extension cable.

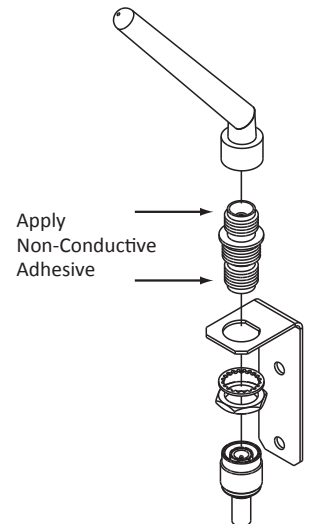

Fig. 8 Antenna Bracket Assembly Wall Mounted

## Suggested Mounting Options:

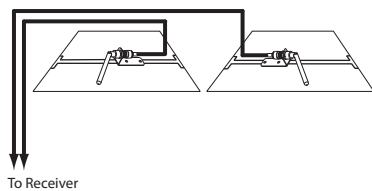

Fig. 9  
Plenum Rated Antennas Mounted in the Crawl Space above the Ceiling Tiles using 3rd party "T-Bracket".

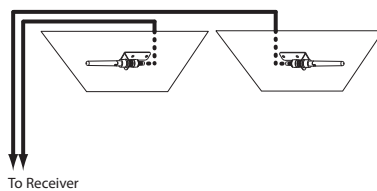

Fig. 10  
Plenum Rated Antennas Mounted below the Ceiling Tiles.

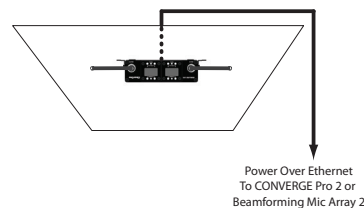

Fig. 11  
Receiver Mounted on Outside of Ceiling Tile with PoE to CONVERGE Pro 2 or Beamforming Mic Array 2

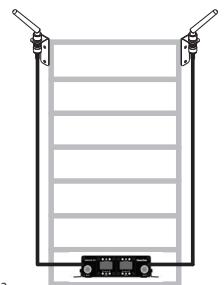

Fig. 12  
Antenna Position AV Rack Mounted

Professional installation is required. Installer is responsible for securing antennas with a non-conductive adhesive and ensuring mounting hardware is appropriate to their particular installation.



# ClearOne®

## CLEARONE LOCATIONS

---

### HEADQUARTERS:

**Salt Lake City, UT USA**  
5225 Wiley Post Way  
Suite 500  
Salt Lake City, UT 84116

**Tel:** 801.975.7200  
**Toll Free:** 800.945.7730  
**Fax:** 801.303.5711  
**e-mail:** sales@clearone.com

### EMEA

**Tel:** 44 (0) 1189.036.053  
**e-mail:** global@clearone.com

### APAC

**Tel:** 852.3590.4526  
**e-mail:** global@clearone.com

### LATAM

**Tel:** 801.974.3621  
**e-mail:** global@clearone.com

### TechSales

**Tel:** 800.707.6694  
**e-mail:** techsales@clearone.com

### Technical Support

**Tel:** 800.283.5936  
**e-mail:** tech.support@clearone.com