



Maintenance and Service Guide

HP ProDesk 400 G5/G6 SFF

© Copyright 2019 HP Development Company, L.P.

Product notice

Bluetooth is a trademark owned by its proprietor and used by HP Inc. under license. Intel, Core, Celeron, and Pentium are trademarks of Intel Corporation or its subsidiaries in the U.S. and/or other countries. Microsoft and Windows are either registered trademarks or trademarks of Microsoft Corporation in the United States and/or other countries. SD Logo is a trademark of its proprietor.

This guide describes features that are common to most models. Some features may not be available on your computer.

Not all features are available in all editions of Windows 10. This computer may require upgraded and/or separately purchased hardware, drivers and/or software to take full advantage of Windows 10 functionality. See <http://www.microsoft.com> for details.

The only warranties for HP products and services are set forth in the express warranty statements accompanying such products and services. Nothing herein should be construed as constituting an additional warranty. HP shall not be liable for technical or editorial errors or omissions contained herein.

The information contained herein is subject to change without notice. The only warranties for HP products and services are set forth in the express warranty statements accompanying such products and services. Nothing herein should be construed as constituting an additional warranty. HP shall not be liable for technical or editorial errors or omissions contained herein.

Second Edition: November 2019

First Edition: January 2019

Document Part Number: L17239-002

Software terms

By installing, copying, downloading, or otherwise using any software product preinstalled on this computer, you agree to be bound by the terms of the HP End User License Agreement (EULA). If you do not accept these license terms, your sole remedy is to return the entire unused product (hardware and software) within 14 days for a full refund subject to the refund policy of your seller.

Table of contents

1 Product features	1
Standard configuration features	1
Front panel components	2
Rear panel components	3
2 Illustrated parts catalog	4
Serial number location	4
Computer major components	4
Miscellaneous parts	8
3 Routine care, SATA drive guidelines, and disassembly preparation	25
Electrostatic discharge information	25
Generating static	25
Preventing electrostatic damage to equipment	26
Personal grounding methods and equipment	26
Grounding the work area	26
Recommended materials and equipment	27
Operating guidelines	27
Routine care	28
General cleaning safety precautions	28
Cleaning the computer case	28
Cleaning the keyboard	28
Cleaning the monitor	29
Cleaning the mouse	29
Service considerations	29
Tools and software requirements	29
Screws	29
Cables and connectors	30
Hard Drives	30
Lithium coin cell battery	30
SMART ATA drives	30
4 Removal and replacement procedures	31
Preparation for disassembly	31
Access panel	32
Optical drive	33

Front bezel	34
Drive cage	35
Hard drives	36
Memory card reader	38
WLAN module	39
Memory module	40
Speaker	41
Power supply	42
Fan shroud	43
Fan-sink	44
Processor	45
Serial connector module	47
System board	48

5 Computer Setup (F10)Utility 51

Computer Setup (F10)Utilities	51
Using Computer Setup (F10)Utilities	52
Computer Setup—Main	53
Computer Setup—Security	55
Computer Setup—Advanced	57
Recovering the Configuration Settings	62

6 Troubleshooting without diagnostics 63

Safety and comfort	63
Before you call for technical support	63
Helpful hints	64
Solving general problems	65
Solving power problems	68
Solving hard drive problems	69
Solving media card reader problems	71
Solving display problems	72
Solving audio problems	76
Solving printer problems	78
Solving keyboard and mouse problems	79
Solving hardware installation problems	81
Solving network problems	82
Solving memory problems	85
Solving USB flash drive problems	86
Solving front panel component problems	87
Solving Internet access problems	87
Solving software problems	88

7 POST error messages and diagnostic front panel LEDs and audible codes	89
POST numeric codes and text messages	89
Interpreting system validation diagnostic front panel LEDs and audible codes	94
8 Password security and resetting CMOS	96
Resetting CMOS and/or the password jumper	97
Changing a Setup or Power-on password	99
Deleting a Setup or Power-on password	99
9 Using HP PC Hardware Diagnostics (UEFI)	100
Downloading HP PC Hardware Diagnostics (UEFI) to a USB device	101
10 Backing up, restoring, and recovering	102
Backing up information and creating recovery media	102
Using Windows tools	102
Using the HP Cloud Recovery Download Tool to create recovery media (select products only)	102
Restoring and recovery	103
Restoring, resetting, and refreshing using Windows tools	103
Recovering using HP Recovery media	103
Changing the computer boot order	103
Using HP Sure Recover (select products only)	104
Appendix A Battery replacement	105
Appendix B Statement of memory volatility	108
Current BIOS steps	108
Nonvolatile memory usage	110
Questions and answers	112
Using HP Sure Start	113
Appendix C Power cord set requirements	114
General requirements	114
Japanese power cord requirements	114
Country-specific requirements	115
Appendix D Specifications	116
Index	117

1 Product features

Standard configuration features

Features can vary depending on the model. For support assistance and to learn more about the hardware and software installed on the computer model, run the HP Support Assistant utility.

 **NOTE:** This computer model can be used in a desktop orientation or a tower orientation with optional vertical stand.



Front panel components

Drive configuration can vary by model. Some models have a bezel blank covering the slim optical drive bay.

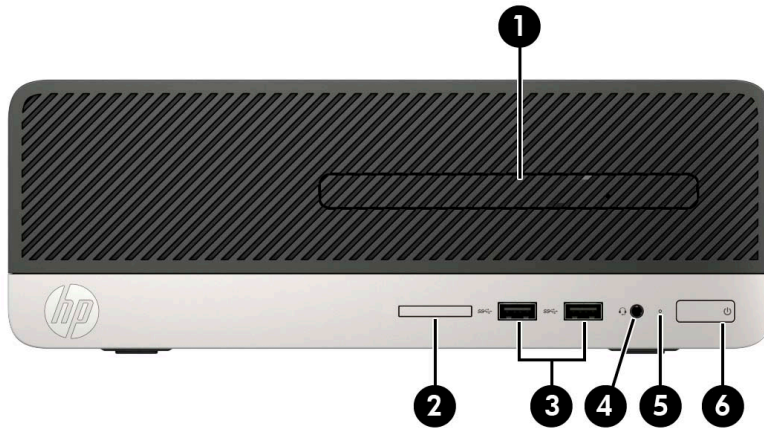

Table 1-1 Front panel components and their descriptions

Front panel components			
(1)	Slim optical drive (select products only)	(4)	Audio-out (headphone)/Audio-in (microphone) combo jack
(2)	Memory card reader	(5)	Hard drive activity light
(3)	USB SuperSpeed ports (2)	(6)	Dual-state power button

NOTE: When a device is plugged into the combo jack, a dialog box is displayed. Select the type of device that is connected.

Rear panel components

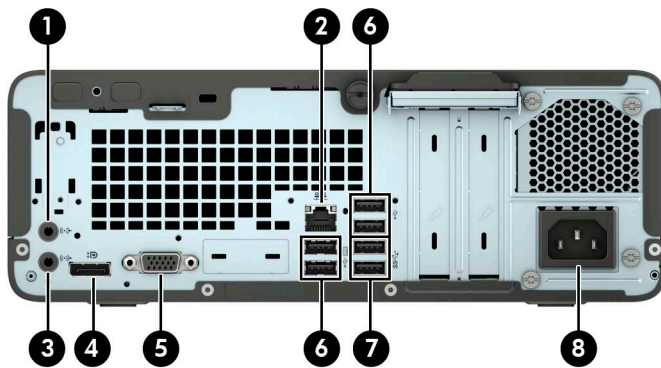









Table 1-2 Rear panel components and their descriptions

Rear panel components			
(1) 	Audio-in jack	(5) 	VGA monitor connector
(2) 	RJ-45 (network) jack	(6) 	USB ports (4)
(3) 	Audio-out jack for powered audio device	(7) 	USB SuperSpeed ports (2)
(4) 	DisplayPort monitor connectors (2)	(8) 	Power cord connector

NOTE: When a graphics card is installed in one of the system board slots, the video connectors on the graphics card and/or the integrated graphics on the system board may be used. The specific graphics card installed and software configuration will determine the behavior.

The system board graphics can be disabled by changing settings in Computer Setup.

Table 2-1 Computer major components and their descriptions (continued)

Description
Intel Core i5-9400 2.90-GHz processor (2666-MHz FSB, 9.0-MB SmartCache, six cores)
Intel Core i3-9300 3.70-GHz processor (2400-MHz FSB, 8.0-MB SmartCache, quad core)
Intel Core i3-9100 3.60-GHz processor (2400-MHz FSB, 8.0-MB SmartCache, quad core)
Intel Core i7-8700 3.20-GHz processor (2666-MHz front-side bus [FSB], 12.0-MB SmartCache, six cores)
Intel Core i5-8600 3.10-GHz processor (2666-MHz FSB, 9.0-MB SmartCache, six cores)
Intel Core i5-8500 3.00-GHz processor (2666-MHz FSB, 9.0-MB SmartCache, six cores)
Intel Core i3-8300 3.70-GHz processor (2400-MHz FSB, 8.0-MB SmartCache, quad core)
Intel Core i3-8100 3.60-GHz processor (2400-MHz FSB, 6.0-MB SmartCache, quad core)
Intel Pentium Gold G5620 4.00-GHz processor (2400-MHz FSB, 4.0-MB SmartCache, dual core)
Intel Pentium Gold G5600 3.90-GHz processor (2400-MHz FSB, 4.0-MB SmartCache, dual core)
Intel Pentium Gold G5500 3.80-GHz processor (2400-MHz FSB, 4.0-MB SmartCache, dual core)
Intel Pentium Gold G5420 3.80-GHz processor (2400-MHz FSB, 4.0-MB SmartCache, dual core)
Intel Pentium Gold G5500 3.80-GHz processor (2400-MHz FSB, 4.0-MB SmartCache, dual core)
Intel Pentium Gold G5400 3.70-GHz processor (2400-MHz FSB, 4.0-MB SmartCache, dual core)
Intel Celeron G4930 3.20-GHz processor (2.0-MB SmartCache, dual core)
Intel Celeron G4900 3.10-GHz processor (2.0-MB SmartCache, dual core)
Power supply (includes cables):
310-W, 12-V, 90-percent high volume, 2 out connectors
250-W, 12-V, 92-percent high volume, 2 out connectors
180-W, 12-V, 90-percent high volume, 1 out connector
Fan-sink , 65-W (includes retention-clips)
Fan (includes cable)
Speaker , 40×28.5-mm, 2-W, 4-ohm, 140-mm (includes cable)
Hood sensor module
Serial port modules:
PS2/serial port combination module
Serial port module
Optical drive:
DVD-BluRay 6x Writer Drive, 9.5-mm, slim
DVD±RW SuperMulti Dual Layer Drive, 9.5-mm, slim
DVD-ROM Drive, 9.5-mm, slim
Optical drive long bezel blank, 9.5-mm, slim
Optical drive latch, 9.5-mm, slim

Table 2-1 Computer major components and their descriptions (continued)

Description
Networking:
Intel Ethernet I210-T1 GbE network interface card (NIC)
Intel 9560 ac 2×2 + Bluetooth 5 non-vPro WW
Realtek 8822BE 802.11ac PCIe×1 Card
Realtek ac 1×1 + Bluetooth 4.2 LE M.2 2230 PCI-e+USB WW
Realtek RTL8723DE bgn 1×1 + Bluetooth 4.2 LE M.2 2230 PCI-e+USB WW with 1 antenna
Antenna cover
Internal wireless antenna cable assembly
Memory modules (4, DDR4-2666, 1.2-V, NECC, UDIMM):
64-GB (32 GB×2)
32-GB (32 GB×1)
32-GB (16 GB×2)
16-GB (16 GB×1)
16-GB (8 GB×2)
8-GB (8 GB×1)
8-GB (4 GB×2)
4-GB (4 GB×1)
Hard drive:
2-TB, 7200-rpm, SATA-3, 3.5-in.
2-TB, 7200-rpm, SATA-3, 3.5-in., second hard drive
2-TB, 5400-rpm, 7.0-mm, HYBRID 8-GB
2-TB, 5400-rpm, 7.0-mm
2-TB, 5400-rpm, 7.0-mm, HYBRID 8-GB
1-TB, 7200-rpm, SATA-3, 3.5-in.
1-TB, 7200-rpm, SATA-3, 3.5-in., second hard drive
1-TB, 7200-rpm, 2.5-in.
1-TB, 7200-rpm, 2.5-in., SATA, 6.0-GB/sec
1-TB, 7200-rpm, 3.5-in.
1-TB, 7200-rpm, 9.5-mm
1-TB, 5400-rpm, 7.0-mm, HYBRID 8-GB
500-GB, 7200-rpm, 3.5-in.
500-GB, 7200-rpm, 3.5-in., second hard drive
500-GB, 7200-rpm, 3.5-in., third hard drive

Table 2-1 Computer major components and their descriptions (continued)

Description
500-GB, 7200-rpm, 3.5-in., SATA, 6.0-GB/sec, Smart IV hard drive
500-GB, 7200-rpm, 7.0-mm
500-GB, 5400-rpm, 7.0-mm, HYBRID 8-GB
500-GB, 7200-rpm with Federal Information Processing Standard (140-2)security and OPAL2
500-GB, 5400-rpm with (FIPS 140-2)security and OPAL2
500-GB, 7200-rpm, SATA with self-encryption (SED)and OPAL2
500-GB, 7200-rpm, Hybrid 8-GB NAND with OPAL2
500-GB, 7200-rpm, 2.5-in.
500-GB, 7200-rpm, 7.0-mm
500-GB, 5400-rpm, 7.0-mm, HYBRID 8-GB
500-GB, 5400-rpm with Federal Information Processing Standard (FIPS)security and OPAL2
500-GB, 7200-rpm, SATA with self-encryption (SED)and OPAL2
500-GB, 7200-rpm, Hybrid 8-GB NAND with OPAL2
Removable SATA slim hard drive carrier
5.25-in.–to–3.5-in. hard drive adapter
Solid-state drive:
1-TB, M.2 2280, Non-Volatile Memory express (NVMe)solid-state drive with secure seal (SS)and triple-level cell (TLC)
512-GB, M.2 2280, peripheral component interconnect express (PCIe), NVMe solid-state drive with SS and TLC
512-GB, M.2 2280, PCIe, NVMe solid-state drive with self-encryption (SED), OPAL2, and TLC
512-GB, M.2 2280, PCIe, NVMe solid-state drive with TLC
512-GB, M.2 2280, PCIe, NVMe solid-state drive (value)
512-GB, M.2 2280, PCIe×4 solid-state drive with self-encryption (SED)and TLC
512-GB, M.2, PCIe, NVMe solid-state drive with TLC
512-GB, SATA-3 solid-state drive with TLC
512-GB, SATA-3 solid-state drive with TLC, second drive
512-GB, SATA-3 solid-state drive with Federal Information Processing Standard (FIPS)security and TLC
512-GB, SATA-3 solid-state drive with SED, OPAL2, and TLC
512-GB, SATA-3 solid-state drive with SED, OPAL2, and TLC, second drive
512-GB solid-state drive with FIPS security
512-GB solid-state drive with FIPS security, second drive
256-GB, M.2 2280, PCIe, NVMe solid-state drive with SS and TLC
256-GB, M.2 2280, PCIe, NVMe solid-state drive with TLC
256-GB, M.2 2280, PCIe, NVMe solid-state drive (value)

Table 2-1 Computer major components and their descriptions (continued)

Description
256-GB, M.2 2280, PCIe, NVMe solid-state drive with SED, OPAL2, and TLC
256-GB, M.2 2280, PCIe3×4 solid-state drive with SED and TLC
256-GB, M.2, PCIe, NVMe solid-state drive with TLC (value)
256-GB, SATA-3 solid-state drive with TLC
256-GB, SATA-3 solid-state drive with SED, OPAL2, and TLC
256-GB, SATA-3 solid-state drive with SED, OPAL2, and TLC, second drive
256-GB, SATA-3 solid-state drive with TLC
256-GB, SATA-3 solid-state drive with TLC, second drive
256-GB, SATA-3 solid-state drive with FIPS security and TLC
256-GB, SATA-3 solid-state drive with SED, OPAL2, and TLC
256-GB, solid-state drive with FIPS
256-GB, SATA-3 solid-state drive with FIPS, second drive
128-GB, M2 2280, PCIe3×4, NVMe solid-state drive with TLC
128-GB, M2 2280, PCIe3×4, NVMe solid-state drive
128-GB, M2 2280, PCIe3×2 solid-state drive with TLC
118-GB, M2 2280, PCIe, NVMe solid-state drive
16-GB, M2 2280, PCIe3×2, NVMe solid-state drive with TLC

Miscellaneous parts

Table 2-2 Miscellaneous parts and their descriptions

Description
Power cord with C13 receptacle, 2.50-meter (6.00-feet):
For use in Argentina
For use in Australia and New Zealand
Power cord with C13 receptacle, 1.83-meter (6.00-feet)
For use in Brazil
For use in Denmark
For use in Europe
For use in Israel
For use in Italy
For use in the North America
For use in the People's Republic of China
For use in South Africa

Table 2-2 Miscellaneous parts and their descriptions (continued)

Description
For use in South Korea
For use in Switzerland
For use in Taiwan
For use in the United Kingdom and Singapore
Power cord with C13 receptacle, 1.83-meter (6.00-feet)5-15P for use in Thailand
Power cord with C13 receptacle, 1.83-meter (6.00-feet)6-amp for use in India
Power cord with 7A certification for use in Japan
Power cord with Option-949 adapter ROHS
Adapters:
HP DisplayPort-to-DVI SL adapter
HP DisplayPort-to-HDMI 2.0 adapter
HP DisplayPort-to-VGA adapter
HP USB-to-serial port adapter
HP USB Type-C-to-DisplayPort adapter
HP USB Type-C-to-DisplayPort adapter
HP USB Type-C-to-USB Type-A hub
Cables:
DisplayPort cable (1.83-m)
DisplayPort-to-VGA cable
DVI monitor cable
Hard drive SATA power cable (2×2-pin)
Optical drive SATA power cable (2×2-pin)
SATA cable (straight-to-right angle connector, 11-in.)
SATA cable (straight-to-right angle connector, 11-in., RF solution)
SATA cable (straight-to-straight connector, 11-in.)
SATA cable (straight-to-straight connector, 11-in., RF solution)
SATA cable (straight-to-straight connector, 14-in.)
SATA cable (straight-to-straight connector, 14-in., RF solution)
Wireless antenna cable (internal)
Expansion cards:
DisplayPort option board
HDMI option board
Parallel port PCIe x1 card

Table 2-2 Miscellaneous parts and their descriptions (continued)

Description
VGA option board
Graphics cards:
AMD Radeon R7 430 2-GB 2DP Card
AMD Radeon R7 430 2-GB LP 2DP PCIe×16 2nd GFX
AMD Radeon R7 430 2-GB LP 2DP PCIe×16 GFX
AMD Radeon R7 430 2-GB LP DP VGA PCIe x16
AMD Radeon R7 430 PCIe×16 GFX (for use only in the People's Republic of China)
AMD Radeon RX550 4-GB 2DP Card
AMD Radeon RX550 4-GB FH 2DP 1HDMI PCIe×16
AMD Radeon RX580 4-GB FH 3DP 1HDMI PCIe×16 GFX
NVIDIA GeForce GT730 2-GB DP DVI PCIe×8 GFX
NVIDIA GeForce GT730 2-GB DP PCIe×8 GFX
Keyboards:
HP antimicrobial slim business keyboard for use in the People's Republic of China
HP conferencing keyboard:
For use in Asia/Pacific countries and regions
For use in Belgium
For use in Bulgaria
For use in Canada
For use in Denmark
For use in Denmark, Finland, and Norway
For use in France
For use in Germany
For use in Greece
For use in Hungary
For use in India
For use in Israel
For use in Italy
For use in the Netherlands
For use in Norway
For use in the People's Republic of China
For use in Poland
For use in Portugal

Table 2-2 Miscellaneous parts and their descriptions (continued)

Description
For use in Romania
For use in Russia
For use in Saudi Arabia
For use in Spain
For use in Sweden
For use in Switzerland
For use in Turkey
For use in the United Kingdom and Singapore
For use in the United States
HP essential keyboard:
For use in India
For use in Japan
For use in Latin America
For use in the People's Republic of China
For use in Taiwan
For use in Thailand
For use in the United States
HP Premium Wireless Keyboard/Mouse Kit:
For use in Belgium
For use in Bosnia, Herzegovina, Croatia, Slovenia, Yugoslavia
For use in Bulgaria
For use in Canada
For use in Denmark
For use in Denmark, Finland, and Norway
For use in France
For use in Germany
For use in Greece
For use in Hungary
For use in Israel
For use in Italy
For use in Latin America
For use in the Netherlands
For use in the Northwest Africa

Table 2-2 Miscellaneous parts and their descriptions (continued)

Description
For use in Norway
For use in Portugal
For use in Romania
For use in Russia
For use in Saudi Arabia
For use in Spain
For use in Sweden
For use in Switzerland
For use in Taiwan
For use in Turkey
For use in the United Kingdom and Singapore
For use in the United States
HP PS/2 slim Windows 8 keyboard:
For use in Belgium
For use in Bosnia, Herzegovina, Croatia, Slovenia, and Yugoslavia
For use in Brazil
For use in Bulgaria
For use in Canada
For use in the Czech Republic and Slovakia
For use in Denmark
For use in Denmark, Finland, and Norway
For use in France
For use in Germany
For use in Greece
For use in Hungary
For use in India
For use in Israel
For use in Italy
For use in Japan
For use in Latin America
For use in the Netherlands
For use in Northwest Africa
For use in Norway

Table 2-2 Miscellaneous parts and their descriptions (continued)

Description
For use in the People's Republic of China
For use in Portugal
For use in Romania
For use in Russia
For use in Saudi Arabia
For use in South Korea
For use in Spain
For use in Sweden
For use in Switzerland
For use in Taiwan
For use in Thailand
For use in Turkey
For use in the United Kingdom and Singapore
For use in the United States
HP USB slim business keyboard in grey finish:
For use in Belgium
For use in France
For use in Germany
HP USB collaboration keyboard:
For use in Belgium
For use in Bulgaria
For use in Denmark
For use in Denmark, Finland, and Norway
For use in France
For use in Germany
For use in Greece
For use in Hungary
For use in Israel
For use in Italy
For use in the Netherlands
For use in Northwest Africa
For use in Norway
For use in Portugal

Table 2-2 Miscellaneous parts and their descriptions (continued)

Description
For use in Romania
For use in Russia
For use in Saudi Arabia
For use in SCC
For use in Spain
For use in Sweden
For use in Switzerland
For use in Taiwan
For use in Turkey
For use in the United Kingdom and Singapore
For use in the United States
HP USB premium keyboard:
For use in Belgium
For use in Bulgaria
For use in Canada
For use in Denmark
For use in Denmark, Finland, and Norway
For use in France
For use in Germany
For use in Greece
For use in Hungary
For use in Israel
For use in Italy
For use in Latin America
For use in the Netherlands
For use in Northwest Africa
For use in Norway
For use in Portugal
For use in Romania
For use in Russia
For use in Saudi Arabia
For use in SCC
For use in Spain

Table 2-2 Miscellaneous parts and their descriptions (continued)

Description
For use in Sweden
For use in Switzerland
For use in Taiwan
For use in Turkey
For use in the United Kingdom and Singapore
For use in the United States
HP USB slim Windows 8 keyboard:
For use in Belgium
For use in Bosnia, Herzegovina, Croatia, Slovenia, and Yugoslavia
For use in Bulgaria
For use in Canada
For use in the Czech Republic and Slovakia
For use in Denmark
For use in Denmark, Finland, and Norway
For use in France
For use in Germany
For use in Greece
For use in Hungary
For use in India
For use in Israel
For use in Italy
For use in Japan
For use in Latin America
For use in the Netherlands
For use in Northwest Africa
For use in Norway
For use in the People's Republic of China
For use in Portugal
For use in Romania
For use in Russia
For use in Saudi Arabia
For use in South Korea
For use in Spain

Table 2-2 Miscellaneous parts and their descriptions (continued)

Description
For use in Sweden
For use in Switzerland
For use in Taiwan
For use in Thailand
For use in Turkey
For use in the United Kingdom and Singapore
For use in the United States
HP USB slim Windows 8 keyboard with PCR:
For use in Brazil
For use in Latin America
HP USB SmartCard slim keyboard with CCID:
For use in Belgium
For use in Bosnia, Herzegovina, Croatia, Slovenia, and Yugoslavia
For use in Brazil
For use in Bulgaria
For use in Canada
For use in the Czech Republic and Slovakia
For use in Denmark
For use in Denmark, Finland, and Norway
For use in France
For use in Germany
For use in Greece
For use in Hungary
For use in India
For use in Israel
For use in Italy
For use in Japan
For use in Latin America
For use in the Netherlands
For use in Northwest Africa
For use in Norway
For use in the People's Republic of China
For use in Portugal

Table 2-2 Miscellaneous parts and their descriptions (continued)

Description
For use in Romania
For use in Russia
For use in Saudi Arabia
For use in South Korea
For use in Spain
For use in Sweden
For use in Switzerland
For use in Taiwan
For use in Thailand
For use in Turkey
For use in the United Kingdom and Singapore
For use in the United States
HP wireless collaboration keyboard:
For use in Belgium
For use in Bulgaria
For use in Canada
For use in Denmark
For use in Denmark, Finland, and Norway
For use in France
For use in Germany
For use in Greece
For use in Hungary
For use in Israel
For use in Italy
For use in Latin America
For use in the Netherlands
For use in Northwest Africa
For use in Norway
For use in Portugal
For use in Romania
For use in Russia
For use in Saudi Arabia
For use in SCC

Table 2-2 Miscellaneous parts and their descriptions (continued)

Description
For use in Spain
For use in Sweden
For use in Switzerland
For use in Taiwan
For use in Turkey
For use in the United Kingdom and Singapore
For use in the United States
HP wireless premium keyboard:
For use in Belgium
For use in Bulgaria
For use in Canada
For use in Denmark
For use in Denmark, Finland, and Norway
For use in France
For use in Germany
For use in Greece
For use in Hungary
For use in Israel
For use in Italy
For use in Latin America
For use in the Netherlands
For use in Northwest Africa
For use in Norway
For use in Portugal
For use in Romania
For use in Russia
For use in Saudi Arabia
For use in SCC
For use in Spain
For use in Sweden
For use in Switzerland
For use in Taiwan
For use in Turkey

Table 2-2 Miscellaneous parts and their descriptions (continued)

Description
For use in the United Kingdom and Singapore
For use in the United States
HP wireless Windows 8 keyboard/mouse combination with dongle:
For use in Belgium
For use in Bosnia, Herzegovina, Croatia, Slovenia, and Yugoslavia
For use in Brazil
For use in Bulgaria
For use in Canada
For use in the Czech Republic and Slovakia
For use in Denmark
For use in Denmark, Finland, and Norway
For use in France
For use in Germany
For use in Greece
For use in Hungary
For use in Israel
For use in Italy
For use in Japan
For use in Latin America
For use in the Netherlands
For use in Northwest Africa
For use in Norway
For use in the People's Republic of China
For use in Portugal
For use in Russia
For use in Saudi Arabia
For use in South Korea
For use in Spain
For use in Sweden
For use in Switzerland
For use in Taiwan
For use in Thailand
For use in Turkey

Table 2-2 Miscellaneous parts and their descriptions (continued)

Description
For use in the United Kingdom and Singapore
For use in the United States
Katydid black USB keyboard with U.S. layout:
For use in Brazil
For use in KD2
Moonraker Healthcare USB wired keyboard:
For use in Canada
For use in Latin America
For use in the United Kingdom
For use in the United States
Unbranded USB keyboard:
For use in Australia
For use in Belgium
For use in Bosnia, Herzegovina, Croatia, Slovenia, and Yugoslavia
For use in Bulgaria
For use in Canada
For use in the Czech Republic and Slovakia
For use in Denmark
For use in France
For use in Greece
For use in Hungary
For use in Israel
For use in Italy
For use in Latin America
For use in Northwest Africa
For use in Norway
For use in Portugal
For use in Romania
For use in Russia
For use in Saudi Arabia
For use in Spain
For use in Sweden and Finland
For use in Switzerland

Table 2-2 Miscellaneous parts and their descriptions (continued)

Description
For use in Turkey
For use in the United Kingdom and Singapore
Unbranded USB keyboard ME:
For use in Belgium
For use in Bosnia, Herzegovina, Croatia, Slovenia, and Yugoslavia
For use in Brazil
For use in Bulgaria
For use in Canada
For use in the Czech Republic and Slovakia
For use in Denmark
For use in Denmark, Finland, and Norway
For use in France
For use in Germany
For use in Greece
For use in Hungary
For use in India
For use in Israel
For use in Italy
For use in Japan
For use in Latin America
For use in the Netherlands
For use in Northwest Africa
For use in Norway
For use in the People's Republic of China
For use in Portugal
For use in Romania
For use in Russia
For use in Saudi Arabia
For use in South Korea
For use in Spain
For use in Sweden
For use in Switzerland
For use in Taiwan

Table 2-2 Miscellaneous parts and their descriptions (continued)

Description
For use in Thailand
For use in Turkey
For use in United Kingdom and Singapore
For use in the United States
Unbranded USB slim business keyboard in grey finish:
For use in Belgium
For use in Germany
Unbranded USB SmartCard slim keyboard with CCID:
For use in Belgium
For use in Bosnia, Herzegovina, Croatia, Slovenia, and Yugoslavia
For use in Brazil
For use in Bulgaria
For use in Canada
For use in the Czech Republic and Slovakia
For use in Denmark
For use in France
For use in Germany
For use in Greece
For use in Hungary
For use in India
For use in Israel
For use in Italy
For use in Japan
For use in Latin America
For use in the Netherlands
For use in Northwest Africa
For use in Norway
For use in the People's Republic of China
For use in Portugal
For use in Romania
For use in Russia
For use in Saudi Arabia
For use in South Korea

Table 2-2 Miscellaneous parts and their descriptions (continued)

Description
For use in Spain
For use in Sweden and Finland
For use in Switzerland
For use in Taiwan
For use in Thailand
For use in Turkey
For use in the United Kingdom and Singapore
For use in the United States
Unbranded USB SmartCard slim keyboard with CCID:
For use in Belgium
For use in Bosnia, Herzegovina, Croatia, Slovenia, and Yugoslavia
For use in Brazil
For use in Bulgaria
Unbranded USB/PS2 BFRAPVC washable Windows 8 keyboard:
For use in Canada
For use in Latin America
For use in the United Kingdom
For use in the United States
Security hardware:
Business PC security lock V.3
Dual Head Keyed Cable Lock Kit
HP keyed cable lock (10 mm)
Trusted platform module (TPM)2.0
Solenoid lock
Mouse:
HP PS/2 optical mouse
HP USB antimicrobial mouse
HP USB hardened mouse
HP USB laser mouse
HP USB mouse in grey finish
HP USB mouse in grey finish v.2
HP USB optical mouse
HP USB premium mouse

Table 2-2 Miscellaneous parts and their descriptions (continued)

Description
Moonraker Healthcare USB wired mouse
USB PS/2 washable mouse
USB 3.0 SD Card reader
Wired local area network (LAN)
Intel Ethernet I210-T1 PCIe×1 Gb network interface card (NIC)
Realtek RTL8111HSH-CG GbE Ethernet

3 Routine care, SATA drive guidelines, and disassembly preparation

This chapter provides general service information for the computer. Adherence to the procedures and precautions described in this chapter is essential for proper service.

CAUTION: When the computer is plugged into an AC power source, voltage is always applied to the system board. The power cord must be disconnected from the power source before opening the computer to prevent system board or component damage.

Electrostatic discharge information

A sudden discharge of static electricity from your finger or other conductor can destroy static-sensitive devices or microcircuitry. Often the spark is neither felt nor heard, but damage occurs. An electronic device exposed to electrostatic discharge (ESD) may not appear to be affected at all and can work perfectly throughout a normal cycle. The device may function normally for a while, but it has been degraded in the internal layers, reducing its life expectancy.

Networks built into many integrated circuits provide some protection, but in many cases, the discharge contains enough power to alter device parameters or melt silicon junctions.

Generating static

The following table shows how humidity affects the electrostatic voltage levels generated by different activities. A product can be degraded by 700 V.

- Different activities generate different amounts of static electricity.
- Static electricity increases as humidity decreases.

Table 3-1 Static electricity occurrence based on activity and humidity

Event	Relative Humidity		
	55%	40%	10%
Walking across carpet	7,500 V	15,000 V	35,000 V
Walking across vinyl floor	3,000 V	5,000 V	12,000 V
Motions of bench worker	400 V	800 V	6,000 V
Removing DIPs from plastic tube	400 V	700 V	2,000 V
Removing DIPs from vinyl tray	2,000 V	4,000 V	11,500 V
Removing DIPs from Styrofoam	3,500 V	5,000 V	14,500 V
Removing bubble pack from PCB	7,000 V	20,000 V	26,500 V
Packing PCBs in foam-lined box	5,000 V	11,000 V	21,000 V

Preventing electrostatic damage to equipment

Many electronic components are sensitive to ESD. Circuitry design and structure determine the degree of sensitivity. The following packaging and grounding precautions are necessary to prevent damage to electric components and accessories.

- To avoid hand contact, transport products in static-safe containers such as tubes, bags, or boxes.
- Protect all electrostatic-sensitive parts and assemblies with conductive or approved containers or packaging.
- Keep electrostatic-sensitive parts in their containers until they arrive at static-free stations.
- Place items on a grounded surface before removing them from their containers.
- Always be properly grounded when touching a sensitive component or assembly.
- Avoid contact with pins, leads, or circuitry.
- Place reusable electrostatic-sensitive parts from assemblies in protective packaging or conductive foam.

Personal grounding methods and equipment

Use the following equipment to prevent static electricity damage to equipment:

- **Wrist straps** are flexible straps with a maximum of $1\text{ M}\Omega \pm 10\%$ resistance in the ground cords. To provide proper ground, a strap must be worn snugly against bare skin. The ground cord must be connected to the banana plug connector on the grounding mat or workstation and fit snugly into it.
- **Heel straps/Toe straps/Boot straps** can be used at standing workstations and are compatible with most types of shoes or boots. On conductive floors or dissipative floor mats, use them on both feet with a maximum of $1\text{ M}\Omega \pm 10\%$ resistance between the operator and ground.

Table 3-2 Static shielding protection levels

Static Shielding Protection Levels	
Method	Voltage
Antistatic plastic	1,500
Carbon-loaded plastic	7,500
Metallized laminate	15,000

Grounding the work area

To prevent static damage at the work area, observe the following precautions:

- Cover the work surface with approved static-dissipative material. Provide a wrist strap connected to the work surface and use properly grounded tools and equipment.
- Use static-dissipative mats, foot straps, or air ionizers to give added protection.
- Handle electrostatic-sensitive components, parts, and assemblies by the case or PCB laminate. Handle them only at static-free work areas.
- Turn off power and input signals before inserting and removing connectors or test equipment.
- Use fixtures made of static-safe materials when fixtures must directly contact dissipative surfaces.

- Keep work area free of non-conductive materials such as ordinary plastic assembly aids and Styrofoam.
- Use field service tools, such as cutters, screwdrivers, and vacuums, that are conductive.

Recommended materials and equipment

HP recommends the following grounding equipment to prevent electrostatic damage:

- Antistatic tape
- Antistatic smocks, aprons, or sleeve protectors
- Conductive bins and other assembly or soldering aids
- Conductive foam
- Conductive tabletop workstations with ground cords of $1\text{ M}\Omega \pm 10\%$ resistance
- Static-dissipative table or floor mats with hard ties to ground
- Field service kits
- Static awareness labels
- Wrist straps and footwear straps providing $1\text{ M}\Omega \pm 10\%$ resistance
- Material handling packages
- Conductive plastic bags
- Conductive plastic tubes
- Conductive tote boxes
- Opaque shielding bags
- Transparent metallized shielding bags
- Transparent shielding tubes

Operating guidelines

To prevent overheating and to help prolong the life of the computer:

- Keep the computer away from excessive moisture, direct sunlight, and extremes of heat and cold.
- Operate the computer on a sturdy, level surface. Leave a 10.2 cm (4-inch) clearance on all vented sides of the computer and above the monitor to permit the required airflow.
- Never restrict the airflow into the computer by blocking any vents or air intakes. Do not place the keyboard, with the keyboard feet down, directly against the front of the desktop unit as this also restricts airflow.
- Occasionally clean the air vents on all vented sides of the computer. Lint, dust, and other foreign matter can block the vents and limit the airflow. Be sure to unplug the computer before cleaning the air vents.
- Never operate the computer with the cover or side panel removed.
- Do not stack computers on top of each other or place computers so near each other that they are subject to each other's recirculated or preheated air.
- If the computer is to be operated within a separate enclosure, intake and exhaust ventilation must be provided on the enclosure, and the same operating guidelines listed above will still apply.
- Keep liquids away from the computer and keyboard.

- Never cover the ventilation slots on the monitor with any type of material.
- Install or enable power management functions of the operating system or other software, including sleep states.

Routine care

General cleaning safety precautions

1. Never use solvents or flammable solutions to clean the computer.
2. Never immerse any parts in water or cleaning solutions; apply any liquids to a clean cloth and then use the cloth on the component.
3. Always unplug the computer when cleaning with liquids or damp cloths.
4. Always unplug the computer before cleaning the keyboard, mouse, or air vents.
5. Disconnect the keyboard before cleaning it.
6. Wear safety glasses equipped with side shields when cleaning the keyboard.

Cleaning the computer case

Follow all safety precautions in [General cleaning safety precautions on page 28](#) before cleaning the computer.

To clean the computer case, follow these procedures:

- To remove light stains or dirt, use plain water with a clean, lint-free cloth or swab.
- For stronger stains, use a mild dishwashing liquid diluted with water. Rinse well by wiping the surface with a cloth or swab dampened with clear water.
- For stubborn stains, use isopropyl (rubbing) alcohol. No rinsing is needed; alcohol will evaporate quickly without leaving a residue.
- After cleaning, always wipe the unit with a clean, lint-free cloth.
- Occasionally clean the air vents on the computer. Lint and other foreign matter can block the vents and limit the airflow.

Cleaning the keyboard

Follow all safety precautions in [General cleaning safety precautions on page 28](#) before cleaning the keyboard.

To clean the tops of the keys or the keyboard body, follow the procedures described in [Cleaning the computer case on page 28](#).

When cleaning debris from under the keys, review all rules in [General cleaning safety precautions on page 28](#) before following these procedures:

⚠ CAUTION: Use safety glasses equipped with side shields before attempting to clean debris from under the keys.

- Visible debris underneath or between the keys may be removed by vacuuming or shaking.
- Canned, pressurized air may be used to clean debris from under the keys. Caution should be used as too much air pressure can dislodge lubricants applied under the wide keys.

- If you want to remove a key, use a specially designed key puller to prevent damage to the keys. This tool is available through many electronics supply outlets.

⚠ CAUTION: Never remove a wide, level key (like the space bar) from the keyboard. If these keys are improperly removed or installed, the keyboard may not function properly.

- You can clean under a key with a swab moistened with isopropyl alcohol and then squeezed out. Be careful not to wipe away lubricants necessary for proper key functions. Use tweezers to remove any fibers or dirt in confined areas. Allow the parts to air dry before reassembly.

Cleaning the monitor

- Wipe the monitor screen with a towelette designed for cleaning monitors or with a clean cloth moistened with water. Do not use sprays or aerosols directly on the screen; the liquid may seep into the housing and damage a component. Never use solvents or flammable liquids on the monitor.
- To clean the monitor body follow the procedures in [Cleaning the computer case on page 28](#).

Cleaning the mouse

Before cleaning the mouse, ensure that the power to the computer is turned off.

- Clean the mouse ball by first removing the retaining plate and the ball from the housing. Pull out any debris from the ball socket and wipe the ball with a clean, dry cloth before reassembly.
- To clean the mouse body, follow the procedures in [Cleaning the computer case on page 28](#).

Service considerations

Listed below are some of the considerations that you should keep in mind during the disassembly and assembly of the computer.

Tools and software requirements

To service the computer, you need the following:

- Torx T-15 screwdriver
- Flat-bladed screwdriver (may sometimes be used in place of the Torx screwdriver)
- Phillips #2 screwdriver
- Diagnostics software

Screws

The screws used in the computer are not interchangeable. They may have standard or metric threads and may be of different lengths. If an incorrect screw is used during the reassembly process, it can damage the unit. HP strongly recommends that all screws removed during disassembly be kept with the part that was removed, and then returned to their proper locations.

⚠ CAUTION: Metric screws have a black finish. U.S. screws have a silver finish and are used on hard drives only.

CAUTION: As each subassembly is removed from the computer, it should be placed away from the work area to prevent damage.

Cables and connectors

Most cables used throughout the unit are flat, flexible cables. These cables must be handled with care to avoid damage. Apply only the tension required to seat or unseat the cables during insertion or removal from the connector. Handle cables by the connector whenever possible. In all cases, avoid bending or twisting the cables, and ensure that the cables are routed in such a way that they cannot be caught or snagged by parts being removed or replaced.

 **CAUTION:** When servicing this computer, ensure that cables are placed in their proper location during the reassembly process. Improper cable placement can damage the computer.

Hard Drives

Handle hard drives as delicate, precision components, avoiding all physical shock and vibration. This applies to failed drives as well as replacement spares.

- If a drive must be mailed, place the drive in a bubble-pack mailer or other suitable protective packaging and label the package “Fragile: Handle With Care.”
- Do not remove hard drives from the shipping package for storage. Keep hard drives in their protective packaging until they are actually mounted in the computer.
- Avoid dropping drives from any height onto any surface.
- If you are inserting or removing a hard drive, turn off the computer. Do not remove a hard drive while the computer is on or in standby mode.
- Before handling a drive, ensure that you are discharged of static electricity. While handling a drive, avoid touching the connector.
- Do not use excessive force when inserting a drive.
- Avoid exposing a hard drive to liquids, temperature extremes, or products that have magnetic fields such as monitors or speakers.

Lithium coin cell battery

The battery that comes with the computer provides power to the real-time clock and has a minimum lifetime of about three years.

See the appropriate removal and replacement chapter for the chassis you are working on in this guide for instructions on the replacement procedures.

 **WARNING!** This computer contains a lithium battery. There is a risk of fire and chemical burn if the battery is handled improperly. Do not disassemble, crush, puncture, short external contacts, dispose in water or fire, or expose it to temperatures higher than 140°F (60°C). Do not attempt to recharge the battery.

 **NOTE:** Batteries, battery packs, and accumulators should not be disposed of together with general household waste. In order to forward them for recycling or proper disposal, please use the public collection system or return them to HP.

SMART ATA drives

The Self Monitoring Analysis and Recording Technology (SMART)ATA drives for HP personal computers have built-in drive failure prediction that warns the user or network administrator of an impending failure (crash) of the hard drive. The SMART drive tracks fault prediction and failure indication parameters such as reallocated sector count, spin retry count, and calibration retry count. If the drive determines that a failure is imminent, it generates a fault alert.

4 Removal and replacement procedures

Adherence to the procedures and precautions described in this chapter is essential for proper service. After completing all necessary removal and replacement procedures, run the Diagnostics utility to verify that all components operate properly.

 **NOTE:** Not all features listed in this guide are available on all computers.

Preparation for disassembly

 **WARNING!** Voltage is always present on the system board when the computer is plugged into an active AC outlet. To avoid possible personal injury and damage to the equipment the power cord should be disconnected from the computer and/or the AC outlet before opening the computer.

See [Routine care, SATA drive guidelines, and disassembly preparation on page 25](#) for initial safety procedures.

1. Remove/disengage any security devices that prohibit opening the computer.
2. Remove all removable media, such as compact discs or USB flash drives, from the computer.
3. Turn off the computer properly through the operating system, then turn off any external devices.
4. Disconnect the power cord from the power outlet and disconnect any external devices.

 **CAUTION:** Turn off the computer before disconnecting any cables.

Regardless of the power-on state, voltage is always present on the system board as long as the system is plugged into an active AC outlet. In some systems the cooling fan is on even when the computer is in the “Standby,” or “Suspend” modes. The power cord should always be disconnected before servicing a unit.

 **NOTE:** During disassembly, label each cable as you remove it, noting its position and routing. Keep all screws with the removed components.

Access panel

1. Prepare the computer for disassembly (see [Preparation for disassembly on page 31](#)).
2. Position the computer with the rear toward you.
3. Loosen the access panel locking screw (1).
4. Use the access panel release handle (2) to pull the access panel back.
5. Remove the access panel (3).

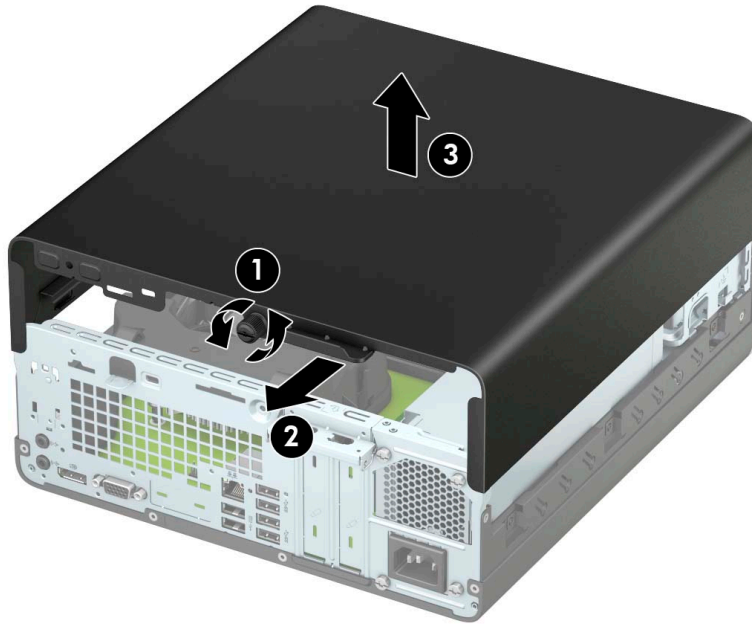

Reverse this procedure to install the access panel.

Optical drive

1. Prepare the computer for disassembly (see [Preparation for disassembly on page 31](#)).
2. Remove the access panel (see [Access panel on page 32](#)).
3. Disconnect the optical drive SATA cable (1) from the back of the optical drive.
4. Disconnect the optical drive power cable (2) from the back of the optical drive.

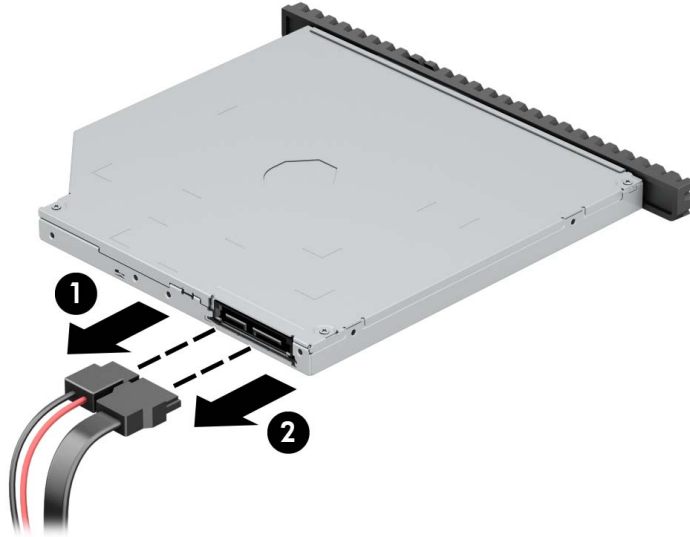

5. Press the optical drive release latch (1).
6. Remove the optical drive (2).

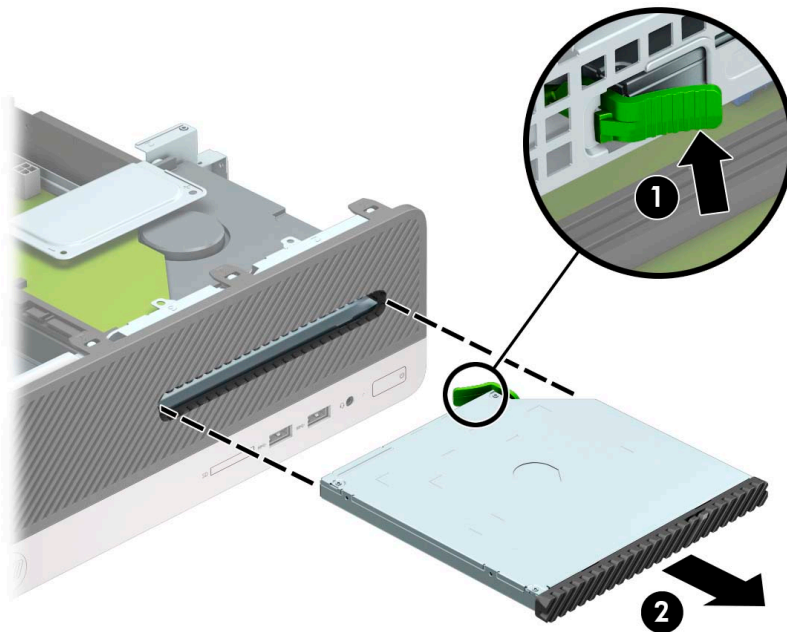

Reverse this procedure to install the optical drive.

Front bezel

1. Prepare the computer for disassembly (see [Preparation for disassembly on page 31](#)).
2. Remove the access panel (see [Access panel on page 32](#)).
3. Detach the four clips (1) on the top edge of the front bezel from the tabs on the computer chassis.
4. Swing the top edge of the front cover (2) away from the computer chassis.

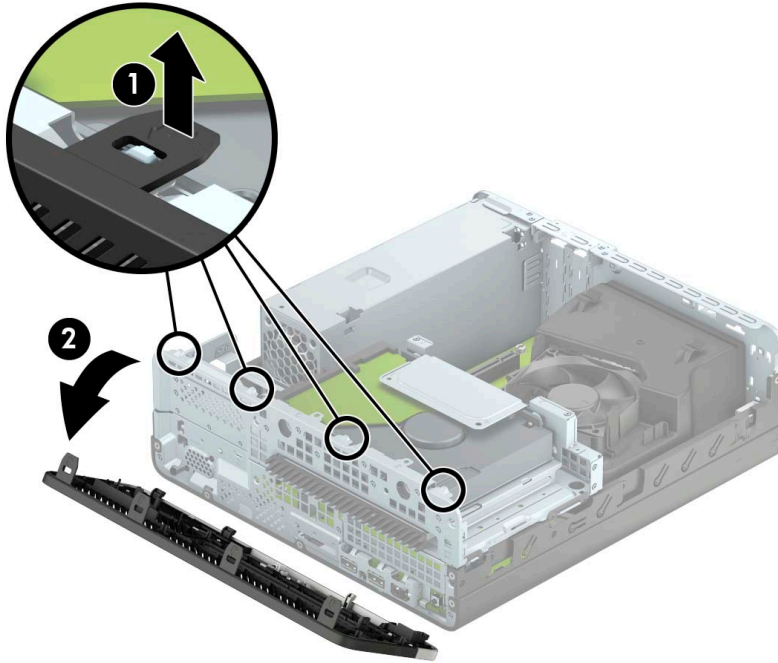

5. Remove the front bezel.

Reverse this procedure to install the front bezel.

Drive cage

Follow these steps to remove the drive cage:

1. Prepare the computer for disassembly (see [Preparation for disassembly on page 31](#)).
2. Remove the access panel (see [Access panel on page 32](#)).
3. Disconnect the power cable (1) from the 2.5-inch hard drive.
4. Disconnect the data cable (2) from the 2.5-inch hard drive.

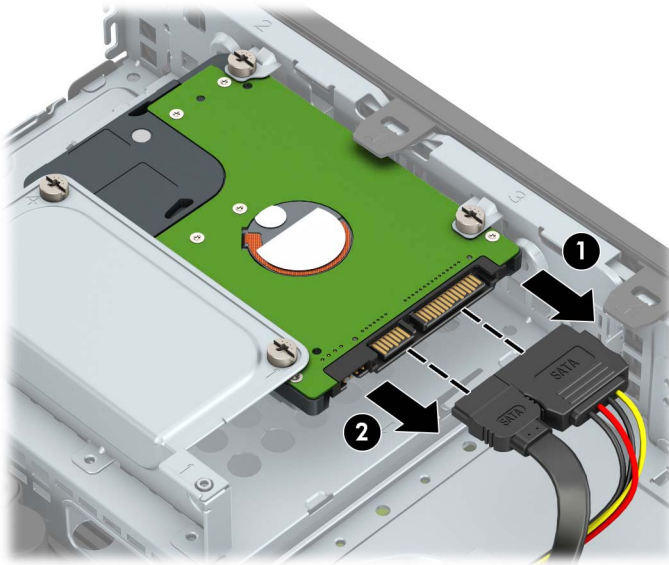

5. Disconnect the power cable (1) from the 3.5-inch hard drive.
6. Disconnect the data cable (2) from the 3.5-inch hard drive.

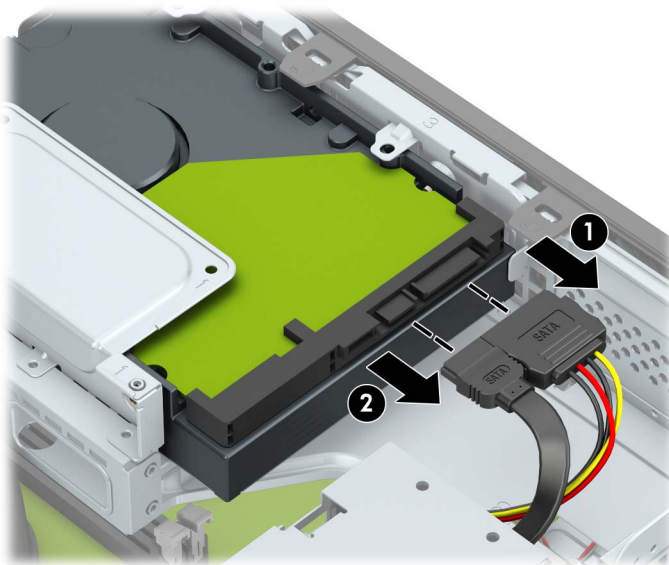

7. Press down on the drive cage release tab (1).
8. Lift the right side of the drive cage (2) until it rests at an angle.

9. Slide the drive cage (2) up and to the right at an angle and remove it.

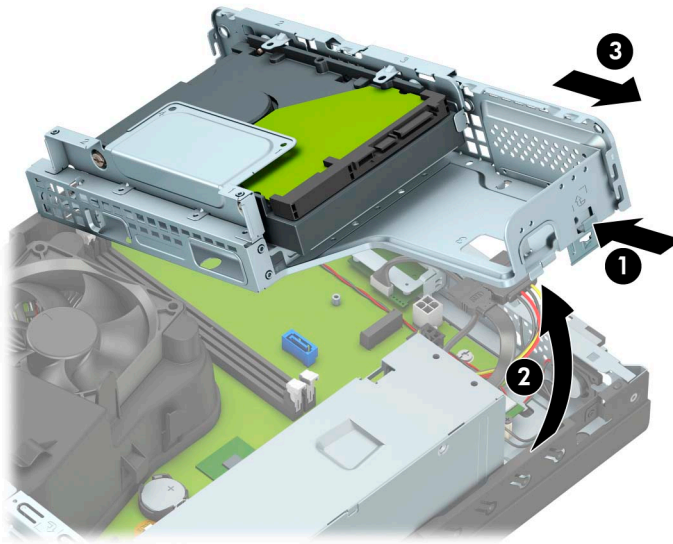

Reverse this procedure to install the drive cage.

Hard drives

Follow these steps to remove a 2.5-inch hard drive:

1. Prepare the computer for disassembly (see [Preparation for disassembly on page 31](#)).
2. Remove the access panel (see [Access panel on page 32](#)).
3. Remove the drive cage (see [Drive cage on page 35](#)).
4. If it is necessary to remove the top hard drive from the drive cage, remove the four Torx-15 M3.0×9.0 screws (1) that secure the top hard drive to the drive cage.

5. Remove the top hard drive (2) from the hard drive cage.

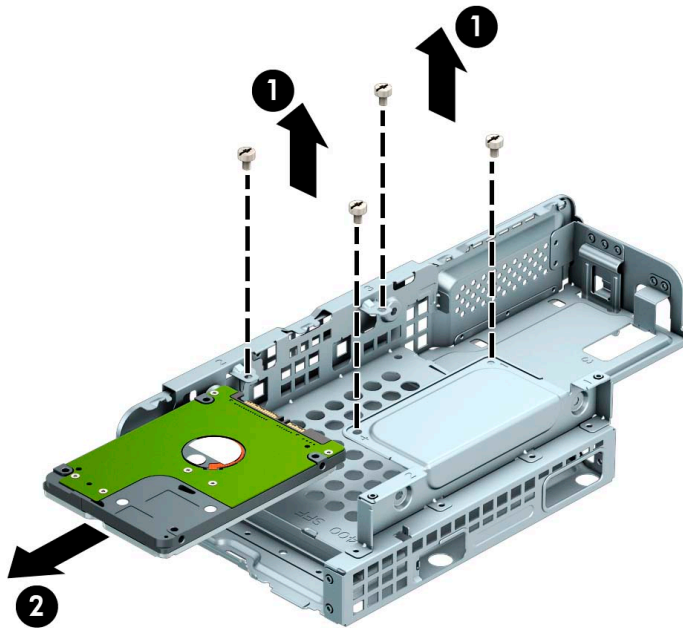

6. If it is necessary to remove the bottom hard drive from the drive cage, remove the four Torx-15 M3.0×9.0 screws (2) that secure the bottom hard drive to the cage.
7. Remove the bottom hard drive from the hard cage (3).

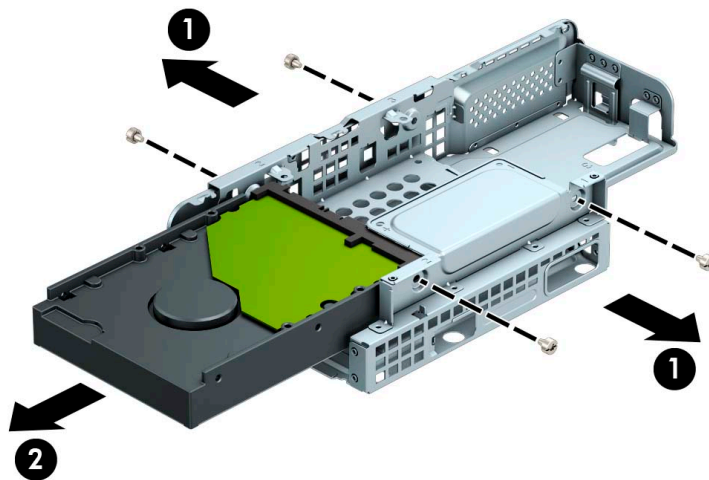

Reverse this procedure to install the hard drives.

Memory card reader

Follow these steps to remove the memory card reader:

1. Prepare the computer for disassembly (see [Preparation for disassembly on page 31](#)).
2. Remove the access panel (see [Access panel on page 32](#)).
3. Remove the front bezel (see [Front bezel on page 34](#)).
4. Remove the drive cage (see [Drive cage on page 35](#)).

Remove the memory card reader:

1. Position the computer with the front panel toward you.
2. Disconnect the memory card reader cable (1) from the system board.
3. Remove the Torx-15 M3.0×9.0 screw (2) that secures the memory card reader to the computer chassis.
4. Slide the memory card reader (3) back into the computer chassis, and then remove the memory card reader.

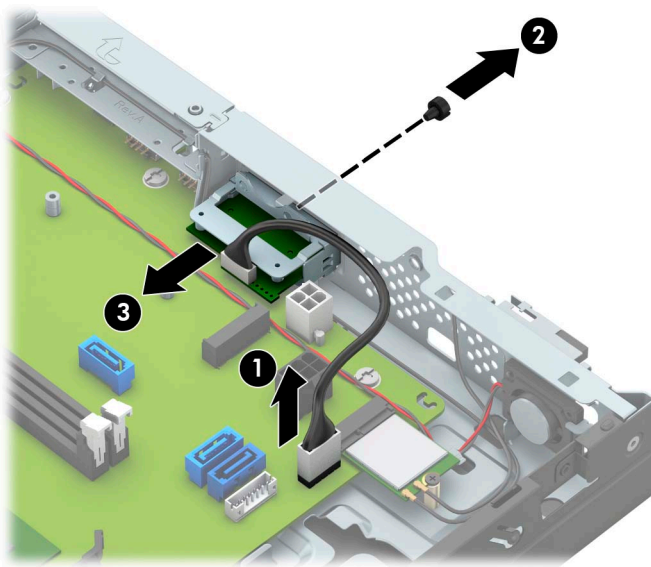

Reverse this procedure to install the memory card reader.

WLAN module

⚠ CAUTION: To prevent an unresponsive system, replace the wireless module only with a wireless module authorized for use in the computer by the governmental agency that regulates wireless devices in your country or region. If you replace the module and then receive a warning message, remove the module to restore device functionality, and then contact technical support.

Before removing the WLAN module, follow these steps:

1. Prepare the computer for disassembly (see [Preparation for disassembly on page 31](#)).
2. Remove the access panel (see [Access panel on page 32](#)).
3. Remove the front bezel (see [Front bezel on page 34](#)).
4. Remove the drive cage (see [Drive cage on page 35](#)).

Remove the WLAN module:

1. Disconnect the WLAN antenna cables (1) from the terminals on the WLAN module.

📝 NOTE: The WLAN antenna cable labeled "1/MAIN" connects to the WLAN module "Main" terminal. The WLAN antenna cable labeled "2/AUX" connects to the WLAN module "Aux" terminal.

2. Remove the Phillips M2.0×3.5 screw (2) that secures the WLAN module to the computer chassis. (The module tilts up.)
3. Remove the WLAN module (3) by pulling the module away from the slot at an angle.

📝 NOTE: WLAN modules are designed with a notch to prevent incorrect insertion.

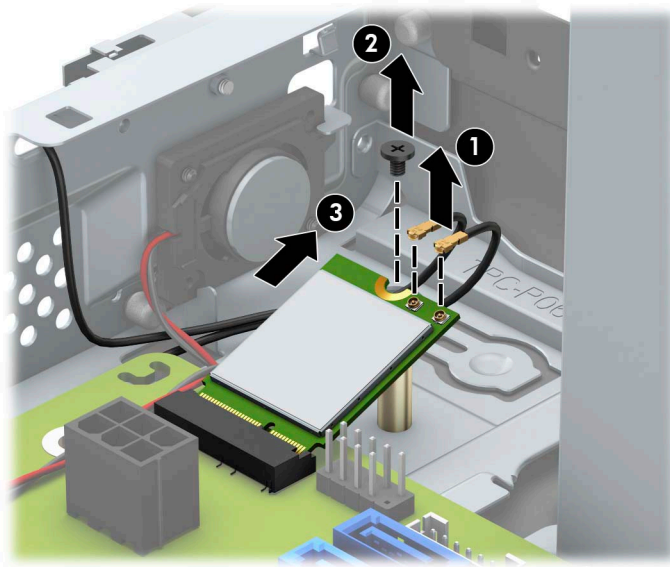

Reverse this procedure to install the WLAN module.

Memory module

The computer has four memory module sockets.

⚠ CAUTION: You must disconnect the power cord and wait approximately 30 seconds for the power to drain before adding or removing memory modules. Regardless of the power-on state, voltage is always supplied to the memory modules as long as the computer is plugged into an active AC outlet. Adding or removing memory modules while voltage is present may cause irreparable damage to the memory modules or system board.

The memory module sockets have gold-plated metal contacts. When upgrading the memory, it is important to use memory modules with gold-plated metal contacts to prevent corrosion and/or oxidation resulting from having incompatible metals in contact with each other.

Static electricity can damage the electronic components of the computer or optional cards. Before beginning these procedures, ensure that you are discharged of static electricity by briefly touching a grounded metal object.

When handling a memory module, be careful not to touch any of the contacts. Doing so may damage the module.

Follow these steps to remove a memory module:

1. Prepare the computer for disassembly (see [Preparation for disassembly on page 31](#)).
2. Remove the front bezel (see [Front bezel on page 34](#)).
3. Remove the drive cage (see [Drive cage on page 35](#)).

Remove the memory module:

1. Open both latches (1) of the memory module socket.
2. Remove the memory module (2) from the socket.

📝 NOTE: Memory modules are designed with notches to prevent incorrect insertion.

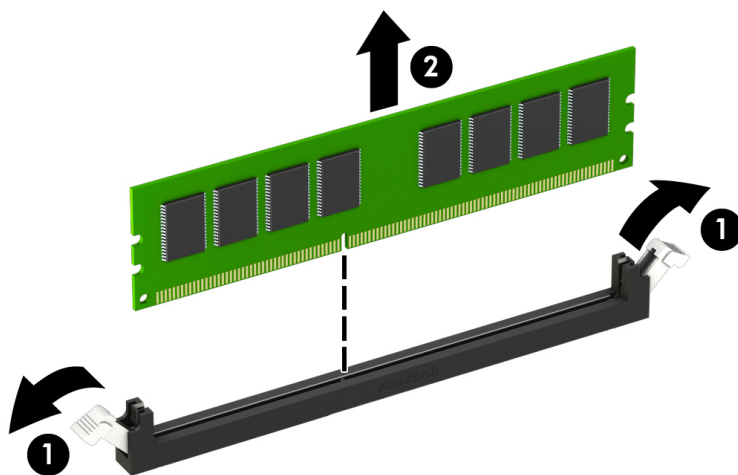

Reverse this procedure to install a memory module. Reconfigure the computer, if necessary.

Speaker

Follow these steps to remove the speaker:

1. Prepare the computer for disassembly (see [Preparation for disassembly on page 31](#)).
2. Remove the access panel (see [Access panel on page 32](#)).
3. Remove the front bezel (see [Front bezel on page 34](#)).
4. Remove the drive cage (see [Drive cage on page 35](#)).

Remove the speaker:

1. Position the computer with the front panel toward you.
2. Disconnect the speaker cable (1) from the system board.
3. Release the speaker cable (2) from the retention clip built into the computer chassis.
4. Remove the two Phillips M2.0×5.5 screws (3) that secure the speaker to the computer chassis.
5. Slide the speaker (4) back into the computer chassis, and then remove the speaker.

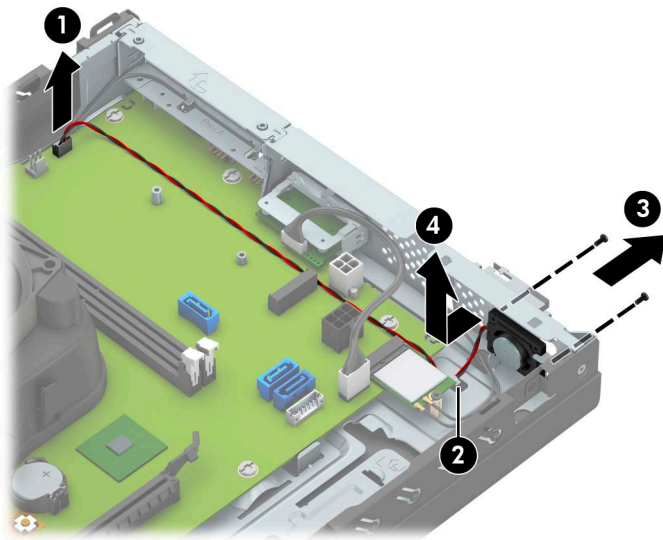

Reverse this procedure to install the speaker.

Power supply

Follow these steps to remove the power supply:

1. Prepare the computer for disassembly (see [Preparation for disassembly on page 31](#)).
2. Remove the access panel (see [Access panel on page 32](#)).
3. Remove the front bezel (see [Front bezel on page 34](#)).
4. Remove the drive cage (see [Drive cage on page 35](#)).

Remove the power supply:

1. Position the computer with the rear panel toward you.
2. Disconnect the power supply P1 (1), P2 (2), and P3 (3) cables from the system board.
3. Release the power supply P3 cable from the retention clips built into the fan shroud (4).
4. Remove the four Torx-15 M3.0×9.0 screws (5) that secure the power supply to the computer chassis.
5. Press down on the power supply release tab (6).
6. Slide the power supply forward (7), and then remove the power supply.

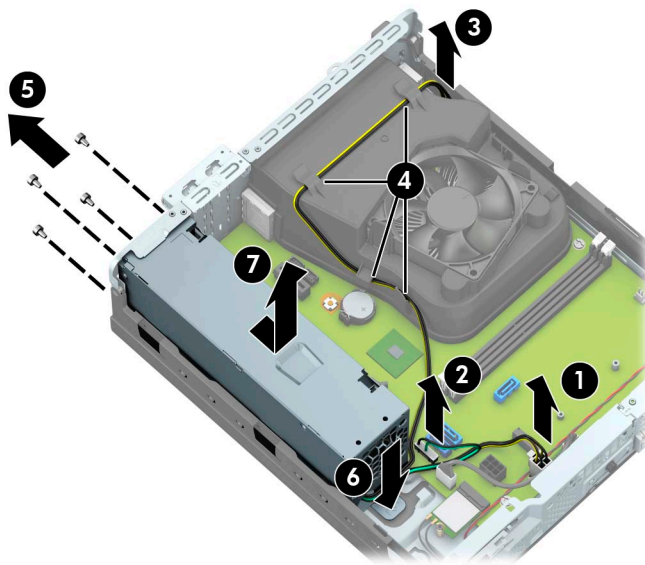

Reverse this procedure to install the power supply.

Fan shroud

Follow these steps to remove the fan shroud:

1. Prepare the computer for disassembly (see [Preparation for disassembly on page 31](#)).
2. Remove the access panel (see [Access panel on page 32](#)).
3. Remove the front bezel (see [Front bezel on page 34](#)).
4. Remove the drive cage (see [Drive cage on page 35](#)).

Remove the fan shroud:

1. Position the computer with the rear panel toward you.
2. Disconnect the power supply P3 (1) cable from the system board.
3. Release the power supply P3 cable from the retention clips built into the fan shroud (2).
4. Press out on the fan shroud release tabs (3).
5. Remove the fan shroud (4).

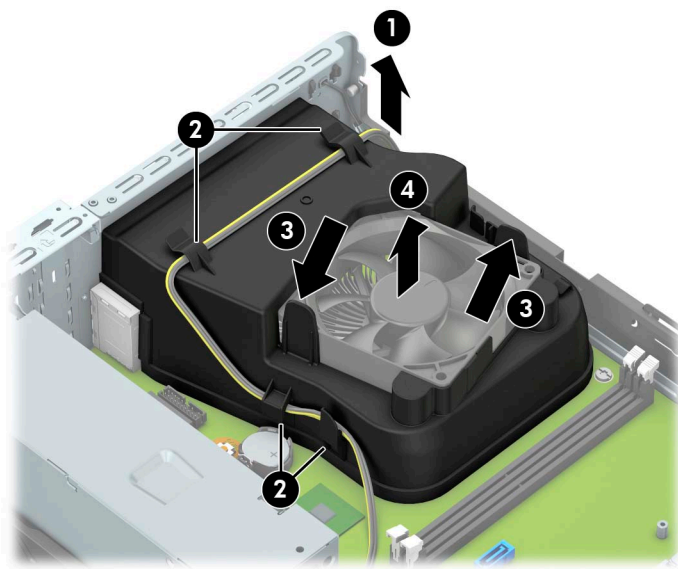

Reverse this procedure to install the fan shroud.

Fan-sink

 **NOTE:** The fan-sink spare park kit includes replacement thermal material.

Follow these steps to remove the fan-sink:

1. Prepare the computer for disassembly (see [Preparation for disassembly on page 31](#)).
2. Remove the access panel (see [Access panel on page 32](#)), and then remove the following components:
 - a. Front bezel (see [Front bezel on page 34](#))
 - b. Drive cage (see [Drive cage on page 35](#))
 - c. Shroud (see [Fan shroud on page 43](#))

Remove the fan-sink:

1. Disconnect the fan-sink cable (1) from the system board.
2. Loosen the four slotted Torx-15 captive screws (2) that secure the fan-sink to the computer chassis.

 **NOTE:** Due to the adhesive nature of the thermal material located between the fan-sink and the processor, it may be necessary to move the fan-sink from side to side when removing the it.

3. Remove the fan-sink (3).

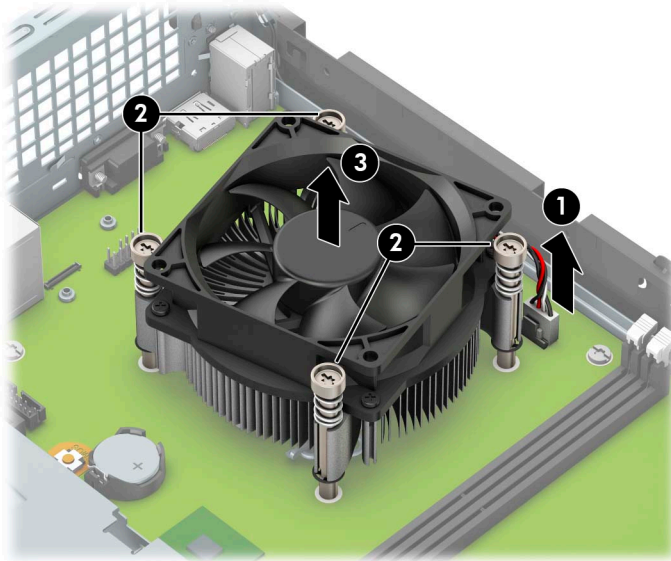

Reverse this procedure to install the fan-sink.

Processor

 **NOTE:** The processor spare part kit includes replacement thermal material.

Follow these steps to remove the fan-sink:

1. Prepare the computer for disassembly (see [Preparation for disassembly on page 31](#)), and then remove the following components:
2. Remove the access panel (see [Access panel on page 32](#)), and then remove the following components:
 - a. Front bezel (see [Front bezel on page 34](#))
 - b. Drive cage (see [Drive cage on page 35](#))
 - c. Shroud (see [Fan shroud on page 43](#))
 - d. Fan-sink (see [Fan-sink on page 44](#))

Remove the processor:

1. Depress the processor release lever **(1)**, and then slide the lever to the right until it clears the locking clip.
2. Swing the processor release lever **(2)** up and back as far as it will go.
3. Swing the processor retention bracket **(3)** up and back as far as it will go.

Serial connector module

Follow these steps to remove the serial connector module:

1. Prepare the computer for disassembly (see [Preparation for disassembly on page 31](#)).
2. Remove the access panel (see [Access panel on page 32](#)), and then remove the following components:
 - a. Front bezel (see [Front bezel on page 34](#))
 - b. Drive cage (see [Drive cage on page 35](#))
 - c. Shroud (see [Fan shroud on page 43](#))

Remove the serial connector module:

1. Disconnect the serial connector module cable (1) from the system board.
2. Remove the two 3/16-in. screw locks (2) that secure the serial connector module to the computer chassis.
3. Remove the serial connector module (3).

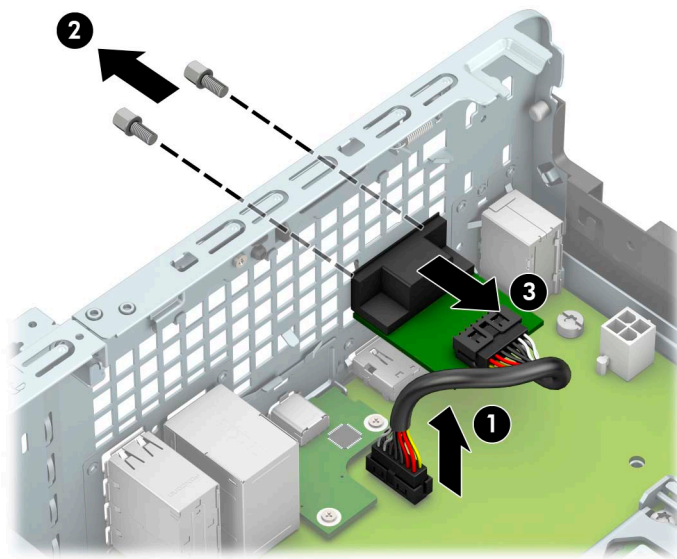

Reverse this procedure to install the serial connector module.

System board

 **NOTE:** The system board spare park kit includes replacement thermal material.

Follow these steps to remove the system board:

1. Prepare the computer for disassembly (see [Preparation for disassembly on page 31](#)).
2. Remove the access panel (see [Access panel on page 32](#)), and then remove the following components:
 - a. Front bezel (see [Front bezel on page 34](#))
 - b. WLAN module (see [WLAN module on page 39](#))
 - c. Drive cage (see [Drive cage on page 35](#))
 - d. Shroud (see [Fan shroud on page 43](#))
 - e. Fan-sink (see [Fan-sink on page 44](#))

 **NOTE:** When replacing the system board, be sure that the processor (see [Processor on page 45](#)) is removed from the defective system board and installed on the replacement system board.

3. Disconnect the following cables from the system board:
 - (1) Power supply P1 cable
 - (2) Speaker cable
 - (3) Device power cable
 - (4) Power supply P2 cable
 - (5) Device data cables (three locations)
 - (6) Speaker cable

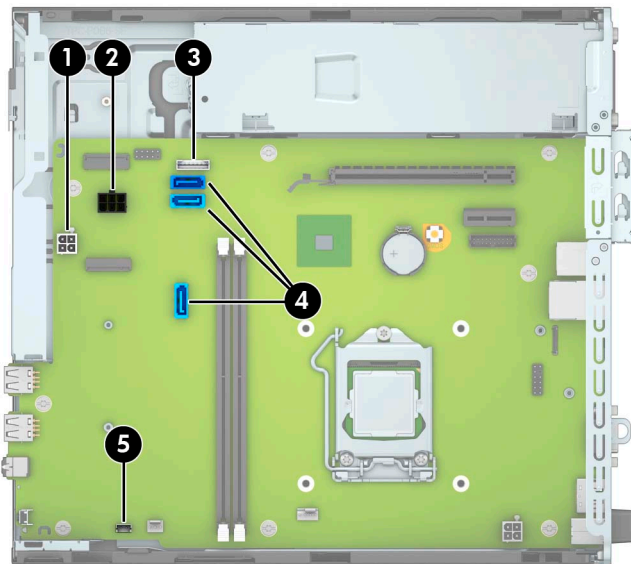

4. Remove the eight Torx-15 M3.0×9.0 screws that secure the system board to the computer chassis.

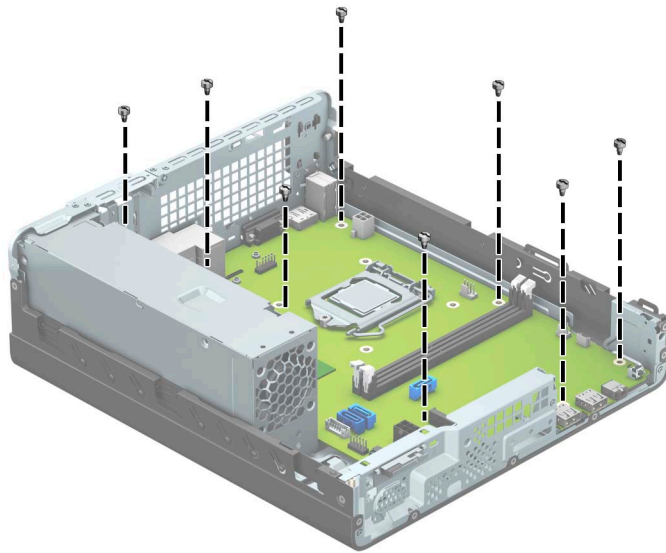

5. Swing the top edge of the lower cage (1) away from the computer chassis.
6. Remove the lower cage (2).

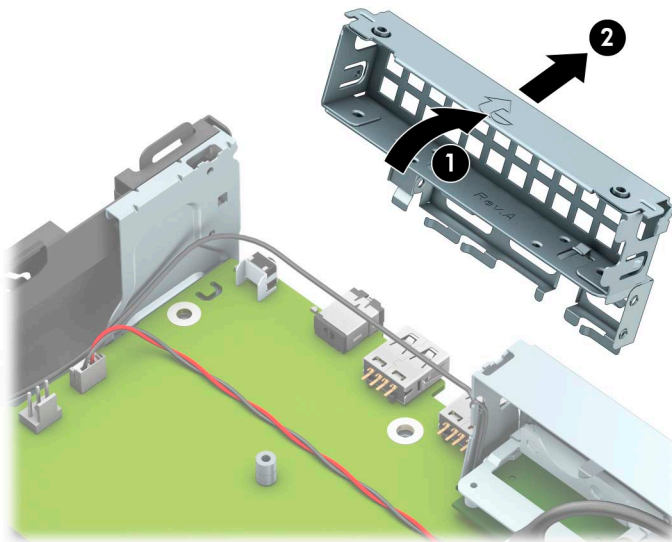

7. Lift the front edge of the system board (1) until it rests at an angle.

8. Remove the system board (2) by sliding the front edge up and forward at an angle.

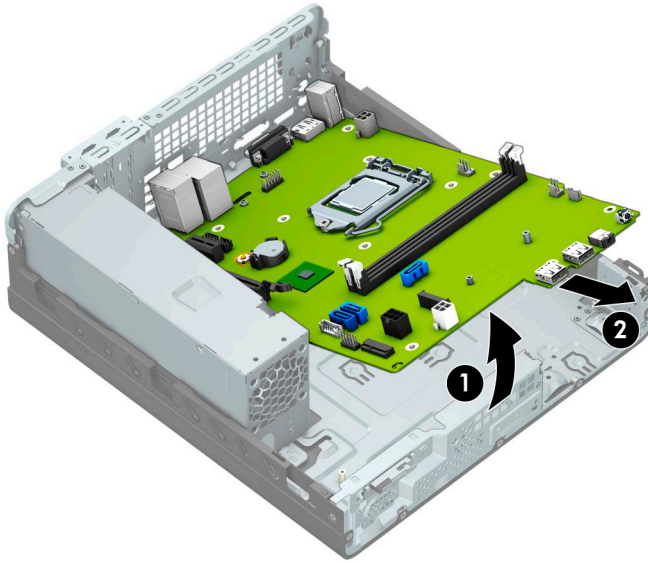

Reverse this procedure to install the system board.

5 Computer Setup (F10)Utility

Computer Setup (F10)Utilities

Use Computer Setup (F10)Utility to do the following:

- Change settings from the defaults or restore the settings to default values.
- View the system configuration, including settings for processor, graphics, memory, audio, storage, communications, and input devices.
- Modify the boot order of bootable devices such as hard drives, optical drives, or USB flash media devices.
- Enter the Asset Tag or property identification number assigned by the company to this computer.
- Enable the power-on password prompt during system restarts (warm boots)as well as during power-on.
- Establish an administrator password that controls access to the Computer Setup (F10)Utility and the settings described in this section.
- Establish minimum requirements for valid passwords, including length and required types of characters.
- Secure integrated I/O functionality, including the serial, USB, or audio, or embedded NIC, so that they cannot be used until they are unsecured.
- Enable or disable different types of boot sources.
- Configure features such as Secure Boot, power management, virtualization support, and language and keyboard type used in Setup and POST.
- Replicate the system setup by saving system configuration information on a USB device and restoring it on one or more computers.
- Enable or disable DriveLock security or securely erase a hard drive (when supported by drive).

Using Computer Setup (F10)Utilities

Computer Setup can be accessed only by turning the computer on or restarting the system. To access the Computer Setup Utilities menu, complete the following steps:

1. Turn on or restart the computer.
2. Repeatedly press **F10** when the monitor light turns green to access the utility.

You can also press **Esc** to a menu that allows you to access different options available at startup, including the Computer Setup utility.

 **NOTE:** If you do not press **F10** at the appropriate time, you must restart the computer and again repeatedly press **F10** when the monitor light turns green to access the utility.

3. A choice of four headings appears in the Computer Setup Utilities menu: Main, Security, Advanced, and UEFI Drivers.

 **NOTE:** Selecting UEFI Drivers restarts the computer into the 3rd party option ROM management application. You can access this application directly by pressing **F3** during startup.

4. Use the arrow (left and right)keys to select the appropriate heading. Use the arrow (up and down)keys to select the option you want, then press **Enter**. To return to the Computer Setup Utilities menu, press **Esc**.

5. To apply and save changes, select **Main > Save Changes and Exit**.

- If you have made changes that you do not want applied, select **Ignore Changes and Exit**.
- To restore settings from the Advanced and Main menus to original values, select **Apply Factory Defaults and Exit**.
- To restore settings from the Advanced and Main menus to those previously saved by **Save Custom Defaults**, select **Apply Custom Defaults and Exit**. If no custom defaults have been saved, then factory defaults are used.

 **NOTE:** Settings in the **Security** menu are not modified by **Apply Defaults**. Those values are reset by **Restore Security Settings to Default** at the bottom of the **Security** menu.

 **NOTE:** Not all settings shown in the following sections are available for all models

 **CAUTION:** Do NOT turn the computer power OFF while the BIOS is saving the Computer Setup (F10)changes because the settings could become corrupted. It is safe to turn off the computer only after exiting the F10 Setup screen.

Computer Setup—Main



NOTE: Support for specific Computer Setup options can vary depending on the hardware configuration.

Table 5-1 Computer Setup—Main

Option	Description
System Information	<p>Lists all information in following list if Advanced System Information is selected. Lists smaller subset if Basic System Information is selected.</p> <ul style="list-style-type: none">• Product name• Installed memory size• Processor type• Processor cache size (L1/L2/L3)• Processor speed• MicroCode Revision• Processor Stepping• DIMM size (for each installed module)• System BIOS version• ME Firmware version (Intel only)• Video BIOS version• Super I/O Firmware version• Born On Date• Serial Number• SKU number• UUID (Universally Unique Identifier)• Asset Tracking Number• Feature Byte• Build ID• Product Family• System Board ID• System Board CT• Integrated MAC Address
System Diagnostics	<p>If the hard drive has the HP Advanced Diagnostics installed, the application will launch. If HP Advanced Diagnostics is not installed, then a basic version built into the BIOS will provide the capability to perform the following functions:</p> <ul style="list-style-type: none">• Memory Test• Hard Drive Check• Language
Update System BIOS	<p>Lets you update the system BIOS from www.hp.com or another network server, from a removable USB drive, or from a file located on the hard drive.</p> <ul style="list-style-type: none">• 'Check HP.com for BIOS Updates' or 'Check the Network for BIOS Updates' <p>The string that appears here depends on the setting in 'BIOS Update Preferences'.</p>

Table 5-1 Computer Setup—Main (continued)

Option	Description
	<ul style="list-style-type: none"> • Lock BIOS Version If this option is checked, the system is locked to the current BIOS version and updates are not allowed. • BIOS Update Preferences Allows the administrator to select the source of network updates (www.hp.com or another network server) and allows configuration of a periodic check for updates, including policies for: <ul style="list-style-type: none"> ■ Check for updates and prompt the user to accept or reject the update at that time ■ Check for updates and install all new versions ■ Check for updates and install only new versions marked important • Network Configuration Settings • Update BIOS Using Local Media Lets you access files on either USB storage or the hard drive. The HP BIOS Update and Recovery application included in BIOS Softpaqs at www.hp.com will copy the BIOS file to the correct location on the hard drive or USB device.
System IDs	<p>Lets you set the following values:</p> <ul style="list-style-type: none"> • Asset Tracking Number • Ownership Tag
Replicated Setup	<p>Backup current settings to USB device Saves system configuration to a formatted USB flash media device.</p> <p>Restore current settings from USB device Restores system configuration from a USB flash media device.</p>
Save Custom Defaults	Saves the current system configuration settings as the custom default set.
Apply Custom Defaults and Exit	Applies the custom default settings to the computer after rebooting. Does not apply to options in the Security menu.
Apply Factory Defaults and Exit	Restores the factory system configuration settings to the computer after rebooting. Does not apply to options in the Security menu.
Ignore Changes and Exit	Exits Computer Setup without applying or saving any changes.
Save Changes and Exit	Saves changes to current system configuration, exits Computer Setup, and reboots.

Computer Setup—Security



NOTE: Support for specific Computer Setup options can vary depending on the hardware configuration.

Table 5-2 Computer Setup—Security

Option	Description
Set up BIOS Administrator Password	<p>Lets you set and enable a BIOS administrator password, which includes the following privileges:</p> <ul style="list-style-type: none">• Manage other BIOS users• Full access to BIOS policy and settings• Unlock the computer when other BIOS users fail the preboot authentication. <p>NOTE: Creating a BIOS user disables the Fast Boot option.</p> <p>NOTE: If the password is set, it is required to change Computer Setup options, update the BIOS, and make changes to certain plug and play settings under Windows.</p>
Change BIOS Administrator Password (This selection is active only if a BIOS administrator password is set.)	<p>Lets you change the BIOS administrator password.</p> <p>You must know the current password to be able to change it.</p>
Password Policies	<p>Let you set the guidelines for a valid password. Options include:</p> <ul style="list-style-type: none">• Password minimum length• Requires at least one symbol• Requires at least one number• Requires at least one upper case character• Requires at least one lower case character• Allow spaces <p>Clear Password Jumper</p> <p>Select 'Honor' to allow or 'Ignore' to not allow the absence of the password jumper to clear the passwords at boot up. Default is 'Honor'.</p>
Security Configuration	<p>TPM Embedded Security</p> <ul style="list-style-type: none">• TPM Device Lets you set the Trusted Platform Module as available or hidden.• TPM State Select to enable the TPM.• TPM Clear Select to reset the TPM to an unowned state. After the TPM is cleared, it is also turned off. To temporarily suspend TPM operations, turn the TPM off instead of clearing it. CAUTION: Clearing the TPM resets it to factory defaults and turns it off. You will lose all created keys and data protected by those keys. <p>BIOS Sure Start</p> <ul style="list-style-type: none">• Verify Boot Block on every Boot Select to check validity of boot block region each boot. If not selected, boot block region will be validated on power cycles.

Table 5-2 Computer Setup—Security (continued)

Option	Description
	<ul style="list-style-type: none"> Data Recovery Policy Select 'Automatic' or 'Manual' to set data recovery policy. 'Manual' lets you select whether or not to execute recovery of a corrupted region if it is detected.
Set Up BIOS Power-On Password	Lets you set and enable a BIOS power-on password. The power-on password prompt appears after a power cycle or reboot. If the user does not enter the correct power-on password, the unit will not boot.
Change BIOS Power-On Password (This selection is active only if a BIOS power-on password is set.)	Lets you change the BIOS power-on password. You must know the current password to be able to change it.
DriveLock	Allows you to assign or modify a master or user password for hard drives. When this feature is enabled, the user is prompted to provide one of the DriveLock passwords during POST. If neither is successfully entered, the hard drive will remain inaccessible until one of the passwords is successfully provided during a subsequent cold-boot sequence. NOTE: This selection will only appear when at least one drive that supports the DriveLock feature is attached to the system. CAUTION: Be aware that these settings take place immediately. A save is not necessary. CAUTION: Be sure to document the DriveLock password. Losing a DriveLock password will render a drive permanently locked. After you select a drive, the following options are available: Set DriveLock Master Password. Sets the drive's master password but does not enable DriveLock. Enable DriveLock. Sets the drive's user password and enables DriveLock.
Secure Erase	Lets you select a hard drive to completely erase. Once a hard drive has been erased with a program that utilizes Secure Erase firmware commands, no file recovery program, partition recovery program, or other data recovery method will be able to extract data from the drive.
Save/Restore MBR of the system hard drive	NOTE: Windows 10 systems are generally not formatted to include an MBR. Instead they use GUID Partition Table (GPT) format, which better supports large hard drives. Enabling this feature will save the Master Boot Record (MBR) of the system hard drive. If the MBR gets changed, the user will be prompted to restore the MBR. Default is disabled. The MBR contains information needed to successfully boot from a disk and to access the data stored on the disk. Master Boot Record Security may prevent unintentional or malicious changes to the MBR, such as those caused by some viruses or by the incorrect use of certain disk utilities. It also allows you to recover the "last known good" MBR, should changes to the MBR be detected when the system is restarted. NOTE: Most operating systems control access to the MBR of the current bootable disk; the BIOS cannot prevent changes that may occur while the operating system is running. Restores the backup Master Boot Record to the current bootable disk. Default is disabled. Only appears if all of the following conditions are true: <ul style="list-style-type: none"> MBR security is enabled A backup copy of the MBR has been previously saved The current bootable disk is the same disk from which the backup copy was saved CAUTION: Restoring a previously saved MBR after a disk utility or operating system has modified the MBR, may cause the data on the disk to become inaccessible. Only restore a previously saved MBR if you are confident that the current bootable disk's MBR has been corrupted or infected with a virus.
Smart Cover	Cover Lock (Lock/Unlock)

Table 5-2 Computer Setup—Security (continued)

Option	Description
	<p>Default is 'Unlock'.</p> <p>Cover Removal Sensor (Disabled/Notify user/Administrator password)</p> <p>Lets you disable the cover sensor or configure what action is taken if the computer cover was removed. Default is 'Disabled'.</p> <p>NOTE: Notify user alerts the user with a POST error on the first boot after the sensor detects removal of the cover. If the password is set, Administrator Password requires that the password be entered to boot the computer if the sensor detects that the cover has been removed.</p>
System Management Command	Allows authorized personnel to reset security settings during a service event. Default is enabled.
Restore Security Settings to Default	This action resets security devices, clears BIOS passwords (not including DriveLock), and restores settings in the Security menu to factory defaults.

Computer Setup—Advanced

 **NOTE:** Support for specific Computer Setup options can vary depending on the hardware configuration.

Table 5-3 Computer Setup—Advanced (for advanced users)

Option	Heading
Display Language	Lets you select the language of the menus in F10 Setup and the keyboard layout.
Scheduled Power-On	This feature wakes the system up from a powered off state at a specified date and time.
Boot Options	<p>Select the devices that the computer can boot from, as well as other options, including:</p> <ul style="list-style-type: none"> • Startup Menu Delay(sec). Enabling this feature will add a user-specified delay to the POST process. One purpose for the delay is to provide additional time to activate hotkeys such as Esc for the Startup Menu or F10 for Computer Setup. • Fast Boot. Default is enabled. • CD-ROM Boot. Default is enabled. • Network (PXE)Boot. Default is enabled. • Prompt on Memory Size Change. Default is enabled. • Prompt on Fixed Storage Change. Default is disabled. • After Power Loss. Default is Power Off. <ul style="list-style-type: none"> ■ Power off—causes the computer to remain powered off when power is restored. ■ Power on—causes the computer to power on automatically as soon as power is restored. ■ Previous state—causes the computer to power on automatically as soon as power is restored, if it was on when power was lost. <p>NOTE: If the system is configured to 'Power On from Keyboard Ports' (see Power Management Options), then this setting is forced to 'Power On'.</p> <ul style="list-style-type: none"> • Audio Alerts During Boot. Default is enabled. When disabled, most audible beeps from errors, warnings, and password prompts during boot up are suppressed. • UEFI Boot Order. <p>Default is enabled. Specify the order in which UEFI boot sources (such as a internal hard drive, USB hard drive, USB optical drive, or internal optical drive)are checked for a bootable operating system image.</p>

Table 5-3 Computer Setup—Advanced (for advanced users) (continued)

Option	Heading
	<p>UEFI boot sources always have precedence over legacy boot sources.</p> <ul style="list-style-type: none"> Legacy Boot Order <p>Specify the order in which legacy boot sources (such as a network interface card, internal hard drive, USB optical drive, or internal optical drive) are checked for a bootable operating system image.</p> <p>Specify the order of attached hard drives. The first hard drive in the order will have priority in the boot sequence and will be recognized as drive C (if any devices are attached).</p> <p>NOTE: To drag a device to a preferred place, press Enter.</p> <p>NOTE: MS-DOS drive lettering assignments may not apply after a non-MS-DOS operating system has started.</p> <p>Shortcut to Temporarily Override Boot Order</p> <p>To boot one time from a device other than the default device specified in Boot Order, restart the computer and press Esc (to access the Startup menu) and then F9 (Boot Menu), or only F9 (skipping the Startup menu) when the monitor light turns green. After POST is completed, a list of bootable devices is displayed. Use the arrow keys to select the preferred bootable device and press Enter. The computer then boots from the selected non-default device for this one time.</p>
Secure Boot Configuration	<p>Configure Legacy Support and Secure Boot</p> <p>Legacy Support – Lets you turn off all legacy support on the computer, including booting to DOS, running legacy graphics cards, booting to legacy devices, and so on.</p> <p>Secure Boot – Lets you make sure an operating system is legitimate before booting to it, making Windows resistant to malicious modification from preboot to full OS booting, preventing firmware attacks. UEFI and Windows Secure Boot only allow code signed by pre-approved digital certificates to run during the firmware and OS boot process.</p> <p>Default is 'Legacy Support Enable and Secure Boot Disable' for non-Windows configurations. Default is 'Legacy Support Disable and Secure Boot Enable' for Windows 10 configurations.</p> <p>Secure Boot Key Management</p> <p>Lets you manage the custom key settings.</p> <p>Clear Secure Boot Keys</p> <p>Lets you delete any previously loaded custom boot keys. Clearing keys will disable secure boot. Default is disabled.</p> <p>Reset Secure Boot keys to factory defaults</p> <p>Default is disabled.</p> <p>Enable MS UEFI CA key</p> <p>Disabling this setting alters the Secure Boot key list to further restrict the allowed software components. Set this option to 'disable' to support Device Guard.</p>
System Options	<p>Configure Storage Controller for RAID (enable/disable)</p> <p>Lets you enable onboard RAID. Default is disabled.</p> <p>POST Prompt for RAID Configuration (Intel only)</p> <p>When disabled, the prompt for 'RAID option ROM' in legacy mode is suppressed.</p> <p>SVM CPU Virtualization (AMD only)</p> <p>Controls the virtualization features of the processor. Changing this setting requires turning the computer off and then back on. Default is disabled.</p> <p>Virtualization Technology (VTx)(Intel only)</p>

Table 5-3 Computer Setup—Advanced (for advanced users) (continued)

Option	Heading
	<p>Controls the virtualization features of the processor. Changing this setting requires turning the computer off and then back on. Default is disabled.</p> <p>Virtualization Technology for Directed I/O (VTd)(Intel only)</p> <p>Controls virtualization DMA remapping features of the chipset. Changing this setting requires turning the computer off and then back on. Default is disabled.</p> <p>PCI Express Slot x (enable/disable)</p> <p>Lets you disable individual expansion slots.</p> <p>Allow PCIe/PCI SERR# Interrupt (enable/disable)</p> <p>Allows PCI devices to report PCI/PCIe System Error signals, such as address parity errors, data parity errors, and critical errors other than parity. Default is enabled.</p> <p>Power Button Override (disable/4 sec/15 sec)</p> <p>Lets you disable or enable and select the number of seconds you have to hold down the power button for it to force the system to power off. Default is '4 sec'.</p>
Built-In Device Options	<p>Embedded LAN Controller</p> <p>Select to show the device in the operating system. Default is enabled.</p> <p>Wake On LAN</p> <p>Lets you either disable the Wake On LAN feature, or configure where the computer boots, including the network or hard drive. Default is Boot to Network.</p> <p>Dust Filter</p> <p>Select to enable the Dust Filter replacement reminder, which can be set for 15, 30, 60, 90, 120, or 180 days. The reminder will show during POST after the reminder timer has expired.</p> <p>Video Memory Size</p> <p>Use this option to manage graphics memory allocation. The value you choose is allocated permanently to graphics and is unavailable to the operating system.</p> <p>Audio Device</p> <p>Select to show the device in the operating system. Default is enabled.</p> <p>Internal Speakers (does not affect external speakers)</p> <p>Clear to disable the chassis speaker or speakers. This function is applicable to normal audio playback in the operating system and does not affect the error or warning beeps during POST. Default is enabled.</p> <p>Integrated Microphone</p> <p>Clear to disable the integrated microphone. This does not affect devices plugged into audio jacks. Default is enabled.</p> <p>Integrated Camera</p> <p>Clear to disable the integrated webcam. Default is enabled.</p> <p>Increase Idle Fan Speed(%)</p> <p>Sets idle fan speed percentage. This setting only changes the minimum fan speed. The fan is still automatically controlled.</p> <p>Fingerprint Device</p> <p>Select to show the device in the operating system. Default is enabled.</p> <p>Touch Panel</p>

Table 5-3 Computer Setup—Advanced (for advanced users) (continued)

Option	Heading
	Clear to disable the display panel touch feature. Default is enabled.
Port Options	<p>Allows you to hide the following ports from the operating system:</p> <ul style="list-style-type: none"> • Serial port A • Serial port B • SATA0 • SATA1 • SATA2 • SATA3 • SATA5 • Front USB ports • Rear USB ports • USB charging port function • Media card reader <p>Restrict USB Devices</p> <p>Specify the following categories of USB devices to enable:</p> <ul style="list-style-type: none"> • Allow all USB devices • Allow only keyboard and mouse • Allow all but storage devices and hubs. <p>When some devices are restricted, the system will disable USB ports that do not meet the allowed criteria. This feature is usually combined with similar policies within the operating system since USB devices can be moved to different ports. The ports disabled by the BIOS will remain disabled until the system is restarted.</p>
Option ROM Launch Policy	<p>These policies control whether Legacy Option ROMs or UEFI drivers are loaded. Default is 'All legacy' for non-Windows configurations. Default is 'All UEFI' for Windows 10.</p> <p>Configure Option ROM Launch Policy</p> <ul style="list-style-type: none"> • All legacy • All UEFI • All UEFI except video
Power Management Options	<p>Runtime Power Management (enable/disable)</p> <p>Allows certain operating systems to reduce processor voltage and frequency when the current software load does not require the full capabilities of the processor. Default is enabled.</p> <p>Extended Idle Power States (enable/disable)</p> <p>Allows certain operating systems to decrease the processors power consumption when the processor is idle. Default is enabled.</p> <p>S5 Maximum Power Savings (enable/disable)</p> <p>Enabling this feature reduces the power of the system as much as possible in the S5 state. Power is removed from the wake up circuitry, the expansion slots, and any management features while in S5. Default is disabled.</p> <p>SATA Power Management (enable/disable)</p>

Table 5-3 Computer Setup—Advanced (for advanced users) (continued)

Option	Heading
	<p>Enables or disables SATA bus and/or device power management. Default is enabled.</p> <p>PCI Express Power Management (enable/disable)</p> <p>Enabling this option permits the PCI Express links to use Active Power State Management (ASPM) to enter lower power states while not in use. Default is enabled.</p> <p>Unique Sleep State Blink Rates (enable/disable)</p> <p>This feature is designed to provide a visual indication of what sleep state the system is in. Each sleep state has a unique blink pattern. Default is disabled.</p> <p>NOTE: A normal shutdown goes to the S4 state for Windows 10.</p> <p>S0 (On)= Solid white LED.</p> <p>S3 (Stand By)= 3 blinks at 1Hz (50% duty cycle) followed by a pause of 2 seconds (white LED)— repeated cycles of 3 blinks and a pause.</p> <p>S4 (Hibernation)= 4 blinks at 1Hz (50% duty cycle) followed by a pause of 2 seconds (white LED)— repeated cycles of 4 blinks and a pause.</p> <p>S5 (Soft Off)= LED is off.</p> <p>Power On from Keyboard Ports (enable/disable)</p> <p>When enabled, this feature allows a key press to power on the system when it is off (S5 state). If using a USB keyboard, it must be plugged into one of the rear ports labeled with the keyboard icon. Default is disabled.</p>
Remote Management Options	<p>Active Management (AMT)(Intel only)(enable/disable). Default is enabled.</p> <p>Allows you to discover, repair, and protect networked computing devices.</p> <p>USB Key Provisioning Support (enable/disable)Default is disabled.</p> <p>USB Redirection Support (enable/disable). Default is enabled.</p> <p>USB redirection allows USB devices plugged into a client computer to be transparently redirected to the guest operating system.</p> <p>Unconfigure AMT on next boot (Do Not Apply/Apply). Default is 'Do Not Apply'.</p> <p>SOL Terminal Emulation Mode (ANSI / VT100). Default is ANSI.</p> <p>SOL terminal emulation mode is only activated during remote AMT redirection operations. The emulation options allow administrators to select which mode works best with their console.</p> <p>Show Unconfigure ME Confirmation Prompt (enable/disable). Default is enabled.</p> <p>Verbose Boot Messages (enable/disable). Default is enabled.</p> <p>Verbose boot shows additional logging information during the boot. mainly for debugging if something goes wrong during bootup.</p> <p>Watchdog Timer (enable/disable). Default is enabled.</p> <p>Allows you to set amount of time for a operating system and BIOS watchdog alert to be sent if the timers are not deactivated. BIOS watchdog is deactivated by BIOS and would indicate that a halt occurred during execution if the alert is sent to the management console. An operating system alert is deactivated by the operating system image and would indicate that a hang occurred during its initialization.</p> <ul style="list-style-type: none"> • OS Watchdog Timer (min.)– (5/10/15/20/25). Default is 5 min. • BIOS Watchdog Timer (min.)– (5/10/15/20/25). Default is 5 min. <p>CIRA Timeout (min.)(1/2/3/4/Never)</p> <p>CIRA is Customer Initiated Remote Assistance, an Intel service to help users employing Active Management Technology (AMT).</p>

Recovering the Configuration Settings

This method of recovery requires that you first perform the **Save to Removable Media** command with the Computer Setup (F10)Utility before **Restore** is needed. (See [Computer Setup—Main on page 53](#) in the Computer Setup—File table.)

The **Save to Removable Media** option creates a file named HPSETUP.TXT on an inserted USB flash media device. This file can be edited to change the settings on Restore. An asterisk (*)marks the selected option for a setting.



NOTE: It is recommended that you save any modified computer configuration settings to a USB flash media device and save the device for possible future use.

To restore the configuration, insert the USB flash media device with the saved configuration and perform the **Restore from Removable Media** command with the Computer Setup (F10)Utility. (See [Computer Setup—Main on page 53](#) in the Computer Setup—File table.)

6 Troubleshooting without diagnostics

This chapter provides information on how to identify and correct minor problems, such as USB devices, hard drive, graphics, audio, memory, and software problems. If you encounter problems with the computer, refer to the tables in this chapter for probable causes and recommended solutions.

 **NOTE:** For information on specific error messages that may appear on the screen during Power-On Self-Test (POST) at startup, refer to [POST error messages and diagnostic front panel LEDs and audible codes on page 89](#).

Safety and comfort

 **WARNING!** Misuse of the computer or failure to establish a safe and comfortable work environment may result in discomfort or serious injury. Refer to the *Safety & Comfort Guide* at <http://www.hp.com/ergo> for more information on choosing a workspace and creating a safe and comfortable work environment. For more information, refer to the *Safety & Regulatory Information* guide.

Before you call for technical support

If you are having problems with the computer, try the appropriate solutions below to try to isolate the exact problem before calling for technical support.

- Run the HP diagnostic tool.
- Run the hard drive self-test in Computer Setup. Refer to [Computer Setup \(F10\) Utility on page 51](#) for more information.
- Check the Power LED on the front of the computer to see if it is flashing red. The flashing lights are error codes that will help you diagnose the problem. Refer to [POST error messages and diagnostic front panel LEDs and audible codes on page 89](#) for more information.
- If the screen is blank, plug the monitor into a different video port on the computer if one is available. Or, replace the monitor with a monitor that you know is functioning properly.
- If you are working on a network, plug another computer with a different cable into the network connection. There may be a problem with the network plug or cable.
- If you recently added new hardware, remove the hardware and see if the computer functions properly.
- If you recently installed new software, uninstall the software and see if the computer functions properly.
- Boot the computer to the Safe Mode to see if it will boot without all of the drivers loaded. When booting the operating system, use “Last Known Configuration.”
- Refer to the comprehensive online technical support at <http://www.hp.com/support>.
- Refer to [Helpful hints on page 64](#) in this guide.

To assist you in resolving problems online, HP Instant Support Professional Edition provides you with self-solve diagnostics. If you need to contact HP support, use HP Instant Support Professional Edition's online chat feature. Access HP Instant Support Professional Edition at: <http://www.hp.com/go/ispe>.

Access the Business Support Center (BSC) at <http://www.hp.com/go/bizsupport> for the latest online support information, software and drivers, proactive notification, and worldwide community of peers and HP experts.

If it becomes necessary to call for technical assistance, be prepared to do the following to ensure that your service call is handled properly:

- Be in front of your computer when you call.
- Write down the computer serial number, product ID number, and monitor serial number before calling.
- Spend time troubleshooting the problem with the service technician.
- Remove any hardware that was recently added to your system.
- Remove any software that was recently installed.
- Restore the system from the Recovery Disc Set that you created or restore the system to its original factory condition in System Software Requirement Disks (SSRD).

 **CAUTION:** Restoring the system will erase all data on the hard drive. Be sure to back up all data files before running the restore process.

 **NOTE:** For sales information and warranty upgrades (Care Packs), call your local authorized service provider or dealer.

Helpful hints

If you encounter problems with the computer, monitor, or software, see the following list of general suggestions before taking further action:

- Check that the computer and monitor are plugged into a working electrical outlet.
- Check that the voltage select switch (some models) is set to the appropriate voltage for your region (115V or 230V).
- Check that the computer is turned on and the white power light is on.
- Check that the monitor is turned on and the green monitor light is on.
- Check the Power LED on the front of the computer to see if it is flashing red. The flashing lights are error codes that will help you diagnose the problem. Refer to [POST error messages and diagnostic front panel LEDs and audible codes on page 89](#) for more information.
- Turn up the brightness and contrast controls of the monitor if the monitor is dim.
- Press and hold any key. If the system beeps, then the keyboard should be operating correctly.
- Check all cable connections for loose connections or incorrect connections.
- Wake the computer by pressing any key on the keyboard or pressing the power button. If the system remains in suspend mode, shut down the computer by pressing and holding the power button for at least four seconds then press the power button again to restart the computer. If the system will not shut down, unplug the power cord, wait a few seconds, then plug it in again. The computer will restart if it is set to power on automatically as soon as power is restored in Computer Setup. If it does not restart, press the power button to start the computer.
- Reconfigure the computer after installing a non-plug and play expansion board or other option. See [Solving hardware installation problems on page 81](#) for instructions.
- Be sure that all the needed device drivers have been installed. For example, if you are using a printer, you need a driver for that model printer.
- Remove all bootable media (CD/DVD or USB device) from the system before turning it on.

- If you have installed an operating system other than the factory-installed operating system, check to be sure that it is supported on the system.
- If the system has multiple video sources (embedded, PCI, or PCI-Express adapters) installed (embedded video on some models only) and a single monitor, the monitor must be plugged into the monitor connector on the source selected as the primary VGA adapter. During boot, the other monitor connectors are disabled and if the monitor is connected into these ports, the monitor will not function. You can select which source will be the default VGA source in Computer Setup.

⚠ CAUTION: When the computer is plugged into an AC power source, there is always voltage applied to the system board. You must disconnect the power cord from the power source before opening the computer to prevent system board or component damage.

Solving general problems

You may be able to easily resolve the general problems described in this section. If a problem persists and you are unable to resolve it yourself or if you feel uncomfortable about performing the operation, contact an authorized dealer or reseller.

⚠ WARNING! When the computer is plugged into an AC power source, voltage is always applied to the system board. To reduce the risk of personal injury from electrical shock and/or hot surfaces, be sure to disconnect the power cord from the wall outlet and allow the internal system components to cool before touching.

Cannot access the Computer Setup (F10) Utility when booting the computer.

Cause	Solution
The Computer Setup (F10) Utility is set to “fast boot” causing the F10 access screen to display too briefly when booting the computer.	<p>Before turning on the computer, press and hold F10. Turn on the computer and continue to hold F10 until the Computer Setup (F10) Utility is displayed.</p> <p>- or -</p> <p>Follow the Windows instructions for rebooting the computer into the Computer Setup (F10) Utility.</p>

Computer appears locked up and will not turn off when the power button is pressed.

Cause	Solution
Software control of the power switch is not functional.	<ol style="list-style-type: none"> 1. Press and hold the power button for at least four seconds until the computer turns off. 2. Disconnect the power cord from the electrical outlet.

Computer will not respond to keyboard or mouse.

Cause	Solution
Computer is in Sleep state.	<p>To resume from Sleep state, press the power button.</p> <p>CAUTION: When attempting to resume from Sleep state, do not hold down the power button for more than four seconds. Otherwise, the computer will shut down and you will lose any unsaved data.</p>
System has locked up.	Restart computer.

Computer date and time display is incorrect.

Cause	Solution
RTC (real-time clock) battery may need to be replaced. NOTE: Connecting the computer to a live AC outlet prolongs the life of the RTC battery.	Reset the date and time under Control Panel (Computer Setup can also be used to update the RTC date and time). If the problem persists, replace the RTC battery. See the Removal and Replacement section for instructions on installing a new battery, or contact an authorized dealer or reseller for RTC battery replacement. To access Control Panel, type <code>control panel</code> in the taskbar search box, and then select Control Panel.

There is no sound or sound volume is too low.

Cause	Solution
System volume may be set low or muted.	<ol style="list-style-type: none">1. Check the Computer Setup settings to make sure the internal system speaker is not muted (this setting does not affect the external speakers).2. Make sure the external speakers are properly connected and powered on and that the speakers' volume control is set correctly.3. Use the system volume control available in the operating system to make sure the speakers are not muted or to increase the volume.

Cannot remove computer cover or access panel.

Cause	Solution
Smart Cover Lock, featured on some computers, is locked.	Unlock the Smart Cover Lock using Computer Setup. In case of forgotten password, power loss, or computer malfunction, you must manually disable the Smart Cover lock . A key to unlock the Smart Cover Lock is not available from HP. Keys are typically available from a hardware store.

Poor performance.

Cause	Solution
Processor is too hot.	<ol style="list-style-type: none">1. Make sure airflow to the computer is not blocked. Leave a 10.2-cm (4-inch) clearance on all vented sides of the computer and above the monitor to permit the required airflow.2. Make sure fans are connected and working properly (some fans only operate when needed).3. Make sure the processor heat sink is installed properly.
Hard drive is full.	Transfer data from the hard drive to create more space on the hard drive.
Low on memory.	Add more memory.

Poor performance.

Cause	Solution
Hard drive fragmented.	Defragment hard drive.
Program previously accessed did not release reserved memory back to the system.	Restart the computer.
Virus resident on the hard drive.	Run virus protection program.
Too many applications running.	<ol style="list-style-type: none">1. Close unnecessary applications to free up memory.2. Add more memory.3. Some applications run in the background and can be closed by right-clicking on their corresponding icons in the task tray. To prevent these applications from launching at startup:<ol style="list-style-type: none">a. Type <code>msconfig</code> in the taskbar search box, and then select msconfig.b. On the Startup tab of the System Configuration Utility, click Open Task Manager.c. Select applications that you do not want to launch automatically, and then click Disable.
Some software applications, especially games, are stressful on the graphics subsystem.	<ol style="list-style-type: none">1. Lower the display resolution for the current application or consult the documentation that came with the application for suggestions on how to improve performance by adjusting parameters in the application.2. Add more memory.3. Upgrade the graphics solution.
Cause unknown.	Restart the computer.

Computer powered off automatically and the Power LED flashes red four times and then white two times.

Cause	Solution
Processor thermal protection activated: A fan may be blocked or not turning. OR The heat sink is not properly attached to the processor.	<ol style="list-style-type: none">1. Ensure that the computer air vents are not blocked and the processor cooling fan is running.2. Open the access panel, press the power button, and see if the processor fan (or other system fan) spins. If the fan does not spin, make sure the fan cable is plugged onto the system board header.3. If fan is plugged in and not spinning, replace it.

System does not power on and the LEDs on the front of the computer are not flashing.

Cause	Solution
System unable to power on.	Press and hold the power button for less than 4 seconds. If the hard drive LED turns white, then: <ol style="list-style-type: none">1. If equipped with a voltage selector, check that the voltage selector (located on the rear of the power supply) is set to the appropriate voltage. Proper voltage setting depends on your region.

System does not power on and the LEDs on the front of the computer are not flashing.

Cause	Solution
	<ol style="list-style-type: none">2. Remove the expansion cards one at a time until the 5V_aux light on the system board turns on.3. Replace the system board.
	OR
	Press and hold the power button for less than 4 seconds. If the hard drive LED does not turn on white then:
	<ol style="list-style-type: none">1. Check that the unit is plugged into a working AC outlet.2. Open the access panel and check that the power button cable is properly connected to the system board.3. Check that the power supply cables are properly connected to the system board.4. Check to see if the 5V_aux light on the system board is turned on. If it is turned on, then replace the power button assembly.5. If the 5V_aux light on the system board is off, then replace the power supply.6. Replace the system board.

Solving power problems

Common causes and solutions for power problems are listed in the following table.

Power supply shuts down intermittently.

Cause	Solution
If equipped with a voltage selector, voltage selector switch on rear of computer chassis (some models)not switched to correct line voltage (115V or 230V).	Select the proper AC voltage using the selector switch.
Power supply will not turn on because of internal power supply fault.	Replace the power supply.

Computer powered off automatically and the Power LED flashes red two times, once every second, followed by a two second pause, and the computer beeps two times. (Beeps stop after fifth iteration but LEDs continue flashing.)Computer powered off automatically and the Power LED flashes red four times and then white two times.

Cause	Solution
Processor thermal protection activated: A fan may be blocked or not turning.	<ol style="list-style-type: none">1. Ensure that the computer air vents are not blocked and the processor cooling fan is running.2. Open the access panel, press the power button, and see if the processor fan (or other system fan)spins. If the fan does not spin, make sure the fan cable is plugged onto the system board header.3. If fan a plugged in and not spinning, replace it.
OR	
The heat sink is not properly attached to the processor.	

Power LED flashes red four times, once every second, followed by a two second pause, and the computer beeps four times. (Beeps stop after fifth iteration but LEDs continue flashing.) Computer powered off automatically and the Power LED flashes red three times and then white four times.

Cause	Solution
Power failure (power supply is overloaded).	<ol style="list-style-type: none">1. If equipped with a voltage selector, check that the voltage selector, located on the rear of the power supply (some models), is set to the appropriate voltage. Proper voltage setting depends on your region.2. Open the access panel and ensure the power supply cable is seated into the connector on the system board.3. Check if a device is causing the problem by removing ALL attached devices (such as hard drives or optical drives). Power on the system. If the system enters POST, then power off and replace one device at a time and repeat this procedure until failure occurs. Replace the device that is causing the failure. Continue adding devices one at a time to ensure all devices are functioning properly.4. Replace the power supply.5. Replace the system board.

Solving hard drive problems

Hard drive error occurs.

Cause	Solution
Hard disk has bad sectors or has failed.	<ol style="list-style-type: none">1. Type <code>file</code> in the taskbar search box, and then select File Explorer from the list of applications. In the left column, expand This PC, right-click on a drive, select Properties, and then select the Tools tab. Under Error checking click Check.2. Use a utility to locate and block usage of bad sectors. If necessary, reformat the hard disk.

Disk transaction problem.

Cause	Solution
Either the directory structure is bad or there is a problem with a file.	Type <code>file</code> in the taskbar search box, and then select File Explorer from the list of applications. In the left column, expand This PC , right-click on a drive, select Properties , and then select the Tools tab. Under Error checking click Check .

Drive not found (identified).

Cause	Solution
Cable could be loose.	Check cable connections.
The system may not have automatically recognized a newly installed device.	See reconfiguration directions in the Solving hardware installation problems on page 81 section. If the system still does not recognize the new device, check to see if the device is listed within

Drive not found (identified).

Cause	Solution
	Computer Setup. If it is listed, the probable cause is a driver problem. If it is not listed, the probable cause is a hardware problem. If this is a newly installed drive, run the Computer Setup utility and try adding a POST delay under Advanced > Boot Options .
The device is attached to a SATA port that has been hidden in Computer Setup.	Run the Computer Setup utility and ensure Device Available is selected for the device's SATA port in Advanced > Port Options .
Drive responds slowly immediately after power-up.	Run Computer Setup and increase the POST Delay in Advanced > Boot Options .

Nonsystem disk/NTLDR missing message.

Cause	Solution
The system is trying to start from the hard drive but the hard drive may have been damaged.	▲ Perform Drive Protection System (DPS) testing in system ROM.
System files missing or not properly installed.	<ol style="list-style-type: none">1. Insert bootable media and restart the computer.2. Boot to the windows installation media and select the recovery option. If only a restore kit is available, then select the File Backup Program option, and then restore the system.3. Install system files for the appropriate operating system.
Hard drive boot has been disabled in Computer Setup.	Run the Computer Setup utility and enable the hard drive entry in the Advanced > Boot Options list.
Bootable hard drive is not attached as first in a multi-hard drive configuration.	If attempting to boot from a hard drive, ensure it is attached to the system board dark blue SATA connector.
Bootable hard drive is not listed first in the Boot Order.	Run the Computer Setup utility and select Advanced > Boot Options and ensure the bootable hard drive is listed immediately under the Hard Drive entry.

Computer will not boot from hard drive.

Cause	Solution
The device is attached to a SATA port that has been hidden in Computer Setup.	<ol style="list-style-type: none">1. Check SATA cable connections.2. Run the Computer Setup utility and ensure Device Available is selected for the device's SATA port in Advanced > Port Options.
Boot order is not correct.	Run the Computer Setup utility and change boot sequence in Advanced > Boot Options .
Hard drive is damaged.	Observe if the front panel Power LED is blinking RED and if any beeps are heard. See POST error messages and diagnostic front panel LEDs and audible codes on page 89 to determine possible causes for the blinking red and beep codes. See the Worldwide Limited Warranty for terms and conditions.

Computer seems to be locked up.

Cause	Solution
Program in use has stopped responding to commands.	<ol style="list-style-type: none">1. Use the task manager to close programs that do not respond.2. Attempt the normal Windows “Shut Down” procedure. If this fails, press the power button for four or more seconds to turn off the power. To restart the computer, press the power button again.

Solving media card reader problems

Media card will not work in a digital camera after formatting it in Windows.

Cause	Solution
By default, Windows will format any media card with a capacity greater than 32MB with the FAT32 format. Some digital cameras use the FAT (FAT16 & FAT12) format and can not operate with a FAT32 formatted card.	Either format the media card in the digital camera or select FAT file system to format the media card in a computer with Windows.

A write-protected or locked error occurs when attempting to write to the media card.

Cause	Solution
Media card is locked. Locking the media card is a safety feature that prevents writing to and deleting from an SD/Memory Stick/PRO card.	If using an SD card, make sure that the lock tab located on the right of the SD card is not in the locked position. If using a Memory Stick/PRO card, make sure that the lock tab located on the bottom of the Memory Stick/PRO card is not in the locked position.

Can not write to the media card.

Cause	Solution
The media card is a read-only memory (ROM) card.	Check the manufacturer’s documentation included with your card to see if it writable. Refer to the previous section for a list of compatible cards.
Media card is locked. Locking the media card is a safety feature that prevents writing to and deleting from an SD/Memory Stick/PRO card.	If using an SD card, make sure that the lock tab located on the right of the SD card is not in the locked position. If using a Memory Stick/PRO card, make sure that the lock tab located on the bottom of the Memory Stick/PRO card is not in the locked position.

Unable to access data on the media card after inserting it into a slot.

Cause	Solution
The media card is not inserted properly, is inserted in the wrong slot, or is not supported.	Ensure that the card is inserted properly with the gold contact on the correct side. The green LED will light if inserted properly.

Do not know how to remove a media card correctly.

Cause	Solution
The computer's software is used to safely eject the card.	Type <code>File Explorer</code> in the taskbar search box, and then select File Explorer from the list of applications. In the left column, expand This PC , right-click on the corresponding drive icon, and then select Eject . Pull the card out of the slot.
	NOTE: Never remove the card when the green LED is flashing

After installing the media card reader and booting to Windows, the reader and the inserted cards are not recognized by the computer.

Cause	Solution
The operating system needs time to recognize the device if the reader was just installed into the computer and you are turning the PC on for the first time.	Wait a few seconds so that the operating system can recognize the reader and the available ports, and then recognize the media inserted in the reader.

After inserting a media card in the reader, the computer attempts to boot from the media card.

Cause	Solution
The inserted media card has boot capability.	<ol style="list-style-type: none">1. If you do not want to boot from the media card, remove it during boot or do not select the option to boot from the inserted media card during the boot process.2. During POST (Power On Self-Test), press F9 to modify the boot menu.3. Change the boot sequence in F10 Computer Setup.

Solving display problems

If you encounter display problems, see the documentation that came with the monitor and to the common causes and solutions listed in the following table.

Blank screen (no video).

Cause	Solution
Monitor is not turned on and the monitor light is not on.	Turn on the monitor and check that the monitor light is on.
Bad monitor.	Try a different monitor.
The cable connections are not correct.	Check the cable connection from the monitor to the computer and to the electrical outlet.
You may have a screen blanking utility installed or energy saver features are enabled.	Press any key or click the mouse button and type your password (if set).
System ROM is corrupted; system is running in Boot Block Emergency Recovery Mode (indicated by eight beeps).	Reflash the system ROM with the latest BIOS image.
You are using a fixed-sync monitor and it will not sync at the resolution chosen.	Be sure that the monitor can accept the same horizontal scan rate as the resolution chosen.
Computer is in Sleep state.	Press the power button to resume from Sleep state.

Blank screen (no video).

Cause	Solution
	CAUTION: When attempting to resume from Sleep state, do not hold down the power button for more than four seconds. Otherwise, the computer will shut down and you will lose any unsaved data.
Monitor cable is plugged into the wrong connector.	Systems may have a monitor connection on both the motherboard or an add-in card. Try moving the monitor connection to a different connector on the back of the computer
Monitor settings in the computer are not compatible with the monitor.	<ol style="list-style-type: none">1. In Control Panel, select Category from the View by list, then under Appearance and Personalization, select Adjust screen resolution. To access Control Panel, type <code>control panel</code> in the taskbar search box, and then select Control Panel from the list of applications.2. Expand the Resolution box, and then use the sliding control to reset the resolution.
Monitor is configured to use an input that is not active.	Use the monitor's on-screen menu controls to select the input that is being driven by the system. Refer to the monitor's user documentation for more information on the on-screen controls and settings.

Blank screen and the power LED flashes Red five times, once every second, followed by a two second pause, and the computer beeps five times. (Beeps stop after fifth iteration but LEDs continue flashing.)

Cause	Solution
Pre-video memory error.	<ol style="list-style-type: none">1. Reseat DIMMs. Power on the system.2. Replace DIMMs one at a time to isolate the faulty module.3. Replace third-party memory with HP memory.4. Replace the system board.

Blank screen and the power LED flashes Red six times, once every second, followed by a two second pause, and the computer beeps six times. (Beeps stop after fifth iteration but LEDs continue flashing.)

Cause	Solution
Pre-video graphics error.	For systems with a graphics card: <ol style="list-style-type: none">1. Reseat the graphics card (if applicable). Power on the system.2. Replace the graphics card (if applicable).3. Replace the system board. For systems with integrated graphics, replace the system board.

Blank screen and the power LED flashes Red seven times, once every second, followed by a two second pause, and the computer beeps seven times. (Beeps stop after fifth iteration but LEDs continue flashing.)

Cause	Solution
System board failure (ROM detected failure prior to video).	Replace the system board.

Monitor does not function properly when used with energy saver features.

Cause	Solution
Monitor without energy saver capabilities is being used with energy saver features enabled.	Disable monitor energy saver feature.

Dim characters.

Cause	Solution
The brightness and contrast controls are not set properly.	Adjust the monitor brightness and contrast controls.
Cables are not properly connected.	Check that the graphics cable is securely connected to the graphics card (if applicable) or video connector and the monitor.

Blurry video or requested resolution cannot be set.

Cause	Solution
If the graphics controller was upgraded, the correct graphics drivers may not be loaded.	Install the video drivers included in the upgrade kit.
Monitor is not capable of displaying requested resolution.	Change requested resolution.
Graphics card is bad.	Replace the graphics card.

The picture is broken up, rolls, jitters, or flashes.

Cause	Solution
The monitor connections may be incomplete or the monitor may be incorrectly adjusted.	<ol style="list-style-type: none">1. Be sure the monitor cable is securely connected to the computer.2. In a two-monitor system or if another monitor is in close proximity, be sure the monitors are not interfering with each other's electromagnetic field by moving them apart.3. Fluorescent lights or fans may be too close to the monitor.
Monitor needs to be degaussed.	Degauss the monitor. Refer to the documentation that came with the monitor for instructions.

Image is not centered.

Cause	Solution
Position may need adjustment.	Press the monitor's Menu button to access the OSD menu. Select ImageControl/ Horizontal Position or Vertical Position to adjust the horizontal or vertical position of the image.

"No Connection, Check Signal Cable" displays on screen.

Cause	Solution
Monitor video cable is disconnected.	Connect the video cable between the monitor and computer. CAUTION: Ensure that the computer power is off while connecting the video cable.

"Out of Range" displays on screen.

Cause	Solution
Video resolution and refresh rate are set higher than what the monitor supports.	Restart the computer and enter Safe Mode. Change the settings to a supported setting then restart the computer so that the new settings take effect. To enter Safe Mode: <ol style="list-style-type: none">1. Log into the computer using an Administrator account.2. Type <code>msconfig</code> in the taskbar search box, and then select msconfig from the list of applications.3. Click the Boot tab, select Safe boot and then click OK. When your computer is in safe mode, Safe Mode displays in the corners of your monitor. To exit safe mode, restart your computer and let Windows start normally.

High pitched noise coming from inside a flat panel monitor.

Cause	Solution
Brightness and/or contrast settings are too high.	Lower brightness and/or contrast settings.

Fuzzy focus; streaking, ghosting, or shadowing effects; horizontal scrolling lines; faint vertical bars; or unable to center the picture on the screen (flat panel monitors using an analog VGA input connection only).

Cause	Solution
Flat panel monitor's internal digital conversion circuits may be unable to correctly interpret the output synchronization of the graphics card.	<ol style="list-style-type: none">1. Select the monitor's Auto-Adjustment option in the monitor's on-screen display menu.2. Manually synchronize the Clock and Clock Phase on-screen display functions. To download a SoftPaq that will assist you with the synchronization, go to the following Web site, select

Fuzzy focus; streaking, ghosting, or shadowing effects; horizontal scrolling lines; faint vertical bars; or unable to center the picture on the screen (flat panel monitors using an analog VGA input connection only).

Cause	Solution
	the appropriate monitor, and download either SP32347 or SP32202: http://www.hp.com/support
Graphics card is not seated properly or is bad (some models).	<ol style="list-style-type: none"> 1. Reseat the graphics card. 2. Replace the graphics card.

Certain typed symbols do not appear correct.

Cause	Solution
The font you are using does not support that particular symbol.	<p>Use the Character Map to locate and select the appropriate symbol. You can copy the symbol from the Character Map into a document.</p> <p>Type <code>ch</code> in the taskbar search box, and then select Character Map from the list of applications.</p>

Solving audio problems

If the computer has audio features and you encounter audio problems, see the common causes and solutions listed in the following table.

Sound cuts in and out.

Cause	Solution
Processor resources are being used by other open applications.	Shut down all open processor-intensive applications.

Sound does not come out of the speaker or headphones.

Cause	Solution
Software volume control is turned down or muted.	Double-click the Speaker icon on the taskbar, then make sure that Mute is not selected and use the volume slider to adjust the volume.
Audio is hidden in Computer Setup.	Enable the audio in Computer Setup: Advanced > Built-in Device Options .
The external speakers are not turned on.	Turn on the external speakers.
The audio device may be connected to the wrong jack.	Ensure that the device is connected to the correct jack on the computer. The speakers should be plugged into the line-out jack and the headphones should be plugged into the headphone jack.
External speakers plugged into the wrong audio jack on a recently installed sound card.	See the sound card documentation for proper speaker connection. The rear audio jack output is the green receptacle.
Headphones or devices connected to the line-out connector mute the internal speaker.	Turn on and use headphones or external speakers, if connected, or disconnect headphones or external speakers.
Computer is in Sleep state.	Press the power button to resume from Sleep state.

Sound does not come out of the speaker or headphones.

Cause	Solution
	CAUTION: When attempting to resume from Sleep state, do not hold down the power button for more than four seconds. Otherwise, the computer will shut down and you will lose any unsaved data.
Internal speaker is disabled in Computer Setup.	Enable the internal speaker in Computer Setup. Select Advanced > Built-in Device Options .
The application is set to use a different audio device than speakers.	Some graphics cards support audio over the DisplayPort connection (if applicable), so multiple audio devices may be listed in Device Manager. Make sure the correct device is being used. To access Device Manager, type <code>device manager</code> in the taskbar search box, and then select Device Manager from the list of applications.
Some applications can select which audio output device is used.	Make sure the application has selected the correct audio device.
The operating system controls may be set to use a different audio device as the default output device than what is expected.	Set the operating system to use the correct audio device.

Sound from headphones is not clear or muffled.

Cause	Solution
Headphones are plugged into the rear audio output connector. The rear audio output connector is for powered audio devices and is not designed for headphone use.	Plug the headphones into the headphone connector on the front of the computer.

Computer appears to be locked up while recording audio.

Cause	Solution
The hard disk may be full.	Before recording, make sure there is enough free space on the hard disk. You can also try recording the audio file in a compressed format.

Line-in jack is not functioning properly.

Cause	Solution
Jack has been reconfigured in the audio driver or application software.	In the audio driver or application software, reconfigure the jack or set the jack to its default value.

There is no sound or very weak sound is detected by the headset microphone.

Cause	Solution
The incorrect style of headset is being used.	The front headset jack supports only Cellular Telephone Industries Association (CTIA) style headsets. Open Mobile Terminal Platform (OMTP) style headsets are not supported. These styles of headsets differ by the way that the microphone signals are oriented on the

There is no sound or very weak sound is detected by the headset microphone.

Cause	Solution
	connector. To solve the issue, use a CTIA style headset or a commercially available adapter that will convert from OMTP to CTIA signaling.

There is no sound or sound volume is too low.

Cause	Solution
The application is set to use a different audio device than speakers.	Some graphics cards support audio over the DisplayPort connection (if applicable), so multiple audio devices may be listed in Device Manager. Make sure the correct device is being used. To access Device Manager, type <code>device manager</code> in the taskbar search box, and then select Device Manager from the list of applications.
Some applications can select which audio output device is used.	Make sure the application has selected the correct audio device.
The operating system controls may be set to use a different audio device as the default output device than what is expected.	Set the operating system to use the correct audio device.

Solving printer problems

If you encounter printer problems, see the documentation that came with the printer and to the common causes and solutions listed in the following table.

Printer will not print.

Cause	Solution
Printer is not turned on and online.	Turn the printer on and make sure it is online.
The correct printer drivers for the application are not installed.	<ol style="list-style-type: none">1. Install the correct printer driver for the application.2. Try printing using the MS-DOS command: <pre>DIR C:\ > [printer port]</pre>where <code>[printer port]</code> is the address of the printer being used. If the printer works, reload the printer driver. To run MS-DOS commands, press the Windows key + <code>r</code>, type <code>cmd</code> in the Open box, and then click OK.
If you are on a network, you may not have made the connection to the printer.	Make the proper network connections to the printer.
Printer may have failed.	Run printer self-test.

Printer will not turn on.

Cause	Solution
The cables may not be connected properly.	Reconnect all cables and check the power cord and electrical outlet.

Printer prints garbled information.

Cause	Solution
The correct printer driver for the application is not installed.	Install the correct printer driver for the application.
The cables may not be connected properly.	Reconnect all cables.
Printer memory may be overloaded.	Reset the printer by turning it off for one minute, then turn it back on.

Printer will not print.

Cause	Solution
The printer may be out of paper.	Check the paper tray and refill it if it is empty.

Solving keyboard and mouse problems

If you encounter keyboard or mouse problems, see the documentation that came with the equipment and to the common causes and solutions listed in the following table.

A wireless keyboard/mouse is not working correctly. Symptoms include lagging mouse movement, jumpy mouse/keyboard, or no function of mouse/keyboard and external drive.

Cause	Solution
If your computer is equipped with USB 3.0 ports, connected USB 3.0 devices can interfere with the wireless keyboard USB receiver.	Connect the wireless keyboard USB receiver to a USB 2.0 port that is separated from ports with USB 3.0 devices. If you still experience interference, you may have to place the connectors farther apart using an external USB hub.

Keyboard commands and typing are not recognized by the computer.

Cause	Solution
Keyboard connector is not properly connected.	Shut down the computer, reconnect the keyboard to the back of the computer, and then restart the computer.
Program in use has stopped responding to commands.	Shut down your computer using the mouse and then restart the computer.
Keyboard needs repairs.	See the Worldwide Limited Warranty for terms and conditions.
Computer is in Sleep state.	Press the power button to resume from Sleep state. CAUTION: When attempting to resume from Sleep state, do not hold down the power button for more than four seconds. Otherwise, the computer will shut down and you will lose any unsaved data.

Mouse does not respond to movement or is too slow.

Cause	Solution
Mouse connector is not properly plugged into the back of the computer.	Shut down the computer using the keyboard. <ol style="list-style-type: none">1. Press the Ctrl and Esc keys at the same time (or press the Windows logo key) to display the Start menu.2. Use the arrow keys to scroll to and select the power icon at the top right on the menu, and then press Enter.3. Use the arrow keys to select Shut Down, and then press Enter.4. After the shutdown is complete, plug the mouse connector into the back of the computer (or the keyboard) and restart.
Program in use has stopped responding to commands.	Shut down the computer using the keyboard then restart the computer.
Mouse may need cleaning.	Remove the roller ball cover on the mouse and clean the internal components.
Mouse may need repair.	See the Worldwide Limited Warranty for terms and conditions.
Computer is in Sleep state.	Press the power button to resume from Sleep state. CAUTION: When attempting to resume from Sleep state, do not hold down the power button for more than four seconds. Otherwise, the computer will shut down and you will lose any unsaved data.

Mouse will only move vertically, horizontally, or movement is jerky.

Cause	Solution
Mouse roller ball or the rotating encoder shafts that make contact with the ball are dirty.	Remove roller ball cover from the bottom of the mouse and clean the internal components with a mouse cleaning kit available from most computer stores.

Solving hardware installation problems

You may need to reconfigure the computer when you add or remove hardware, such as an additional drive or expansion card. If you install a plug and play device, Windows automatically recognizes the device and configures the computer. If you install a non-plug and play device, you must reconfigure the computer after completing installation of the new hardware. In Windows, use the **Add Hardware Wizard** and follow the instructions that appear on the screen.

To open the Add Hardware Wizard, open a Command Prompt and open hdwwiz.exe.

⚠ WARNING! When the computer is plugged into an AC power source, voltage is always applied to the system board. To reduce the risk of personal injury from electrical shock and/or hot surfaces, be sure to disconnect the power cord from the wall outlet and allow the internal system components to cool before touching.

Table 6-1 Solving hardware installation problems

A new device is not recognized as part of the system.	
Cause	Solution
Device is not seated or connected properly.	Ensure that the device is properly and securely connected and that pins in the connector are not bent down.
Cable(s) of new external device are loose or power cables are unplugged.	Ensure that all cables are properly and securely connected and that pins in the cable or connector are not bent down.
Power switch of new external device is not turned on.	Turn off the computer, turn on the external device, then turn on the computer to integrate the device with the computer system.
When the system advised you of changes to the configuration, you did not accept them.	Reboot the computer and follow the instructions for accepting the changes.
A plug and play board may not automatically configure when added if the default configuration conflicts with other devices.	Use Windows Device Manager to deselect the automatic settings for the board and choose a basic configuration that does not cause a resource conflict. You can also use Computer Setup to reconfigure or disable devices to resolve the resource conflict. To access Device Manager, type <code>device manager</code> in the taskbar search box, and then select Device Manager from the list of applications.
USB ports on the computer are disabled in Computer Setup.	Run the Computer Setup utility and ensure that Device available is selected for appropriate USB ports under Advanced > Port Options .

Computer will not start.

Cause	Solution
Wrong memory modules were used in the upgrade or memory modules were installed in the wrong location.	<ol style="list-style-type: none">1. Review the documentation that came with the system to determine if you are using the correct memory modules and to verify the proper installation. NOTE: DIMM1 or XMM1 must always be installed. DIMM1 must be installed before DIMM2, and DIMM3 must be installed before DIMM4.2. Observe the beeps and LED lights on the front of the computer. Beeps and flashing LEDs are codes for specific problems.3. If you still cannot resolve the issue, contact Customer Support.

Power LED flashes Red three times and then white two times.

Cause	Solution
Memory is installed incorrectly or is bad.	<p>CAUTION: To avoid damage to the DIMMs or the system board, you must unplug the computer power cord before attempting to reseat, install, or remove a DIMM module.</p> <ol style="list-style-type: none">1. Reseat DIMMs. Power on the system.2. Replace DIMMs one at a time to isolate the faulty module. <p>NOTE: DIMM1 or XMM1 must always be installed. DIMM1 must be installed before DIMM2, and DIMM3 must be installed before DIMM4</p> <ol style="list-style-type: none">3. Replace third-party memory with HP memory.4. Replace the system board.

Solving network problems

Some common causes and solutions for network problems are listed in the following table. These guidelines do not discuss the process of debugging the network cabling.

Table 6-2 Solving network problems

Network driver does not detect network controller.

Cause	Solution
Network controller is disabled.	<ol style="list-style-type: none">1. Run Computer Setup and enable network controller.2. Enable the network controller in the operating system using Device Manager. <p>To access Device Manager, type <code>device manager</code> in the taskbar search box, and then select Device Manager from the list of applications.</p>
Incorrect network driver.	Check the network controller documentation for the correct driver or obtain the latest driver from the manufacturer's Web site.

Network status link light never flashes.

NOTE: The network status light is supposed to flash when there is network activity.

Cause	Solution
No active network is detected.	Check cabling and network equipment for proper connection.
Network controller is not set up properly.	<p>Check for the device status within Windows, such as Device Manager for driver load and the Network Connections applet within Windows for link status.</p> <p>To access Device Manager, type <code>device manager</code> in the taskbar search box, and then select Device Manager from the list of applications.</p>
Network controller is disabled.	<ol style="list-style-type: none">1. Run Computer Setup and enable network controller.

Table 6-2 Solving network problems (continued)

Network status link light never flashes.

NOTE: The network status light is supposed to flash when there is network activity.

Cause	Solution
	<ol style="list-style-type: none">2. Enable the network controller in the operating system using Device Manager. To access Device Manager, type <code>device manager</code> in the taskbar search box, and then select Device Manager from the list of applications.
Network driver is not properly loaded.	Reinstall network drivers.
System cannot autosense the network.	Disable auto-sensing capabilities and force the system into the correct operating mode.

Diagnostics reports a failure.

Cause	Solution
The cable is not securely connected.	Ensure that the cable is securely attached to the network connector and that the other end of the cable is securely attached to the correct device.
The cable is attached to the incorrect connector.	Ensure that the cable is attached to the correct connector.
There is a problem with the cable or a device at the other end of the cable.	Ensure that the cable and device at the other end are operating correctly.
The network controller is defective.	Contact an authorized service provider.

Diagnostics passes, but the computer does not communicate with the network.

Cause	Solution
Network drivers are not loaded, or driver parameters do not match current configuration.	Make sure the network drivers are loaded and that the driver parameters match the configuration of the network controller. Make sure the correct network client and protocol is installed.
The network controller is not configured for this computer.	Select the Network and Sharing Center icon in the Control Panel and configure the network controller. To access Control Panel, type <code>control panel</code> in the taskbar search box, and then select Control Panel from the list of applications.

Network controller stopped working when an expansion board was added to the computer.

Cause	Solution
The network controller requires drivers.	Verify that the drivers were not accidentally deleted when the drivers for a new expansion board were installed.

Network controller stops working without apparent cause.

Cause	Solution
The files containing the network drivers are corrupted.	Reinstall the network drivers using the Windows recovery tools. If necessary, download the softpaq from the web (from a different computer).
The cable is not securely connected.	Ensure that the cable is securely attached to the network connector and that the other end of the cable is securely attached to the correct device.
The network controller is defective.	Contact an authorized service provider.

New network card will not boot.

Cause	Solution
New network card may be defective or may not meet industry-standard specifications.	Install a working, industry-standard NIC, or change the boot sequence to boot from another source.

Cannot connect to network server when attempting Remote System Installation.

Cause	Solution
The network controller is not configured properly.	Verify Network Connectivity, that a DHCP Server is present, and that the Remote System Installation Server contains the NIC drivers for your NIC.

System setup utility reports unprogrammed EEPROM.

Cause	Solution
Unprogrammed EEPROM.	Contact an authorized service provider.

Solving memory problems

If you encounter memory problems, some common causes and solutions are listed in the following table.

 **CAUTION:** Power may still be supplied to the DIMMs when the computer is turned off (depending on the Management Engine (ME) settings). To avoid damage to the DIMMs or the system board, you must unplug the computer power cord before attempting to reseat, install, or remove a memory module.

For those systems that support ECC memory, HP does not support mixing ECC and non-ECC memory. Otherwise, the computer will not boot the operating system.

 **NOTE:** The memory count will be affected by configurations with the Management Engine (ME) enabled. The ME uses 8MB of system memory in single channel mode or 16MB of memory in dual-channel mode to download, decompress, and execute the ME firmware for Out-of-Band (OOB), third-party data storage, and other management functions.

System will not boot or does not function properly after installing additional memory modules.

Cause	Solution
A memory module is not installed in the DIMM1 or XMM1 socket.	Ensure that a memory module is installed in the DIMM1 or XMM1 socket on the system board. This socket must be populated with a memory module.
Memory module is not the correct type or speed grade for the system or the new memory module is not seated properly.	Replace module with the correct industry-standard device for the computer. On some models, ECC and non-ECC memory modules cannot be mixed.

Out of memory error.

Cause	Solution
You have run out of memory to run the application.	Check the application documentation to determine the memory requirements.

Memory count during POST is wrong.

Cause	Solution
The memory modules may not be installed correctly.	Check that the memory modules have been installed correctly and that proper modules are used.
Integrated graphics may use system memory.	No action required.

Insufficient memory error during operation.

Cause	Solution
Too many Terminate and Stay Resident programs (TSRs) are installed.	Delete any TSRs that you do not need.
You have run out of memory for the application.	Check the memory requirements for the application or add more memory to the computer.

Power LED flashes Red five times, once every second, followed by a two second pause, and the computer beeps five times. (Beeps stop after fifth iteration but LEDs continue flashing.)

Cause	Solution
Memory is installed incorrectly or is bad.	<ol style="list-style-type: none">1. Reseat DIMMs. Power on the system.2. Replace DIMMs one at a time to isolate the faulty module.3. Replace third-party memory with HP memory.4. Replace the system board.

Solving USB flash drive problems

If you encounter USB flash drive problems, common causes and solutions are listed in the following table.

USB flash drive is not seen as a drive letter in Windows.

Cause	Solution
The drive letter after the last physical drive is not available.	Change the default drive letter for the flash drive in Windows.

USB flash drive not found (identified).

Cause	Solution
The device is attached to a USB port that has been hidden in Computer Setup.	Run the Computer Setup utility and enable USB ports in Advanced > Port Options .
The device was not properly seated before power-up.	Ensure the device is fully inserted into the USB port before applying power to the system

System will not boot from USB flash drive.

Cause	Solution
Boot order is not correct.	Run the Computer Setup utility and change boot sequence in Advanced > Boot Options .
Removable Media Boot is disabled in the Computer Setup utility.	Run the Computer Setup utility and enable booting to removable media in Advanced > Boot Options . Ensure USB is enabled in Storage > Boot Order .

The computer boots to DOS after making a bootable flash drive.

Cause	Solution
Flash drive is bootable.	Install the flash drive only after the operating system boots.
Flash drive is defective.	Try a different flash drive.

Solving front panel component problems

If you encounter problems with devices connected to the front panel, refer to the common causes and solutions listed in the following table.

A USB device, headphone, or microphone is not recognized by the computer.

Cause	Solution
Device is not properly connected.	<ol style="list-style-type: none">1. Turn off the computer.2. Reconnect the device to the front of the computer and restart the computer.
The device does not have power.	If the USB device requires AC power, be sure one end is connected to the device and one end is connected to a live outlet.
The correct device driver is not installed.	<ol style="list-style-type: none">1. Install the correct driver for the device.2. You might need to reboot the computer.
The cable from the device to the computer does not work.	<ol style="list-style-type: none">1. If possible, replace the cable.2. Restart the computer.
The device is not working.	<ol style="list-style-type: none">1. Replace the device.2. Restart the computer.
USB ports on the computer are disabled in Computer Setup.	Run the Computer Setup utility and ensure that the USB ports are set to Enabled in Security > USB Security .

Solving Internet access problems

If you encounter Internet access problems, consult your Internet Service Provider (ISP) or refer to the common causes and solutions listed in the following table.

Unable to connect to the Internet.

Cause	Solution
Internet Service Provider (ISP) account is not set up properly.	Verify Internet settings or contact your ISP for assistance.
Web browser is not set up properly.	Verify that the Web browser is installed and set up to work with your ISP.
Cable/DSL modem is not plugged in.	Plug in cable/DSL modem. You should see a "power" LED light on the front of the cable/DSL modem.
Cable/DSL service is not available or has been interrupted due to bad weather.	Try connecting to the Internet at a later time or contact your ISP. (If the cable/DSL service is connected, the "cable" LED light on the front of the cable/DSL modem will be on.)
The CAT5 UTP cable is disconnected.	Connect the CAT5 UTP cable between the cable modem and the computer's RJ-45 connector. (If the connection is good, the "PC" LED light on the front of the cable/DSL modem will be on.)
IP address is not configured properly.	Contact your ISP for the correct IP address.
Cookies are corrupted. (A "cookie" is a small piece of information that a Web server can store temporarily with the Web browser. This is useful for having the browser remember some specific information that the Web server can later retrieve.)	<ol style="list-style-type: none">1. Type <code>control panel</code> in the taskbar search box, and then select Control Panel from the list of applications.2. Click Internet Options.

Unable to connect to the Internet.

Cause	Solution
	<ol style="list-style-type: none">In the Browsing history section, click the Delete button.Select the Cookies and website data check box and click the Delete button.

Cannot automatically launch Internet programs.

Cause	Solution
You must log on to your ISP before some programs will start.	Log on to your ISP and launch the desired program.

Solving software problems

Most software problems occur as a result of the following:

- The application was not installed or configured correctly.
- There is insufficient memory available to run the application.
- There is a conflict between applications.
- Be sure that all the needed device drivers have been installed.
- If you have installed an operating system other than the factory-installed operating system, check to be sure it is supported on the system.

If you encounter software problems, see the applicable solutions listed in the following table.

Computer will not continue and the HP logo does not display.

Cause	Solution
ROM issue - POST error has occurred.	Observe the beeps and LED lights on the front of the computer. See POST error messages and diagnostic front panel LEDs and audible codes on page 89 to determine possible causes. See the Worldwide Limited Warranty for terms and conditions.

"Illegal Operation has Occurred" error message is displayed.

Cause	Solution
Software being used is not Microsoft-certified for your version of Windows.	Verify that the software is certified by Microsoft for your version of Windows (see program packaging for this information).
Configuration files are corrupt.	If possible, save all data, close all programs, and restart the computer.

7 POST error messages and diagnostic front panel LEDs and audible codes

This appendix lists the error codes, error messages, and the various indicator light and audible sequences that you may encounter during Power-On Self-Test (POST) or computer restart, the probable source of the problem, and steps you can take to resolve the error condition.

POST Message Disabled suppresses most system messages during POST, such as memory count and non-error text messages. If a POST error occurs, the screen will display the error message. To manually switch to the POST Messages Enabled mode during POST, press any key (except **F10**, **F11**, or **F12**). The default mode is POST Message Disabled.

The speed at which the computer loads the operating system and the extent to which it is tested are determined by the POST mode selection.

Quick Boot is a fast startup process that does not run all of the system level tests, such as the memory test. Full Boot runs all of the ROM-based system tests and takes longer to complete.

Full Boot may also be enabled to run every 1 to 30 days on a regularly scheduled basis. To establish the schedule, reconfigure the computer to the Full Boot Every x Days mode, using Computer Setup.

 **NOTE:** For more information on Computer Setup, see [Computer Setup \(F10\) Utility on page 51](#).

POST numeric codes and text messages

This section covers those POST errors that have numeric codes associated with them. The section also includes some text messages that may be encountered during POST.

 **NOTE:** The computer will beep once after a POST text message is displayed on the screen.

Control panel message	Description	Recommended action
002-Option ROM Checksum Error	System ROM or expansion board option ROM checksum.	<ol style="list-style-type: none">1. Verify the correct ROM.2. Flash the ROM if needed.3. If an expansion board was recently added, remove it to see if the problem remains.4. Clear CMOS. (See Password security and resetting CMOS on page 96.)5. If the message disappears, there may be a problem with the expansion card.6. Replace the system board.
003-System Board Failure	DMA or timers.	<ol style="list-style-type: none">1. Clear CMOS. (See Password security and resetting CMOS on page 96.)2. Remove expansion boards.3. Replace the system board.
005-Real-Time Clock Power Loss	Invalid time or date in configuration memory.	Reset the date and time under Control Panel (Computer Setup can also be used). If

Control panel message	Description	Recommended action
	RTC (real-time clock)battery may need to be replaced.	the problem persists, replace the RTC battery. See the Removal and Replacement section for instructions on installing a new battery.
008–Microcode Patch Error	Processor is not supported by the BIOS.	<ol style="list-style-type: none"> 1. Upgrade BIOS to proper version. 2. Change the processor.
009–PMM Allocation Error during MEBx Download	Memory error during POST execution of the Management Engine (ME)BIOS Extensions option ROM.	<ol style="list-style-type: none"> 1. Reboot the computer. 2. Unplug the power cord, re-seat the memory modules, and reboot the computer. 3. If the memory configuration was recently changed, unplug the computer, restore the original memory configuration, and reboot the computer. 4. If the error persists, replace the system board.
00A–Product Information Not Valid	The product information programmed into the system board is missing or invalid.	Use Computer Setup to update this information.
00B–MEBx Module did not checksum correctly	Memory error during POST execution of the Management Engine (ME)BIOS Extensions option ROM.	<ol style="list-style-type: none"> 1. Reboot the computer. 2. Unplug the power cord, re-seat the memory modules, and reboot the computer. 3. If the memory configuration was recently changed, unplug the power cord, restore the original memory configuration, and reboot the computer. 4. If the error persists, replace the system board.
00C–PMM Deallocation Error during MEBx Cleanup	Memory error during POST execution of the Management Engine (ME)BIOS Extensions option ROM.	<ol style="list-style-type: none"> 1. Reboot the computer. 2. Unplug the power cord, re-seat the memory modules, and reboot the computer. 3. If the memory configuration was recently changed, unplug the power cord, restore the original memory configuration, and reboot the computer. 4. If the error persists, replace the system board.
00D–Setup Error during MEBx Execution	MEBx selection or exit resulted in a setup failure.	<ol style="list-style-type: none"> 1. Reboot the computer. 2. Unplug the power cord, re-seat the memory modules, and reboot the computer. 3. If the memory configuration was recently changed, unplug the power cord, restore the original memory configuration, and reboot the computer. 4. If the error persists, replace the system board.

Control panel message	Description	Recommended action
00E-Inventory Error during MEBx Execution	BIOS information passed to the MEBx resulted in a failure.	<ol style="list-style-type: none"> 1. Reboot the computer. 2. If the error persists, update to the latest BIOS version. 3. If the error still persists, replace the system board.
00F-Interface Error during MEBx Execution	MEBx operation experienced a hardware error during communication with the ME.	<ol style="list-style-type: none"> 1. Reboot the computer. 2. If the error persists, update to the latest BIOS version. 3. If the error still persists, replace the system board.
100-Front Audio Not Connected	Front audio cable has been detached or unseated from system board.	Reconnect or replace front audio cable.
2E1-MemorySize Error	Memory amount has changed since the last boot (memory added or removed).	The system memory size is different from the last startup. The most common reason is the removal of memory from the system board. Press the F1 key to save the memory changes. If this message persists, verify that the memory modules are installed correctly.
2E2-Memory Error	Memory module configuration failed during boot up.	<ol style="list-style-type: none"> 1. Ensure memory modules are correctly installed. 2. Verify proper memory module type. 3. Remove and replace the identified faulty memory module(s). 4. If the error persists after replacing memory modules, replace the system board.
2E3-Incompatible Memory Module in Memory Socket(s)X, X, ...	A memory module in memory socket identified in the error message is missing critical SPD information, or is incompatible with the chipset.	<ol style="list-style-type: none"> 1. Verify proper memory module type. 2. Try another memory socket. 3. Replace with a supported module.
2E4-DIMM Configuration Warning	The current memory configuration is not optimized.	Rearrange the DIMMs so that each channel has the same amount of memory.
2E5-ECC Memory Module Detected on Unsupported Platform	Recently added memory module(s) support ECC memory error correction.	<ol style="list-style-type: none"> 1. If additional memory was recently added, remove it to see if the problem remains. 2. Check product documentation for memory support information.
2E6-Memory Not Configured Correctly for Proper MEBx Execution	DIMM1 is not installed.	Make sure there is a memory module in the DIMM1 socket and that it is properly seated.
300-Configuration Change Warning	The storage device configuration will be updated as shown.	Not applicable
301-Hard Disk 1: SMART Hard Drive Detects Imminent Failure	Hard drive is about to fail. (Some hard drives have a hard drive firmware patch that will fix an erroneous error message.)	<ol style="list-style-type: none"> 1. Determine if hard drive is giving correct error message. Run the Drive Protection System test under using F2 Diagnostics when booting the computer. 2. Apply hard drive firmware patch if applicable. (Available at http://www.hp.com/support.) 3. Back up contents and replace hard drive.

Control panel message	Description	Recommended action
302–Hard Disk 2: SMART Hard Drive Detects Imminent Failure	Hard drive is about to fail. (Some hard drives have a hard drive firmware patch that will fix an erroneous error message.)	<ol style="list-style-type: none"> 1. Determine if hard drive is giving correct error message. Run the Drive Protection System test under using F2 Diagnostics when booting the computer. 2. Apply hard drive firmware patch if applicable. (Available at http://www.hp.com/support.) 3. Back up contents and replace hard drive.
309 – 30C: Hard Disk 3–6: SMART Hard Drive Detects Imminent Failure	Hard drive is about to fail. (Some hard drives have a hard drive firmware patch that will fix an erroneous error message.)	<ol style="list-style-type: none"> 1. Determine if hard drive is giving correct error message. Run the Drive Protection System test under using F2 Diagnostics when booting the computer. 2. Apply hard drive firmware patch if applicable. (Available at http://www.hp.com/support.) 3. Back up contents and replace hard drive.
3F0–Boot Device Not Found	Boot device not found.	Insert boot device or load operating system.
3F1–Hard Disk 1 Error	Hard disk 1 error.	<ol style="list-style-type: none"> 1. Check and/or replace cables. 2. Clear CMOS. (See Password security and resetting CMOS on page 96.) 3. Replace the hard disk drive.
3F2–Hard Disk 2 Error	Hard disk 2 error.	<ol style="list-style-type: none"> 1. Check and/or replace cables. 2. Clear CMOS. (See Password security and resetting CMOS on page 96.) 3. Replace the hard disk drive.
400–Serial Port A Address Conflict Detected	Both external and internal serial ports are assigned to the same resources.	<ol style="list-style-type: none"> 1. Remove any serial port expansion cards. 2. Clear CMOS. (See Password security and resetting CMOS on page 96.) 3. Reconfigure card resources and/or run Computer Setup or Windows utilities.
401–Serial Port B Address Conflict Detected	Both external and internal serial ports are assigned to the same resources.	<ol style="list-style-type: none"> 1. Remove any serial port expansion cards. 2. Clear CMOS. (See Password security and resetting CMOS on page 96.) 3. Reconfigure card resources and/or run Computer Setup or Windows utilities.
402–Serial Port C Address Conflict Detected	Both external and internal serial ports are assigned to the same resources.	<ol style="list-style-type: none"> 1. Remove any serial port expansion cards. 2. Clear CMOS. (See Password security and resetting CMOS on page 96.) 3. Reconfigure card resources and/or run Computer Setup or Windows utilities.
403–Serial Port D Address Conflict Detected	Both external and internal serial ports are assigned to the same resources.	<ol style="list-style-type: none"> 1. Remove any serial port expansion cards. 2. Clear CMOS. (See Password security and resetting CMOS on page 96.) 3. Reconfigure card resources and/or run Computer Setup or Windows utilities.

Control panel message	Description	Recommended action
419-Out of Memory Space for Option ROMs	Recently added PCI expansion card contains an option ROM too large to download during POST.	▲ If a PCI expansion card was recently added, remove it to see if the problem remains.
41A-Front USB1/USB2 Not Connected	Front USB cable has been detached or unseated from system board.	Reconnect or replace front USB cable.
41B-Device in PCI Express Slot Failed To Initialize	There is an incompatibility or problem with a PCIe device and the system or PCIe link could not be configured to a valid bus width or speed.	Try rebooting the system. If the error reoccurs, the device may not work with this system
43A-USB Type-C I2C Not Connected	Cable is required between I2C on card and USB-C on the system board.	Install cable between I2C on card and USB-C on the system board.
43B-More Than One USB type-C Cards Are Installed	More than one USB type-C card is installed.	Remove USB type-C card so only one is installed.
500-BIOS Recovery	A system BIOS recovery has occurred.	Not applicable.
70x-Wireless Mode Not Supported	The system has detected a wireless module installed in the system that is not supported and has been disabled.	Replace with a supported module.
800-Keyboard Error	Keyboard failure.	<ol style="list-style-type: none"> 1. Reconnect keyboard with computer turned off. 2. Check connector for bent or missing pins. 3. Ensure that none of the keys are depressed. 4. Replace keyboard.
801-Keyboard or System Unit Error	Keyboard failure.	<ol style="list-style-type: none"> 1. Reconnect the keyboard with computer turned off. 2. Ensure that none of the keys are depressed. 3. Replace the keyboard. 4. Replace the system board.
900-CPU Fan Not Detected	CPU fan is not connected or may have malfunctioned.	<ol style="list-style-type: none"> 1. Reseat CPU fan. 2. Reseat fan cable. 3. Replace CPU fan.
901-Chassis, Rear Chassis, or Front Chassis Fan not Detected	Chassis, rear chassis, or front chassis fan is not connected or may have malfunctioned.	<ol style="list-style-type: none"> 1. Reseat chassis, rear chassis, or front chassis fan. 2. Reseat fan cable. 3. Replace chassis, rear chassis, or front chassis fan.
903-Computer Cover Has Been Removed Since Last System Startup		N/A
904-SATA Cabling Error	One or more SATA devices are improperly attached. For optimal performance, the SATA 0 and SATA 1 ports should be used for hard drives before other ports.	Ensure SATA connectors are used in ascending order. For one device, use SATA 0. For two devices, use SATA 0 and SATA 1. For three devices, use SATA 0, SATA 1, and SATA 2.
90B-Fan Failure	The system has detected that a cooling fan is not operating correctly.	<ol style="list-style-type: none"> 1. Reseat fan. 2. Reseat fan cable.

Control panel message	Description	Recommended action
		3. Replace fan.
90D-System Temperature	Thermal shutdown occurred. The system BIOS has detected your machine was previously shut down to avoid overheating. Overheating may occur if the cooling vents are blocked or the operating temperature exceeds the system specifications. The machine should return to normal operation once the situation is resolved.	Make sure system has proper airflow.
90E-Power Supply Fan Not detected	Power supply fan is not connected or may have malfunctioned.	<ol style="list-style-type: none"> 1. Reseat power supply fan. 2. Reseat fan cable. 3. Replace power supply fan.
910-Filter Warning	Airflow filter is dirty.	Replace the airflow filter.

Interpreting system validation diagnostic front panel LEDs and audible codes

During the system validation phase that occurs at system startup, the BIOS validates the functionality of the following subsystems and conditions:

- AC adapter
- System board power
- Processor failure
- BIOS corruption
- Memory failure
- Graphics failure
- System board failure
- BIOS authentication failure

If an error is detected, specific patterns of long and short blinks, accompanied by long and short beeps (where applicable) are used to identify the error. These patterns will make up a two part code:

- Major – the category of the error
- Minor – the specific error within the category



NOTE: Single beep/blink codes are not used.

Number of long beeps/blinks	Error category
1	Not used
2	BIOS
3	Hardware
4	Thermal
5	System board

Patterns of blink/beep codes are determined by using the following parameters:

- 1 second pause occurs after the last major blink.
- 2 second pause occurs after the last minor blink.
- Beep error code sequences occur for the first 5 iterations of the pattern and then stop.
- Blink error code sequences continue until the computer is unplugged or the power button is pressed.



NOTE: Not all diagnostic lights and audible codes are available on all models.

The red LED blinks to represent the major error category (long blinks). The white LED blinks to represent the minor error category (short blinks). For example, '3.5' indicates 3 long red blinks and 5 short white blinks to communicate the processor is not detected.

Category	Major/minor code	Description
BIOS	2.2	The main area (DXE) of BIOS has become corrupted and there is no recovery binary image available.
	2.3	The embedded controller policy requires the user to enter a key sequence.
	2.4	The embedded controller is checking or recovering the boot block.
Hardware	3.2	The embedded controller has timed out waiting for BIOS to return from memory initialization.
	3.3	The embedded controller has timed out waiting for BIOS to return from graphics initialization.
	3.4	The system board displays a power failure (crowbar).*
	3.5	The processor is not detected.*
	3.6	The processor does not support an enabled feature.
Thermal	4.2	A processor over temperature condition has been detected.*
	4.3	An ambient temperature over temperature condition has been detected.
	4.4	An MXM over temperature condition has been detected.
System board	5.2	The embedded controller cannot find valid firmware.
	5.3	The embedded controller has timed out waiting for the BIOS.
	5.4	The embedded controller has timed out waiting for BIOS to return from system board initialization.
	5.5	The embedded controller rebooted the system after a possible lockup condition had been detected through the use of a System Health Timer, Automated System Recovery Timer, or other mechanism.

* Indicates hardware triggered event; all other events are controlled by the BIOS.

8 Password security and resetting CMOS

This computer supports security password features, which can be established through the Computer Setup Utilities menu.

This computer supports two security password features that are established through the Computer Setup Utilities menu: administrator password and power-on password. When you establish only an administrator password, any user can access all the information on the computer except Computer Setup. When you establish only a power-on password, the power-on password is required to access Computer Setup and any other information on the computer. When you establish both passwords, only the administrator password will give you access to Computer Setup.

When both passwords are set, the administrator password can also be used in place of the power-on password as an override to log in to the computer. This is a useful feature for a network administrator.

If you forget one or both passwords, you can clear all passwords by powering off the system, opening the cover, temporarily removing the CLR_PSWD jumper, and booting once. This will erase the administrator and power-on passwords. You must restore the jumper to create new passwords.

The computer's configuration memory (CMOS) stores information about the computer's configuration.

The CMOS jumper resets CMOS but does not clear the power-on and setup passwords.

 **CAUTION:** Resetting the CMOS with power removed will reset the BIOS settings to factory defaults. It may be useful to back up the BIOS settings or save them as custom defaults before resetting them in case they are needed later. Back up can be performed in Computer Setup or using the BiosConfigUtility tool available from www.hp.com. See [Computer Setup \(F10\)Utility on page 51](#) for information on backing up the BIOS settings.

Resetting CMOS resets BIOS settings to default, but does not clear the passwords or affect any of the other Security settings. On Intel systems with advanced manageability features, resetting CMOS will also partially unprovision AMT.

 **CAUTION:** Stringent security is a mode where there is no physical bypass of the password function. If enabled, removing the password jumper will be ignored. To enable this mode, change the security setting **Clear Password Jumper** in Password Policies to **Ignore**.

If you lose or forget the password when in stringent security mode, the system can only be reset by System Management Command. This is a way for HP Service and Support to provide a secure method to access the BIOS and command a password reset for a specifically identified unit under the direction of the owner. This scenario may not be covered under warranty.

To prevent needing a customer service event to restore access to the system, record your configured administrator and power-on passwords in a safe place away from your computer.

 **NOTE:** You will receive POST error messages after clearing CMOS and rebooting advising you that configuration changes have occurred. Use Computer Setup to reset any special system setups along with the date and time.

 **CAUTION:** It is important to back up the computer CMOS settings before resetting them in case they are needed later. Back up is easily done through Computer Setup. See [Computer Setup \(F10\)Utility on page 51](#) for information on backing up the CMOS settings.

Resetting CMOS and/or the password jumper

This computer supports security password features, which can be established through the Computer Setup Utilities menu.

This computer supports two security password features that are established through the Computer Setup Utilities menu: administrator password and power-on password. When you establish only an administrator password, any user can access all the information on the computer except Computer Setup. When you establish only a power-on password, the power-on password is required to access Computer Setup and any other information on the computer. When you establish both passwords, only the administrator password will give you access to Computer Setup.

When both passwords are set, the administrator password can also be used in place of the power-on password as an override to log in to the computer. This is a useful feature for a network administrator.

If you forget one or both passwords, you can clear all passwords by powering off the system, opening the cover, temporarily removing the CMOS/PSWD jumper, and booting once. This will erase the administrator and power-on passwords. You must restore the jumper to create new passwords.

 **CAUTION:** Resetting the CMOS with power removed will reset the BIOS settings to factory defaults. It may be useful to back up the BIOS settings or save them as custom defaults before resetting them in case they are needed later. Back up can be performed in Computer Setup or using the BiosConfigUtility tool available from www.hp.com. See [Computer Setup \(F10\)Utility on page 51](#) for information on backing up the BIOS settings.

Resetting CMOS resets BIOS settings to default, but does not clear the passwords or affect any of the other Security settings. On Intel systems with advanced manageability features, resetting CMOS will also partially unprovision AMT.

 **CAUTION:** Stringent security is a mode where there is no physical bypass of the password function. If enabled, removing the password jumper will be ignored. To enable this mode, change the security setting **Clear Password Jumper** in Password Policies to **Ignore**.

If you lose or forget the password when in stringent security mode, the system can only be reset by System Management Command. This is a way for HP Service and Support to provide a secure method to access the BIOS and command a password reset for a specifically identified unit under the direction of the owner. This scenario may not be covered under warranty.

To prevent needing a customer service event to restore access to the system, record your configured administrator and power-on passwords in a safe place away from your computer.

 **NOTE:** You will receive POST error messages after clearing CMOS and rebooting advising you that configuration changes have occurred. Use Computer Setup to reset any special system setups along with the date and time.

To clear CMOS, disable the power-on or administrator password features, or to clear the power-on or administrator passwords, complete the following steps:

1. Shut down the operating system properly, then turn off the computer and any external devices, and disconnect the power cord from the power outlet.
2. With the power cord disconnected, press the power button again to drain the system of any residual power.

 **WARNING!** To reduce the risk of personal injury from electrical shock and/or hot surfaces, be sure to disconnect the power cord from the wall outlet, and allow the internal system components to cool before touching.

 **CAUTION:** When the computer is plugged in, the power supply always has voltage applied to the system board even when the unit is turned off. Failure to disconnect the power cord can result in damage to the system.

Static electricity can damage the electronic components of the computer or optional equipment. Before beginning these procedures, ensure that you are discharged of static electricity by briefly touching a grounded metal object. See the *Safety & Regulatory Information* guide for more information.

3. Remove the access panel.
4. Locate the header and jumper labeled CMOS/PSWD.

 **NOTE:** The password jumper is blue so that it can be easily identified.

5. Remove the jumper from pins 1 and 2.
6. Place the jumper on either pin 1 or 2, but not both, so that it does not get lost.
7. Replace the access panel and reconnect the external equipment.
8. Plug in the computer and turn on power. Allow the operating system to start. This clears the current passwords and disables the password features.
9. Shut down the computer, unplug the power, and disconnect the external equipment.
10. Remove the access panel.
11. Place the jumper on pins 1 and 2.
12. Replace the access panel.
13. Reconnect the external equipment and plug in the computer.

Changing a Setup or Power-on password

To change the power-on or setup password, complete the following steps:

1. Turn on or restart the computer.
To change the Setup password, go to step 2.
To change the Power-on password, go to step 3.
2. To change the Setup password, as soon as the computer turns on:
 - Press the Esc key while “Press the ESC key for Startup Menu” message is displayed.
 - Press the F10 key to enter Computer Setup.
3. When the key icon appears, type your current password, a slash (/) or alternate delimiter character, your new password, another slash (/) or alternate delimiter character, and your new password again as shown:
current password/new password/new password



NOTE: Type the new password carefully since the characters do not appear on the screen.

4. Press [Enter](#).

The new password will take effect the next time the computer is restarted.

Deleting a Setup or Power-on password

To delete the power-on or setup password, complete the following steps:

1. Turn on or restart the computer.
To delete the Setup password, go to step 2.
To delete the Power-on password, go to step 3.
2. To delete the Setup password, as soon as the computer turns on:
 - Press the Esc key while “Press the ESC key for Startup Menu” message is displayed.
 - Press the F10 key to enter Computer Setup.
3. When the key icon appears, type your current password, a slash (/) or alternate delimiter character, your new password, another slash (/) or alternate delimiter character, and your new password again as shown:
current password/
4. Press [Enter](#).

9 Using HP PC Hardware Diagnostics (UEFI)

HP PC Hardware Diagnostics is a Unified Extensible Firmware Interface (UEFI) that allows you to run diagnostic tests to determine whether the computer hardware is functioning properly. The tool runs outside the operating system so that it can isolate hardware failures from issues that are caused by the operating system or other software components.

When HP PC Hardware Diagnostics (UEFI) detects a failure that requires hardware replacement, a 24-digit Failure ID is generated. This ID can then be provided to support to help determine how to correct the problem.

To start HP PC Hardware Diagnostics (UEFI), follow these steps:

1. Turn on or restart the computer, and quickly press `esc`
2. Press `F2`.

The BIOS searches three places for the diagnostic tools, in the following order:

- a. Connected USB drive



NOTE: To download the HP PC Hardware Diagnostics (UEFI) tool to a USB drive, see [Downloading HP PC Hardware Diagnostics \(UEFI\) to a USB device on page 101](#).

- b. Hard drive
- c. BIOS

3. When the diagnostic tool opens, select the type of diagnostic test you want to run, and then follow the on-screen instructions.



NOTE: If you need to stop a diagnostic test, press `esc`.

Downloading HP PC Hardware Diagnostics (UEFI) to a USB device

 **NOTE:** The HP PC Hardware Diagnostics (UEFI) download instructions are provided in English only, and you must use a Windows computer to download and create the HP UEFI support environment because only .exe files are offered.

There are two options to download HP PC Hardware Diagnostics to USB device.

Download the latest UEFI version

1. Go to <http://www.hp.com/go/techcenter/pcdiags>. The HP PC Diagnostics home page is displayed.
2. In the HP PC Hardware Diagnostics section, click the **Download** link, and then select **Run**.

Download any version of UEFI for a specific product

1. Go to <http://www.hp.com/support>, and then select your country. The HP Support page is displayed.
2. Click **Drivers & Downloads**.
3. Use the categories listed to find your product.

– or –

Click **Find Now** to let HP automatically detect your product.

4. Select your computer, and then select your operating system.
5. In the **Diagnostic** section, follow the on-screen instructions to select and download the UEFI version you want.

10 Backing up, restoring, and recovering

This chapter provides information about the following processes, which are standard procedure for most products:

- **Backing up your personal information**—You can use Windows tools to back up your personal information (see [Using Windows tools on page 102](#)).
- **Creating a restore point**—You can use Windows tools to create a restore point (see [Using Windows tools on page 102](#)).
- **Creating recovery media** (select products only)—You can use the HP Cloud Recovery Download Tool (select products only) to create recovery media (see [Using the HP Cloud Recovery Download Tool to create recovery media \(select products only\) on page 102](#)).
- **Restoring and recovery**—Windows offers several options for restoring from backup, refreshing the computer, and resetting the computer to its original state (see [Using Windows tools on page 102](#)).

 **IMPORTANT:** If you will be performing recovery procedures on a tablet, the tablet battery must be at least 70% charged before you start the recovery process.

IMPORTANT: For a tablet with a detachable keyboard, connect the tablet to the keyboard base before beginning any recovery process.

Backing up information and creating recovery media

Using Windows tools

 **IMPORTANT:** Windows is the only option that allows you to back up your personal information. Schedule regular backups to avoid information loss.

You can use Windows tools to back up personal information and create system restore points and recovery media.

 **NOTE:** If computer storage is 32 GB or less, Microsoft System Restore is disabled by default.

For more information and steps, see the Get Help app.

1. Select the **Start** button, and then select the **Get Help** app.
2. Enter the task you want to perform.

 **NOTE:** You must be connected to the Internet to access the Get Help app.

Using the HP Cloud Recovery Download Tool to create recovery media (select products only)

You can use the HP Cloud Recovery Download Tool to create HP Recovery media on a bootable USB flash drive.

To download the tool:

- ▲ Go to the Microsoft Store and search for HP Cloud Recovery.

For details, go to <http://www.hp.com/support>, search for HP Cloud Recovery, and then select "HP PCs – Using the Cloud Recovery Tool (Windows 10, 7)."

 **NOTE:** If you cannot create recovery media yourself, contact support to obtain recovery discs. Go to <http://www.hp.com/support>, select your country or region, and then follow the on-screen instructions.

Restoring and recovery

Restoring, resetting, and refreshing using Windows tools

Windows offers several options for restoring, resetting, and refreshing the computer. For details, see [Using Windows tools on page 102](#).

Recovering using HP Recovery media

HP Recovery media is used to recover the original operating system and software programs that were installed at the factory. On select products, it can be created on a bootable USB flash drive using the HP Cloud Recovery Download Tool. For details, see [Using the HP Cloud Recovery Download Tool to create recovery media \(select products only\) on page 102](#).

 **NOTE:** If you cannot create recovery media yourself, contact support to obtain recovery discs. Go to <http://www.hp.com/support>, select your country or region, and then follow the on-screen instructions.

To recover your system:

- ▲ Insert the HP Recovery media, and then restart the computer.

Changing the computer boot order

If your computer does not restart using the HP Recovery media, you can change the computer boot order. This is the order of devices listed in BIOS where the computer looks for startup information. You can change the selection to an optical drive or a USB flash drive, depending on the location of your HP Recovery media.

To change the boot order:

 **IMPORTANT:** For a tablet with a detachable keyboard, connect the tablet to the keyboard base before beginning these steps.

1. Insert the HP Recovery media.
2. Access the system **Startup** menu.

For computers or tablets with keyboards attached:

- ▲ Turn on or restart the computer or tablet, quickly press **esc**, and then press **f9** for boot options.

For tablets without keyboards:

- ▲ Turn on or restart the tablet, quickly hold down the volume up button, and then select **f9**.

– or –

Turn on or restart the tablet, quickly hold down the volume down button, and then select **f9**.

3. Select the optical drive or USB flash drive from which you want to boot, and then follow the on-screen instructions.

Using HP Sure Recover (select products only)

Select computer models are configured with HP Sure Recover, a PC OS recovery solution built into the hardware and firmware. HP Sure Recover can fully restore the HP OS image without installed recovery software.

Using HP Sure Recover, an administrator or user can restore the system and install:

- Latest version of the operating system
- Platform-specific device drivers
- Software applications, in the case of a custom image

To access the latest documentation for HP Sure Recover, go to <http://www.hp.com/support>. Select **Find your product**, and then follow the on-screen instructions.

A Battery replacement

The battery that comes with the computer provides power to the real-time clock. When replacing the battery, use a battery equivalent to the battery originally installed in the computer. The computer comes with a 3-volt lithium coin cell battery.

 **WARNING!** The computer contains an internal lithium manganese dioxide battery. There is a risk of fire and burns if the battery is not handled properly. To reduce the risk of personal injury:

Do not attempt to recharge the battery.

Do not expose to temperatures higher than 60°C (140°F).

Do not disassemble, crush, puncture, short external contacts, or dispose of in fire or water.

Replace the battery only with the HP spare designated for this product.

 **CAUTION:** Before replacing the battery, it is important to back up the computer CMOS settings. When the battery is removed or replaced, the CMOS settings will be cleared.

Static electricity can damage the electronic components of the computer or optional equipment. Before beginning these procedures, ensure that you are discharged of static electricity by briefly touching a grounded metal object.

 **NOTE:** The lifetime of the lithium battery can be extended by plugging the computer into a live AC wall socket. The lithium battery is only used when the computer is not connected to AC power.

HP encourages customers to recycle used electronic hardware, HP original print cartridges, and rechargeable batteries. For more information about recycling programs, go to <http://www.hp.com/recycle>.

1. Remove/disengage any security devices that prohibit opening the computer.
2. Remove all removable media, such as compact discs or USB flash drives, from the computer.
3. Turn off the computer properly through the operating system, and then turn off any external devices.
4. Disconnect the power cord from the power outlet and disconnect any external devices.

 **CAUTION:** Regardless of the power-on state, voltage is always present on the system board as long as the system is plugged into an active AC outlet. You must disconnect the power cord to avoid damage to the internal components of the computer.

5. Remove the access panel.
6. Locate the battery and battery holder on the system board.

 **NOTE:** On some computer models, it may be necessary to remove an internal component to gain access to the battery.

7. Depending on the type of battery holder on the system board, complete the following instructions to replace the battery.

Type 1

- a. Lift the battery out of its holder.

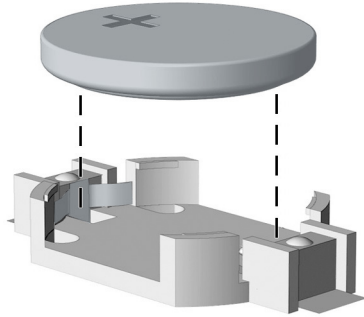

- b. Slide the replacement battery into position, positive side up. The battery holder automatically secures the battery in the proper position.

Type 2

- a. To release the battery from its holder, squeeze the metal clamp that extends above one edge of the battery. When the battery pops up, lift it out (1).
- b. To insert the new battery, slide one edge of the replacement battery under the holder's lip with the positive side up. Push the other edge down until the clamp snaps over the other edge of the battery (2).

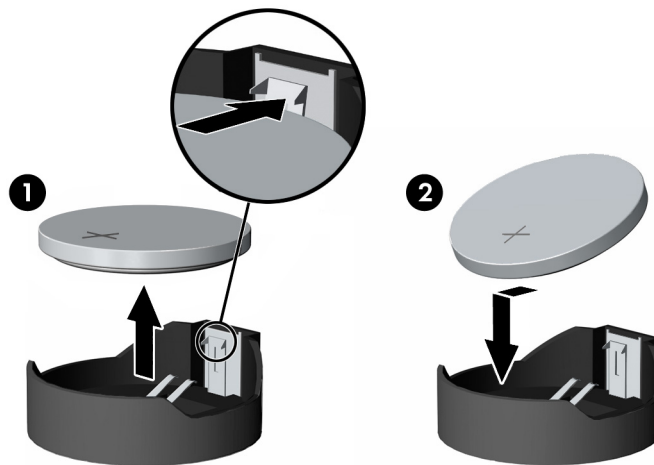

Type 3

- a. Pull back on the clip (1) that is holding the battery in place, and remove the battery (2).

- b. Insert the new battery and position the clip back into place.

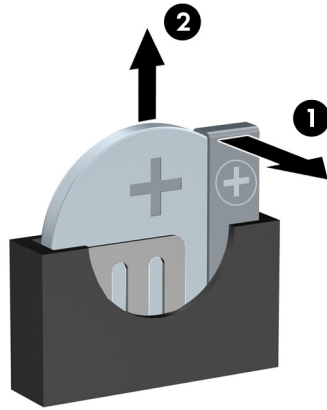

 **NOTE:** After the battery has been replaced, use the following steps to complete this procedure.

8. Replace the access panel.
9. Plug in the computer and turn on power to the computer.
10. Reset the date and time, your passwords, and any special system setups using Computer Setup.
11. Lock any security devices that were disengaged when the access panel was removed.

B Statement of memory volatility

The purpose of this appendix is to provide general information regarding nonvolatile memory in HP Business PCs. This appendix also provides general instructions for restoring nonvolatile memory that can contain personal data after the system has been powered off and the hard drive has been removed.

HP Business PC products that use Intel®-based or AMD®-based system boards contain volatile DDR memory. The amount of nonvolatile memory present in the system depends upon the system configuration. Intel-based and AMD-based system boards contain nonvolatile memory subcomponents as originally shipped from HP, assuming that no subsequent modifications have been made to the system and assuming that no applications, features, or functionality have been added to or installed on the system.

Following system shutdown and removal of all power sources from an HP Business PC system, personal data can remain on volatile system memory (DIMMs) for a finite period of time and will also remain in nonvolatile memory. Use the steps below to remove personal data from the PC, including the nonvolatile memory found in Intel-based and AMD-based system boards.

Current BIOS steps

1. Follow steps (a) through (l) to restore the nonvolatile memory that can contain personal data. Restoring or reprogramming nonvolatile memory that does not store personal data is neither necessary nor recommended.

- a. Turn on or restart the computer, and then press **esc**.



NOTE: If the system has a BIOS administrator password, enter the password at the prompt.

- b. Select **Main**, select **Apply Factory Defaults and Exit**, and then select **Yes** to load defaults.

The computer will reboot.

- c. During the reboot, press **esc**.



NOTE: If the system has a BIOS administrator password, enter the password at the prompt.

- d. Select the **Security** menu, select **Restore Security Settings to Factory Defaults**, and then select **Yes** to restore security level defaults.

The computer will reboot.

- e. During the reboot, press **esc**.



NOTE: If the system has a BIOS administrator password, enter the password at the prompt.

- f. If an asset or ownership tag is set, select the **Security** menu and scroll down to the **Utilities** menu. Select **System IDs**, and then select **Asset Tracking Number**. Clear the tag, and then make the selection to return to the prior menu.

- g. If a DriveLock password is set, select the **Security** menu, and scroll down to **Hard Drive Utilities** under the **Utilities** menu. Select **Hard Drive Utilities**, select **DriveLock**, and then uncheck the checkbox for **DriveLock** password on restart. Select **OK** to proceed.

Nonvolatile memory usage

Nonvolatile memory type	Amount (Size)	Does this memory store customer data?	Does this memory retain data when power is removed?	What is the purpose of this memory?	How is data input into this memory?	How is this memory write-protected?
HP Sure Start flash (select models only)	8 MBytes	No	Yes	Provides protected backup of critical System BIOS code, EC firmware, and critical PC configuration data for select platforms that support HP Sure Start. For more information, see Using HP Sure Start on page 113 .	Data cannot be written to this device via the host processor. The content is managed solely by the HP Sure Start Embedded Controller.	This memory is protected by the HP Sure Start Embedded Controller.
Real Time Clock (RTC) battery backed-up CMOS configuration memory	256 Bytes	No	Yes	Stores system date and time and noncritical data.	RTC battery backed-up CMOS is programmed using the Computer Setup (BIOS), or changing the Microsoft Windows date and time.	This memory is not write-protected.
Controller (NIC) EEPROM	64 KBytes (not customer accessible)	No	Yes	Stores NIC configuration and NIC firmware.	NIC EEPROM is programmed using a utility from the NIC vendor that can be run from DOS.	A utility is required to write data to this memory and is available from the NIC vendor. Writing data to this ROM in an inappropriate manner will render the NIC non-functional.
DIMM Serial Presence Detect (SPD) configuration data	256 Bytes per memory board, 128 Bytes programmable (not customer accessible)	No	Yes	Stores memory board information.	DIMM SPD is programmed by the memory vendor.	Data cannot be written to this memory when the board is installed in a PC. The specific write-protection method varies by memory vendor.
System BIOS	9 MBytes	Yes	Yes	Stores system BIOS code and PC configuration data.	System BIOS code is programmed at the factory. Code is updated when the system BIOS is updated. Configuration data and settings are input using the Computer Setup (BIOS) or a custom utility.	NOTE: Writing data to this ROM in an inappropriate manner can render the PC non-functional. A utility is required for writing data to this memory and is available on the HP website; go to http://www.hp.com/support , and select your country. Select Drivers & Downloads , and then

Nonvolatile memory type	Amount (Size)	Does this memory store customer data?	Does this memory retain data when power is removed?	What is the purpose of this memory?	How is data input into this memory?	How is this memory write-protected?
Intel Management Engine Firmware	7 MBytes	Yes	Yes	Stores Management Engine Code, Settings, Provisioning Data and iAMT third-party data store.	Management Engine Code is programmed at the factory. Code is updated via Intel secure firmware update utility. Unique Provisioning Data can be entered at the factory or by an administrator using the Management Engine (MEBx) setup utility. The third-party data store contents can be populated by a remote management console or local applications that have been registered by an administrator to have access to the space.	follow the on-screen instructions. The Intel chipset is configured to enforce hardware protection to block all direct read/write access to this area. An Intel utility is required for updating the firmware. Only firmware updates digitally signed by Intel can be applied using this utility.

Questions and answers

1. How can the BIOS settings be restored (returned to factory settings)?



IMPORTANT: Restore defaults does not securely erase any data on your hard drive. See question and answer 6 for steps to securely erase data.

Restore defaults does not reset the Custom Secure Boot keys. See question and answer 7 for information about resetting the keys.

- a. Turn on or restart the computer, and then press **esc** while the “Press the ESC key for Startup Menu” message is displayed at the bottom of the screen.
- b. Select **Main**, and then select **Restore defaults**.
- c. Follow the on-screen instructions.
- d. Select **Main**, select **Save Changes and Exit**, and then follow the on-screen instructions.

2. What is a UEFI BIOS, and how is it different from a legacy BIOS?

The Unified Extensible Firmware Interface (UEFI) BIOS is an industry-standard software interface between the platform firmware and an operating system (OS). It is a replacement for the older BIOS architecture, but supports much of the legacy BIOS functionality.

Like the legacy BIOS, the UEFI BIOS provides an interface to display the system information and configuration settings and to change the configuration of your computer before an OS is loaded. BIOS provides a secure run-time environment that supports a Graphic User Interface (GUI). In this environment, you can use either a pointing device (Touchscreen, TouchPad, pointing stick, or USB mouse) or the keyboard to navigate and make menu and configuration selections. The UEFI BIOS also contains basic system diagnostics.

The UEFI BIOS provides functionality beyond that of the legacy BIOS. In addition, the UEFI BIOS works to initialize the computer’s hardware before loading and executing the OS; the run-time environment allows the loading and execution of software programs from storage devices to provide more functionality, such as advanced hardware diagnostics (with the ability to display more detailed system information) and advanced firmware management and recovery software.

HP has provided options in Computer Setup (BIOS) to allow you to run in legacy BIOS, if required by the operating system. Examples of this requirement would be if you upgrade or downgrade the OS.

3. Where does the UEFI BIOS reside?

The UEFI BIOS resides on a flash memory chip. A utility is required to write to the chip.

4. What kind of configuration data is stored on the DIMM Serial Presence Detect (SPD) memory board? How would this data be written?

The DIMM SPD memory contains information about the memory board, such as size, serial number, data width, speed/timing, voltage, and thermal information. This information is written by the board manufacturer and stored on an EEPROM. This EEPROM cannot be written to when the memory board is installed in a PC. Third-party tools do exist that can write to the EEPROM when the memory board is not installed in a PC. Various third-party tools are available to read SPD memory.

5. What is meant by “Restore the nonvolatile memory found in Intel-based system boards”?

This message relates to clearing the Real Time Clock (RTC) CMOS memory that contains PC configuration data.

6. How can the BIOS security be reset to factory defaults and data erased?

 **IMPORTANT:** Resetting will result in the loss of information.

These steps will not reset Custom Secure Boot Keys. See question and answer 7 for information about resetting the keys.

- a. Turn on or restart the computer, and then press **esc** while the “Press the ESC key for Startup Menu” message is displayed at the bottom of the screen.
- b. Select **Main**, and then select **Reset BIOS Security to Factory Default**.
- c. Follow the on-screen instructions.
- d. Select **Main**, select **Save Changes and Exit**, and then follow the on-screen instructions.

7. How can the Custom Secure Boot Keys be reset?

Secure Boot is a feature to ensure that only authenticated code can start on a platform. If you enabled Secure Boot and created Custom Secure Boot Keys, simply disabling Secure Boot will not clear the keys. You must also select to clear the Custom Secure Boot Keys. Use the same Secure Boot access procedure you used to create the Custom Secure Boot Keys, but make the selection to clear or delete all Secure Boot Keys.

- a. Turn on or restart the computer, and then press **esc** while the “Press the ESC key for Startup Menu” message is displayed at the bottom of the screen.
- b. Select the **Security** menu, select **Secure Boot Configuration**, and then follow the on-screen instructions.
- c. At the **Secure Boot Configuration** window, select **Secure Boot**, select **Clear Secure Boot Keys**, and then follow the on-screen instructions to continue.

Using HP Sure Start

Select computer models are configured with HP Sure Start, a technology that continuously monitors your computer's BIOS for attacks or corruption. If the BIOS becomes corrupted or is attacked, HP Sure Start restores the BIOS to its previously safe state, without user intervention. Those select computer models ship with HP Sure Start configured and enabled. HP Sure Start is configured and already enabled so that most users can use the HP Sure Start default configuration. The default configuration can be customized by advanced users.

To access the latest documentation on HP Sure Start, go to <http://www.hp.com/support>, and select your country. Select **Drivers & Downloads**, and then follow the on-screen instructions.

C Power cord set requirements

The power supplies on some computers have external power switches. The voltage select switch feature on the computer permits it to operate from any line voltage between 100-120 or 220-240 volts AC. Power supplies on those computers that do not have external power switches are equipped with internal switches that sense the incoming voltage and automatically switch to the proper voltage.

The power cord set received with the computer meets the requirements for use in the country where you purchased the equipment.

Power cord sets for use in other countries must meet the requirements of the country where you use the computer.

General requirements

The requirements listed below are applicable to all countries:

1. The power cord must be approved by an acceptable accredited agency responsible for evaluation in the country where the power cord set will be installed.
2. The power cord set must have a minimum current capacity of 10A (7A Japan only) and a nominal voltage rating of 125 or 250 VAC, as required by each country's power system.
3. The diameter of the wire must be a minimum of 0.75 mm² or 18AWG, and the length of the cord must be between 1.8 m (6 ft) and 3.6 m (12 ft).

The power cord should be routed so that it is not likely to be walked on or pinched by items placed upon it or against it. Particular attention should be paid to the plug, electrical outlet, and the point where the cord exits from the product.

 **WARNING!** Do not operate this product with a damaged power cord set. If the power cord set is damaged in any manner, replace it immediately.

Japanese power cord requirements

For use in Japan, use only the power cord received with this product.

 **CAUTION:** Do not use the power cord received with this product on any other products.

Country-specific requirements

Additional requirements specific to a country are shown in parentheses and explained below.

Country	Accrediting Agency	Country	Accrediting Agency
Australia (1)	EANSW	Italy (1)	IMQ
Austria (1)	OVE	Japan (3)	METI
Belgium (1)	CEBC	Norway (1)	NEMKO
Canada (2)	CSA	Sweden (1)	SEMKO
Denmark (1)	DEMKO	Switzerland (1)	SEV
Finland (1)	SETI	United Kingdom (1)	BSI
France (1)	UTE	United States (2)	UL
Germany (1)	VDE		

1. The flexible cord must be Type H05VV-F, 3-conductor, 0.75mm² conductor size. Power cord set fittings (appliance coupler and wall plug) must bear the certification mark of the agency responsible for evaluation in the country where it will be used.
2. The flexible cord must be Type SVT or equivalent, No. 18 AWG, 3-conductor. The wall plug must be a two-pole grounding type with a NEMA 5-15P (15 A, 125 V) or NEMA 6-15P (15A, 250V) configuration.
3. Appliance coupler, flexible cord, and wall plug must bear a T mark and registration number in accordance with the Japanese Dentori Law. Flexible cord must be Type VCT or VCTF, 3-conductor, 0.75 mm² conductor size. Wall plug must be a two-pole grounding type with a Japanese Industrial Standard C8303 (7 A, 125 V) configuration.

D Specifications

Unit	Metric value	Standard value
Chassis (in the desktop position)		
Height	95 mm	3.7 in
Width	270 mm	10.6 in
Depth	300 mm	11.8 in
Approximate Weight		
	4.43 kg	9.8 lb
Weight Supported (maximum distributed load in desktop position)		
	35 kg	77 lb
Temperature Range		
Operating	10°C to 35°C	50°F to 95°F
Nonoperating	-30°C to 60°C	-22°F to 140°F
NOTE: Operating temperature is derated 1.0°C per 300 m (1000 ft) to 3000 m (10,000 ft) above sea level; no direct sustained sunlight. Maximum rate of change is 10°C/Hr. The upper limit may be limited by the type and number of options installed.		
Relative Humidity (noncondensing)		
Operating	10% to 90%	10% to 90%
Nonoperating (38.7°C max wet bulb)	5% to 95%	5% to 95%
Maximum Altitude (unpressurized)		
Operating	5,000 m	16,404 ft
Nonoperating	15,240 m	50,000 ft
Power Supply		
Operating Voltage Range	90 VAC to 264 VAC	
Rated Voltage Range ¹	100 VAC to 240 VAC	
Rated Line Frequency	50 Hz to 60 Hz	
Operating Line Frequency	47 Hz to 63 Hz	
Standard Efficiency		
	180 W / 310 W active PFC	
High Efficiency		
	87/90/87 % efficient at 20/50/100% load (115 V)	
Standard Efficiency		
	250 W active PFC	
High Efficiency		
	90/92/89 % efficient at 20/50/100% load (115 V)	
Rated Input Current		
	310 W / 4 A	
	250 W / 3 A	
	180 W / 2.3 A	

¹ This system uses an active power factor corrected power supply. This allows the system to pass the CE mark requirements for use in the countries of the European Union. The active power factor corrected power supply also has the added benefit of not requiring an input voltage range select switch.

Index

A

- access panel
 - locked 66
 - removal and replacement 32
- audible codes 94
- audio problems 76
- audio-in jack 2, 3
- audio-out jack 2, 3

B

- backup, creating 102
- backups 102
- battery
 - disposal 30
- battery replacement 105
- beep codes 94
- boot order, changing 103
- booting options
 - Full Boot 89
 - Quick Boot 89
- buttons
 - dual-state power 2

C

- cautions
 - AC power 25
 - cables 30
 - electrostatic discharge 25
 - keyboard cleaning 28
 - keyboard keys 29
- changing a Power-On password 99
- changing a Setup password 99
- cleaning
 - computer 28
 - mouse 29
 - safety precautions 28
- CMOS
 - backing up 96
- components
 - front panel 2
 - rear panel 3
- computer
 - serial number 4
- computer cleaning 28

- Computer Setup
 - access problem 65
- connector board
 - removal and replacement 47
- connectors
 - DisplayPort monitor 3
 - power cord 3
 - VGA monitor 3
- country power cord set requirements 115
- Customer Support 63

D

- deleting a Power-On password 99
- deleting a Setup password 99
- disassembly preparation 31
- DisplayPort monitor connector 3
- drive cage
 - removal and replacement 35

E

- electrostatic discharge (ESD) 25
 - preventing damage 26
- error
 - codes 89, 94
 - messages 89

F

- F10 Setup
 - access problem 65
- fan-sink
 - removal and replacement 44
- flash drive problems 86
- flashing LEDs 94
- front bezel
 - removal and replacement 34
- front panel components 2
- front panel problems 87

G

- general problems 65
- grounding methods 26

H

- hard drive
 - proper handling 30
- hard drive activity light 2
- hard drive problems 69
- hard drives
 - removal and replacement 36
- hardware installation problems 81
- headphone jack 2
- helpful hints 64
- HP PC Hardware Diagnostics (UEFI)
 - downloading 101
- HP Recovery media
 - recovery 103
- HP Sure Recover 104
- HP Sure Start 113

I

- installing
 - battery 105
- Internet access problems 87

J

- jacks
 - audio-in 2, 3
 - audio-out 2, 3
 - headphone 2
 - microphone 2
 - network 3
 - RJ-45 3

K

- keyboard
 - cleaning 28
- keyboard problems 79

L

- lights
 - hard drive activity 2

M

- media card reader
 - problems 71
- memory
 - nonvolatile 108

- problems 85
- volatile 108
- memory card reader 2
- memory module
 - removal and replacement 40
- microphone jack 2
- monitor problems 72
- mouse
 - cleaning 29
 - problems 79

N

- network jack 3
- network problems 82
- nonvolatile memory 108
- numeric error codes 89

O

- operating guidelines 27
- optical drive
 - removal and replacement 33
- overheating, prevention 27

P

- password
 - clearing 96
 - power-on 96
 - setup 96
- passwords 99
- ports
 - USB 3
 - USB SuperSpeed 3
 - USB SuperSpeed port 2
- POST error messages 89
- power button 2
- power cord connector 3
- power cord set requirements
 - country specific 115
- power problems 68
- power supply
 - operating voltage range 116
 - removal and replacement 31, 42, 43
- Power-On password 99
- power-on password 96
- printer problems 78
- problems
 - audio 76
 - Computer Setup 65
 - F10 Setup 65
 - flash drive 86

- front panel 87
- general 65
- hard drive 69
- hardware installation 81
- Internet access 87
- keyboard 79
- Media Card Reader 71
- memory 85
- monitor 72
- mouse 79
- network 82
- power 68
- printer 78
- software 88
- processor
 - removal and replacement 45

R

- rear panel components 3
- recovery 102
 - discs 103
 - HP Recovery partition 103
 - media 103
 - USB flash drive 103
- recovery media
 - creating using HP Cloud Recovery Download Tool 102
 - creating using Windows tools 102
- removal and replacement
 - access panel 32
 - drive cage 35
 - fan shroud 43
 - fan-sink 44
 - front bezel 34
 - hard drives 36
 - memory module 40
 - optical drive 33
 - power supply 31, 42
 - processor 45
 - serial connector module 47
 - speaker 38, 41
 - system board 48
- removing
 - battery 105
- removing personal data from volatile
 - system memory 108
- resetting
 - CMOS 96
 - password jumper 96

- restoring 102
- RJ-45 jack 3

S

- safety and comfort 63
- safety precautions
 - cleaning 28
- screws, correct size 29
- service considerations 29
- Setup password 99
- setup password 96
- slim optical drive
 - location 2
- software
 - problems 88
 - servicing computer 29
- speaker
 - removal and replacement 38, 41
- specifications
 - computer 116
- static electricity 25
- system board
 - removal and replacement 48
- system memory, removing personal
 - data from volatile 108
- system restore point, creating 102

T

- temperature control 27
- tools, servicing 29
- Torx T-15 screwdriver 29

U

- USB port 3
- USB SuperSpeed ports 3
- USB SuperSpeed port port 2

V

- ventilation, proper 27
- VGA monitor connector 3

W

- Windows
 - backup 102
 - recovery media 102
 - system restore point 102
- Windows tools, using 102
- WLAN module
 - removal 39
 - spare part number 39