

Environmental Services essentials



Your guide to choosing the right EVS products and solutions



You're on the frontlines of healthcare

And so are we

Cleaning protocols, hand hygiene and infection prevention

When it comes to managing Environmental Services, patient and staff safety are priority number one. So it's important to identify the right products and best practices to help you achieve your goals.

What does it take to succeed? A dedicated partner who understands healthcare and EVS needs

Discover better options

Innovations designed to help you achieve your goals—we own patents in every environmental services category

Learn best practices

Solid advice and valuable insights—our team of EVS specialists has over 135 years of combined healthcare industry experience

Consolidate orders

Everything you need in one invoice—we provide over 550,000 products to the entire continuum of care

Control costs

Low minimums for free shipping—qualifying is easy if you include your med-surg supplies



Paper supplies	4–9
Liners, hampers and trash cans	10–25
Cleaning tools and cart necessities	26–33
Floor care	34–55
Microfiber	56–65
Carts and containers	66–75
Surface cleaning chemicals and disinfectants	76–103
Soap and hand hygiene products	104–107
Textiles	108–125
Interiors	126–143
Safety and essentials	144–149
Reference guide	150–167

Paper supplies



Premium facial tissue

- Our softest, strongest and most absorbent tissue
- Boxes come in stylish designs for a feels-like-home environment
- Shields help repel dust particles

Item No.	Description	Pkg.
NON245278	Cube box, premium 2-ply	85 sheets/bx, 36 bx/cs
NON245277	Flat box, premium 2-ply	100 sheets/bx, 36 bx/cs
NON245276	Medium, premium 2 ply	60 sheets/bx, 48 bx/cs
NON245273	Pocket pack, 3-ply	10 sheets/pk, 100 bx/cs
NON245288	Animal pals, 2 ply, cube box	75 sheets/pk, 36 bx/cs



NON245277

NON245278



NON245288

Standard facial tissue

- Packaging is made from recycled paper
- Available in three different box sizes to suit your needs

Item No.	Description	Pkg.
NON243277	Large box, tree print, 2-ply	90 sheets/bx, 30 bx/cs
NON243276	Medium box, leaf print, 2-ply	60 sheets/bx, 72 bx/cs
NON243275	Small box, circle print, 2-ply	40 sheets/bx, 200 bx/cs



NON243277

Toilet seat cover

- Helps ensure a cleaner bathroom environment
- Dispensed easily

Item No.	Description	Pkg.
NON26899	Toilet seat covers, half fold, refill	250/pk, 20 pk/cs, 5,000/cs



NON26899

Single-fold towels

- One side of the towel is folded once
- Requires a larger dispenser than multi-fold or C-fold towels

Item No.	Description	Sheet Size	Pkg.
NONPBMSFB	White, 1-ply	9.5" x 10.62"	250/pk, 16 pk/cs, 4,000/cs
NONPBMSFK	Natural, 1-ply	9.5" x 10.62"	250/pk, 16 pk/cs, 4,000/cs



NONPBMSFK

NONPBMSFB

Green Tree® paper products



NON26835

Green Tree perforated roll towel

- Standard household roll towel
- Ready for any job

Item No.	Description	Sheet Size	Pkg.
NON26835	White, 2-ply	8.8" x 11"	85 sheets/roll, 30 rolls/cs



NON26800

Green Tree toilet tissue

- Soft, environmentally conscious and affordable to help improve patient experience and your bottom line
- Part of our Green Tree Basics portfolio of paper products

Item No.	Description	Pkg.
NON26800	Standard roll, 2-ply, renewable pulp	500 sheets/roll, 96 rolls/cs
NON26801	Standard roll, 1-ply	1,000 sheets/roll, 96 rolls/cs
NON26805	Jumbo junior, 3.8" X 1,000' roll, standard	8 rolls/cs
NON27800	Standard roll, 2-ply	500 sheets/roll, 96 rolls/cs
NON28800	Standard roll, 2-ply, deluxe	400 sheets/roll, 96 rolls/cs
NON28805	Jumbo junior, 3.8" X 650' roll, deluxe	12 rolls/cs
NON28830*	Small core, 2-ply	800 sheets/roll, 36 rolls/cs
NON28831	Small core, 2-ply	1,500 sheets/roll, 18 rolls/cs

*Fits most small core and coreless dispensers.



NON26810

Green Tree multi-fold towels

- Folded into the next towel for automatic feeding
- Deluxe option features a heavier paper

Item No.	Description	Sheet Size	Pkg.
NON26810	Standard, white	9.13" x 9.5"	250/pk, 16 pk/cs, 4,000/cs
NON26813	Deluxe, white	9.13" x 9.5"	250/pk, 16 pk/cs, 4,000/cs
NON25815	Deluxe, natural	9.13" x 9.5"	250/pk, 16 pk/cs, 4,000/cs
NON26818	Premium, TAD, white	8.75" x 9.5"	200/pk, 12/cs, 2,400/cs
NON26812	Standard, white	9.25" x 7.7"	250/pk, 16 pk/cs, 4,000/cs



NON26820

Green Tree c-fold towel

- Both sides of the towel are folded inwards
- Stacked individually

Item No.	Description	Sheet Size	Pkg.
NON26820	White, 1-ply	13" x 10"	150/pk, 16 pk/cs, 2,400/cs

Green Tree roll towels

- An economical choice
- Center-pull design to help reduce cross-contamination
- Deluxe option with thicker, fluffier paper

Item No.	Description	Color	Sheet Size	Pkg.
NON26830	Center-pull	White	600 sheets/roll, 8.25" x 12"	6 rolls/cs
NON26836	Center-pull jr.	White	330 sheets/roll, 7.6" x 11"	6 rolls/cs
NONPBM350	Standard	White	8" x 350'	12 rolls/cs
NON25825	Standard	Natural	8" x 350'	12 rolls/cs
NONPBM800B	Standard	White	8" x 800'	6 rolls/cs
NONPBM800N	Standard	Natural	8" x 800'	6 rolls/cs
NON288425	Deluxe	White	8" x 425'	6 rolls/cs
NON26872	Standard	White	10" x 800'	6 rolls/cs
NON26870	Deluxe	White	10" x 425'	6 rolls/cs



NON25825

NONPBM350

Green Tree napkins

- An economical choice for your facilities
- Ideal for high-volume applications

Item No.	Description	Pkg.
NONPLT257DN	Dinner napkin, 15" x 17", white	3,000 ea/cs
NON25803	Beverage napkin, white	4,000 ea/cs
NON25806	Dinner napkin, square, white	4,008 ea/cs
NON25807	Lunch napkin, 12" x 12", white	6,000 ea/cs



NON25807

The Green Tree collection

includes paper towels, toilet tissue and facial tissue made from renewable sources or recycled content. All Green Tree products are pleasantly soft and gentle on the environment, but strong enough to stand up to tough cleaning needs.

Find out for yourself!

Ask your Medline Rep how you can

TAKE
the **TISSUE**
TEST



Dispensers



EVSDSMFB

Manual dispenser for Ultrafold® c-fold and multi-fold towels

- Low-profile design makes this plastic dispenser ideal for small places
- Compatible paper products: NON26810, NON26813, NON25815, NON26820, NON26818

Item No.	Description	Color	Pkg.
EVSDSMFB	11.5"H x 11.5"W x 6"D	Smoke Black	1 ea



EVSDSMFB2

Black multifold dispenser

- Compatible paper products: NON25815, NON26810, NON26813, NON26818, NON26820

Item No.	Description	Pkg.
EVSDSMFB2	11.5"H x 11.5"W x 6"D	1 ea
EVSDSMFW	11.5"H x 11.5"W x 6"D	1 ea



EVDSMFCOUNTER

Countertop multifold towel dispenser

- Compatible paper products: NON25815, NON26810, NON26813, NON26818, NON26820

Item No.	Description	Pkg.
EVDSMFCOUNTER	Countertop multifold towel dispenser	1 ea



EVSDSCOVER

Black toilet seat cover dispenser, 1/2 fold

- Compatible paper product: NON26899

Item No.	Description	Pkg.
EVSDSCOVER	Black toilet seat cover dispenser, 1/2 fold	1 ea

Manual dispenser for center-pull towel

- Dispenses single sheets for reliable portion control
- Touchless center-pull design to help prevent cross-contamination
- Large capacity for long intervals between refills
- Designed to reduce maintenance costs and provide a hygienic hand-drying environment
- Compatible paper products: NON26830, NON26836

Item No.	Description	Pkg.
EVSDSRCENTERP	11.63" H x 9.13" W x 9.5" D	1 ea



EVSDSRCENTERP

8" automatic roll towel dispenser

- Compatible paper products: NON25825, NON288425, NONPBM350, NONPBM800B, NONPBM800N

Item No.	Description	Pkg.
EVSDSRAUTO2	8" automatic roll towel dispenser	1 ea



EVSDSRAUTO2

8" mechanical roll towel dispenser

- Compatible paper products: NON25825, NON288425, NONPBM350, NONPBM800B, NONPBM800N

Item No.	Description	Pkg.
EVSDSRMECH2	8" mechanical roll towel dispenser	1 ea



EVSDSRMECH2

Two-roll small core dispenser

- Compatible paper products: NON28830, NON28831

Item No.	Description	Pkg.
EVSDSTPSMC	Two-roll small core dispenser	1 ea



EVSDSTPSMC

Single and double roll dispensers

- Compatible paper products: NON26805, NON28805

Item No.	Description	Pkg.
EVSDSTP91	Two-roll small core dispenser	1 ea
EVSDSTP92	Two-roll small core dispenser	1 ea



EVSDSTP91

Two-roll toilet paper dispensers

- Compatible paper products: standard size NON26800, NON27800, NON28800

Item No.	Description	Pkg.
EVSDSTPVSTD	Two-roll dispenser	1 ea
EVSDSTPHSTD	Two-roll dispenser	1 ea



EVSDSTPVSTD

**Liners,
hampers and
trash cans**



How to choose the right bag

What's the difference between a high density and low density liner?



High density

- Think "plastic grocery store bags"
- Measured in microns (mics)
- Features: strong and thin—less material so it's less expensive
- Waste type: soft waste (i.e. tissue paper, paper towels and heavy, not sharp waste)

Low density

- Think "trash liners at home"
- Measured in mils
- Features: superior stretch for heavier items
- Waste type: heavy waste (i.e. linens, food, infectious waste and sharp objects)

Helpful hints on selecting can liners

To convert mil to microns, multiply the mil by 25.4 to arrive at true micron thickness.

How to measure for correct can liner size

Bag width: Half the outer circumference of the container.

Bag length: For round containers, use the height of the container, plus half of the diameter of the bottom, plus 3 inches (for overhang).

For square or rectangular containers, use the diagonal of the container bottom, rather than the diameter.

Types of waste	Low density high mil	Low density med mil	Low density low mil	High density high mic	High density med mic	High density low-med mic	High density low mic
Heavy sharp objects	●						
Average weight sharps, broken glass		●					
Lightweight waste with sharp corners			●				
Rough cafeteria waste, sharp objects		●	●				
General food waste			●	●			
Heavy paper (i.e., newspaper, magazines)				●			
Terries, linens, microfiber				●	●		
General mixed restroom waste						●	
Tissue paper							●

Mil thickness	Approx. micron equivalent
0.23	6
0.27	7
0.31	8
0.35	9
0.39	10
0.43	11
0.47	12
0.51	13
0.55	14
0.59	15
0.62	16
0.66	17
0.70	18
0.74	19
0.78	20
0.82	21
0.86	22
0.90	23
0.94	24
0.98	25

Standard Trash Liners



NON022207

Low Density—Clear and Black

- Superior stretch and tear resistance
- Ideal for heavy or sharp waste
- Choose from black and clear in a wide range of sizes and thickness

24" x 23", 7-10-Gal. Capacity

Size	Item No.	Color	Thickness	Pkg.	Style
24 x 23	NON022207	Clear	0.35 Mil	500/cs	Flat
24 x 23	NONCRC23H	Clear	0.6 Mil	500/cs	Roll

24" x 32", 15-Gal. Capacity

24 x 32	NONCRC32HRL	Clear	0.6 Mil	500/cs	Roll
24 x 32	NONCXC32H	Clear	0.6 Mil	500/cs	Flat
24 x 32	NONCRPXC32	Clear	1 Mil	250/cs	Roll

30" x 36", 20-30-Gal. Capacity

30 x 36	NONPXC36X	Clear	1 Mil	250/cs	Flat
---------	-----------	-------	-------	--------	------

33" x 40", 33-Gal. Capacity

33 x 40	NONPXC39XRL	Clear	1 Mil	250/cs	Roll
33 x 40	NONPXC39X	Clear	1 Mil	250/cs	Flat

38" x 58", 55-Gal. Capacity

38 x 58	NONPXC58XH	Clear	1.35 Mil	100/cs	Flat
---------	------------	-------	----------	--------	------

40" x 46", 40-45-Gal. Capacity

40 x 46	NONPXC46XXH	Clear	1.8 Mil	100/cs	Flat
40 x 46	NONCRPXC46XXH	Clear	1.8 Mil	100/cs	Roll
40 x 46	NON022237	Clear	2 Mil	100/cs	Flat

43" x 47", 56-Gal. Capacity

43 x 47	NONPXC47XH	Clear	1.35 Mil	100/cs	Flat
43 x 47	NONPXC47XXH	Clear	1.8 Mil	100/cs	Flat

High Density—Clear and Black

- A great choice for soft trash (typical office, restroom, paper, etc.)
- Strong while offering a cost savings over traditional low-density products



NONHCR48STB

24" x 24", 10-Gal. Capacity

Size	Item No.	Color	Thickness	Pkg.	Style
24 x 24	NONHCR24LB	Black	6 Mic	1000/cs	Roll
24 x 24	NONHCR24LC	Clear	6 Mic	1000/cs	Roll
24 x 24	NONCHD24MC	Clear	8 Mic	1000/cs	Flat
24 x 24	NONHCR24MC	Clear	8 Mic	1000/cs	Roll
24 x 24	NONHCR24MB	Black	8 Mic	1000/cs	Roll
24 x 24	NONHCR2410C	Clear	10 Mic	1000/cs	Roll
24 x 24	NONHCR2412C	Clear	12 Mic	1000/cs	Roll

24" x 33", 15-Gal. Capacity

24 x 33	NONHCR33LC	Clear	6 Mic	1000/cs	Roll
24 x 33	NONHCR33MB	Black	8 Mic	1000/cs	Roll
24 x 33	NONHCR243311	Clear	11 Mic	500/cs	Roll
24 x 33	NONHCR2411B	Black	11 Mic	500/cs	Roll

30" x 37", 30-Gal. Capacity

30 x 37	NONCHD37MC	Clear	8 Mic	500/cs	Flat
30 x 37	NONHCR3710B	Black	10 Mic	500/cs	Roll
30 x 37	NONHCR37XB	Black	16 Mic	500/cs	Roll

33" x 40", 33-Gal. Capacity

33 x 40	NONHCR40MB	Black	10 Mic	500/cs	Roll
33 x 40	NON334019B	Black	19 Mic	250/cs	Roll
33 x 40	NONCHD40STC	Clear	22 Mic	250/cs	Flat

40" x 48", 45-Gal. Capacity

40 x 48	NONHCR48HB	Black	13 Mic	250/cs	Roll
40 x 48	NONHCR48XB	Black	16 Mic	250/cs	Roll
40 x 48	NONHCR48STB	Black	22 Mic	150/cs	Roll

38" x 58", 55-Gal. Capacity

38 X 58	NONHCR62XC	Clear	17 Mic	200/cs	Roll
38 X 58	NONCHD62XC	Clear	17 Mic	200/cs	Flat

43" x 48", 56-Gal. Capacity

43 x 48	NONHCR47HC	Clear	14 Mic	200/cs	Roll
43 x 48	NONCHD47HC	Clear	14 Mic	200/cs	Flat
43 x 48	NONHCR47STB	Black	22 Mic	150/cs	Roll



NON122424

Red Biohazard Liners

- Printed with the universal biohazard symbol and "Infectious Waste" in English and Spanish
- Low-density bags meet the 165-gram Dart Drop Test (ASTM-D1709-85) and 480-gram Elmendorf Tear Test (ASTM-D1922-67)

12" x 12", 2-Gal. Capacity

Size	Item No.	Color	Thickness	Pkg.	Style
12 x 12	NON151212	Red	2 Mil, Ziploc Closure	1000/cs	Flat

17" x 17", 4-Gal. Capacity

17 x 17	NON151717	Red	1.5 Mil	500/cs	Flat
---------	-----------	-----	---------	--------	------

24" x 24", 10-Gal. Capacity

24 x 24	NON122424	Red	1.2 Mil	500/cs	Flat
---------	-----------	-----	---------	--------	------

31" x 43", 33-Gal. Capacity

31 x 43	NON153143	Red	1.5 Mil	250/cs	Flat
31 x 43	NON203143	Red	2 Mil	100/cs	Flat
31 x 43	NON303143	Red	3 Mil	100/cs	Flat

40" x 46", 44-Gal. Capacity

40 x 46	NON154046	Red	1.5 Mil	100/cs	Flat
---------	-----------	-----	---------	--------	------



NON024048

Yellow Infectious Linen Liners

- Color-coding, biohazard symbols and bilingual markings help keep materials safely separated
- Use with rectangular hamper stand, item no. MDS80529

Size	Item No.	Color	Thickness	Pkg.	Style
31 x 41	NON024048	Yellow	1.5 Mil	250/cs	Flat
31 x 43	NON024042	Yellow	1.2 Mil	100/cs	Roll
40 x 46	NON024046RL	Yellow	1.5 Mil	100/cs	Roll
40 x 46	NON024046	Yellow	1.5 Mil	100/cs	Flat

Water Soluble Liners

- Designed to isolate infectious or contaminated linen
- Clear bags can be washed along with linen contents
- Hold wet or damp linen for hours without rupturing
- Bag dissolves in hot water flush at 149°F



NON022249

Item No.	Dimensions	Thickness	Capacity	Pkg.	Style
NON02800	26" x 33"	1 mil	15-20-gal.	100/cs	Roll
NON02825	28" x 39"	1 mil	30-gal.	100/cs	Roll
NON02850	36" x 39"	1 mil	35-gal.	100/cs	Roll

Blend Right Bags



Low Density—Clear and Black

- Composed of a mixture of several types of resin to offer a more cost-effective solution

24" x 32", 15-Gal. Capacity

Size	Item No.	Color	Thickness	Pkg.	Style
24 x 32	EVSBL243235CF	Clear	0.35 Mil	1000/cs	Flat
24 x 32	EVSBL243235C	Clear	0.35 Mil	1000/cs	Roll
24 x 32	EVSBL24327BK	Black	0.7 Mil	500/cs	Roll

30" x 36", 20–30-Gal. Capacity

30 x 36	EVSBL303645CF	Clear	0.45 Mil	250/cs	Flat
30 x 36	EVSBL30365BK	Black	0.65 Mil	250/cs	Roll

33" x 39", 33-Gal. Capacity

33 X 39	EVSBL333965C	Clear	0.65 Mil	250/cs	Roll
33 X 39	EVSBL333965CF	Clear	0.65 Mil	250/cs	Flat
33 X 39	EVSBL33399C	Clear	0.9 Mil	150/cs	Roll
33 X 39	EVSBL333995KF	Black	0.9 Mil	100/cs	Flat
33 X 39	EVSBL333995BK	Black	0.95 Mil	100/cs	Roll

Low Density—White and Gray

24" x 32", 15-Gal. Capacity

Size	Item No.	Color	Thickness	Pkg.	Style
24 x 32	EVSBL24327W	White	0.7 Mil	500/cs	Roll

30" x 45", 33-Gal. Capacity

30 x 45	EVSBL304513W	White	1.3 Mil	200/cs	Roll
---------	--------------	-------	---------	--------	------

33" x 39", 33-Gal. Capacity

33 x 39	EVSBL33391W	White	1 Mil	250/cs	Roll
---------	-------------	-------	-------	--------	------

40" x 46", 40-45-Gal. Capacity

40 x 46	EVSBL40467C	Clear	0.7 Mil	125/cs	Roll
40 x 46	EVSBL40467CFT	Clear	0.7 Mil	125/cs	Flat
40 x 46	EVSBL40469BK	Black	0.9 Mil	100/cs	Roll
40 x 46	EVSBL404611C	Clear	1.1 Mil	125/cs	Roll
40 x 46	EVSBL404611CF	Clear	1.1 Mil	125/cs	Flat
40 x 46	EVSBL404615BK	Black	1.5 Mil	250/cs	Roll
40 x 46	EVSBL404615KF	Black	1.5 Mil	250/cs	Flat

38" x 58", 55-Gal. Capacity

38 x 58	EVSBL38589C	Clear	0.9 Mil	100/cs	Roll
38 x 58	EVSBL385813C	Clear	1.3 Mil	100/cs	Roll

43" x 47", 56-Gal. Capacity

43 x 47	EVSBL4347115C	Clear	1.15 Mil	100/cs	Roll
---------	---------------	-------	----------	--------	------

40" x 46", 40-45-Gal. Capacity

40 x 46	EVSBL40461W	White	1 Mil	125/cs	Roll
40 x 46	EVSBL404611G	Gray	1.1 Mil	125/cs	Roll

38" x 58", 55-Gal. Capacity

38 x 58	EVSBL385895W	White	0.95 Mil	100/cs	Roll
---------	--------------	-------	----------	--------	------

43" x 47", 56-Gal. Capacity

43 x 48	EVSBL4254811G	Gray	1.1 Mil	100/cs	Roll
---------	---------------	------	---------	--------	------



High Density—Clear and Black

24" x 33", 15-Gal. Capacity

Size	Item No.	Color	Thickness	Pkg.	Style
24 x 33	EVSBH24338NFT	Clear	8 Mic	1000/cs	Flat

30" x 37", 20–30-Gal. Capacity

30 x 37	EVSBH30378N	Clear	8 Mic	500/cs	Roll
30 x 37	EVSBH303710N	Clear	10 Mic	500/cs	Roll
30 x 37	EVSBH303710NF	Clear	10 Mic	500/cs	Flat
30 x 37	EVSBH303712N	Clear	12 Mic	500/cs	Roll
30 x 37	EVSBH303712NF	Clear	12 Mic	500/cs	Flat
30 x 37	EVSBH303714BK	Black	14 Mic	500/cs	Roll
30 x 37	EVSBH303716N	Clear	16 Mic	500/cs	Roll
30 x 37	EVSBH303716NF	Clear	16 Mic	500/cs	Flat

33" x 40", 33-Gal. Capacity

33 x 40	EVSBH334010N	Clear	10 Mic	500/cs	Roll
33 x 40	EVSBH334012N	Clear	12 Mic	500/cs	Roll
33 x 40	EVSBH334012NF	Clear	12 Mic	500/cs	Flat
33 x 40	EVSBH334016N	Clear	16 Mic	250/cs	Roll
33 x 40	EVSBH334016NF	Clear	16 Mic	250/cs	Flat

40" x 48", 40-45-Gal. Capacity

40 x 48	EVSBH404813N	Clear	13 Mic	250/cs	Roll
40 x 48	EVSBH404813NF	Clear	13 Mic	250/cs	Flat
40 x 48	EVSBH404816N	Clear	16 Mic	250/cs	Roll
40 x 48	EVSBH404816NF	Clear	16 Mic	250/cs	Flat
40 x 48	EVSBH404822N	Clear	22 Mic	150/cs	Roll
40 x 48	EVSBH404822NF	Clear	22 Mic	150/cs	Flat

43" x 48", 56-Gal. Capacity

43 x 48	EVSBH434817N	Clear	17 Mic	200/cs	Roll
---------	--------------	-------	--------	--------	------



EVSBL404613RP

Blend Right Bag Biohazard Liners

24" x 24", 7-10-Gal. Capacity

Size	Item No.	Color	Thickness	Pkg.	Style
24 x 24	EVSBL242412RP	Red	1.2 Mil	500/cs	Roll

40" x 46", 40-45-Gal. Capacity

40 x 46	EVSBL404613RP	Red	1.3 Mil	200/cs	Roll
40 x 46	EVSBL40462RPF	Red	2 Mil	100/cs	Flat
40 x 46	EVSBL40462RP	Red	2 Mil	100/cs	Roll
40 x 46	EVSBL40463RP	Red	3 Mil	75/cs	Roll
40 x 46	EVSBL40463RPF	Red	3 Mil	75/cs	Flat



EVSBH304314BP

Blend Right Bag Soiled Linen Liners

Size	Item No.	Color	Thickness	Pkg.	Style
30 x 43	EVSBL304313BP	Blue	1.3 Mil	200/cs	Roll
30 x 43	EVSBH304314BP	Blue	14 Mic	250/cs	Roll
37 x 50	EVSBL375013BP	Blue	1.3 Mil	150/cs	Roll
40 x 48	EVSBH404818BP	Blue	18 Mic	200/cs	Roll

Soiled Linen Liners

Soiled Linen Liners

- Printed with "Soiled Linen" in English and Spanish
- Low-density bags available in multiple sizes, thicknesses and colors to suit your needs



NON023143

29" x 33", 30-Gal. Capacity

Size	Item No.	Color	Thickness	Pkg.	Style
29 x 33	IRDPL33C	Pink	1 Mil	240/cs	Roll

29" x 38", 32-Gal. Capacity

29 x 38	IRDBL38C	Blue	1 Mil	240/cs	Roll
---------	----------	------	-------	--------	------

29" x 43", 32-Gal. Capacity

29 x 43	EVSAGGRN	Mint Green	1 Mil	200/cs	Roll
29 x 43	EVSAGBLUE	Blue	1 Mil	200/cs	Roll
29 x 43	NON023143P	Purple	1.1 Mil	200/cs	Roll
29 x 43	NON294311MG	Mint Green	1.1 Mil	200/cs	Roll
29 x 43	NON023143	Blue	1.1 Mil	200/cs	Roll
29 x 43	NON294311MG	Mint Green	1.1 Mil	200/cs	Roll
29 x 43	NON202943B	Blue	2 Mil	100/cs	Roll

29" x 45", 32-Gal. Capacity

29 X 45	IRDPL45C	Pink	1 Mil	240/cs	Roll
29 X 45	IRDWL45C	White	1 Mil	240/cs	Roll
29 X 45	IRDBL45C	Blue	1 Mil	240/cs	Roll
29 X 45	IRDPR45C	Purple	1 Mil	240/cs	Roll
29 X 45	IRDOR45C	Orange	1 Mil	240/cs	Roll

30" x 33", 32-Gal. Capacity

30 x 33	NON303214W	White	1.4 Mil	250/cs	Roll
---------	------------	-------	---------	--------	------

40" x 45", 40-45-Gal. Capacity

40 x 45	IRDBL46C	Blue	1 Mil	100/cs	Roll
40 x 45	WW4045IJ	White	1.1 Mil	100/cs	Roll

38" x 58", 55-Gal. Capacity

38 x 58	NON02221658	Blue	1.5 Mil	100/cs	Flat
---------	-------------	------	---------	--------	------

Drawtape Soiled Linen Liners

29" x 38", 30-Gal. Capacity

29 x 38	LB2938C	Blue	0.9 Mil	150/cs	Roll
29 x 38	LW2938D	White	1.1 Mil	150/cs	Roll
29 x 38	LB2938D	Blue	1.1 Mil	150/cs	Roll
29 x 38	LG2938D	Mint Green	1.2 Mil	200/cs	Roll
29 x 38	LB2938SP	Blue	1.5 Mil	150/cs	Roll
29 x 38	LB2938E	Blue	1.5 Mil	150/cs	Roll

30" x 33", 32-Gal. Capacity

Size	Item No.	Color	Thickness	Pkg.	Style
30 x 33	LW2933C	White	0.9 Mil	150/cs	Roll
30 x 33	LB2933C	Blue	0.9 Mil	150/cs	Roll

29" x 41", 32-Gal. Capacity

29 x 41	EVSAGBD2901	Blue	1 Mil	200/cs	Roll
29 x 41	NON022939WH	White	1.1 Mil	200/cs	Roll
29 x 41	EVSAGBD2915	Blue	1.5 Mil	150/cs	Roll
29 x 41	EVSAGGD2902	Green	2 Mil	100/cs	Roll
29 x 41	EVSAGWD2902	White	2 Mil	100/cs	Roll
29 x 41	EVSAGBD2902	Blue	2 Mil	100/cs	Roll
29 x 41	NON022270C	Clear	3 Mil	100/cs	Roll

Peerless Soiled Linen Liners

- Made with prime virgin resin—the highest quality material in the industry
- Designed to hold manageable loads effectively
- Fits carts/hampers perfectly and great for laundry chutes
- Superior strength, yet tear open easily for sorting with no need for heavy overhead lifting—sorting can be done very quickly and efficiently



RDBL43A

25" x 43", 30-Gal. Capacity

Size	Item No.	Color	Thickness	Pkg.	Style
25 x 43	RDB2543B	Light Blue	0.9 Mil	250/cs	Roll

29" x 33", 30-Gal. Capacity

29 x 33	RDWL33B	White	0.79 Mil	240/cs	Roll
29 x 33	RDBL33B	Blue	0.79 Mil	240/cs	Roll

29" x 38", 32-Gal. Capacity

29 x 38	RDBL38A	Light Blue	0.54 Mil	240/cs	Roll
29 x 38	RDYL38B	Yellow	0.79 Mil	240/cs	Roll
29 x 38	RDWL38B	White	0.79 Mil	240/cs	Roll
29 x 38	RDPR38B	Lavender	0.79 Mil	240/cs	Roll
29 x 38	RDPL38B	Pink	0.79 Mil	240/cs	Roll
29 x 38	RDGL38B	Mint Green	0.79 Mil	240/cs	Roll
29 x 38	RDDG38B	Dark Green	0.79 Mil	240/cs	Roll
29 x 38	RDBL38B	Light Blue	0.79 Mil	240/cs	Roll
29 x 38	RDBL38BPC	Light Blue	0.79 Mil	240/cs	Roll
29 x 38	RDBL38C1	Blue	0.9 Mil	240/cs	Roll

29" x 43", 32-Gal. Capacity

29 x 43	RDPL43A	Purple	0.55 Mil	240/cs	Roll
29 x 43	RDGL43A	Mint Green	0.55 Mil	240/cs	Roll
29 x 43	RDDG43A	Dark Green	0.55 Mil	240/cs	Roll
29 x 43	Rddb43A	Dark Blue	0.55 Mil	240/cs	Roll
29 x 43	RDBL43A	Light Blue	0.55 Mil	240/cs	Roll
29 x 43	RDYL43B	Yellow	0.79 Mil	240/cs	Roll
29 x 43	RDWL43B	White	0.79 Mil	240/cs	Roll
29 x 43	Rddb43B	Dark Blue	0.79 Mil	240/cs	Roll
29 x 43	RDBL43B	Light Blue	0.79 Mil	240/cs	Roll
29 x 43	RDBL43BPC	Light Blue	0.79 Mil	240/cs	Roll
29 x 43	RDCL43B	Clear	0.79 Mil	240/cs	Roll
29 x 43	RRDBL45C	Light Blue	0.9 Mil	240/cs	Roll

40" x 45-47", 40-45-Gal. Capacity

40 x 45	RDYL45C	Yellow	0.9 Mil	100/cs	Roll
40 x 47	RDGL47	Mint Green	0.9 Mil	150/cs	Roll

Protective Equipment Bags



Laundry Cart Covers

Size	Item No.	Color	Thickness	Pkg.	Style
50 x 28 x 71	IC7878LM	Clear	0.5 Mil	150/cs	Roll
54 x 28.5 x 74	EVSA54285746C	Clear	0.6 Mil	450/cs	Roll
40 x 32 x 72	EVSA4032726C	Clear	0.6 Mil	450/cs	Roll
20 x 13 x 40	EVSA2013406C	Clear	0.6 Mil	450/cs	Roll
68 x 31 x 107	EVSCRTLNR180C	Clear	0.65 Mil	200/cs	Roll
62 x 26 x 73	EVSCRTLNR170C	Clear	0.65 Mil	200/cs	Roll
23 x 21 x 42	EVSBAG232142	Red	0.7 Mil	250/cs	Flat
50 x 30 x 48	EVSBAG503048	Red	0.7 Mil	100/cs	Roll
55 x 30 x 70	NON0222992	Clear	0.8 Mil	100/cs	Roll
45 x 27 x 48	NON022291	Clear	0.8 Mil	100/cs	Roll
60 x 30 x 75	NON022290	Clear	0.8 Mil	160/cs	Roll
62.5 x 24 x 69	EVSA6224698B	Blue	0.8 Mil	100/cs	Roll
38 x 36 x 48	NON0222991	Clear	0.9 Mil	50/cs	Roll
29 x 23 x 65	C5265E	Clear	1.25 Mil	100/cs	Flat
42 x 24 x 68	NON4224683	Clear	3 Mil	60/cs	Roll



EVSIVBAG1

IV Pole/Garment Bags

Size	Item No.	Color	Thickness	Pkg.	Style
21 x 15 x 64	EVSIVBAG1	Clear	0.75 Mil	160/cs	Roll
29 x 54	EVSGARMENT1	Clear	14 Mic	500/cs	Roll

Bed Bag Covers

Size	Item No.	Color	Thickness	Pkg.	Style
36.5 x 144	EVSBBC365144B	Blue	0.7 Mil	100/cs	Roll
36 x 145	NON14536	Blue	0.75 Mil	150/cs	Roll



NON14536

Hampers

Soiled linen carts

- Hands-free lid opens easily with a foot pedal and shuts automatically to seal in odors
- Bags lock easily into place with no-slip friction bar; rolled bags store easily in Wallaby™ pouch or basket on the back of the hamper
- Open-frame design helps reduce heavy upward lifting
- Non-marking casters won't mark floors

29" x 43"—Assembled

Item No.	Description	Pkg.
CX102	Cart with Wallaby, soiled linen lid, large	1 ea
CX9	ContinuCart with soiled linen lid, large	1 ea

29" x 38"

Item No.	Description	Pkg.
CX302	Cart with Wallaby, soiled linen lid, medium	1 ea
CX402	Cart with Wallaby, soiled linen lid, medium, tall base	1 ea
CX7	ContinuCart with soiled linen lid, medium	1 ea

29" x 33"

Item No.	Description	Pkg.
CX502	Cart with Wallaby, soiled linen lid, small	1ea
MDS80530KD	Cart with Wallaby, large, triangle, quiet closing, metal lid	1 ea

29" x 43"—Unassembled

Item No.	Description	Pkg.
MDS80529	Cart with Wallaby, plain lid, large, metal painted lid	1 ea
MDS802525	Cart, large, no lid, x-frame	1 ea
MDS8057455	Cart, large, no lid, round	1 ea



CX102



CX302



CX402



CX502



CX7



CX9

Trash cans and decals



EVSTCSTEP8RD



EVSTCSTP12WH



EVSTCSTEP23BE



BRW45296

Plastic step-on trash cans

- Plastic trash cans with foot-operated pedal for hands-free disposal
- Unique "key-way" notch holds standard size liners

8-Gal.

Item No.	Dimensions	Color	Pkg.
CCJ8BE	16"L x 15"W x 17"H	Beige	1 ea
CCJ8WH	16"L x 15"W x 17"H	White	1 ea
CCJ8RD	16"L x 15"W x 17"H	Red	1 ea

12-Gal.

CCJ12BE	16.25"L x 15.75"W x 23.75"H	Beige	1 ea
CCJ12WH	16.25"L x 15.75"W x 23.75"H	White	1 ea
CCJ12RD	16.25"L x 15.75"W x 23.75"H	Red	1 ea

18-Gal.

CCJ18BE	19"L x 16" W x 25"H	Beige	1 ea
CCJ18WH	19"L x 16" W x 25"H	White	1 ea
CCJ18RD	19"L x 16" W x 25"H	Red	1 ea

23-Gal.

CCJ23BE	16.25"L x 15.75"W x 23.75"H	Beige	1 ea
CCJ23WH	16.25"L x 15.75"W x 23.75"H	White	1 ea
CCJ23RD	16.25"L x 15.75"W x 23.75"H	Red	1 ea

Round metal step-on cans

Item No.	Size	Color	Pkg.
BRW45267	32-qt	Red	1 ea
BRW45266	32-qt	White	1 ea
BRW45268	32-qt	Beige	1 ea
BRW45296	32-qt	Steel	1 ea

Square/rectangle metal step-on cans

Item No.	Size	Color	Pkg.
BRW35270	20-qt	Red	1 ea
BRW35269	20-qt	White	1 ea
BRW35271	20-qt	Beige	1 ea
MPHP24R	24-qt	Red	1 ea
DETC24SS	24-qt	Steel	1 ea
BRW35267	32-qt	Red	1 ea
DETP32	32-qt	White	1 ea
DETP32	32-qt	Beige	1 ea
UME1474SS	32-qt	Steel	1 ea
MPHP48R	48-qt	Red	1 ea
MPHP48	48-qt	White	1 ea
UMESS1475	48-qt	Steel	1 ea
BRW25267	52-qt	Red	1 ea
BRW25266	52-qt	White	1 ea
BRW25268	52-qt	Beige	1 ea

Fire-rated desk side cans

- For use in patient rooms, nurses stations and other small areas
- Thermoset material with fiberglass reinforcement that rarely burn or melt

8-qt.

Item No.	Dimensions	Color	Pkg.
MABMB8	8.5"L x 6.375"W x 10.75"H	Beige/Sand	6/cs
MABMB8BLK	8.5"L x 6.375"W x 10.75"H	Black	6/cs
MABMB8B	8.5"L x 6.375"W x 10.75"H	Brown	6/cs

14-qt.

EVSTCFR14SND	16.25"L x 15.75"W x 23.75"H	Beige/Sand	1 ea
EVSTCFR14BLK	16.25"L x 15.75"W x 23.75"H	Black	1 ea
EVSTCFR14BRN	16.25"L x 15.75"W x 23.75"H	Brown	1 ea

27-qt.

EVSTCFR27SND	16"L x 8.5"W x 14"H	Beige/Sand	1 ea
EVSTCFR27BLK	16"L x 8.5"W x 14"H	Black	1 ea
EVSTCFR27BRN	16"L x 8.5"W x 14"H	Brown	1 ea

40-qt.

EVSTCFR40SND	15.5"L x 11.625"W x 20.375"H	Sand	1 ea
EVSTCFR40BLK	15.5"L x 11.625"W x 20.375"H	Black	1 ea

23-gallon thin bins

- Heavy-duty polymer for strength and rigidity
- Won't rust or chip; resistant to denting and bending
- Handles feature bag cinches for easy bag management without tying knots
- Holds can down during liner removal
- Extra-large air channels allow for effortless liner removal

Item No.	Dimensions	Color	Pkg.
EVSTCTHIN23BE	15.75"W x 15.75"L x 17.5"H	Beige	1 ea
EVSTCTHIN23BK	15.75"W x 15.75"L x 17.5"H	Black	1 ea
EVSTCTHIN23BL	15.75"W x 15.75"L x 17.5"H	Recycle Blue	1 ea

Outdoor trash cans

Item No.	Capacity	Shape	Color	Pkg.
SRWRMCC3501J	35-gal.	Square	Black Resin	1 ea
SRWMTCSQ300	30-gal.	Square	Black Metal	1 ea

Decals

- Bilingual in English and Spanish.

Item No.	Description	Dimensions	Color	Pkg.
EVS173901	Rejected linen	4" x 10"	Green	1 ea
EVS173900	Soiled linen	4" x 10"	Blue	1 ea



EVSTCFR40BLK,
EVSTCFR40SND



EVSTCTHIN23BK



Beige (BE)



Black (BK)



Recycle Blue (BL)



SRWRMCC3501J



EVSTC20GRA



White (WHI)



Gray (GRA)



Blue (BLU)



Red (RED)



Yellow (YEL)

Large round trash containers

- Round trash container, lid, and dolly
- One-piece, molded construction made with the highest-quality polyethylene resin for high-impact and crush resistance
- With lid locked, container is spill resistant—even when tipped over
- Offset ridge design allows container to nest without jamming

10-gal.

Item No.	Dimensions	Color	Pkg.
EVSTCRD10WHI	15.75"W x 15.75"L x 17.5"H	White	1 ea
EVSTCRD10GRA	15.75"W x 15.75"L x 17.5"H	Gray	1 ea

20-gal.

EVSTC20WHI	19.5"W x 19.5"L x 22.5"H	White	1 ea
EVSTC20GRA	19.5"W x 19.5"L x 22.5"H	Gray	1 ea

32-gal.

EVSTCRD32WHI	22"W x 22"L x 27"H	White	1 ea
EVSTCRD32GRA	22"W x 22"L x 27"H	Gray	1 ea
EVSTCRD32BLU	22"W x 22"L x 27"H	Blue	1 ea
EVSTCRD32RED	22"W x 22"L x 27"H	Red	1 ea
EVSTCRD32YEL	22"W x 22"L x 27"H	Yellow	1 ea

44-gal.

EVSTCRD44WHI	24"W x 24"L x 31"H	White	1 ea
EVSTCRD44GRA	24"W x 24"L x 31"H	Gray	1 ea

55-gal.

EVSTCRD55GRA	26.5"W x 26.5"L x 33"H	Gray	1 ea
--------------	------------------------	------	------



EVSTC7705

Dolly

- Round dolly holds up to 55-gallon cans

Item No.	Description	Capacity	Color	Pkg.
EVSTC7704	Dolly	Up to 55-gal. cans	Black	2/cs
EVSTC7705	Trash dolly with quiet casters	Up to 55-gal. cans	Black	2/cs



TOTMWC3200RED

2-wheel carts

Item No.	Capacity	Color	Pkg.
TOTWC3260594	32-gal	Grey	1 ea
TOTWC3257311	32-gal	Blue	1 ea
TOTWC3255410	32-gal	Green	1 ea
TOTWC3211289	32 gal	Yellow	1 ea
TOTWC3210767	32-gal	Black	1 ea
TOTWC4800GST	48-gal	Grey	1 ea
TOTWC4855399	48-gal	Blue	1 ea
TOTWC4851406	48-gal	Green	1 ea
TOTWC4811117	48-gal	Yellow	1 ea
TOTWC4856599	48-gal	Black	1 ea
TOTWC6410827	64-gal	Grey	1 ea
TOTWC6400BLU	64-gal	Blue	1 ea
TOTWC6457359	64-gal	Green	1 ea
TOTWC6444428	64-gal	Yellow	1 ea
TOTWC6410548	64-gal	Black	1 ea
TOTWC9610599	96-gal	Grey	1 ea
TOTWC9657430	96-gal	Blue	1 ea
TOTWC9654342	96-gal	Green	1 ea
TOTWC9610056	96-gal	Yellow	1 ea
TOTWC9600BKS	96-gal	Black	1 ea

4-wheel carts

Item No.	Capacity	Color	Pkg.
TOTACC9654386	96-gal	Blue	1 ea
TOTACC9654793	96-gal	Green	1 ea

Medical waste containers

Item No.	Capacity	Color	Pkg.
TOTMWC3200RED	32-gal	Red	1 ea
TOTMWC6401RED	64-gal	Red	1 ea
TOTMWC9600RED	96-gal	Red	1 ea

PPE carts

Item No.	Capacity	Color	Pkg.
TOTPPECC64	32-gal	Black	1 ea
TOTPPECC32	64-gal	Black	1 ea
TOTPPECC96	96-gal	Black	1 ea

Cleaning tools and cart necessities





EVS2600



EVSTOOL300F



EVSTOOL333



EVS2601H

Lobby dust pan

- Rubber blade on the pan head provides good floor contact
- Pan head swivels up when carrying
- Made of high-impact plastic

Item No.	Description	Pkg.
EVS2600	Lobby dust pan	1 ea

Angled broom

- Angled and flagged synthetic bristles
- Sweeps fine particles as well as fine debris
- Smooth plastic fibers that are washable, durable and water resistant

Item No.	Description	Pkg.
EVSTOOL300F	Angled broom with wood handle	1 ea

Hand dust pan

- Heavy duty
- Molded ridges for broom and counter brush cleaning
- Fine line edge for maximum pick-up

Item No.	Description	Pkg.
EVSTOOL333	Hand dust pan 12", Black	12/cs

Lobby dust broom

- Stiff bristles will resist breakage or shedding
- Plastic bristles
- Angled, frayed, bristle construction
- Water resistant
- Hang-up hole on top of handle

Item No.	Description	Pkg.
EVS2601	Lobby dust broom	12/cs
EVS2601H	Lobby dust broom	1 ea



MPHMCPA20300S



VACPCS2



EVS9152H



EVST00L901

Squeegee sweeper

- A disposable bag collection system, including a squeegee, dust pan and disposable bag
- Easy to clean without transferring dust into the air or other surfaces
- Does not require special bag; can be used with existing liners
- An easy way to clean up messes

Item No.	Description	Pkg.
MPHMCPA20300S	Squeegee sweeper, next gen, Blue	6/cs
MPHMCPA20300C	Squeegee sweeper, next gen, Blue	12/cs

Battery-operated carpet sweeper

- Lightweight, compact, 4.6-lb. sweeper
- Powered by a rechargeable battery, providing approximately 50 cleanings/charge
- Bagless, easy-empty, large-capacity dust pan
- Lays flat to clean under beds and furniture
- Ergonomic top grip and telescoping handle

Item No.	Description	Pkg.
VACPCS2	Battery operated carpet sweeper	1 ea

"CAUTION Wet Floor" signs

- Highly visible
- Secures areas needing to be marked off
- Impact resistant
- Folds flat for space-saving storage
- Ridges on feet to minimize contact with floors

Item No.	Description	Color	Pkg.
EVS9152H	10.75" L x 1" W x 24.63" H	Yellow	1 ea
EVS9152	10.75" L x 1" W x 24.63" H	Yellow	6/cs

Pop-out safety cones

- Yellow-and-black safety cone helps secure areas that need to be marked off
- Features a symbol for wet floor and trilingual message on each of the three sides to help ensure readability
- Plastic storage tube allows multiple mounting options; hardware included
- Cone measures 18-3/4" W x 18-3/4" D x 31" H

Item No.	Description	Pkg.
EVST00L901	Pop-out cone, 31"	1 ea
EVST00L902	Pop-out cone, 20"	1 ea

Cling and clean dust sheets

- Disposable 2-sided sheets help double your cleaning power

Item No.	Description	Pkg.
EVSTOOL423	5" x 6", 60 sheets per roll	1 ea
EVSTOOL420	8" x 6", 250 sheets per roll	1/cs



EVSTOOL423

Plastic bottle

- For mixing and dispensing concentrated cleaning products
- Graduated for convenient measuring
- Sprayer sold separately

Item No.	Description	Pkg.
EVS4932H	Plastic bottle, 32-oz.	1 ea
EVS4900H	Trigger sprayer	1 ea
EVSCHEM010	Flip top cap	1 ea



EVS4932H



EVS4900H

Bottles with trigger sprayer

- For mixing and dispensing concentrated cleaning products
- Graduated for convenient measuring

Item No.	Description	Pkg.
EVS5024WG	Bottle and trigger, 24-oz.	6/cs
EVS5016	Bottle and trigger, 16-oz.	6/cs



EVS5024WG

Pump

- Fits standard gallon
- Internal restriction clips available
- Used in food and and disinfectant applications

Item No.	Description	Pkg.
EVSTOOL480	Gallon bottle pump	24/cs
EVS90450	Restriction clip 0.5 oz	1 ea



EVSTOOL480

Traditional duster

- Lambswool dusters quickly and easily lift fine dust particles without harming surfaces
- When they become heavily soiled, these dusters may be washed out and conveniently hung to dry by a hole in the handle
- Handle extends from 38"-50"

Item No.	Description	Pkg.
EVSTOOL470	Lambswool duster, with expendable handle	1 ea



EVSTOOL470



EVSTOOL471

Polywool duster

- Made of nonallergenic materials and is fully washable
- Metal handle is coated with plastic

Item No.	Description	Pkg.
EVSTOOL471	Polywool duster, 23" L	12/cs



EVSTOOL474

Duster kit with disposable pads

- Wand rotates 270° and locks into place
- Telescoping extension handle 24"-30"

Item No.	Description	Pkg.
EVSTOOL474	Duster kit with disposable pads	12/cs
EVSTOOL475	Duster pad refills	24/cs



EVSTOOL111F



EVSTOOL121P

Fiberglass handle

- Extra-durable jaws head

Item No.	Description	Pkg.
EVSTOOL111F	Mop handle jaw 1" x 60"	1 ea

Traditional quick change wet mop handle

- Polypropylene-molded head for corrosion resistance

Item No.	Description	Pkg.
EVSTOOL121P	Mop handle quick change 1" x 60"	1 ea



EVSTOOL101W

Threaded broom handle

- Made with hard wood
- Wood thread at the end of handle with standard threads
- Fits multiple broom products

Item No.	Description	Pkg.
EVSTOOL101W	Threaded wood 60" broom handle	1 ea

Putty knife

- Comfortable polypropylene handle
- Stainless steel blade

Item No.	Description	Color	Pkg.
EVSTOOL490	1.25" Wide, 8" Length	Black	12/pk



EVSTOOL490

Floor scrapers

- Ideal for removing gum, tape and wax buildup
- Reversible, tempered, 4" steel blade has a blunt edge and a razor edge
- Includes blade cover for safe transport and storage

Item No.	Description	Pkg.
EVSTOOL141	Scraper, long handle, 48"	1 ea
EVSTOOL142	Handheld scraper, 12"	1 ea
EVSTOOL143	Replacement blades	60/cs



EVSTOOL141



EVSTOOL142

Mop buckets with wringer

- High-density polypropylene
- 3" non-marking swivel casters and protective bumpers
- Yellow with "Caution" printed on sides
- Wringer features a corrosion-resistant handle and accommodates 12-oz. to 32-oz. mops
- 35-qt. capacity

Item No.	Description	Pkg.
EVSTOOL463	Bucket with down wringer	1 ea
EVSTOOL464	Bucket with side wringer	1 ea



EVSTOOL464

Metal squeeze wringer metal mop bucket

- Wringers feature two-piece tubular steel handle and solid .625" square steel shaft
- Graduations are permanent and embossed for 1 easy measuring
- 2" casters for 1 easy movement

Item No.	Description	Pkg.
EVSTOOL465	Galvanized metal with wringer	1 ea



EVSTOOL465



EVSTOOL431



EVSTOOL432



EVSHPAD4



EVSHPAD32BRCS



EVSHPAD31BCS



EVSHPAD11GCS



EVSHPAD10WCS



EVSHPAD22GCS



EVSHPAD21GCS



EV57150

Tile and grout brush

- Plastic-handled grout brush with nylon bristles
- Handle features hole on top for hanging

Item No.	Description	Pkg.
EVSTOOL431	Tile and grout nylon brush	1 ea

PolyPro scrub brush

- 1.125"L bristles can get down into tough areas
- Large cleaning surface helps to shorten time spent cleaning
- Measures 6.25"L

Item No.	Description	Pkg.
EVSTOOL432	Brush scrub iron handle PolyPro Blue, 6"	6/cs

Hand pads

- Made of polyester fibers in an open-textured, nonwoven pattern
- Abrasive particles are dispersed throughout and bonded to the nonwoven construction with a durable adhesive
- Designed for cleaning of floors, baseboards and corners

Item No.	Description	Pkg.
EVSHPAD32BRCS	Heavy-duty utility pad, Brown	20/cs
EVSHPAD31BCS	Medium-duty utility pad, Blue	20/cs
EVSHPAD11GCS	Medium-duty scrubbing sponge, Green	20/cs
EVSHPAD10WCS	Light-duty scrubbing sponge, White	20/cs
EVSHPAD22GCS	Heavy-duty scouring pad, Green	60/cs
EVSHPAD21GCS	Medium-duty scouring pad, Green	60/cs
EVSHPAD4	Handblock pad holder	1 ea

Amazing sponge

- Be prepared to be "wowed" by this extra powerful sponge
- Fits comfortably in hand
- Melamine cleaning surface on both sides
- Yellow gripping in middle prolongs use and improves performance
- Larger surface area for extended durability

Item No.	Description	Pkg.
EV57150	Amazing sponge	30/cs

Toilet bowl cleaning

Mops and brushes

- Mop features a strong 12" plastic handle and 4" strands of acid-resistant polypropylene
- Cylindrical bowl brush has 11" plastic handle with cylindrical staple fibers to prevent scratching surfaces
- Toilet plunger has a large cup for maximum pressure and a 21", heavy-duty wooden handle

Item No.	Description	Pkg.
EVS204	Toilet bowl mop	100/cs
EVS204H	Toilet bowl mop	1 ea
EVSTOOL412	Toilet bowl brush	1 ea
EVSTOOL450	Toilet plunger	1 ea
EVSTOOLPUM	Pumice scouring stick	12/cs

EVSTOOL412

EVSTOOL450

EVS204H

Caddies

- White plastic caddy conveniently holds toilet bowl mop and cleaner
- Handy cleaning basket fits most carts
- Features a handle, three molded compartments for carrying supplies and two small-item trays

Item No.	Description	Pkg.
EVS18801	Toilet bowl caddy	12/cs
EVSTOOL440	Maids caddy	1 ea

EVS18801

EVSTOOL440

Scented urinal screens

- Screen EVSTOOL501 has tapered drain holes to help prevent splash-back; measures 8" L x 8" and is designed to fit most urinals
- Screen EVSTOOL502 has a strong sudsing action to help assure sanitation; built-in hook for easy removal; measures 6-3/4" L x 6-3/4" W
- Both are cherry scented

Item No.	Description	Pkg.
EVSTOOL501	Deluxe urinal screen, red/cherry	50/cs
EVSTOOL502	Urinal screen block, cherry	12/cs

EVSTOOL501

EVSTOOL502

**Floor
care**



SuperScrape™ mat

- **Clean**—Surface cleats effectively remove and trap dirt and sand below shoe level to prevent tracking
- **Safe**—Slip-resistant even in wet environments; certified high-traction by the National Floor Safety Institute (NFSI)
- **Durable**—Grease/oil proof; chemical resistant
- **Easy to clean**—Lightweight flexible design ensures easy handling and cleaning (shake off soil and hose off)

Item No.	Dimensions	Pkg.
MAC5553X5	3' x 5'	1 ea
MAC5554X6	4' x 6'	1 ea
MAC5556X8	6' x 8'	1 ea

Additional sizes and colors available



MAC5553X5

WaterHog® diamond mat

- **Clean & dry**—Bi-level surface effectively scrapes dirt and moisture from shoes, trapping it beneath shoe level to prevent tracking; water dam border holds moisture keeping it off your floors (WaterHog mats can hold up to 1.5 gallons of water per square yard)
- **Durable**—Reinforced rubber nubs prevent pile from crushing & extend the performance life of the mat
- **Fade & stain resistant**—Solution-dyed, eco-friendly PET fabric is resistant to staining, dries quickly, and will not fade or rot
- **Safe**—Beveled edges provide a safe transition from floor to mat; certified high-traction by the NFSI

Item No.	Dimensions	Color	Pkg.
MAC2083x5CH	3' x 5'	Charcoal	1 ea
MAC2083x10CH	3' x 10'	Charcoal	1 ea
MAC2084x6CH	4' x 6'	Charcoal	1 ea



MAC2083x10CH



MAC1203x5BLA

MicroLuxx™ mat

- **Superior moisture & dust control**—Unique "microfiber" blend absorbs and retains 2.5 times more moisture and dust than standard carpeted mats
- **Resilient**—High-twist, heat-set nylon resists crushing to better trap dirt and extend the useful life of the mat
- **Fade resistant**—Solution-dyed nylon is resistant to fading and impervious to bleach
- **Safe**—Certified high-traction by the National Floor Safety Institute (NFSI)

Item No.	Dimensions	Color	Pkg.
MAC1203x5BLA	3' x 5'	Black	1 ea
MAC1203x10BLA	3' x 10'	Black	1 ea
MAC1204x6BLA	4' x 6'	Black	1 ea



EVSPM183634W

Sticky mats

- Multi-layered, adhesive-coated mat
- Removes and traps unwanted dirt, dust and debris from foot traffic and wheels
- Made of low-density polyethylene
- 30 mats per pad

Item No.	Dimensions	Color	Pkg.
EVSPM183634B	18" x 36"	Blue	4/cs
EVSPM184534W	18" x 45"	White	4/cs
EVSPM184534B	18" x 45"	Blue	4/cs
EVSPM184534G	18" x 45"	Gray	4/cs
EVSPM243634W	24" x 36"	White	4/cs
EVSPM243634B	24" x 36"	Blue	4/cs
EVSPM243634G	24" x 36"	Gray	4/cs
EVSPM264534W	26" x 45"	White	4/cs
EVSPM264534B	26" x 45"	Blue	4/cs
EVSPM264534G	26" x 45"	Gray	4/cs
EVSPM363634W	36" x 36"	White	4/cs
EVSPM363634B	36" x 36"	Blue	4/cs
EVSPM243034W	24" x 30"	White	1 ea
EVSPFM2531310	25" x 31"	White	1 ea

Happy Feet anti-fatigue mats

- Heavy-duty anti-fatigue mat that features a dense foam cushion encapsulated in nitrile rubber
- Suitable for both wet and dry environments

Item No.	Dimensions	Color	Pkg.
MAC4652x3	2' x 3'	Black	1 ea
MAC46535x	5' x 8'	Black	1 ea

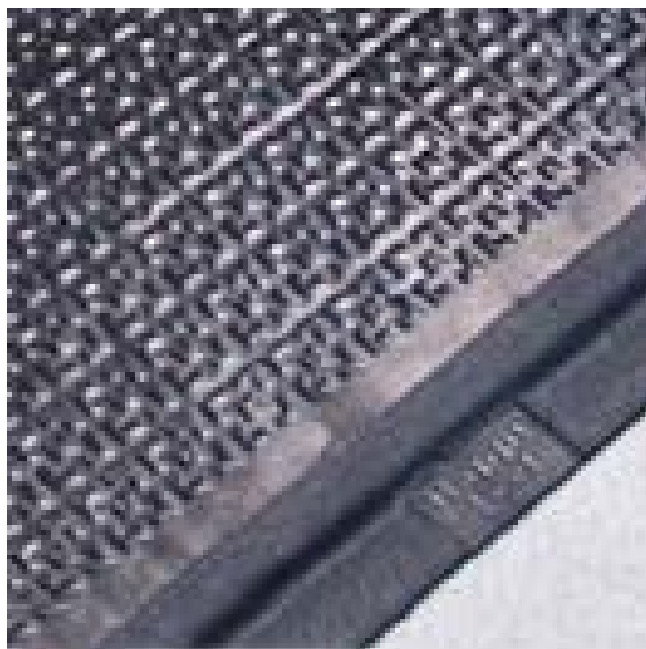

MAC4652x3

Wet Step mats

- **Slip-resistant & safe**—Drainage holes allow water to freely drain away; certified high-traction by the National Floor Safety Institute (NFSI)
- **Comfortable**—.25" thick high-density nitrile rubber foam provides excellent anti-fatigue properties making it very comfortable for bare feet
- **Clean**—Anti-microbially treated to help prevent odors and degradation; can be autoclave sterilized*
- **Durable**—Nitrile rubber foam is UV resistant and provides years of service life

Item No.	Dimensions	Color	Pkg.
MAC7892x3	2' x 3'		1 ea
MAC7893x5	3' x 5'		1 ea
MAC7893x7	3' x 7'		1 ea
MaC7893x10	3' x 10'		1 ea



MAC7893x7

*This product is treated with an antimicrobial agent built in to protect the product. This product does not protect users or others against bacteria, viruses, germs or other disease organisms. This product has been treated to resist bacterial odors.



Blue



Grey



FMT5113X5, Grey, Blue, Black

Superior Marble Tuff anti-fatigue mats

- Attractive, marble-pattern design; durable, smooth, vinyl top is easy to sweep or mop clean
- Dense, closed-cell foam base provides ergonomic support
- Sloped, beveled edges to reduce tripping hazards and allow easy access on and off the mat
- Custom lengths available (2', 3', and 4' widths)
- Available in Gray, Blue or Black

Item No.	Dimensions	Pkg.
FMT5112X3	2' x 3'	1 ea
FMT5113X5	3' x 5'	1 ea



MAC44616900

Stick & stand adhesive mats

- Stick & Stand mats are adhesive backed mats designed to clearly mark floors and provide customers with a safe place to stand while waiting in lines. Will perform up to 3-4 months and then will need to be replaced.

Item No.	Dimensions	Pkg.
MAC44616900	Adhesive/removable	6/cs



MAC8353

Sanitizing mats/step well

- 2'x3' well that holds an abrasive insert for your liquid sanitizer, followed by 3' x 5' carpeted section to help remove any excess moisture from shoes.

Item No.	Dimensions	Pkg.
MAC8353	Black border	1 ea
MAC8351	Red border	1 ea
MAC8352	Yellow border	1 ea
MAC8362349	Replacement well	4/cs

Scuff-free floor savers®

- Stop furniture from damaging your floors
- Reduce the noise level in your facility where chairs and tables are frequently moved to accommodate daily activities
- Minimize maintenance costs by reducing damage and wear to flooring and furniture
- Prolong the appearance of the furniture
- Minimize the chance of furniture tipping over while an individual is seated

Item No.	Description	Dimensions	Color	Pkg.
MPHF141B	Heavy-duty felt pads	2.25" square	Brown	100/cs
MPHFCS2B	Sleeve floor protector	0.63" to 0.75"	Clear	100/cs
MPHFCS3B	Sleeve floor protector	0.88" to 1.06"	Clear	100/cs
MPHFCS4B	Sleeve floor protector	1.12" to 1.25"	Clear	100/cs
MPHFCS5B	Sleeve floor protector	1.5" to 1.63"	Clear	100/cs
MPHFCS6B	Sleeve floor protector	1.63" to 1.75"	Clear	100/cs
MPHFCS7B	Sleeve floor protector	1.88" to 2"	Clear	100/cs
MPHFCS8B	Sleeve floor protector	2" to 2.13"	Clear	100/cs
MPHFCS9B	Sleeve floor protector	2.1" to 2.3"	Clear	100/cs
MPHFCS10B	Sleeve floor protector	2.3" to 2.4"	Clear	100/cs
MPHFFF3B	Form felt floor protector	1" round	Brown	100/cs
MPHFFF5B	Form felt floor protector	1.25" round	Brown	100/cs
MPHFFF7B	Form felt floor protector	1.5" round	Brown	100/cs
MPHFFF8B	Form felt floor protector	2" round	Brown	100/cs
MPHF018020	Chair tip floor protector	0.88" round	Gray	100/cs
MPHF018021	Chair tip floor protector	1" round	Gray	100/cs
MPHF018037	Walker tip floor protector	1.12" round	Black	100/cs
MPHF133B	Slip-on floor protector	1.25" round	Gray	100/cs
MPHF134B	Slip-on floor protector	1.5" round	Gray	100/cs
MPHF135B	Slip-on floor protector	1.25" round	Brown	100/cs
MPHF136B	Slip-on floor protector	1.5" round	Brown	100/cs
MPHF137B	Slip-over floor protector	1.25" round	Gray	100/cs
MPHF138B	Slip-over floor protector	1.5" round	Gray	100/cs
MPHF13224	Slider floor protector	3.5" x 4.5"	Gray	16/cs
MPHF411B	Caster floor protector	0.38" x 1.75"	Gray	100/cs
MPHFWRAPGYLGB	Wraparound floor maintainer	1.8" x 3.1"	Gray	100/cs
MPHF01606424P	Door wedge	2.25" D x 1.25" H x 3" W	Blue	24/cs



MPHF411B



MPHF13224



MPHF133B



MPHFWRAPG4LGB



MPHF411B



MPHFCS5B



MPHF01606424P

Floor safe caster

- **Floor safe**—polyurethane construction reduces risk of scuff marks on most hard floor surfaces
- **Proven quieter**—85% quieter than traditional casters*
- **Promote rest and comfort**—noise reduction may help improve HCAHPS (patient satisfaction) scores
- **Universal fit**—designed to fit most nurse station and office chairs
- **Specifications**—wheel diameter: 3"; stem diameter: 7/16"; stem length: .87"; weight capacity: 200 lbs.



MPHFCASTERS

Item No.	Description	Pkg.
MPHFCASTERS	Healthcare chair casters	5/bx

*Data on file

Floor pads



EVSPBUFF20R

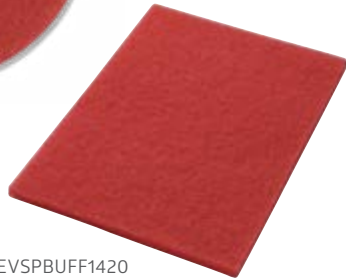

EVSPBUFF1420



EVSPCLEAN20B

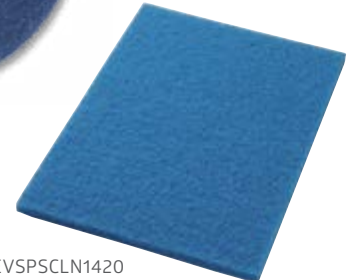

EVSPSCLN1420

Low-speed buffing pads

- For light cleaning and buffing
- Remove light scuff marks and dirt while producing a high-gloss shine
- Machine speed: up to 800 RPM

Item No.	Dimensions	Color	Pkg.
EVSPBUFF11R	11"	Red	5/cs
EVSPBUFF12R	12"	Red	5/cs
EVSPBUFF13R	13"	Red	5/cs
EVSPBUFF14R	14"	Red	5/cs
EVSPBUFF15R	15"	Red	5/cs
EVSPBUFF17R	17"	Red	5/cs
EVSPBUFF18R	18"	Red	5/cs
EVSPBUFF19R	19"	Red	5/cs
EVSPBUFF20R	20"	Red	5/cs
EVSPBUFF21R	21"	Red	5/cs
EVSPSBUFF1420	14" x 20"	Red	5/cs
EVSPBUFF12X18	14" x 28"	Red	5/cs

Low-speed buffing pads

- For routine scrubbing
- Removes dirt and scuff marks from heavily soiled floors prior to recoating
- Machine speed: up to 350 RPM

Item No.	Dimensions	Color	Pkg.
EVSPCLEAN12B	12"	Blue	5/cs
EVSPCLEAN13B	13"	Blue	5/cs
EVSPCLEAN17B	17"	Blue	5/cs
EVSPCLEAN19B	19"	Blue	5/cs
EVSPCLEAN20B	20"	Blue	5/cs
EVSPSCLN1420	14" x 20"	Blue	5/cs
EVSPCLN1428	14" x 28"	Blue	5/cs



EVSPSCRUB20G

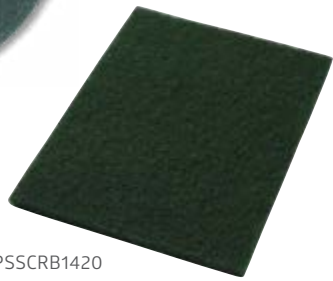

EVSPSSCRB1420



EVSPBURN20A



EVSPBURN20T



EVSPBURN20PK



EVSPBURN20HA

Low-speed scrubbing pads

- For heavy-duty scrubbing or light stripping
- Removes heavy dirt and scuff marks prior to recoating
- Machine speed: up to 350 RPM

Item No.	Dimensions	Color	Pkg.
EVSPSCRUB12G	12"	Green	5/cs
EVSPSCRUB13G	13"	Green	5/cs
EVSPSCRUB17G	17"	Green	5/cs
EVSPSCRUB19G	19"	Green	5/cs
EVSPSCRUB20G	20"	Green	5/cs
EVSPSSCRB1420	14" x 20"	Green	5/cs
EVSPSSCRB1428	14" x 28"	Green	5/cs

High-speed burnishing pads

- UHS burnishing pad blended polyester and natural fibers for an extra high gloss when buffing or burnishing with an ultra-high floor machine
- For use on machines up to 3,000 RPM

Item No.	Dimensions	Color	Pkg.
EVSPBURN12A	12"	Aqua	5/cs
EVSPBURN13A	13"	Aqua	5/cs
EVSPBURN17A	17"	Aqua	5/cs
EVSPBURN19A	19"	Aqua	5/cs
EVSPBURN20A	20"	Aqua	5/cs
EVSPBURN24A	24"	Aqua	5/cs
EVSPBURN27A	27"	Aqua	5/cs

EVSPBURN12T	12"	Tan	5/cs
EVSPBURN13T	13"	Tan	5/cs
EVSPBURN16T	16"	Tan	5/cs
EVSPBURN17T	17"	Tan	5/cs
EVSPBURN19T	19"	Tan	5/cs
EVSPBURN20T	20"	Tan	5/cs
EVSPBURN27T	27"	Tan	5/cs

EVSPBURN18PK	18"	Pink	5/cs
EVSPBURN20PK	20"	Pink	5/cs
EVSPBURN27PK	27"	Pink	5/cs

EVSPBURN12HA	12"	Natural Fiber	5/cs
EVSPBURN13HA	13"	Natural Fiber	5/cs
EVSPBURN16HA	16"	Natural Fiber	5/cs
EVSPBURN17HA	17"	Natural Fiber	5/cs
EVSPBURN19HA	19"	Natural Fiber	5/cs
EVSPBURN20HA	20"	Natural Fiber	5/cs
EVSPBURN24HA	20"	Natural Fiber	5/cs
EVSPBURN27HA	27"	Natural Fiber	5/cs



EVSPHYPRO20M

Low-speed extra heavy-duty aggressive stripping pads

- Designed specifically for the heaviest duty stripping tasks
- This pad is made with extra heavy denier fiber, more abrasive grit, and more open weave to produce the ultimate stripping pad
- Machine speed: up to 350 RPM

Item No.	Dimensions	Color	Pkg.
EVSPHYPRO12M	12"	Maroon	5/cs
EVSPHYPRO13M	13"	Maroon	5/cs
EVSPHYPRO17M	17"	Maroon	5/cs
EVSPHYPRO19M	19"	Maroon	5/cs
EVSPHYPRO20M	20"	Maroon	5/cs



EVSPSTRP20BK



EVSPSSTRP1420

Low-speed stripping pads

- For heavy-duty scrubbing or light stripping
- Removes heavy dirt and scuff marks prior to recoating
- Machine speed: up to 350 RPM

Item No.	Dimensions	Color	Pkg.
EVSPSTRP12BK	12"	Black	5/cs
EVSPSTRP13BK	13"	Black	5/cs
EVSPSTRP14BK	14"	Black	5/cs
EVSPSTRP15BK	15"	Black	5/cs
EVSPSTRP17BK	17"	Black	5/cs
EVSPSTRP18BK	18"	Black	5/cs
EVSPSTRP19BK	19"	Black	5/cs
EVSPSTRP20BK	20"	Black	5/cs
EVSPSSTRP1420	14" x 20"	Black	5/cs
EVSPSSTRP1218	12" x 18"	Black	5/cs
EVSPSSTRP1428	14" x 28"	Black	5/cs

High-speed polishing pads

- Extra-fine pad for polishing clean dry floors
- For buffing soft finishes and low-traffic areas
- Ideal for marble floors
- Machine speed: up to 3,000 RPM

Item No.	Dimensions	Color	Pkg.
EVSPPLSH12W	12"	White	5/cs
EVSPPLSH13W	13"	White	5/cs
EVSPPLSH14W	14"	White	5/cs
EVSPPLSH15W	15"	White	5/cs
EVSPPLSH16W	16"	White	5/cs
EVSPPLSH17W	17"	White	5/cs
EVSPPLSH18W	18"	White	5/cs
EVSPPLSH19W	19"	White	5/cs
EVSPPLSH20W	20"	White	5/cs
EVSPPLSH24W	24"	White	5/cs
EVSPPLSH27W	27"	White	5/cs
EVSPSPLSH1420	14" x 20"	White	5/cs



EVSPPLSH20W



EVSPSPLSH1420

Eco-prep pads

- Designed for wet or dry use for removing floor finish without harsh stripping chemicals
- Excellent for repairing acrylic or urethane finishes for recoating
- Machine speed up to 300 RPM

Item No.	Dimensions	Color	Pkg.
EVSPSFP13M	13"	Maroon	10/cs
EVSPSFP17M	17"	Maroon	10/cs
EVSPSFP19M	19"	Maroon	10/cs
EVSPSFP20M	20"	Maroon	10/cs
EVSPSFP1420	14" x 20"	Maroon	10/cs
EVSPSFP1428	14" x 28"	Maroon	10/cs



EVSPSFP19M

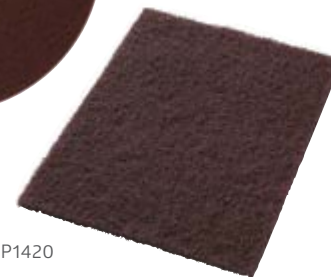

EVSPSFP1420

Diamond floor pads

- Diamond composition designed to clean and polish floors
- Ideal for daily use to maintain a high luster surface
- Use on stone, vinyl, linoleum, smooth concrete, terrazzo and natural stone floors

Item No.	Description	Color	Pkg.
EVSPDIA20G	3000 grit, 20"	Grey	2/cs
EVSPDIA20G15	1500 grit, 20"	Grey	2/cs



EVSPDIA20G

i-Mop®

Extremely mobile

- Maneuvers easily to clean under tables, washroom sinks and other tight spaces
- 360-degree flexibility
- Titanium hinge never wears out
- Lightweight for easy transport
- Easily steers through curves; makes u-turns with the flip of a wrist

Easy to use

- Applies the solution, scrubs the floor and removes soil in one motion
- Cordless—runs on long-lasting, quick-charging lithium-ion batteries

Powerfully effective

- Places over 48 lbs. of brush pressure on the surface
- 350-rpm counter-rotating brushes
- Cleans 1,000 sq. ft. or more in only 4.5 minutes (vs. 35 minutes with a wet mop)
- Dries faster than other methods



EVSIMOPXXLT

i-Mop Turbo

- i-Mop XXL Turbo machine
- Two solution tanks with blue and green caps
- Recovery tank
- Turbo quick charger and set of turbo batteries
- Set of medium brushes, blue; set of heavy-duty brushes, red

Item No.	Description	Pkg.
EVSIMOPXLT	i-Mop XXL Turbo, 18"	1 ea
EVSIMOPXXLT	i-Mop XXL Turbo, 24"	1 ea

i-scrub™ 21

- Manually dose solution with the push of a button
- Adjustable head, 360 degrees of flexibility, cleans in any angle on a horizontal and vertical plane
- 8" dual brush heads for higher mechanical power and grout cleaning
- Ideal for scrubbing base boards, back of toilets, restroom stalls, bath tubs and shower stalls

Item No.	Description	Pkg.
EVSIMSCRUB21	Includes i-scrub unit that converts into hand held unit, battery adapter, belt clip, 1 solution tank	1 ea
EVSIMSCRUBBAT	Extra battery for i-scrub 21	1 ea



EVSIMSCRUB21

i-Mop accessories

Brushes

Soft brushes, Light Blue

- Typically used on natural stone or high-polish floors.

Item No.	Description	Pkg.
EVSIMSB1	For i-mop XL Turbo, 18"	2/cs

Medium brushes, Blue

- Used on 90% of floors, both finished and unfinished.

Item No.	Description	Pkg.
EVSIMMB1	For i-mop XL Turbo, 18"	2/cs
EVSIMMB2	For i-mop XXL Turbo, 24"	2/cs

Heavy-duty brushes, Red

- Typically used on concrete.

Item No.	Description	Pkg.
EVSIMHDB1	For i-mop XL Turbo, 18"	2/cs
EVSIMHDB2	For i-mop XXL Turbo, 24"	2/cs

Floor pads

Floor pads, Red

Item No.	Description	Pkg.
EVSIMFPR1	For i-mop XL Turbo, 18"	10/set, 5 sets/cs
EVSIMFPR2	For i-mop XXL Turbo, 24"	10/set, 5 sets/cs

Floor pads, White

EVSIMFPW1	For i-mop XL Turbo, 18"	10/set, 5 sets/cs
EVSIMFPW2	For i-mop XXL Turbo, 24"	10/set, 5 sets/cs

Floor pads, Blue

EVSIMFPB1	For i-mop XL Turbo, 18"	10/set, 5 sets/cs
EVSIMFPB2	For i-mop XXL Turbo, 24"	10/set, 5 sets/cs

Pad drivers

EVSIMPDM	For i-mop XL Turbo, 18"	2/cs
EVSIMPDM2	For i-mop XXL Turbo, 24"	2/cs

Batteries

Item No.	Description	Pkg.
EVSIMBATTURBO	Set of grey turbo batteries	1 set
EVSIMBATTCH2	Turbo battery charger	1 ea



EVSIMSB1



EVSIMMB1



EVSIMHDB1



EVSIMFPW1



EVSIMFPR1



EVSIMBATTURBO

Scrubbers



KNA11270300

BD 50/50 walk-behind floor scrubbers

- Three cleaning modes make it easy to operate
- Slim design with 20" cleaning path
- 13.2 gallon solution/recovery tanks
- Easy access to batteries

Item No.	Description	Battery Type	Ship Wt.	Dimensions
KNA11270300	20" with pad driver	AGM	306 lbs.	47" x 21" x 39"
KNA11270290	20" with pad driver	Wet	306 lbs.	47" x 21" x 39"



KNA98409010

Chariot 2 iScrub 20" ride-on floor scrubber

- Patented stand-on design is remarkably maneuverable
- Leading the industry with a 360° view of the cleaning area
- Ultra quiet to avoid disturbing others

Item No.	Description	Battery Type	Ship Wt.	Dimensions
KNA98409010	20" disk, pad driver	AGM	615 lbs.	44" x 27.2" x 51.75"



EVSM28SLBP1

Disk Auto Scrubbers, 11-Gal.

- Quiet, with noise levels as low as 60 dBA
- 1-2-3 step training graphics on the control panel
- Automatic brush on/off system helps eliminate kneeling and back strain
- Small and extremely maneuverable for tight spaces and aisles (EVSM24LBP1, EVSM24ABP1 and EVSM24LBSP1 only)
- BatteryShield® stops the machine when battery water is low, and HydroLink® battery watering system optimizes battery life (EVSM20LBSP1 and EVSM24LBSP1 only)

Item No.	Description	Battery Type	Ship Wt.	Dimensions
EVSM20SLBP1	20" Disk, transaxle drive	155ah lead acid	455 lbs.	31" x 50" x 55"
EVSM20ABP1	20" Disk, transaxle drive	140ah agm	455 lbs.	31" x 50" x 55"
EVSM20LBSP1	20" Disk, transaxle drive	155ah lead acid	455 lbs.	31" x 50" x 55"
EVSM24LBP1	24" Disk, transaxle drive	155ah lead acid	480 lbs.	31" x 50" x 55"
EVSM24ABP1	24" Disk, transaxle drive	140ah agm	480 lbs.	31" x 50" x 55"
EVSM24LBSP1	24" Disk, transaxle drive	155ah lead acid	480 lbs.	31" x 50" x 55"

Floor machines

Low speed floor machines

- Functions only when the operator is ready, with safety interlock triggers and upright lock-out
- Quiet, with noise levels less than 58 dBA
- "Safe start" indicator helps keep the operator in control during startup
- Easy handle adjustments from the operator position, with no knobs or awkward levers

Item No.	Description	Ship Wt.	Dimensions
EVSM17LP	17" disk, 175 RPM	98 lbs.	24.5" x 24" x 47"
EVSM20LP	20" disk, 175 RPM	98 lbs.	26" x 21" x 45"



Floor machines, orbital

- Reach-under cleaning on three sides with weights in place
- Quiet, with noise levels as low as 64 dBA
- Easy handle adjustments from the operator position, with no knobs or awkward levers
- Optional HEPA filtration dust control to protect indoor air quality
- Single-cord operation with unique design

Item No.	Description	Ship Wt.	Dimensions
EVSMR20H	20" disk, 3,530 RPM	145 lbs.	21" x 26" x 49"
EVSMR28H	28" disk, 3,530 RPM	170 lbs.	34" x 21" x 50"



Advance orbital floor machines

- Designed to get cleaner floors in fewer passes during wet and dry applications
- Versatile and easy to use
- 1.5 horsepower motor helps get floors clean or stripped quickly

Item No.	Description	Ship Wt.	Dimensions
NIL56105616	Orbital floor machine, 14" x 20", FM810XP	169 lbs.	20" x 20.5" x 44"
NIL56105614	Orbital floor machine, 14" x 20", 3540 rpm	161 lbs.	20" x 20.5" x 44"



Burnishers

Venom VN1500 burnisher

- Burnisher with 1,500 rpm and 20" cleaning path
- Easy to use and maneuver with flexible pad driver and large wheels for easy transporting

Item No.	Description	Ship Wt.	Dimensions
NILVN1500	Viper Burnisher, 1, 500 RPM, 20"	102 lbs.	35" x 20" x 48"



NILVN1500

Commercial burnisher

- Durable burnisher produces brilliant shine
- 2000 RPM with dust control
- Floating handle automatically adjusts to operator height
- Safety interlock and built-in circuit breaker
- 75' power cord

Item No.	Description	Ship Wt.	Dimensions
KNA98414270	Burnisher, BDP 51/2000C, 20	112 lbs.	32" x 24" x 48.5"



KNA98414270

High-RPM cord-electric burnisher, 20"

- 1,500 rpm delivering pad tip speedover 7,850 ft./min., for a reflective finish
- Easy handle adjustments from the operator position, with no knobs or awkward levers
- Functions only when the operator is ready, with safety interlock triggers and upright lock-out
- Unique wraparound cord clamp

Item No.	Description	Ship Wt.	Dimensions
EVSM20H	1,500 RPM	79 lbs.	37" x 21" x 47"



EVSM20H

Air blowers

AB 84 CUL air blower

- Powerful fast-drying radial fan
- Tough plastic housing with handy power-cord storage
- Built-in carpet clip makes drying loosely laid carpets a breeze
- Extra-large wheels for easy transport
- Compact design with foldable handle

Item No.	Description	Pkg.
KNA1004053	AB 84 CUL air blower, 3 speed	1 ea



KNA1004053

3-speed air mover

- 3-speed induction motor with thermal protection for 2400 CFM air flow with minimal energy use
- Quicky dries floors and circulates air

Item No.	Description	Pkg.
NIL50000390	3-speed air mover	1 ea
NILVV78406	Trolley kit	1 ea



NIL50000390

Extractors



KNA9840424

Extractor and interim cleaner duo

- Simply flip a switch and convert from extraction to interim cleaning
- Keep carpets looking great longer with interim cleanings
- Extremely quiet in interim mode, for cleaning in noise-sensitive areas
- Free up space with one machine instead of two

Item No.	Description	Ship Wt.	Dimensions
KNA9840424	Commodore DUO, 36 V/234 Ah AGM batteries		54" x 27" x 43"



KNA10080250

12-gal. 18" carpet extractor

- Mid-size carpet extractor
- Flip handle for push or pull operation to increase extraction productivity

Item No.	Description	Ship Wt.	Dimensions
KNA10080250	Clipper 12-gal. 18" carpet extractor	105 lbs.	28" x 23" x 46"



KNA11001330

Commercial extraction cleaner

- Compact and powerful for cleaning small areas
- Easy to use and transport
- 8' solution and recovery hose and hand tool

Item No.	Description	Ship Wt.	Dimensions
KNA11001330	8/1C commercial carpet extractor		



EVSM16ESE1

11-Gal. carpet extractor by Pacific

- Even carpet agitation with unique floating brush deck
- High-pressure 100 PSI pump
- 1 easy to move with brush-assist movement
- Dent and corrosion resistant

Item No.	Description	Ship Wt.	Dimensions
EVSM16ESE1	11 Gallon Extractor	100-lb.	18" x 41" x 47"

Vacuums

Pacific upright vacuums

- Low profile, adjustable handle, onboard tools and HEPA filter included

Item No.	Description	Pkg.
PAC675405	V15ED, 15"	1 ea
PAC675404	V12ES, 12"	1 ea
PAC673308	Bag package, 6 vac bags 2 microfilters	1 ea



CV 300, 12" combination upright and canister

- Easy detail cleaning—converts to a canister vacuum with ease
- Deep-cleaning strength—dual motors (1,000 watts)

Item No.	Description	Pkg.
KNA1012059	CV 300, 12"	1 ea
KNA86333980	Bags for CV 300, 12"	10/cs



KNA1012059

Sensor S2 upright vacuums

- Extremely quiet—only 67 dBA for cleaning in noise-sensitive areas
- Reliable—no worn-out swivels or connectors as all electronics are housed in the base
- Improved indoor air quality—HEPA final stage filtration, standard

Item No.	Description	Pkg.
KNA1012070	Sensor S2, 12"	1 ea
KNA10120710	Sensor S2, 14"	1 ea
KNA8600050	Bags for Sensor S2	110/cs



KNA1012070

Sensor XP upright vacuums

- Automatic brush-height adjustment ensures optimum cleaning performance
- Efficiently removes soils that could ruin carpets and hard floors, saving you time and money
- Comes standard with a high-efficiency filter
- Ultra-light handle weight lessens operator fatigue while increasing productivity
- Flat-to-floor feature allows vacuum to easily clean under beds and furniture for added convenience

Item No.	Description	Pkg.
KNA1012024	12" Sensor XP vacuum	1 ea
KNA1012027	15" Sensor XP vacuum	1 ea
KNA10120300	18" Sensor XP vacuum	1 ea
KNA8600050	Bags for Sensor XP	10/cs



KNA1012024



EVSM30V



Wide area vacuums

- High-productivity vacuums are designed to remove the soils tracked into your facility that can reduce its appearance
- CRI certified
- For daily vacuuming

Item No.	Description	Pkg.
EVSM30V	Wide area vacuums, 30, w/tools	1 ea
EVSM650602	Shake out bag	1 ea
EVSM650602	Papaer bag	1 ea

Wet/dry

KNA14286230



NT 48/1 wet / dry commercial vacuum

- Good for wet and dry vacuuming of small areas
- Provides powerful suction performance
- Pick up dirt and liquid

Item No.	Description	Pkg.
KNA14286230	Nt 48/1 wet / dry vacuum, 12 gal.	1 ea

EVSM695401



Wet / dry commercial vacuum

- Wet/dry vacuum is great for use in slip and fall zones, flood recovery, stripper recovery, etc.
- Tilt-to-drain feature allows emptying when a floor drain is not available
- Cord wrap keeps the whole cord visible
- Safe, easy-to-use lever engages squeegee
- Two usable edges on squeegee, which is easy to change without tools

Item No.	Description	Pkg.
EVSM695401	Wet vac, 18 gal.	1 ea

Sweepers

12" Cordless electric EB 30/1 sweeper

- Flat design enables it to reach beneath radiators and furniture with low ground clearance, allowing for more coverage
- Picks up loose dirt within just 2 mm of its edges for a more efficient cleaning job
- Telescopic broomstick has a push handle and can be adjusted to suit the operator's height, while a universal joint enables it to move in all directions
- No additional tools needed to change batteries or remove the roller brush, resulting in low maintenance

KNA15451210



Item No.	Description	Pkg.
KNA15451210	Karcher EB 30/1 12" cordless electric sweeper	1 ea

KM 70/30 C BP sweeper

- Main roller brush and side brush are electric-powered, making sweeping corners simple
- Push handle adjusts to 3 different positions and folds for easy storage
- Main roller brush and side brush are also height adjustable for adaptability to various surfaces
- 12V battery and corresponding charger are located onboard

KNA15172180



Item No.	Description	Pkg.
KNA15172180	28" KM 70/30 C BP sweeper	1 ea

28" Radius manual walk-behind sweeper

- Compact, durable sweeper that provides a fast and efficient way to clean halls, sidewalks, warehouses, etc.
- Both wheels drive the roller brush, so it continues to sweep well during turns
- Adjustable roller height
- Ergonomic handle
- Flat design for easy storage



KNA15171040

Item No.	Description	Pkg.
KNA15171040	Radius manual walk behind sweeper with brushes	1 ea

9.5" manual sweeper

- Dual debris canisters are easy to empty and feature a handy viewing window
- Soft rubber wheels conform to a variety of floor surfaces
- Corner brushes for hard-to-reach areas
- Two rows of rubber rotors lift dirt fast
- Hand-friendly grip

BCBG21



Item No.	Description	Pkg.
BCBG21	9.5" manual sweeper	1 ea

Floor Mops



Loop mops

- Made of recycled, 4-ply yarn blend including, post-consumer and post-industrial waste
- Fantail spread covers more floor per sweep, helping to reduce time and labor cost
- Poly-mesh headband dries quickly
- Headband/tail-band color: yellow = small, green = medium, red = large
- Use with jaw mop handle (EVSTOOL111F) or quick-change mop handle (EVSTOOL121P)



GSC72601

GSC72702

Item No.	Size	Color	Pkg.
GSC72301	12-oz., Small	Natural	12/cs
GSC72302	16-oz., Medium	Natural	12/cs
GSC72303	24-oz., Large	Natural	12/cs
GSC72501	12-oz., Small	Blue	12/cs
GSC72502	16-oz., Medium	Blue	12/cs
GSC72503	24-oz., Large	Blue	12/cs
GSC72701	12-oz., Small	Orange	12/cs
GSC72702	16-oz., Medium	Orange	12/cs
GSC72703	24-oz., Large	Orange	12/cs
GSC72601	12-oz., Small	Green	12/cs
GSC72602	16-oz., Medium	Green	12/cs
GSC72603	24-oz., Large	Green	12/cs



GSC71412

Rayon mops

- Rayon-blend mop is ideal for when the highest cleaning standards are required
- Low-linting, ideal for surgery
- Loop end construction prevents unraveling and limits fraying

Item No.	Description	Size	Pkg.
GSC71412	Rayon Loop Mop	Medium, 16-oz.	12/cs
GSC60716	4-Ply Loop Mop	Medium, 16-oz.	12/cs



EVS67448

Disposable economy white mop

- Made from polyester/rayon material
- Absorbs seven times its weight
- Low-linting and lightweight
- Cut-end mop
- Narrow 1.25" headband

Item No.	Description	Pkg.
EVS67448	Disposable economy white mop	12/cs



GSC212180



GSC201189, GSC201185



GSC25118

BEST
Premium Synthetic Dust Mops

- Dries quicker and saves energy
- Ideal for laundry facilities
- Maximum particle attraction
- Exceptional laundering quality
- Slot pocket for easy frame insertion

Item No.	Dimensions	Color	Pkg.
GSC212180	5" x 18"	White	12/cs
GSC212240	5" x 24"	White	12/cs
GSC212360	5" x 36"	White	12/cs
GSC212480	5" x 48"	White	12/cs

BETTER
Premium Dust Mops

- Featuring a slot pocket for easy frame insertion
- Durable poly-twill yarn withstands repeated laundering

Item No.	Dimensions	Color	Pkg.
GSC201185	5" x 18"	Blue	12/cs
GSC201245	5" x 24"	Blue	12/cs
GSC201365	5" x 36"	Blue	12/cs
GSC201485	5" x 48"	Blue	12/cs
GSC201189	5" x 18"	Red	12/cs
GSC201249	5" x 24"	Red	12/cs
GSC201369	5" x 36"	Red	12/cs
GSC201489	5" x 48"	Red	12/cs

GOOD
Economy Cotton Dust Mops

- A low-cost alternative
- Can be laundered without shrinking
- Durable, sewn construction
- Natural cotton yarn
- Polyester backing with keyhole ties

Item No.	Dimensions	Color	Pkg.
GSC25118	5" x 18"	Natural	12/cs
GSC25124	5" x 24"	Natural	12/cs
GSC25136	5" x 36"	Natural	12/cs



GSC71213

Premium Finishing Mops

- Made of a synthetic, twisted polyester/rayon blend to help reduce linting
- Looped ends and tail-bands help reduce streaking for a smooth application
- Blue and white striped yarn
- Narrow 1.25" headband
- Headband/tail-band color: blue (medium), red (large)

Item No.	Description	Pkg.
GSC71213	Premium Mop, Large	12/cs
GSC71212	4-Ply Loop Mop	12/cs



GSC26518

Dust Mop Wire Frames and Handle

- Wire frames available to fit a variety of mop sizes
- Clip-on wood handle works with most standard frames

Item No.	Description	Dimensions	Pkg.
GSC26518	Dust Mop Wire Frames	5" x 18"	12/cs
GSC26524	Dust Mop Wire Frames	5" x 24"	12/cs
GSC26536	Dust Mop Wire Frames	5" x 36"	12/cs
GSC26548	Dust Mop Wire Frames	5" x 48"	12/cs
GSC26560	Dust Mop Wire Frames	5" x 60"	12/cs
GSC25555Z	Wooden Clip-On Dust Mop Handle	60" L	1 ea

Microfiber



Microfiber flat mop pads

Premium scrubber mops

- Low-nap blue yarn with white microfiber inner liner
- Industrial-style hook and loop
- Dark blue banding for extended laundering
- Scrubbing strips to enhance cleaning performance

Item No.	Size	Color	Pkg.
MDT217741B	20.5"	Blue	100/cs
MDT2177410B	20.5"	Blue/Orange	100/cs
MDT217741ORB	20.5"	Orange	100/cs
MDT217741LGB	20.5"	Green	100/cs



MDT217741B

Premium micro-fill wet mop

- For daily wet or damp cleaning of floors and walls
- Double layer of 100% split microfiber with a microfiber fill offering more durability than foam-filled alternatives
- Increased size to accommodate laundry customers
- Banding around the edge for increased durability
- Hook-and-loop construction for improved adherence to the mop frame and square corners to clean corners more efficiently

Item No.	Size	Color	Pkg.
MDT217775P	20.5"	Green	100/cs



MDT217775P

Premium poly-fill wet mop

- For daily wet or damp cleaning of floors and walls
- Double layer of 100% split microfiber for exceptional durability
- Increased size to accommodate laundry customers
- Banding around the edge for increased durability
- Hook-and-loop construction for improved adherence to the mop frame

Item No.	Size	Color	Pkg.
MDT217520P	20.5"	Blue	100/cs



MDT217520P



MDT217620P

Premium foam-fill wet mop

- For daily wet or damp cleaning of floors and walls
- Double layer of 100% split microfiber with a foam fill for increased absorption and longevity
- Increased size to accommodate laundry customers
- Banding around the edge for increased durability
- Hook-and-loop construction for improved adherence to the mop frame

Item No.	Size	Color	Pkg.
MDT217620P	20.5"	Blue	100/cs



MDT217775, MDT217771 (with fringe)

Micro-fill wet/dry mops

- For daily wet or damp cleaning of floors and walls
- Double layer of 100% split microfiber with a microfiber fill offering more durability than foam-filled alternatives
- Available with or without microfiber fringe sewn around the edges

Item No.	Size	Color	Pkg.
MDT217775	18"	Green	100/cs
MDT217771	18"	Green w/fringe	100/cs



MDT217520

Poly-fill wet mop

- For daily wet or damp cleaning of floors and walls
- Double layer of 100% split microfiber for exceptional durability
- Perfect for use with dust mop, MDT217630

Item No.	Size	Color	Pkg.
MDT217520	18"	Blue	100/cs



MDT217619

Foam-fill wet mops

- For daily wet or damp cleaning of floors and walls
- Double layer of 100% split microfiber with a foam fill for increased absorption and longevity
- Perfect for use with dust mop (MDT217630)

Item No.	Size	Color	Pkg.
MDT217619	18"	Blue / Select	100/cs
MDT217620	18"	Blue	100/cs
MDT217625	18"	Blue	100/cs
MDT217621	24"	Blue	12/cs
MDT217622	36"	Blue	12/cs
MDT217623	48"	Blue	3/cs

Microfiber pocket mops

Pocket mop hardware kit

- Includes one mop frame and one mop handle
- Fits all standard 18" (46 cm) microfiber pocket mops
- Frame design allows for hands-free removal of soiled pads
- The flat frame surface enables maximum mop contact with the floor
- The telescoping handle's height can be adjusted for optimal use

Item No.	Description	Pkg.
MDT217PKIT	Pocket mop hardware kit	100/cs

Mop buckets

- Holds up to twenty 18" (46 cm) microfiber mop heads
- Used for wetting or "charging" microfiber with cleaning solution
- Dimensions: 19" W x 10" H x 10" D (48 x 25 x 25 cm)

Item No.	Description	Color	Pkg.
MDT217608	Microfiber mop bucket with strainer and casters	Yellow	2/cs
IPESECC0015B	Mop bucket	Blue	1 ea
IPESECC0019B	Lid for blue mop bucket	Blue	1 ea
IPESECC0015Y	Mop bucket	Yellow	1 ea
IPESECC0019Y	Lid for yellow mop bucket	Yellow	1 ea
MDTBUCKETBLU	Microfiber bucket with lid	Blue	1 ea



MDT217PKIT



MDTBUCKETBLU

Twisted-loop pocket mops

- Designed with looped ends and tailbands; the Medline string mop picks up liquid and dirt
- Does not tangle while in use and dries floors without streaking
- Can be used with any standard wringer and fits standard mop handles, holders and frames
- Use with Pocket Mop Hardware Kit: MDT217PKIT

Item No.	Description	Color	Pkg.
MDT217PKT18B	Traditional loop mop	Blue	100/cs
MDT217PKT18SB	Scrubber mop	Blue	100/cs



MDT217PKT18B

Advantage system canister

- Designed to provide an optimal water to chemical measurement for each mop

Item No.	Description	Pkg.
MDTCANISTER2	Microfiber advantage system canister	10/cs



MDTCANISTER2

**Absorbs
30% more**
than a traditional
cotton string
mop



MDT217657

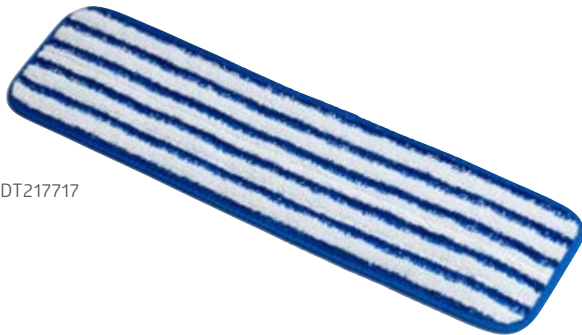

MDT217717



MDT217757

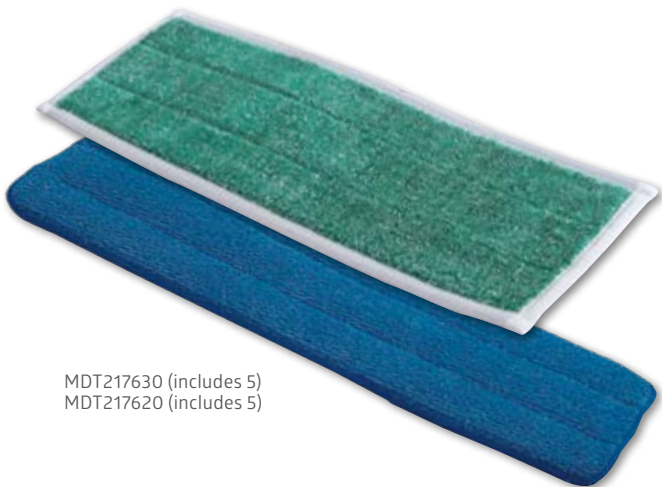

MDT217630 (includes 5)
MDT217620 (includes 5)

Heavy-duty wet mop

- For wet mopping to absorb larger spills and soil from floors; perfect for tile and grout
- 100% split microfiber with knobs for heavy-duty absorption

Item No.	Size	Color	Pkg.
MDT217657	18"	Purple	25/cs

Microfiber Scrubbing Pads

- For wet scouring to remove heavy, sticky soils or rubber marks from floors
- Ideal for any room with grout, such as kitchens, restrooms and other high-traffic areas
- Double layer of 100% split microfiber with abrasive scrubber strips throughout the pad

Item No.	Description	Color	Pkg.
MDT217718	Vertical scrubber mop, 18"	Blue	100/cs
MDT217717	Horizontal scrubber mop, 18"	White	100/cs

Finishing Mop

- For floor finishing with floor finish or wax
- 100% split microfiber specifically designed to provide a smooth, streak-free finish

Item No.	Description	Pkg.
MDT217757	18" Finishing mop	5/cs

Microfiber Starter Kit

- Ideal for facilities that want to try out the system or have a small area to clean

Item No.	Description	Pkg.
MICROINSKIT1	Microfiber starter kit, includes all items listed below	1 ea

Kit contents:

Item No.	Description	Pkg.
MDT217610Z1	Mop frame, 18" non-locking mop head	1 ea
MDT217605Z1	Telescoping handle, 39" closed, 70" extended	1 ea
MDT217620	Wet mop, 18" wet mop, blue	5 ea
MDT217630	Dust mop, 18" dust mop, green	5 ea
MDT217750	High duster with microfiber sleeve	1 ea
MDT217608	Microfiber bucket	1 ea
MDT217658	Glass towel, 12" x 12", blue	1 ea
MDT217647	Cleaning Cloth, 12" x 12", Blue	1 ea

Microfiber dusters

Microfiber high duster

- Can be used with telescoping mop handle
- Conforms to various surfaces and hard-to-reach spots for easy dust removal
- Traps dust particles without releasing them into the air on curtain tracks, ceiling fans, shelving and more

Item No.	Description	Pkg.
MDT217750	High duster with microfiber sleeve	1 ea
MDT217751	High duster sleeve replacement	10/cs



heavy duty microfiber duster*

- Dual sided: "grabber" side picks up larger particles and big messes, smooth side traps dust, dirt and particles
- Conforms to various surfaces and hard-to-reach spots for easy dust removal
- Traps dust particles without releasing them into the air

Item No.	Description	Pkg.
MDT217851	Purple high duster sleeve	10/cs

*This will match the purple mop version



Microfiber products

Microfiber slow-speed carpet bonnet pads

- Designed for bonnet-saturated carpet cleaning
- Used with slow-speed floor machines
- High-absorbency, reversible pads

Item No.	Dimensions	Color	Pkg.
MDT217787	17" diameter	Blue	1 ea
MDT217788	19" diameter	Blue	1 ea
MDT217789	21" diameter	Blue	1 ea



Microfiber traditional mops



MDT217793



MDT217635

Traditional wet mops

- A traditional mop design, but made of microfiber for better cleaning
- Fits standard mop handles, holders, frames and wringers
- Use with plastic jaw: EVSTOOL111F, and wet mop handle: EVSTOOL121P

Item No.	Size	Color	Pkg.
MDT217793	10-oz.	Blue	6/cs
MDT217794	14-oz.	Blue	6/cs
MDT217796	18-oz.	Blue	6/cs

Traditional dry loop dust mops

- Traditional mop with the benefits of microfiber
- Works with your existing wire frame and handle
- Canvas backing has ties and pockets for convenience
- Use with dust mop handle: GSC25555Z

Item No.	Size	Color	Pkg.
MDT217635	24"	Blue	6/cs
MDT217636	36"	Blue	3/cs
MDT217634WHT	18"	White	6/cs
MDT217635WHT	24"	White	6/cs



Telescoping mop handles

- Made of lightweight aluminum to reduce worker strain
- Ergonomic, adjustable to worker's height

Item No.	Size	Pkg.
MDT217605	39"-70"	25/cs
MDT217605Z	39"-70"	5/cs
MDT217605Z1	39"-70"	1 ea
MDT217820	39"-70" with Lock	1 ea

Mop frames

- Use with telescoping mop handle (MDT217605)

Item No.	Size	Pkg.
MDT217610	18"	10/cs
MDT217610Z	18"	5/cs
MDT217610Z1	18"	1 ea
MDT2176122	24"	10/cs
MDT217712	36"	1 ea
MDT217713	48"	1 ea

Touchless mop handle and frame

- Remove mop pad in one swift hands-free motion
- Frame features a rotating swivel head for cleaning in tight spaces and under furniture
- Lightweight handle adjusts in height from 49" to 63"

Item No.	Size	Pkg.
MDTHANDLE1	Handle and frame	1 ea

Microfiber bucketless mop

- The direct-dispensing design of these mops helps save labor time as well as cleaning solution and water use
- Plus, the direct application of cleaning solution is more efficient and hygienic
- System includes a mop handle, hook-and-loop mop head and mop frame and two 32 oz. solution tanks

Item No.	Size	Pkg.
MDTHANDLE2	Mop, microfiber, bucketless, 2 32oz tank	1 ea

Microfiber cleaning cloths

Cleaning cloths

- Multi-surface cloths
- For wet or dry cleaning of all above-the-floor surfaces, such as countertops, bedside tables, etc.
- 100% split microfiber for extra durability
- Washable up to 160° F



MDT2176 series

Light weight

Item No.	Dimensions	Color	Pkg.
MDT217649	12" x 12"	Blue	250/cs
MDT217688	12" x 12"	Green	250/cs
MDT217637	12" x 12"	Orange	250/cs
MDT217639	12" x 12"	Purple	250/cs

Light weight

Item No.	Dimensions	Color	Pkg.
MDT217671	16" x 16"	Blue	250/cs
MDT217672	16" x 16"	Green	250/cs
MDT217673	16" x 16"	Orange	250/cs
MDT217674	16" x 16"	Purple	250/cs

Heavy weight

Item No.	Dimensions	Color	Pkg.
MDT217643	12" x 12"	Yellow	250/cs
MDT217647	12" x 12"	Blue	250/cs
MDT217840	12" x 12"	Pink	144/cs
MDT217841	12" x 12"	Red	400/cs
MDT217895	12" x 12"	Purple	144/cs
MDT217897	12" x 12"	Orange	144/cs

Heavy weight

Item No.	Dimensions	Color	Pkg.
MDT217616	16" x 16"	Yellow	250/cs
MDT217645	16" x 16"	Blue	250/cs
MDT217675	16" x 16"	Dark Blue	200/cs
MDT217846	16" x 16"	Pink	200/cs
MDT217847	16" x 16"	Red	200/cs
MDT217848	16" x 16"	Green	250/cs
MDT217896	16" x 16"	Purple	144/cs
MDT217898	16" x 16"	Orange	144/cs



MDT217690

MDT217691

Reusable Clean by Sequence microfiber booklets

- Our numbered microfiber booklets ensure a separate cloth is used for each surface and no surface is missed

Item No.	Description	Pkg.
MDT217690	Blue, patient room	250/cs
MDT217691	Orange, patient bathroom	250/cs
MDT217692	Purple, discharge	250/cs
MDT217697	Green, resident room	100/cs
MDT217698	Blue, resident bathroom	100/cs

Glass cloths

- For wet or dry glass cleaning
- 100% split microfiber with a special coating to prevent linting

Item No.	Dimensions	Color	Pkg.
MDT217658	12" x 12"	Blue	250/cs
MDT217843	12" x 12"	Green	250/cs



MDT217 series

Disposable products

Microfiber disposable mops

- For one-time wet, dry or damp dusting and floor cleaning
- Use in isolation rooms, clean rooms, operating rooms

Item No.	Size	Pkg.
MDT217618	No fill 18" Blue	100/cs
MDT217DISP	18" White	100/cs
MDT217DISP2	18" White with scrubbing strips	100/cs
MDT217DISP3	18" White, pocket mop	400/cs
MDT217DISP4	18" White, economy	1050/cs



MDT217618



MDT217DISP



MDT217DISP2

Microfiber disposable cloths

- Ideal for daily dusting and damp cleaning
- Can be used with cleaning solutions

Item No.	Description	Pkg.
MDT217DC10	Microfiber disposable cloths, kit with tub	25 ea/bag, 10 bags/cs
MDT217DC20	Disposable cloths refill	250 ea/cs
MDT217DC30	Disposable cloth economy, non-woven	3000/cs



MDT217DC10



EVS70111B

Disposable dry wipes

- Simple and convenient refillable wipes-and-bucket system
- Simply put in your cleaning solution to create cleaning wipes

Item No.	Description	Pkg.
EVS70111B	Dry wipe bucket only	1 ea
EVS70111R3	Dry wipe refill only	6/cs

Carts and containers



Custom cart covers



Keeping linens and other items clean and protected helps prevent infections. The Centers for Medicare and Medicaid Services (CMS) recommends to "handle, store, process and transport linens so as to prevent the spread of infection."¹ Providing the proper fit and coverage requires custom sizing your cart covers.

We've streamlined our ordering process to make it easier than ever to get the exact custom cart covers you need. Plus, they're built to last, with strong double-stitched reinforced vinyl and heavyweight nylon materials.

You can create custom covers for virtually any equipment in your facility, including:

- Polyvinyl bulk trucks
- Tilt trucks (covers and liners)
- Morgue carts
- Suture carts
- Housekeeping carts
- Utility carts
- Crash carts
- Computer carts
- O.R. machines
- Catheter carts
- Beds in storage
- ...and more

1 Choose your cover type



Vinyl pocket



Grommets for locking



Reject linen pouch with silk screen

Standard covers—available in nylon or antimicrobial-treated vinyl to protect the product

Standard covers have a single front flap that is fastened shut with either zippers or hook-and-loop closures. Also available without a flap.

*This product is treated with an antimicrobial agent built in to protect the product. This product does not protect users or others against bacteria, viruses, germs or other disease organisms.

Silk screening is available as a custom extra





Easy-grab covers—convenient access and permanent protection

- Keep your linens covered at all times with Clear view vinyl window strips.
- Vertical panels let you easily see what you're grabbing
- No flaps to close. Linens are never left uncovered
- Back and sides can be ordered in wipe-clean vinyl treated with an antimicrobial agent to protect the product or washable 420-denier nylon

*This product is treated with an antimicrobial agent built in to protect the product. This product does not protect users or others against bacteria, viruses, germs or other disease organisms.



Easy access to linens



Removable window strips for trouble-free laundering. Easily replaced if damaged or lost.

Half cart covers—for poly bulk trucks

- Only a 12" cover on the sides and back is needed to hold this durable cover in place—plus a full front flap to cover the opening. Options include:
- Hook & loop to secure the front flap to the cart
- Elastic corners for a more snug fit
- Silk screen your logo on the flap to market your business

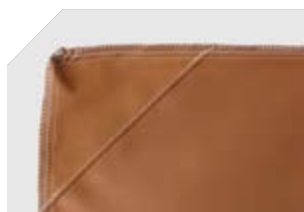

Reinforced corners



Elastic corners available for a more snug fit

2 Select your material and cover

200 denier nylon color options—standard covers



200 denier nylon (Red)

420 denier nylon color options—standard, easy-grab covers



420 denier nylon (Khaki)

600 denier nylon color options—standard covers



600 denier nylon (Royal Blue)

1,000 denier nylon color options—standard covers



1000 denier nylon (Green)

11-oz. antimicrobial vinyl* to protect the product—standard, easy-grab covers

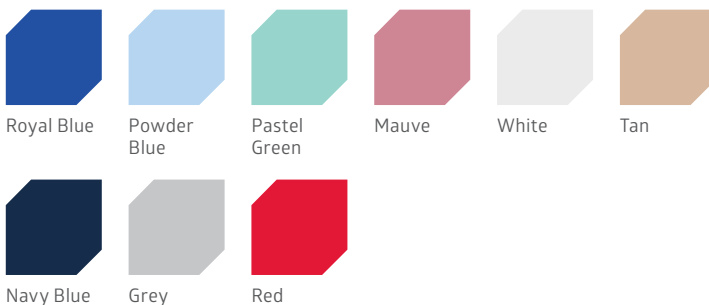

11-oz. antimicrobial vinyl (Pastel Green)

*This product is treated with an antimicrobial agent built in to protect the product. This product does not protect users or others against bacteria, viruses, germs or other disease organisms.

11-oz. vinyl—standard, easy-grab covers



Colors are reproduced as faithfully as the printing process allows. Please contact your Medline representative for fabric samples to ensure satisfaction.

3 Measure your cart

Do not include casters when measuring height

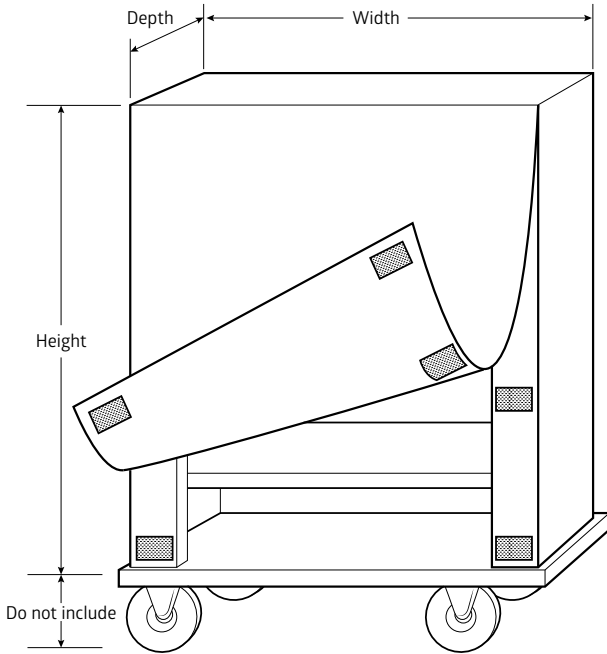

4 Indicate your closure type

For standard covers only



None



Zipper closure



Hook-and loop closure

5 Add your extra options

Cutouts, pockets, graphics or windows can be located just about anywhere.

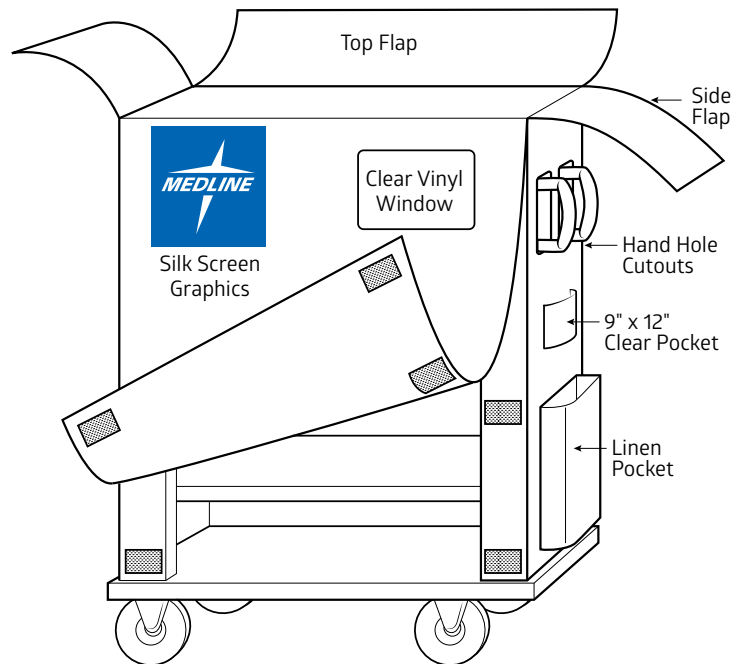

Medline MIYO healthcare housekeeping workstations



MPHMCECO2
(Bucket & shelf sold separately)

Housekeeping workstations

- A convenient EVS mobile workstation designed for h1 healthcare
- Stands up to disinfectants, power washing and even autoclaving
- Quiet and clean, helping to enhance the patient experience

Item No.	Description	Pkg.
MPHMCECO2	One tower, economy, short base	1 ea
MPHMCPLUS1C	Two towers storage/collection, microfiber platform	1 ea
MPHMCPLUS1-2	Two towers storage/collection, extended platform	1 ea
MPHMCPLUS2-2	Two towers all storage, extended platform	1 ea
MPHMCOR2	One tower, enclosed, or build, large base	1 ea
MPHMCOPEN3	One tower, open or build with drawers	1 ea
MPHMCDISC1	Three tower	1 ea
MPHMCED150	Two tower, single equidose	1 ea
MPHMCED250	Two tower, double equidose	1 ea



MPHMCPLUS1C*
* Bucket sold separately.



MPHMCPLUS2-2



MPHMCOR2



MPHMCED150

Cleaning carts

High security cleaning cart

- Features a locking hood and storage compartment for extra security
- Spacious interior for collecting laundry or refuse; one standard bag included
- Non-marring bumper reduces costly wall damage
- Four-sided long-handle tool storage doubles as a hanging rack for spray bottles
- Handle folds up to help reduce space when cart is not in use



EVSCART250

Item No.	Dimensions	Pkg.
EVSCART250	44.25"L x 23.25"W x 19.25"H	1 ea

Janitor cart

- Designed to accommodate and organize tools and supplies required for facility cleaning
- Features over-sized, 8" r1 ear wheels and 3", gray, non-marking casters
- 25-gal. vinyl bag with zipper for 1 easy trash removal
- Plastic construction resists corrosion and rust, and is unlikely to scratch doors, furniture or walls



CCJR184GRA

Item No.	Description	Color	Pkg.
CCJR184GRA	44.62"L x 20.75"W x 38"H	Gray	1 ea
CCJ187YW	Pilfer-proof locking cabinet	Yellow	1 ea

Utility and serving carts



EVSC11SP5B

2-Shelf heavy-duty utility carts

- Sturdy multipurpose cart is designed to smoothly carry loads
- Shelves lip on all sides to help keep cart contents secure
- Features an ergonomically molded handle and four casters for easy maneuverability

Item No.	Description	Material	Dimensions	Color	Pkg.
EVSC11BLKXL	2-Shelf cart tub, 5" lip	Poly	24.5" x 45.5"	Black	1 ea
EVSC11SP5B	2-Shelf cart tub, 2.5" Lip	Poly	35.25" x 18"	Black	1 ea



EVSHE32BLK

2-Shelf tub carts

- Polyethylene shelves and legs resist stains, scratches, dents and rust
- Push handle is molded into the top tub shelf
- Four 4" casters, two with locking brake

Item No.	Description	Material	Dimensions	Color	Pkg.
EVSHE32BLK	2-Shelf cart flat	Poly	24" x 18"	Black	1 ea
EVSHE38BLK	2-Shelf cart flat	Poly	32" x 24"	Black	1 ea



EVSSTC111BLK

3-shelf carts

- Polyethylene shelves and legs resist stains, scratches, dents and rust
- Push handle is molded into the top tub shelf
- Four 4" casters, two with locking brake

Item No.	Description	Material	Dimensions	Color	Pkg.
EVSBUSTC111BL	3-Shelf cart tub	Poly	24" x 18"	Blue	1 ea
EVSHE34GRY	3-Shelf cart flat	Poly	24" x 18"	Gray	1 ea
EVSHE42BLK	3-Shelf cart flat	Poly	24" x 18"	Black	1 ea
EVSSTC111BLK	3-Shelf cart tub	Poly	24" x 18"	Black	1 ea
EVSSTC111GRY	3-Shelf cart tub	Poly	24" x 18"	Gray	1 ea

3-Shelf stainless steel utility cart

- Satin-finished, durable, stainless steel, welded construction
- Platform folds up for compact storage
- Locking device holds platform securely in place

Our only stainless steel cart

Item No.	Description	Material	Dimensions	Color	Pkg.
EVSL100S3	3-Shelf cart	Stainless	26" x 16"	Stainless	1 ea



EVSL100S3

3-Shelf serving carts

- Multipurpose cart is ideal for a variety of healthcare applications
- Polypropylene shelves resist scratches, chips and dents and have a 1" lip on all sides to help keep cart contents secure
- Lightweight aluminum uprights provide stacking strength
- Ergonomic push handle on both sides for versatility and easy maneuverability; rolls on four 4"-dia. PVC casters

Item No.	Description	Material	Dimensions	Color	Pkg.
EVSSC12BLK	3-Shelf cart lip 1"	Poly	33.5" x 16.75"	Black	1 ea
EVSSC13G	3 Shelf cart lip 1" ply	Poly	3.5" x 16.75"	Grey	1 ea



EVSSC12BLK

Large 3-shelf serving cart

- Designed for maximum storage and weight capacity
- Durable polypropylene shelves resist dents and scratches
- Generous handles on each side for maximum control
- Easy to maneuver with 4" PVC casters
- Shelves are spaced 12" apart for easy loading and unloading
- Shelves include a 1" lip on both sides and the back to help control contents

Item No.	Description	Material	Dimensions	Color	Pkg.
EVSSC13G	3-Shelf cart lip 1"	Poly	40.5" x 19.75"	Gray	1 ea



EVSSC13G

Surface disinfection wipes



Micro-organisms in descending order of resistance¹ and corresponding product:*

	Micro-Kill Bleach	Micro-Kill One	Microkill+	Micro-Kill AF ²	Micro-Kill
HARDEST TO KILL ↑ BACTERIAL ENDOSPORE e.g.: <i>C. diff</i> spores	●				
MYCOBACTERIA e.g.: <i>M. tuberculosis</i>		●	●		●
NON-ENVELOPED VIRUSES e.g.: norovirus, rhinovirus, poliovirus, rotavirus, adenovirus	●	●		●	●
FUNGI e.g.: <i>T. mentagrophytes</i> , <i>Candida albicans</i> , <i>Candida auris</i>	●	●	●	●	
VEGETATIVE BACTERIA e.g.: <i>Staphylococcus aureus</i> , MRSA, VRE	●	●	●	●	●
EASIEST TO KILL ↓ ENVELOPED VIRUSES e.g.: HBV, HCV, HIV, Influenza A (H1N1), coronavirus	●	●	●	●	●

*See product page for information regarding kill claims specific to each product.

Micro-Kill Bleach	78–79
Micro-Kill One	80
Micro-Kill+	81
Micro-Kill AF ²	82–83
Micro-Kill	84

Micro-Kill Bleach Germicidal Bleach Wipes

Bleach

EPA-registered product that kills *Clostridium difficile* spores¹ in 3 minutes* and *Candida auris* in 2 minutes*

Pre-moistened with solution equivalent to 1:10 dilution of 6.5% bleach

Ordering information**

Item No.	Wipe Dimensions	Pkg.
MSC351400AN	7" x 8" wipes, 150 count canister	8/cs
MSC351410AN	6" x 5" wipes, 150 count canister	6/cs
MSC351420AN	3" x 3" wipes, 100 count box, individually wrapped	12 bx/cs
MSC351430A	7" x 8" wipes, 50 count box, individually wrapped	6 bx/cs
MSC351440AN	12" x 12" wipes, 55 count canister	8/cs
MSC351450AN	12" x 12" wipes, 110 count bag, starter kit	4 bags/cs and 1 bucket
MSC351450BG4	12" x 12" wipes, 110 count bag	4/cs
MSC351450BKT8	Labeled buckets	8/cs



MSC351420AN, MSC351450AN, MSC351400AN, MSC351440AN, MSC351410AN

1. Environmental Protection Agency List K: Registered Antimicrobial Products Effective against *Clostridium difficile* Spores. January 10, 2018.



Overall
kill time of
3 min

Common uses

For disinfection of glucose meters, patient-care equipment, point-of-care equipment and hard, non-porous healthcare surfaces. See label for specific instructions for use.

Micro-Kill Bleach Wipes kill times*

Kill (i.e., contact) time for a disinfectant is the amount of time a surface must remain wet with the product to achieve disinfection.

Micro-organism	Kill time
<i>Acinetobacter baumannii</i> , MDR	30 seconds
Adenovirus type 5	30 seconds
<i>Bordetella pertussis</i>	30 seconds
<i>Campylobacter jejuni</i>	30 seconds
<i>Candida albicans</i>	1 minute
<i>Candida auris</i>	2 minutes
<i>Clostridium difficile</i> spores	3 minutes
Coronavirus, human	30 seconds
Cytomegalovirus	30 seconds
<i>Enterobacter aerogenes</i>	30 seconds
<i>Enterobacter cloacae</i>	30 seconds
<i>Enterococcus faecalis</i> , Vancomycin-Resistant (VRE)	30 seconds
<i>Enterococcus faecium</i> , MDR	30 seconds
Enterovirus D68	30 seconds
<i>Escherichia coli</i>	30 seconds
<i>Escherichia coli</i> , O157:H7	30 seconds
<i>Escherichia coli</i> , ESBL	30 seconds
<i>Escherichia coli</i> , NDM-1	30 seconds
Hepatitis A Virus, (HAV)	30 seconds
Hepatitis B Virus, (HBV)	30 seconds
Hepatitis C Virus, (HCV)	30 seconds
Herpes Simplex Virus, Type 2 (HSV 2)	30 seconds
Human Immunodeficiency Virus, Type 1 (HIV-1) (AIDS Virus)	30 seconds
Influenza A Virus, (H1N1)	30 seconds
Influenza A Virus, (H3N2) Avian	30 seconds
Influenza A Virus, (H5N1) Avian	30 seconds
Influenza A Virus, (H7N9) Avian	30 seconds
Influenza A Virus, Strain A2/Hong Kong	30 seconds
Influenza B Virus	30 seconds
<i>Klebsiella pneumoniae</i>	30 seconds

Micro-organism	Kill time
<i>Klebsiella pneumoniae</i> , Carbapenem-Resistant (CRKP) (CRE)	30 seconds
<i>Klebsiella pneumoniae</i> , ESBL	30 seconds
<i>Klebsiella pneumoniae</i> , NDM-1	30 seconds
<i>Legionella pneumophila</i>	30 seconds
<i>Listeria monocytogenes</i>	30 seconds
Norwalk Virus, (Norovirus)	30 seconds
Poliovirus, Type 1	30 seconds
<i>Proteus mirabilis</i>	30 seconds
<i>Pseudomonas aeruginosa</i>	30 seconds
Respiratory Syncytial Virus (RSV)	30 seconds
Rhinovirus	30 seconds
Rotavirus	30 seconds
<i>Salmonella enterica</i>	30 seconds
<i>Serratia marcescens</i>	30 seconds
<i>Shigella dysenteriae</i>	30 seconds
<i>Staphylococcus aureus</i>	30 seconds
<i>Staphylococcus aureus</i> , (CA-MRSA USA400)	30 seconds
<i>Staphylococcus aureus</i> , Linezolid-Resistant (LRSA)	30 seconds
<i>Staphylococcus aureus</i> , Methicillin-Resistant (MRSA)	30 seconds
<i>Staphylococcus aureus</i> , Vancomycin Intermediate-Resistant (VISA)	30 seconds
<i>Staphylococcus aureus</i> , Vancomycin-Resistant (VRSA)	30 seconds
<i>Streptococcus pneumoniae</i>	30 seconds
<i>Streptococcus pyogenes</i> , associated with scarlet fever	30 seconds
<i>Trichopyton interdigitale</i> (formerly <i>T. mentagrophytes</i>) (Athlete's Foot)	1 minute
Bovine Diarrhea Virus †	30 seconds
Canine Parvovirus †	30 seconds
Duck Hepatitis B Virus †	30 seconds
Feline Calicivirus †	30 seconds
Feline Panleukopenia Virus—(Feline Parvovirus) †	30 seconds

EPA Reg. No. 37549-1

* Ensure that the hard, non-porous surface remains wet for the entire contact time.

**May not be available in all 50 states.

† See Master Label EPA Reg. 37549-1 for complete list of micro-organisms.

‡ Animal pathogen.

Micro-Kill One

Quat/Alcohol

Overall
kill time of
1 min

Effective in one minute*

Kills TB, Norovirus, Rotavirus and Rhinovirus in one minute

Micro-Kill One is a durable, low-lint polypropylene cloth that features a quaternary ammonium and alcohol solution. It contains ethyl alcohol and quaternary ammonium compounds.

- One-step clean and disinfect for hard non-porous surfaces
- Bactericidal, tuberculocidal, fungicidal and virucidal

Ordering information**

Item No.	Description	Pkg.
MSC351300	6" x 6.75" Wipes, 160 Count Canister	12/cs
MSC351310	7.5" x 1.5" Wipes, 65 Count Canister	12/cs



MSC351310

MSC351300

KILLS
25
MICRO-ORGANISMS†

Common uses

For use on hard, non-porous surfaces only, including medical, dental and laboratory countertops, exam tables, carts, patient care equipment, point-of-care equipment, telephones, sink tops, toilet seats, glazed porcelain, stainless steel, Formica®, vinyl and most plastic surfaces. See label for specific instructions for use.

Micro-Kill One kill times*

Kill (i.e., contact) time for a disinfectant is the amount of time a surface must remain wet with the product to achieve disinfection.

Micro-organism	Kill time
<i>Acinetobacter baumannii</i>	1 minute
<i>Burkholderia cepacia</i>	1 minute
<i>Campylobacter jejuni</i>	1 minute
Coronavirus, Human	1 minute
<i>Enterococcus faecalis</i> , Vancomycin-Resistant (VRE)	1 minute
<i>Escherichia coli</i> , O157:H7	1 minute
Hepatitis B Virus, (HBV)	1 minute
Hepatitis C Virus, (HCV)	1 minute
Herpes Simplex Virus, Type 1 (HSV 1)	1 minute
Human Immunodeficiency Virus, Type 1 (HIV-1) (AIDS Virus)	1 minute
Influenza A Virus, Strain A2/Hong Kong	1 minute
<i>Klebsiella pneumoniae</i>	1 minute
<i>Listeria monocytogenes</i>	1 minute
Norwalk Virus, (Norovirus)	1 minute
Poliovirus, Type 1	1 minute
<i>Pseudomonas aeruginosa</i>	1 minute
Respiratory Syncytial Virus (RSV)	1 minute
Rhinovirus	1 minute
Rotavirus	1 minute
<i>Salmonella enterica</i>	1 minute
<i>Staphylococcus aureus</i>	1 minute
<i>Staphylococcus aureus</i> , Methicillin-Resistant (MRSA)	1 minute
<i>Streptococcus pyogenes</i> , associated with scarlet fever	1 minute
<i>Trichopyton interdigitale</i> (formerly <i>T. mentagrophytes</i>) (Athlete's Foot)	1 minute
Tuberculosis (TB) via <i>Mycobacterium bovis</i> , BCG	1 minute

EPA Reg. No. 88494-2-37549

* Ensure that the hard, non-porous surface remains wet for the entire contact time.

**May not be available in all 50 states.

†See Master Label EPA Reg. 88494-2 for complete list of micro-organisms.

Micro-Kill+ Disinfecting, Deodorizing Cleaning Wipes with Alcohol

Quat/Alcohol

Overall kill time of **5 min**

Kills 13 different infectious micro-organisms

These include *Trichophyton mentagrophytes* (athlete's foot fungus) in five minutes; Tuberculosis, *E. coli*, Hepatitis B and C, *Salmonella* and VRE in two minutes; and HIV-1 (AIDS virus) in one minute.¹

Ordering information**

Item No.	Description	Pkg.
MSC351200	6" X 6.75" wipes, 160 count canister	12/cs
MSC351210	10" X 10" wipes, 65 count canister	12/cs
MSC351230	7" X 10" wipes, 50 count narrow canister	12/cs
MSC351240	10" X 14" wipes, 42 count canister	12/cs

Common uses

Micro-Kill+ is made of non-woven disposable cloth that stands up to hard-surface scrubbing and can be used to clean and disinfect most hard, non-porous surfaces. See label for specific instructions for use.

Micro-Kill+ kill times*

Kill (i.e., contact) time for a disinfectant is the amount of time a surface must remain wet with the product to achieve disinfection.

Micro-organism	Kill time
<i>Enterococcus faecalis</i> , Vancomycin-Resistant (VRE)	2 minutes
<i>Escherichia coli</i> , O157:H7	2 minutes
Hepatitis B Virus, (HBV)	2 minutes
Hepatitis C Virus, (HCV)	2 minutes
Herpes Simplex Virus, Type 2 (HSV 2)	2 minutes
Human Immunodeficiency Virus, (HIV-1) (AIDS Virus)	1 minute
Influenza A Virus, (H1N1)	2 minutes
<i>Pseudomonas aeruginosa</i>	2 minutes
<i>Salmonella enterica</i>	2 minutes
<i>Staphylococcus aureus</i>	2 minutes
<i>Staphylococcus aureus</i> , Methicillin-Resistant (MRSA)	2 minutes
Tuberculosis (TB) via <i>Mycobacterium bovis</i> , BCG	2 minutes
<i>Trichophyton interdigitale</i> (formerly <i>T. mentagrophytes</i>) (Athlete's Foot)	5 minutes



MSC351230

MSC351210

MSC351200

MSC351240

EPA Reg. No. 59894-10-37549

* Ensure that the hard, non-porous surface remains wet for the entire contact time.

** May not be available in all 50 states.

† See Master Label EPA Reg. 88494-2 for complete list of micro-organisms.

1. Environmental Protection Agency Office of Pesticide Programs; master label. September 10, 2010.

Medline Micro-Kill AF²

Quat

No bleach or alcohol added

- 2-minute kill time*
- Kills 45 micro-organisms on hard, non-food, non-porous surfaces
- Quat-based disinfectant

Ordering Information**

Item No.	Wipe Dimensions	Pkg.
MSC351000	6" X 6.75" Wipes, 160 Count Canister	12/cs
MSC351010	7" x 15" Wipes, 65 Count Canister	6/cs



MSC351000

MSC351010



Overall
kill time of
2 min

Micro-Kill AF² kill times*

Kill (i.e., contact) time for a disinfectant is the amount of time a surface must remain wet with the product to achieve disinfection.

Micro-organism	Kill time	Micro-organism	Kill time
<i>Acinetobacter baumannii</i>	2 minutes	Influenza A Virus, Strain A2/Hong Kong	2 minutes
<i>Acinetobacter baumannii</i> , MDR	2 minutes	<i>Klebsiella pneumoniae</i>	2 minutes
<i>Burkholderia cepacia</i>	2 minutes	<i>Klebsiella pneumoniae</i> , ESBL	2 minutes
<i>Campylobacter jejuni</i>	2 minutes	<i>Klebsiella pneumoniae</i> , NDM-1	2 minutes
<i>Candida albicans</i>	2 minutes	<i>Listeria monocytogenes</i>	2 minutes
Coronavirus, Human	2 minutes	<i>Proteus vulgaris</i>	2 minutes
Coronavirus, SARS Associated	2 minutes	<i>Pseudomonas aeruginosa</i>	2 minutes
<i>Enterobacter aerogenes</i>	2 minutes	Respiratory Syncytial Virus (RSV)	2 minutes
<i>Enterococcus faecalis</i>	2 minutes	Rotavirus	2 minutes
<i>Enterococcus faecalis</i> , Vancomycin-Resistant (VRE)	2 minutes	<i>Salmonella enterica</i>	2 minutes
<i>Escherichia coli</i>	2 minutes	<i>Salmonella enterica</i> , serovar Typhi	2 minutes
<i>Escherichia coli</i> , O157:H7	2 minutes	<i>Shigella dysenteriae</i>	2 minutes
<i>Escherichia coli</i> , ESBL	2 minutes	<i>Staphylococcus aureus</i>	2 minutes
<i>Escherichia coli</i> , NDM-1	2 minutes	<i>Staphylococcus aureus</i> , (CA-MRSA USA300)	2 minutes
Hepatitis B Virus, (HBV)	2 minutes	<i>Staphylococcus aureus</i> , (CA-MRSA USA400)	2 minutes
Hepatitis C Virus, (HCV)	2 minutes	<i>Staphylococcus aureus</i> , MDR to [Tc], [Pc], [Em], and [Cli]	2 minutes
Herpes Simplex Virus, Type 1 (HSV 1)	2 minutes	<i>Staphylococcus aureus</i> , Methicillin-Resistant (MRSA)	2 minutes
Herpes Simplex Virus, Type 2 (HSV 2)	2 minutes	<i>Staphylococcus aureus</i> , Vancomycin Intermediate-Resistant (VISA)	2 minutes
Human Immunodeficiency Virus, Type 1 (HIV-1) (AIDS Virus)	2 minutes	<i>Staphylococcus aureus</i> , Vancomycin-Resistant (VRSA)	2 minutes
Influenza A Virus, (H1N1)	2 minutes	<i>Streptococcus pneumoniae</i> , Penicillin-Resistant (PRSP)	2 minutes
Influenza A Virus, (H3N2) Avian	2 minutes	<i>Streptococcus pyogenes</i> , associated with scarlet fever	2 minutes
Influenza A Virus, (H5N1) Avian	2 minutes	<i>Vibrio cholerae</i>	2 minutes
Influenza A Virus, (H7N9) Human	2 minutes		

EPA Reg. No. 6836-372-37549

* Ensure that the hard, non-porous surface remains wet for the entire contact time.

** May not be available in all 50 states.

† See Master Label EPA Reg. 6836-372-37549 for complete list of micro-organisms.

Medline Micro-Kill

Quat

Overall
kill time of
10 min

Bleach-free and alcohol-free

Micro-Kill is an effective bleach-free and alcohol-free disinfectant cleaner wipe.

Effective against TB*

Even without bleach or alcohol, Micro-Kill can achieve disinfection of Tuberculosis and other micro-organisms—see table.

Common uses

Wipes are intended for use on hard, non-porous surfaces. Alcohol free formula to use on non-polycarbonate plastic surfaces. Spot test on inconspicuous area before use.

Micro-Kill kill times

Kill (i.e., contact) time for a disinfectant is the amount of time a surface must remain wet with the product to achieve disinfection.

Ordering information**

Item No.	Wipe Dimensions	Pkg.
MSC351201	6" x 6.75" Wipes, 160 Count Canister	12/cs
MSC351221	10" x 10" Wipes, 60 Count Canister	12/cs
MSC351231	7" x 8" Wipes, 40 Count Narrow Canister	12/cs

Micro-organism	Kill time
<i>Enterococcus faecalis</i> , Vancomycin-Resistant (VRE)	10 minutes
<i>Escherichia coli</i>	10 minutes
<i>Escherichia coli</i> , 0157:H7	10 minutes
Human Immunodeficiency Virus, Type 1 (HIV-1) (AIDS Virus)	2 minutes
Influenza A Virus, (H1N1)	10 minutes
Norwalk Virus, (Norovirus)	10 minutes
<i>Pseudomonas aeruginosa</i>	10 minutes
<i>Salmonella enterica</i>	10 minutes
<i>Staphylococcus aureus</i>	10 minutes
<i>Staphylococcus aureus</i> , Methicillin-Resistant (MRSA)	10 minutes
<i>Staphylococcus aureus</i> , Vancomycin Intermediate-Resistant (VISA)	10 minutes
Tuberculosis (TB) via <i>Mycobacterium bovis</i> , BCG	10 minutes
Feline Calicivirus ‡	10 minutes

MSC351231



MSC351221

MSC351201

KILLS
13
MICRO-ORGANISMS†

EPA Reg. No. 1839-174-37549

* Ensure that the hard, non-porous surface remains wet for the entire contact time.

**May not be available in all 50 states.

† See Master Label EPA Reg. No. 1839-174 for complete list of micro-organisms.

‡ Animal pathogen.

Canister holders

Standard canister holder

- Holds most canister sizes for ease and quick accessibility of wipes
- Wall mountable*
- Also compatible with hand hygiene



MSC351128

Item No.	Description	Pkg.
MSC351128	Standard wall mount canister bracket	12/cs

*Mounting hardware included

Narrow canister holder

- Wire brackets conveniently hold narrow canisters MSC351230 and MSC351231
- Wall-mountable*



MSC3511081

Item No.	Description	Pkg.
MSC3511081	Narrow wall mount canister bracket	12/cs

*Mounting hardware included

Bleach

Micro-Kill Bleach Germicidal Bleach Solution

EPA-registered product which kills *Clostridium difficile* spores¹ in 5 minutes.*

Common uses

Micro-Kill Bleach Solution is an effective method to clean, deodorize and disinfect hard, non-porous environmental and healthcare surfaces. See label for specific instructions for use.

Micro-Kill Bleach Solution kill times*

Kill (i.e., contact) time for a disinfectant is the amount of time a surface must remain wet with the product to achieve disinfection.

Bleach Solution equivalent to 1:10 dilution of 6.5% bleach.

KILLS 58 MICRO-ORGANISMS†



EVSCH900

EVSCH910

1. Environmental Protection Agency List K: Registered Antimicrobial Products Effective against *Clostridium difficile* Spores. January 10, 2018.



Overall
kill time of
5 min

Micro-organism	Kill time
<i>Acinetobacter baumannii</i> -MDR	30 seconds
Adenovirus Type 5	30 seconds
Avian Influenza A Virus (H3N2)	30 seconds
Avian Influenza A Virus (H5N1)	30 seconds
Avian Influenza A Virus (H7N9)	30 seconds
Bordetella pertussis	30 seconds
CA-Methicillin Resistant <i>Staphylococcus aureus</i>	30 seconds
Campylobacter jejuni	30 seconds
Canine Parvovirus	30 seconds
Enterobacter aerogenes	30 seconds
Enterobacter cloacae	30 seconds
<i>Enterococcus faecalis</i> -VRE	30 seconds
<i>Enterococcus faecium</i> -MDR	30 seconds
Escherichia coli	30 seconds
<i>Escherichia coli</i> O157:H7	30 seconds
<i>Escherichia coli</i> -ESBL	30 seconds
<i>Escherichia coli</i> -NDM-1	30 seconds
Feline Panleukopenia Virus (Feline Parvovirus)	30 seconds
Hepatitis A Virus	30 seconds
Hepatitis B Virus	30 seconds
Hepatitis C Virus	30 seconds
Herpes Simplex Virus Type 2	30 seconds
Human Coronavirus	30 seconds
Human Immunodeficiency Virus Type 1	30 seconds
Influenza A Virus (Hong Kong)	30 seconds
Influenza A Virus (Novel H1N1)	30 seconds
Klebsiella pneumoniae	30 seconds

Micro-organism	Kill time
<i>Klebsiella pneumoniae</i> -CRKP (CRE)	30 seconds
<i>Klebsiella pneumoniae</i> -ESBL	30 seconds
<i>Klebsiella pneumoniae</i> -NDM-1	30 seconds
Legionella pneumophila	30 seconds
Linezolid Resistant <i>Staphylococcus aureus</i>	30 seconds
Listeria monocytogenes	30 seconds
Methicillin Resistant <i>Staphylococcus aureus</i> (MRSA)	30 seconds
Norovirus (Feline Calicivirus) (Norwalk Virus)	30 seconds
Polio Virus Type 1	30 seconds
Proteus mirabilis	30 seconds
Pseudomonas aeruginosa	30 seconds
Respiratory Syncytial Virus	30 seconds
Rhinovirus Type 37	30 seconds
Rotavirus	30 seconds
Salmonella enterica	30 seconds
Serratia marcescens	30 seconds
Shigella dysenteriae	30 seconds
<i>Staphylococcus aureus</i>	30 seconds
<i>Staphylococcus aureus</i> -VISA	30 seconds
<i>Staphylococcus aureus</i> -VRSA	30 seconds
Streptococcus pneumoniae	30 seconds
Streptococcus pyogenes	30 seconds
Candida albicans	1 min
Trichophyton interdigitale	1 min
<i>Clostridium difficile</i> spores	5 min

EPA Reg. No. 37549-2

Ordering information**

Item No.	Description	Pkg.
EVSCHEM900	Liquid Bleach, 1-gal.	4/cs
EVSCHEM910	Liquid Bleach, 32-oz.	12/cs

* Ensure that the hard, non-porous surface remains wet for the entire contact time.

** May not be available in all 50 states.

† See Master Label EPA Reg. 37549-2 for complete list of micro-organisms.

Cleaning chemical systems

Ten ways that Medline cleaning chemicals help you improve safety and efficiency

- Improved safety with the right dilution
- Less waste from using only the chemicals you need
- A time-saving bottle-fill
- Green seal products are environmentally friendly
- Virtually maintenance-free
- Easy training and product selection
- Easy operation
- SKU consolidation
- Streamlined chemical purchasing
- Strong, effective cleaning products



Dispensed chemicals

Concentrated chemicals designed for use in any dispenser in this section. All dispensed chemicals come with four 64-oz. containers per case.

Disinfectants

Micro-Kill Q3 Concentrated Disinfectant, Cleaner & Deodorizer

- Concentrated disinfectant, cleaner and deodorizer with 40 efficacy claims
- 3 minute contact time -see product label for the specific micro-organism list
- EPA-registered disinfectant, cleaner and deodorizer for hard, non-porous, non-food contact surfaces
- Fragrance-free
- For Medline chemical dispensing systems (1:256 dilution)

EPA Reg. No. 6836-349-37549

Item No.	Description	Pkg
EVSCHM110	Micro-Kill Q3 disinfectant, 0.5-gal.	4/cs
EVSCHM005	Preprinted empty "Micro-Kill Q3" Spray Bottles, 32-oz.	6/cs



EVSCHM110



EVSCHM005

Medline Micro-Kill NQ5*

- One-step disinfectant with a neutral pH—ideal for disinfecting floors when a quick turnover is needed
- 5-minute contact time
- EPA-registered disinfectant, cleaner and deodorizer for hard non-porous surfaces
- Ocean-breeze fragrance
- For Medline chemical dispensing systems (1:256 dilution)

EPA Reg. No. 6836-364-37549

Item No.	Description	Pkg
EVSCHM215	Micro-Kill NQ5 disinfectant, 0.5-gal.	4/cs
EVSCHM007	Preprinted empty "Micro-Kill NQ5" spray bottles, 32-oz.	6/cs



EVSCHM007



EVSCHM215

*May not be available in all states.

Micro-Kill Q10

- All-in-one cleaner for surfaces, glass and floors—mildly acidic yet will not dull floors finishes
- EPA-registered disinfectant, cleaner and deodorizer for hard non-porous surfaces
- Sassafras fragrance
- For Medline chemical dispensing systems (1:256 dilution)
- 10-minute contact time

EPA Reg. No. 106-73-37549

Item No.	Description	Pkg
EVSCHM100A	Micro-Kill Q10 disinfectant, 0.5-gal.	4/cs
EVSCHM008	Preprinted empty "Micro-Kill Q10" spray bottles, 32-oz.	6/cs



EVSCHM100A



EVSCHM008

Floor care



EVSICHEM210

Neutral floor cleaner

- Designed for daily cleaning and damp dusting
- Neutral pH will not dull floors
- Citrus fragrance
- For Medline chemical dispensing systems (1:512 dilution)

Item No.	Description	Pkg.
EVSICHEM210	Neutral floor cleaner, 0.5-gal.	4/cs



EVSICHEM220

General purpose cleaner

- Designed for removing heavy soils and performing scrub-and-recoat procedures
- High-alkaline, heavy-duty cleaner and floor degreaser
- Citrus fragrance
- For Medline chemical dispensing systems (1:256 dilution)

Item No.	Description	Pkg.
EVSICHEM220	General purpose cleaner, 0.5-gal.	4/cs



EVSICHEM580

Floor rejuvenator

- Extends strip cycle, fills in light scratches and removes embedded soil
- Restorer that makes floors shine like new
- Fragrance-free
- For Medline chemical dispensing systems (1:128 dilution)

Item No.	Description	Pkg.
EVSICHEM580	Floor restorer/maintainer, 0.5-gal.	4/cs



EVSICHEM212

Multi-surface lavender cleaner

- Multi-purpose cleaner to deodorize and remove soil from surfaces
- Lavender fragrance
- For Medline chemical dispensing systems (1:64 dilution)

Item No.	Description	Pkg.
EVSICHEM212	Multi-surface lavender cleaner, 0.5-gal.	4/cs
EVSICHEM006	Preprinted empty multi-surface lavender spray bottles, 32 oz.	6/cs

Surface cleaners

Glass/multi-surface cleaner

- Streak-free on glass and reflective surfaces, and can be used to clean stainless steel
- Non-ammoniated for lower odor
- Fresh, clean fragrance
- For Medline chemical dispensing systems (1:32 dilution)

Item No.	Description	Pkg.
EVSCHEM200	Multi-surface glass cleaner, 0.5-gal.	4/cs
EVSCHEM003	Preprinted empty "Glass Cleaner" spray bottles, 32-oz.	6/cs



EVSCHEM200

EVSCHEM003

Multi-surface peroxide

- True all-in-one surface cleaner
- Hydrogen-peroxide based solution for heavy-duty soils on glass, surfaces, floors and carpets
- Floral fragrance
- For Medline chemical dispensing systems (1:256 dilution)

Item No.	Description	Pkg.
EVSCHEM230	Multi-surface peroxide cleaner, 0.5-gal.	4/cs
EVSCHEM001	Preprinted empty "multi-surface peroxide" spray bottles, 32-oz.	6/cs



EVSCHEM230

EVSCHEM001

Odor counteractant

- Reducing odors can help patient satisfaction
- Non-staining, can be sprayed in air and on surfaces
- Citrus/floral blend fragrance
- For Medline chemical dispensing systems (1:64 dilution)

Item No.	Description	Pkg.
EVSCHEM300	Odor counteractant, 0.5-Gal.	4/cs
EVSCHEM002	Preprinted "odor control" spray bottles, 32-oz.	6/cs



EVSCHEM300

EVSCHEM002

Medline chemical dispensers



EVSCHEMDISP04

4-chamber chemical dispenser

- Lockable cabinet for dispensing chemicals from half-gallon containers
- Two-button design makes filling bottles and buckets easy
- Metering tips built into the chemicals, not the dispenser, minimizing maintenance and breakdowns
- Easy-to-lock doors for security; on-unit bucket hose storage
- Easy installation

Item No.	Description	Pkg
EVSCHEMDISP04	4-Chamber wall-mounted chemical dispenser	1 ea



EVSCHEMDISP02

2-chamber chemical dispenser

- Wall-mounted dispenser for dispensing chemicals from half-gallon containers
- Two-button design makes filling bottles and buckets easy
- Metering tips built into the chemicals, not the dispenser, minimizing maintenance and breakdowns
- Easy-to-lock doors for security; on-unit bucket hose storage
- Easy installation

Item No.	Description	Pkg
EVSCHEMDISP02	2-Chamber wall-mounted chemical dispenser	1 ea



EVSCHEMDISP01

Handheld chemical dispenser

- Handheld dispenser for filling machines with chemicals in situations that don't allow for easy access inside the water closet.

Item No.	Description	Pkg
EVSCHEMDISP01	Handheld chemical dispenser	1 ea



EVS4900H

EVSCHEM010

EVS4932H

Accessories

- For mixing and dispensing concentrated cleaning products
- Graduated for convenient measuring

Item No.	Description	Pkg
EVS4932H	Plastic bottle, 32-oz.	1 ea
EVS4900H	Trigger sprayer	1 ea
EVSCHEM010	Flip-top cap	1 ea

Non-dispensed chemicals

Provide your staff with convenience and efficiency when a water closet is not available

Non-sporicidal disinfectants

Medline Micro-Kill R2*

- Low, 2-minute contact time – see product label for specific list of micro-organisms
- EPA-registered disinfectant, cleaner and deodorizer for hard non-porous surfaces
- EPA-registered soft surface sanitizer

EPA Reg. No. 1839-220-37549

Item No.	Description	Pkg
EVSCHM122	Medline Micro-Kill R2, 32-oz bottles	12/cs

*May not be available in all states.



EVSCHM122



CADEVS81403

Husky 814 Q / T Tuberculocidal spray disinfectant

- Cleaner, deodorizer and mildewstat
- Effective tuberculocidal disinfectant on hard, nonporous surfaces
- Contact time from 30 seconds to 10 minutes
- Meets OSHA Bloodborne Pathogen Standard for HIV, HBV, & HCV

EPA Reg. number: 1839-83-8155

Item No.	Description	Pkg
CADEVS81403	Husky 814 Q / T Tuberculocidal spray disinfectant, 32 oz.	12/cs



CBL4215014

CBL400011

Pure Hard Surface

- Patented molecule, silver dihydrogen citrate (SDC), is rated in the lowest toxicity category, IV—traditional disinfectants are categories I and II
- 5-minute contact time—see product label for specific list of micro-organisms
- Safe to use on food contact surfaces without rinsing
- Child Safety Network 2011 Safe Family Seal of Approval
- EPA-registered disinfectant, cleaner and deodorizer for hard non-porous surfaces

Item No.	Description	Pkg
CBL400011	Pure hard surface disinfectant, 32-oz., 2 trigger sprayers	12/cs
CBL4215014	Pure hard surface disinfectant, 1-gal.	2/cs
CBL4215035	Pure hard surface disinfectant, 2.5-gal.	1 ea

Medline Micro-Kill Foaming Disinfectant Cleaner

- Aerosol spray for easy cleaning
- 10-minute contact time
- Non-abrasive quat-based formula—no scrubbing or rinsing necessary
- EPA-registered disinfectant, cleaner and deodorizer for hard non-porous surfaces

EPA Reg. No. 498-62-37549

Item No.	Description	Pkg
EVSCHM711	17-oz. Medline Micro-Kill foaming disinfectant cleaner	12/cs



EVSCHM711

Sporicidal disinfectants

Micro-Kill Bleach Germicidal Bleach Solution

- 5-minute contact time for *C. diff.* spores
- Equivalent to 1:10 dilution of 6.5% bleach
- 58 efficacy claims

EPA Reg. No. 37549-2

Item No.	Description	Pkg
EVSCHEM900	Liquid bleach, 1-gal.	4/cs
EVSCHEM910	Liquid bleach, 32-oz.	12/cs



EVSCHEM900

EVSCHEM910

Disinfectant tablets

- 4-minute contact time for *C. diff.* spores, 1- minute contact time for norovirus and much more.
- Bleach alternative in effervescent tablet form
- Chlorine donor based technology is much gentler on clothing and floor finishes than bleach

Item No.	Description	Pkg.
BRI1612018G	BruTab6S disinfectant tablets, 3.34 g, 200 tablets/tub	6 tubs/cs
BRI1612018N	BruTab6S disinfectant tablets, 13.1 g, 256 tablets/tub	2 tubs/cs
BRI001	BruTab6S wide-neck trigger spray bottles, 24-oz	6 ea/cs
BRI002	BruTab6S wide-neck pour top bottles, 32-oz, 1 trigger spray included	6 ea/cs
BRI002L	BruTab6S labels	10 ea/cs
BRI002T	Trigger spray head for wide neck	1 ea
BRI003	BruTab6s disinfectant tablets transport pack	10 ea/cs
BRI1610548N	Bru-Clean tbc2 disinfectant tablets, 256 tablets/tub	2 tubs/cs
BRI002TbC	Preprinted empty bru-Clean pour top bottles, 32-oz, 1 trigger sprayer included	6 ea/cs



EPA REG. NO.
71847-6-106

EPA REG. NO.
71847-7-106

Laundry detergent



EVSCHEM820

Free and clear laundry detergent with built-in fabric softener

- Detergent is free of formaldehyde and dyes
- Biodegradable, greywater and septic safe, pH balanced
- Protects colors and fabrics
- Uses one ounce per high-efficiency (HE) load and two ounces for standard loads

Item No.	Description	Pkg.
EVSCHEM820	Free and Clear, 1 gallon	4/cs

Surface cleaners

Touch screen cleaning wipes*

- Designed to clean touch screens and energized equipment recommending 70% isopropyl alcohol
- Cleans dirt, grime, fingerprints and smudges
- For cleaning purposes only; this is not a disinfectant or sterilant

Item No.	Wipe Dimensions	Pkg.
MSC351500	6" x 6" touch screen cleaning wipes, 160 count canister	12/cs

*This item is a cleaning product and is not intended for disinfection.



Great for digital tech

MSC351500

Floor care

Low-odor floor finish

- High performance with low odor
- High-gloss with excellent resistance to marks and scuffs
- Superb response to burnishing with 18% solids
- Quick dry time

Item No.	Description	Pkg
EVSCHEM500	Low-odor floor finish, 2.5 gal.	2/cs



EVSCHEM500

Multi-speed floor finish

- Premium blend of 22% solids provides great durability and shine, regardless of maintenance program used
- Shows excellent resistance to alcohol-based sanitizers
- Multi-speed—can be used with low/high speed machines
- Multi-surface—can be used on VCT and stone

Item No.	Description	Pkg
EVSCHEM510	Multi-speed floor finish, 2.5-gal.	2/cs



EVSCHEM510

DuraPro 25 floor finish

- Fast shine and superb gloss with 25% solids
- Consistent spreading and easy leveling
- Excellent mark and scuff resistance to stand up to heavy traffic
- The durability to extend your scrub, recoat and strip cycle
- Can be maintained with any program, frequency or equipment

Item No.	Description	Pkg
EVSCHEM520	DuraPro high gloss floor finish, 2.5-gal.	2/cs



EVSCHEM520



EVSCHM550



EVSCHM560



EVSCHM750



EVSCHM490



EVSCHM590

Heavy-duty floor stripper

- Removes finish down to bare floors; innovative "dosing" quart bottle ensures 1:20 dilution.

Item No.	Description	Pkg.
EVSCHM550	Heavy-duty floor stripper, 32-oz.	6/cs

Low-odor floor stripper

- Designed for areas with high traffic or patient/resident rooms; dilute to a 1:32 ratio.

Item No.	Description	Pkg.
EVSCHM560	Low-odor floor stripper, 32-oz.	6/cs

Baseboard stripper

- Protect your baseboards by using an aerosol instead of a traditional floor stripper.

Item No.	Description	Pkg.
EVSCHM750	Baseboard stripper, 19-oz.	6/cs

Foam control agent

- Works as a defoamer and an antifoam agent
- Provides effective control in auto scrubbers, extraction machines, and wet vacs
- Dilutes 1:640

Item No.	Description	Pkg.
EVSCHM490	Chemical defoamer, 32-oz.	6/cs

Ultra shine floor finish restorer

- Designed to reduce mop and machine drag and enhance burnishing results
- Brilliant floor finish restorer
- Provides a brilliant reflective shine
- Dilute to a 1:64 ratio

Item No.	Description	Pkg.
EVSCHM590	Ultra shine floor finish restorer, 32-oz.	4/cs

Bathroom cleaners

Heavy-duty toilet bowl cleaner

- For heavy rust and scale buildup
- Contains hydrochloric acid to remove rust and scale from toilet bowls
- Floral fragrance

Item No.	Description	Pkg.
EVSCHM440	9.5% heavy-duty toilet bowl cleaner, 32-oz.	12/cs



EVSCHM440

Non-acid bowl cleaner

- Budget friendly, for daily-use
- Blue color so you know the toilet is clean
- Fresh fragrance

Item No.	Description	Pkg.
EVSCHM430	Non-acid toilet bowl cleaner, 32-oz.	12/cs



EVSCHM430

Crème cleanser

- For removal of heavy buildup of soap scum, scale, and rust
- Mildly-abrasive thickened cleanser
- Sassafras fragrance

Item No.	Description	Pkg.
EVSCHM410	Mild abrasive crème cleanser, 32-oz.	12/cs



EVSCHM410

Foaming acid shower cleaner

- Dissolves tough rust, scale and soap scum
- Foaming acidic shower cleaner
- Lime fragrance

Item No.	Description	Pkg.
EVSCHM450	Foaming acid shower cleaner, 32-oz.	12/cs



EVSCHM450

Drain opener

- Thickened formula sinks and clings to point of obstruction
- Highly effective against fats, oils, lint and hair
- Odorless and non-flammable

Item No.	Description	Pkg.
EVSCHM470	Drain opener, 32-oz.	12/cs



EVSCHM470

Cleaners



EVSCH400 EVSCH740



EVSCH610



EVSCH201



EVSCH460



EVSCH480



EVSCH600

Polishes

- Use on both wood and stainless steel for SKU consolidation
- Cleaner, polish and protectant
- Lemon fragrance

Item No.	Description	Pkg.
EVSCH400	Multi-purpose cream polish, 32-oz.	12/cs
EVSCH740	Multi-surface polish, aerosol, 20-oz	12/cs

Heavy-duty degreaser

- Removes graffiti, oils, and sticky residues with ease
- Non-butyl, heavy solvent-based degreaser
- Floral fragrance

Item No.	Description	Pkg.
EVSCH460	Heavy-duty degreaser, 32-oz.	12/cs

Carpet spotter

- Versatile, multi-stain spotter brings out carpet colors
- Removes general stains, organic soils, and even red juice
- Hydrogen-peroxide based
- Floral fragrance

Item No.	Description	Pkg.
EVSCH610	General purpose carpet spotter, 32-oz.	12/cs

Digester/eliminator

- Effective hard surface cleaner and odor counteractant
- Enzymatic to eliminate odors
- Removes odors from organic soils such as urine and uric acid
- Lavender fragrance

Item No.	Description	Pkg.
EVSCH480	Uric eradicant, 32-oz.	12/cs

Ammoniated glass cleaner

- Streak-free cleaner for glass, mirrors and other hard surfaces
- Dries quickly
- Ready to use

Item No.	Description	Pkg.
EVSCH201	Glass and utility cleaner, 32-oz.	12/cs

Tile and grout cleaner

- Highly effective at removing mold and mildew stains
- Leaves surfaces clean and smelling fresh
- Gentler than using straight bleach

Item No.	Description	Pkg.
EVSCH600	Tile and grout cleaner, 32-oz.	12/cs

Victory sprayers

Convenient, effective professional dispensers for disinfecting, sanitizing, odor removal, decontamination, pesticides/fertilizing, and more.

Cordless electrostatic handheld sprayer

- Ergonomic chemical dispenser with a 1 liter easy fill tank.
- 3-in-1 nozzle adjusts for coverage and run time per tank
- Long lasting battery with up to 4 hours run time
- Handle lock for safety and comfort
- LED headlight for visibility
- Durable glass-filled housing
- 3.8 pounds empty
- 5.9 pounds full
- Includes heavy duty kit box



EVSSPRAYHH

Item No.	Description	Pkg.
EVSSPRAYHH	Victory handheld sprayer	1/ea
EVSSPRAYBAT	Victory sprayer rechargeable battery	1/ea

Cordless electrostatic backpack sprayer

- Wearable chemical dispenser with a 2.25 gallon easy fill tank.
- 3-in-1 nozzle adjusts for coverage and run time per tank
- Long lasting battery with up to 4 hours run time
- Handle lock for safety and comfort
- LED headlight for visibility
- Durable glass-filled housing
- 10 pounds empty
- 28.8 pounds full
- Includes heavy duty kit box



EVSSPRAYBP

Item No.	Description	Pkg.
EVSSPRAYBP	Victory backpack sprayer	1/ea
EVSSPRAYBAT	Victory sprayer rechargeable battery	1/ea

Sprayers



NIL524093

FlexSpray sprayer

- Sprayers engineered for smaller surfaces and objects
- Great speed and portability for smaller jobs
- Flow speed can be adjusted for greater control
- Max flow of 0.20 gpm

Item No.	Description	Pkg.
NIL524093	Handheld sprayer	1/ea



NIL56394501

Impact 410 sprayers

- Airless sprayers provide high application speed
- Assists with regular application of cleaning and disinfectant solutions

Item No.	Description	Pkg.
NIL56394501	Impact 410 skid with 2 hea 413 tips	1/ea
NIL56394504	Impact 410 transport wheels and bucket holder	1/ea



NIL56394508

Impact 440 HR sprayer

- Sprayers with highly efficient airless spray technology to help deliver optimal wetting with a large fan pattern with bigger droplets
- Great for medium-sized surfaces
- Configure pressure from 500 to 1,200 PSI, 0.47 to 0.70 gpm

Item No.	Description	Pkg.
NIL56394508	Impact 440 hr impact sprayer with 2 hea 413 tips	1/ea



PAC685401

Air mister

- Versatile spraying unit
- 15 gallon tank to provide continual usage

Item No.	Description	Pkg.
PAC685401	Air mister	1/ea

AccuPoint® HC

A single AccuPoint HC reading connects many data points

- Where the sample was taken (bed rail, table, toilet seat, light switches, doorknob, etc.)
- The room number
- Housekeeper on duty
- When the sample was taken

Multiple AccuPoint HC readings are analyzed in Data Manager

- Trends and patterns are observed in real time
- Historical reviews by surface, area or housekeeper
- Audits or epidemiological studies are supported
- Actions are taken based on observations
- Superior performance can be promoted or deficiencies addressed
- Staff can be trained or reinforced on protocols
- Protocols can be changed or enhanced

Item No.	Description	Pkg.
EVSATPSYSTEM	Monitor and Software	1 ea
EVSATP9905	Samplers	100/cs



EVSATP9905



EVSATPSYSTEM

Document your cleaning protocol effectiveness and infection control measures with AccuPoint HC

- ATP (adenosine triphosphate): cellular matter found in organic substances
- Residual ATP: the industry standard for cleanliness monitoring
- The cleaner the surface, the less ATP is found
- AccuPoint HC provides unbiased, reliable and accurate test results
- Documentation provided by AccuPoint HC supports your infection control measures

UV light disinfectants



EVSSL001

Solaris eliminates pathogens from high-touch surfaces rapidly and reliably

- High pulsed UV flash rate for increased efficacy
- Engineered reflector targets high-touch areas where pathogens hide
- Simple 3 and 5-minute cycles are 15–40% faster than competitors
- IoT-enabled data collection and system diagnosis

Solaris is engineered for ease of use and built to last

- Robust outer shell designed with hospital operations in mind
- 360-degree rotation for whole room coverage
- Subscription programs provide service and maintenance for one convenient monthly fee

Item No.	Description	Pkg.
EVSSL-002	Lytbot machine and software	1 ea
EVSSLSERV2	Monthly service for Solaris Lytbot	1 ea
EVSSLSUBSCRIP2	Monthly subscription for Solaris Lytbot	1 ea



EVSUVAIR

S400 portable air disinfection device

- Effective against specific viruses* and bacteria* less than 0.3 micron in size
- 360° system circulates air at 400 cubic feet per minute (CFM)
- Complete odor and VOC removal
- Patented UV-C technology
- On-board digital screen reporting

Item No.	Description	Pkg.
EVSUVAIR	S400 portable air disinfection device	1 ea
EVSUVAIRSERV	S400 portable air disinfection device annual filter replacement kit	1 ea



EVSUVEXPRO

ExpressPro disinfecting units

- Rapid UV disinfection station for busy work environments with individual and shared-use devices (phones, tablets, etc.) that require quick, effective, and consistent disinfection*
- Up to 99.99% reduction in 30 seconds for the following pathogens: *C.difficile*, MRSA and SARS-CoV-2
- Touchless operation
- 360° disinfection
- OLED display for any product instructions or notifications

Item No.	Description	Pkg.
EVSUVEXPRO	ExpressPro disinfection unit	1 ea
EVSUVEXPDS	Desk stand, ExpressPro	1 ea
EVSUVEXPRS	Portable roller stand, ExpressPro	1 ea

*Not intended for use on medical devices.

Air fresheners

Medline solid passive air deodorizer

- One refill lasts up to 60 days
- Each refill covers up to 6,000 cubic feet

Item No.	Description	Pkg.
EVSAIRDISP1	Solid dispenser, 2.48"L 2.76"W 5.67"H, Black	1 ea
EVSAIR1	Solid freshener, apple orchard	6/cs
EVSAIR2	Solid freshener, cucumber melon	6/cs
EVSAIR4	Solid freshener, ocean spray	6/cs
EVSAIR5	Solid freshener, citrus mango	6/cs
EVSAIR6	Air freshener, lavender and geranium	6/cs
EVSAIR7	Air freshener, bergamot and sandalwood	6/cs
EVSAIR8	Air freshener, sea salt and bamboo	6/cs
EVSAIR9	Air freshener, linen breeze	6/cs

Solid air freshener dispenser and refills

- High-quality fragrance delivery for up to 30 days, covering up to 3,500 cubic feet
- EVA material for optimum fragrance performance
- Recyclable, cost effective, and VOC exempt

Item No.	Description	Pkg.
EVSAIR5E	30-Day citrus and mango air freshener	12/cs

Clip and go air freshener

- Large internal surface area for effective, high-quality fragrance performance
- Clip-and-go, clip-and-throw™ design—replace used dispenser with a brand new version using the same fixing
- Economical to run; no aerosols, batteries, fans or propellants—just natural airflow

Item No.	Description	Pkg.
EVSAIRSHELL7	Air freshener, bergamot and sandalwood	6/cs

Medline urinal screen air freshener

- One screen lasts up to 30 days

Item No.	Description	Color	Pkg.
EVSSCREEN5A	Urinal screen, 7" x 7", citrus mango	Yellow	10/cs



EVSAIRDISP1



EVSAIR4



EVSSCREEN5A

**Soap and
hand hygiene
products**



Medline foam hand soap

- Easy foaming
- Gentle enough for everyday use

Item No.	Description	Size	Pkg.
HHSP1000FM	Hand soap, foam	1,000 ml	4/cs



HHSP1000FM

Medline lotion soap

- Aloe vera to condition skin
- Gently moisturizes and cleans hands

Item No.	Description	Size	Pkg.
HHSP04	Hand soap, lotion, flip-top	4 oz.	12/cs
HHSP75	Hand soap, pump bottle	7.5 oz.	12/cs
HHSP16	Hand soap, lotion, pump bottle	16 oz.	12/cs
HHSP1000	Hand soap, dispenser	1,000 ml	4/cs
HHSPG	Hand soap, lotion	gallon	4/cs



HHSP series



HHABSP1000FM

Medline foam antibacterial hand soap

- 13% benzalkonium choride active ingredient
- Helps kill harmful germs
- Gentle enough for everyday use

Item No.	Description	Size	Pkg.
HHABSP1000FM	Antibacterial hand soap, foam	1,000 ml	4/cs

Medline lotion soap

- Aloe vera to condition skin
- Gently moisturizes and cleans hands

Item No.	Description	Size	Pkg.
HHABSP04	Antibacterial hand soap, liquid	4 oz.	12/cs
HHABSP75	Antibacterial hand soap, liquid	7.5 oz.	12/cs
HHABSP16	Antibacterial hand soap, liquid	16 oz.	12/cs
HHABSP1000	Antibacterial hand soap, liquid	1,000 ml	4/cs
HHABSPG	Antibacterial hand soap, liquid	gallon	4/cs



HHABSP series

Hand hygiene solutions

Spectrum™ 70% ethyl alcohol hand sanitizer foam

Item No.	Description	Size	Pkg.
HH70F1000	Medline hand sanitizer foam - 70%	1,000 ml	4/cs



HH70F1000

Spectrum™ 70% ethyl alcohol hand sanitizer gel

Item No.	Description	Size	Pkg.
HH70G02	Spectrum hand sanitizer gel - 70%	2 oz.	48/cs
HH70G04	Spectrum hand sanitizer gel - 70%	4 oz.	24/cs
HH70G08	Spectrum hand sanitizer gel - 70%	8 oz.	12/cs
HH70G15	Spectrum hand sanitizer gel - 70%	15 oz.	6/cs
HH70G1000	Spectrum hand sanitizer gel - 70%	1,000 ml	4/cs

Dispensing systems

Item No.	Description	Pkg.
MANDISPW	White manual dispenser	6/cs
MANDISPB	Black manual dispenser	6/cs
AUTODISPW	White auto dispenser	1 ea
AUTODISPB	Black auto dispenser	1 ea



MANDISPW



AUTODISPW



HH70G series

Textiles



Maximizing your budget while enhancing care

The ideal bed

Our recommended product mix for a standard healthcare bed that gives you the "biggest bang" for your budget dollars while enhancing patient care.

1 **MedSoft® pillows**
These fluffy pillows feature soft vinyl ticking that is antimicrobial-treated to protect the product; and hypoallergenic and fluid proof. Designed for maximum patient comfort and safety. This product is treated with an antimicrobial agent built in to protect the product. This product does not protect users or others against bacteria, viruses, germs or other disease organisms. **MDT219683** (pg. 110)

2 **Percal pillowcases**
Comfort and durability in one affordable package, this pillowcase is made from a premium 55% cotton/45% polyester blend that is soft to the touch, but long-wearing and wrinkle-resistant. **MDTPC4P34** (pg. 111)

3 **Soft-Fit® knitted contour sheets**
Super soft Soft-Fit sheets move with the patient to provide exceptional comfort. Wrinkle resistant fabric stretches to fit a wide range of bed sizes. **MDTNC4J15** (pg.113)

4 **Quick Dry reusable underpad**
Dries to the touch in minutes. Performs like a high-end disposable underpad but features the sustainability and cost benefits of a reusable. **MDTIU8SEFBLU** (pg. 115)

5 **Muslin flat sheets**
Constructed from a durable blend of 55% cotton/45% polyester, these quality sheets are designed to easily fit within any budget. **MDTFS4M04** (page 111)

6 **Herringbone blankets**
Available in a variety of colors to fit any décor, this blanket is highly durable, yet light weight at 3.0 lbs. Soft and comfortable, our Herringbone spread retains body heat effectively because of its tight weave construction. **MDTSB4B30CAP** (page 114)

7 **Suede Touch quilt**
Adds warmth
MITQSQPEAT (page 138)



Pillows



MDT219683

Medsoft pillows

- Soft, vinyl ticking is inherently flame resistant, antistatic and fluid-resistant
- This product is treated with an antimicrobial agent built in to protect the product. This product does not protect users or others against bacteria, viruses, germs or other disease organisms
- Indicated items are vacuum-packed, which results in smaller cartons for delivery and storage
- Please allow 4 hours for vacuum-packed pillows to fully expand

Item No.	Description	Pkg.
MDT219683	White, 20" x 26"	12/cs
MDT219684	White, 18" x 24"	20/cs
MDT219684C	White, 18" x 24"; vacuum-packed	20/cs



MDT219715

Nylox Ultra and Nylox Ultra II pillows

- Takes up to 50% less storage space yet plumps up for full-size comfort
- Fluid-resistant woven nylon ticking is treated with an antimicrobial agent built in to protect the product. This product does not protect users or others against bacteria, viruses, germs or other disease organisms
- Flame-resistant and stain-resistant ticking
- Vacuum packed, which results in smaller cartons for delivery and storage
- Please allow 4 hours for vacuum-packed pillows to fully expand

Item No.	Description	Pkg.
MDT219715	Tan, 20" x 26"	12/cs
MDT219716	Tan, 18" x 24"	10/cs
MDT219800D	Blue, 20" x 26"	12/cs
MDT219801D	Blue, 18" x 24"	20/cs



MDT219860, MDT219885

Ovation® pillows

- Fluid-resistant with polypropylene ticking
- Priced to meet your budget
- Vacuum packed, which results in smaller cartons for delivery and storage
- Please allow 4 hours for pillow to fully expand

Item No.	Description	Pkg.
MDT219860	White, 20" x 26"	12/cs
MDT219861	White, 18" x 24"	20/cs
MDT219885	Blue, 20" x 26"	12/cs
MDT219886	Blue, 18" x 24"	20/cs

Woven sheets and pillowcases

Medline interblend percale linens ✓✓

- Hydrogen peroxide bleached for whiter color and softer feel
- Outstanding comfort and durability
- Long wearing, wrinkle-resistant provides clean, crisp appearance
- Intimate blend of 55% cotton/polyester percale fabric

Flat sheets

Item No.	Description	Pkg.
MDTFS4P08N	60" x 108"	5 dz/cs
MDTFS4P04	66" x 104"	5 dz/cs
MDTFS4P04Z	66" x 104"	2 dz/cs
MDTFS4P08	66" x 108"	5 dz/cs
MDTFS4P15	66" x 115"	5 dz/cs

Contour sheets

MDTCS4P80	36" x 80" x 9"	5 dz/cs
MDTCS4P80Z	36" x 80" x 9"	2 dz/cs
MDTCS4P84	36" x 84" x 9"	5 dz/cs

Draw sheets

MDTDS4P72	54" x 72"	5 dz/cs
MDTDS4P72Z	54" x 72"	2 dz/cs
MDTDS4P81	54" x 81"	5 dz/cs

Pillowcases

MDTPC4P34	42" x 34"	12 dz/cs
MDTPC4P34Z	42" x 34"	2 dz/cs

Additional sizes available
Additional low delivery units available



Medline interblend percale linens series

Best ✓✓✓ Better ✓✓ Good ✓



Medline classic muslin linen series

Lightweight and easy to launder

Medline classic muslin linens ✓

- Hydrogen peroxide bleached for whiter color and softer feel
- Durable blend of 55% cotton/45% polyester muslin fabric

Flat sheets

Item No.	Description	Pkg.
MDTFS4M04	66" x 104"	5 dz/cs
MDTFS4M04Z	66" x 104"	2 dz/cs
MDTFS4M08	66" x 108"	5 dz/cs
MDTFS4M15	66" x 115"	5 dz/cs

Contour sheets

MDTCS4M80	36" x 80" x 9"	5 dz/cs
MDTCS4M80Z	36" x 80" x 9"	2 dz/cs
MDTCS4M84	36" x 84" x 9"	5 dz/cs

Draw sheets

MDTDS4M72	54" x 72"	5 dz/cs
MDTDS4M72Z	54" x 72"	2 dz/cs
MDTDS4M81	54" x 81"	5 dz/cs

Pillowcases

MDTPC4M34	42" x 34"	12 dz/cs
MDTPC4M34Z	42" x 34"	2 dz/cs

Additional sizes available
Additional low delivery units available

Knitted contour sheets



MDTNC8S27, MDTNC8S21

PerforMAX envelope contour sheets

- 100% polyester with cotton-like softness
- Wrinkle-resistant surface moves with patient to help reduce friction
- Long-lasting, stain-resistant and maintains bright white appearance longer
- Fits wide range of mattress sizes from 32" x 80" to 42" x 88" and every size in between

Item No.	Description	Pkg.
MDTNC8S27	27 oz	3 dz/cs
MDTNC8S21	21 oz	3 dz/cs

Additional low delivery units available

Envelope contour sheet

- 100% stain-resistant polyester fibers easily wash away natural or water-based stains
- Maintains bright white appearance even after repeated washings
- Minimal shrinkage allows for greater longevity

Item No.	Description	Pkg.
MDTNC6S27	27 oz.	3 dz/cs



MDTNC5L19

Medline Soft-Span™ knitted sheets with 4-way stretch

- Soft-Span has stronger elasticity to better fit most sizes of healthcare mattresses
- Excellent memory retention allows the sheets to cling to the mattress
- Strength of the spandex fibers gives this product exceptional durability and greatly reduced pinholing
- 55% combed cotton/41% polyester/4% spandex
- 19, 21 & 24 oz sheets will fit mattresses up to 42" wide and 88" long

Item No.	Description	Pkg.
MDTNC5L24	White, 24 oz	3 dz/cs
MDTNC5L21	White, 21 oz	3 dz/cs
MDTNC5L19	White, 19 oz	3 dz/cs

Additional low delivery units available

Medline's Soft-Fit knitted contour sheets ✓

- Exceptional patient comfort
- Knitted sheets come out of the dryer virtually wrinkle-free with no need for ironing
- Constructed with spandex in the bias to provide an even better fit
- All Soft-Fit knitted sheets have a 14" gusset

Item No.	Description	Pkg.
MDTNC4J24	White, 24 oz	5 dz/cs
MDTNC4J21	White, 21 oz	5 dz/cs
MDTNC4J19	White, 19 oz	5 dz/cs
MDTNC4J15	White, 15 oz	5 dz/cs
MDTNC4J15Z	White, 15 oz	2 dz/cs
MDTNC4J13	White, 13 oz, no spandex	5 dz/cs

Additional low delivery units available



MDTNC4J Series

Medline stretcher sheets

- Virtually wrinkle-free, no ironing required
- Soft-Fit is made of 55% combed cotton/45% polyester
- PerformAX material is a blend of synthetic fibers that fade less, resist stains, shrink less and maintain their shape

Item No.	Description	Pkg.
*MDTNC5J12BLU	Soft-Fit, Blue, 55% cotton/45% polyester, 30" x 80" x 8", 12 oz	5 dz/cs
MDTNC4J10BLU	Jersey, Blue, 55% cotton/45% polyester, 24" x 72" x 12", 10 oz	5 dz/cs
MDTNC4J10WHT	Jersey, White, 55% cotton/45% polyester, 24" x 72" x 12", 10 oz	5 dz/cs

* Larger size stretcher sheets. Other sizes and weights available



Medline's Soft-Fit Knitted Contour Sheets Series



MDTNC5J12BLU

Blankets

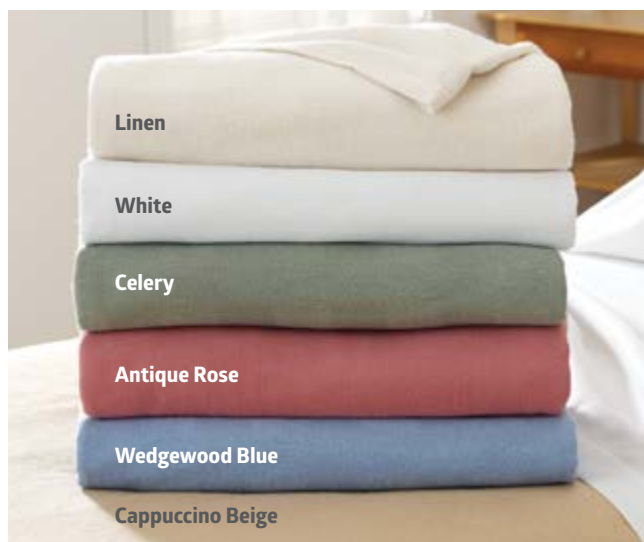

MDTSB4B Series

Herringbone spread blankets

- Our number one seller
- Extremely cost effective due to durability
- Efficiently retains body heat because of tight weave
- Napped on both sides for added comfort
- 55% cotton/45% polyester
- Measures 70" x 108"

Item No.	Color	Weight (ea)	Pkg.
MDTSB4B30LIN	Linen	3.0 lbs	12/bl
MDTSB4B30WHI	White	3.0 lbs	12/bl
MDTSB4B30CEL	Celery	3.0 lbs	12/bl
MDTSB4B30ANT	Antique Rose	3.0 lbs	12/bl
MDTSB4B30WED	Wedgewood Blue	3.0 lbs	12/bl
MDTSB4B30CAP	Cappuccino Beige	3.0 lbs	12/bl



MDTBB3B14T

Medline bath blankets

- Unbleached bath blankets made from exceptional yarns
- Napped on both sides for a soft flannel surface with minimal pilling
- Soft, warm, comfortable and highly absorbent

82% cotton/18% polyester

Item No.	Description	Weight (ea)	Pkg.
MDTBB3B14T	70" x 90"	1.4 lbs	24/cs
MDTBB3B17T	72" x 90"	1.75 lbs	24/cs

100% cotton

MDTBB3C14Z	70" x 90"	1.4 lbs	12/cs
MDTBB3C14T	70" x 90"	1.4 lbs	12/cs

Underpads

Quick Dry reusable underpad

- Dry to the touch in minutes—Fast and efficient fluid wicking, absorption and distribution within the underpad
- Performs like a high-end disposable underpad but with the sustainability and cost benefits of a reusable
- Lays flat and stays flat—Unique bonded construction; won't bunch or roll under the patient

Item No.	Description	Pkg.
MDTIU8SEFBLU	Quick Dry, 34"x 36", heavy soaker, green face	2 dz/cs



MDTIU8SEFBLU

Sofnit® 300 Reusable Underpads

- Features durable, comfortable twill facing or plaid Ibex® facing that conceals staining
- Vinyl knit barrier withstands heavy demands of multiple washing and drying cycles
- Stays soft and water resistant

Moderate soaker, white face

Item No.	Description	Pkg.
MDTIU3TABPNK	Sofnit 300 18" x 24"	2 dz/cs
MDTIU3TCFPNK	Sofnit 300 30" x 36"	2 dz/cs
MDTIU3TEFPNK	Sofnit 300 34" x 36"	2 dz/cs
MDTIU3TEFPNKZ	Sofnit 300 34" x 36"	1 dz/cs
MDTIU3TEFPNKH	Sofnit 300 34" x 36"	1 ea
MDTIU3TEFPNKW	Sofnit 300 34" x 36", w/ wings	2 dz/cs
MDTIU3TEIPNK	Sofnit 300 34" x 48"	2 dz/cs



Moderate soaker, plaid face

MDTIU3XABGRE	Sofnit 300 18" x 24"	2 dz/cs
MDTIU3XCFHUN	Sofnit 300 30" x 36"	2 dz/cs
MDTIU3XEFHUN	Sofnit 300 34" x 36"	2 dz/cs
MDTIU3XEFHUNZ	Sofnit 300 34" x 36"	1 dz/cs
MDTIU3XEIHUN	Sofnit 300 34" x 36"	1 dz/cs

Sofnit® 200 Reusable Underpads

- Economical and durable
- Cotton/polyester twill face fabric remains soft for patient comfort and offers high-heat resistance during drying
- Lightweight soaker allows for processing efficiencies and remains water resistant

Item No.	Description	Pkg.
MDTIU2TDFPEA	Sofnit 200 32" x 36", light soaker, white face	2 dz/cs
MDTIU2TDFPEAH	Sofnit 200 32" x 36", light soaker, white face	1 ea
MDTIU2TCFPEA	Sofnit 200 30" x 36", light soaker, white face	2 dz/cs
MDTIU2TEIPEA	Sofnit 200 34" x 48", light soaker, white face	2 dz/cs
MDTIU2TEFPEA	Sofnit 200 34" x 36", light soaker, w/wings, white face	1 dz/cs



MDTIU2TDFPEA

Mattress encasements and covers

What is the difference between covers and encasements?

Covers

- Fits like a traditional contour sheet to protect top of mattress
- Easy application and removal for cleaning
- Ideal for beds with higher patient/resident change over
- Protects mattress from wetness and staining
- Processes easily in a regular commercial-style machine or an industrial laundry

Encasements

- Envelopes entire mattress in protection with zip closure and lock
- Ideal for long-term residents
- Allergen-blocking and bed bug protection, as well as water resistant to prevent wetness and staining
- Processes easily in a regular commercial-style machine (not intended for industrial laundry)



MDT219403

Frostlite mattress covers/encasements

- 3-gauge vinyl
- Economical method to protect mattresses and pillows from fluid penetration
- Choose contour item for a mattress cover version of this option

Mattress encasements

Item No.	Description	Pkg.
MDT219409	Zipper, 36" x 80" x 9"	1 dz/cs

Mattress covers

MDT219403	Contour, 36" x 80" x 9"	1 dz/cs
-----------	-------------------------	---------

Pillow encasements

MDT219411Z	Zipper, 21" x 27"	2 dz/cs
------------	-------------------	---------

Best ✓✓✓

Better ✓✓

Good ✓

Vinyl mattress covers/encasements ✓✓

- 6-gauge vinyl
- Treated with Ultra-Fresh®, an antimicrobial which inhibits the growth of mold, mildew, fungi and odor-causing bacteria on the product
- This product is treated with an antimicrobial agent built in to protect the product. This product does not protect users or others against bacteria, viruses, germs or other disease organisms
- Choose contour item for a mattress cover version of this option

Mattress encasements

Item No.	Description	Pkg.
MDT219428	Zipper, 36" x 80" x 7"	1 dz/cs
MDT219429	Zipper, 36" x 84" x 9"	1 dz/cs

Mattress covers

MDT219422	Contour, 36" x 80" x 9"	1 dz/cs
-----------	-------------------------	---------

Pillow encasements

MDT219430Z	Zipper, 21" x 27"	2 dz/cs
------------	-------------------	---------



MDT219428

Bath towels



MDTBT5C series



MDTBT4B series

Medline fine spun towels ✓✓

- Premium-grade 100% ring-spun cotton gives these terries a plush, luxurious look and feel
- Treated with hydrogen peroxide for a brighter white appearance
- Using our finest 16/1 ring-spun cotton, these terries are strong with a significantly softer hand to offer you the best in patient experience

Bath towels

Item No.	Description	Pkg.
MDTBT5C55Z	20" x 40", 5.5 lb/dz	5 dz/cs
MDTBT5C60Z	22" x 44", 6 lb/dz	5 dz/cs
MDTBT5C80R	24" x 48", 8 lb/dz	10 dz/cs
MDTBT5C10R	24" x 50", 10.5 lb/dz	10 dz/cs

Washcloths

MDTWC5C16SZ	12" x 12", 1 lb/dz	10 dz/cs
-------------	--------------------	----------

Hand towels

MDTHT5C30Z	16" x 27", 3 lb/dz	5 dz/cscs
------------	--------------------	-----------

Medline interblend towels ✓✓

- These blended terries are the ultimate soft and durable towels at affordable prices
- Ideal blend of 85% cotton/15% polyester
- Woven to last long and dry fast
- Includes 16/1 ring spun yarns in the construction for added strength and softness
- Treated with hydrogen peroxide for a brighter white appearance

Bath towels

Item No.	Description	Pkg.
MDTBT4B55Z	20" x 40", 5.5 lb/dz	5 dz/cs
MDTBT4B60Z	22" x 44", 6 lb/dz	5 dz/cs
MDTBT4B80R	24" x 48", 8 lb/dz	10 dz/cs
MDTBT4B80Z	24" x 48", 8 lb/dz	5 dz/cs
MDTBT4B10R	24" x 50", 10 lb/dz	10 dz/cs

Washcloths

MDTWC4B11HZ	12" x 12", 0.7 lb/dz	10 dz/cs
MDTWC4B12SZ	12" X 12", 0.75 lb/dz	10 dz/cs
MDTWC4B16SZ	12" x 12", 1 lb/dz	10 dz/cs

Hand towels

MDTHT4B30Z	16" x 27", 3 lb/dz	5 dz/cs
------------	--------------------	---------



MDTBT3C series

Priced to meet your budget

Medline classic

- 100% open-end cotton terries provide excellent absorbency and performance while meeting your budget
- Treated with hydrogen peroxide for a brighter white appearance

Bath towels

Item No.	Description	Pkg.
MDTBT3C40T	20" x 40", 4 lb/dz	10 dz/cs
MDTBT3C40Z	20" x 40", 4 lb/dz	5 dz/cs
MDTBT3C50T	20" x 40", 5 lb/dz	10 dz/cs
MDTBT3C50Z	20" x 40", 5 lb/dz	5 dz/cs
MDTBT3C55T	20" x 40", 5.5 lb/dz	10 dz/cs
MDTBT3C55Z	20" x 40", 5.5 lb/dz	5 dz/cs
MDTBT3C60Z	22" x 44", 6 lb/dz	5 dz/cs

Washcloths

MDTWC3C07SZ	11" x 11", 0.5 lb/dz	10 dz/cs
MDTWC3C08SZ	12" x 12", 0.5 lb/dz	10 dz/cs
MDTWC3C11HZ	12" x 12", 0.7 lb/dz	10 dz/cs
MDTWC3C14SZ	12" x 12", 0.9 lb/dz	10 dz/cs
MDTWC3C16HZ	12" x 12", 1 lb/dz	10 dz/cs

Hand towels

MDTHT3C26R	16" x 27", 2.62 lb /dz	50 dz/bl
MDTHT3C26T	16" x 27", 2.62 lb /dz	25 dz/bl
MDTHT3C26Z	16" x 27", 2.62 lb /dz	5 dz/cs

Best ✓✓✓

Better ✓✓

Good ✓



MDTWC3C08BLUR

Blue utility terry cloths

- 100% cotton, which makes these cloths more absorbent than a standard flat woven fabric
- Perfect for a variety of tasks such as perineal care

Item No.	Description	Pkg.
MDTWC3C08BLUR	11" x 11", 8 oz/dz	200 dz/bl

Clothing protectors



MDTAB3I33WHI



MDTAB4I33PLD



MDTAB4I34TER

Impervious clothing protectors ✓✓

- Vinyl protective backing for the ultimate fluid protection
- Excellent chest and lap protectors
- Hook-and-loop or snap closure

Hook-and-loop closure, 85% cotton/15% polyester

Item No.	Description	Pkg.
MDTAB3I33WHI	21" x 33", 10 oz, White with Blue binding	2 dz/cs

Hook-and-loop closure, 80% cotton/20% polyester

MDTAB3I33PLD	21" x 33", Tartan Plaid	2 dz/cs
--------------	-------------------------	---------

Snap closure, 80% cotton/20% polyester

MDTAB4I33PLD	21" x 33", Tartan Plaid	2 dz/cs
--------------	-------------------------	---------

Snap closure, 100% spun brushed quilted polyester

MDTAB4I34TER	18" x 34", Terra-Cotta	2 dz/cs
--------------	------------------------	---------



MDTAB5B38WHI



MDTAB5B41STP

EZ-tie terrycloth clothing protectors ✓✓

- Generously cut from soft, 12-oz. heavyweight terrycloth
- These clothing protectors cover a large surface area and offer extremely effective spill protection
- EZ-tie closures will last longer than snaps or hook-and-loop

85% cotton/15% polyester

Item No.	Description	Pkg.
MDTAB5B38WHI	21"W x 38"H, White with Blue binding	2 dz/cs

90% cotton/10% polyester

MDTAB5B41STP	22"W x 41"H, 12 oz, multi color stripe	2 dz/cs
--------------	--	---------

Terrycloth clothing protectors ✓

- Cut from soft, 10 oz cotton/polyester blend heavyweight terrycloth
- Effective spill protection
- Large surface area coverage
- Hook-and-loop or snap closure

Terry cloth striped

Item No.	Description	Pkg.
MDTAB3C34STP	17"W x 34"L, 13 oz, Pastel Stripes	2 dz/cs
MDTAB3C36STP	22"W x 36"L, 13 oz, Bright Stripes	2 dz/cs

Snap closure

MDTAB4B33WHI	21"W x 33"L, White with Blue Binding	2 dz/cs
--------------	--------------------------------------	---------

Hook-and-loop closure

MDTAB3B30WHI	18"W x 30"L, White with White binding	2 dz/cs
MDTAB3B30BLU	18"W x 30"L, Blue with White binding	2 dz/cs
MDTAB3B33WHI	21"W x 33"L, White with Blue binding	2 dz/cs
MDTAB3B33BLU	21"W x 33"L, Blue with White binding	2 dz/cs



Teflon®-coated smoker's aprons

- Provides total chest and lap protection while seated or standing
- Hook-and-loop neck closure with additional around-the-back ties provide extra protection
- 100% Teflon coated fiberglass, protects clothing and furniture from burns and damage caused by smouldering ashes or dropped cigarettes

Item No.	Description	Pkg.
MDT014119	30"W x 36"H, Grey	1 ea



Reusable hamper bags



Rubber grip closure



Drawcord closure



Zipper closure

Washable mesh laundry bags

- Eliminate the hassle of sorting patient laundry
- Contents can be washed and dried in the bag to keep separate from other laundry and linens
- The polyester mesh weave allows water and soap to penetrate, minimizing odors and mold caused when storing damp items
- Colors include: red, green, blue, orange, yellow and white
- Contact your Medline representative to check availability of additional colors; specify color when ordering

Item No.	Description	Color	Size	Pkg.
MDT2436HN	Laundry net, open, heavy mesh	White	24" x 36"	12/dz
MDT2436MD	Laundry net with drawcord	White	24" x 36"	12/dz
MDT2436MNID	Laundry net with id patch, open	White	24" x 36"	12/dz
MDT2436MZ	Laundry net with zipper	White	24" x 36"	12/dz
MDT3040HD	Laundry net with drawcord, heavy mesh	White	30" x 40"	12/dz
MDT3040HN	Laundry net, open, heavy mesh	White	30" x 40"	12/dz
MDT3040HNID	Laundry net with id patch, open	White	30" x 40"	12/dz
MDT3040MD	Laundry net, open	White	30" x 40"	12/dz
MDT3040MZ	Laundry net with zipper	White	30" x 40"	12/dz

Poly cotton hamper bags ✓

- Heavy-duty, poly/cotton bags are strong and reliable
- Made with a round bottom for extra capacity
- Dumping loops for ease of use
- Bags only; hamper not included

Item No.	Description	Color	Size	Color	Pkg.
MDT021340	Poly/cotton hamper bag, 18"	Drawcord	30"W x 40"H	Natural	24/cs
MDT021345	Poly/cotton hamper bag, 25"	Drawcord	40"W x 40"H	Natural	24/cs
MDT021350	Poly/cotton hamper bag, 18"	Flip top	30"W x 40"H	Natural	24/cs
MDT021351	Poly/cotton hamper bag, 18"	Flip top, elastic	30"W x 40"H	Natural	24/cs
MDT021355	Poly/cotton hamper bag, 25"	Flip top, elastic	40"W x 40"H	Natural	24/cs
MDT021362	Poly/cotton hamper bag, 25"	Flip top	40"W x 40"H	Natural	24/cs



MDT021340

200 denier nylon hamper bags ✓✓

- Great for storage and transport of dry linens
- Variety of colors available (see item descriptions)
- Available in chairback, drawcord and flip top with elastic closure
- 18" bags are 30" x 40" when laid out,
- 25" bags are 40" x 35" when laid out
- Bags only; hamper stand not included

Chairback

Item No.	Size	Color	Pkg.
MDT021344FOR	24" x 36"	Forest Green	24/cs
MDT021344NVY	24" x 36"	Navy Blue	24/cs
MDT021344ROY	24" x 36"	Royal Blue	24/cs
MDT021344	24" x 36"	White	24/cs
MDT021344YEL	24" x 36"	Yellow	24/cs



MDT021344YEL
Chairback



MDT021348ORG
Drawcord

Drawcord

Item No.	Size	Color	Pkg.
MDT021348	18"	White	24/cs
MDT021349	25"	White	24/cs

Flip top with elastic closure

Item No.	Size	Color	Pkg.
MDT021363	18"	White	24/cs
MDT021364	25"	White	24/cs



MDT021364ROY
Flip top with
elastic closure





MDT021353

Blockade hamper bags 100% poly ✓✓

- For bagging and transporting soiled linen
- Retains fluid-resistant properties for up to 75 processings, helping to decrease cost of use
- Made with 100% polyester for a high level of fluid resistance
- Handles at the corners of bags for easier handling
- Bags only; hamper not included

Item No.	Description	Closure	Size	Color	Pkg.
MDT021353	Blockade hamper bag for flip-top hamper	Elastic	30"W x 40"H	Yellow	12/cs
MDT021354	Blockade hamper bag for flip-top hamper	Elastic	40"W x 35"H	Yellow	12/cs
MDT021366	Blockade hamper bag for chair back	None	27"W x 35"H	Yellow	12/cs
MDT021370	Blockade hamper bag for chair back	None	27"W x 35"H	Gray	12/cs
MDT021373	Blockade hamper bag for flip-top hamper	Elastic	30"W x 40"H	Gray	12/cs
MDT021374	Blockade hamper bag for flip-top hamper	Elastic	40"W x 35"H	Gray	12/cs
MDT021375	Blockade hamper bag for flip-top hamper	Elastic	30"W x 40"H	Ciel Blue	12/cs
MDT021377	Blockade hamper bag for flip-top hamper	Elastic	40"W x 35"H	Ciel Blue	12/cs



MSC201000C

Sofnit hamper bags ✓✓✓

- Made with fluid-resistant vinyl fabric
- Ultrasonically sealed seams enhance bag strength
- Can withstand up to 150 processings, decreasing cost of use
- Select cord or flip/elastic cord closure

Item No.	Description	Size	Pkg.
MSC201000C	Hamper bag with drawcord, fluid-resistant	25"	12/cs
MSC201005C	Hamper bag with drawcord, fluid-resistant	18"	12/cs
MSC201100C	Hamper bag with flip top, fluid-resistant	25"	12/cs
MSC201100ELSC	Hamper bag with flip top with elastic, fluid-resistant	18"	12/cs
MSC201105C	Hamper bag with flip top, fluid-resistant	18"	12/cs
MSC201105ELSC	Hamper bag with flip top with elastic, fluid-resistant	18"	12/cs



MSC201005BIO

Sofnit biohazard hamper bags ✓✓✓

- Fluid-resistant properties for up to 150 processings, helping to decrease cost of use
- Prominent red biohazard logo promotes caution and safety
- Ultrasonically sealed seams offer strength, durability and the highest level of fluid protection
- Select cord or flip/elastic cord closure

Item No.	Description	Cord Length	Pkg.
MSC201005BIO	Hamper bag, biohazard, cord	18"	12/cs
MSC201105BIO	Hamper bag, biohazard, cord	25"	12/cs
MSC201000BIO	Hamper bag, biohazard, flip / elastic, cord	18"	12/cs
MSC201105EBIO	Hamper bag, biohazard, flip / elastic, cord	25"	12/cs



ave® unisex standard 1-pocket top and combo waist zip fly cargo pant

Style 5910 & 5800

Fashion meets function

The latest addition to our popular ave® scrubs line, this unique top is designed for environmental services staff.

Quality fabric

- Unique four-way stretch, for a flattering fit, flexibility and comfort
- 72% polyester, 23% rayon, 5% spandex blend

Professional style

- V-neck top with short sleeves
- Unisex sizes
- Same material and colors as any regular ave pants
- Pockets on pants



Textiles

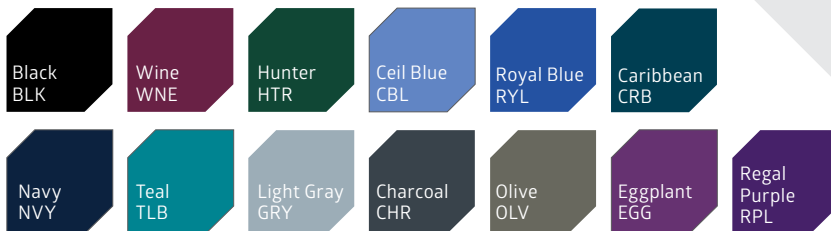

Choose your color:

Color	Color code
Wine	WNE
Olive	OLV
Hunter	HTR
Charcoal	CHR
Royal	RYL
Red	RED
Caribbean	CRB

Note: Other colors and styles are available, contact your Medline representative for more information.

Select your size:

Size	Size code
X-Small	XS
Small	S
Medium	M
Large	L
X-Large	XL
2X-Large	2XL
3X-Large	3XL
4X-Large	4XL
5X-Large	5XL

Build your item numbers:

Style number + Color + Size



Example: 5910WNES is the item number for size small top in wine color.

Interiors



Traditional shower curtains

Medline 10-gauge

- Our traditional shower curtains generally require no change to your current protocols. These 10-gauge curtains are stocked, pre-cut and ready to ship for your immediate needs.
- Flame-retardant
- Extra heavy-duty 10-gauge vinyl provides durability and long-lasting use

Item No.	Dimensions	Color	Pkg.
MITSC103672B	36"W x 72"L	Beige	1 ea
MITSC103672W	36"W x 72"L	White	1 ea
MITSC107272B	72"W x 72"L	Beige	1 ea
MITSC107272W	72"W x 72"L	White	1 ea



White



Beige

Spring shower collection

- Heavy-duty vinyl shower curtains are water-repellant and feature an embossed stripe pattern.
- Flame-retardant
- Made from 8-gauge vinyl for durability
- Treated to inhibit the growth of bacteria, fungus and mildew to prolong the use of the product
- This product is treated with an antimicrobial agent built in to protect the product. This product does not protect users or others against bacteria, viruses, germs or other disease organisms.

Item No.	Dimensions	Color	Pkg.
SSQ36X72BGE	36"W x 72"L	Beige	1 ea
SSQ36X72WHI	36"W x 72"L	White	1 ea
SSQ72X72BGE	72"W x 72"L	Beige	1 ea
SSQ72X72WHI	72"W x 72"L	White	1 ea



White



Beige



Ships within
2 to 5
business
days

Traditional shower curtain shown in Medline 10-gauge Beige (MITSC107272B)

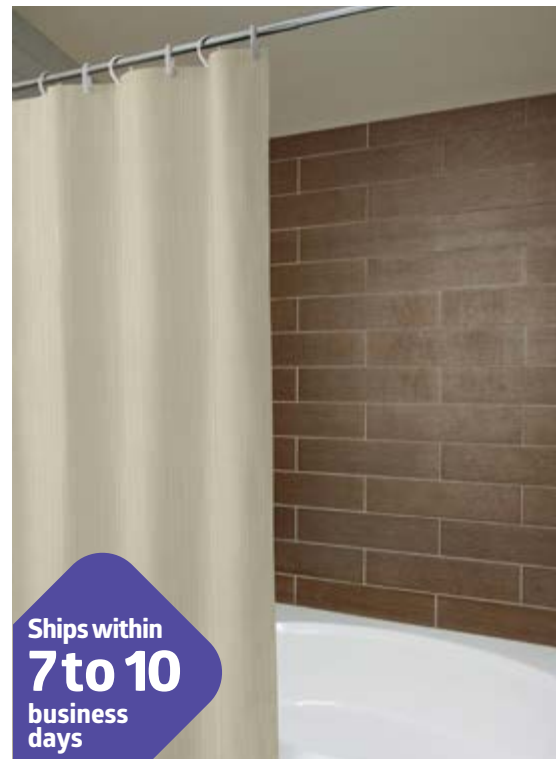

Ships within
7 to 10
business
days

Traditional shower curtain shown in spring shower collection Beige (SSQ72X72BGE)



Traditional Shower Curtain shown in Spray Collection Blue (SPQ36X72BLU)

Spray collection

- Easy-to-maintain shower curtains are fashioned from 100% nylon with a water-repellant finish. Available in a variety of colors to meet your needs.
- Made from 100% nylon
- Water-repellant finish is easy to clean to avoid stains for enhanced appearance and prolonged use
- Available in two convenient sizes to fit most standard showers

Item No.	Dimensions	Color	Pkg.
SPQ36X72WHI	36"W x 72"L	White	1 ea
SPQ36X72BGE	36"W x 72"L	Beige	1 ea
SPQ36X72GRY	36"W x 72"L	Grey	1 ea
SPQ36X72CHP	36"W x 72"L	Champagne	1 ea
SPQ36X72GRN	36"W x 72"L	Green	1 ea
SPQ36X72BLU	36"W x 72"L"	Blue	1 ea
SPQ72X72WHI	72"W x 72"L	White	1 ea
SPQ72X72BGE	72"W x 72"L	Beige	1 ea
SPQ72X72GRY	72"W x 72"L	Grey	1 ea
SPQ72X72CHP	72"W x 72"L	Champagne	1 ea
SPQ72X72GRN	72"W x 72"L	Green	1 ea
SPQ72X72BLU	72"W x 72"L	Blue	1 ea



White (WHI)



Beige (BGE)

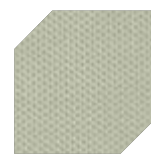

Grey (GRY)

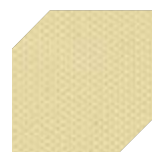

Champagne (CHP)



Green (GRN)



Blue (BLU)

Rain collection

- Economical, .5" double-turn hem shower curtains feature an embossed taffeta pattern.
- Made from 6-gauge vinyl
- Antimicrobial-treated to inhibit mildew and prolong the use of the product
- This product is treated with an antimicrobial agent built in to protect the product. This product does not protect users or others against bacteria, viruses, germs or other disease organisms
- Metal grommets for added durability

Item No.	Dimensions	Color	Pkg.
RAQ36X72WHI	36"W x 72"L	White	1 ea
RAQ36X72FRO	36"W x 72"L	Frosty	1 ea
RAQ36X72BGE	36"W x 72"L	Beige	1 ea
RAQ36X72GRN	36"W x 72"L	Green	1 ea
RAQ36X72BLU	36"W x 72"L	Blue	1 ea
RAQ72X72WHI	72"W x 72"L	White	1 ea
RAQ72X72FRO	72"W x 72"L	Frosty	1 ea
RAQ72X72BGE	72"W x 72"L	Beige	1 ea
RAQ72X72GRN	72"W x 72"L	Green	1 ea
RAQ72X72BLU	72"W x 72"L	Blue	1 ea



White (WHI)



Frosty (FRO)



Beige (BGE)

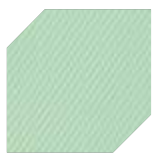

Green (GRN)

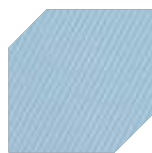

Blue (BLU)



**Ships within
7 to 10
business
days**

Traditional shower curtain shown in rain collection
Beige (RAQ36X72BGE)

Hookless shower curtains



**Ships within
2 to 3
business
days**

Hookless shower curtain shown in raindance collection Beige (SHWRD71X74BEI)

Raindance collection

- Hookless 100% polyester shower curtains feature a sheer window that allows light into the shower for a feeling of space and security
- Water repellent
- Ultrasonically cut bottom hem
- Magnet-weighted bottom hem
- Compatible with 1"-diameter shower rods only
- No liner necessary

Item No.	Dimensions	Color	Pkg.
SHWRD71X74WHI	71"W x 74"L	White	1 ea
SHWRD71X74BEI	71"W x 74"L	Beige	1 ea



White (WHI)



Beige (BGE)



**Ships within
2 to 3
business
days**

Hookless shower curtain shown in rainshadow collection Beige (SHWRS71X74BEI)

Rainshadow collection

- Hookless 100% polyester shower curtains feature a subtle woven pattern that adds a contemporary feel to the design
- Water repellent
- Ultrasonically cut bottom hem
- Magnet-weighted bottom hem
- Compatible with 1"-diameter shower rods only
- No liner necessary

Item No.	Dimensions	Color	Pkg.
SHWRS71X74WHI	71"W x 74"L	White	1 ea
SHWRS71X74BEI	71"W x 74"L	Beige	1 ea



White (WHI)



Beige (BGE)

Raindrop collection

- Hookless, 8-gauge, heavyweight vinyl shower curtains are durable and long lasting—ideal for almost any healthcare environment
- Antimicrobial-treated to help prevent stains and odors
- This product is treated with an antimicrobial agent built in to protect the product. This product does not protect users or others against bacteria, viruses, germs or other disease organisms
- Ultrasonically cut bottom hem
- Magnet-weighted bottom hem
- Compatible with 1"-diameter shower rods only

Item No.	Dimensions	Color	Pkg.
SHWRP71X74WHI	71"W x 74"L	White	1 ea
SHWRP71X74BEI	71"W x 74"L	Beige	1 ea



White (WHI)



Beige (BGE)



**Ships within
2 to 3
business
days**

Hookless shower curtain shown in raindrop collection White (SHWRP71X74WHI)

Disposable shower curtains

Cost-effective disposable curtains

- Temporary replacement while reusable curtains are being laundered
- For areas where there is an elevated risk of infection
- Emergency curtains when inventory is depleted
- Cost-effective alternative to reusables
- Can be cut down from 90" to a custom height as needed

Item No.	Dimensions	Color	Pkg.
SCD36X90WHI	36"W x 90"L	White	24/cs
SCD72X90WHI	72"W x 90"L	White	24/cs



White (WHI)



Disposable curtains shown in White (SCD72X90WHI)

Reusable cubicle curtains



Traditional reusable cubicle curtain shown in Spring Frost Cookie (MITQCSF109COK)

*Quantities of 9 or less ship in 7-10 business days. For other quantities, please contact ProductSupportInteriors@medline.com for lead time.

Traditional—Spring Frost collection

- Attractive reusable fabric, with its tone-on-tone basket-weave design, is our best-selling cubicle curtain fabric
- Excellent stain- and odor-release properties
- Six sizes available
- Will work with nearly any track and carrier system already in place.

Item No.	Description	Color	Pkg.
MITQCSF104BLM	108"W x 82"H	Blue Moon	1 ea
MITQCSF104COK	108"W x 82"H	Cookie	1 ea
MITQCSF104OA	108"W x 82"H	Oatmeal	1 ea
MITQCSF104SPA	108"W x 82"H	Spa	1 ea
MITQCSF107BLM	144"W x 82"H	Blue Moon	1 ea
MITQCSF107COK	144"W x 82"H	Cookie	1 ea
MITQCSF107OA	144"W x 82"H	Oatmeal	1 ea
MITQCSF107SPA	144"W x 82"H	Spa	1 ea
MITQCSF108BLM	144"W x 88"H	Blue Moon	1 ea
MITQCSF108COK	144"W x 88"H	Cookie	1 ea
MITQCSF108OA	144"W x 88"H	Oatmeal	1 ea
MITQCSF108SPA	144"W x 88"H	Spa	1 ea
MITQCSF109BLM	144"W x 94"H	Blue Moon	1 ea
MITQCSF109COK	144"W x 94"H	Cookie	1 ea
MITQCSF109OA	144"W x 94"H	Oatmeal	1 ea
MITQCSF109SPA	144"W x 94"H	Spa	1 ea
MITQCSF113BLM	216"W x 82"H	Blue Moon	1 ea
MITQCSF113COK	216"W x 82"H	Cookie	1 ea
MITQCSF113OA	216"W x 82"H	Oatmeal	1 ea
MITQCSF113SPA	216"W x 82"H	Spa	1 ea
MITQCSF115BLM	216"W x 94"H	Blue Moon	1 ea
MITQCSF115COK	216"W x 94"H	Cookie	1 ea
MITQCSF115OA	216"W x 94"H	Oatmeal	1 ea
MITQCSF115SPA	216"W x 94"H	Spa	1 ea



Blue Moon (BLM)



Cookie (COK)



Oatmeal (OA)

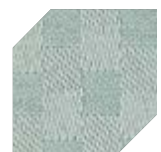

Spa (SPA)

Snap panel system

- For easy installation, storage and changes. Order mesh and fabric panels separately
- Panels available in variety of colors, contact ProductSupportInteriors@medline.com for more information
- Number of panels determined by mesh width and track length (see chart below)
- Antimicrobial mesh used to protect the product (white only)
- This product is treated with an antimicrobial agent built in to protect the product. This product does not protect users or others against bacteria, viruses, germs or other disease organisms

Snap panel fabric

Item No.	Description	Color	Pkg.
SNAP66PSFBLM	66"W x 66"H	Spring Frost Blue Moon	6/cs
SNAP66PSFOAT	66"W x 66"H	Spring Frost Oatmeal	6/cs
SNAP66PSFSPA	66"W x 66"H	Spring Frost Spa	6/cs
SNAP66PUTEDEN	66"W x 66"H	Uptown Eden	6/cs



Spring Frost Blue Moon (BLM)



Spring Frost Oatmeal (OA)



Spring Frost Spa (SPA)



Uptown Eden (UTEDEN)



**Ships within
2 to 5
business
days**

Snap panel system reusable cubicle curtain shown in Uptown Eden (SNAP66PUTEDEN)

Mesh Panels†

All mesh panels use white mesh with white snaps, stocked 6 ea/cs

Mesh Height	Item No.	Mesh Width				
		66"	124"	184"	242"	300"
20"		MIT6M066X20V	MIT6M124X20V	MIT6M184X20V	MIT6M242X20V	MIT6M300X20V
28"		MIT6M066X28V	MIT6M124X28V	MIT6M184X28V	MIT6M242X28V	MIT6M300X28V

Determine the number of panels needed for your track length

Track Length	50"-60"	61"-112"	113"-167"	168"-220"	221"-272"
Mesh Width	66"	124"	184"	242"	300"
Number of Panels	1 panel	2 panels	3 panels	4 panels	5 panels

† A reusable top mesh is required for snap panel systems



**Ships within
2 to 5
business
days**

Snap panel system disposable cubicle curtain shown in Uptown Eden (MIT6DUPTOWN)

Mesh panels†

All mesh panels use white mesh with white snaps, stocked 6 ea/cs



Mesh Width	Mesh Height	28"
66"	MIT6M066X20V	MIT6M066X28V
124"	MIT6M124X20V	MIT6M124X28V
184"	MIT6M184X20V	MIT6M184X28V
242"	MIT6M242X20V	MIT6M242X28V
300"	MIT6M300X20V	MIT6M300X28V

Determine the number of panels needed for your track length

Track Length	Mesh Width	Number of Panels
50"-60"	66"	1 panel
61"-112"	124"	2 panels
113"-167"	184"	3 panels
168"-220"	242"	4panels
221"-272"	300"	5 panels

† A reusable top mesh is required for snap panel systems

Snap panel system

- Easy installation; will fit existing track dimensions
- Panels available in variety of colors, contact ProductSupportInteriors@medline.com for more information
- Number of panels determined by track length and mesh width (see chart below)
- Antimicrobial mesh used to protect the product (white only)
- This product is treated with an antimicrobial agent built in to protect the product. This product does not protect users or others against bacteria, viruses, germs or other disease organisms.

Item No.	Dimensions	Pattern/Color	Pkg.
MIT6DBEIGE	66"W x 66"H	Uptown Beige	12/cs
MIT6SEREN	66"W x 66"H	Serenity	12/cs
MIT6DMAMBRZ	66"W x 66"H	Mambo Breeze	12/cs
MIT6DCANCOF	66"W x 66"H	Canon Coffee	12/cs
MIT6DUPTOWN	66"W x 66"H	Uptown	12/cs
MIT6DUTNSPR	66"W x 66"H	Uptown Spring	12/cs
MIT6UTNSUM	66"W x 66"H	Uptown Summer	12/cs
MIT6UTNWNT	66"W x 66"H	Uptown Winter	12/cs
MIT6PETPAR	66"W x 66"H	Pet Parade	12/cs
MIT6DHORIZON	66"W x 66"H	Horizon	12/cs



Disposable cubicle curtains

Traditional

- Choose from a variety of colors
- Traditional track attachment
- No laundering required
- This product is treated with an antimicrobial agent built in to protect the product. This product does not protect users or others against bacteria, viruses, germs or other disease organisms

Item No.	Dimensions	Pattern/Color	Pkg.
CCDE100X99UPT	100"W x 99"H	Uptown	4/cs
CCD144X99LTTE	144"W x 99"H	Latte	4/cs
CCD144X99COR	144"W x 99"H	Coronado	4/cs
CCD144X99UPT	144"W x 99"H	Uptown	4/cs
CCD240X99LTTE	240"W x 99"H	Latte	4/cs
CCD240X99COR	240"W x 99"H	Coronado	4/cs
CCD240X99UPT	240"W x 99"H	Uptown	4/cs



Latte (LTTE)

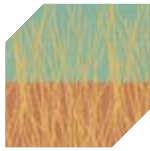

Coronado (COR)

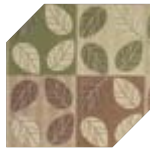

Uptown (UPT)



Traditional disposable cubicle curtain shown in Coronado (CCD144X99COR)

Ships within
7 to 10
business days

Shower curtain accessories

MTSHWRTENRD72



Curved shower rods

- Designed exclusively for tubs

Item No.	Description	Pkg.
MTSHWRCRVRD63	38"-63" wide	4/cs
MTSHWRCRVRD72	56"-72" wide	6/cs

Shower tension rods

- Rust resistant
- Adjustable up to 72"
- Easy installation

Item No.	Description	Pkg.
MTSHWRTENRD40	24"-40" wide	1 ea
MTSHWRTENRD72	42"-72" wide	6/cs

MTSHWRRNGWH



Shower stationary rods

- Constructed of 1" seamless aluminum tubing
- Available in a variety of sizes (custom sizes available)

Item No.	Description	Pkg.
MTSHWRRD3FT	3' wide	1 ea
MTSHWRRD4FT	4' wide	1 ea
MTSHWRRD5FT	5' wide	1 ea
MTSHWRRD6FT	6' wide	1 ea
MTSHWRRD7FT	7' wide	1 ea
MTSHWRRD8FT	8' wide	1 ea
MTSHWRRD9FT	9' wide	1 ea
MTSHWRBRKT	Wall mount brackets	2 ea; order min. 4 ea

*Brackets and screws not included. To purchase, order MTSHWRBRKT.



MTSHWRHKRLR15

Shower rings and hooks

- Heavy duty closing hooks to hold heavy vinyl curtains
- Metal hooks with seal shut design to prevent curtains from falling off during normal use

Item No.	Description	Pkg.
MTSHWRRNGCL	Clear plastic shower curtain ring	1 dz
MTSHWRRNGWH	White plastic shower curtain ring	1 dz
MTSHWRRNGBG	Beige plastic shower curtain ring	1 dz
MTSHWRHKPIN15	Snap pin shower curtain hooks, for 1.5" rod	1 dz
MTSHWRHKRLR1	Wire shower curtain hooks with 4 rollers, for 1" rod	1 dz
MTSHWRHKRLR15	Wire shower curtain hooks with 5 rollers, for 1.5" rod	1 dz

Ships within
7 to 10
business
days

Cubicle curtain accessories

Supreme track with spool carriers

- Durable, easy-to-install track system for smooth operation
- Track is available in 1-foot increments up to the desired length
- Includes 3 carriers (MTSUSPCAR) per foot
- Straight pieces ship with 2 end caps and 1 pull out
- Bend pieces ship with 2 splices

Item No.	Description	Pkg.
MTSUSP**FT	Supreme track with spool carriers	1 ft and up
MTSUSP**FTW	Supreme track with spool carriers, White track	1 ft and up
MTSUSPCAR	Spool carriers for supreme track	ea †
MTSUSP2X245	2 x 2' with 45° bend	ea
MTSUSP2X290	2 x 2' with 90° bend	ea

**Replace asterisks with length.

† Minimum ordering quantities apply.

Note: screws/hardware not included.

Additional supreme track accessories

Item No.	Description	Pkg.
MTSUSPCAR	Spool carrier	1/ea
MTSUCHCAR	Chain carrier	1/ea
MTSUBKCAR	Breakaway carrier	1/ea
MTSUSPCARHNL	Spool carrier with hook and loop	1/ea
MTSUENDCAP	End cap	1/ea
MTSUSPLICE	Splice	1/ea
MTSUPULLOUT	Pull out/snap out	1/ea
MTACHNDRP**IN	Chain drop	1/ea
MTAPVCDRP**IN	PVC drop	1/ea
MTABATON**FT	Cubicle curtain baton	1/ea
MIT6DTIEBACK	Disposable snap tieback	20/cs

**Replace asterisks with length.

Timestrip indicators

- Automatically tracks the life of your curtain
- Available in 1, 3 and 6 month time intervals
- Sized .75"W x 1.5"H to stick to instruction tag or any location on curtain
- Press-activated button begins filling white space with red ink to indicate when it is time to replace the curtain

Item No.	Description	Pkg.
TIMESTRIP1MO	1-Month timestrips	100/bx
TIMESTRIP3MO	3-Month timestrips	100/bx
TIMESTRIP6MO	6-Month timestrips	100/bx



TIMESTRIP3MO

MIT6DTIEBACK

For additional track systems and accessories, contact your Medline representative or visit interiors.medline.com.

Quilts and bedspreads

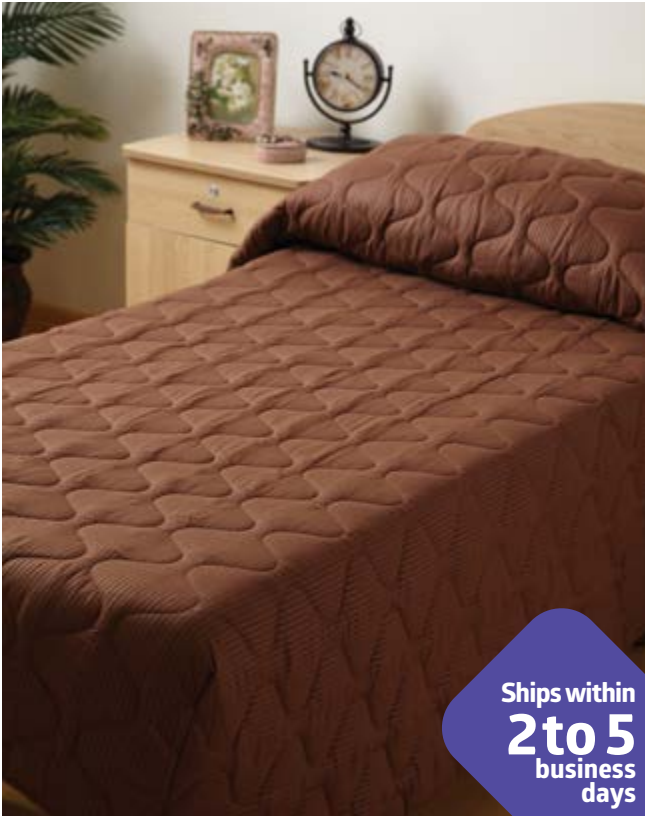

Suede Touch FR Quilt shown in Chocolate (MITQSQCCHCT)

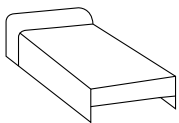

Capped style

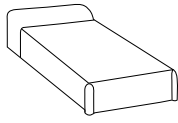

Throw style

Suede Touch FR quilts

- Flame-retardant and compliant with ISO12952-1&2 and Canadian CAN/CGSB 4.2 No.27.5-94 fire code standards for the protection and comfort of your patients and residents.
- 100% fire-retardant
- Generous 5 oz. per square yard of 100% polyester fill for warmth and softness
- Onion-stitched pattern complements both contemporary and transitional settings
- Reversible and non-reversible available
- Throw or capped styles available
- Vacuum packaged helps reduce freight costs, maximizes storage space and protects quilt

Reversible, throw style, twin

Item No.	Dimensions	Color	Pkg.
MITQSQPBEPT	81"W x 110"L, twin	Pebble Tan	1 ea
MITQSQZINT	81"W x 110"L, twin	Zinfandel Red	1 ea
MITQSQPEAT	81"W x 110"L, twin	Peacoat Blue	1 ea
MITQSQSAGT	81"W x 110"L, twin	Sage Green	1 ea
MITQSQCCHCT	81"W x 110"L, twin	Chocolate	1 ea

Non-reversible, capped style, twin

MITQSQPEBC	71"W x 102"L, twin	Pebble Tan	1 ea
MITQSQZINC	71"W x 102"L, twin	Zinfandel Red	1 ea
MITQSQPEAC	71"W x 102"L, twin	Peacoat Blue	1 ea
MITQSQSAGC	71"W x 102"L, twin	Sage Green	1 ea
MITQSQCCHCC	71"W x 102"L, twin	Chocolate	1 ea



Pebble Tan



Zinfandel Red



Peacoat Blue



Sage Green



Chocolate

Embrace quilts

- A contemporary, warm look that matches any room design.
- 100% polyester, 3 oz. per square yard of 100% polyester fill
- Diamond-stitched pattern complements both contemporary and transitional settings
- Reversible and non-reversible available
- Throw or capped styles available

Reversible, throw style, twin

Item No.	Dimensions	Color	Pkg.
MITQEQCGR	81"W x 110"L, twin	Charcoal Grey	1 ea
MITQEQHGR	81"W x 110"L, twin	Hunter Green	1 ea
MITQEQRNT	81"W x 110"L, twin	Cranberry	1 ea
MITQEQWHT	81"W x 110"L, twin	Wheat	1 ea

Non-reversible, capped style, twin

MITQEQCGR	71"W x 102"L, twin	Charcoal Grey	1 ea
MITQEQHGR	71"W x 102"L, twin	Hunter Green	1 ea
MITQEQRNC	71"W x 102"L, twin	Cranberry	1 ea
MITQEQWHT	71"W x 102"L, twin	Wheat	1 ea



Embrace quilt shown in Charcoal Grey (MITQEQCGR)



Charcoal Grey



Hunter Green



Cranberry



Wheat

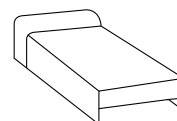

Capped style

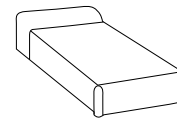

Throw style

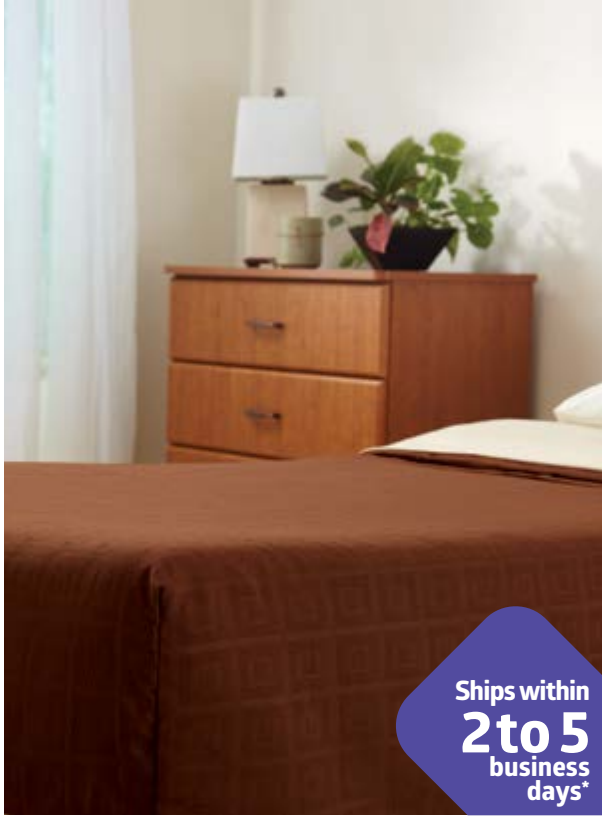

**Ships within
2 to 5
business
days***

Lanister bedspread shown in Java (MITUQBJAVC)

*Certain options ship within 2 to 5 business days.

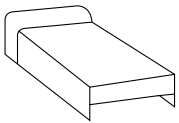

Capped style

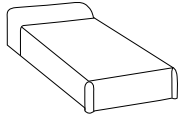

Throw style

Lanister unquilted bedspreads

- Graceful contemporary geometric design adds style to any décor.
- Flame-retardant and compliant with ASTM D4151 fire code standards for the protection and comfort of your patients and residents³
- Face: 100% polyester
- Variety of colors available to match your décor
- Non-reversible
- Throw or capped styles available

Reversible, throw style, twin

Item No.	Dimensions	Color	Pkg.
MITUQBASHT	81"W x 110"L, twin	Ash	1 ea
MITUQBJAVT	81"W x 110"L, twin	Java	1 ea
MITUQBLATT	81"W x 110"L, twin	Latte	1 ea
MITUQBMOST	81"W x 110"L, twin	Moss	1 ea

Non-reversible, capped style, twin

MITUQBASHC	71"W x 102"L, twin	Ash	1 ea
MITUQBJAVC	71"W x 102"L, twin	Java	1 ea
MITUQBLATC	71"W x 102"L, twin	Latte	1 ea
MITUQBMOSC	71"W x 102"L, twin	Moss	1 ea



Ash



Java



Latte

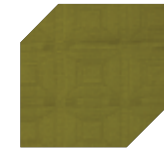

Moss

Table linens

Elegance table linens

- The ultimate in spun polyester, elegance satisfies customers with its cotton-like softness and top quality construction. Available in a variety of sizes and colors.
- 100% spun polyester
- 7.2 oz. per square yard
- Captures the look and feel of cotton with softness and shine
- Excellent color retention and absorption
- Superior stain release
- No picking, snagging or linting
- Additional colors, sizes and quantities available, contact ProductSupportInteriors@medline.com for more information

Item No.	Dimensions	Pkg.
MITLNEL204*	Napkin, 20" x 20"	12 ea; order min 6 dz
MITLNEL210*	Tablecloth, 52" x 52"	12/cs
MITLNEL214*	Tablecloth, 62" x 62"	12/cs
MITLNEL217*	Tablecloth, 71" x 71"	12/cs
MITLNEL215*	Tablecloth, 63" round	12/cs
MITLNEL216*	Tablecloth, 70" round	12/cs

*Add color code to item number when ordering.

†Tablecloths may have longer lead times in these colors. Ask your Medline Representative for availability.



Flag Blue
(NAV)



Forest Green
(FOR)

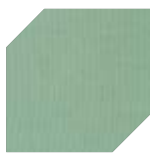

Seafoam
(SEA)†



Black
(BLK)

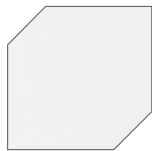

White
(WHI)



Sandalwood
(SDW)



Burgundy
(BUR)



Chocolate
(CHC)



Rust
(RST)†



Brown
(BRW)



Napkins (MITLNEL204 series)

Roller shades

Modern designs to manage light, privacy and energy efficiency



Easy
to clean

Smart design on a roll

Roller shades complement any décor, combining upscale design with low maintenance. They're a simple way to elevate the look of your space while delivering a major impact on comfort and energy efficiency.

Control your environment

Manage the sun's heat and light with interior solar shade fabrics. Choose from a wide selection to help protect your furnishings from UV damage and improve patient and staff experience by reducing glare.

Manage privacy

Tighter fabric weave shades keep light out and provide greater privacy for patient and exam rooms, offices and meeting rooms. Our dual shades offer a sunscreen fabric shade and blackout shade, on the same window.

Elevate energy efficiency

Roller shades help conserve energy year-round. In the winter, they keep heat from escaping, while in the summer, they help control the heat coming into your facility. They also allow for more natural light further reducing energy use.

From the finest fabrics to uniquely engineered mechanicals and comprehensive design consultation, we have you covered.

Let us manage your project from start to finish

From design consultation through implementation, our on-staff experts can manage your project every step of the way.



Sheerweave 7500 blackout fabric specifications

Openness Factor:	0% (opaque)
UV Blockage:	100%
Composition:	100% polyester with acrylic coating (PVC-free)
Mesh Weight:	11.8 oz./yd ²
Fabric Thickness:	.013 in
Breaking Strength (lb/in):	160 warp/167 fill
Fire Classification:	California U.S. Title 19 (small scale) and NFPA 701-2004 TM#1 (small scale)

Bacteria and Fungal Resistance*: ASTM-E2180 and ASTM-G21
 This product is treated with an antimicrobial agent built in to protect the product. This product does not protect users or others against bacteria, viruses, germs or other disease organisms. Colors may vary slightly from swatch samples. All variations are within industry standards.



E Screen 75 fabric specifications

Openness Factor:	1%	3%	5%
UV Blockage:	99%	99%	99%
Composition:	36% fiberglass; 64% vinyl		
Fabric Weight:	13.3 oz./yd ²		
Fabric Thickness:	0.020 in		
Breaking Strength (lbs):	Warp 280/Weft 250 lbs.		
Fire Classification:	NFPA 701-10 TM#1, California U.S. Title 19		



A close-up photograph of a healthcare worker's hands, wearing blue nitrile gloves, gently holding the hand of an elderly patient. The patient's skin is wrinkled and aged. The healthcare worker is wearing blue scrubs and a stethoscope is visible around their neck. The background is a soft-focus blue and yellow. A purple triangular graphic is in the top-left corner.

Safety and essentials

Industrial grade gloves

EQPT™ industrial grade nitrile, latex, and vinyl gloves

- Industrial strength at a gr1 eat value
- Latex for feel and flexibility
- Vinyl for basic protection
- Available in powder-free (PF) or powdered (P)

Nitrile

Item No.	Description	Size	Pkg.
EQPT4141	Nitrile, PF, Blue	Small	100/bx
EQPT4142	Nitrile, PF, Blue	Medium	100/bx
EQPT4143	Nitrile, PF, Blue	Large	100/bx
EQPT4144	Nitrile, PF, Blue	X-Large	100/bx

Latex

EQPT4121	Latex, PF, Natural	Small	100/bx
EQPT4122	Latex, PF, Natural	Medium	100/bx
EQPT4123	Latex, PF, Natural	Large	100/bx
EQPT4124	Latex, PF, Natural	X-Large	100/bx
EQPT4121P	Latex, P, Natural	Small	100/bx
EQPT4122P	Latex, P, Natural	Medium	100/bx
EQPT4123P	Latex, P, Natural	Large	100/bx
EQPT4124P	Latex, P, Natural	X-Large	100/bx

Vinyl

EQPT4131	Latex, PF, Clear	Small	100/bx
EQPT4132	Latex, PF, Clear	Medium	100/bx
EQPT4133	Latex, PF, Clear	Large	100/bx
EQPT4134	Latex, PF, Clear	X-Large	100/bx
EQPT4131P	Latex, P, Clear	Small	100/bx
EQPT4132P	Latex, P, Clear	Medium	100/bx
EQPT4133P	Latex, P, Clear	Large	100/bx
EQPT4134P	Latex, P, Clear	X-Large	100/bx

Aloetouch® latex household gloves

- Reusable gloves soothes skin with pure organic aloe coating
- Inner flock lining adds extra comfort

Item No.	Description	Size	Pkg.
HKP195015	Housekeeping, latex, aloe	Medium	8 pr/bx
HKP195016	Housekeeping, latex, aloe	Large	8 pr/bx



EQPT family



HKP195015

Exam Grade Gloves



FG3000 family

FitGuard® Touch nitrile exam gloves

- Great tactile feel with durable nitrile protection
- Textured fingertips for sure grip
- High glove count per box to help optimize storage
- Max sensitivity

Item No.	Description	Size	Pkg.
FG3000	Exam, PF, nitrile, FG Touch	X-Small	300/bx
FG3001	Exam, PF, nitrile, FG Touch	Small	300/bx
FG3002	Exam, PF, nitrile, FG Touch	Medium	300/bx
FG3003	Exam, PF, nitrile, FG Touch	Large	300/bx
FG3004	Exam, PF, nitrile, FG Touch	X-Large	250/bx



CR911M

Critical Response orange nitrile exam gloves

- High visibility orange stands out in an emergency
- Advanced protection and optimal grip

Item No.	Description	Size	Pkg.
CR911S	Exam, PF, nitrile, orange, w/film	Small	100/bx
CR911M	Exam, PF, nitrile, orange, w/film	Medium	100/bx
CR911L	Exam, PF, nitrile, orange, w/film	Large	100/bx
CR911XL	Exam, PF, nitrile, orange, w/film	X-Large	90/bx
CR911XXL	Exam, PF, nitrile, orange, w/film	XX-Large	80/bx



MDS2585

SensiCare® silk nitrile exam gloves

- Outstanding tactile sensitivity, stretch, and comfortability
- Textured fingertips for sure grip
- Thicker for stronger protection

Item No.	Description	Size	Pkg.
MDS2583	Exam, PF, nitrile, silk, w/film	X-Small	250/bx
MDS2584	Exam, PF, nitrile, silk, w/film	Small	250/bx
MDS2585	Exam, PF, nitrile, silk, w/film	Medium	250/bx
MDS2586	Exam, PF, nitrile, silk, w/film	Large	250/bx
MDS2587	Exam, PF, nitrile, silk, w/film	X-Large	250/bx



MPH17CE210

Fluid clean-up kits

- For safe containment and clean-up of spills and the decontamination of exposed hard surfaces. Kit components not made with natural rubber latex.

Item No.	Description	Contents	Pkg.
MPH17CD410	Deluxe spill kit-quat	Pair non-latex gloves, 1 protective gown, 1 protective mask with eye shield, 10 gram absorbent powder, 1 disposable scoop with detachable scraper, 1 clear disposable bag, 1 red bio-hazard bag, 2 twist ties, 1 disinfectant wipe, 1 absorbent towel, 1 hand wipe, and instructions for use. Packaged in a heat-sealed poly bag.	6/cs
MPH17CD410B	Deluxe spill kit-bleach	Pair non-latex gloves, 1 protective gown, 1 protective mask with eye shield, 10 gram absorbent powder, 1 disposable scoop with detachable scraper, 1 clear disposable bag, 1 red bio-hazard bag, 2 twist ties, 1 bleach wipe, 1 absorbent towel, 1 hand wipe, and instructions for use. Packaged in a heat-sealed poly bag.	6/cs
MPH17CE210	Standard spill kit-quat	Pair non-latex gloves, 4g absorbent powder, 1 absorbent towel, 1 disposable scoop with detachable scraper, 1 red bio-hazard bag, 1 twist tie, 1 disinfectant wipe, 1 hand wipe, and instructions for use. Packaged in a heat-sealed poly bag.	36/cs
RDYHG575	Mercury spill kit	Mercury "caution" label, absorbent towel, activator bottle, pair non-latex gloves, reclosable bag, disposable bag, twist tie, scoop with scraper, mercury absorbent powder, mask with eye shield; packaged in a poly bag.	12/cs
RDYFSK100	Formaldehyde spill kit	Pair nitrile gloves, 1 respirator/cartridges, 1 fluid resistant gown, 1 vented goggles, 1 bottle of solidifier (1-oz solidifies approx. 1L of Formaldehyde), 3 absorbent towels, 4 disposable scoops with detachable scrapers, 4 clear disposable bags, 4 twist ties, and instructions for use. Packaged in a heat-sealed poly bag.	1 ea



RMICR1H

The clean remote

- Universal TV remote
- A spill proof, easy wipe, non-porous surface makes it simple to clean and disinfect
- Hidden battery compartment with attached door so batteries are not taken
- Never has to be reprogrammed, even if batteries are removed
- Patients cannot change menu settings

Item No.	Description	Pkg.
RMICR1H	Universal remote	1 ea
RMICR1Z	Universal remote	50/cs
RMICR1	Universal remote	100/cs
RMICR2BBH	Universal remote big button	1 ea
RMICR3BCBH	Universal remote cable box	1 ea



FA024000001

Eye/face wash station

- Durable stations include tamper evident bottles
- Eye wash stations provide quick and easy access to eye wash for emergencies
- Include sterile, irrigating solution for flushing or irrigating the eyes

Item No.	Description	Pkg.
FA024000001	Eye wash station 1-16 oz btl	6/cs
FA024101001	Eye wash refill 16 oz	12/cs
FA024102001	Eye wash station 2-16 oz btl	6/cs
FA07006	Eye wash, 4 oz bottle, screw top	48/cs
FA024300001	Eye wash station 2-32oz btls	6/cs
FAOM7501	15 Min eye wash station	1 ea



EVSEARPLUG

Ear plugs

- Plug gently expands and self adjusts to all size ear canals
- Meets ansi 53:1974 requirements
- Noise reduction rating (NRR) of 31

Item No.	Description	Pkg.
EVSEARPLUG	Ear plug, foam, no cord	200/cs



NON24318

Disposable bath mats

- Absorb moisture and resist slipping
- Heavyweight

Item No.	Description	Color	Pkg.
NON24318	13.88" x 21.5" (35.3 x 54.6 cm)	White with Blue Print	500/cs

MedCell alkaline batteries

- Designed to provide maximum performance in high-tech medical devices
- Built to the same specs as the name brand alkaline batteries
- Five-year shelf life

MedCell series

Item No.	Description	Pkg.
MPHBAAA	AAA	144/cs
MPHBAAAZ	AAA	24/cs
MPHBAA	AA	144/cs
MPHBAAZ	AA	24/cs
MPHB9V	9V	72/cs
MPHB9VZ	9V	12/cs
MPHBC	C	72/cs
MPHBCZ	C	12/cs
MPHBD	D	72/cs
MPHBDZ	D	12/cs

Specialty

Item No.	Description	Pkg.
MPHBCR2032	Coin battery	10/bx

Hearing aid

RAYL10ZA	1.4v size 10 - 8 per card	32/bx
RAYL13ZA	1.4v size 13 - 8 per card	32/bx
RAYL312ZA	1.4v size 312 - 8 per card	32/bx
RAYL675	1.4v size 675 - 8 per card	24/bx



MPHBCR2032



MPHB series

Reference guide



Glossary of terms

Terms commonly used by environmental services professionals

A

Active Ingredient

Chemical component of a cleaner that deactivates, reduces or destroys microorganisms. Phenols and quaternary ammonium compounds (quats) are typical ingredients in disinfectants. PCMX, CHG and quats are common active ingredients in hand cleaners.

Adenovirus

A virus that causes acute respiratory infections.

AIDS

Abbreviation for Acquired Immunodeficiency Syndrome, a disease caused by the Human Immunodeficiency Virus (HIV).

Alcohol

A skin antiseptic and disinfectant for clinical surfaces and equipment. Alcohol evaporates rapidly and can dry and irritate skin. Organic materials inactivate alcohol and is often used to reduce kill times.

Antibacterial

A chemical substance that kills bacteria that can cause risks to public health.

Antibiotic

A chemical substance that is produced by microorganisms and has the ability to kill or inhibit the growth of other microorganisms.

Antimicrobial

Substances or mixtures of substances used to destroy or suppress the growth of harmful microorganisms such as bacteria, viruses, or fungi on inanimate objects and surfaces.

Antiseptic

A chemical substance that kills or inhibits growth and reproduction of microorganisms in or on humans or animals. Antiseptics are drugs applied topically to the skin to help prevent infection and cross contamination.

ATP

Abbreviation for adenosine triphosphate, a substance found in all living cells, including skin, bodily fluids and microbes.

B

Bacteria

Single-cell microorganisms that are members of the plant kingdom. Pathogenic bacteria are capable of producing infections and are sometimes referred to as "germs" or "microbes." They multiply by the division of a single cell into two bacterial cells.

Bactericide/cidal

A chemical that kills or destroys bacteria, also known as germicides.

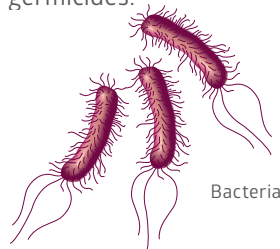

Biodegradable

A substance that decomposes from bacteria or natural environmental factors.

Biofilm

A dynamic, self-organized accumulation of microorganisms and environmental by-products immobilized on a substrate and embedded in an organic polymer mix.

Bleach

Another name for Sodium Hypochlorite (NaOCl), a low-cost oxidizer that is effective in the decontamination of blood or other potentially infectious materials. Bleach has a high level of activity against both gram-positive and gram-negative bacteria. It is corrosive to metal. Organic matter inactivates bleach, and it is relatively unstable when diluted with a very short shelf life.

Blood-Borne Pathogens (BBP)

Pathogenic organisms that are transmitted via human blood and can cause diseases in humans. They include viruses such as Hepatitis B and HIV-1.

Broad Spectrum Disinfectant

A disinfectant that is effective against both gram-positive and gram-negative bacteria (*Staphylococcus aureus* and *Salmonella enterica*) is considered to be a general or broad spectrum disinfectant.

C**Carrier**

An individual harboring a specific strain of microorganisms, capable of disseminating it throughout the environment. A carrier might not exhibit symptoms of infections but may merely be a transporter of pathogenic strains.

CFUs

Abbreviation for Colony Forming Units, a measure of the number of microbes capable of growing into its own colony.

Chain of Infection

The methods and intermediate vehicles by which microorganisms and diseases can be transferred between individuals.

CHG

Abbreviation for chlorhexidine gluconate, the ingredient commonly used in hand care products. It has a broad spectrum of activity on fungi, viruses and bacteria and is not diminished by blood or other organic material. The unique attribute of CHG is persistence, which is desirable when there is a high risk of infection and where a sustained and high-level reduction in microbial flora is desired, such as during surgery.

Chlorine

Powerful oxidizing agent often used as a germicide.

Cidal

A toxic property of some chemicals by which living matter can be destroyed. This term is usually used in combination with a specific prefix by which the cidal activity is defined, such as virucidal, bactericidal, etc.

***Clostridium difficile* (C. diff.)**

A spore forming bacterium found in the intestines causing a variety of symptoms, from diarrhea to more life-threatening intestinal disease. *C. diff* is found in feces and can be transmitted by hands to surfaces such as bedding, toilets, light switches and grab bars. People can become infected if they touch contaminated surfaces or items and then touch their mouths or mucous membranes.

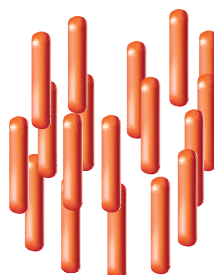

Clostridium difficile
(*C. diff.*)

Communicable

Refers to a disease or infection that may be transmitted from one person to another by various means. Synonymous with transferable or contagious.

Contact Time

The published time that a disinfectant or sanitizing chemical must remain wet on the surface being treated in order to achieve label claims. These chemicals are killing germs only when wet.

Contagious

The state whereby a disease or infection may be transmitted or spread from one person to another. Also refers to a microorganism that is capable of causing a communicable disease.

Contamination

A condition of being soiled.

Cross-Contamination

The act of transmitting an infection from one infected person or surface to another. Also refers to becoming infected by a microorganism picked up through contact with a surface or air that has been contaminated with pathogenic microorganisms.

D

Daily Clean

Process of an EVS worker cleaning the room and restroom that is occupied or recently vacated to reduce risks of transmitting germs.

Decontaminate

To remove pathogenic and undesirable microorganisms or soil from surfaces by chemical or physical means. Renders medical instruments, devices or environmental surfaces safe for handling but not necessarily safe for patient reuse.

Detergent

A chemical used for cleaning surfaces. Detergents may possess surface wetting, soil emulsification, soil dispersion or soil suspending properties. These cleaning agents by themselves are not antimicrobial; however dispersing and removing soil and organic material from surfaces allows a disinfectant to reach and destroy microbes beneath the dirt.

Disease

An impairment of body health, such as an illness or sickness. An "infectious disease" is caused by pathogenic microorganisms. A "contagious disease" is transmitted by contact with an infected person.

Disinfectant

A substance or mixture of substances that destroys or irreversibly inactivates bacteria, fungi and viruses, but not necessarily bacterial spores, in the inanimate environment. A healthcare grade disinfectant should kill 99.9999+% (6-log reduction) of specific pathogens.

Disinfectant Claims

Statements made by disinfectant manufacturers, claiming the control or destruction of specific germs. These claims are tested, typically by independent laboratories, and submitted to the EPA and approved for use on the label prior to production.

Disinfecting

Process by which pathogens are destroyed permanently. In healthcare, the expectation is a 6-log (99.9999+% of specific pathogens). There is no such thing as a 100% kill rate for a disinfectant.

Doodlebug®

Rectangle scrubber pad and handle used for cleaning baseboards, corners and edges during floor stripping and general scrubbing.



Doodlebug,
see item EVSPAD116 and
item EVSPAD4 on pg. 32

Dwell Time

Maximum time it takes for any disinfectant to properly kill germs, also known as kill time.

E

Efficacy

Effectiveness of the product. A list of microorganisms that are destroyed or reduced when the disinfectant is used in accordance with label directions.

Enveloped Virus

A virus with a viral envelope derived from proteins and covering the capsid (shell). Viral envelopes help viruses enter host cells. The lipid bilayer envelope of these viruses is relatively sensitive to dry environments, heat and detergents, making them easier to kill than non-enveloped viruses. They have limited survival outside host environments and typically must transfer directly from host to host.

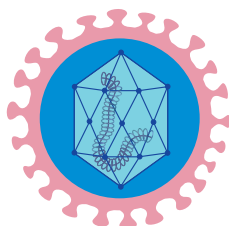

Enveloped
Virus

EPA

Abbreviation for the Environmental Protection Agency of the US Government.

Epidemic

Outbreak of disease. Occurs quickly and involves a large number of individuals at the same time.

F

Flash point

The temperature at which a chemical will ignite in the presence of a spark or flame.

Fungicide

A substance or mixture of substances intended to destroy fungi (including yeasts) and/or fungal spores.

G

General Disinfectant

Disinfectant that is labeled for usage against both gram-positive and gram-negative bacteria. Efficacy demonstrated against both *Salmonella choleraesuis* and *Staphylococcus aureus* bacteria.

General Purpose Cleaner

More aggressive than a neutral cleaner, often used as a scrub and recoat cleaner or spot cleaner for tougher stains.

Germ

A microorganism that usually causes some type of disease.

Germicide

A germicide is a substance or mixtures of substances that kill a number of microorganisms (e.g., viruses, fungi and bacteria).

Gram-Negative Bacteria

Bacteria that respond to a dye test (cannot retain the dye). Gram-negative bacteria differ from other bacteria due to the structure of the outer membrane. The outer membrane is comprised of complex lipopolysaccharide with a liquid portion that acts as an endotoxin—the body recognizes this as a toxin and causes a rise in temperature. The outer membrane protects the bacteria from several antibiotics, dyes and detergents that would normally damage the inner membrane or cell wall. Once these bacteria enter the blood stream, they destroy tissues at a very rapid pace. This might cause depression, weakness, cold, dehydration, upset stomach, diarrhea, pneumonia, infections in the blood stream and urine passing. Gram-negative bacteria survive in moist areas.

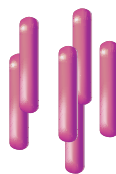

Gram-Negative
Bacteria

Gram-Positive Bacteria

Bacteria with a thick outer cell wall and defined by response to a dye test. Gram-positive bacteria lack the outer membrane found in gram-negative bacteria. These bacteria are especially deadly. Gram-positive bacteria survive in dry areas.



Gram-Positive
Bacteria

H

HAC

Abbreviation for Hospital Acquired Conditions.

HCAHPS

Pronounced "H-Caps," this is the abbreviation for Hospital Consumer Assessment of Healthcare Providers and Systems, a patient satisfaction survey required by the Centers for Medicare and Medicaid Services (CMS) for adult inpatients.

Hepatitis A (HeAdSHAVE)

The virus that causes Hepatitis A, a highly contagious infection of the liver. HAV is found in feces and is usually contracted through poor personal hygiene or consumption of contaminated water, ice, fruits, vegetables or shellfish. Diapered children in day care centers can be at special risk. Hepatitis A can be prevented by an effective vaccine.

Hepatitis B (HBV)

The virus that causes Hepatitis B, which affects the liver and can lead to cancer and death. HBV is 100% more contagious than HIV, the virus that causes AIDS. Once contracted, there is no cure. Hepatitis B can be prevented by vaccine.

Hepatitis C (HCV)

The virus that causes Hepatitis C. This form of hepatitis is most frequently transmitted by large or repeated contact with blood or blood products, and can lead to liver cancer and death. At this time, there is no vaccine against Hepatitis C.

Herpes Simplex

The virus that causes infectious mononucleosis and cold sores.

High Density (highD)

Refers to trash liners for light, non-sharp trash, such as paper, wrappers, cups and facial tissue. Measured in microns (mic).

High-Level Disinfection

The complete elimination of all microorganisms in or on a surface, except for a small number of bacterial spores. The FDA definition of a high-level disinfectant is a sterilant used for a shorter contact time to achieve a 6-log₁₀ kill of an appropriate mycobacterium species.

HIV

Abbreviation for Human Immunodeficiency Virus, a virus that causes Acquired Immunodeficiency Syndrome (AIDS).

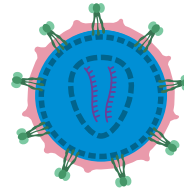

HIV Virus

Hospital-Grade Disinfectant

A disinfectant's with demonstrated efficacy against *Salmonella choleraesuis*, *Staphylococcus aureus* and *Pseudomonas aeruginosa* bacteria. These disinfectants are labeled for use in hospitals, clinics, dental offices or any other healthcare facility.

Host

Any organism—human, animal or plant—that acts as a growth site for parasitic microorganisms.

Hydrogen Peroxide

Active Ingredient used in different bactericidal, tuberculocidal, virucidal, fungicidal disinfectants that can be used on non-critical items. Should not be used for cleaning wounds because it slows healing. Peroxide can slightly decompose brass, copper, zinc and mild steel. Some disinfectants can remove the gloss seal from toilet seats as well.

Immune Being

Protected against infectious organisms or allergic conditions by a system involving antibodies.

Inert Ingredients

Components—solvent, carrier, or surfactant—of an antimicrobial product that are not active in destroying target organisms.

Infection

Invasion of the body by a microorganism that can reproduce, multiply and cause disease.

Influenza

Diseases caused by a lipophilic virus. Influenza is one of the most common forms of the flu. It leads to inflammation of the respiratory tract and causes fever, chills and muscular pain.

Iodophors

Used for hand washing and as a skin antiseptic. Kills a broad spectrum of organisms with quick disinfectant and detergent action. Iodophors are inactivated by organic materials, are not sporicidal and are not suitable for hard surface disinfecting.

IP / ICP

Abbreviations for Infection Prevention and Infection Control and Prevention.

J

Johnny Mop

A combination toilet brush and mop.

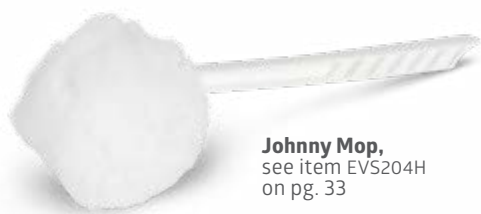

Johnny Mop,
see item EVS204H
on pg. 33

K

Kill Time

Maximum time it takes for a disinfectant to properly kill the pathogens specified on the product label.

L

Lethal

Capable of causing death.

Log Reduction

The logarithmic count of a pathogen reduction. Simply calculated as the "number of 9s", a log reduction of 5 equals a 99.999% reduction in pathogens. A non-food contact surface sanitizer reduces bacterial contamination by 99.9% (log3 reduction within 5 minutes). Hospital disinfectant require 99.9999% reduction(log6 reduction) of *Staphylococcus aureus*, *Salmonella enterica* and *Pseudomonas aeruginosa*.

Low Density (lowD)

Refers to trash liners for heavier trash, such as food garbage, sharper objects with corners or edges. Measured in MilS.

M

Microbe

Another word for a microorganism.

Mode of Transmission

Means by which microbes travel from one site to another. Modes include direct and indirect contact, droplet, vehicle, airborne and vector transmission.

MRSA

Abbreviation for Methicillin-Resistant *Staphylococcus aureus*. The infection often begins as a painful skin boil. It is spread by skin-to-skin contact. It can spread to and effect vital organs if not treated quickly. Pronounced by spelling out the four letters M-R-S-A.

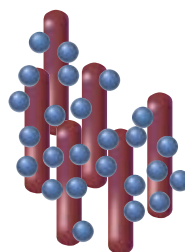

Methicillin-Resistant
Staphylococcus

N

Non-Enveloped Virus

Viruses that lack protein envelopes. The capsids are solely responsible for attachment of the virus to the to-be-infected cell. They are much harder to kill than enveloped viruses, since their cell walls are more durable.

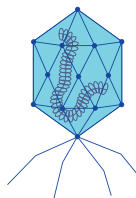

Non-Enveloped
Virus

Non-Pathogenic

Microorganisms that do not cause disease.

Nonionic Detergent

A type of chemical that possesses surfactant properties, including surface wetting, soil dispersion, etc. Does not ionize with positive or negative charges. Is compatible in mixtures with either cationic or anionic surfactants. Is not compatible with phenolic germicides. Does not react with positive or negative charge. Is compatible in mixtures with either cationic or anionic surfactants.

P

Pathogenic

Disease producing.

Phenol

Active ingredient used in disinfectants. Provides broad spectrum of organism kill. Cannot be used on semi-critical items or on bassinets and incubators. Phenols can leave a buildup of film on surfaces and can cause severe skin irritation and discoloration.

Portal of Entry

A location or method by which a pathogen enters a new host. Typical portals include mouth, nose, eyes, mucus membranes and wounds.

Q

Quat

Abbreviation for a chemical that contains a quaternary ammonium compound.

Quaternary Ammonium Compounds (Quats)

Active ingredient used in disinfectants products. Advantages: less irritating to the skin, good cleaning properties, does not form a buildup, remains active in hard water and kills a broad spectrum of organisms.

Quick-Change Handle

Traditional loop mop handle with an arm that locks in place.



Quick-Change Handle,
see item EVST00L121P
on pg. 30

R

Recommended Use Dilution

The published rate at which antimicrobial products must be mixed with water to be effective against specific germs.

RTU

Abbreviation for Ready To Use.

S

Sanitize

Reduce of the bacterial population in the inanimate environment by significant numbers, (e.g., 3 log₁₀ reduction or more), but does not destroy or eliminate all bacteria.

Sanitizer

Products used to reduce, but not necessarily eliminate, microorganisms from the inanimate environment to levels considered safe as determined by public health codes or regulations.

Scrub and Recoat

Process of removing embedded dirt and soil from floors without stripping. Scrubbing, also known as deep scrubbing or top scrubbing, removes one to two coats of floor finish with embedded dirt, delaying the need for floor stripping. Scrubbing is recommended when the floor no longer responds to burnishing or spray buffing. Use a slow speed machine or an auto-scrubber combined with a general purpose cleaner or heavy-duty floor cleaner/degreaser.

Scrubber

Walk-behind or ride-on machines with large disc pads for maximum coverage that rotate at 175 revolutions per minute (RPMs), typically used for scrubbing and maintaining floor surfaces.

SDS

Abbreviation for Safety Data Sheet. A form required by law to describe hazardous ingredients and handling risks for chemical products. Previously known under old regulations as an MSDS, for Material Safety Data Sheet.

Semi-Critical Use

Refers to items that touch mucous membranes. Requires high-level disinfection, such as glutaraldehyde.

Shelf Life

Length of time an undiluted product can remain active and effective. Light, temperature, organic matter and metals can affect chemical stability.

Soap

A natural cleaning agent produced by the reaction of a fat and an alkali.

Spore

Structure formed by certain microorganisms that enhances their resistance to heat and chemical disinfectants. Bacteria turns into a spore when conditions become unfavorable as a mechanism to survive. The most common example is a *C. Diff* spore.

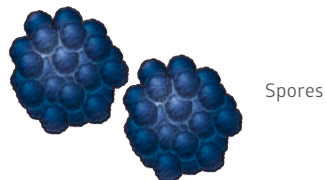

Sporicide

A substance or mixture of substances intended to irreversibly inactivate bacterial spores in the inanimate environment.

Stability

The ability of an antimicrobial product to remain unchanged during storage.

Standard Precautions

Infection control techniques that healthcare workers are required to practice when exposed to blood or body fluids.

Sterile

Free of living organisms.

Sterilization

Any process or treatment that destroys or removes all microbial life, including bacteria spores. Methods commonly used are dry or wet heat and/or liquid or gaseous chemical sterilants.

Sterilant

A substance or mixture of substances intended to destroy or eliminate all forms of microbial life in the inanimate environment, including all forms of vegetative bacteria, bacterial spores, fungi, fungal spores, and viruses.

Stripping

Process of removing finish from a floor surface with a stripping chemical and swing machine.

Surfactant

Agent that reduces the surface tension of water or the tension at the interface between water and another liquid. Also called Wetting Agents, surfactants can be found in many antimicrobial products.

Susceptible Host

Any organism (human, animal or plant) with weakened body defenses that allow a pathogen to enter and produce a reaction.

Swing Machine

Oscillating floor machine that spins at 175 revolutions per minute (RPMs), typically used for stripping or scrubbing hard floor surfaces.

T

Transient Flora

Microbes that live on the outer layer of the skin and typically can survive no more than 24 hours. Typically picked up through direct or indirect contact and usually easily removed by hand washing.

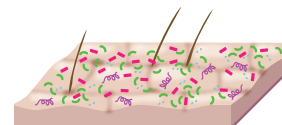

Transient Flora

Tuberculocide

A substance or mixture of substances that destroys or irreversibly inactivates tubercle bacilli (e.g. *Mycobacterium*) in the inanimate environment. Tuberculocidal claims are an indicator of product strength, because tuberculosis bacteria are more difficult to kill than most other microorganisms, although tuberculosis is not contracted from environmental surfaces, clothing, drinking glasses, eating utensils, cell phones, handshakes, toilets, etc. It is commonly spread through someone breathing in air that has TB discharged into it from someone who has TB and has coughed, spoken or sung.

V

Vaccinia Virus

Lipophilic virus, representative of the Pox viruses (i.e. Smallpox).

Vegetative State

Refers to bacteria or microorganisms that can grow and reproduce in areas with soil filled with nutrients and moisture. When nutrients and moisture are depleted, some bacteria, such as *Clostridium*, produce an endospore inside each vegetative cell. When the active bacteria no longer have nutrients or moisture, they release spores (endospores). Spores can remain viable for long periods. When the right conditions return for growth, the spore creates a vegetative cell and the bacteria becomes active again.

Virucide

A substance or mixture of substances that destroys or irreversibly inactivates viruses in the inanimate environment.

Virulence

Power of a microorganism to produce disease.

Best housekeeper habits

At all times:

Protect yourself

- **Block germs**—wear gloves, especially when cleaning toilets
- **Leave sharps alone**—if you find a needle, ask a member of the nursing staff to remove it
- **Use caution with chemicals**—don't let any near your eyes or face
- **Don't hurt your back**—ask for help when lifting any heavy object
- **Avoid falls**—Never stand on a chair or toilet

Prevent cross-contamination

- Each room should get a fresh rag
- Never use a rag that touched a toilet anywhere else

Remember your manners

- Be friendly and welcoming
- Avoid making too much noise

At the start of each day:

Fill bottles and buckets with premixed chemicals

If any are empty, ask your supervisor to mix them for you.

- All-purpose cleaners
- Window cleaners

Quick tip

Make sure your cart has everything you'll need—broom/dust pan, mop, rags, gloves, paper products, trash bags, etc.

Cleaning guide for patient rooms

1 Prepare to enter the room

- Perform proper hand hygiene.
- Put on protective apparel such as gloves. Before going into isolation rooms, put on additional personal protective equipment.
- Announce your presence before entering the room.



Product recommended: CRI4000

2 Enter the room

- Survey the room for anything that doesn't belong. If you find something, contact the nursing staff about removing it.
- Inspect the privacy curtains. If the room was just used for isolation, or if the curtain is visibly soiled, contact the manager to arrange for cubicle curtain replacement.



Product recommended: MIT6DSEREN (Snap panel curtain)

3 Dispose of waste

- Remove soiled linens.
- Keep hazardous waste separate (i.e., soiled linen, infectious waste, infectious linens).
- Dispose of liners, making sure to close, twist, and tie a knot in the liner while it's still in the trash can. (**NOTE:** Watch out for sharp objects. Never put your hand into the bag or push on it.)



Product recommended: NON022938 (soiled linen liner) and other Medline trash liners

4 Dust the room

- Remove gloves, apply hand hygiene and put on new gloves.
- Start dusting near patient bed and then move outwards (do not dust in occupied ICU/CCU patient rooms).



Product recommended: MDT217750 (Microfiber overhead duster)

5 Wipe high-touch surfaces

- First remove soils and residue with a microfiber cloth or one-step germicide.
- Then apply disposable disinfectant wipes. Use a new wipe for each surface to avoid cross contamination. If a surface starts to dry before the contact time (printed on the disinfectant), apply more product until the correct amount of time has passed.
- For rooms used for isolation, ask the nursing staff if additional cleaning is needed. To kill *Clostridium difficile* (*C. diff.*), a bleach or peracetic acid disinfectant or wipe is needed.

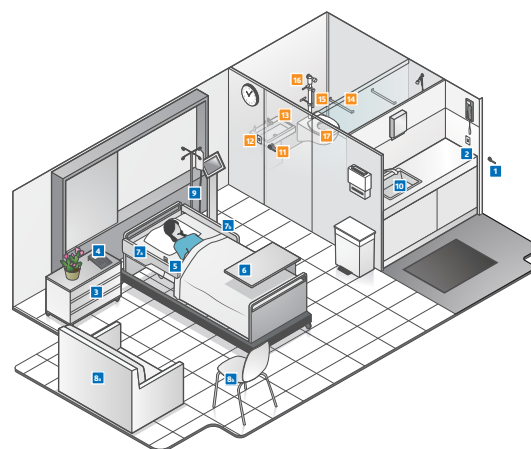

Products recommended: MSC351300 (Micro-Kill One) and MSC351400A (Micro-Kill Bleach)

6 Begin cleaning the bathroom

- Clean the mirror.
- Disinfect the rest of the bathroom, including: toilet bowl, flushers and seat, sink and countertops, shower, hand rails, and fixtures.
- For tougher stains, use heavy-duty products, such as a more acidic toilet bowl cleaner, foaming acid shower cleaner, or a crème cleanser for soap scum, scale and rust.
- To remove stains and odors from urine, an odor digester/eliminator is recommended.
- Refill soap and lotion dispensers and wipe the outside of these containers.



Products recommended: EVSCHEM420 (toilet bowl cleaner), EVSCHEM410 (crème cleanser), EVSCHEM480 (odor digester/ Eliminator), EVSCHEM100 (disinfectant), and EVSCHEM200 (glass cleaner)

7 Sweep and mop the entire floor

- Work from the furthest corner to the entrance.
- Sweep the floor.
- Mop using a disinfectant or neutral floor cleaner.
- Change the solution every three rooms. For heavier soils, use a general purpose cleaner.



Product recommended: EVSCHEM210 (neutral floor cleaner) and MICROINSKIT1 (Microfiber starter kit)

8 At the end of the day

- Clean the cleaning tools.
- Remove mop heads and cloths to be washed.
- Wipe down spray bottles.
- Clean the mop and cart handles.
- Dispose of trash in the proper bins.
- Dispose of gloves and wash hands.



Product recommended: EVSCHEM230

High-touch surfaces

Disinfect high-touch areas

Avoid cross-contamination by disinfecting with antimicrobial wipes using the numbered order below. It is recommended that you use one wipe for one application per surface to prevent cross-contamination.

Resident room

1. Door knob
2. Light switch
3. Bedside table handles
4. Phone
5. Call button
6. Tray table
- 7a. Left bed rails
- 7b. Right bed rails
- 8a. Chair
- 8b. Chair
9. IV pole
10. Room sink

Restroom

11. Door knob
12. Light switch
13. Restroom sink
14. Handrails
15. Bedpan cleaner
16. Toilet flush handle
17. Toilet seat

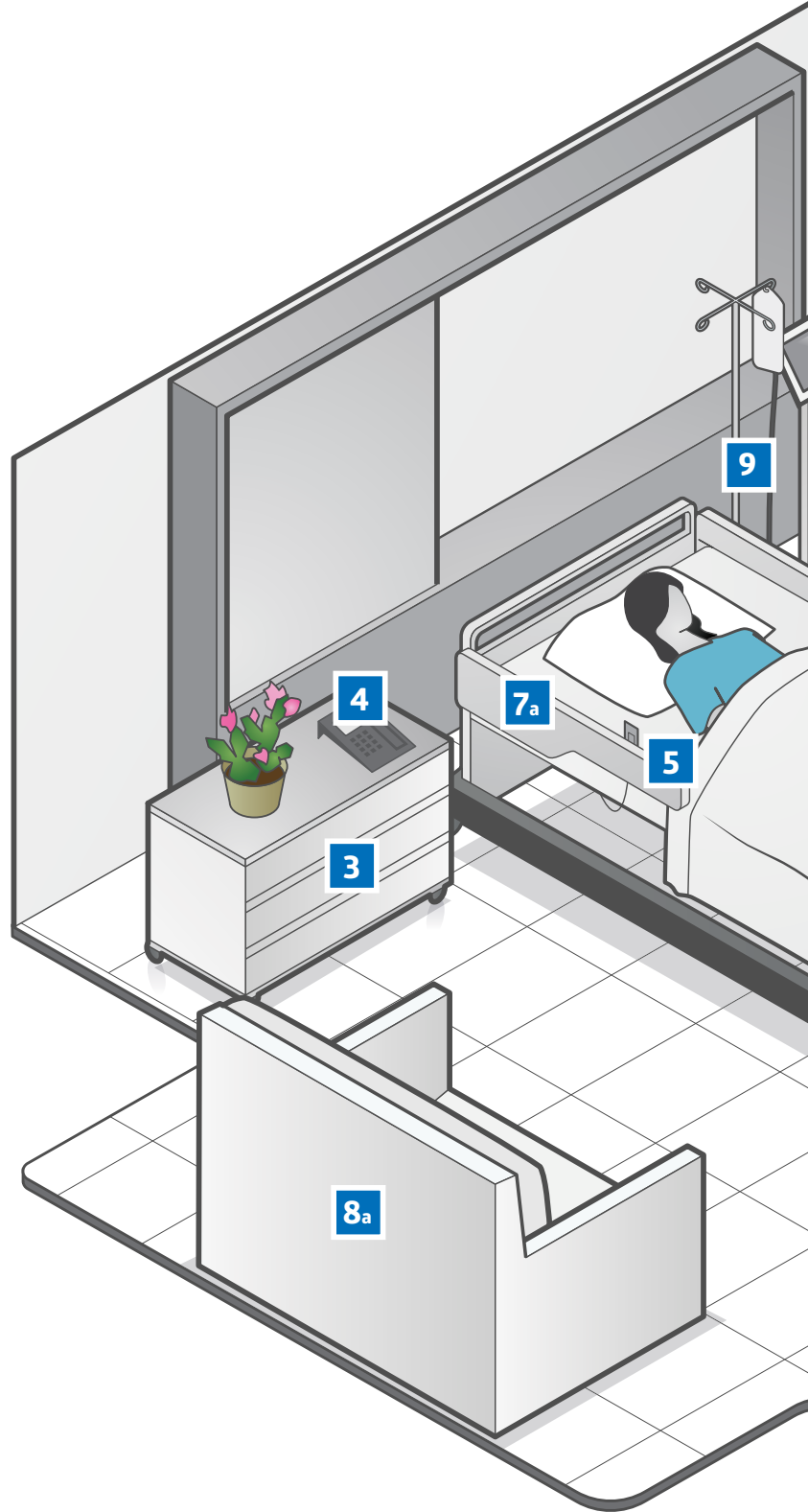

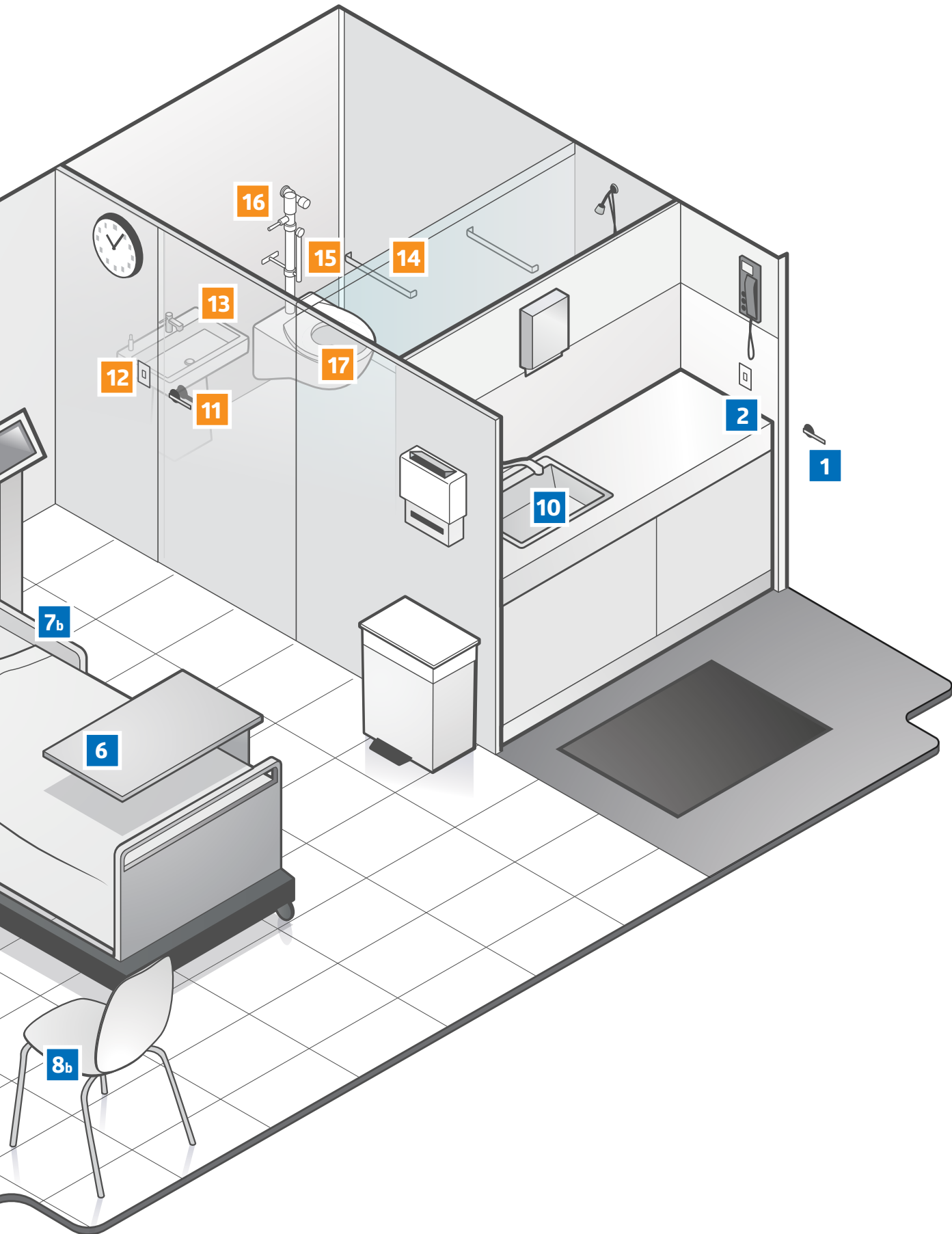

Checklist for new facility

Lobby area/foyers

- Scraper mats** (Exterior) Pg. 35–38
- Entrance mats** (Interior) Pg. 36
- Floors** (Finish/recoat) Pg. 90, 95
- Wet floor signs** Pg. 28

Elevator area

- Trash/recycle cans** Pg. 22–25
- Cleaners for elevator surfaces** Pg. 78–90

Waiting area

- Garbage bags** Pg. 12–19
- Facial tissues** Pg. 5

Patient room

- Floors (surfaces)** Pg. 89, 93–93
- Trash/recycle cans** Pg. 22–25
- Germicidal wipes** Pg. 78–84
- Air fresheners** Pg. 103
- Facial tissues** Pg. 5
- Paper towels/dispensers** Pg. 6–9
- Scuff mark removers** Pg. 95

Public restroom

- Tile/grout brush** Pg. 32
- Baseboard cleaners** Pg. 96
- Paper towels/dispensers** Pg. 6–9
- Trash cans** Pg. 22–25
- Garbage bags** Pg. 12–19
- Air freshener** Pg. 103
- Toilet seat covers** Pg. 5

Nursing unit

- Facial tissue** Pg. 5
- Trash/recycle cans** Pg. 22–25
- Garbage bags** Pg. 12–19
- Eye-wash stations** Pg. 148
- Germicidal wipes** Pg. 78
- Blood spill kits** Pg. 147
- Paper towels/dispensers** Pg. 6–9
- Scuff mark removers** Pg. 95

Reception area

- Facial tissues** Pg. 5
- Trash/recycle cans** Pg. 22–25
- Scuff mark removers** Pg. 95

Patient bathroom

- Trash/recycle cans** Pg. 22–25
- Paper towels/dispensers** Pg. 6–9
- Toilet paper/dispensers** Pg. 6–9
- Toilet seat covers** Pg. 5
- Air fresheners** Pg. 103
- Mirror cleaners** Pg. 91, 98
- Shower cleaners** Pg. 97
- Tile/grout/baseboard cleaners** Pg. 96

Basement storage area

- Linen carts/cart covers** Pg. 67–73
- Floor scrubbers** Pg. 46
- High-speed floor machines** Pg. 47–50
- Vacuum cleaners** Pg. 51–52

Janitor's closet

- Chemical dispensers** Pg. 92
- Chemicals** Pg. 78–98
- Ready-to-use products** Pg. 78–98
- 32-gal. large round receptacles** Pg. 24

**Medline MIYO HealthCare
Housekeeping Workstations**
Pg. 72



Ideal cart checklist

Housekeeping cart

- Healthcare housekeeping cart Pg. 72

Chemicals

- Bleach Pg. 94

Wipes

- Dry wipes Pg. 65
- Bleach wipes Pg. 80–80

Sweeping

- Squeegee sweeper Pg.28
- Lobby broom Pg. 27
- Angled broom Pg. 27
- Hand dust pan Pg. 27
- Lobby dust pan Pg. 27
- Threaded wood broom handle Pg. 30

Toilet bowl

- Disposable toilet seat covers Pg. 5
- Disposable toilet bowl mop Pg. 33
- Cylindrical bowl brush Pg. 33
- Caddy Pg. 33
- Toilet plunger Pg. 33

Wet floor signs

- Wet floor sign Pg. 28

Dusting

- High-duster kit/reusable cover Pg. 30
- Disposable high-duster covers Pg. 30
- Lamb's wool duster Pg. 29

Mopping

- Touchless mop handle Pg. 63
- Adjustable mop handle Pg. 63
- Quick-change mop handle Pg. 30
- Jaw mop handle Pg. 30
- 18" mop frame Pg. 63
- Microfiber screen wringing bucket Pg.59
- Mop bucket with down wringer Pg. 31
- Mop bucket with side wringer Pg. 31

Spray bottles

- Bottle and spray trigger Pg. 29
- Empty bottles (32 oz.) Pg.29
- Trigger sprayer tops Pg.29

Putty knife

- Putty knife Pg. 31

Tile and grout

- Tile and grout brushes Pg. 32

Hand pads/sponges

- Amazing sponge Pg. 32
- Heavy-duty utility pad Pg. 32
- Medium-duty utility pad Pg. 32
- Medium-duty scrubbing sponge Pg. 32
- Light-duty scrubbing sponge Pg. 32
- Heavy-duty scouring pad Pg. 32
- Medium-duty scouring pad Pg. 32
- Hand pad holder Pg. 32

The EVS struggle is real

Proper cleaning and disinfection are critical to keeping patients safe from infection. But Environmental Services (EVS) managers and staff deal with tough issues on a daily basis that create roadblocks to doing their job effectively. Topping the list of concerns: pressure to speed up room turns, unclear responsibility for who cleans mobile objects, high staff turnover, no standard cleaning practice, and lack of knowledge about the role the environment plays in cross contamination and transmission.

Tracking the problem

Clear-cut guidelines on how to solve surface contamination don't exist. That's why we've worked with experts nationwide to develop a comprehensive cleaning and disinfecting program. It combines process with evidence-based products and education to help prevent the spread of HAIs.



Clean like lives depend on it

Contact your Medline representative to request a free discovery assessment.



Empower EVS staff with the right tools and training to help prevent HAIs.

Scan the code to [learn more](#)

Clean like lives depend on it

Empower EVS staff with the right tools and training to help prevent HAIs.



Cleaning, disinfecting and sterilizing

Help your staff understand the three essential steps in maintaining safe healthcare objects and surfaces: cleaning, disinfecting and sterilizing.

Scan the code to [watch the video](#)



How to select healthcare disinfectants

Learn tips for selecting healthcare disinfectants, and the key terminology to support best practices.

Scan the code to [watch the video](#)



**We make
healthcare
run better™**

Medline Industries, Inc.

Three Lakes Drive, Northfield, IL 60093
Medline United States | 1-800-MEDLINE (633-5463)
medline.com | info@medline.com

Medline Canada

1-800-268-2848 | medline.ca | canada@medline.com

Medline México

01-800-831-0898 | medlinemexico.com | mexico@medline.com

Follow us    