

PM1000+ POWER ANALYZER USER MANUAL

Need help?

Thank you for choosing to use this Voltech Power Analyzer. It has been designed to be safe and easy to use.

Should you experience any difficulty during the set up or use of any Voltech product, or are unsure of any of their features or abilities, please do not hesitate to contact either your local supplier or visit our **applications support** center at **www.voltech.com**

Voltech Instruments Inc.
11637 Kelly road, Suite 306
Fort Myers, FL33908
U.S.A.
Tel: 239 437 0494
Fax: 239 437 3841
sales@voltech.com

Voltech Instruments Ltd.
148 Harwell Business Centre
Didcot, Oxon, OX11 0RA
U.K.
Tel: +44 1235 834555
Fax: +44 1235 835016
sales@voltech.co.uk

Voltech Instruments is committed to a policy of continuous product development. Hence product specification and the information given in this manual are subject to change without notice.

No part of this publication may be reproduced, stored in a retrieval system, or transmitted in any form, or by means electronic, mechanical photocopying, recording or otherwise, without prior written permission of Voltech Instruments.

© 2007 Voltech Instruments. All rights reserved.

Microsoft, Windows and the Windows logo are either registered trademarks or trademarks of Microsoft Corporation in the United States and/or other countries.

Voltech Part Number: 98-115

Manual Issue	PM1000+ Firmware Revision
1	V4.07

For the latest version of the manual and firmware please see our website at www.voltech.com



DANGER OF ELECTRIC SHOCK

Only qualified personnel should install this equipment, after reading and understanding this user manual. If in doubt, consult your supplier.



RISQUE D'ELECTROCUTION

L'installation de cet équipement ne doit être confiée qu'à un personnel qualifié ayant lu et compris le présent manuel d'utilisation. Dans le doute, s'adresser au fournisseur.



GEFAHR VON ELEKTRISCHEM SCHOCK

Nur entsprechend ausgebildetes Personal ist berechtigt, diese Ausrüstung nach dem Lesen und Verständnis dieses Anwendungshandbuches zu installieren. Falls Sie Zweifel haben sollten, wenden Sie sich bitte an Ihren Lieferanten.



RISCHIO DI SCARICHE ELETTRICHE

Solo personale qualificato può installare questo strumento, dopo la lettura e la comprensione di questo manuale. Se esistono dubbi consultate il vostro rivenditore.

IMPORTANT: Please consult the safety information section of this user manual before installation and use.

Contents

1. Introduction	1-1
1.1. Features & Abilities	1-1
1.2. Package Contents.....	1-2
1.3. Accessories	1-2
2. Quick Start	2-1
2.1. Power On.....	2-1
2.2. Connecting to the Product Under Test	2-2
2.3. Default Measurements	2-3
2.4. Navigating the Menu System	2-4
2.5. Menu Keys.....	2-5
2.6. Example: Choosing Measurements to Display	2-5
2.7. Key Shortcuts:	2-6
3. Using Voltage and Current Transducers.....	3-1
3.1. Input Overview.....	3-1
3.2. To connect a Simple Current transformer.....	3-2
Scaling.....	3-2
3.3. To connect an external resistive shunt:.....	3-3
3.4. To connect a transducer with a voltage output	3-5
3.5. To connect a Voltage Transformer / Transducer	3-6
Scaling.....	3-6
4. The Menu System.....	4-1
4.1. Navigation.....	4-1
4.2. Menu Items	4-1
4.3. Main Menu	4-1
4.4. Measurements.....	4-1
4.5. Modes.....	4-2
Select Mode.....	4-2
Ballast Setup.....	4-2

Inrush Setup	4-2
Standby Power Setup	4-3
Integrator Setup	4-3
4.6. Inputs.....	4-3
Fixed/Auto Ranging	4-3
Scaling.....	4-3
Frequency Source.....	4-4
Shunts	4-4
Blanking.....	4-4
4.7. Graphs.....	4-4
Waveform Graph.....	4-5
Harmonic Bar Chart	4-5
Integration Graph	4-5
4.8. Interfaces.....	4-5
RS232 Baud Rate.....	4-5
GPIB Address	4-6
4.9. User Configuration.....	4-6
4.10. System Configuration.....	4-6
Auto Zero	4-6
Clock Setup	4-6
4.11. View.....	4-7
Zoom	4-7
Contrast.....	4-7
5. Remote Operation	5-1
5.1. Overview.....	5-1
5.2. Command Listing.....	5-1
5.3. Communications examples.....	5-5
Basic selection and returning of result.....	5-5
Harmonics.....	5-6
Standby power	5-6
Inrush.....	5-7
6. Specification	6-1

6.1. Mechanical.....	6-1
6.2. Power Supply.....	6-1
6.3. Communications	6-1
RS232.....	6-1
AUX/TRIG.....	6-2
GPIB	6-2
USB	6-2
6.4. Measured Parameters.....	6-3
6.5. Measurement Accuracy	6-5
7. Warranty, Service and Updates	7-1
7.1. Warranty	7-1
7.2. Calibration and Service.....	7-1
7.3. Obtaining Service and Applications Support	7-2
7.4. Updating Firmware.....	7-2
8. Safety Information.....	8-1
8.1. Safety Features	8-1
8.2. Safety Instructions	8-1
8.3. Declaration of Conformity.....	8-2

1. INTRODUCTION

1.1. FEATURES & ABILITIES

The Voltech PM1000+ is a powerful and versatile precision power analyzer. Designed to provide clear and accurate measurements of electrical power and energy on all electrical products, the PM1000+ is both an easy to use bench instrument and a fast and programmable automatic test interface.

Basic Features:

- Measures Watts, Volts, Amps, Volt-Amperes and Power Factor.
Always accurate, even on distorted waveforms.
- Range of measurement from milli-watts to mega-watts.
- Built-in energy analyzer (watt-hour integrator) for measuring energy consumption over time.
- Standby power measurement mode for fast and accurate low power measurements.
- Harmonic analyzer with built in spectrum display
- Bright color display
- Comprehensive range of computer interfaces including RS232, IEEE488 and USB
- Inrush current measurement mode for measuring switch-on and other transient peak currents.
- Ballast mode for measuring the tube power of electronic ballasts.
- Easy-to-use menu system with context-sensitive help.

1.2. PACKAGE CONTENTS

The following items are supplied with your PM1000+.

Please check that you have every item and report any missing items to your Voltech supplier as soon as possible

- PM1000+ Power Analyzer
- Certificate of Conformance and Calibration
- CD including user's manual and calibration data
- Mains power cable
- 2 pairs of yellow and black measuring leads

1.3. ACCESSORIES

Please see our website at www.voltech.com for accessories available from Voltech and other suppliers. These include:

- Spare measuring lead set (part number 78-124)
- A range of current transformers to extend the measuring range from <1mA to 3000A
- Connectors for the 2mm external shunt input
Part numbers 78-128 (red) and 78-129 (black).
- Communications leads (RS232, USB...)

2. QUICK START

2.1. POWER ON



1. Check the power analyser is in good condition with no signs of damage.
2. Connect the line power supply cable.
3. Ensure the supply is Earth grounded.

4. Press the power switch at the front to on (I)

The PM1000+ will start its power up sequence. This takes approximately one minute.

During power up you will see the PM1000+'s serial number and last calibration date.

5. The instrument is now ready for use

2.2. CONNECTING TO THE PRODUCT UNDER TEST

The PM1000+ will measure up to 600Vrms and 20Arms directly using the 4mm terminals on the front panel. For measurements outside the range (low or high power) see the section on Using Current and Voltage Transducers later in this manual.

To measure power, connect the PM1000+'s measuring terminals in parallel with the supply voltage and in series with the load current.



Always use good quality safety cables as supplied and check that they are not damaged before use.

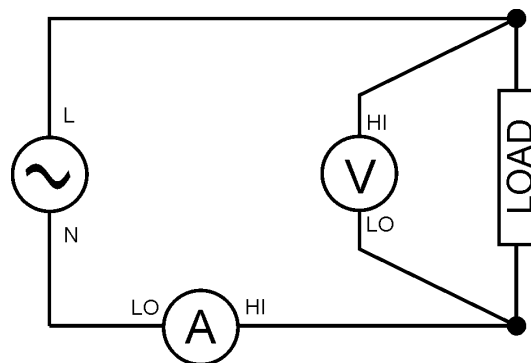

V HI

To ac supply live

V LO

To load neutral

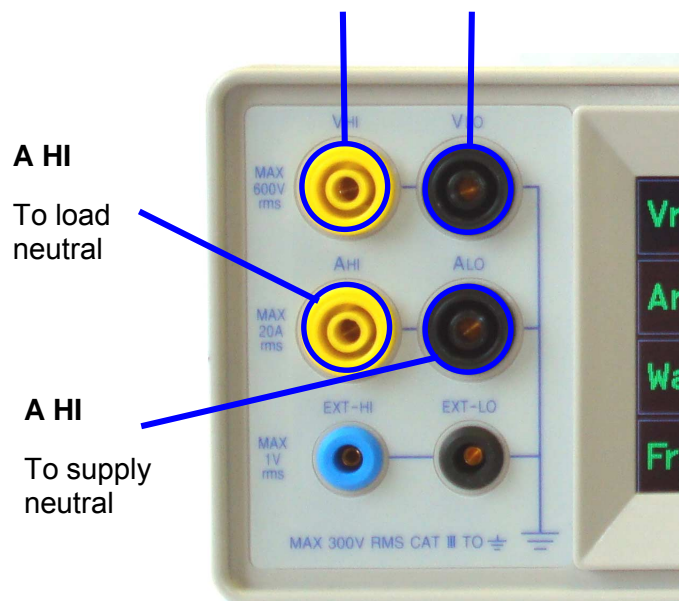

The simplest and safest way to make a connection to the product under test is to use a Voltech Break Out Box. This provides a line socket for connection of the product and 4 x 4mm sockets for direct connection to the PM1000+ terminals as described above.







2.3. DEFAULT MEASUREMENTS

Switch on the supply to the load and the PM1000+ is now ready to make measurements. Note that it is not necessary to switch the PM1000+ either off or on when the load is being connected.



The default display shows 4 values. Each line clearly shows the measurement type 'Vrms', the measured value, '248.4' and the measurement units, 'V'. Normal engineering notation is used to describe units, e.g. mV = milli-volts (10⁻³) and MV = mega-watts (10⁺³).

To scroll through the measurements, use the 4 keys to the right of the display:

-  **Jump Up** Display the page above.
-  **Up** Move up through the measurement list.
-  **Down** Move down through the measurement list.
-  **Jump Down** Display the page below.

2.4. NAVIGATING THE MENU SYSTEM

The menu system provides complete access to all settings of the PM1000+. To access the menu system, press the MENU key.

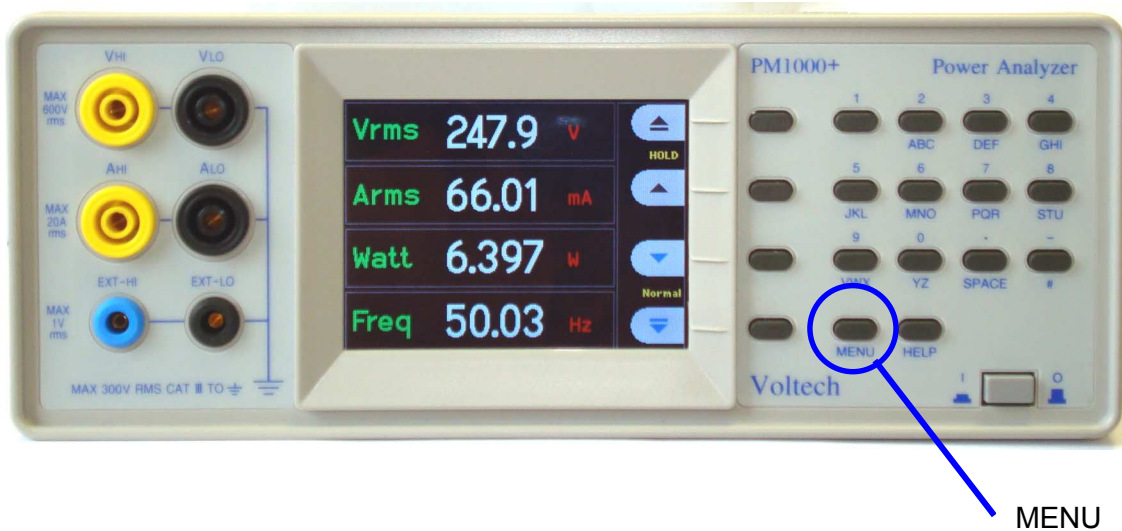





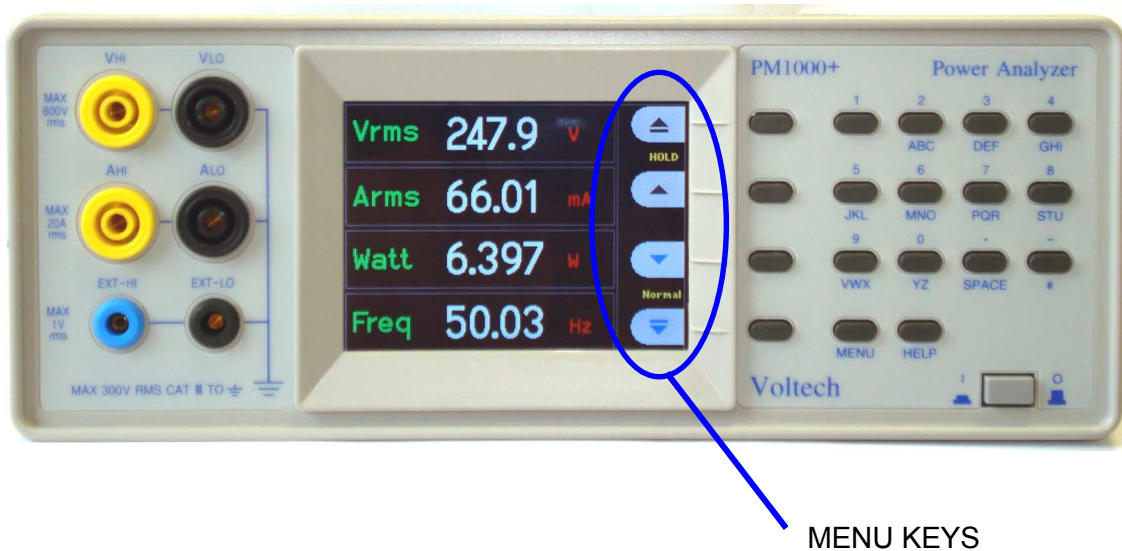



To return to the measurement display at any time, simply press the MENU key again.

With the menu system active, the 4 soft keys to the right of the display may be used to navigate and select options.









2.5. MENU KEYS

	Up	Move up through the list of displayed options
	Down	Move down through the list of displayed options
	Up	Accept or switch on the option shown
	Down	Decline or switch off the option shown
	Up menu	Go up to a higher menu level
	Down menu	Go down to a lower, more detailed, menu
	Delete	Delete the character to the left.
	Help	Switch the help display on or off.

2.6. EXAMPLE: CHOOSING MEASUREMENTS TO DISPLAY

To choose the measurements on the display:

1. press MENU (to show the menu)
2. press  (to see the list of Measurements)
Measurements with a  will be displayed in the order shown.
3. Select   the measurement to display and press .
4. (Option). Move the measurement  
5. Press **OK**.

To remove a measurement, select it and press **X**

Hint:

To restore the default list, see the User Configuration Menu.

2.7. KEY SHORTCUTS:

Display freeze:	Press SPACE
Display graph:	Press YZ
Print:	Press VWX
Local control (from remote):	Press #

3. USING VOLTAGE AND CURRENT TRANSDUCERS

3.1. INPUT OVERVIEW

Voltage

Voltages of up to 600V rms may be connected directly to the black and yellow 4mm VHI and VLO safety sockets at the front of the PM1000+

Current

Currents of up to 20A rms may be connected directly to the black and yellow 4mm AHI and ALO safety sockets at the front of the PM1000+

External Current Inputs

The external current inputs accept a voltage of up to 1V rms that is proportional to the current being measured. This input allows a very wide range of external current transducers to be connected, from low mA current shunts to MA current transformers. For each type of transducer, the PM1000+ may be scaled to read the correct current. See the INPUTS menu.

The choice of current transducer will depend on:

- The current being measured, including peaks and transients.
- The accuracy required.
- The bandwidth required: Unless the waveforms are purely sinusoidal, a bandwidth in excess of the fundamental frequency will be required.
- Whether there is DC current present.
- Convenience of connection – E.g. using a clamp-on current transformer, with jaws that open, for quick connection in a fixed wiring loom.
- The effect of the transducer on the circuit.

3.2. TO CONNECT A SIMPLE CURRENT TRANSFORMER

To use a conventional current transformer (CT) like the Voltech CL series (or any other transducer with a current output), connect the normal AHI and ALO inputs of the PM1000+ to the outputs of the current transformer. Follow the manufacturer's instructions for the safe use and installation of the transducer.

Normally the positive or HI output of the transducer will be marked with the point of an arrow or a '+' symbol. Connect this terminal to the AHI input of the PM1000+.

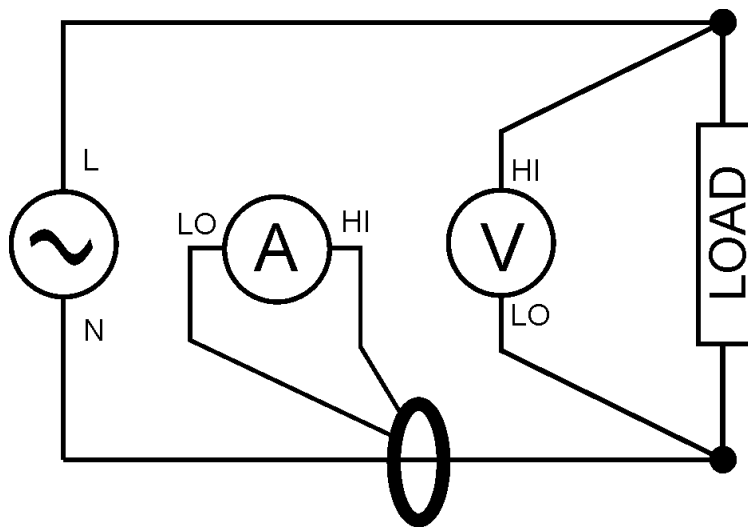

Scaling.

A current transformer produces an output current which is proportional to the load current being measured. For example, the Voltech CL100 produces an output current that is 1/100 of the current being measured.

To measure the correct current on the PM1000+, use the scale function of the analyzer to scale, or multiply, the CT output current.

For example, the CL100 is a 100:1 CT. When measuring 100A, its output is 1A. To scale this on the PM1000+, a scale factor of 100 must be entered:

Press 'MENU'

Select ▲▼ 'Inputs' and press ►

Select ▲▼ 'Scaling' and press ►

Use the  delete key to clear the entry.

Type the new scale factor (100)

Press **OK**

Press 'MENU' to return to the measurement display.

The PM1000+ is now ready to make measurements using a CT.

3.3. TO CONNECT AN EXTERNAL RESISTIVE SHUNT:

Using resistive shunt is a straightforward method of extending the current measuring range of the PM1000+. The shunt resistor is connected in series with the load and the voltage across the shunt is directly proportional to current.

That voltage may be connected directly to the External Current Inputs of the PM1000+.

For example, a 1milli-ohm shunt is to be used to measure 200A rms.

1. Check the voltage that will be generated is suitable for the PM1000+

$$V = I \times R \text{ (Ohm's law)}$$

$$V_{\text{shunt}} = I \times R_{\text{shunt}}$$

$$V_{\text{shunt}} = 200 \times 0.001 \text{ Ohms}$$

$$V_{\text{shunt}} = 0.2\text{V}$$

This is well within the 1V rating of the PM1000+'s External Current Inputs

2. Connect the shunt in series with the load and to the EXT-HI and EXT-LO inputs as shown.

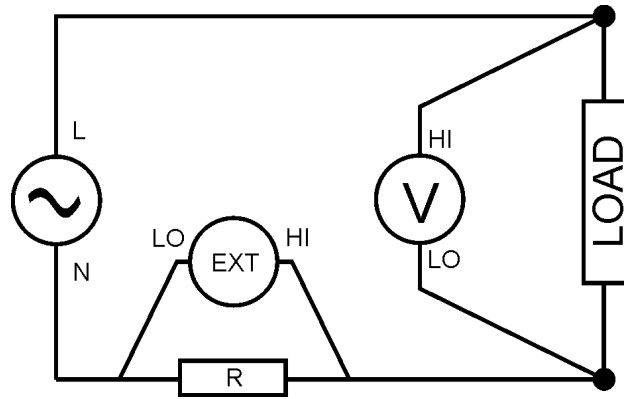

REMOVE ANY CONNECTIONS TO THE NORMAL ALO TERMINAL!
EXT-LO and ALO are connected inside the PM1000+. To avoid errors and a risk of electric shock, remove all connections to ALO.

3. Set up the PM1000+ to measure current from the EXT-HI and EXT-LO terminals.

Press 'MENU'

Select ▲▼ 'Inputs' and press ►

Select ▲▼ 'Shunts' and press ►

Select ▲▼ 'External' and press ✓

Press 'MENU' to return to the measurement display.

4. Scale the measurement on the display.

The default scale is 1V = 100A.

The scale required for any external shunt is given by:

$$\text{Scale} = 1 / (100 \times R) \quad (\text{where } R \text{ is the resistance value of the shunt}).$$

In this example where $R = 0.001$ Ohms

$$\text{Scale} = 1 / (100 \times 0.001)$$

$$\text{Scale} = 1 / 0.1 = 10$$

To enter a scale factor for current:

Press 'MENU'

Select ▲▼ 'Inputs' and press ►

Select ▲▼ 'Scaling' and press ►

Select ▲▼ 'Amps' and press ►

Use the  delete key to clear the entry.

Type the new scale factor (e.g.10)

Press **OK**

Press 'MENU' to return to the measurement display.

The PM1000+ is now ready to make measurements using an external shunt.

3.4. TO CONNECT A TRANSDUCER WITH A VOLTAGE OUTPUT

These transducers contain active circuits that help to improve performance at high bandwidth. They may be of the 'hall effect' or Rogowski coil type.

The procedure is similar to that of installing an external shunt as described above.

1. Follow the manufacturer's instructions for the safe use and installation of the transducer.
2. Connect the voltage output to the EXT-HI and EXT-LO terminals of the PM1000++ channel as above.
3. Select 'Inputs' – 'Shunts' – 'External' as above.

Press 'MENU'

Select ▲▼ 'Inputs' and press ►

Select ▲▼ 'Shunts' and press ►

Select ▲▼ 'External' and press ✓

Press 'MENU' to return to the measurement display.

4. Select and input a scale factor. These types of transducers are often rated in terms of mV / amp. For example a transducer with an output of 100mV / amp is the equivalent of a 100 milli-ohm external shunt resistor.

Scale = $1 / (100 \times R)$ (where R is the resistance value of the shunt).

In this example where R = 0.1 Ohms

$$\text{Scale} = 1 / (100 \times 0.1)$$

$$\text{Scale} = 1 / 10 = 0.1$$

Press 'MENU'

Select ▲▼ 'Inputs' and press ►

Select ▲▼ 'Scaling' and press ►

Select ▲▼ 'Amps' and press ►

Use the  delete key to clear the entry.

Type the new scale factor (e.g. 0.1)

Press **OK**

5. Press 'MENU' to return to the measurement display.

The PM1000+ is now ready to make measurements using a current transducer with a voltage output.

3.5. TO CONNECT A VOLTAGE TRANSFORMER / TRANSDUCER

The PM1000+ may be used with a voltage transformer (VT) or other transducer to extend its measuring range. Follow the manufacturer's instructions for the safe use and installation of the transducer.

The output of the transducer is connected to the normal VHI and VLO terminals. Normally the positive or HI output of the transducer will be marked with the point of an arrow or a '+' symbol. Connect this terminal to the VHI input of the PM1000+.

Scaling.

A voltage transformer (VT) produces a voltage output which is proportional to the voltage being measured.

To measure the correct voltage on the PM1000+, use the scale function of the analyzer to scale, or multiply, the VT output current.

For example, when measuring with a 1000:1 VT a scale factor of 1000 must be used.

Press 'MENU'

Select ▲▼ 'Inputs' and press ►

Select ▲▼ 'Scaling' and press ►

Select ▲▼ 'Volts' and press ►

Use the  delete key to clear the entry.

Type the new scale factor (100)

Press **OK**

Press 'MENU' to return to the measurement display.

The PM1000+ is now ready to make measurements using a VT.

4. THE MENU SYSTEM

4.1. NAVIGATION

The PM1000+'s menu is a powerful yet easy-to-use system for control of the analyzer. See the 'Quick Start' section of this manual for an overview of how to access and use the menu system.

For help at any time whilst using the PM1000+ press the HELP key at any time.

4.2. MENU ITEMS

To switch the display of the menu system off or on, press the 'MENU' key at any time.

4.3. MAIN MENU

To select a menu, press ►.

4.4. MEASUREMENTS.

Choose the measurements to display.

To add a new measurement:

1. Select it ▲▼ and press ✓.
2. (Option). Move the measurement ▲▼
3. Press OK.

To remove a measurement, select it and press X

Hint:

To restore the default list, see the User Configuration Menu.

For harmonics only, there are further choices:

- Enable / Disable
- Sequence - All or odd harmonics only
- Range - The maximum harmonic (up to 50)

4.5. MODES.

Special application modes.

Select Mode

Choose this option to set the PM1000+ into one of its operating modes. Each mode is indicated on the front panel measurement display once set.

The modes are:

Normal – Ideal for most general measurements.

Ballast – For measuring the output of electronic ballasts. See www.voltech.com for application notes on this subject.

The frequency displayed is the ballast switching frequency.

Inrush – For measuring the peak current during any event. Typically this is used to measure the peak current when a product is switched on.

Standby Power – A special mode in the analyzer that automatically sets continuous sampling and ensures that no data is lost even when the load current or power is fluctuating. Ideal for products that operate in burst mode when in standby.

Integrator – For energy consumption (W-h) measurements over time. Ideal for rating products whose energy consumption is not constant like washing machines and refrigerators.

Ballast Setup

The ballast mode is fully automatic and no setup is required.

In ballast mode, the PM1000+ automatically makes measurements that are synchronized to 50, 60 or 400Hz line inputs and simultaneously measures the switching high frequency output.

Inrush Setup

Choose the starting current range. Start with the maximum range and then set the mode and make measurements. Choose a lower range with the soft-keys for more accuracy once you begin to make measurements.

Standby Power Setup

The time window is the time over which the PM1000++ will average the samples. Note that the measurements will only update at this rate. See the technical notes at www.voltech.com for more information.

Integrator Setup

These options are for future use.

4.6. INPUTS.

Set up the measurement inputs – range, scale and low value blanking.

This menu may be used to set up the physical inputs of the PM1000. For normal operation 20mA to 20A and up to 600V it is not necessary to change these settings from default.

To select an Inputs menu item, use the ▲▼ keys and then press ► for detailed options.

Fixed/Auto Ranging

For most measurements, auto-ranging is the best choice. Choosing a fixed range may be useful if the voltage or current is changing continuously or has large peaks which make the analyzer spend excessive time changing range.

Select ▲▼ Volts or Amps and press ► to choose the range.

Scaling

When the 600 V and 30A inputs are used directly then the scaling for Volts and Amps is 1, which is the default setting.

To use the PM1000+ with external voltage or current transducers, enter a scale factor to have the PM1000+ display the true scaled measurements.

Select ▲▼ Volts or Amps and press ► to enter the scale factor.

See the Chapter ‘Using External Voltage and Current Transducers’ for further information.

Frequency Source

To make accurate rms measurements the PM1000+ must first determine frequency. Normally the PM1000+ detects frequency from the voltage signal using proprietary algorithms.

If no voltage signal is present, or it is a chopped waveform, then it may be necessary to select Amps as the frequency source.

Select Volts or Amps Frequency Source using the ▲▼ keys and press ✓ to confirm.

Shunts

The internal shunt of the PM1000+ is suitable for measurements in the range 20mA to 20A rms and this may be extended by the use of suitable current transducers from uA to MA.

Some current transducers (including simple resistive shunts) produce a voltage that is proportional to current. External Shunt Inputs are provided on the PM1000+ for use with current transducers that provide a voltage output.

Because the 0V is common to both the internal and external shunts, only one type may be connected at any time.

Select Internal or External Shunt using the ▲▼ keys and press ✓ to confirm.

See the Chapter 'Using External Voltage and Current Transducers' for further information.

Blanking

Normally Enabled, select Disable to measure voltage or current that is small (<0.25V or <3mA). If blanking operates on either voltage or current then all related measurements will be blanked including W, VA and PF.

Select Disable or Enable using the ▲▼ keys and press ✓ to confirm.

4.7. GRAPHS.

Set up the graphical displays of the PM1000+

Select the graph type using the ▲▼ keys and press ► for options.

HINT: Use the 'YZ' key to toggle between graphic and numeric displays.

Waveform Graph

This will display the voltage, current and (optionally) the watts waveform.

The scale of the graph is set automatically according to the selected range and scaling. Display of the Watts graph may be disabled.

Select ▲▼ Show and press ✓ to display the Waveform Graph.

Select 'Watts' to add the instantaneous watts waveform to the display.

Harmonic Bar Chart

Select Voltage or Current harmonic barchart using the ▲▼ keys and press ► for details.

The 'scale' is the maximum amplitude that will be displayed. Set the scale to be similar to the rms value to see an overview of the spectrum. To view smaller harmonics in more detail a smaller 'scale' may be set.

If the harmonic exceeds the set scale it will be shown as a grey ■ bar.

The right ⇨ and left ⇦ arrow keys may be used to select the harmonic whose amplitude and phase are shown at the top of the screen. The selected harmonic is shown in yellow. ■

Select ▲▼ Show and press ✓ to display the harmonic barchart (voltage or current).

Integration Graph

This function will be available in a future release of firmware.

4.8. INTERFACES.

This menu may be used to set up the interfaces of the PM1000+

To select set up an interface, use the ▲▼ keys and then press ► for detailed options.

RS232 Baud Rate

Select ▲▼ the desired baud rate and press ✓ to confirm.

9600, 19200 (default) and 38400 are available.

The PM1000++ uses hardware handshaking (RTS / CTS) with no parity, 8 data bits and 1stop bit (N,8,1).

GPIB Address

Enter the GPIB address and press **OK**.

Default address is 6.

4.9. USER CONFIGURATION.

Save and recall your set up.

To select a menu item, use the **▲▼** keys and then press **▶** for detailed options.

The first option is to 'Load Default'. Choosing this option will set every menu option of the PM1000+ to its factory default.

The other menu items (Default 'Configuration n') may be used to store and recall all settings of the PM1000+

For each User Configuration, you may:

Apply – apply the saved configuration

Rename – give the configuration an meaningful name

Save Current – save a configuration. This is always the complete settings of the PM1000+ at the time you choose this option.

Print – Print the configuration.

4.10. SYSTEM CONFIGURATION.

Set up Clock and Auto Zero.

To select a menu item, use the **▲▼** keys and then press **▶** for detailed options.

Auto Zero

Normally the PM1000+ will cancel any small dc offsets in the measurement automatically. This is called Auto Zero.

Auto Zero should always be enabled.

Select **▲▼** Disable and Enable and press **✓** to confirm.

Clock Setup

These options may be used to check or set the PM1000+'s internal clock.

To select a menu item, use the **▲▼** keys and then press **▶** for detailed options.

Set Time - Enter the time using the format shown and press **OK** to confirm.

Set Date - Enter the date using the format shown and press **OK** to confirm.

Time Format - Select ▲▼ 12 Hour or 24 Hour and press ✓ to confirm.

Date Format - Select ▲▼ the required date format and press ✓ to confirm.

4.11. VIEW.

Set up zoom and contrast.

To select a menu item, use the ▲▼ keys and then press ► for detailed options.

Zoom

Select ▲▼ either 4 results or 14 results display and press ✓ to confirm.

Contrast

Enter a contrast number and press **OK** to confirm.

50 is the default value.

5. REMOTE OPERATION

5.1. OVERVIEW

Using the remote commands the PM1000+ can be used to perform high speed, complex or repetitive measurements.

5.2. COMMAND LISTING

Commands may be in upper or lower case.

Please see the next section for examples.

":BLK:ENB"	enables blanking
":BLK:DIS"	disables blanking
":BLK?"	returns current blanking setting 1 = enabled 0 = disabled
":CAL:DATE?"	Sends the date of last calibration
":CFG:LOAD"	Loads requested configuration value = 0 to 6 0 = default
":CFG:SAVE"	Saves the specified configuration value = 1 through 6
":CFG:PRINT"	Prints the specified configuration value = 1 through 6
":COM:RS2:BAUD"	sets the RS232 baud rate "value" = 9600, 19200 or 38400
":COM:RS2:BAUD?"	returns the current baud rate setting
":COM:IEE:ADDR"	sets the IEEE488 (GPIB) address "value" = 1 - 31
":COM:IEE:ADDR?"	108 returns the current IEEE488 (GPIB) address setting
":FRD?"	returns the selected values
":FRF?"	returns the current selection list
":FSR:VLT"	sets the frequency source for voltage
":FSR:AMP"	sets the frequency source for current
":FSR?"	returns the freq source 0 = volts 1 = amps

":GRA:HRM:VLT:SCL"	Set scaling in harmonic bar chart for Volts "value" = 0 - 1000
":GRA:HRM:AMP:SCL"	Set scaling in harmonic bar chart for Amps "value" = 0 - 100
":GRA:HRM:AMP:SHW"	Show current bar chart
":GRA:HRM:VLT:SHW"	Show voltage bar chart
":GRA:HRM:HLT"	Highlights required harmonic "value" = 1 through 50
":GRA:WAV:VLT:SCL"	Set scaling in waveform graph, value = scale in Vpk
":GRA:WAV:AMP:SCL"	Set scaling in waveform graph, value = scale in Apk
":GRA:WAV:WAT"	value = 0 (watts graph disabled)
":GRA:WAV:SHW"	Show waveform graph
":HMX:VLT:SEQ"	Sets odd or odd/even harmonics 0 = odd/even 1 = odd only
":HMX:VLT:RNG"	Sets harmonic range "value" = 1 - 50
":HMX:AMP:SEQ"	Sets odd or odd/even harmonics 0 = odd/even 1 = odd only
":HMX:AMP:RNG"	Sets harmonic range "value" = 1 - 50
":HMX:WAT:SEQ"	Sets odd or odd/even harmonics 0 = odd/even 1 = odd only
":HMX:WAT:RNG"	Sets harmonic range "value" = 1 - 50
"*IDN?"	returns the product ID string
":MOD:NOR"	sets normal mode
":MOD:INR"	sets inrush mode
":MOD:SBY"	sets standby power mode
":MOD:BALL"	sets ballast mode
":MOD?"	returns the current mode 0 = normal 1 = ballast 2 = inrush 3 = standby 4 = integrator

":MOD:INR:RNG"	Default Inrush current range "value" = 1 through 6
":MOD:SBY:PER"	Sets the user defined period of averaging in Low Power Standby mode. value = 1 - 300 seconds.
":DSP:Z04"	displays 4 results screen
":DSP:Z14"	displays 14 results screen
":REM:OFF"	returns PM1000+ from remote control
:RNG	
":RNG:VLT:FIX"	fixes voltage range "value" = 1 (10V) – 4 (1000V)
":RNG:AMP:FIX"	fixes current range "value" = 1 (0.1A) - 6 (100A)
":RNG:VLT:AUT"	sets voltage on auto range
":RNG:AMP:AUT"	sets current on auto range
":RNG:VLT?"	returns the current voltage range
":RNG:AMP?"	returns the current amps range
**RST"	clears the PM1000+ to default settings
":SCL:VLT"	sets voltage scaling "value" = scaling factor
":SCL:AMP"	sets current scaling "value" = scaling factor
":SCL:VLT?"	returns the current voltage scaling factor
":SCL:AMP?"	returns the current amps scaling factor
":SEL:CLR"	clears the results selection list
":SEL:WAT"	selects watts
":SEL:VAS"	selects VA
":SEL:VAR"	selects VAR
":SEL:VLT"	selects Vrms
":SEL:AMP"	selects Arms

":SEL:PWF"	selects PF
":SEL:VPK+"	selects Vpk
":SEL:APK+"	selects Apk
":SCL:VCF"	selects Vcf
":SCL:ACF"	selects Acf
":SEL:WHR"	selects watt hrs
":SEL:VAH"	selects VA hrs
":SEL:VRH"	selects VAr hrs
":SEL:AHR"	selects A hrs
":SEL:VDF"	selects Vdf
":SEL:ADF"	selects Adf
":SEL:FRQ"	selects frequency
":SEL:RES"	selects resistance R
":SEL:IMP"	selects impedance Z
":SEL:REA"	selects reactance X
":SEL:VHM"	selects voltage harmonic series
":SEL:AHM"	selects current harmonic series
":SEL:HRS"	selects integration elapsed time
":SEL:VPK-"	select Vpk-
":SEL:APK-"	select apk-
":SEL:VDC"	selects Volts DC
":SEL:ADC"	selects Amps DC
":SEL:VRNG"	Add the active Voltage range to the screen
":SEL:ARNG"	Add the active current range to the screen
":SHU:INT"	selects internal shunt
":SHU:EXT"	selects external shunt
":SHU?"	returns the current shunt setting 0 = internal 1 = external
":SYST:TIME?"	returns the current RTC time setting
":SYST:DATE?"	returns the current RTC date setting

":SYST:SET:TIME"	sets the RTC time "value" = Example 10-10-00
":SYST:SET:DATE"	sets the RTC date "value" = Example 12-12-2006
":SYST:FOR:TIME"	sets the RTC time format "value" = 12 or 24
":SYST:FOR:DATE"	sets the RTC date format "value" = 0 mmddyyyy 1 = ddmmyyyy 2 = yyyyymmdd
":SYST:ZERO"	Set auto zero "value" 0 = disabled 1= enabled
":SYST:ZERO?"	Read auto zero state

5.3. COMMUNICATIONS EXAMPLES.

Basic selection and returning of result.

The results are returned using the FRD command. This returns the results that are shown on the screen, in the order in which they appear on the screen. As results are selected using comms, the results are added to the bottom of the list, with the exception of harmonics which always appear at the end of the list.

:SEL:CLR	clears all results
:SEL:VLT	
:SEL:AMP	
:SEL:FRQ	
:SEL:WAT	
:SEL:VAS	
:SEL:VAR	
:SEL:PWF	
:SEL:VPK+	
:SEL:APK+	
:FRD?	Returns Vrms, Arms, Frequency, Watts, VA, Var, power factor, Vpeak + and Vpeak- in floating point format.

:FRF? Returns the results selected for confirmation using the label that appears on the display. In this case will return, "Vrms, Arms, Freq, Watt, VA, Var, PF, Vpk+,Apk+

Harmonics

To return harmonics, first the number of harmonic and the scope need to be selected and then they need to be added to the list of results on the display.

:HMX:VLT:SEQ 0 Select odd and even harmonics (use 1 to select odd harmonics only)

:HMX:VLT:RNG 9 Return all harmonic from 1 to 9.

:SEL:VHM Add Voltage harmonics to the list.

Now, assuming :SEL:CLR has not be issued after example 1, then the following results would be returned by FRD?

Vrms, Arms, Freq, Watt, VA, Var, PF, Vpk+,Apk+, Vh1 Mag, Vh1 phase, Vh2 Mag, Vh2 phase, Vh9 Mag, Vh9 phase.

Standby power

First, select standby power mode

:MOD:SDY:PER 60 Set the standby power mode period to 60 seconds.

:MOD:SDY

:SEL:CLR Clears selection of results

:SEL:VLT Selects Vrms

:SEL:WAT Selects Watts

:SEL:FRQ Selects Frequency

:SEL:VCF Selects Volts crest factor

:SEL:VDF Selects Volts distortion factor
 :RNG:VLT:FIX 4 Fix the voltage range to 1000Vpk
 :RNG:AMP:FIX 2 Fix the current range to 1.6Apk

Wait 60 seconds

:FRD? Read back values including average power over 60 seconds

Wait 60 seconds

:FRD? Read back value including average power over 60 seconds.
 Check against previous power.

Inrush

:MOD:INR Select in rush mode
 :MOD:INR:RNG 4 Fixes the current range for in rush mode to range 4 (6.25Apk)
 :MOD:INR:CLR
 :SEL:CLR Clear measurements
 :SEL:APK+ Selects peak positive current
 :SEL:APK- Selects peak negative current

Ensure equipment under test is off

:MOD:INR:CLR Clear the Apk+ and Apk-

Switch on equipment under test

:FRD? Returns Apk+ and Apk-.

6. SPECIFICATION

6.1. MECHANICAL

Height 102mm Including feet.

Width 223mm without Handle

Width 260mm with Handle

Depth 285mm without Handle

Depth 358mm with Handle Straight out

Weight = 3.2Kg with handle

6.2. POWER SUPPLY

AC input voltage = 85 - 264V, 45 to 65Hz

Protection = 1AT, 20mm fuse

Consumption = 25VA max.

6.3. COMMUNICATIONS

RS232

9-pin d-type female.

Requires 'straight through' cable for a pc connection.

1 - open

2 - Tx (o/p)

3 - Rx (i/p)

4 -open

5 - 0V

6 - Open

7 - CTS (i/p)

8 - RTS (o/p)

9 - Open

AUX/TRIG

For Voltech Use Only.

GPIB

To IEEE488 standard.

USB

USB 2.0 compatible. Will work with any USB 2.0 system.

Full Speed (12Mbits/sec).

1 - VBus (i/p)

2 - D- (i/p and o/p)

3 - D+ (i/p and o/p)

4 - 0V (i/p)

6.4. MEASURED PARAMETERS

Abbreviation	Description	Units	Formula
V _{RMS}	RMS Voltage	Volt (V)	$V_{RMS} = \sqrt{\frac{1}{T} \int_0^T v_i^2 dt}$
A _{RMS}	RMS Current	Amp (A)	$A_{RMS} = \sqrt{\frac{1}{T} \int_0^T i_i^2 dt}$
F	Frequency	Hertz (Hz)	
W	True Power	Watt (W)	$W = \frac{1}{T} \int_0^T v_i i_i dt$
PF	Power factor		$PF = \left[\frac{Watt}{V_{rms} \times A_{rms}} \right]$
VA	Apparent Power	Volt-Amps (VA)	$VA = [V_{rms} \times A_{rms}]$
VA _r	Reactive Power	Volt-Amps Reactive (VA _r)	$VA_r = \sqrt{(VA)^2 - W^2}$
V _{CF}	Voltage Crest Factor		$CF = \frac{Peak Value}{RMS Value}$
A _{CF}	Current Crest Factor		$CF = \frac{Peak Value}{RMS Value}$
V _{THD}	Voltage Total Harmonic Distortion	%	$thd = \frac{\sqrt{H2^2 + H3^2 + H4^2 + H5^2 + \dots}}{REF}$
A _{THD}	Current Total Harmonic Distortion	%	$thd = \frac{\sqrt{H2^2 + H3^2 + H4^2 + H5^2 + \dots}}{REF}$
Z	Impedance	Ohm (θ)	$Z = \frac{V_{rms}}{I_{rms}}$
V _{DC}	DC Voltage	Volt (V)	$V_{DC} = \frac{1}{T} \int_0^T v dt$

A_{DC}	DC Current	Amp (A)	$A_{DC} = \frac{1}{T} \int_0^T i dt$
R	Resistance	Ohms (Ω)	$R = \frac{Vf}{Af} \times \cos \theta$ (θ = phase angle)
X	Reactance	Ohms (Ω)	$X = \frac{Vf}{Af} \times \sin \theta$ (θ = phase angle)
V_{h_n}	Voltage harmonic n	Volt (V)	$Mag = \sqrt{(V_{h_n}.r^2 + V_{h_n}.q^2)}$ $Phase = \tan^{-1} \left(\frac{V_{h_n}.q}{V_{h_n}.r} \right)$
A_{h_n}	Current harmonic n	Amp (A)	$Mag = \sqrt{(A_{h_n}.r^2 + A_{h_n}.q^2)}$ $Phase = \tan^{-1} \left(\frac{A_{h_n}.q}{A_{h_n}.r} \right)$
V_{PK+}	(+)ve Peak Voltage	Volt (V)	$\max\{v\}$
V_{PK-}	(-)ve Peak Voltage	Volt (V)	$\min \{v\}$
A_{PK-}	(+)ve Peak Current	Amp (A)	$\max\{i\}$
A_{PK+}	(-)ve Peak Current	Amp (A)	$\min\{i\}$

6.5. MEASUREMENT ACCURACY

The table below lists the formulae for calculating the accuracy specification for each measurement.

In the equations below

- It is assumed the waveform measured is a sine wave.
- F is the frequency measured in kHz
- V is the voltage measured in V
- I is the current measured in A
- FS_v is the full-scale value of the voltage range used for the measurement
- FS_i is the full-scale value of the current range used for the measurement (including shunt impedance)
- Z_{EXT} is the external shunt impedance (0.5Ω for 1A shunt, 10mΩ for 30A shunt)
- Θ is the phase angle in degrees (i.e. phase of the current with reference to the voltage).

All specifications are valid 23°C ±5°C

Temperature coefficient ±0.02% of reading / °C, 0 to 18°C, 28 to 40°C.

VOLTAGE		
RMS	RANGES	900, 215, 46, 10 Vpk
VRMS	Frequency range	10Hz to 1MHz
	Peak continuous	1500Vpk
	Peak < 1 second	5000Vpk
	Input Impedance	1 MOhm
	Crest Factor	20
	Accuracy	0.1% of Reading + 0.1% of range + 5mV + 0.02%/kHz
VDC	Accuracy	0.1% of Reading + 0.2% of range + 5mV + 0.02%/kHz
VOLTAGE +/--PEAK	Accuracy	0.5% of Reading + 0.5% of Range + 0.02%/kHz

CURRENT	RANGES	100, 25, 6.25, 1.6, 0.4, 0.1 Apk
RMS	Frequency range	10Hz to 1MHz
ARMS	Peak continuous	20Arms
	Peak < 1 second	Apk
	Input Resistance	12.5 mOhm
	Crest Factor	20 (Peak/RMS)
	Accuracy	0.1% of Reading + 0.1% of range + 1mA + 0.02%/kHz
	ADC	Accuracy
CURRENT +/- PEAK	Accuracy	0.5% of Reading + 0.5% of Range + 0.02%/kHz
WATTS	RANGES	1Wpk to 90kWpk
	Frequency range	10Hz to 1MHz
	Accuracy	0.2% of Reading + 0.1% of range +5mW +(0.05/PF)%/kHz
VA	RANGES	1 VA to 90kVA
	Frequency range	10Hz to 1MHz
	Accuracy	0.2% Reading + 0.1 % of range +5mVA + 0.05%/kHz
Var	RANGES	1 VA to 90kVA
	Frequency range	10Hz to 1MHz
	Accuracy	0.2% of Reading + 0.1% of range +5mW +(0.05/1- PF)%/kHz

Power Factor	Range	+ - 0.000 to 1.000
	Accuracy	+-(0.002+-(0.001/PF)/kHz) + indicates leading PF and – indicates lagging PF
FREQUENCY	Range	DC and 10Hz to 1MHz (Maximum 22kHz when frequency source is set to current)
	Accuracy	0.1%
VOLTAGE CREST FACTOR	RANGE	1.00 to 20.0
	Accuracy	%Vpk error + %Vrms error
CURRENT CREST FACTOR	RANGE	1.00 to 20.0
	Accuracy	%Apk error + %Arms error
PEAK INRUSH CURRENT	RANGE	100Apk
	Accuracy	2% of range +/- 20mA
HARMONIC ANALYSIS	Number of Voltage & Current harmonics	50
	Maximum Harmonic Frequency	450kHz
	Accuracy	0.2% of Reading + 0.1% of Range +0.04% per kHz of harmonic
	Frequency Range	10Hz to 450kHz
Total Harmonic Distortion	Range & Accuracy	Range 0-999% Accuracy 0.4% + 0.1%/kHz

Standby Power	Time Window	1-300 sec
	Resolution	1 second
IMPEDANCE	Range	0.005Ohms to 1Mohm
	Accuracy	0.2% of Reading + 0.1% of range +5mW +(0.05/ PF)%/kHz
RESISTANCE	Range	0.005Ohms to 1Mohm
	Accuracy	0.2% of Reading + 0.1% of range +5mOhms +(0.05/PF)%/kHz
REACTANCE	Range	0.005Ohms to 1Mohm
	Accuracy	0.2% of Reading + 0.1% of range +5mW +(0.05/1- PF)%/kHz
External Shunt	Input Range	+ - 1250 mVpk
Scaling		0.0001 to 100000

7. WARRANTY, SERVICE AND UPDATES

7.1. WARRANTY

The Voltech PM1000+ Power Analyzer is warranted against defects in materials and workmanship for a period of twelve (12) months from the date of shipment.

In the event of failure of a customer unit during this period, Voltech will:

- At Voltech's discretion, repair or replace the faulty unit free-of-charge for a unit returned to an authorized service center. Shipment from the customer address will be the responsibility of the customer.

Voltech reserves the right to waive this benefit in any event where it is clear upon inspection that the cause of the failure is due to customer misuse.

Voltech will be the sole arbiter in this circumstance.

- Pay all return shipment charges from the Voltech service center to the customer.
- Repair/verify the customer unit before dispatch. A certificate of verification will be issued as a matter of course.

The PM1000+ is a complex product and may not be completely free of errors. You are advised to verify your work. In no event will Voltech be liable for direct, indirect, special, incidental or consequential damages arising out of the use of or inability to use the PM1000+ or its accessories, even if advised of the possibility of such damage. In particular, Voltech is not responsible for any lost profits or revenue, loss of use of software, loss of data, cost of substitute products, claims by third parties, or for other similar costs.

7.2. CALIBRATION AND SERVICE

To confirm the accuracy of your PM1000+ a calibration should be carried out every 12 months.

Verification is carried out using purpose-built equipment. The verification can be performed by an authorized Voltech service center.

For details of verification facilities and any other service requests, please see the service area of our website at www.voltech.com. Voltech strongly recommends that you discuss your service requirements with your supplier before service is needed.

7.3. OBTAINING SERVICE AND APPLICATIONS SUPPORT

Please see the service and applications support centers on our website at www.voltech.com.

7.4. UPDATING FIRMWARE

Regular firmware updates will be made available and maintenance updates are free of charge for all users.

Please see the applications support center on our website at www.voltech.com

8. SAFETY INFORMATION

8.1. SAFETY FEATURES

The PM1000+ has been designed with safety features, such as shrouded safety connectors, that provide the operator with a high level of protection against the risk of electric shock. As with any dangerous equipment, however, it is important that an assessment of the overall risk to safety is made during installation. It is the user's responsibility to ensure compliance with any local regulations that may be applicable to the health and safety of operators

8.2. SAFETY INSTRUCTIONS



- The PM1000+ and its accessories have been constructed in compliance with the requirements of EN61010-1, Pollution Degree 2, Installation Category II, FOR INDOOR USE ONLY. This ensures the safety of the analyzer and the user when normal precautions are followed
- **WARNING:** The analyzer **MUST** be earthed. The power source should be inserted in a socket with a protective ground contact
- The power source should be inserted before connections are made to measuring or control circuits
- Do not attempt to remove outer cover without first disconnecting auxiliary and test power supply
- This instrument must only be serviced by qualified personnel who understand the danger of shock hazards
- When the instrument is removed from its case hazardous voltages are present
- The electronic circuitry of this instrument is fully floating with respect to ground. If the instrument is opened and dangerous voltages (above 50V peak) applied to the input terminals then all the circuitry must be considered 'Live'
- The signal leads must be in good condition with no damage.

- Replace fuses only with the same type and rating as specified in this manual

8.3. DECLARATION OF CONFORMITY

DECLARATION OF CONFORMITY	
Manufacturer's Name	Voltech Instruments, Inc.
Manufacturer's Address	11637 Kelly Road Fort Myers FL USA
declares, that the product	
Product Name:	Precision Power Analyzer
Model Number:	PM1000+
conforms to the following Product Specifications	
Safety:	BS EN 61010 (1993)
EMC:	BS EN 55022 (1995): Class A BS EN 50082-2 (1992)
Supplementary Information:	The product herewith complies with the requirements of the EMC Directives 89/336/EEC and 92/31/EEC and the Low Voltage Directive 73/23/EEC
Signed for on behalf of Voltech Instruments Ltd	
September 2007	