



WIRELESS QUARTER

Issue 2, 2020

**DAMAGE CONTROL:**  
CELLULAR TRACKING  
IDENTIFIES WHO PAYS FOR  
MISHANDLED GOODS

**FULL STEAM AHEAD:**  
EDUCATING THE CODERS  
OF THE FUTURE

SPECIAL REPORT

# The Good Fight

The vital wireless tech  
helping front line staff in  
the war against COVID-19

WIRELESS SURFING BUT  
NOT AS YOU KNOW IT

CELLULAR CERTIFICATION  
GAINS MOMENTUM

A NEW LANGUAGE FOR  
IoT PROGRAMMING



# Contents

News	3
News Extra	7
Global certification	
-----	
<b>SPECIAL REPORT: COVID-19</b>	
Feature	
<b>The Good Fight</b>	8
Wireless tech is helping beat the spread of COVID-19	
CaseStudy	12
Smart thermometers detect virus symptoms	
Analysis	15
How wireless tech can benefit a post-pandemic world	
Feature	
<b>Tracking In, Privacy Out</b>	16
Contact tracing means trading personal freedom for safety	
-----	
<b>Full STEAM Ahead</b>	18
Wireless educational tech helps kids develop coding skills	
<b>Damage Control</b>	22
Who pays for goods damaged in transit is a billion dollar question	
<b>Nordic Inside</b>	26
Carv ski trainer	
<b>Tech Zone News</b>	28
<b>Tech Briefing</b>	29
A new language for Cortex-M programming	
<b>Tech Perspective</b>	30
End-device certified modems ease cellular IoT design	
<b>Nordic Product Summary</b>	32



# Welcome

Svenn-Tore Larsen  
CEO



My [previous](#) welcome column in *Wireless Quarter* recognized the despair coronavirus and the disease it causes, COVID-19, brought to the world. The pandemic is a once-in-a-lifetime event that is still far from over – but there are some encouraging signs that we might be getting the upper hand. And even at the lowest point there were some heartwarming things to raise spirits. For example, the world's essential workers— in healthcare, transport, the emergency services and many others—showed remarkable courage to keep us safe, and engineers and scientists from many countries have collaborated to fight coronavirus in a global effort the like of which we have rarely seen before.

Early in the crisis it was suggested that electronics technology might help in tackling and then controlling coronavirus. That has turned out to be true; the semiconductor industry in particular has played a very significant role in this global endeavor, and electronics engineers have [embraced wireless tech](#) to accelerate the effort. I see evidence of this all around in the way our customers have taken Nordic's technology and turned it into impressive products at an unprecedented pace. These wireless products have particularly helped with tracking outbreaks, monitoring the symptoms of patients and assisting healthcare staff manage hygiene. Other applications include contact tracing to inform people if anyone they've been near is later diagnosed with COVID-19. And once coronavirus is under control we will need wireless tech to keep us safe ahead of any vaccination program.

This edition's special report brings you up-to-date on how Nordic's technology is being used to fight today's crisis and how it will help us tomorrow. Continue to stay safe.

“Customers have taken Nordic's technology and turned it into impressive products at an unprecedented pace to fight COVID-19”

*Wireless Quarter* is published on behalf of Nordic Semiconductor by Ecritech [www.ecritech.tech](http://www.ecritech.tech)

**Editor**  
Steven Keeping [sk@ecritech.tech](mailto:sk@ecritech.tech)

**Assistant Editor**  
Chris Williams [cw@ecritech.tech](mailto:cw@ecritech.tech)

**Production Editor**  
Andrew Woolls-King [awk@ecritech.tech](mailto:awk@ecritech.tech)

**Creative Director**  
Sam Grimmer

**Image Editors**  
Nathan Sargent, Neale Hobday

**Print & Distribution**  
Printech Europe



The Bluetooth® word mark and logos are registered trademarks owned by the Bluetooth SIG, Inc. and any use of such marks by Nordic Semiconductor is under license.

© Nordic Semiconductor 2020



To subscribe to WQ visit [www.nordicsemi.com/wqmag](http://www.nordicsemi.com/wqmag)

# News

The latest developments from Nordic Semiconductor



## Sports & Fitness

### Bluetooth LE electric board allows surfers to ride above water

A Melbourne, Australia-based technology company has designed a remote-controlled electric board that allows watersport enthusiasts to ride on any body of water with a depth of at least one meter up to speeds of 45 kph.

The Fliteboard system, designed by Tekt Industries, comprises a 6 kW brushless electric motor-powered hydrofoil ("eFoil") board, as well as the Flite Controller remote handset. Both the board and the handset integrate a Rigado Bluetooth LE module based on Nordic's [nRF52832](#) SoC.

The handset relays control data to the board via low latency Bluetooth LE connectivity, enabling the rider to wirelessly control the speed of the motor, even when both devices are submerged in water. Bidirectional Bluetooth LE connectivity also allows the handset to receive key data from the board itself—such as telemetry and battery status—then display the information on the integrated screen.

The board's fully sealed subassembly is embedded directly into the carbon fiber shell and provides GPS data recording, motion measurement, telemetry transport and data transfer hardwired to the main eFoil module. As well as connecting the board to the handset, the Bluetooth LE link enables the board to communicate with the accompanying iOS-compatible Flite App on the user's smartphone.



Fliteboard creates a similar feel to kite- or wind-surfing

The companion app can be used to download session data and provide a visual representation of the session using a map view and various icons including tilt and roll angles, speed, and battery status. The rider can also use the app to share the rides and upload the content to the Cloud.

"The Fliteboard allows its rider to 'surf' on the water whether it be by the beach or on a lake without wind but creates a similar feel to kite- or wind-surfing," says Matthew Adams, CEO of Tekt Industries. "It's easy to learn, even for the first time rider, and it's fast, quiet and emission free."

### Sensor delivers maintenance alerts

IIoT company, Lynxemi, has launched its Vibration and Temperature Sensor platform, which provides reliable sensor data for predictive maintenance of machines.

The sensor integrates a MEMS accelerometer as well as a temperature sensor to capture data such as temperature and vibration performance of electrical motors. A Nordic [nRF52840](#) SoC enables the device to relay periodic performance reports as well as anomalous measurement alerts to maintenance personnel via Bluetooth LE.

Wireless connectivity is supported by MQTT—a simple and light weight network protocol, designed for constrained devices—running over Bluetooth LE. Complete data samples and system alerts are relayed from the sensor to a gateway for additional processing, and then to the Cloud for later deeper analysis.



## Smart City

### Cellular IoT solution streamlines power grid operations

U.S. design agency, Apricity, is helping power utilities avoid relying on polluting auxiliary power stations to meet prime time demand.

The company's Apricity Ara cellular IoT and wireless mesh domestic water heater controller employs a Nordic [nRF9160](#) SiP and nRF52840 SoC and is attached inline with the power supply of each water heater. This allows the heater to be controlled remotely by the local power utility using the LTE-M version of cellular IoT wireless technology.

As some water heaters are in areas with poor LTE-M coverage, Apricity also needed to support the solution with a back up proprietary wireless mesh.

The solution allows any Ara unit with no cellular service to communicate with any other Ara that has good cellular reception and

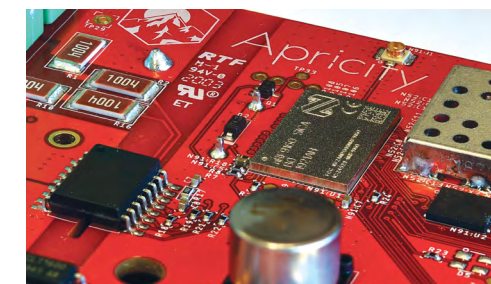

continues to be controlled by the utility.

"In the U.S. tanked water heaters are often installed as always-on devices with no user- or demand-based control and as such the units continually consume energy reheating the water," explains Apricity COO, Jacob C Betcher.

"During times of peak demand, asking dormant hot water heaters to temporarily reduce their energy consumption is a very effective power load reducing method. With some simple local monitoring, it is possible to allow water heaters in use to continue heating, while reducing standby heating of those water heaters not in use," adds Betcher.

Logistics & Transport

# Smart home delivery box eliminates human contact in COVID-19 fight

A smart home delivery box developed by a Norwegian startup of the same name, Homeboxx, could become a useful tool in the battle against COVID-19.

Homeboxx employs a Nordic cellular IoT nRF9160 SiP to allow confirmation of all successful deliveries by NB-IoT with both the delivery company and consumer. It also allows deliveries to be made without any need for contact between the consumer and delivery driver, thus supporting overnight deliveries at a time when the demand for online grocery shopping far outstrips supply in most countries due to social distancing guidelines.

"We've long recognized that the next evolutionary step in online shopping required a much smarter 'last mile' delivery solution than relying on consumers to be home to receive their goods or taking the risk of leaving items outside where they could be stolen or damaged by bad weather," explains Karl-Einar Jensen, Founder & Board Director of Homeboxx.

"This is hindering the growth of online shopping because it forces delivery companies to deliver only during the day at peak traffic periods," says Jensen. "For groceries in particular, if the consumer is not



Homeboxx allows for safe deliveries outside of peak hours and in poor weather

home this can result in food being left on doorsteps where it can spoil, especially in countries with extreme temperature climates such as Norway."

Homeboxx is claimed to eliminate these problems by providing a thermally isolated (basic battery-powered model) or climatically controlled (advanced mains-powered model) environment to store deliveries that do not rely on consumers being home.

In operation, each delivery is assigned a unique code that is then used to both track the item during shipping and to allow the delivery driver to gain access to the Homeboxx. Sensors within the Homeboxx detect the exact date and time its lid was opened, as well as the ambient temperature in the box. This data is then sent to both the delivery company and consumer to confirm successful delivery was made.

Internet of Things

## Sensor-to-Cloud IoT platform

Embedded design consultant, Signetik, has unveiled a precertified, battery powered cellular IoT module platform called SigCell. The platform offers basic and big data AI analysis and machine learning capabilities.

The company says the SigCell platform offers a range of environmental sensing and image processing capabilities including temperature, humidity, movement, sound, light, rain, gun shot and visual tracking. Typical battery life is quoted at two to five years depending on duty cycle.

The platform uses Nordic's nRF9160 SiP's 64MHz Arm Cortex-M33 processor to perform sensor data acquisition and edge computing to avoid the cost of sending large amounts of data to the Cloud.



## Plug and play NB-IoT platform speeds product development

Leading German IoT solution provider grandcentrix—now part of Vodafone—has released the low cost Cellular Twin NB-IoT platform, which enables product manufacturers to transfer telemetry and usage data to the Cloud.

The hardware of Cellular Twin is a compact, standardized mainboard with optional expansion modules. The product turns almost any existing product into a smart IoT device by adding it to a network. This includes all required IT, hardware and built in connectivity all the way up to native Microsoft Azure IoT support and compatibility with all other major IoT Cloud platforms via secure https and MQTT communications.

The mainboard is connected to a product controller via a 15-pin interface and establishes a secure connection to Vodafone's global NB-IoT cellular network via the integrated Nordic nRF9160 SiP, which also

supports over-the-air updates and GPS functionality.

Four digital inputs, four analog inputs (0-10 V) and two digital outputs are available on the interface to cover most common industrial applications. Simple analog sensors and digital buttons as well as more complex interfaces such as TTL-UART can also be connected.

"We designed Cellular Twin to be simple and secure while supporting low cost, high volume adoption in the widest range of products and applications," says Fabian Kochem, the Cellular Twin Product Manager at grandcentrix. "Most of our customers will have working prototypes within a few weeks to test and assess, and can expect to go into volume production at anywhere between 100 thousand and tens of millions of units in as little as six to nine months."



Wearables

# Wearable makes healthy food choices based on user's DNA

U.K.-based DnaNudge has released a new wristworn wearable dubbed the DnaBand, enabling users to make food choices aligned with their DNA.

After a one-time cheek swab test that analyzes and maps the user's genetic profile and key traits, the results are loaded onto a capsule that can be worn as "digital DNA" on the wrist, as part of the DnaBand wearable.

The device is powered by Insight SiP's ISP1507-AX RF module which employs Nordic's nRF52832 Bluetooth LE SoC. The chip provides the wireless connectivity to the user's smartphone.

From the DnaNudge smartphone app, the user can scan the barcodes of approximately half a million food products and instantly have



the device determine if the food is suitable for them based on their unique genetic traits. For example, if an individual has a high sensitivity to sugar, saturated fat or salt, and scans the barcode on a product with high levels of these ingredients, the DnaBand and smartphone app will notify them, and steer them towards a healthier alternative.

Once the barcode is scanned, the device's LED display will flash either green, to indicate a suitable food choice, or red, to indicate a choice less well matched to their DNA profile. When the wearable is also used to monitor the user's activity, an amber LED indicates that a scanned product that might usually be suitable is not recommended because of the wearer's level of activity.

From the app the user can also view their genetic report, view their scan history and lists of alternative product recommendations, as well as nominate specific ingredients they would like to avoid to assist the device in improving product choices.

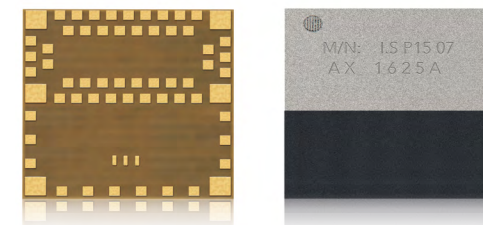

## By the Numbers

**\$70.2 million** in revenue

Nordic Semiconductor has reported Q1 2020 revenue of \$70.2 million, representing growth of 33.5 percent over Q1 2019. The result comes on the back of a continued strong market position in Bluetooth LE, which represented 73 percent of total revenue during the quarter. Cellular IoT is still in the early stages of commercialization with reported revenue of \$1.1 million in Q1 2020. This was an increase from \$0.1 million on Q1 2019 and \$0.2 million from last quarter, reflecting a shift in sales from mainly development kits to initial sales for end user products.

**25 billion** IoT connections by 2025

IoT connections will reach almost 25 billion globally by 2025, up from 12 billion in 2019, according to a new report by the GSMA. Enterprise IoT connections will overtake those in the consumer sector in 2024, and will almost triple between 2019 and 2025 to reach 13.3 billion. This will account for just over half of all IoT connections in 2025, according to the GSMA study. Consumer IoT connections will almost double to 11.4 billion in the same time frame. According to the report, IoT is forecast to generate revenues of \$1.1 trillion in 2025, compared to \$3.43 billion in 2019. The report says that smart buildings will be the largest growth sector, in particular lighting, HVAC systems, security and automation.

In Brief

### NORDIC JOINS UN COVID-19 CHALLENGE

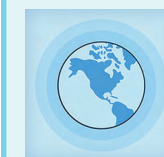

Nordic Semiconductor has joined forces with the United Nations Developer Program as well as Hackster.io to call on developers, product designers, scientists, hackers, makers and innovators to come together and develop connected solutions to help slow or prevent the spread of COVID-19 in developing countries. As part of the effort Nordic is giving away free development kits for its nRF52840 SoC to people registering online.

### ENERGY HARVESTING FOR SMART SENSORS

A team led by Penn State scientists have developed a method of harvesting waste magnetic energy and converting it into enough electricity to power next-generation sensor networks for smart buildings and factories. The device is said to provide 400 percent higher power output compared to other technology when working with low-level magnetic fields. The researchers said the technology had implications for the design of smart buildings, which could benefit from self-powered wireless sensor networks.

### SOUTHEAST ASIA EXPANSION FOR NORDIC

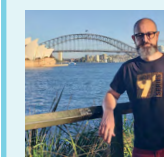

A new sales, marketing and customer support office for Southeast Asia will allow Nordic to provide faster customer support to the region's rapidly expanding wireless design and manufacturing sectors. The new office based in Sydney, will service Australia, New Zealand, Singapore, Thailand, Vietnam, Indonesia, Malaysia and the Philippines. Wendell Boyd, Regional Sales Manager for ASEAN and ANZ, will head up the office, while Engineering support for Nordic's ASEAN and ANZ customers will continue to be serviced from Nordic's established Asian HQ in Hong Kong.

### DISTRIBUTION AGREEMENT OPENS UP TURKEY

Nordic Semiconductor has signed a distribution agreement with Özdisan Elektronik, an Istanbul, Turkey-based components distributor specializing in electronics hardware and software design, and RF technical support for IoT developers. The deal covers distribution and design support for Nordic's entire portfolio of low power cellular IoT and short range wireless solutions. Özdisan Elektronik employs 205 members of staff across the country.

Smart Health

# Home testing wearable helps doctors diagnose sleep apnea

Belgian [medical technology](#) startup, Ectosense, has launched a battery powered home sleep testing wearable dubbed NightOwl. Following the closure of sleep labs around the world due to COVID-19, the company claims the sleep monitor is providing doctors with results just as accurate, but at a fraction of the inpatient costs.

The NightOwl comes in two versions—either an advanced rechargeable device or a ten-night disposable version—that both take the form of a small, wearable finger sensor. The device records photoplethysmography (PPG) readings using a 50 Hz optical reflective sensor. This shines light onto the finger and from the intensity of reflections determines, among other parameters, the oxygen saturation level of the blood (SpO<sub>2</sub>).

Sudden changes in this blood oxygen level are the most accurate indicator of sleep apnea – a condition where an individual's breathing

stops temporarily while asleep. As this forces them to wake up, it prevents sufferers from getting a good night's sleep.

The optical sensor is supported by an accelerometer that can be used to pause monitoring to conserve battery power if the wearer wakes up and starts moving about during a typical eight-to-ten hour night analysis period.

Collected data is continuously streamed to a user's smartphone via Bluetooth LE using a Nordic SoC and then processed in the Cloud using what is claimed to give the NightOwl its professional sleep lab accuracy: An advanced sensor data algorithm developed by Ectosense CTO, Frederik Massie, that looks for sleep apnea events. Collected results are displayed on an online dashboard available to doctors.



The NightOwl takes the form of a small, wearable finger sensor

Smart Agriculture

# Water quality sensor keeps fish swimming

Solar powered Bluetooth LE water quality sensors developed at the King Abdullah University of Science and Technology (KAUST) in Saudi Arabia, could help fish farmers protect their aquatic assets and help safeguard the future of food.

Aquaculture currently supplies more than half the world's seafood and in the last 10 years, the profits from global fish farming have quadrupled to more than \$230 billion annually. However, pollution from industrial activities is seeping into commercial ponds and killing off millions of dollars' worth of fish. According to Electrical engineer Muhammed Hussain, most existing commercial sensors only monitor one thing at a time, such as acidity or oxygen levels, on individual devices that the farmer must check manually. However, Hussain and his team have created a small self powered sensor that monitors multiple water quality characteristics and transmits the data via Bluetooth LE.

"Integrating different functions on to one computer chip is complex and expensive," explains lead author Nazek El-Atab. "But we have combined several chips into a cube so

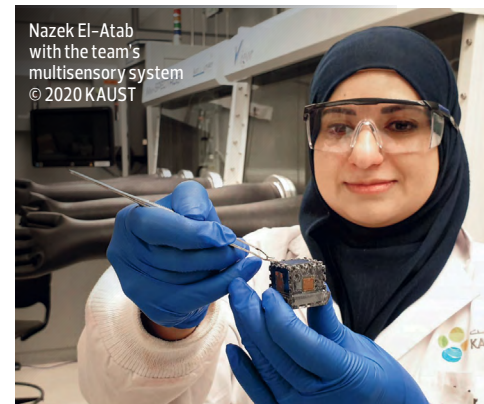

Nazek El-Atab with the team's multisensory system © 2020 KAUST

that each face serves a different purpose." The connected chips then act as one device.

The cube is designed to float with the sensors for pH, temperature, salinity and ammonia levels on the downward facing side. The casing is weighted to ensure it remains that way, even when disturbed by fish. "We wanted to create something small and light weight," says El-Atab. "The farmer can simply throw the device into the water, and it rotates itself into the right position."

The other outer faces include sensors that monitor air pollution, solar cells to charge the battery sealed within the cube, and an antenna for transmitting data via Bluetooth LE to a smartphone.

The researchers are now working on improving the device's self cooling technology to stop it from overheating and the next step will be to test it in the field.

Internet of Things

# Cross tech IoT info exchange now possible

Researchers at Graz University of Technology in Austria have developed a system that enables information exchange between commercially available devices that use different RF protocols but the same frequencies. The generic framework, called X-Burst, enables IoT devices using different protocols such as [Bluetooth LE](#) and [Zigbee](#) to communicate with one another without the need for a gateway.

The researchers make use of time-controlled energy pulses in the radio channel, which can be generated by any smart device and detected by most of them: "We send data packets of varying lengths," explain Rainer Hofmann and Hannah Brunner, who were in charge of the project. "The information is stored in the duration of the packets. The receivers monitor the energy level ... and can thus detect the packets, determine their duration and extract the information."

The invention also enables the system clocks of the various devices to be synchronized, which allows them, for example, to perform certain actions simultaneously. X-Burst also allows for intelligent use of frequencies by allowing all devices to communicate.

News Extra

# Global certification maintains momentum

Australia's 4G operator Telstra joins Deutsche Telekom, Verizon and Vodafone in granting the nRF9160 access to its network

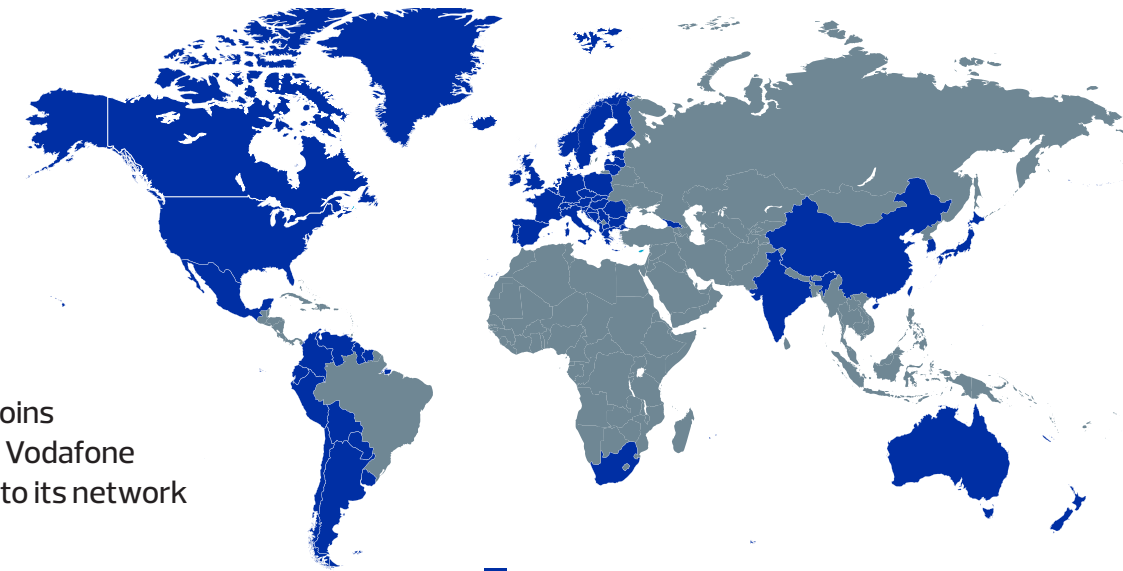

Countries that have granted regulatory certification for Nordic's nRF9160 SiP

[Cellular IoT](#) (LTE-M and NB-IoT) brings many advantages over other LPWANs. Key to these advantages is that cellular operates in licensed bands. By controlling access to these bands, the owners can guarantee the performance and reliability of communication and interference between devices is kept to a minimum. As a result, cellular offers very high Quality-of-Service (QoS). Tight control of the spectrum also brings unrivaled security.

To maintain such high QoS and security, network companies operate a highly regulated environment and demand that before a wireless device can connect it meets various levels of certification. For cellular IoT products the first level of certification is governed by the [Global Certification Forum](#) (GCF) and [PTCRB](#), and once achieved demonstrates the product is compatible with the [LTE 3GPP specifications](#) for LTE-M and NB-IoT.

Hurdles to clear

Additional certification is then required from regional bodies to allow the sale of radio equipment into a geographical area. Such testing ensures an RF device works properly and does not interfere unduly with other equipment. There are a host of regional regulatory bodies across the globe including FCC (U.S.), CE (Europe) and SRRC (China).

LTE-M and NB-IoT operate within designated bands across the cellular spectrum allocation ranging from B1 to B85. Separate certification is required from the global and regional authorities although only a subset of the bands is applicable to each region.

Since its volume production in July 2019, Nordic's nRF9160 low power SiP with integrated LTE-M/NB-IoT modem and GPS has been moving rapidly through the [certification](#) process. At the time of writing the cellular IoT solution—available in a single version capable of operating in most of the LTE frequencies used across the globe—has been certified as meeting the LTE 3GPP specifications by GCF and PTCRB and no less than 13 regional regulatory bodies on every continent bar Antarctica. (See map.)

Once the global specification and regional compatibility certification is acquired, there is potentially another hurdle to overcome – that of the network operator. This certification demonstrates that the network operator is happy that the cellular IoT solution connects and operates according to the strict rules for its network. Without this



Since its volume production in July 2019, Nordic's nRF9160 low power SiP has been moving rapidly through the certification process

certification, an end-product would be barred from cellular access. Separate certification is needed for LTE-M and NB-IoT network access. (Not all operators have certification schemes.)

The nRF9160 down under

The latest company to grant certification for the nRF9160 SiP is Telstra, Australia's premier network operator. The certification is for the company's LTE-M network which covers approximately three million square kilometers of the country.

"Telstra is one of the leading technology companies in the region and is recognized throughout the world," says Bjørn Åge "Bob" Brandal, Nordic's Director of Sales & Marketing – APAC. "With LTE-M certification in place we expect to soon follow with certification for Telstra's NB-IoT network."

"What this certification means for Nordic customers is that if they are a Telstra partner, or want to use the Telstra network, they can use the nRF9160 SiP with confidence," explains Wendell Boyd, Nordic's Regional Sales Manager for ASEAN, Australia and New Zealand.

"For projects that require extremely low power, battery operation and a small form factor, the nRF9160 really is the only choice. Nordic customers already have volume projects under development using the nRF9160 that we should see operating on the Telstra network during H2 2020."

Telstra's certification follows that of Deutsche Telekom (for its LTE-M network in Germany and NB-IoT networks in Austria, Czech Republic, Germany, Croatia, Netherlands, Poland and Slovakia), Verizon (LTE-M network in the U.S.) and Vodafone (NB-IoT networks in Australia, Czech Republic, Germany, Greece, Hungary, Ireland, Italy, Malta, New Zealand, Portugal, Spain, South Africa, The Netherlands, Turkey, U.K. and Ukraine).

In addition to operational certification, the nRF9160 has also been certified by the Arm Platform Security Architecture (PSA) scheme and meets PSA Certified Level 1. PSA [certification](#) aims to improve IoT protection assurances and accelerate IoT device deployment.



Tech Check

The nRF9160 SiP's integrated modem supports both LTE-M and NB-IoT. With 700 to 2200 MHz LTE band support the product can operate across the globe removing the need for regional variants

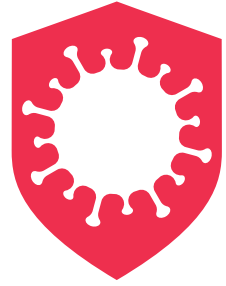

# The Good Fight

COVID-19 is wreaking havoc on health and the global economy. But the world is rising to the challenge and arming itself with technology to beat novel coronavirus

## In Short

SARS-CoV-2 is believed to have originated in bats before chance mutations enabled the virus to ultimately jump to humans

The virus has spread rapidly because it is highly infectious, and carriers don't always show symptoms, rarely die, and traveled widely, making it easy for COVID-19 to propagate

The high infection rate and lack of a vaccine has led to the rapid adoption of technology to help fight further spread of the virus

Wearables, wireless pulse oximeters, Bluetooth LE-powered handwashing and hand sanitization solutions have all been rapidly deployed by tech companies

The smart money is on SARS-CoV-2 originating in bats. That's because the 'novel' coronavirus currently terrorizing the world is 96 percent genetically identical to another coronavirus that scientists had already identified in the flying mammals. And SARS-CoV-1, the virus which caused and is named for the severe acute respiratory syndrome (SARS) outbreak in 2002-3, and MERS-CoV, the one that caused the later outbreak of Middle East respiratory syndrome (MERS), were also traced back to bats.

The next animal to be infected with coronavirus was likely not a human, but something that lives near bat caves such as a pangolin. (The SARS virus infected humans via civet cats and MERS did the same via camels. "It's likely that this new SARS virus has a similar route," evolutionary biologist Dr Jemma Geoghegan of the University of Otago, NZ, told Australian broadcaster ABC.)

From there, chance mutations that enabled the virus to jump to humans and a potent cocktail of live wild creatures, domestic animals and humans living cheek-by-jowl triggered coronavirus disease 2019 (COVID-19). [According to U.S. magazine National Geographic](#), a wet market in Wuhan, China, is believed to be the original epicenter of COVID-19. This wet market had a wild animal section where live snakes, beavers, porcupines and baby crocodiles were for sale. And, [according to The Economist magazine](#), while officially off limits because they are an endangered species, pangolins have also been known to make it from wet markets to Chinese menus.

While SARS and MERS quickly ran their course and deaths were limited to under a thousand in each case, today's coronavirus has become a pandemic, with fatalities running to hundreds of thousands.

This is a challenge the like of which hasn't been seen before by virtually anyone alive today. But when backed into a corner, the world rises to the task. Now a global cohort of scientists, engineers and medical professionals are pooling their skills and resources to fight back against SARS-CoV-2. And wireless connectivity is proving to be one of the most useful weapons enabling them to fight this global threat in a way that's never been done before.

## KNOW THE ENEMY

SARS-CoV-2 was first identified in a 55-year-old in Wuhan, the capital of the central Chinese province of Hubei, in mid-November 2019. Appearing without fanfare, the coronavirus gripped the population of Wuhan with such speed that the authorities had little time to react. But when it came time to draw up plans to combat the virus it became clear it was similar to the versions that caused SARS and MERS yet more far more infectious and with subtle twists.

SARS and MERS might be harder to catch but they are deadlier, killing a greater percentage of victims. But while outbreaks of the disease were nasty, they were much easier to contain because victims only became infectious when showing symptoms. That meant patients could be shunted hastily into quarantine, limiting contact with others. SARS-CoV-2 is much sneakier; victims are infectious for up to a week before symptoms show, and often sufferers exhibit no outward signs of illness even as the disease runs its course. As many asymptomatic carriers jumped on planes and flew to destinations across the planet, they unknowingly became perfect vectors for COVID-19, sowing the seeds of major outbreaks in Iran, Italy, Germany, the U.K. and the U.S. and dozens of other countries besides.

Every cough, sneeze or touch from a carrier spreads hundreds of millions of viruses far and wide. For example, recent research, published in the *Journal of the American Medical Association* and originating from [a study](#) by MIT associate professor Lydia Bourouiba, warned that virus-laden droplets from a sneeze can travel up to eight meters and remain suspended in the air for up to ten minutes. Other research shows the pathogen can live in droplets that land on hard surfaces certainly for hours and perhaps even days. A person who breathes in the suspended droplets will become infected, and others that get droplets on their hands from the surfaces on which they land will transfer it to eyes, nose or mouth by touching their face — something we all do about 15 to 20 times an hour.

The infection rate of SARS-CoV-2 (called R or R0) determines how rapidly things develop by quantifying how many people each virus carrier will infect. The reason

why this novel coronavirus has gripped the world is that its initial R value was around 2.5. That is frighteningly high compared to the other coronaviruses and is primarily due to four things: First, the virus is highly contagious; second, carriers are infectious without showing any symptoms; third, apart from seniors or those with co-morbidities such as heart disease or diabetes, this coronavirus generally doesn't kill — allowing the host to spread the disease to people such as healthcare workers who have to come into contact with them; and finally, even in the decade or two since SARS and MERS broke out, international travel has become far more routine — making it easier for the virus to radiate quickly from its source.

## FIRST LINE OF DEFENSE

While viruses are unrelenting in their attack (see sidebar *Life, but not as we know it: Anatomy of a virus*) the human immune system is well designed to engage in a vicious battle to repel the invaders. The struggle goes one of two ways: The immune system wins and the patient lives (but the damage to organs can leave the victim with long term health problems) or the virus does. And victory for the virus means the end of the host.

Survival from an infectious disease sometimes bestows the victim with immunity because the original illness 'primes' the system against further attack. Should the virus reappear at a later date, the immune system recognizes it immediately and launches a powerful assault before the virus can replicate in large numbers. Immunity is not assured though, because even a minor mutation can disguise a largely unchanged virus such that it can slip beyond the body's defenses.

A vaccine is the ultimate man-made weapon in the battle against a virus. For example, Smallpox, a disease caused by the variola virus and which killed an estimated 300 million people in the 20th century, became the first infectious disease to be eradicated, largely by vaccination, in 1980.

But a vaccine can take years to develop and test, so is far from a quick fix. Or even a fix at all; despite considerable research, there is still no vaccine for SARS-CoV-1 or MERS-CoV or indeed any other coronavirus.

If enough people gain immunity—whether through surviving the full-blown disease or vaccination—the virus fails to find enough hosts and the outbreaks stops in its tracks. The effect is known as 'herd immunity' and requires perhaps 60 to 90 percent of the population to be exposed to the disease to be effective.

Some governments were keen to establish herd immunity by letting coronavirus rip through the population. But they soon changed tack when it was realized that while most victims might not die, many would get very sick and need hospital treatment—often expensive and comparatively rare intensive care—overwhelming healthcare services and exposing medical staff to the brunt of the viral attack. And second, a lot of vulnerable people would succumb quickly. "Eventually, we [will] achieve herd immunity, but we don't want that to happen quickly," Gypsyamber D'Souza, a professor of epidemiology at





Johns Hopkins University told *Time* magazine. "There would be so many deaths." Perhaps as many as 35,000 for every million infected. That is too high a price to bear.

**TECHNOLOGY FIGHTS BACK**

Considering the high infection rate, lack of a vaccine and the political untenability of gaining herd immunity by natural means, SARS-CoV-2 presents a challenging opponent. That has encouraged the use of technology to bring the virus to heel.

Testing for the virus is critical to managing the infection rate because so many carriers are asymptomatic. If apparently well people know that have the disease, they can stay away from others until it runs its course (typically 14 days). But it is impossible to rapidly check the whole population—even a country with the resources of the U.S. took several months to test just 10 million people out of a population of 328 million—so testing has to be targeted at high-risk individuals.

Early efforts in China used machine learning, a form of AI, to zero in on those who should be tested. Because a fever



Technology is needed to enforce social distancing. Bluetooth LE wearables are emerging as one of the most promising workplace solutions

is a key early symptom of COVID-19, the country combined CCTV, facial recognition and temperature-sensing robots to feed machine-learning programs that then identified potential victims early. Taiwan used an existing household registration system, cell phone data, a national health insurance database and immigration records to build an AI algorithm that tracked individuals based on their travel and medical history. This identified vulnerable individuals and made it much easier to inform people who had been in contact with a potentially infected person so they could then volunteer for testing.

In the U.S. connected health specialist, [Kinsa Health](#), for example, used data from millions of Nordic Semiconductor Bluetooth LE smart thermometers to gather anonymized data then forwarded this information from smartphone apps to build a patient-temperature 'heat map' of the country that could be used to quickly identify potential COVID-19 hotspots and help agencies precisely target scarce resources. (See Case Study pg12.)

The main method of lowering the infection rate and bringing an outbreak under control is to keep people apart so that the virus runs out of hosts. Governments around the world have implemented strict 'lockdown' regimes and then social distancing for the occasions when people do have to leave the safety of their homes. But even when everyone tries hard to abide by the rules, slip ups happen, and people pass close enough for the virus to take its chance. Bluetooth LE is at the heart of one technology being used to advise people if they've been unfortunate enough to pass close to someone who's later tested positive for COVID-19 so they can arrange for their own test. The system is based on a [cooperation](#) between tech-giants Apple and Google and uses a Bluetooth LE service together with an app for detecting smartphone proximity.

Such technology is valuable but does have a drawback: While the virus doesn't discriminate, the technology requires the services of an expensive smartphone, which is beyond much of the world's population. An alternative that still takes advantage of proximity measurement through Bluetooth LE, but costs a lot less than a smartphone, is a wearable. One example has been developed by Spanish engineering company, [Accent Systems](#); the Covid-19 BLE wristband is uniquely identifiable and uses Bluetooth LE to detect and record the user ID of every other wristband that it comes near over a 30-day period. If a wearer later develops COVID-19 symptoms, their data is automatically downloaded at a medical center so everyone they have come into contact with can be advised.

One challenge with contact tracing devices is that some perceive them to be an infringement on civil liberties. This perhaps explains the reticence of many to use government-mandated smartphone contact tracing apps.

**State of Play**

**Unholy trinity: Killer coronaviruses**

Researchers have identified hundreds of coronaviruses—so-called because under the microscope the pathogens look like they're wearing crowns—since they were first identified in chickens in the 1930s. Seven infect humans of which four cause little more than the common cold. The other three are deadly, with the one causing MERS the worst, but SARS-CoV-2 is by far the most contagious.

Coronavirus	Outbreak	Countries infected	Infections	Deaths	Fatality rate
SARS-CoV-1	2002-3	29	8,100	774	9.5%
MERS-CoV	2013-20	27	2,519	866	34.3%
<b>SARS-CoV-2</b>	<b>2019-mid 20</b>	<b>216</b>	<b>7.3 million</b>	<b>415,000</b>	<b>3.4% (est.)</b>

Source: CDC, WHO, The Lancet

**Life, but not as we know it: Anatomy of a virus**

Viruses have been on this planet for 1.5 billion years. According to 2015 research published in *Science Advances*, cellular life came first with bacteria and then multicellular forms taking that basic unit of life and becoming more complex. Viruses took the opposite path, getting rid of all but the most essential genes in an evolutionary track toward simplicity (although recent French research has unearthed a virus with 1000 genes, not far short of that found in a bacteria). Some even suggest they represent the pinnacle of evolution – fine-tuned to perfection.

But perhaps not quite, because viruses are not alive in the sense a cell is because they lack the fundamental machinery—such as a nucleus, organelles and mitochondria—that humans define as being necessary for life. And they now have so few genes that they can't reproduce (or 'replicate' as virologists prefer) on their own. Unfortunately, that's where the problems start for multicellular creatures like mammals.

Streamlined virus architecture comprises little more than DNA (or its precursor, RNA), a protein shell, an outer envelope and protein spikes. Once the virus gets inside a host such as a mammal, the protein

spikes act as 'keys' locking onto to the host's cell and opening a door in the cell membrane. Particular spikes only unlock particular cells which is why viruses can thrive only inside a 'compatible' host. Inside the cell the virus does the one and only thing it has evolved to do – replicate. It does this by hijacking the cell's machinery to make copies of itself – millions of copies. Eventually the cell succumbs to the workload and dies. Meanwhile the newly-hatched viruses flood into the bloodstream to repeat the process by hijacking cells elsewhere.

Because viruses contain only a few genes (the influenza virus, for example, comprises 14 active genes) random mutations can have a significant effect. And genes can even be swapped between viruses. This could mean, for example, that a coronavirus from a bat infecting a pangolin swaps genetic material with another virus in the animal's cells resulting in a new coronavirus with protein spikes that can open up human cells. That's not something that happens overnight; [according to The Economist](#) magazine, the four percent genetic difference between the related coronavirus identified in bats and that currently infecting humans took at least 20 years and maybe as



long as five decades of mutations to occur.

Only comparatively few viruses are deadly to humans and even fewer run riot. But when they do it can get very bad. The last pandemic was caused by 'Spanish Flu', and it killed up to 100 million people in 1918-19. But that was caused by an influenza virus rather than a coronavirus. The latter has proved relatively benign and we have lived alongside coronaviruses for thousands of years with no harm done beyond a few sniffles due to the four types that cause 25 percent of common colds. Coronaviruses have never before been responsible for a pandemic. That's why SARS-CoV-2 has caught us napping.

In Australia, for example, after a big publicity campaign only four million people had downloaded the contact tracing app several weeks after its launch. The Australian government said at least ten million (40 percent of the population) need to download the app for contact tracing to work.

Companies are aware of the privacy concerns and have issued statements to reassure the public. Apple and Google say "user privacy and security [are] central to the design" of their technology and Accent Systems CEO, Jordi Casamada noted: "Only authorized authorities can access the [wristband] data, and only when required. Otherwise the whole system is completely anonymous and collected data [is] automatically deleted after 15 to 30 days." (See pg16 for more about contact tracing privacy issues.)

**LIFE ON THE FRONT LINE**

Suffering from COVID-19 is no fun for anyone, but for some the suffering is easier to bear. SARS-CoV-2 seems to hit the elderly the hardest followed by those of any age who are unfortunate enough to suffer from co-morbidities. Meanwhile, younger, healthy people seem only to be troubled by little more than a raised temperature.

But it's not always true that mild symptoms at the beginning of the illness will signal the same throughout. British Prime Minister Boris Johnson, for example, a healthy 55-year-old, contracted COVID-19 and spent ten days at home with few problems, before his condition deteriorated rapidly, and he was admitted to a hospital intensive care unit requiring specialist treatment including oxygen. And what happened to Johnson has affected others.

**By the Numbers**

**76** SARS-CoV-2 vaccines under development

**14** SARS-CoV-2 antiviral drugs under development

Source: WHO

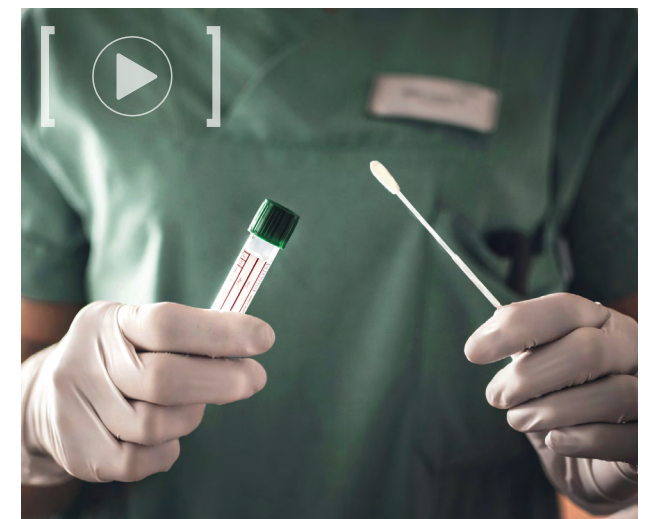

According to *National Geographic* magazine, one nasty aspect of SARS-CoV-2 is that it while it causes the oxygen saturation of the blood to dive, patients don't feel breathless. That's different to other respiratory diseases. As an example, the magazine [reported](#) that one COVID-19 patient in Oslo, Norway was talking and smiling, but his blue lips told another story, an oxygen saturation of 66 percent (compared with a normal level of 96 percent or greater) a level that causes major organ damage.

This gradual worsening of COVID-19 can get missed

until a sudden collapse which then requires expensive and restricted hospital care. If the decline could be picked up earlier, less intensive therapy could be sufficient to arrest the disease and take pressure off hospital resources.

Pulse oximeters are one solution. These devices monitor the blood oxygen level such that the tell-tale signs of COVID-19 getting on top of a patient are indicated early.

Nordic customer Masimo's Radius PPG pulse oximeter is a wireless device renowned for its accuracy, and, according to the company, is the preferred choice in nine out of the top ten hospitals in the U.S. The pulse oximeter is wirelessly connected to a patient's smartphone which reports blood oxygen levels to a Cloud server. In this way medical staff can manage large numbers of patients remotely.

"We didn't originally develop Radius PPG to combat COVID-19," says Bilal Muhsin, Chief Operating Officer of Masimo. "But it turns out that in the current crisis this wireless capability, when paired with a secure, Cloud-based telehealth platform ... can provide a valuable way to manage COVID-19 patients who do not require hospitalization."

Home monitoring with pulse oximeters and smart thermometers relieves pressure on health services, allowing them to focus on the thousands who are hospitalized, but that means doctors, nurses and support staff must put their own safety at risk to help the sick. Social distancing is not an option when tending a patient and faith is put in personal protection equipment (PPE) such as gloves, masks, gowns and goggles.

The supply of PPE has been compromised by high demand, not just from hospitals but also from the public keen to protect themselves. Yet medical staff need PPE more than others because when treating victims, the virus is ever-present. The gloves and masks offering protection



The Masimo Radius PPG pulse oximeter wirelessly reports blood oxygen levels to a Cloud server



Cleanbox Technology has re-engineered its VR headset cleaner to sterilize multiple medical masks for reuse

while handling patients must be immediately discarded after the examination to avoid cross-contaminating anyone else. While industry has responded to shortages by repurposing machines to manufacture desperately needed PPE (see sidebar *Retooling: From monocoques to masks*), there is still pressure on stocks. Nordic customer Cleanbox Technology has taken repurposing a step further to save precious supplies. The company has adapted its VR headset cleaner to sterilize worn masks so they can be reused. As part of the process the company's CX1 system employs UV light and super-hydrophobic nanotech coatings that repel fluids and prevent them from seeping into masks, as well as an air system that removes detritus and any wetness remaining at the surface of the mask. The 60-second cleaning and drying cycle eliminates bacteria, viruses and fungi. Nordic Bluetooth LE connectivity makes it easy for technicians to configure the machine for extended cleaning cycles or longer air bursts, for example.

"[The machine enables] continuous cleaning throughout the day ... without the use of chemicals," explains Amy Hedrick, CEO of Cleanbox Technology.

Discarding PPE to avoid cross-contamination means there are times when medical staff are without gloves. It only takes the droplets from a patient's sneeze to alight on a door handle, a light switch or a pen and the virus ends up on medical staff's hands, just a touch of the face away from infection. The solution is systematic handwashing - soap or the alcohol in hand sanitizer breaks down the protein coat of the virus, rendering it harmless.

Doctors and nurses can be so busy coping with the number of patients that handwashing can be forgotten. "Before COVID-19 ... healthcare workers saw [hand hygiene] more as a task that 'just had to be done,'" says Dr. Marco Bo Hansen, Medical Director of Sani nudge, a Danish



Sani nudge uses staff-worn Bluetooth LE tags and sensors attached to hand sanitizer dispensers to track hand hygiene compliance

healthcare company. "Now in the eye of the hurricane hand hygiene compliance is at the top of the quality list."

The company has developed Bluetooth LE sensors which are attached to sanitizer dispensers to detect when staff use them. In addition, staff wear a tag which determines how often they use a sanitizer or other handwashing facilities. Sensors are also fitted above patient beds so that staff contact with them can be precisely monitored. A smartphone app summarizes the data so users can quickly see if their hygiene regime is satisfactory.

### LEAVING THE TRENCHES

The problem with lockdowns is that while they help 'flatten the curve' of outbreaks they put people out of work and pull the rug from under economies. During the course of the pandemic, the U.S.'s unemployment rate is set to peak at a staggering 25 percent. Elsewhere, the U.K.'s economic output has contracted by a crippling 35 percent so far; added to the costs of supporting workers and tax cuts for business to help them stay afloat, such a contraction



PHYTEC's social distancing tracker enables face-to-face separation measurements within 5-10 cm accuracy

could see even the world's sixth largest economy in trouble unless restrictions are eased. And the U.K. is far from alone. In the absence of a vaccine but with restrictions eased, technology will become even more important. "Even as lockdowns are eased and workers return, COVID-19 will remain a risk factor for some time," explains Geir Langeland, Nordic's Director of Sales & Marketing. "Technology is needed to enforce social distancing even when workers are distracted, along with rapid contact tracing should someone contract the virus. Bluetooth LE wearables are emerging as one of the most promising workplace solutions."

Nordic customer Estimote has introduced a range of workplace safety contract tracing wearables. The wearables are worn by everyone within a specific work location, and if one worker is unfortunate enough to develop COVID-19, this data can be used to identify which employees may have been exposed to the virus and—crucially—the exposure time and thus the risk of infection. While contact tracing wearables for public use trigger notification but can't determine positional information, an employer using the Estimote system can add reference-location Bluetooth beacons around the premises to determine where the infected person had been working and target that area for extra cleaning.

PHYTEC, a German technology company is generating positional information in a different way by combining Nordic Bluetooth LE with ultra wideband (UWB), a short range wireless technology. Bluetooth LE is used to determine proximity while UWB determines exactly how close people have approached.

Such precision allows an alarm to sound if a person moves into the 1.5 meter danger zone where the risk of infection dramatically escalates. Precise distance information is also



## Case Study: Smart thermometers detect virus symptoms early to identify COVID-19 clusters

Now more than ever, early detection of the symptoms of contagious illness is vital to protect individual patients and entire communities. An early response to confirmed symptoms is equally important. For example, being able to rapidly and accurately identify clusters of people with high temperatures—and thus potential COVID-19 outbreaks—could help combat the spread of coronavirus. Thanks to U.S. connected health specialist, Kinsa Health, this is now possible.

For a number of years, Kinsa Health has been dedicated to developing affordable yet highly effective wireless medical devices to track and curb the spread of infectious diseases, including influenza-like illnesses.

Two such devices are smart thermometers. The first is the low cost Kinsa QuickCare oral thermometer that can provide a temperature reading in around eight seconds and the other is the Kinsa Smart Ear aural thermometer that can supply a temperature reading in as little as a second. Both devices connect via Bluetooth LE to the Kinsa App, which keeps a log of readings and serves as a 'nurse in the pocket' by providing users with information including guidance on the illness severity and when to seek further medical advice.

In the midst of the current pandemic or at any time in the future, Kinsa Health's network of millions of Bluetooth LE-enabled smart thermometers are capable of not only

measuring human body temperature, but also providing anonymized data through the Kinsa App to produce a temperature heat map of the U.S. known as the 'U.S. HealthWeather map'. By following this map, government agencies and healthcare organizations are able to identify potential virus hotspots immediately.

"On the back end we anonymize and aggregate temperature and symptom inputs to [generate] an illness signal, which tells us what percentage of a population is ill in any given U.S. geography be that county, state or region," says David Gal, Kinsa Health CTO and VP of Engineering. "Additionally, using machine learning and AI, we [extrapolate] these illness signals. We use these signals and forecasts to

“ A high fever is considered one of the key symptoms of COVID-19 so being able to track this health data is an extremely powerful way to quickly identify any new outbreaks”

help predict and curb the spread of disease outbreaks.”

According to the company, these solutions are capable of making a difference in a crisis such as COVID-19. "A high fever is considered one of the key symptoms of COVID-19 so being able to track this health data is an extremely powerful way to quickly identify any new outbreaks," says Gal. "If testing and containment resources can then be focused on these areas the spread of the virus could be significantly slowed down and lives saved."

### Low power processing

Both the QuickCare and Smart Ear devices are battery powered. Because replacing batteries frequently on the front line is not an option, Kinsa Health required an ultra low power Bluetooth LE solution that also provided sufficient onboard processing power and memory allocation to essentially run the complete smart medical applications from a single chip. Nordic's nRF52810 SoC fit the bill.

The reliability of the Bluetooth LE connectivity and the ultra low power consumption, particularly in sleep mode, allow the Kinsa smart thermometers to transmit data relatively infrequently and extend battery life.

"For the most part our devices live in a medicine cabinet, but when a user pulls out the device in the middle of flu season, the product needs to work," says Gal.

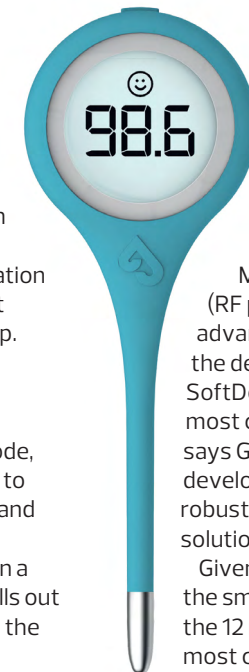

The nRF52810 has the lowest power consumption in Nordic's proven nRF52 Series yet retains the 64 MHz, 32-bit Arm Cortex M4 processor for the performance demands of secure Bluetooth LE connectivity and fast data processing.

Moreover, Nordic's SoftDevice (RF protocol 'stack') provided a major advantage for Kinsa Health throughout the development process. "The SoftDevice is unquestionably one of the most compelling reasons to use Nordic," says Gal. "It lets us focus on application development knowing that we have a robust and well implemented Bluetooth LE solution we can rely on."

Given Kinsa Health made nine in ten of the smart thermometers sold in the U.S. in the 12 months up to March 2020, it seems most consumers agree.

useful in deciding who needs to be tested; for example, moving within three meters of an infected person is considerably less risky than being within two meters.

Hygiene will be just as vital in workplaces as it currently is in hospitals. While people already wash their hands frequently, dealing with coronavirus contamination requires a greater level of care to ensure no trace of the virus remains. WashSense, a U.S.-based Nordic customer, has developed an easy-to-fit monitor that ensures good hand washing. Mounted above existing wall-mounted soap dispensers, the battery-powered WashSense includes an e-paper screen that activates once a user pushes the soap dispenser. Using thermal sensors, it is then able to monitor how well an individual is washing their hands.



Estimote's workplace safety wearables were designed to protect essential workers during the pandemic



Washsense's monitor uses thermal sensors to assess how well individuals wash their hands



offerings and as patients embrace the technology".

The company also notes that key healthcare providers benefit from tech giants' data and computing capabilities because the tech companies offer solutions that can be widely disseminated and scaled up in times of crisis. "In the future, this could impact how ... public health responses are orchestrated, with tech incumbents playing a large role in strategy and implementation." (See Analysis *How response technologies could benefit post-pandemic world.*)

Unfortunately, scientists have identified no less than 31 coronaviruses in bats, and they are continuously mutating. That makes it highly likely that SARS-CoV-2 is not the last coronavirus pandemic we will see. But while this one may have caught us off guard, we can win the fight using technology in a way that's never been done before. And next time we will be ready.

### WHEN THE BATTLE IS WON

As successive governments relax lockdowns and things return to normal, it won't be the same as before the pandemic. Even if a vaccine appears it will take years for it to have a global impact. As such, the good fight against SARS-CoV-2 still has a considerable time to run.

But the silver lining of this pandemic is its spur to innovation; not only will the tech developed to overcome coronavirus be vital for keeping it at bay it also lends itself to tackling other medical or non-medical problems.

For example, in its *State Of Healthcare Q1'20* report, analyst CBInsights notes that telehealth usage has significantly accelerated during the pandemic and while its use is likely to recede when things calm down it will remain above pre-pandemic levels "as providers expand their

## Retooling: From monocoques to masks

Car makers, underwear and vacuum cleaner manufacturers, oil and gas conglomerates, brewers and distillers, F1 teams, cosmetic, fashion and jewelry brands, musical instrument makers – the list goes on.

It's only a cross-section, but the list of companies that have pivoted their manufacturing operations to respond to the SARS-CoV-2 pandemic reads like the corporate version of a Hollywood A-list. Ford, General Motors, Mercedes, Armani, Prada, L'Oreal, Bulgari, Red Bull, Bacardi, Colgate, Jockey, Nike, Dyson, ExxonMobil. All household names, all agile enough to shift production for the greater good.



Within weeks of the outbreak, seven F1 motor racing teams announced their collaboration on 'Project Pitlane', pooling their combined resources and capabilities to manufacture and deliver respiratory devices. What F1 teams possess is the skill to rapidly design, prototype, test, and manufacture complex technology, and as such offered to create 10,000 ventilators at the request of the U.K. government.

Vacuum cleaner manufacturer Dyson also answered the call to quickly design and produce ventilators, partnering on a brand-new ventilator design that meets clinician specifications.

Ventilators aren't the only medical equipment in high demand. Intubation boxes—a device that acts as a protective shield between a patient and medical staff when inserting a tube in an airway—are also much required. Thalia Capos, a manufacturer of guitar accessories, has come to the rescue. As it turns out, moving production from guitar picks and capos when you run six high-end laser cutters, isn't such a stretch.

The company is not the only musical equipment manufacturer to respond. Instrument maker D'Addario rapidly converted its drum skin manufacturing operations into a face shield plant. As

CIO, Jim D'Addario told *Acoustic Guitar* magazine: "We knew we had that core ingredient", after that it was just a case of working with the engineers on how to repurpose the plant. Guitar strap makers with in-situ sewing equipment have also taken up the cause of producing Personal Protective Equipment (PPE), as indeed have high-end fashion houses.

Back in March, luxury Italian fashion brand Armani converted all its factories for the manufacture of single-use medical overalls. PRADA followed suit, producing medical overalls and masks rather than handbags and shoes. In the U.S. sportswear giant Nike began manufacturing face shields and respirator lenses, while underwear maker Jockey is working with partners to produce isolation gowns.

Alongside PPE, hand sanitizer has been in equally high demand. Rum producer Bacardi has put the cocktails on ice while it shifts to ethanol production, while Diageo—the maker of Smirnoff and Johnnie Walker—has donated two million liters of ethyl alcohol for hand sanitizer production. Cosmetic giant L'Oreal has switched production from face cream to sanitizer gel, while jeweler Bulgari is doing likewise with its fragrances partner.



### Analysis:

## How response technologies could benefit a post-pandemic world

During the response to the SARS-CoV-2 pandemic and the strict isolation and distancing measures that have followed, certain wireless technologies have emerged as potential solutions to unprecedented challenges. While the world attempts to 'flatten the curve' of COVID-19, forward-thinking industries and organizations are trying to get ahead of that curve by embracing wireless innovation.

As difficult as it might have been to imagine only a few short months ago, the latest evidence suggests that COVID-19, for all its undeniable damage, might ultimately leave some lasting positive impressions on industries like manufacturing, construction and healthcare – industries demonstrating a willingness to adapt and evolve with existing or emerging technology. The not-so-recent past offers a clue to the possibilities – defining historical events such as the Second World War and NASA's Apollo program spawned major technological advancements such as materials, jet engines, inertial navigation and digital computers, that have stood the test of time. In the eyes of various industry experts, it wouldn't surprise to see wireless technologies developed or deployed as a result of the coronavirus crisis remaining a highly valuable part of the post-pandemic world.

### Conservative industries evolve

When it comes to embracing the IoT, AI and the power of wireless protocols including [Bluetooth LE](#) and [cellular IoT](#) (LTE-M/NB-IoT), traditionally conservative industries such as manufacturing and medicine have often been slow to adapt. However, if the immediate response to COVID-19 is anything to go by, the impact of this pandemic will likely reshape the future of factories, offices and hospitals.

Today, factory lines need to be reconfigured with a greater focus on physical distancing of human workers, which in part can be achieved by greater automation and remote monitoring of production. But while machines can't be infected by a virus (at least not the biological kind) they do bring their own challenges. Parameters such as humidity, condensation, temperature and other key data must be

controlled if the machines are to produce products of the highest quality. Short range wireless networks, pioneered in applications such as building lighting are the perfect solution. By using wireless sensors, engineers can remotely and reliably monitor factory conditions and use machine-learning insights to refine the production process without ever going inside the building. Efficient and affordable factory automation is possible with low latency communication technology able to meet the tough RF demands of industrial environments.

San Francisco, CA-based Instrumental is already helping manufacturers implement remote monitoring as factories in China open up as the coronavirus outbreak there fades. *The Economist* magazine reports, for example, that one of Instrumental's clients,

It wouldn't surprise to see technologies developed or deployed as a direct result of the current crisis remain a highly valuable part of the post-pandemic world

P2i, a developer of nanotechnology coatings for electronic devices, is using the company's machine learning system to allow its engineers to closely inspect and manage production at factories in China from their headquarters in Oxford, U.K. Anna Shedletsky, Founder and CEO of Instrumental, told the magazine's *Money Talks* podcast in April that due to COVID-19: "We're going to see probably five years' worth of innovation in ... the next 18 months."

While already an emerging technology, wireless occupancy sensors—introduced to monitor how many people are using a building and adjust lighting and HVAC to suit—will receive a major boost to the mainstream through their use in fighting the pandemic. Today they are being repurposed to make sure occupation thresholds in buildings determined by social distancing are obeyed and to direct additional cleaning to areas of high use.

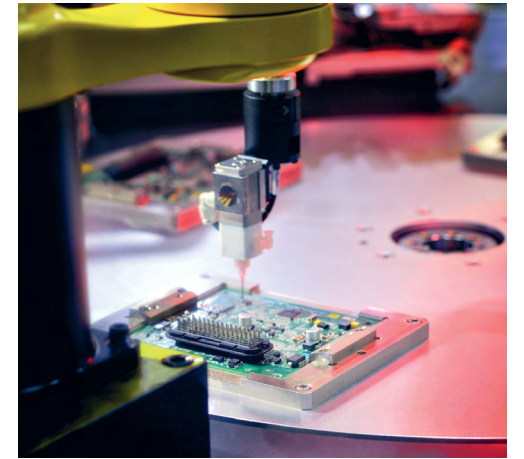

Building engineers are already working on a post-pandemic workplace. Over the last four to five years, companies have increasingly used wireless sensors installed in lighting fixtures to maximize space use. Now they're going to be used for the opposite.

### Medical home monitoring

The pandemic is also dramatically accelerating the use of wireless tech in healthcare – a highly regulated sector where new technology typically takes years to become established. During the battle with COVID-19 wireless applications are playing a critical role in the rise of the telehealth/telemedicine sector—both in the immediate response to the risks for patients and hospitals presented by the coronavirus, and just as importantly in the transition towards patient home monitoring.

The popularity of compact, connected diagnostic tools like smart thermometers and smart pulse oximeters—which report a home patient's underlying health data directly to medical practitioners via an app on the patient's smartphone—has risen sharply since the coronavirus outbreak. These solutions can speed up patient triaging and provide a safety net for monitoring respiratory systems remotely, enabling medical professionals to detect the early indicators not only of COVID-19 but of any respiratory disease.

Several hospitals around the world have started using connected AI solutions to help clinicians make potential COVID-19 treatment decisions. For example, at Australia's first fully operational virtual hospital, a wireless remote monitoring program combining AI software and human data observation is helping medical staff identify when a patient's respiratory condition worsens. Unless urgent, the patient can receive care via a telehealth system. In both the short- and long-term, patients staying at home when possible helps reduce the spread of a virus and prevents hospitals from being overwhelmed. With healthcare facing increasing pressure from a graying population, with or without coronavirus, that technology is here to stay.



# Tracking In, Privacy Out

Contact tracking means trading off personal freedom for safety. That's a lesson for those building the IoT

Essential workers in places like hospitals, warehouses, factories, grocery stores, post offices, and delivery depots have kept a locked-down world functional during the COVID-19 pandemic. Without them there would have been more deaths, greater shortages and widespread panic buying.

Because the coronavirus that causes COVID-19, SARS-CoV-2, is so contagious, it caught the world off-guard, and these essential workers faced increased daily exposure to the virus with little or no protection. They bravely carried on doing their jobs taking high risks to do so. Many paid with their lives to keep the majority of the public safe. For example, the U.K. Government reported 49 officially-verified deaths of NHS staff from COVID-19 during the pandemic. But the country's *The Guardian* newspaper suggests the number could be as high as 200.

No one wants to see that continue, so as the first wave of the pandemic starts to ease, essential workers must get better protection from any second spikes. Essential workers are just that, and by protecting their health, we protect the health and wellbeing of everybody.

At the same time, such is the economic carnage, the rest of the world cannot afford to stay locked down indefinitely. And that means in the not-too-distant future figuring how to get the majority of people back to work in a way where the risks are low enough that everyone feels safe.

Contact tracing—typically using Bluetooth technology to record close associations such that if one person later contracts the virus others can be notified and tested—offers an answer. But it faces resistance, primarily because of fears of intrusions on civil liberties (see sidebar *The contact tracing conundrum*). Those fears need to be addressed, not just to aid the fight against SARS-CoV-2 but also to unleash the potential of the IoT.

## SELLING TRACKING AND TRACING

The one tactic that proved extremely effective in countries such as South Korea and Singapore, that put the brakes on early to slow the spread of coronavirus, was detailed contact tracing. But with populations elsewhere feeling suppressed by the lock down and effective contact tracing demanding 80 percent-plus continuous tracking compliance to work, will workers buy into it?

"Unless we can find an effective pharmaceutical way to treat COVID-19 through some kind of vaccine or antiviral that's at least effective enough to mitigate its health

### By the Numbers

**120**  
Number of N.Y. MTA (public transport) workers who have died from COVID-19

**10.6 million**  
Number of 'essential workers' in the U.K

**2.7 billion**  
Number of workers across the globe affected by lockdowns

Source: The Lancet, U.K. ONS, International Labour Organization



impact, containing the pandemic is in many ways a data challenge," says Jakub Krzych, CEO of Estimote. (Estimote is one of a number of Nordic Semiconductor customers that has developed Bluetooth LE contact tracing wearables. (See pg8.))

"Who's tested positive and is carrying the virus? Who have they been in close contact with over the past two weeks who could now also be infected? How can they be traced and alerted? And in the near future, who's tested positive for having had the virus and so potentially immune? It could be that once mass antibody testing is in place, workforces may have to be divided into those who've had COVID-19 and those who have not."

"In 99 percent of infectious diseases, if you've had it and you've got antibodies, you wouldn't get it again," Dr Christian Jessen, a British physician told U.K. magazine *Closer*. "For the tiny proportion who may get it twice, it would be remarkably milder. We don't absolutely understand this virus, but we understand many others that are very similar, and they all behave pretty much the same way."

Krzych explains that in the workplace, a large-scale, continuous surveillance operation is unprecedented in terms of invasion of privacy, and only likely to work if it has the backing of the workforce. "This is particularly the case in the Western world," he says. "And particularly in the EU where attitudes to privacy are much stricter than in the U.S., for example."

### TRANSPARENCY IS THE KEY

In a recent opinion item published on *Bloomberg* (*If we must build a surveillance state, let's do it properly*) author Andreas Kluth noted: "The most successful data model in the world so far is not South Korea or Singapore but Taiwan. Like South Korea, Taiwan enforces quarantines with cellphone tracking and has stitched together various government databases, such as travel and health records. But Taiwan and its people added a twist."

Kluth goes on to explain that in Taiwan, the whole country voluntarily partnered with the government to create databases in which information flows both from the bottom up and from the top down.

To make new online and offline tools for fighting the virus, 'hacktivists', developers and citizens have been collaborating with the government on "vTaiwan", a sort of "online democracy town hall and brainstorming site". One tool, for example, prevented a run on face masks by mapping where the stocks were and allocating them where they were needed. Kluth notes that by involving people in solutions, rather than dictating policies, the process is transparent and inspires trust.

It's this transparency that Estimote's Krzych agrees is the key to an effective workplace tracking and tracing program: "Nobody wants interminable lockdowns, and that means we have to accept some loss of privacy to regain some semblance of a return to normal life. If the payoff is large enough, people will trade some loss

## The contact tracing conundrum

Before 2020, few of us were familiar with the terms 'social distancing' or 'contact tracing', but in the grip of the COVID-19 pandemic these phrases have become commonplace. While many have accepted mandated social distancing as a necessary means to curb coronavirus, contact tracing remains less welcome.

According to the journal *Science*, Singapore, which pioneered smartphone app-based contact tracing, reports only 1.4 million users of its 'TraceTogether' app, roughly a quarter of its population. Australia, another country quick to launch a contact tracing app, claims an uptake of around four million people. With the other 84 percent of the population reluctant the total falls well short of the ten million people the Australian government claim need to download the app for it to work. It is a similar story elsewhere.

The reasons for the lack of enthusiasm for contact tracing are many, but one key concern surfaces – data privacy and a 'Big Brother' paranoia about what else the data may be used for. Whether such concerns are valid is debatable but they certainly present a paradox; many people willingly share their data with both companies and governments when it suits—for example, the home delivery of groceries, the upload of data from fitness wearables to the Cloud, online benefit claims, social media and so on—but not when it doesn't.

It needs greater government openness and education across the world to drive the shift in national mindset required to encourage contact tracing and reveal personal digital trails when it not only suits individuals, but also the greater good ... such as during a pandemic.



People will trade some loss of privacy in exchange for escape from lockdown and better safety at work

of privacy for greater freedom from lockdown and better safety at work. But it's important the privacy they trade isn't abused by employers to, for example, continuously monitor where they are working and who they are working with or speaking to."

### A LESSON FOR THE IoT

One bright light that could emerge from the hell that is the COVID-19 pandemic is the powerful lessons that can be applied to the IoT, which has long been hampered by concerns over privacy. Like effectively combating COVID-19, but on a vastly and more detailed scale, the IoT is all about processing data gained by digitizing the physical world at a granular level. Such a system creates unprecedented potential for privacy intrusion to the point of knowing not only where an individual is located, but what they are doing, and with whom, at any time.

The key lesson from those countries where the pandemic response proved most effective is that there will always be privacy tradeoffs for applications leveraging the IoT. And these will only get larger over time.

But if the perceived benefits outweigh those tradeoffs, and citizens ultimately believe they have control through full transparency over how their data is collected and used, then privacy concerns over the IoT could finally be addressed and accepted.

That will mean a world that's a lot safer, happier, healthier, creative and productive than today's.

# Full STEAM Ahead

Wireless educational tools and technologies are helping children develop essential STEAM skills

What do the coders, engineers, entrepreneurs and innovators of tomorrow need to begin building their skills and experience? It's a question many 'STEAM' (science, technology, engineering, the arts, and mathematics) experts, as well as educational device manufacturers, are attempting to answer with [wireless educational tools and technologies](#).

The challenge involves introducing a new generation of digital pioneers to the world of hands on Information & Communication Technology (ICT) and computer science, helping children develop computational and critical thinking, and encouraging young learners to be not only safe and savvy technology users, but active participants in future technologies.

According to the experts, these objectives are crucial on at least two fronts. First, to help as many children as possible obtain the interdisciplinary education they will need to reach their full potential as industry becomes increasingly reliant on technology. And second, to ensure a highly educated, knowledgeable and creative future workforce will continue to advance individual industries, and society as a whole.

In recent times, wireless tech has become important in the creation of STEAM education tools and platforms. In turn, these new applications are being wholeheartedly embraced by education providers, schools, teachers, parents and various organizations. Most importantly, young people themselves are excited by the possibilities. Human participants might currently be keeping a safe distance from each other, but more than ever the fields of education and technology are working side by side.

## MICRO:BIT GOES GLOBAL

In March 2016, the British Broadcasting Corporation (BBC) delivered one million Nordic-powered micro:bits—tiny yet powerful programmable pocket computers—to Year 7 school students across U.K. schools. Just over four years later, adoption is tracking impressively. Around 4.5 million units are now in circulation and an estimated 20 million

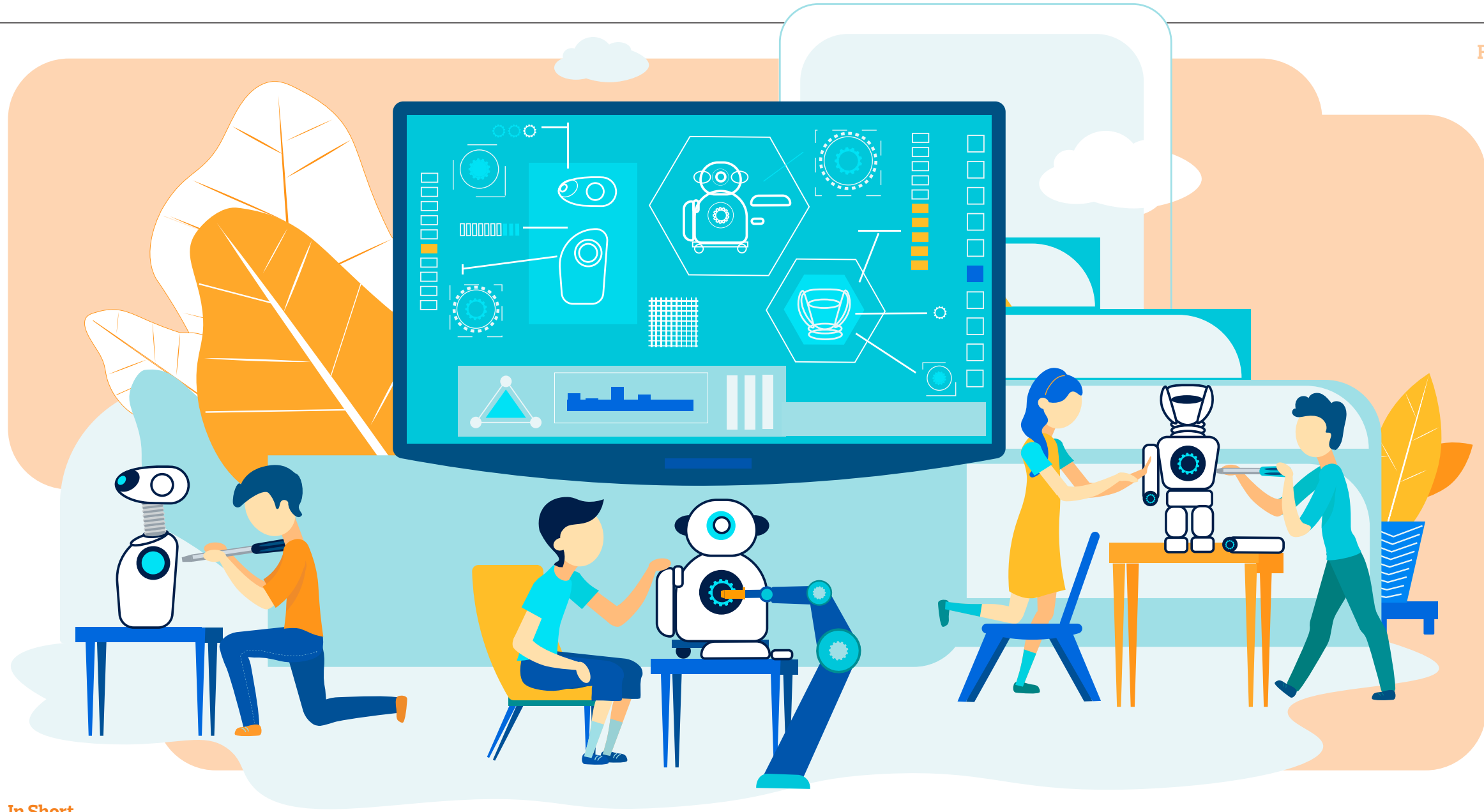

## In Short

It's important to proactively introduce the next generation of digital pioneers to the world of coding, programming and ICT

STEAM educators are turning to wireless tech educational tools to engage students and enhance the learning process

Connected educational devices such as the BBC micro:bit, Raspberry Pi and smart programmable robots are teaching children essential skills for the future

Wireless connectivity plays a key role in the user friendly functionality and enjoyment of these STEAM education technologies

children have learned digital skills using the device.

Today [micro:bits](#) are available in over 60 countries including Denmark, Finland, Uruguay, Singapore, Canada and Bangladesh. New programs and pilots have recently been launched in The Gambia with Rotary International, and Colombia working with the Colombian government and British Council. The micro:bit is central to over 30 large scale national and regional projects led by, for example, national broadcasters or NGOs. Moreover, according to the [Micro:bit Educational Foundation](#), the micro:bit is making a positive impact on global education systems and strongly influencing STEAM education platforms and other worthwhile programs around the world.

For example, the Ultra:bit program, launched by the Danish Broadcasting Corporation (DR) in 2018, saw the micro:bit incorporated into popular fiction and technology-focused content. The program has reached 90 percent of schools and over 70,000 students in Denmark.

An August 2018 study by the Danish Center for Evaluation and Development of Science Education (NEUC) surveyed 330 teachers, of which 95 percent felt that Danish Year 4 (age 8-9) students found it easier to code after working with the micro:bits, while 96 percent

thought students wanted to learn more about coding and technology since using the devices. Dr Grit Dørup Lund, a teacher implementing the micro:bit at a school in Gammelgaardsskolen, said her Grade 4 students are learning about technology with an open mind: "They get super inspired. They don't have any barriers to learning how to program as we adults have. They just do it."

Meanwhile, the not-for-profit Micro:bit Educational Foundation is continuing to grow and has just manufactured its five millionth micro:bit.

"We have also given away 5,000 micro:bits to parents in the U.K. to help them home educate their children during the COVID-19 lockdown and released resources to help those with or without micro:bits to start their journey with technology and digital creativity at home," says Gareth Stockdale, CEO of the Foundation.

Recently the Foundation announced the winners of its "[do your:bit](#)" BBC micro:bit challenge for children and teens to combine creativity and technology in solutions designed to tackle the United Nations' 'Global Goals' for sustainable development. The initiative focused on finding innovative ways to use the micro:bit to help protect life on land and underwater.

"The benefits of using physical computing to solve problems is shown in our recent do your:bit challenge where children from around the globe created solutions using the micro:bit," explains Stockdale. "Our North America winner, Lynn, created a complex device as a solution towards Global Goal 15, Life on Land. With this creation, Lynn aims to solve the issue of deforestation."

To detect loud sounds in forests, Lynn used a Raspberry Pi—a low cost, credit card-sized computer that plugs into a monitor or TV and uses a standard keyboard and mouse—and a connected microphone and camera. The microphone communicates with a micro:bit which then relays a signal to the Raspberry Pi when a sound has been detected. The system then automatically takes a photo and posts it to a public Twitter account for a park ranger to review, and to raise awareness of the challenge of deforestation.

## SMART ROBOTICS AND CODING

In addition to well established educational smart devices like the micro:bit and Raspberry Pi, other wireless tech-based solutions are helping children around the world develop valuable STEAM education skills in different ways. Smart robots, for example, are encouraging kids to take a

## By the Numbers

The scale and reach of micro:bit

An estimated **20 million** children are learning with the **micro:bit** worldwide

**5 million** **micro:bits** have been manufactured and

**4.5 million** devices are in circulation

**1 million** **micro:bits** were given for free to U.K. students in 2016

A further **20,000** new devices are available for loan from U.K. libraries

**micro:bits** are in **over 60** countries around the world

Source: Micro:bit Educational Foundation

genuine interest in coding, programming and development, while building practical skills and having fun in the process.

One such example is [Sphero RVR](#), an all-terrain programmable and customizable robot developed by Boulder, CO-based consumer robotics and toy company, Sphero. The device is suitable for beginners to advanced coders along with STEAM educators and students. It features a diverse suite of sensors enabling the robot to interact with its environment including an ambient light, color, infrared, accelerometer and gyroscope.

Using Nordic SoC-enabled Bluetooth LE connectivity, users can wirelessly code RVR from the Sphero Edu app on a smartphone or tablet as well as via macOS, Windows, Chrome OS and Fire OS devices. The companion app is a hub for programming Sphero robots and creating STEAM activities, alternatively, RVR can be coded using a Raspberry Pi, Arduino, a micro:bit or the company's own 'littleBits' platform.

"For beginners looking to grow, RVR is the perfect coding robot because of its unique ability to expand and change based on the user's growing skill level," says Jeff Wiencrot, Director of Firmware & Hardware at Sphero.

According to Wiencrot, smart robotics and coding platforms can help pave the way to universally improved STEAM education and skills for the next generation of professionals and experts.

"Educators are looking for ways to teach the '4 Cs' of critical thinking, collaboration, communication and creativity to help better prepare their students for the future as well as teach those 21st century skills alongside core content such as mathematics, science, language and the arts," he says.

"Educators are seeing the value of robotics, as students work in teams to creatively solve problems and demonstrate these solutions through the robot itself. More than any computer program, robots bring code to life and can help support themes and topics that are

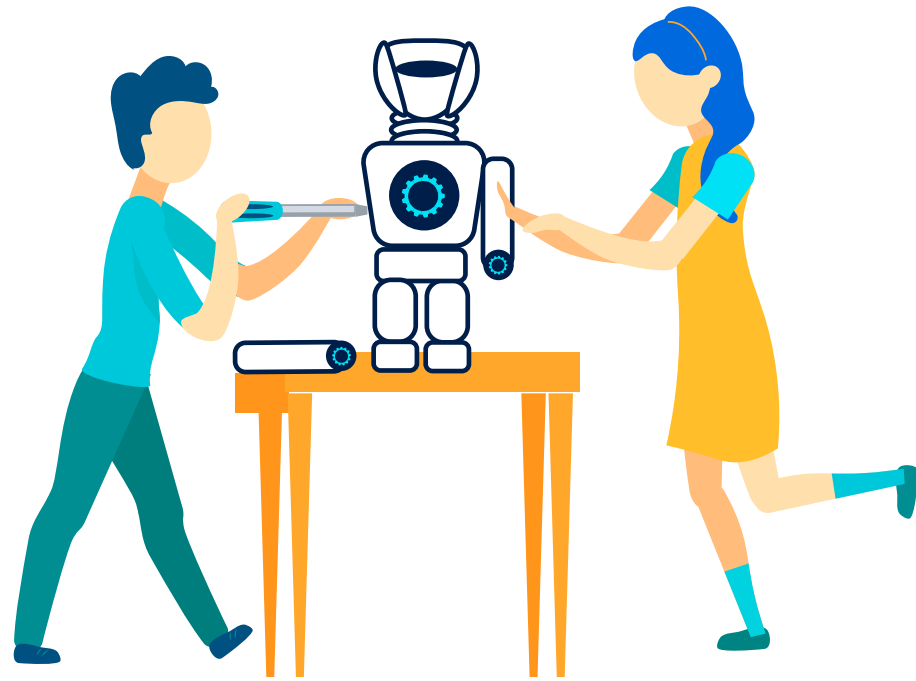

currently being taught in the classroom. We'll start to see this emerge as companies, like Sphero, create curriculums that can be used in your traditional classrooms to support teachers in integrating robotics and coding."

Still in the smart robot space, the [mTiny](#) by global STEAM education solution provider, Makeblock, brings something different to the table. Combining the connected robot with a tap pen controller and interactive map, mTiny is a screen-free smart education robot platform designed to help children aged four and older learn basic coding principles, as well as engage multiple senses, develop logical thinking and interactively solve problems through language, math and music. Both the tap pen controller and the robot feature optical identification, a six-axis gyroscope and the Nordic [nRF52832](#) SoC, enabling the pen to wirelessly send commands to the robot using Bluetooth LE connectivity, up to a range of approximately ten meters in open areas.

"At Makeblock we consider it our company mission to promote STEAM education skills. Our business idea supports this vision ... so that we can help people turn their ideas into reality and take education to the next level," says Makeblock's Product Manager.

Kano, a London, U.K.-based educational technology company, also employs the nRF52832 SoC for its [Harry Potter Kano Coding Kit](#), a Bluetooth LE wand that helps people of all ages learn how to code. The Nordic SoC wirelessly connects the 'magic' wand with the multiplatform Kano app where users can follow 70 step-by-step coding challenges and creations using intuitive coding 'blocks' and a JavaScript inspector. Once the wand is paired with a tablet, laptop or desktop computer, makers can bring their coding creations to life and view the wand movements onscreen, for example, moving floating feathers, growing pumpkins or throwing flames – all inspired by the Harry Potter films and books.

The wand employs a nine-degrees-of-freedom (9DoF) IMU—including a three-axis accelerometer, three-axis gyroscope and three-axis magnetometer—that tracks the wand's movement, speed and direction of use.

"We wanted to capture movement on every axis so our makers have a more immersive experience and the gesture recognition featured in our app can make use of more data," says Ricardo Luz, Senior Technical Product Manager at Kano.

### THE POWER OF WIRELESS

The Sphero RVR, Makeblock mTiny and Harry Potter Kano Coding Kit each offer their own unique STEAM education benefits, but from a technical perspective all three solutions are connected by a common feature – low latency Bluetooth LE connectivity enabling flexible, interactive, user-friendly wireless coding and programming.

This functionality plays a key role in engaging younger users and ensuring the platforms are both educational and enjoyable. Without the component of wireless connectivity, such devices would lose their impact.

"A positive user experience of the Harry Potter Kano Coding Kit relies on the ability to achieve a 'first time, every time' connection between the hardware and the Kano App," Luz explains. "We wanted to bypass a complex initial set-up, and thanks to Nordic's [software architecture] we were able to implement a seamless and rapid connection between the kit's hardware and the app."

Beyond Bluetooth LE wireless connectivity, the integration of Nordic technology is also crucial in terms of core processing and battery life capabilities for these smart education devices.

How do we build advanced STEAM education into fluid, dynamic and relevant everyday learning environments? According to educators it's all about providing a connection between abstract ideas and real world outcomes.

The final word goes to Stockdale: "We think it is really important that children learn to create and solve problems using technology," he says. "If we can provide the developers and engineers of the future the tools to follow their passion, then it's a future we can look forward to."



Sphero RVR and Makeblock mTiny use Bluetooth LE to provide flexible, interactive, user-friendly wireless coding and programming



## What is STEAM education and why is it important?

If 21st century innovators, educators, leaders and learners begin their journeys as inquisitive and engaged young students given the freedom to explore their ideas, our future society will almost certainly find itself in better hands. For this to happen, providing effective STEAM education must be a global priority.

But what exactly is STEAM education? The term refers to a learning approach incorporating the fields of science, technology, engineering, the arts and mathematics to guide children toward enhanced communication, inquiry and critical thinking for the real world. In school settings, STEAM education provides students with opportunities to learn more creatively using contemporary skills such as problem solving; the kind of skills they will need to thrive in future workforces and take industries to the next level.

Originally, the 'STEM' acronym was introduced in 2001 by scientific administrators at the U.S. National Science Foundation (NSF) to describe the career fields in the disciplines of science, technology, engineering and mathematics, or to describe a curriculum that integrated knowledge and skills from those fields. For better or worse, STEM excluded the arts – humanities, language arts, visual arts, design, music, dance, drama and new media.

While STEAM opponents still argue that the inclusion of the arts could dilute the strength of the other core components, it is now generally acknowledged that STEAM offers a valuable intersection between scientific concepts and arts practices and principles. This in turn promotes problem-based, collaborative and creative learning methods. A prime example of this intersection at play can be seen in the mathematics of the parabola used to create fine art imagery.

While Leonardo Da Vinci proved the critical importance of combining science with art to make new discoveries, in modern times there are numerous cases of educators and collaborators demonstrating the potential of STEM plus the arts.

Investment in STEAM education platforms and initiatives, particularly in schools, has been rising steadily for a number of years. This evolution includes the provision of mobile devices for students, STEAM curriculum, extracurricular STEAM clubs and programs, BYOD (bring your own device) initiatives, robotics programs and of course wireless STEAM education tools and technologies.

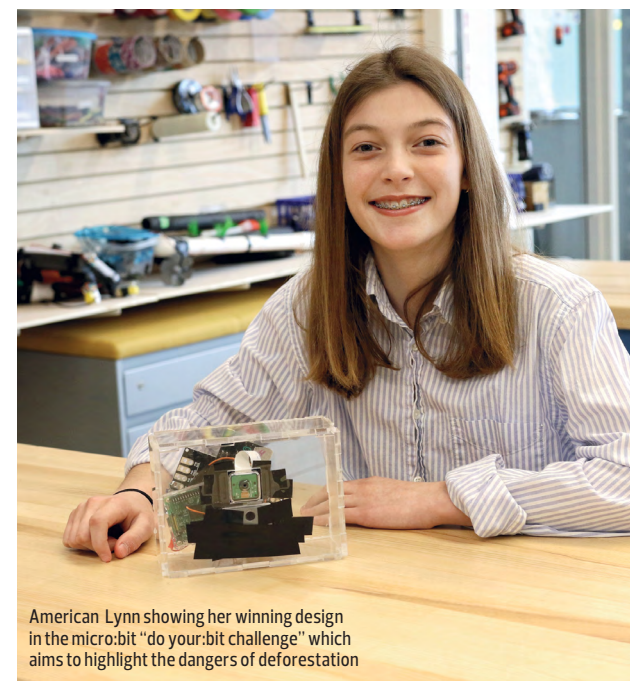

American Lynn showing her winning design in the micro:bit "do your:bit challenge" which aims to highlight the dangers of deforestation

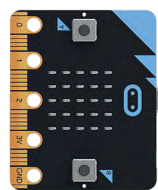

### Need to Know

The BBC micro:bit comprises a small circuit board that has everything children need to build complex projects. A Nordic SoC sits at the heart of the micro:bit, with code written by the user running on the SoC's Arm Cortex M0 processor. The chip's Bluetooth LE connectivity allows micro:bits to communicate with each other or a smartphone



Children are encouraged to put the Harry Potter Kano Coding Kit wand together before using it to drive the onscreen experience

# Damage Control

Hundreds of thousands of goods in transit are damaged each year. Determining who picks up the bill is a multibillion dollar question

**D**uring February 2014, Danish container ship *Svendborg Maersk* sailed from Rotterdam in the Netherlands, bound for Sri Lanka. The next day, off the coast of France, the ship was unexpectedly struck by strong winds and high waves, and by the time she limped into the Spanish port of Malaga, 520 containers had been lost overboard. Another 250 units had been damaged.

Fortunately, 442 of the containers were subsequently declared to be empty, but the accident remains one of the worst losses of cargo in peace time history. It was also a drop in the ocean compared with the total volume and cost of freight damaged in transit each year, and the astronomical bill that comes with it.

According to the International Transport Forum (ITF), an intergovernmental think tank with 60 member countries, 108 trillion tonne-kilometers (a tonne-kilometer or tkm is a unit of measurement representing one tonne of goods transported over a distance of one kilometer) of freight was transported around the world in 2015. Seventy percent of that freight traveled by sea and 18 percent by road, with the rest moving by rail, inland waterway and air. How much of this cargo arrived 'out of spec'—a term widely used in industry to indicate received goods that were not delivered in acceptable condition—is anyone's guess.

## In Short

Of the 108 trillion tonne-kilometers of freight transported around the world each year, approximately half a percent arrives at its destination damaged

Identifying who is responsible can be a complex issue, and one that costs industry billions of dollars every year

LTE-M- and NB-IoT-powered sensors can provide 'live' visibility of goods in transit anywhere in the world, and a record of what went wrong in the event of a claim

## State of Play

### Global Freight Transport by Mode in 2050

Global demand for freight transport will continue to grow dramatically over the next three decades and is expected to triple by 2050 on the back of continued rapid growth in e-commerce, according to projections by the International Transport Forum (ITF). Air freight—while representing a marginal share of total freight transport—will have the highest CAGR of all modes through 2050 at 4.5 percent, but seaborne trade volumes are expected to near triple over the same period, continuing to dwarf all other modes of transport

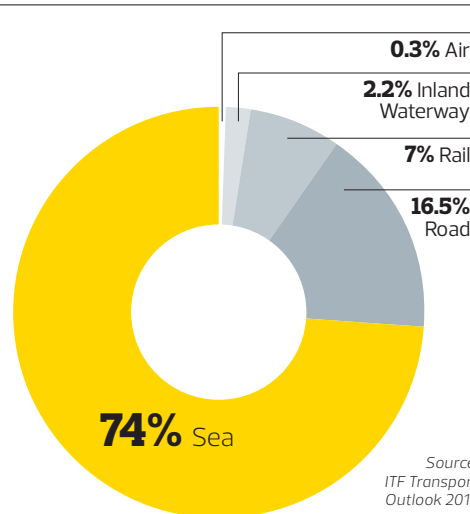

The Grocery Manufacturers Association (GMA) and the Food Marketing Institute (FMI) estimate about half a percent of consumer products are subject to shipping damage each year, which amounts to about \$1 billion of losses. But that is just consumer goods in the U.S., the real number will be a magnitude higher.

Take for example the world's largest online retailer Amazon; the company controls almost half of U.S. online sales and spent nearly \$38 billion on shipping costs in 2019. However, according to Forrester Research, approximately 25 percent of all items bought online are returned, with the Narvar Consumer Report 2019 claiming that 21 percent of Amazon's returns are due to the item arriving damaged. Eliminating damage in transit would save companies a lot of money.

## WHY THINGS ARRIVE DAMAGED

Whether it is a shipment of luxury cars, a television set, or a vanload of perishable goods, according to British packaging company, GWP Group, the reason why things arrive damaged almost always falls into one of eight categories; impact, vibration, moisture, dust, temperature/humidity, poor handling, electrostatic discharge (ESD), or incorrect packaging.

GWP Group say impact is the most common way that equipment or products become damaged in transit, usually as a result of products being dropped, collisions while on the move or even individual items crashing into each other

inside their packaging. Vibration is also a major source of damage particularly if that vibration matches the resonant frequency of the product.

Dust is a risk factor in particular for electronic equipment. It not only inhibits the movement of air, but also attracts moisture, which increases the risk of corrosion, short circuits and spoilage. Moisture can also be introduced via leaks, spillages and rain with similarly harmful results, while temperature extremes can not only spoil perishable goods, but cause components to deform if the heat becomes too high, or brittle and degrade if too low.

Lastly ESD can play havoc with electronic products, and packaging specifically designed to combat ESD is critical to their safe transportation and storage and to mitigate the risk of catastrophic failure. Static electricity can be caused by a range of factors, not least other devices, friction and climate.

"If you are sending out extremely high value, or fragile products that cost thousands ... then corrugated cardboard packaging is unlikely to be the best solution," says Richard Coombes, General Manager with GWP Protective. "It is worth thinking about the cost of packaging versus the cost of having to replace returned items or faulty equipment.

"If a protective case with custom foam costs £300 [\$370] to provide the optimum level of protection, but the cost of replacing a specialist part would cost £5,000 [\$6,100] or more, then it does not make sense to underspecify the packaging."

## COUNTING THE REAL COST

Even with careful handling and appropriate packaging, accidents happen, and when goods arrive at their destination spoiled, damaged or broken, someone has to pay, and the cost goes well beyond the invoice cost or the item's retail value. The true cost of intransit damage has to factor in a myriad of other outlays; repackaging, return freight, replacement, administrative costs, reshipping and compensation, just for starters. Then there are the intangibles, damage to a company's image, brand equity, potential loss of customers and so on.

Who picks up the bill can be a contentious and complex issue, and one that needs to be addressed in the contract of carriage by the owner of the goods—both seller and buyer—as well as the carrier and its insurers. According to J. Paul Dittmann, Executive Director of the Global Supply Chain Institute at the University of Tennessee, it would be wrong to assume a carrier will be wholly responsible for any damage while they are in possession of your cargo. Standard carrier liability is not insurance, and in fact he says, is there to protect the carrier not its customer.

For the most part, carrier liability covers up to a certain dollar amount per pound of freight, protecting the carrier from uncapped losses, as well as damage caused due to 'Acts of God' or shipper negligence (improper packaging or loading, for example). The onus can then be on the shipper to prove the carrier is at fault, which hasn't traditionally been easy to establish. Most contested cases typically become



Environmental asset tracking is emerging as a prime early use case in industrial IoT ... centered around the cost savings that can be made from avoiding lost, wrong or spoilt consignments

disputes between the carrier's insurers and the insurers of the goods in transit, and when that dispute cannot be resolved, in turn by their respective legal representation. But now technology is available that can help establish what went wrong and when, and settle cases before they end up as disputes between expensive legal teams.

**HOW TECH CAN HELP**

Using [technology to track freight](#) through the supply chain is already well established. The Bill of Lading (in effect the receipt for the cargo being shipped by the carrier) will in addition to a range of details about the freight contain a progressive, or PRO, number. This PRO number is used to create a barcode that's printed on a sticker and placed on the parcel or pallet, so it's visible and scannable. When scanned during freight handling, this is the simplest way to establish the last known whereabouts of freight – but offers little other information.

RFID-based tags are also commonplace and eliminate the manual process of scanning a barcode. Passive RFID tags are cost effective but with limited data storage don't offer much more insight into cargo than a barcode, require additional infrastructure and cannot actively track the movement of freight through the supply chain in 'real time'. Active, battery powered RFID tags can function as a beacon to provide live data on the location of cargo and can support sensors that measure and transmit environmental data such as temperature, humidity and light. They also offer larger memory for data storage, but to provide this data in real time still requires receiving infrastructure and a gateway at every



The Meshtech Cloud Tracker provides perishable goods suppliers and logistics companies with end-to-end 'live' visibility of perishable goods in transit

“ Perishable goods suppliers now have a viable way to prevent unnecessary compensation costs while also being able to exceed both current and future regulations



step of the journey to relay the information to the Cloud. Then there is the not inconsequential issue of cost. A passive RFID tag typically costs between 10 and 50 cents, an active tag can range anywhere from \$5 to 15, making it impractical as a solution for individual item tracking unless the value of that item can justify it.

Global Navigation Satellite System (GNSS) receivers are useful not only for tracking a ship, truck or delivery van's whereabouts, but can also be paired with sensors and a long range radio transceiver or cellular modem to enable live tracking of high value freight via the Cloud. Cost is again an issue, making the use of such systems for singular pallets let alone individual items unrealistic for all but essential applications.

The large scale rollout of the new IoT targeted LPWAN version of cellular wireless technology—called LTE-M and NB-IoT—in the last 12 months, may well offer a better alternative. Cellular IoT devices such as Nordic Semiconductor's [nRF9160](#) low power SiP with integrated LTE-M/NB-IoT modem and GPS offer the ability to track and monitor the condition of assets across cities, countries, or even the globe without recourse to a gateway or any additional infrastructure. Cellular is also as reliable and secure as wireless tech gets and, depending on the application, multiyear battery life can be expected.

While not yet economical enough to be employed at the individual parcel level, these devices can be easily incorporated into modules teamed with [Bluetooth LE](#) transceivers and then paired with relatively inexpensive Bluetooth LE-powered sensors. With the long- and short-range wireless protocols working together seamlessly, real time end-to-end supply chain monitoring of an individual parcel's whereabouts and, for example, movement, impact, orientation and environmental data is possible.

Nordic recently demonstrated a concept based exactly on this premise, [nRF Pizza](#). Individual pizza boxes fitted with the [Nordic Thingy:91](#) cellular IoT development tool (which incorporates an [nRF52840](#) advanced Bluetooth SoC and a Bosch BME680 environmental sensor) recorded location, temperature, pressure and acceleration data, enabling a customer via an app to not only follow their pizza's location as it travels from the store to their home, but also see if it has gone cold, or has been dropped or flipped. While the concept is light-hearted, this technology applied to determining liability in the billions of dollars of claims each year arising from goods damaged in transit is now gaining serious traction.

"Environmental asset tracking is emerging as a prime early use case in industrial IoT," says Geir Langeland, Nordic Semiconductor's Director of Sales & Marketing. "This is being driven by a compelling and clear cut benefits analysis centered around the cost savings that can be made from avoiding lost, wrong or spoilt consignments, and at the same time reducing the risk of disappointing or even losing valuable end customers."

One company pioneering this technology is Norwegian asset tracking and monitoring specialist Meshtech. Last year the company announced development of an environmental asset tracker combining cellular IoT and Bluetooth LE technologies, designed to provide



perishable goods suppliers and logistics companies with end-to-end 'live' visibility of perishable goods in transit. The [Meshtech Cloud Tracker](#) can not only continuously monitor environmental parameters such as temperature, but also whether a consignment has been dropped, tilted or folded, the location of individual shipping items within a consignment, the order in which they were loaded and unloaded, and the geographical location of the entire consignment anywhere in the world.

Employing both Nordic Semiconductor's nRF9160 SiP and [nRF52811](#) Bluetooth LE SoC, the device relays sensor data to the Cloud every thirty minutes, for example alerting vested parties if a consignment of perishable goods exceeds its specified temperature range or is dropped or otherwise mishandled. This potentially allows the carrier to take immediate corrective action to save the goods, as well as providing traceability and evidence in the event of an insurance or compensation claim.

"Cloud Tracker is designed to detect delivery or storage issues quickly enough that they can be corrected without jeopardizing an entire consignment," says Meshtech Interim CEO, Preben Skretteberg. "Perishable goods suppliers now have a viable way to prevent unnecessary compensation costs, while also being able to exceed both current and [increasingly strict] future regulations that may apply to the shipment and storage of perishable goods. The next step is to take the Cloud Tracker beyond perishable goods, and we are already in discussions with multiple large enterprises in other market segments and industries regarding this."

As the technology and infrastructure matures, the cost of cellular based tracking systems will fall, to the point tracking and condition monitoring systems for low unit cost goods such as pizzas could become a commercial reality. Then the goal will be to not only locate, but also know the condition of any individual item of freight, at any time, anywhere on our planet. Even inside a shipping container in the middle of the ocean, potentially 1600 km from the nearest cell phone tower and where the closest human life bar the ship's crew can be found on the International Space Station.

The technology already exists, as the data can in theory be relayed via the ship's own communications system and satellite, but it remains way off a cost-effective prospect. Not that it would have saved the *Svendborg Maersk* from her unfortunate fate, but it could help settle the multibillion dollar blame game that is goods damaged in transit.



**Tech Check**

Nordic's nRF9160 low power SiP with integrated LTE-M/NB-IoT modem and GPS is certified for global cellular IoT applications. Comprising a dedicated 64 MHz Arm Cortex-M33 processor and 1 MB Flash and 256 KB RAM, integrated TrustZone and CryptoCell technology ensures application security



**Transporting Titanic Things**

Getting an Airbus A380 from A to B is usually a matter of firing up its Rolls-Royce Trent 900 turbofan engines and taxiing onto the runway, but not when it hasn't yet been built. That requires a hugely complex multinational logistics operation. While the aircraft is assembled at Airbus' headquarters in Toulouse in the south of France, its wingset is shipped from Wales, the tailplane from Spain, the rear fuselage and vertical tail fin from Germany, while the remainder of the fuselage has a shorter trip from Saint-Nazaire in Brittany.

With the exception of the vertical tail fin which can be flown from Hamburg to Toulouse in one of the company's super transporters, all the other major components must travel via a combination of land and sea. Airbus has a fleet of specially designed vessels to transport the components to a floating pontoon dock on France's Atlantic coast, from where they are moved onto barges for a 95 km trip up the Garonne River, a process that requires multiple trips over the course of eight days.

At Langon, the sections of the plane are loaded into specially designed trailers that travel at night across the course of two evenings to make the road trip to Toulouse. While the road has been specially widened to handle the size of the A380's components, it is still a tight squeeze. At its narrowest point, the clearance between the plane's sections and the buildings on the side of the road is a mere 50 centimeters.

Then there is the just plain huge. At 323 meters in length and with a gross tonnage of 133,596, cruise ship *Carnival Vista* is herself a behemoth of the ocean. But when she needed to be drydocked last year, something bigger still was needed to transport her into the shipyard in Freeport, Bahamas for repairs. The *BOKA Vanguard* was the vessel for the job. A semi-submersible heavy lift ship and the largest vessel of her type ever built, the *BOKA Vanguard* has an open deck measuring 275 by 70 meters and was designed to move offshore oil and gas platforms.

To load the *Carnival Vista*, the *BOKA Vanguard*'s ballast tanks were flooded to sink the deck up to 16 meters below the surface, enabling her to accommodate the other vessel's substantial draft. [The precision operation](#) took a total of 12 hours.

## Sports & Fitness

# Carv

This Bluetooth LE sensor ski training solution helps skiers improve technique with live audio feedback

According to analyst Grand View Research, the size of the global [sports technology](#) market—comprising devices, smart stadiums, analytics and statistics, and e-sports—was valued at \$9.8 billion in 2018, and it is estimated it will register a CAGR of 20.3 percent over the forecast period up to 2025

In 1972, Apollo 17 astronaut Harrison Schmitt became the twelfth person to walk on the moon. Schmitt later said astronauts traveling to the moon should learn the art of cross country skiing as he believed the techniques involved would make walking on the moon easier. He also predicted lunar skiing holidays in the future

The ski was invented before the wheel. Twenty two thousand years ago, when Cro-Magnon man first attached two sticks to his feet, it was to cross wetlands and marshes in the winter when they iced over. The sticks enabled people to travel during the winter and hunt reindeer and elk across the frozen tundra

The official world record for speed skiing was set by Italian [Ivan Origone](#) in March 2016 in Vars, France. Origone hit a top speed of 254.958 kph. Without a motor, there is no way on earth for a human to go faster. Usain Bolt ran 100 meters in 9.58 seconds. Origone skied the equivalent in 1.41 seconds

Carv wirelessly relays comprehensive metrics and analysis to the iOS- and Android-compatible Carv app on the user's smartphone. The app provides easy-to-understand graphical insights and performance scores across the four key skiing categories, along with 'real time' professional audio coaching with actionable feedback



Carv comprises two ultra-thin footbeds with MEMS accelerometers, gyroscopes, magnetometers and capacitive pressure sensors that fit underneath the linings of any ski boots and are connected to a slim ski tracker attached to the boot. The sensors track motion and pressure distribution during each individual ski run, providing a comprehensive data set across four key skiing categories – balance, edging, rotation and pressure

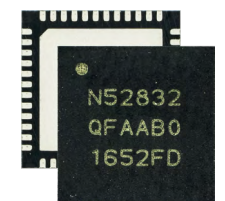

### Tech Check

Nordic's [nRF52832](#) Bluetooth LE multiprotocol SoC provides low latency wireless connectivity between Carv and the skier's smartphone. The SoC's powerful 64MHz, 32-bit Arm Cortex M4 processor with floating point unit (FPU) ably supports the application's complex Floating Point and Digital Signal Processing (DSP) computations to offer real time feedback from the sensors

# [Tech Zone]

An in-depth look at Nordic's wireless IoT solutions



## nRF Connect SDK support extends to nRF52 Series

Nordic Semiconductor's [nRF Connect SDK](#) for short range wireless and cellular IoT products will support the market leading nRF52 Series SoCs from v1.3, with code and documentation already available in the Master branch of development.

The enhancement makes it possible to design with nRF52 Series devices on the same platform as the recently launched flagship [nRF5340](#) SoC and the award-winning [nRF9160](#) SiP for cellular IoT applications.

To complement the nRF Connect SDK release the nRF Connect suite of tools has added features which ease the development process. The new Toolchain Manager in [nRF Connect for Desktop](#) makes

setting up an advanced configuration and build environment for nRF Connect SDK straightforward for Windows users, with Linux and macOS to follow.

The nRF Connect SDK has been available for more than a year to support cellular IoT development with the nRF9160 SiP. With the latest version, developers can now apply a feature rich and scalable RTOS, or a powerful enterprise build system, to their future short range wireless application development.

According to Nordic, the nRF Connect SDK brings a step change in flexibility and scalability for development with the company's RF products.

The SDK incorporates the open-source

Zephyr RTOS for constrained, energy efficient and secure IoT products.

Development with nRF Connect SDK enables developers to build highly reliable, efficient, multithreaded applications that can scale better than previously possible.

"nRF Connect will be a one-stop-shop for developing any kind of connectivity product using Nordic technology," says Kjetil Holstad, Director of Product Management with Nordic Semiconductor.

"This makes things much simpler for developers in the long run and offers many fantastic benefits in addition to code reuse across platforms."

## Cellular IoT development engine offers rapid product prototyping

U.S. design startup, Croxel, has put a Nordic nRF9160 SiP at the heart of the Croxel KIOTE/11 cellular IoT development platform. The product is claimed to accelerate prototyping and commercialization of even the most challenging IoT applications.

The Croxel KIOTE/11 platform includes all necessary hardware (including packaging), firmware and software, including a fully interactive and customizable web dashboard boasting MQTT support.

The KIOTE/11's extensive sensing capability features include temperature, humidity, atmospheric pressure, indoor air quality, RGB light color, ambient light level, 2D gesture and LIDAR proximity measurement (up to 2 m), motion, shock and vibration detection, sound level, magnetic proximity, both GPS and cellular location, three-axis acceleration,

vibration, orientation plus a three-axis electronic compass.

The platform leverages the Nordic [nRF9160](#) SiP's dedicated 64 MHz Arm Cortex-M33 application processor, with 1 MB of Flash and 256 KB of RAM, and the LTE-M/NB-IoT modem with GPS support. The product also features an onboard antenna and battery, USB charging, USB/UART interface, audio DAC with 1 W speaker amp, digital microphone, RGB LED plus piezo beeper and user button, and a range of expansion interfaces such as GPIO, UART and I2C.



### Toys and Gaming

## Module supports SteamVR gaming

U.S. tech firm, Tundra Labs, has released its TL448K6D-VR module. The module assists developers and lowers the cost of designing six-degrees-of-freedom (6DoF) tracked devices for Valve's SteamVR gaming platform.

The highly integrated module employs the 3.0 by 3.2 mm WL-CSP version of Nordic's [nRF52832](#) SoC to deliver an ultra compact 10 by 16.35 by 2.01 mm SiP form factor weighing less than 1 g. A compact and lightweight form factor is a key attribute for wearable devices as well as head-mounted displays. In addition to VR and AR, the module is suitable for computationally intensive tracking, eye tracking, sensor fusion, and motor control applications. The module also includes the 64 MHz, 32-bit Arm Cortex processor-based nRF52832 SoC, a second 120 MHz Arm Cortex M4 processor, an 8 k LUT FPGA, two precision MEMS oscillators and a crystal oscillator.



### Tech Briefing

## A new language for Cortex-M programming

Developers were faced with a choice of just C or C++ to program Cortex-M based IoT products. That's changed with the introduction of Rust

Product development consultancy, 42 Technology, has seen a growing demand for IoT connectivity across the consumer, medical, agricultural and industrial sectors among others.

The company says that product manufacturers are looking to use IoT connectivity to add features that differentiate their products for end users or to generate new streams of data for service-based offerings.

The hardware for this IoT connectivity often comprises small, portable, battery powered devices incorporating an embedded processor from the Arm Cortex-M family, such as the M33 device at the heart of Nordic Semiconductor's [nRF9160](#) SiP.

Until now, developers looking to program such a Cortex-M device were limited to either C or C++ languages. Now 42 Technology has proposed a third option called [Rust](#). The adoption of Rust would bring a number of useful new features to developers.

### Maximizing resources

The Rust programming language is aimed at platforms and environments where performance and resource usage are critical. But the language is more than that; it also brings in some facilities to help developers be more productive and produce more secure code. One example of this is the Rust package manager, known as Cargo. This manager lets the developer pull down open source packages from a central repository, much like Python's pip or Node's npm, so the packages can easily be used in the project.

Another unique feature of Rust is a part of the compiler known as the "borrow checker". The facility checks code during compilation to ensure no two pieces of code try to access the same data simultaneously (which would be undefined behavior). In other words, if a function is called, the developer needs to specify whether the callee is "borrowing" the value temporarily (either exclusively or as a shared borrow) or taking ownership of it.

A language that offers security, speed and productivity seems too good to be true. However, 42 Technology reports that companies like Microsoft, Dropbox, Facebook, Google, Cloudflare and others have all reported success in using Rust for new projects; both on Cloud infrastructure, and, in Google's case, on its next-generation mobile OS, Fuchsia.

And with the big push from the Rust Embedded Working Group, moving support for a range of embedded platforms up towards "1.0" status, 42 Technology is seeing more companies enjoying those same benefits on compact, low power systems like Nordic's nRF52 and nRF53 Series [short range wireless](#) SoCs and nRF9160 low power cellular IoT SiP.

### Rusty sockets

Developers working with the nRF9160 use the Nordic Socket API, either directly or through Zephyr, which very closely follows the standard Berkeley socket API (as used



The Rust wrapper around the Nordic socket library uses high level strongly-typed objects, like "TcpSocket" and "ATSocket", which automatically close when they go out of scope and let the developer send formatted data

on Linux and Windows). But there are some drawbacks, such as using "int" for both the socket type and the socket family, which means if the developer muddles them up the compiler can't help. In addition, the developer must remember to call "nrf\_close" on the socket because if the variable goes out of scope, the socket will be leaked and cause hard-to-debug issues at run time.

To enable Rust developers to take advantage of this powerful and well-tested library, whilst helping them avoid these pitfalls, 42 Technology has developed a Rust wrapper around the Nordic socket library. The wrapper uses high level strongly-typed objects, like "TcpSocket" and "ATSocket", which automatically close when they go out of scope and let the developer send formatted data (as shown in image above; see reference 2 for more detail).

The approach has proved so powerful that 42 Technology says it has been able to develop the world's first example of QUIC (part of the upcoming HTTP/3 standard) running directly on the nRF9160, using Cloudflare's new Rust-language QUIC library.

### Rust + Zephyr

Another advantage of Rust is that it can be mixed with the Zephyr RTOS. A Rust library can be compiled down to a standard C static library, allowing it to be linked with all the developer's existing C and C++ projects. Some projects even convert from C to Rust simply by replacing one function at a time. For example, with an SVG library where the resultant library has the same API but works much faster and more safely internally.

The Rust programming language aims to provide performance, security and developer productivity, and works well on everything from hyper-scale Cloud infrastructure down to the smallest Cortex-M microcontroller. In addition, since it compiles down to standard object files, the developer can take advantage of all its benefits while still integrating it into his or her existing C and C++ projects.

### References

- <https://msrc-blog.microsoft.com/2019/07/22/why-rust-for-safe-systems-programming/>
- <https://www.42technology.com/news/electronics-weekly-embedded-rust/>
- <https://github.com/cloudflare/quiche>
- <https://gitlab.gnome.org/GNOME/librsvg>



The Rust programming language is aimed at platforms and environments where performance and resource usage are critical

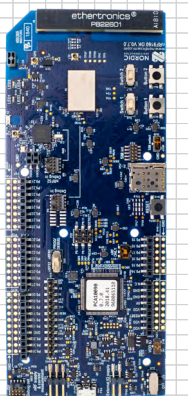

### Tech Check

Nordic's nRF9160 DK is an affordable, pre-certified single-board development kit for evaluation and development on the nRF9160 SiP for LTE-M, NB-IoT and GPS. Programming and debugging is enabled through the Segger J-Link OB, which also supports external targets

## Tech Perspective

# End-device certified embedded modems ease path to cellular IoT

By simplifying design and certification, low power cellular IoT applications can move from concept to deployment in just a few weeks

One of the perceived drawbacks of cellular IoT when compared with LPWANs that use license-free RF allocations is the need for certification before an end device can join an LTE-M or NB-IoT network. Certification takes time and money, but the path to success can be eased by choosing the right technology suppliers. And once certified, the global coverage and quality of service (QoS) advantages of tightly-regulated cellular networks make the effort well worthwhile.

Certification is required to prove that a cellular IoT end device has passed the performance and quality assurance tests required to meet a regulatory body's specifications for connection to a network. Without it, a product cannot be brought to market.

### Chipset, module and end device certification

Cellular IoT end devices are typically required to meet three levels of product certification: One for the chipset, one for the module upon which an end device is based and the third for the end device itself.

Typically the chipset supplier certifies the chipset. Then the module supplier integrates the chipset and certifies the module. Then the module is integrated into the end product, and that is certified as well.

However, there are a few exceptions. One is Nordic's [nRF9160 SiP](#) with integrated LTE-M/NB-IoT modem and GPS. The nRF9160 SiP is a low power cellular IoT solution that integrates the chipset (also developed by Nordic) together with components such as an RF front end and a power management IC. Nordic then looks after certification of the SiP at the module level for use on cellular networks across the globe (see pg7)

However, special permission is still needed from the carriers to connect devices to the network with a module

that has only module certification. This permission is granted for testing only and extends to just a few units. If the module-based design is then carried through to even small volume production, the manufacturer will need to submit the product for end-device certification. That can be time consuming and expensive, especially if several design iterations are needed to get over the line as each iteration requires a new certification.

### The embedded modem route

There is an alternative path to end-device certification which can mitigate risk and save time and money: Use an embedded modem as the basis of a cellular IoT design.

An embedded modem takes the design one stage further than a module by adding essential design elements that are not supplied with a module—such as ensuring access to IO pins, including antenna connections and adding voltage regulation—to create a fully-operational modem. As the embedded modem is a complete working cellular IoT solution, the modem maker can achieve end-product certification rather than just module certification.

The end product designer can therefore source a 'drop-in' embedded modem that is not only based on a proven and tested cellular IoT design, but also eliminates the need for further certification once incorporated into the end product.

U.S. embedded modem company NimbeLink's [Skywire Nano NL-SW-LTE-NRF9160](#) is the first publicly announced, third-party end-device certified embedded modem based on Nordic's nRF9160 SiP. That means any product or application incorporating the Skywire Nano—with a few special exceptions—doesn't have to go through further cellular carrier certification process before joining an LTE-M or NB-IoT network.

### Cellular IoT design made easy

The nRF9160 SiP and associated development tools remove much of the complexity of cellular IoT design and ease certification to encourage companies with little or no cellular IoT experience to enter the sector.

The SiP's dedicated application memory space allows developers to port and run their own code while the firmware to control the functions of the embedded modem are stored in a separate memory allocation.

NimbeLink have carried over Nordic's ease-of-design to the Skywire Nano. The company says with the embedded modem it has focused on making cellular connectivity easier for product developers by taking away much of the design work from the customer.

By using the embedded modem, a developer who wants to add cellular IoT connectivity to their design can easily take their product from concept to deployment in as little as a few weeks.



Cellular IoT end devices are typically required to meet three levels of product certification before connection to a network: Chipset, module and end device

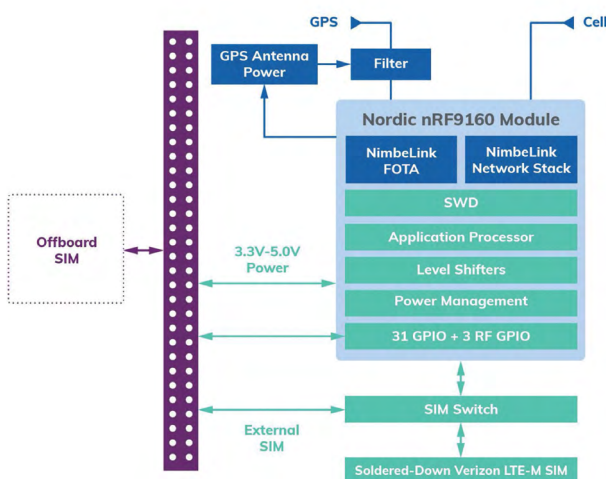

The Skywire Nano NL-SW-LTE-NRF9160 is based on the nRF9160 SiP and is a certified, fully-operational embedded modem for cellular IoT applications

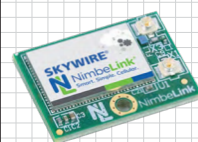

### Tech Check

The Skywire Nano takes advantage of the nRF9160 SiP's compact size and low power consumption to achieve the tiniest form-factor and lowest power consumption of any cellular IoT modem available on the market today.

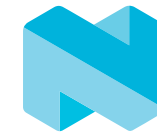

NORDIC  
SEMICONDUCTOR

# All-in-one wireless development solution



## nRF Connect SDK

One common platform to build powerful, richly featured cellular IoT and short-range wireless products

LEARN MORE

[www.nordicsemi.com/nRFConnectSDK](http://www.nordicsemi.com/nRFConnectSDK)





# Product Summary

Full product details at: [www.nordicsemi.com/Products](http://www.nordicsemi.com/Products)



	nRF9160	nRF5340	nRF52840	nRF52833	nRF52832	nRF52820	nRF52811	nRF52810	nRF52805	nRF51822	nRF51422	nRF51824	
WIRELESS PROTOCOL	LTE-M	•											
	NB-IOT	•											
	GPS	•											
	BLUETOOTH LOW ENERGY		•	•	•	•	•	•	•	•	•	•	
	BLUETOOTH 5.2		•	•	•	•	•	•	•	•	•	•	
	DIRECTION FINDING		•	•	•	•	•	•	•	•	•	•	
	2 MBPS		•	•	•	•	•	•	•	•	•	•	
	LONG RANGE		•	•	•	•	•	•	•	•	•	•	
	BLUETOOTH MESH		•	•	•	•	•	•	•	•	•	•	
	THREAD		•	•	•	•	•	•	•	•	•	•	
	ZIGBEE		•	•	•	•	•	•	•	•	•	•	
	ANT		•	•	•	•	•	•	•	•	•	•	
	2.4 GHZ PROPRIETARY		•	•	•	•	•	•	•	•	•	•	
NFC		•	•	•	•	•	•	•	•	•	•		
TYPE	SYSTEM-ON-CHIP	•	•	•	•	•	•	•	•	•	•	•	
	SYSTEM-IN-PACKAGE	•	•	•	•	•	•	•	•	•	•	•	
CORE SYSTEM	CPU	64 MHz Arm Cortex-M33	128 MHz Arm Cortex-M33 +64 MHz Arm Cortex-M33	64 MHz Arm Cortex-M4	64 MHz Arm Cortex-M4	64 MHz Arm Cortex-M4	64 MHz Arm Cortex-M4	64 MHz Arm Cortex-M4	64 MHz Arm Cortex-M4	64 MHz Arm Cortex-M4	16 MHz Arm Cortex-M0	16 MHz Arm Cortex-M0	
	FPU	•	•	•	•	•	•	•	•	•	•	•	
	DSP INSTRUCTION SET	•	•	•	•	•	•	•	•	•	•	•	
	CACHE	•	•	•	•	•	•	•	•	•	•	•	
	MEMORY	1MB Flash, 256 kB RAM	1MB Flash, 512 kB RAM +256 kB Flash, 64 kB RAM	1MB Flash, 256 kB RAM	512 kB Flash, 128 kB RAM	512 kB or 256 kB Flash, 64 kB or 32 kB RAM	256 kB Flash, 32 kB RAM	192 kB Flash, 24 kB RAM	192 kB Flash, 24 kB RAM	192 kB Flash, 24 kB RAM	128 kB or 256 kB Flash, 32 kB or 16 kB RAM	128 kB or 256 kB Flash, 32 kB or 16 kB RAM	256 kB Flash, 16 kB RAM
	CLOCKS	64 MHz / 32 kHz	128 MHz / 64 MHz / 32 kHz	64 MHz / 32 kHz	64 MHz / 32 kHz	64 MHz / 32 kHz	64 MHz / 32 kHz	64 MHz / 32 kHz	64 MHz / 32 kHz	64 MHz / 32 kHz	16 MHz / 32 kHz	16 MHz / 32 kHz	16 MHz / 32 kHz
SECURITY	ARM TRUSTZONE	•	•	•	•	•	•	•	•	•	•	•	
	ARM CRYPTOCELL	310	312	310									
	ROOT-OF-TRUST	•	•	•	•	•	•	•	•	•	•	•	
	SECURE KEY STORAGE	•	•	•	•	•	•	•	•	•	•	•	
	AES ENCRYPTION	•	•	•	•	•	•	•	•	•	•	•	
RADIO	LTE-M/NB-IOT/GPS MODEM	•											
	CERTIFIED LTE BANDS	1-5, 8, 12-14, 17-20, 25-26, 28, 66											
	FREQUENCY	700-2200 MHz	2.4 GHz	2.4 GHz	2.4 GHz	2.4 GHz	2.4 GHz	2.4 GHz	2.4 GHz	2.4 GHz	2.4 GHz	2.4 GHz	
	MAXIMUM TX POWER	23 dBm	3 dBm	8 dBm	8 dBm	4 dBm	8 dBm	4 dBm	4 dBm	4 dBm	4 dBm	4 dBm	
	RX SENSITIVITY	-108 dBm (LTE-M), -114 dBm (NB-IoT), -155 dBm (GPS)	-97.5 dBm (1Mbps)	-95 dBm (1Mbps)	-95 dBm (1Mbps)	-96 dBm (1Mbps)	-95 dBm (1Mbps)	-97 dBm (1Mbps)	-96 dBm (1Mbps)	-97 dBm (1Mbps)	-93 dBm (1Mbps)	-93 dBm (1Mbps)	-93 dBm (1Mbps)
	ANTENNA INTERFACE	50 Ω Single-ended	Single-ended	Single-ended	Single-ended	Single-ended	Single-ended	Single-ended	Single-ended	Single-ended	Differential	Differential	Differential
PERIPHERALS	HIGH SPEED SPI	•	•	•	•	•	•	•	•	•	•	•	
	TWI, SPI, UART	4xTWI/SPI/UART	4xTWI/SPI/UART +TWI/SPI/UART	2xTWI/SPI, SPI, 2xUART	2xTWI/SPI, SPI, 2xUART	2xTWI/SPI, SPI, UART	2xTWI/SPI, UART	TWI/SPI, SPI, UART	TWI, SPI, UART	TWI, SPI, UART	2xTWI/SPI, UART	2xTWI/SPI, UART	
	QSPI		•	•	•	•	•	•	•	•	•	•	
	USB		•	•	•	•	•	•	•	•	•	•	
	PWM	4	4	4	4	3		1	1				
	PDM	•	•	•	•	•	•	•	•	•	•	•	
	I2S	•	•	•	•	•	•	•	•	•	•	•	
	ADC, COMPARATOR	ADC					COMP	ADC, COMP	ADC, COMP	ADC	ADC, LPCOMP	ADC, LPCOMP	ADC, LPCOMP
	TIMER, RTC	3,2	3,2+3,2	5,3	5,3	5,3	4,2	3,2	3,2	3,2	3,2	3,2	
	TEMPERATURE SENSOR	•	•	•	•	•	•	•	•	•	•	•	
	APPLICATIONS	AGRICULTURE	•	•	•	•	•	•	•	•	•	•	•
ASSET TRACKING		•	•	•	•	•	•	•	•	•	•	•	
AUTOMATION		•	•	•	•	•	•	•	•	•	•	•	
BEACON		•	•	•	•	•	•	•	•	•	•	•	
CONSUMER ELECTRONICS		•	•	•	•	•	•	•	•	•	•	•	
DIRECTION FINDING		•	•	•	•	•	•	•	•	•	•	•	
GAMING / VR + AR		•	•	•	•	•	•	•	•	•	•	•	
HEALTHCARE & MEDICAL		•	•	•	•	•	•	•	•	•	•	•	
INDUSTRIAL SYSTEMS		•	•	•	•	•	•	•	•	•	•	•	
MESH NETWORKS		•	•	•	•	•	•	•	•	•	•	•	
PC PERIPHERALS		•	•	•	•	•	•	•	•	•	•	•	
PROFESSIONAL LIGHTING		•	•	•	•	•	•	•	•	•	•	•	
SMART BUILDINGS		•	•	•	•	•	•	•	•	•	•	•	
SMART CITY		•	•	•	•	•	•	•	•	•	•	•	
SMART HOME		•	•	•	•	•	•	•	•	•	•	•	
SMART METERING		•	•	•	•	•	•	•	•	•	•	•	
SPORTS & FITNESS		•	•	•	•	•	•	•	•	•	•	•	
TOYS	•	•	•	•	•	•	•	•	•	•	•		
WEARABLES	•	•	•	•	•	•	•	•	•	•	•		
CERTIFICATIONS	GCF, PTCRB, CE, FCC, Verizon ++	CE, FCC	CE, FCC	CE, FCC	CE, FCC	CE, FCC	CE, FCC	CE, FCC	CE, FCC	CE, FCC	CE, FCC	CE, FCC	
OPERATING TEMPERATURE	-40 to 85°C	-40 to 105°C	-40 to 85°C	-40 to 105°C	-40 to 85°C	-40 to 105°C	-40 to 85°C	-40 to 85°C	-40 to 85°C	-40 to 85°C	-40 to 85°C	-40 to 105°C	
SUPPLY VOLTAGE RANGE	3.0 to 5.5 V	1.7 to 5.5 V	1.7 to 5.5 V	1.7 to 5.5 V	1.7 to 3.6 V	1.7 to 5.5 V	1.7 to 3.6 V	1.7 to 3.6 V	1.7 to 3.6 V	1.8 to 3.6 V	1.8 to 3.6 V	1.8 to 3.6 V	
DEVELOPMENT KITS	nRF9160 DK, Nordic Thingy:91	nRF5340 PDK	nRF52840 DK, nRF52840 Dongle	nRF52833 DK	nRF52833 DK	nRF52833 DK	nRF52833 DK	nRF52833 DK	nRF52833 DK	nRF51DK, nRF51Dongle	nRF51DK, nRF51Dongle	nRF51DK, nRF51Dongle	
PACKAGES	10x16x1mm LGA	7x7 mm aQFN94 (48 GPIOs)	7x7 mm aQFN73 (48 GPIOs), 3.5x3.6 mm WLCSP94 (48 GPIOs)	7x7 mm aQFN73 (42 GPIOs), 5x5 mm QFN40 (18 GPIOs), 3.2x3.2 mm WLCSP (42 GPIOs)	6x6 mm QFN48 (32 GPIOs), 3.0x3.2 mm WLCSP50 (32 GPIOs)	5x5 mm QFN40 (18 GPIOs)	6x6 mm QFN48 (32 GPIOs), 5x5 mm QFN32 (17 GPIOs), 2.48x2.46 mm WLCSP33 (15 GPIOs)	6x6 mm QFN48 (32 GPIOs), 5x5 mm QFN32 (16 GPIOs), 2.48x2.46 mm WLCSP33 (15 GPIOs)	2.48x2.46 mm WLCSP28 (10 GPIOs)	6x6 mm QFN48, WLCSP48, Thin CSP	6x6 mm QFN48, WLCSP48	6x6 mm QFN48, WLCSP48	

# Tech Profile nRF52820



**Description:** The nRF52820 SoC is the sixth addition to the nRF52 Series. It brings a lower end option with built in USB and a fully featured multiprotocol radio. These capabilities, together with +8 dBm output power, makes it a good choice for pairing with an application processor in gateways and other smart home, commercial and industrial applications. The SoC also boasts Bluetooth Direction Finding capabilities and an extended temperature range of -40 to 105 °C making it suitable for asset tracking and professional lighting applications.

**Hardware:** The nRF52820 incorporates a 64 MHz 32-bit Arm Cortex-M4 processor. The hardware includes 256 KB Flash and 32 KB RAM. The SoC's 2.4 GHz radio features +8 dBm TX power (programmable from -20 dBm in +4 dBm steps) and -95 dBm sensitivity (Bluetooth LE at 1 Mbps) for a link budget of +103 dBm. When connected to a USB host, the SoC can be directly powered by the always-present 5 V VBUS signal (a reference layout is available for this configuration). The integrated USB peripheral includes a dedicated regulator for converting the 5 V VBUS signal to the 3.3 V needed for supplying the USB signaling interface, removing the cost and space for an external regulator. The SoC has an integrated balun with single-ended output and includes up to 18 GPIOs, 12 Mbps Full Speed USB device, UART, 2 x SPI/TWI and QDEC. The SoC has a 1.7 to 5.5 V supply voltage range, an LDO regulator and a DC-DC converter. Peak power consumption is TX 4.9 mA (0 dBm) and RX 4.7 mA (1 Mbps). The SoC is available in a 5 by 5 mm QFN40 and is drop in compatible with the nRF52833 SoC.

**Software:** The nRF52820 is a multiprotocol wireless SoC supporting all Bluetooth 5.2 features, high throughput 2 Mbps and Long Range. It also capable of Bluetooth mesh, Thread and Zigbee mesh protocols. The SoC is available with three SoftDevices (Bluetooth LE protocol "stacks"). The S112 is a memory optimized peripheral stack, the S122 is a memory optimized central stack, while the S140 is a feature-rich Bluetooth 5 stack supporting both central and peripheral operation.

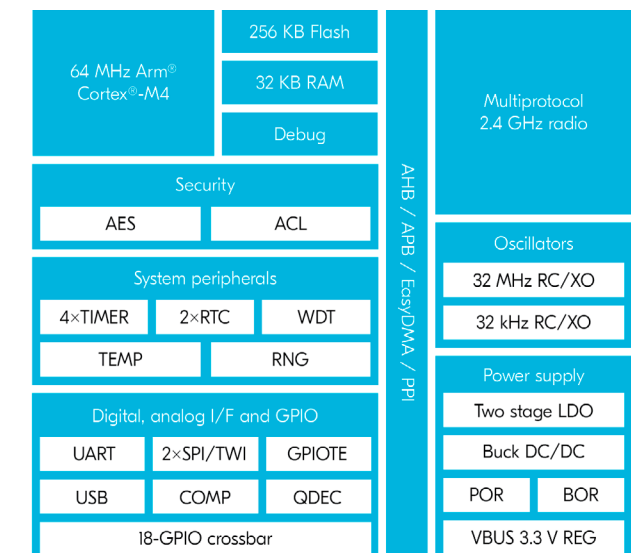

The nRF52820 SoC's integrated USB peripheral includes a dedicated regulator for converting the 5 V VBUS signal to the 3.3 V needed for supplying the USB signaling interface, removing the cost and space for an external regulator