



at&t

Abridged user's manual

CL84102/CL84152/CL84202/
CL84252/CL84342/CL84352
DECT 6.0 corded/cordless
telephone/answering system
with caller ID/call waiting



This Abridged user's manual provides you with basic installation and major operation instructions. A limited set of features are described in an abridged form.

Please refer to the online **CL84102/CL84152/CL84202/CL84252/CL84342/CL84352 DECT 6.0 corded/cordless telephone/answering system with caller ID/call waiting** Complete user's manual for a full set of installation and operation instructions at **www.telephones.att.com/manuals**.

This telephone system is compatible with certain AT&T DECT 6.0 cordless headsets. Visit **www.telephones.att.com/headsets** for a list of compatible cordless headsets.

For customer service, visit our website at **www.telephones.att.com** or call **1 (800) 222-3111**. In Canada, dial **1 (866) 288-4268**.

Model number: CL84102/CL84152 (one handset)
CL84202/CL84252 (two handsets)
CL84342/CL84352 (three handsets)

Type: DECT 6.0 corded/cordless telephone/answering system with caller ID/call waiting

Serial number: _____

Purchase date: _____

Place of purchase: _____

Both the model and serial numbers of your AT&T product can be found on the bottom of the telephone base.

Save your sales receipt and original packaging in case it is necessary to return your telephone for warranty service.

Parts checklist

Your telephone package contains the following items. Save your sales receipt and original packaging in the event warranty service is necessary.



Abridged user's manual



Quick start guide



Cordless handset

(1 for CL84102/CL84152)
(2 for CL84202/CL84252)
(3 for CL84342/CL84352)



Telephone base



Corded handset with coiled handset cord attached



Power adapter for telephone base

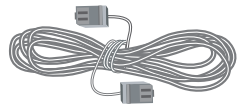

Telephone line cord



Battery for cordless handset

(1 for CL84102/CL84152)
(2 for CL84202/CL84252)
(3 for CL84342/CL84352)



Battery compartment cover

(1 for CL84102/CL84152)
(2 for CL84202/CL84252)
(3 for CL84342/CL84352)



Charger for cordless handset with power adapter installed

(1 for CL84102/CL84152)
(2 for CL84202/CL84252)
(3 for CL84342/CL84352)

Abridged user's manual

CL84102/CL84152/CL84202/
CL84252/CL84342/CL84352
DECT 6.0 corded/cordless
telephone/ answering system
with caller ID/call waiting



Table of contents

Getting started

Quick reference guide - handset.....	1
Quick reference guide - telephone base.....	3
Telephone base and charger installation	5
Battery installation and charging.....	6
Installation options.....	7
Tabletop to wall mount installation.....	7

Telephone settings

Handset and telephone base settings.....	9
Ringer volume.....	9
Ringer tone.....	9
Set date/time	10
LCD language	10
Voice mail (visual message waiting) indicator.....	11
Set speed dial voicemail number.....	11
Clear voicemail indicator	12
Key tone.....	12
Caller ID announce.....	13
Home area code.....	14
Dial mode.....	14

Telephone operation

Telephone operation.....	15
Making a call.....	15
Answering a call	15
Ending a call.....	15
Temporary ringer silencing.....	15
Handset speakerphone.....	16
Last number redial.....	16

Equalizer.....	16
Volume control	16
Call waiting.....	17
Mute	17
Chain dialing.....	17
Blind transfer.....	18

Multiple handset use

Multiple handset use.....	19
Handset locator.....	19
Join a call in progress.....	19
Intercom.....	20
Answer an incoming call during an intercom call	21
Call transfer using intercom	22
Push-to-talk (PTT)	23
Turn PTT on or off.....	23
PTT call to a single device.....	23
PTT call to group	25
Answer a PTT call.....	26

Directory

Directory	27
Create a new directory entry	27
Review directory entries	28
Search by name.....	28
Display dial	28
Delete a directory entry.....	28
Edit a directory entry.....	29
Speed dial	30
Assign a speed dial number.....	30
Assign your speed dial voicemail number.....	30
Make a call using speed dial	31
Check your voicemail using speed dial.....	31

Caller ID

Caller ID	32
Information about caller ID with call waiting.....	32
Missed (new) call indicator.....	32
Review the caller ID history.....	32
View dialing options.....	32
Dial a caller ID log entry	33
Save a caller ID log entry to the directory.....	33

Redefining long range coverage and clarity	56
HD audio	56

Index

Index.....	57
------------	----

Answering system

Answering system settings.....	34
Announcement	34
Answer on/off.....	35
Call screening.....	35
Number of rings.....	36
Remote access code.....	36
Message alert tone.....	37
Message recording time.....	37
About the answering system.....	38
Answering system and voicemail indicators	38
Using the answering machine and voicemail together	38
Message capacity	39
Voice prompts	39
Call screening.....	39
Call intercept.....	40
Temporarily turning off the message alert tone.....	40
Message playback.....	40
Options during playback.....	41
Delete all old messages.....	42
Recording and playing memos.....	42
Remote access.....	43
Adding and registering handsets/ headsets.....	44
Deregistering handsets	45
Troubleshooting.....	46
Maintenance.....	49
Important safety information	50
FCC Part 68 and ACTA.....	52
FCC Part 15.....	53
Limited warranty.....	54
Technical specifications	56
DECT 6.0 digital technology.....	56
Telephone operating range.....	56

Quick reference guide - handset

▼CID/VOLUME

Press ▼CID to show caller ID history when the handset is not in use (page 32).

Press to scroll down while in menus.

While entering names or numbers, press to move the cursor to the left.

Press to decrease the listening volume when on a call (page 16), or to decrease the message playback volume (page 41).

MUTE/DELETE

During a call, press to mute the microphone (page 17).

When the handset is ringing, press to mute the ringer temporarily (page 15).

While reviewing the caller ID history, the directory or the redial memory, press to delete an individual entry (page 32, page 28 and page 16 respectively).

During message or announcement playback, press to delete the playing message or the recorded announcement. (page 41 and page 34 respectively).

PHONE/FLASH

Press to make or answer a call (page 15).

During a call, press to answer an incoming call when you receive a call waiting alert (page 17).

During message playback, press to call back the caller if the caller's number is available (page 41).

1

While reviewing a caller ID log entry, press repeatedly to add or remove 1 in front of the telephone number before dialing or saving it in the directory (page 32).

Press and hold to set (page 11) or dial your voicemail number (page 31).

TONE*

Press to switch to tone dialing temporarily during a call if you have pulse service.

CHARGE indicator

On when the handset is charging in the charger.

▲DIR/VOLUME

Press ▲DIR to show directory entries when the handset is not in use (page 28).

Press to scroll up while in menus.

While entering names or numbers, press to move the cursor to the right.

Press to increase the listening volume when on a call (page 16), or to increase the message playback volume (page 41).

MENU/SELECT

When the handset is not in use, press to show the menu.

While in the menu, press to select an item or save an entry or setting.

OFF/CANCEL

During a call, press to hang up (page 15).

While in a menu, press to cancel an operation, back up to the previous menu, or exit the menu display, or press and hold this button to exit to idle mode.

When the handset is ringing, press to mute the ringer temporarily (page 15).

Press and hold while the telephone is not in use to erase the missed call indicator.

(pound key)

Press repeatedly to display other dialing options when reviewing a caller ID log entry (page 32).

EQ

During an outside call, intercom call, message or announcement playback, press to change the audio quality to best suit your hearing (page 16).

)/SPEAKER

Press to make or answer a call using the speakerphone (page 15).

Press to switch between the speakerphone and the handset (page 16).

REDIAL/PAUSE

Press repeatedly to view the last 10 numbers dialed (page 16).

While entering numbers, press and hold to insert a dialing pause.



Quick reference guide - handset



PUSH TO TALK

Press to initiate a one-to-one (page 23) or one-to-group broadcast (page 25).

Press and hold to broadcast to a group of system devices (page 25).

Main menu

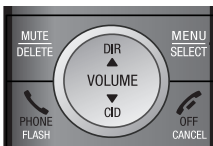

Main menu

- Play messages (page 40)
- Answering sys (page 34)
- Directory (page 27)
- Caller ID log (page 32)
- Intercom (page 20)
- Ringers (page 9)
- Set date/time (page 10)
- Settings (page 10)
- Website

The > symbol highlights a menu item.

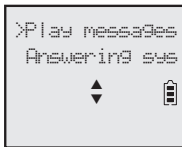

Using menus:

- Press **MENU/SELECT** to show the menu.
- Press **▼CID** or **▲DIR** to scroll through menu items.
- Press **MENU/SELECT** to confirm or save changes to a highlighted menu item.
- Press **OFF/CANCEL** to cancel an operation, back up to the previous menu, or exit the menu display.

Quick reference guide - telephone base

Large tilt display

Move the top of the display forward or backward to adjust the angle of the screen for maximum visibility.

IN USE indicator

On when the telephone is in use, or when the answering system is answering an incoming call.
On when a handset is being registered.
Flashes when there is an incoming call or when all handsets are being deregistered.
Flashes when another telephone is in use on the same line.



PTT

Press to initiate a one-to-one (page 24) or one-to-group broadcast (page 25).

Press and hold to broadcast to a group of system devices (page 25).

X/DELETE

While reviewing the caller ID history, the directory or the redial memory, press to delete an individual entry (page 32, page 28 and page 16 respectively).

During message or announcement playback, press to delete the playing message or announcement (page 41 and page 34 respectively).

Press twice to delete all old messages when the telephone is not in use (page 42).

/HANDSET LOCATOR

While the telephone is idle, press to page all handsets (page 19).

CANCEL

While in a menu, press to cancel an operation, back up to the previous menu or exit the menu display.

Press and hold to go back to idle mode.

When the telephone base is ringing, press to mute the ringer temporarily (page 15).

▼CID

Press to display the caller ID history when the telephone is not in use (page 32).

Press to scroll down while in menus and lists.

While entering names or numbers, press to move the cursor to the left.

MENU/SELECT

When the telephone base is not in use, press to show the menu.

While in the menu, press to confirm or save an entry or setting.

▲DIR

Press to display the directory when the telephone is not in use (page 28).

Press to scroll up while in menus and lists.

While entering names or numbers, press to move the cursor to the right.

REDIAL/PAUSE

Press repeatedly to view the last 10 numbers dialed (page 16).

While entering numbers, press and hold to insert a dialing pause.

Quick reference guide - telephone base



MIC
Microphone

⏻/ANSWER ON/OFF
Press to turn the built-in answering system on or off (page 35).
▶/■/PLAY/STOP
Press to start or stop message playback (page 40).
◀/REPEAT
During playback, press to repeat the playing message (page 41). During playback, press twice to play the previous message (page 41).
▶▶/SKIP
Press to skip a message (page 41).
🔊/EQ
During an outside call, intercom call, message or announcement playback, press to change the audio quality to best suit your hearing (page 16).
FLASH
During a call, press to answer an incoming call when you receive a call waiting alert (page 17).
▼/VOLUME/▲
During message playback or MIC screening, press to adjust the listening volume (page 41). While in idle mode, press to adjust the base ringer volume. When on a call, press to adjust the listening volume (page 16).
MUTE
During a call, press to mute the microphone (page 17). When the telephone is ringing, press to mute the ringer temporarily (page 15).
SPEAKER 🗣️
Press to make or answer a call using the speakerphone.

Main menu



The > symbol highlights a menu item.

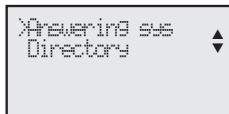

Main menu

- Answering sys (page 34)
- Directory (page 27)
- Caller ID log (page 32)
- Intercom (page 20)
- Ringers (page 9)
- Set date/time (page 10)
- Settings (page 10)
- Website

Using menus:

- Press **MENU/SELECT** to show the menu.
- Press **▼CID** or **▲DIR** to scroll through menu items.
- Press **MENU/SELECT** to confirm or save changes to a highlighted menu item.
- Press **CANCEL** to cancel an operation, back up to the previous menu, or exit the menu display.

Telephone base and charger installation

Install the telephone base and charger as shown below.

The telephone base is ready for tabletop use. If you want to change to wall mounting, see **Installation options** on page 7 for details.

Telephone base installation

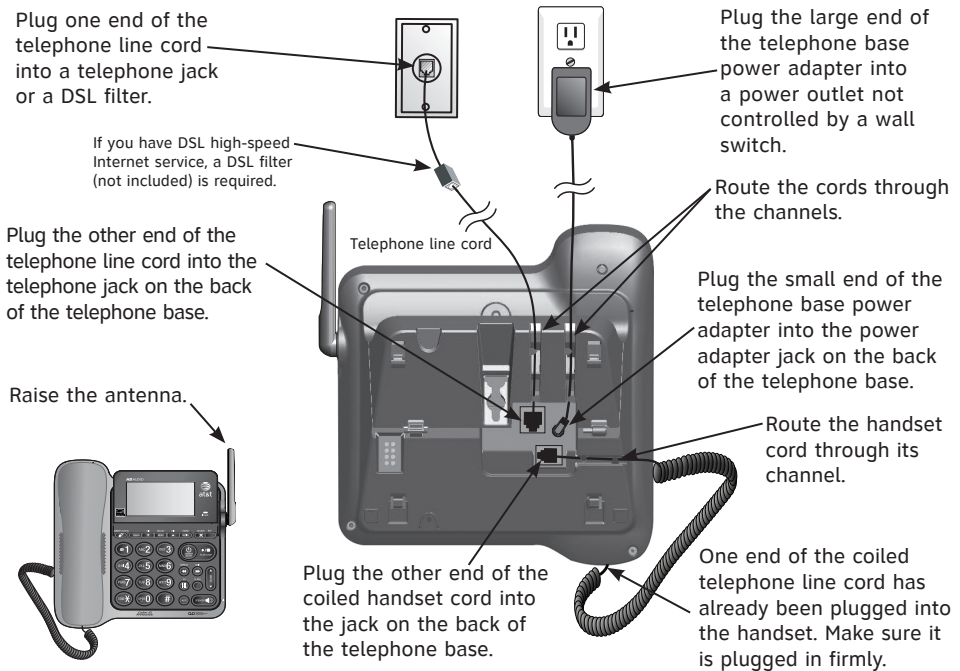

Charger installation

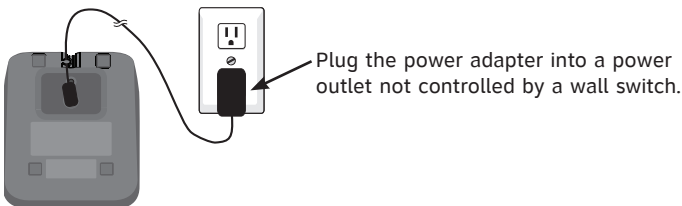

IMPORTANT INFORMATION



- Use only the power adapter(s) supplied with this product. To order a replacement power adapter, visit our website at **www.telephones.att.com** or call **1 (800) 222-3111**. In Canada, dial **1 (866) 288-4268**.

For more detailed instructions, refer to the online Complete user's manual at **www.telephones.att.com/manuals**.

- The power adapters are intended to be correctly oriented in a vertical or floor mount position. The prongs are not designed to hold the plug in place if it is plugged into a ceiling, under-the-table or cabinet outlet.

Battery installation and charging

Once you have installed the battery, the screen indicates the battery status (see the table below). For best performance, keep the handset in the charger when not in use. The battery is fully charged after 10 hours of continuous charging. See the table in the **Technical specifications** section on page 56 for battery operating times.

Battery indicators	Battery status	Action
The screen is blank, or shows Place in charger and  (flashing).	Battery has no or very little charge. The handset cannot be used.	Charge without interruption (at least 30 minutes).
The screen shows Low battery and  (flashing).	Battery has enough charge to be used for a short time.	Charge without interruption (at least 30 minutes).
The screen shows HANDESET X .	Battery is charged.	To keep the battery charged, place the handset in the charger when not in use.



Step 1

Plug the battery connector securely into the socket inside the handset battery compartment. Insert the supplied battery with the label **THIS SIDE UP** facing up as indicated.



Step 2

Align the cover flat against the battery compartment, then slide it upwards until it clicks into place.

CHARGE light

Step 3

Charge the handset by placing it face forward in the charger. The **CHARGE** light on the top of the handset is on during charging.



IMPORTANT INFORMATION

- Use only the supplied rechargeable battery or replacement battery (model BT166342). To order, visit our website at **www.telephones.att.com** or call **1 (800) 222-3111**. In Canada, dial **1 (866) 288-4268**. For more detailed instructions, refer to the online Complete user's manual at **www.telephones.att.com/manuals**.
- If you do not use the handset for a long time, disconnect and remove the battery to prevent possible leakage.

Installation options

The telephone base comes with a mount bracket set for tabletop use. If you want to mount your telephone on a wall, rotate the mount bracket down so the telephone can connect with a standard dual-stud telephone wall mounting plate. If you do not have this mounting plate, you can purchase one from many hardware or consumer electronics retailers. You might need a professional to install the mounting plate.

Tabletop to wall mount installation

To install the telephone base in the wall mount position, make sure that you first unplug the telephone line cord and power adapter from the telephone wall jack and power outlet. Make sure they are plugged into their jacks on the telephone base and routed through the channels.

1. Press the tabs indicated by the arrows. The bracket will detach from the telephone base. Rotate it down into wall mount position, making sure it clicks into place.

Rear view

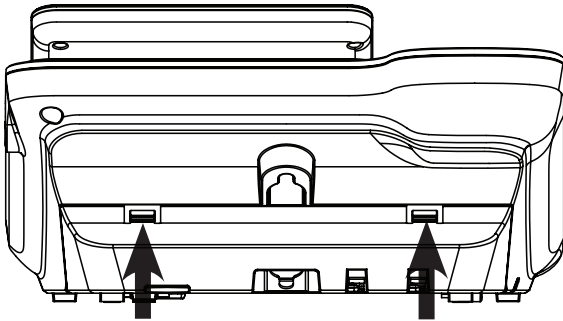

Side view

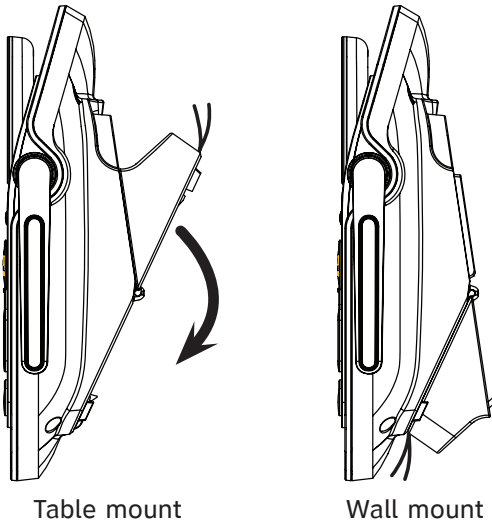
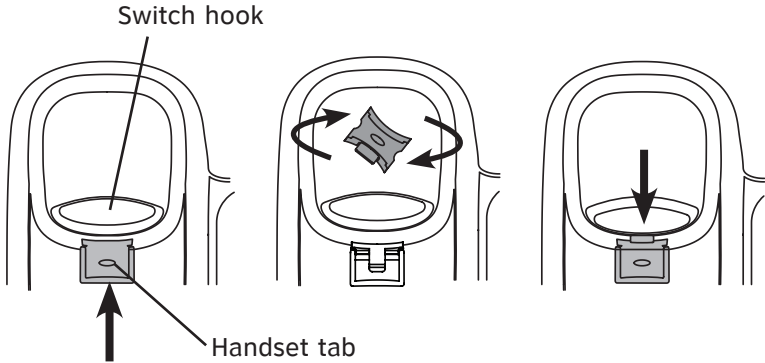

Table mount

Wall mount

Installation options

2. Press down the switch hook and slide the handset tab upward to remove it from the slot. Rotate the handset tab by 180 degrees. Press down the switch hook and then replace the handset tab to its slot. The protruding edge of the handset tab holds the corded handset in place when the telephone is mounted on the wall.



3. If necessary, bundle the telephone cord and power adapter cord, and secure them with twist ties. Plug the power adapter and telephone line into the wall outlets.

4. Align the mounting studs on the mounting plate with the mounting holes on the bracket and press the telephone base down until it clicks securely into place.

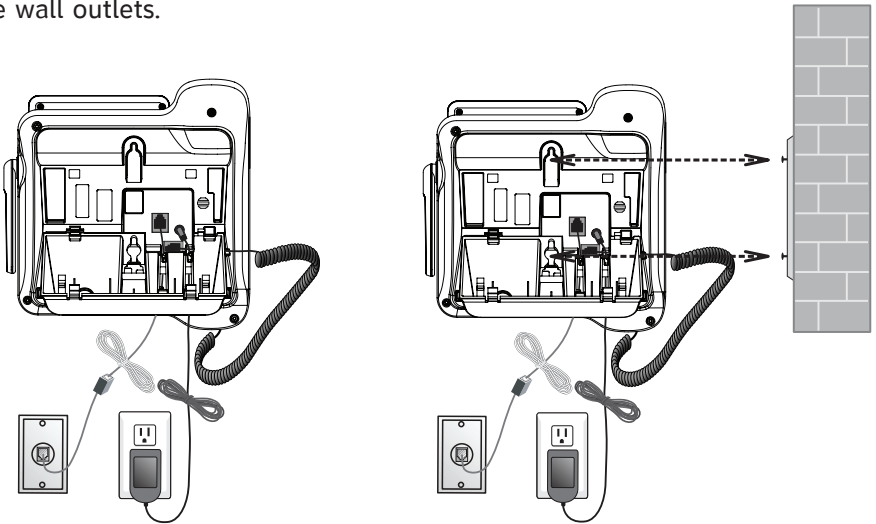

Handset and telephone base settings

Use the menu to change the telephone settings.

1. Press **MENU/SELECT** on the handset or telephone base when it is not in use to enter the main menu.
2. Press **▼CID** or **▲DIR** to scroll to the feature to be changed. When scrolling through the menu, the **>** symbol indicates the selected menu item.
3. Press **MENU/SELECT** to select the highlighted item.



NOTE: Press **OFF/CANCEL** to cancel an operation, back up to the previous menu or exit the menu display. Press and hold **OFF/CANCEL** to return to idle mode. On the telephone base, use **CANCEL** instead of **OFF/CANCEL**.

Ringer volume

You can set the ringer volume level to one of six levels or turn the ringer off.

On a cordless handset or the telephone base:

1. Press **MENU/SELECT** in idle mode to enter the main menu.
2. Use **▼CID** or **▲DIR** to scroll to **>Ringers**, then press **MENU/SELECT**.
3. Press **MENU/SELECT** again to select **>Ringer volume**.
4. Press **▼CID** or **▲DIR** to sample each volume level.
5. Press **MENU/SELECT** to save your preference.



NOTE: The handset ringer volume also determines the ringer volume for intercom calls.

Ringer tone

You can choose one of ten ringer tones.

On a cordless handset or the telephone base:

1. Press **MENU/SELECT** in idle mode to enter the main menu.
2. Use **▼CID** or **▲DIR** to scroll to **>Ringers**, then press **MENU/SELECT**.
3. Press **▼CID** or **▲DIR** to scroll to **>Ringer tone**, then press **MENU/SELECT**.
4. Press **▼CID** or **▲DIR** to sample each ringer tone.
5. Press **MENU/SELECT** to save your preference.



NOTE: If you turn off the ringer volume, you will not hear ringer tone samples.

Handset and telephone base settings

Set date/time

The answering system announces the day and time of each message prior to playing it. Before using the answering system, set the date and time as follows. If you subscribe to caller ID service, the day, month and time are set automatically with each incoming call. The year must be set so that the day of the week can be calculated from the caller ID information.

On a cordless handset or the telephone base:

1. When in idle mode, press **MENU/SELECT** to enter the main menu.
2. Press **▼CID** or **▲DIR** to scroll to **>Set date/time** and then press **MENU/SELECT**.
3. Enter the month using the dialing keys.
4. Enter the day using the dialing keys.
5. Enter the year using the dialing keys, then press **MENU/SELECT** to move on to set the time.
6. Enter the hour using the dialing keys.
7. Enter the minute using the dialing keys.
8. Press **▼CID** or **▲DIR** to highlight **AM** or **PM**, then press **MENU/SELECT** to confirm.



NOTE: If the clock is not set when a message is recorded, the system announces, "Time and day not set," before it plays the message.

LCD language

You can select the language used for all screen displays.

On a cordless handset or the telephone base:

1. Press **MENU/SELECT** in idle mode to enter the main menu.
2. Use **▼CID** or **▲DIR** to scroll to **>Settings**, then press **MENU/SELECT**.
3. Press **MENU/SELECT** to choose **>LCD language**.
4. Press **▼CID** or **▲DIR** to highlight **>English**, **>Français** or **>Español**, then press **MENU/SELECT**. The screen prompts **Set English/Français/Español as LCD language?**
5. Press **MENU/SELECT** to confirm.



NOTE: If you accidentally change the LCD language to French or Spanish, you can reset it back to English without going through the French or Spanish menus. Press **MENU/SELECT** once on the handset or telephone base, then enter **364#**. There is a confirmation tone.

Handset and telephone base settings

Voicemail (visual message waiting) indicator

If you subscribe to a voicemail service offered by your telephone service provider, **New voicemail** and the  icon appear on the telephone base and handset screens when you have new voicemail messages. Contact your service provider for more information and assistance about using your voicemail service.

Set speed dial voicemail number

This feature lets you save your voicemail number for quick access when you press and hold the  **1** key.

To save your voicemail number on a cordless handset or the telephone base:

1. Press **MENU/SELECT** in idle mode to enter the main menu.
2. Use **▼CID** or **▲DIR** to scroll to **>Settings**, then press **MENU/SELECT**.
3. Use **▼CID** or **▲DIR** to scroll to **>Voicemail #**, then press **MENU/SELECT**.
4. Use the dialing keys to enter the voicemail access number provided by your telephone service provider.
 - Press **▼CID** or **▲DIR** to move the cursor to the left or right.
 - Press **MUTE/DELETE** on a cordless handset or **X/DELETE** on the base to erase a digit.
 - Press and hold **MUTE/DELETE** on a cordless handset or **X/DELETE** on the base to erase all digits.
 - Press **REDIAL/PAUSE** to enter a three-second dialing pause (a **p** appears).
5. Press **MENU/SELECT** to save.

Handset and telephone base settings

Clear voicemail indicator

Use this feature when the telephone indicates there is new voicemail but there is none. For example, when you have accessed your voicemail while away from home. This feature only turns off the displayed **New voicemail** and the  icon; it does not delete your voicemail messages. As long as you have new voicemail messages, your telephone service provider continues to send the signal to turn on the indicator.

To manually turn off the new voicemail indicator on a cordless handset or the telephone base:

1. Press **MENU/SELECT** when in idle mode to enter the main menu.
2. Use **▼CID** or **▲DIR** to scroll to **>Settings**, then press **MENU/SELECT**.
3. Use **▼CID** or **▲DIR** to scroll to **>Clr voicemail**, then press **MENU/SELECT**.
The screen shows **Turn off indicator?**
4. Press **MENU/SELECT** again to turn the voicemail indicator off.



NOTE: For information about using your voicemail service, contact your telephone service provider.

Key tone

The handset is set to beep with each key press. You can adjust the key tone volume or turn it off.

To change the key tone setting on a cordless handset or the telephone base:

1. Press **MENU/SELECT** in idle mode to enter the main menu.
2. Use **▼CID** or **▲DIR** to scroll to **>Settings**, then press **MENU/SELECT**.
3. Use **▼CID** or **▲DIR** to scroll to **>Key tone**, then press **MENU/SELECT**.
4. Use **▼CID** or **▲DIR** to select the desired volume or **Off**.
5. Press **MENU/SELECT** to save your preference.

Handset and telephone base settings

Caller ID announce

The caller ID announce feature lets you know who's calling without having to look at the display.

To turn on or off the caller ID announce on a cordless handset or the telephone base:

1. Press **MENU/SELECT** in idle mode to enter the main menu.
2. Use **▼CID** or **▲DIR** to scroll to **>Settings**, then press **MENU/SELECT**.
3. Use **▼CID** or **▲DIR** to scroll to **>Caller ID annnc**, then press **MENU/SELECT**.
4. Use **▼CID** or **▲DIR** to scroll to the desired option, then press **MENU/SELECT**.
 - **Set all On/Off** - Change the setting for the base and all handsets.
 - **Local handset** - Change the setting for that handset only (when programming from a cordless handset only).
 - **Base** - Change the setting for the telephone base only.
5. Use **▼CID** or **▲DIR** to highlight **>On** or **>Off**, then press **MENU/SELECT**.



NOTES:

- To use the caller ID announce feature, you must subscribe to caller ID service from your telephone service provider.
- Pronunciation of names may vary with this feature. Not all names may be pronounced correctly.

Handset and telephone base settings

Home area code

If you dial seven digits to make a local call (no area code required), enter your area code into the telephone as the home area code. When you receive a call from within your home area code, the caller ID history only displays the seven digits of the telephone number.

This feature makes it easy for you to place a call from the caller ID log. If you dial 10 digits to make a local phone call, do not use this home area code feature. If you do, you cannot place local calls from your caller ID log, as they will have only seven digits.

To set the home area code on a cordless handset or the telephone base:

1. Press **MENU/SELECT** in idle mode to enter the main menu.
2. Use **▼CID** or **▲DIR** to scroll to **>Settings**, then press **MENU/SELECT**.
3. Use **▼CID** or **▲DIR** to scroll to **>Home area code**, then press **MENU/SELECT**. The screen briefly shows **Only for 7digit dial from CID**.
4. Use the dialing keys to enter a three-digit home area code.
 - To delete a digit, press **MUTE/DELETE** on a cordless handset or **X/DELETE** on the base.
 - To delete all digits, press and hold **MUTE/DELETE** on a cordless handset or **X/DELETE** on the base.
5. Press **MENU/SELECT** to save.



NOTE: If in the future, your telephone service provider requires you to dial 10 digits to make a local call (area code plus telephone number), you need to delete your home area code and dial out locally from the call ID log. With the home area code displayed, press and hold **MUTE/DELETE** on a cordless handset or **X/DELETE** on the telephone base until the digits are deleted, and then press **MENU/SELECT**. The home area code is restored to its default setting of **_ _ _** (empty).

Dial mode

The dial mode is preset to tone dialing. If you have pulse (rotary) service, you must change the dial mode to pulse dialing before using the telephone.

To set the dial mode on a cordless handset or the telephone base:

1. Press **MENU/SELECT** in idle mode to enter the main menu.
2. Use **▼CID** or **▲DIR** to scroll to **>Settings**, then press **MENU/SELECT**.
3. Use **▼CID** or **▲DIR** to scroll to **>Dial mode**, then press **MENU/SELECT**.
4. Use **▼CID** or **▲DIR** to highlight **>Tone** or **>Pulse**, then press **MENU/SELECT**.

Telephone operation

Making a call

Using a cordless handset:

- Press **\PHONE/FLASH** or **📞/SPEAKER**, then enter the telephone number.

Using the telephone base:

- Lift the corded handset or press **📞/SPEAKER**, then enter the telephone number.

Answering a call

Using a cordless handset:

- Press **\PHONE/FLASH** or **📞/SPEAKER**, or press any dialing key (**0-9, TONE X** or **#**).

Using the telephone base:

- Lift the corded handset, or press **📞/SPEAKER**, or press any dialing key (**0-9, TONE X** or **#**).

Ending a call

Using a cordless handset:

- Press **📞/OFF/CANCEL** or return the handset to the charger.

Using the telephone base:

- Return the corded handset to the telephone base, or press **📞/SPEAKER**.

Temporary ringer silencing

Using a cordless handset:

Press **📞/OFF/CANCEL** or **MUTE/DELETE** while the telephone is ringing to silence the ringer temporarily on that handset only. This turns off the ringer without disconnecting the call. The next incoming call rings normally at the preset volume.

Using the telephone base:

Press **CANCEL** or **MUTE** while the telephone is ringing to silence the ringer temporarily on the telephone base only. This turns off the ringer without disconnecting the call. The next incoming call rings normally at the preset volume.

Telephone operation

Handset speakerphone

During a call, press **📞/SPEAKER** to switch between handsfree speakerphone and normal handset use. Press **📞/OFF/CANCEL** to hang up.



NOTE: The speakerphone uses more power than the normal handset. If the handset battery becomes very low while you are using the speakerphone, the call remains in speakerphone mode until you hang up or the battery becomes depleted.

Last number redial

Each handset and the telephone base stores the last 10 telephone numbers dialed (up to 30 digits each).

Using a cordless handset or the telephone base:

- Press **REDIAL/PAUSE**, then press **▼CID**, **▲DIR** or **REDIAL/PAUSE** repeatedly to view up to 10 recently called numbers. To dial the displayed number on the handset, press **📞/PHONE/FLASH** or **📞/SPEAKER**. To dial the displayed number with the telephone base, lift the corded handset or press **📞/SPEAKER**.

Equalizer

The handset and base equalizers enable you to change the quality of the audio to best suit your hearing.

While on a call or intercom call, or listening to a message or announcement, press **EQ** on the cordless handset or base to select the equalizer setting **Treble 1**, **Treble 2**, **Bass** or **Natural** (the default setting). The current setting is shown on the handset or base screen for 2 seconds.

Volume control

Using a cordless handset:

While on a call, press **▼CID/VOLUME** to decrease or press **▲DIR/VOLUME** to increase the listening volume to one of six levels.

Using the telephone base:

While on a call, press **▼VOLUME** to decrease or **VOLUME▲** to increase the listening volume to one of eight levels.

Telephone operation

Call waiting

If you subscribe to call waiting service from your telephone service provider, you hear two beeps if someone calls while you are already on a call.

- Press **\PHONE/FLASH** on the cordless handset or **FLASH** on the telephone base to put your current call on hold and take the new call.
- Press **\PHONE/FLASH** on the cordless handset or **FLASH** on the telephone base at any time to switch back and forth between calls.

Mute

Use the mute function to turn off the microphone. You can hear the caller, but the caller cannot hear you.

While on a call, press **MUTE/DELETE** on the handset or **MUTE** on the telephone base to enable or disable the mute feature.

Options while on calls

Chain dialing

Use this feature to initiate a dialing sequence from the numbers in the directory, caller ID history or redial memory while you are on a call.

Using a cordless handset or the telephone base:

To access the directory or caller ID log while on a call:

1. Press **MENU/SELECT**.
2. Press **▼CID** or **▲DIR** to scroll to **>Directory** or **>Caller ID log**, and then press **MENU/SELECT**.
3. Press **▼CID** or **▲DIR** to scroll to the desired number.
4. Press **MENU/SELECT** to dial the number shown.

To access the redial list while on a call:

1. Press **REDIAL/PAUSE** to show the most recently dialed number.
2. Press **▼CID** or **▲DIR** to scroll to the desired number, or press **REDIAL/PAUSE** repeatedly to find the desired number. Then press **MENU/SELECT** to dial the number shown.

Options while on calls

Blind transfer

While on an outside call, you can transfer the call to a specific device or any device without notifying them.

To transfer an outside call from a handset:

1. During the call, press **MENU/SELECT**.
2. Press **MENU/SELECT** to choose **>Transfer**.
 - If you have one handset, the outside call is put on hold and your handset shows **Transferring call...** The telephone base rings and shows **Transfer from HANDSET**.
 - If you have more than one handset, your screen shows **TRANSFER TO:** Use the dialing keys to enter a specific device number (**0** for the telephone base, **1-9** for handsets 1-9, **TONE~~X~~** followed by **0-2** for handsets 10-12, or **TONE~~X~~** followed by **#** for all devices), or press **▼CID** or **▲DIR** to scroll to the desired device and press **MENU/SELECT**. The outside call is put on hold and your handset screen shows **Transferring call...** or **Transferring call to all...** The other device rings and shows **Transfer from HANDSET X** (**HANDSET** represents the handset name, **X** represents the handset number).
3. To answer the call on the destination handset, press **\PHONE/FLASH** or **📞/SPEAKER**. To answer the call on the telephone base, lift the corded handset or press **📞/SPEAKER**. The initiating handset shows **Call transferred** and goes to idle mode.

To transfer an outside call from the telephone base:

1. During the call, press **MENU/SELECT**.
2. Press **MENU/SELECT** to choose **>Transfer**.
 - If you have one handset, the outside call is put on hold and the telephone base shows **Transferring call...** The handset rings and shows **Transfer from BASE 0** (**BASE** represents the base name).
 - If you have more than one handset, the telephone base shows **TRANSFER TO:** Use the dialing keys to enter a specific handset number (**1-9** for handsets 1-9, **TONE~~X~~** followed by **0-2** for handsets 10-12, or **TONE~~X~~** followed by **#** for all handsets), or press **▼CID** or **▲DIR** to scroll to the desired handset and press **MENU/SELECT**. The outside call is put on hold and the telephone base shows **Transferring call...** or **Transferring call to all...** The other handset(s) rings and shows **Transfer from BASE 0** (**BASE** represents the base name).
3. To answer the call on the destination handset, press **\PHONE/FLASH** or **📞/SPEAKER**. The telephone base shows **Call transferred** and goes to idle mode.

Multiple handset use

Handset locator

The handset locator feature is useful if you misplace any handsets.





To start the paging tone:

- Press /**HANDSET LOCATOR** on the telephone base to start the paging tone on all handsets for 60 seconds.







NOTE: If you press  **OFF/CANCEL** or **MUTE/DELETE** on a handset, the ringer of that handset stops, but the paging to the rest of the handsets continues.

To stop the paging tone:

- Press  **PHONE/FLASH**,  **SPEAKER**, or any dialing key (**0-9**, **TONE**  or **#**) on the handset(s).
- OR-
- Press /**HANDSET LOCATOR**, **MUTE** or **CANCEL** on the telephone base.

Join a call in progress

When a handset or the telephone base is already on a call and you would like to join the call, press  **PHONE/FLASH** or  **SPEAKER** on your handset or  **SPEAKER** on your telephone base.

To end the call using a handset, press  **OFF/CANCEL** or place the handset in the charger. To end the call using the telephone base, press  **SPEAKER**. The call does not end until all handsets and the telephone base hang up.



NOTE: You can use up to four system handsets and the telephone base at the same time on an outside call.

Intercom

Use the intercom feature for conversations between two handsets, or a handset and the telephone base. You can buy additional expansion handsets (model AT&T CL80111) for this telephone base to expand your telephone system (up to 12 handsets).

Using a cordless handset:

1. Press **MENU/SELECT** in idle mode to enter the main menu. Press **▼CID** or **▲DIR** to scroll to **>Intercom**, then press **MENU/SELECT**.
 - If you have one handset, the handset shows **Calling base**.
 - If you have more than one handset, the handset shows **INTERCOM TO:** Press **▼CID** or **▲DIR** to scroll to the desired device and press **MENU/SELECT**. Your handset screen shows **Calling HANDSET X**, **Calling BASE 0** or **Calling all devices**.

The destination device(s) rings and shows **HANDSET is calling**, **HANDSET X is calling** or **HANDSET X is calling all** (**HANDSET** represents the handset name, **X** represents the handset number).

2. To answer the intercom call, press **PHONE/FLASH**, **📞/SPEAKER** or any dialing key (**0-9**, **TONEX**, or **#**) on the called cordless handset. Or on the called telephone base, press **📞/SPEAKER** or any dialing key (**0-9**, **TONEX**, or **#**), or lift the corded handset. Both devices now show **Intercom**.
3. To end the intercom call, one party presses **OFF/CANCEL** or places the cordless handset back in the charger, presses **CANCEL** on the telephone base, or hangs up the corded handset. **The other party hears four beeps.** Both devices display **Intercom ended**.

Intercom

Using the telephone base:

1. Press **MENU/SELECT** in idle mode to enter the main menu. Press **▼CID** or **▲DIR** to scroll to **>Intercom**, then press **MENU/SELECT**.
 - If you have one handset, the telephone base shows **Calling HANDSET X**.
 - If you have more than one handset, the telephone base shows **INTERCOM TO:** Press **▼CID** or **▲DIR** to scroll to the desired handset and press **MENU/SELECT**. The telephone base shows **Calling HANDSET X** or **Calling all handsets**.

The destination handset(s) rings and shows **Base is calling, BASE 0 is calling** or **BASE 0 is calling all**.
2. To answer the intercom call, press **☎PHONE/FLASH**, **🔊SPEAKER** or any dialing key (**0-9**, **TONEX**, or **#**) on the destination handset. Both the base and the handset now show **Intercom**.
3. To end the intercom call, one party presses **🔌OFF/CANCEL** or places the cordless handset back in the charger, presses **CANCEL** on the telephone base, or hangs up the corded handset. **The other party hears four beeps**. Both devices display **Intercom ended**.

Answer an incoming call during an intercom call

If you receive an outside call during an intercom call, there is a two-beep call waiting tone.

- To answer the call, press **☎PHONE/FLASH** on the cordless handset. Or on the telephone base, lift the corded handset or press **🔊SPEAKER**. The intercom call ends automatically. The party on the intercom call hears four beeps. Other system devices can also answer the incoming call by pressing **☎PHONE/FLASH** or **🔊SPEAKER** on the handset, or pressing **🔊SPEAKER** or lifting the corded handset on the telephone base.
- To end the intercom call without answering the incoming call, press **🔌OFF/CANCEL** on the handset or **CANCEL** on the telephone base; or return the corded handset back to the telephone base.

Call transfer using intercom

Use the intercom feature to transfer an outside call to another system handset or the telephone base. You can also share an outside call with another system handset or the telephone base.

To transfer or share an outside call using intercom:

Using a cordless handset:

1. During the call, press **MENU/SELECT**.
2. Press **▼CID** or **▲DIR** to scroll to **>Intercom** and press **MENU/SELECT**.
3. Press **▼CID** or **▲DIR** to scroll to the desired device and press **MENU/SELECT**.
4. When the destination device picks up, your handset shows **Intercom** and the outside call is put on hold. Then you have the following options:
 - You can transfer the call. Press **MENU/SELECT** twice to choose **>Transfer**. The handset shows **Call transferred**. The other device automatically connects to the outside call.
 - You can let the other device join you on the outside call in a three-way conversation. Press **MENU/SELECT**. Press **▼CID** or **▲DIR** to highlight **>Share call**, then press **MENU/SELECT**.
 - You can end the intercom call and continue the outside call with your handset. Press **☎PHONE/FLASH** on your handset (the ended intercom call party hears four beeps).

Using the telephone base:

1. During the call, press **MENU/SELECT**.
2. Press **▼CID** or **▲DIR** to scroll to **>Intercom** and press **MENU/SELECT**.
3. Press **▼CID** or **▲DIR** to scroll to the desired handset and press **MENU/SELECT**.
4. When the destination handset(s) picks up, the telephone base shows **Intercom** and the outside call is put on hold. Then you have the following options:
 - You can transfer the call. Press **MENU/SELECT** twice to choose **>Transfer**. The telephone base shows **Call transferred**. The other handset automatically connects to the outside call.
 - You can let the other handset join you on the outside call in a three-way conversation. Press **MENU/SELECT**. Press **▼CID** or **▲DIR** to highlight **>Share call**, then press **MENU/SELECT**.
 - You can end the intercom call and continue the outside call with the telephone base. Press **CANCEL** on the telephone base (the ended intercom call party hears four beeps).

Push-to-talk (PTT)

You can directly broadcast messages to the speakerphone of any device. Press and hold **PUSH TO TALK** on a handset or **PTT** on the telephone base to begin two-way communication.

- Only one device can talk at a time. While talking to another device, press and hold **PUSH TO TALK** on the handset or **PTT** on the telephone base.
- You must release **PUSH TO TALK** on the handset or **PTT** on the telephone base, so the other person can respond.
- Only one PTT session can be active at a time.
- While PTT is in use between two devices, other devices cannot use the intercom feature but can access the answering system.
- When you attempt to place a PTT call to another device which is accessing the answering system or on an intercom call or outside call, your device screen shows **Not available at this time**.

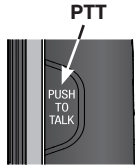

Turn PTT on or off

Using a cordless handset or the telephone base:

1. Press **PUSH TO TALK** on the handset or **PTT** on the base when in idle mode. The **PUSH TO TALK** menu displays.
2. Press **▼CID** or **▲DIR** to highlight **>PTT On/Off**, then press **MENU/SELECT**.
3. Press **▼CID** or **▲DIR** to choose **>On** or **>Off**, then press **MENU/SELECT**.

PTT call to a single device

Using a cordless handset:

1. When the handset is not in use:
 - If you have one handset, press and hold **PUSH TO TALK**.
 - If you have more than one handset. Press **PUSH TO TALK** on the handset. Press **▼CID** or **▲DIR** to highlight the destination device number. Then press **MENU/SELECT** or **PUSH TO TALK**.

The handset shows **Connecting to HANDSET X...** (**HANDSET** represents the handset name, **X** represents the destination handset number) or **Connecting to BASE 0...** (**BASE** represents the base name) for a few seconds. When the connection is made, both your and the destination device screens display **Press and hold [PTT] to talk**.

2. Press and hold **PUSH TO TALK**. A chirp indicates your microphone is on. Speak towards the device. Your voice is broadcast to the destination device. While you speak, your handset shows **PTT To handset: X** or **PTT To base**.

Push-to-talk (PTT)

3. Release **PUSH TO TALK** after speaking. Both devices beep once again and the screens show **Press and hold [PTT] to talk**. Then you can press and hold **PUSH TO TALK** to continue speaking or the destination device can respond (see **Answer a PTT call** on page 26).
4. To end the PTT call, press  **OFF/CANCEL** or place the handset in the charger. The handset shows **Push to talk Ended** for a few seconds.

Using the telephone base:

1. When the telephone base is not in use:
 - If you have one handset, press and hold **PTT**.
 - If you have more than one handset, press **PTT**. Then use the dialing keys to enter the destination handset number.

The telephone base shows **Connecting to HANDSET X... (HANDSET** represents the handset name, **X** represents the destination handset number) for a few seconds. When the connection is made, both the telephone base and destination handset display **Press and hold [PTT] to talk**.

2. Press and hold **PTT**. A chirp indicates your microphone is on. **Speak** towards the telephone base. Your voice is broadcast to the destination handset. While you are speaking, the telephone base shows **PTT To handset: X**.
3. Release **PTT** after speaking. Both devices beep once again and the screens show **Press and hold [PTT] to talk**. Then you can press and hold **PTT** to continue speaking or the destination device can respond (see **Answer a PTT call** on page 26).
4. To end the PTT call, press **CANCEL**. The telephone base shows **Push to talk Ended** for a few seconds.

Push-to-talk (PTT)

PTT call to group

When there are multiple handsets registered to the phone system, PTT supports one-to-group calls. PTT supports a maximum of one-to-five calls when one to five handsets are registered, and a maximum of one-to-four calls when six or more handsets are registered. The first four registered handsets will be eligible to use this feature. Other handsets can only use PTT for one-to-one calls.

To call a group of devices:

Using a cordless handset:

1. You have three ways to call multiple devices. When the handset is not in use:
 - Press and hold **PUSH TO TALK** until the handset shows **Connecting to group...**
 - Press **PUSH TO TALK**. Press **▼CID** or **▲DIR** to choose **Group**. Press **MENU/SELECT** or press **PUSH TO TALK** then your handset shows **Connecting to group...**
 - Press **PUSH TO TALK**. Press **TONEX** followed by **#** (pound key). The handset shows **Connecting to group...**

When the connection is made, both the caller and the destination parties hear a beep. The speakerphones on all other devices automatically activate.

2. You need to press and hold **PUSH TO TALK** when you want to speak. Speak towards the handset. Your voice is broadcast to all devices.
3. Release **PUSH TO TALK** after speaking.
4. Any extension can reply (see **Answer a PTT call** on page 46).

Using the telephone base:

1. You have three ways to call multiple handsets. When the telephone base is not in use:
 - Press and hold **PTT** until the screen shows **Connecting to group...**
 - Press **PTT**. Press **▼CID** or **▲DIR** to choose **Group**. Press **MENU/SELECT** or press **PTT** then the telephone base shows **Connecting to group...**
 - Press **PTT**. Press **TONEX** followed by **#** (pound key). The screen shows **Connecting to group...**

When the connection is made, both the caller and the destination parties hear a beep. The speakerphones on all other devices automatically activate.

2. You need to press and hold **PTT** when you want to speak. Speak towards the telephone base. Your voice is broadcast to all devices.
3. Release **PTT** after speaking.
4. Any extension can reply (see **Answer a PTT call** on page 26).

Push-to-talk (PTT)

Answer a PTT call

You can respond to a PTT call as described below.

1. When your device receives a PTT call, it beeps and shows **Press and hold [PTT] to talk**.
2. When the other party is speaking, your speakerphone light is on, and your device shows:
 - **PTT From HS X To HS X** (the first **X** represents the initiating handset number, and the second **X** represents your handset number; a maximum of four handset numbers appear).

-OR-

 - **PTT From HS X To Base** (**X** represents the initiating handset number), or **PTT From HS X To Base & HS X** (the first **X** represents the initiating handset number, and the second **X** represents your handset number; a maximum of four handset numbers appear).

-OR-

 - **PTT From Base To HS X** (the **X** represents your handset number; a maximum of five handset numbers appear).
3. When your speakerphone light is off (the screen shows **Press and hold [PTT] to talk**), press and hold **PUSH TO TALK** on your handset or **PTT** on your telephone base. You will hear a chirp. Speak towards the device.
 - While you are speaking, your device shows **PTT To Handset: X** (**X** represents the handset numbers of one or more destination handsets; a maximum of five handset numbers appear) or **PTT To Base & Handset: X** (**X** represents the handset numbers of one or more destination handsets; a maximum of four handset numbers appear).
 - Your voice is broadcast to all destination devices.

After speaking, release **PUSH TO TALK** on your handset or **PTT** on your telephone base. Your device will beep. After the beep, if your speakerphone light is off, you can press and hold **PUSH TO TALK** on your handset or **PTT** on your telephone base to continue speaking, or the destination device can respond.

Directory

The directory can store up to 50 entries which are shared by all handsets and the telephone base. Changes made to the directory from any device apply to all.

Create a new directory entry

Using a cordless handset or the telephone base:

1. Press **MENU/SELECT** in idle mode to enter the main menu.
2. Press **▼CID** or **▲DIR** to scroll to **>Directory**, then press **MENU/SELECT**.
3. Press **▼CID** or **▲DIR** to scroll to **>Add contact**, then press **MENU/SELECT**.
4. Use the dialing keys to enter a telephone number (up to 30 digits) when prompted.
 - Press **▼CID** or **▲DIR** to move the cursor to the left or right.
 - Press **MUTE/DELETE** on the handset or **X/DELETE** on the telephone base to erase a digit.
 - Press and hold **MUTE/DELETE** on the handset or **X/DELETE** on the telephone base to erase all digits.
 - Press and hold **REDIAL/PAUSE** to enter a three-second dialing pause (a **p** appears).

-OR-

Copy a number from the redial list by pressing **REDIAL/PAUSE** repeatedly to locate the number. Press **MENU/SELECT** to copy the number.

5. Press **MENU/SELECT** to move on to the name.
6. Use the dialing keys to enter a name (up to 15 characters) when prompted. Each time you press a key, the character on that key appears. Additional key presses produce other characters on that key. See the chart below.
 - Press **▼CID** or **▲DIR** to move the cursor to the left or right.
 - Press **0** to add a space.
 - Press **MUTE/DELETE** on the handset or **X/DELETE** on the telephone base to erase a character.
 - Press and hold **MUTE/DELETE** on the handset or **X/DELETE** on the telephone base to erase all characters.
7. Press **MENU/SELECT** to store your new directory entry.

Directory

Review directory entries

Press **▲DIR** on the cordless handset or telephone base when in idle mode. The summary screen shows briefly and then the first entry in the directory shows. Press **▼CID** or **▲DIR** to browse through the directory.

Search by name

Using a cordless handset or the telephone base:

1. Press **▲DIR** in idle mode to show the first listing in the directory.
2. When an entry appears, press the dialing keys (**0-9**) to start a name search. The directory shows the first name beginning with the first letter associated with the dialing key if there is an entry in the directory beginning with that letter. Press **▼CID** or **▲DIR** to scroll through the directory.
3. To see other names starting with the letters on the same dialing key, keep pressing the key. The names appear in alphabetical order.

Display dial

To dial a displayed number from the directory:

Press **\PHONE/FLASH** or **📞/SPEAKER** on the handset.

-OR-

On the telephone base, lift the corded handset or press **📞/SPEAKER**.

Delete a directory entry

Using a cordless handset or the telephone base:

To delete the displayed directory entry, press **MUTE/DELETE** on the handset or **X/DELETE** on the telephone base. Press **MENU/SELECT** to confirm. You cannot retrieve a deleted entry.

Edit a directory entry

Using a cordless handset or the telephone base:

1. When a directory entry displays, press **MENU/SELECT**. The screen shows **EDIT NUMBER** along with the phone number to be edited. If you only want to edit the name, skip to Step 3.
2. To edit the number:
 - Press the dialing keys to add digits.
 - Press **▼CID** or **▲DIR** to move the cursor to the left or right.
 - Press **MUTE/DELETE** on the handset or **X/DELETE** on the telephone base to erase a digit.
 - Press and hold **MUTE/DELETE** on the handset or **X/DELETE** on the telephone base to erase all digits.
 - Press and hold **REDIAL/PAUSE** to add a three-second dialing pause (a **p** appears).
3. Press **MENU/SELECT** to move on to the name. The screen shows **EDIT NAME** along with the name to be edited.
4. To edit the name:
 - Press the dialing keys to add characters.
 - Press **▼CID** or **▲DIR** to move the cursor to the left or right.
 - Press **MUTE/DELETE** on the handset or **X/DELETE** on the telephone base to erase a character.
 - Press and hold **MUTE/DELETE** on your handset or **X/DELETE** on your telephone base to erase all characters.
5. Press **MENU/SELECT** to save.

Speed dial

The telephone system has 10 speed dial locations (**2-9** and **0**, location **1** is reserved for voicemail) where you can store the telephone numbers you wish to dial more quickly. You can store up to 30 digits in each location. Speed dial assignments can only be selected from the existing directory entries, with the exception of **1**, which must be manually entered. In the directory, speed dial locations except for **1** are indicated by their number in the bottom right hand corner of the entry.

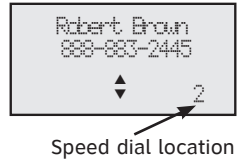

Assign a speed dial number

Using a cordless handset or the telephone base:

1. When the telephone is idle, press **MENU/SELECT**.
2. Press **▼CID** or **▲DIR** to scroll to **>Directory**. Press **MENU/SELECT**.
3. Press **▼CID** or **▲DIR** to scroll to **>Speed dial**. Press **MENU/SELECT**.
4. Press **▼CID** or **▲DIR** to choose your desired speed dial location (**2-9, 0**), then press **MENU/SELECT**. The screen briefly shows **Copy from Directory...** then displays the directory list.
5. Press **▼CID** or **▲DIR** to scroll to the phone number you wish to assign to the selected speed dial location.
6. Press **MENU/SELECT** to save the setting and return to the previous menu.

-OR-

1. When the telephone is idle, press and hold a dialing key (**2-9, 0**).
2. Press **▼CID** or **▲DIR** to choose your desired speed dial location (**2-9, 0**), then press **MENU/SELECT**. The screen briefly shows **Copy from Directory...** then displays the directory list.
3. Press **▼CID** or **▲DIR** to scroll to the phone number you wish to assign to the selected speed dial location.
4. Press **MENU/SELECT** to save the setting and return to the previous menu.

Assign your speed dial voicemail number

Using a cordless handset or the telephone base:

See the **Set speed dial voicemail number** section on page 11 for instructions on assigning your speed dial voicemail number.

Speed dial

Make a call using speed dial

Using a cordless handset or the telephone base:

When in idle mode, press and hold the dialing key (**2-9, 0**) corresponding to the assigned location you wish to call.

-OR-

1. Press **MENU/SELECT** when in idle mode.
2. Press **▼CID** or **▲DIR** to scroll to **>Directory**, then press **MENU/SELECT**.
3. Press **▼CID** or **▲DIR** to scroll to **>Speed dial**, then press **MENU/SELECT**.
4. Press **▼CID** or **▲DIR** to scroll to the desired location and then press **☎/PHONE/FLASH** or **🔊/SPEAKER** on the cordless handset, or press **🔊/SPEAKER** or lift the corded handset on the telephone base.

Check your voicemail using speed dial

Using a cordless handset or the telephone base:

Press and hold the **☑ 1** key on a cordless handset or the telephone base to dial your voicemail number. If you are using the telephone base, the speakerphone is used to dial out. You may switch to corded handset mode by picking up the corded handset.

Caller ID

This product supports caller ID services offered by most telephone service providers. The telephone stores caller ID information about the last 50 incoming calls in the telephone base. This information is common to all handsets and the base.

Information about caller ID with call waiting

Caller ID with call waiting lets you see the name and telephone number of the caller before answering the call, even while on another call.

There are fees for caller ID services. In addition, services may not be available in all areas. Contact your telephone service provider for more information about caller ID services.

Missed (new) call indicator

When a handset or the telephone base is in idle mode and has new or missed calls, its screen shows **XX Missed calls**.

If you do not want to review the missed calls one by one, but still want to keep them in the caller ID history, you can make the missed calls message go away. Press and hold **OFF/CANCEL** on the handset for four seconds when the handset is idle, or press and hold **CANCEL** on the telephone base for four seconds when the telephone base is idle.

Review the caller ID history

Review the caller ID history to find out who called, to return the call, or to copy the caller's name and number into your directory. **Caller ID log empty** appears if there are no records in the caller ID log.

Using a cordless handset or the telephone base:

1. When the handset or the telephone base is in idle mode, press **▼CID** to review the caller ID history in reverse chronological order starting with the most recent call. Press **▼CID** or **▲DIR** to scroll through the list.



NOTE: Only one handset or the telephone base can review the caller ID history at a time. If another device tries to enter the directory or caller ID history, it shows **Not available at this time**.

View dialing options

While reviewing the caller ID log, press **#** (pound key) repeatedly to show different dialing options for local and long distance numbers before dialing or saving the telephone number in the directory.

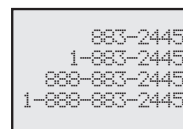

Press **#**

Caller ID

Press **1** repeatedly if you need to add or remove 1 in front of the telephone number before dialing or saving it in the directory. When the number is in the correct format for dialing, call the number by pressing

PHONE/FLASH or **SPEAKER** on the cordless handset, or by pressing **SPEAKER** or lifting the corded handset on the telephone base.

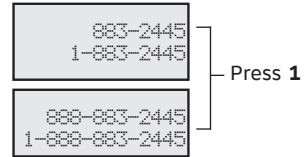

Dial a caller ID log entry

1. When in the caller ID log, press **▼CID** or **▲DIR** to browse.
2. Press **PHONE/FLASH** or **SPEAKER** on the cordless handset, or press **SPEAKER** or lift the corded handset on the telephone base to dial the displayed entry.

Save a caller ID log entry to the directory

Using a cordless handset or the telephone base:

1. When in the caller ID log, press **▼CID** or **▲DIR** to browse.
2. Press **MENU/SELECT** to select an entry.
3. When the screen displays **EDIT NUMBER**, use the dialing keys to edit the number.
 - Press **▼CID** or **▲DIR** to move the cursor to the left or right.
 - Press **MUTE/DELETE** on the handset or **X/DELETE** on the telephone base to backspace and erase a digit.
 - Press and hold **MUTE/DELETE** on the handset or **X/DELETE** on the telephone base to erase the entire entry.
 - Press and hold **REDIAL/PAUSE** to insert a three-second dialing pause (a **p** appears).
4. Press **MENU/SELECT** to move to the name.
5. When the screen displays **EDIT NAME**, use the dialing keys to edit the name.
 - Press **▼CID** or **▲DIR** to move the cursor to the left or right.
 - Press **MUTE/DELETE** on the handset or **X/DELETE** on the telephone base to erase a character.
 - Press and hold **MUTE/DELETE** on the handset or **X/DELETE** on the telephone base to erase all characters.
 - Press **#** (pound key) to move the last word to the front. For example, Johnson Charlie becomes **Charlie Johnson** when you press **#** (pound key).
6. Press **MENU/SELECT** when done. The screen shows **Saved**.



NOTES:

- You may need to change how a caller ID number is dialed if the entry does not appear in the correct format. Caller ID numbers may appear with an area code that may not be necessary for local calls, or without a 1 that may be necessary for long distance calls (see **View dialing options** on the previous page).

Answering system settings

Use the answering system menu of a system handset or the telephone base to set up the announcement message, turn on or off the answering system or message alert tone, activate call screening, or change the number of rings, remote access code or message recording time.

Announcement

Your outgoing announcement plays when calls are answered by the answering system.

The telephone has a default outgoing announcement, *"Hello. Please leave a message after the tone."* You can use this announcement, or record your own.

To record a new outgoing announcement:

Using a cordless handset or the telephone base:

1. When the handset is in idle mode, press **MENU/SELECT** to enter the main menu.
2. Press **▼CID** or **▲DIR** to scroll to **>Answering sys**, then press **MENU/SELECT**.
3. Press **MENU/SELECT** again to select **>Announcement**.
4. Press **▼CID** or **▲DIR** to scroll to **>Record annc** and press **MENU/SELECT**.
The system announces, *"Record after the tone. Press 5 when you are done."*
5. Speak towards the handset or telephone base to record your announcement.
Press **5** to end recording. Your recorded announcement plays.

To listen to the recorded announcement again, scroll to **>Play annc** and press **MENU/SELECT**.

To delete your outgoing announcement:

Using a cordless handset or the telephone base:

1. When the handset is in idle mode, press **MENU/SELECT** to enter the main menu.
2. Press **▼CID** or **▲DIR** to scroll to **>Answering sys**, then press **MENU/SELECT**.
3. Press **MENU/SELECT** again to select **>Announcement**.
4. Press **MENU/SELECT** again to select **>Play annc** and play the announcement.
5. While the announcement is playing, press **MUTE/DELETE** on the handset or **X/DELETE** on the base to delete the announcement. The system announces, *"Announcement deleted"*.

When your announcement is deleted, the system answers calls with the default announcement described above. You cannot delete the default announcement.

Answering system settings

Answer on/off

By default, the answering system is on and ready to record messages. If you turn the answering system off, it does not answer calls and record messages.

To turn the answering system on or off:

Using a cordless handset:

1. When the handset is in idle mode, press **MENU/SELECT** to enter the main menu.
2. Press **▼CID** or **▲DIR** to scroll to **>Answering sys**, then press **MENU/SELECT**.
3. Press **▼CID** or **▲DIR** to scroll to **>Answer ON/OFF**, then press **MENU/SELECT**.
4. Press **▼CID** or **▲DIR** to highlight **>On** or **>Off**, then press **MENU/SELECT** to save the setting.

When the answering system is on, the handset shows **ANS ON**.

Using the telephone base:

- Press **⏻/ANSWER ON** to turn the answering system on or off. If the answering system is turned on, it announces, *"Calls will be answered."* If the answering system is turned off, it announces, *"Calls will not be answered."*



Call screening

Use this feature to choose whether incoming messages can be heard over the speaker when they are being recorded. If you turn call screening on, you hear the incoming message. While monitoring an incoming message, you can answer the call by pressing **☎/PHONE/FLASH** or **🔊/SPEAKER** on a cordless handset, or pressing **🔊/SPEAKER** or lifting the corded handset on the telephone base.

To change the setting:

Using a cordless handset or the telephone base:

1. When the handset or telephone base is in idle mode, press **MENU/SELECT** to enter the main menu.
2. Press **▼CID** or **▲DIR** to scroll to **>Answering sys**, then press **MENU/SELECT**.
3. Press **▼CID** or **▲DIR** to scroll to **>Ans sys setup**, then press **MENU/SELECT**.
4. Press **MENU/SELECT** to select **>Call screening**.
5. Press **▼CID** or **▲DIR** to choose **>On** or **>Off**.
6. Press **MENU/SELECT** to save the setting.

Answering system settings

Number of rings

You can set the answering system to answer an incoming call after two, three, four, five or six rings. You can also select toll saver. If toll saver is selected, the answering system answers a call after two rings when you have new messages, or after four rings when there are no new messages. By default, the answering system answers an incoming call after four rings.

To set the number of rings:

Using a cordless handset or the telephone base:

1. When the handset or telephone base is in idle mode, press **MENU/SELECT** to enter the main menu.
2. Press **▼CID** or **▲DIR** to scroll to **>Answering sys**, then press **MENU/SELECT**.
3. Press **▼CID** or **▲DIR** to scroll to **>Ans sys setup**, then press **MENU/SELECT**.
4. Press **▼CID** or **▲DIR** to scroll to **># of rings**, then press **MENU/SELECT**.
5. Press **▼CID** or **▲DIR** to choose among **>2**, **>3**, **>4**, **>5**, **>6** or **>Toll saver**.
6. Press **MENU/SELECT** to save the setting.

Remote access code

To access your answering system remotely from any touch-tone phone, you need to enter a two-digit number (00-99). By default, the remote access code is **19**.

To change the remote access code:

Using a cordless handset or the telephone base:

1. When the handset or telephone base is in idle mode, press **MENU/SELECT** to enter the main menu.
2. Press **▼CID** or **▲DIR** to scroll to **>Answering sys**, then press **MENU/SELECT**.
3. Press **▼CID** or **▲DIR** to scroll to **>Ans sys setup**, then press **MENU/SELECT**.
4. Press **▼CID** or **▲DIR** to scroll to **>Remote code**, then press **MENU/SELECT**.
5. Use the dialing keys to enter a 2-digit number. To backspace and delete a digit, press **MUTE/DELETE** on the handset or **X/DELETE** on the telephone base.
6. Press **MENU/SELECT** to save the setting.

Answering system settings

Message alert tone

When the message alert tone is set to **On**, and there is at least one new message, the telephone base beeps every 10 seconds. By default, the message alert tone is set to off.

There is no audible alert at the handset.

Using a cordless handset or the telephone base:

1. When the handset or telephone base is in idle mode, press **MENU/SELECT** to enter the main menu.
2. Press **▼CID** or **▲DIR** to scroll to **>Answering sys**, then press **MENU/SELECT**.
3. Press **▼CID** or **▲DIR** to scroll to **>Ans sys setup**, then press **MENU/SELECT**.
4. Press **▼CID** or **▲DIR** to scroll to **>Msg alert tone**, then press **MENU/SELECT**.
5. Press **▼CID** or **▲DIR** to choose **>On** or **>Off**.
6. Press **MENU/SELECT** to save the setting.

Message recording time

You can set the recording time allowed for incoming messages. The message length is three minutes by default.

Using a cordless handset or the telephone base:

1. When the handset or telephone base is in idle mode, press **MENU/SELECT** to enter the main menu.
2. Press **▼CID** or **▲DIR** to scroll to **>Answering sys**, then press **MENU/SELECT**.
3. Press **▼CID** or **▲DIR** to scroll to **>Ans sys setup**, then press **MENU/SELECT**.
4. Press **▼CID** or **▲DIR** to scroll to **>Recording time**, then press **MENU/SELECT**.
5. Press **▼CID** or **▲DIR** to choose **>3 minutes**, **>2 minutes** or **>1 minute**, then press **MENU/SELECT** to save the setting.

About the answering system

Answering system and voicemail indicators

Your telephone has separate indicators for two different types of voice messages: those left on its built-in digital answering system and those left at your telephone service provider's voicemail (fees may apply). Your telephone's built-in digital answering system messages and voicemail messages are separate. Each alerts you to new messages differently.

- If **OO** and **XX New messages** show on the handset, and **XX New messages** shows and **▶/■/PLAY/STOP** flashes on the telephone base, there are new messages in the built-in answering system. To listen to messages recorded on your digital answering system, press **▶/■/PLAY/STOP** on the telephone base (page 40).
- If **✉** and **New voicemail** display on the handset and the telephone base, your telephone service provider is indicating that it has new voicemail for you. To listen to your voicemail, you typically dial an access number provided by your telephone service provider, followed by a security code or PIN.



Some telephone service providers bundle or combine multiple services like voicemail and call waiting, so you may not be aware that you have voicemail. To check what services you have and how to access them, contact your telephone service provider.

To use your voicemail service rather than your answering system, turn off your answering system. To use your answering system rather than your voicemail service, contact your telephone service provider to deactivate your voicemail service.



NOTE: After reviewing all new messages, the number of old messages appears on the message counter.

Using the answering machine and voicemail together

You can also use your telephone answering system and voicemail together by setting your built-in answering system to answer before voicemail answers as described below. To learn how to program your voicemail settings, contact your telephone service provider. Then, if you are on a call, or if the answering system is busy recording a message and you receive another call, the second caller can leave a voicemail message.

Set your answering system to answer calls at least two rings earlier than your voicemail is set to answer. For example, if your voicemail answers after six rings, set your answering system to answer after four rings. Some voicemail providers may program the delay before answering calls in seconds instead of rings. In this case, allow six seconds per ring when determining the appropriate setting.

About the answering system

Message capacity

The answering system can record up to 99 messages, depending on the length of each message. Individual messages can be up to 3 minutes, and the maximum recording time is approximately 14 minutes. The actual recording time depends on individual message characteristics. Messages remain available for replay until you delete them.

Voice prompts

The system provides voice prompts to guide you through the setup procedures at the telephone base, message playback, remote access and recording outgoing announcements.

Call screening

To screen a call at the telephone base:

If the answering system and call screening are on (see **Call screening** on page 35), the announcement and the incoming message broadcast at the telephone base when a call is answered by the answering system.

Options while a message is being recorded:

- Press ▼/**VOLUME**/▲ on the telephone base to adjust the call screening volume.
- Press ►/■/**PLAY/STOP** or **CANCEL** to temporarily silence the call screening.
- Press ►/■/**PLAY/STOP** to temporarily turn on the call screening if call screening is set to off.
- Lift the corded handset or press ◀/▶/**SPEAKER** to answer the call.

To screen a call at the handset:

If the answering system is on, you can hear the announcement and the incoming message with the handset when a call is answered by the answering system. While a message is being recorded, the handset shows **To screen call, press [SELECT]**. Press **MENU/SELECT** to screen the call.

Options while screening a call at the handset:

- Press ▼/**CID/VOLUME** or ▲/**DIR/VOLUME** on the handset to adjust the call screening volume.
- Press ✎/**OFF/CANCEL** to temporarily silence the call screening.
- Press **MENU/SELECT** to temporarily turn on the call screening if call screening is set to off.
- Press ◀/▶/**SPEAKER** to broadcast the announcement and the incoming message through the speakerphone. Press again to turn off the speakerphone.

About the answering system

Call intercept

While screening a call, you can stop recording and speak to the caller by pressing **PHONE/FLASH** or **SPEAKER** on the cordless handset, pressing **SPEAKER** on the telephone base, or lifting the corded handset.

Temporarily turning off the message alert tone

If the message alert tone is turned on, the telephone base beeps every 10 seconds when there are new messages. Pressing any telephone base key (except **HANDSET LOCATOR**) temporarily silences the message alert tone.

If you press **X/DELETE** when in idle mode to temporarily turn off the message alert tone, there is a voice prompt directing you to press **X/DELETE** again to delete all old messages. The message alert tone is temporarily off. Only press **X/DELETE** a second time if you wish to erase all old messages in your answering system.

The message alert tone resumes when you receive another message.

Message playback

To listen to messages at the telephone base:

Press **PLAY/STOP** on the telephone base to listen to the messages.

- If there are new and old messages, press **▼CID** or **▲DIR** to select **>Play new msgs** or **>Play old msgs**, then press **MENU/SELECT** or **PLAY/STOP**.
- If there are only new or only old messages, they are played automatically.

To listen to messages on a cordless handset:

1. When the handset is in idle mode, press **MENU/SELECT** to enter the main menu.
2. Press **MENU/SELECT** again to select **>Play messages**.
 - If there are new and old messages, press **▼CID** or **▲DIR** to select **>Play new msgs** or **>Play old msgs**, then press **MENU/SELECT**.
 - If there are only new or only old messages, they are played automatically.

Message playback

Options during playback

When messages are playing on the telephone base:

- Press **▼/VOLUME/▲** to adjust the message playback volume.
- Press **EQ**  to adjust the message playback audio quality.
- Press **▶/SKIP** to skip to the next message.
- Press **◀/REPEAT** to repeat the message. Press twice to hear the previous message.
- Press **X/DELETE** to delete the message.
- Press **▶/■/PLAY/STOP** to stop the playback.
- Press **📞/SPEAKER** to stop playback. The screen shows **Call back?**, then press **MENU/SELECT**, or **📞/SPEAKER** to call back the caller if the caller's number is available. If the dialing format used is not correct, then use the option below to choose the correct dialing format before calling back the caller.
- Press **MENU/SELECT** to pause playback and show the caller ID information if available. From here, you can press **CANCEL** to resume playback. Or press **#** (pound key) repeatedly to show the desired dialing option (page 32), then press **📞/SPEAKER** or **MENU/SELECT** to call back the caller. If you do not call back within 10 seconds, message playback resumes automatically.

When messages are playing on the handset:

- Press **▼CID/VOLUME** or **▲DIR/VOLUME** to adjust the message playback volume.
- Press **EQ**  to adjust the message playback audio quality.
- Press **6** to skip to the next message.
- Press **4** to repeat the message. Press twice to hear the previous message.
- Press **MUTE/DELETE** to delete the message.
- Press **5** or **📞/OFF/CANCEL** to stop the playback.
- Press **📞/SPEAKER** to switch between speakerphone mode and handset mode.
- Press **\PHONE/FLASH** to stop playback. The screen shows **Call back?**, then press **MENU/SELECT**, **\PHONE/FLASH**, or **📞/SPEAKER** to call back the caller if the caller's number is available. If the dialing format used is not correct, then use the option below to choose the correct dialing format before calling back the caller.
- Press **MENU/SELECT** to pause playback and show the caller ID information if available. From here, you can press **📞/OFF/CANCEL** to resume playback. Or press **#** (pound key) repeatedly to show the desired dialing option (page 32), then press **\PHONE/FLASH** or **📞/SPEAKER** to call back the caller. If you do not call back within 10 seconds, message playback resumes automatically.

Message playback

Delete all old messages

To delete all old messages on the telephone base:

1. When the telephone is idle, press **X/DELETE**. The screen shows **Delete all old messages?** and the system announces, *"To delete all old messages, press **DELETE** again."*
2. Press **X/DELETE** again. The system announces, *"All old messages deleted."*

To delete all old messages on the handset:

1. Press **MENU/SELECT** when in idle mode to enter the main menu.
2. Press **▼CID** or **▲DIR** to scroll to **>Answering sys.** Press **MENU/SELECT**.
3. Press **▼CID** or **▲DIR** to highlight **Delete all old**, then press **MENU/SELECT**. The screen shows **Delete all old messages?**
4. Press **MENU/SELECT** again to confirm. The screen displays **Deleting...** then **All old msgs deleted!**

Recording and playing memos

Memos are your own recorded messages used as reminders for yourself or others using the same answering system. You can record your own memos using a system handset or the telephone base. Play and delete them in the same way as incoming messages.

Record a memo

Using a cordless handset or the telephone base:

1. When the handset is in idle mode, press **MENU/SELECT** to enter the main menu.
2. Press **▼CID** or **▲DIR** to scroll to **>Answering sys.** Press **MENU/SELECT**.
3. Press **▼CID** or **▲DIR** to highlight **Record memo**, then press **MENU/SELECT**. The system announces, *"Record after the tone. Press **5** when you are done."* You can record a memo for up to four minutes.
4. Speak towards the handset or telephone base to record a memo.
5. Press **5** to stop recording. The system announces, *"Recorded."* The system does not save memos shorter than two seconds.

Play back a memo

Play memos the same way as messages. See **Message playback** on page 40.

Remote access

You can reach your answering system remotely by dialing your home telephone number from any touch-tone telephone.

To remotely reach your answering system:

1. Dial your telephone number from any touch-tone telephone.
2. When the system answers, enter the two-digit remote access code (**19** is the default code. See page 72 to change it).
 - The system automatically announces the number of new or old messages (if any), and then begins to play them.
3. You can also enter the following remote commands:

Remote commands

1	Press to listen to all messages.
2	Press to listen to new messages only.
3	Press to delete the current message (during playback).
33	Press twice to delete all old messages.
4	Press to repeat the current message (during playback).
44	Press twice to listen to the previous message.
5	Press to stop any operation (including recording).
*5	Press to listen to a list of remote commands.
6	Press to skip to the next message (during playback).
*7	Press to record a new announcement.
8	Press to end remote access (the call will be terminated).
0	Press to turn the answering system on or off.

4. Hang up or press **8** to end the calls.

Adding and registering handsets/headsets

Your telephone can support up to 12 DECT 6.0 cordless handsets (AT&T model CL80111, sold separately) or up to 10 cordless handsets and 2 cordless headsets (sold separately). Visit **www.telephones.att.com/headsets** for a list of compatible DECT 6.0 cordless headsets. Each new handset or headset must be registered to the telephone base before use.

You must register each handset or headset separately.

To register a cordless headset to this telephone system, please refer to the user's manual of the cordless headset for more details. To register a cordless handset, see below.

The handsets provided within your product box are already registered as **HANDSET 1** and so forth. Additional handsets are assigned numbers in the sequential order they are registered (up to **HANDSET 12**).

Register a handset to the telephone base

1. Before you begin registration, put the handset you wish to register near the telephone base. Make sure the handset shows **To register, see manual**.
2. On the telephone base, press **MENU/SELECT**.
3. On the telephone base, use **▼CID** or **▲DIR** to scroll to **>Settings**, then press **MENU/SELECT**.
4. On the telephone base, use **▼CID** or **▲DIR** to scroll to **>Registration**, then press **MENU/SELECT**.
5. The handset shows **To register, see manual**. Press **#** (pound key) on the handset. Both the handset and the telephone base show **Registering...** **Please wait** and the **IN USE** light turns on.
6. After a while, both the handset and the telephone base beep and the **IN USE** light turns off. **Handset Registered** shows on both the handset and telephone base. The handset is now registered with the telephone base.

If registration fails, the system will automatically try to register again. If registration fails after the third try, **Registration failed** appears on both screens before returning to idle mode. This may take up to five minutes to occur. Please start again from Step 1 above.



NOTES:

- You cannot register a handset if any other system handset is in use.
- If you try to register more than 12 handsets to the telephone base, the telephone base shows **Registration slots are full** and sounds 2 beeps.

Deregistering handsets

You may need to deregister your handsets if:

- You have 12 registered handsets and need to replace a handset.





-OR-

- You wish to change the designated handset number of your registered handsets.

You must first deregister ALL handsets, and then register each handset you wish to use again, one at a time.

Please read carefully through all the instructions on this page before beginning the deregistration process.

Deregister all handsets from the telephone base

1. Make sure that all handsets are out of the chargers before you begin deregistration.
2. Press and hold /**HANDSET LOCATOR** on the telephone base for about 10 seconds. The **IN USE** light turns on after about four seconds. Keep holding /**HANDSET LOCATOR** until the screen shows **Deregister all devices?** and the **IN USE** light begins to flash. Release /**HANDSET LOCATOR**.
3. Immediately press /**HANDSET LOCATOR** or **MENU/SELECT** while the **IN USE** light is still flashing. (If the light stops flashing, start again with Step 1 above.)
4. It takes up to 10 seconds to complete the deregistration process. Before registering the handset again, wait for the cordless handset screen to display **To register, see manual**.
5. To register the handset(s) to the telephone base again, follow the registration instructions on the previous page.

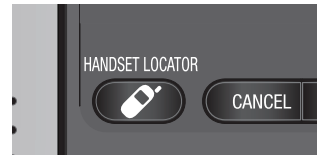

NOTES:

- If the deregistration process fails, you may need to reset the system and try again. To reset, unplug the power from the telephone base and plug it back in.
- You cannot deregister the handsets if any other system handset is in use. Any call activity will cancel the deregistration process.
- Even if the battery is depleted, you can still deregister the handsets by following the steps above. After the handset is charged for at least 10 minutes, the screen shows **To register, see manual**.

Troubleshooting

For more detailed instructions, refer to the online Complete user's manual at **www.telephones.att.com/manuals**.

If you have difficulty with your phone, please try the suggestions below. For Customer Service, visit our website at **www.telephones.att.com** or call **1 (800) 222-3111**. In Canada, dial **1 (866) 288-4268**.

My telephone doesn't work at all.

- Make sure the power cord is securely plugged in.
- Make sure you plug the battery connector securely into the cordless handset.
- Make sure you plug the telephone line cord securely and firmly into the telephone base and the telephone wall jack.
- Charge the battery in the cordless handset for at least 10 hours. For optimum daily performance, return the cordless handset to the charger when not in use.
- If the battery is depleted, it may take approximately 30 minutes to charge the handset before it shows **Low battery**. See page 6 for details.
- Reset the telephone base. Unplug the electrical power. Wait for approximately 15 seconds, then plug it back in. Allow up to one minute for the cordless handset and telephone base to reset.
- You may need to purchase a new battery. Please refer to **Battery installation and charging** in this user's manual on page 6.

I cannot get a dial tone.

- Try all the suggestions above.
- Move the cordless handset closer to the telephone base. You may have moved out of range.
- If the previous suggestions do not work, disconnect the telephone base from the telephone jack and connect to a different phone. If there is no dial tone on that phone either, the problem is in your wiring or telephone service. Contact your telephone service provider.
- Your line cord may be defective. Try installing a new line cord.

I cannot dial out.

- Try all the suggestions above.
- Make sure you have a dial tone before dialing. The cordless handset may take a second or two to find the telephone base and produce a dial tone. This is normal. Wait an extra second before dialing.
- Eliminate any background noise. Noise from a television, radio or other appliances may cause the phone to not dial out properly. If you cannot eliminate the background noise, first try muting the cordless handset before dialing, or dialing from another room with less background noise.
- If other phones in your home are having the same problem, contact your telephone service provider (charges may apply).

Troubleshooting

My cordless handset isn't performing normally.

- Make sure you plug the power cord securely into the telephone base. Plug the power adapter into a different working electrical outlet without a wall switch.
- Move the cordless handset closer to the telephone base. You may have moved out of range.
- Reset the telephone base. Unplug the electrical power. Wait for 15 seconds then plug it back in. Allow up to one minute for the cordless handset and telephone base to reset.
- Other electronic products such as HAM radios and other DECT phones can cause interference with your cordless phone. Try installing your phone as far away as possible from these types of electronic devices.

The batteries do not hold a charge.

- Charge the battery in the cordless handset for at least 10 hours. For optimum daily performance, return the cordless handset to the charger when not in use.
- If the battery is depleted, it may take approximately 30 minutes to charge the handset before it shows **Low battery**. Refer to the table on page 6 for details.
- You may need to purchase a new battery. Please refer to **Battery installation and charging** in this user's manual on page 6.

I get noise, static, or weak signals even when I'm near the telephone base.

- If you subscribe to high-speed Internet service (DSL - digital subscriber line) through your telephone line, you must install a DSL filter between the telephone line cord and the telephone wall jack (page 5). The filter prevents noise and caller ID problems as a result of DSL interference. Please contact your DSL service provider for more information about DSL filters.
- You may be able to improve the performance of your cordless phone by installing your new telephone base as far as possible from any other existing cordless telephone system that may already be installed.
- Other electronic products such as HAM radios and other DECT phones can cause interference with your cordless phone. Try installing your phone as far away as possible from these types of electronic devices.
- Do not install this phone near a microwave oven or on the same electrical outlet. You may experience decreased performance while the microwave oven is operating.
- If you plug your phone in with a modem or a surge protector, plug the phone (or modem/surge protector) into a different location. If this does not solve the problem, relocate your phone or modem farther apart from one another, or use a different surge protector.
- Move your phone to a higher location. The phone may have better reception in a high area.
- If other phones in your home are having the same problem, contact your telephone service provider (charges may apply).

Troubleshooting

I experience poor sound quality when using the handset speakerphone.

- For increased sound quality while using the handset speakerphone, place the handset on a flat surface with the dial pad facing up.

My caller ID isn't working.

- Caller ID is a subscription service. You must subscribe to this service from your telephone service provider for this feature to work on your phone.
- The caller may not be calling from an area that supports caller ID.
- Both your and your caller's telephone service providers must use caller ID compatible equipment.
- If you subscribe to high-speed Internet service (DSL - digital subscriber line) through your telephone line, you must install a DSL filter between the telephone line cord and the telephone wall jack (page 5). The filter prevents noise and caller ID problems resulting from DSL interference. Please contact your DSL service provider for more information about DSL filters.

System does not receive caller ID when on a call.

- Make sure you subscribe to caller ID with call waiting features from your telephone service provider. The caller ID feature works only if both you and the caller are in areas offering caller ID service, and if both telephone service providers use compatible equipment.

System does not answer after the correct number of rings.

- Make sure that the answering system is on. **ANS ON** should show on the handset and the **📞/ANSWER ON/OFF** light on the telephone base should be on.
- If toll saver is activated, the number of rings changes to two when you have new messages stored (page 36).
- If the memory is full or the system is off, the system will answer after 10 rings.
- In some cases, the answering system is affected by the ringing system used by your telephone service provider.
- If you subscribe to voicemail service, change the number of rings so that your answering system answers before your voicemail answers (pages 36). To determine how many rings activate your voicemail, contact your telephone service provider.
- If there is a fax machine connected to the same telephone line, try disconnecting the fax machine. If that solves the problem, consult your fax machine documentation for information on compatibility with answering systems.

Troubleshooting

I cannot retrieve voicemail messages.

- Your telephone has both a built-in answering system and voicemail indicator. They are independent features and each alerts you to new messages differently (page 38). If you subscribe to voicemail service from your telephone service provider, contact your telephone service provider for more information on how to access your voicemail.

I've set my LCD language to Spanish or French and I don't know how to change it back to English.

- Press **MENU/SELECT** once on your handset or base. Then, on the handset or base enter **364#**. You hear a confirmation tone.

Maintenance

Taking care of your telephone

- Your cordless telephone contains sophisticated electronic parts, so you must treat it with care.
- Avoid rough treatment.
- Place the handset down gently.
- Save the original packing materials to protect your telephone if you ever need to ship it.

Avoid water

- You can damage your telephone if it gets wet. Do not use the handset in the rain, or handle it with wet hands. Do not install the telephone base near a sink, bathtub or shower.

Electrical storms

- Electrical storms can sometimes cause power surges harmful to electronic equipment. For your own safety, take caution when using electric appliances during storms.

Cleaning your telephone

- Your telephone has a durable plastic casing that should retain its luster for many years. Clean it only with a soft cloth slightly dampened with water or mild soap.
- Do not use excess water or cleaning solvents of any kind.

Remember that electrical appliances can cause serious injury if used when you are wet or standing in water. If the telephone base should fall into water, **DO NOT RETRIEVE IT UNTIL YOU UNPLUG THE POWER CORD AND TELEPHONE LINE CORDS FROM THE WALL.** Then pull the unit out by the unplugged cords.

Important safety information



This symbol is to alert you to important operating or servicing instructions that may appear in this user's manual. Always follow basic safety precautions when using this product to reduce the risk of injury, fire, or electric shock.

Safety information

- Read and understand all instructions in the user's manual. Observe all markings on the product.
- Avoid using a telephone during a thunderstorm. There may be a slight chance of electric shock from lightning.
- Do not use a telephone in the vicinity of a gas leak. Under certain circumstances, a spark may be created when the adapter is plugged into the power outlet, or when the handset is replaced in its cradle. This is a common event associated with the closing of any electrical circuit. The user should not plug the phone into a power outlet, and should not put a charged handset into the cradle, if the phone is located in an environment containing concentrations of flammable or flame-supporting gases, unless there is adequate ventilation. A spark in such an environment could create a fire or explosion. Such environments may include: medical use of oxygen without adequate ventilation; industrial gases (cleaning solvents; gasoline vapors; etc.); a leak of natural gas; etc.
- Do not use this product near water, or when you are wet. For example, do not use it in a wet basement or shower, or next to a swimming pool, bathtub, kitchen sink, or laundry tub. Do not use liquids or aerosol sprays for cleaning. If the product comes in contact with any liquid, unplug any line or power cord immediately. Do not plug the product back in until it has dried thoroughly.
- Install this product in a protected location where no one can trip over any line or power cords. Protect cords from damage or abrasion.
- If this product does not operate normally, see the **Troubleshooting** section on pages 46-49 of this user's manual. If you cannot solve the problem, or if the product is damaged, refer to the **Limited warranty** section on pages 54-55. Do not open this product except as directed in your user's manual. Opening the product or reassembling it incorrectly may expose you to hazardous voltages or other risks.
- Replace batteries only as described in your user's manual (page 6). Do not burn or puncture batteries — they contain caustic chemicals.
- The power adapters are intended to be correctly oriented in a vertical or floor mount position. The prongs are not designed to hold the plug in place if it is plugged into a ceiling, under-the-table or cabinet outlet.



Caution: Use only the power adapters provided with this product. To obtain a replacement, visit our website at **www.telephones.att.com** or call **1 (800) 222-3111**. In Canada, dial **1 (866) 288-4268**.

For more detailed instructions, refer to the online Complete user's manual at **www.telephones.att.com/manuals**.

Important safety information

Especially about cordless telephones

- **Privacy:** The same features that make a cordless telephone convenient create some limitations. Telephone calls are transmitted between the telephone base and the handset by radio waves, so there is a possibility that your cordless telephone conversations could be intercepted by radio receiving equipment within range of the cordless handset. For this reason, you should not think of cordless telephone conversations as being as private as those on corded telephones.
- **Electrical power:** The telephone base of this cordless telephone must be connected to a working electrical outlet which is not controlled by a wall switch. Calls cannot be made from the handset if the telephone base is unplugged, switched off or if the electrical power is interrupted.
- **Potential TV interference:** Some cordless telephones operate at frequencies that may cause interference to TVs and VCRs. To minimize or prevent such interference, do not place the telephone base of the cordless telephone near or on top of a TV or VCR. If interference is experienced, moving the cordless telephone farther away from the TV or VCR will often reduce or eliminate the interference.
- **Rechargeable batteries:** This product contains nickel-metal hydride rechargeable batteries. Exercise care in handling batteries in order not to create a short circuit with conductive material such as rings, bracelets and keys. The battery or conductor may overheat and cause harm. Observe proper polarity between the battery and the battery charger.
- **Nickel-metal hydride rechargeable batteries:** Dispose of these batteries in a safe manner. Do not burn or puncture. Like other batteries of this type, if burned or punctured, they could release caustic material which could cause injury.



The RBRC™ Seal means that the manufacturer is voluntarily participating in an industry program to collect and recycle nickel-metal hydride rechargeable batteries when taken out of service within the United States. These batteries may be taken to a participating local retailer of replacement batteries or recycling center. Or you may call 1 (800) 8-BATTERY for locations accepting spent Ni-MH batteries.

Precautions for users of implanted cardiac pacemakers

Cardiac pacemakers (applies only to digital cordless telephones):

Wireless Technology Research, LLC (WTR), an independent research entity, led a multidisciplinary evaluation of the interference between portable wireless telephones and implanted cardiac pacemakers. Supported by the U.S. Food and Drug Administration, WTR recommends to physicians that:

Pacemaker patients

Should keep wireless telephones at least six inches from the pacemaker.

Should NOT place wireless telephones directly over the pacemaker, such as in a breast pocket, when it is turned ON.

Should use the wireless telephone at the ear opposite the pacemaker.

WTR's evaluation did not identify any risk to bystanders with pacemakers from other persons using wireless telephones.

Especially about telephone answering systems

Two-way recording: This unit does not sound warning beeps to inform the other party that the call is being recorded. To ensure that you are in compliance with any federal or state regulations regarding recording a telephone call, you should start the recording process and then inform the other party that you are recording the conversation.

SAVE THESE INSTRUCTIONS

FCC Part 68 and ACTA

This equipment complies with Part 68 of the FCC rules and with technical requirements adopted by the Administrative Council for Terminal Attachments (ACTA). The label on the back or bottom of this equipment contains, among other things, a product identifier in the format US:AAAEQ##TXXXX. This identifier must be provided to your telephone service provider upon request.

The plug and jack used to connect this equipment to premises wiring and the telephone network must comply with the applicable Part 68 rules and technical requirements adopted by ACTA. A compliant telephone cord and modular plug is provided with this product. It is designed to be connected to a compatible modular jack that is also compliant. An RJ11 jack should normally be used for connecting to a single line and an RJ14 jack for two lines. See the installation instructions in the user's manual.

The Ringer Equivalence Number (REN) is used to determine how many devices you may connect to your telephone line and still have them ring when you are called. The REN for this product is encoded as the 6th and 7th characters following the US: in the product identifier (e.g., if ## is 03, the REN is 0.3). In most, but not all areas, the sum of all RENs should be five (5.0) or less. For more information, please contact your telephone service provider.

This equipment may not be used with Party Lines. If you have specially wired alarm dialing equipment connected to your telephone line, ensure the connection of this equipment does not disable your alarm equipment. If you have questions about what will disable the alarm equipment, consult your telephone service provider or a qualified installer.

If this equipment is malfunctioning, it must be unplugged from the modular jack until the problem has been corrected. Repairs to this telephone equipment can only be made by the manufacturer or its authorized agents. For repair procedures, follow the instructions outlined under the Limited warranty.

If this equipment is causing harm to the telephone network, the telephone service provider may temporarily discontinue your telephone service. The telephone service provider is required to notify you before interrupting service. If advance notice is not practical, you will be notified as soon as possible. You will be given the opportunity to correct the problem and the telephone service provider is required to inform you of your right to file a complaint with the FCC. Your telephone service provider may make changes in its facilities, equipment, operation, or procedures that could affect the proper functioning of this product. The telephone service provider is required to notify you if such changes are planned.

If this product is equipped with a corded or cordless handset, it is hearing aid compatible.

If this product has memory dialing locations, you may choose to store emergency telephone numbers (e.g., police, fire, medical) in these locations. If you do store or test emergency numbers, please:

Remain on the line and briefly explain the reason for the call before hanging up.

Perform such activities in off-peak hours, such as early morning or late evening.

Industry Canada

Operation is subject to the following two conditions: (1) this device may not cause harmful interference, and (2) this device must accept any interference, including interference that may cause undesired operation.

The term "IC:" before the certification/registration number only signifies that the Industry Canada technical specifications were met.

The Ringer Equivalence Number (REN) for this terminal equipment is 1.0. The REN is an indication of the maximum number of devices allowed to be connected to a telephone interface. The termination on an interface may consist of any combination of devices subject only to the requirement that the sum of the RENs of all the devices does not exceed five.

This product meets the applicable Industry Canada technical specifications.

Appendix
FCC Part 15

This equipment has been tested and found to comply with the requirements for a Class B digital device under Part 15 of the Federal Communications Commission (FCC) rules. These requirements are intended to provide reasonable protection against harmful interference in a residential installation. This equipment generates, uses and can radiate radio frequency energy and, if not installed and used in accordance with the instructions, may cause harmful interference to radio communications. However, there is no guarantee that interference will not occur in a particular installation. If this equipment does cause harmful interference to radio or television reception, which can be determined by turning the equipment off and on, the user is encouraged to try to correct the interference by one or more of the following measures:

- Reorient or relocate the receiving antenna.
- Increase the separation between the equipment and receiver.
- Connect the equipment into an outlet on a circuit different from that to which the receiver is connected.
- Consult the dealer or an experienced radio/TV technician for help.

Changes or modifications to this equipment not expressly approved by the party responsible for compliance could void the user's authority to operate the equipment.

This device complies with Part 15 of the FCC Rules. Operation is subject to the following two conditions: (1) this device may not cause harmful interference, and (2) this device must accept any interference received, including interference that may cause undesired operation. Privacy of communications may not be ensured when using this telephone.

To ensure safety of users, the FCC has established criteria for the amount of radio frequency energy that can be safely absorbed by a user or bystander according to the intended usage of the product. This product has been tested and found to comply with the FCC criteria. The handset may be safely held against the ear of the user. The telephone base shall be installed and used such that parts of the user's body other than the hands are maintained at a distance of approximately 20 cm (8 inches) or more.

This Class B digital apparatus complies with Canadian ICES-003.

Limited warranty

The AT&T brand is used under license - any repair, replacement or warranty service, and all questions about this product should be directed to our website at **www.telephones.att.com** or call **1 (800) 222-3111**. In Canada, dial **1 (866) 288-4268**.

For more detailed instructions, refer to the online Complete user's manual at **www.telephones.att.com/manuals**.

1. What does this limited warranty cover?

The manufacturer of this AT&T branded product warrants to the holder of a valid proof of purchase ("CONSUMER" or "you") that the product and all accessories provided in the sales package ("PRODUCT") are free from defects in material and workmanship, pursuant to the following terms and conditions, when installed and used normally and in accordance with the PRODUCT operating instructions. This limited warranty extends only to the CONSUMER for products purchased and used in the United States of America and Canada.

2. What will be done if the PRODUCT is not free from defects in materials and workmanship during the limited warranty period ("materially defective PRODUCT")?

During the limited warranty period, the manufacturer's authorized service representative will repair or replace at the manufacturer's option, without charge, a materially defective PRODUCT. If the manufacturer repairs the PRODUCT, they may use new or refurbished replacement parts. If the manufacturer chooses to replace the PRODUCT, they may replace it with a new or refurbished PRODUCT of the same or similar design. The manufacturer will retain defective parts, modules, or equipment. Repair or replacement of the PRODUCT, at the manufacturer's option, is your exclusive remedy. The manufacturer will return repaired or replacement products to you in working condition. You should expect the repair or replacement to take approximately 30 days.

3. How long is the limited warranty period?

The limited warranty period for the PRODUCT extends for ONE (1) YEAR from the date of purchase. If the manufacturer repairs or replaces a materially defective PRODUCT under the terms of this limited warranty, this limited warranty also applies to repaired or replacement PRODUCT for a period of either (a) 90 days from the date the repaired or replacement PRODUCT is shipped to you or (b) the time remaining on the original one-year limited warranty; whichever is longer.

4. What is not covered by this limited warranty?

This limited warranty does not cover:

- PRODUCT that has been subjected to misuse, accident, shipping or other physical damage, improper installation, abnormal operation or handling, neglect, inundation, fire, water, or other liquid intrusion; or
- PRODUCT that has been damaged due to repair, alteration, or modification by anyone other than an authorized service representative of the manufacturer; or
- PRODUCT to the extent that the problem experienced is caused by signal conditions, network reliability or cable or antenna systems; or
- PRODUCT to the extent that the problem is caused by use with non-AT&T accessories; or
- PRODUCT whose warranty/quality stickers, PRODUCT serial number plates or electronic serial numbers have been removed, altered or rendered illegible; or
- PRODUCT purchased, used, serviced, or shipped for repair from outside the United States of America or Canada, or used for commercial or institutional purposes (including but not limited to products used for rental purposes); or
- PRODUCT returned without valid proof of purchase (see item 6 below); or
- Charges for installation or setup, adjustment of customer controls, and installation or repair of systems outside the unit.

Limited warranty

5. How do you get warranty service?

To obtain warranty service, visit our website at **www.telephones.att.com** or call **1 (800) 222-3111**. In Canada, dial **1 (866) 288-4268**.

For more detailed instructions, refer to the online Complete user's manual at **www.telephones.att.com/manuals**.

NOTE: Before calling for service, please review the user's manual; a check of the PRODUCT's controls and features may save you a service call.

Except as provided by applicable law, you assume the risk of loss or damage during transit and transportation and are responsible for delivery or handling charges incurred in the transport of the PRODUCT(s) to the service location. The manufacturer will return repaired or replaced PRODUCT under this limited warranty to you. Transportation, delivery or handling charges are prepaid. The manufacturer assumes no risk for damage or loss of the PRODUCT in transit. If the PRODUCT failure is not covered by this limited warranty, or proof of purchase does not meet the terms of this limited warranty, the manufacturer will notify you and will request that you authorize the cost of repair prior to any further repair activity. You must pay for the cost of repair and return shipping costs for the repair of products that are not covered by this limited warranty.

6. What must you return with the PRODUCT to get warranty service?

You must:

- Return the entire original package and contents including the PRODUCT to the service location along with a description of the malfunction or difficulty; and
- Include a "valid proof of purchase" (sales receipt) identifying the PRODUCT purchased (PRODUCT model) and the date of purchase or receipt; and
- Provide your name, complete and correct mailing address, and telephone number.

7. Other limitations

This warranty is the complete and exclusive agreement between you and the manufacturer of this AT&T branded PRODUCT. It supersedes all other written or oral communications related to this PRODUCT. The manufacturer provides no other warranties for this PRODUCT. The warranty exclusively describes all of the manufacturer's responsibilities regarding the PRODUCT. There are no other express warranties. No one is authorized to make modifications to this limited warranty and you should not rely on any such modification.

State/Provincial Law rights: This warranty gives you specific legal rights, and you may also have other rights which vary from state to state or province to province.

Limitations: Implied warranties, including those of fitness for a particular purpose and merchantability (an unwritten warranty that the PRODUCT is fit for ordinary use) are limited to one year from date of purchase. Some states/provinces do not allow limitations on how long an implied warranty lasts, so the above limitation may not apply to you. In no event shall the manufacturer be liable for any indirect, special, incidental, consequential, or similar damages (including, but not limited to lost profits or revenue, inability to use the PRODUCT or other associated equipment, the cost of substitute equipment, and claims by third parties) resulting from the use of this PRODUCT. Some states/provinces do not allow the exclusion or limitation of incidental or consequential damages, so the above limitation or exclusion may not apply to you.

Please retain your original sales receipt as proof of purchase.

Technical specifications

Operation	Operating time*
Talk time (cordless handset)	Up to 7 hours
Talk time (cordless handset speakerphone)	Up to 5 hours
Standby	Up to 7 days

* Operating times vary depending on your actual use and the age of the battery.

DECT 6.0 digital technology

The AT&T DECT 6.0 products offer unsurpassed range performance and sound clarity. This is achieved through a unique antenna design and advances in noise-filtering technology. An independent laboratory has confirmed that AT&T DECT 6.0 products perform up to 45% better in range competitions against similarly equipped phones of the leading competition. Now calls can be taken in the basement, backyard and garage with exceptional sound quality.

Telephone operating range

This cordless telephone operates within the maximum power allowed by the Federal Communications Commission (FCC). Even so, this handset and telephone base can communicate over only a certain distance — which can vary with the locations of the telephone base and handset, the weather, and the construction of your home or office.

Redefining long range coverage and clarity

This telephone base comes with an antenna which gives much better clarity and covers a longer range than before.

HD audio

HD audio improves sound quality by expanding and rebuilding frequencies that are lost with traditional phone calls. There is no additional telephone service requirement to use HD audio. It is designed to work with standard telephone service. Your system will automatically enhance all received sound with HD audio.



Telephones identified with this logo have reduced noise and interference when used with most T-coil equipped hearing aids and cochlear implants. The TIA-1083 Compliant Logo is a trademark of the Telecommunications Industry Association. Used under license.



The ENERGY STAR® program (www.energystar.gov) recognizes and encourages the use of products that save energy and help protect our environment. We are proud to mark this product with the ENERGY STAR® label indicating it meets the latest energy efficiency guidelines.

A

- Announcement 34
- Answer an incoming call
 - during an intercom call 21
- Answering calls 15
- Answering system 34–43
- Assign a speed dial number 30

B

- Battery charging 6
- Battery installation 6
- Blind transfer 18

C

- Caller ID (CID)
 - add entries to phone directory 33
 - dial entries 33
 - review entries 32
- Call transfer 22
- Chain dialing 17
- Charger installation 5
- Clock 10

D

- Date and time 10
- Delete
 - a directory entry 28
 - all old messages 42
- Dialing
 - from a record in the caller ID history 33
 - from the directory 28
- Directory
 - dial a number 28
 - edit entries 29
 - name search 28
- Display dial 28
- DSL 5

E

- Ending a call 15

H

- Handset
 - handset locator 19
 - quick reference guide 1–2
 - ringer tone 9
 - ringer volume 9
 - speakerphone 16
 - temporary ringer silencing 15
 - voicemail indicator 12
- HD audio 56

I

- Important safety information 50–51
- Intercom 20–22

L

- Language reset, 10, 49
- Last number redial 16
- LCD language 10
- Limited warranty 54–55

M

- Maintenance 49
- Message
 - alert tone 37
 - playback 40–43

N

- Names
 - enter into directory 27
 - search 28
- Number of rings 36

O

- Outgoing announcement 34

P

- Paging tone 19
- Power adapter 5
- Push-to-talk 23–26

Q

- Quick reference guide 1–4

R

- Recharging 6
- Redial 16–17
- Remote access 43
- Ringer silencing 15
- Ring tone options 9

S

- Safety information 50–51
- Speakerphone 16
- Speed dial
 - assign a number 30
 - make a call 31

T

- Technical specifications 56
- Telephone base
 - quick reference guide 3–4
 - voicemail indicator 11

Time 10

- Troubleshooting 46–49

V

- Visual message waiting indicator 11
- Voicemail 11, 38
 - quick access, 11
- Voice prompts 39
- Volume control 9, 41

W

- Warranty 54–55



For more detailed instructions, refer to the Complete user's manual at www.telephones.att.com/manuals.

For customer service or product information, please visit our website at www.telephones.att.com, or call 1 (800) 222-3111. In Canada, dial 1 (866) 288-4268.