



**ACCESSORIES & PARTS**



# KIT UP YOUR FIREARMS

New polymer magazine additions include a 25 round .308/7.62X51 windowed magazine, 10 round 5.56/.223 magazine, and a 33 round GLOCK® 9mm double-stack magazine. After the many requests from our customers who enjoy building from the ground up and in addition to our well-received 6 position tube kits, new A2 rifle extension tube build kits will be added to our product line. Coming out of our Michigan UTG PRO® manufacturing is the addition of a ½"-28 9mm stubby muzzle brake and a new series of iron sights starting out with a pair of low profile mechanical flip-up back up iron sights.

## JUMP TO A SERIES

- **Polymer Magazines** ..... Page 132
- **Front & Rear Sights**..... Page 136
- **Fixed Stocks & Assemblies** ..... Page 140
- **Pistol Grips**..... Page 146
- **AR Control Components** ..... Page 147
- **AR Platform Armorer's Wrenches** ..... Page 149
- **Index Mounts & Handstops** ..... Page 150
- **Foregrips** ..... Page 151
- **Pistol Magazine Base Pads** ..... Page 155
- **AK/SKS/CZ® Scorpion™ Accessories**..... Page 156
- **Miscellaneous Accessories** ..... Page 160

**LEAPERS, INC.**  
**THE BEST NEVER REST**  
**LIFETIME WARRANTY**

(Third party trademarks may be used in this catalog for the convenience of customers to indicate the fit or compatibility of the applicable Leapers items.)

## NEW & MUST HAVE PRODUCTS FOR 2021

POLYMER MAGAZINES

NEW



AR15 FLIP-UP FRONT & REAR SIGHTS

NEW



AR LOWER UPGRADE KIT



AR15 OPS READY  
S5 FIXED STOCK





# AR PLATFORM POLYMER MAGAZINES

ACCESSORIES AND PARTS

AR PLATFORM POLYMER MAGAZINES

- IMPACT/HEAT RESISTANT POLYMER
- AVAILABLE COLOR(S)
  - Black
- US PAT. D849178

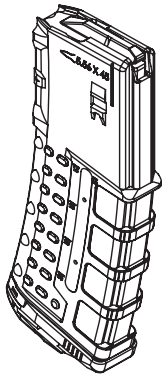

Cutout for Attaching Pull Tabs or Loops



Four-way Anti-tilt High Visibility Blue Follower and High Longevity Stainless Steel Spring for Reliable Feeding



Removable Flared Floor Plate



High Contrast Blue Anti-tilt Follower

Reinforced Impact & Heat Resistant Polymer

Over Travel Stop

Windowed with Remaining Round Count Indicators

Aggressively Molded Grip Texture

Easily Removable Base Plate for Cleaning



High Contrast Blue Anti-tilt Follower

Reinforced Impact & Heat Resistant Polymer

Over Travel Stop

Easily Removable Base Plate for Cleaning



Full-auto Reliability Testing

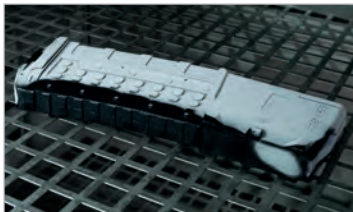

Adverse Temperature Testing

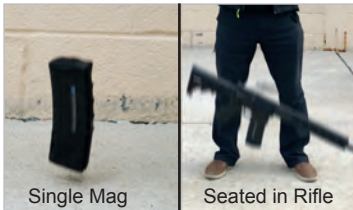

Single Mag Seated in Rifle

Drop Testing

RBT-AM30

## 30 Round Windowed .223/5.56 Polymer Magazine

- Durable and Impact Resistant Glass Fiber Reinforced Matte Black Polymer Construction
- Four-way Anti-tilt High Visibility Blue Follower and High Longevity Stainless Steel Spring for Reliable Feeding
- Aggressively Molded Grip Textured with Left and Right Side Windowed Main Body with Remaining Round Count Indicators, Over-insertion Stop, and Removable Flared Floor Plate

RBT-AM10

## 10 Round .223/5.56 Polymer Magazine

- Impact and Heat Resistant Glass Fiber Reinforced Matte Black Polymer Construction
- Four-way Anti-tilt High Visibility Blue Follower, High Longevity Stainless Steel Spring, and Over Travel Stop for Reliable Feeding
- Removable Flared Floor Plate for Cleaning



RBUAM01

**UTG PRO® 30 Round .223/5.56 Polymer Magazine**

- Impact and Heat Resistant Glass Fiber Reinforced Matte Black Polymer Construction
- Four-way Anti-tilt High Visibility Blue Follower, High Longevity Stainless Steel Spring, and Over Travel Stop for Reliable Feeding
- Aggressively Molded Grip Texture on the Magazine's Forward and Rearward Spine
- Magazine Side Walls Feature Open Surface Areas for User Applied Grip Tape or Stippling
- Removable Flared Plate for Cleaning

RBT-DM25

**25 Round Windowed LR/SR .308/7.62X51 Polymer Magazine**

- Durable and Impact Resistant Glass Fiber Reinforced Matte Black Polymer Construction
- Four-way Anti-tilt High Visibility Blue Follower and High Longevity Stainless Steel Spring for Reliable Feeding
- Features Positive Grip Texturing, Left and Right Side Windowed Main Body with Remaining Round Count Indicators, Over-insertion Stop, and Removable Flared Floor Plate
- Not Compatible with AR-10B, SCAR 17S, LAR8, HK417, or Rifles that Use M14, FAL, or HK G3/91 Patterned Magazines





# GL933, 33 ROUND 9MM DOUBLE-STACK POLYMER MAGAZINE - GLOCK®



IMPACT/HEAT RESISTANT POLYMER



AVAILABLE COLOR(S)

■ Black

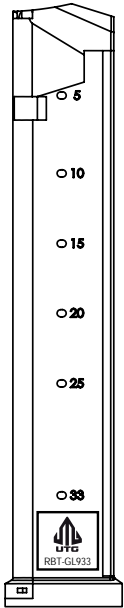

RBT-GL933

## GL933, 33 Round 9mm Double-stack Polymer Magazine - Glock®

NEW

- Durable and Impact Resistant Glass Fiber Reinforced Matte Black Polymer Construction
- Anti-tilt High Visibility Blue Follower and High Longevity Stainless Steel Spring for Reliable Feeding
- Left and Right Side Capacity Indicator Holes
- Easy Disassembly and Maintenance with Removable Flared Floor Plate
- Compatible with Reversible Magazine Release for Left or Right-handed Users



**GLOCK® 17**



**GLOCK® 34MOS**



Adverse Temperature Testing



Drop Testing

High Contrast Blue Anti-tilt Follower

Left and Right Side Capacity Indicator Holes

Durable and Impact Resistant Glass Fiber Reinforced Matte Black Polymer Construction

Easily Removable Base Plate for Cleaning



# FEED IT 33 ROUNDS WITH UTG®



**FREEDOM**  
**ORDNANCE FX-9™**



**CENTURY ARMS®**  
**WASR-M™**



**PSA®** **PA-X9™**



**CMMG®** **BANSHEE®**



**RUGGER®** **PC CARBINE™**



**B&T®** **APC PRO-G™**





# AR15 FLIP-UP FRONT & REAR SIGHTS

ACCESSORIES AND PARTS

AR15 FLIP-UP FRONT & REAR SIGHTS



**NEW**



## UTG PRO® Flip-up Front Sight

- Proudly Designed and Made in the USA
- Durable Aircraft Aluminum Construction with Reinforced Steel Components
- Finished in a Durable Matte Black Anodization
- Designed for the AR Platform and Fits Most Picatinny Rails
- Utilizes Standard Elevation Adjustable A2 Front Sight Post
- Manual Flip-up Sight Tower Locks into Place when Deployed, Unlocks via Spring-loaded Push Button, Low Profile 0.55" Stowed Height
- Lightweight at 1.3 oz.

**NEW**



## UTG PRO® Flip-up Rear Sight

- Proudly Designed and Made in USA
- Durable Aircraft Aluminum Construction with Reinforced Steel Components
- Finished in a Durable Matte Black Anodization
- Designed for the AR Platform and Fits Most Picatinny Rails
- Dual Aperture Tool-free Windage Adjustment
- Manual Flip-up Sight Tower Locks into Place when Deployed, Unlocks via Spring-loaded Push Button, Low Profile 0.55" Stowed Height
- Lightweight at 1.52 oz.

US PAT. 10030935

US PAT. D851203



MT-745

### ACCU-SYNC® 45 Degree Flip-up Front Sight

- Precision Machined from Aircraft Aluminum with a Matte Black Finish
- 45 Degree Angled Offset Allows Access to Iron Sights Simultaneously with Primary Mounted Magnified Optics
- Posi-lock Retention Plunger Locks Sight in Deployed Position
- Tool-free Front Sight Post Elevation Adjustment Wheel
- Utilizes a Single Locking Torx Screw and Squared Recoil Stops for a Secure Zero Hold and Return to Zero on Picatinny Rails

US PAT. 10030935

US PAT. D852920



MT-945

### ACCU-SYNC® 45 Degree Flip-up Rear Sight

- Precision Machined from Aircraft Aluminum with a Matte Black Finish
- 45 Degree Angled Offset Allows Access to Iron Sights Simultaneously with Primary Mounted Magnified Optics
- Posi-lock Retention Plunger Locks Sight in Deployed Position
- Dual Aperture Rear Sight with Tool-free Windage Adjustment Wheel
- Utilizes a Single Locking Torx Screw and Squared Recoil Stops for a Secure Zero Hold and Return to Zero on Picatinny Rails

US PAT. 10119784

US PAT. D863490



MNT-757

### ACCU-SYNC® Spring-loaded Flip-up Front Sight

- Precision Machined from Aircraft Aluminum with a Matte Black Finish
- Lightweight, Space Saving, Fold Over Design Uses Minimal Rail Space, 0.51" Stowed Height
- Posi-lock Push Button Automatically Deploys the Spring Loaded Sight and Prevents Sight from Collapsing when Deployed
- Utilizes a Single Locking Torx Screw and Squared Recoil Stops for a Secure Zero Hold and Return to Zero on Picatinny Rails

US PAT. 10119784

US PAT. D863489



MNT-957

### ACCU-SYNC® Spring-loaded Flip-up Rear Sight

- Precision Machined from Aircraft Aluminum with a Matte Black Finish
- Lightweight, Space Saving, Fold Over Design Uses Minimal Rail Space, 0.63" Stowed Height
- Posi-lock Push Button Automatically Deploys the Spring Loaded Sight and Prevents Sight from Collapsing when Deployed
- Dual Aperture Rear Sight with Tool-free Windage Adjustment Wheel
- Utilizes a Single Locking Torx Screw and Squared Recoil Stops for a Secure Zero Hold and Return to Zero on Picatinny Rails



MNT-755

### Super Slim Flip-up Front Sight

- Aluminum/Steel Construction with a Matte Black Finish
- Standard A2 Front Sight Post with Precise Elevation Adjustment
- Low Profile 3mm Locking Bolt and Mounting Deck Securely Attaches to any Picatinny Rail, 0.55" Stowed Height



MNT-955

### Super Slim Flip-up Rear Sight

- Aluminum/Steel Construction with a Matte Black Finish
- Dual Aperture Rear Sight with Tool-free Windage Adjustment Wheel
- Low Profile 3mm Locking Bolt and Mounting Deck Securely Attaches to any Picatinny Rail, 0.55" Stowed Height





# AR15 FIXED FRONT & REAR SIGHTS

ACCESSORIES AND PARTS

AR15 FIXED FRONT & REAR SIGHTS



**LOW PROFILE SIGHT**  
FOR SAME PLANE APPLICATIONS



(Designed to Match MT-950RS03 Rear Sight)

MT-754X

## Low Profile Super Slim Front Sight

- Low Profile Front Sight with Adjustable A2 Front Sight Post, Fits on Picatinny Handguard or High Profile Gas Block Leveled with Flat Top Upper Receiver
- Utilizes a Locking Torx Screw Side Plate and Squared Recoil Stop to Ensure a Secure Zero Hold
- CNC Machined 6061-T6 Aircraft Aluminum and Steel Construction with a Matte Black Finish

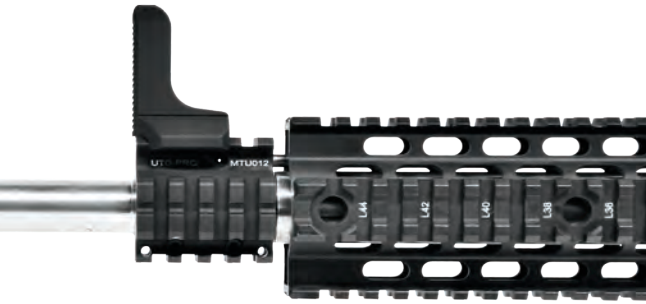

**HIGH PROFILE SIGHT**  
FOR LOWERED OFFSET GAS BLOCK APPLICATIONS



(Designed to Match MT-950RS03 Rear Sight)

MT-750X

## High Profile Super Slim Front Sight

- High Profile Front Sight with Adjustable A2 Front Sight Post, Fits Lowered Offset Picatinny Railed Gas Blocks
- Utilizes a Locking Torx Screw Side Plate and ISquared Recoil Stop to Ensure a Secure Zero Hold
- CNC Machined 6061-T6 Aircraft Aluminum and Steel Construction with a Matte Black Finish



(Designed to Match MT-754X & MT-750X Front Sight)

MT-950RS03

## Super Slim Rear Sight

- Precision CNC Machined 6061-T6 Aircraft Aluminum Base with Steel A2 Sight Assembly
- Slim and Lightweight Profile with a Durable Wear Resistant Matte Black Finish
- Tool-free Windage and Elevation Adjustment with Dual Apertures
- Utilizes a Single Locking Torx Screw and Squared Recoil Stop for a Secure Zero Hold and Return to Zero on MIL-STD-1913 Picatinny Rails



# AR15 CARRY HANDLE SIGHTS



# SHOTGUN SIGHTS



FORGED 7075-T6 ALUMINUM



TLURS001

## UTG PRO® Mil-spec Forged Carry Handle Sight

- Mil-spec Match Grade Detachable Carry Handle with A2 Sight Assembly
- Picatinny Mounting Base with Full Length Locking Plate and Dual Oversized Locking Thumb Wheels
- Forged 7075-T6 Aluminum and Steel Construction Finished in a Matte Black Anodization
- Steel A2 Sight Assembly Provides Precise and Reliable Windage/Elevation Adjustment, Complete with Dual Aiming Apertures



OEM



MT-950X

## Enhanced Carry Handle Rear Sight

- Utilizes a Full Length Two Point Locking Side Plate with Low Profile Thumb Wheels and Four Integral Recoil Stops to Ensure a Secure Zero Hold
- CNC Machined 6061-T6 Aluminum and Steel Construction with a Matte Black Finish

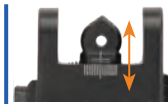
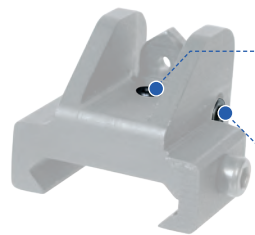

Elevation Adjustment

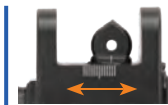

Windage Adjustment



MNT-910

## 12 GA. Shotgun Sub-compact Rear Sight

- Precision Machined from Aircraft Aluminum and Finished in a Matte Black Anodization
- Unobtrusive Low Profile Picatinny Mounting Deck
- Complete Windage and Elevation Adjustment in a Super Compact Size
- Optimally Sized Aperture for Quick Target Acquisition while Minimizing View Obstruction
- Designed to Match 12 Ga. Shotgun Front Sight, MNT-722



Elevation Locking Set Screw



MNT-722

## 12 GA. Shotgun Clamp-on Front Sight

- Compatible with Mossberg® 12 Ga. Shotguns Equipped with a Front Bead Sight and Other Shotguns with Equivalent Barrel Diameter and Sight Arrangement
- Precision Machined from Aircraft Aluminum and Finished in a Matte Black Anodization
- Complete with 2-in-1 Steel Sight Adjustment Tool
- Designed to Match UTG® 12 Ga. Shotgun Sub-Compact Rear Sight, MNT-910





# AR15 OPS READY S5 FIXED STOCK



# A2 RECEIVER EXTENSION TUBE KIT

ACCESSORIES AND PARTS  
S5 FIXED STOCK & A2 RECEIVER EXTENSION TUBE KIT

- IMPACT/HEAT RESISTANT POLYMER
- FIXED STOCK

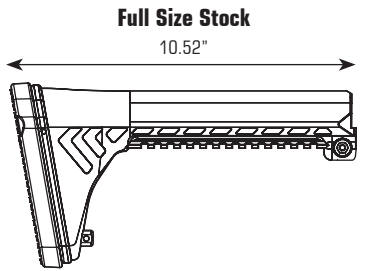

- AVAILABLE COLOR(S)  
■ Black
- PARTS INCLUDED

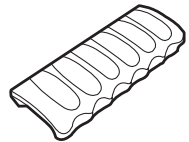

Picatinny Panel Covers (X2)



Stock Screw

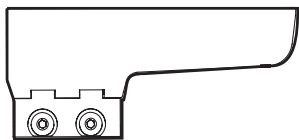

Removable Cheek Rest



**NEW**



**BLACK**



S5 Fixed Stock Cheek Riser

## UTG PRO® AR15 Ops Ready S5 Fixed Stock

- Proudly Designed and Made in USA
- Stock Molded from Impact Resistant High Strength Matte Black Polymer
- Built for Heavy Duty Use with the Tightest Tolerance Controls to Provide the Most Secure Fit and Function
- Compatible with Rifle-length Receiver Extension Tube, Does Not Require A2 Buttstock Spacer
- Overall Length with Ergonomic Slanted Cheek Rest and Steel Reinforced Rubberized Butt Pad
- Integral Picatinny Rail Attaches Included 0.23" Cheek Riser and Other Accessories
- Reversible Quick Detach Sling Swivel Housing for Left or Right Handed Shooters and Standard Sling Swivel Stud for Traditional Slings

Model #	RBUS5BMS-A
Type	Stock Only
Color	Black
Dimensions	10.5"x 2.0"x 5.6"
Weight	14.8oz



- PARTS INCLUDED IN KIT

**NEW**



Rifle Length Extension Tube



Stock Spacer



Stock Screw

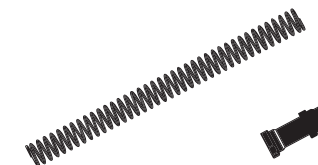

Buffer Spring



Recoil Buffer

## A2 Receiver Extension Tube Kit

- Rifle-length Extension Tube Precision Machined from 6061-T6 Aluminum and Finished in a Matte Black Anodization
- Includes Rifle-length Extension Tube, Buffer, and Spring, A2 Stock Spacer, and Stock Screw

Model #	TLT-A2KT
Platform	AR15
Type	Fixed A2 / Stock Assembly
Color	Black
Dimensions	10.15" x 1.3" x 1.3"
Weight	10.5oz



# AR15 | AR308 FIXED STOCK ASSEMBLIES

- IMPACT/HEAT RESISTANT POLYMER
- FIXED STOCK

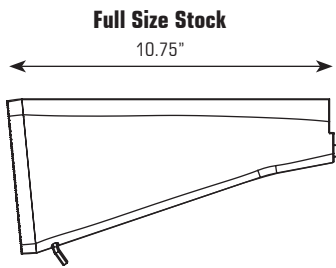

- AVAILABLE COLOR(S)**
- Black
  - Flat Dark Earth

- PARTS INCLUDED**

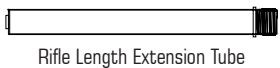

Storage Compartment

## AR15 A2 Fixed Butt Stock Assembly

- Stock Molded from Impact Resistant High Strength Polymer



Storage Compartment

## AR308 A2 Fixed Butt Stock Assembly

- Stock Molded from Impact Resistant High Strength Polymer
- Compatible with Armalite® AR-10®, DPMS® LR-308, S&W M&P®10, and Other Clones

Model #	RB-T469B	RB-T469D	RB-T308FB
Platform	AR15		AR308
Type	Fixed A2 / Stock Assembly		
Color	Black	FDE	Black
Dimensions	10.8" x 1.6" x 5.1"		
Weight	26.4oz		25.5oz





# AR15 COLLAPSIBLE STOCKS & ASSEMBLIES

- MADE IN USA
- IMPACT/HEAT RESISTANT POLYMER
- ADJUSTABLE STOCK

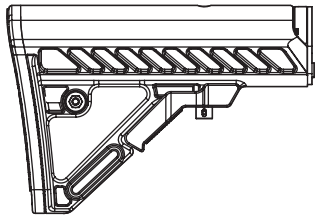

- AVAILABLE COLOR(S)
  - Black
  - Flat Dark Earth
- PARTS INCLUDED IN KIT



6 Position Mil-spec Extension Tube



Recoil Buffer



Receiver End Plate



Castle Nut



Dual Storage Compartments with Removable Waterproof Caps Store Up to 8 CR123 Batteries



## UTG PRO® AR15 S1 6 Position Stocks & Assemblies

- Stock Molded from Impact Resistant High Strength Polymer
- Extended 8" Length for Increased Length of Pull
- Built for Heavy Duty Use with the Tightest Tolerance Controls to Provide the Most Secure Fit and Function



## UTG PRO® AR15 S2 6 Position Stocks & Assemblies

- Stock Molded from Impact Resistant High Strength Polymer
- Lightweight Slim Profile with Extended 7.5" Length for Increased Length of Pull
- Built for Heavy Duty Use with the Tightest Tolerance Controls to Provide the Most Secure Fit and Function

Model #	RBUS1BM	RBUS1DM	RBUS1BMS	RBUS1DMS	RBUS2BM	RBUS2DM	RBUS2BMS	RBUS2DMS
Type	Mil-spec							
	Stock Assembly		Stock Only		Stock Assembly		Stock Only	
Color	Black	FDE	Black	FDE	Black	FDE	Black	FDE
Dimensions	8.5"x2.3"x5.5"				8.0"x1.5"x5.3"			
Weight	23.1oz		12.6oz		19.7oz		9.9oz	

US PAT. D773005



FDE  
BLACK

### UTG PRO® AR15 S3 6 Position Stocks & Assemblies

- Stock Molded from Impact Resistant High Strength Polymer
- Sub-compact Profile for Lightweight, Comfortable Performance
- Built for Heavy Duty Use with the Tightest Tolerance Controls to Provide the Most Secure Fit and Function

US PAT. D818074



FDE  
BLACK

### UTG PRO® AR15 S4 4 Position Stocks & Assemblies

- Stock and Cheek Rest Molded from Impact Resistant High Strength Polymer
- Lightweight, Ultra Sub-compact Profile, Ideal for Compact Applications
- Built for Heavy Duty Use with the Tightest Tolerance Controls to Provide the Most Secure Fit and Function
- Included Removable Cheek Rest for Improved Shooting Stability and Comfort



FDE  
BLACK

### UTG PRO® AR15 U6 6 Position Stock Assemblies

- Stock Molded from Impact Resistant Polymer with Reinforced Stress Points for Maximum Durability
- Built for Heavy Duty Use with the Tightest Tolerance Controls to Provide the Most Secure Fit and Function
- Dual Standard Sling Loop Attachment Points
- Lightweight Design with a Classic Look and Feel

Model #	RBUS3BM	RBUS3DM	RBUS3BMS	RBUS3DMS	RBUS4BM	RBUS4DM	RBUS4BMS	RBUS4DMS	RBU6BM	RBU6DM
Type	Mil-spec									
	Stock Assembly		Stock Only		Stock Assembly		Stock Only		Stock Assembly	
Color	Black	FDE	Black	FDE	Black	FDE	Black	FDE	Black	FDE
Dimensions	6.1"x1.5" x4.8"				4.3" x1.7" x4.8"				6.9" x1.7" x5.2"	
Weight	16.9oz		7.0oz		15.5oz		5.7oz		17.0oz	





# AR15 | AR308 6 POSITION RECEIVER EXTENSION TUBES & KITS

**MADE IN USA**

6065-T6 ALUMINUM

7075-T6 ALUMINUM

PRECISION MACHINED

### 6 Position Extension Tube



Mil-spec



Commercial-spec

**AVAILABLE COLOR(S)**

- Matte Black Anodization
- Matte Blue Anodization
- Matte Red Anodization
- Matte Bronze Anodization
- FDE CERAKOTE®

**PARTS INCLUDED IN KIT**



6 Position Mil-spec Extension Tube



Buffer Spring



Recoil Buffer



Receiver End Plate



Castle Nut

## UTG PRO® AR15 & AR308 6 Position Receiver Extension Tubes & Kits

- Extension Tube CNC Machined from 7075-T6 or 6061-T6 Aircraft Aluminum with Precisely Rolled Threads for Durable Thread Engagement with Lower Receiver
- Tightest Tolerance Controls for a Secure Fit and Function with Various Collapsible Stocks
- Finished in a Matte Black/Blue/Red/Bronze Hard Coat Anodization or FDE CERAKOTE®



7075-T6 | 6061-T6

**AR15 Mil-spec 6 Position Receiver Extension Tubes** | **AR15 Mil-spec 6 Position Receiver Extension Tube Kits** | **AR15 Commercial-spec 6 Position Receiver Extension Tube** | **AR308 6 Position Receiver Extension Tube**

BLACK TLU001MS | BLACK TLU001 | BLUE TLU001B | RED TLU001R | BRONZE TLU001Z | FDE TLU001D

BLACK TLU001-KIT | FDE TLU001D-KIT

BLACK TLU006

BLACK TLU002

Model #	TLU001-KIT	TLU001D-KIT	TLU001MS	TLU001	TLU001R	TLU001B	TLU001Z	TLU001D	TLU006	TLU002
Platform	AR15									AR308
Type	Mil-spec								Commercial-spec	Mil-spec
	Tube Kit			Tube Only						
Material	6061-T6		7075-T6	6061-T6						
Color	Black	FDE	Black	Black	Red	Blue	Bronze	FDE	Black	Black
Dimensions	7.3"x1.1"x1.4"								7.8"x1.2"x1.5"	7.9"x1.1"x1.4"
Weight	9.3oz			4.0oz					5.0oz	4.0oz





# AR PISTOL RECEIVER EXTENSION TUBES & KITS

## UTG PRO® AR Pistol Receiver Extension Tube & Kits

- 1.2" OD Receiver Extension Tube Compatible with AR15 Lower Receivers
- Precision Machined from 7075-T6 Aircraft Aluminum with a Dry Film Lube Coated Interior for Smoother and More Reliable Cycling
- Finished in a Matte Black Type III Class II Hard Coat Anodized Finish
- Compatible with Standard AR15 Type Buffers and Springs
- Compatible with Most AR Pistol Receiver Extension Tube Covers



**AR Pistol Receiver Extension Tube**  
BLACK  
TLU008

### PARTS INCLUDED IN KIT

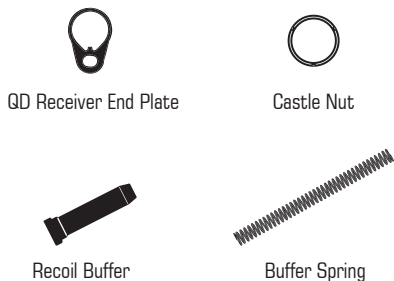

**AR Pistol Receiver Extension Tube Kit**  
BLACK  
TLU008-KIT

## UTG PRO® AR Pistol Extended Receiver Extension Tube & Kits

- Precision Machined from 7075-T6 Aircraft Aluminum with a Dry Film Lube Coated Interior for Smoother and More Reliable Cycling
- Finished in a Matte Black Type III Class II Hard Coat Anodized Finish
- Compatible with Standard AR15 Type Buffers and Springs
- 8.5" Extended Length and Compatible with Gear Head Works® Tailhook™ Mod 1 Brace and or Most AR Pistol Receiver Extension Tube Covers



**AR Pistol Extended Receiver Extension Tube**  
BLACK  
TLU009

### PARTS INCLUDED IN KIT

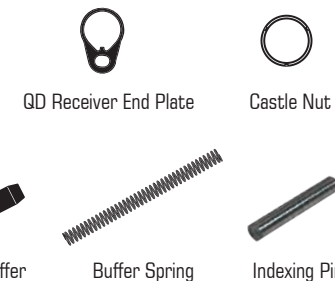

**AR Pistol Extended Receiver Extension Tube Kit**  
BLACK  
TLU009-KIT

### OPTIONAL ACCESSORIES



**H3 Recoil Buffer**  
• 3 Heavy Tungsten Weights  
• Potentially Increases Dwell Time, Eases Extraction, and Reduces Felt Recoil  
• Total Weight 5.4 oz



**H2 Recoil Buffer**  
• 2 Heavy Tungsten Weights and 1 Steel Weight  
• Potentially Increases Dwell Time, Eases Extraction, and Reduces Felt Recoil  
• Total Weight 4.6 oz



**Carbine Recoil Buffer**  
• 3 Steel Weights  
• Total Weight 3.0 oz

Model #	TLU008	TLU008-KIT	TLU009	TLU009-KIT
Platform	AR Pistol			
Type	Tube Only	Tube Kit	Tube Only	Tube Kit
Material	7075-T6			
Color	Black			
Dimensions	OD 1.2"x7.2"		OD 1.3"x8.5"	
Weight	4.0oz	9.9oz	6.2oz	12.2oz





# AR15 PISTOL GRIPS



**AMBIDEXTROUS**  
Compatible with  
Ambi Safeties



25°  
Straighter 25°  
Vertical Grip Angle

BLACK RBUPG01B  
FDE RBUPG01D

## Ambidextrous Contoured Pistol Grip



Model #	RBUPG01B	RBUPG01D
Color	Black	FDE
Material	Polymer	
Height	4.6"	
Weight	3.7oz	

- Compatible with Most Ambidextrous Safety Levers
- Ergonomic Finger Grooves with Nonslip Textured Grip Serrations Provide a Solid and Repeatable Grip
- Ergonomic Symmetrical Palm Swells Reduce Fatigue and Improve Handling Comfort
- Built-in Storage Compartment with Removable End Cap for Small Parts, Batteries, and or Other Accessories



**RIGHT  
HAND**



BLACK RB-TPG172B  
FDE RB-TPG172D

## Combat Sniper Pistol Grip



Model #	RB-TPG172B	RB-TPG172D	RB-TPG269B
Color	Black	FDE	Black
Material	Polymer with Rubberized Coating		
Height	4.8"		4.6"
Weight	5.1oz		4.8oz

- Nonslip Textured Finger Grooves Provide a Solid and Repeatable Grip
- Ergonomic Symmetrical Palm Swells Reduce Fatigue and Improve Handling Comfort
- Built-in Storage Compartment with Removable End Cap for Small Parts, Batteries, and or Other Accessories



**RIGHT  
HAND**



BLACK RB-TPG269B

## Ergonomic Pistol Grip



# AR LOWER COMPONENTS

**NEW**



**AMBIDEXTROUS**  
Compatible with  
Ambi Safeties



Straighter 18°  
Vertical Grip Angle



BLACK RBT-APG01B

**Ultra Slim Pistol Grip**

Model #	RBT-APG01B
Color	Black
Material	Polymer
Height	4.65"
Weight	3.8oz

Compatible with Most Ambidextrous Safeties

Nonslip Textured Front, Back, and Side to Side Grip Paneling

Impact Resistant Matte Black Polymer Construction

Built-in Grip Storage with Hinged Floor Plate



Oversized Bolt Catch

TLI-TKS01

## AR15 Lower Upgrade Kit



TLI-TKSBC

### Oversized Bolt Catch

- Serrated and Oversized Bolt Release and Extended Catch for Easier Reach and Manipulation
- Steel Construction Finished in Matte Black Anodization
- Includes Installation Hardware



TLI-TKSLT

TLI-TKSLTB

TLI-TKSLTR

### Ambidextrous 45/90 Safety Selector

- Reversible Short and Long Oversized Levers Finished in a Matte Black Anodization
- Aluminum and Steel Construction
- 45 or 90 Degree Throw Configurable
- Includes Installation Tool and Hardware, Detent, and Detent Spring



Oversized Trigger Guard



Ambidextrous 45/90 Safety Selector



Ambidextrous Extended Magazine Release



TLI-TKSTG

TLI-TKSTGB

TLI-TKSTGR

### Oversized Trigger Guard

- Enlarged Open Geometry Provides Easier and Safer Access to Trigger Particularly when Wearing Gloves
- Aluminum Construction Finished in Matte Black Anodization
- Includes Installation Tool and Hardware



TLI-TKSMR

TLI-TKSMRB

TLI-TKSMRR

### Ambidextrous Extended Magazine Release

- Features Oversized and Extended Left and Right Side Releases for Easier Reach and Manipulation
- Aluminum and Steel Construction Finished in Matte Black Anodization
- Includes Installation Tool and Hardware





# AR UPPER COMPONENTS

ACCESSORIES AND PARTS



TL-CHL01

## Extended Charging Handle Latch

- Larger Surface Area for Faster Manipulation
- Durable Steel Construction with Wear Resistant Finish
- Compatible with Standard Mil-spec AR15 Charging Handles



RBT-TKSDC

## Quick Install Dust Cover

- Matte Black Impact and Heat Resistant Polymer Construction with Steel Spring-loaded Detent
- Patented Tool-free Design Quickly Installs Without Having to Remove The Handguard Prior
- Compatible with all .223/5.56 Mil-spec. and Most Billet Upper Receivers



NEW



MTU012AG7

## UTG PRO® AR15 Adjustable Micro Gas Block

- 12 Position Gas Port Adjustments
- Low Profile, Fits Underneath Most Free Float Handguards
- Precision Machined Steel to Exacting Tolerances for .750" Diameter Barrels at the Gas Port
- Durable and Corrosion Resistant Manganese Phosphate Finish
- Includes Gas Tube Roll Pin, Serrated Self-locking Set Screws, and Adjustment and Installation Tool



MNT-ARMGB01

## AR15 Micro Gas Block

- Low Profile, Fits Underneath Most Free Float Handguards
- Precision Machined Steel to Exacting Tolerances for .750" Diameter Barrels at the Gas Port
- Durable and Corrosion Resistant Manganese Phosphate Finish
- Includes Gas Tube Roll Pin, Serrated Self-locking Set Screws, and Installation Tool



12 Position Gas Port Adjustment

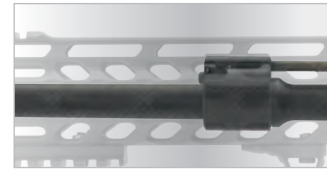

Low Profile, Fits Underneath Most Free Float Handguards

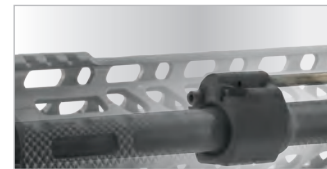

Compatible with Direct Impingement Systems

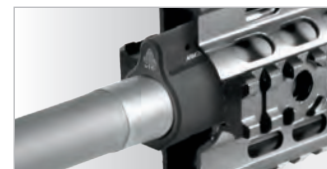

Precision Machined Steel to Exacting Tolerances

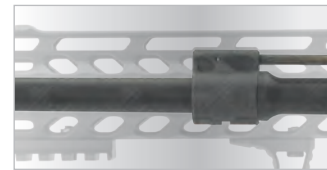

Low Profile, Fits Underneath Most Free Float Handguards

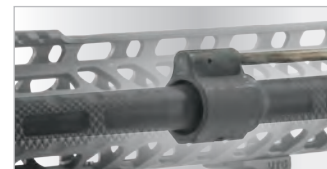

Compatible with Direct Impingement Systems



NEW



TLUMD03

## UTG PRO® Stubby Muzzle Brake - 9MM

- Steel Construction Finished in Black Nitride
- 1/2"-28 UNEF Thread Compatible and Includes Crush Washer
- Gas Dispersion Porting Lessens Felt Recoil and Muzzle Rise
- 1.75" Length Model



TLUMD01

## UTG PRO® Stubby Muzzle Brake - 5.56

- Steel Construction Finished in a Matte Black Manganese Phosphate Surface Treatment for Corrosion Resistance
- 1/2"-28 UNEF Thread Compatible, Crush Washer Included
- 1.75" Length with Three Left and Right Sided Gas Dispersion Ports for Improved Recoil Reduction and Handling



TLUMD02

## UTG PRO® Muzzle Brake - 5.56

- Steel Construction Finished in a Matte Black Manganese Phosphate Surface Treatment for Corrosion Resistance
- 1/2"-28 UNEF Thread Compatible, Crush Washer Included
- 2.25" Length with Four Left and Right Sided Gas Dispersion Ports for Improved Recoil Reduction and Handling

AR UPPER COMPONENTS



# AR PLATFORM ARMORER'S WRENCHES

TL-ARWR01

## AR15/AR308 Armorer's Multi-function Combo Wrench

- Provides the Tools to Install and Remove Parts Often Replaced and or Reinstalled on Both the AR15 and AR308 Platforms such as: Standard A2 Flash Hider, Delta Ring Barrel Nut Assembly, Rifle Length Buffer Tube, Carbine Buffer Tube Castle Nut, and More
- Steel Construction with Wear Resistant Finish for Long Lasting Durability



TL-ARWR02

## Mini AR15 Armorer's Wrench

- Provides the Tools to Install and Remove Parts Often Replaced and or Reinstalled on the AR15 Platforms such as: Standard A2 Flash Hider, Delta Ring Barrel Nut Assembly, Rifle Length Buffer Tube, Carbine Buffer Tube Castle Nut, and More
- Steel Construction with Wear Resistant Finish for Long Lasting Durability



1. Delta Ring Barrel Nut

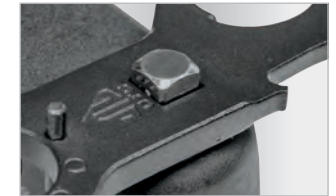

2. 1/2" and or 3/8" Socket Adaptor



3. Jam Nut - YHM® Compatible



4. UTG PRO® Super Slim Barrel Nut



5. AR15 Muzzle Device



6. A2 Stock Extension Tube



7. AR308 Muzzle Device



8. Castle Nut



9. 3-prong Muzzle Device



10. Flat Head Screw Driver





# ANGLED FOREGRIPS, INDEX MOUNTS & HANDSTOPS

ACCESSORIES AND PARTS

ANGLED FOREGRIPS, INDEX MOUNTS & HANDSTOPS



## M-LOK®, Keymod & Picatinny Angled Foregrips

- 6061-T6 Aluminum Construction Available in Matte Black, Blue, or Red Anodization, and Available for M-LOK®, Keymod, and Picatinny Modular Systems
- Weight Reduction Lightening Cuts, Ergonomic Contours, and Serrated Front, Bottom, and Rear Faces for Added Grip Retention
- Promotes Proper Support Hand Memory Placement and Retention

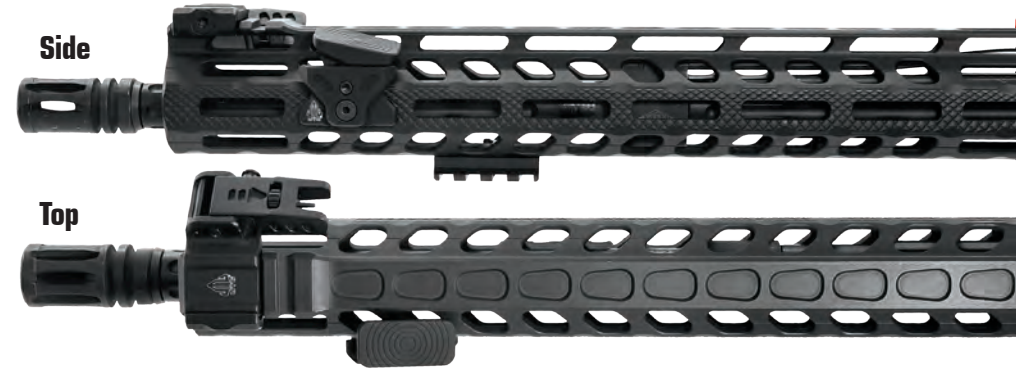

Reversible Design for Installation at the 3 or 9 O'clock Handguard Positions



## M-LOK® & Keymod Angled Index Mounts

- Precision Machined from 6061-T6 Aluminum and Finished in a Matte Black Anodization
- Provides an Additional Support Hand Indexing and Retention Point
- Reversible Design for Installation at the 3 or 9 O'clock Handguard Positions
- Compatible with the Majority of Octagonal Handguards
- Thumb Indexing Deck Configurable for Forward or Rearward Cant
- Spacer Included for Adjusting Clearance with 12 O'clock Mounted Accessories and Pressure Switches

Model #	<ul style="list-style-type: none"> <li>■ Matte Black</li> <li>■ AB=Matte Blue</li> <li>■ AR=Matte Red</li> </ul>	MT-AFGP01	MT-AFGM01	MT-AFGK01	TL-TRM01	TL-TRK01
		N/A	MT-AFGM01B	MT-AFGK01B	TL-TRM01B	TL-TRK01B
		N/A	MT-AFGM01R	MT-AFGK01R	TL-TRM01R	TL-TRK01R
Type		PICATINNY	M-LOK®	KEYMOD	M-LOK®	KEYMOD





Reversible Design is Customizable to the User's Specific Requirements



Mount as a Barricade Rest to Provide Stable Support for more Accurate Shooting

Promotes Proper Support Hand Memory Placement and Retention



### M-LOK® & Keymod Ultra Slim Hand Stops

- 6061-T6 Aluminum Construction Available in Matte Black, Blue, or Red Anodization for M-LOK® or Keymod Modular Systems
- Weight Reduction Lightening Cuts, Ergonomic Contours, and Serrated Front, Bottom, and Rear Faces for Added Grip Retention
- Promotes Proper Support Hand Memory Placement and Retention

Model #	<ul style="list-style-type: none"> <li>■ Matte Black</li> <li>■ AB=Matte Blue</li> <li>■ AR=Matte Red</li> </ul>	TL-HSM01	TL-HSK01
		TL-HSM01B	TL-HSK01B
		TL-HSM01R	TL-HSK01R
Type		M-LOK®	KEYMOD



### Keymod Hand Stop/Barricade Rest

- 6061-T6 Aircraft Aluminum Construction with a Matte Black Finish
- Compatible with UTG PRO® Super Slim AR15/AK Keymod Handguards
- Ergonomic Contour Improves Firearm Handling and Speeds Up Transitions
- Promotes Proper Support Hand Memory Placement and Retention

Model #	■ Matte Black	TL-HS02B
Type		KEYMOD



# COMPACT POLYMER VERTICAL FOREGRIPS

ACCESSORIES AND PARTS

COMPACT POLYMER VERTICAL FOREGRIPS



Steel Insert

Nonslip Rubberized



BLACK RB-FGM01

### Compact Polymer M-LOK® Foregrip

- Impact Resistant Matte Black Polymer Construction
- Nonslip Rubberized Grip Texture
- Lightweight, Short, and Compact Profile

Steel Insert

Nonslip Rubberized



BLACK RB-FGK01

### Compact Polymer Keymod Foregrip

- Impact Resistant Matte Black Polymer Construction
- Nonslip Rubberized Grip Texture
- Lightweight, Short, and Compact Profile

Model #	RB-FGM01	RB-FGK01
Color	Black	
Type	M-LOK®	KEYMOD
Material	Polymer with Rubberized Coating	
Height	1.6"	
Weight	2.8oz	



# ALUMINUM FOREGRIPS

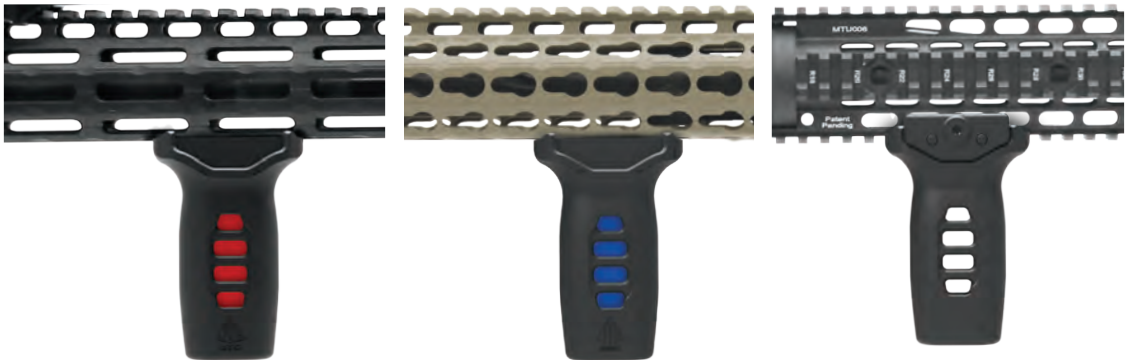

## Removable Red & Blue Anodized Inserts Included (For M-LOK® & Keymod Only)



PICATINNY



MT-FGP01X



M-LOK



MT-FGM01X

2.4"



### Ultra Slim Foregrip

- CNC Machined from 6061-T6 Aluminum and Finished in a Matte Black Anodization
- Mounts Bidirectionally and Features Two Different Ergonomically Serrated Contours to Choose From
- Lightening Cuts Reduce Overall Weight



M-LOK



MT-FGM01



KEYMOD



MT-FGK01



PICATINNY



MT-FGP01

3.5"



### Super Slim Aluminum Foregrips

- Precision Machined from Aircraft Aluminum Finished in a Matte Black Anodization
- Removable Red and Blue Anodized Inserts for M-LOK® and Keymod Models Adds a Level of Personalization
- Slim, lightweight, ergonomic, with dehorned corners and melted contours for a comfortable support hand grip

Model #	MT-FGM01X	MT-FGP01X	MT-FGM01	MT-FGK01	MT-FGP01
Type	M-LOK®	PICATINNY	M-LOK®	KEYMOD	PICATINNY
Width	0.7"	1.11"	1.5"	1.5"	1.5"
Saddle Height	2.4"	2.4"	3.5"	3.5"	3.5"
Weight	1.4oz	1.5oz	4.3oz	4.2oz	4.6oz





# CLASSIC FOREGRIPS

ACCESSORIES AND PARTS



## 2 POSITION FOLDABLE

MNT-GRP002SQ

### 4.7" Quick Detach/Foldable Foregrip

US PAT. 8397421  
US PAT. 8429843

### Aluminum QD Foldable Foregrip

- Precision Machined from Aircraft Aluminum with a Matte Black Finish
- Quick Detachable Picatinny Lever Lock Mounting Base
- Posi-lock Cross Bolt and Spring Tensioned Locking Plate with Steel Insert for a Secure Installation
- Removable End Cap with Waterproof Storage within Foregrip
- Ergonomic Knurled Surface

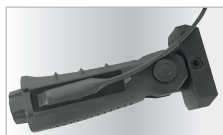

Side Inserts Allow for Use of Pressure Switch



Heavy Duty Full Metal Locking and Folding Mechanism



Ergonomic Finger Grooves



Built-in Battery Storage Compartment



## 5 POSITION FOLDABLE

BLACK RB-FGRP170B

### 5 Position Foldable Foregrip

- End Cap Provides Battery Storage and Mount Tension
- Side Inserts Allow for Use of Pressure Switch
- Simple Slide-on Mounting Deck
- Reinforced Locking Mechanism for Added Durability
- 5 Position Adjustable



Nonslip Textured Finger Grooves and Back Strap



Built-in Storage Compartment with Removable End Cap

BLACK RB-FGRP172B

### Ambidextrous Contoured Foregrip

- Contoured Finger Grooves for a Solid and Repeatable Grip
- Symmetrically Shaped Palm Swell with Nonslip Texture
- Removable End Cap with Storage Compartment within Foregrip
- Molded from Impact Resistant Polymer



Built-in Battery Storage Compartment



Side Inserts Allow for Use of Pressure Switch

BLACK RB-FGRP168B

### Ambidextrous Foregrip

- End Cap Provides Battery Storage and Mount Tension
- Side Inserts Allow for Use of Pressure Switch
- Simple Slide-on Mounting Deck
- Ergonomic Finger Grooves and Nonslip Grip Texture
- Molded from Impact Resistant Polymer



Model #	MNT-GRP002SQ	RB-FGRP170B	RB-FGRP168B	RB-FGRP172B
Operation		Foldable		Fixed
Color	Black	Black	Black	Black
Width	1.4"	1.6"	1.7"	2.3"
Saddle Height	4.6"	5.6"	5.4"	4.5"
Weight	9.7oz	6.9oz	6.8oz	6.0oz

Classic FOREGRIPS



# PISTOL MAGAZINE BASE PADS

- MADE IN USA**
- 6061-T6 ALUMINUM**
- PRECISION MACHINED**
- AVAILABLE COLOR(S)**
  - Matte Black Anodization
  - Matte Blue Anodization
  - Matte Red Anodization
  - Matte Bronze Anodization

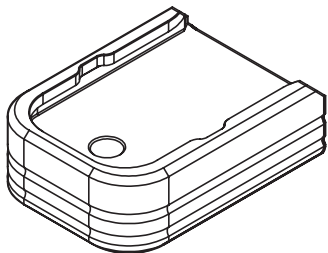

## UTG PRO® +0 Pistol Magazine Base Pads

- Models Available for Some of the Most Popular Double Stack Pistols on the Market
- 0.347" Extended Height and 1 oz. Weight Helps Facilitate Faster Reloads with or without a Magwell

**+0 CAPACITY**



BLACK

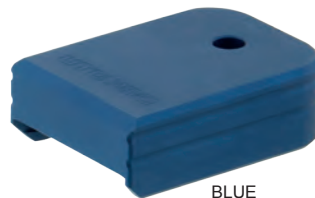

BLUE



RED



BRONZE



Added Weight Facilitates  
Faster Reloads

Melted Contours and  
Dehorned Corners

Extended Height and Grip Serrations  
Improve Magazine Indexing

Model #	<ul style="list-style-type: none"> <li><span style="display: inline-block; width: 10px; height: 10px; background-color: black; margin-right: 5px;"></span> Matte Black</li> <li><span style="display: inline-block; width: 10px; height: 10px; background-color: blue; margin-right: 5px;"></span> B=Matte Blue</li> <li><span style="display: inline-block; width: 10px; height: 10px; background-color: red; margin-right: 5px;"></span> R=Matte Red</li> <li><span style="display: inline-block; width: 10px; height: 10px; background-color: brown; margin-right: 5px;"></span> Z=Matte Bronze</li> </ul>	PUBGL01 PUBGL01B PUBGL01R PUBGL01Z	PUBGL02 PUBGL02B PUBGL02R PUBGL02Z	PUBCZ01 PUBCZ01B PUBCZ01R PUBCZ01Z	PUBHK01 PUBHK01B PUBHK01R PUBHK01Z	PUBSG01 PUBSG01B PUBSG01R PUBSG01Z	PUBSI01 PUBSI01B PUBSI01R PUBSI01Z	PUBSW01 PUBSW01B PUBSW01R PUBSW01Z	PUBWR01 PUBWR01B PUBWR01R PUBWR01Z
Make/Model		<b>GLOCK®</b> Small Frame	<b>GLOCK®</b> Large Frame	<b>CZ®</b> • P07 • P10C 9/40	<b>HK®</b> • VP9	<b>SIG SAUER®</b> • P320 9/40 • P320 X5	<b>SPRINGFIELD ARMORY®</b> • XDm 9mm (with square magazine spring)	<b>SMITH &amp; WESSON®</b> • M&P® 9/40 (double stack only)	<b>WALTHER®</b> • PPQ 9/40
Capacity		+0							
Weight		1.0oz							



# AK | SKS ACCESSORIES



# CZ® CONTROL COMPONENTS



TL-M47SR

## Ak Steel Side Plate

- Durable Steel Construction with a Matte Black Finish
- Fits Both Milled and Stamped AK Receivers and Accepts a Wide Variety of Side Optic Mounts
- Permanent Modification Required



TL-K7FAD01

## AK Side Folding Stock Adaptor

- Requires UTG AK Stock Adaptor (TL-A68747-AD1) for Conversion, Compatible with Most 4/6 Position AR15 Stocks and Extension Tubes
- Heavy Duty Steel Construction with a Matte Black Finish



NEW

- TLT-CSCHO1
- TLT-CSCHO1B
- TLT-CSCHO1R

## Charging Handle for CZ® Scorpion™ EVO 3

- Reversible for Left or Right Side Drop-in Installation
- Extended and Partially Serrated Handle with Dehorned Corners and Melted Contours
- Steel Guide with 6061-T6 Aluminum Handle Finished in a Matte Black, Red, or Blue Anodization
- Compatible with Both Pistol and Carbine Models



NEW

- TLT-CSSLT01
- TLT-CSSLT01B
- TLT-CSSLT01R

## Safety Selectors for CZ® Scorpion™ EVO 3

- Machined from 6061-T6 Aluminum Finished in a Matte Black, Red, or Blue Anodization
- Drop-in Installation, No Permanent Modification Required
- Compatible with Both Pistol and Carbine Models
- Extended and Partially Serrated Selectors with Dehorned Corners and Melted Contours
- Ergonomic Thumb Index for Ease of Manipulating Safety On and Off



Elevation Adjustment



Windage Adjustment

SCP-WEA05

## AK/SKS Front Sight Tool

- An Essential Tool for Making Fine Front Sight Post Windage and Elevation Adjustments
- Compatible with AK, SKS, MAK, and SLR95 Pattern Rifles



RB-K7BTP01

## AK Butt Pad

- Ergonomic Slip-on Design with Reinforced Outer Lip
- 1" LOP Extension





# RAIL PANEL COVERS



Bidirectional to Accommodate Installation around Other Mounted Accessories



Simple and Secure Slide and Snap-on Installation



US PAT. 9989328



RB-HP25B (Set of 7)

## Low Profile Keymod Rail Panel Covers

- 5.5" in Length, Slim, Lightweight, and Securely Fits Into Standard Keymod Rail Slots
- Unique Aggressive Honeycomb Nonslip Textured Design Provides a Sure Grip Every Time
- Heat Resistant Polymer Construction



Bidirectional to Accommodate Installation around Other Mounted Accessories



RB-HP30M (Set of 4)

## Low Profile M-LOK® Rail Panel Covers

- 3.15" in Length, Slim, lightweight, and Securely Installs via Two M-LOK® Screws and Nuts
- Unique Aggressive Nonslip Textured Design Provides a Sure Grip Every Time
- Molded from Durable Impact and Heat Resistant Polymer with a Rubberized Overmold for Added Grip Traction

Nonslip Rubberized Texture



2.7" in Length, Slim, Lightweight, and Securely Fits into Any Picatinny Rail



Simple and Secure Snap-on Installation with Posi-lock Stop Bar to Prevent Shifting

RB-HP27B (Set of 6)

## Low Profile Picatinny Panel Covers

- Molded from Durable Impact and Heat Resistant Polymer
- 2.7" in Length, Slim, Lightweight, and Securely Fits into Any Picatinny Rail
- Unique Scalloped Design Provides a Comfortable Nonslip Gripping Surface While Protecting the Rail Underneath it



2" in Length, Slim, Lightweight, and Securely Fits into Any Picatinny Rail



Simple and Secure Snap-on Installation with Posi-lock Stop Bar to Prevent Shifting



US PAT. 6725594  
US PAT. D730474

BLACK RB-HP12B-B (Set of 12)

## Low Profile Picatinny Rubber Rail Guards

- Provides a More Comfortable Gripping Surface
- Easily Snaps onto Picatinny Rails Without Shifting due to Integral Stop Bar
- Protects the User from Sharp Rail Edges While Protecting the Rail Itself





# QUICK DETACH SLING SWIVEL ADAPTORS & PLATE

ACCESSORIES AND PARTS



TL-SWPK01

## Picatinny/Keymod QD Sling Swivel Adaptor

- Innovative, Compact, and Lightweight Design Adaptable for Installation on Both Picatinny or Keymod Rails
- Accepts Any Standard Quick Detach Sling Swivel with 0.37" Diameter Swivel Stud
- Precision Machined from Aircraft Aluminum with a Matte Black Finish



TL-SWK01

## Keymod QD Sling Swivel Adaptor

- Compact, Lightweight, Super Low Profile Keymod Base
- Accepts Any Standard Quick Detach Sling Swivel with 0.37" Diameter Swivel Stud
- Precision Machined from Aircraft Aluminum with a Matte Black Finish



TL-SWPM01

## Angled QD Sling Swivel Picatinny Adaptor

- Accepts Any Standard Quick Detach Sling Swivel with 0.37" Diameter Swivel Stud
- Precision Machined from Aircraft Aluminum with a Matte Black Finish
- Low Profile and Lightweight Design with 45 Degree Offset
- Designed with Quarter-turn Rotational Over Travel Stops to Restrict Swivel Movement and Prevent Sling Tangling



BLACK TLUSW001  
FDE TLUSW001D

## UTG PRO® M-LOK® QD Sling Swivel Adaptor

- Precision Machined from 6061-T6 Aircraft Aluminum with a Matte Black Anodization or FDE CERAKOTE®
- Lightweight, Low Profile Design Requires Minimal M-LOK® Rail Space while Retaining Optimum Mount Performance
- Bidirectionally Mounts and Efficiently Utilizes Rail Real Estate by Mounting Either in One Slot or In-between Adjacent Slots on the Same Track
- Accepts Any Standard Quick Detach Sling Swivel with 0.37" Diameter Swivel Stud
- Designed with Quarter Turn Rotational Over Travel Stops to Restrict Swivel Movement and Prevent Sling Tangling



TLUSW002

## UTG PRO® Keymod QD Sling Swivel Adaptor

- Precision Machined from 6061-T6 Aircraft Aluminum with a Matte Black Anodization
- Accepts Any Standard Quick Detach Sling Swivel with 0.37" Diameter Swivel Stud
- Designed with Quarter Turn Rotational Over Travel Stops to Restrict Swivel Movement and Prevent Sling Tangling



TL-T6TD03

## AR15 QD Receiver End Plate

- Compatible with Standard Mil-spec AR15 Lower Receiver
- Solid Steel Construction with a Matte Black Finish
- Accepts Any Standard Quick Detach Sling Swivel with 0.37" Diameter Swivel Stud
- Designed with Quarter Turn Rotational Over Travel Stops to Restrict Swivel Movement and Prevent Binding Against the Buffer Tube and Sling Tangling





# QUICK DETACH SLING SWIVELS



TL-SWMTPO1

## Picatinny Sling Swivel Mount with 1.25" Loop

- Precision Machined Aircraft Aluminum and Steel Construction with a Matte Black Finish
- Solid Steel 1.25" Sling Loop Compatible with Most Slings on the Market



TL-QDSW38

## Push Button QD Sling Swivel with 1.41" Loop

- High Strength Steel Construction with a Matte Black Finish



TL-QDSW18

## Standard Push Button QD Sling Swivel with 1.38" Loop

- High Strength Steel Construction with a Matte Black Finish



TL-QDSW08A

## Standard Push Button QD Sling Swivel with 1.09" Loop

- High Strength Steel Construction with a Matte Black Finish



TL-QDSW08B

## Standard Push Button QD Sling Swivel with 1.25" Loop

- High Strength Steel Construction with a Matte Black Finish



TL-QDSW08C

## Standard Push Button QD Sling Swivel with 1.29" C-Shape Loop

- High Strength Steel Construction with a Matte Black Finish



Model #	TL-QDSW38	TL-QDSW18	TL-QDSW08A	TL-QDSW08B	TL-QDSW08C
A-Loop Width	1.41"	1.38"	1.09"	1.25"	1.29"
B-Loop Thickness	0.18"	0.17"	0.13"	0.13"	0.13"
C- Push Button Diameter	0.64"	0.60"	0.47"	0.47"	0.47"
D-Stud Diameter	0.37"	0.37"	0.37"	0.37"	0.37"
E-Stud Height	0.35"	0.37"	0.35"	0.35"	0.35"

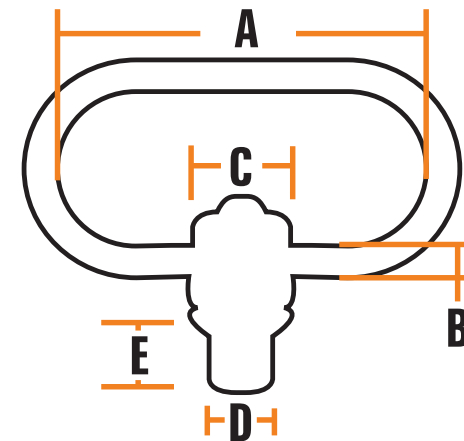





# MISCELLANEOUS FIREARM ACCESSORIES

ACCESSORIES AND PARTS

MISCELLANEOUS FIREARM ACCESSORIES



TL-EX223  
**.223/5.56 Broken Shell Extractor**



TL-EX308  
**.308 Broken Shell Extractor**

## Broken Shell Extractor

- Removes Broken Shell Casings from a Jammed Chamber
- Threaded Two-piece Design to Adjust Overall Length, Compatible with Bolt Action and Semi-automatic Rifles
- Precision Machined from Steel
- Keep One with Your Shooting Gear, in Your Tool Kit, or Gun Case



TL-GLK01  
**California DOJ Approved Firearm Cable Lock**

- Certified by California Department of Justice
- Universal Design Compatible with Most Long Guns and Pistols
- Locking Cable is 0.21"(5.3mm) in Diameter and 15"(381mm) in Length
- Plastic Wrap Prevents Cable from Scratching Firearm Finishes



TL-SHWR01  
**Universal Shotgun Forend Wrench**

- Nickel Plated Steel Construction
- User Friendly with Ergonomic Handles for Easy Forend Removal and Installation
- Compatible with Remington® 870™, Mossberg® 500A/C, 835, and Other Clones



RB-CSF06 (Set of 6)

## Chamber Safety Flag

- Bright Red for High Visibility and Reliable Confirmation of an Unloaded Firearm
- Molded from Impact Resistant Polymer with Reinforced Head for Maximum Durability
- Ideal for Cold Range Use and Mass Produced Firearms



RB-A005  
**AR15 Receiver Wedge**

- Snugly Fits Behind Rear Take Down Pin
- Keeps the Upper Snug and Tight Against the Lower
- Prevents Upper and Lower Receiver Rattle



Reliably Proven and Exceeds  
**MILITARY STANDARDS**  
with Tens of Thousands Sold

MNT-16AD2-C  
**AR15 Blank Firing Adaptor**

- Precision Machined High Strength Steel Construction
- Color Coated for Protection and Discernibility
- Reinforced Frame Surpasses Military Standards
- Ideal for Law Enforcement and Military Training
- User Friendly Bolt Ring for Simple Installation and Removal





# CLEANING KITS, MAT & FRONT SIGHT TOOL

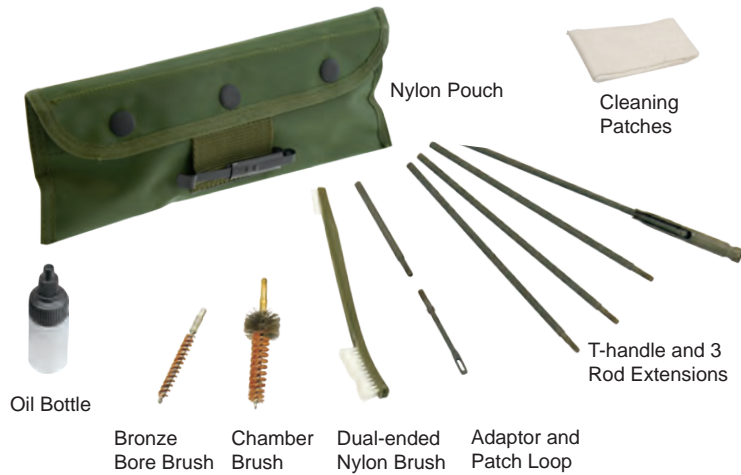

Nylon Pouch

Cleaning Patches

T-handle and 3 Rod Extensions

Oil Bottle

Bronze Bore Brush

Chamber Brush

Dual-ended Nylon Brush

Adaptor and Patch Loop

TL-AD41

## .223/5.56mm Cleaning Kit

- Includes a 5-piece Extension Steel Cleaning Rod with Adaptor, Patch Loop, Bronze Bore Brush, Chamber Brush, Double-Ended Nylon Utility Brush, ½ oz Oil Bottle, and Cleaning Patches
- All Parts Conveniently Store within the Included OD Green Nylon Pouch with Belt Loop and ALICE Clip Attachment Point and Featuring Two Hook-and-Loop Closure Pockets and External Snap Button Flap



Cleaning Rod

Rod Extensions

Patch Loop

Nylon Bore Brush

Bronze Bore Brush

Cotton Mop Brush

TL-CLP9MMKT

## 9mm Pistol Cleaning Kit

- Conveniently Stows Away in Any Range Bag in Its Compact Polymer Case (4.63"x2.88"x1.50")
- Kit Includes an 8-32 Threaded Copper Alloy Cleaning Rod with the Following Threaded Cleaning Accessories: Patch Loop, Bronze and Nylon Brush, and a Cotton Mop



SCP-A1245-A

## Dual A2 Front Sight Tool

- Machined Steel with Knurled Surface Texture
- For Use on Both 4 and 5-prong Front Sight posts

PVC-CLMAT01

## Universal Firearm Cleaning Mat

- 14.75"x52" Universal Firearm Cleaning Mat with Nonslip Rubberized Backing
- 4" Wide Side Pocket with Zipper Closure for Cleaning Tools and Small Parts
- Durable Solvent and Chemical Resistant Material for Long Lasting Performance [Also Refer to P.187]



leapers.com  
734-542-1500  
E-mail: office@leapers.com