

WISENET

DIGITAL VIDEO RECORDER

Quick Manual

HRX-1621/HRX-1620
HRX-821/HRX-820
HRX-421/HRX-420

CE

Features

The product records video and audio from cameras to a hard disk, and enables playback from the hard disk. It also provides remote monitoring environment for video and audio over the network using a remote computer.

- User-friendly UI
- Supports a range of 4K analog/network camera resolutions
- Outputs a 4K high definition image using HDMI
- Record and play video
- Record and play audio
- Supports ONVIF Profile S standard and RTP / RTSP protocols
- Display the HDD operation status by HDD SMART
- Dual Stream recording
- HDD overwrite enabled
- Backup using USB 2.0, 3.0 protocols and external HDD
- Simultaneous play of 6, 10, 18 channels
- Various Search Modes (Time, Event, Smart, Text, Backup, ARB)
- Supports ARB (Network camera)
- Various Recording Modes (Normal, Event, Scheduled Recording)
- Alarm Input / Output
- Remote Monitoring function by UWA3.0
- Installation Wizard Function
- Supports the smartphone remote monitoring feature by P2P support
- Provides smartphone event alarm (sending real-time event messages)

IMPORTANT







- See Installation Instructions Before Connecting to the Supply.
<https://www.hanwha-security.com/en/data-center/download-data/video-recorder/>

Package Contents



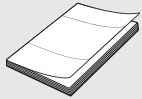

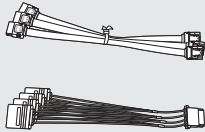

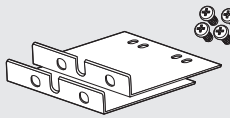
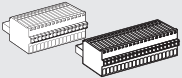



- The actual parts may differ from the images.
- Accessories and quantities may vary by sales region.
- For some regions, HDD is not pre-installed. The quantities of HDD fixing screws and SATA cable vary depending on the number of fixed HDD.

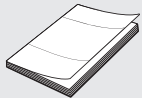

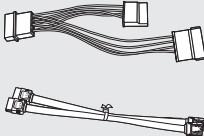

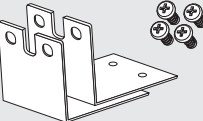

HRX-1621/HRX-821

			
Recorder	Mouse	Quick Manual	Power Cord
			
SATA Cable (HRX-1621: 8 EA, HRX-821: 4 EA)	HDD Fixing Screw (HRX-1621: 32 EA, HRX-821: 16 EA)	Bracket Racks (2 EA)/ Screws (4 EA)	Terminal block (HRX-1621: 15 pins, 20 pins, HRX-821: 12 pins, 15 pins)

HRX-1620/HRX-820/HRX-421

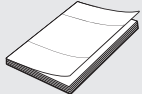
			
Recorder	Mouse	Quick Manual	Power Cord
			
Power Adapter	SATA Cables (2 EA)	HDD Fixing Screws (8 EA)	Bracket Racks (2 EA)/ Screws (4 EA)
			
Terminal block (20 pins) (Only for HRX-421)			

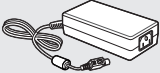
HRX-420

			
Recorder	Mouse	Quick Manual	Power Cord
			
Power Adapter	SATA Cable (1 EA)	HDD Fixing Screw (4 EA)	

HDD Installation

- ! If you are adding a new or previously used HDD to this product in addition to the HDD(s) originally installed, format the new HDD manually in the set before use.
To learn how to format, see "**Device/Format**" in the Wisenet Recorder User Manual.

HRX-1621/HRX-821

- ✍ The images below are based on the HRX-1621 model.

- 1 Loosen the screws on the left/right sides and back and slide the cover back to remove it.
- 2 Loosen the left/right screws and remove the bracket.

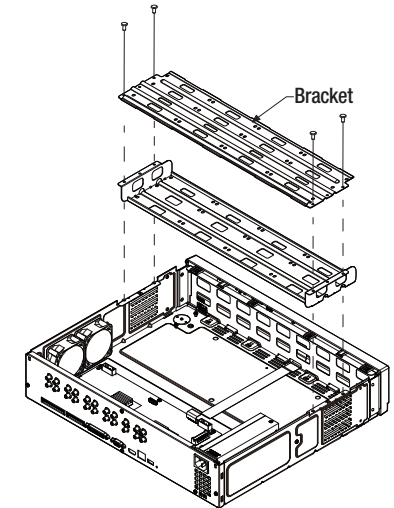
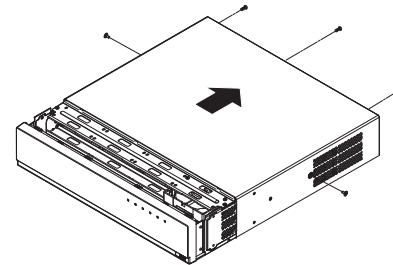

- 3 Install 8 HDDs to the bracket and fix them with screws.
 - For the HRX-821, install the HDD only to the bottom bracket.
- 4 Fix the bracket with the HDD to the recorder with screws.

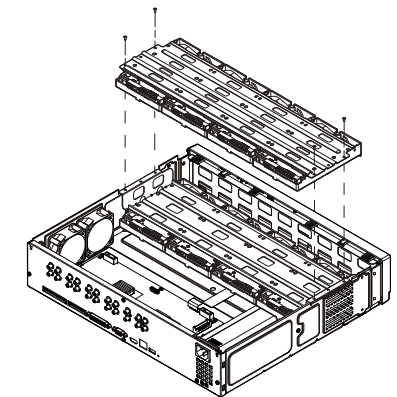
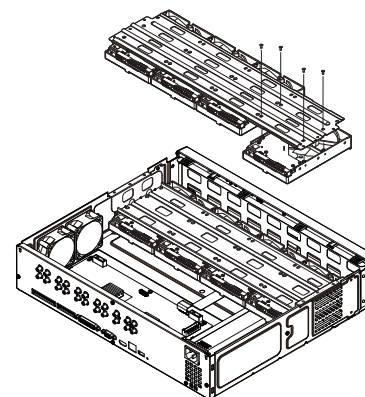

- 5** Connect the SATA/power cable of the HDD to the connector on the motherboard.
- Refer to the figure below for the location/connector number of the HDD.

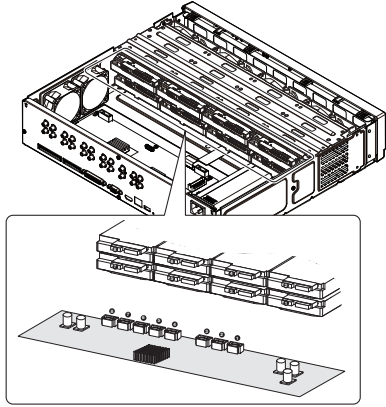

- 6** After making sure that there is no problem with the connection terminal and wiring inside the product, close the cover and fix it with screws.

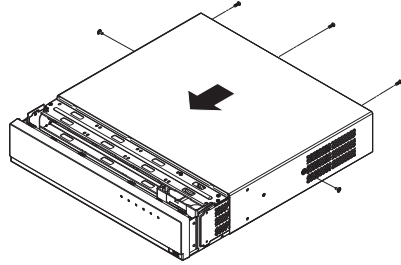

HRX-1620/HRX-820/HRX-421

-  The images below are based on the HRX-1620 model.

- 1** Loosen the screws on the left/right sides and back and slide the cover back to remove it.

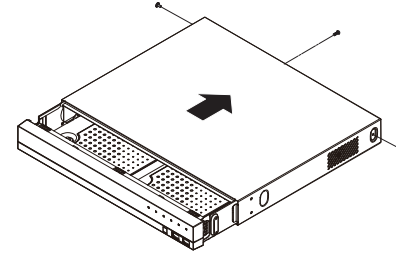

- 2** Connect the SATA/power cable of the HDD to the connector on the motherboard.

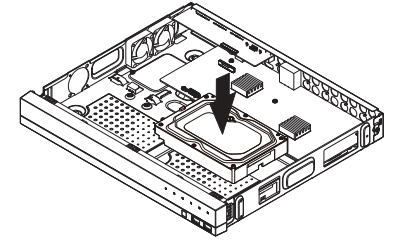

- 3** Fix the HDD to the bottom of the recorder with screws.

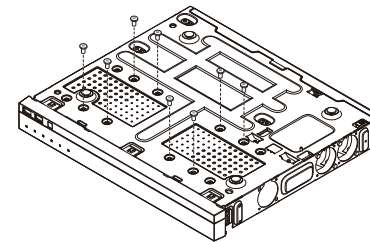

- 4** Check if there is any problem with the connection terminal and wiring inside the product.

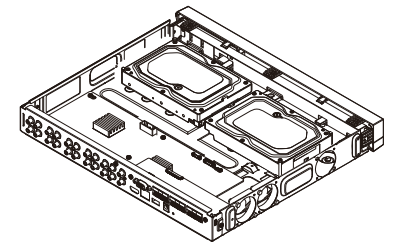

- 5** Close the cover and secure it with screws.

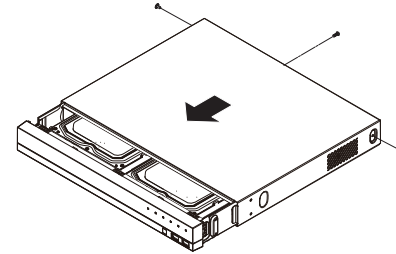

HRX-420

- 1** Loosen the screws on the left/right sides and back and slide the cover back to remove it.

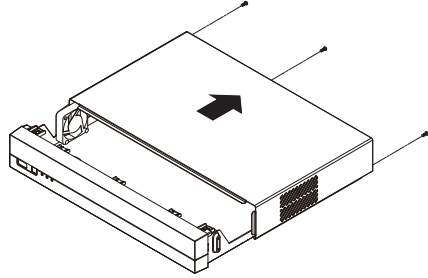

- 2** Connect the SATA/power cable of the HDD to the connector on the motherboard.

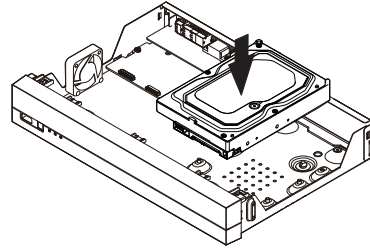

- 3** Fix the HDD to the bottom of the recorder with screws.

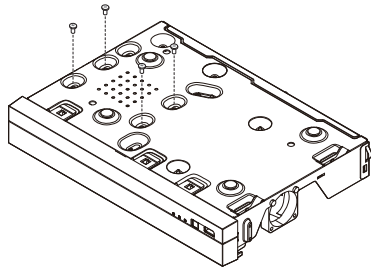

- 4** Check if there is any problem with the connection terminal and wiring inside the product.

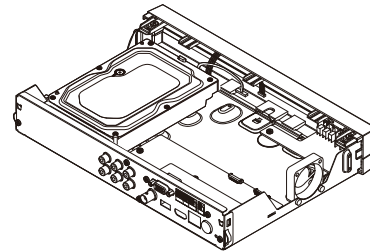

- 5** Close the cover and secure it with screws.

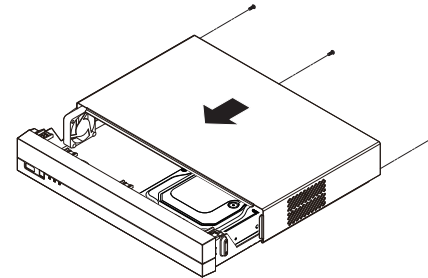

Install Wizard Setup

1 Select the language

Select your preferred language.

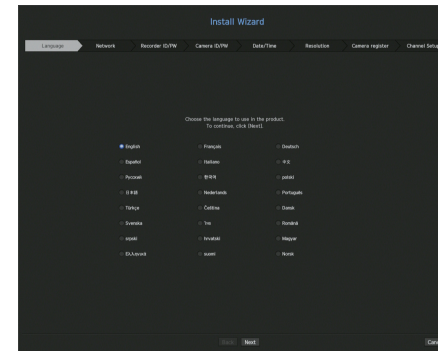

2 Network Settings

- DHCP server: If the DHCP server is set to On, an IP is automatically assigned to the camera.
 - Network 1 (All): It is the port for network camera and external client connection.
- ※ For detailed network settings instructions, refer to the product user manual.
- ▶ To use a simple intranet, click the <Next> button.

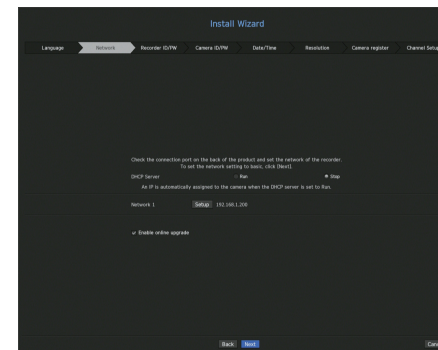

3 Recorder ID/PW Setup

Sets the administrator's password.

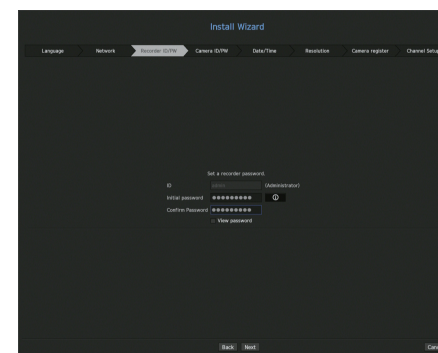

※ Click < ? > to view the basic guide for setting a password. Refer to the password setup rules.

4 Camera ID/PW Setup

- 4-1. Set a camera password in factory reset. The initial password for the camera must be entered.
- 4-2. If ID/PW is already set in the camera, register the ID/PW and click <Next>.

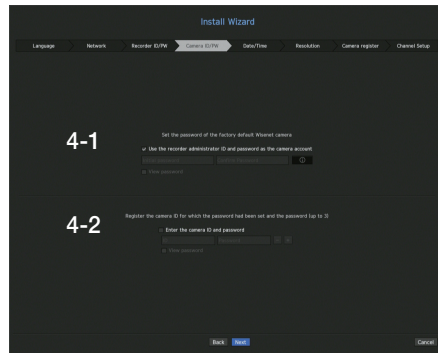

- ※Click < ? > to view the basic guide for setting a password. Refer to the password setup rules.
- ※ When the password is in factory reset, it can be changed and managed in a batch.
- ※ Up to 3 sets of camera ID with password and password can be registered.
- ※ You cannot change the password for cameras registered with ONVIF and RTSP.

5 Date/Time Setup

Set the date, time, time zone, and DST, and then click the <Next> button.

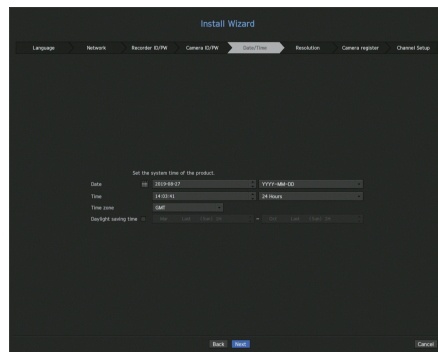

6 Resolution Setup

To set the recommended resolution, click <Apply> followed by the <Next> button.

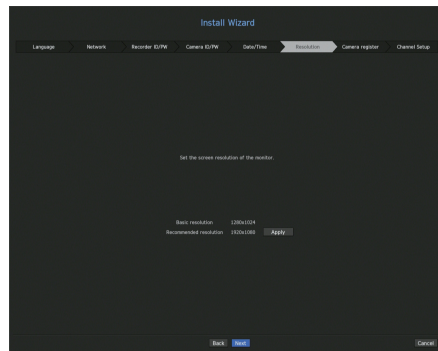

7 Camera Register

- Registers the searched network cameras.
- Select a camera to register from the searched camera list and click the <Register> button.
- Select a camera to register from the list and click the <Change IP> button.
- After completing camera register, click <Next>.

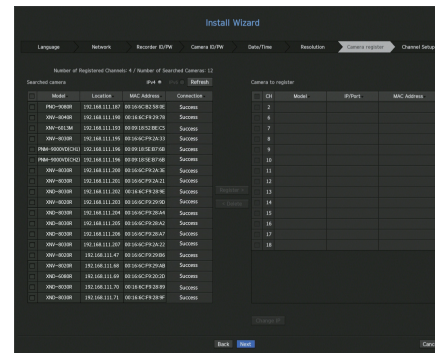

8 Channel Setup

- You can view the camera videos registered to each channel in split mode along with thumbnail information.
- To change the camera video position, select a video and drag and drop it to the desired location.

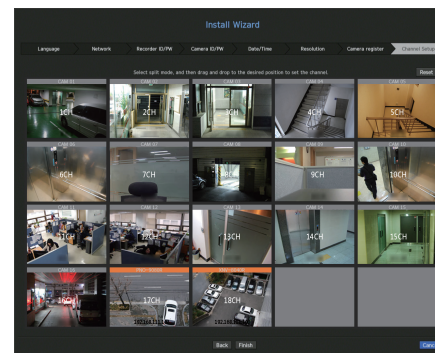

Click the <Finish> button to complete the Install Wizard.

Record Setup

You can set resolution, FPS, and quality of recordings by channel, and by recording type of standard / event. You can check frame rates and data transfer amount of Full Frame and Key Frame recordings for each channel, and set the transfer limit for recordings.

Menu > Record > Record Setup

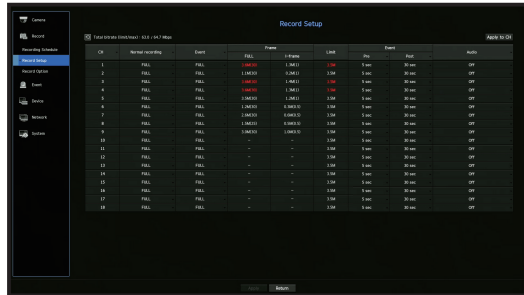

- CH : Click < CH > to display the channel information table.
- Apply to CH : If you select <Apply to CH>, the "Apply to CH" confirmation window will appear. After selecting channels that the settings will be applied to, click on <OK> to apply them to the selected channels.
- Standard, Event : Configures Standard recording and Event recording.
 - FULL : Records all frames fed by the camera.
 - I-frame : Records only key frames fed by the camera. Actual recording rate may differ from camera settings. In general, 1 to 2 frames per second are recorded.
 - OFF : No recording is made.
- Frame
 - FULL : Shows the amount of data for all the scene recordings.
 - I-frame : Shows the amount of data for the main scene recordings.
- Limit : Set the amount of data allowed for input for each channel.
- Event : When an event occurs, you can set which point you will start or stop recording.
 - Pre : When an event occurs, recording will be started regardless of the time set. If you set it to five seconds, recording will start at five seconds before an event occurs.
 - Post : When an event occurs, recording will continue after the time set. If you set it to five seconds, recording will continue for a further five seconds after an event is finished.
- Audio : Specify whether to record the sound received from the camera or not.

- If a channel's data transfer exceeds defined allowed limit, then it may affect to other channels, and may force switching to <I-frame> recording even when the channel is configured to <FULL> recording mode. For Key Frame recording channels, the icon for limited recording appears on the live screen's top side. But if the sum of the limits is below the max limit, you can still receive the entire frames despite exceeding the permitted bitrates for each channel.
- A channel displayed in yellow indicates that the recorded data is not being transferred from the camera and that the recording is being performed temporarily using another profile on the camera. Check the channel information to see the applied profile to the channel listed in yellow. A channel displayed in orange indicates that the amount of inputted data is greater than the permitted data amount. In this case, it is impossible to record all of the incoming frames. Instead, only part of the frames (1 or 2 frames per second) can be recorded. To resolve this issue, you must set the permitted data amount to be greater than the amount of inputted data.

Set up and run the layout

The layout set on the live screen can also be used for time search and can be searched and played according to the channel order and channel combination set by the user.

- For more information on how to set each step, refer to the "User Manual."

1 Live channel layout Setup

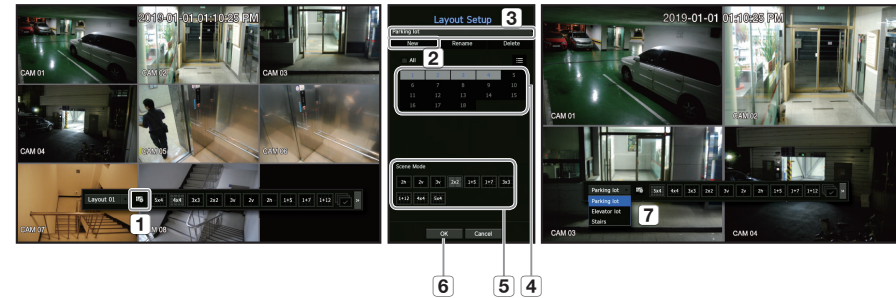

- 1 Open the channel layout setup page.
- 2 Click <New>.
- 3 Specify the layout name of the selected channel (ex. Parking lot).
- 4 Select the channels you want to add to the layout (ex. 1, 2, 3, 4, etc.).
- 5 Decide the split mode to apply (ex. 4-split).
- 6 Click <OK>.
- 7 Select the layout you want to move, and it will be moved immediately (ex. It moves to Parking lot.).

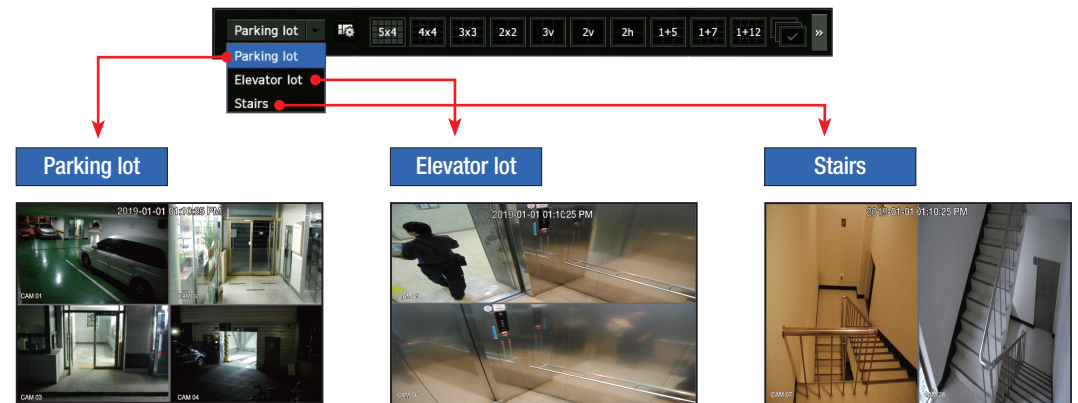

2 Search/Play

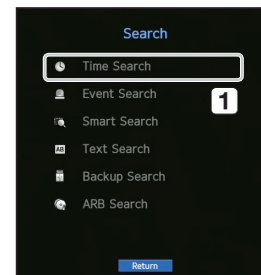

- 1 In live mode, right-click and select <Search>. Select <Time Search>.

2-1 Browse



- 1 The default value is <All channels>. Select the desired layout from the live channel groups.
- 2 Select a channel by the selected group.
- 3 When moving the time bar, you can see the preview screen in the picture of 4.
- 5 Press the <Play> button to play the video.

2-2 Audio Play



- 1 These are the various functions required for play. Hover over it to view the tooltip. Refer to the information to adjust the play controls (Ex.: Skip Backward).
- 2 You can set the specific functions in 1 through playback settings (Ex. Skip play: 10 minutes, 30 minutes, 1 hour, 24 hours, etc.).
- 3 Displays the functions that operate during split mode and other plays.

3 Backup

Right-click the live screen and select <Backup>.

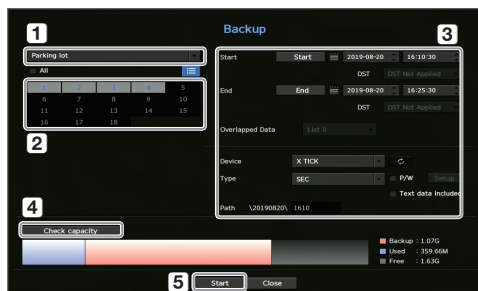

- 1 Select a layout
- 2 Select a channel.
- 3 Set the time, device, and format for backup.
- 4 Click the <Capacity check> button to see if you can back up.
- 5 Click the <Start> button to proceed with the backup.

Using the basic guide

View shortcut menu

By right-clicking the live screen, you can use various functions provided by the recorder. If you hover over the icon, the definition of terms for each function is briefly displayed.

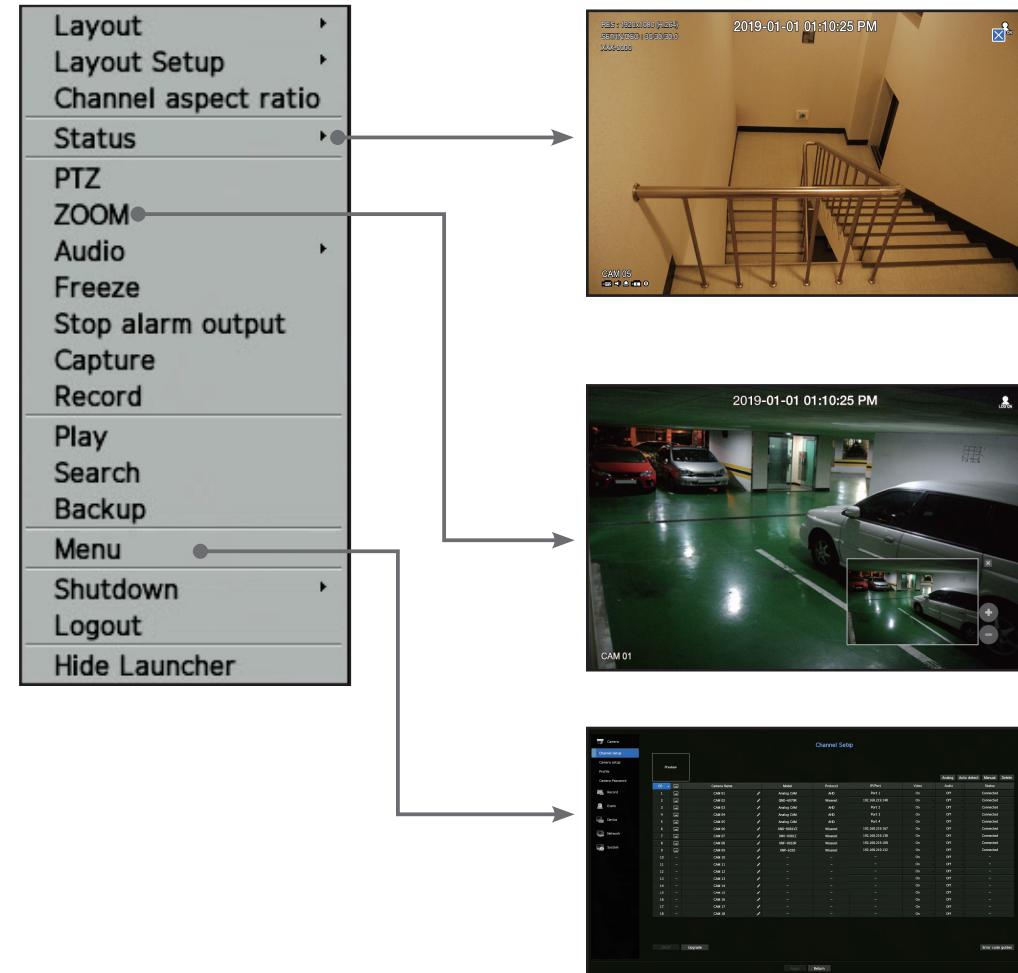

Live launcher

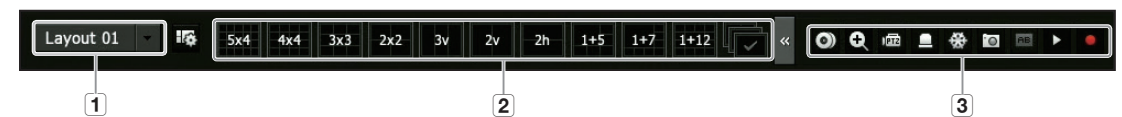

- 1 Sets the live layout.
- 2 You can set the supported split mode. The end sequence (1+12) can be viewed sequentially for a specific time in each split mode.
- 3 Sets additional functions such as alarm control and audio in live.

Using product information

You can check the product information/manual/firmware information/FAQ/HDD compatibility list on the homepage or mobile web of your smartphone.

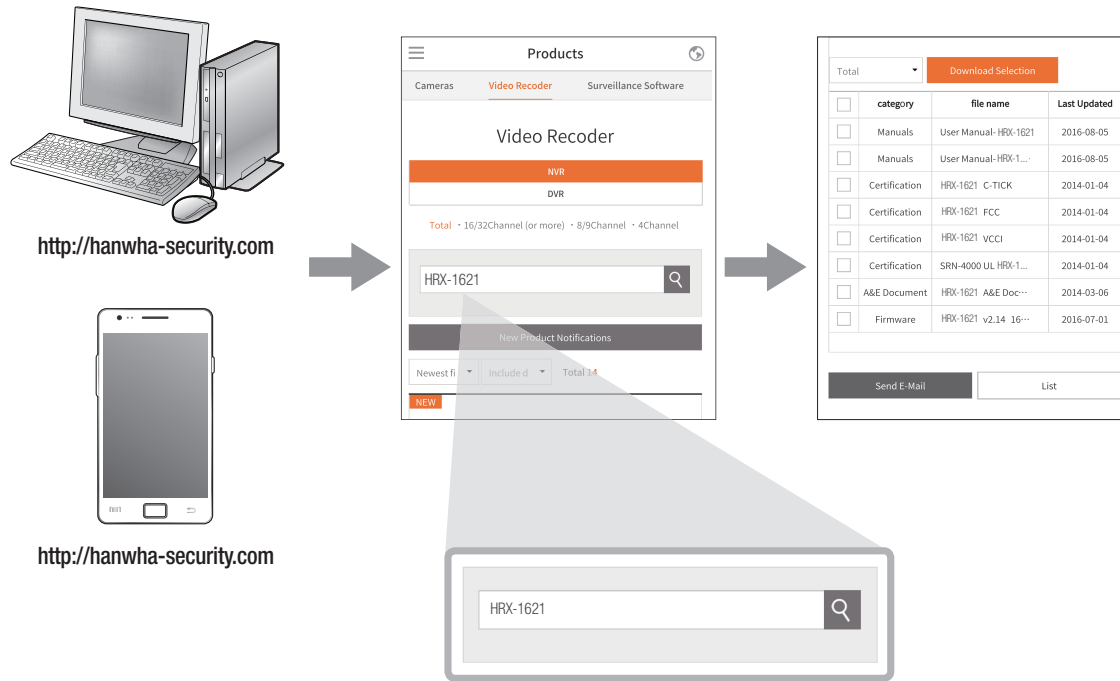

Using P2P Service

This function is available only for products that support P2P. To find products that support P2P, see "**Supported Products by Function**" in the Wisenet recorder manual.

In case of using the P2P service, the recorder can be connected directly to the mobile web viewer.

- 1 Check <Enable P2P> to test the connection to see if the current recorder can be connected remotely.

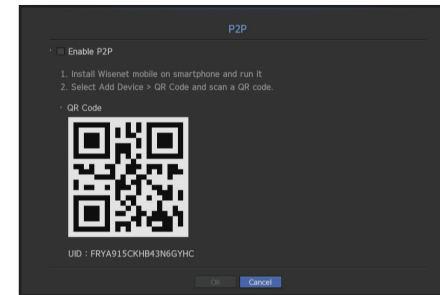

- 2 If the connection is successful, search for WiseNet mobile on your smartphone and install and run it.
 - You can scan the QR code on the recorder by selecting Add device> QR code.
- 3 If you scan the QR code, the device ID shown in the recorder is automatically reflected as the mobile viewer ID. You can use the mobile viewer immediately by entering the ID/password of the recorder.

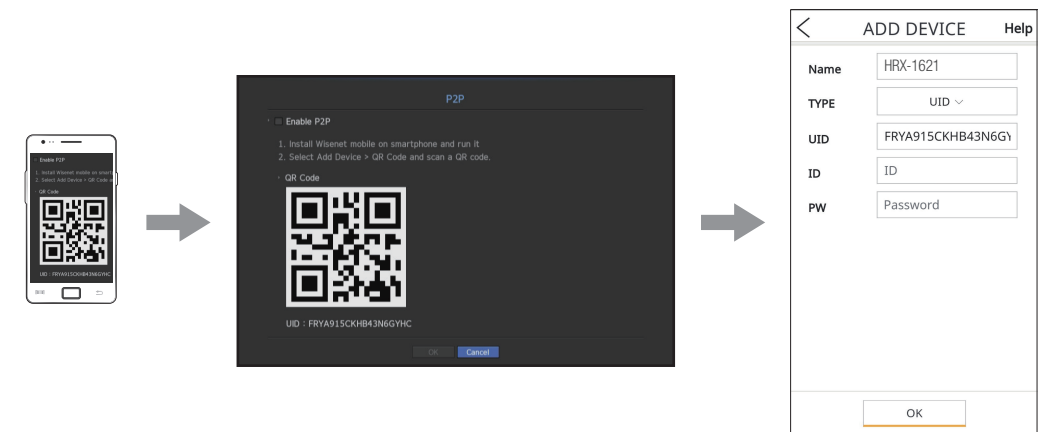

- 4 From now on, when you run the WiseNet mobile application saved to your smartphone, you can easily monitor with your smartphone as you are automatically connected to the recorder.

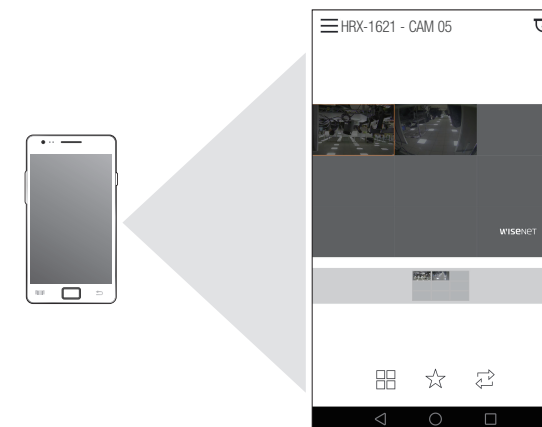

- The P2P service period expires in 5 years. If you want to extend it after expiration, contact your vendor.
- Only motion and video loss events are forwarded to the event push.

Connecting to a network using a router

If you want to add 1-3 PCs and recorders in an environment using xDSL/Cable modem, you can use the router with only one Internet line.

This guide is an installation guide for network beginners.

Follow the instructions to set up your router, local PC, and recorder.

Connecting the cable

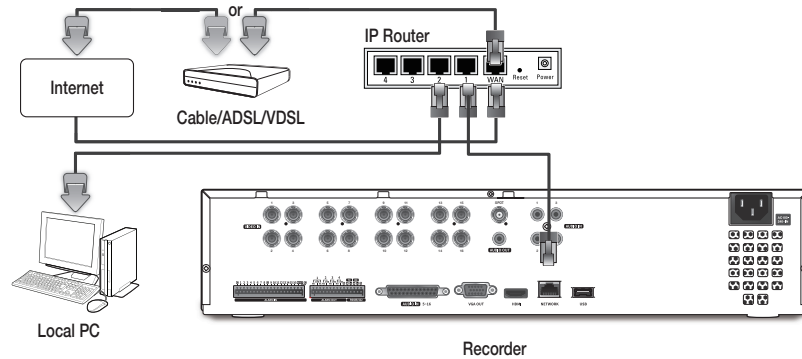

Connecting a router with PC



- Refer to the router's user manual.

Connecting a recorder and a router

Move to **<Interface>** of the Recorder **<Network>** Setting menu, and set the **1 <IP Address>** and **2 <Gateway>** in **<Setup>**.

※ The **<Default Gateway>** checked on the [cmd.exe] window of the local PC and the **<Gateway>** of the recorder must be the same.

※ At least the third number of the recorder **<IP Address>** should be set to be the same as the **<Default Gateway>** checked on the [cmd.exe] window of the local PC.

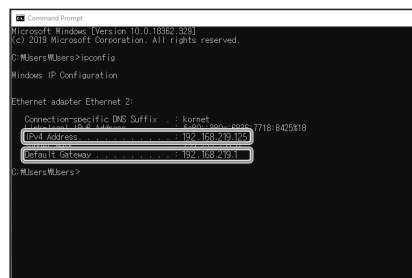

<cmd. screen>



<ex. Recorder screen>

Checking the recorder connection from the PC

Enter the IP set in the recorder menu in the local PC address bar to go to the web viewer screen of the recorder.

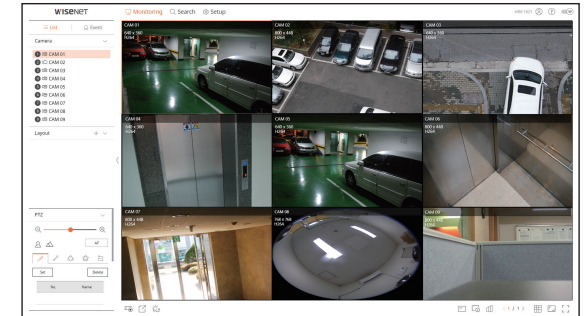
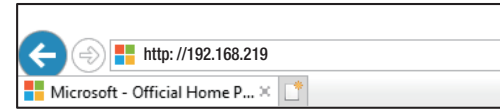

System Requirements

The following lists the minimum suggested hardware and operating system requirements needed to run the Web Viewer.

- Recommended browser : Chrome
- Supported browsers : Chrome, Edge, and Safari
- Supported OS : Works on all of the Windows, Linux, and OS X environments given the platform-independent nature of the web.
- Tested environments : Tested and certified to run on Windows® 10 with Google Chrome™ version 76 and Intel® Core™ i7-7700 processor 3.60 Ghz with NVIDIA® GeForce® GTX™ 1050 or Intel™ HD Graphics 630.
- Performance restrictions : The performance of users' CPU/GPU may impact the video playback performance of the web viewer.

Router and Internet Connection setup

Since each router has a different connection method, check the settings for each router.

Port forwarding on the router setup

Set up the router's port forwarding to connect to a PC or a recorder connected to the router's local LAN from outside.

The recorder uses the **<RTSP port>**, **<HTTP>**, **<HTTPS>**, and camera proxy ports. You must set up port forwarding for all the ports you use.

※ If only **<HTTP Port>** is set for port forwarding, **<RTSP Port>**, which is a video transmission port, is connected, but no video is displayed.

※ If only **<RTSP port>** is set for port forwarding, no connection is available because **<HTTP Port>**, which is a web connection port, is connected.

※ Refer to the router's user manual.

Accessing using DDNS address in the dynamic IP environment

In the dynamic IP environment such as xDSL/Cable modem, the router's WAN IP can be changed, so we provide DDNS (Dynamic Domain Name Server) service so that you can always access the recorder with only the DDNS address even in the dynamic IP environment.

• Wisenet DDNS Setup

Since you will be accessing the recorder remotely, set up a Wisenet DDNS account first using a PC.

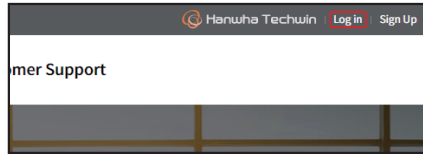

- 3 Click the **<Register Product>** tab to add a recorder to your account.

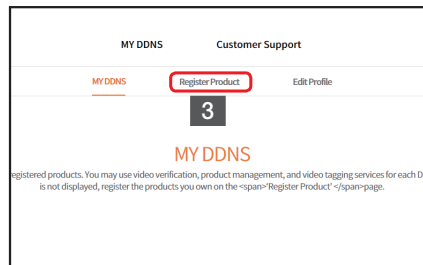

- 7 After registration, your product will appear in the list.



Open a browser, go to ddns.hanwha-security.com, and click **<Log In>**.

- 1 Click **<Sign Up>** and follow the instructions to register an account on the website.
- 2 Log in after completing account registration.



- 4 Create a name for your recorder (product ID).
- 5 Select the type of recorder and model name.
- 6 Click **<Product Registration>**.

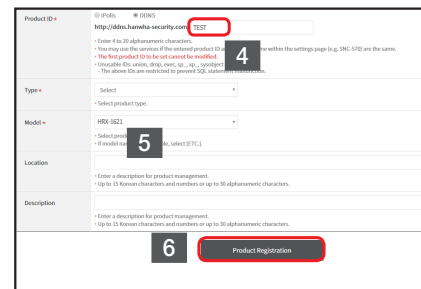

• Connect using DDNS address

Go to **<DDNS>** in the recorder **<Network>** setup menu.

- 1 Select **<ddns.hanwha-security.com>**.
- 2 Enter the **<Manufacturer ID>**.
 - Enter the **<Product ID>** created on the Wisenet DDNS website in **<Manufacturer ID>**.
- 3 When the DDNS setup is finished, select **<OK>**.

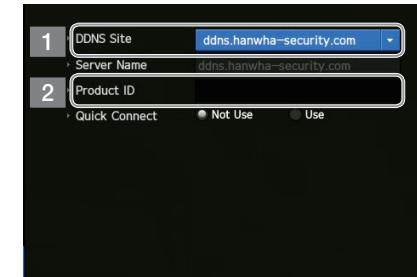

<ex. Recorder screen>

- 5 You can connect to the recorder by connecting to the **<DDNS host address>** set on the Internet Explorer address window, **<http://ddns.hanwha-security.com/recorder TEST>**. You can also click **< View >** in Item 4 to connect to the recorder.

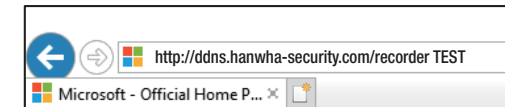

- 4 Connect to **<ddns.hanwha-security.com>** and check if the connection status of the registered product is set to **<ON>**.

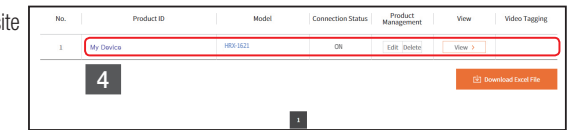

<Wisenet DDNS Setup screen>

- 6 The web viewer screen of the recorder appears.

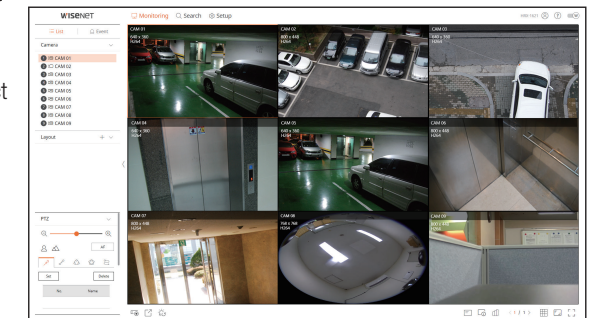

All settings are complete.

If you remember your DDNS address and ID / password, you can access the recorder from any PC with an Internet connection.

For more information, refer to the user manual.



Hanwha Techwin cares for the environment at all product manufacturing stages, and is taking measures to provide customers with more environmentally friendly products.

The Eco mark represents Hanwha Techwin's devotion to creating environmentally friendly products, and indicates that the product satisfies the EU RoHS Directive.

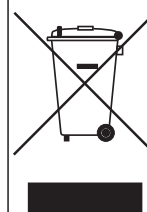

Correct Disposal of This Product (Waste Electrical & Electronic Equipment)

(Applicable in the European Union and other European countries with separate collection systems)

This marking on the product, accessories or literature indicates that the product and its electronic accessories (e.g. charger, headset, USB cable) should not be disposed of with other household waste at the end of their working life. To prevent possible harm to the environment or human health from uncontrolled waste disposal, please separate these items from other types of waste and recycle them responsibly to promote the sustainable reuse of material resources.

Household users should contact either the retailer where they purchased this product, or their local government office, for details of where and how they can take these items for environmentally safe recycling.

Business users should contact their supplier and check the terms and conditions of the purchase contract. This product and its electronic accessories should not be mixed with other commercial wastes for disposal.



Correct disposal of batteries in this product

(Applicable in the European Union and other European countries with separate battery return systems.)

This marking on the battery, manual or packaging indicates that the batteries in this product should not be disposed of with other household waste at the end of their working life. Where marked, the chemical symbols Hg, Cd or Pb indicate that the battery contains mercury, cadmium or lead above the reference levels in EC Directive 2006/66. If batteries are not properly disposed of, these substances can cause harm to human health or the environment.

To protect natural resources and to promote material reuse, please separate batteries from other types of waste and recycle them through your local, free battery return system.

Head Office

6, Pangyo-ro 319 beon-gil, Bundang-gu, Seongnam-si,
Gyeonggi-do, 463-400 Rep. of KOREA

Tel : +82.70.7147.8753 Fax : +82.31.8018.3740

www.hanwha-security.com

Hanwha Techwin America

500 Frank W. Burr Blvd. Suite 43 Teaneck, NJ 07666

Toll Free +1.877.213.1222 Direct +1.201.325.6920

Fax +1.201.373.0124

www.hanwhasecurity.com

Hanwha Techwin Europe

Heriot House, Heriot Road, Chertsey, Surrey, KT16 9DT, United Kingdom

Tel +44.1932.57.8100 Fax +44.1932.57.8101

www.hanwha-security.eu