

Compact 5000 I/O EtherNet/IP Adapters

Catalog Numbers 5069-AENTR, 5069-AENTRK, 5069-AEN2TR

Topic	Page
About the Adapters	5
Install a Compact 5000 I/O System	6
Set the Network Internet Protocol (IP) Address	9
Install the Adapter onto the DIN Rail	10
Connect Power to the 5069-AEN2TR Adapter	10
Connect Power to the 5069-AENTR or 5069-AENTRK Adapter	13
Connect the Adapter to an EtherNet/IP Network	17
Install the End Cap	17
Power the System	18
Remove or Replace the Adapter	18
Specifications	19
Additional Resources	20

The Compact 5000™ I/O EtherNet/IP adapters perform the following functions:

- Facilitate high-speed data transfer across an EtherNet/IP network between Compact 5000 I/O modules and a Logix 5000™ controller.
- Provide system-side and field-side power to Compact 5000 I/O modules.
- Support as many as 31 Compact 5000 I/O modules

The adapters are configured with the Studio 5000 Logix Designer® application. For more information on how to use Compact 5000 I/O EtherNet/IP adapters, including the compatible Logix 5000 controllers and Logix Designer application versions, see the publications that are listed in [Additional Resources on page 20](#).

Summary of Changes

The publication has been changed as follows:

- Add Waste Electrical and Electronic Equipment (WEEE) information on [page 3](#).
- Add information about how to install an end cap on [page 17](#).
- Update the SA power and SA power Passthrough specification for the 5069-AENTR, and 5069-AENTRK adapters on [page 19](#).



ATTENTION: Read this document and the documents listed in the Additional Resources section about installation, configuration and operation of this equipment before you install, configure, operate or maintain this product. Users are required to familiarize themselves with installation and wiring instructions in addition to requirements of all applicable codes, laws, and standards.

Activities including installation, adjustments, putting into service, use, assembly, disassembly, and maintenance are required to be carried out by suitably trained personnel in accordance with applicable code of practice.

If this equipment is used in a manner not specified by the manufacturer, the protection provided by the equipment may be impaired.

注意: 在安装、配置、操作和维护本产品前, 请阅读本文档以及“其他资源”部分列出的有关设备安装、配置和操作的相应文档。除了所有适用规范、法律和标准的相关要求之外, 用户还必须熟悉安装和接线说明。

安装、调整、投运、使用、组装、拆卸和维护等各项操作必须由经过适当训练的专业人员按照适用的操作规范实施。

如果未按照制造商指定的方式使用该设备, 则可能会损害设备提供的保护。

ATENCIÓN: Antes de instalar, configurar, poner en funcionamiento o realizar el mantenimiento de este producto, lea este documento y los documentos listados en la sección Recursos adicionales acerca de la instalación, configuración y operación de este equipo. Los usuarios deben familiarizarse con las instrucciones de instalación y cableado y con los requisitos de todos los códigos, leyes y estándares vigentes.

El personal debidamente capacitado debe realizar las actividades relacionadas a la instalación, ajustes, puesta en servicio, uso, ensamblaje, desensamblaje y mantenimiento de conformidad con el código de práctica aplicable.

Si este equipo se usa de una manera no especificada por el fabricante, la protección provista por el equipo puede resultar afectada.

ATENÇÃO: Leia este e os demais documentos sobre instalação, configuração e operação do equipamento que estão na seção Recursos adicionais antes de instalar, configurar, operar ou manter este produto. Os usuários devem se familiarizar com as instruções de instalação e fiação além das especificações para todos os códigos, leis e normas aplicáveis.

É necessário que as atividades, incluindo instalação, ajustes, colocação em serviço, utilização, montagem, desmontagem e manutenção sejam realizadas por pessoal qualificado e especializado, de acordo com o código de prática aplicável.

Caso este equipamento seja utilizado de maneira não estabelecida pelo fabricante, a proteção fornecida pelo equipamento pode ficar prejudicada.

ВНИМАНИЕ: Перед тем как устанавливать, настраивать, эксплуатировать или обслуживать данное оборудование, прочитайте этот документ и документы, перечисленные в разделе «Дополнительные ресурсы». В этих документах изложены сведения об установке, настройке и эксплуатации данного оборудования. Пользователи обязаны ознакомиться с инструкциями по установке и прокладке соединений, а также с требованиями всех применимых норм, законов и стандартов.

Все действия, включая установку, наладку, ввод в эксплуатацию, использование, сборку, разборку и техническое обслуживание, должны выполняться обученным персоналом в соответствии с применимыми нормами и правилами.

Если оборудование используется не предусмотренным производителем образом, защита оборудования может быть нарушена.

注意: 本製品を設置、構成、稼動または保守する前に、本書および本機器の設置、設定、操作についての参考資料の該当箇所に記載されている文書に目を通してください。ユーザは、すべての該当する条例、法律、規格の要件に加えて、設置および配線の手順に習熟している必要があります。

設置調整、運転の開始、使用、組立て、解体、保守を含む諸作業は、該当する実施規則に従って訓練を受けた適切な作業員が実行する必要があります。

本機器が製造メーカーにより指定されていない方法で使用されている場合、機器により提供されている保護が損なわれる恐れがあります。

ACHTUNG: Lesen Sie dieses Dokument und die im Abschnitt „Weitere Informationen“ aufgeführten Dokumente, die Informationen zu Installation, Konfiguration und Bedienung dieses Produkts enthalten, bevor Sie dieses Produkt installieren, konfigurieren, bedienen oder warten. Anwender müssen sich neben den Bestimmungen aller anwendbaren Vorschriften, Gesetze und Normen zusätzlich mit den Installations- und Verdrahtungsanweisungen vertraut machen.

Arbeiten im Rahmen der Installation, Anpassung, Inbetriebnahme, Verwendung, Montage, Demontage oder Instandhaltung dürfen nur durch ausreichend geschulte Mitarbeiter und in Übereinstimmung mit den anwendbaren Ausführungsvorschriften vorgenommen werden.

Wenn das Gerät in einer Weise verwendet wird, die vom Hersteller nicht vorgesehen ist, kann die Schutzfunktion beeinträchtigt sein.

ATTENTION : Lisez ce document et les documents listés dans la section Ressources complémentaires relatifs à l'installation, la configuration et le fonctionnement de cet équipement avant d'installer, configurer, utiliser ou entretenir ce produit. Les utilisateurs doivent se familiariser avec les instructions d'installation et de câblage en plus des exigences relatives aux codes, lois et normes en vigueur.

Les activités relatives à l'installation, le réglage, la mise en service, l'utilisation, l'assemblage, le démontage et l'entretien doivent être réalisées par des personnes formées selon le code de pratique en vigueur.

Si cet équipement est utilisé d'une façon qui n'a pas été définie par le fabricant, la protection fournie par l'équipement peut être compromise.

주의: 본 제품 설치, 설정, 작동 또는 유지 보수하기 전에 본 문서를 포함하여 설치, 설정 및 작동에 관한 참고 자료 섹션의 문서들을 반드시 읽고 숙지하십시오. 사용자는 모든 관련 규정, 법규 및 표준에서 요구하는 사항에 대해 반드시 설치 및 배선 지침을 숙지해야 합니다.

설치, 조정, 가동, 사용, 조립, 분해, 유지보수 등 모든 작업은 관련 규정에 따라 적절한 교육을 받은 사용자를 통해서만 수행해야 합니다.

본 장비를 제조사가 명시하지 않은 방법으로 사용하면 장비의 보호 기능이 손상될 수 있습니다.

ATTENZIONE Prima di installare, configurare ed utilizzare il prodotto, o effettuare interventi di manutenzione su di esso, leggere il presente documento ed i documenti elencati nella sezione "Altre risorse", riguardanti l'installazione, la configurazione ed il funzionamento dell'apparecchiatura. Gli utenti devono leggere e comprendere le istruzioni di installazione e cablaggio, oltre ai requisiti previsti dalle leggi, codici e standard applicabili.

Le attività come installazione, regolazioni, utilizzo, assemblaggio, disassemblaggio e manutenzione devono essere svolte da personale adeguatamente addestrato, nel rispetto delle procedure previste.

Qualora l'apparecchio venga utilizzato con modalità diverse da quanto previsto dal produttore, la sua funzione di protezione potrebbe venire compromessa.

DIKKAT: Bu ürünün kurulumu, yapılandırılması, işletilmesi veya bakımı öncesinde bu dokümanı ve bu ekipmanın kurulumu, yapılandırılması ve işletimi ile ilgili ilave Kaynaklar bölümünde yer listelenmiş dokümanları okuyun. Kullanıcılar yürürlükteki tüm yönetmelikler, yasalar ve standartların gereksinimlerine ek olarak kurulum ve kablolama talimatlarını da öğrenmek zorundadır.

Kurulum, ayarlama, hizmet alma, kulanma, parçaları birleştirme, parçaları sökme ve bakım gibi aktiviteler sadece uygun eğitimleri almış kişiler tarafından yürürlükteki uygulama yönetmeliklerine uygun şekilde yapılabilir.

Bu ekipman üretici tarafından belirlenmiş amacın dışında kullanılırsa, ekipman tarafından sağlanan koruma bozulabilir.

注意事項: 在安装、設定、操作或維護本產品前, 請先閱讀此文件以及列於「其他資源」章節中有關安裝、設定與操作此設備的文件。使用者必須熟悉安裝和配線指示, 並符合所有法規、法律和標準要求。

包括安裝、調整、交付使用、使用、組裝、拆卸和維護等動作都必須交由已經過適當訓練的人員進行, 以符合適用的實作法規。

如果將設備用於非製造商指定的用途時, 可能會造成設備所提供的保護功能受損。

POZOR: Než začnete instalovat, konfigurovat či provozovat tento výrobek nebo provádět jeho údržbu, přečtěte si tento dokument a dokumenty uvedené v části Dodatečné zdroje ohledně instalace, konfigurace a provozu tohoto zařízení. Uživatelé se musejí vedle požadavků všech relevantních vyhlášek, zákonů a norem nutně seznámit také s pokyny pro instalaci elektrické zapojení.

Činnosti zahrnující instalaci, nastavení, uvedení do provozu, užívání, montáž, demontáž a údržbu musí vykonávat vhodně proškolený personál v souladu s příslušnými prováděcími předpisy.

Pokud se toto zařízení používá způsobem neodpovídajícím specifikaci výrobce, může být narušena ochrana, kterou toto zařízení poskytuje.

UWAGA: Przed instalacją, konfiguracją, użytkowaniem lub konserwacją tego produktu należy przeczytać niniejszy dokument oraz wszystkie dokumenty wymienione w sekcji Dodatkowe źródła omawiające instalację, konfigurację i procedury użytkowania tego urządzenia. Użytkownicy mają obowiązek zapoznać się z instrukcjami dotyczącymi instalacji oraz oprzewodowania, jak również z obowiązującymi kodeksami, prawem i normami.

Działania obejmujące instalację, regulację, przekazanie do użytkowania, użytkowanie, montaż, demontaż oraz konserwację muszą być wykonywane przez odpowiednio przeszkolony personel zgodnie z obowiązującym kodeksem postępowania.

Jeśli urządzenie jest użytkowane w sposób inny niż określony przez producenta, zabezpieczenie zapewniane przez urządzenie może zostać ograniczone.

OBST! Läs detta dokument samt dokumentet, som står listat i avsnittet Övriga resurser, om installation, konfigurering och drift av denna utrustning innan du installerar, konfigurerar eller börjar använda eller utföra underhållsarbete på produkten. Användare måste bekanta sig med instruktioner för installation och kabeldragning, förutom krav enligt gällande koder, lagar och standarder.

Åtgärder som installation, justering, service, användning, montering, demontering och underhållsarbete måste utföras av personal med lämplig utbildning enligt lämpligt bruk.

Om denna utrustning används på ett sätt som inte anges av tillverkaren kan det hända att utrustningens skyddsanordningar försätts ur funktion.

LET OP: Lees dit document en de documenten die genoemd worden in de paragraaf Aanvullende informatie over de installatie, configuratie en bediening van deze apparatuur voordat u dit product installeert, configureert, bedient of onderhoudt. Gebruikers moeten zich vertrouwd maken met de installatie en de bedringsinstructies, naast de vereisten van alle toepasselijke regels, wetten en normen.

Activiteiten zoals het installeren, afstellen, in gebruik stellen, gebruiken, monteren, demonteren en het uitvoeren van onderhoud mogen uitsluitend worden uitgevoerd door hiervoor opgeleid personeel en in overeenstemming met de geldende praktijkregels.

Indien de apparatuur wordt gebruikt op een wijze die niet is gespecificeerd door de fabrikant, dan bestaat het gevaar dat de beveiliging van de apparatuur niet goed werkt.

Waste Electrical and Electronic Equipment (WEEE)



At the end of its life, this equipment should be collected separately from any unsorted municipal waste.

Environment and Enclosure



ATTENTION: This equipment is intended for use in a Pollution Degree 2 industrial environment, in overvoltage Category II applications (as defined in EN/IEC 60664-1), at altitudes up to 2000 m (6562 ft) without derating.



This equipment is not intended for use in residential environments and may not provide adequate protection to radio communication services in such environments.

This equipment is supplied as open-type equipment for indoor use. It must be mounted within an enclosure that is suitably designed for those specific environmental conditions that will be present and appropriately designed to prevent personal injury resulting from accessibility to live parts. The enclosure must have suitable flame-retardant properties to prevent or minimize the spread of flame, complying with a flame spread rating of 5VA or be approved for the application if nonmetallic. The interior of the enclosure must be accessible only by the use of a tool. Subsequent sections of this publication may contain more information regarding specific enclosure type ratings that are required to comply with certain product safety certifications.

In addition to this publication, see the following:

- Industrial Automation Wiring and Grounding Guidelines, publication [1770-4.1](#), for more installation requirements.
- NEMA 250 and EN/IEC 60529, as applicable, for explanations of the degrees of protection provided by enclosures.

North American Hazardous Location Approval

The following information applies when operating this equipment in hazardous locations:	Informations sur l'utilisation de cet équipement en environnements dangereux:
<p>Products marked "CL I, DIV 2, GP A, B, C, D" are suitable for use in Class I Division 2 Groups A, B, C, D, Hazardous Locations and nonhazardous locations only. Each product is supplied with markings on the rating nameplate indicating the hazardous location temperature code. When combining products within a system, the most adverse temperature code (lowest "T" number) may be used to help determine the overall temperature code of the system. Combinations of equipment in your system are subject to investigation by the local Authority Having Jurisdiction at the time of installation.</p>	<p>Les produits marqués "CL I, DIV 2, GP A, B, C, D" ne conviennent qu'à une utilisation en environnements de Classe I Division 2 Groupes A, B, C, D dangereux et non dangereux. Chaque produit est livré avec des marquages sur sa plaque d'identification qui indiquent le code de température pour les environnements dangereux. Lorsque plusieurs produits sont combinés dans un système, le code de température le plus défavorable (code de température le plus faible) peut être utilisé pour déterminer le code de température global du système. Les combinaisons d'équipements dans le système sont sujettes à inspection par les autorités locales qualifiées au moment de l'installation.</p>
<div style="display: flex; align-items: center;">  <div> <p>WARNING EXPLOSION HAZARD</p> <ul style="list-style-type: none"> • Do not disconnect equipment unless power has been removed or the area is known to be nonhazardous. • Do not disconnect connections to this equipment unless power has been removed or the area is known to be nonhazardous. Secure any external connections that mate to this equipment by using screws, sliding latches, threaded connectors, or other means provided with this product. • Substitution of components may impair suitability for Class I, Division 2. • If this product contains batteries, they must be changed only in an area known to be nonhazardous. </div> </div>	<div style="display: flex; align-items: center;">  <div> <p>AVERTISSEMENT RISQUE D'EXPLOSION</p> <ul style="list-style-type: none"> • Couper le courant ou s'assurer que l'environnement est classé non dangereux avant de débrancher l'équipement. • Couper le courant ou s'assurer que l'environnement est classé non dangereux avant de débrancher les connecteurs. Fixer tous les connecteurs externes reliés à cet équipement à l'aide de vis, loquets coulissants, connecteurs filetés ou autres moyens fournis avec ce produit. • La substitution de composants peut rendre cet équipement inadapté à une utilisation en environnement de Classe I, Division 2. • S'assurer que l'environnement est classé non dangereux avant de changer les piles. </div> </div>

European Hazardous Location Approval

The following applies to products marked ,  II 3 G.

- Are Equipment Group II, Equipment Category 3, and comply with the Essential Health and Safety Requirements relating to the design and construction of such equipment given in Annex II to Directive 2014/34/EU. See the EC Declaration of Conformity at <http://www.rockwellautomation.com/products/certification> for details.
- The type of protection is "Ex nA IIC T4 Gc" according to EN 60079-15.
- The 5069-AEN2TR EtherNet/IP adapter complies to standards: EN 60079-0:2012+A11:2013, EN 60079-15:2010 when used at or below 125V AC, reference certificate number DEMKO 15 ATEX 1455X.
- The 5069-AENTR and 5069-AENTRK EtherNet/IP adapter complies to standards: EN 60079-0:2012+A11:2013, EN 60079-15:2010, reference certificate number DEMKO 16 ATEX 1758X.
- Are intended for use in areas in which explosive atmospheres caused by gases, vapors, mists, or air are unlikely to occur, or are likely to occur only infrequently and for short periods. Such locations correspond to Zone 2 classification according to ATEX directive 2014/34/EU.

IEC Hazardous Location Approval

The following applies to products with IECEx certification: Such modules:

- Are intended for use in areas in which explosive atmospheres caused by gases, vapors, mists, or air are unlikely to occur, or are likely to occur only infrequently and for short periods. Such locations correspond to Zone 2 classification to IEC 60079-0.
 - The type of protection is "Ex nA IIC T4 Gc" according to IEC 60079-15.
 - The 5069-AEN2TR EtherNet/IP adapter complies to standards IEC 60079-0:6th Edition, IEC-60079-15:4th Edition when used at or below 125V AC, reference IECEx certificate number IECEx UL 15.0007X.
 - The 5069-AENTR and 5069-AENTRK EtherNet/IP adapter complies to standards IEC 60079-0:6th Edition, IEC-60079-15:4th Edition, reference IECEx certificate number IECEx UL 16.0124X.
 - May have catalog numbers followed by a "K" to indicate a conformal coating option
-



WARNING: Special Conditions for Safe Use:

- This equipment is not resistant to sunlight or other sources of UV radiation.
 - This equipment shall be mounted in an ATEX/IECEx Zone 2 certified enclosure with a minimum ingress protection rating of at least IP54 (as defined in EN/IEC 60529) and used in an environment of not more than Pollution Degree 2 (as defined in EN/IEC 60664-1) when applied in Zone 2 environments. The enclosure must be accessible only by the use of a tool.
 - This equipment shall be used within its specified ratings defined by Rockwell Automation.
 - Provision shall be made to prevent the rated voltage from being exceeded by transient disturbances of more than 140% of the rated voltage when applied in Zone 2 environments.
 - The instructions in the user manual shall be observed.
 - Secure any external connections that mate to this equipment by using screws, sliding latches, threaded connectors, or other means provided with this product.
 - Do not disconnect equipment unless power has been removed or the area is known to be nonhazardous.
 - Earthing is accomplished through mounting of modules on rail.
 - Devices shall be used in an environment of not more than Pollution Degree 2.
 - The equipment must be used only with ATEX/IECEx certified Rockwell Automation backplanes.
 - When installed in a non-hazardous area, the equipment may alternatively be installed in a controlled environment that provides equivalent protection.
 - 5069-AEN2TR EtherNet/IP adapter only — The USB port is intended for temporary local programming purposes only and not intended for permanent connection. Do not use the USB port in hazardous locations.
-

Prevent Electrostatic Discharge



ATTENTION: This equipment is sensitive to electrostatic discharge, which can cause internal damage and affect normal operation. Follow these guidelines when you handle this equipment:

- Touch a grounded object to discharge potential static.
 - Wear an approved grounding wriststrap.
 - Do not touch connectors or pins on component boards.
 - Do not touch circuit components inside the equipment.
 - Use a static-safe workstation, if available.
 - Store the equipment in appropriate static-safe packaging when not in use.
-

Electrical Safety Considerations



ATTENTION:

- SELV-listed supplies must be used for MOD and SA power if there are Functional Safety modules connected to the Compact 5000 I/O system.
 - 5069-AEN2TR EtherNet/IP adapter only:
 - Do not wire more than 1 conductor on any single RTB terminal.
 - 5069-AENTR and 5069-AENTRK EtherNet/IP adapter:
 - All wiring must comply with applicable electrical installation requirements (e.g., N.E.C. article 501-4(b)).
 - Wire conductor and insulation ratings shall support minimum temperature rating of 105 °C (221 °F).
 - Do not wire more than 1 conductors on any single terminal.
-



ATTENTION:

- In case of malfunction or damage, no attempts at repair should be made. The module should be returned to the manufacturer for repair. Do not dismantle the module.
- This equipment is certified for use only within the surrounding air temperature range of 0...60 °C (32...140 °F) The equipment must not be used outside of this range.
- Use only a soft dry anti-static cloth to wipe down equipment. Do not use any cleaning agents.
- 5069-AEN2TR EtherNet/IP adapter only — The USB port is intended for temporary local programming purposes only and not intended for permanent connection. The USB cable is not to exceed 3.0 m (9.84 ft) and must not contain hubs.



WARNING:

- If you connect or disconnect wiring while the field-side power is on, an electric arc can occur. This could cause an explosion in hazardous location installations. Be sure that power is removed or the area is nonhazardous before proceeding.
- When used in a Class I, Division 2, hazardous location, this equipment must be mounted in a suitable enclosure with proper wiring method that complies with the governing electrical codes.
- 5069-AEN2TR EtherNet/IP adapter only:
 - When you insert or remove the SD memory Card while power is on, an electric arc can occur. This could cause an explosion in hazardous location installations. Be sure that power is removed or the area is nonhazardous before proceeding.
 - When you press the reset button while power is on, an electric arc can occur. This could cause an explosion in hazardous location installations. Be sure that power is removed or the area is nonhazardous before proceeding.



WARNING: Do not use the USB port in hazardous locations. (5069-AEN2TR EtherNet/IP adapter only.)

IMPORTANT Any illustrations, charts, sample programs, and layout examples shown in this publication are intended solely for the purposes of example. Since there are many variables and requirements associated with any particular installation, Rockwell Automation does not assume responsibility or liability for actual use based upon the examples shown in this publication.

About the Adapters

5069-AEN2TR Adapter

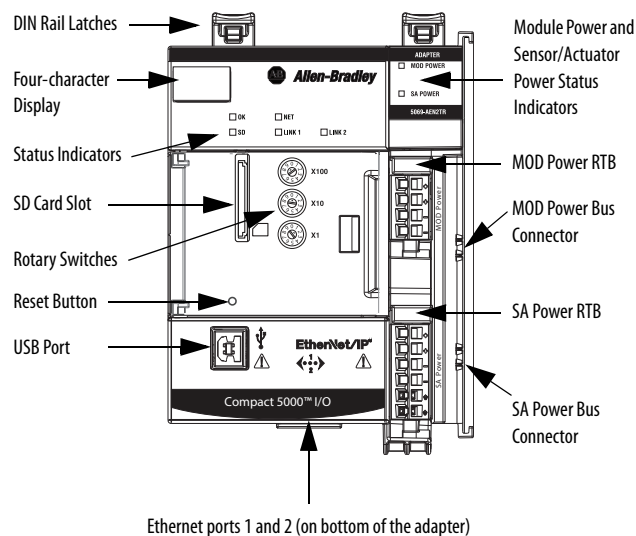

IMPORTANT: Port 1 is the front port and port 2 is the rear port.

5069-AENTR (5069-AENTRK) Adapter

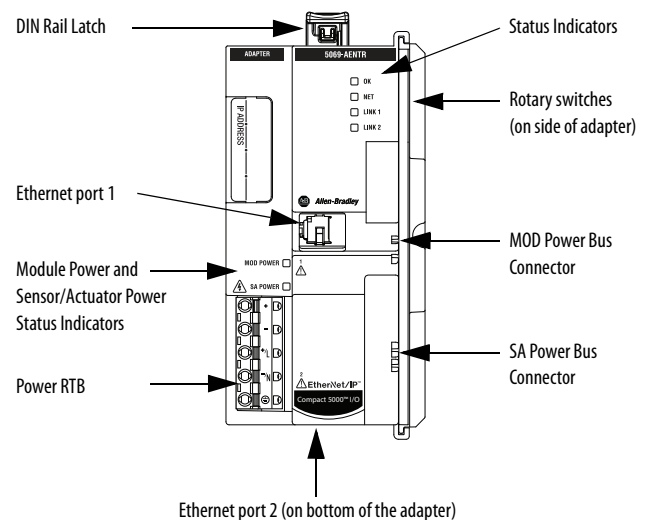

Install a Compact 5000 I/O System

Before you install the adapter, verify that you have the following:

Components Needed to Install a Compact 5000 I/O EtherNet/IP Adapter

Component	Description		
Removable Terminal Blocks (RTB)	One of the following RTB types for each power type:		
	<table border="1"> <tr> <td>5069-AEN2TR</td> <td> <ul style="list-style-type: none"> MOD power (system-side power) <ul style="list-style-type: none"> 5069-RTB4-SCREW RTB 5069-RTB4-SPRING RTB SA power (field-side power) <ul style="list-style-type: none"> 5069-RTB6-SCREW RTB 5069-RTB6-SPRING RTB </td> </tr> </table>	5069-AEN2TR	<ul style="list-style-type: none"> MOD power (system-side power) <ul style="list-style-type: none"> 5069-RTB4-SCREW RTB 5069-RTB4-SPRING RTB SA power (field-side power) <ul style="list-style-type: none"> 5069-RTB6-SCREW RTB 5069-RTB6-SPRING RTB
	5069-AEN2TR	<ul style="list-style-type: none"> MOD power (system-side power) <ul style="list-style-type: none"> 5069-RTB4-SCREW RTB 5069-RTB4-SPRING RTB SA power (field-side power) <ul style="list-style-type: none"> 5069-RTB6-SCREW RTB 5069-RTB6-SPRING RTB 	
5069-AENTR, 5069-AENTRK	Power (MOD power and SA power on same terminal) <ul style="list-style-type: none"> 5069-RTB5-SCREW RTB 5069-RTB5-SPRING RTB 		
	<p>IMPORTANT: You must order RTBs separately. The RTBs are available in 5069 RTB kits.</p> <ul style="list-style-type: none"> The 5069-RTB64-SCREW kit contains the 5069-RTB6-SCREW and 5069-RTB4-SCREW RTBs. The 5069-RTB64-SPRING kit contains the 5069-RTB6-SPRING and 5069-RTB4-SPRING RTBs. The 5069-RTB5-SCREW kit contains the 5069-RTB5-SCREW RTBs. The 5069-RTB5-SPRING kit contains the 5069-RTB5-SPRING RTBs. <p>We recommend that you order only the RTB type that your system requires.</p>		
External power supply for Module (MOD) Power	A power supply that is adequately sized to provide MOD power, that is, system-side power, to the Compact 5000 I/O system. For more information, see System Power Considerations on page 8 .		
External power supply for Sensor/ Actuator (SA) Power	A power supply that is adequately sized to provide SA power, that is, field-side power, to the Compact 5000 I/O system. For more information, see System Power Considerations on page 8 .		
Tools	You use the following tools to wire the RTBs: <ul style="list-style-type: none"> Screwdriver Wire stripper Wires For more information on available wire sizes and wire insulation stripping length, see Specifications on page 19 .		
DIN rail	Compatible zinc-plated, chromate-passivated steel DIN rail. You can use the following DIN rails: <ul style="list-style-type: none"> EN50022 - 35 x 7.5 mm (1.38 x 0.30 in.) EN50022-35 x 15 mm (1.38 x 0.59 in.) - 5069-AENTR and 5069-AENTRK only 		
EtherNet/IP network components	You must install the network and all required components.		
Software	If you do not use the rotary switches to set the adapter IP address, you can use the following software to set the IP address: <ul style="list-style-type: none"> DHCP server BOOTP DHCP EtherNet/IP Commissioning Tool - We recommend that you use version 3.02.00 or later. RSLinx™ Classic software For more information, see Set the Network Internet Protocol (IP) Address on page 9 .		

System Planning

Follow these rules when planning your system configuration:

- 5069-AEN2TR adapter only — You must mount the DIN rail horizontally.

Rockwell Automation does not support a Compact 5000 I/O system that is installed vertically if it uses a 5069-AEN2TR adapter.

- The adapter is the left-most component in the bank.
- Local Compact 5000 I/O modules are installed to the right of the adapter.
- The adapter can communicate with as many as 31 local I/O modules.
- Before powerup, verify that the end cap is installed on the right-most Compact 5000 I/O module in the system.



ATTENTION: Do not discard the end cap. Use this end cap to cover the exposed interconnections on the last module on the DIN rail. Failure to do so could result in equipment damage or injury from electric shock.

Spacing

Maintain spacing from enclosure walls, wireways, and adjacent equipment. Consider the following:

- 5069-AEN2TR adapter - You must mount the DIN rail horizontally.
- 5069-AENTR and 5069-AENTRK adapters - You can mount the DIN rail horizontally or vertically.

IMPORTANT When you mount the DIN rail vertically, the operating ambient temperature must be derated to 30% of the maximum Ta or 42 °C (108 °F).

Compact 5000 I/O EtherNet/IP Adapter Spacing

Horizontal Mounting

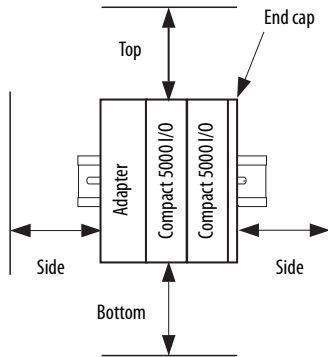

IMPORTANT: Allow 25 mm (1 in.) of space on all sides of the system for adequate ventilation.

Vertical Mounting

Only the 5069-AEN2R and 5069-AEN2RK adapters support vertical mounting.

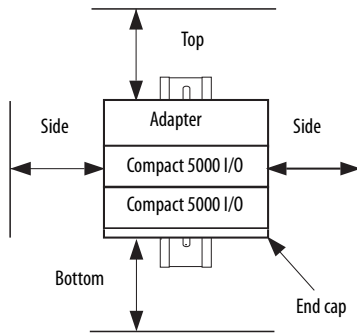

Adapter Dimensions

5069-AEN2TR Adapter Dimensions

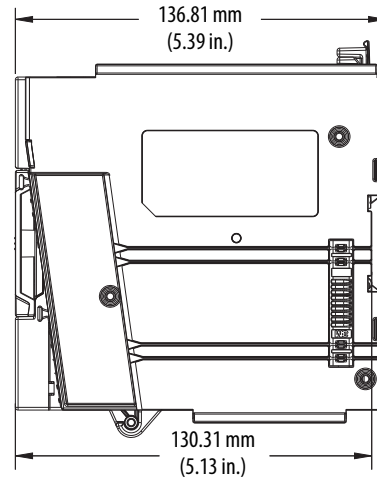
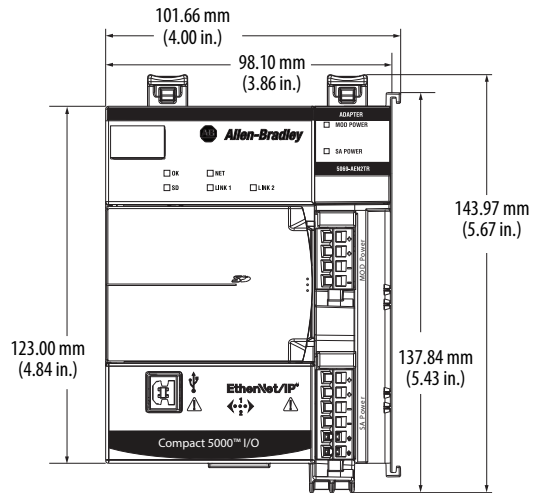

5069-AENTR and 5069-AENTRK Adapter Dimensions

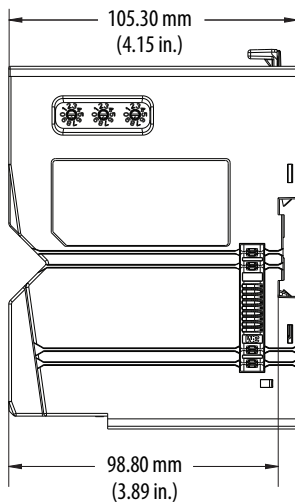
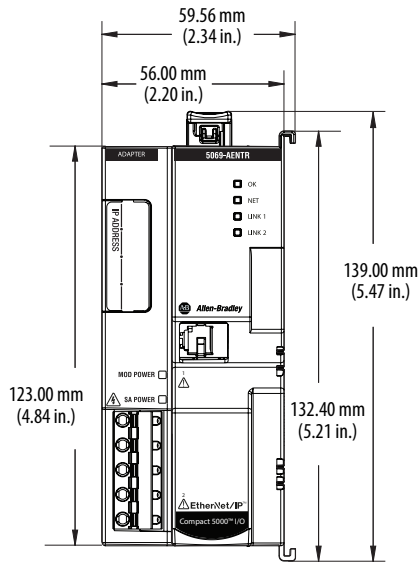

Ground Considerations

You must ground DIN rails according to the Industrial Automation Wiring and Grounding Guidelines, publication [1770-4.1](#)



ATTENTION: This product is grounded through the DIN rail to chassis ground. Use zinc-plated chromate-passivated steel DIN rail to assure proper grounding. The use of other DIN rail materials (for example, aluminum or plastic) that can corrode, oxidize, or are poor conductors, can result in improper or intermittent grounding. Secure DIN rail to mounting surface approximately every 200 mm (7.8 in.) and use end-anchors appropriately. Be sure to ground the DIN rail properly. See Industrial Automation Wiring and Grounding Guidelines, Rockwell Automation publication [1770-4.1](#) for more information.

You can use the following DIN rails with the adapters:

- EN50022 - 35 x 7.5 mm (1.38 x 0.30 in.)
- EN50022 - 35 x 15 mm (1.38 x 0.59 in.) - 5069-AENTR and 5069-AENTRK only

System Power Considerations

Compact 5000 I/O EtherNet/IP adapters provide power to a Compact 5000 I/O system via RTBs that are connected to external power supplies and installed on the adapter.

The RTBs provide the following power to the system.

Power Type	Description
MOD power	<p>System-side power that is used to operate the Compact 5000 I/O system. MOD power is provided through the MOD power RTB and passed across the MOD power bus.</p> <ul style="list-style-type: none"> • The total continuous current draw across the MOD power bus must not be more than 10 A, max, at 18...32V DC. • Confirm that the external MOD power supply is adequately sized for the total MOD power current draw in the system, plus the MOD power inrush current requirements.
SA power	<p>Field-side power that is used to power field-side devices. SA power is provided through the SA power RTB and passed across the SA power bus.</p> <ul style="list-style-type: none"> • If you are using DC voltage for SA power, the continuous current draw across the SA power bus must not be more than 10 A, max at 18...32V DC. • If you are using AC voltage for SA power, the continuous current draw across the SA power bus must not be more than 10 A, max at 18...240V AC. • Confirm that the external SA power supply is sized adequately for the total SA power current draw in the system, including the combined inrush current requirements for all connected modules.

IMPORTANT The Compact 5000 I/O EtherNet/IP adapters **do not** have an embedded power supply that powers the system.

- You must use SELV-listed power supplies for MOD power and SA power if there are Functional Safety modules that are connected to the Compact 5000 I/O system.
- If the adapter is used in a safety system, more restrictions can apply to the power supply that is used for SA power.
- Not all Class 2/SELV-listed power supplies are certified for use in all applications, for example, nonhazardous and hazardous environments.

IMPORTANT We strongly recommend that you use **separate external power supplies** for MOD power and SA power respectively. This practice helps to prevent unintended consequences that can result if you use one supply.

If you use separate external power supplies, the loss of power from one external power supply does not affect the availability of power from the other supply. For example, if separate external power supplies are used and SA power is lost, MOD power remains available for the Compact 5000 I/O modules.

For more information on electrical safety considerations, see [Electrical Safety Considerations on page 4](#) and the publications that are listed on [page 20](#).

Set the Network Internet Protocol (IP) Address

Compact 5000 I/O EtherNet/IP adapters ship DHCP-enabled and with their rotary switches set to 000.

If the network uses 192.168.1.x, we recommend that you use the rotary switches to set the last octet of network IP address. Valid numbers range from 001...254.

To use the rotary switches to set the IP address, turn the switches to the appropriate numbers before you install the adapter.

- 5069-AEN2TR- The bottom switch represents the first digit in the octet, the middle switch represents the second digit, and the top switch represents the third digit.
- 5069-AENTR and 5069-AENTRK - The left-most switch represents the first digit in the octet, the middle switch represents the second digit, and the right-most switch represents the third digit.

5069-AEN2TR Adapter Rotary Switches

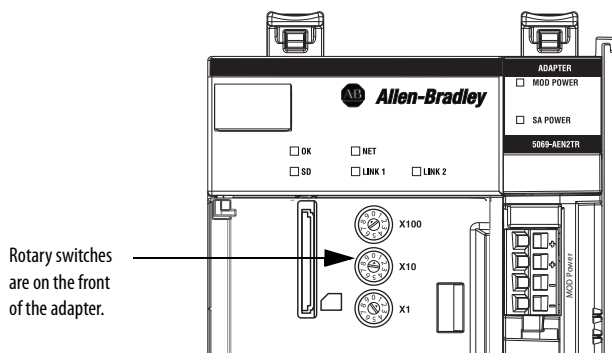

5069-AENTR and 5069-AENTRK Adapter Rotary Switches

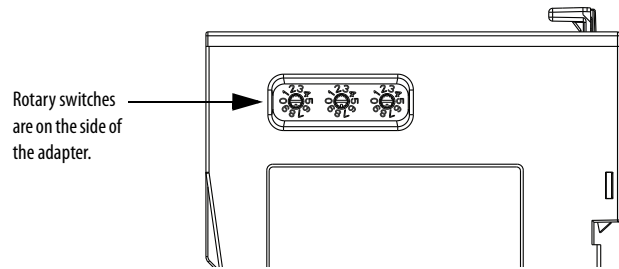

WARNING: When you change switch settings while power is on, an electric arc can occur. This arc could cause an explosion in hazardous location installations. Be sure that power is removed or the area is nonhazardous before proceeding.

When you press the reset button while power is on, an electric arc can occur. This arc could cause an explosion in hazardous location installations. Be sure that power is removed or the area is nonhazardous before proceeding. (5069-AEN2TR EtherNet/IP adapter only)

At powerup, the adapter reads the rotary switches to determine if they are set to a valid number for the last octet of the IP address. If the settings are a valid number, these conditions result:

- IP address = 192.168.1.xxx (where xxx represents the switch settings)
- Subnet mask = 255.255.255.0
- Gateway address = 0.0.0.0
- The adapter does not have an assigned host name, nor does it use any Domain Name System

If the network does not use 192.168.1.x, do not change the switch positions before you install the adapter. After you install and power up the adapter, you can use the following to set the network IP address:

- DHCP server
- BOOTP DHCP EtherNet/IP Commissioning Tool - We recommend that you use version 3.02.00 or later.
- RSLinx Classic software

For more information on how to use software to set the IP address, see the EtherNet/IP Communication Modules in Logix 5000 Control Systems User Manual, publication [ENET-UM004](#).

Install the Adapter onto the DIN Rail

The adapter is the first and left-most module in a Compact 5000 I/O system.



ATTENTION:

- Do not remove or replace the adapter while power is applied. Interruption of the backplane can result in unintentional operation or machine motion.
- During DIN rail mounting of all devices, be sure that all debris (metal chips, wire strands) is kept from falling into the adapter or modules. Debris that falls into the adapter or modules could cause damage on powerup.



WARNING: If you insert or remove the adapter while power is on, an electric arc can occur. This arc could cause an explosion in hazardous location installations. The module does not support "Removal and Insertion Under Power" (RIUP) capability. Do not connect or disconnect the module while power is applied. Be sure that power is removed before proceeding.

1. Confirm that the DIN rail latches are closed.
2. If the DIN rail latches are open, gently push the rear latch back until the front latch pops up and clicks.

5069-AEN2TR Adapter

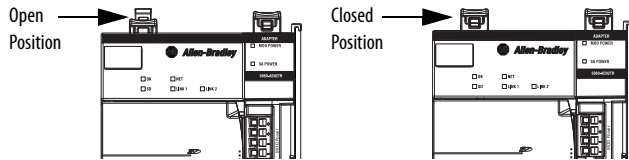

5069-AENTR and 5069-AENTRK Adapters

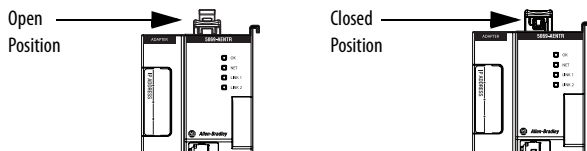

3. Position the adapter so that the back of it faces the DIN rail.
4. Press the adapter against the DIN rail until you hear a click.
5. Confirm that the adapter is latched securely.

Connect Power to the 5069-AEN2TR Adapter

Before you connect MOD power or SA power to a 5069-AEN2TR adapter, complete the following tasks:

- Read [System Power Considerations on page 8](#).
- Confirm that the external power supplies that supply MOD power and SA power are adequately sized for your Compact 5000 I/O system. For more information, see [page 8](#).
- Verify that the external power supplies that provide MOD power and SA power are turned off.
- Install the MOD power RTB and the SA power RTB, if used, on the 5069-AEN2TR adapter before you connect power to the adapter.

Install the MOD Power RTB



WARNING: If you connect or disconnect the Removable Terminal Block (RTB) with power applied, an Electric Arc can occur. This arc could cause an explosion in hazardous location installations.

The Removable Terminal Block (RTB) does not support "Removal and Insertion Under Power" (RIUP) capability. Do not connect or disconnect the Removable Terminal Block (RTB) while power is applied. Be sure that power is removed before proceeding.

IMPORTANT The MOD power RTB is used only on the 5069-AEN2TR adapter.

1. Hook the bottom of the MOD power RTB on the adapter.
2. Push the RTB against the adapter until the RTB clicks into place.

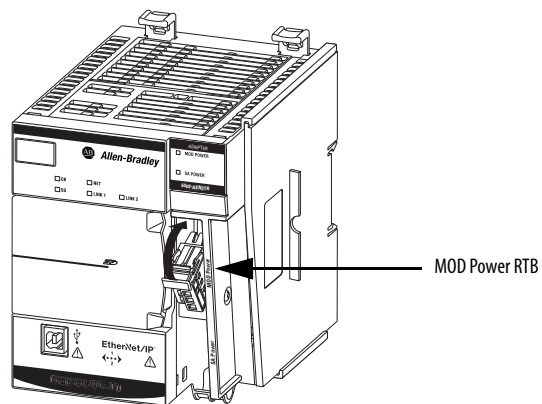

3. Push the RTB handle against the RTB until you hear another click.

Connect MOD Power to the 5069-AEN2TR Adapter

Before you connect an external power source to the MOD power RTB, make sure that the MOD power source is properly sized.

IMPORTANT Your application can require a power control device, for example, a switch, between the external 24V DC power source and the adapter to control when the module is powered. If so, you must install the power control device at the VDC+ terminal on the removable terminal block.

If you install the power control device at the VDC-terminal, the adapter can fail to power up or power down properly.



WARNING: If you connect or disconnect wiring while the field-side power is on, an electric arc can occur. This arc could cause an explosion in hazardous location installations. Be sure that power is removed or the area is nonhazardous before proceeding.

1. Verify that the external power supply is not powered.
2. Strip insulation from the wires that you connect to the RTB.

RTB Type	Action
Screw	Strip 12 mm (0.47 in.) of insulation from the wires.
Spring	Strip 10 mm (0.39 in.) of insulation from the wires.

3. Connect the 24V DC(+) wire from the external power supply to the first + terminal.

RTB Type	Action
Screw	1. Insert the wire into the terminal. 2. Turn the screwdriver to close the terminal on the wire. Torque the screw to 0.4 N·m (3.5 lb-in).
Spring	Push the wire into the terminal. If the wire is too thin, crimp a wire ferrule on the wire and insert it.

5069-RTB4-SCREW RTB

5069-RTB4-SPRING RTB

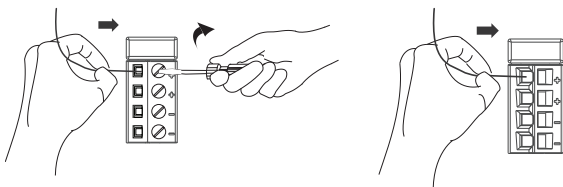

4. Connect the 24V DC(–) wire from the external power supply to the first – terminal.

RTB Type	Action
Screw	1. Insert the wire into the terminal. 2. Turn the screwdriver to close the terminal on the wire. Torque the screw to 0.4 N·m (3.5 lb-in).
Spring	Push the wire into the terminal. If the wire is too thin, crimp a wire ferrule on the wire and insert it.

5069-RTB4-SCREW RTB

5069-RTB4-SPRING RTB

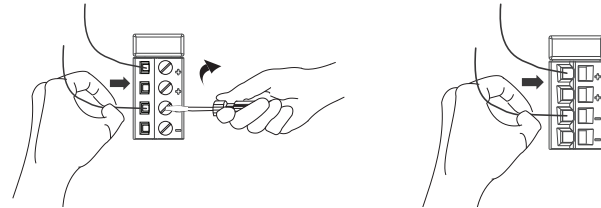

Install the SA Power RTB



WARNING: If you connect or disconnect the Removable Terminal Block (RTB) with power applied, an Electric Arc can occur. This arc could cause an explosion in hazardous location installations.

The Removable Terminal Block (RTB) does not support "Removal and Insertion Under Power" (RIUP) capability. Do not connect or disconnect the Removable Terminal Block (RTB) while power is applied. Be sure that power is removed before proceeding.

IMPORTANT The SA power RTB is used only on the 5069-AEN2TR adapter.

1. Hook the bottom of the SA power RTB on the adapter.
2. Push the RTB against the adapter until the RTB clicks into place.

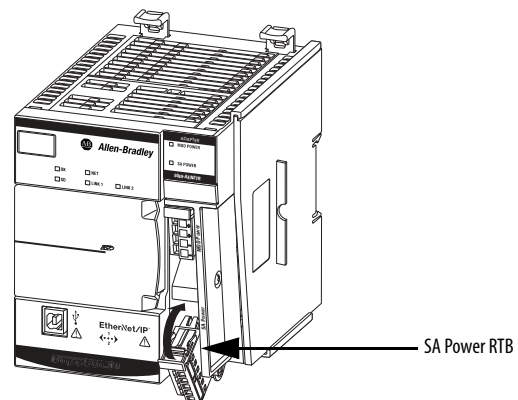

3. Push the RTB handle against the RTB until you hear another click.

Connect SA DC Power to the 5069-AEN2TR Adapter

Before you connect an external DC power source to the SA power RTB, make sure that the SA power source is adequately sized.



WARNING: If you connect or disconnect wiring while the field-side power is on, an electric arc can occur. This arc could cause an explosion in hazardous location installations. Be sure that power is removed or the area is nonhazardous before proceeding.

1. Confirm that MOD power and all sources of SA power are turned off.
2. Strip insulation from the wires that you connect to the RTB.

RTB Type	Action
Screw	Strip 12 mm (0.47 in.) of insulation from the wires.
Spring	Strip 10 mm (0.39 in.) of insulation from the wires.

3. Connect the DC(+) wire from the external DC power supply to the first + terminal.

RTB Type	Action
Screw	1. Insert the wire into the terminal. 2. Turn the screwdriver to close the terminal on the wire. Torque the screw to 0.4 N·m (3.5 lb-in).
Spring	Push the wire into the terminal. If the wire is too thin, crimp a wire ferrule on the wire and insert it.

5069-RTB6-SCREW RTB

5069-RTB6-SPRING RTB

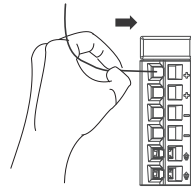
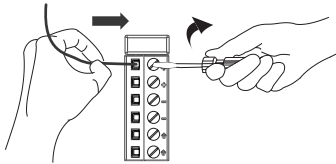

4. Connect the DC(−) wire from the external SA DC power supply to the first − terminal.

RTB Type	Action
Screw	1. Insert the wire into the terminal. 2. Turn the screwdriver to close the terminal on the wire. Torque the screw to 0.4 N·m (3.5 lb-in).
Spring	Push the wire into the terminal. If the wire is too thin, crimp a wire ferrule on the wire and insert it.

5069-RTB6-SCREW RTB

5069-RTB6-SPRING RTB

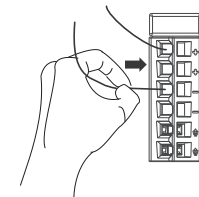
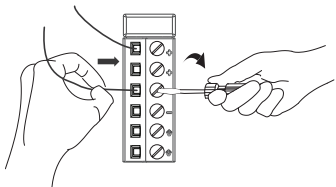

5. Connect a wire from an earth ground location to the first terminal on the RTB. The earth ground location can be the external SA power supply, the DIN rail, or other earth ground location.

RTB Type	Action
Screw	1. Insert the wire into the terminal. 2. Turn the screwdriver to close the terminal on the wire. Torque the screw to 0.4 N·m (3.5 lb-in).
Spring	Push the wire into the terminal. If the wire is too thin, crimp a wire ferrule on the wire and insert it.

5069-RTB6-SCREW RTB

5069-RTB6-SPRING RTB

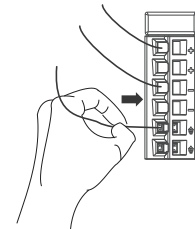
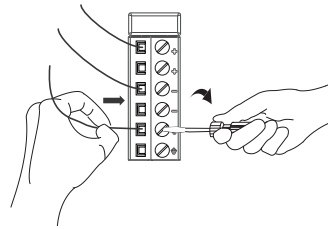

TIP The symbol denotes an earth ground terminal that provides a low impedance path between electrical circuits and earth for functional purposes and provides noise immunity improvement. This connection must be made for functional purposes.

Connect SA AC Power to the 5069-AEN2TR Adapter

Before you connect an external AC power source to the SA power RTB, make sure that the SA power source is adequately sized.



WARNING: If you connect or disconnect wiring while the field-side power is on, an electric arc can occur. This arc could cause an explosion in hazardous location installations. Be sure that power is removed or the area is nonhazardous before proceeding.

1. Verify that the SA power source is not powered on.
2. Strip insulation from the wires that you connect to the RTB.

RTB Type	Action
Screw	Strip 12 mm (0.47 in.) of insulation from the wires.
Spring	Strip 10 mm (0.39 in.) of insulation from the wires.

3. Connect the L1/AC(+) wire from the external SA AC power source to the first + terminal.

RTB Type	Action
Screw	1. Insert the wire into the terminal. 2. Turn the screwdriver to close the terminal on the wire. Torque the screw to 0.4 N·m (3.5 lb·in).
Spring	Push the wire into the terminal. If the wire is too thin, crimp a wire ferrule on the wire and insert it.

5069-RTB6-SCREW RTB

5069-RTB6-SPRING RTB

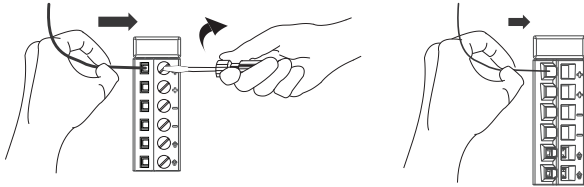



4. Connect the L2/N/AC(−) wire from the external SA AC power source to the first − terminal.

RTB Type	Action
Screw	1. Insert the wire into the terminal. 2. Turn the screwdriver to close the terminal on the wire. Torque the screw to 0.4 N·m (3.5 lb·in).
Spring	Push the wire into the terminal. If the wire is too thin, crimp a wire ferrule on the wire and insert it.

5069-RTB6-SCREW RTB

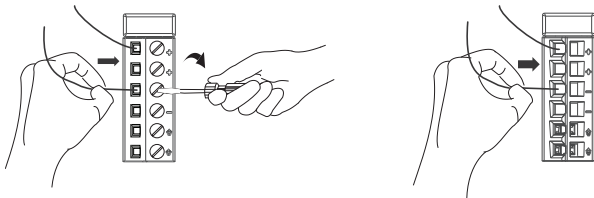
5069-RTB6-SPRING RTB





5. Connect a wire from an earth ground location to the first  terminal on the RTB. The earth ground location can be the external SA power supply, the DIN rail, or other earth ground location.

RTB Type	Action
Screw	1. Insert the wire into the terminal. 2. Turn the screwdriver to close the terminal on the wire. Torque the screw to 0.4 N·m (3.5 lb·in).
Spring	Push the wire into the terminal. If the wire is too thin, crimp a wire ferrule on the wire and insert it.

5069-RTB6-SCREW RTB

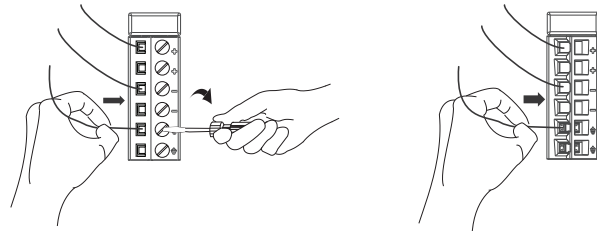
5069-RTB6-SPRING RTB

**TIP**

The  symbol denotes an earth ground terminal that provides a low impedance path between electrical circuits and earth for functional purposes and provides noise immunity improvement. This connection must be made for functional purposes.

Connect Power to the 5069-AENTR or 5069-AENTRK Adapter

Before you connect MOD power or SA power to a 5069-AENTR or 5069-AENTRK adapter, complete the following tasks:

- Read [System Power Considerations on page 8](#).
- Confirm that the external power supplies that supply MOD power and SA power are adequately sized for your Compact 5000 I/O system. For more information, see [page 8](#).
- Install the Power RTB on the 5069-AENTR or 5069-AENTRK adapter before you connect power to the adapter.

Install the Power RTB



WARNING: If you connect or disconnect the Removable Terminal Block (RTB) with power applied, an Electric Arc can occur. This arc could cause an explosion in hazardous location installations.

The Removable Terminal Block (RTB) does not support "Removal and Insertion Under Power" (RIUP) capability. Do not connect or disconnect the Removable Terminal Block (RTB) while power is applied. Be sure that power is removed before proceeding.

IMPORTANT The Power RTB is used only on the 5069-AENTR or 5069-AENTRK adapter.

1. Align the Power RTB with the open connection area on the adapter.
2. Push the RTB in place.

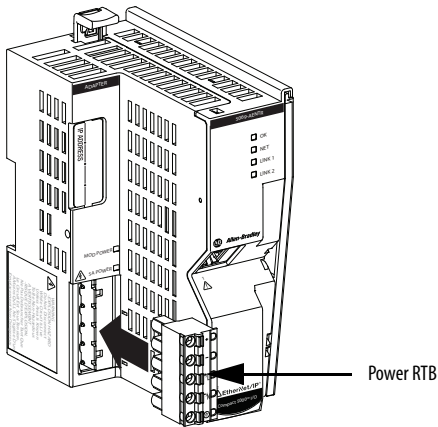

Connect MOD Power to the 5069-AENTR or 5069-AENTRK Adapter

Before you connect an external power source to the Power RTB terminals that are used for MOD power, make sure that the power source is properly sized.

IMPORTANT Your application can require a power control device, for example, a switch, between the external 24V DC power source and the adapter to control when the module is powered. If so, you must install the power control device at the VDC+ terminal on the removable terminal block.

If you install the power control device at the VDC-terminal, the adapter can fail to power up or power down properly.



WARNING: If you connect or disconnect wiring while the field-side power is on, an electric arc can occur. This arc could cause an explosion in hazardous location installations. Be sure that power is removed or the area is nonhazardous before proceeding.

1. Verify that the external power supply is not powered.
2. Strip insulation from the wires that you connect to the RTB.

RTB Type	Action
Screw	Strip 10 mm (0.39 in.) of insulation from the wires.
Spring	Strip 10 mm (0.39 in.) of insulation from the wires.

3. Connect the 24V DC(+) wire from the external power supply to the + terminal.

RTB Type	Action
Screw	<ol style="list-style-type: none"> 1. Insert the wire into the terminal. 2. Turn the screwdriver to close the terminal on the wire. Torque the screw to 0.5...0.6 N·m (4.4...5.3 lb-in).
Spring	Push the wire into the terminal. If the wire is too thin, crimp a wire ferrule on the wire and insert it.

5069-RTB5-SCREW RTB

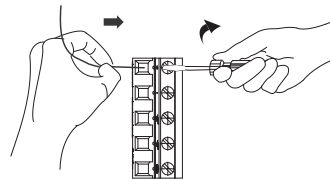

5069-RTB5-SPRING RTB

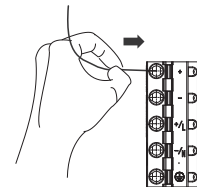

- Connect the 24V DC(—) wire from the external power supply to the — terminal.

RTB Type	Action
Screw	1. Insert the wire into the terminal. 2. Turn the screwdriver to close the terminal on the wire. Torque the screw to 0.5...0.6 N·m (4.4...5.3 lb-in).
Spring	Push the wire into the terminal. If the wire is too thin, crimp a wire ferrule on the wire and insert it.

5069-RTB5-SCREW RTB

5069-RTB5-SPRING RTB

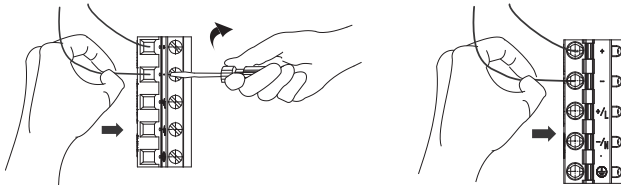

- Connect the DC(—) wire from the external SA DC power supply to the —/N terminal.

RTB Type	Action
Screw	1. Insert the wire into the terminal. 2. Turn the screwdriver to close the terminal on the wire. Torque the screw to 0.5...0.6 N·m (4.4...5.3 lb-in).
Spring	Push the wire into the terminal. If the wire is too thin, crimp a wire ferrule on the wire and insert it.

5069-RTB5-SCREW RTB

5069-RTB5-SPRING RTB

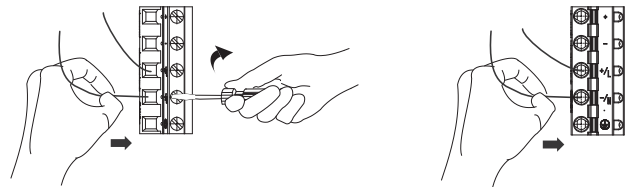

Connect SA DC Power to the 5069-AENTR or 5069-AENTRK Adapter

Before you connect an external power source to the Power RTB terminals that are used for SA power, make sure that the power source is properly sized.



WARNING: If you connect or disconnect wiring while the field-side power is on, an electric arc can occur. This arc could cause an explosion in hazardous location installations. Be sure that power is removed or the area is nonhazardous before proceeding.

- Confirm that MOD power and all sources of SA power are turned off.
- Strip insulation from the wires that you connect to the RTB.

RTB Type	Action
Screw	Strip 10 mm (0.39 in.) of insulation from the wires.
Spring	Strip 10 mm (0.39 in.) of insulation from the wires.

- Connect the DC(+) wire from the external DC power supply to the +/L terminal.

RTB Type	Action
Screw	1. Insert the wire into the terminal. 2. Turn the screwdriver to close the terminal on the wire. Torque the screw to 0.5...0.6 N·m (4.4...5.3 lb-in).
Spring	Push the wire into the terminal. If the wire is too thin, crimp a wire ferrule on the wire and insert it.

5069-RTB5-SCREW RTB

5069-RTB5-SPRING RTB

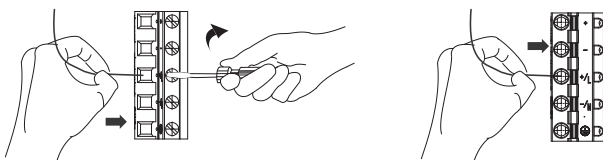

- Connect a wire from an earth ground location to the ⊕ terminal on the RTB.

RTB Type	Action
Screw	1. Insert the wire into the terminal. 2. Turn the screwdriver to close the terminal on the wire. Torque the screw to 0.5...0.6 N·m (4.4...5.3 lb-in).
Spring	Push the wire into the terminal. If the wire is too thin, crimp a wire ferrule on the wire and insert it.

5069-RTB5-SCREW RTB

5069-RTB5-SPRING RTB

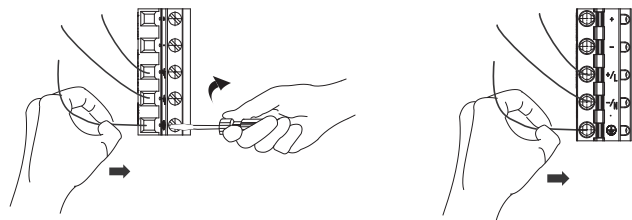

TIP

The ⊕ symbol denotes an earth ground terminal that provides a low impedance path between electrical circuits and earth for protective earth purposes and provides noise immunity improvement.

We recommend that you use the AWG 14 wire type or equivalent for grounding purposes. Make sure that you securely connect the ground to proper earth grounding via the ground bus.



WARNING: Protection is relied upon an external branch circuit protection.

Connect SA AC Power to the 5069-AENTR or 5069-AENTRK Adapter

Before you connect an external power source to the Power RTB terminals that are used for SA power, make sure that the power source is properly sized.



WARNING: If you connect or disconnect wiring while the field-side power is on, an electric arc can occur. This arc could cause an explosion in hazardous location installations. Be sure that power is removed or the area is nonhazardous before proceeding.

1. Verify that the SA power source is not powered on.
2. Strip insulation from the wires that you connect to the RTB.

RTB Type	Action
Screw	Strip 10 mm (0.39 in.) of insulation from the wires.
Spring	Strip 10 mm (0.39 in.) of insulation from the wires.

3. Connect the L1/AC(+) wire from the external SA AC power source to the +/L terminal.

RTB Type	Action
Screw	1. Insert the wire into the terminal. 2. Turn the screwdriver to close the terminal on the wire. Torque the screw to 0.5...0.6 N·m (4.4...5.3 lb·in).
Spring	Push the wire into the terminal. If the wire is too thin, crimp a wire ferrule on the wire and insert it.

5069-RTB5-SCREW RTB

5069-RTB5-SPRING RTB

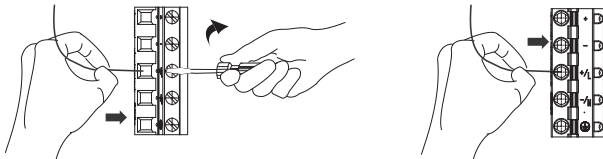

4. Connect the L2/N/AC(—) wire from the external SA AC power source to the —/N terminal.

RTB Type	Action
Screw	1. Insert the wire into the terminal. 2. Turn the screwdriver to close the terminal on the wire. Torque the screw to 0.5...0.6 N·m (4.4...5.3 lb·in).
Spring	Push the wire into the terminal. If the wire is too thin, crimp a wire ferrule on the wire and insert it.

5069-RTB5-SCREW RTB

5069-RTB5-SPRING RTB

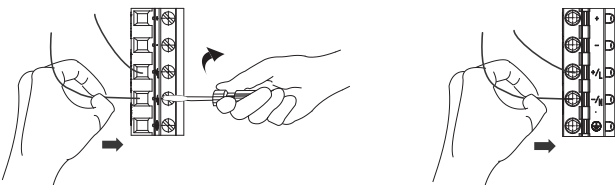

5. Connect a wire from an earth ground location to the terminal on the RTB.

RTB Type	Action
Screw	1. Insert the wire into the terminal. 2. Turn the screwdriver to close the terminal on the wire. Torque the screw to 0.5...0.6 N·m (4.4...5.3 lb·in).
Spring	Push the wire into the terminal. If the wire is too thin, crimp a wire ferrule on the wire and insert it.

5069-RTB5-SCREW RTB

5069-RTB5-SPRING RTB

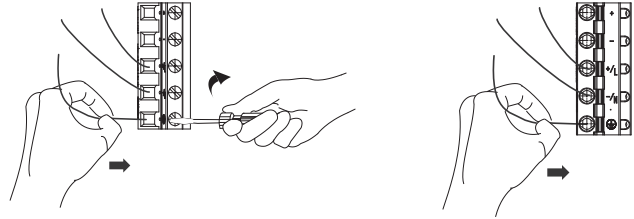

TIP

The symbol denotes an earth ground terminal that provides a low impedance path between electrical circuits and earth for protective earth purposes and provides noise immunity improvement.

We recommend that you use the AWG14 wire type or equivalent for grounding purposes. Make sure that you securely connect the ground to proper earth grounding via the ground bus.

Disconnect Wires from RTBs



WARNING: If you connect or disconnect wiring while the field-side power is on, an electric arc can occur. This arc could cause an explosion in hazardous location installations. Be sure that power is removed or the area is nonhazardous before proceeding.

If necessary, complete the following tasks to disconnect wires from any RTB on the adapter. The actions apply to every catalog number for an RTB type.

For example, the graphic shows the 5069-RTB4-SCREW RTB. However, you complete the same actions to disconnect wires for any Screw-type RTB.

RTB Type	Action
Screw	1. Turn the screwdriver counter-clockwise to open the terminal. 2. Remove the wire.
Spring	1. Insert and hold a screwdriver in the right-side terminal. 2. Remove the wire. 3. Pull out the screwdriver.

Screw-type RTB

Spring-type RTB

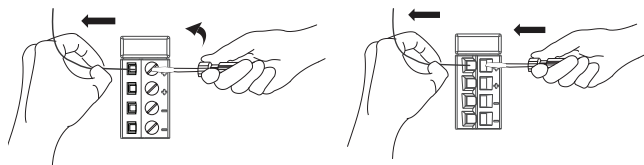

Connect the Adapter to an EtherNet/IP Network

Use an RJ45 straight cable to connect the adapter to an EtherNet/IP network.



WARNING: If you connect or disconnect the communication cable with power that is applied to this module or any device on the network, an electric arc can occur. This arc could cause an explosion in hazardous location installations.

Be sure that power is removed or the area is nonhazardous before proceeding.

This warning applies to connections to ports 1 and 2 on both adapters. For more information on where the ports are on the adapter, see [About the Adapters on page 5](#).

1. If needed, wire the RJ45 connector as shown.

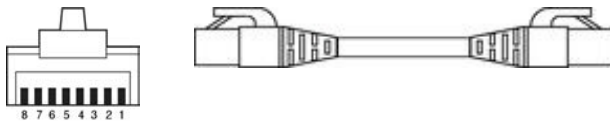

Connector Number	Color	1585J 8-pin Cables with Support for 10/100/1000 Mbps	1585J 8-pin Cables with Support for 10/100 Mbps	1585J 4-pin Cables with Support for 10/100 Mbps
1	White/Orange	BI_DA+	TxData +	
2	Orange	BI_DA-	TxData -	
3	White/Green	BI_DB+	Recv Data +	
4	Blue	BI_DC+	Unused	N/A
5	White/Blue	BI_DC-	Unused	N/A
6	Green	BI_DB-	Recv Data -	
7	White/Brown	BI_DD+	Unused	N/A
8	Brown	BI_DD-	Unused	N/A

2. Connect the RJ45 cable to an Ethernet port on the bottom of the adapter. You can connect two RJ45 cables to the adapter.

Install Compact 5000 I/O Modules

Install Compact 5000 I/O modules on the right side of the adapter.

If the end cap is installed on the adapter, you must remove it before you can install the I/O modules.

For more information on how to install Compact 5000 I/O modules, see the installation instructions available with each Compact 5000 I/O module catalog number.

Install the End Cap

A 5069-ECR end cap ships with the adapter.

You must install an end cap on the right side of the last module in a Compact 5000 I/O system. The end cap covers the exposed interconnections on the last module in the system. If you do not install the end cap before powering the system, equipment damage or injury from electric shock can result.

If the end cap is not installed and you have installed all required modules in the system, install the end cap.

IMPORTANT You install the end cap after the last module is installed on the DIN rail. This design helps to prevent the end cap from going beyond the locked position.

If you push the end cap beyond the locked position or insert it from the backwards direction, you can damage the MOD power bus and SA power bus connector.

1. Align the end cap with interlocking pieces on the adapter.
2. Push the end cap toward the DIN rail until it locks into place.

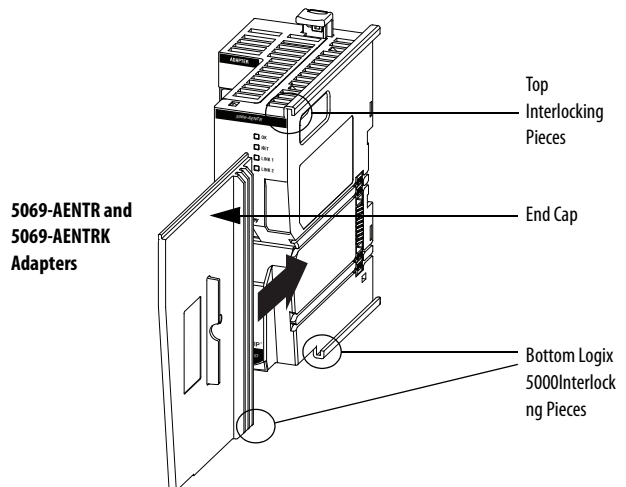
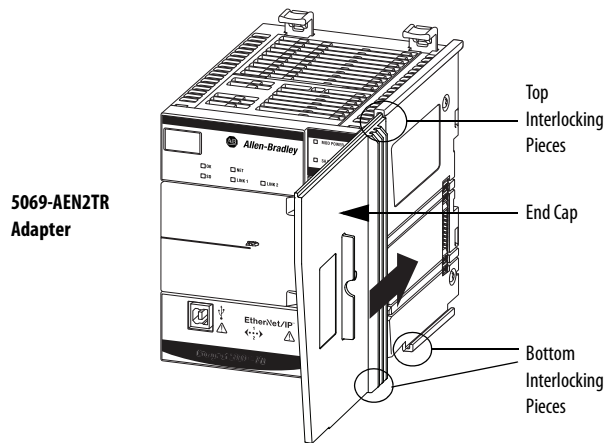

Power the System

After the end cap is installed on the last module in the system, turn on power to the MOD power RTB and the SA power RTB on the 5069-AEN2TR adapter or the Power RTB on the 5069-AENTR or 5069-AENTRK adapter.

Remove or Replace the Adapter



ATTENTION: Do not remove or replace an adapter while power is applied. Interruption of the backplane can result in unintentional operation or machine motion.



WARNING: If you insert or remove the adapter while power is on, an electric arc can occur. This arc could cause an explosion in hazardous location installations. The module does not support "Removal and Insertion Under Power" (RIUP) capability. Do not connect or disconnect the module while power is applied. Be sure that power is removed before proceeding.

1. Turn off power to the MOD power RTB and, if used, the SA power RTB on the 5069-AEN2TR adapter or Power RTB on the 5069-AENTR or 5069-AENTRK adapter.

IMPORTANT When you remove MOD power from a Compact 5000 I/O EtherNet/IP adapter, you shut down power to all modules in the Compact 5000 I/O system. That is, all system-side is removed. When you remove SA power from the Compact 5000 I/O EtherNet/IP adapter, all field-side power that is provided by the adapter is removed. If the system uses the SA power that is provided by the 5069-FPD field potential distributor, the system does not lose field-side power to the right of the field potential distributor.

In this case, you must use a separate power source for the SA power RTB on the field potential distributor.

We strongly recommend that you take the appropriate actions to help prevent unintended consequences that can result from a system power shutdown before you remove MOD power or SA power from the adapter or field potential distributor.

Despite the removal of field-side power from SA RTBs on the adapter or field potential distributor, the 5069-OB16 and 5069-OB16F modules continue to receive field-side power from an external power source connected to the LA (+) and LA (-) terminals on the modules.

2. Disconnect wires from the RTBs. For more information, see [Disconnect Wires from RTBs on page 16](#).

3. Remove the RTBs:



ATTENTION: Do not remove or replace a Terminal Base unit while power is applied. Interruption of the backplane can result in unintentional operation or machine motion.

- 5069-AEN2TR adapter - Pull the RTB handles to remove the MOD power RTB and SA power RTB.

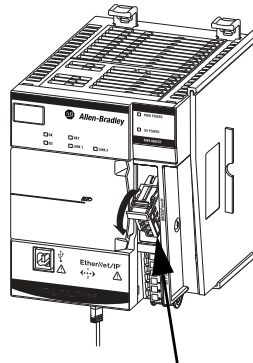

MOD Power RTB

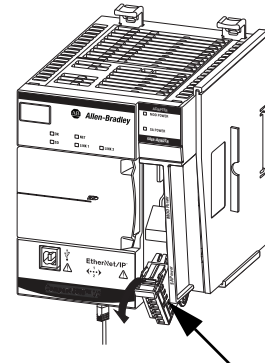

SA Power RTB

- 5069-AENTR or 5069-AENTRK adapter - Hold the top and bottom of the RTB and pull the RTB off the adapter.

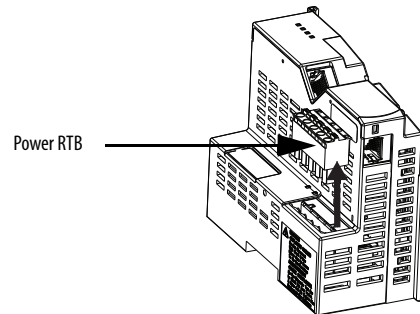

Power RTB

4. Remove the Ethernet cable from the adapter.
5. Push down on the front of the DIN rail latches. A click indicates that the DIN rail latches are open.

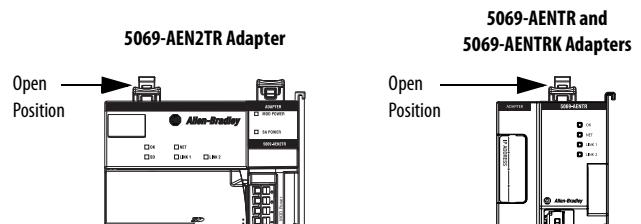

If the DIN rail latches fail to remain in the open position, hold them down.

6. Pull the adapter off the DIN rail.
7. Repeat the installation steps that are described beginning at [Set the Network Internet Protocol \(IP\) Address on page 9](#).
8. Apply MOD power and, if necessary, SA power to the system.

Specifications

This table includes a subset of specifications for the adapter. For full specifications, see the Compact 5000 I/O Modules and EtherNet/IP Adapters Technical Data, publication [5069-TD001](#).

Attribute	5069-AEN2TR	5069-AENTR, 5069-AENTRK
Temperature, operating <ul style="list-style-type: none"> IEC 60068-2-1 (Test Ad, Operating Cold) IEC 60068-2-2 (Test Bd, Operating Dry Heat) IEC 60068-2-14 (Test Nb, Operating Thermal Shock) 	0 °C < Ta < +60 °C (+32 °F < Ta < +140 °F)	
Temperature, surrounding air, max	60 °C (140 °F)	
Enclosure type rating	None (open-style)	
Voltage and current ratings		
MOD power	450 mA @ 18...32V DC	220 mA @ 18...32V DC
MOD power inrush	850 mA for 125 ms	1750 mA for 70 ms
MOD power passthrough	9.55 A @ 18...32V DC	9.78 A @ 18...32V DC
SA power	10 mA @ 0...32V DC 25 mA @ 0...240V AC, 47...63 Hz ATEX/IECEX, 125V AC Max	5 mA @ 0...32V DC 2 mA @ 0...240V AC, 47...63 Hz ATEX/IECEX, 125V AC Max
SA power passthrough	9.95 A @ 0...32V DC 9.975 A @ 0...240V AC, 47...63 Hz ATEX/IECEX, 125V AC Max	9.95 A @ 0...32V DC 9.975 A @ 0...240V AC, 47...63 Hz ATEX/IECEX, 125V AC Max
Do not exceed 10 A current draw at the MOD power RTB or SA power RTB.		
Isolation voltage	300V (continuous), Basic Insulation Type, SA, and MOD power to Backplane 300V (continuous), Basic Insulation Type, SA to MOD power 300V (continuous), Basic Insulation Type, Ethernet to Backplane 300V (continuous), Double Insulation Type, Ethernet to MOD power 300V (continuous), Double Insulation Type, Ethernet to SA power 50V (continuous), Functional Insulation Type, Ethernet to USB 300V (continuous), Basic Insulation Type, USB to Backplane 300V (continuous), Double Insulation Type, USB to MOD power 300V (continuous), Double Insulation Type, USB to SA power No isolation between Ethernet ports Type tested at 1500V AC for 60 s	300V (continuous), Basic Insulation Type, SA, and MOD power to Backplane 300V (continuous), Basic Insulation Type, SA to MOD power 300V (continuous), Basic Insulation Type, Ethernet to Backplane Type tested at 1500V AC for 60 s 300V (continuous), Double Insulation Type, Ethernet to MOD power 300V (continuous), Double Insulation Type, Ethernet to SA power Type tested at 4242V DC for 60 s No isolation between Ethernet ports
Recommended external overcurrent protection	—	MOD power: 10...12A @ 22.5...43.2 A2t, Fast Acting SA power: 20 A @ 250V AC
Wire size	5069-RTB4-SCREW, 5069-RTB6-SCREW connections: 0.5...1.5 mm ² (22...16 AWG) solid or stranded copper wire rated at 105 °C (221 °F), or greater, 3.5 mm (0.14 in.) max diameter including insulation, single wire connection only. 5069-RTB4-SPRING, 5069-RTB6-SPRING connections: 0.5...1.5 mm ² (22...16 AWG) solid or stranded copper wire rated at 105 °C (221 °F), or greater, 2.9 mm (0.11 in.) max diameter including insulation, single wire connection only. Ethernet connections: Ethernet Cabling and Installation according to IEC 61918 and IEC 61784-5-2.	0.25...2.5 mm ² (22...14 AWG) solid or stranded copper wire rated at 105 °C (221 °F), or greater, 1.2 mm (3/64 in.) insulation m, single wire connection only. Grounding: 2.5 mm ² (14 AWG) solid or stranded copper wire rated at 105 °C (221 °F), or greater, 3.5mm (0.14in) max diameter including insulation, single wire connection only. Ethernet connections: Ethernet Cabling and Installation according to IEC 61918 and IEC 61784-5-2.
Insulation stripping length	5069-RTB4-SCREW, 5069-RTB6-SCREW connections: 12 mm (0.47 in.) 5069-RTB4-SPRING, 5069-RTB6-SPRING connections: 10 mm (0.39 in.)	5069-RTB5-SCREW connections: 10 mm (0.39 in.) 5069-RTB5-SPRING connections: 10 mm (0.39 in.)
Terminal block torque specifications	5069-RTB4-SCREW and 5069-RTB6-SCREW: 0.4 N•m (3.5 lb•in) 5069-RTB4-SPRING and 5069-RTB6-SPRING: Not applicable	5069-RTB5-SCREW: 0.5...0.6 N•m (4.4...5.3 lb•in) 5069-RTB5-SPRING: Not applicable
North American temp code	T4	
ATEX temp code	T4	
IECEx temp code	T4	

Additional Resources

For more information on the products that are described in this publication, use these resources.

Resource	Description
Compact 5000 I/O Modules and EtherNet/IP Adapters Technical Data, publication 5069-TD001	Provides specifications and wiring diagrams for Compact 5000 I/O modules and EtherNet/IP adapter.
EtherNet/IP Communication Modules in Logix 5000 Control Systems User Manual, publication ENET-UM004	Describes how to use the Compact 5000 I/O EtherNet/IP adapters.
Ethernet Design Considerations Reference Manual, publication ENET-RM002	Describes how to use EtherNet/IP adapters with Logix 5000 controllers and communicate with other devices on the EtherNet/IP network.
EtherNet/IP Embedded Switch Technology Application Guide, publication ENET-AP005	Describes how to install, configure, and maintain linear and Device Level Ring (DLR) networks by using Allen-Bradley® EtherNet/IP devices that are equipped with embedded switch technology.
EtherNet/IP Media Planning and Installation Manual This manual is available from the Open DeviceNet Vendor Association (ODVA) at http://www.odva.org	Describes how to use the required media components and provides information on how to plan for, install, verify, troubleshoot, and certify your EtherNet/IP network.
Industrial Automation Wiring and Grounding Guidelines, publication 1770-4.1	Provides general guidelines for installing a Rockwell Automation® industrial system.
Product Certifications website, http://www.rockwellautomation.com/global/certification/overview.page	Provides declarations of conformity, certificates, and other certification details.

You can view or download publications at <http://www.rockwellautomation.com/literature/>. To order paper copies of technical documentation, contact your local Allen-Bradley distributor or Rockwell Automation sales representative.

Rockwell Automation Support

Use the following resources to access support information.

Technical Support Center	Knowledgebase Articles, How-to Videos, FAQs, Chat, User Forums, and Product Notification Updates.	https://rockwellautomation.custhelp.com/
Local Technical Support Phone Numbers	Locate the phone number for your country.	http://www.rockwellautomation.com/global/support/get-support-now.page
Direct Dial Codes	Find the Direct Dial Code for your product. Use the code to route your call directly to a technical support engineer.	http://www.rockwellautomation.com/global/support/direct-dial.page
Literature Library	Installation Instructions, Manuals, Brochures, and Technical Data.	http://www.rockwellautomation.com/global/literature-library/overview.page
Product Compatibility and Download Center (PCDC)	Get help determining how products interact, check features and capabilities, and find associated firmware.	http://www.rockwellautomation.com/global/support/pcdc.page

Documentation Feedback

Your comments will help us serve your documentation needs better. If you have any suggestions on how to improve this document, complete the How Are We Doing? form at http://literature.rockwellautomation.com/idc/groups/literature/documents/du/ra-du002_-en-e.pdf.

Rockwell Automation maintains current product environmental information on its website at <http://www.rockwellautomation.com/rockwellautomation/about-us/sustainability-ethics/product-environmental-compliance.page>.

Allen-Bradley, Compact 5000, Logix 5000, Rockwell Automation, Rockwell Software, RSLinx, and Studio 5000 Logix Designer are trademarks of Rockwell Automation, Inc. Trademarks not belonging to Rockwell Automation are property of their respective companies.

Rockwell Otomasyon Ticaret A.Ş., Kar Plaza İş Merkezi E Blok Kat:6 34752 İçerenköy, İstanbul, Tel: +90 (216) 5698400

www.rockwellautomation.com

Power, Control and Information Solutions Headquarters

Americas: Rockwell Automation, 1201 South Second Street, Milwaukee, WI 53204-2496 USA, Tel: (1) 414.382.2000, Fax: (1) 414.382.4444
Europe/Middle East/Africa: Rockwell Automation NV, Pegasus Park, De Kleetlaan 12a, 1831 Diegem, Belgium, Tel: (32) 2 663 0600, Fax: (32) 2 663 0640
Asia Pacific: Rockwell Automation, Level 14, Core F, Cyberport 3, 100 Cyberport Road, Hong Kong, Tel: (852) 2887 4788, Fax: (852) 2508 1846

Publication 5069-IN003E-EN-P - October 2018

Supersedes Publication 5069-IN003D-EN-P - April 2018

PN-512294

Copyright © 2018 Rockwell Automation, Inc. All rights reserved. Printed in the U.S.A.