

Technical Application Papers No.8

Power factor correction and harmonic filtering in electrical plants

Power factor correction and harmonic filtering in electrical plants

Index

| | | | |
|--|----|---|----|
| Introduction | 2 | 8 Harmonics in electrical plants | |
| 1 Generalities on power factor correction | 3 | 8.1 Harmonics..... | 20 |
| 2 Technical advantages of power factor correction | 4 | 8.2 The prescriptions of the Standards | 21 |
| 2.1 Better utilization of electrical machines | 5 | 8.3 Harmonic effects..... | 21 |
| 2.2 Better utilization of electrical lines | 5 | 8.3.1 Overloads | 21 |
| 2.3 Reduction of losses | 6 | 8.3.2 Resonance | 22 |
| 2.4 Reduction of voltage drop | 6 | 8.4 Harmonic filters | 23 |
| 3 Economic advantages of power factor correction | 7 | 9 Switching and protection of capacitor banks | |
| 4 Production means of reactive power | | 9.1 Switching electrical phenomena..... | 25 |
| 4.1 Synchronous alternators..... | 8 | 9.2 Switching and protection..... | 26 |
| 4.2 Synchronous compensators..... | 8 | 9.2.1 Choice of the protective device..... | 26 |
| 4.3 Static var compensators..... | 8 | 9.2.2 Choice of the switching device (contactor)..... | 26 |
| 4.4 Banks of static capacitors | 9 | 9.2.3 Choice of the capacitor | 27 |
| 5 Types of power factor (PF) correction | | 9.2.4 Discharge of capacitors | 28 |
| 5.1 Distributed PF correction..... | 10 | 10 ABB offer | |
| 5.2 Group PF correction..... | 11 | 10.1 Circuit-breakers | 30 |
| 5.3 Centralized PF correction | 11 | 10.1.1 Moulded-case circuit-breakers Tmax T | 30 |
| 5.4 Combined PF correction..... | 11 | 10.1.2 Moulded-case circuit-breakers SACE Tmax XT.... | 32 |
| 5.5 Automatic PF correction | 11 | 10.1.3 Air circuit-breakers Emax | 34 |
| 6 Calculation of the power factor | 12 | 10.2 Contactors | 35 |
| 7 Calculation of the necessary reactive power | 13 | 10.2.1 Contactors UA...RA | 35 |
| 7.1 PF correction of three-phase motors..... | 14 | 10.2.2 Contactors UA..... | 36 |
| 7.2 PF correction of three-phase transformers..... | 17 | 10.2.3 Contactors A and AF..... | 36 |
| | | 10.3 Automatic compensators..... | 37 |
| | | 10.4 PQF filters | 39 |
| | | Annex A: | |
| | | Selection tables for circuit-breakers and contactors | 44 |
| | | Annex B: | |
| | | Reactive power at voltage variations | 47 |
| | | Annex C: | |
| | | Filtering and power factor correction in distorted steady-state | 48 |
| | | Annex D: | |
| | | Voltagés and currents upon switching and discharging of capacitors..... | 53 |
| | | Annex E: | |
| | | Power factor correction in photovoltaic plants | 55 |
| | | Annex F: | |
| | | Harmonics in three-phase systems with neutral ... | 56 |
| | | Glossary | 58 |

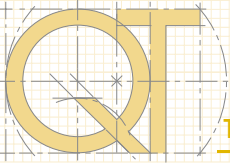

Introduction

In electrical plants the loads draw from the network electric power (active) as power supply source (e.g. personal computers, printers, diagnostic equipment, etc.) or convert it into another form of energy (e.g. electrical lamps or stoves) or into mechanical output (e.g. electrical motors). To get this, it is often necessary that the load exchanges with the network (with net null consumption) the reactive energy, mainly of inductive type. This energy, even if not immediately converted into other forms, contributes to increase the total power flowing through in the electrical network, from the generators, all along the conductors, to the users. To smooth such negative effect, the power factor correction of the electrical plants is carried out. The power factor correction obtained by using capacitor banks to generate locally the reactive energy necessary for the transfer of electrical useful power, allows a better and more rational technical-economical management of the plants.

Moreover, the present spreading of direct current users, such as electronic circuits and electric drives, involve the generation of current harmonics which are injected into the network, with the consequent pollution and distortion of the waveforms on other connected loads. Therefore, the use of harmonic filters, both of passive as well as of active type, contributes to improve the overall power-quality of the network, carrying out also power factor correction at the network frequency, when such filters are properly sized.

This technical paper has the purpose of analyzing these problems without going into technical details, but, starting from the definition of power factor correction, from an analysis of the technical-economical advantages and describing the forms and modalities to achieve power factor correction, it wishes to guide to the convenient choice of the devices for the

switching of the capacitor banks and the filtering of the harmonics. In fact, after a first descriptive part, the ABB offer is illustrated in terms of power factor correction devices, intended not only as suitable capacitors, but also as those devices able to carry out switching and protection of the capacitor banks. Besides, some solutions are given for both the passive and active filtering of the current harmonics generated by distorting non-linear loads.

To integrate this technical paper there are also six annexes providing:

- tables for the quick choice and coordination of circuit-breakers and contactors for switching and protection of capacitor banks of a determined power;
- indications on how the reactive power generated at the variations of supply voltages changes and necessary considerations to prevent reactive power from being injected into the network;
- considerations on power factor correction and filtering under distorted steady-state conditions to point out how canonical power factor correction implies a reduction of the value of the harmonics present in the network;
- descriptions of the voltage and current characteristics during the switching on and discharging of capacitor banks;
- considerations on power factor correction in photovoltaic plants;
- remarks about the contribution of harmonics to the evaluation of the current in the neutral conductor of three-phase systems.

1 Generalities on power factor correction

In alternating current circuits, the current absorbed by a load can be represented by two components:

- the *active component* I_R , in phase with the supply voltage, is directly related to the output (and therefore to the part of electric energy converted into energy of different types: mechanical energy, light energy, thermal energy...);
- the *reactive component* I_Q , in quadrature to the voltage, is used to generate the flow necessary for the conversion of powers through the electric or magnetic field and it is index of the transfer of energy between supply and load. Without this, there could be no net transfer of power, for example, thanks to the magnetic coupling in the core of a transformer or in the air gap of a motor.

In the most common case, in the presence of ohmic-inductive type loads, the total current I lags with respect to the active component I_R .

Therefore, in an electrical installation, it is necessary to generate and transmit, in addition to the active power P , a certain reactive power Q , which is essential for the conversion of the electrical energy but is not available to the load because exchanged with the network. The complex of the power generated and transmitted constitutes the apparent power S .

Power factor $\cos\varphi$ is defined as the ratio between the active component I_R and the total value of the current I ; φ is the phase angle between the voltage and the current. For a given phase voltage V , it results:

$$\cos\varphi = \frac{I_R}{I} = \frac{P}{S}$$

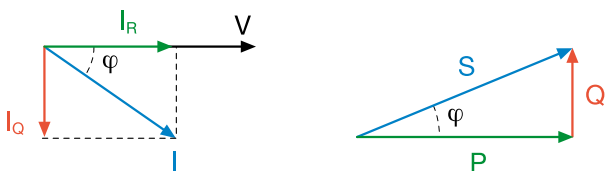

Table 1.1 shows the typical power factors of some electrical equipment.

Table 1.1

| Load | $\cos\varphi$ power factor |
|----------------------------------|-------------------------------|
| Transformers (no load condition) | 0.1÷0.15 |
| Motor | 0.7÷0.85 |
| Metal working apparatuses: | |
| - Arc welding | 0.35÷0.6 |
| - Arc welding compensated | 0.7÷0.8 |
| - Resistance welding: | 0.4÷0.6 |
| -Arc melting furnace | 0.75÷0.9 |
| Fluorescent lamps | |
| -compensated | 0.9 |
| -uncompensated | 0.4÷0.6 |
| AC DC converters | 0.6÷0.95 |
| DC drives | 0.4÷0.75 |
| AC drives | 0.95÷0.97 |
| Resistive load | 1 |

Improving the power factor means taking the necessary steps to increase the power factor in a defined section of the installation by locally delivering the necessary reactive power so that the value of the current and consequently of the power flowing through the upstream network can be reduced, at the same required output power. In this way, the lines, the generators and the transformers can be sized for a lower apparent power, as better explained in the following chapter.

From a strictly technical point of view, a suitably sized installation can operate properly also in case of a low power factor; for this reason there aren't standards prescribing the precise value of power factor that an electrical installation should have.

However, improving the power factor is a solution which allows technical and economic advantages; in fact, managing an installation with a low $\cos\varphi$ implies an increase of costs for the power supply authority, who consequently applies a tariff structure which penalizes the withdrawal of energy with low power factors.

The legislative measures in force in the different countries allow the national power supply authorities to create a more or less detailed tariff system; without going deeply into details, such system is structured so that the absorbed reactive energy exceeding that corresponding to a $\cos\varphi$ equal to 0.9 must be paid according to defined amounts depending on the voltage level of the supply (low, medium or high) and on the power factor.

According to the tariff system applied, the consumer can determine the amount of his own additional charge and therefore can evaluate the savings on the penalties to be paid in comparison with the cost of an installation for power factor correction.

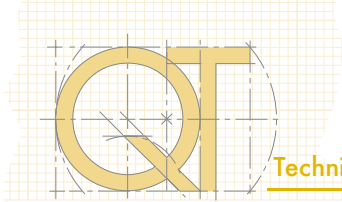

2 Technical advantages of power factor correction

As previously mentioned, by correcting the power factor of an installation supplying locally the necessary reactive power, at the same level of required output power, it is possible to reduce the current value and consequently the total power absorbed on the load side; this implies numerous advantages, among which a better utilization of electrical machines (generators and transformers) and of electrical lines (transmission and distribution lines).

In the case of sinusoidal waveforms, the reactive power necessary to pass from one power factor $\cos\varphi_1$ to a power factor $\cos\varphi_2$ is given by the relation (valid for both three-phase as well as single-phase systems):

$$Q_c = Q_1 - Q_2 = P \cdot (\operatorname{tg}\varphi_1 - \operatorname{tg}\varphi_2) \quad [2.1]$$

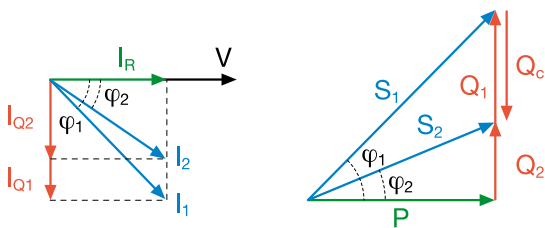
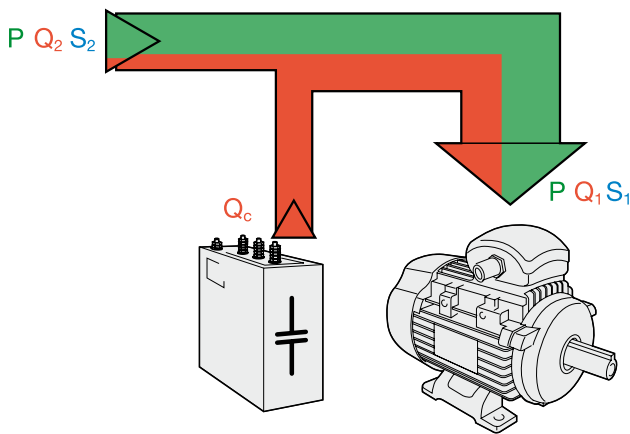

where:

- P is the active power;
- Q_1, φ_1 are the reactive power and the phase displacement angle before power factor correction;
- Q_2, φ_2 are the reactive power and the phase displacement angle after power factor correction;
- Q_c is the reactive power for power factor correction.

Example

Suppose we wish to increase from 0.8 to 0.93 the power factor in a three-phase plant ($U_n=400$ V) absorbing an average power of 300 kW.

The absorbed current shall be:

$$I_1 = \frac{P}{\sqrt{3} \cdot U_n \cdot \cos\varphi_1} = \frac{300 \cdot 10^3}{\sqrt{3} \cdot 400 \cdot 0.8} = 540 \text{ A}$$

By applying the formula previously described, the reactive power to be locally generated by Q_c can be obtained:

$$Q_c = P \cdot (\operatorname{tg}\varphi_1 - \operatorname{tg}\varphi_2) = 300 \cdot (0.75 - 0.39) = 108 \text{ kvar}$$

Due to the effect of power factor correction, the absorbed current decreases from 540 A to:

$$I_2 = \frac{P}{\sqrt{3} \cdot U_n \cdot \cos\varphi_2} = \frac{300 \cdot 10^3}{\sqrt{3} \cdot 400 \cdot 0.93} = 465 \text{ A}$$

(about 15% reduction)

For what said above, the main advantages of power factor correction can be summarized as follows:

- better utilization of electrical machines;
- better utilization of electrical lines;
- reduction of losses;
- reduction of voltage drops.

2.1 Better utilization of electrical machines

Generators and transformers are sized according to the apparent power S. At the same active power P, the smaller the reactive power Q to be delivered, the smaller the apparent power. Thus, by improving the power factor of the installation, these machines can be sized for a lower apparent power, but still deliver the same active power.

As an example, Table 2.1 shows the variation of the transmissible power for MV/LV three-phase transformers as a function of the $\cos\varphi$ of the load.

Table 2.1

| Power of the transformer [kVA] | Power of the transformer [kW] | | | | | |
|--------------------------------|-------------------------------|-----|------------|------|------------|------|
| | $\cos\varphi$ | | | | | |
| | 0.5 | 0.6 | 0.7 | 0.8 | 0.9 | 1 |
| 63 | 32 | 38 | 44 | 50 | 57 | 63 |
| 100 | 50 | 60 | 70 | 80 | 90 | 100 |
| 125 | 63 | 75 | 88 | 100 | 113 | 125 |
| 160 | 80 | 96 | 112 | 128 | 144 | 160 |
| 200 | 100 | 120 | 140 | 160 | 180 | 200 |
| 250 | 125 | 150 | 175 | 200 | 225 | 250 |
| 315 | 158 | 189 | 221 | 252 | 284 | 315 |
| 400 | 200 | 240 | 280 | 320 | 360 | 400 |
| 630 | 315 | 378 | 441 | 504 | 567 | 630 |
| 800 | 400 | 480 | 560 | 640 | 720 | 800 |
| 1000 | 500 | 600 | 700 | 800 | 900 | 1000 |
| 1250 | 625 | 750 | 875 | 1000 | 1125 | 1250 |

From the above table it results that to supply 170 kW total power with $\cos\varphi=0.7$ to a series of loads, a 250 kVA transformer must be used. If the loads absorbed the same power with $\cos\varphi=0.9$, instead of 0.7, it would be sufficient to use a 200 kVA transformer.

The same is valid also for generators.

2.2 Better utilization of electrical lines

Power factor correction allows to obtain advantages also for cable sizing. In fact, as previously said, at the same output power, by increasing the power factor the current diminishes. This reduction in current can be such as to allow the choice of conductors with lower cross sectional area.

To make it clear through a practical example, take into consideration a load requiring a power P_n equal to 170 kW with $\cos\varphi = 0.7$, at a voltage $U_n = 400$ V; the absorbed current $I_{0.7}$ is:

$$I_{0.7} = \frac{P_n}{\sqrt{3} \cdot U_n \cdot \cos\varphi_1} = \frac{170}{\sqrt{3} \cdot 400 \cdot 0.7} = 350.5 \text{ A}$$

When choosing a copper single-core cable with EPR insulation, installed flat on a perforated tray, under standard conditions, a cross sectional area of 120 mm² shall be necessary (see Table 2.2).

By locally correcting the power factor so as to obtain a $\cos\varphi$ value of 0.9, the required current shall be:

$$I_{0.9} = \frac{P_n}{\sqrt{3} \cdot U_n \cdot \cos\varphi_2} = \frac{170}{\sqrt{3} \cdot 400 \cdot 0.9} = 272.6 \text{ A}$$

With this value of current, the cable can have a cross sectional area of 70 mm².

Table 2.2: Current carrying capacity I_0 of copper single-core cables on perforated tray

| S [mm ²] | Cu | |
|----------------------|------------|-----|
| | XLPE/EPR | PVC |
| | I_0 [A] | |
| 25 | 141 | 114 |
| 35 | 176 | 143 |
| 50 | 216 | 174 |
| 70 | 279 | 225 |
| 95 | 342 | 275 |
| 120 | 400 | 321 |
| 150 | 464 | 372 |
| 185 | 533 | 427 |
| 240 | 634 | 507 |
| 300 | 736 | 587 |
| 400 | 868 | 689 |
| 500 | 998 | 789 |
| 630 | 1151 | 905 |

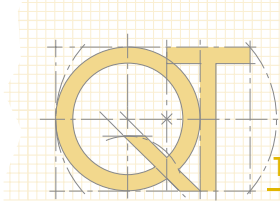

2.3 Reduction of losses

The power losses of an electric conductor depend on the resistance of the conductor itself and on the square of the current flowing through it; since, with the same value of transmitted active power, the higher the $\cos\varphi$, the lower the current, it follows that when the power factor rises, the losses in the conductor on the supply side of the point where the power factor correction has been carried out will decrease.

In a three-phase system the losses are expressed as follows:

$$p = 3 \cdot R \cdot I^2 = R \cdot \frac{(P^2 + Q^2)}{U_n^2} \quad [2.2]$$

since:

$$I = \frac{S}{\sqrt{3} \cdot U_n} = \frac{\sqrt{(P^2 + Q^2)}}{\sqrt{3} \cdot U_n} \rightarrow 3 \cdot I^2 = \frac{(P^2 + Q^2)}{U_n^2} \quad [2.3]$$

where:

- I is the current flowing through the conductor;
- R is the resistance of the conductor;
- S is the apparent power required by the load;
- P is the active power required by the load;
- Q is the reactive power required by the load;
- U_n is the rated supply voltage.

The reduction in the losses Δp after power factor correction is given by¹:

$$\Delta p = p_1 \cdot \left[1 - \left(\frac{\cos\varphi_1}{\cos\varphi_2} \right)^2 \right] \quad [2.4]$$

where:

- p_1 are the losses before power factor correction;
- $\cos\varphi_1$ is the power factor before power factor correction;
- $\cos\varphi_2$ is the power factor after power factor correction.

From this formula [2.4] it results that, for example, by increasing the power factor from 0.7 to 0.9, about 39.5% saving on losses is obtained. Table 2.3 shows the saving on losses obtained by increasing the power factor from an initial $\cos\varphi_1$ to the final value of 0.9 and 0.95.

Table 2.3

| | $\cos\varphi_1$ | | | | | | |
|---|-----------------|------|------|------|------|------|------|
| | 0.4 | 0.5 | 0.6 | 0.7 | 0.8 | 0.9 | 0.95 |
| $\Delta p\%$ from $\cos\varphi_1$ to 0.9 | 80.2 | 69.1 | 55.6 | 39.5 | 20.9 | - | - |
| $\Delta p\%$ from $\cos\varphi_1$ to 0.95 | 82.3 | 72.3 | 60.1 | 45.7 | 29.1 | 10.2 | - |

By improving the power factor, a reduction of power losses is obtained in all the parts of the installation upstream the point where the power factor has been improved.

¹

$$p_1 = R \cdot \frac{(P^2 + Q^2)}{U_n^2} = \frac{R}{U_n^2} \cdot S^2 = \frac{R}{U_n^2} \cdot \frac{P^2}{(\cos\varphi_1)^2} \quad p_2 = \frac{R}{U_n^2} \cdot \frac{P^2}{(\cos\varphi_2)^2}$$

$$\Delta p = p_1 - p_2 = \frac{R}{U_n^2} \cdot \frac{P^2}{\cos\varphi_1} - \frac{R}{U_n^2} \cdot \frac{P^2}{\cos\varphi_2} = p_1 \cdot \left[1 - \left(\frac{\cos\varphi_1}{\cos\varphi_2} \right)^2 \right]$$

2.4 Reduction of voltage drop

The drop of the line-to-line voltage in a three-phase line can be expressed as follows:

$$\Delta U = \sqrt{3} \cdot I \cdot (R \cos\varphi + X \sin\varphi) = \frac{P}{U_n} \cdot (R + X \operatorname{tg}\varphi) \quad [2.5]$$

where:

- R and X are respectively the resistance and the reactance of the line;
- P is the transmitted active power;
- I is the current;
- U_n is the rated voltage.

At the same level of transmitted active power, the voltage drop shall be the smaller, the higher the power factor².

As it can be noticed in the following figures showing the diagrams of the phase voltage drop ΔV , the smaller the phase displacement angle φ between voltage and current (with the same active component of the load current and therefore with the same active power) the smaller the voltage variation; moreover, this variation is minimum if there is no reactive power absorption (current in phase)³.

Figure 2.1: phasor diagram without power factor correction displaying the voltage drop on the line

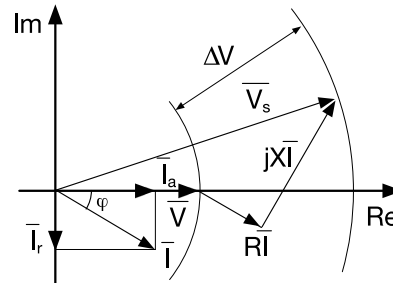
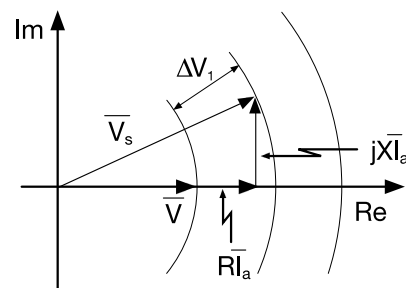

Figure 2.2: phasor diagram with total power factor correction displaying the voltage drop on the line in case of a purely ohmic load



² In very high voltage lines, which are designed so that the power transmitted by them is equal to the characteristic power, the voltage variation is already limited in itself (null if the line is considered without losses) and moreover the consumption of inductive reactive power due to the flowing of the current in the series inductance is perfectly equal to the capacitive reactive power generated by the derived capacitances.

³ By definition and as can be noted in the diagrams, the voltage drop is the difference between the module of the incoming and outgoing voltage. In the calculation of ΔV by the formula [2.5] an additional term equal to about 1/200 of the voltage value is not given, therefore it can be neglected.

3 Economic advantages of power factor correction

Power supply authorities apply a tariff system which imposes penalties on the drawing of energy with a monthly average power factor lower than 0.9. The contracts applied are different from country to country and can vary also according to the typology of customer; as a consequence, the following remarks are to be considered as a mere didactic and indicative information aimed at showing the economic saving which can be obtained thanks to the power factor correction. Generally speaking, the power supply contractual clauses require the payment of the absorbed reactive energy when the power factor is included in the range from 0.7 and 0.9, whereas nothing is due if it is higher than 0.9. For $\cos\varphi < 0.7$ power supply authorities can oblige consumers to carry out power factor correction. It is to be noted that having a monthly average power factor higher than or equal to 0.9 means requesting from the network a reactive energy lower than or equal to 50% of the active energy:

$$\operatorname{tg}\varphi = \frac{Q}{P} \leq 0.5 \rightarrow \cos\varphi \geq 0.89 \quad [3.1]$$

Therefore no penalties are applied if the requirements for reactive energy do not exceed 50% of the active one. The cost that the consumer bears on a yearly base when drawing a reactive energy exceeding that corresponding to a power factor equal to 0.9 can be expressed by the following relation:

$$C_{EQ} = (E_Q - 0.5 \cdot E_p) \cdot c \quad [3.2]$$

where:

- C_{EQ} is the cost of the reactive energy per year in €;
- E_Q is the reactive energy consumed per year in kvarh;
- E_p is the active energy consumed per year in kWh;
- $E_Q - 0.5 \cdot E_p$ is the amount of reactive energy to be paid;
- c is the unit cost of the reactive energy in €/kvarh.

If the power factor is corrected at 0.9 not to pay the consumption of reactive energy, the cost of the capacitor bank and of the relevant installation will be:

$$C_{Qc} = C_Q \cdot c_c \quad [3.3]$$

where:

- C_{Qc} is the yearly cost in € to get a power factor equal to 0.9;
- Q_c is the power of the capacitor bank necessary to have a $\cos\varphi$ of 0.9, in kvar;
- c_c is the yearly installation cost of the capacitor bank in €/kvar.

The saving for the consumer shall be:

$$C_{EQ} - C_{Qc} = (E_Q - 0.5 \cdot E_p) \cdot c - Q_c \cdot c_c \quad [3.4]$$

It is necessary to note that the capacitor bank represents an "installation cost" to be divided suitably for the years of life of the installation itself applying one or more economic coefficients; in the practice, the savings obtained by correcting the power factor allow the payback of the installation cost of the capacitor bank within the first

years of use. As a matter of fact, an accurate analysis of an investment implies the use of some economic parameters that go beyond the purposes of this Technical Application Paper.

Example

A company absorbs active and reactive energy according to table 3.1:

Table 3.1

| Month | active energy [kWh] | reactive energy [kvarh] | monthly average pf |
|-------|---------------------|-------------------------|--------------------|
| Jan | 7221 | 6119 | 0.76 |
| Feb | 8664 | 5802 | 0.83 |
| Mar | 5306 | 3858 | 0.81 |
| Apr | 8312 | 6375 | 0.79 |
| May | 5000 | 3948 | 0.78 |
| June | 9896 | 8966 | 0.74 |
| July | 10800 | 10001 | 0.73 |
| Aug | 9170 | 8910 | 0.72 |
| Sep | 5339 | 4558 | 0.76 |
| Oct | 7560 | 6119 | 0.78 |
| Nov | 9700 | 8870 | 0.74 |
| Dec | 6778 | 5879 | 0.76 |
| Total | 93746 | 79405 | - |

By assuming a unit cost of the reactive energy equal to 0.0421 €/kvarh, the total cost per year is:

$$C_{EQ} = (E_Q - 0.5 \cdot E_p) \cdot c = (79405 - 0.5 \cdot 93746) \cdot 0.0421 = 1370 \text{ €}$$

Table 3.2 shows the reactive power necessary to increase the power factor up to 0.9.

Table 3.2

| Month | active energy [kWh] | monthly average pf | operating hours | active power P [kW] | $Q_c = P \cdot (\tan\varphi - 0.484)^1$ |
|-------|---------------------|--------------------|-----------------|---------------------|---|
| Jan | 7221 | 0.76 | 160 | 45.1 | 16.4 |
| Feb | 8664 | 0.83 | 160 | 54.2 | 10.0 |
| Mar | 5306 | 0.81 | 160 | 33.2 | 8.1 |
| Apr | 8312 | 0.79 | 160 | 52.0 | 14.7 |
| May | 5000 | 0.78 | 160 | 31.3 | 9.5 |
| June | 9896 | 0.74 | 160 | 61.9 | 26.1 |
| July | 10800 | 0.73 | 160 | 67.5 | 29.8 |
| Aug | 9170 | 0.72 | 160 | 57.3 | 27.9 |
| Sep | 5339 | 0.76 | 160 | 33.4 | 12.3 |
| Oct | 7560 | 0.78 | 160 | 47.3 | 15.4 |
| Nov | 9700 | 0.74 | 160 | 60.6 | 26.1 |
| Dec | 6778 | 0.76 | 160 | 42.4 | 16.2 |

¹ 0.484 is the tangent corresponding to a $\cos\varphi$ equal to 0.9

If an automatically-controlled capacitor bank for power factor correction with $Q_c = 30$ kvar, against a total installation cost per year c_c of 25 €/kvar, a total cost of 750 € is obtained. The saving for the consumer, without keeping into account the payback and the financial charges, shall be:

$$C_{EQ} - C_{Qc} = 1370 - 750 = 620 \text{ €}$$

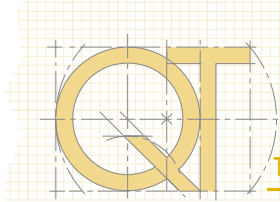

4 Generation means of reactive power

The main means for the generation of reactive power are:

- synchronous alternators;
- synchronous compensators (SC);
- static var compensators (SVC);
- banks of static capacitors.

4.1 Synchronous alternators

Synchronous alternators are the main machines used for the generation of electrical energy. They are intended to supply electrical power to the final loads through transmission and distribution systems. Besides, without going into technical details, by acting on the excitation of alternators, it is possible to vary the value of the generated voltage and consequently to regulate the injections of reactive power into the network, so that the voltage profiles of the system can be improved and the losses due to joule effect along the lines can be reduced.

4.2 Synchronous compensators

They are synchronous motors running no-load in synchronism with the network and having the only function to absorb the reactive power in excess (under-excited operation) or to supply the missing one (over-excited operation).

Figure 4.1: under-excited synchronous compensator

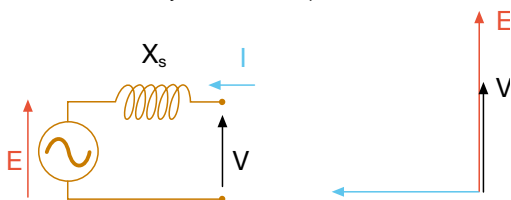
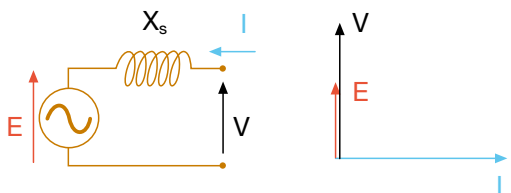

Figure 4.2: over-excited synchronous compensator



E : e.m.f. induced in the stator phases
 V : phase voltage imposed by the network to the alternator terminals
 I : stator current
 X_s : stator reactance

These devices are used mainly in definite nodes of the power transmission and sub-transmission network for the regulation of voltages and of reactive power flows. The use of synchronous compensators in power distribution networks is not favourable from an economic point of view because of their high installation and maintenance costs.

4.3 Static var compensators

The considerable development of power electronics is encouraging the replacement of synchronous compensators with static systems for the control of the reactive power such as for example TSC (*thyristor switched capacitors*) and TCR (*thyristor controlled reactors*). These are an electronic version of the reactive power compensation systems based on electromechanical components in which, however, the switching of the various capacitors is not carried out through the opening and closing of suitable contactors, but through the control carried out by couples of antiparallel thyristors.

Figure 4.3

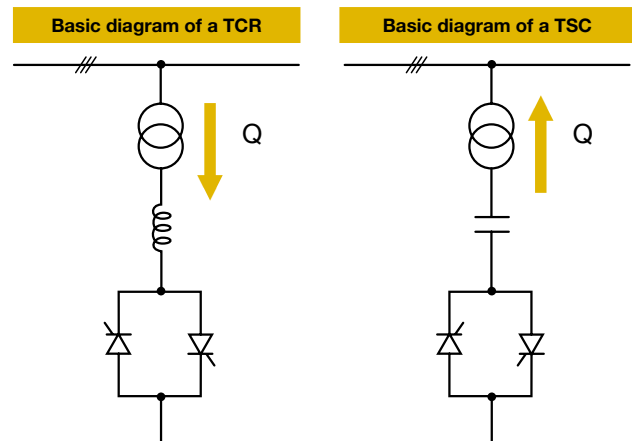

TSC allow a step-by-step control of the reactive power delivered by groups of capacitors, whereas with TCR a continuous control of the reactive power drawn by the inductors is possible.

By coupling a TSC with a TCR it is possible to obtain a continuous modulated regulation of the delivered/drawn reactive power.

From the point of view of applications, these devices are used above all in high and very high voltage networks.

4.4 Banks of static capacitors

A capacitor is a passive dipole consisting of two conducting surfaces called plates, isolated from one another by a dielectric material.

Figure 4.4

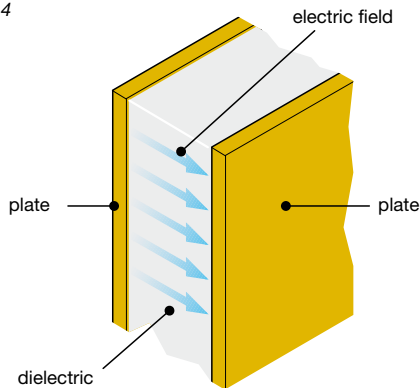

The system thus obtained is impregnated to prevent the penetration of humidity or of gas pockets which could cause electrical discharges.

The last generation capacitors are dry-type and undergo a specific treatment which improve their electrical characteristics. Using dry-type capacitors there is no risk of pollution because of the incidental leak of the impregnating substance.

According to the geometry of the metal plates, it is possible to have:

- plane capacitors;
- cylindrical capacitors;
- spherical capacitors.

The main parameters which characterize a capacitor are:

- the *rated capacitance* C_n : the value obtained from the rated values of power, voltage and frequency of the capacitor;
- the *rated power* Q_n : the reactive power for which the capacitor has been designed;
- the *rated voltage* U_n : the r.m.s. value of the alternating voltage for which the capacitor has been designed;
- the *rated frequency* f_n : the frequency for which the capacitor has been designed.

When an alternating voltage is applied across the plates, the capacitor is subjected to charge and discharge cycles, during which it stores reactive energy (capacitor charge) and injects such energy into the circuit to which it is connected (capacitor discharge).

Such energy is given by the following relation:

$$E_c = \frac{1}{2} \cdot C \cdot U^2$$

where:

- C is the capacitance;
- U is the voltage applied to the terminals of the capacitor.

Because of their capability of storing and delivering energy, capacitors are used as basic element for the realization of power factor correction banks (for all voltage levels) and of static devices for the regulation of reactive power¹.

In particular, the power factor correction capacitors used for low voltage applications are constituted by single-phase components of metalized polypropylene film and can be of the self-healing type. In these capacitors, the dielectric part damaged by a discharge is capable of self-restoring; in fact, when such situations occur, the part of the polypropylene film affected by the discharge evaporates due to the thermal effect caused by the discharge itself, thus restoring the damaged part.

¹ As a matter of fact, the capacitors draw a minimum value of active power owing to the non-null conductivity of the interposed dielectric material and to the dielectric hysteresis losses

Figure 4.5

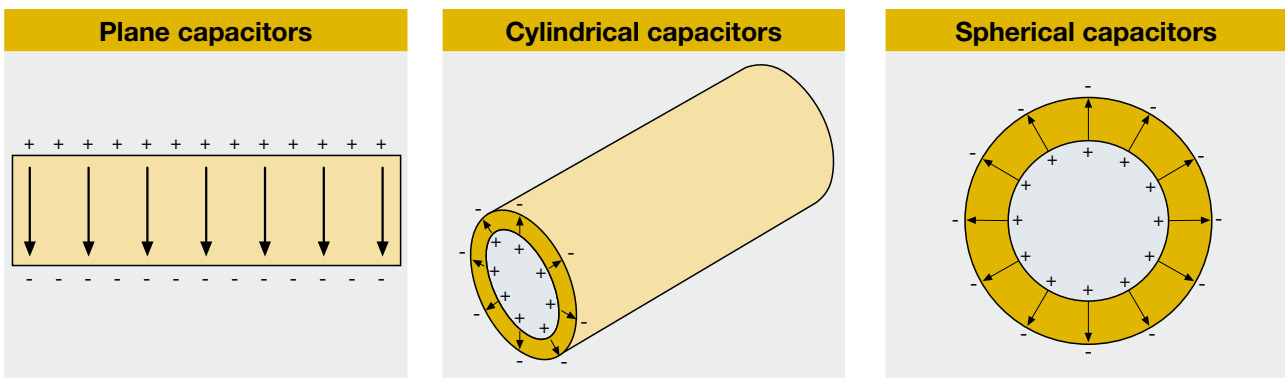

5 Types of power factor correction

In the previous chapters the technical and economic advantages of power factor correction have been discussed. Now it is important to understand where the capacitors are to be installed for a better exploitation of such advantages.

There are no general rules applicable to every type of installation and, in theory, capacitors can be installed at any point, but it is necessary to evaluate the relevant practical and economical feasibility.

According to the location modalities of the capacitors, the main methods of power factor correction are:

- distributed power factor correction;
- group power factor correction;
- centralized power factor correction;
- combined power factor correction;
- automatic power factor correction.

5.1 Distributed power factor correction

Distributed power factor correction is achieved by connecting a capacitor bank properly sized directly to the terminals of the load which demands reactive power.

The installation is simple and inexpensive; capacitor and load can use the same protective devices against overcurrents and are connected and disconnected si-

multaneously.

This type of power factor correction is advisable in the case of large electrical equipment with constant load and power and long connection times and it is generally used for motors and fluorescent lamps.

Figure 5.1 shows the common connection diagrams for the power factor correction of motors.

In case of direct connection (diagrams 1 and 2), the following risk may be run: after the disconnection from the supply, the motor will continue to rotate (residual kinetic energy) and self-excite with the reactive energy drawn from the capacitor bank, and may turn into an asynchronous generator. In this case, the voltage on the load side of the switching and control device is maintained, with the risk of dangerous overvoltages (up to twice the rated voltage value).

When using diagram 3, the compensation bank is connected only after the motor has been started and disconnected in advance with respect to the switching off of the motor supply.

With this type of power factor correction the network on the supply side of the load works with a high power factor; on the other hand, this solution results economically onerous.

Figure 5.1

Diagram 1

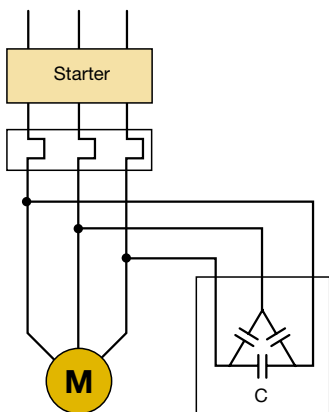

Diagram 2

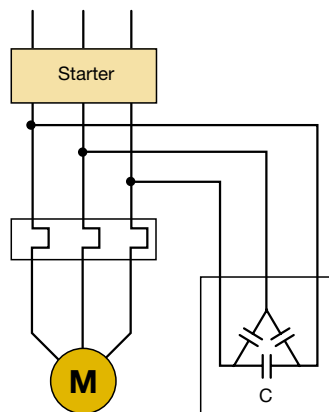
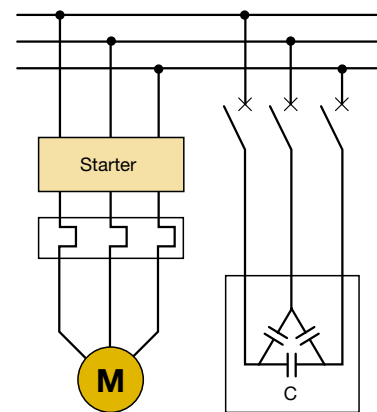

Diagram 3



5.2 Group power factor correction

It consists in improving locally the power factor of groups of loads having similar functioning characteristics by installing a dedicated capacitor bank.

This is the method reaching a compromise between the inexpensive solution and the proper management of the installation since the benefits deriving from power factor correction shall be felt only by the line upstream the point where the capacitor bank is located.

Figure 5.2

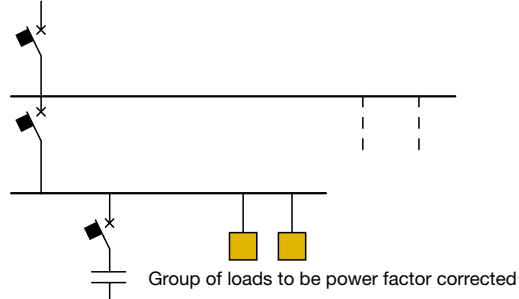

5.3 Centralized power factor correction

The profile of loads connected during the day has a primary importance for the choice of the most convenient type of power factor correction.

For installations with many loads, where not all the loads function simultaneously and/or some loads are connected for just a few hours a day, it is evident that the solution of distributed power factor correction becomes too onerous since many of the installed capacitors stay idle for a long time. Therefore the use of one compensation system only located at the origin of the installation allows a remarkable reduction of the total power of the installed capacitors.

Figure 5.3

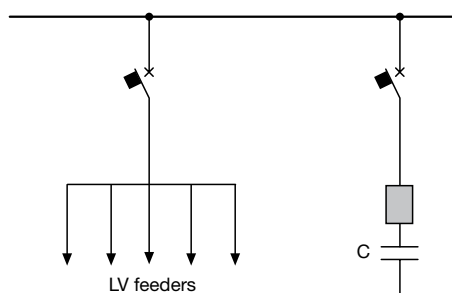

In centralized power factor correction automatic assemblies are normally used (see below automatic power factor correction) with banks divided into steps, installed directly in the main distribution boards; the use of a per-

manently connected bank is possible only if the absorption of reactive energy is quite constant all day long.

The centralized solution allows an optimization of the costs of the capacitor bank, but presents the disadvantage that the distribution lines on the load side of the power factor correction device shall be sized keeping into account the full reactive power absorbed by the loads.

5.4 Combined power factor correction

This solution derives from a compromise between the two solutions of distributed and centralized power factor correction and it exploits the advantages they offer. In such way, the distributed compensation is used for high power electrical equipment and the centralized modality for the remaining part.

Combined power factor correction is prevalently used in installations where large equipment only are frequently used; in such circumstances their power factor is corrected individually, whereas the power factor of small equipment is corrected by the centralized modality.

5.5 Automatic power factor correction

In most installations there is not a constant absorption of reactive power for example due to working cycles for which machines with different electrical characteristics are used.

In such installations there are systems for automatic power factor correction which, thanks to a monitoring varmetric device and a power factor regulator, allow the automatic switching of different capacitor banks, thus following the variations of the absorbed reactive power and keeping constant the power factor of the installation constant.

An automatic compensation system is formed by:

- some sensors detecting current and voltage signals;
- an intelligent unit which compares the measured power factor with the desired one and operates the connection and disconnection of the capacitor banks with the necessary reactive power (power factor regulator);
- an electric power board comprising switching and protection devices;
- some capacitor banks.

To supply a power as near as possible to the demanded one, the connection of the capacitors is implemented step by step with a control accuracy which will be the greater the more steps are foreseen and the smaller the difference is between them.

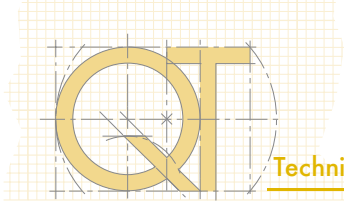

6 Calculation of the power factor

For the dimensioning of the capacitor bank to be installed in order to improve the power factor of a plant, it is necessary to calculate correctly the power factor according to the consumption or to the load cycle of the plant; this in order to avoid the intake of excess reactive energy, which is a condition normally forbidden by power supply authorities.

To carry out distributed or group power factor correction, it is necessary to calculate the $\cos\varphi$ of the single load or of the group of loads (factory areas); this can be carried out as follows:

- directly, through direct measuring by means of a power-factor meter;
- indirectly, through the reading of the active and reactive energy meters.

The power-factor meter is a measuring instrument able to display the power factor $\cos\varphi$ according to which the load is absorbing energy. The reading of the instrument shall be carried out in different moments of the load cycle, so that an average power factor value can be obtained.

If the readings of the active and reactive energy absorbed by the load or by the whole of the loads constituting the factory areas during a work cycle are available, the average power factor can be calculated as follows:

$$\cos\varphi = \cos \left(\operatorname{tg}^{-1} \left(\frac{E_{Qf} - E_{Qi}}{E_{Pf} - E_{Pi}} \right) \right)$$

where:

- E_{Pi} and E_{Qi} are the values of active and reactive energy read at the beginning of the work cycle;
- E_{Pf} and E_{Qf} are the values of active and reactive energy read at the end of the work cycle.

To carry out a centralized power factor correction, the average monthly power factor can be obtained as previously illustrated or directly from the bills of the power supply authority.

7 Calculation of the necessary reactive power

Once the power factor ($\cos\varphi_1$) of the installation and the power factor to be obtained ($\cos\varphi_2$) are known, it is possible to calculate the reactive power of the capacitor bank necessary to improve the power factor.

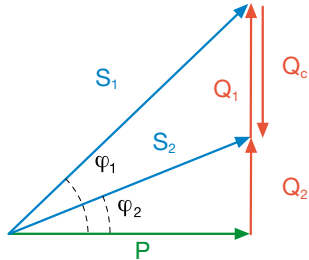

Indicating by:

- P the installed active power
 - φ_1 the phase displacement angle before power factor correction
 - φ_2 the phase displacement angle to be obtained with the power factor correction
- the power of the capacitor bank Q_c is:

$$Q_c = (\text{tg}\varphi_1 - \text{tg}\varphi_2) \cdot P = K \cdot P \quad [7.1]$$

Once the initial $\cos\varphi$ is known, Table 7.1 allows to calculate (in kvar per kW installed) the power of the capacitor bank necessary to obtain a defined power factor.

In a three-phase system, the capacitor bank constituted by three capacitors having the same capacitance, can be delta- or star-connected. When selecting the connection modality, it is necessary to keep into account that with delta connection, each capacitance is subject to the supply line-to-line voltage, but, at the same level of generated reactive power, it has a value equal to 1/3 of the value it will have in case of star-connection:

$$Q_{cY} = Q_{c\Delta} \rightarrow C_Y = 3 \cdot C_{\Delta} \quad [7.2]$$

In the low voltage field, where insulation problems are less important, the delta connection is usually preferred for the capacitor bank, since it allows a smaller sizing of the capacitances of each phase.

$$Q_{cY} = 3 \cdot \omega \cdot C_Y \cdot \left(\frac{U_n}{\sqrt{3}}\right)^2 = \omega \cdot C_Y \cdot U_n^2 = Q_{c\Delta} = 3 \cdot \omega \cdot C_{\Delta} \cdot U_n^2 \rightarrow C_Y = 3 \cdot C_{\Delta}$$

Table 7.1

Factor K (kvar/kW)

| initial $\cos\varphi$ | final $\cos\varphi$ | | | | | | | | | | | | |
|-----------------------|---------------------|-------|-------|-------|-------|-------|-------|-------|-------|-------|-------|-------|-------|
| | 0.80 | 0.85 | 0.90 | 0.91 | 0.92 | 0.93 | 0.94 | 0.95 | 0.96 | 0.97 | 0.98 | 0.99 | 1 |
| 0.60 | 0.583 | 0.714 | 0.849 | 0.878 | 0.907 | 0.938 | 0.970 | 1.005 | 1.042 | 1.083 | 1.130 | 1.191 | 1.333 |
| 0.61 | 0.549 | 0.679 | 0.815 | 0.843 | 0.873 | 0.904 | 0.936 | 0.970 | 1.007 | 1.048 | 1.096 | 1.157 | 1.299 |
| 0.62 | 0.515 | 0.646 | 0.781 | 0.810 | 0.839 | 0.870 | 0.903 | 0.937 | 0.974 | 1.015 | 1.062 | 1.123 | 1.265 |
| 0.63 | 0.483 | 0.613 | 0.748 | 0.777 | 0.807 | 0.837 | 0.870 | 0.904 | 0.941 | 0.982 | 1.030 | 1.090 | 1.233 |
| 0.64 | 0.451 | 0.581 | 0.716 | 0.745 | 0.775 | 0.805 | 0.838 | 0.872 | 0.909 | 0.950 | 0.998 | 1.058 | 1.201 |
| 0.65 | 0.419 | 0.549 | 0.685 | 0.714 | 0.743 | 0.774 | 0.806 | 0.840 | 0.877 | 0.919 | 0.966 | 1.027 | 1.169 |
| 0.66 | 0.388 | 0.519 | 0.654 | 0.683 | 0.712 | 0.743 | 0.775 | 0.810 | 0.847 | 0.888 | 0.935 | 0.996 | 1.138 |
| 0.67 | 0.358 | 0.488 | 0.624 | 0.652 | 0.682 | 0.713 | 0.745 | 0.779 | 0.816 | 0.857 | 0.905 | 0.966 | 1.108 |
| 0.68 | 0.328 | 0.459 | 0.594 | 0.623 | 0.652 | 0.683 | 0.715 | 0.750 | 0.787 | 0.828 | 0.875 | 0.936 | 1.078 |
| 0.69 | 0.299 | 0.429 | 0.565 | 0.593 | 0.623 | 0.654 | 0.686 | 0.720 | 0.757 | 0.798 | 0.846 | 0.907 | 1.049 |
| 0.70 | 0.270 | 0.400 | 0.536 | 0.565 | 0.594 | 0.625 | 0.657 | 0.692 | 0.729 | 0.770 | 0.817 | 0.878 | 1.020 |
| 0.71 | 0.242 | 0.372 | 0.508 | 0.536 | 0.566 | 0.597 | 0.629 | 0.663 | 0.700 | 0.741 | 0.789 | 0.849 | 0.992 |
| 0.72 | 0.214 | 0.344 | 0.480 | 0.508 | 0.538 | 0.569 | 0.601 | 0.635 | 0.672 | 0.713 | 0.761 | 0.821 | 0.964 |
| 0.73 | 0.186 | 0.316 | 0.452 | 0.481 | 0.510 | 0.541 | 0.573 | 0.608 | 0.645 | 0.686 | 0.733 | 0.794 | 0.936 |
| 0.74 | 0.159 | 0.289 | 0.425 | 0.453 | 0.483 | 0.514 | 0.546 | 0.580 | 0.617 | 0.658 | 0.706 | 0.766 | 0.909 |
| 0.75 | 0.132 | 0.262 | 0.398 | 0.426 | 0.456 | 0.487 | 0.519 | 0.553 | 0.590 | 0.631 | 0.679 | 0.739 | 0.882 |
| 0.76 | 0.105 | 0.235 | 0.371 | 0.400 | 0.429 | 0.460 | 0.492 | 0.526 | 0.563 | 0.605 | 0.652 | 0.713 | 0.855 |
| 0.77 | 0.079 | 0.209 | 0.344 | 0.373 | 0.403 | 0.433 | 0.466 | 0.500 | 0.537 | 0.578 | 0.626 | 0.686 | 0.829 |
| 0.78 | 0.052 | 0.183 | 0.318 | 0.347 | 0.376 | 0.407 | 0.439 | 0.474 | 0.511 | 0.552 | 0.599 | 0.660 | 0.802 |
| 0.79 | 0.026 | 0.156 | 0.292 | 0.320 | 0.350 | 0.381 | 0.413 | 0.447 | 0.484 | 0.525 | 0.573 | 0.634 | 0.776 |
| 0.80 | | 0.130 | 0.266 | 0.294 | 0.324 | 0.355 | 0.387 | 0.421 | 0.458 | 0.499 | 0.547 | 0.608 | 0.750 |
| 0.81 | | 0.104 | 0.240 | 0.268 | 0.298 | 0.329 | 0.361 | 0.395 | 0.432 | 0.473 | 0.521 | 0.581 | 0.724 |
| 0.82 | | 0.078 | 0.214 | 0.242 | 0.272 | 0.303 | 0.335 | 0.369 | 0.406 | 0.447 | 0.495 | 0.556 | 0.698 |
| 0.83 | | 0.052 | 0.188 | 0.216 | 0.246 | 0.277 | 0.309 | 0.343 | 0.380 | 0.421 | 0.469 | 0.530 | 0.672 |
| 0.84 | | 0.026 | 0.162 | 0.190 | 0.220 | 0.251 | 0.283 | 0.317 | 0.354 | 0.395 | 0.443 | 0.503 | 0.646 |
| 0.85 | | | 0.135 | 0.164 | 0.194 | 0.225 | 0.257 | 0.291 | 0.328 | 0.369 | 0.417 | 0.477 | 0.620 |
| 0.86 | | | 0.109 | 0.138 | 0.167 | 0.198 | 0.230 | 0.265 | 0.302 | 0.343 | 0.390 | 0.451 | 0.593 |
| 0.87 | | | 0.082 | 0.111 | 0.141 | 0.172 | 0.204 | 0.238 | 0.275 | 0.316 | 0.364 | 0.424 | 0.567 |
| 0.88 | | | 0.055 | 0.084 | 0.114 | 0.145 | 0.177 | 0.211 | 0.248 | 0.289 | 0.337 | 0.397 | 0.540 |
| 0.89 | | | 0.028 | 0.057 | 0.086 | 0.117 | 0.149 | 0.184 | 0.221 | 0.262 | 0.309 | 0.370 | 0.512 |
| 0.90 | | | | 0.029 | 0.058 | 0.089 | 0.121 | 0.156 | 0.193 | 0.234 | 0.281 | 0.342 | 0.484 |

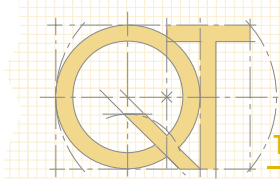

Example

In a plant with active power equal to 300 kW at 400 V and $\cos\varphi = 0.75$, we want to increase the power factor up to 0.90. In the table 7.1, at the intersection between the row “initial $\cos\varphi$ ” 0.75 with the column “final $\cos\varphi$ ” 0.9, a value of 0.398 for the coefficient K is obtained.

Therefore a capacitor bank is necessary with power Q_c equal to:

$$Q_c = K \cdot P = 0.398 \cdot 300 = 119.4 \text{ kvar}$$

The factor K can be determined also using the following nomograph².

Figure 7.1: nomograph for the calculation of the correction power

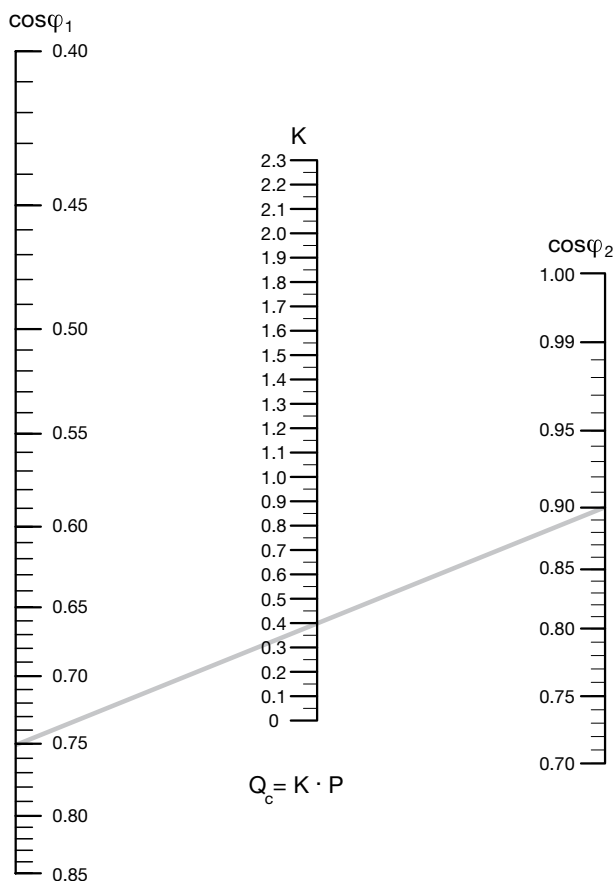

² As shown in the figure, tracing a line segment from the value of the initial $\cos\varphi$ to the value to be obtained, the intersection of the line with the middle graduated scale, gives the value of K which, multiplied by the active power P of the load, defines the necessary reactive power Q_c .

7.1 Power factor correction of three-phase motors

The power factor correction of asynchronous motors cannot be assessed with great precision because the power factor is highly influenced by the load conditions. In fact, assuming to have a 11 kW motor with 6 poles, from the table and the diagram below, the power factor obtained under normal conditions results to be $\cos\varphi_n = 0.77$, whereas the rated efficiency is $\eta_n \approx 0.86$.

Table 7.2

| Rated power | | No. of poles | | | |
|-------------|-----|--------------|------|------|------|
| kW | HP | 2 | 4 | 6 | 8 |
| 1.1 | 1.5 | 0.85 | 0.79 | 0.75 | 0.75 |
| 1.5 | 2 | 0.85 | 0.79 | 0.75 | 0.75 |
| 2.2 | 3 | 0.85 | 0.79 | 0.75 | 0.75 |
| 3 | 4 | 0.86 | 0.80 | 0.75 | 0.75 |
| 4 | 5.5 | 0.86 | 0.82 | 0.76 | 0.76 |
| 5.5 | 7.5 | 0.87 | 0.85 | 0.76 | 0.76 |
| 7.5 | 10 | 0.88 | 0.85 | 0.76 | 0.76 |
| 11 | 15 | 0.88 | 0.85 | 0.77 | 0.80 |
| 15 | 20 | 0.88 | 0.85 | 0.80 | 0.80 |
| 18.5 | 25 | 0.88 | 0.85 | 0.82 | 0.81 |
| 22 | 30 | 0.88 | 0.85 | 0.83 | 0.82 |
| 30 | 40 | 0.88 | 0.86 | 0.84 | 0.83 |
| 45 | 60 | 0.89 | 0.87 | 0.86 | 0.84 |
| 55 | 75 | 0.89 | 0.88 | 0.87 | 0.85 |
| 75 | 100 | 0.89 | 0.88 | 0.88 | 0.86 |
| 90 | 125 | 0.89 | 0.88 | 0.88 | 0.86 |

Efficiency as a function of power

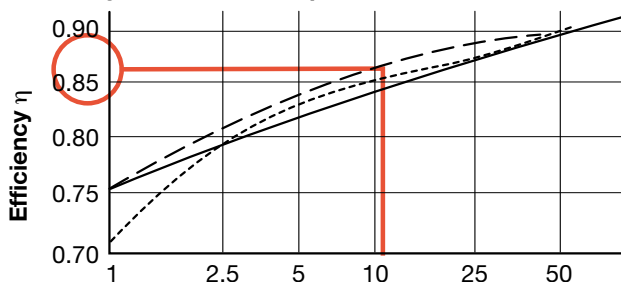

Rated power of the motor

- 2 poles ———
- 4-6 poles - - - -
- 8 poles ······

If this motor runs at 40% of the rated power, from the following diagram of coefficient reduction, it can be obtained that:

$$\cos\varphi = \cos\varphi_n \cdot 0.67 = 0.52$$

$$\eta = \eta_n \cdot 0.9 = 0.77$$

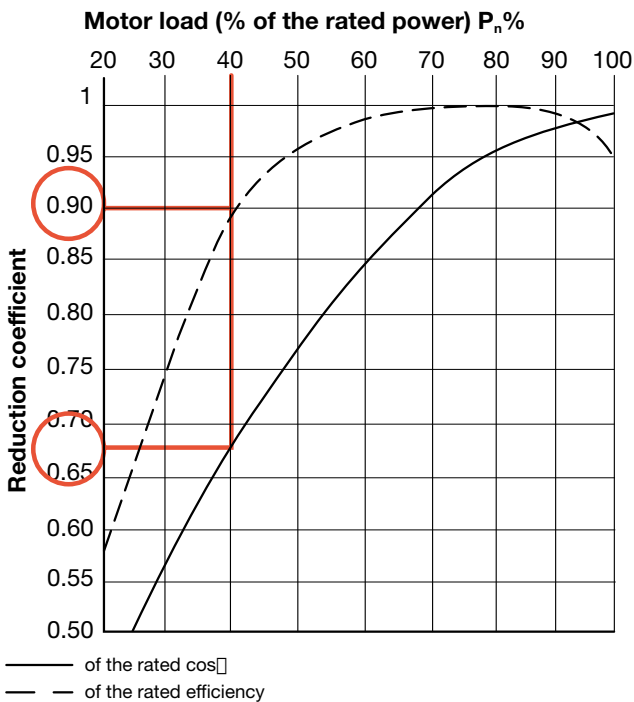

Therefore the active power absorbed P_a by the network is given by:

$$P_a = \frac{P_n}{\eta} = \frac{0.4 \cdot P_n}{\eta} = \frac{0.4 \cdot 11}{0.77} = 5.68 \text{ kW}$$

Table 7.3: reactive power for the compensation of ABB motors

| P_n [kW] | Q_c [kvar] | Before PFC | | After PFC | |
|---|-----------------|-----------------|-----------|-----------------|-----------|
| | | $\cos\varphi_1$ | I_n [A] | $\cos\varphi_2$ | I_2 [A] |
| 400 V / 50 Hz / 2 poles / 3000 r/min | | | | | |
| 7.5 | 2.5 | 0.89 | 13.9 | 0.98 | 12.7 |
| 11 | 2.5 | 0.88 | 20 | 0.95 | 18.6 |
| 15 | 5 | 0.9 | 26.5 | 0.98 | 24.2 |
| 18.5 | 5 | 0.91 | 32 | 0.98 | 29.7 |
| 22 | 5 | 0.89 | 38.5 | 0.96 | 35.8 |
| 30 | 10 | 0.88 | 53 | 0.97 | 47.9 |
| 37 | 10 | 0.89 | 64 | 0.97 | 58.8 |
| 45 | 12.5 | 0.88 | 79 | 0.96 | 72.2 |
| 55 | 15 | 0.89 | 95 | 0.97 | 87.3 |
| 75 | 15 | 0.88 | 131 | 0.94 | 122.2 |
| 90 | 15 | 0.9 | 152 | 0.95 | 143.9 |
| 110 | 20 | 0.86 | 194 | 0.92 | 181.0 |
| 132 | 30 | 0.88 | 228 | 0.95 | 210.9 |
| 160 | 30 | 0.89 | 269 | 0.95 | 252.2 |
| 200 | 30 | 0.9 | 334 | 0.95 | 317.5 |
| 250 | 40 | 0.92 | 410 | 0.96 | 391.0 |
| 315 | 50 | 0.92 | 510 | 0.96 | 486.3 |

whereas the reactive power Q_c necessary to correct the power factor and get $\cos\varphi=0.9$ with $K=1.15$ derived from the nomograph above is:

$$Q_c = K \cdot P = 1.15 \cdot 5.68 = 6.53 \text{ kvar}$$

A general rule to release the power factor correction from the utilization conditions of the motor is using, for a motor with power P_n , a compensation reactive power Q_c not higher than 90% of the reactive power Q_0 absorbed by the motor with no load at the rated voltage U_n , so that an anticipated power factor can be avoided. Besides, thanks to this measure, it is possible to reduce the disconnection overvoltage of the motor from the network; in fact, when still running, the motor may operate as a self-excited generator and may generate voltages considerably higher than the network ones [IEC 60831-1].

Considering that without load the absorbed current I_0 [A] is purely reactive ($\sin\varphi = 1$), the compensation reactive power shall be:

$$Q_c = 0.9 \cdot Q_0 = 0.9 \cdot \frac{\sqrt{3} \cdot U_n \cdot I_0}{1000} \text{ [kvar]}$$

The current I_0 is usually given in the documentation of the motor manufacturer.

Table 7.3 shows the reactive power values to correct the power factor of some types of ABB motors, as a function of the rated power and of the number of poles.

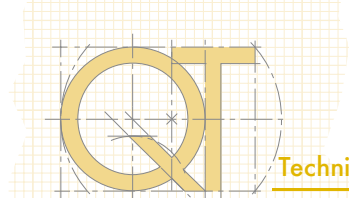

| P _n [kW] | Q _c [kvar] | Before PFC | | After PFC | |
|---|--------------------------|-------------------|--------------------|-------------------|--------------------|
| | | cosφ _r | I _n [A] | cosφ ₂ | I ₂ [A] |
| 400 V / 50 Hz / 4 poles / 1500 r/min | | | | | |
| 7.5 | 2.5 | 0.86 | 14.2 | 0.96 | 12.7 |
| 11 | 5 | 0.81 | 21.5 | 0.96 | 18.2 |
| 15 | 5 | 0.84 | 28.5 | 0.95 | 25.3 |
| 18.5 | 7.5 | 0.84 | 35 | 0.96 | 30.5 |
| 22 | 10 | 0.83 | 41 | 0.97 | 35.1 |
| 30 | 15 | 0.83 | 56 | 0.98 | 47.5 |
| 37 | 15 | 0.84 | 68 | 0.97 | 59.1 |
| 45 | 20 | 0.83 | 83 | 0.97 | 71.1 |
| 55 | 20 | 0.86 | 98 | 0.97 | 86.9 |
| 75 | 20 | 0.86 | 135 | 0.95 | 122.8 |
| 90 | 20 | 0.87 | 158 | 0.94 | 145.9 |
| 110 | 30 | 0.87 | 192 | 0.96 | 174.8 |
| 132 | 40 | 0.87 | 232 | 0.96 | 209.6 |
| 160 | 40 | 0.86 | 282 | 0.94 | 257.4 |
| 200 | 50 | 0.86 | 351 | 0.94 | 320.2 |
| 250 | 50 | 0.87 | 430 | 0.94 | 399.4 |
| 315 | 60 | 0.87 | 545 | 0.93 | 507.9 |
| 400 V / 50 Hz / 6 poles / 1000 r/min | | | | | |
| 7.5 | 5 | 0.79 | 15.4 | 0.98 | 12.4 |
| 11 | 5 | 0.78 | 23 | 0.93 | 19.3 |
| 15 | 7.5 | 0.78 | 31 | 0.94 | 25.7 |
| 18.5 | 7.5 | 0.81 | 36 | 0.94 | 30.9 |
| 22 | 10 | 0.81 | 43 | 0.96 | 36.5 |
| 30 | 10 | 0.83 | 56 | 0.94 | 49.4 |
| 37 | 12.5 | 0.83 | 69 | 0.94 | 60.8 |
| 45 | 15 | 0.84 | 82 | 0.95 | 72.6 |
| 55 | 20 | 0.84 | 101 | 0.96 | 88.7 |
| 75 | 25 | 0.82 | 141 | 0.93 | 123.9 |
| 90 | 30 | 0.84 | 163 | 0.95 | 144.2 |
| 110 | 35 | 0.83 | 202 | 0.94 | 178.8 |
| 132 | 45 | 0.83 | 240 | 0.95 | 210.8 |
| 160 | 50 | 0.85 | 280 | 0.95 | 249.6 |
| 200 | 60 | 0.85 | 355 | 0.95 | 318.0 |
| 250 | 70 | 0.84 | 450 | 0.94 | 404.2 |
| 315 | 75 | 0.84 | 565 | 0.92 | 514.4 |
| 400 V / 50 Hz / 8 poles / 750 r/min | | | | | |
| 7.5 | 5 | 0.7 | 18.1 | 0.91 | 13.9 |
| 11 | 7.5 | 0.76 | 23.5 | 0.97 | 18.4 |
| 15 | 7.5 | 0.82 | 29 | 0.97 | 24.5 |
| 18.5 | 7.5 | 0.79 | 37 | 0.93 | 31.5 |
| 22 | 10 | 0.77 | 45 | 0.92 | 37.5 |
| 30 | 12.5 | 0.79 | 59 | 0.93 | 50.0 |
| 37 | 15 | 0.78 | 74 | 0.92 | 62.8 |
| 45 | 20 | 0.78 | 90 | 0.93 | 75.4 |
| 55 | 20 | 0.81 | 104 | 0.93 | 90.2 |
| 75 | 30 | 0.82 | 140 | 0.95 | 120.6 |
| 90 | 30 | 0.82 | 167 | 0.93 | 146.6 |
| 110 | 35 | 0.83 | 202 | 0.94 | 178.8 |
| 132 | 50 | 0.8 | 250 | 0.93 | 214.6 |

Example

For a three-phase asynchronous motor, 110 kW (400 V - 50 Hz - 4 poles), the suggested value of power factor correction is 30 kvar.

7.2 Power factor correction of three-phase transformers

Transformers are electrical machines of primary importance; due to installation reasons they often are in constant service.

In particular, in the electrical plants constituted by different transformation and supply substations it is advisable that power factor correction is carried out by keeping into account the transformer reactive power so that an average power factor equal to 0.9 on the MV side is guaranteed.

Generally speaking, the compensation power Q_c in a transformer having a rated S_r [kVA], shall not exceed the reactive power absorbed under minimum reference load conditions.

Deriving from the nameplate characteristics of the transformer the percentage no-load current $i_0\%$, the percentage short-circuit voltage $u_k\%$, the iron losses P_{fe} and the copper losses P_{cu} [kW], the required compensation power results to be about:

$$Q_c = \sqrt{\left(\frac{i_0\%}{100} \cdot S_r\right)^2 - P_{fe}^2} + K_L^2 \cdot \sqrt{\left(\frac{u_k\%}{100} \cdot S_r\right)^2 - P_{cu}^2} \approx \dots$$

$$\dots \rightarrow \left(\frac{i_0\%}{100} \cdot S_r\right) + K_L^2 \cdot \left(\frac{u_k\%}{100} \cdot S_r\right) \text{ [kvar]}$$

where K_L is the load factor, defined as the ratio between the minimum reference load and the rated power of the transformer.

Example

Assume that the power factor of a 630 kVA oil distribution transformer which supplies a load equal to 60% of its rated power is to be corrected.

From the nameplate characteristics of the transformer:

$$i_0\% = 1.8\%$$

$$u_k\% = 4\%$$

$$P_{cu} = 8.9 \text{ kW}$$

$$P_{fe} = 1.2 \text{ kW}$$

the compensation power of the capacitor bank connected to the transformer shall be:

$$Q_c = \sqrt{\left(\frac{1.8\%}{100} \cdot 630\right)^2 - 1.2^2} + 0.6^2 \cdot \sqrt{\left(\frac{4\%}{100} \cdot 630\right)^2 - 8.9^2} = \dots$$

$$\dots \rightarrow \sqrt{\left(\frac{1.8\%}{100} \cdot 630\right)^2 - 1.2^2} + 0.6^2 \cdot \sqrt{\left(\frac{4\%}{100} \cdot 630\right)^2 - 8.9^2} = 19.8 \text{ kvar}$$

while, using the simplified formula, it results:

$$Q_c = \left(\frac{1.8\%}{100} \cdot 630\right) + 0.6^2 \cdot \left(\frac{4\%}{100} \cdot 630\right) = \dots$$

$$\dots \rightarrow 0.6^2 \cdot \left(\frac{4\%}{100} \cdot 630\right) = 20.4 \text{ kvar}$$

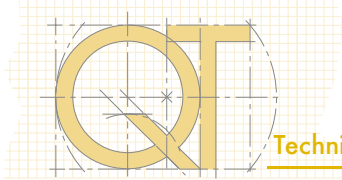

Table 7.4 shows the reactive power of the capacitor bank Q_c [kvar] to be connected to the secondary winding of an ABB transformer according to the different foreseen

load level. In particular, the reactive compensation power shall vary following a quadratic law with respect to the load coefficient of the transformer.

Table 7.4: reactive power for the compensation of ABB transformers

| Transformer | | | | | Q_c [kvar] | | | | |
|--|----------------|----------------|------------------|------------------|-------------------|------|-----|------|-----|
| S_r [kVA] | $u_k\%$ [%] | $i_0\%$ [%] | P_{fe} [kW] | P_{cu} [kW] | load factor K_L | | | | |
| | | | | | 0 | 0.25 | 0.5 | 0.75 | 1 |
| Oil Distribution Transformer MV-LV | | | | | | | | | |
| 50 | 4 | 2.9 | 0.25 | 1.35 | 1.4 | 1.5 | 1.8 | 2.3 | 2.9 |
| 100 | 4 | 2.5 | 0.35 | 2.30 | 2.5 | 2.7 | 3.3 | 4.3 | 5.7 |
| 160 | 4 | 2.3 | 0.48 | 3.20 | 3.6 | 4 | 5 | 6.8 | 9.2 |
| 200 | 4 | 2.2 | 0.55 | 3.80 | 4.4 | 4.8 | 6.1 | 8.3 | 11 |
| 250 | 4 | 2.1 | 0.61 | 4.50 | 5.2 | 5.8 | 7.4 | 10 | 14 |
| 315 | 4 | 2 | 0.72 | 5.40 | 6.3 | 7 | 9.1 | 13 | 18 |
| 400 | 4 | 1.9 | 0.85 | 6.50 | 7.6 | 8.5 | 11 | 16 | 22 |
| 500 | 4 | 1.9 | 1.00 | 7.40 | 9.4 | 11 | 14 | 20 | 28 |
| 630 | 4 | 1.8 | 1.20 | 8.90 | 11 | 13 | 17 | 25 | 35 |
| 800 | 6 | 1.7 | 1.45 | 10.60 | 14 | 16 | 25 | 40 | 60 |
| 1000 | 6 | 1.6 | 1.75 | 13.00 | 16 | 20 | 31 | 49 | 74 |
| 1250 | 6 | 1.6 | 2.10 | 16.00 | 20 | 24 | 38 | 61 | 93 |
| 1600 | 6 | 1.5 | 2.80 | 18.00 | 24 | 30 | 47 | 77 | 118 |
| 2000 | 6 | 1.2 | 3.20 | 21.50 | 24 | 31 | 53 | 90 | 142 |
| 2500 | 6 | 1.1 | 3.70 | 24.00 | 27 | 37 | 64 | 111 | 175 |
| 3150 | 7 | 1.1 | 4.00 | 33.00 | 34 | 48 | 89 | 157 | 252 |
| 4000 | 7 | 1.4 | 4.80 | 38.00 | 56 | 73 | 125 | 212 | 333 |
| Cast Resin Distribution Transformer MV-LV | | | | | | | | | |
| 100 | 6 | 2.3 | 0.50 | 1.70 | 2.2 | 2.6 | 3.7 | 5.5 | 8 |
| 160 | 6 | 2 | 0.65 | 2.40 | 3.1 | 3.7 | 5.5 | 8.4 | 12 |
| 200 | 6 | 1.9 | 0.85 | 2.90 | 3.7 | 4.4 | 6.6 | 10 | 15 |
| 250 | 6 | 1.8 | 0.95 | 3.30 | 4.4 | 5.3 | 8.1 | 13 | 19 |
| 315 | 6 | 1.7 | 1.05 | 4.20 | 5.3 | 6.4 | 9.9 | 16 | 24 |
| 400 | 6 | 1.5 | 1.20 | 4.80 | 5.9 | 7.3 | 12 | 19 | 29 |
| 500 | 6 | 1.4 | 1.45 | 5.80 | 6.8 | 8.7 | 14 | 23 | 36 |
| 630 | 6 | 1.3 | 1.60 | 7.00 | 8 | 10 | 17 | 29 | 45 |
| 800 | 6 | 1.1 | 1.94 | 8.20 | 8.6 | 12 | 20 | 35 | 56 |
| 1000 | 6 | 1 | 2.25 | 9.80 | 9.7 | 13 | 25 | 43 | 69 |
| 1250 | 6 | 0.9 | 3.30 | 13.00 | 11 | 15 | 29 | 52 | 85 |
| 1600 | 6 | 0.9 | 4.00 | 14.50 | 14 | 20 | 38 | 67 | 109 |
| 2000 | 6 | 0.8 | 4.60 | 15.50 | 15 | 23 | 45 | 82 | 134 |
| 2500 | 6 | 0.7 | 5.20 | 17.50 | 17 | 26 | 54 | 101 | 166 |
| 3150 | 8 | 0.6 | 6.00 | 19.00 | 18 | 34 | 81 | 159 | 269 |

Example

For an ABB 630 kVA oil distribution transformer with load factor equal to 0.5, the necessary compensation power is 17 kvar. The $\cos\varphi$ controller in low voltage applications shall be set keeping into account also this power in addition to the reactive power required by the load.

As a consequence, to obtain a power factor equal to 0.9 also for medium voltage, the controller shall be set at a value exceeding 0.9. Actually, assuming that the transformer operates with a load factor of 50%, the apparent power supplied is:

$$S = 0.5 \cdot S_r = 0.5 \cdot 630 = 315 \text{ kVA}$$

If, by assumption, the load works with a power factor equal to 0.8, the active power P absorbed by the motor shall be:

$$P = S \cdot \cos\varphi = 315 \cdot 0.8 = 252 \text{ kW}$$

To correct the power factor and get the value of 0.9, the necessary reactive power results:

$$Q_r = P \cdot (\operatorname{tg}(\cos^{-1}(0.8)) - \operatorname{tg}(\cos^{-1}(0.9))) = \dots$$

$$\dots \rightarrow 252 \cdot (0.75 - 0.48) = 68 \text{ kvar}$$

Taking into account also the reactive power necessary to the transformer, the total power to be delivered by the power factor correction unit becomes:

$$Q_c = Q_r + Q_t = 68 + 17 = 85 \text{ kvar}$$

As a consequence the power factor controller shall be set at:

$$\cos\varphi' = \cos\left(\operatorname{tg}^{-1}\left(\operatorname{tg}(\cos^{-1}(0.8)) - \frac{Q_c}{P}\right)\right) = \dots$$

$$\dots \rightarrow \cos\left(\operatorname{tg}^{-1}\left(\operatorname{tg}(36.87^\circ) - \frac{85}{252}\right)\right) = \cos\left(\operatorname{tg}^{-1}(0.75 - 0.34)\right) = 0.925$$

8 Harmonics in electrical plants

8.1 Harmonics

Technological development in the industrial and household field has led to the spread of electronic equipment which, due to their operating principle, absorb a non sinusoidal current (non linear load). Such current causes on the supply side of the network a voltage drop of non sinusoidal type with the consequence that also the linear loads are supplied by a distorted voltage.

The harmonics are the components of a distorted waveform and their use allows to analyze any non-sinusoidal periodic waveform by decomposing it into several sinusoidal components.

According to the Fourier theorem, any periodic function with period T generally continuous and limited may be represented by a series of infinite sinusoidal terms with a frequency equal to integer multiples of the frequency of the original function.

The harmonic with the frequency corresponding to the period of the original waveform is called fundamental harmonic and the harmonic with frequency equal to “n” times the fundamental one is called *harmonic of order “n”*.

Based on the Fourier theorem, a perfectly sinusoidal waveform does not present harmonics of different order from the fundamental one. Therefore the presence of harmonics in an electrical system is an indicator of the distortion of the voltage or current waveform and this implies such a distribution of the electric power that malfunctioning of the equipment may be caused.

¹ A function is defined periodic, generally continuous and limited if it takes the same value after a period T ($f(x+T) = f(x)$) and if it has a finite number of no-essential discontinuities (that is, it has an upper and a lower limit).

Figure 8.1

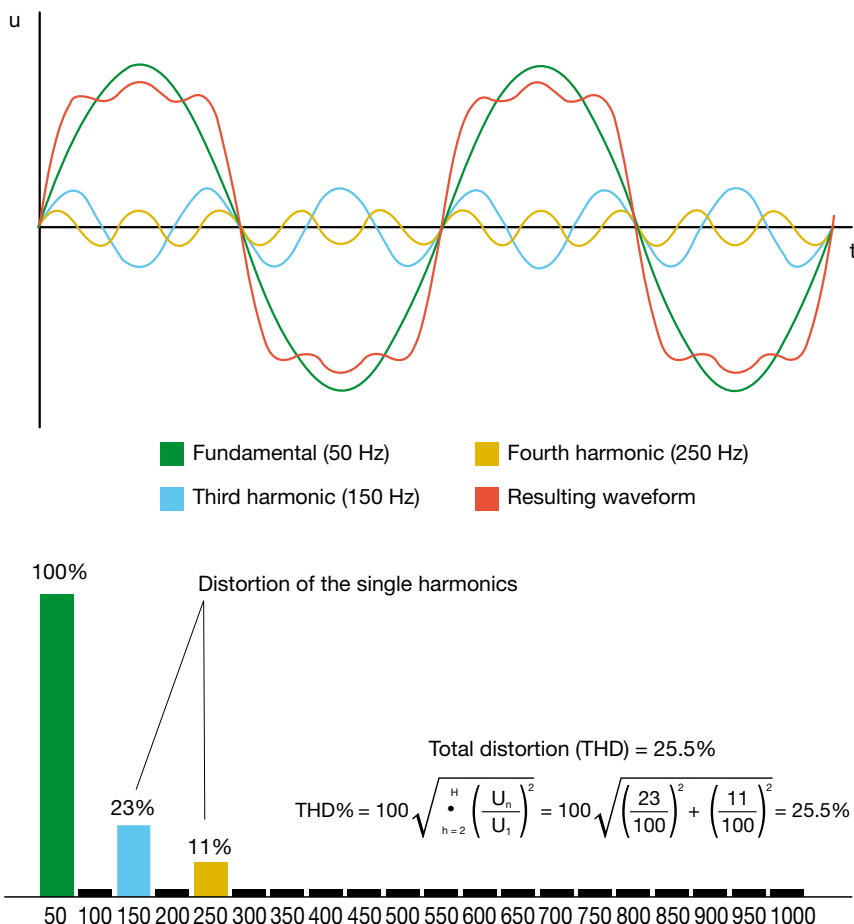

The main apparatus generating harmonics are:

- personal computers;
- fluorescent and gas discharge lamps;
- static converters;
- continuity groups;
- variable speed drives;
- welding machines;
- arc and induction furnaces.

In general, waveform distortion is due to the presence, inside of these apparatus, of non linear or time-variable² impedances or of bridge rectifiers, whose semiconductor devices carry the current only for a fraction of the whole period, thus originating discontinuous curves with the consequent introduction of several harmonics.

As illustrated in the following paragraphs, the presence of harmonics in the electrical network may cause the damage of a capacitor bank.

8.2 The prescriptions of the Standards

The technical Standards give precise prescriptions aimed at reducing the effects of harmonics on the capacitors. The Standard IEC 61642 "*Industrial a.c. networks affected by harmonics – Application of filters and shunt capacitors*" identifies the problems and gives advices for the general applications of capacitors and harmonic filters in a.c networks affected by the presence of harmonic voltages and currents. In particular, this Standard illustrates the problem of resonance in series and in parallel and gives some explanatory examples.

8.3 Harmonic effects

8.3.1 Overloads

The presence of harmonics in the electrical network may be the cause of malfunctioning of the equipment, such as in the case of overloading of the neutral conductor, of increase of losses in the transformers, of disturbances in the torque of motors, etc.

In particular, harmonics are the phenomenon which most heavily affect power factor correction capacitors.

In fact, as it is known, capacitive reactance is inversely proportional to frequency, therefore the impedance offered to the voltage harmonics decreases as the harmonic order increases. This means that, if supplied by a distorted voltage, the capacitors can draw a current of such intensity that it could seriously damage them.

Figure 8.2

| | |
|--|--|
| $X_c = \frac{1}{\omega \cdot C} = \frac{1}{2 \cdot \pi \cdot f \cdot C}$ | $X_L = \omega \cdot L = 2 \cdot \pi \cdot f \cdot L$ |
| capacitive reactance | inductive reactance |

In a capacitor bank, assumed to be delta connected, it is possible to calculate the line current corresponding to the n^{th} harmonic according to the following relation:

$$I_n = \sqrt{3} \cdot n \cdot \omega \cdot C \cdot U_n \quad [8.1]$$

where:

- I_n is the current corresponding to the n^{th} harmonic;
- n is the order of the harmonics;
- ω is the pulsation of the fundamental harmonic;
- C is the capacitance;
- U_n is the line-to-line voltage corresponding to the n^{th} harmonic.

The total line current drawn by the capacitor banks shall be³:

$$I_c = \sqrt{3} \cdot \omega \cdot C \cdot \sqrt{U_1^2 + \sum_{n=2}^{\infty} (n \cdot U_n)^2} \quad [8.2]$$

From this relation it is evident that the current absorbed in the presence of voltage harmonics is higher than the current to be considered in case of their absence. For this reason, the Standards IEC 60831-1 and IEC 60931-1 prescribe that capacitors shall be suitable for permanent operation with a current value higher than the rated current of the capacitor bank (as it is better explained in the following chapter).

² Time-variable loads such as for example the devices for the control through wave or phase trains, introduce non only harmonics which are multiple of the fundamental harmonic, but also interharmonics.

³ Algebraic sum valid also with the r.m.s. values, since the current harmonic components are all in phase with one another and with the fundamental one.

8.3.2 Resonance

A still more important problem occurs when the linear distortion reaches high values and the danger of resonances between the power factor correction system (equivalent capacitance of the capacitors) and the equivalent inductance of the network becomes clear.

The resonance occurs when the inductive and the capacitive reactances are equal. As a consequence, we shall talk of series resonant circuit when the inductance and the capacitance are connected in series or of parallel resonant circuit when the inductance and the capacitance are connected in parallel. A series resonance and a parallel resonance can be present in the same network. Resonance occurs at a precise frequency, which is called resonance frequency f_r :⁴

$$X_L = X_C \rightarrow f_r = \frac{1}{2 \cdot \pi \cdot \sqrt{L \cdot C}} \quad [8.3]$$

If there is series resonance, the total impedance is theoretically neutralized⁵:

$$\bar{Z}_{tot} = j(X_L - X_C) = 0 \quad [8.4]$$

Analogously, in the presence of parallel resonance, the total impedance tends to zero:

$$\bar{Z}_{tot} = \frac{X_L \cdot X_C}{j(X_L - X_C)} \rightarrow \infty \quad [8.5]$$

If a series resonant circuit is supplied by an alternating voltage with a frequency value close to the resonance frequency, an amplification of the drawn current may occur causing disturbances, overcurrents and also damaging of the network components.

On the contrary, if a parallel resonant circuit is supplied by harmonics of non linear load current, an overvoltage may occur in correspondence with the resonance harmonic.

$$\begin{aligned} X_L = X_C &\rightarrow \omega_r \cdot L = \frac{1}{\omega_r \cdot C} \rightarrow \omega_r^2 \cdot L \cdot C = 1 \quad \dots \\ \dots &\rightarrow (2 \cdot \pi \cdot f_r)^2 = \frac{1}{L \cdot C} \rightarrow f_r = \frac{1}{2 \cdot \pi \cdot \sqrt{L \cdot C}} \end{aligned}$$

⁵ Actually, the impedance decreases remarkably and corresponds only to the resistive component of the connection cables.

Figure 8.3: example of series resonant circuit

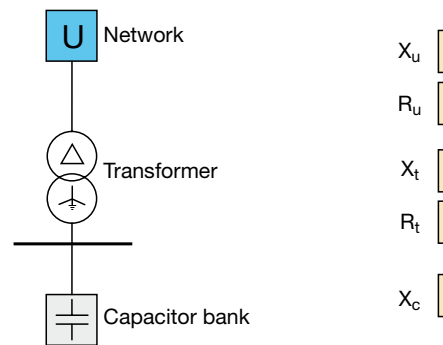

The following diagram shows the curves relevant to capacitive reactance (decreasing with the harmonic order), inductive reactance (increasing with the harmonic order) and total reactance of a network; the total series reactance takes its minimum value in correspondence with the resonance frequency (in the graph example three times the fundamental frequency).

Figure 8.4

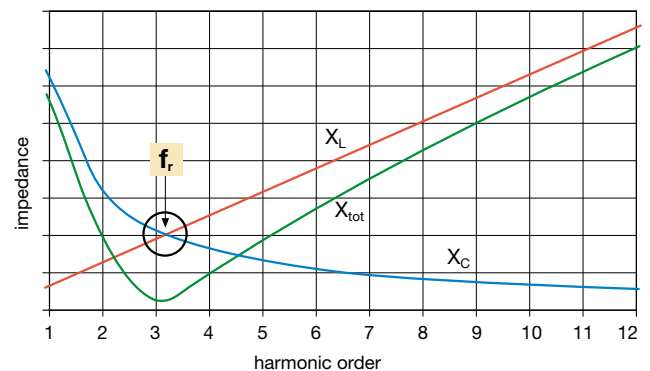

The resonance frequency f_r can be obtained from the following formula:

$$f_r = f_1 \cdot \sqrt{\frac{X_{C1}}{X_{L1}}} \quad [8.6]$$

where:

- f_1 is the fundamental frequency;
- X_{C1} is the capacitive reactance of the capacitor at the fundamental frequency;
- X_{L1} is the inductive reactance (at the fundamental frequency) of the network on the supply side of the installation point of the capacitor.

In case of absence of harmonics and assuming that the resonance frequency is sufficiently different from the fundamental frequency of the power supply system, there are no overcurrents on the lines.

If harmonics were present, an amplification of the current in correspondence with the harmonic of order close to the resonance frequency might occur. For a further analysis see the Std. IEC 61642 which gives also a numerical example of a series resonant circuit from which it results that if the frequency is close to the series resonance frequency, a relatively low voltage on the supply-busbars can cause a high current.

To avoid the resonance phenomenon, and consequently to avoid a shortening of life for the capacitor, it is necessary that the network has a resonance frequency as different as possible from that of the present harmonics.

The most common solution, as illustrated in the Std. IEC 61642, consists in connecting in series an inductive reactance with the capacitor (detuning reactance); the inductor shall be sized so that a resonance frequency which is below the lowest frequency of the harmonic voltage in the network is achieved.

Example

Assuming that in the series resonant circuit of Figure 8.3 the lowest harmonic with a remarkable amplitude is the fifth, from the previous relation it results:

$$f_1 \cdot \sqrt{\frac{X_{C1}}{X_{L1}}} < f_5 \rightarrow \sqrt{\frac{X_{C1}}{X_{L1}}} < \frac{f_5}{f_1} = 5 \rightarrow X_{L1} > 4\% X_{C1} \quad [8.7]$$

where:

- X_{C1} is the capacitive reactance of the capacitor at the fundamental frequency;
- X_{L1} is the reactance in series with the capacitor at the fundamental frequency.

If the lowest harmonic with a remarkable amplitude were the third, it would result:

$$X_{L1} > 11.1\% X_{C1} \quad [8.7]$$

Dimensioning in this way the inductance, the interaction of the network inductance with the impedance (inductive) of the connection inductor-capacitor cannot create any more resonance conditions, at the frequencies of the voltage and current harmonics present in the network.

8.4 Harmonic filters

Capacitor banks can be used combined with inductors in order to limit the effects of the harmonics on a network. Actually, the combination capacitor-inductor constitutes a filter for harmonics.

Previously it has been illustrated how, to avoid the negative effects of resonance, it is necessary to insert an inductor in series with a capacitor. By applying an analogous reasoning, it is possible to think of placing in a point of the network a combination of an inductor and a capacitor properly dimensioned in order to get the same resonance frequency of the order of the current harmonic to be eliminated.

In this way, the assembly inductor-capacitor presents a very low reactance in correspondence with the harmonic to be eliminated which shall circulate in the assembly without affecting the whole network.

Figure 8.5

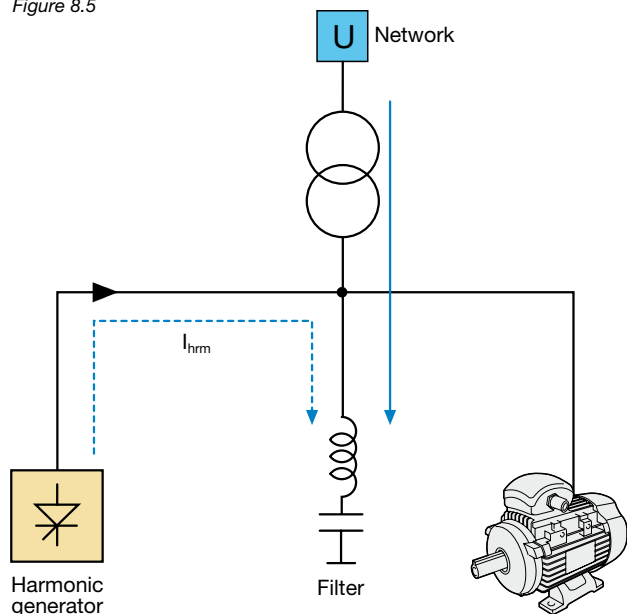

Therefore this filter, called *passive filter*, consists in a capacitor connected in series with an inductor so that the resonance frequency is altogether equal to the frequency of the harmonic to be eliminated.

Passive filters, which are defined on a case by case basis, according to a particular harmonic to be filtered, are cost-effective and easy to be connected and put into function.

Active filters instead can automatically eliminate the current harmonics present in a network in a wide range of frequencies. Exploiting power electronic technology, they can inject a system of harmonics able to neutralize those present in the network.

Figure 8.6

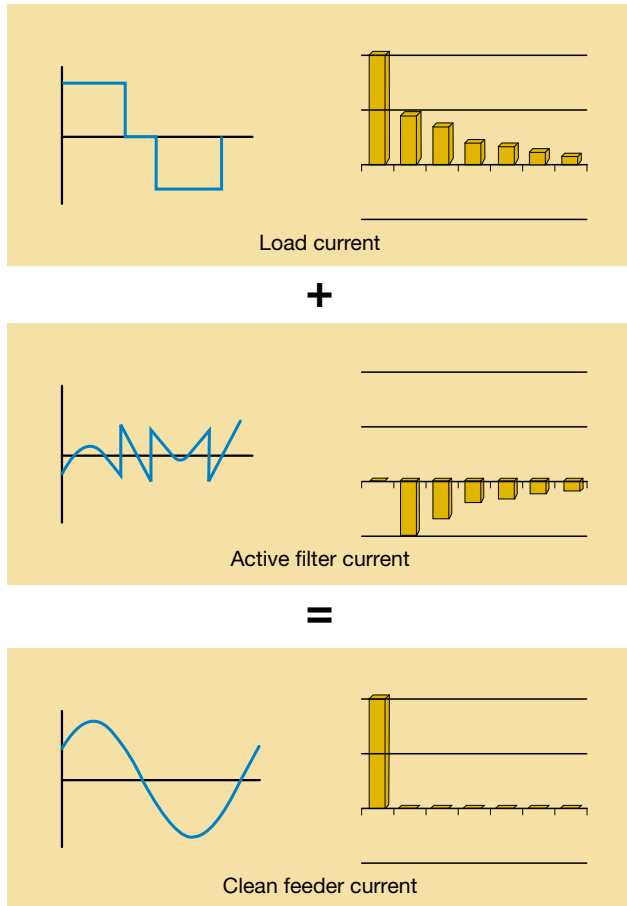

The active filter has the advantage of filtering simultaneously dozens of harmonics and does not involve design costs for dimensioning.

Figure 8.7

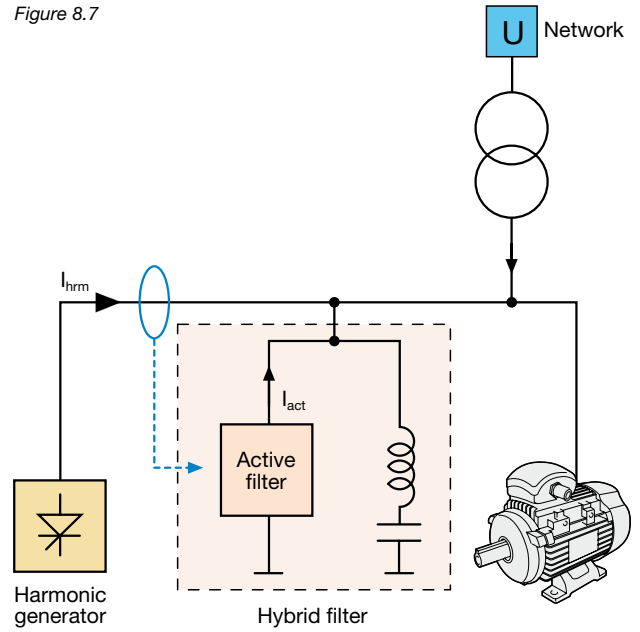

9 Switching and protection of capacitor banks

9.1 Switching electrical phenomena

The connection of a capacitor bank causes an electric transient due to the phenomena of electric charging of the bank. Actually, there is an overcurrent at high frequency (in its first instants equivalent to a short-time short-circuit) whose amplitude is a function of the parameters of the upstream network and of the characteristics of the bank. Moreover, the switching implies an overvoltage whose disturbance wave propagates through the network.

The entity of the overvoltage depends on the reactive power Q_c supplied by the capacitor bank and on the installation point of the bank itself. In particular, two important situations may occur:

- installation immediately on the load side of a transformer with apparent power S_r (supplied by a network with infinitive power) and having a percentage short-circuit voltage $U_{cc}\%$. In this case there is an overvoltage whose value can be calculated as follows¹:

$$\frac{\Delta U}{U_n} = \frac{U_{cc}\%}{100} \cdot \frac{Q_c}{S_r} \quad [9.1]$$

- installation at a point in the network with short-circuit power S_{cc} . In this case, the overvoltage can be evaluated according to the relation²:

$$\frac{\Delta U}{U_n} = \frac{Q_c}{S_{cc}} \quad [9.2]$$

The overcurrents which can be found at the moment of switching in depend greatly both from the inductance of the upstream network as well as from the number of connected capacitor banks.

¹ The voltage variation is given by:

$$\frac{\Delta U}{U_n} = \frac{R \cdot P + X \cdot Q}{U_n^2}$$

In a transformer, the resistance of the winding is negligible in comparison with the leakage reactance, which means:
 $X_{cc} \approx Z_{cc}$

Besides, since:

$$U_{cc}\% \approx Z_{cc}\% = \frac{Z_{cc}}{Z} \cdot 100 = \frac{Z_{cc}}{\frac{U_n^2}{S_n}} \cdot 100$$

the voltage variation can be expressed as:

$$\frac{\Delta U}{U_n} = \frac{X_{cc} \cdot Q}{U_n^2} \approx \frac{Z_{cc} \cdot Q}{U_n^2} = \frac{U_{cc}\%}{100} \cdot \frac{U_n^2}{S_n} \cdot \frac{Q}{U_n^2} = \frac{U_{cc}\%}{100} \cdot \frac{Q}{S_n}$$

from which, by replacing Q with the reactive power of the capacitor bank Q_c during switching on, the overvoltage caused by the bank itself can be obtained by [9.1].

² Valid as long as the upstream network is prevalently inductive. In fact, since:

$$S_{cc} = \frac{U_n^2}{X}$$

it results:

$$\frac{\Delta U}{U_n} \approx \frac{X \cdot Q}{U_n^2} = \frac{U_n^2}{S_{cc}} \cdot \frac{Q}{U_n^2} = \frac{Q}{S_{cc}}$$

In the case of an individual bank, the peak of the connection current depends strongly from the short-circuit current I_{cc} of the upstream network, influenced by the typical inductance L_0 of the network, according to the relation:

$$L_0 = \frac{U_n}{\sqrt{3} \cdot \omega \cdot I_{cc}} \quad [9.3]$$

The Standards IEC 62271-100 and IEC 60831-1 give the formulas for the calculation of the inrush current peak. In this case, it results:

$$i_p = U_n \cdot \sqrt{\frac{2}{3} \cdot \frac{C}{L_0 + L}} \approx U_n \cdot \sqrt{\frac{2}{3} \cdot \frac{C}{L_0}} \approx I_{cn} \cdot \sqrt{\frac{2 \cdot S_{cc}}{Q_c}} \quad [9.4]$$

since the connection inductance of the capacitor banks is much lower than the inductance of the upstream network $L \ll L_0$.

Generally, in the installations, the peak value of the current does not exceed the maximum value established for capacitor banks (100 times the rated current of the bank); if the peak value exceeds such maximum value or it has to be reduced to guarantee the proper operation of the switching devices, the use of limitation inductances in series with the capacitor bank shall be necessary³.

In case of connection of a bank when one or more banks are already energized, it is necessary to provide in series with each of them some limitation inductances because now the peak current value is much higher due to the sudden transfer of power from the bank/s already in service to the bank being connected. The relations given by the above mentioned Standards for the calculation of the peak values are respectively:

- connection when one bank is already connected

$$i_p = U_n \cdot \sqrt{\frac{2}{3} \cdot \frac{C_1 \cdot C}{C_1 + C} \cdot \frac{1}{L_1 + L}} \quad [9.5]$$

Se $L_1 = L$ e $C_1 = C$ allora:

$$i_p = U_n \cdot \sqrt{\frac{C}{6 \cdot L}} \quad [9.6]$$

- connection when n banks are already connected:

$$L' = \frac{1}{\frac{1}{L_1} + \frac{1}{L_2} + \dots + \frac{1}{L_n}} \quad [9.7]$$

Se $L_1 = L_2 = \dots = L$ e $C_1 = C_2 = \dots = C_n$ allora:

$$i_p = U_n \cdot \frac{n}{n+1} \cdot \sqrt{\frac{2}{3} \cdot \frac{C}{L}} \quad [9.8]$$

The limitation inductances used are generally in air without magnetic core and the values more often used are: 50, 100 or 150 μH .

³ On the contrary, there are no problems when a capacitor for power factor correction is switched on together with the load it has to compensate, such as for example a motor, since the capacitor current is compensated by the inductive component of the current absorbed by the motor.

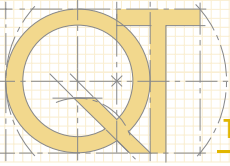

9.2 Switching and protection

A system for power factor correction is constituted essentially by:

- a protective device;
- a switching device (contactor);
- one or more capacitors suitably connected;
- resistors for capacitor discharge.

In case of an automatic compensation system, also a control station unit to command switching in/off of the capacitors.

9.2.1 Choice of the protective device

The devices used for the protection of capacitor banks shall satisfy the following requirements and therefore shall:

1. sustain the transient currents which occurs when connecting and disconnecting the capacitor banks. In particular, the instantaneous protections of the thermal magnetic and electronic trip units shall not trip due to inrush currents;
2. sustain the periodic or permanent overcurrents due to the voltage harmonics and to the tolerance on the rated capacitance value;
3. be coordinated with any external switching device (contactors).

Furthermore, the making and breaking capacity of the circuit-breaker shall be suitable to the short-circuit level of the installation.

The Standards IEC 60831-1 and IEC 60931-1 prescribe that:

- capacitors shall be able to operate under steady-state conditions with an r.m.s. current value up to 30% higher than their rated current I_{cn} (this is due to the possible presence of voltage harmonics in the network);
- a tolerance of +10% on the capacitance for banks up to 100 kvar and of 5% for banks exceeding 100 kvar is admitted (Amendment 1 of the above mentioned standards).

Therefore, a capacitor bank can absorb a maximum current I_{cmax} of:

$$Q_c \leq 100 \text{ kvar} \rightarrow I_{cmax} = 1.3 \cdot 1.1 \cdot \frac{Q_c}{\sqrt{3} \cdot U_n} = 1.43 \cdot I_{cn} \quad [9.9]$$

$$Q_c > 100 \text{ kvar} \rightarrow I_{cmax} = 1.3 \cdot 1.05 \cdot \frac{Q_c}{\sqrt{3} \cdot U_n} = 1.365 \cdot I_{cn}$$

where:

- Q_c is the reactive power;
- U_n is the rated line-to-line voltage;
- I_{cn} is the rated current.

To summarize, depending on the rated reactive power of the capacitor bank, to guarantee a correct protection against overload:

- the rated current of the circuit-breaker shall be higher than the above mentioned values;
- the setting of the overload protection shall be equal to the given values.

The connection of a capacitor bank, comparable to a making operation under short-circuit condition, is associated with transient currents, at high frequency (1 to 15 kHz), of short duration (1 to 3 ms), with high peak (25 to $200 \cdot I_{cn}$).

For the protection of the capacitor bank:

- the circuit-breaker shall have an adequate making capacity;
- the setting of the instantaneous protection against short-circuit shall not cause unwanted tripping.

The second condition is usually respected:

- for thermal magnetic trip units, by setting the magnetic protection I_3 at values not lower than $10 \cdot I_{cmax}$

$$I_3 \geq 10 \cdot I_{cmax} \quad [9.10]$$

- for electronic trip units, by setting in OFF the instantaneous protection against short-circuit ($I_3 = \text{OFF}$).

9.2.2 Choice of the switching device (contactor)

Capacitors or capacitors banks are usually switched by a contactor which shall be chosen so that it can operate properly; more precisely, the contactor shall be sized so that:

- it can sustain a current equal to the I_{cmax} of the capacitor bank;
- it can sustain without damages the inrush current of the capacitors.

Furthermore the contactor must be protected against short-circuit by the protection device.

9.2.3 Choice of the capacitor

The capacitor supplies the reactive power necessary to increase the power factor up to the desired value.

The characteristics of a capacitor, reported on its nameplate, are:

- rated voltage U_n ;
- rated frequency f ;
- reactive power Q_c , expressed in kvar (reactive power of the capacitor bank).

It is necessary to note that the reactive power at the service voltage is different from the rated power given on the nameplate and referred to the rated voltage; the following formula allows to calculate the effective power of a capacitor or of a capacitor bank:

$$Q_{\text{resa}} = Q_c \cdot \left(\frac{U_e}{U_n} \right)^2 \quad [9.11]$$

where:

- Q_c is the reactive power at the rated voltage U_n ;
- Q_{supplied} is the effective power at the service voltage U_e .

For example, a capacitor with 100 kvar rated reactive power at 500 V shall deliver 64 kvar power at 400 V.

From the data on the nameplate it is possible to obtain the characteristic parameters of the capacitor:

Single-phase circuit

Table 9.1

| | |
|---------------|--|
| Rated current | $I_{cn} = \frac{Q_c}{V_n}$ |
| Reactance | $X_c = \frac{1}{\omega \cdot C}$ |
| Capacitance | $C = \frac{1}{\omega \cdot X_c} = \frac{Q_c}{2 \cdot \pi \cdot f \cdot V_n^2}$ |

Three-phase circuit

In a three-phase circuit, the capacitors can be star- or delta-connected; the following table shows the values of power and rated current according to the connection modality.

Table 9.2

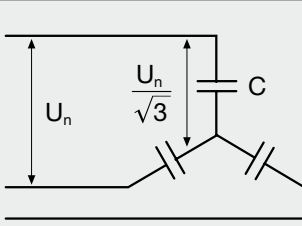
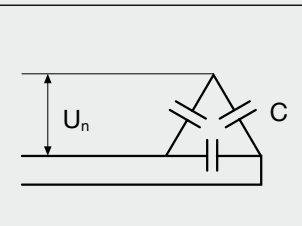
| | Rated current (line) | Current in the capacitor banks | Power |
|---|--|----------------------------------|--|
|  | $I_{cn} = \omega \cdot C \cdot \frac{U_n}{\sqrt{3}}$ | $I_c = I_{cn}$ | $Q_c = \sqrt{3} \cdot I_{cn} \cdot U_n = \omega \cdot C \cdot U_n^2$ |
|  | $I_{cn} = \sqrt{3} \cdot \omega \cdot C \cdot U_n$ | $I_c = \omega \cdot C \cdot U_n$ | $Q_c = \sqrt{3} \cdot I_{cn} \cdot U_n = 3 \cdot \omega \cdot C \cdot U_n^2$ |

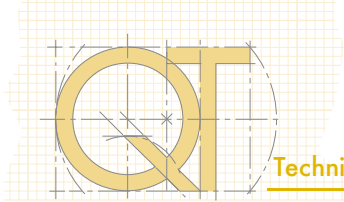

9.2.4 Discharge of capacitors

When installing a capacitor it is necessary to verify that at the moment when it is switched off it can discharge so that the presence, at its terminals, of a voltage dangerous for people and things can be avoided.

In compliance with the Std. IEC 60252-2 for the power factor correction of motors discharge devices are not often required, in particular when the capacitors are permanently connected to the terminals of the motor windings functioning as discharge resistances. When a discharge device is provided, it shall reduce the voltage at the capacitor terminals from the peak value of the rated voltage to a value of 50 V or less in the time of 1 min from the moment the capacitor is switched off. A discharge device may sometimes be specified, not for safety reasons, but to prevent electrical overstress on the capacitor: this may occur when a disconnected capacitor still charged is reconnected across another capacitor of different polarity.

The Std. IEC 60364-5-55, clause 559.8) prescribes the use of discharge resistors for compensation capacitors having a total capacitance exceeding 0.5 μF (75/25 kvar with star/delta connection at 400 V).

Resistors have the purpose of nullifying, within a short-time, the residual charge on the plates of the capacitor once it has been disconnected from the network. It is a good rule to provide discharge resistances for all the capacitors with power exceeding 0.5 kvar, for whatever supply voltage.

In compliance with the Std. IEC 60831-1 clause 22 'Each capacitor unit and/or bank shall be provided with a means for discharging each unit in 3 min to 75 V or less, from an initial peak voltage of $\sqrt{2}$ times rated voltage U_n .' Attention is drawn to the fact that in some countries smaller discharge times and voltages are required.

The discharge resistance in a single-phase unit or in a phase of a polyphase unit is given by:

$$R \leq \frac{t}{k \cdot C \cdot \ln \left(\frac{\sqrt{2} \cdot U_n}{U_r} \right)} \quad [9.12]$$

where:

- R is the discharge resistance in [Ω];
- t is the discharge time from $\sqrt{2} U_n$ to U_r , in [s];
- U_n is the rated voltage in [V];
- U_r is the admitted residual voltage⁴ in [V];
- k is a coefficient depending on the connection modality of resistors to capacitor units, see Table 9.3;
- C is the capacitance of the capacitor bank [F].

To comply with the prescriptions of the Std. IEC 60831-1, $t = 180$ s and $U_r = 75$ V shall be put in the above formula.

⁴ At the moment of energizing, the residual voltage must not exceed 10% of the rated voltage

Table 9.3

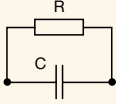
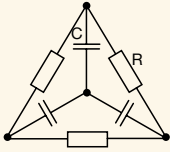
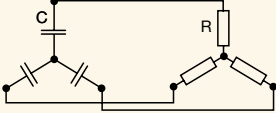
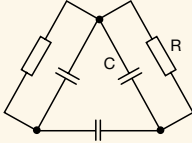
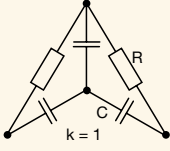
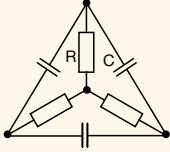
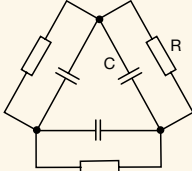
| Connection | k |
|---|---------------|
|  | 1 |
|  | $\frac{1}{3}$ |
|  | 1 |
|  | 3 |
|  | 1 |
|  | 3 |
|  | 1 |

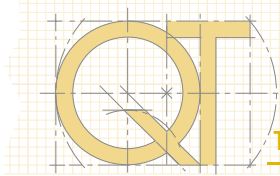

10 ABB offer

10.1 Circuit-breakers

ABB offers the following types of moulded-case and air circuit-breakers for protection against overloads and disconnection of the capacitor banks.

10.1.1 Moulded-case circuit-breakers Tmax T

Three-phase moulded-case circuit-breakers Tmax T series complying with the Std. IEC 60947-2, equipped with thermomagnetic or electronic trip units, with application range from 1.6 A to 1600 A and breaking capacities from 10 kA to 200 kA @ 400 V.

The available moulded-case circuit-breakers are:

- Tmax T1, T2, T3, T4 circuit-breakers equipped with thermomagnetic releases type TMD with adjustable thermal threshold ($I_1=0.7..1I_n$) and fixed magnetic threshold ($I_3=10I_n$);
- Tmax T4, T5, T6 circuit-breakers equipped with thermomagnetic releases type TMA with adjustable thermal

- ($I_1=0.7..1I_n$) and magnetic threshold ($I_3=5..10I_n$);
- Tmax T2, T4, T5, T6 circuit-breakers equipped with electronic relays type PR221DS;
- Tmax T4, T5, T6 circuit-breakers equipped with electronic relays type PR222DS/P, PR222DS/PD and PR223DS;
- Tmax T7 circuit-breakers equipped with electronic relays type PR231/P, PR232/P, PR331/P and PR332/P.



Rated currents available for molded-case circuit-breakers with the different typologies of electronic trip units

| | In [A] | 10 | 25 | 63 | 100 | 160 | 250 | 320 | 400 | 630 | 800 | 1000 | 1250 | 1600 |
|--|--------|----|----|----|-----|-----|-----|-----|-----|-----|-----|------|------|------|
| PR221DS | T2 | ■ | ■ | ■ | ■ | ■ | | | | | | | | |
| | T4 | | | | ■ | ■ | ■ | ■ | | | | | | |
| | T5 | | | | | | | ■ | ■ | ■ | | | | |
| | T6 | | | | | | | | | ■ | ■ | ■ | | |
| PR222DS/P | T4 | | | | ■ | ■ | ■ | ■ | | | | | | |
| PR222DS/PD | T5 | | | | | | | ■ | ■ | ■ | | | | |
| PR223DS | T6 | | | | | | | | | ■ | ■ | ■ | | |
| PR231/P PR232/P PR331/P PR332/P | T7 | | | | | | | | ■ | ■ | ■ | ■ | ■ | ■ |

Characteristics of moulded-case circuit-breakers Tmax T for the protection of capacitor banks

| | | T1 | | | T2 | | | | | | T3 | |
|--|------|------|----|----|------|----|----|----|-----|-----|------|----|
| | | B | C | N | B | C | N | S | H | L | N | S |
| Rated uninterrupted current Iu | [A] | 160 | | | 160 | | | | | | 250 | |
| Rated service voltage Ue | [V] | 690 | | | 690 | | | | | | 690 | |
| Rated impulse withstand voltage Uimp | [kV] | 8 | | | 8 | | | | | | 8 | |
| Rated insulation voltage Ui | [V] | 800 | | | 800 | | | | | | 800 | |
| Test voltage at industrial frequency for 1min. | [V] | 3000 | | | 3000 | | | | | | 3000 | |
| Rated ultimate short-circuit breaking capacity Icu | | B | C | N | B | C | N | S | H | L | N | S |
| 220-230V 50-60Hz | [kA] | 25 | 40 | 50 | 25 | 40 | 65 | 85 | 100 | 120 | 50 | 85 |
| 380-400-415V 50-60Hz | [kA] | 16 | 25 | 36 | 16 | 25 | 36 | 50 | 70 | 85 | 36 | 50 |
| 440V 50-60Hz | [kA] | 10 | 15 | 22 | 10 | 15 | 30 | 45 | 55 | 75 | 25 | 40 |
| 500V 50-60Hz | [kA] | 8 | 10 | 15 | 8 | 10 | 25 | 30 | 36 | 50 | 20 | 30 |
| 690V 50-60Hz | [kA] | 3 | 4 | 6 | 3 | 4 | 6 | 7 | 8 | 10 | 5 | 8 |
| Utilization category (IEC 60947-2) | | A | | | A | | | | | | A | |
| Isolation behaviour | | ■ | | | ■ | | | | | | ■ | |
| Releases: thermomagnetic | | | | | | | | | | | | |
| T adjustable, M fixed | TMD | ■ | | | ■ | | | | | | ■ | |
| T adjustable, M adjustable (5..10 x In) | TMA | - | | | - | | | | | | - | |
| electronic | | | | | | | | | | | | |
| PR221DS | | - | | | ■ | | | | | | - | |
| PR222DS | | - | | | - | | | | | | - | |
| PR223DS | | - | | | - | | | | | | - | |
| PR231/P | | - | | | - | | | | | | - | |
| PR232/P | | - | | | - | | | | | | - | |
| PR331/P | | - | | | - | | | | | | - | |
| PR332/P | | - | | | - | | | | | | - | |
| Interchangeability | | - | | | - | | | | | | - | |
| Versions | | F | | | F-P | | | | | | F-P | |

(1) Icw = 5kA - (2) Icw = 7.6kA (630A) - 10kA (800A) - (3) For T7 800/1000/1250A only - (4) Icw = 20kA (type S,H,L) - 15kA (type V)

Rated currents available for circuit-breakers Tmax T with two typologies of thermomagnetic releases

| In [A] | T1 160 | T2 160 | T3 250 | T4 250-320 | | T5 400-630 | T6 630-800 |
|--------|--------|--------|--------|------------|-----|------------|------------|
| | TMD | TMD | TMD | TMD | TMA | TMA | TMA |
| 1,6 | | ■ | | | | | |
| 2 | | ■ | | | | | |
| 2,5 | | ■ | | | | | |
| 3,2 | | ■ | | | | | |
| 4 | | ■ | | | | | |
| 5 | | ■ | | | | | |
| 6,3 | | ■ | | | | | |
| 8 | | ■ | | | | | |
| 10 | | ■ | | | | | |
| 12,5 | | ■ | | | | | |
| 16 | ■ | ■ | | | | | |
| 20 | ■ | ■ | | ■ | | | |
| 25 | ■ | ■ | | | | | |
| 32 | ■ | ■ | | ■ | | | |
| 40 | ■ | ■ | | | | | |
| 50 | ■ | ■ | | ■ | | | |
| 63 | ■ | ■ | ■ | | | | |
| 80 | ■ | ■ | ■ | | ■ | | |
| 100 | ■ | ■ | ■ | | ■ | | |
| 125 | ■ | ■ | ■ | | ■ | | |
| 160 | ■ | ■ | ■ | | ■ | | |
| 200 | | | ■ | | ■ | | |
| 250 | | | ■ | | ■ | | |
| 320 | | | | | | ■ | |
| 400 | | | | | | ■ | |
| 500 | | | | | | ■ | |
| 630 | | | | | | | ■ |
| 800 | | | | | | | ■ |

Thermomagnetic release TMD with adjustable thermal and fixed magnetic threshold
 Thermomagnetic release TMA with adjustable thermal and magnetic thresholds

| T4 | | | | | T5 | | | | | T6 | | | | T7 | | | |
|----------------|----|-----|-----|-----|------------------------------------|----|-----|-----|-----|--|----|-----|-----|--------------------|-----|-----|------------------|
| 250/320 | | | | | 400/630 | | | | | 630/800/1000 | | | | 800/1000/1250/1600 | | | |
| 690 | | | | | 690 | | | | | 690 | | | | 690 | | | |
| 8 | | | | | 8 | | | | | 8 | | | | 8 | | | |
| 1000 | | | | | 1000 | | | | | 1000 | | | | 1000 | | | |
| 3500 | | | | | 3500 | | | | | 3500 | | | | 3500 | | | |
| N | S | H | L | V | N | S | H | L | V | N | S | H | L | S | H | L | V ⁽³⁾ |
| 70 | 85 | 100 | 200 | 200 | 70 | 85 | 100 | 200 | 200 | 70 | 85 | 100 | 200 | 85 | 100 | 200 | 200 |
| 36 | 50 | 70 | 120 | 200 | 36 | 50 | 70 | 120 | 200 | 36 | 50 | 70 | 100 | 50 | 70 | 120 | 150 |
| 30 | 40 | 65 | 100 | 180 | 30 | 40 | 65 | 100 | 180 | 30 | 45 | 50 | 80 | 50 | 65 | 100 | 130 |
| 25 | 30 | 50 | 85 | 150 | 25 | 30 | 50 | 85 | 150 | 25 | 35 | 50 | 65 | 50 | 50 | 85 | 100 |
| 20 | 25 | 40 | 70 | 80 | 20 | 25 | 40 | 70 | 80 | 20 | 22 | 25 | 30 | 30 | 42 | 50 | 60 |
| A | | | | | B (400A) ⁽¹⁾ - A (630A) | | | | | B (630A-800A) ⁽²⁾ - A (1000A) | | | | B ⁽⁴⁾ | | | |
| ■ | | | | | ■ | | | | | ■ | | | | ■ | | | |
| ■ (up to 50A) | | | | | - | | | | | - | | | | - | | | |
| ■ (up to 250A) | | | | | ■ (up to 500A) | | | | | ■ (up to 800A) | | | | - | | | |
| ■ | | | | | ■ | | | | | ■ | | | | - | | | |
| ■ | | | | | ■ | | | | | ■ | | | | - | | | |
| ■ | | | | | ■ | | | | | ■ | | | | - | | | |
| - | | | | | - | | | | | - | | | | ■ | | | |
| - | | | | | - | | | | | - | | | | ■ | | | |
| - | | | | | - | | | | | - | | | | ■ | | | |
| - | | | | | - | | | | | - | | | | ■ | | | |
| - | | | | | - | | | | | - | | | | ■ | | | |
| ■ | | | | | ■ | | | | | ■ | | | | ■ | | | |
| F-P-W | | | | | F-P-W | | | | | F-W | | | | F-W | | | |

10.1.2 New range of molded-case circuit-breakers SACE Tmax XT

In addition, ABB offers the new range of molded-case circuit-breakers SACE Tmax XT up to 250A.

For the protection of the AC section of the PV installations the following circuit-breakers are available:

- XT1 160 and XT3 250 circuit-breakers equipped with thermomagnetic trip units type TMD with adjustable thermal threshold ($I_1 = 0.7..1 \times I_n$) and fixed magnetic threshold ($I_3 = 10 \times I_n$);

- XT2 160 and XT4 250 circuit-breakers equipped with thermomagnetic trip units type TMA (for $I_n \geq 40A$) with adjustable thermal threshold ($I_1 = 0.7..1 \times I_n$) and magnetic threshold I_3 adjustable in the range $8..10 \times I_n$ for 40A, $6..10 \times I_n$ for 50A and $5..10 \times I_n$ for $I_n \geq 63A$, or with Ekip electronic trip units also with neutral increased at 160%.

Characteristics of moulded-case circuit-breakers SACE Tmax XT for the protection of capacitor banks

| | | XT1 | | | | | XT2 | | | | | XT3 | | XT4 | | | | |
|--|----------------------|-----|----|----|----|-----|---------------|----|-----|-----|-----|-----|----|---------------|----|-----|-----|------------------------|
| Size | [A] | 160 | | | | | 160 | | | | | 250 | | 160/250 | | | | |
| Poles | [Nr.] | 3/4 | | | | | 3/4 | | | | | 3/4 | | 3/4 | | | | |
| Rated service voltage, U_e | [V] (AC) 50-60 Hz | 690 | | | | | 690 | | | | | 690 | | 690 | | | | |
| Rated impulse withstand voltage, U_{imp} | [kV] | 8 | | | | | 8 | | | | | 8 | | 8 | | | | |
| Rated insulation voltage, U_i | [V] | 800 | | | | | 1000 | | | | | 800 | | 1000 | | | | |
| Rated ultimate short-circuit breaking capacity, I_{cu} | | B | C | N | S | H | N | S | H | L | V | N | S | N | S | H | L | V |
| (AC) 240V 50-60Hz | [kA] | 25 | 40 | 65 | 85 | 100 | 65 | 85 | 100 | 150 | 200 | 50 | 85 | 65 | 85 | 100 | 150 | 200 |
| (AC) 380V 50-60Hz | [kA] | 18 | 25 | 36 | 50 | 70 | 36 | 50 | 70 | 120 | 200 | 36 | 50 | 36 | 50 | 70 | 120 | 150 |
| (AC) 415V 50-60Hz | [kA] | 18 | 25 | 36 | 50 | 70 | 36 | 50 | 70 | 120 | 150 | 36 | 50 | 36 | 50 | 70 | 120 | 150 |
| (AC) 440V 50-60Hz | [kA] | 15 | 25 | 36 | 50 | 65 | 36 | 50 | 65 | 100 | 150 | 25 | 40 | 36 | 50 | 65 | 100 | 150 |
| (AC) 500V 50-60Hz | [kA] | 8 | 18 | 30 | 36 | 50 | 30 | 36 | 50 | 60 | 70 | 20 | 30 | 30 | 36 | 50 | 60 | 70 |
| (AC) 525V 50-60Hz | [kA] | 6 | 8 | 22 | 35 | 35 | 20 | 25 | 30 | 36 | 50 | 13 | 20 | 20 | 25 | 45 | 50 | 50 |
| (AC) 690V 50-60Hz | [kA] | 3 | 4 | 6 | 8 | 10 | 10 | 12 | 15 | 18 | 20 | 5 | 8 | 10 | 12 | 15 | 20 | 25 (90) ⁽¹⁾ |
| Utilization Category (IEC 60947-2) | | A | | | | | A | | | | | A | | A | | | | |
| Isolation behaviour | | ■ | | | | | ■ | | | | | ■ | | ■ | | | | |
| Trip units: thermomagnetic | | | | | | | | | | | | | | | | | | |
| T regulabile, M fixed | TMD | ■ | | | | | ■ (up to 32A) | | | | | ■ | | ■ (up to 32A) | | | | |
| T adjustable, M adjustable | TMA | - | | | | | ■ | | | | | - | | ■ | | | | |
| magnetic only | MF/MA | - | | | | | ■ | | | | | ■ | | ■ | | | | |
| electronic Ekip | | - | | | | | ■ | | | | | - | | ■ | | | | |
| Interchangeable | | - | | | | | ■ | | | | | - | | ■ | | | | |
| Versions | | F-P | | | | | F-P-W | | | | | F-P | | F-P-W | | | | |

⁽¹⁾ 90kA@690V only for XT4 160. Available shortly, please ask ABB SACE.



Rated currents available for molded-case circuit-breakers SACE Tmax XT with Ekip electronic trip unit

| | In [A] | 10 | 25 | 40 | 63 | 100 | 160 | 250 |
|------|--------|----|----|----|----|-----|-----|-----|
| Ekip | XT2 | ■ | ■ | | ■ | ■ | ■ | |
| | XT4 | | | ■ | ■ | ■ | ■ | ■ |

Rated currents available for molded-case circuit-breakers SACE Tmax XT with the typologies of magnetic trip units

| | XT1 160 | XT2 160 | | | XT3 250 | | XT4 160-250 | |
|--------|------------|------------|----|----|------------|----|----------------|----|
| In [A] | TMD | TMD/TMA | MF | MA | TMD | MA | TMD/TMA | MA |
| 1 | | | ■ | | | | | |
| 1,6 | | ■ | | | | | | |
| 2 | | ■ | ■ | | | | | |
| 2,5 | | ■ | | | | | | |
| 3,2 | | ■ | | | | | | |
| 4 | | ■ | ■ | | | | | |
| 5 | | ■ | | | | | | |
| 6,3 | | ■ | | | | | | |
| 8 | | ■ | | | | | | |
| 8,5 | | | ■ | | | | | |
| 10 | | ■ | | | | | | ■ |
| 12,5 | | ■ | ■ | | | | | ■ |
| 16 | ■ | ■ | | | | | ■ | |
| 20 | ■ | ■ | | ■ | | | ■ | ■ |
| 25 | ■ | ■ | | | | | ■ | ■ |
| 32 | ■ | ■ | | ■ | | | ■ | ■ |
| 40 | ■ | ■ | | | | | ■ | |
| 50 | ■ | ■ | | | | | ■ | |
| 52 | | | | ■ | | | | ■ |
| 63 | ■ | ■ | | | ■ | | ■ | |
| 80 | ■ | ■ | | ■ | ■ | | ■ | ■ |
| 100 | ■ | ■ | | ■ | ■ | ■ | ■ | ■ |
| 125 | ■ | ■ | | | ■ | ■ | ■ | ■ |
| 160 | ■ | ■ | | | ■ | ■ | ■ | ■ |
| 200 | | | | | ■ | ■ | ■ | ■ |
| 225 | | | | | | | | |
| 250 | | | | | ■ | | ■ | |

MF = magnetic only trip unit with fixed magnetic thresholds

MA = magnetic only trip unit with adjustable magnetic thresholds

TMD = thermomagnetic trip unit with adjustable thermal and fixed magnetic thresholds

TMA = thermomagnetic trip unit with adjustable thermal and magnetic thresholds

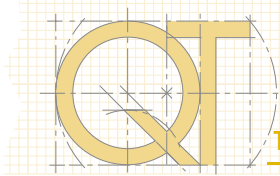

10.1.3 Air circuit-breakers Emax

Air circuit-breakers Emax E1...E6 series complying with the Std. IEC 60947-2, with application range from 400 A to 6300 A, breaking capacities from 42 kA to 150 kA @ 400 V and equipped with electronic relays type PR121/P, PR122/P and PR123/P.

Emax X1 circuit-breakers, with an application range from 400 A to 1600 A, breaking capacities from 42 kA to 65 kA @ 400 V and equipped with electronic relays type PR331/P, PR332/P and PR333/P.



Characteristics of air circuit-breakers Emax for the protection of capacitor banks

| | | E1 | | E2 | | | E3 | | | | E4 | | | E6 | | X1 | |
|--|------|------|------|------|------|------|------|------|------|------|------|------|------|------|------|------|------|
| Rated service voltage Ue | [V] | 690 | | 690 | | | 690 | | | | 690 | | | 690 | | 690 | |
| Rated impulse withstand voltage Uimp | [kV] | 12 | | 12 | | | 12 | | | | 12 | | | 12 | | 12 | |
| Rated insulation voltage Ui | [V] | 1000 | | 1000 | | | 1000 | | | | 1000 | | | 1000 | | 1000 | |
| Rated uninterrupted current Iu | | B | N | B | N | S | N | S | H | V | S | H | V | H | V | B | N |
| | [A] | 800 | 800 | 1600 | 1000 | 800 | 2500 | 1000 | 800 | 800 | 4000 | 3200 | 3200 | 4000 | 3200 | 630 | 630 |
| | [A] | 1000 | 1000 | 2000 | 1250 | 1000 | 3200 | 1250 | 1000 | 1250 | | 4000 | 4000 | 5000 | 4000 | 800 | 800 |
| | [A] | 1250 | 1250 | | 1600 | 1250 | | 1600 | 1250 | 1600 | | | | 6300 | 5000 | 1000 | 1000 |
| | [A] | 1600 | 1600 | | 2000 | 1600 | | 2000 | 1600 | 2000 | | | | | 6300 | 1250 | 1250 |
| | [A] | | | | | 2000 | | 2500 | 2000 | 2500 | | | | | | 1600 | 1600 |
| | [A] | | | | | | | 3200 | 2500 | 3200 | | | | | | | |
| [A] | | | | | | | | 3200 | | | | | | | | | |
| Rated ultimate short-circuit breaking capacity Icu | | | | | | | | | | | | | | | | | |
| 220-230-380-400-415V 50-60Hz | [kA] | 42 | 50 | 42 | 65 | 85 | 65 | 75 | 100 | 130 | 75 | 100 | 150 | 100 | 150 | 42 | 65 |
| 440V 50-60Hz | [kA] | 42 | 50 | 42 | 65 | 85 | 65 | 75 | 100 | 130 | 75 | 100 | 150 | 100 | 150 | 42 | 65 |
| 500V 50-60Hz | [kA] | 42 | 50 | 42 | 65 | 65 | 65 | 75 | 100 | 100 | 75 | 100 | 130 | 100 | 130 | 42 | 55 |
| 690V 50-60Hz | [kA] | 42 | 50 | 42 | 65 | 65 | 65 | 75 | 85 | 100 | 75 | 85 | 100 | 100 | 100 | 42 | 55 |
| Rated short-time withstand current (1s) Icw | [kA] | 42 | 50 | 42 | 55 | 65 | 65 | 75 | 75 | 85 | 75 | 100 | 100 | 100 | 100 | 42 | 42 |
| Utilization category (IEC 60947-2) | | B | B | B | B | B | B | B | B | B | B | B | B | B | B | B | B |
| Insulation behaviour | | ■ | | ■ | | | ■ | | | | ■ | | | ■ | | ■ | |
| Versions | | F-W | | F-W | | | F-W | | | | F-W | | | F-W | | F-W | |

Rated currents available for the circuit-breakers with the various typologies of electronic releases

| | | I _n [A] | 400 | 630 | 800 | 1000 | 1250 | 1600 | 2000 | 2500 | 3200 | 4000 | 5000 | 6300 |
|-------------------------------|----|--------------------|-----|-----|-----|------|------|------|------|------|------|------|------|------|
| PR121/P PR122/P PR123/P | E1 | ■ | ■ | ■ | ■ | ■ | ■ | ■ | | | | | | |
| | E2 | ■ | ■ | ■ | ■ | ■ | ■ | ■ | | | | | | |
| | E3 | ■ | ■ | ■ | ■ | ■ | ■ | ■ | ■ | ■ | ■ | | | |
| | E4 | | | ■ | ■ | ■ | ■ | ■ | ■ | ■ | ■ | ■ | | |
| | E6 | | | ■ | ■ | ■ | ■ | ■ | ■ | ■ | ■ | ■ | ■ | ■ |
| PR331/P PR332/P PR333/P | X1 | ■ | ■ | ■ | ■ | ■ | ■ | ■ | | | | | | |
| | | ■ | ■ | ■ | ■ | ■ | ■ | ■ | | | | | | |
| | | ■ | ■ | ■ | ■ | ■ | ■ | ■ | | | | | | |

10.2 Contactors

ABB offers three different versions of contactors according to the peak current value at switching on and to the power of the capacitor bank:

- *UA..RA 3-pole contactors* with unlimited peak current;
- *UA 3-pole contactors* with peak current lower than or equal to 100 times the r.m.s value of the rated current;
- *A and AF standard 3-pole contactors* for single capacitor bank switching with peak current lower than or equal to 30 times the r.m.s. value of the rated current.

10.2.1 UA..RA contactors

UA..RA contactors are used in installations in which the peak currents far exceed 100 times the r.m.s. value of the rated current. They are delivered complete with their damping resistors and therefore they are used without additional inductances. The capacitors must be discharged (maximum residual voltage at terminals ≤ 50 V) before being re-energized when the contactors are making. Their electrical life is 250,000 operations for $U_e < 500$ V and 100,000 operations for $500\text{V} \leq U_e \leq 690$ V. UA..RA contactors are equipped with a special front mounted block which ensures the serial insertion of three damping resistors into the circuit to limit the first current peak on energization of the capacitor bank and which, by ensuring capacitor precharging, limit also the second current peak upon making of the main poles.

As shown in the following scheme, when the coil is energized, the early making auxiliary contacts PA connect the capacitor to the network via the set of resistors.

Figure 10.1

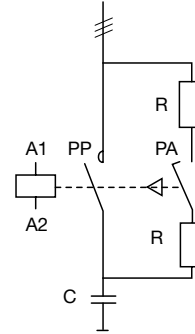

When the main poles PP are closed, the opening of the auxiliary poles is automatically carried out by switching off the resistors as shown in the following diagram.

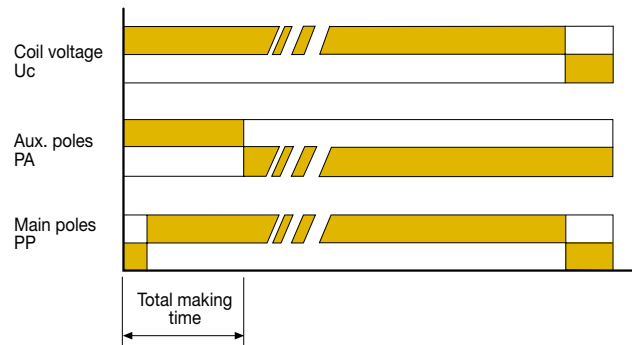

UA..RA contactors for capacitor switching (UA16RA...UA110RA)

The connection of the absorption resistances protects the contactor and the capacitor against the highest inrush currents.



10.2.2 UA contactors

UA contactors are used for the switching of capacitor banks whose inrush current peaks do not exceed 100 times the rated current. The capacitors must be discharged and in this case their electrical life corresponds to 100,000 operations.

10.2.3 A and AF contactors

A and AF contactors are suited for capacitor bank switching with peak currents lower than 30 times the rated current. The capacitors must be discharged before being re-energized when the contactors are making and, in this case, their electrical life corresponds to 100,000 operations.

UA contactors for capacitor switching (UA16...UA110)

Permissible maximum peak current $\hat{I} \leq 100$ times the rms value of the capacitor rated current.



Standard contactors A and AF (A12 ... A300 and AF50 ... AF750)

Permissible maximum peak current $\hat{I} < 30$ times the rms value of the capacitor rated current.



10.3 Automatic compensators

The ABB range of products for automatic power factor correction includes:

- the *APC series*, static compensators equipped with contactors to switch the capacitor banks. These products, available with or without detuning reactors are the ideal solution for the power factor correction of slow varying loads. They can produce reactive power from 25 to 800 kvar, with the power factor set from 0.7 inductive to 0.7 capacitive and with a rated voltage up to 690 V.
- the *Dynacomp series*, static compensators consisting of capacitors and inductors connected to the network by means of static power switches. The *Dynacomp* are designed to meet any possible requirement of a fast varying load. They can produce reactive power up to 400 kvar per unit, with a rated voltage up to 690 V.

In the *Dynacomp* the thyristors in antiparallel are switched in such instants so that no high current transients are generated. Besides, the control is such that no unwanted harmonics are generated in the network. Conventional capacitor banks are equipped with discharge resistors to limit the residual voltage on switching off. This operation may require various seconds; therefore

the response to the requirements for reactive power from the network can be too slow, in particular in the presence of loads whose absorption of reactive power changes frequently. On the contrary, control through thyristors and control of their closing operations limits a lot in the *Dynacomp* the response time to the demand for reactive power, as it can be noticed from the following two graphs.

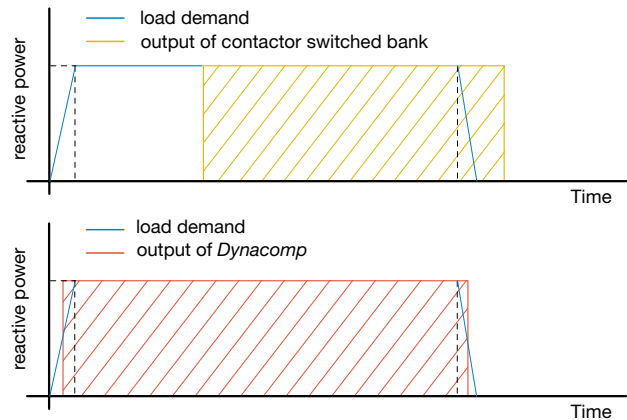

As shown in the figure, the *Dynacomp* consists of capacitors, reactors, dynaswitches and electronic control systems. These components are mounted in a cubicle together with auxiliary apparatus to form a factory assembled and tested system.

APC

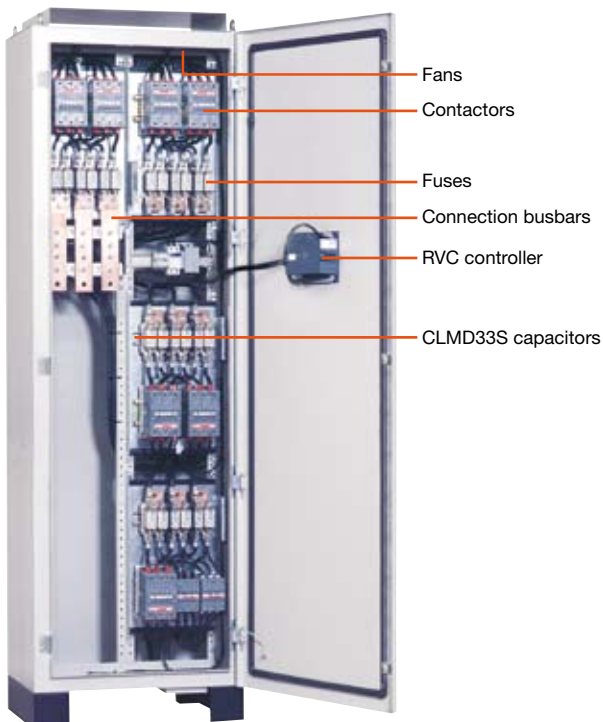

Dynacomp

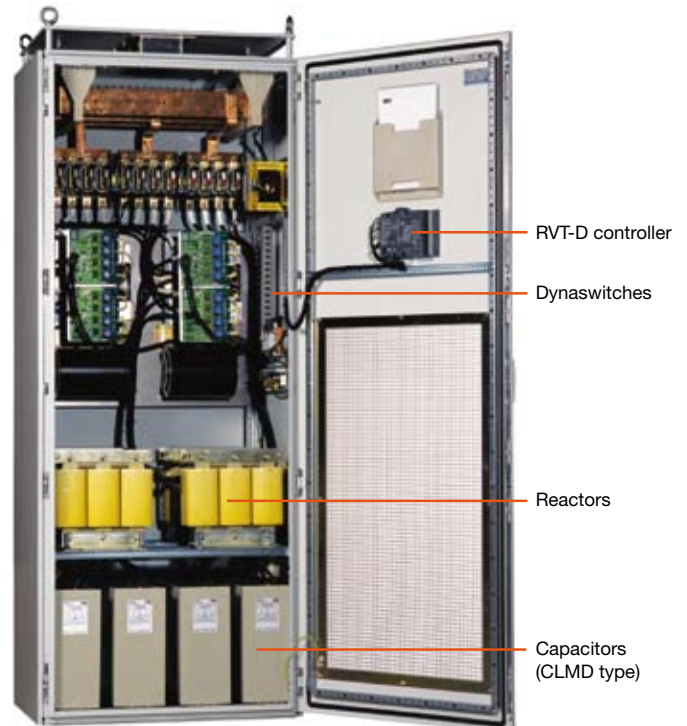

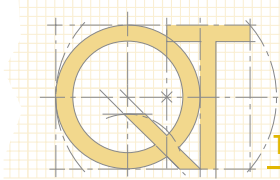

Wide network voltage range, flexible power range, modular design, choice of detuning reactors etc. are some of the features which make the *Dynacomp* the ideal solution for all applications needing a fast and smooth switching of reactive power.

The CLMD capacitors consist of a number of wound elements and made of a dielectric of metalized polypropylene film. They are equipped with discharge resistors (< 50 V in 1 minute) and can be used without the need for further additional discharge resistors.

They offer the following advantages: dry type design, so that there are no risks of leakage and pollution for the environment. The metalized polypropylene film guarantees high voltage withstand capability and excellent peak current handling capacity, exceptional self-healing properties, low losses and high capacitance stability.

These elements, encapsulated in a hermetic plastic case are vacuum-treated to improve their electrical characteristics and each of them is provided with a protective system guaranteeing safe and selective disconnection from the circuit at the end of life.

Finally, these elements are placed in a sheet steel box filled with inert and fire-proof material and connected so that the required power (single-phase or three-phase) is delivered at the established voltage/frequency values.

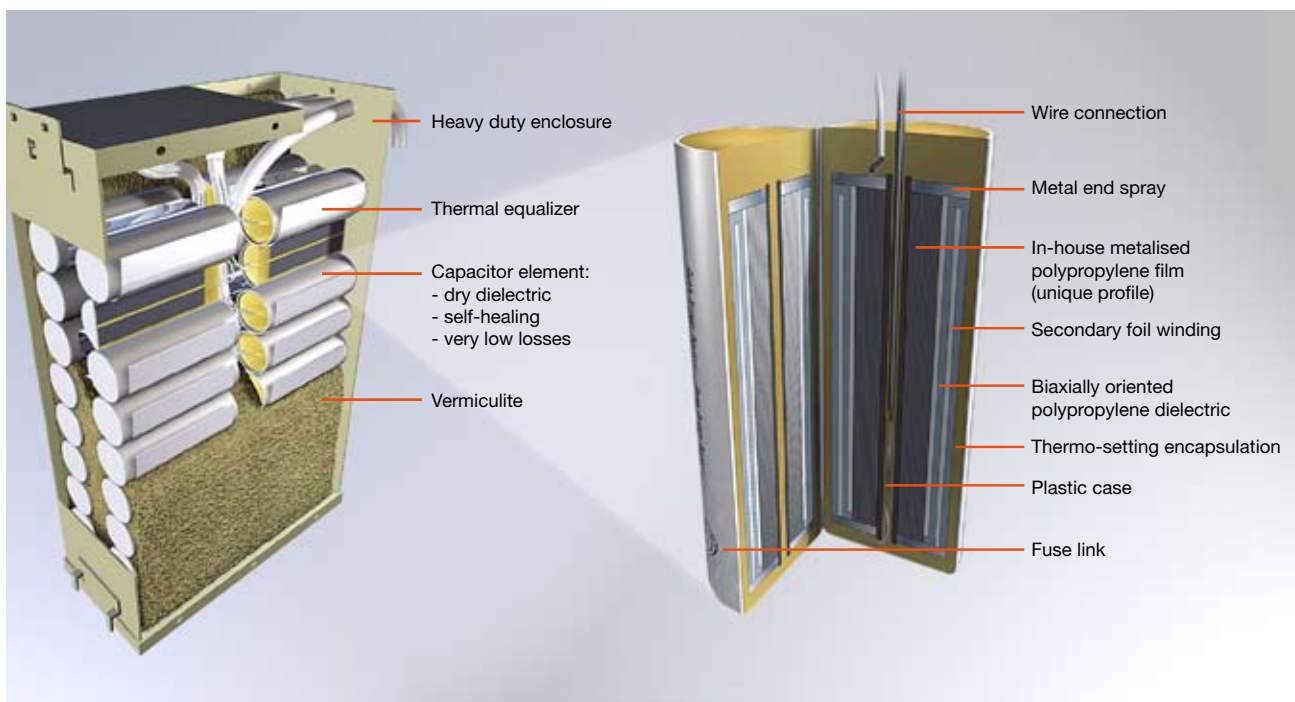

10.4 PQF filters

ABB filters (*Power Quality Filters*) perform the triple function of harmonic filtering, reactive power compensation and load balancing.

The PQF filters, insensitive to large network impedance changes, monitor the line current in real time and convert the measured harmonics into digital signals; these are processed by a digital controller generating PWM (*Pulse Width Modulation*) control signals that drive IGBT power modules which through dc capacitors inject harmonic currents in the network with exactly the opposite phase to the components that are to be filtered.

The PQF also offer communication facilities: in fact, depending on the existing customer communication network, different solutions are available ranging from digital I/O contacts to a Modbus RTU communication interface.

The operating principle is shown in the two following figures.

The load balancing function allows load current to be distributed evenly over the three phases, thus reducing the neutral current.

The reactive power compensation mode allows to compensate precisely up to target power factor values for both inductive as well as for capacitive loads.

The closed loop control system offers the additional advantage of accurate and reliable operation, without any need of special measuring devices.

The main technical advantages of the PQF filters are:

- filtering up to 20 harmonics simultaneously;
- filtering up to the 50th harmonic;
- harmonic attenuation factor higher than 97%;
- operation with closed loop control for better accuracy;
- auto-adaptation to network impedance changes;
- filtering without generation of reactive power;
- generation of reactive power and control of power factor;
- balancing of the load across the phases and phases and neutral.

Figure 10.2

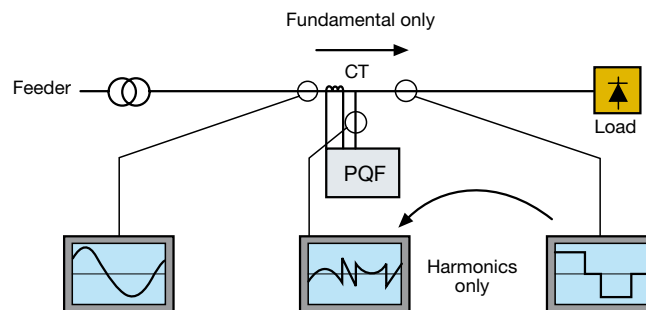
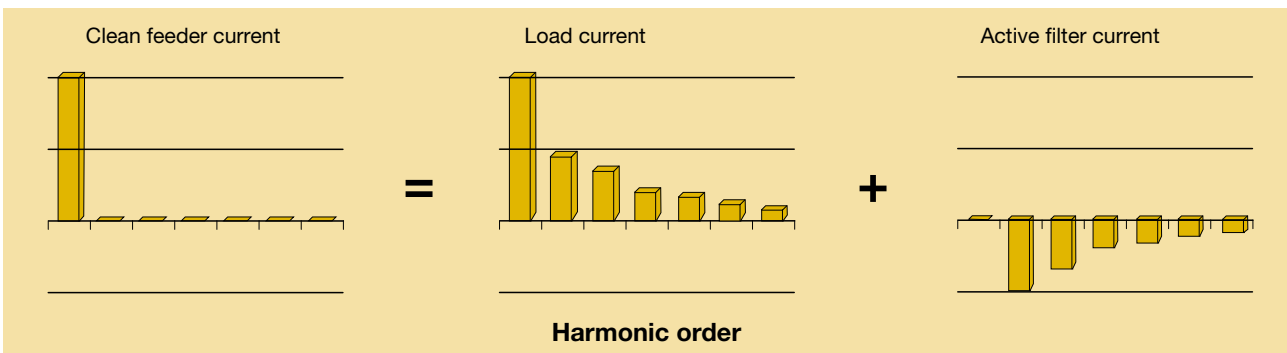
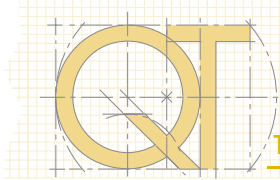

Figure 10.3





PQF filters can be divided into:

- **PQFI filters – Active filters for heavy industrial loads.** Active filters for three-phase networks with or without neutral for filtering of non zero-sequence harmonics and reactive power compensation including load balancing. The figure shows the cubicle constituting the PQFI, with its main components and the relevant main technical features.

These filters have the following main technical characteristics:

- Rated current:

| 208 V ≤ U ≤ 480 V | 480 V ≤ U ≤ 690 V |
|-------------------|-------------------|
| 250 A | 180 A* |
| 450 A | 320 A* |

* If the system voltage is higher than 600 V the current rating of PQFI units may be derated automatically depending on the load conditions for ambient temperatures higher than 30°C.

- Filterable harmonics: 20 harmonics selectable from 2nd to 50th order.
- Reactive power: target displacement power factor programmable from 0.6 inductive to 0.6 capacitive.

Typical result of an application with PQFI

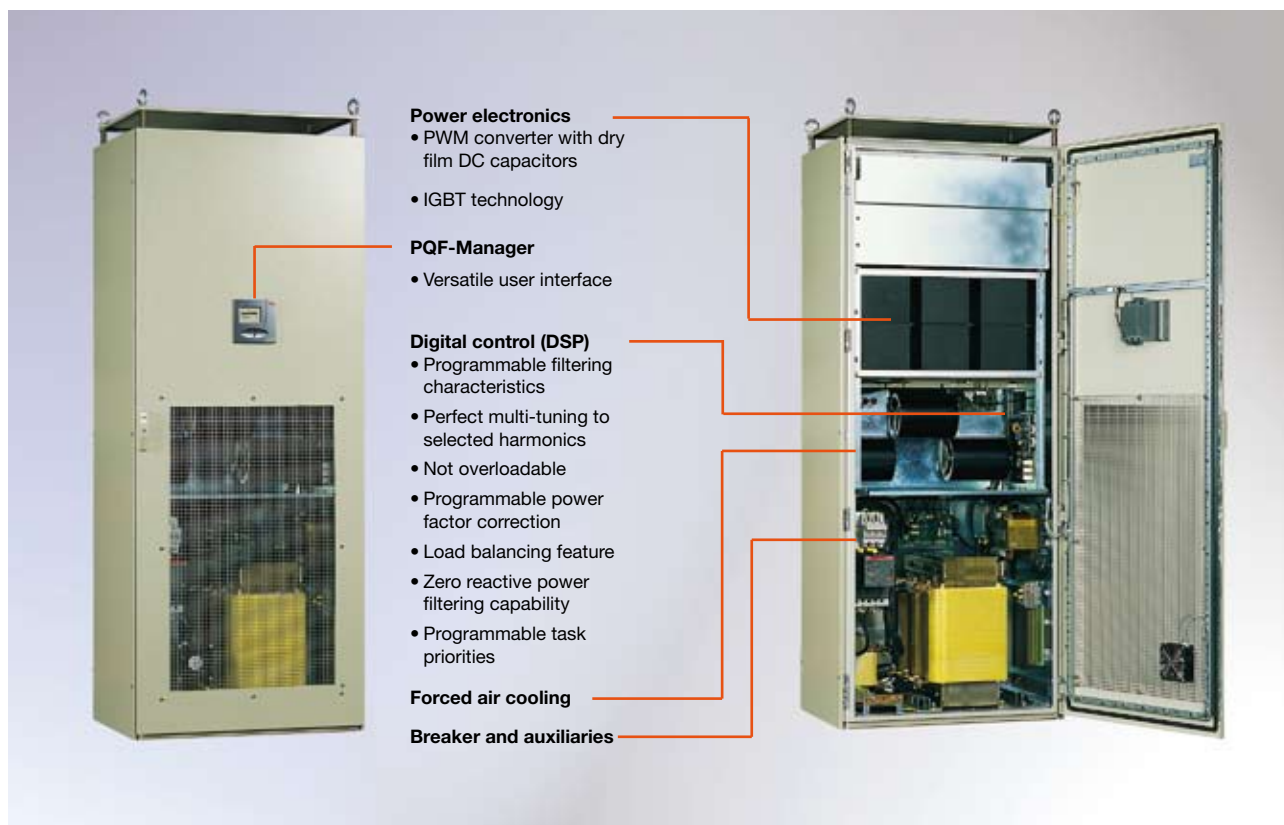
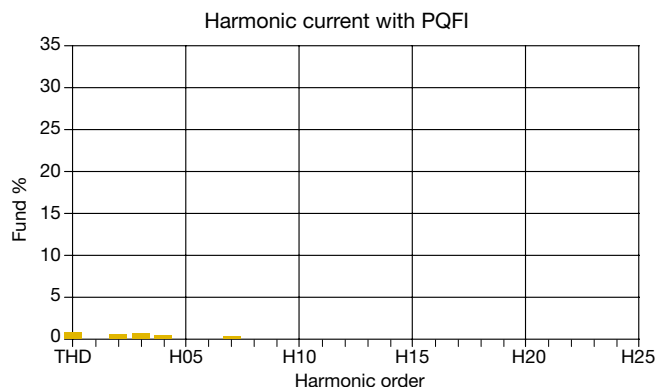
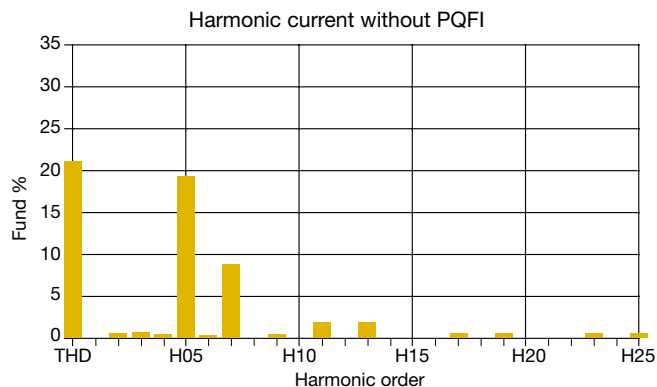

- **PQFM filters** – Active filters for industrial loads of lower capacity. Active filters for three-phase networks with or without neutral for filtering of non zero-sequence harmonics and for reactive power compensation including load balancing.

These filters have the following main technical characteristics:

- Rated current:

| 208 V ≤ U ≤ 480 V | 480 V ≤ U ≤ 690 V |
|-------------------|-------------------|
| 70 A | 100 A* |
| 100 A | - |
| 130 A | - |
| 150 A | - |

* If the system voltage is higher than 600 V the current rating of PQFM units may be derated automatically depending on the load conditions for ambient temperatures higher than 30°C.

- Filterable harmonics: 20 harmonics selectable from 2nd to 50th order.
- Reactive power: target displacement power factor programmable from 0.6 inductive to 0.6 capacitive.

Typical result of an application with PQFM

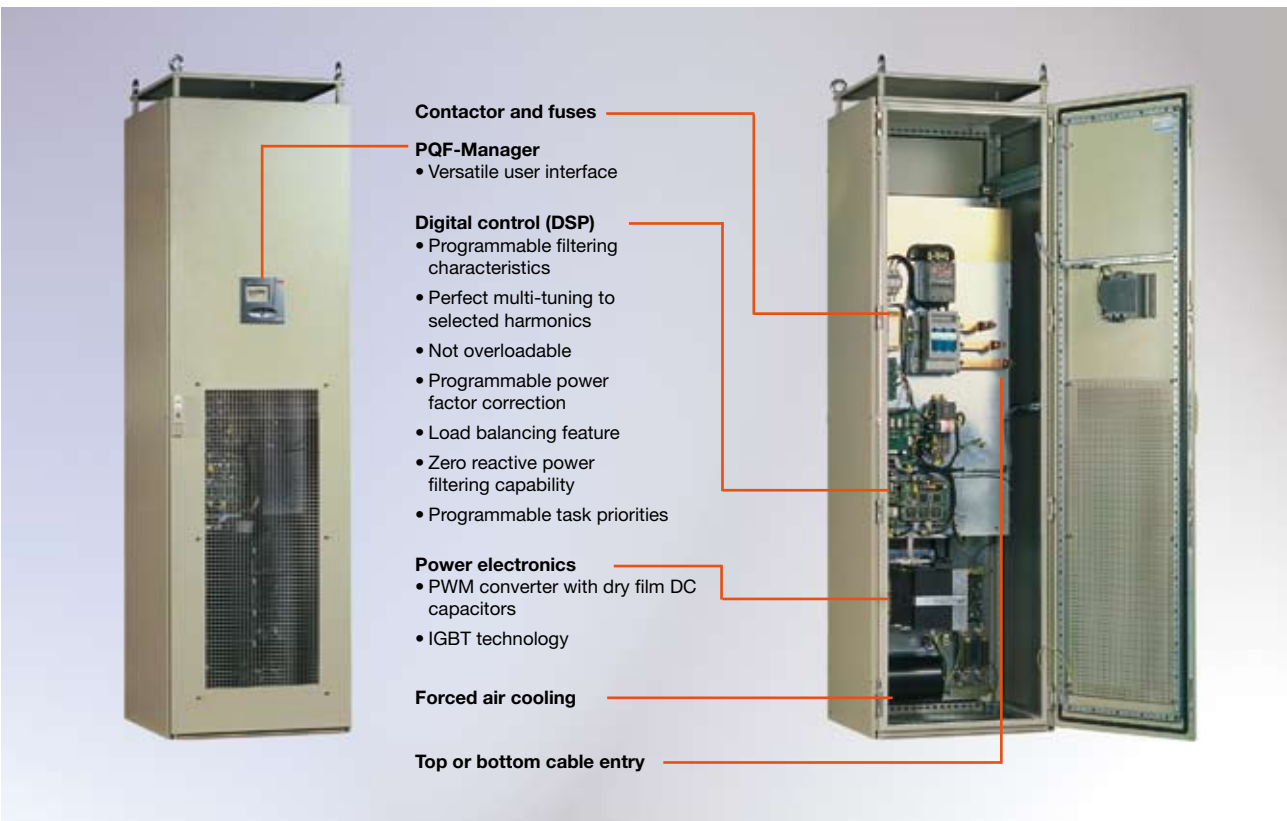
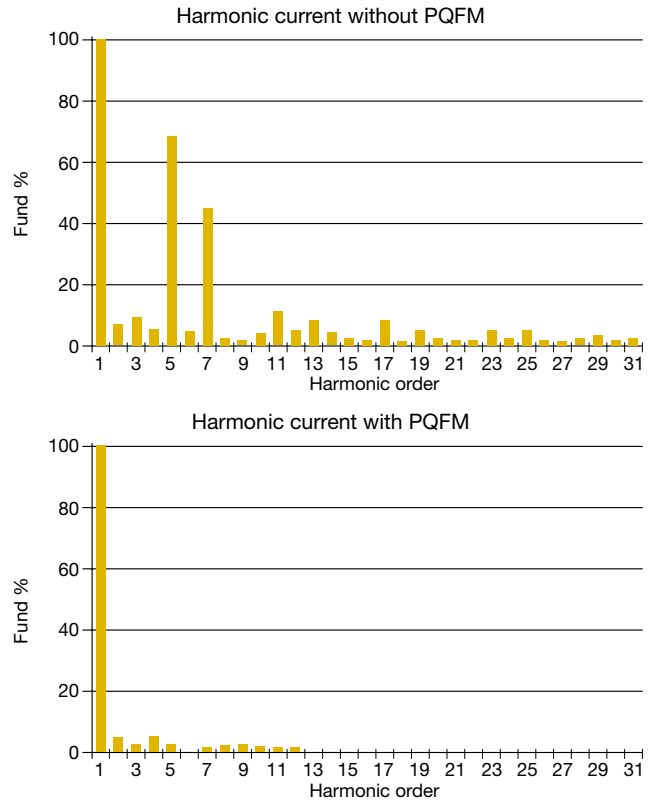

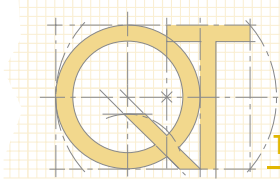

- PQFK filters – Active filters for commercial loads including zero-sequence harmonics in the neutral. Active filters for three-phase networks with neutral wire for filtering of harmonics, including zero-sequence harmonics, for reactive power compensation and load balancing both between phases as well as between phases and neutral.

These filters have the following main technical characteristics:

- Rated current:

| |
|--------------------------|
| 208 V ≤ U ≤ 415 V |
| 70 A |
| 100 A |

- Filterable harmonics: 15 harmonics selectable from 2nd to 50th order.
- Reactive power: target displacement power factor programmable from 0.6 inductive to 0.6 capacitive.

Typical result of an application with PQFK

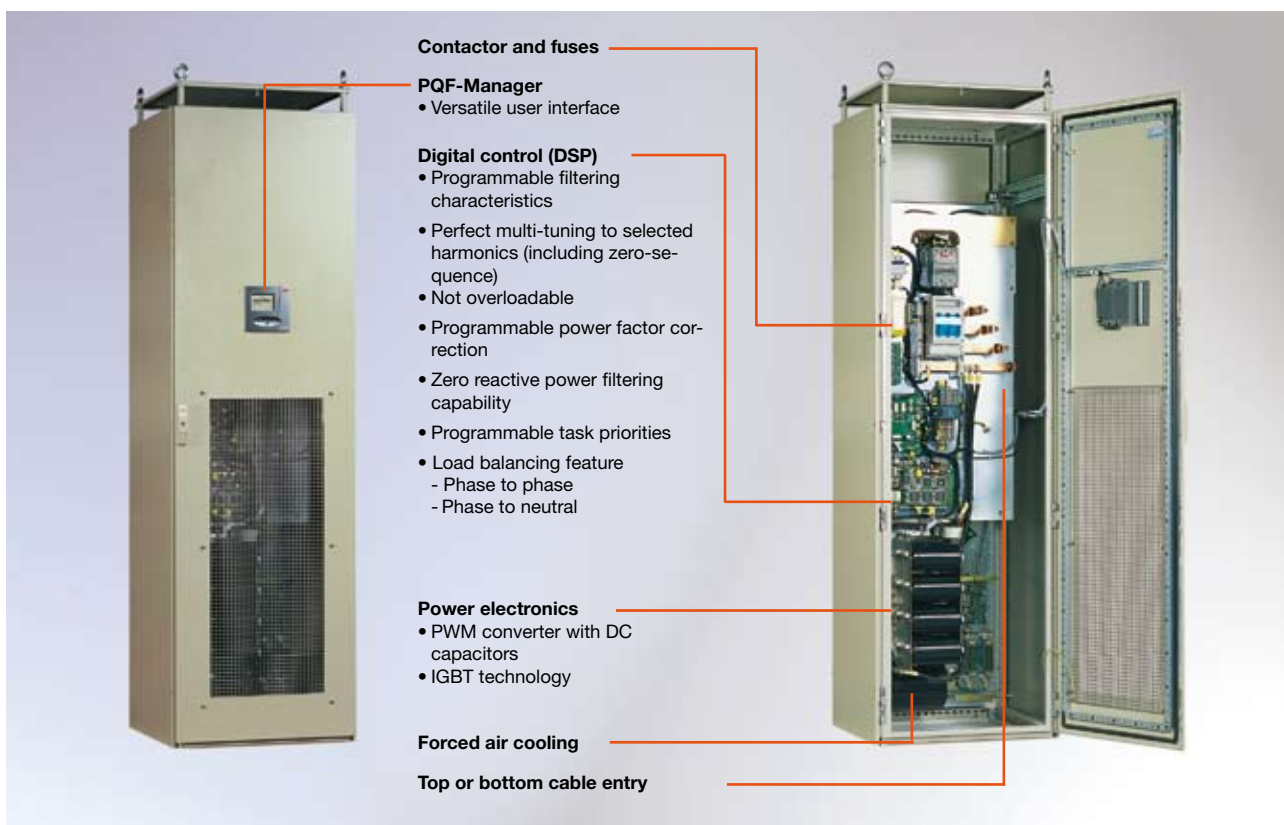
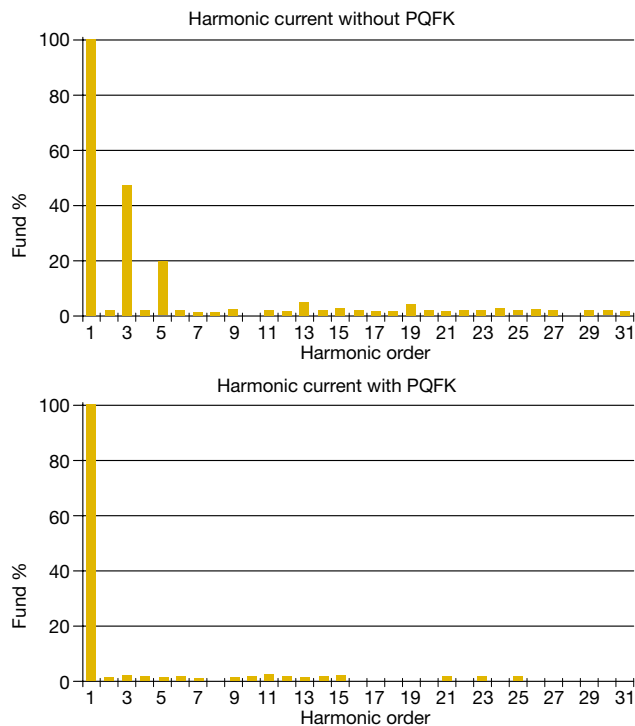

- **PQFS filters** – Active filters for commercial, residential and light industrial loads for installations with or without neutral. Active filters for three-phase networks with or without neutral wire for filtering of harmonics, including zero-sequence harmonics, for reactive power compensation and load balancing between phases as well as between phases and neutral.

These filters have the following main technical characteristics:

- Rated current:

| 208 V ≤ U ≤ 240 V | 380 V ≤ U ≤ 415 V |
|-------------------|-------------------|
| 30 A | 30 A |
| 45 A | 45 A |
| 60 A | 60 A |
| 70 A | 70 A |
| 80 A | 80 A |
| 90 A | 90 A |
| 100 A | 100 A |

- Filterable harmonics:
 - 3-wire connection: 20 harmonics selectable from 2nd to 50th order;
 - 4-wire connection: 15 harmonics selectable from 2nd to 50th order.
- Reactive power: target displacement power factor programmable from 0.6 inductive to 0.6 capacitive.

Typical result of an application with PQFS

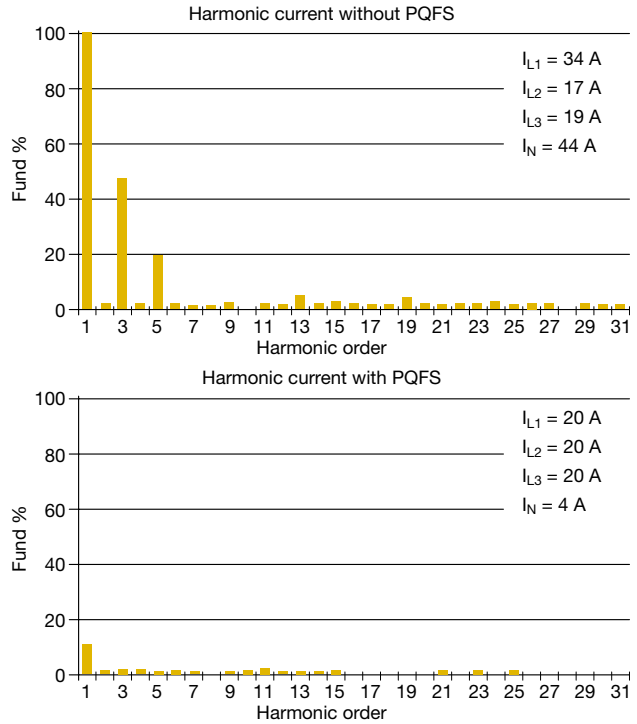

Compact wall mounted design
3 and 4 wire functionality

PQF-Manager
• Versatile user interface

Digital control (DSP)

- Programmable filtering characteristics
- Perfect multi-tuning to selected harmonics (including zero-sequence)
- Not overloadable
- Programmable power factor correction
- Load balancing feature
 - Phase to phase
 - Phase to neutral
- Zero reactive power filtering capability
- Programmable task priorities

Power electronics

- PWM converter with DC capacitors
- IGBT technology

Bottom cable entry

Annex A

Selection tables for circuit-breakers and contactors

The following tables show the coordination between Tmax T, SACE Tmax XT moulded-case circuit-breakers and ABB contactors for the switching and protection of capacitor banks. A prospective short-circuit current of 50 kA for voltages up to 500 V and of 10 kA for a voltage of 690 V and a coordination type 2 are considered. The rated currents of the circuit-breaker and of the

contactor are selected according to the maximum current which can be absorbed by the capacitor bank (I_{cmax}), in compliance with the prescriptions of the Std. IEC 60831-1 A1.

It is necessary to install limiting inductances in order to reduce the inrush current.

¹ Please be reminded that in coordination type 2, the welding of the contactor contacts is allowed provided that they can be easily separated (e.g. with a screwdriver) without any significant deformation.

Table A.1

Coordination type 2 circuit breaker-contactor for the switching of capacitor banks at 400 V, 50 kA

| Q_c [kvar] | I_{cn} [A] | I_{cmax} [A] | MCCB Tmax | I_n [A] | Contactor |
|--------------|--------------|----------------|--------------------------|-----------|-----------|
| 10 | 14 | 21 | XTS160 TMD 25 | 25 | A30 |
| 15 | 22 | 31 | XT2S160 TMA 40 | 40 | A/AF50 |
| 20 | 29 | 41 | XT2S160 TMA 50 | 50 | A/AF50 |
| 30 | 43 | 62 | XT2S160 TMA 80 | 80 | A/AF63 |
| 40 | 58 | 83 | XT2S160 TMA 100 | 100 | A/AF63 |
| 50 | 72 | 103 | XT2S160 TMA 125 | 125 | A/AF95 |
| 60 | 87 | 124 | XT2S160 TMA 160 | 160 | A/AF95 |
| 70 | 101 | 144 | XT2S160 TMA 160 | 160 | A/AF110 |
| 80 | 115 | 165 | XT3S250 TMD 200 | 200 | A/AF145 |
| 90 | 130 | 186 | XT3S250 TMD 200 | 200 | A/AF145 |
| 110 | 159 | 217 | XT3S250 TMD 250 | 250 | A/AF185 |
| 130 | 188 | 256 | T4S320 PR221LS/I In=320 | 320 | A/AF210 |
| 150 | 217 | 296 | T4S320 PR221LS/I In=320 | 320 | A/AF260 |
| 180 | 260 | 355 | T5S400 PR221LS/I In=400 | 400 | AF400 |
| 200 | 289 | 394 | T5S400 PR221LS/I In=400 | 400 | AF400 |
| 250 | 361 | 493 | T6S630 PR221LS/I In=630 | 630 | AF580 |
| 280 | 404 | 552 | T6S630 PR221LS/I In=630 | 630 | AF580 |
| 300 | 433 | 591 | T6S630 PR221LS/I In=630 | 630 | AF750 |
| 350 | 505 | 690 | T6S800 PR221LS/I In=800 | 800 | AF750 |
| 400 | 577 | 788 | T6S800 PR221LS/I In=800 | 800 | AF750 |
| 500 | 722 | 985 | T7S1000 PR232LSI In=1000 | 1000 | AF1650 |

Table A.2

Coordination type 2 circuit breaker-contactor for the switching of capacitor banks at 440 V, 50 kA

| Q_c [kvar] | I_{cn} [A] | I_{cmax} [A] | MCCB Tmax | I_n [A] | Contactor |
|--------------|--------------|----------------|--------------------------|-----------|-----------|
| 10 | 13 | 19 | XT2S160 TMD 25 | 25 | A/AF50 |
| 15 | 20 | 28 | XT2S160 TMD 32 | 32 | A/AF50 |
| 20 | 26 | 38 | XT2S160 TMA 40 | 40 | A/AF50 |
| 30 | 39 | 56 | XT2S160 TMA 63 | 63 | A/AF50 |
| 40 | 52 | 75 | XT2S160 TMA 100 | 100 | A/AF95 |
| 50 | 66 | 94 | XT2S160 TMA 125 | 125 | A/AF95 |
| 60 | 79 | 113 | XT2S160 TMA 125 | 125 | A/AF95 |
| 70 | 92 | 131 | XT2S160 TMA 160 | 160 | A/AF110 |
| 80 | 105 | 150 | XT2S160 TMA 160 | 160 | A/AF145 |
| 90 | 118 | 169 | XT4S250 EkipLS/I In=250 | 250 | A/AF145 |
| 110 | 144 | 197 | XT4S250 EkipLS/I In=250 | 250 | A/AF185 |
| 130 | 171 | 233 | XT4S250 EkipLS/I In=250 | 250 | A/AF210 |
| 150 | 197 | 269 | T4H320 PR221LS/I In=320 | 320 | A/AF260 |
| 180 | 236 | 322 | T5H400 PR221LS/I In=400 | 400 | A/AF300 |
| 200 | 262 | 358 | T5H400 PR221LS/I In=400 | 400 | AF400 |
| 250 | 328 | 448 | T6H630 PR221LS/I In=630 | 630 | AF460 |
| 280 | 367 | 502 | T6H630 PR221LS/I In=630 | 630 | AF580 |
| 300 | 394 | 537 | T6H630 PR221LS/I In=630 | 630 | AF580 |
| 350 | 459 | 627 | T6H800 PR221LS/I In=800 | 800 | AF750 |
| 400 | 525 | 716 | T6H800 PR221LS/I In=800 | 800 | AF750 |
| 500 | 656 | 896 | T7S1000 PR232LSI In=1000 | 1000 | AF1650 |

Table A.3

Coordination type 2 circuit breaker-contactor for the switching of capacitor banks at 500 V, 50 kA

| Q_c [kvar] | I_{cn} [A] | I_{cmax} [A] | MCCB Tmax | I_n [A] | Contactor |
|--------------|--------------|----------------|--------------------------|-----------|-----------|
| 10 | 12 | 17 | XT2H160 TMD 20 | 20 | A/AF50 |
| 15 | 17 | 25 | XT2H160 TMD 32 | 32 | A/AF50 |
| 20 | 23 | 33 | XT2H160 TMA 40 | 40 | A/AF50 |
| 30 | 35 | 50 | XT2H160 TMA 63 | 63 | A/AF63 |
| 40 | 46 | 66 | XT2H160 TMA 80 | 80 | A/AF75 |
| 50 | 58 | 83 | XT2H160 TMA 100 | 100 | A/AF95 |
| 60 | 69 | 99 | XT2H160 TMA 125 | 125 | A/AF95 |
| 70 | 81 | 116 | XT2H160 TMA 125 | 125 | A/AF95 |
| 80 | 92 | 132 | XT2H160 TMA 160 | 160 | A/AF110 |
| 90 | 104 | 149 | XT2H160 TMA 160 | 160 | A/AF145 |
| 110 | 127 | 173 | XT4H250 EkipLS/I In=250 | 250 | A/AF145 |
| 130 | 150 | 205 | XT4H250 EkipLS/I In=250 | 250 | A/AF185 |
| 150 | 173 | 236 | XT4H250 EkipLS/I In=250 | 250 | A/AF210 |
| 180 | 208 | 284 | T4H320 PR221LS/I In=320 | 320 | A/AF260 |
| 200 | 231 | 315 | T5H400 PR221LS/I In=400 | 400 | A/AF300 |
| 250 | 289 | 394 | T5H400 PR221LS/I In=400 | 400 | AF400 |
| 280 | 323 | 441 | T6H630 PR221LS/I In=630 | 630 | AF460 |
| 300 | 346 | 473 | T6H630 PR221LS/I In=630 | 630 | AF460 |
| 350 | 404 | 552 | T6H630 PR221LS/I In=630 | 630 | AF580 |
| 400 | 462 | 630 | T6H800 PR221LS/I In=800 | 800 | AF750 |
| 500 | 577 | 788 | T6H800 PR221LS/I In=800 | 800 | AF1350 |
| 600 | 693 | 946 | T7H1000 PR232LSI In=1000 | 1000 | AF1650 |

Table A.4

Coordination type 2 circuit breaker-contactor for the switching of capacitor banks at 690 V, 10 kA

| Q_c [kvar] | I_{cn} [A] | I_{cmax} [A] | MCCB Tmax | I_n [A] | Contactor |
|--------------|--------------|----------------|--------------------------|-----------|-----------|
| 10 | 8 | 12 | XT2N160 TMD 16 | 16 | A/AF50 |
| 15 | 13 | 18 | XT2N160 TMD 20 | 20 | A/AF50 |
| 20 | 17 | 24 | XT2N160 TMD 25 | 25 | A/AF50 |
| 30 | 25 | 36 | XT2N160 TMA 40 | 40 | A/AF50 |
| 40 | 33 | 48 | XT2N160 TMA 50 | 50 | A/AF63 |
| 50 | 42 | 60 | XT2N160 TMA 63 | 63 | A/AF63 |
| 60 | 50 | 72 | XT2N160 TMA 80 | 80 | A/AF75 |
| 70 | 59 | 84 | XT2N160 TMA 100 | 100 | A/AF95 |
| 80 | 67 | 96 | XT2N160 TMA 100 | 100 | A/AF95 |
| 90 | 75 | 108 | XT2N160 TMA 125 | 125 | A/AF110 |
| 110 | 92 | 126 | XT2N160 TMA 160 | 160 | A/AF145 |
| 130 | 109 | 148 | XT2N160 TMA 160 | 160 | A/AF185 |
| 150 | 126 | 171 | XT4N250 EkipLS/I In=250 | 250 | A/AF210 |
| 180 | 151 | 206 | XT4N250 EkipLS/I In=250 | 250 | A/AF260 |
| 200 | 167 | 228 | XT4N250 EkipLS/I In=250 | 250 | A/AF260 |
| 250 | 209 | 286 | T4N320 PR221LS/I In=320 | 320 | AF400 |
| 280 | 234 | 320 | T5N400 PR221LS/I In=400 | 400 | AF400 |
| 300 | 251 | 343 | T5N400 PR221LS/I In=400 | 400 | AF400 |
| 350 | 293 | 400 | T6N630 PR221LS/I In=630 | 630 | AF460 |
| 400 | 335 | 457 | T6N630 PR221LS/I In=630 | 630 | AF580 |
| 500 | 418 | 571 | T6N630 PR221LS/I In=630 | 630 | AF750 |
| 600 | 502 | 685 | T6N800 PR221LS/I In=800 | 800 | AF1350 |
| 700 | 586 | 800 | T7S1000 PR232LSI In=1000 | 1000 | AF1650 |
| 800 | 669 | 914 | T7S1000 PR232LSI In=1000 | 1000 | AF1650 |

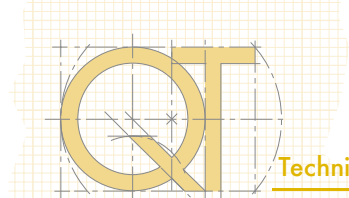

In the following table regarding the switching and protection of capacitors by means of air circuit-breakers, the following symbols are used:

- N_{mech} number of mechanical operations;
- f_{mech} frequency of mechanical operations [op/h];
- N_{el} number of electrical operations with reference to a voltage of 440 V;
- f_{el} frequency of electrical operations [op/h].

In this case, due to the big size of the capacitor bank, switching through contactor is not taken into consideration; on the contrary, direct switching by means of circuit-breaker is considered because the number of operations

shall be limited and therefore they shall be carried out by the air circuit-breaker itself.

Moreover, a precise value for the prospective short-circuit current is not established and consequently, for each value of rated power of the bank, the different breaking capacities of each circuit-breaker are considered.

In this case too, if the inrush current is excessive, the installation of limiting inductances shall be necessary.

Table A.5

| Circuit-breaker | I_{CBn} [A] | I_{cn} [A] | Q_c [kvar] | | | | N_{mech} | f_{mech} [op/h] | N_{el} | f_{el} [op/h] |
|-----------------|------------------|-----------------|--------------|-------|-------|-------|------------|----------------------|----------|--------------------|
| | | | 400 V | 440 V | 500 V | 690 V | | | | |
| X1 B-N | 630 | 421 | 291 | 320 | 364 | 502 | 12500 | 60 | 6000 | 30 |
| X1 B-N | 800 | 533 | 369 | 406 | 461 | 637 | 12500 | 60 | 6000 | 30 |
| X1 B-N | 1000 | 666 | 461 | 507 | 576 | 795 | 12500 | 60 | 4000 | 30 |
| X1 B-N | 1250 | 834 | 578 | 636 | 722 | 997 | 12500 | 60 | 4000 | 30 |
| X1 B-N | 1600 | 1067 | 739 | 813 | 924 | 1275 | 12500 | 60 | 3000 | 30 |
| E1 B-N | 800 | 533 | 369 | 406 | 461 | 637 | 25000 | 60 | 10000 | 30 |
| E1 B-N | 1000 | 666 | 461 | 507 | 576 | 795 | 25000 | 60 | 10000 | 30 |
| E1 B-N | 1250 | 834 | 578 | 636 | 722 | 997 | 25000 | 60 | 10000 | 30 |
| E1 B-N | 1600 | 1067 | 739 | 813 | 924 | 1275 | 25000 | 60 | 10000 | 30 |
| E2 B-N-S | 800 | 533 | 369 | 406 | 461 | 637 | 25000 | 60 | 15000 | 30 |
| E2 B-N-S | 1000 | 666 | 461 | 507 | 576 | 795 | 25000 | 60 | 15000 | 30 |
| E2 B-N-S | 1250 | 834 | 578 | 636 | 722 | 997 | 25000 | 60 | 15000 | 30 |
| E2 B-N-S | 1600 | 1067 | 739 | 813 | 924 | 1275 | 25000 | 60 | 12000 | 30 |
| E2 B-N-S | 2000 | 1334 | 924 | 1017 | 1155 | 1594 | 25000 | 60 | 10000 | 30 |
| E3 N-S-H-V | 800 | 533 | 369 | 406 | 461 | 637 | 20000 | 60 | 12000 | 20 |
| E3 N-S-H-V | 1000 | 666 | 461 | 507 | 576 | 795 | 20000 | 60 | 12000 | 20 |
| E3 N-S-H-V | 1250 | 834 | 578 | 636 | 722 | 997 | 20000 | 60 | 12000 | 20 |
| E3 N-S-H-V | 1600 | 1067 | 739 | 813 | 924 | 1275 | 20000 | 60 | 10000 | 20 |
| E3 N-S-H-V | 2000 | 1334 | 924 | 1017 | 1155 | 1594 | 20000 | 60 | 9000 | 20 |
| E3 N-S-H-V | 2500 | 1667 | 1155 | 1270 | 1444 | 1992 | 20000 | 60 | 8000 | 20 |
| E3 N-S-H-V | 3200 | 2134 | 1478 | 1626 | 1848 | 2550 | 20000 | 60 | 6000 | 20 |
| E4 S-H-V | 3200 | 2134 | 1478 | 1626 | 1848 | 2550 | 15000 | 60 | 7000 | 10 |
| E6 H-V | 3200 | 2134 | 1478 | 1626 | 1848 | 2550 | 12000 | 60 | 5000 | 10 |

Annex B

Reactive power at voltage variations

The reactive power delivered by a three-phase bank of delta- or star-connected capacitors is given respectively by:

$$Q_{c\Delta} = 3 \cdot \frac{U_n^2}{X_c} \quad Q_{cY} = \frac{U_n^2}{X_c} \quad [\text{B.1}]$$

To vary the generated reactive power once the voltage is fixed, it is necessary to vary the values of capacitive reactance X_c and therefore of the capacitances of the inserted capacitors. On the contrary, once the capacitance of the capacitor bank has been fixed, the reactive power varies according to the square of the voltage. In fact, carrying out the dimensioning in order to get a pre-established reactive power Q_{c1} at a voltage value U_{n1} , at a value U_{n2} the reactive power changes complying with the following relation¹:

$$Q_{c2} = Q_{c1} \cdot \left(\frac{U_{n2}}{U_{n1}} \right)^2 \quad [\text{B.2}]$$

which is valid independently of the type of connection of the capacitor bank. Instead, to keep constant the generated reactive power when the voltage varies, it would be necessary to change the capacitance of the capacitors according to the following relation:

$$C_2 = C_1 \cdot \left(\frac{U_{n1}}{U_{n2}} \right)^2 \quad [\text{B.3}]$$

Assuming a supply voltage variation within a range of $\pm 10\%$ of the nominal value, if the power factor has to be equal to 0.9 even at the minimum voltage value, it is necessary to size the capacitor bank (at the same reactive power required by the load) with a capacitance equal to about 124% of that considered at the rated voltage. In fact, from the previous formula:

$$C_2 = C_1 \cdot \left(\frac{U_{n1}}{0.9 \cdot U_{n1}} \right)^2 \rightarrow C_2 = C_1 \cdot \left(\frac{1}{0.81} \right) \rightarrow C_2 = 1.24 \cdot C_1 \quad [\text{B.4}]$$

Nevertheless, with this capacitance value, it is necessary to verify that if the voltage is increased by 10% with respect to the nominal value, the generated reactive power² shall not exceed the power required by the load.

To this purpose, the power factor is fixed at 0.9 when the voltage is 90% of the rated voltage and the active power P drawn by the load, which remains constant, is expressed as a function of the load reactive power Q and of the compensation reactive power Q_c ³:

$$Q - Q_{c_{90\%}} = P \cdot \text{tg}\varphi \rightarrow P = \frac{Q - Q_{c_{90\%}}}{0.49} = \frac{Q - Q_c}{0.49} \quad [\text{B.5}]$$

When the voltage exceeds by 10% the nominal value and with the capacitance increased by 24%, in case of a delta connection, the reactive power results to be equal to:

$$Q_{c_{110\%}} = 3 \cdot \omega \cdot 1.24 \cdot C_1 \cdot (1.1 \cdot V_n)^2 = \dots \leftarrow [\text{B.6}]$$

$$\dots \rightarrow 1.24 \cdot 1.1^2 \cdot 3 \cdot \omega \cdot C_1 \cdot V_n^2 = 1.5 \cdot Q_c$$

In order not to inject reactive power into the network, the following condition has to be satisfied:

$$Q - Q_{c_{110\%}} = P \cdot \text{tg}\varphi' \rightarrow \text{tg}\varphi' = \frac{Q - Q_{c_{110\%}}}{P} > 0 \quad [\text{B.7}]$$

Replacing P with the expression [B.5] and introducing [B.6], the following is obtained:

$$\text{tg}\varphi' = \frac{0.49 \cdot (Q - 1.5 \cdot Q_c)}{Q - Q_c} > 0 \quad [\text{B.8}]$$

Since the denominator is positive due to dimensioning, the ratio shall be positive if the numerator is positive, that is:

$$0.49 \cdot (Q - 1.5 \cdot Q_c) > 0 \rightarrow Q_c < 0.66 \cdot Q \quad [\text{B.9}]$$

Therefore, at first, the value of Q_c shall be calculated to carry out power factor correction at the rated voltage; then the relevant capacitance C_1 is determined and multiplied by 1.24 to obtain the effective value if reactive compensation is wanted at the minimum value of voltage variation; finally, through the inequality [B.9], it is necessary to verify that in case of an increase of 10% of the supply voltage, no reactive power is injected into the network.

In case of reactive compensation, as it is usual, at 100% of the rated voltage instead of 90% the relation [B.6] becomes:

$$Q_{c_{110\%}} = 3 \cdot \omega \cdot C_1 \cdot (1.1 \cdot V_n)^2 = 1.21 \cdot Q_c \quad [\text{B.10}]$$

and consequently, not to inject reactive power into the network, [B.9] becomes:

$$0.49 \cdot (Q - 1.21 \cdot Q_c) > 0 \rightarrow Q_c < 0.83 \cdot Q \quad [\text{B.11}]$$

¹ $Q_{c1} = 3 \frac{U_{n1}^2}{X_c}$ $Q_{c2} = 3 \frac{U_{n2}^2}{X_c}$

making the invariant capacitive reactance explicit and equalling the two equations, [B.2] is obtained.

² $\cos\varphi = 0.9 \rightarrow \text{tg}\varphi = 0.49$

³ $Q_{c_{90\%}} = 3 \cdot \omega \cdot 1.24 \cdot C_1 \cdot (0.9 \cdot V_n)^2 = Q_c$

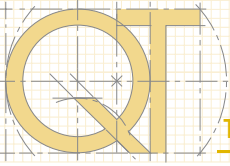

Annex C

Filtering and power factor correction in distorted steady-state

C.1 Introduction

The present plant engineering applications frequently imply the presence of non linear loads generating current harmonics and therefore it may be necessary to carry out power factor correction in non-sinusoidal steady state. When the presence of harmonics reaches a level no more acceptable and consequently the adoption of filters L-C is to be provided to compensate one or more of them, the simultaneous aptitude of such filters for the power factor correction at the fundamental frequency may be exploited: if properly dimensioned, they can deliver all the reactive power required, thus avoiding the installation of dedicated banks of capacitors. Hereunder such operating conditions and the relevant sizing of the filters are analyzed and developed, also through an application example; to this purpose, a preliminary introduction is given concerning some formulas and definitions of quantities useful for the analysis under consideration.

C.2 Analysis of quantities in distorted steady-state

A periodic, generally continuous and limited quantity can be developed in a Fourier series according to the following relation:

$$f(x) = \frac{a_0}{2} + \sum_{n=1}^{\infty} (a_n \cdot \cos nx + b_n \cdot \sin nx) \quad [C.1]$$

where the first term of the right-hand member represents the average value of the function in the period T, that is:

$$\frac{a_0}{2} = \frac{1}{T} \int_0^T f(x) \cdot dx \quad [C.2]$$

whereas the coefficients a_n and b_n of the series are calculated by:

$$a_n = \frac{2}{T} \int_0^T f(x) \cdot \cos nx \cdot dx \quad b_n = \frac{2}{T} \int_0^T f(x) \cdot \sin nx \cdot dx \quad [C.3]$$

The development in Fourier series may be also expressed in terms of cosines only as follows (in the time domain):

$$f(t) = \frac{a_0}{2} + \sum_{k=1}^{\infty} A_k \cdot \cos(k\omega t - \vartheta_k) \quad [C.4]$$

Passing from general quantities to alternating electrical quantities (average value zero $\frac{a_0}{2} = 0$) such as voltage and current, these, in distorted steady-state, can be expressed in the harmonic series with frequencies which are multiple of the fundamental in compliance with the following relations¹:

$$v = \sum_{k=1}^{\infty} \sqrt{2} \cdot V_k \cdot \cos(k\omega t - \vartheta_k) \quad i = \sum_{k=1}^{\infty} \sqrt{2} \cdot I_k \cdot \cos(k\omega t - \vartheta_k - \varphi_k) \quad [C.5]$$

whose phase r.m.s. values are defined as the square root of the sum of the square of the r.m.s. values of the single harmonics:

$$V = \sqrt{\sum_{k=1}^{\infty} V_k^2} \quad I = \sqrt{\sum_{k=1}^{\infty} I_k^2} \quad [C.6]$$

To get information about the harmonic content of voltage and current waveforms and to take measures if such values are high, the Total Harmonic Distortion THD is defined:

$$THD_i = \frac{\sqrt{\sum_{k=2}^{\infty} I_k^2}}{I_1} \quad \text{THD for current} \quad [C.7]$$

$$THD_v = \frac{\sqrt{\sum_{k=2}^{\infty} V_k^2}}{V_1} \quad \text{THD for voltage} \quad [C.8]$$

If $THD_i < 10\%$ and $THD_v < 5\%$, the harmonic ratio is considered low and such that no measures shall be taken, while, in the opposite case, the use of one or more filters for the harmonics of wider amplitude shall be provided for, so that the values of the harmonic distortion ratios can be brought back to acceptable limits.

¹ The angle φ_k represents the displacement of the k-th current harmonic with respect to the k-th voltage harmonic.

C.3 Powers in distorted steady-state

Under distorted steady-state conditions, an extension of the definition of powers in sinusoidal steady-state is possible. In fact, *the total apparent power S*, index of the thermal stress of an electrical component in a three-phase system, is defined as follows:

$$S = 3 \cdot V \cdot I = 3 \cdot \sqrt{\sum_{k=1}^{\infty} V_k^2 \cdot \sum_{k=1}^{\infty} I_k^2} \quad [\text{C.9}]$$

Given the presence of voltage and current harmonics added to the fundamental harmonic, the expressions for the *active power P* and *reactive power Q* become²:

$$P = 3 \cdot \sum_{k=1}^{\infty} V_k \cdot I_k \cdot \cos \varphi_k \quad Q = 3 \cdot \sum_{k=1}^{\infty} V_k \cdot I_k \cdot \sin \varphi_k \quad [\text{C.10}]$$

from which the apparent power A with the usual definition:

$$A = \sqrt{P^2 + Q^2} \quad [\text{C.11}]$$

This power differs from the total apparent power defined in [C.9]; in particular, the following relation is valid:

$$S^2 = P^2 + Q^2 + D^2 \quad [\text{C.12}]$$

in which the term *D* (*defined as distortion power*) takes into account the distortion of the voltage and current³ waveforms.

The sum of the squares of the reactive power *Q* and of the distortion power *D* gives the square of the *non active power N*:

$$N^2 = Q^2 + D^2 \quad [\text{C.13}]$$

which is defined “non active” because it is given by the difference between the squares of the total apparent power *S* and the active power *P*:

$$N^2 = S^2 - P^2 \quad [\text{C.14}]$$

To explain this concept it is possible to give the graphic interpretation of Figure C.1, which is a three-dimensional extension of the two-dimensional triangle of the power in sinusoidal steady state. As it can be noticed, *P*, *Q* and *D* represent the vertices of a parallelepiped whose main diagonal is *S*, *A* is the diagonal of the face having its edges in *P* and *Q*, and *N* is the diagonal of the face whose edges are *Q* and *D*.

Figure C.1

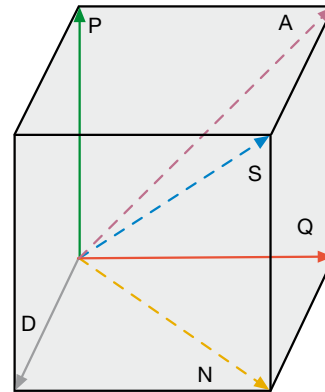

Along the supply line of a load which operates with an active power *P* in distorted steady state, the current defined in [C.6] flows with a voltage defined in the same formula; as a consequence, the total phase displacement factor $\cos \phi$ between the active power *P* and the total apparent power *S* seen from the network is by definition:

$$\cos \phi = \frac{P}{S} \quad [\text{C.15}]$$

In power factor correction, reference is made to such displacement factor by fixing as target value 0.9; thus, with the same value of active power drawn by the load, the total apparent power (and consequently the flowing current) seen by the network decreases. The total displacement factor represents an extension to the distorted steady-state of the usual power factor $\cos \phi$ of the sinusoidal steady-state, which, also in this case, results:

$$\cos \phi = \frac{P}{A} \quad [\text{C.16}]$$

If there were no distortion of the voltage and current waveforms, the factors appearing in the two equations above would coincide; on the contrary, in the presence of harmonics, they differ and the following relation is valid:

$$\cos \phi = \cos \varphi \cdot \cos \psi \quad [\text{C.17}]$$

in which the distortion factor $\cos \psi$ takes into account the presence of the distortion power and is defined as:

$$\cos \psi = \frac{A}{S} \quad [\text{C.18}]$$

² According to Budeanu's approach, the active and reactive power drawn by a load in the presence of harmonic distortion are the sum of the powers at the k^{th} -harmonic and only the products of the voltage and current of the same harmonic are present, not “combined” products of different harmonics.

³ The apparent powers *S* and *A* are different since, by definition, the first takes into account also the “combined” products of the voltage and current r.m.s. values of different harmonics.

C.4 Filters L-C functioning as capacitors

Take into consideration a branch of a passive series filter L-C resonant at an established frequency and represent graphically, as shown below, the capacitive and inductive reactance as a function of the frequency.

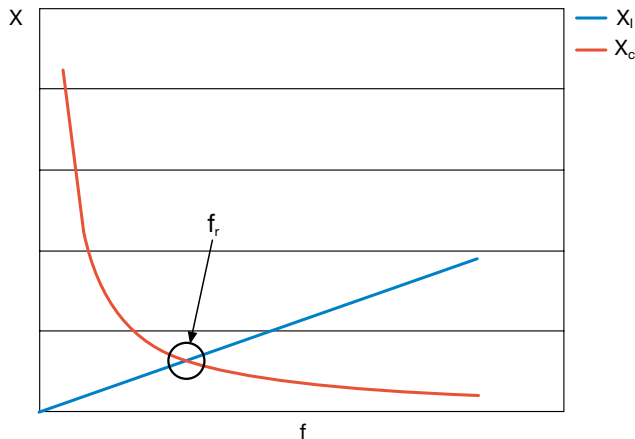

As shown in the graph, it is possible to observe that below the resonance frequency⁴ $f_r = \frac{1}{2 \cdot \pi \cdot \sqrt{L \cdot C}}$ the capacitive reactance prevails and consequently also the generated reactive power prevails over the drawn one, that is:

$$Q = Q_L - Q_C = \omega \cdot L \cdot I^2 - \frac{1}{\omega \cdot C} \cdot I^2 < 0 \quad [C.19]$$

Therefore, by using passive filters for harmonic filtering at resonance frequencies, power factor correction at lower frequencies is obtained and this effect shall be taken into consideration for the dimensioning of the capacitor banks of the filters themselves. In other words, when dimensioning filters L-C it is possible to choose simultaneously such inductance and capacitance values, so that the sum of the reactive power generated at the fundamental harmonic by all the filters installed corresponds to the reactive power required to make the total displacement factor seen from the upstream network reach the value of 0.9.

At frequencies higher than the resonance one, the inductive effect prevails, but the amplitude of the harmonics present in the distorted current waveform, in common plant engineering applications, decreases as the frequency rises; consequently, the reactive power drawn by the filter at a frequency value higher than the resonance

⁴ The resonance frequency is that defined frequency value for which the inductive and capacitive reactances coincide (see Chapter 8). In a formula:

$$X_L = X_C \rightarrow 2 \cdot \pi \cdot f \cdot L = \frac{1}{2 \cdot \pi \cdot f \cdot C} \rightarrow 4 \cdot \pi^2 \cdot f^2 \cdot L \cdot C = 1 \rightarrow f = \frac{1}{2 \cdot \pi \cdot \sqrt{L \cdot C}}$$

If the inductance and the capacitance are in series, the total impedance shall tend to zero and consequently a short-circuit shall occur for the current harmonic having the same frequency as the resonance frequency. Analogously, if the inductance and the capacitance are in parallel, the total impedance shall theoretically tend to infinity with a consequent overvoltage at the ends.

one decreases as the harmonic order rises and besides, for higher frequencies, the compensation bank presents itself to the network on the whole as an inductance, thus eliminating the possibility of parallel resonance with the network inductance.

Application example

Assume that a totally controlled three-phase Graetz static rectifier has to be supplied by a network at 50 Hz with a short-circuit power sufficiently high to make it possible to disregard the distortion of the set of three voltages caused by the distorted current injected into the network by the rectifier.

Figura C.2

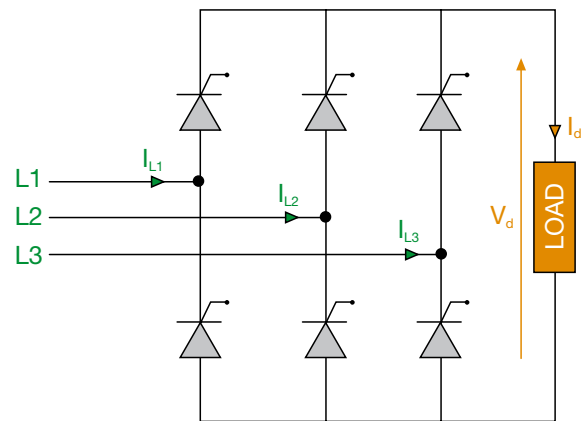

The current in each phase of the line (assuming a high inductance value on the d.c. side) has a rectangular waveform with the fundamental harmonic frequency equal to that of the sinusoidal voltage. The development in Fourier series of such waveform gives only harmonics⁶ of order $k = 6n \pm 1$ ($n = 0, 1, 2, \dots$), whose theoretical amplitude is inversely proportional to the harmonic of order k^7 , that is:

$$I_k = \frac{I_1}{k} \quad [C.20]$$

where I_1 is the amplitude of the fundamental harmonic (in the case under examination equal to 50 Hz). As, by initial hypothesis, the voltage waveform is not subject to distortion, its development in series is reduced to the fundamental harmonic only and consequently the active

⁵ This means that, as shown in the figure, the silicon valves are all thyristors, which can be operated with a delay (phase control angle α); in this way it is possible to change the value of the rectified voltage V_d and the power values P according to the following relations:

$$V_d = V_{do} \cdot \cos \alpha \quad P = P_{do} \cdot \cos \alpha$$

where V_{do} and P_{do} are respectively the average value of the rectified voltage and the power on the d.c. side with no phase control ($\alpha = 0$).

The effect of the phase control angle α on the a.c. side is causing a phase displacement φ between voltage and current, which implies absorption of reactive power Q . In particular, the relation $\alpha = \varphi$ is valid.

⁶ This depends on the typology of the bridge rectifier (single-phase, three-phase, hexa-phase, etc.) and on the type of control (non-control, semi-control or hybrid, total control).

⁷ In fact, non-instantaneous switching and a phase control angle different from 0° reduce the amplitude of the harmonics with respect to the theoretical value.

and reactive powers absorbed by the rectifier (assumed without losses), calculated in compliance with [C.10], are equal to⁸:

$$P = 3 \cdot \sum_{k=1}^{\infty} V_k \cdot I_k \cdot \cos \varphi_k = 3 \cdot V_1 \cdot I_1 \cdot \cos \varphi_1 = P_1 = V_{do} \cdot I_d \cdot \cos \alpha = P_d \quad [C.21]$$

$$Q = 3 \cdot \sum_{k=1}^{\infty} V_k \cdot I_k \cdot \sin \varphi_k = 3 \cdot V_1 \cdot I_1 \cdot \sin \varphi_1 = 3 \cdot V_1 \cdot I_1 \cdot \sin \alpha = Q_1 \quad [C.22]$$

where:

V_{do} is the voltage value on the d.c. side;

I_d is the current value on the d.c. side.

The apparent power which corresponds to these powers is:

$$A = \sqrt{P_1^2 + Q_1^2} = A_1 \quad [C.23]$$

Since the total apparent power seen from the supply network is:

$$S = 3 \cdot V \cdot I = 3 \cdot \sqrt{V_1^2 \cdot \sum_{k=1}^{\infty} I_k^2} \quad [C.24]$$

a distortion power due to the distorted current waveform is present:

$$D = \sqrt{S^2 - A_1^2} \quad [C.25]$$

Assuming that the bridge rectifier has a rated power P_{do} , delivered on the d.c. side, equal to 140 kW, when it is supplied by a network with non-distorted rated voltage and assuming that the switching is instantaneous and the phase control angle α is such that $\cos \varphi = \cos \alpha = 0.8$, the following values for the powers on the a.c. side are obtained:

$$P = P_d = P_{do} \cdot \cos \alpha = 140 \cdot 0.8 = 112 \text{ kW}$$

from which a first harmonic current:

$$I_1 = \frac{P}{\sqrt{3} \cdot U_n \cdot \cos \varphi} = \frac{112 \cdot 10^3}{\sqrt{3} \cdot 400 \cdot 0.8} = 202 \text{ A}$$

and consequently a reactive and apparent power⁹:

$$Q = \sqrt{3} \cdot U_n \cdot I_1 \cdot \sin \varphi = \sqrt{3} \cdot 400 \cdot 202 \cdot 0.6 = 84 \text{ kvar}$$

$$A = \sqrt{P^2 + Q^2} = 140 \text{ kVA}$$

⁸ Since there are no harmonics of higher order in the voltage, all the addends in the sum are equal to zero for $k > 1$. Moreover, as the displacement angle φ and the phase control angle α (in the instant when the thyristors are required to operate) coincide, it can be noticed how the absorption of reactive power from the rectifier rises by increasing the phase control angle.

⁹ $\cos \varphi = 0.8 \rightarrow \psi = 36.9^\circ \rightarrow \sin \varphi = 0.6$

By developing in Fourier series the distorted waveform of the current on the a.c. side, according to [C.20], the following values for the harmonic amplitudes are obtained (the harmonics up to the 25th have been considered):

Table C.1

| k | I_k [A] | I_k/I_1 % |
|----|-----------|-------------|
| 1 | 202 | 100 |
| 5 | 40 | 20 |
| 7 | 29 | 14 |
| 11 | 18 | 9 |
| 13 | 15 | 8 |
| 17 | 12 | 6 |
| 19 | 11 | 5 |
| 23 | 9 | 4 |
| 25 | 8 | 4 |

Therefore, in the upstream network, in case of absence of harmonic filters, a current would flow with a total r.m.s. value equal to the square root of the sum of the squares of the r.m.s. values of the harmonics given in the previous Table:

$$I = \sqrt{\sum_{k=1}^{25} I_k^2} = 210 \text{ A}$$

with a total apparent power:

$$S = \sqrt{3} \cdot U_n \cdot I = \sqrt{3} \cdot 400 \cdot 210 = 146 \text{ kVA}$$

and a total harmonic distortion equal to:

$$\text{THD} = \frac{\sqrt{\sum_{k=5}^{25} I_k^2}}{I_1} = 29\%$$

As a consequence, there would be a distortion factor $\cos \psi = \frac{A}{S} = 0.96$ and, seen from the upstream network, a phase displacement factor $\cos \phi = \cos \varphi \cdot \cos \psi = 0.8 \cdot 0.96 = 0.77$.

The target is obtaining a total phase displacement factor equal to $\cos \phi = 0.9$ and to this purpose it is assumed to size and insert in parallel some filters L-C for the 5th-7th-

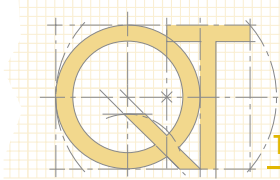

11th and 13th harmonic as shown in the following figure.

Figura C.3

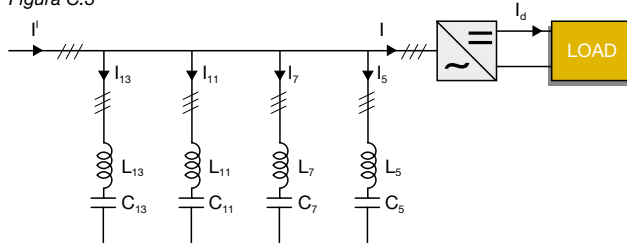

Therefore the final value of $\cos\phi'$ shall exceed 0.9. Assuming to set this value at 0.91, the obtained reactive power compensation is equal to:

$$Q_c = P \cdot (\operatorname{tg}\varphi - \operatorname{tg}\varphi') = 112 \cdot (\operatorname{tg}(\cos^{-1}(0.8)) - \operatorname{tg}(\cos^{-1}(0.91))) = 33 \text{ kvar}$$

from which the final reactive power Q' after power factor correction:

$$Q' = Q - Q_c = 84 - 33 = 51 \text{ kvar}$$

Proceeding by attempts and setting some inductance values for the harmonics to be filtered, the following capacitance values causing series resonance are obtained:

$$C_k = \frac{1}{(2\pi f)^2 \cdot L_k}$$

Table C.2

| k | f [Hz] | L _k [mH] | C _k [μF] |
|----|--------|---------------------|---------------------|
| 5 | 250 | 1 | 406 |
| 7 | 350 | 2 | 103 |
| 11 | 550 | 1 | 84 |
| 13 | 650 | 1 | 6 |

The reactive power at 50 Hz supplied, for example, by the filter L-C resonant at the 5th harmonic is calculated as follows:

$$I_{1,5} = \frac{U_n}{\sqrt{3} \cdot \left(2\pi \cdot 50 \cdot L_5 - \frac{1}{2\pi \cdot 50 \cdot C_5} \right)}$$

$$Q_{1,5} = 3 \cdot \left(\frac{1}{2\pi \cdot 50 \cdot C_5} - 2\pi \cdot 50 \cdot L_5 \right) \cdot I_{1,5}^2$$

Analogously, the contributions of the other harmonics are calculated. The sum of the compensation reactive powers at 50 Hz is very close to the predefined one (with the inductance and capacitance values given in Table C.2); considering the value of apparent power A' (at the same value of absorbed active power P):

$$A' = \sqrt{P^2 + Q'^2} = 123 \text{ kVA}$$

the r.m.s. value of the first harmonic current becomes equal to:

$$I_1' = \frac{A'}{\sqrt{3} \cdot U_n} = \frac{123 \cdot 10^3}{\sqrt{3} \cdot 400} = 177 \text{ A}$$

which is about 12% lower than the initial value of I_1 , to which the current values of the non-filtered harmonics correspond:

Table C.3

| k | I _k [A] | I _k /I ₁ ' % |
|----|--------------------|------------------------------------|
| 17 | 10 | 6 |
| 19 | 9 | 5 |
| 23 | 8 | 4 |
| 25 | 7 | 4 |

As it can be noticed when comparing the absolute values of the r.m.s. values in the Tables C.1 and C.3, the power factor correction at 50 Hz determines a reduction in the r.m.s. value of the first harmonic of current, which affects the reduction of the non-filtered harmonics (since $I_k' = \frac{I_1'}{k}$).

This also involves a further reduction in the total current seen from the upstream network becoming equal to $I' = 178 \text{ A}$ (16% lower than the total initial current I) with a total apparent power S' :

$$S' = \sqrt{3} \cdot U_n \cdot I' = \sqrt{3} \cdot 400 \cdot 178 = 124 \text{ kVA}$$

The distortion factor passes from 0.96 to:

$$\cos\psi' = \frac{A'}{S'} = \frac{123}{124} = 0.99$$

and the total displacement factor results:

$$\cos\phi' = \cos\varphi' \cdot \cos\psi' = 0.91 \cdot 0.99 = 0.906$$

Thus the appointed goal has been reached; otherwise, the set value of $\cos\varphi$ should have been increased and the previous procedure should have been repeated. The total harmonic distortion ratio decreases to $\operatorname{THD}' = 9.9\%$ (lower than the wished 10%).

To conclude, thanks to this example, it has been possible to notice how in distorted steady-state, if the inductances and the capacitances of the passive filters are suitably sized, it is possible to obtain two further effects in addition to harmonic filtering for which the filters are used:

- common power factor correction at 50 Hz since at the fundamental frequency the capacitive effect prevails over the inductive effect and consequently the generated reactive power over the absorbed one;
- by reducing, through the power factor correction, the r.m.s. value of the fundamental harmonic of the current, consequently also the r.m.s. values of the non-filtered harmonics diminish; therefore a further reduction of the total current flowing through the network and of the total THD is obtained, which means a reduction in the distortion of the waveform of the current itself.

Annex D

Voltages and currents upon switching and discharging of capacitors

D.1 Switching of capacitor banks

Taking into consideration the series single-phase equivalent circuit of a capacitance and the resistance of the wiring as shown in the following diagram:

Figure D.1

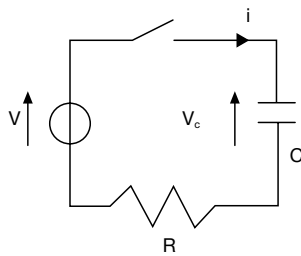

with:

$$v = \sqrt{2} \cdot V_m \cdot \sin(\omega t + \psi) \quad [D.1]$$

the following equation is valid:

$$R \cdot i + \frac{1}{C} \cdot \int_0^t i dt = \sqrt{2} \cdot V_m \cdot \sin(\omega t + \psi) \quad [D.2]$$

With the capacitor voltage V_c as unknown quantity and with $i = i_c = C \cdot \frac{dv_c}{dt}$ it results:

$$R \cdot C \cdot \frac{dv_c}{dt} + v_c = \sqrt{2} \cdot V_m \cdot \sin(\omega t + \psi) \quad [D.3]$$

The solution of the first order linear differential equation is the sum of two components: the steady-state solution v_c^i (particular integral) and a unidirectional component with damped exponential function v_c'' (general integral), that is:

$$v_c = v_c^i + v_c'' \quad [D.4]$$

from which:

$$R \cdot C \cdot \frac{dv_c^i}{dt} + v_c^i = \sqrt{2} \cdot V_m \cdot \sin(\omega t + \psi) \quad R \cdot C \cdot \frac{dv_c''}{dt} + v_c'' = 0 \quad [D.5]$$

Since in steady-state the current flowing through the circuit is the following¹:

$$i^i = \sqrt{2} \cdot I \cdot \sin(\omega t + \psi + \varphi) \quad [D.6]$$

$$I = \frac{V_m}{\sqrt{R^2 + \left(\frac{1}{\omega C}\right)^2}}$$

from the first equation of those in [D.5] the capacitor voltage in steady-state is obtained:

$$v_c^i = \frac{1}{C} \cdot \int_0^t i^i dt = -\frac{\sqrt{2} \cdot I}{\omega \cdot C} \cdot \cos(\omega t + \psi + \varphi) \quad [D.7]$$

For the voltage v_c'' it results²:

$$v_c'' = V_c'' \cdot e^{-\frac{t}{\tau}} \quad [D.8]$$

imposing as initial conditions null voltage on the capacitor for $t=0$:

$$v_{c0} = v_{c0}^i + v_{c0}'' = -\frac{\sqrt{2} \cdot I}{\omega \cdot C} \cdot \cos(\psi + \varphi) + V_c'' = 0 \quad [D.9]$$

from which:

$$V_c'' = \frac{\sqrt{2} \cdot I}{\omega \cdot C} \cdot \cos(\psi + \varphi) \quad [D.10]$$

and therefore:

$$v_c = \frac{\sqrt{2} \cdot I}{\omega \cdot C} \cdot \left[\cos(\psi + \varphi) \cdot e^{-\frac{t}{\tau}} - \cos(\omega t + \psi + \varphi) \right] \quad [D.11]$$

Analogously, for the current too, we have the sum of the steady-state and transient components:

$$i = i^i + i'' \quad [D.12]$$

The steady-state component is given by [D.6], whereas the transient component results by deriving [D.8] with respect to time, that is:

$$i'' = C \cdot \frac{dv_c''}{dt} = C \cdot \frac{\sqrt{2} \cdot I}{\omega \cdot C} \cdot \cos(\psi + \varphi) \cdot e^{-\frac{t}{\tau}} \cdot \left(-\frac{1}{R \cdot C} \right) = \dots \leftarrow [D.13]$$

$$\dots \rightarrow -\frac{\sqrt{2} \cdot I}{\omega \cdot R \cdot C} \cdot \cos(\psi + \varphi) \cdot e^{-\frac{t}{\tau}}$$

from which:

$$i = \sqrt{2} \cdot I \cdot \left[-\frac{1}{\omega \cdot R \cdot C} \cdot \cos(\psi + \varphi) \cdot e^{-\frac{t}{\tau}} + \sin(\omega t + \psi + \varphi) \right] \quad [D.14]$$

The unidirectional component becomes equal to 0 when:

$$\cos(\psi + \varphi) = 0 \rightarrow \psi = 90^\circ - \varphi$$

that is when the insertion angle of the voltage is complementary to the phase displacement angle between voltage and current under steady-state conditions. In this case there are not current peaks and switching overvoltages. On the contrary, if:

$$\cos(\psi + \varphi) = 1 \rightarrow \psi = -\varphi$$

there shall be the maximum value of the unidirectional component with the maximum peak of current and the highest overvoltage.

² It is defined τ the time constant of the system under consideration equal to $\tau = RC$

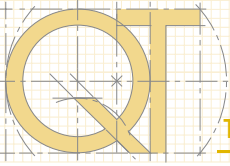

Example

Let us suppose we want to switch a 50 kvar three-phase bank of star-connected capacitors supplied by a network with infinite power at 400 V @ 50 Hz and by a three-pole PVC cable, 10 m long. The capacitance per phase results equal to:

$$Q_c = 3 \cdot \omega \cdot C \cdot \left(\frac{U_n}{\sqrt{3}}\right)^2 \rightarrow C = \frac{Q_c}{\omega \cdot U_n^2} = \frac{50 \cdot 10^3}{314 \cdot 400^2} = 1 \text{ mF}$$

The r.m.s. value of the rated current absorbed in steady-state is:

$$I_n = \frac{Q_c}{\sqrt{3} \cdot U_n} = \frac{5 \cdot 10^3}{\sqrt{3} \cdot 400} = 72 \text{ A}$$

With such a rated current, a 16 mm² cable installed on a tray and having a total resistance per phase equal to 15 mΩ is chosen. As a consequence, the time constant τ of the circuit RC is 15 μs, whereas the phase displacement angle between current and voltage results:

$$\varphi = \text{tg}^{-1}\left(\frac{1}{\omega \cdot R \cdot C}\right) = \text{tg}^{-1}\left(\frac{1}{314 \cdot 15 \cdot 10^{-3} \cdot 10^{-3}}\right) = 89.73^\circ \text{ (anticipo)}$$

Replacing I (negligible error) in [D.13] with the values of resistance, capacitance and I_n, it results that the maximum peak of the inrush current (assuming ψ = -φ) is about 22 kA, that is 300 times the rated current of the bank, as shown in the following diagram. In plant engineering practice, the impedance of the upstream network contributes to limit this peak. However, should it be too high for the present electrical equipment, further limiting inductances should be put as suggested in Chapter 9.

Maximum peak of the inrush current of the capacitor bank

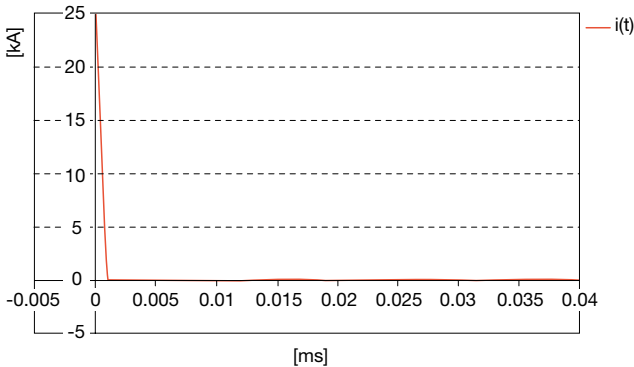

D.2 Discharge of capacitors

Take into consideration a charged capacitor bank having an initial voltage V_{c0} and connected to a discharge resistor R as shown in the following diagram:

Figure D.2

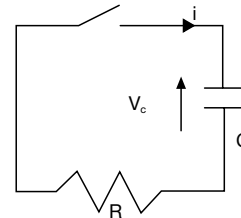

In the absence of an applied voltage, it is possible to write, as a function of the capacitor voltage:

$$R \cdot C \cdot \frac{dv_c}{dt} + v_c = 0 \tag{D.15}$$

the solution of which gives:

$$v_c = V_{c0} \cdot e^{-\frac{t}{\tau}} \tag{D.16}$$

which, in the worst case, becomes:

$$v_c = \sqrt{2} \cdot V_n \cdot e^{-\frac{t}{\tau}} \tag{D.17}$$

Moreover, knowing that $i = i_c = C \frac{dv_c}{dt}$, the current results to be:

$$i = -\frac{V_{c0}}{R} \cdot e^{-\frac{t}{\tau}} \tag{D.18}$$

Inserting in [D.17], in compliance with the prescriptions of the Standard IEC 60831-1, t=180 s and v_c=75 V and solving it with respect to R, the maximum value of the discharge resistance is determined as indicated in the formula [9.12] of Chapter 9.

Example

Let us suppose we want to dimension the discharge resistors for the capacitor bank of the previous example. Starting from [D.17] and replacing the values under consideration it results (with the coefficient k = 1):

$$75 \geq \sqrt{2} \cdot 230 \cdot e^{-\frac{3 \cdot 60}{R \cdot 10^{-3}}} \rightarrow R \leq \frac{180}{10^{-3} \cdot \ln\left(\frac{\sqrt{2} \cdot 230}{75}\right)} = 123 \text{ k}\Omega$$

By choosing a resistor with the same value as that indicated, since in 3 min the resistor dissipates into heat the electrostatic energy stored by each capacitor, the maximum developed power results to be:

$$P = \frac{V_{c0}^2}{R} = \frac{(\sqrt{2} \cdot 230)^2}{123 \cdot 10^3} = 0.86 \text{ W}$$

As it can be noticed, in spite of the resistance value of the order of hundreds kΩ, the maximum power dissipated into heat is lower than 1W, because the maximum value of the discharge current is about:

$$I = \frac{V_{c0}}{R} = \frac{\sqrt{2} \cdot 230}{123 \cdot 10^3} = 2.6 \text{ mA}$$

The consequence is a small cross section of the connection cables and limited thermal phenomena.

Annex E

Power factor correction in photovoltaic plants

A photovoltaic plant usually supplies only active power, therefore it is however necessary to draw from the network the reactive power required for the loads of the user plant.

If a photovoltaic plant is added to an already existing electrical installation, the reactive power drawn by the network remains the same, whereas the active power decreases by the quantity supplied by the photovoltaic generator as shown in the following figure:

Figure E.1

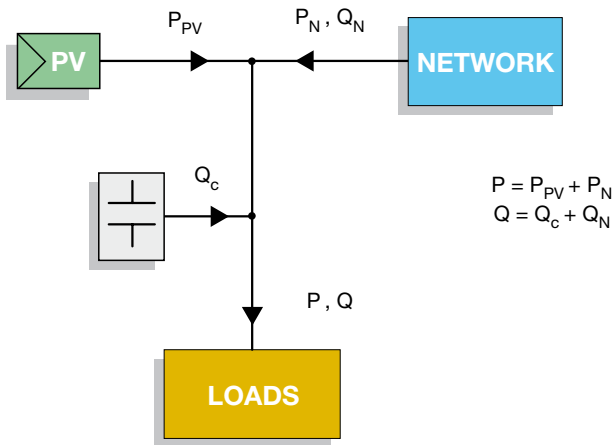

From the point of view of the network, the electrical installation as a whole (photovoltaic generator and user plant) shall have, not to incur penalties, an average power factor equal to 0.9 from which it results:

$$\cos \varphi_R \geq 0.9 \rightarrow \operatorname{tg} \varphi_R \leq 0.5 \rightarrow \frac{Q_R}{P_R} \leq 0.5 \quad [\text{E.1}]$$

Taking into account the indications given in the figure, the previous formula can be rewritten as:

$$\frac{Q - Q_C}{P - P_{PV}} \leq 0.5 \quad [\text{E.2}]$$

from which:

$$Q_C \geq Q - 0.5 \cdot (P - P_{PV}) = P \cdot \left(\operatorname{tg} \varphi_1 - 0.5 \cdot \left(1 - \frac{P_{PV}}{P} \right) \right) = \dots \quad [\text{E.3}]$$

$\dots \rightarrow P \cdot (\operatorname{tg} \varphi_1 - \operatorname{tg} \varphi_2)$

where:

$$\operatorname{tg} \varphi_2 = 0.5 \cdot \left(1 - \frac{P_{PV}}{P} \right) \quad [\text{E.4}]$$

If there is not a photovoltaic plant ($P_{PV} = 0$):

$$\operatorname{tg} \varphi_2 = 0.5 \cdot \left(1 - \frac{0}{P} \right) = 0.5 \rightarrow \cos \varphi_2 = 0.9 \quad [\text{E.5}]$$

that is why the power factor controller is set at 0.9 as usually prescribed.

In the presence of a photovoltaic plant, active power is generated and the power factor regulator shall be set at a value higher than 0.9. In fact, for example, if the generated power is half the power drawn by the loads ($P_{PV} = 0.5 \cdot P$), it results:

$$\operatorname{tg} \varphi_2 = 0.5 \cdot \left(1 - \frac{0.5 \cdot P}{P} \right) = 0.25 \rightarrow \cos \varphi_2 = 0.97 \quad [\text{E.6}]$$

In the limit case, when the photovoltaic plant supplies all the active power required by the loads ($P_{PV} = P$), the power factor controller shall be set at a value equal to:

$$\operatorname{tg} \varphi_2 = 0.5 \cdot \left(1 - \frac{P}{P} \right) = 0 \rightarrow \cos \varphi_2 = 1 \quad [\text{E.7}]$$

and consequently the capacitor bank shall deliver all the reactive power required by the loads.

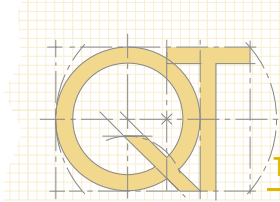

Annex F

Harmonics in three-phase systems with neutral

F.1 Introduction

In three-phase systems with neutral it is possible to have installation applications implying in the neutral conductor the circulation of a current with an r.m.s. value higher than the value of the phase currents.

Hence the necessity to size the neutral with a cross section larger than that of the phases and to have a different setting for the overcurrent protection of the phases and of the neutral in four-pole circuit-breakers.

As a consequence, the use of the harmonic filters and of the power correction techniques previously described contribute also towards a reduction in the amount of the neutral current, whose ratio with the phase current shall be analyzed under the different conditions of harmonic pollution in the following cases.

F.2 Symmetrical three-phase supply system and three single-phase loads balanced but not linear

Figure F.1

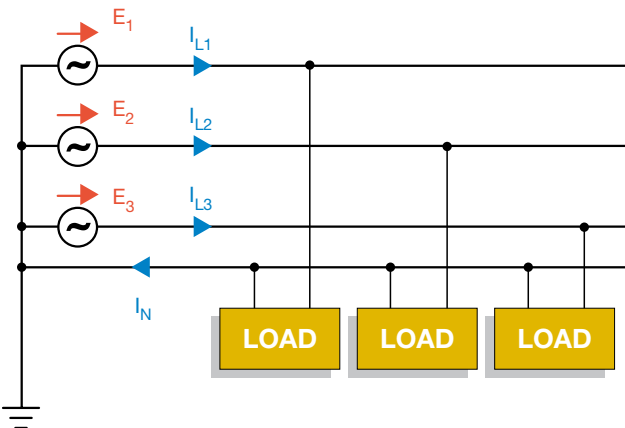

Take into consideration the presence in the three-phase currents of the 3rd harmonic only, in addition to the fundamental one, with a value given by the Standard IEC 60947-2 Annex F option b):

$$I_3 = 0.6 \cdot I_1$$

The r.m.s. value of the phase current as a function of the 1st harmonic results to be:

$$I_{L1} = I_{L2} = I_{L3} = I_L = \sqrt{I_1^2 + I_3^2} = \sqrt{I_1^2 \cdot (1 + 0.6^2)} = 1.17 \cdot I_1 \quad [F.1]$$

In the neutral conductor a current flows which is equal to the algebraic sum of the r.m.s. values of the three 3rd harmonic components in phase between them:

$$I_N = 3 \cdot I_3 = 3 \cdot 0.6 \cdot I_1 = 1.8 \cdot I_1 \quad [F.2]$$

from which, expressing the neutral current as a function of the phase current, it results:

$$I_N = 1.8 \cdot I_1 = 1.8 \cdot \frac{I_L}{1.17} = 1.54 \cdot I_L \approx 160\% I_L \quad [F.3]$$

Whereas, assuming as 3rd harmonic value that given in the Standard IEC 60947-2 Annex F option a):

$$I_3 = 0.88 \cdot I_1$$

the previous relationships become:

$$I_{L1} = I_{L2} = I_{L3} = I_L = \sqrt{I_1^2 + I_3^2} = \sqrt{I_1^2 \cdot (1 + 0.88^2)} = 1.33 \cdot I_1 \quad [F.4]$$

$$I_N = 3 \cdot I_3 = 3 \cdot 0.88 \cdot I_1 = 2.64 \cdot I_1 \quad [F.5]$$

$$I_N = 2.64 \cdot I_1 = 2.64 \cdot \frac{I_L}{1.33} = 1.98 \cdot I_L \approx 200\% I_L \quad [F.6]$$

As it can be noticed, in the neutral, a current which is even twice the phase current may flow with the consequent repercussion in the size of the cross section of the conductor and in the settings of the overload protections. The ratio between the current in the neutral and in the phase would increase if also harmonics multiple of the 3rd one were present. Instead, the assumption that other harmonics not multiple of the 3rd one are absent represents a pejorative situation: their presence would reduce the ratio previously given since such harmonics would not flow through the neutral being balanced symmetrical sets.

F.3 Symmetrical three-phase supply system and two single-phase loads balanced but not linear

Figure F.2

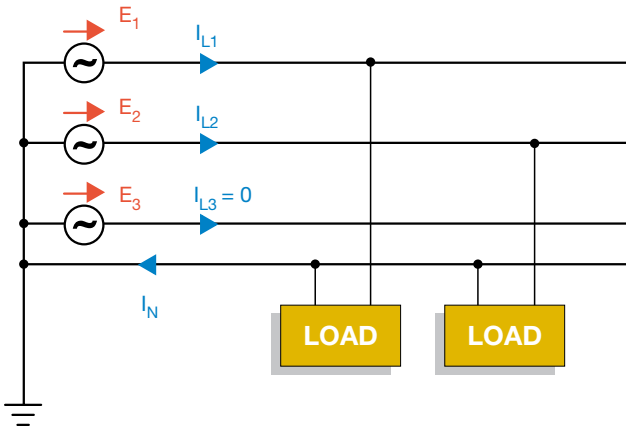

At first, take into consideration the presence of the 3rd harmonic only in addition to the fundamental one. Compared with the previous case, now the current flowing in the neutral is the square root of the sum of the square of the fundamental component plus the square of the sum of the two 3rd harmonics, that is:

$$I_N = \sqrt{I_1^2 + (2 \cdot I_3)^2} \quad [F.7]$$

In this particular case, the fundamental component of the neutral current is the vectorial sum of the fundamental components of the phase currents; since the latter are equal in module and phase-displaced by 120°, the sum gives, as resulting r.m.s value, the same value of the phase fundamental component.

Assuming by hypothesis $I_3 = 0.88 \cdot I_1$ (which can be verified in the single-phase rectifiers), it results:

$$I_N = \sqrt{I_1^2 + (2 \cdot 0.88 \cdot I_1)^2} = I_1 \cdot \sqrt{1 + (2 \cdot 0.88)^2} = 2.02 \cdot I_1 \quad [F.8]$$

$$I_{L1} = I_{L2} = I_L = \sqrt{I_1^2 + I_3^2} = \sqrt{I_1^2 \cdot (1 + 0.88^2)} = 1.33 \cdot I_1 \quad [F.9]$$

$$I_N = \frac{2.02}{1.33} \cdot I_L = 1.52 \cdot I_L \quad [F.10]$$

If also the 5th and the 7th harmonics are present, with the following values given by the Standard IEC 60947-2 Annex F:

- $I_5 = 0.55 \cdot I_1$
- $I_7 = 0.07 \cdot I_1$

the ratio between the neutral current and the phase current becomes:

$$I_N = I_1 \cdot \sqrt{1 + (2 \cdot 0.88)^2 + 0.55^2 + 0.07^2} = 2.1 \cdot I_1 \quad [F.11]$$

$$I_{L1} = I_{L2} = I_L = I_1 \cdot \sqrt{1 + 0.88^2 + 0.55^2 + 0.07^2} = 1.44 \cdot I_1 \quad [F.12]$$

$$I_N = \frac{2.1}{1.44} \cdot I_L = 1.46 \cdot I_L \quad [F.13]$$

As it can be noticed comparing the formula [F.13] with [F.10], also in this case the presence of harmonics not multiple of the 3rd reduces the ratio between the neutral current and the phase current.

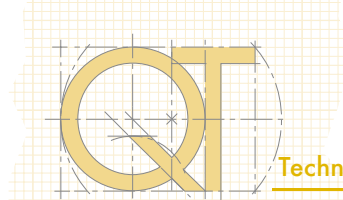

Glossary

| | |
|-----------------|---|
| I | r.m.s. value of the total current |
| I_r | current component in phase with the voltage |
| I_q | current component in quadrature with the voltage |
| I_1 | r.m.s. value of the first current harmonic |
| I_k | r.m.s. value of the k-th current harmonic |
| U | r.m.s. value of the line-to-line voltage |
| V | r.m.s. value of the total phase voltage |
| V_1 | r.m.s. value of the first voltage harmonic |
| V_k | r.m.s. value of the k-th voltage harmonic |
| P | active power absorbed by the load |
| Q | reactive power absorbed by the load |
| Q_1 | total reactive power before power factor correction |
| Q_2 | total reactive power after power factor correction |
| A | apparent power absorbed by the load |
| D | distortion power |
| N | non-active power |
| S | total apparent power |
| S_1 | total apparent power before power factor correction |
| S_2 | total apparent power after power factor correction |
| Q_c | reactive power of the capacitor bank |
| I_{cn} | rated current of the capacitor |
| I_{cmax} | maximum current drawn by the capacitor |
| $\cos\varphi$ | power factor |
| $\cos\psi$ | distortion factor |
| $\cos\phi$ | phase displacement factor |
| $\cos\varphi_1$ | power factor before reactive power compensation |
| $\cos\varphi_2$ | power factor after reactive power |
| THD | total harmonic distortion factor |
| f_r | resonance frequency |
| P_{PV} | active power supplied by a photovoltaic generator |
| P_N | active power supplied by the network |
| Q_N | reactive power supplied by the network |

Technical Application Papers

QT1

Low voltage selectivity with ABB circuit-breakers

QT7

**Three-phase asynchronous motors
Generalities and ABB proposals for the coordination of protective devices**

QT2

MV/LV transformer substations: theory and examples of short-circuit calculation

QT8

Power factor correction and harmonic filtering in electrical plants

QT3

Distribution systems and protection against indirect contact and earth fault

QT9

Bus communication with ABB circuit-breakers

QT4

ABB circuit-breakers inside LV switchboards

QT10

Photovoltaic plants

QT5

ABB circuit-breakers for direct current applications

QT11

Guidelines to the construction of a low-voltage switchgear and controlgear assembly complying with the Standards IEC 61439 Part 1 and Part 2

QT6

Arc-proof low voltage switchgear and controlgear assemblies

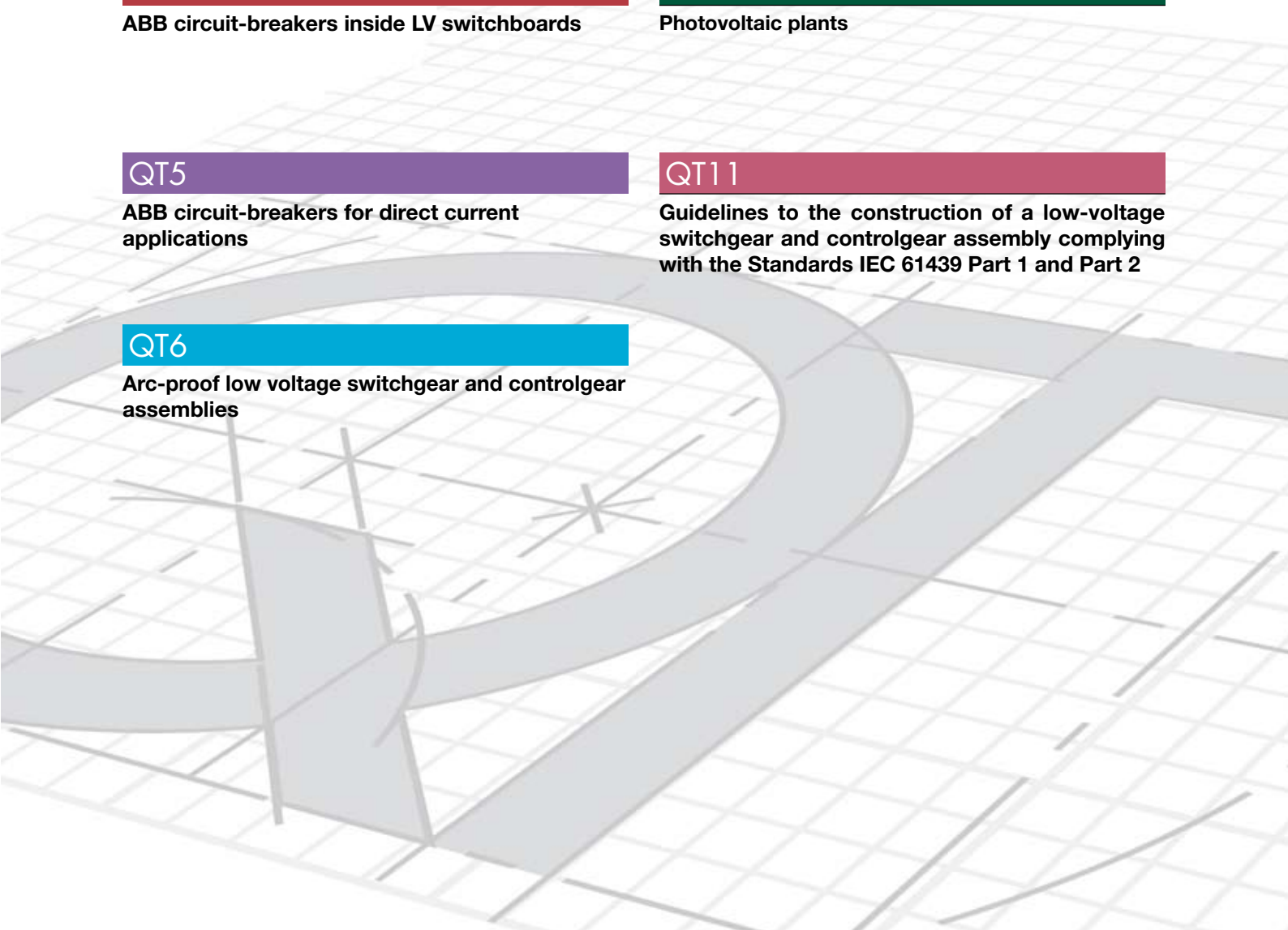

Contact us

ABB SACE

A division of ABB S.p.A.

L.V. Breakers

Via Baioni, 35

24123 Bergamo - Italy

Tel.: +39 035 395 111

Fax: +39 035 395306-433

www.abb.com

The data and illustrations are not binding. We reserve the right to modify the contents of this document on the basis of technical development of the products, without prior notice.

Copyright 2010 ABB. All rights reserved.