

GARMIN®

æra®

model: 760



Pilot's Guide

OVERVIEW

NAVIGATION

FLIGHT PLANNING

HAZARD AVOIDANCE

ADDITIONAL FEATURES

APPENDICES

INDEX

Copyright © 2020 Garmin Ltd. or its subsidiaries. All rights reserved.

This manual reflects the operation of System Software version 1.10 or later. Some differences in operation may be observed when comparing the information in this manual to earlier or later software versions.

Garmin International, Inc., 1200 East 151st Street, Olathe, Kansas 66062, U.S.A.

Garmin AT, Inc., 2345 Turner Road SE, Salem, OR 97302, U.S.A.

Garmin (Europe) Ltd., Liberty House, Hounsdown Business Park, Southampton, Hampshire SO40 9LR U.K.

Garmin Corporation, No. 68, Zhangshu 2nd Road, Xizhi District, New Taipei City, Taiwan

For warranty information, visit:

<https://www.garmin.com/en-US/legal/aviation-limited-warranty/>

[flygarmin.com](https://www.flygarmin.com)

Except as expressly provided herein, no part of this manual may be reproduced, copied, transmitted, disseminated, downloaded or stored in any storage medium, for any purpose without the express written permission of Garmin. Garmin hereby grants permission to download a single copy of this manual and of any revision to this manual onto a hard drive or other electronic storage medium to be viewed for personal use, provided that such electronic or printed copy of this manual or revision must contain the complete text of this copyright notice and provided further that any unauthorized commercial distribution of this manual or any revision hereto is strictly prohibited.

Garmin®, ANT+®, FliteCharts®, SafeTaxi®, and MapSource® are registered trademarks of Garmin Ltd. or its subsidiaries. aera 760™ is a trademark of Garmin Ltd. or its subsidiaries. These trademarks may not be used without the express permission of Garmin.

This product is ANT+® certified. Visit www.thisisant.com/directory for a list of compatible products and apps.

Jeppesen® is a registered trademark of Jeppesen, Inc.

NavData™ is a trademark of Jeppesen, Inc.

AC-U-KWIK® is a registered trademark of Penton Business Media, Inc.

©2020 The Bluetooth® word mark and logos are registered trademarks owned by Bluetooth SIG, Inc. and any use of such marks by Garmin is under license. Other trademarks and trade names are those of their respective owners.

USB-C® is a registered trademark of the USB Implementers Forum.

SOFTWARE LICENSE AGREEMENT

BY USING THE DEVICE, COMPONENT OR SYSTEM MANUFACTURED OR SOLD BY GARMIN (“THE GARMIN PRODUCT”), YOU AGREE TO BE BOUND BY THE TERMS AND CONDITIONS OF THE FOLLOWING SOFTWARE LICENSE AGREEMENT. PLEASE READ THIS AGREEMENT CAREFULLY. Garmin Ltd. and its subsidiaries (“Garmin”) grants you a limited license to use the software embedded in the Garmin Product (the “Software”) in binary executable form in the normal operation of the Garmin Product. Title, ownership rights, and intellectual property rights in and to the Software remain with Garmin and/or its third-party providers. You acknowledge that the Software is the property of Garmin and/or its third-party providers and is protected under the United States of America copyright laws and international copyright treaties. You further acknowledge that the structure, organization, and code of the Software are valuable trade secrets of Garmin and/or its third-party providers and the Software in source code form remains a valuable trade secret of Garmin and/or its third-party providers. You agree not to reproduce, decompile, disassemble, modify, reverse assemble, reverse engineer, or reduce to human readable form the Software or any part thereof or create any derivative works based on the Software. You agree not to export or re-export the Software to any country in violation of the export control laws of the United States of America.

Wireless Frequency/Protocols

2.4 GHz @ 17 dBm nominal





WARNING: When installing the aera 760™, place the unit so it does not obstruct the field of view or interfere with operating controls.



WARNING: The indicators represented on the Panel are based on GPS-derived data and may differ from the instruments in the aircraft.



WARNING: Navigation and terrain separation must NOT be predicated upon the use of the terrain function. The aera 760 Terrain Proximity feature is NOT intended to be used as a primary reference for terrain avoidance and does not relieve the pilot from the responsibility of being aware of surroundings during flight. The Terrain Proximity feature is only to be used as an aid for terrain avoidance and is not certified for use in applications requiring a certified terrain awareness system. Terrain data is obtained from third party sources. Garmin is not able to independently verify the accuracy of the terrain data.



WARNING: The displayed minimum safe altitudes (MSAs) are only advisory in nature and should not be relied upon as the sole source of obstacle and terrain avoidance information. Always refer to current aeronautical charts for appropriate minimum clearance altitudes.



WARNING: The altitude calculated by the GPS and GLONASS receivers is geometric height above Mean Sea Level and could vary significantly from the altitude displayed by pressure altimeters.



WARNING: Do not use outdated database information. Databases used in the aera 760 system must be updated regularly in order to ensure the information remains current. Pilots using any outdated database do so entirely at their own risk.



WARNING: Do not use data link weather information for maneuvering in, near, or around areas of hazardous weather. Information contained within data link weather products may not accurately depict current weather conditions.



WARNING: Do not use the indicated data link weather product age to determine the age of the weather information shown by the data link weather product. Due to time delays inherent in gathering and processing weather data for data link transmission, the weather information shown by the data link weather product may be significantly older than the indicated weather product age.



WARNING: To reduce the risk of unsafe operation, carefully review and understand all aspects of the aera 760 Pilot's Guide documentation and the Pilot's Operating Handbook of the aircraft. Thoroughly practice basic operation prior to actual use. During flight operations, carefully compare indications from the aera 760 to all available navigation sources, including the information from other NAVAIDs, visual sightings, charts, etc. For safety purposes, always resolve any discrepancies before continuing navigation.



WARNING: The Garmin aera 760 has a very high degree of functional integrity. However, the pilot must recognize that providing monitoring and/or self-test capability for all conceivable system failures is not practical. Although unlikely, it may be possible for erroneous operation to occur without a fault indication shown by the aera 760. It is thus the responsibility of the pilot to detect such an occurrence by means of cross-checking with all redundant or correlated information available in the cockpit.



WARNING: For safety reasons, aera 760 operational procedures must be learned on the ground.



WARNING: The government entities operating the satellite-based navigation systems (GPS/GLONASS) are solely responsible for their accuracy and maintenance. The satellite-based navigation systems are subject to changes which could affect the accuracy and performance of all GPS/GLONASS equipment. Portions of the system utilize GPS/GLONASS as a precision electronic NAVigation AID (NAVAID). Therefore, as with all NAVAIDs, information presented by the system can be misused or misinterpreted and, therefore, become unsafe.



WARNING: The data contained in the terrain and obstacle databases comes from government agencies. Garmin accurately processes and cross-validates the data, but cannot guarantee the accuracy and completeness of the data.



WARNING: Do not use basemap (land and water data) information for primary navigation. Basemap data is intended only to supplement other approved navigation data sources and should be considered as an aid to enhance situational awareness.



WARNING: Do not rely solely upon the display of traffic information for collision avoidance maneuvering. The traffic display does not provide collision avoidance resolution advisories and does not, under any circumstances or conditions, relieve the pilot's responsibility to see and avoid other aircraft.



WARNING: Do not rely solely upon the display of traffic information to accurately depict all of the traffic within range of the aircraft. Due to lack of equipment, poor signal reception, and/or inaccurate information from aircraft or ground stations, traffic may be present that is not represented on the display.



WARNING: This product is not an approved navigator for IFR procedures or flight, and should only be used to aid situational awareness in conjunction with installed, IFR certified navigation sources in the aircraft.



CAUTION: The display uses a lens coated with a special coating that is very sensitive to abrasive cleaners. **AVOID CHEMICAL CLEANERS AND SOLVENTS THAT WILL HARM THE SPECIAL COATING.** It is very important when cleaning the touchscreen to use a clean, lint-free cloth (lightly dampened with water, if necessary).



CAUTION: The Garmin aera 760 does not contain any user-serviceable parts. Repairs should only be made by an authorized Garmin service center. Unauthorized repairs or modifications could void both the warranty and the pilot's authority to operate this device under FAA/FCC regulations.



NOTE: All visual depictions contained within this document, including screen images of the aera 760 panel and displays, are subject to change and may not reflect the most current aera 760 system and aviation databases. Depictions of equipment may differ slightly from the actual equipment.



NOTE: This product, its packaging, and its components contain chemicals known to the State of California to cause cancer, birth defects, or reproductive harm. This notice is being provided in accordance with California's Proposition 65. For questions or additional information, please refer to our web site at www.garmin.com/prop65.



NOTE: Use of polarized eyewear may cause the display to appear dim or blank.



NOTE: Temporary Flight Restriction (TFR) data is provided by the FAA and may not be updated outside of normal business hours. Confirm data currency through alternate sources and contact the local FSS for interpretation of TFR data.



NOTE: The navigation databases used in Garmin navigation systems contain Special Procedures. Prior to flying these procedures, pilots must have specific FAA authorization, training, and possession of the corresponding current, and legitimately-sourced chart (approach plate, etc....). Inclusion of the Special Procedure in the navigation database DOES NOT imply specific FAA authorization to fly the procedure.

Blank Page

Part Number	Change Summary
190-02674-00	Initial release

Rev	Date	Description
A	April, 2020	Production Release
B	May, 2020	User interface and compliance updates

Blank Page

SECTION 1 OVERVIEW	1
1.1 Unit Overview	1
1.2 Getting Started	2
Charging the Battery	2
Mounting the aera 760 in the Aircraft.....	3
Turning the Unit On/Off	3
Receiver Status.....	4
Display Orientation.....	6
1.3 Operation	7
Basic Touchscreen Operation	7
Button Bar Icons	8
Main Menu.....	10
1.4 Accessing System Functionality	14
Option Menus	14
Data Entry.....	15
Quick Settings Page.....	18
Power Info Page.....	18
Title Bar Timer	20
1.5 Using Map Displays	20
Map Range	21
Map Panning	22
Map Overlays.....	25
Map Symbols	25
Map Detail.....	25
1.6 System Settings	26
Display Setup	26
Sound Setup	28
Map Setup	29
Bluetooth® Setup.....	30
Connex Setup	31
Weather Setup	32
Wi-Fi Setup	32
3D Vision Setup.....	33
Navigation Setup	34
Keyboard Setup.....	34
Additional Settings.....	34
1.7 Nearest Airport Criteria Settings	35
1.8 Present Position	36
1.9 New Location	37
1.10 Simulator Mode	37

SECTION 2 NAVIGATION	39
2.1 Introduction	39
Data Fields	40
Compass Arc	42
2.2 3D Vision	43
3D Vision Operation	45
2.3 Vertical Navigation (VNAV)	48
Using the VNAV Feature	49
2.4 Map Display Setup	51
Map Orientation	51
Airports, Nav aids, Cities & Roads	52
Airways	52
2.5 Waypoints	53
Nearest Information	57
Weather and NOTAM Information (Optional)	59
Accessing Additional information	60
2.6 Direct-to Navigation	72
SECTION 3 FLIGHT PLANNING	75
3.1 Introduction	75
Data Fields	75
3.2 Flight Plan Creation	76
Adding Waypoints to an Existing Flight Plan	78
Airways	79
Holding Patterns	81
Transferring Flight Plans Using Connex	83
3.3 Flight Plan Storage	84
3.4 Flight Plan Activation	85
Editing Speed and Fuel Flow	86
Copying Flight Plans	87
Deleting Flight Plans	87
Inverting a Flight Plan	88
3.5 Procedures	88
Departure Procedures	89
Arrival Procedures	91
Approach Procedures	93
SECTION 4 HAZARD AVOIDANCE	99
4.1 Weather	99
Weather Data Sources	99
Using Weather Products	99
SIRIUSXM® Weather	101
Data Link Weather (FIS-B)	114
Internet Weather	127

4.2 Terrain	131
Terrain Information.....	132
Obstacle Information.....	132
Terrain and Obstacle Color Code.....	134
Terrain Views.....	134
Terrain Alerts & Setup.....	135
4.3 Traffic	137
Traffic Information Service (TIS-A).....	137
Traffic Ground Track.....	139
Displaying Traffic Data.....	139
Data Link Traffic.....	140
SECTION 5 ADDITIONAL FEATURES	153
5.1 Charts	153
Geo-Referenced Aircraft Position and Chart Overlay.....	155
5.2 SafeTaxi	156
SafeTaxi Cycle Number and Revision.....	157
5.3 Airport Directory Data	158
Fuel Prices.....	160
5.4 SiriusXM® Radio	160
Compatible SiriusXM Devices.....	160
Activating SiriusXM Satellite Radio Services.....	161
Using SiriusXM Radio.....	162
SECTION 6 APPENDICES	165
Appendix A: Messages, Alerts & Data Field Options	165
Miscellaneous Message Advisories.....	165
Airspace Messages.....	166
Data Field & Numeric Data Options.....	167
Appendix B: Abnormal Operation	171
Loss of GNSS Position.....	171
Hazard Display with Loss of GNSS Position.....	171
Appendix C: Managing Files and Databases	173
Connecting to a Computer.....	173
Managing Files.....	174
MicroSD™ Card Use (Optional).....	175
Database Types.....	176
Database Purchase, Installation, and Updates.....	179
Software Updates.....	186
Appendix D: Installation and Interfacing	189
Mounting the aera 760 in the Aircraft.....	189
Connecting to a Garmin VHF Comm Radio.....	193
Information about USB Drivers.....	195
Interfacing.....	195

Configuring aera 760 for a GDL 39.....	197
Configuring aera 760 with the GTX 345.....	200
Configuring aera 760 for a GDL 50/51/52.....	200
Configuring aera 760 for a GDL 50R/51R/52R.....	203
Configuring aera 760 with the GNX 375.....	205
Pairing a GDL, GTX, or Navigator Device via Bluetooth.....	206
Pairing the GDL 51/52 to an Audio Device.....	206
Using an external GPS Antenna (Optional).....	207
Appendix E: Battery and Care Information	209
Battery Information.....	209
Changing the Fuse.....	209
Cleaning the Casing.....	210
Cleaning the Touchscreen.....	210
Protecting the Unit.....	210
Appendix F: General TIS-A Information	211
TIS-A vs. TAS/TCAS.....	211
TIS-A Limitations.....	212
Appendix G: Utilities	215
PDF Viewer.....	215
Flight Log.....	215
Track Log.....	216
Track Vector.....	219
E6B Calculator.....	219
Aircraft Profile.....	221
Weight & Balance.....	223
Proximity Waypoints.....	225
Appendix H: Display Symbols	227
VFR Symbols.....	227
IFR Symbols.....	228
Airspace Symbols.....	230
Appendix I: Map Datum and Location Formats	233
Map Datums.....	233
Location Formats.....	233
Appendix J: Glossary	235
Appendix K: Warranty and Compliance	241
Contact Garmin.....	241
Warranty.....	241
AOPA Airport Directory Notice.....	241
AC-U-KWIK License Agreement.....	241
FCC Compliance.....	242
Innovation, Science, and Economic Development Compliance.....	242
Radiation Exposure Statement.....	242
Index	Index-1

SECTION 1 OVERVIEW

1.1 UNIT OVERVIEW

The aera 760 presents GNSS-derived analog flight instrumentation, position, navigation, and hazard avoidance information to the pilot using a 7" display with a capacitive touch screen.



Unit Overview

1.2 GETTING STARTED



WARNING: The product contains a lithium-ion battery. To prevent damage, remove the unit from the aircraft or vehicle when exiting or store it out of direct sunlight.

CHARGING THE BATTERY



NOTE: Refer to Appendix E for additional battery information.



NOTE: While in Charge Mode, the unit draws a current from the aircraft. To avoid discharging the aircraft's battery, disconnect the external power cable from the unit when not in use for several days.

Charge the aera 760 for at least 4 hours before using on battery power. Charge the battery by connecting the aviation power cable or a Garmin USB-C[®] AC adapter that supports USB Power Delivery.

Plug the unit into a 12-Volt or 24-Volt connector to charge. The unit can be used while it is charging. Charge the unit within the following temperature range: 41° to 95°F (5° to 35°C).

INITIAL BATTERY CHARGING

After fully charging the battery for the first time, the aera 760 battery indicator may report significantly less than full charge. In this case, the battery will need to be conditioned to report the correct capacity. This can be accomplished by allowing the battery to discharge completely and then fully recharging the battery.

USING CHARGE MODE

Applying external power to the aera 760 automatically turns on the unit for full operation. If the battery needs to be charged, the external power source charges the battery while the unit is in use.

If you do not want to use the unit, but you would like to charge the battery, you can put the unit into Charge Mode. Connect the unit to an external power supply. Press and hold the  **POWER** Button. Instead of completely turning off, the unit now goes into Charge Mode.

The unit will run cooler and may allow more current to be available for charging the battery while in Charge Mode.



MOUNTING THE aera 760 IN THE AIRCRAFT

Refer to Appendix D 'Installation & Interfacing' for information on mounting the aera 760 in the aircraft.

TURNING THE UNIT ON/OFF



NOTE: *The unit will turn off automatically after five minutes if on battery power and the Initialization Page is not acknowledged.*

Press the  **POWER** Button to turn the unit on. Press and hold the  **POWER** Button to turn the unit off.

The first time the unit is turned on, the receiver must collect satellite data and establish its present location. To ensure proper initialization, the aera 760 is shipped from the factory in Autolocate mode, which allows the receiver to “find itself” anywhere in the world.

During initialization, current database information is displayed. Database information includes valid operating dates, cycle number, and database type. When this information has been reviewed for currency (to ensure that no databases have expired), the pilot is prompted to continue.

Touching the **Press To Accept** Button acknowledges this information, and the **Main Menu** is displayed.



Database Initialization

RECEIVER STATUS

The receiver status displays one of the following conditions:

- Autolocate—Receiver is looking for any satellite whose almanac has been collected, which can take up to 5 minutes
- Searching The Sky—Receiver is looking for satellites
- Acquiring Satellites—Receiver is looking for and collecting data from satellites visible at its last known or initialized location, but has not acquired a fix
- 2D GPS Location—At least three satellites have been acquired and a two-dimensional location fix has been calculated. “2D Differential” appears when you are receiving DGPS corrections in 2D mode
- 3D GPS Location—At least four satellites have been acquired and a three-dimensional fix has been calculated. “3D Differential” appears when you are receiving DGPS corrections in 3D mode
- Lost Satellite Reception—Receiver is no longer tracking enough satellites for a 2D or 3D fix

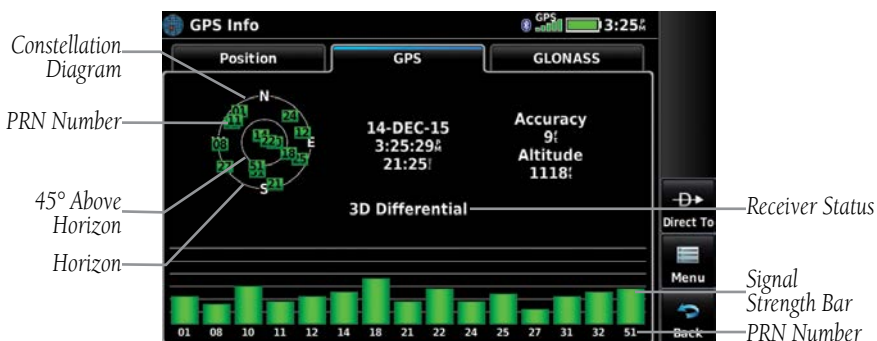

GPS Status

Viewing the GPS status:

From the **Main Menu**, touch **Tools** > **GPS Info** > **GPS** Tab.

ACQUIRING SATELLITES

The  bars on the **Main Menu** indicate the GPS signal strength.

When the receiver is in the process of acquiring enough satellite signals for navigation, the receiver uses satellite orbital data (collected continuously from the satellites) and last known position to determine the satellites that should be in view. 'Acquiring Satellites' is indicated as the solution until a sufficient number of satellites have been acquired for computing a solution.

When the receiver is in the process of acquiring a 3D differential solution, '3D GPS Location' is indicated as the solution until the 3D differential fix has finished acquisition.

SATELLITE INFORMATION

Satellites currently in view are shown at their respective positions on a satellite constellation diagram. The outer circle of the constellation diagram represents the horizon, the inner circle represents 45° above the horizon, and the center point shows the position directly overhead. Each satellite is represented by a square containing the Pseudo-Random Noise (PRN) number (i.e., satellite identification number).

GPS Info can be helpful in troubleshooting weak (or missing) signal levels due to poor satellite coverage or installation problems. As the receiver locks onto satellites, a signal strength bar is displayed for each satellite in view, with the appropriate satellite PRN number (01-32; 33-64 for WAAS; 65-99 for GLONASS) below each bar. The progress of satellite acquisition is shown in three stages, as indicated by signal bar appearance:

- No bar—Receiver is looking for the indicated satellite
- Gray bar—Receiver has collected the necessary data and the satellite signal can be used
- Green bar—Satellite is being used for the GPS solution

DISPLAY ORIENTATION

The aera 760 can be viewed in either Portrait or Landscape Mode.

Changing the display orientation:

- 1) From the **Main Menu**, touch **Tools** > **Setup** > **Display**

Or:

Press the Power Button once quickly.

- 2) Touch **Landscape** or **Portrait**.

1.3 OPERATION

BASIC TOUCHSCREEN OPERATION

Touch the desired selection. The icon, menu option, etc., will momentarily turn blue when selected.

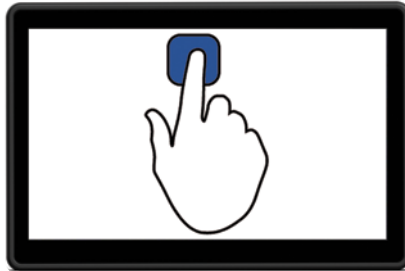

Basic Touchscreen Operation

SCROLLING AND PANNING

Scrolling and panning on the touchscreen:

Drag up or down to scroll menus, documents, etc.

Or:

Drag in any direction to pan maps or charts.

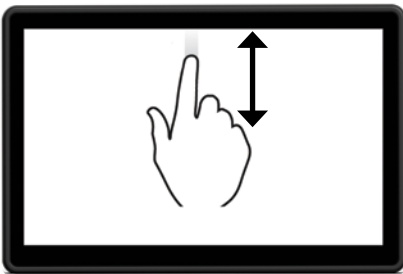

Scroll

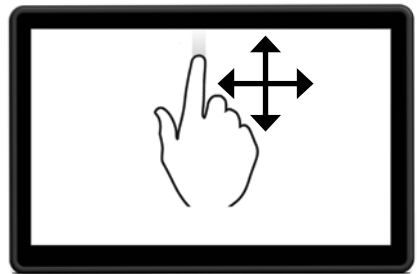

Pan

ZOOMING

Zooming in and out on the touchscreen map displays:

Pinch fingers together (zoom out), or pull fingers apart (zoom in).

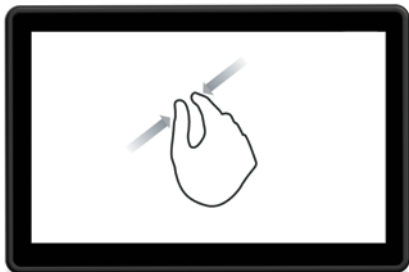

Zoom Out

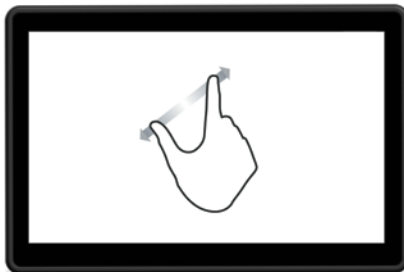

Zoom In

BUTTON BAR ICONS

Button Bar Icons are located vertically on the right side of the screen in landscape mode or horizontally along the bottom of the screen in portrait mode.

Dedicated Page Icons on the Button Bar



Nearest Airports Page



Tools
Displays second-level Tools Icons (available from the Main Menu Button Bar).



Up
Scroll up



Zoom Out
Touch to zoom out



Down
Scroll down



Zoom In
Touch to zoom in



Direct To
Direct-to function



Menu
Page menu



- Previous Screen
- Main Menu (Touch and Hold)



Return
Cancel map pointer



Products
Weather Group Icons (Weather Page Only)

Nearest Group Icons (Nearest Page Only)



Airport



Apt Wx



VOR



NDB



INT



User WPT



City



ARTCC



FSS



Airspace

MAIN MENU



Touch and hold the **Back** icon at any time to display the **Main Menu**.

MAIN MENU ICONS

Touch the following icons to display the associated page or menu:

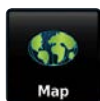

Map

Displays the Map View.



Flight Plan List

Displays the Flight Plan List.



En Route Charts

Displays the En Route VFR or IFR charts.



Weather

Displays Weather Map Page.



3D Vision

Displays 3D Vision.



Terrain

Displays the Terrain View.



Nearest

Displays the Nearest Page.



Traffic

Displays the dedicated Traffic Page.



Waypoint

Displays Waypoint Information.



PDF Viewer

Displays the PFD Viewer Page.



Active Flight Plan

Displays the Active Flight Plan.



Tools

Displays second-level Tools Icons.

TOOLS

From the **Main Menu**, touch the **Tools** icon  to access the second-level Tools icons. Touch these second-level icons to display the associated function:



Setup

Displays third-level Setup Icons.



User WPT

Displays User Waypoints and Proximity Waypoints.



Flight Log

Displays Flight Logs.



Track Log

Displays Track Logs.



VNAV

Displays Vertical Navigation.



Profile

Displays Aircraft Profiles.



E6B

Displays the E6B Calculator.



Weight/Balance

Displays the Weight & Balance.



Downloads

Displays available downloads.



Data Link

Displays the Data Link Info Page.



SiriusXM Audio

Displays the Sirius XM Audio Page.



System Info

Displays database and software version information.



GPS Info

Displays current position and satellite status.



User Timer

Displays User Timer.



VIRB

Displays VIRB Remote Page.



Simulator

Drives simulator.



Power Info

Displays charge voltage and battery percentage information.

NEAREST ICONS

From the **Main Menu**, touch the **Nearest** icon  to access the Nearest Page. Touch these Nearest Group Icons to display the associated function:



Airport
Displays nearest airports.



User WPT
Displays nearest user waypoints.



Airport WX
Displays nearest airport weather.



City
Displays nearest cities.



VOR
Displays nearest VORs.



ARTCC
Displays nearest ARTCCs (Air Route Traffic Control Centers).



NDB
Displays nearest NDBs.



FSS
Displays nearest Flight Service Stations (FSS).



Intersection
Displays nearest intersections.



Airspace
Displays nearest airspace.

WEATHER ICONS

With the Weather Page displayed, touch the **Products** icon  to access the Weather Products:



Radar
Displays radar (composite or base reflectivity).

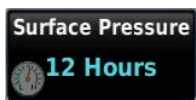

Surface Pressure
Displays pressure isobars and centers.



Cloud Tops Forecast
Forecasted cloud top heights.













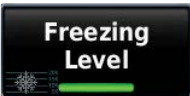

Echo Tops
Highest altitude with precipitation.

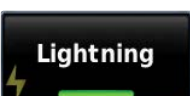

Temps Aloft
Displays forecasted temperatures.







Storm Cells
Displays storm cells and projected path.

	AIRMET Displays AIRmen's METeoro logical Info.		TFR Displays Temporary Flight Restrictions.
	Freezing Level Displays where icing conditions are likely.		Icing Forecast Displays SIP and SLD data.
	Cloud Tops Displays cloud top height contours.		Winds Aloft The forecasted wind speed/direction.
	Lightning Displays lightning data.		METAR METeoro logical Aerodrome Report.
	SIGMET Displays potentially hazardous weather.		Pilot Reports Pilot Weather Reports.
	Turbulence Forecast Displays turbulence data.		Wx Forecast Current & forecast weather conditions.
	IR Satellite Displays cloud top temperatures.		

SETUP ICONS

From the **Main Menu**, touch the **Tools**  > **Setup**  to access the third-level Setup Icons. Touch these third-level icons to perform the associated function:

	Display Displays backlight intensity/timeout, color mode (map/chart), screenshot (on/off), and aircraft position settings.		Connex[®] Displays flight plan transfer settings.
	Sound Displays sound settings.		Wi-Fi Displays Wi-Fi connection settings.

- Overview
- Navigation
- Flight Planning
- Hazard Avoidance
- Additional Features
- Appendices
- Index



Units

Units

Displays unit settings.



Time

Time

Displays time settings.



Map

Map

Displays Navigation Map settings.



Position

Position

Displays position settings.



Interface

Interface

Displays interface settings.



Alarms

Alarms

Displays alarm settings.



Airspace

Airspace

Displays Special Use Airspace alarm settings.



Weather

Weather

Displays weather data source setting.



Bluetooth

Bluetooth[®]

Displays Bluetooth connection settings.



Power

Power

Displays 'Automatic Power Off' setting.



3D Vision

3D Vision

Displays 3D Vision settings.



Navigation

Navigation

Displays Navigation settings.



Keyboard

Keyboard

Displays Keyboard settings.

1.4 ACCESSING SYSTEM FUNCTIONALITY

OPTION MENUS



The aera 760 has a dedicated  icon on the Button Bar that displays a context-sensitive list of menu options available.

Navigating the option menu:

- 1 Touch the  icon
- 2 Touch the desired menu option.

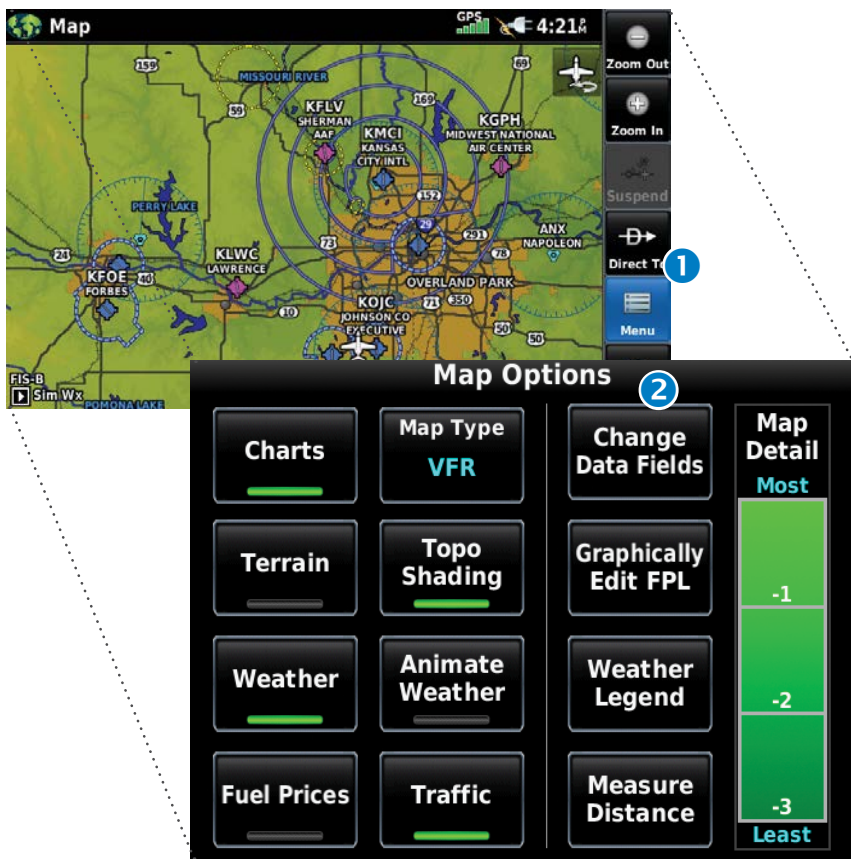

DATA ENTRY

DATA ENTRY ICONS

The following icons are displayed in the data entry window.

	Enter	Exits the keypad function and accepts the changes.
	Backspace	Erases the current data.
	Alpha/Numeric/Symbol	Displays the alpha, numeric, or symbol keypad.
	Cancel	Cancels a value that has been edited.

Entering alphanumeric or symbol data:

- 1 When alphanumeric and/or symbol data can be entered, a keypad will appear after touching the desired datafield.
- 2 Touch **Alpha**, **Numeric**, or **Symbol**
- 3 Touch the keypad letters, numbers, or symbols to enter the desired data.
- 4 Touch **Enter**.



Changing Alpha Keypad Layout:

- 1) From the **Main Menu**, touch **Tools** > **Setup** > **Keyboard**.
- 2) Touch **Landscape Keyboard Format** to toggle between alphabetical and QWERTY layouts.
- 3) Touch **Preview** to view the keypad layout before committing changes.

The setting only affects the keypad while the aera 760 is in landscape mode. While in portrait mode, the aera 760 will only display the keypad in the alphabetical layout.

Entering predetermined data options:

- 1 Touch the Data Option Button to display a vertical list of data options (if applicable), or toggle two data options (i.e., On/Off).
- 2 If using the vertical list, touch the desired data option from the list.

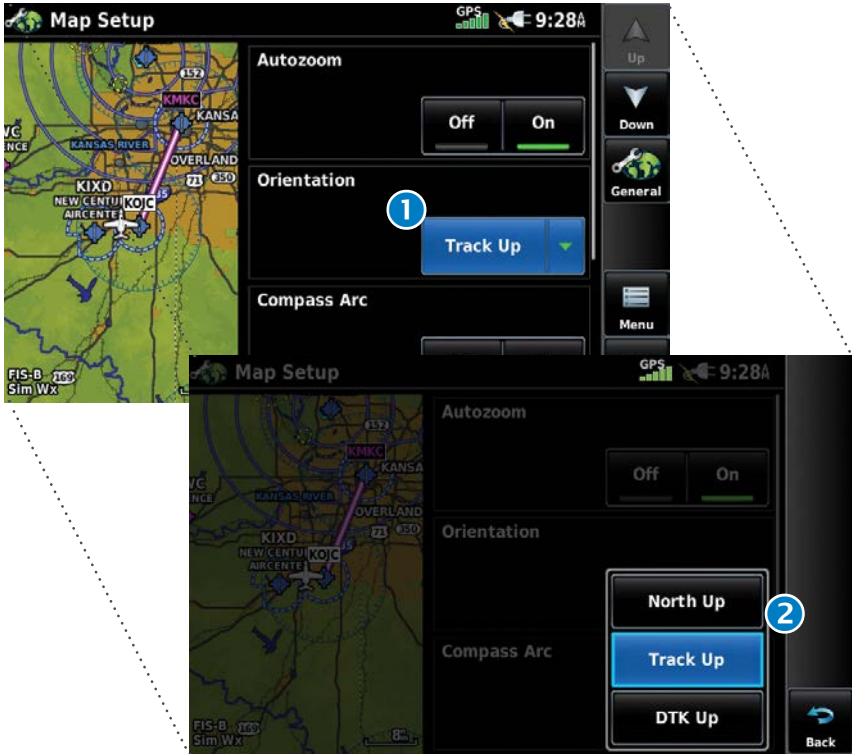

QUICK SETTINGS PAGE

Quickly tap and release the power button to access the Quick Settings page. The Quick Settings page provides access to important usability settings and common functions. The menu bar displays a shortcut to the Nearest page and a shortcut to mark the current position as a User Waypoint. Touching the Back button clears the Quick Settings menu and returns to the previous page.



POWER INFO PAGE

The Power Info page displays the current battery percentage, related messages, and backlighting adjustment. Backlighting affects performance and charging. Touch the '+' and/or '-' buttons to adjust the backlighting.

Displaying the Power Info page:

From the **Main Menu**, touch **Tools** > **Power Info**

Or:

Touch the battery icon on the title bar.

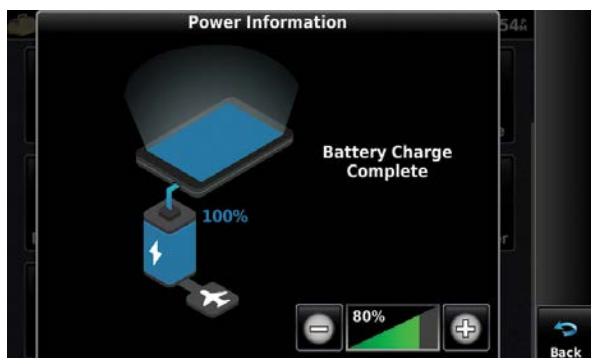

Power Info Page

POWER INFO PAGE MESSAGES

A message icon will flash over the battery icon on the title bar when a Power Info page message exists. In addition to 'Charging Battery' and 'Battery Charge Complete', the following messages may appear:

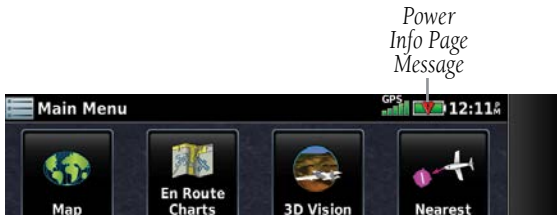

Power Info Page Message

Message	Comments
Charge Voltage Too Low	The voltage is not sufficient to charge the battery. The backlight will automatically be reduced or the user can reduce it manually.
Battery Temperature Too Low	The internal temperature is too low for the battery to be charged. Charging will resume once the temperature is in range.
Battery Temperature Too High	The internal temperature is too high for the battery to be charged. Charging will resume once the temperature is in range.
Charge Time Expired	The charge time exceeded the time expected to completely charge the battery. Power cycle the unit to reset the timer.

TITLE BAR TIMER

The User Timer can be accessed through the title bar from any screen. Touch the time indication to access the User Timer window to start, stop or reset the User Timer. The clock/timer text will appear in cyan while showing the timer, and white while showing the time.

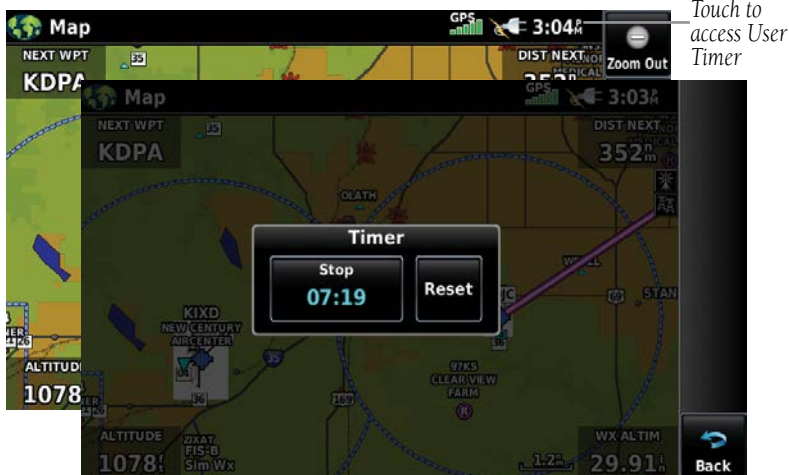

1.5 USING MAP DISPLAYS



NOTE: Refer to the GPS Navigation section for more information on Map Display Setup.

Map displays are used extensively in the aera 760 to provide situational awareness in flight. Most aera 760 maps can display the following information:

- Airports, NAVAIDs, airspaces, airways, land data (highways, cities, lakes, rivers, borders, etc.) with names
- Map Pointer information (distance and bearing to pointer, location of pointer, name, and other pertinent information)
- Map range
- Aircraft icon (representing present position)

- Flight plan legs
- User waypoints
- Track vector
- Topography data

MAP RANGE

There are 23 different map ranges available, from 200 feet to 800 nm. The current map range is indicated in the lower right. The scale bar represents the map scale.

Changing the map range:



Zoom Out (out)



Zoom In (in)

Use the **Zoom Out** (out) or **Zoom In** (in) icons to zoom 'out' (increasing), or zoom 'in' (decreasing).

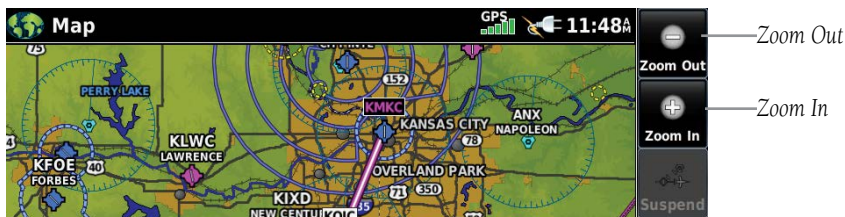

Or:

Pinch fingers together (zoom out), or pull fingers apart (zoom in).

AUTOZOOM

Autozoom allows the aera 760 to change the map display range to the smallest range clearly showing the active waypoint. Autozoom can be overridden by adjusting the range and remains that way until the active waypoint changes, a terrain or traffic alert occurs, or the aircraft takes off.

Enabling/disabling Autozoom:

- 1) From the **Main Menu**, touch **Map** > **Menu** > **Set Up Map**.
- 2) If necessary, touch the **Map Group** Button and touch **General**.

- 3) Touch the 'On/Off' Data Option Button for 'Autozoom'.

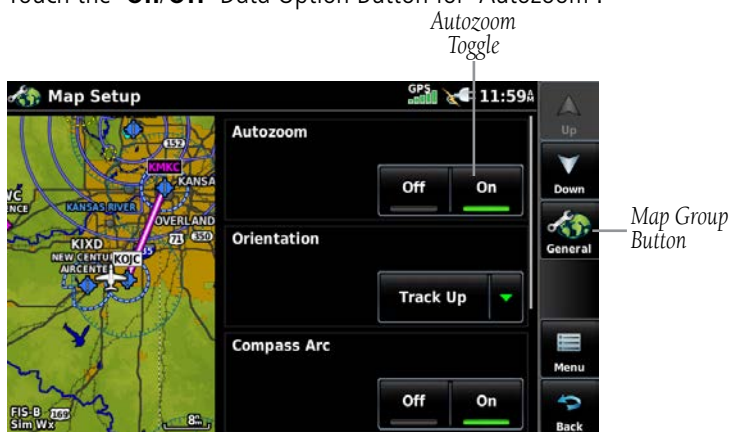

MAP PANNING

Map panning allows the pilot to:

- View parts of the map outside the displayed range without adjusting the map range
- Highlight and select locations on the map
- Review information for a selected airport, NAVAID, or user waypoint
- Designate locations for use in flight planning
- View airspace and airway information

When the panning function is selected by touching anywhere on the Map, the Map Pointer is displayed. An Information Window also appears at the bottom of the map display showing the bearing, distance, and time to the pointer from the aircraft's present position, the elevation of the land at the position of the pointer, or the object's (airports, obstacles, etc.) elevation, if known.

When the Map Pointer is over a map feature, the map feature is highlighted, an information box appears on the map, and the highlighted map feature is displayed on the Map Feature Button (even if the name was not originally displayed on the map).

Touching the **Map Feature** Button displays additional information for the highlighted map feature. If multiple features are present at the Map Pointer position, green arrows will appear on the Map Feature Button. Touching the  will cycle through the list of map features present at that position.

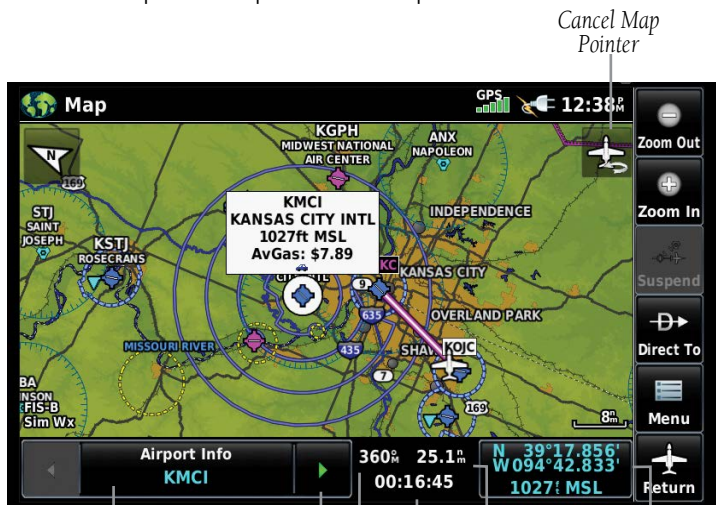

Map Feature Button

Green Arrow Indicating Multiple Features are Present at the Map Pointer Location

Bearing to the Pointer from the Aircraft's Present Position

Time En Route to the Pointer from the Aircraft's Present Position

Distance to the Pointer from the Aircraft's Present Position

Elevation at the Pointer Location

Lat/Lon at the Pointer Location

Map Panning (Navigation Map)

Activating the map pointer:

While viewing a Map Display, touch anywhere on the map to activate the map pointer. Touch the  icon to cancel the map pointer.

Panning the map:

While viewing a Map Display, touch anywhere on the map and drag.

Reviewing information for a map feature:

- 1 While viewing a Map Display, touch anywhere on the map to activate the map pointer. When the Map Pointer is over a map feature, the map feature is highlighted, an information box appears on the map, and the highlighted map feature is displayed on the Map Feature Button. If multiple features are present at the Map Pointer position, green arrows will appear on the Map Feature Button.
- 2 If necessary, touch the buttons to cycle through the list of map features present at that position. Touching the buttons changes the highlight and description.
- 3 Touch the Map Feature Button to review information for the Map Feature.
- 4 If desired, touch **Direct-to** to navigate to the map feature.



MAP OVERLAYS

The VFR, IFR, Terrain, Topography, Weather, Fuel Prices, or Traffic map overlays can be displayed or removed.

Displaying/removing map overlays:

- 1) From the **Main Menu**, touch **Map > Menu**.
- 2) Touch **VFR, IFR, Terrain, Topo Shading, Weather/Animate Weather, Fuel Prices**, or **Traffic** to display or remove the map overlay.

MAP SYMBOLS

Refer to Appendix H for a list of map symbols.

MAP DETAIL

The map can be adjusted to declutter the map.

Adjusting the declutter level of the Navigation Map:

- 1) From the **Main Menu**, touch **Map > Menu**.
- 2) Touch the desired **Map Detail** level (**-1, -2, -3**) on the right side of the screen. The currently selected level is highlighted green.

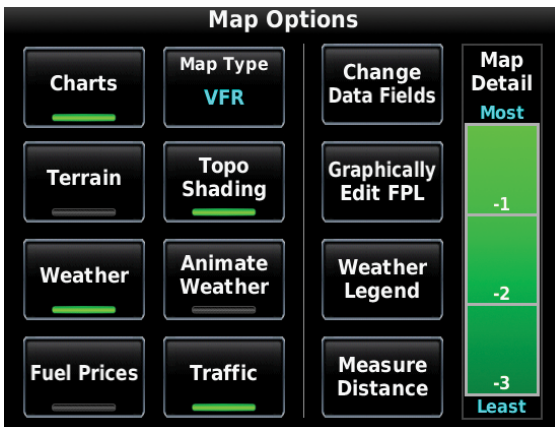

Map Detail

1.6 SYSTEM SETTINGS

The third-level **Setup** Icons allow management of the following system parameters:

- Display
- Sound
- Units
- Time
- Map
- Position
- Interface
- Alarms
- Airspace
- Connex
- Weather
- Bluetooth
- Wi-Fi
- Power
- 3D Vision
- Navigation
- Keyboard

Restoring system setting defaults:

- 1) From the **Main Menu**, touch **Tools** > **Setup**.
- 2) Touch the desired Setup Icon.
- 3) Touch **Menu** > **Restore Default**.

DISPLAY SETUP

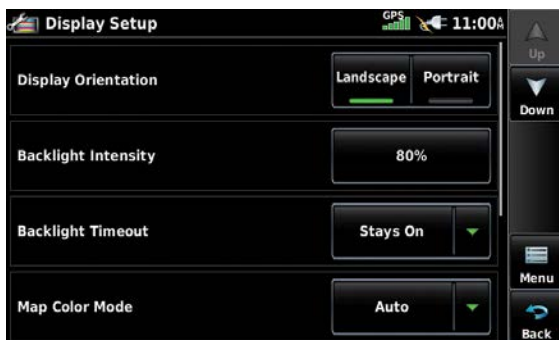

Display Setup

DISPLAY ORIENTATION

The aera 760 can be viewed in either Portrait or Landscape Mode.

Changing the display orientation:

From the **Main Menu**, touch **Tools > Setup > Display**.

Or:

Press the Power Button once quickly.

BACKLIGHT INTENSITY

The aera 760 has two backlight intensity settings, one for day operations and the other for night operations. The appropriate settings will automatically be selected based on the time of day.

Adjusting backlight intensity:

- 1) From the **Main Menu**, touch **Tools > Setup > Display**.
- 2) Select either **Day Backlight Intensity** or **Night Backlight Intensity**.
- 3) Touch '+' or '-' or touch and drag the percentage triangle to adjust the desired backlight intensity percentage.

Or:

Press the  **POWER** Button to quickly access the current backlight intensity.

Also, with Quick Settings displayed, press the  **POWER** Button again to increase the backlight intensity to 100%.

BACKLIGHT TIMEOUT

When running on battery power, after a specified period of inactivity the backlight will turn off to save power.

Adjusting backlight timeout:

- 1) From the **Main Menu**, touch **Tools > Setup > Display**.
- 2) Touch the '**Backlight Timeout**' Data Option Button, and touch the desired option from the list (**Stays On, 15 Seconds, 30 Seconds, 1 Minute, or 2 Minutes**).

MAP COLOR MODE

Adjusting the map color mode:

- 1) From the **Main Menu**, touch **Tools** > **Setup** > **Display**.
- 2) Touch the '**Map Color Mode**' Data Option Button, and touch the desired option from the list (**Day**, **Night**, or **Auto**).

CHART COLOR MODE

Adjusting the chart color mode:

- 1) From the **Main Menu**, touch **Tools** > **Setup** > **Display**.
- 2) Touch the '**Chart Color Mode**' Data Option Button, and touch the desired option from the list (**Auto**, **Day**, or **Night**).

ENABLING SCREENSHOTS

Enabling/disabling screenshots:

- 1) From the **Main Menu**, touch **Tools** > **Setup** > **Display**.
- 2) Touch **On** or **Off** in the 'Screenshot' field. An SD card is required.

AIRCRAFT POSITION

Showing/hiding the aircraft position:

- 1) From the **Main Menu**, touch **Tools** > **Setup** > **Display**.
- 2) Touch **Show** or **Hide** in the 'Aircraft Position' field.

SOUND SETUP



NOTE: The aera 760 does not include an internal speaker. For audio output, connect to an external speaker, headset, or audio panel. Refer to Appendix D.

Sound is broken down into 'Master', 'Alert', and 'Message'. 'Master' controls ALL sound. 'Alerts' and 'Message' are a percentage of the 'Master' sound. 'Alerts' refers to navigation phrases (e.g. "Pull Up"). The Terrain Audio, Traffic Audio, Traffic N/A Alert, and Key Tone can also be enabled or disabled.



Sound Setup

Adjusting the sound:

- 1) From the **Main Menu**, touch **Tools > Setup > Sound**.
- 2) Touch '+' or '-' or touch and drag the percentage triangle to adjust the desired volume percentage.

Or:

Touch the  icon to mute the **Master, Alerts, or Message** audio. A blue 'X' will appear over the icon.

Or:

Touch **Enable** to enable/disable Terrain Audio, Traffic Audio, Traffic N/A Alert, or Key Tone.

Or:

Press the  **POWER** Button to quickly access the **Master** volume/mute.

Muting sound:

See the 'Adjusting the Sound' procedure above.

MAP SETUP

AUTOZOOM

Enabling/disabling autozoom:

- 1) From the **Main Menu**, touch **Tools > Setup > Map**.
- 2) Touch **On** or **Off** in the 'Autozoom' field.

ORIENTATION

Adjusting the map orientation:

- 1) From the **Main Menu**, touch **Tools > Setup > Map**.
- 2) Touch the '**Orientation**' Data Option Button, and touch the desired option from the list (**North Up**, **Track Up**, or **DTK Up**).

COMPASS ARC

Enabling/disabling the compass arc:

- 1) From the **Main Menu**, touch **Tools > Setup > Map**.
- 2) Touch **On** or **Off** in the 'Compass Arc' field.

NORTH UP ABOVE

Setting North Up Above:

- 1) From the **Main Menu**, touch **Tools > Setup > Map**.
- 2) Touch the '**North Up Above**' Data Option Button, and touch the desired mileage.

NORTH UP ON GROUND

Enabling/disabling North Up On Ground:

- 1) From the **Main Menu**, touch **Tools > Setup > Map**.
- 2) Touch **On** or **Off** in the 'North Up On Ground' field.

BLUETOOTH[®] SETUP



NOTE: Only one Bluetooth connection is allowed at a time.

Connecting/Pairing to a weather/traffic device via Bluetooth:

- 1) Ensure the weather/traffic device is turned ON. From the **Main Menu**, touch **Tools > Setup > Bluetooth > On**.
- 2) Touch **Not Paired** or **Not Connected** next to the Device. A Bluetooth Passkey window will open.
- 3) Touch **OK**. The weather/traffic device is now connected.

The Bluetooth Setup Menu provides several options for connecting to Bluetooth devices. **Manage Paired Devices** can enable Automatic Reconnect and remove connections on a per-device basis. **Forget all devices** will remove all Bluetooth connections. **Edit Device Name** is used to change the name the aera 760 shows other devices while pairing. **Restore Default** will disable Bluetooth and remove all Bluetooth connections.

Managing Connected Bluetooth Devices:

From the **Main Menu**, touch **Tools > Setup > Bluetooth > Menu**.

CONNEXT SETUP



NOTE: Connex features require a Bluetooth or RS-232 serial connection to an external Connex device.

Setting the preferred attitude source:

- 1) From the **Main Menu**, touch **Tools > Setup > Connex**.
- 2) Touch the '**Preferred Attitude Source**' Data Option Button, and touch the desired option.

Setting the preferred FIS-B source:

- 1) From the **Main Menu**, touch **Tools > Setup > Connex**.
- 2) Touch the '**Preferred FIS-B Source**' Data Option Button, and touch the desired option.

Setting the preferred SiriusXM weather source:

- 1) From the **Main Menu**, touch **Tools > Setup > Connex**.
- 2) Touch the '**Preferred SiriusXM Weather Source**' Data Option Button, and touch the desired option.

The Connex Setup Menu can also configure how the aera 760 sends and receives flight plans from other Connex devices. Flight plans received from other devices will be added to the aera 760's Flight Plan List.

Setting the incoming/outgoing flight plan mode:

- 1) From the **Main Menu**, touch **Tools > Setup > Connex**.
- 2) Touch the '**Incoming** or **Outgoing Flight Plan Mode**' Data Option Button, and touch the desired option (refer to table below).

	No Transfer	Require Action	Automatic
Incoming Flight Plan Mode	Do not accept flight plans from other devices.	aira 760 will prompt to accept or decline a flight plan sent from another device.	aira 760 will automatically accept flight plans from any connected device.
Outgoing Flight Plan Mode		aira 760 will prompt to confirm sending a flight plan to another device.	aira 760 will send flight plans to other devices with no prompt.

Connex Flight Plan Mode Options

WEATHER SETUP**Changing the weather data source:**

- 1) From the **Main Menu**, touch **Tools > Setup > Weather**.
- 2) Touch the '**Weather Data Source**' Data Option Button, and touch the desired option.

WI-FI SETUP**Connecting to a Wi-Fi network:**

- 1) From the **Main Menu**, touch **Tools > Setup > Wi-Fi > On**.
- 2) Touch **Add Network**.
- 3) Touch the desired network to add.
- 4) If necessary, enter the password using the keypad and touch **Enter**.

Removing a Wi-Fi network:

- 1) From the **Main Menu**, touch **Tools > Setup > Wi-Fi**.
- 2) Touch the network button.
- 3) Touch **Remove**.
- 4) Touch **Yes**.

Turning Wi-Fi off:

- 1) From the **Main Menu**, touch **Tools > Setup > Wi-Fi**.
- 2) Touch **Off**.

3D VISION SETUP

Setting up 3D Vision:

- 1) From the **Main Menu**, touch **Tools > Setup > 3D Vision**.
- 2) Touch the '**Attitude Source**' Data Option Button, and touch the desired option from the list (**Connex** or **Off**).

Or:



CAUTION: Only enable the following panel mount option if the unit is hard-mounted to the panel, perpendicular to the path of flight.

Touch **Menu > Enable Panel Mount**. Touch the '**Attitude Source**' Data Option Button, and touch the desired option from the list (**Connex**, **Internal**, or **Off**)

- 3) Touch the '**Bug Indicator**' Data Option Button, and touch the desired option from the list (**User Selected**, **Bearing**, **Desired Track**, or **Off**).
- 4) Touch the desired settings to display (**Ground Speed**, **Altitude**, **AGL**, **Heading**, **Lateral Deviation**, **Vertical Deviation**, **Vertical Speed**, **Slip/Skid**, **Synthetic Vision** and **Traffic**).
- 5) Touch **On/Off** to enable/disable '**Panning Timeout**'.

NAVIGATION SETUP

Waypoint Transition Mode can be set to 'Auto' or 'Distance'. In 'Auto' mode the unit selects the "best" next waypoint based on the aircraft's present position. 'Distance' mode allows the pilot to enter a radius around the active leg destination so that when the aircraft is within the entered distance, the unit transitions to the next waypoint in the route.

Changing the waypoint transition mode:

- 1) From the **Main Menu**, touch **Tools** > **Setup** > **Navigation**.
- 2) Touch the '**Waypoint Transition Mode**' Data Option Button, and touch the desired option from the list (**Auto** or **Distance**).

KEYBOARD SETUP

Setting up keyboard format:

- 1) From the **Main Menu**, touch **Tools** > **Setup** > **Keyboard**.
- 2) From the '**Keyboard Format**' Data Field, touch **ABCDE** or **QWERTY** to arrange the keyboard in alphabetic or traditional layout.
- 3) Touch **Preview** to inspect keyboard layout.

ADDITIONAL SETTINGS

Changing settings (Units, Time, Position, Interface, Alarms, Airspace, and Power):

- 1) From the **Main Menu**, touch **Tools** > **Setup**.
- 2) Touch the desired Settings Icon (**Units**, **Time**, **Position**, **Interface**, **Alarms**, **Airspace**, or **Power**).
- 3) Touch the desired setting to change. Touch the desired setting from the vertical list (if applicable).
Or: Use the keypad to enter numerical values and touch **Enter** (if applicable).
Or: Touch **On** or **Off** to enable or disable a feature (if applicable).
- 4) Touch and hold the **Back** Icon to return to the **Main Menu**.

1.7 NEAREST AIRPORT CRITERIA SETTINGS

The Nearest Airports Option Menu allows the pilot to filter out airports that do not meet a defined criteria. Specific surface types and runway lengths can be defined, as well as the option to include private airports and/or heliports.

Runway Surface—allows you to set criteria for the type of surface on the runway:

- **Hard Only**—shows only runways with a concrete, asphalt, or similar sealed surface.
- **Hard or Soft**—shows all runways except water landing facilities.
- **Water Only**—shows only water landing facilities.
- **Any**—shows any runway, regardless of surface type, including water landing facilities.

Minimum Runway Length—allows the pilot to enter a specific length for the shortest runway allowed.

Entering airport criteria:

- 1) From the **Main Menu**, touch **Nearest**.
- 2) Touch the Dedicated Nearest Page Icon on the Button Bar and touch **Airport**.
- 3) Touch **Menu**.
- 4) Touch **Surface**, and touch the desired runway surface from the list.
- 5) Touch **Min Length**, and enter the desired Minimum Runway Length using the keypad.
- 6) Touch **Private Airports** to include Private Airports in the search.
- 7) Touch **Heliports** to include Heliports in the search.
- 8) Touch **City Names** or **Facility Names** to display the airport's city or facility name.

1.8 PRESENT POSITION

The Present Position function displays latitude, longitude, GPS altitude, reference waypoint, type, distance, direction, and bearing. The reference waypoint is designed to display the current position in relation to a prominent landmark. The pilot can change the reference waypoint 'Nearest Type' using the 'Change Nearest Type' menu option. By default the Nearest Type is set to 'Automatic', which will display the nearest large airport, enroute VOR, or city (in that order).



Position

Changing the Nearest Type:

- 1) From the **Main Menu**, touch **Tools** > **GPS Info** > **Position Tab** > **Menu** > **Change Nearest Type**.
- 2) Touch the desired nearest type ('Automatic', 'Airport', 'VOR', 'NDB', 'Intersection', 'City', or 'Waypoint').

Viewing the present position:

From the **Main Menu**, touch **Tools** > **GPS Info** > **Position Tab**.

1.9 NEW LOCATION

The 'New Location' menu option is used when the GPS Receiver is having trouble finding the satellites it expects to be there.

Entering a new location:

- 1) From the **Main Menu**, touch **Tools** > **GPS Info** > **GPS Tab** > **Menu** > **New Location**.
- 2) Touch '**Automatic**', '**Use Map**', or '**Use Identifier**'.
- 3) After selecting your approximate position using the map pointer or entering an identifier, touch **OK**.
- 4) The GPS Receiver will begin a new search based on the location entered.

1.10 SIMULATOR MODE

Simulator Mode is helpful for practicing with the unit indoors or when no satellite signals are available. All waypoints and routes created in Simulator Mode are retained in memory for future use.



NOTE: Do not attempt to navigate using Simulator Mode. When the unit is set to Simulator Mode, the GPS/GLONASS receiver is turned off. Any Satellite Signal Strength Bars shown are only simulations and do not represent the strength of actual satellite signals.

Starting/Stopping Simulator Mode:

From the **Main Menu**, touch **Tools** > **GPS Info** > **GPS Tab** > **Menu** > **Simulator**.

Adjusting the simulated altitude, track, speed, waypoint, & position:

- 1) From the **Main Menu**, touch **Tools** > **GPS Info** > **GPS Tab** > **Menu** > **Start Simulator**.
- 2) Touch **Menu** > **Drive Simulator**.
- 3) Touch the fields to enter the desired data using the keypad.

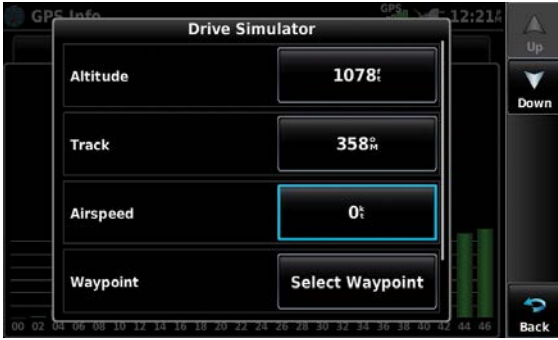

Simulator Mode

SECTION 2 NAVIGATION

2.1 INTRODUCTION

The Navigation Map displays aviation data (e.g., airports, VORs, airways, airspaces), geographic data (e.g., cities, lakes, highways, borders), and topographic data (map shading indicating elevation). The Navigation Map can be oriented three different ways: North Up (NORTH UP), Track Up (TRK UP) or Desired Track Up (DTK UP).

An aircraft icon is placed on the Navigation Map at the location corresponding to the calculated present position. The aircraft position and the flight plan legs are accurately based on GPS/GLONASS calculations. The basemap upon which these are placed are from a source with less resolution, therefore the relative position of the aircraft to map features is not exact. The leg of the active flight plan currently being flown is shown as a magenta line on the Navigation Map. The other legs are shown in white.

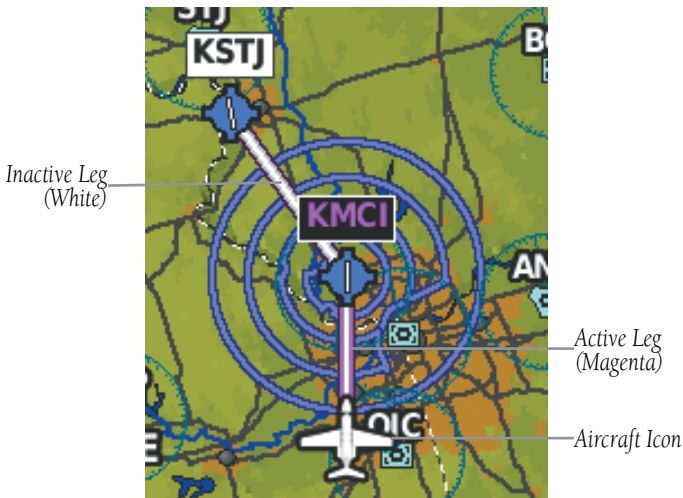

Flight Plan Legs (Navigation Map)

DATA FIELDS

The data fields can be independently configured by the user.

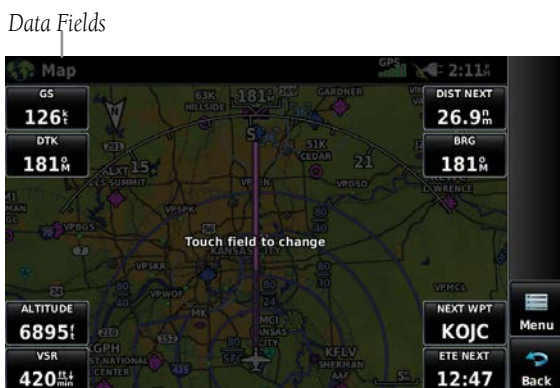

Data Fields (Navigation Map)

By default, the Data Bar Fields are set to display Ground Speed (GS), Distance - Next (DIST NEXT), Vertical Speed Required (VSR), Time En Route - Next (ETE NEXT), and four blank data fields. These eight data fields can be changed to display any of the Data Field Options.

Changing the information shown in the data fields:

- 1) From the **Main Menu**, touch **Map** or **Enroute Charts** > **Menu** > **Change Data Fields**.
- 2) Touch the desired Data Field to change. A list of available Data Field Options is displayed.
- 3) Touch the desired Data Field Option.

DATA FIELD OPTIONS

- Accuracy
- Altitude
- Bearing (BRG)
- Climb Gradient (Alt per NM) (CLIMB/NM)
- Climb Gradient (Percent) (CLIMB GRAD)
- Course to Steer (CTS)
- Crosstrack Error (XTK)
- Desired Track (DTK)
- Distance (Destination) (DIST DEST)
- Distance (Next) (DIST NEXT)
- En Route Safe Altitude (ESA)
- Flight Timer (FLT TIMER)
- Fuel Timer
- Glide Ratio (G/R)
- Ground Speed (GS)
- Ground Track (TRK)
- Height Above Ground Level (AGL)
- Minimum Safe Altitude (MSA)
- Next Waypoint (NEXT WPT)
- Sunrise
- Sunset
- Time Over Target (Next) (TOT NEXT)
- Time En Route (Destination) (ETE DEST)
- Time En Route (Next) (ETE NEXT)
- Time of Arrival (Destination) (ETA DEST)
- Time of Arrival (NEXT) (ETA NEXT)
- Time to VNAV (VNAV TIME)
- Time (Local)
- Time (UTC)
- Vertical Speed (VS)
- Vertical Speed Required (VSR)
- Wx (Altimeter) (WX ALTIM)
- Wx (Dew Point) (WX DEW PT)
- Wx (Humidity) (WX HUMIDITY)
- Wx (Temp) (WX TEMP)
- Wx (Wind) (WX WIND)

COMPASS ARC

A compass arc appears by default on the Navigation Map. The magenta bug indicator (similar to the bug indicator on the HSI) can be set by touching **TRK** on the 3D Vision Page.

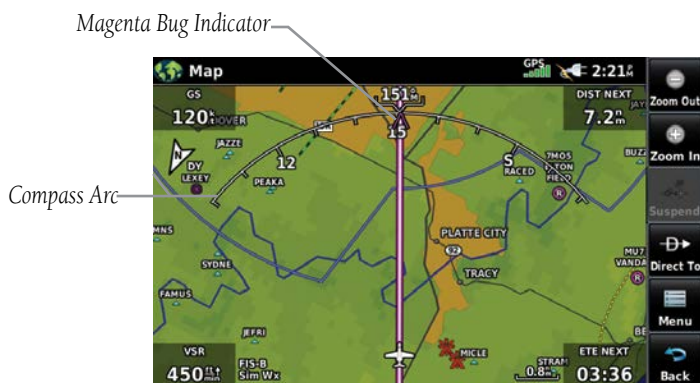

Compass Arc (Navigation Map)

Displaying/Removing the Compass Arc on the Navigation Map:

- 1) From the **Main Menu**, touch **Map** > **Menu** > **Set Up**.
- 2) Touch the Dedicated Page Icon on the Button Bar, and touch **General**.
- 3) Touch **On** or **Off** to display or remove the Compass Arc.

2.2 3D VISION

3D Vision provides a three-dimensional view of terrain features as seen from outside the aircraft. 3D Vision imagery shows the relevant features in relation to the aircraft.



WARNING: Use appropriate systems for navigation, and for terrain, obstacle, and traffic avoidance. 3D Vision does not provide either the accuracy or reliability upon which to base decisions and/or plan maneuvers to avoid terrain, obstacles, or traffic.

3D Vision is a visual enhancement to the aera 760. 3D Vision depicts the topography as seen from outside the aircraft. The depicted imagery is derived from the aircraft's three-dimensional position, and databases of terrain, obstacles, and other relevant features. Loss of the GPS signal, will cause 3D Vision to be disabled until it is restored.

The 3D Vision terrain display shows land contours (colors are consistent with those of the topographical map display), large water features, towers, and other obstacles over 200' AGL that are included in the obstacle database (if present). Cultural features on the ground such as roads, highways, railroad tracks, cities, and state boundaries are not displayed even if those features are found on the Navigation Map. The terrain display also includes a north-south east-west grid with lines oriented with true north.

Terrain is integrated within 3D Vision to provide visual and auditory alerts to indicate the presence of terrain and obstacle threats relevant to the projected flight path. Terrain alerts are displayed in red and yellow shading.

3D Vision does not provide the accuracy or fidelity on which to base decisions and plan maneuvers to avoid terrain or obstacles. Navigation should not be predicated upon the use of the terrain or obstacle data displayed by 3D Vision.

Touch and drag the three-dimensional view to change the perspective.



3D Vision (Tapes)



3D Vision (Round Gauges)



3D Vision (HSI Navigation)

3D VISION OPERATION

3D Vision is accessed from the **Main Menu**.

Viewing 3D Vision:

From the **Main Menu**, touch **3D Vision**.

Display instrument tapes or round gauges:

From the **Main Menu**, touch **3D Vision > Menu > Tapes** or **Round Gauges**.

Changing the Bearing Pointers:

- 1) From the **Main Menu**, touch **3D Vision > Menu**.
- 2) Touch a '**Bearing Pointer**' Data Option Button, and touch the desired option from the list (**Off**, **GPS**, or **Nearest Airport**).

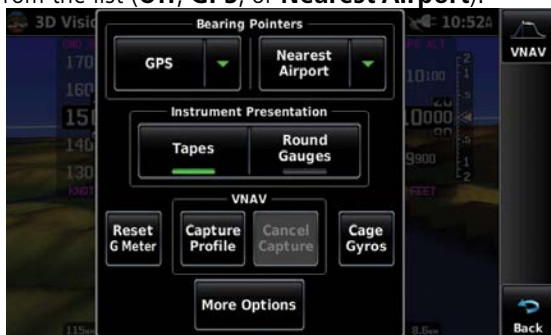

3D Vision Menu

HORIZONTAL SITUATION INDICATOR (HSI)

The graphic HSI displays current course, course (or crosstrack) error, To/From indication, course pointer, bearing desired track, and course deviation indicator/scale only when navigation is active (flight plan or direct-to); current ground track is always displayed. The rotating compass indicates the aircraft's current ground track.

The course pointer and course deviation needle indicate the current course and how closely the aircraft is following it. The Bug Indicator can be set to 'Bearing', 'Desired Track', a specific heading reference ('User Selected'), or 'Off' (default).

Bearing is the compass direction from the present position to a destination waypoint. Desired Track is the recommended direction to steer in order to reduce cross-track error and return to the course line.

The Course Deviation Indicator, or needle, indicates the aircraft's distance off course, left or right, based on its placement along the course deviation scale.

Manually selecting 0.25 nm, 1.25 nm, or 5.00 nm full-scale deflection overrides Auto CDI selection. The manually-selected CDI scale setting remains active until conditions are met for Auto CDI (below), at which time Auto CDI resumes. The active course deviation scale (either automatically- or manually-selected) displays on the upper right portion of the HSI. The default CDI scale setting is Auto CDI (not user-selectable), which is selected when applying power to the system. Auto CDI uses three factors to determine the distance from the center of the CDI to full left or right limits:

- CDI scale = 1.25 - within 30 nm of any airport in the active route.
- CDI scale = 0.25 - on an approach leg or within 2 nm of the FAF or MAP.
- CDI scale = 5.0 - if the previous two conditions are not met.

CHANGING THE CDI SCALE

Changing the CDI scale:

- 1) From the **Main Menu**, touch **3D Vision** > **Menu** > **More Options**.
- 2) Touch the '**CDI Scale**' Data Option Button, and touch the desired option from the list (**0.25 nm**, **1.25 nm**, or **5.00 nm**).

SETTING THE BUG INDICATOR

The Bug Indicator can be set from the 3D Vision option menu.

Setting the 3D Vision Bug Indicator:

- 1) From the **Main Menu**, touch **3D Vision** > **Menu** > **More Options**.
- 2) Touch the '**Bug Indicator**' Data Option Button, and touch the desired option from the list (**User Selected**, **Bearing**, **Desired Track**, or **Off**).

MANUALLY SETTING A COURSE (ONLY AVAILABLE WITH ACTIVE NAVIGATION)

Touch '**CRS**' on the 3D Vision Page to manually set a course to the destination.

Manually setting a course to the destination waypoint:

- 1) From the **Main Menu**, touch **3D Vision**.
- 2) Touch **CRS**.
- 3) Touch **YES** when the 'Set OBS and hold?' window appears.
- 4) Select a course using the keypad and touch **Enter**.

Returning to only automatic sequencing when route is active (only available when navigating a Direct-To or Flight Plan):

- 1) From the **Main Menu**, touch **3D Vision**.
- 2) Touch **CRS**.
- 3) Touch **Release OBS Hold** returns **OBS** to **CRS**, even though no sequencing occurred (only when Direct-To is active). 3D Vision Setup

3D Vision Settings:

- 1) From the **Main Menu**, touch **Tools > Setup > 3D Vision**.
- 2) Touch the '**Attitude Source**' Data Option Button, and touch the desired option from the list (**Connext** or **Off**).

Or:



CAUTION: Only enable the following panel mount option if the unit is hard-mounted to the panel, perpendicular to the path of flight.

Touch **Menu > Enable Panel Mount**. Touch the '**Attitude Source**' Data Option Button, and touch the desired option from the list (**Connext**, **Internal**, or **Off**)

- 3) Touch the '**Bug Indicator**' Data Option Button, and touch the desired option from the list (**User Selected**, **Bearing**, **Desired Track**, or **Off**).
- 4) Touch the desired settings to display (**Ground Speed**, **Altitude**, **AGL**, **Heading**, **Lateral Deviation**, **Vertical Deviation**, **Vertical Speed**, **Slip/Skid**, **Synthetic Vision** and **Traffic**).
- 5) Touch **On/Off** to enable/disable '**Panning Timeout**'.

2.3 VERTICAL NAVIGATION (VNAV)



NOTE: Vertical Navigation should only be used while conducting VFR operations.

The VNAV function provides settings for the vertical navigation. These settings create a three-dimensional profile from the present location and altitude to a final (target) altitude at a specified location.

When the VNAV profile is defined, the pilot is informed of the progress by message alerts. The teal bar on the HSI (when displayed) shows the VNAV profile.

The Vertical Navigation feature is only available when navigating a Direct To or flight plan, and the ground speed is greater than 35 knots.

The VNAV indicator is displayed and the 'Estimated Time to VNAV' (VNAV TIME) field goes blank one minute prior to the initial descent point; if the VNAV alert messages are enabled, the 'Approaching VNAV profile' message appears.

The 'Approaching VNAV profile' message appears one minute prior to the initial descent point. The descent angle locks to prevent changes in speed from altering the profile. The VNAV feature does not take into account any changes in groundspeed that occur during the transition from level flight to descent or climb.

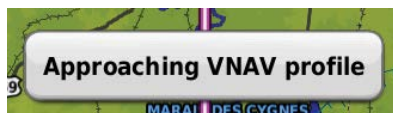

At 500 ft above the target altitude, the VNAV indicator disappears from the altimeter; if the VNAV alert messages are enabled, the 'Approaching VNAV target altitude' message is displayed.



CAUTION: The aera 760 is a VFR navigation tool and should not be used to perform instrument approaches.



CAUTION: VNAV is only a VFR navigation aid and is not intended for instrument approaches.

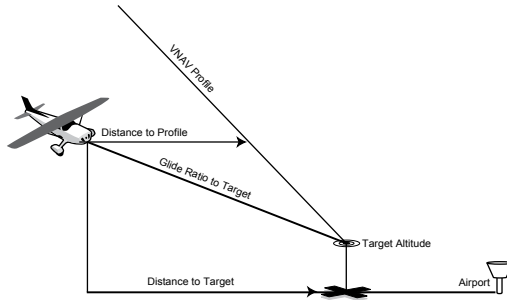

Visual Representation of VNAV

USING THE VNAV FEATURE

Use the VNAV (Vertical Navigation) feature to ensure the aircraft is at the proper altitude. When the appropriate conditions for VNAV are met, the VNAV Indicator displays as a teal pointer next to the altimeter. When the VNAV alert messages are enabled, a message appears when approaching the VNAV Profile. When the teal pointer is in the vertical center of the altimeter, the aircraft is at the proper altitude for the VNAV Profile.



VNAV Indicator (3D Vision)

Capturing/cancelling VNAV profile:

- 1) While navigating a Direct-To or Flight Plan, and wishing to capture (or cancel) the current descent profile, select from the **Main Menu**, touch **3D Vision > Menu**.
- 2) Touch **Capture Profile** or **Cancel Capture**.

Configuring a VNAV profile:



NOTE: Some waypoints such as intersections do not have an altitude in the database and thus only the VNAV altitude in MSL (not Above Waypoint) may be specified for these waypoints.

- 1) From the **Main Menu**, touch **Tools > VNAV**.
- 2) From the **3D Vision** page, select **Menu > VNAV**.
- 3) Touch the desired fields ('**Waypoint**', '**Profile**', '**Altitude**', etc.) to enter the VNAV profile.
- 4) Touch and hold the **Back** Icon to return to the **Main Menu**.



Vertical Navigation Configuration

- **Waypoint**—Enter any waypoint along the currently active route as the reference waypoint. The reference waypoint defines the target location.
- **Profile**—Enter the descent rate.
- **Altitude**—Enter the desired reference waypoint altitude. Select 'Above Waypoint' to use field elevation for airports in the navigation database or 'MSL' to specify an exact MSL altitude target.
- **By**—Enter the target location with settings of distance 'Before' or 'After' a reference waypoint. To set a target location at a reference waypoint, enter a distance of zero.
- **VNAV Messages**—Touch 'On' or 'Off' to enable/disable VNAV alert messages.

2.4 MAP DISPLAY SETUP

Map displays are used extensively in the aera 760 to provide situational awareness in flight. Most aera 760 maps can display the following information:

- Airports, NAVAIDs, airspaces, airways, land data (highways, cities, lakes, rivers, borders, etc.) with names
- Map Pointer information (distance and bearing to pointer, location of pointer, name, and other pertinent information)
- Map range
- Aircraft icon (representing present position)
- Flight plan legs
- User waypoints
- Track vector
- Topography data

MAP ORIENTATION

Maps are shown in one of three different orientation options, allowing flexibility in determining aircraft position relative to other items on the map (North Up), or for determining where map items are relative to where the aircraft is going (Track Up), or desired track up (DTK UP)).

- North Up aligns the top of the map display to north (default setting).
- Track Up aligns the top of the map display to the current ground track.
- Desired Track (DTK) Up aligns the top of the map display to the desired course.



NOTE: *Map orientation can only be changed from the Navigation Map Option Menu. All other maps (except weather maps) that show navigation data reflect the orientation selected for the Navigation Map.*

Adjusting the map orientation:

- 1) From the **Main Menu**, touch **Map > Menu > Set Up**.
- 2) If necessary, touch the Dedicated Page Icon on the Button Bar, and touch the **General** Group.
- 3) Touch the '**Orientation**' Data Option Button, and touch the desired option from the list (**North Up**, **Track Up**, or **DTK Up**).

AIRPORTS, NAVAIDS, CITIES & ROADS

Setting up and customizing airports, NAVAIDs, cities & roads for the Navigation Map:

- 1) From the **Main Menu**, touch **Map > Menu > Set Up**.
- 2) Touch the Dedicated Page Icon on the Button Bar, and touch the '**Airport**', '**Navaid**', '**City**', or '**Road**' Group.
- 3) Touch  to select the desired settings.



Map Setup (Cities)

Dedicated Page Icon on the Button Bar

AIRWAYS

Low Altitude Airways (or Victor Airways) primarily serve smaller piston-engine, propeller-driven airplanes on shorter routes and at lower altitudes. Airways are eight nautical miles wide and start 1,200 feet above ground level (AGL) and extend up to but not including 18,000 feet mean sea level (MSL). Low Altitude Airways are designated with a "V" before the airway number (hence the name "Victor Airways") since they run primarily between VORs.

High Altitude Airways (or Jet Routes) primarily serve airliners, jets, turboprops, and turbocharged piston aircraft operating above 18,000 feet MSL. Jet Routes start at 18,000 feet MSL and extend upward to 45,000 feet MSL (altitudes above 18,000 feet are called "flight levels" and are described as FL450 for 45,000 feet MSL). Jet Routes are designated with a "J" before the route number.

Low Altitude Airways are drawn in gray. High Altitude Airways are drawn in green. When both types of airways are displayed, high altitude airways are drawn on top of Low Altitude Airways.

When airways are selected for display on the map, the airway waypoints (VORs, NDBs and Intersections) are also displayed.

Displaying/removing airways:

- 1) From the **Main Menu**, touch **Map > Menu > Set Up**.
- 2) If necessary, touch the Dedicated Page Icon on the Button Bar, and touch the **Navaid** Group.
- 3) Touch the '**Airways**' Data Option Button, and touch the desired option from the list ('**Off**', '**Low**', '**High**', or '**Both**').

2.5 WAYPOINTS

The WPT INFO (Waypoint Information) function provides airport and waypoint information.

Waypoints are predetermined geographical positions (internal database) or pilot-entered positions, and are used for all phases of flight planning and navigation.

Waypoints can be selected by entering the ICAO identifier, entering the name of the facility, or by entering the city name. As a waypoint identifier, facility name, or location is entered, the aera 760's Spell'N'Find™ feature scrolls through the database, displaying those waypoints matching the characters which have been entered up to that point. A direct-to navigation leg to the selected waypoint can be initiated by pressing the **►** Icon.

The waypoint function allows the pilot to review airport information, runway information, frequencies, AOPA information (if available), weather information (if available), and charts by touching the desired tab. The pilot can manually enter the identifier or the aera 760 will choose the most appropriate identifier based on the current position and phase of flight.



Waypoint Information (Info Tab)

The following descriptions and abbreviations are used:

- Usage type: Public, Military, or Private
- Runway surface type: Hard, Turf, Sealed, Gravel, Dirt, Soft, Unknown, or Water
- Runway lighting type: No Lights, Part Time, Full Time, Unknown, or PCL Freq (for pilot-controlled lighting)
- COM Availability: TX (transmit only), RX (receive only), PT (part time), * (additional information available)

Selecting an airport for review by identifier, facility name, or city:

- 1) From the **Main Menu**, touch **Waypoint** > **Info Tab** (if necessary).
- 2) Touch the Waypoint Identifier Button.
- 3) Enter the desired waypoint using the keypad and touch **Enter**.

Or:

- a) Touch **Find**.
- b) Touch the **Search Name** or **Search City Tab**.
- c) Touch the **Search by Facility Name** or **Search by City** button.
- d) Enter the facility name or city using the keypad and touch **Enter**.

Or:

- a) Touch **Find**.
 - b) Touch the **Recent, Nearest Airports, Flight Plan, or User** Tab.
 - c) Touch the desired waypoint from the list.
- 4) If duplicate entries exist for the entered facility name or location, duplicate waypoints are displayed. Touch the desired waypoint from the list.

Selecting a runway:

- 1) From the **Main Menu**, touch **Waypoint > Runway** Tab (if necessary).
- 2) Touch the Waypoint Identifier Button.
- 3) Enter the desired waypoint using the keypad and touch **Enter**.

Or:

- a) Touch **Find**.
- b) Touch the **Search Name** or **Search City** Tab.
- c) Touch the **Search by Facility Name** or **Search by City** button.
- d) Enter the facility name or city using the keypad and touch **Enter**.

Or:

- a) Touch **Find**.
 - b) Touch the **Recent, Nearest Airports, Flight Plan, or User** Tab.
 - c) Touch the desired waypoint from the list.
- 4) If duplicate entries exist for the entered facility name or location, duplicate waypoints are displayed. Touch the desired waypoint from the list.
- 5) If multiple runways exist, touch the Runway Button, and touch the desired runway from the vertical list.

-Length/Width
 -Surface
 -Lighting
 -Traffic Pattern

Waypoint Identifier Button

Wind vectors are displayed as headwind and crosswind components. The runway with the best headwind is displayed in green.



Runway Tab
 Option Menu

Waypoint Information (Runway Tab)

Selecting additional information for a frequency:

- 1) From the **Main Menu**, touch **Waypoint** > **Freq** Tab (if necessary).
- 2) Touch .



Waypoint Information (Freq Tab)

The Frequencies Box uses the descriptions and abbreviations listed in the following table:

Communication Frequencies			Navigation Frequencies
Approach *	Control	Pre-Taxi	ILS
Arrival *	CTA *	Radar	LOC
ASOS	Departure *	Ramp	
ATIS	Gate	Terminal*	
AWOS	Ground	TMA *	
Center	Helicopter	Tower	
Class B *	Multicom	TRSA *	
Class C *	Other	Unicom	
Clearance			
* May include Additional Information			

Frequency Abbreviations

NEAREST INFORMATION

The aera 760 provides a Nearest function which gives the pilot quick access to nearest airport, weather, VOR, NDB, intersection, user waypoint, city, ARTCC, FSS, and airspace information. If there are none available, "None Within 200 NM" is displayed.

The Nearest functions contain the following information.

- Airport—identifier, bearing, distance, length of the longest runway, and common traffic advisory (CTAF) or tower frequency.
- Airport WX (Airport Weather)—identifier, bearing, distance, METAR text, and ATIS, AWOS, or ASOS frequency.
- VOR (VHF Omnidirectional Radio Beacon)—identifier, facility type (symbol), bearing, distance, and frequency.
- NDB (Non Directional Beacons)—identifier, facility, type (symbol), bearing, distance, and frequency.
- Intersection—identifier, bearing, and distance.
- VRP (Visual Reporting Point) (Atlantic Unit Only)—identifier, bearing, and distance.

- USR WPT (User Waypoints)—name, bearing, and distance.
- City—name, bearing, and distance.
- ARTCC (Air Route Traffic Control Center)—bearing, distance, and frequency.
- FSS (Flight Service Station)—name, bearing, distance, frequency, and VOR (if applicable).
- Airspace—name, time to entry (when applicable), and status.

Viewing nearest information:

- 1) From the **Main Menu**, touch **Nearest**.
- 2) Touch the Dedicated Page Icon on the Button Bar, and touch the desired Nearest Icon (**Airport**, **Apt WX**, **VOR**, **NDB**, **INT**, **User WPT**, **City**, **ARTCC**, **FSS**, or **Airspace**).
- 3) Touch the desired nearest option from the list for additional information.

Or:

If viewing Nearest ARTCCs or FSSs, touch **Multiple Freqs...** to view additional frequencies.

- 4) Touch the **Back** Icon to return to the previous page.



Nearest VORs List



Additional VOR Information

NEAREST AIRPORT CRITERIA

The pilot can define the minimum runway length and surface type used when determining the 15 nearest airports to display. A minimum runway length and/or surface type can be entered to prevent airports with small runways or runways that are not appropriately surfaced from being displayed. Default settings are 0 feet (or meters) for runway length and "Any" for runway surface type. Private airports and Heliports can also be included.

The Nearest Airports Option Menu also allows the pilot to choose between displaying the facility names, city names, bearing, or direction arrows.

Setting nearest airport criteria:

Refer to Section 1.7 'Airport Criteria Settings'.

WEATHER AND NOTAM INFORMATION (OPTIONAL)

Textual weather and NOTAM information can be viewed several different ways.

Viewing airport weather/NOTAM information:

- 1) From the **Main Menu**, touch **Waypoint**.
- 2) Enter the desired waypoint identifier.
- 3) Touch the **Weather** or **NOTAM** Tab.

Or:

- 1) From the **Main Menu**, touch **Nearest**.
- 2) Touch the Dedicated Page Icon on the Button Bar, and touch **Apt WX**.
- 3) Touch the desired Nearest Airport Weather from the list.

Or:

- 1) From the **Main Menu**, touch **Weather**.
- 2) Touch **Products**, and touch **METAR**.
- 3) Touch the desired METAR flag.
- 4) Touch the Map Feature Button with the desired identifier displayed (refer to 'Map Panning' in the Overview Section for more information). The weather information is displayed.

Or:

- 1) From the **Main Menu**, touch **Map**.
- 2) Touch the desired METAR Flag (If the METAR flags are not displayed, adjust the settings from the **Set Up > Weather** menu option).
- 3) Touch the Map Feature Button with the desired identifier displayed (refer to 'Map Panning' in the Overview Section for more information). The weather information is displayed.

METAR Selected



Map Feature Button



Weather Information

ACCESSING ADDITIONAL INFORMATION

In addition to airport and weather information, additional information for VORs, NDBs, Intersections, User Waypoints, Cities, ARTCCs, FSSs, and Airspace can be viewed using the Waypoint Information function, the Nearest function, or the Map Panning function.

Additional Information									
	Airport	VOR	NDB	Intersection	User Wpt	City	ARTCC	FSS	Airspace
Identifier	+	+	+	+	+				
Frequency	+	+	+				+	+	+
Name	+	+	+	+	+				+
City	+	+	+			+			+
State	+	+	+			+			
Type	+	+	+						
Morse Code		+	+						
Radial		+							
Region	+	+	+	+	+				
Bearing	+	+	+	+	+	+	+	+	
Distance	+	+	+	+	+	+	+	+	+

Additional Information									
Lat/Long	+	+	+	+	+	+			
Elevation (MSL)	+					+			
Fuel Available	+								
Time Zone (UTC Offset)	+								
Runway Information	+								
AOPA	+								
Weather	+								
Controlling Agency									+
Vertical Boundaries									+
Class									+

INTERSECTIONS

Intersection information can be viewed using the Waypoint Information function, the Nearest function, or the Map Panning function.

The Nearest Intersection function can be used to quickly find an intersection close to the flight path. The list only includes Intersections that are within 200nm. If there are no Intersections within the range, text indicating that there are no nearest intersections is displayed.

Selecting an intersection:

- 1) From the **Main Menu**, touch **Waypoint**.
- 2) Touch the Waypoint Identifier Field to begin entering the desired intersection. Refer to the Overview Section on 'Data Entry' for more information.

Or:

- 1) From the **Main Menu**, touch **Nearest**.
- 2) Touch the Dedicated Page Icon on the Button Bar, and touch **INT**.
- 3) Touch the desired intersection from the list.

Or:

- 1) From the **Main Menu**, touch **Map**.
- 2) Touch the desired Intersection on the map.

- 3) Touch the Map Feature Button with the desired intersection displayed (refer to the Overview Section on 'Map Panning' for more information). The intersection information is displayed.

NDBs

NDB information can be viewed using the Waypoint Information function, the Nearest function, or the Map Panning function.

The Nearest NDB function can be used to quickly find a NDB close to the flight path. The list only includes NDBs that are within 200nm. If there are no NDBs in the list, text indicating that there are no nearest NDBs is displayed.

Selecting an NDB:

- 1) From the **Main Menu**, touch **Waypoint**.
- 2) Touch the Waypoint Identifier Field to begin entering the desired NDB. Refer to the Overview Section on 'Data Entry' for more information.

Or:

- 1) From the **Main Menu**, touch **Nearest**.
- 2) Touch the Dedicated Page Icon on the Button Bar, and touch **NDB**.
- 3) Touch the desired NDB from the list.

Or:

- 1) From the **Main Menu**, touch **Map**.
- 2) Touch the desired NDB on the map.
- 3) Touch the Map Feature Button with the desired NDB displayed (refer to the Overview Section on 'Map Panning' for more information). The intersection information is displayed.

VORs

VOR information can be viewed using the Waypoint Information function, the Nearest function, or the Map Panning function.

The Nearest VOR function can be used to quickly find a VOR close to the flight path. The list only includes VORs that are within 200nm. If there are no VORs in the list, text indicating that there are no nearest VORs is displayed.

Localizer information cannot be viewed for the VOR. If a VOR station is combined with a TACAN station it is listed as a VORTAC, and if it includes only DME it is displayed as VOR-DME.

Selecting a VOR:

- 1) From the **Main Menu**, touch **Waypoint**.
- 2) Touch the Waypoint Identifier Field to begin entering the desired VOR. Refer to the Overview Section on 'Data Entry' for more information.

Or:

- 1) From the **Main Menu**, touch **Nearest**.
- 2) Touch the Dedicated Page Icon on the Button Bar, and touch **VOR**.
- 3) Touch the desired VOR from the list.

Or:

- 1) From the **Main Menu**, touch **Map**.
- 2) Touch the desired VOR on the map.
- 3) Touch the Map Feature Button with the desired VOR displayed (refer to the Overview Section on 'Map Panning' for more information). The intersection information is displayed.

USER WAYPOINTS

The aera 760 can create and store up to 3,000 user-defined waypoints. Once a waypoint has been created, it can be renamed, deleted, or moved.

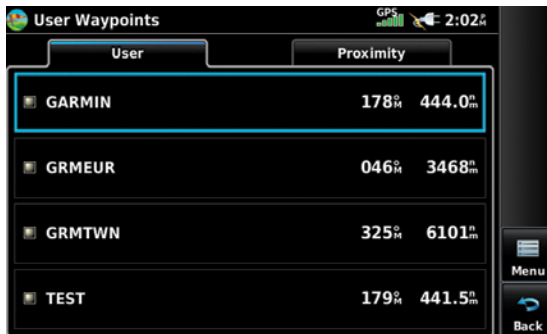

User Waypoints

Creating user waypoints:

- 1) To create a new user waypoint at the current location or using the Map Pointer:
 - a) From the **Main Menu**, touch **Tools > User Waypoints > Menu**.
 - b) Touch **Create Waypoint**.

Or:

 - a) With a map displayed, touch an empty area without any map features.
 - b) Touch the Map Feature Button.
 - c) Touch **Save**.

Or:

 - a) From the **Main Menu**, touch **Tools > GPS Info > Position Tab > Menu**.
 - b) Touch **Mark Waypoint**.
- 2) Enter the desired user waypoint name (up to 10 characters) and touch **Enter**. Refer to the Overview Section on 'Data Entry' for more information.
- 3) If changing the User Waypoint settings (symbol, altitude, location, or reference waypoints) continue with Step 4.
- 4) If desired, touch the **Symbol** Field to change the symbol that will appear on the map.
 - a) Touch the desired symbol.
 - b) Touch **OK**.



User Waypoint Symbols

- 5) If desired, touch the **Altitude** Field
 - a) Enter the desired altitude using the keypad or the +/- buttons. Refer to the Overview Section on 'Data Entry' for more information.
 - b) Touch **Enter**.

- 6) If desired, touch the **Location** Field.
 - a) Touch the arrows to move the blue cursor and use the keypad to enter the desired latitude and longitude.
 - b) Touch **Enter**.



User Waypoint Location

- 7) If desired, touch the **Menu** Icon and touch 'Reference Waypoints' to enter a bearing and distance from another waypoint or the bearing from two other waypoints to define a new waypoint location.
 - a) Touch the **Waypoint Field(s)** to enter the desired waypoint.
 - b) Touch the **Bearing** and/or **Distance** Fields to enter the desired values.
 - c) Touch **OK**.



Reference Waypoints

Selecting and viewing nearest user waypoints:

- 1) From the **Main Menu**, touch **Nearest**.
- 2) Touch the Dedicated Page Icon on the Button Bar, and touch **User WPT**.
- 3) Touch the desired User Waypoint. The User Waypoint information is displayed.

Editing or renaming a user waypoint:

- 1) From the **Main Menu**, touch **Tools** > **User Waypoints** > **User** Tab.
- 2) Touch the desired User Waypoint. The option menu automatically displays.
- 3) Touch **Edit Waypoint**.
- 4) Touch the desired field to edit:
 - a) Touch the **Name** Button.
 - b) Enter the desired user waypoint name (up to 10 characters). Refer to the Overview Section on 'Data Entry' for more information.

Or:

 - a) Touch the **Symbol** Button.
 - b) Touch the desired symbol.

Or:

 - a) Touch the **Altitude** Button.
 - b) Enter the desired altitude. Refer to the Overview Section on 'Data Entry' for more information.

Or:

 - a) Touch the **Location** Button.
 - b) Enter the desired latitude and longitude by touching the left/right arrows to move the cursor, and the up/down arrows to change the value.
- 5) Touch **Enter**.

Deleting user waypoints:

- 1) From the **Main Menu**, touch **Tools** > **User Waypoints** > **User** Tab.
- 2) Delete a single waypoint, delete all waypoints, delete by symbol or delete by distance:
 - a) Touch the desired User Waypoint. The option menu automatically displays
 - b) Touch the '**Delete Waypoint**' menu option. The confirmation window will appear.

Or:

 - a) Touch the **Menu** Icon.
 - b) Touch the '**Delete All**' menu option. The confirmation window will appear.

Or:

- a) Touch the **Menu** Icon.
- b) Touch the '**Delete by Symbol**' menu option.
- c) Touch the desired symbol to delete. The symbol will be highlighted blue.
- d) Touch the **OK** icon. The confirmation window will appear.

Or:

- a) Touch the **Menu** Icon.
- b) Touch the '**Delete by Distance**' menu option.
- c) If desired, touch the **From** Field and touch '**Current Location**' (default), '**Use Identifier**', or '**Use Map**' from the option menu.
- d) If desired, touch the '**Less Than/More Than**' Button, and touch the **Distance** Field to enter the desired distance.
- e) Touch the **OK** icon. The confirmation window will appear.

- 3) Touch **Yes**.

CITIES

City information can be viewed using the Waypoint Information function, the Nearest function, or the Map Panning function.

The Nearest City function can be used to quickly find a city close to the flight path. The list only includes cities that are within 200nm. If there are no cities in the list, text indicating that there are no nearest cities is displayed.

Select a city:

- 1) From the **Main Menu**, touch **Waypoint** > **Info** Tab.
- 2) Touch the Waypoint Identifier Field.
- 3) Touch **Find** > **Search City** Tab > **Search by City**.
- 4) Enter the desired city using the keypad and touch **Enter**. Refer to the Overview Section on 'Data Entry' for more information.

Or:

- 1) From the **Main Menu**, touch **Nearest**.
- 2) Touch the Dedicated Page Icon on the Button Bar, and touch **City**.

- 3) Touch the desired Nearest City from the list.

Or:

- 1) From the **Main Menu**, touch **Map**.
- 2) Touch the desired city symbol on the map.
- 3) Touch the Map Feature Button with the desired city displayed (refer to the Overview Section on 'Map Panning' for more information). The city information is displayed.

ARTCC

ARTCC information can be viewed using the Nearest function.

The Nearest ARTCC function can be used to quickly find a ARTCC close to the flight path. The list only includes ARTCC that are within 200nm. If there are no ARTCCs in the list, text indicating that there are no nearest ARTCCs is displayed.

Select an ARTCC:

- 1) From the **Main Menu**, touch **Nearest**.
- 2) Touch the Dedicated Page Icon on the Button Bar, and touch **ARTCC**.

FSS

FSS information can be viewed using the Nearest function.

The Nearest FSS function can be used to quickly find a FSS close to the flight path. The list only includes FSS that are within 200nm. If there are no FSSs in the list, text indicating that there are no nearest FSSs is displayed.

Select an FSS:

- 1) From the **Main Menu**, touch **Nearest**.
- 2) Touch the Dedicated Page Icon on the Button Bar, and touch **FSS**.

AIRSPACE

The Nearest Airspace function and Airspace Alerts provide information about airspaces and the location of the aircraft in relationship to them. The Nearest Airspace function can be used to quickly find airspaces close to the flight path.

The Nearest Airspace function displays the class of airspace, controlling agency, vertical boundaries, and status.

Selecting and viewing nearest airspaces:

- 1) From the **Main Menu**, touch **Nearest**.
- 2) Touch the Dedicated Page Icon on the Button Bar, and touch **Airspace**.
- 3) Touch the desired airspace from the list. The airspace information is displayed.
- 4) If desired, touch '**Frequencies**' to view frequencies associated with that airspace.



Nearest Airspace

AIRSPACE ALERT MESSAGES

If airspace alarms are set to 'On' (default is 'Off'), the aera 760 will display a message which includes the airspace name, time to entry (if applicable), and status. Touch the message to acknowledge it.

There are four types of status information:

- Ahead—Projected to enter the airspace within the next 10 minutes or less
- Near—Within two nautical miles of an airspace but not projected to enter it.
- Near & Ahead—Project to enter the airspace within two nautical miles.
- Inside Airspace—Within the boundaries of the airspace.

Airspace alert setup:

- 1) From the **Main Menu**, touch **Tools > Setup > Airspace**.
- 2) Touch the desired **On/Off** Button(s).



Airspace Alert Message

SMART AIRSPACE™

Smart Airspace shows airspace at and immediately surrounding the aircraft's current altitude in bold. Airspaces at all other altitudes are de-emphasized.

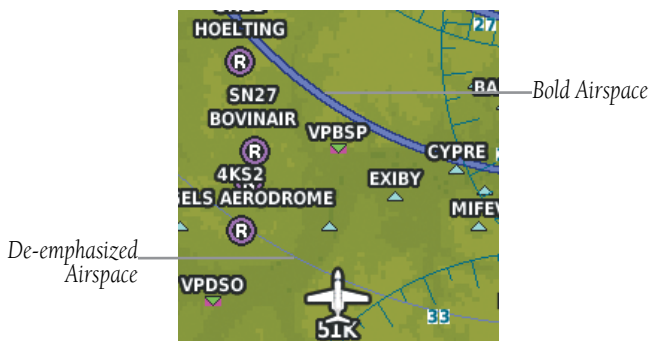

Smart Airspace™

Smart Airspace setup:



NOTE: Smart Airspace selection is not available if the Map Type is set to 'IFR' instead of 'VFR' since IFR flights do not have the same operational concerns with airspace.

- 1) From the **Main Menu**, touch **Map > Menu > Set Up**.
- 2) Touch the Dedicated Page Icon on the Button Bar, and touch **Airspace**.
- 3) Touch the 'Smart Airspace' **On/Off** Button.

AIRSPACE ALTITUDE LABELS

Airspace labels are displayed on any airspace visible on the Navigation Map, worldwide. With Smart Airspace configured, the labels are deemphasized when appropriate. Range visibility and label size are configured under the 'Airspace' Map Setup Menu.

Airspace altitude label setup:

- 1) From the **Main Menu**, touch **Map > Menu > Set Up**.
- 2) Touch the Dedicated Page Icon on the Button Bar, and touch **Airspace**.
- 3) Touch the **Down** Button to view the **Altitude Labels** configuration options.
- 4) Select the desired range visibility and/or text size.

Airspace
Altitude
Label

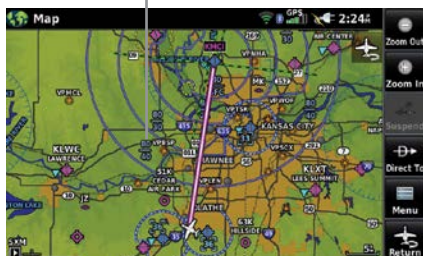

Airspace Altitude Labels (Map Page)



Airspace Altitude Labels (Map Setup Page)

2.6 DIRECT-TO NAVIGATION

The Direct-to method of navigation, initiated by pressing the **Direct To** Icon is quicker to use than a flight plan when the desire is to navigate to a single point such as a nearby airport.

The **Direct To** Icon is available on the Button Bar.

Once a direct-to is activated, the aera 760 establishes a point-to-point course line from the present position to the selected direct-to destination. Course guidance is provided until the direct-to is replaced with a new direct-to or flight plan, or cancelled.



Direct To

Entering a direct-to destination:

- 1) When available, touch the **Direct To** **➤** Icon.
- 2) Touch the **Flight Plan**, **Nearest**, or **Recent** Tab.
- 3) Touch the desired waypoint.
- 4) Touch **Activate**.

Or:

- 1) When available, touch the **Direct To** **➤** Icon.
- 2) From the **Waypoint** Tab, touch **Select Waypoint**.
- 3) Enter a waypoint identifier using the keypad and touch **Enter**.

Or:

- a) Touch **Find**.
- b) Touch the **Recent**, **Nearest Airports**, **Flight Plan**, or **User Tab**.

c) Touch the desired waypoint.

Or:

a) Touch **Find**.

b) Touch the **Search Name** Tab.

c) Touch **Search by Facility Name**.

d) Enter the desired Facility Name using the keypad.

e) Touch **Enter**.

Or:

a) Touch **Find**.

b) Touch the **Search City** Tab.

c) Touch **Search by City**.

d) Enter the desired City using the keypad.

e) Touch **Enter**.

4) Touch **Activate**.

Entering a direct-to and hold:

1) Using the above procedure, enter the desired waypoint to hold at.

2) Touch **Hold**. The Hold At Waypoint window is displayed.

3) Touch the **Course** button to enter the desired inbound or outbound course using the keypad and touch **Enter**.

4) Touch the **Direction** button to toggle between **Inbound** or **Outbound** for the course direction.

5) Touch the **Leg Type** button to toggle between **Time** or **Distance** for the leg type.

6) Touch the **Turn** button to toggle between **Right Turn** or **Left Turn** for the turn direction.

7) Touch the **Leg Time/Leg Distance** button to enter the time/distance using the arrow buttons (time) or keypad (distance) and touch **Enter**.

8) Touch the **EFC** (Expect Further Clearance) **Time** button to enter the EFC time using the arrow buttons and touch **Enter**.

9) Touch the **Load** button to add the hold to the flight plan.

10) Touch **Activate Hold**.

Selecting a nearby airport as a direct-to destination:

- 1) From the **Main Menu**, touch **Nearest**.
- 2) Touch the Dedicated Page Icon on the Button Bar, and touch **Airport**.
- 3) Touch the desired nearest airport.
- 4) Touch **Direct To** .
- 5) Touch **Activate**.

Selecting a waypoint as a direct-to destination using the pointer:

- 1) With a map displayed, activate the map pointer by touching the desired waypoint. If no airport, NAVAID, or User Waypoint exists at the desired location, a temporary waypoint named 'Map Pointer' is automatically created at the location of the map pointer.
- 2) Touch **Direct** .
- 3) Touch **Activate**.

Canceling a direct-to:

- 1) While navigating a Direct To Flight Plan, touch the **Direct To**  icon.
- 2) Touch **Stop Navigation**.

SECTION 3 FLIGHT PLANNING

3.1 INTRODUCTION

Flight planning on the aera 760 consists of building a flight plan by entering waypoints one at a time and inserting approaches as needed. The flight plan is displayed on maps using different line widths, colors, and types, based on the type of leg and the segment of the flight plan currently being flown.

Up to 50 flight plans with up to 300 waypoints each can be created and stored in memory. One flight plan can be activated at a time and becomes the active flight plan. The active flight plan is erased when the destination is reached and the system is turned off. When storing flight plans with an approach, the aera 760 uses the waypoint information from the current database to define the waypoints. If the database is changed or updated, the aera 760 automatically updates the information if the procedure has not been modified. If an approach is no longer available, the procedure is deleted from the affected stored flight plan(s), and an alert is displayed.

DATA FIELDS

The Active and Saved Flight Plan Data Fields can be changed by touching the Data Field Buttons at the top of the flight plan.

Changing the information shown in the flight plan data fields:

- 1) From the **Main Menu**, touch **Active Flight Plan**.
Or:
 - a) From the **Main Menu**, touch **Flight Plan List**.
 - b) Touch the desired Saved Flight Plan from the list. An option menu appears.
 - c) Touch **Edit**.
- 2) Touch the desired Data Field Button at the top of the Flight Plan.
- 3) Touch to select the desired Data Field from the list. The currently selected Data Field is outlined blue.
- 4) If desired, repeat Steps 2-3 for the remaining Data Fields.

Data Field Button



Flight Plan Data Fields

3.2 FLIGHT PLAN CREATION

The active flight plan is the flight plan to which the aera 760 is currently providing guidance, and is shown on the navigation maps. Stored flight plans are flight plans available for activation (becomes the active flight plan).

Data Fields



Active Flight Plan

Creating an active flight plan:

- 1) From the **Main Menu**, touch **Active Flight Plan**.
- 2) Touch **Add Waypoint**.
- 3) Enter a waypoint identifier using the keypad and touch **Enter**.

Or:

- a) Touch **Find**.
- b) Touch the **Recent, Nearest Airports, Flight Plan, or User** Tab.
- c) Touch the desired waypoint.

Or:

- a) Touch **Find**.
- b) Touch the **Search Name** Tab.
- c) Touch **Search by Facility Name**.
- d) Enter the desired Facility Name using the keypad.
- e) Touch **Enter**.

Or:

- a) Touch **Find**.
- b) Touch the **Search City** Tab.
- c) Touch **Search by City**.
- d) Enter the desired City using the keypad.
- e) Touch **Enter**.

- 4) If duplicate entries exist for the entered facility name or location, duplicate waypoints are displayed. Touch the desired waypoint from the list.
- 5) Repeat Steps 2-4 to enter each additional waypoint.

Creating a stored flight plan:

- 1) From the **Main Menu**, touch **Flight Plan List > Menu > New Flight Plan**.
- 2) Touch **Add Waypoint**.
- 3) Enter a waypoint identifier using the keypad and touch **Enter**.

Or:

- a) Touch **Find**.
- b) Touch the **Recent, Nearest Airports, Flight Plan, or User** Tab.
- c) Touch the desired waypoint.

Or:

- a) Touch **Find**.
- b) Touch the **Search Name** Tab.
- c) Touch **Search by Facility Name**.
- d) Enter the desired Facility Name using the keypad.
- e) Touch **Enter**.

Or:

- a) Touch **Find**.
 - b) Touch the **Search City** Tab.
 - c) Touch **Search by City**.
 - d) Enter the desired City using the keypad.
 - e) Touch **Enter**.
- 4) If duplicate entries exist for the entered facility name or location, duplicate waypoints are displayed. Touch the desired waypoint from the list.
 - 5) Repeat Steps 2-4 to enter each additional waypoint.

ADDING WAYPOINTS TO AN EXISTING FLIGHT PLAN

Waypoints can be added to the active flight plan or any stored flight plan. Choose the flight plan, select the desired point of insertion, enter the waypoint, and it is added in front of the selected waypoint. Flight plans are limited to 300 waypoints (including approach waypoints).

Adding a waypoint to an active or stored flight plan:

- 1) With an active or saved flight plan displayed, touch the desired point of insertion. An option menu will appear.
- 2) Touch **Insert Before** or **Insert After**.
- 3) Enter a waypoint identifier using the keypad and touch **Enter**.

Or:

- a) Touch **Find**.
- b) Touch the **Recent, Nearest Airports, Flight Plan, or User** Tab.
- c) Touch the desired waypoint.

Or:

- a) Touch **Find**.
 - b) Touch the **Search Name** Tab.
 - c) Touch **Search by Facility Name**.
 - d) Enter the desired Facility Name using the keypad.
 - e) Touch **Enter**.
- Or:**
- a) Touch **Find**.
 - b) Touch the **Search City** Tab.
 - c) Touch **Search by City**.
 - d) Enter the desired City using the keypad.
 - e) Touch **Enter**.
- 4) If duplicate entries exist for the entered facility name or location, duplicate waypoints are displayed. Touch the desired waypoint from the list.

AIRWAYS

Airways may be added as legs in flight plans with any waypoint that is part of an airway, such as a VOR.

to the flight plan:

- 1) With an active or saved flight plan displayed, touch the desired waypoint that is part of an airway. An options menu will appear.
- 2) Touch **Load Airway**. The Load Airway window is displayed.
- 3) Touch the **Airway** button to display a list of airways the waypoint is a part of.
- 4) Touch the **Exit** button to display a list of exit waypoints which are part of the selected airway.
- 5) If desired, touch **Sort Alpha** to sort the list alphabetically.
- 6) Touch the desired exit waypoint from the list.
- 7) Touch **Load**.

Touch the waypoint that is part of an airway



Touch Load Airway



Touch to choose the desired airway

Touch to choose the desired exit point

Touch to add the airway to the flight plan

Adding an Airway to a Flight Plan

After loading the airway, it is inserted into the flight plan. The airway waypoints are displayed below the **Airway** button in the flight plan.

Airway Button: Touch to edit or remove the airway



Touch Menu > Collapse Airways to show/hide the list of waypoints along the airway



Airway Loaded - Active Flight Plan Page and Map Page

Show/hide the list of waypoints along an airway in the flight plan:

- 1) After an airway has been added to the flight plan, touch **Menu > Collapse Airways** to hide the list of waypoints along the airway.
- 2) Touch **Menu > Collapse Airways** again to show the list of waypoints along the airway.

Editing an airway in the flight plan:

- 1) After an airway has been added to the flight plan, touch the Airway button.

- 2) Touch **Select Airway** from the menu to edit the airway and/or exit point.

Removing an airway from the flight plan:

- 1) After an airway has been added to the flight plan, touch the Airway button.
- 2) Touch **Remove Airway**.

HOLDING PATTERNS

Holding patterns may be added to existing waypoints within the flight plan.

Adding a holding pattern to the flight plan:

- 1) With an active or saved flight plan displayed, touch the desired waypoint to hold at. An option menu will appear.
- 2) Touch **Hold At Waypoint**. The Hold At Waypoint window is displayed.
- 3) Touch the **Course** button to enter the desired inbound or outbound course using the keypad and touch **Enter**.
- 4) Touch the **Direction** button to toggle between **Inbound** or **Outbound** for the course direction.
- 5) Touch the **Leg Type** button to toggle between **Time** or **Distance** for the leg type.
- 6) Touch the **Turn** button to toggle between **Right Turn** or **Left Turn** for the turn direction.
- 7) Touch the **Leg Time/Leg Distance** button to enter the time/distance using the arrow buttons (time) or keypad (distance) and touch **Enter**.
- 8) Touch the **EFC** (Expect Further Clearance) **Time** button to enter the EFC time using the arrow buttons and touch **Enter**.
- 9) Touch the **Load Hold** button to add the hold to the flight plan.

Touch the waypoint to add a hold at that waypoint



Touch Hold At Waypoint

Touch each button to update course, direction, leg type/time, turn direction, and EFC time



Touch to load hold to the flight plan

Adding a Hold to a Flight Plan

Activating, editing, exiting, or removing a holding pattern:

- 1) After a hold has been added to the flight plan, touch the Hold button. The Hold Options menu is displayed.
- 2) Touch **Activate Hold** to activate the holding pattern.

Or:

Touch **Edit Hold** to display the Hold At Waypoint window and make changes to the hold.

Or:

Touch **Exit Hold** to exit the holding pattern.

Or:

Touch **Remove Hold** to remove the holding pattern from the flight plan.

Hold Button: Touch to display Hold Options menu

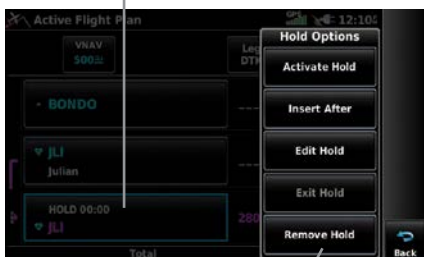

Touch a hold option to activate, edit, exit, or remove a hold



Hold East of JLI, right turns

Hold Loaded - Active Flight Plan Page and Map Page

TRANSFERRING FLIGHT PLANS USING CONNEXT

The aera 760 can share flight plans with other devices using Connex, such as other Garmin portables, panel mount navigators, and the Garmin Pilot app on iPad and Android tablets. Once paired over Bluetooth, the user can decide how flight plans are shared between devices. From the **Main Menu**, go to **Tools > Setup > Connex** to configure the aera 760's flight plan sharing behavior.

Incoming Flight Plan Mode	No Transfer	Ignore received flight plans
	Require Action	Display a popup to confirm receiving a flight plan
	Automatic	Automatically update active flight plan with changes from other devices
Outgoing Flight Plan Mode	Require Action	Only send flight plans from Active Flight Plan page
	Automatic	Automatically send active flight plan to connected devices as it updates

In the case that aera 760 didn't receive a flight plan update when expected to, the aera can request the most recent flight plan from the connected equipment. To pull an active flight plan from the connected equipment, go to **Main Menu > Active Flight Plan > Connex > Load FPL**.



Pulling Flight Plan From Connected Device

All flight plan transfers will send or update the aera 760's active flight plan, unless a Direct-to destination is active. While navigating to a Direct-to destination, the aera 760 will send flight plan updates as long as Outgoing Flight Plan Mode is set to Require Action or Automatic. Note the aera 760 can send Direct-to destinations to other portable devices and the Garmin Pilot app; Direct-to destinations can't be sent to panel-mount navigators over Connex.

When receiving Direct-to destinations, the aera 760 will use the Incoming Flight Plan Mode setting. Require Action will update only the Direct To page, but not start navigation. Automatic will automatically receive the destination and start direct-to navigation.



Receiving a Flight Plan While Set to Require Action

3.3 FLIGHT PLAN STORAGE

The aera 760 can store up to 50 flight plans. The active flight plan is erased when another flight plan is activated. Details about each stored flight plan can be viewed using the Flight Plan List function.

Viewing information about a stored flight plan:

- 1) From the **Main Menu**, touch **Flight Plan List**.
- 2) Touch the desired saved flight plan. An option menu is displayed.
- 3) Touch **Edit**.



Flight Plan List

Storing an active flight plan:

- 1) With the Active Flight Plan displayed, touch **Menu**.
- 2) Touch **Save Copy**. A confirmation window appears.
- 3) Touch **Yes**. A copy of the flight plan is stored in the next available position in the Flight Plan List.

3.4 FLIGHT PLAN ACTIVATION

Activating a stored flight plan erases the active flight plan and replaces it with a copy of the flight plan being activated. Inverting a stored flight plan reverses the waypoint order, erases the active flight plan, and replaces it with the flight plan being activated (the stored flight plan is not changed).

Activating a stored flight plan:

- 1) From the **Main Menu**, touch **Flight Plan List**.
- 2) Touch the desired saved flight plan. An option menu is displayed.
- 3) Touch **Activate**. A confirmation window appears.
- 4) Touch **Yes**.

Activating a Flight Plan Leg:

- 1) From the **Main Menu**, touch **Active Flight Plan**.
- 2) While navigating an active flight plan, touch the desired leg to be activated. An option menu automatically appears.
- 3) Touch **Activate Leg**.
- 4) Touch **Yes**.

EDITING SPEED AND FUEL FLOW

Adjusting the Flight Plan cruise speed and fuel flow:

- 1) From the **Main Menu**, touch **Flight Plan List**.
- 2) Touch the desired saved flight plan. An option menu is displayed.
- 3) Touch **Edit**.
- 4) Touch **Plan Fuel** and/or **Plan Spd** Fields to enter the desired value using the keypad and touch **Enter**.

Or:

- 1) From the **Main Menu**, touch **Active Flight Plan**.
- 2) Touch **Plan Fuel** and/or **Plan Spd** Fields to enter the desired value using the keypad and touch **Enter**.

If **Plan Fuel** or **Plan Spd** aren't present in the Active Flight Plan page, it's necessary to change the page's data fields to show fuel and speed related variables. Selecting Cumulative Fuel or Leg Fuel data fields will show the **Plan Fuel** value. Selecting Cumulative ETE, Cumulative Fuel, Estimated Time of Arrival, Leg ETE, or Leg Fuel data fields will show the **Plan Spd** value.

Editing these values in the Flight Plan List or Active Flight Plan pages will apply to flight plans until the aera 760 unit is powered off. In order to edit these values permanently, go to **Main Menu > Tools > Profile**.

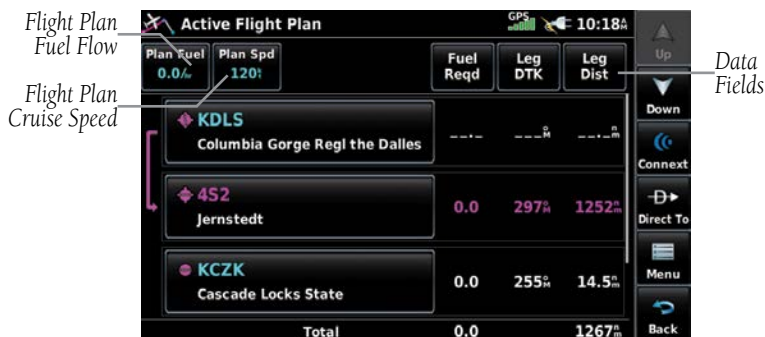

Flight Plan Fuel Flow and Cruise Speed on Active Flight Plan Page

COPYING FLIGHT PLANS

The aera 760 allows copying a flight plan into a new flight plan memory slot, allowing editing, etc., without affecting the original flight plan. This can be used to duplicate an existing stored flight plan for use in creating a modified version of the original stored flight plan.

Copying a stored flight plan:

- 1) From the **Main Menu**, touch **Flight Plan List** and touch the desired Flight Plan.
- 2) Touch **Copy > Yes**.

DELETING FLIGHT PLANS

Individual or all stored flight plans can be deleted from the aera 760 memory.

Deleting a stored flight plan:

- 1) From the **Main Menu**, touch **Flight Plan List** and touch the desired Flight Plan.
- 2) Touch **Delete > Yes**.

Deleting all stored flight plans:

From the **Main Menu**, touch **Flight Plan List > Menu > Delete All > Yes**.



NOTE: The changes made to the active flight plan affect navigation as soon as they are entered. Editing the active flight plan does not affect any saved flight plans. Waypoints in the final approach segment (such as the FAF or MAP) can not be deleted individually.

Deleting the Active Flight Plan:

From the **Main Menu**, touch **Active Flight Plan > Menu > Stop Navigation**.

Deleting an individual waypoint from the active flight plan:

- 1) From the **Main Menu**, touch **Active Flight Plan**.
- 2) While navigating an active flight plan, touch the waypoint to be deleted. An option menu appears.
- 3) Touch **Remove > Yes**.

Deleting an individual waypoint from a saved flight plan:

- 1) From the **Main Menu**, touch **Flight Plan List**.
- 2) Touch the desired saved flight plan. An option menu is displayed.
- 3) Touch **Edit**.
- 4) Touch the desired waypoint to be deleted. An option menu appears.
- 5) Touch **Remove > Yes**.

INVERTING A FLIGHT PLAN

Any flight plan may be inverted (reversed) for navigation back to the original departure point. All procedures will be removed from the flight plan after inverting.

Inverting the active flight plan:

From the **Main Menu**, touch **Active Flight Plan > Menu > Invert > Yes**.

3.5 PROCEDURES



NOTE: With the exception of *Chartered Visual Flight Procedures (CVFPs)*, visual approaches do not have associated approach charts.



NOTE: The *atera 760* provides lateral guidance for visual and GPS/RNAV approaches. The moving map pages can also be used as an aid to situational awareness for ILS, VOR, and NDB approaches (and non-precision localizer-based approaches), but an appropriate radio navigational aid **MUST** be used for primary approach course guidance for non-GPS approaches.

The *atera 760* supports non-precision and precision approaches to airports with published instrument approach procedures. The *atera 760* can also provide visual approach guidance to most airports. Approach procedures are not the same as the approach plates available in ChartView or FliteCharts, which are separate databases.



Procedures are available from the **Menu** on the Active Flight Plan or New Flight Plan Page.

DEPARTURE PROCEDURES

A Departure Procedure (DP) is loaded at the departure airport in the flight plan. Only one departure can be loaded at a time in a flight plan. If a departure is loaded when another departure is already in the active flight plan, the new departure replaces the previous departure. The route is defined by selection of a departure, the transition waypoint, and a runway.

LOADING A DEPARTURE

Loading a departure from the active or saved flight plan:

- 1) With the flight plan displayed, touch **Menu**.
- 2) Touch **Select Departure**.
- 3) Confirm the intended airport is displayed or touch the Airport Button, select the desired airport, and touch **Enter**.
- 4) Touch  to select the desired departure.
- 5) Touch  to select the desired runway.
- 6) Touch  to select the desired transition waypoint.
- 7) Touch **Load Departure**.



Loading a Departure Procedure

REMOVING A DEPARTURE

Removing a loaded departure from the active or saved flight plan:

- 1) From the Flight Plan with the loaded departure, touch the Departure Button.
- 2) Touch **Remove Departure**.

CHANGING A DEPARTURE

Changing a loaded departure from the active or saved flight plan:

- 1) From the Flight Plan with the loaded departure, touch the Departure Button.
- 2) Touch **Select Departure**. The Select Departure Page is displayed.
- 3) Select the desired departure, runway, and transition waypoint.
- 4) Touch **Load Departure**.

Departure Button: Touch to display Departure Options menu

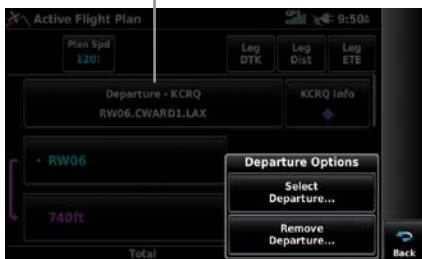

Touch a departure option to edit or remove a departure



Departure procedure



Departure Procedure Loaded - Active Flight Plan Page and Map Page

ARRIVAL PROCEDURES

A Standard Terminal Arrival (STAR) can be loaded at any airport with a published arrival procedure. Only one arrival can be loaded at a time in a flight plan. If an arrival is loaded when another arrival is already in the active flight plan, the new arrival replaces the previous arrival. The route is defined by selection of an arrival, the transition waypoint, and a runway.

LOADING AN ARRIVAL

Loading an arrival from the active or saved flight plan:

- 1) With the flight plan displayed, touch **Menu**.
- 2) Touch **Select Arrival**.
- 3) Confirm the intended airport is displayed or touch the Airport Button, select the desired airport, and touch **Enter**.
- 4) Touch  to select the desired arrival.
- 5) Touch  to select the desired transition waypoint.
- 6) Touch  to select the desired runway if necessary.
- 7) Touch **Load Arrival**.

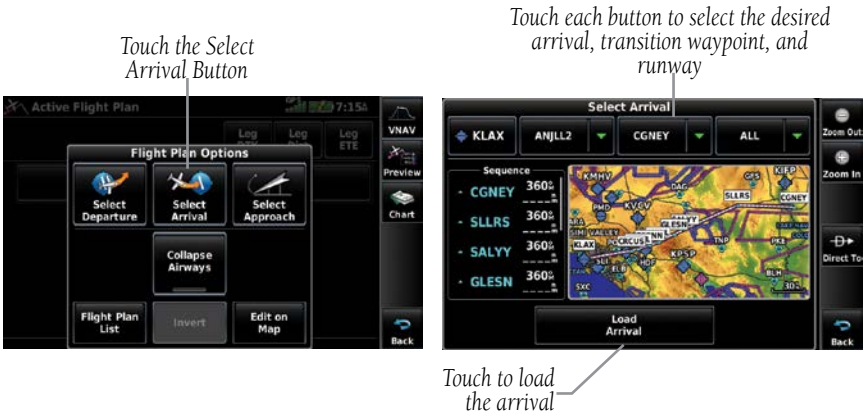

Loading a Arrival Procedure

Overview

Navigation

Flight Planning

Hazard Avoidance

Additional Features

Appendices

Index

REMOVING AN ARRIVAL

Removing a loaded arrival from the active or saved flight plan:

- 1) From the Flight Plan with the loaded arrival, touch the Arrival Button.
- 2) Touch **Remove Arrival**.

CHANGING AN ARRIVAL

Changing a loaded arrival from the active or saved flight plan:

- 1) From the Flight Plan with the loaded arrival, touch the Arrival Button.
- 2) Touch **Select Arrival**. The Select Arrival Page is displayed.
- 3) Select the desired arrival, transition waypoint, and runway.
- 4) Touch **Load Arrival**.

*Arrival Button: Touch to display
Arrival Options menu*

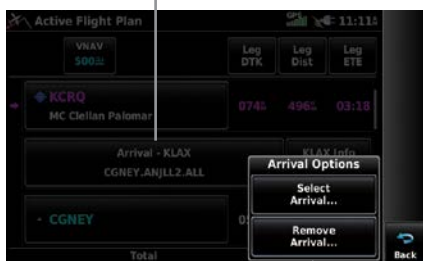

*Touch an arrival option to edit
or remove an arrival*

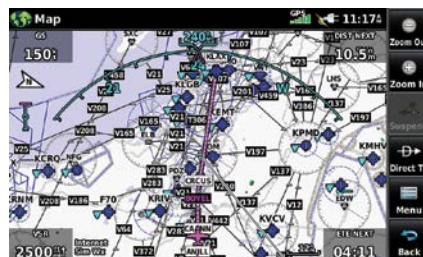

*Arrival
procedure*



Arrival Procedure Loaded - Active Flight Plan Page and Map Page

APPROACH PROCEDURES

Only one approach can be loaded at a time in a flight plan. If an approach is loaded when another approach is already in the active flight plan, the new approach replaces the previous approach. The route is defined by selection of an approach and the transition waypoint.

SELECTING AN APPROACH

Selecting an approach from the active or saved flight plan:

- 1) With the flight plan displayed, touch **Menu**.
- 2) Touch **Select Approach**.
- 3) Confirm the intended airport is displayed or touch the Airport Button, select the desired airport, and touch **Enter**.
- 4) Touch  to select the desired approach. Selections are listed according to approach type: instrument first, visual second.
- 5) Touch  to select the desired transition waypoint or **Vectors**.
- 6) Touch **Load Approach**. The Active Flight Plan Page will be displayed. The approach waypoints are placed at the end of the flight plan and the unit will automatically sequence to them after the en route waypoints.

Or:

Touch **Activate Approach**. Activating the approach makes the active leg Direct-To the selected transition waypoint, or for Vector approaches to activate a leg that is an extended final approach course. You can also "activate" the approach from the Flight Plan by touching the Approach Button > **Menu** > **Activate Approach**, if the approach is not activated on this page.

Touch the Select Approach Button

Touch each button to select the desired approach and transition waypoint/vectors



Touch to load or activate the approach

Selecting an Approach

Selecting an approach using the Direct To function:

- 1) Touch the **Direct To** icon.
- 2) Touch the **Menu** icon.
- 3) Touch **Select Approach** (only available when navigating a flight plan).
- 4) Confirm the intended airport is displayed or touch the Airport Button, select the desired airport, and touch **Enter**.
- 5) Touch to select the desired approach. Selections are listed according to approach type: instrument first, visual second.
- 6) Touch to select the desired transition waypoint or **Vectors**.
- 7) Touch **Load Approach**. The Active Flight Plan Page will be displayed. The approach waypoints are placed at the end of the flight plan and the unit will automatically sequence to them after the en route waypoints.

Or:

Touch **Activate Approach**. Activating the approach makes the active leg Direct-To the selected transition waypoint, or for Vector approaches to activate a leg that is an extended final approach course. You can also "activate" the approach from the Flight Plan by touching the Approach Button > **Menu** > **Activate Approach**, if the approach is not activated on this page.

RESUMING THE FLIGHT PLAN

Resuming the Flight Plan after activating an approach:

Whenever an approach is selected and activated the procedure is added to the end of the flight plan and the aera 760 immediately begins to provide guidance to the first waypoint in the approach. Follow the steps below to resume the flight plan after activating the approach.

- 1) From the **Main Menu**, touch **Active Flight Plan**.

Or:

Touch the **Direct To** Icon.

- 2) With a flight plan and an approach activated, touch the **Menu** Icon.
- 3) Touch **Resume Flight Plan**.

REMOVING AN APPROACH

Removing a loaded approach from the active or saved flight plan:

- 1) From the Flight Plan with the loaded approach, touch the Approach Button.
- 2) Touch **Remove Approach**.

CHANGING AN APPROACH

Changing a loaded approach from the active or saved flight plan:

- 1) From the Flight Plan with the loaded approach, touch the Approach Button.
- 2) Touch **Select Approach**. The Select Approach Page is displayed.
- 3) Select the desired approach and transition waypoint.
- 4) Touch **Load Approach**.

Or:

Touch **Activate Approach**. Activating the approach makes the active leg Direct-To the selected transition waypoint, or for Vector approaches to activate a leg that is an extended final approach course. You can also "activate" the approach from the Flight Plan by touching the Approach Button > **Menu** > **Activate Approach**, if the approach is not activated on this page.

Approach Button: Touch to display Approach Options menu

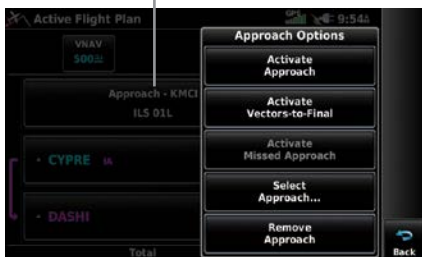

Touch an approach option to activate approach, activate vectors-to-final, activate missed approach, edit or remove an approach

Approach procedure

Approach Procedure - Active Flight Plan Page and Map Page

ACTIVATING VECTORS-TO-FINAL

After an approach has been activated, the 'Activate Vectors-to-Final' option is used when being vectored to the final approach course by Air Traffic Control (ATC).

With the approach activated, the Map Page displays an extension of the final approach course in magenta and "vtf" appears as part of the active leg on the Map page (as a reminder the approach was activated with vectors-to-final).

Activating Vectors-to-Final:

- 1) From the Active Flight Plan Page (with an approach activated), touch the **Menu** Icon.
- 2) Touch the Approach Button.
- 3) Touch **Activate Vectors-to-Final**.

Vectors-to-Final Symbol



Vectors-to-Final (Active Flight Plan)

Final Course Extension



Vectors-to-Final (Map)

FLYING THE MISSED APPROACH

Upon reaching the Final Approach Fix (FAF), the aera 760 continues to give guidance along an extension of the final course segment (FAF to MAP) until the missed approach procedure is initiated.

Activating/Suspending the missed approach upon reaching the MAP:

- 1) Upon reaching the MAP, a pop-up window is displayed.
- 2) Touch the **Remain Suspended** Button to continue with sequencing suspended.

Or:

Touch **Activate GPS Missed Approach** for guidance to the Missed Approach Hold Point.

Activating the missed approach prior to the MAP:

- 1) Activating the missed approach prior to the MAP is accomplished from the Active Flight Plan Page. Touch the Approach Button on the Active Flight Plan Page. The approach options are displayed.
- 2) Touch **Activate Vectors-to-Final**. The aera 760 will continue to provide guidance along the final approach course. Upon reaching the MAP, the unit will automatically sequence to the first leg of the missed approach.

TRANSITIONING FROM MANUAL SEQUENCING BACK TO AUTOMATIC SEQUENCING

During an approach, the aera 760 automatically sequences through each leg of the approach, except in some situations where automatic sequencing of approach waypoints is suspended. This normally appears at holding patterns, upon crossing the missed approach point (MAP), for Climb to Altitude legs, and for Hold to Altitude legs.

Suspending/Unsuspending automatic sequencing of waypoints:

- 1) When automatic sequencing of approach waypoints is suspended, a pop-up window is displayed.
- 2) Touch the **Remain Suspended** Button to continue with sequencing suspended.

Or:

Touch **Unsuspend** to resume automatic sequencing.

SECTION 4 HAZARD AVOIDANCE

4.1 WEATHER

WEATHER DATA SOURCES

When multiple weather information sources are detected, the weather data source options are available. There are four possible options available for selection through the Setup Page or Weather Page; Auto, SiriusXM, GDL FIS-B, and Internet. The default selection is 'Auto.' Data from the selected weather source will apply to all weather shown on the Map Page, Waypoint Page, Weather Page, Nearest Page, and configurable data fields.

Selecting the weather data source:

- 1) From the **Main Menu**, touch the **Weather > Menu > Data Source**.
- 2) Touch the desired weather source (Auto, SiriusXM, GDL FIS-B, or Internet).

Or:

- 1) From the **Main Menu**, touch **Tools > Setup > Weather**.
- 2) Touch the desired weather source (Auto, SiriusXM, GDL FIS-B, or Internet).

USING WEATHER PRODUCTS



WARNING: Do not use data link weather information for maneuvering in, near, or around areas of hazardous weather. Information contained within data link weather products may not accurately depict current weather conditions.



WARNING: Do not use the indicated data link weather product age to determine the age of the weather information shown by the datalink weather product. Due to time delays inherent in gathering and processing weather data for data link transmission, the weather information shown by the data link weather product may be significantly older than the indicated weather product age.

Weather Products can be displayed on the Navigation Map Page and individually on the Weather Page.

The setup menu for the Navigation Map controls the map range settings above which weather products are decluttered from the display. If a map range larger than the weather product map range setting is selected, the weather product data is removed from the map. For weather products such as Lightning and Storm Cells, the weather product is displayed when a map range "smaller" than the weather product map range setting is selected (Cloud Tops works inversely, displaying when a map range 'larger' than the setting is selected). The menu also provides a means for enabling/disabling display of weather products on the Navigation Map.

Additional information about many of the weather products can be displayed by touching the object on the map.



Viewing Weather products on the Navigation Map:

- 1) From the **Main Menu** touch the **Map** Icon.
- 2) Touch the **Menu** Icon.
- 3) Touch the **Weather** button.

Viewing Weather products on the Weather Map:

- 1) From the **Main Menu** touch the **Weather** Icon.
- 2) Touch **Products**.
- 3) Touch the desired weather product(s).

Viewing legends for displayed weather products:

- 1) From the **Main Menu**, touch **Map**.
Or:
 - a) From the **Main Menu**, touch **Weather**.
 - b) Touch the Dedicated Page Icon on the Button Bar and touch the desired weather data.
- 2) Touch **Menu**.
- 3) Touch **Weather Legend**.
- 4) If desired, touch the   buttons until the desired legend is displayed.

Animating weather:

With weather enabled and radar displayed, from the **Main Menu**, touch **Map** or **Weather** > **Menu** > **Animate Weather**.

SIRIUSXM® WEATHER



NOTE: *The displayed weather products are dependant on the SiriusXM Weather Data Service Package purchased.*

The following SiriusXM devices can be used to display SiriusXM weather:

Compatible SiriusXM Devices
GDL 51/51R
GDL 52/52R
*Also additional support via Flight Stream

ACTIVATING SERVICES

Before SiriusXM Satellite Weather can be used, the service must be activated. Service is activated by providing SiriusXM Satellite Radio with a Radio ID unique to the compatible SiriusXM device.

SiriusXM Satellite Radio uses the Radio ID to send an activation signal that allows the aera to display weather data and/or entertainment programming provided through the compatible SiriusXM device.

Refer to the compatible SiriusXM device Owner’s Manual for more information on activating SiriusXM Satellite Radio.

SIRIUSXM WEATHER INFORMATION

- Radio ID—Eight-digit ID number used for activation.
- Service Level—SiriusXM Weather subscription plan purchased.
- Weather Products—List of weather features and age of weather data in minutes.

Accessing the Radio ID:

From the **Main Menu**, touch **Tools > Data Link**.



Accessing the SiriusXM Radio ID

SIRIUSXM SATELLITE WEATHER PRODUCTS

RADAR

NEXRAD (NEXT-generation RADar), is a network of multiple high-resolution Doppler radar sites that are operated by the National Weather Service (NWS). NEXRAD data provides centralized meteorological information for the continental United States and selected overseas locations. The maximum range of a single NEXRAD radar site is 250 nm. In addition to a wide array of services, the NEXRAD network provides important information about severe weather and air traffic safety.

NEXRAD data is not real-time. The lapsed time between collection, processing, and dissemination of NEXRAD images can be significant and may not reflect the current radar synopsis. Due to the inherent delays and the relative age of the data, it should be used for long-range planning purposes only. Never use NEXRAD data or any radar data to maneuver in or near areas of hazardous weather. Rather, use it in an early-warning capacity of pre-departure and enroute evaluation.

Data from all the NEXRAD radar sites in the United States is shown. This data represents the base reflectivity from the individual radar sweeps. The display of the information is color-coded to indicate the weather severity level.

The display of radar coverage is always active when NEXRAD is selected. Areas where NEXRAD radar coverage is not currently available or is not being collected are indicated in grayish-purple. Radar capability exists in these areas, but it is not active or is off-line.

Radar Abnormalities

There are possible abnormalities regarding displayed NEXRAD images. Some, but not all, of those include:

- Ground clutter
- Strokes and spurious radar data
- Sun strokes, when the radar antenna points directly at the sun
- Military aircraft deploy metallic dust (chaff) which can cause alterations in radar scans
- Interference from buildings or mountains, which may cause shadows

Radar Limitations

Certain limitations exist regarding the NEXRAD radar displays. Some, but not all, are listed for the user's awareness:

- NEXRAD does not provide sufficient information to determine cloud layers or precipitation characteristics (hail vs. rain). For example, it is not possible to distinguish between wet snow, wet hail, and rain.
- NEXRAD base reflectivity is sampled at the minimum antenna elevation angle. An individual NEXRAD site cannot depict high altitude storms at close ranges, and has no information about storms directly over the site.
- The composite reflectivity is the maximum dBZ reflectivity from any of the reflectivity angles of the NEXRAD weather radar. (CONUS area only)

Radar Intensity

Colors are used to identify the different NEXRAD echo intensities (reflectivity) measured in dBZ (decibels of Z). "Reflectivity" (designated by the letter Z) is the amount of transmitted power returned to the radar receiver. The dBZ values increase as returned signal strength increases. Precipitation intensity is displayed using colors corresponding to the dBZ values.

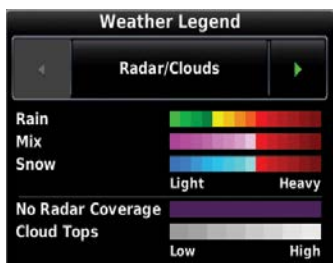

RADAR Legend



Radar Data

CLOUD TOPS

Satellite observation of clouds is represented as temperature data, where colder tops are typically found at higher altitudes. This temperature data is transformed into cloud top height contours, indicating the height of the cloud top in 5,000 foot increments.

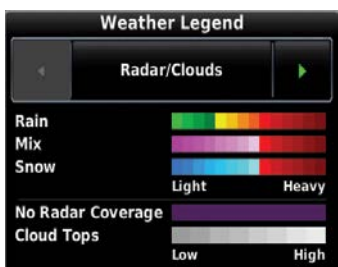

RADAR Legend



Cloud Tops Data

ECHO TOPS

Echo Tops are derived from NEXRAD radar and indicate the highest altitude at which precipitation is falling. Echo Tops at or above the altitude you select are displayed, in 5,000 foot increments up to 70,000 ft. Echo Tops can be helpful in determining the severity of thunderstorms.



Echo Tops Data



Echo Tops Altitudes

WINDS ALOFT

Winds Aloft data shows the forecasted wind speed and direction at the surface and at selected altitudes.

Winds Aloft are displayed using wind barbs or a wind streamline depending on the selected range. The wind barbs indicate wind speed and direction. The wind streamline indicates wind direction with arrows.

The wind barbs always point in the direction the wind is coming from. The wind speed is depicted using flags at the end of the wind barb. A short wind flag is 5 knots, a long wind flag is 10 knots, and a triangle flag is 50 knots.



Winds Aloft Data



Winds Aloft Altitudes



Winds Streamlines



Winds Barbs

TEMPERATURES ALOFT

Temperature Aloft data shows the forecasted temperatures aloft in 3,000-foot increments up to 39,000 feet MSL. For altitudes 18,000 feet and above the relative ISA temperature is shown. Temperatures are color coded with temperatures near and below freezing are shown as shades of blue, green for temperatures just above freezing and shades of orange are used for warmer temperatures.



Temperatures Aloft Data



Temperatures Aloft Altitudes

LIGHTNING

Lightning data shows the approximate location of cloud-to-ground lightning strikes. A strike icon represents a strike that has occurred within a two-kilometer region and within the last seven minutes. The exact location of the lightning strike is not displayed.

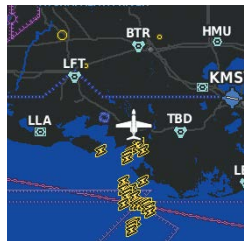

Lightning Data

STORM CELLS

The Storm Cells feature displays storms as well as the storm's projected path in the immediate future.

The direction of the storm is displayed by an arrow. The map range at which the arrow is displayed depends on the storm cell's speed. The tip of the arrow indicates where the storm should be in 15 minutes. Critical information about the storm cell (tops and intensity) can be viewed by selecting the storm cell with the map pointer. Touching the Map Feature Button will display additional information.

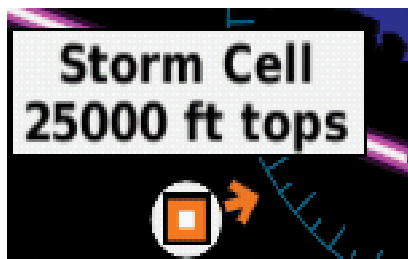

Storm Cell Data (Map)

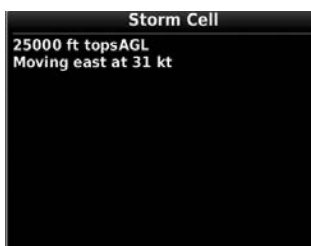

Additional Storm Cell Information

METARs AND TAFs



NOTE: METAR information is only displayed within the installed aviation database service area.

METAR (METeorological Aerodrome Report) is an international code used for reporting weather observations. METARs are updated hourly or as needed. METARs typically contain information about the temperature, dewpoint, wind, precipitation, cloud cover, cloud heights, visibility, and barometric pressure. They can also contain information on precipitation amounts, lightning, and other critical data. If METAR data is available for an airport, a color-coded flag is shown next to the airport.

TAF (Terminal Area Forecast) is the standard format for 24-hour weather forecasts. TAFs may contain some of the same code as METAR data. It typically forecasts significant weather changes, temporary changes, probable changes, and expected changes in weather conditions.

An abbreviated METAR can be viewed by selecting the METAR flag with the map pointer. Touching the Map Feature Button will display additional information. METAR and TAF data can be displayed as raw or decoded text.

Map Feature Button
METAR Selected with Map Pointer



METAR Data (Map)



Additional METAR Data

The METAR flag color is determined by the information in the METAR text.



VFR (ceiling greater than 3000 feet AGL and visibility greater than 5 miles)



Marginal VFR (ceiling 1000-3000 feet AGL and/or visibility 3-5 miles)



IFR (ceiling 500 to below 1000 feet AGL and/or visibility 1 mile to less than 3 miles)



Low IFR (ceiling below 500 feet AGL or visibility less than 1 mile)



METAR text does not contain adequate information to determine flight conditions

AIRMETS

An AIRMET (AIRmen’s METeological Information) can be especially helpful for pilots of light aircraft that have limited flight capability or instrumentation. An AIRMET must affect or be forecast to affect an area of at least 3,000 square miles at any one time. AIRMETS are routinely issued for six-hour periods and are amended as necessary due to changing weather conditions. AIRMETS are displayed as green (surface winds), magenta and red (IFR/mountain obscuration), orange (turbulence), or blue (icing) shaded areas on the map display.

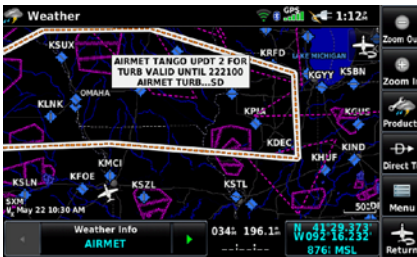

AIRMET Selected

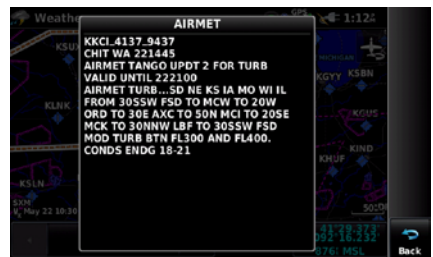

Additional AIRMET Data

SIGMETs

A SIGMET (SIGNificant METeological Information) advises of weather that is potentially hazardous to all aircraft. In the contiguous United States, the following items are covered: severe icing, severe or extreme turbulence, volcanic ash, dust storms, and sandstorms that lower visibility to less than three statute miles.

A Convective SIGMET is issued for the following conditions: thunderstorms, isolated severe thunderstorms, embedded thunderstorms, hail at the surface, and tornadoes.

A SIGMET is widespread and must affect or be forecast to affect an area of at least 3,000 square miles. SIGMETs are displayed as a yellow-dashed line.

TEMPORARY FLIGHT RESTRICTIONS (TFR)



NOTE: Do not rely solely upon data link services to provide Temporary Flight Restriction TFR information. Always confirm TFR information through official sources such as Flight Service Stations of Air Traffic Control.

Temporary Flight Restrictions, or TFRs, temporarily restrict all aircraft from entering the selected airspace unless a waiver has been issued. TFRs are routinely issued for activities such as sporting events, dignitary visits, military depots, and forest fires. TFRs are represented as an area highlighted by red (active) or yellow (not yet active).



TFR Data Selected

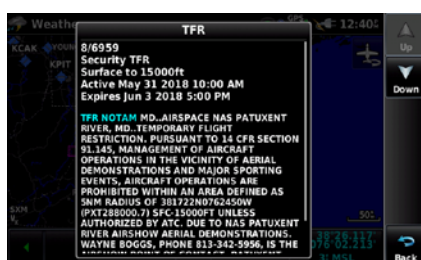

Additional TFR Information

PIREPs

Pilot Weather Reports (PIREPs) provide timely weather information for a particular route of flight. When significant weather conditions are reported or forecast, Air Traffic Control (ATC) facilities are required to solicit PIREPs. A PIREP may contain unforecast adverse weather conditions, such as low in-flight visibility, icing conditions, wind shear, and turbulence. PIREPs are issued as either Routine (UA) or Urgent (UUA).

Icing PIREPs		Sky Condition PIREPs		Turbulence PIREPs	
	Negative Icing		Unknown Sky Condition		Negative Turbulence or Smooth
	Trace Icing		Sky Clear		Light Turbulence
	Trace to Light Icing		Few Clouds		Light to Moderate Turbulence

Icing PIREPs		Sky Condition PIREPs		Turbulence PIREPs	
	Light Icing		Scattered Clouds		Moderate Turbulence
	Light to Moderate Icing		Broken Clouds		Moderate to Severe Turbulence
	Moderate Icing		Overcast		Severe Turbulence
	Moderate to Severe Icing		IMC		Extreme Turbulence
	Severe Icing				

PIREP Icons



PIREP Selected

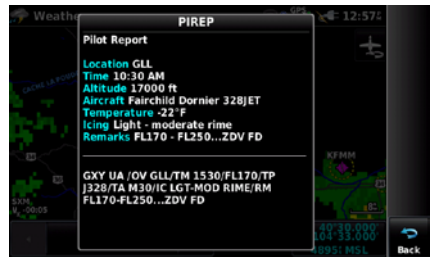

Additional PIREP Data

FREEZING LEVEL

Freezing Level shows contours for the lowest forecast altitude where icing conditions are likely to occur.

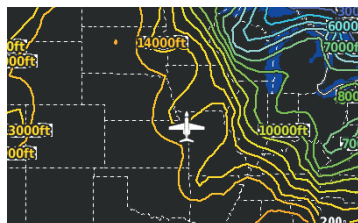

Freezing Level Data

TURBULENCE FORECAST

Turbulence data identifies the potential for erratic movement of high-altitude air mass associated winds. Turbulence is classified as light, moderate, or severe. Turbulence data is intended to supplement AIRMETs and SIGMETs.

Overview

Navigation

Flight Planning

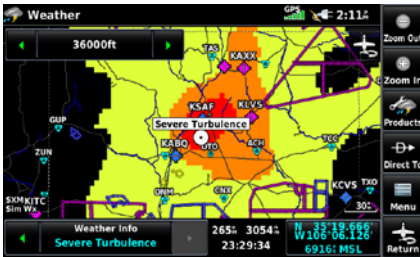

Turbulence Selected

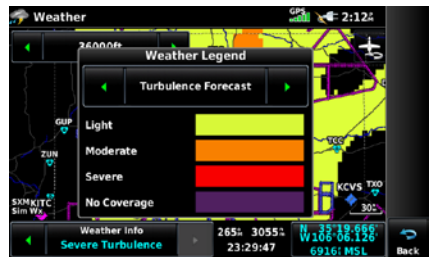

Turbulence Forecast Legend

ICING FORECAST (CIP & SLD)

Icing data depicts the current icing environment at select altitudes.

Current Icing Severity (CIS) is displayed in three categories: light, moderate, and heavy (not specific to aircraft type).

Supercooled Large Droplet (SLD) icing conditions are characterized by the presence of relatively large, super cooled water droplets indicative of freezing drizzle and freezing rain aloft.

Hazard Avoidance

Additional Features

Appendices

Index



Icing Forecast Legend



Moderate Icing Selected With Map Pointer

WEATHER FORECAST

Forecast information is available for current and forecast weather conditions. Forecasts are available for intervals of 12, 24, 36, and 48 hours.



Weather Fronts

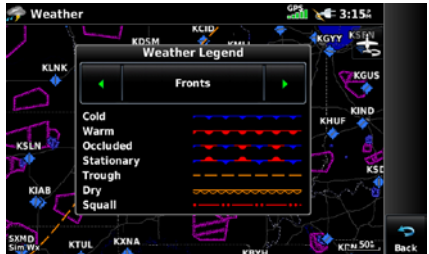

Fronts Legend

SURFACE PRESSURE

Surface Pressure information is available for current and forecast weather conditions. Surface Pressure forecasts are available for intervals of 12, 24, 36, and 48 hours.

This feature displays pressure isobars and pressure centers. The isobars connect points of equal pressure. Pressure readings can help determine weather and wind conditions. High pressure areas are generally associated with fair weather. Low pressure areas are generally associated with clouds and the chance of precipitation. Isobars that are packed closely together show a strong pressure gradient. Strong gradients are associated with areas of stronger winds. Pressure units can be displayed in Millibars (mb), Hectopascals (pa), or Inches of Mercury (in).



Surface Pressure Data

DATA LINK WEATHER (FIS-B)

FIS-B is a subscription-free weather service that is broadcast by Ground Based Transceivers (GBTs) over the 978 MHz UAT frequency band as part of the FAA's Next Generation Air Transportation System (NextGen). To receive FIS-B weather information, the compatible device must be within range and line-of-sight of an operating GBT. Reception may be affected by altitude, terrain, and other factors.

FIS-B Weather Product	Connection	
	Bluetooth	RS-232
NEXRAD	✓	✓
Cloud Tops Forecast	✓	
Winds and Temperatures Aloft	✓	✓
Lightning	✓	
METARs/TAFs	✓	✓
TAFs	✓	✓
AIRMETs	✓	✓
SIGMETs	✓	✓
PIREPs	✓	✓
NOTAM (D)/FDC (Including TFRs)	✓	✓
Turbulence Forecast	✓	
Icing Forecast	✓	

Available FIS-B Weather Products by Connection

Viewing FIS-B Weather product Status:

- 1) From the **Main Menu**, touch **Weather**.
- 2) Touch **Menu > More Info**.

Viewing Ground Station Status:

- 1) From the **Main Menu**, touch **Tools > Data Link**.
- 2) Touch **Menu > Ground Stations**.

FIS-B WEATHER PRODUCTS

FIS-B weather broadcasts are updated regularly and may take approximately ten minutes to transmit all available weather data. Therefore, weather data is not immediately available. No pilot action is required to receive FIS-B weather information. Weather product status can be viewed on the dedicated Weather Page, or the Data Link Page from the Tools menu.

When a FIS-B weather product is active on a map, the age of the data is displayed on the screen in the lower left corner. The age of the product is based on the time difference between when the data was assembled on the ground and the current GPS time. Weather products are broadcast at specific intervals (see broadcast interval in the table below).

If, for any reason, a weather product is not refreshed within the Expiration Time intervals (see table), the data is considered expired and is removed from the display. This ensures that only data that is consistent with FIS-B broadcast data is displayed. If more than half of the expiration time has elapsed, the color of the product age displayed changes to yellow. The system displays dashes instead of a product age when a product has expired.

The table below shows the FIS-B weather expiration time and the broadcast interval. The broadcast interval represents the interval at which FIS-B GBTs broadcast new signals that may or may not contain new weather data. It does not represent the rate at which weather data is updated or new content is received by the compatible device.

FIS-B Products	Expiration Time	Update Interval (Minutes)	Broadcast Interval (Minutes)
NEXRAD Composite Reflectivity (CONUS)	75 minutes	~5 minutes precipitation mode 10 minutes for clear air	15
NEXRAD Composite Reflectivity (Regional)	75 minutes	As Available	2.5
Cloud Tops Forecast	105 minutes	1 hour	15
Winds and Temperatures Aloft	12 hours	12 hours	10
Lightning	75 minutes	5 minutes	5
METAR	8 hours	1 minute (where available), As Available otherwise	5
TAF	12 hours	8 hours	10
AIRMET	12 hours	As Available	5
SIGMET	12 hours	As Available, then at 15 minute intervals for 1 hour	5
PIREP	4 hours	As Available	10
NOTAM (D)/FDC (Including TFRs)	12 hours	As Available	10
Turbulence Forecast	105 minutes	1 hour	15
Icing Forecast	105 minutes	1 hour	15

Weather Product Timing

RADAR

NEXRAD (NEXt-generation RADar), is a network of multiple high-resolution Doppler radar sites that are operated by the National Weather Service (NWS). NEXRAD data provides centralized meteorological information for the continental United States and selected overseas locations. The maximum range of a single NEXRAD radar site is 250 nm. In addition to a wide array of services, the NEXRAD network provides important information about severe weather and air traffic safety.

NEXRAD data is not real-time. The lapsed time between collection, processing, and dissemination of NEXRAD images can be significant and may not reflect the current radar synopsis. Due to the inherent delays and the relative age of the data, it should be used for long-range planning purposes only. Never use NEXRAD data or any radar data to maneuver in or near areas of hazardous weather.

Composite data from all the NEXRAD radar sites in the United States is shown. This data is composed of the maximum reflectivity from the individual radar sweeps. The display of the information is color-coded to indicate the weather severity level.

The display of radar coverage is always active when NEXRAD is selected. Areas where NEXRAD radar coverage is not currently available or is not being collected are indicated in grayish-purple on the NEXRAD weather page. Radar capability exists in these areas, but it is not active or is off-line.

Radar Abnormalities

There are possible abnormalities regarding displayed NEXRAD images. Some, but not all, of those include:

- Ground clutter
- Strokes and spurious radar data
- Sun strokes, when the radar antenna points directly at the sun
- Military aircraft deploy metallic dust (chaff) which can cause alterations in radar scans
- Interference from buildings or mountains, which may cause shadows
- Poor reception from Ground Based Transceivers (GBTs) can cause portions of the received radar imagery to not be displayed

Radar Limitations

Certain limitations exist regarding the NEXRAD radar displays. Some, but not all, are listed for the user's awareness:

- NEXRAD base reflectivity does not provide sufficient information to determine cloud layers or precipitation characteristics (hail vs. rain). For example, it is not possible to distinguish between wet snow, wet hail, and rain.
- NEXRAD base reflectivity is sampled at the minimum antenna elevation angle. An individual NEXRAD site cannot depict high altitude storms at close ranges, and has no information about storms directly over the site.

Radar Intensity

Colors are used to identify the different NEXRAD echo intensities (reflectivity) measured in dBZ (decibels of Z). "Reflectivity" (designated by the letter Z) is the amount of transmitted power returned to the radar receiver. The dBZ values increase as returned signal strength increases. Precipitation intensity is displayed using colors corresponding to the dBZ values.



RADAR Legend



NEXRAD Data

Radar Products

FIS-B weather provides two different Radar products, CONUS and Regional. The system can display each individually or a composite (COMBINED). When Regional Radar is displayed, only precipitation for the current region is displayed. The subdued (grayish-purple colored) area represents the area not covered by the regional radar product. When Combined radar data is viewed, Regional Radar data is displayed on top of CONUS data and the time shown in the lower left corner is associated with Regional Radar data only.



FIS-B Radar CONUS



FIS-B Radar Regional



FIS-B Radar Combined

WINDS ALOFT

Winds Aloft data shows the forecasted wind speed and direction for select altitudes.

Winds Aloft are displayed using wind barsbs. The wind barsbs indicate wind speed and direction.

The wind barsbs always point in the direction the wind is coming from. The wind speed is depicted using flags at the end of the wind barbs. A short wind flag is 5 knots, a long wind flag is 10 knots, and a triangle flag is 50 knots.



Winds Aloft Data



Winds Aloft Altitudes

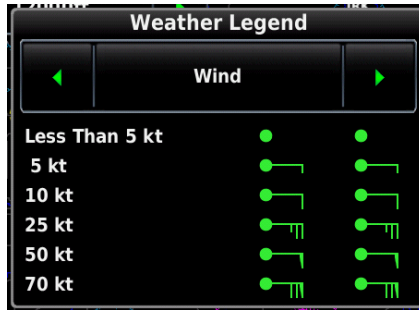

Winds Aloft Legend

TEMPERATURES ALOFT

Temperature Aloft data shows the forecasted temperatures aloft for select altitudes. For altitudes above 18,000 feet, the relative ISA temperature is shown. Temperatures are color coded with temperatures near and below freezing are shown as shades of blue, green for temperatures just above freezing, and shades of orange are used for warmer temperatures.



Temperatures Aloft Data



Temperatures Aloft Altitudes

CLOUD TOPS FORECAST

Cloud Tops Forecast data displays forecasted cloud top heights. Heights are indicated in 1,500 foot increments from 1,500 feet up to 15,000 feet and in 3,000 foot increments from 15,000 feet up to 24,000 feet.



Cloud Tops Forecast Data



Cloud Tops Forecast Legend

METARs AND TAFs



NOTE: METAR information is only displayed within the installed aviation database service area.

METAR (METeoro logical Aerodrome Report) is an international code used for reporting weather observations. METARs are updated hourly or as needed. METARs typically contain information about the temperature, dewpoint, wind, precipitation, cloud cover, cloud heights, visibility, and barometric pressure. They can also contain information on precipitation amounts, lightning, and other critical data. If METAR data is available for an airport, a color-coded flag is shown next to the airport.

TAF (Terminal Area Forecast) is the standard format for 24-hour weather forecasts. TAFs may contain some of the same code as METAR data. It typically forecasts significant weather changes, temporary changes, probable changes, and expected changes in weather conditions.

Abbreviated METAR text can be viewed by selecting the METAR flag with the map pointer. Touching the Map Feature Button will display additional information. METAR and TAF data can be displayed as raw or decoded text.



Map
Feature
Button

METAR Data (Map)

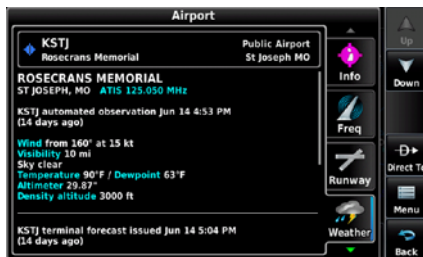

Additional METAR Data

The METAR flag color is determined by the information in the METAR text.

	VFR	Ceiling greater than 3000 feet AGL and visibility greater than 5 miles
	Marginal VFR	Ceiling 1000-3000 feet AGL and/or visibility 3-5 miles
	IFR	Ceiling 500 to below 1000 feet AGL and/or visibility 1 mile to less than 3 miles
	Low IFR	Ceiling below 500 feet AGL or visibility less than 1 mile
	Undetermined	METAR text does not contain adequate information to determine flight conditions

AIRMETS

An AIRMET (AIRmen's METeoroological Information) can be especially helpful for pilots of light aircraft that have limited flight capability or instrumentation. An AIRMET must affect or be forecast to affect an area of at least 3,000 square miles at any one time. AIRMETS are routinely issued for six-hour periods and are amended as necessary due to changing weather conditions. AIRMETS are displayed as colored, dashed lines.



Map
Feature
Button

AIRMET Selected

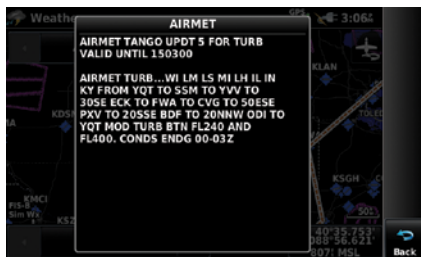

Additional AIRMET Data

SIGMETs

A SIGMET (SIGNificant METeorological Information) advises of weather that is potentially hazardous to all aircraft. In the contiguous United States, the following items are covered: severe icing, severe or extreme turbulence, volcanic ash, dust storms, and sandstorms that lower visibility to less than three statute miles.

A Convective SIGMET is issued for the following conditions: thunderstorms, isolated severe thunderstorms, embedded thunderstorms, hail at the surface, and tornadoes.

A SIGMET is widespread and must affect or be forecast to affect an area of at least 3,000 square miles. SIGMETs are displayed as a yellow-dashed line.

TEMPORARY FLIGHT RESTRICTIONS (TFR)



NOTE: Do not rely solely upon data link services to provide Temporary Flight Restriction TFR information. Always confirm TFR information through official sources such as Flight Service Stations of Air Traffic Control.

Temporary Flight Restrictions, or TFRs, temporarily restrict all aircraft from entering the selected airspace unless a waiver has been issued. TFRs are routinely issued for activities such as sporting events, dignitary visits, military depots, and forest fires. TFRs are represented as an area highlighted by red (active), yellow (not yet active), or orange (undetermined).

TFR Data Selected

Map Feature Button

TFR Legend

PIREPs

Pilot Weather Reports (PIREPs) provide timely weather information for a particular route of flight. When significant weather conditions are reported or forecast, Air Traffic Control (ATC) facilities are required to solicit PIREPs. A PIREP may contain unforecast adverse weather conditions, such as low in-flight visibility, icing conditions, wind shear, and turbulence. PIREPs are issued as either Routine (UA) or Urgent (UUA), and are represented as a small colored icon. The color and style of the icons signify the type and severity of the reported weather conditions.

Icing PIREPs		Sky Condition PIREPs		Turbulence PIREPs	
	Negative Icing		Unknown Sky Condition		Negative Turbulence or Smooth
	Trace Icing		Sky Clear		Light Turbulence
	Trace to Light Icing		Few Clouds		Light to Moderate Turbulence
	Light Icing		Scattered Clouds		Moderate Turbulence
	Light to Moderate Icing		Broken Clouds		Moderate to Severe Turbulence
	Moderate Icing		Overcast		Severe Turbulence
	Moderate to Severe Icing		IMC		Extreme Turbulence
	Severe Icing				

PIREP Icons



Map
Feature
Button

PIREP Selected

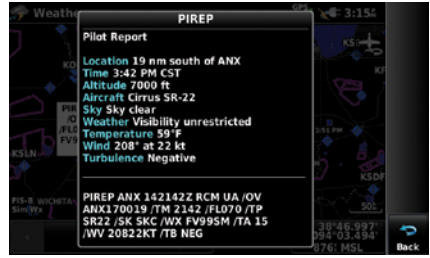

Additional PIREP Data

TURBULENCE FORECAST

Turbulence data identifies the potential for erratic movement of high-altitude air mass associated winds. Turbulence is classified as light, moderate, severe, or extreme. Turbulence data is intended to supplement AIRMETs and SIGMETs.

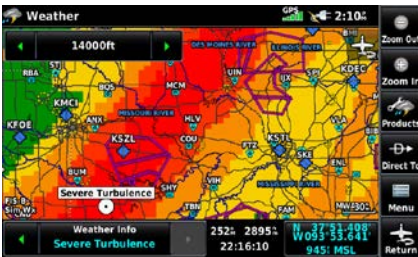

Turbulence Selected

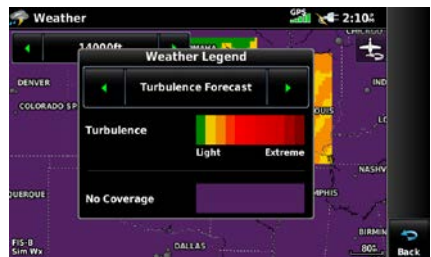

Turbulence Forecast Legend

ICING FORECAST

Overview

Icing Forecast data shows a graphical view of the forecasted icing environment. Icing severity is displayed in four categories: trace, light, moderate, and heavy (not specific to aircraft type).

Navigation

Supercooled Large Droplet icing conditions are characterized by the presence of relatively large, super cooled water droplets indicative of freezing drizzle and freezing rain aloft.

Flight Planning



Light Icing Selected With Map Pointer



SLD Icing Threat Selected With Map Pointer

Hazard Avoidance



Icing Forecast Legend

Additional Features

LIGHTNING

Appendices

Lightning data shows the approximate location, number, and polarity of lightning strikes. A strike icon represents the amount of lightning strikes that have recently occurred within an approximately one-nautical-mile region. The exact location of the lightning strikes are not displayed. The strike icon indicates Polarity(+) if any of the strikes in that region were positive polarity.

Index

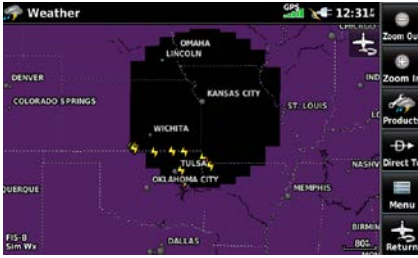

Lightning Data



Lightning Legend

INTERNET WEATHER

Internet weather is a subscription-free weather service proved by Garmin Weather Data Services. Garmin Weather Data Services requires a data connection through Wi-Fi (refer to section 1.6, 'WiFi Setup').

Viewing Internet Weather product Status:

- 1) From the **Main Menu**, touch **Weather**.
- 2) Touch **Menu** > **More Info**.

Weather Product Information	
Data Source	Internet
Status	Connected
METARs	-00:03
NEXRAD (Composite)	-00:05
TAFs	-00:15

Internet Weather Product Information

INTERNET WEATHER PRODUCTS

Garmin Weather Data Services products include Radar, METAR, TAF, and IR Satellite data.

To receive up-to-date weather information, the device must have access to a Wi-Fi data connection. However, once downloaded, some weather products will remain available for up to 90 minutes after connection to the Internet is lost.

RADAR

Weather radar data is collected from radar sites across the United States, Canada, and select overseas locations. It is combined into a mosaic for easier display and analysis.

The radar data displayed is not real-time. The lapsed time between collection, processing, and dissemination of radar images can be significant and may not reflect the current radar synopsis. Due to the inherent delays and the relative age of the data, it should be used for long-range planning purposes only. Never use radar data to penetrate hazardous weather. Rather, use it in an early-warning capacity for pre-departure evaluation.

Composite data from radar sites in the United States is shown. This data is composed of the maximum reflectivity from the individual radar sweeps at different tilt angles of the radar beam with respect to the ground. The display of the information is color-coded to indicate the weather severity level. Colors are used to identify the different echo intensities (reflectivity) measured in dBZ (decibels or Z). "Reflectivity" (designated by the letter Z) is the amount of transmitted power returned to the radar receiver. The dBZ values increase as returned signal strength increases. Precipitation is displayed using colors corresponding to the dBZ values.

Radar Abnormalities

There are possible abnormalities regarding displayed radar images. Some, but not all, of those include:

- Ground clutter
- Strokes and spurious radar data
- Sun strobes (when the radar antenna points directly at the sun)
- Military aircraft deploy metallic dust (chaff) which can cause alterations in radar scans
- Interference from buildings or mountains, which may cause shadows

Radar Limitations

Certain limitations exist regarding radar displays. Some, but not all, are listed for the user's awareness:

- Surface precipitation type is estimated with shades of blue for snow and shades of pink for indeterminate types. The actual precipitation type aloft could vary.

- Radar base reflectivity is sampled at the minimum antenna elevation angle. An individual radar site cannot depict high altitude storms at close ranges, and has no information about storms directly over the site.
- Radar coverage in Canada is only available in the southern 1/4 of the country.

Radar Intensity

Colors are used to identify the different radar echo intensities (reflectivity) measured in dBZ (decibels of Z). “Reflectivity” (designated by the letter Z) is the amount of transmitted power returned to the radar receiver. The dBZ values increase as returned signal strength increases. Precipitation intensity is displayed using colors corresponding to the dBZ values.

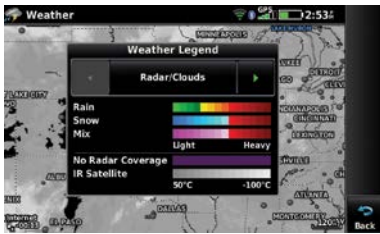

RADAR Legend



Radar Data

METARs AND TAFs



NOTE: METAR information is only displayed within the installed aviation database service area.

METAR (METeorological Aerodrome Report) is an international code used for reporting weather observations. METARs are updated hourly or as needed. METARs typically contain information about the temperature, dewpoint, wind, precipitation, cloud cover, cloud heights, visibility, and barometric pressure. They can also contain information on precipitation amounts, lightning, and other critical data. If METAR data is available for an airport, a color-coded flag is shown next to the airport.

TAF (Terminal Area Forecast) is the standard format for 24-hour weather forecasts. TAFs may contain some of the same code as METAR data. It typically forecasts significant weather changes, temporary changes, probable changes, and expected changes in weather conditions.

An abbreviated version can be viewed by selecting the METAR flag with the map pointer. Touching the Map Feature Button will display additional information. METAR and TAF data can be displayed as raw or decoded text.



METAR Data (Map)



Additional METAR Data

Map Feature Button

The METAR flag color is determined by the information in the METAR text.

	VFR	Ceiling greater than 3000 feet AGL and visibility greater than 5 miles
	Marginal VFR	Ceiling 1000-3000 feet AGL and/or visibility 3-5 miles
	IFR	Ceiling 500 to below 1000 feet AGL and/or visibility 1 mile to less than 3 miles
	Low IFR	Ceiling below 500 feet AGL or visibility less than 1 mile
		METAR text does not contain adequate information to determine flight conditions

IR SATELLITE

IR Satellite data depicts cloud top temperatures from infrared satellite imagery. Brighter shades of white indicate cooler temperatures typically found at higher altitudes.

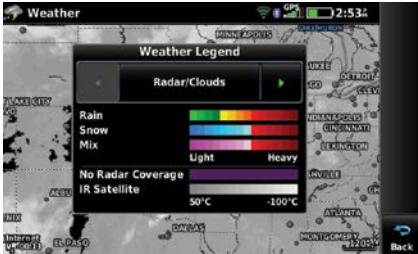

Radar and IR Satellite Legend (Internet)



IR Satellite (Internet)

4.2 TERRAIN



WARNING: Do not use Terrain information for primary terrain avoidance. Terrain information is intended only to enhance situational awareness.



NOTE: Terrain depicted in the Profile View is always "ahead" of the aircraft, and will change as ground track changes.

The Terrain function displays altitudes of terrain and obstructions relative to the aircraft position and altitude with reference to a database that may contain inaccuracies. Terrain and obstructions are shown only if they are in the database. Terrain and obstacle information should be used as an aid to situational awareness. They should never be used to navigate or maneuver around terrain.

Note that all obstructions may not be available in the terrain and obstacle database. No terrain and obstacle information is shown without a valid 3-D GPS position.

The aera 760 GPS receiver provides the horizontal position and altitude of the aircraft. Aircraft GPS altitude is derived from satellite position. GPS altitude is then converted to a mean sea level (MSL)-based altitude (GPS-MSL altitude) and is used to determine terrain and obstacle proximity. GPS-MSL altitude accuracy is affected by satellite geometry, but is not subject to variations in pressure and temperature that normally affect pressure altitude sensors. GPS-MSL altitude does not require local altimeter settings to determine MSL altitude. It is a widely-used MSL altitude source.

Terrain and obstacle databases are referenced to MSL. Using the GPS position and altitude, the Terrain feature portrays a 2-D picture of the surrounding terrain and obstacles relative to the position and altitude of the aircraft. GPS position and GPS-MSL altitude are used to calculate and predict the aircraft's flight path in relation to the surrounding terrain and obstacles. In this way, the pilot can view predicted dangerous terrain and obstacle conditions.

Alert windows appear to inform the pilot of proximity to the terrain and obstacles, as well as an unsafe descent rate. These alerts depend on user-defined parameters in the Terrain Setup.

TERRAIN INFORMATION













Two views are displayed by the Terrain function: the Map View, and the Profile View. The areas of the terrain shaded red are predicted to be within 100 feet below or above the aircraft. The yellow terrain areas are between the user-defined Caution Elevation and 100 feet below the aircraft. By default, the Caution Elevation is 1,000 feet; therefore, the areas in yellow are between 1,000 feet and 100 feet below the aircraft. The black areas are further than the Caution Elevation. A projected point of impact is marked with an "X" symbol.

OBSTACLE INFORMATION

Obstacles are shown on the Terrain Map View, at or below the map range of 12 nm. Obstacles are also shown on the Navigation Map when the map range is set to 5 nm or below.

Standard aeronautical chart symbols are used for lighted or unlighted obstacles taller than 200 feet Above Ground Level (AGL). Refer to the Obstacle Icons legend below.





When selecting an obstacle with the Map Pointer, each obstacle displays the altitude at the top of the obstacle, or Mean Sea Level (MSL). Each obstacle also lists the actual height of the obstacle, or Above Ground Level (AGL).

Unlighted Obstacle		Lighted Obstacle		Power Lines	Potential Impact Points	Obstacle Location
< 1000' AGL	> 1000' AGL	< 1000' AGL	> 1000' AGL			
						WARNING: Red obstacle is above or within 100' below current aircraft altitude
						CAUTION: Yellow obstacle is between 100' and 1000' below current aircraft altitude

Terrain Obstacle Colors and Symbology

MAP STATUS ICONS

These icons will appear in the upper right corner of the map to show what obstacles are represented on the map.

Description	Icon
Point Obstacles such as buildings, towers, and radio masts	
Wire Obstacles such as power lines	
Terrain shading is active with valid GPS position	
Terrain shading is active with invalid GPS position	

Map Status Icons

TERRAIN AND OBSTACLE COLOR CODE

Red—terrain or obstacle is above or within 100 feet below the aircraft.

Yellow—terrain or obstacle is between the user-defined Caution Elevation and 100 feet below the aircraft.

Enabling/Disabling Terrain Shading on the Navigation Map:

- 1) From the **Main Menu**, touch **Map**.
- 2) Touch **Menu**.
- 3) Touch **Terrain**.

TERRAIN VIEWS

Enabling/disabling profile view:

- 1) From the **Main Menu**, touch **Terrain**.
- 2) Touch **Menu**.
- 3) Touch **Profile View**.

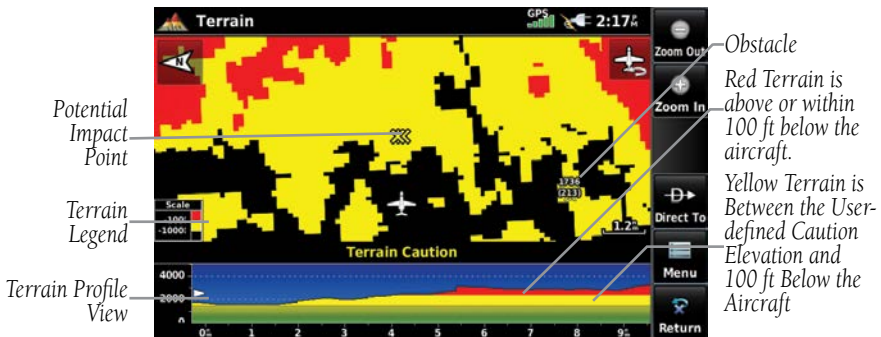

Terrain 'Map with Profile' View

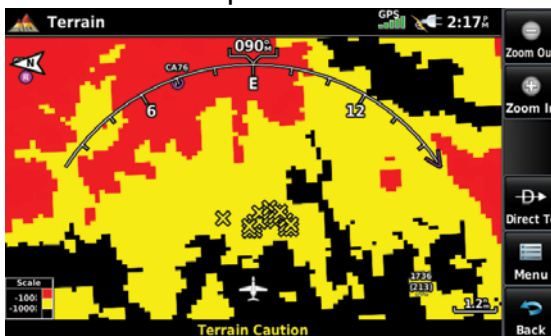

Terrain 'Map Only' View

TERRAIN ALERTS & SETUP

Enabling/Disabling terrain alerts:

- 1) From the **Main Menu**, touch **Terrain**.
- 2) Touch **Menu**.
- 3) Touch **Alerts** to toggle between **Enabled** and **Inhibited**.

Use the Terrain Setup Menu to set levels for terrain alerts as well as obstacles in or near the flight path.

- **Caution Elevation**—The aera 760 will provide an alert if the terrain or obstacle is within the default Caution Elevation or user-defined Caution Elevation
- **Look Ahead Time**—Determines the maximum time when an alert annunciation occurs. For example, if 120 seconds is selected, the aera 760 provides an alert up to 120 seconds before reaching the terrain or obstacle
- **Alert Sensitivity**—The three Alert Sensitivity settings (Terrain, Obstacle, and Descent Rate) determine what level of alerts are annunciated. The aera 760 defaults to 'High' sensitivity, which annunciates all red and yellow alerts at the time set in Look Ahead Time. 'Medium' sensitivity annunciates all of the red and the highest priority of yellow alerts. 'Low' only annunciates red alerts. 'Off' disables the alert.

Accessing terrain/obstacle settings:

- 1) From the **Main Menu**, touch **Terrain**.
- 2) Touch **Menu**.
- 3) Touch **Caution Elevation**, and touch **500ft Below**, **750ft Below**, or **1000ft Below**.
- 4) Touch **Look Ahead Time**, and touch **60 Seconds**, **90 Seconds**, or **120 Seconds**.
- 5) Touch **Terrain** 'Alert Sensitivity', and touch **Off**, **Low**, **Medium**, or **High**.
- 6) Touch **Obstacles** 'Alert Sensitivity', and touch **Off**, **Low**, **Medium**, or **High**.
- 7) Touch **Descent Rate** 'Alert Sensitivity', and touch **Off**, **Low**, or **High**.

Terrain, Obstacle, and Descent Rate Alerts are issued when flight conditions meet parameters that are set within the software algorithms. Terrain alerts typically employ a CAUTION or a WARNING alert severity level, or both. When an alert is issued, visual annunciations are displayed and aural alerts are simultaneously issued. When the aircraft descends through 500 feet above the destination airport an audible "Five Hundred" altitude reminder occurs.

The Terrain Alert Annunciation is shown to the lower left corner of the screen. If the Terrain Map is not displayed, a pop-up alert appears. The Range Rings on the pop-up alert are spaced every whole mile/kilometer/nautical mile. Touch the Terrain Alert Annunciation to acknowledge the pop-up and/or aural alert.

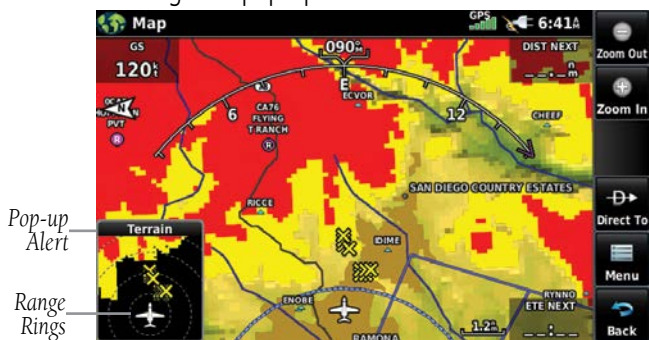

Pop-up Alert (Navigation Map With Terrain Shading)

AURAL ALERTS

- “Five Hundred”—when the aircraft descends through 500 feet above the destination airport.

The following aural terrain alerts are issued when flight conditions meet parameters that are set within the software algorithms, and are dependant on the sensitivity level set in the Terrain Setup Menu.

Alert Severity	Terrain	Obstacle	Descent Rate
Caution	“caution, terrain” “caution, terrain ahead”	“caution, obstacle” “caution, obstacle ahead”	“caution, sink rate”
Warning	“terrain ahead! pull up!” “terrain! terrain! pull up! pull up!”	“obstacle ahead! pull up!” “obstacle! obstacle! pull up! pull up!”	“sink rate, pull up!” “pull up!”

Aural Alerts Summary

Adjusting terrain alert audio:

- 1) From the **Main Menu**, touch **Tools > Setup > Sound**.
- 2) Touch the '**Terrain Audio**' **Enable** Button to toggle the terrain audio on/off:

4.3 TRAFFIC

The following compatible devices are designed to receive, process, and forward traffic (ADS-B air-to-air, and TIS-B traffic information), and weather (Flight Information Service-Broadcast (FIS-B)) information to the aera through a power/data cable or Bluetooth.

Compatible ADS-B Devices
GDL 39/39R
GDL 39-3D
GTX 345/345R/45R
GDL 50/50R
GDL 52/52R
GNX 375
*Also additional support via Flight Stream



TRAFFIC INFORMATION SERVICE (TIS-A)



NOTE: Refer to Appendix F for general information regarding TIS-A. Refer to Appendix D for configuration information.

TIS-A SYMBOLOGY

TIS-A traffic is shown according to TCAS symbology, graphically shown on the Navigation Map, and in the Traffic Warning Window. A Traffic Advisory (TA) symbol appears as a solid yellow circle. All other traffic is shown as a hollow white diamond. Altitude deviation from own aircraft altitude is shown above the target symbol if traffic is above own aircraft altitude, and below the symbol if they are below own aircraft altitude. Altitude trend is shown as an up arrow (>+500 ft/min), down arrow (<-500 ft/min), or no symbol if less than 500 ft/min rate in either direction.

TIS-A Symbol	Description
	Traffic Advisory (TA)
	Other Traffic

TIS-A Traffic Symbols

TIS-A ALERTS

A TIS-A audio alert is generated whenever the number of Traffic Advisories on the aera 760 screen increases from one scan to the next. Limiting Traffic Advisories only reduces the "nuisance" alerting due to proximate aircraft. For example, when the first Traffic Advisories appear on the TIS-A display, the user is alerted audibly. So long as a single aircraft remains on the TIS-A display, no further audio alert is generated. If a second (or more) aircraft appears on the screen, a new audio alert is sounded.

If the number of Traffic Advisories on the TIS-A display decreases and then increases, a new audio alert is sounded. The "Traffic" audio alert is also generated whenever TIS-A service becomes available. The following TIS-A audio alerts are generated:

- "Traffic"—TIS-A traffic alert received.
- "Traffic Not Available"—The traffic source(s) is/are not currently providing traffic information.

Adjusting traffic audio:

- 1) From the **Main Menu**, touch **Tools > Setup > Sound**.
- 2) Touch the '**Traffic Audio**' **Enable** Button to toggle the Traffic Audio on/off.

TRAFFIC WARNING WINDOW

When a traffic threat is imminent, the Traffic Warning Window is shown. The Traffic Warning Window shows a small pop-up map in the lower left corner. The Range Rings on the pop-up alert are spaced every whole mile/kilometer/nautical mile. Touch the Traffic Warning Window to acknowledge and remove it.



NOTE: The Traffic Warning Window is disabled when the aircraft ground speed is less than 30 knots or when on the approach leg of a route.

TRAFFIC GROUND TRACK

Traffic ground track is indicated on the aera 760 screen by a “target track vector,” a short line shown in 45-degree increments, extending in the direction of target movement.

DISPLAYING TRAFFIC DATA

TIS-A traffic can be displayed on the Navigation Map.

Adjusting TIS-A settings on the Navigation Map:

- 1) From the **Main Menu**, touch **Map** > **Menu** > **Set Up**.
- 2) Touch the Dedicated Page Icon on the Button Bar and touch the **Map** group.
- 3) Touch the **Traffic** button and touch the desired setting (**Off**, **Auto**, or range settings).

Displaying TIS-A information using the map pointer:

With traffic displayed on the Navigation Map, touch the desired TIS-A symbol on the map. The traffic range and altitude separation are displayed.

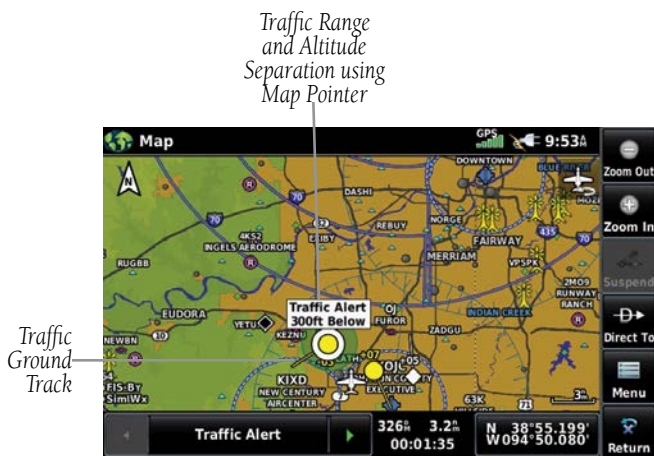

TIS-A (Navigation Map)

DATA LINK TRAFFIC

ADS-B (Automatic Dependent Surveillance-Broadcast) is a surveillance technology deployed across the United States as the cornerstone of the FAA’s Next Generation Air Transportation System (NextGen). ADS-B enables improved surveillance services, both air-to-air and air-to-ground, especially in areas where radar is ineffective due to terrain or where it is impractical or cost prohibitive. Initial applications of air-to-air ADS-B are for “advisory” use only, enhancing a pilot’s visual acquisition of other nearby ADS-B equipped aircraft either when airborne or on the airport surface.

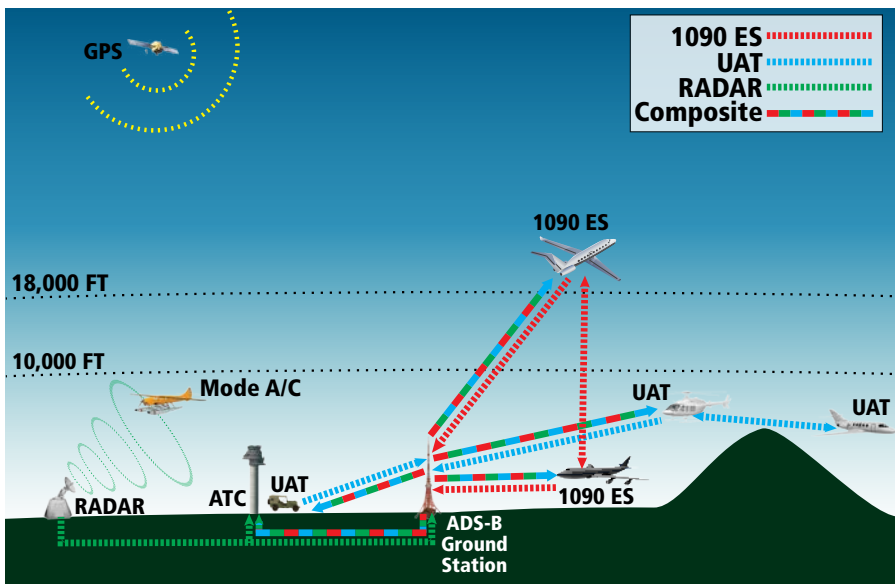

ADS-B System

For the purpose of distinguishing between levels of ADS-B service, there are three classifications of aircraft or system capability; ADS-B In, ADS-B Out, and ADS-B participating. ADS-B In refers to the capability to receive ADS-B information. ADS-B Out refers to the capability to transmit ADS-B information. ADS-B participating refers to the capability to both send and receive ADS-B information. Aircraft lacking either ADS-In, ADS-B Out, or both ADS-B capabilities may also be referred to as ADS-B non-participating aircraft.

Currently, rule-compliant ADS-B Out capability in the United States requires a TSO'ed SBAS-enabled GPS, such as a Garmin GPS 400W or similar, and one of two possible data links: 1090 ES transponder or a 978 MHz UAT. Either data link system is capable of transmitting the aircraft's position, velocity, identification, and other information every second to compatible aircraft and ground stations called Ground Based Transceivers (GBTs).

Because 1090 ES transponders and UATs operate on different frequencies, aircraft not similarly equipped cannot transmit/receive data link information directly to/from each other. Instead, operation within range of a GBT is required to receive data link information on both frequencies.

Thus, the compatible device receives traffic information directly from any ADS-B Out aircraft within range as well as the rebroadcast of ADS-B information from any nearby GBT. This rebroadcast is called Automatic Dependent Surveillance-Rebroadcast (ADS-R) and is automatically triggered by the detection of an ADS-B participating aircraft within the service volume of the GBT. The compatible device can receive both the Traffic Information Service-Broadcast (TIS-B) and Flight Information Service-Broadcast (FIS-B) provided in conjunction with ADS-R services when in range of a GBT.

FIS-B service is provided continuously, but ADS-R including TIS-B will only be broadcast by a GBT when an ADS-B participating aircraft is within the GBT's defined service volume. In this case, a GBT will only rebroadcast TIS-B information relative to the ADS-B participating aircraft. **Only traffic that is within 15 nm lateral and 3,500' vertical of the ADS-B participating aircraft is provided in the broadcast.** Non-participating traffic aircraft located farther than 15 nm laterally and 3,500' vertically from the participating aircraft is are excluded from the information transmitted by the GBT.

TIS-B traffic information includes non-participating aircraft detected by ATC surveillance radar. As TIS-B data is derived from ATC surveillance radar data, TIS-B traffic position updates typically occur every three to thirteen seconds. **Therefore, TIS-B traffic may be displayed with degraded positional accuracy. Aircraft without operating transponders are invisible to TIS-B. Aircraft operating outside of the ATC radar coverage area are also not displayed.**

Since the compatible devices are receive-only, even when used onboard an aircraft equipped with a qualifying GPS and 1090 ES transponder, a GBT may not identify it as an ADS-B participating aircraft. The squitter of some 1090 ES transponders, including the Garmin GTX 23ES, must be configured to communicate the aircraft has 978 MHz receive capability in order to be identified as an ADS-B participating aircraft.



WARNING: Do not rely solely upon the display of traffic information for collision avoidance maneuvering. The traffic display does not provide collision avoidance resolution advisories and does not under any circumstances or conditions relieve the pilot's responsibility to see and avoid other aircraft.





WARNING: Do not rely solely upon the display of traffic information to accurately depict all of the traffic within range of the aircraft. Due to lack of equipment, poor signal reception, and/or inaccurate information from aircraft or ground stations, traffic may be present that is not represented on the display.

Viewing Traffic Status:

- 1) From the **Main Menu**, touch **Tools**.
- 2) Touch **Data Link**.

SYSTEM STATUS

The traffic system status is annunciated in the upper right corner of the Map Page, as well as the bottom of the dedicated Traffic Page.

Traffic Icon	System Status
	<p>Full traffic services available for an ADS-B participating aircraft (ground linked TIS-B, FIS-B and ADS-R, and Air-to-Air ADS-B). If using a compatible device on a non-participating aircraft, this traffic icon may still be visible when within the service area of any participating aircraft. As a non-participating aircraft the compatible device is only receiving TIS-B traffic information for traffic within 15 nm and 3,500' of the participating aircraft.</p>
	<p>Limited traffic services available (may be limited to Air-to-Air ADS-B)</p>
	<p>No Traffic Data Available</p>

Traffic Modes

Some compatible devices also have a pressure altitude sensor to aid in displaying the relative altitude of received traffic information. If the compatible device is used onboard a pressurized aircraft, the pressure altitude sensor should be turned off.

Configuring a compatible ADS-B device for Pressurized or Non-Pressurized Aircraft:

- 1) From the **Main Menu**, touch **Tools > Data Link**
- 2) Touch **Menu > Device Specific Set Up**.
- 3) Touch **Pressurized** or **Not Pressurized**.

TRAFFIC DESCRIPTION

ADS-B traffic operation is similar to TIS-A discussed previously, but ADS-B adds additional symbology and capabilities. The symbols used to display ADS-B traffic are shown in the table below. The traffic label and altitude are displayed below the traffic symbol. A small up or down arrow next to the traffic symbol indicates the traffic is climbing or descending at a rate of at least 500 feet per minute. The vector line that extends from the traffic symbol is just further indication of the intruder aircraft track. For directional traffic symbols, the arrow head points in the direction of aircraft's ground track.











TRAFFIC ADVISORIES (TA)

TAs are issued for traffic when they are predicted to be within a specified volume of airspace around the aircraft in a specified amount of time. The protected volume and time interval varies based on the current geodetic altitude and groundspeed. Thus, the protected volume of airspace increases with altitude and ground speed. Refer to the following table for details.

Altitude (Geodetic)	Look Ahead Time (sec.)	Vertical Separation (ft.)	Horizontal Separation (nm.)
Below 5,000	30	+/-850	.35
5,000-10,000	40	+/-850	.55
10,000-20,000	45	+/-850	.80
20,000-42,000	48	+/-850	1.10
Above 42,000	48	+/-1,200	1.10

Traffic Advisories

Symbol	Description
	Non-threat, non-directional airborne traffic
	Non-threat directional airborne Traffic with absolute vector. Points in the direction of the aircraft track.

	Non-directional airborne Proximity Advisory (PA). Proximity Advisories are issued for any traffic within 6 nautical miles and +/- 1,200'.
	Directional airborne Proximity Advisory (PA) with absolute vector. Points in the direction of the aircraft track. Proximity Advisories are issued for any traffic within 6 nautical miles and +/- 1,200'.
	Non-directional airborne Traffic Advisory (TA)
	Non-directional off-scale airborne Traffic Advisory (TA). Displayed at outer range ring at proper bearing.
	Directional airborne Traffic Advisory (TA) with absolute vector. Points in the direction of the aircraft track.
	Directional off-scale airborne Traffic Advisory (TA). Points in the direction of the aircraft track.
	Ground traffic without directional information.
	Directional surface traffic.
	Non-directional non-aircraft ground traffic.
	Directional non-aircraft ground traffic.

ADS-B Traffic Symbology

TRAFFIC ALERTS (ADS-B TIS-B)

A traffic audio alert is generated whenever the number of Traffic Advisories on the aera 760 display increases. Limiting Traffic Advisories only reduces the “nuisance” alerting due to proximate aircraft. For example, when the first Traffic Advisories appear on the display, the user is alerted audibly. So long as a single aircraft remains on the display, no further audio alert is generated. If additional aircraft appear on the screen, a new audio alert is sounded. Traffic Advisories can only be issued when the compatible device knows its own altitude and the altitude of the intruder aircraft.



CAUTION: *Traffic Advisories can only be issued when the compatible device knows its own altitude and the altitude of the intruder aircraft.*

If the number of Traffic Advisories on the traffic display decreases and then increases, a new audio alert is sounded. The traffic audio alert is also generated whenever TIS-B service becomes available. The following traffic audio alerts are available:

- “Traffic”—TIS-B/ADS-B traffic alert received.
- “Traffic Not Available”—TIS-B/ADS-B service is not available or out of range.

Inhibiting/Enabling the traffic alerts:



NOTE: Traffic alerts are reset to 'enabled' on the next power cycle.

- 1) From the **Main Menu**, touch **Traffic**.
- 2) Touch **Menu > Alerts** to toggle between **Inhibited** and **Enabled**.

Adjusting alert volume:

- 1) From the **Main Menu**, touch **Tools > Setup > Sound**.
- 2) Touch the '**Traffic Audio**' **Enable** Button to toggle the traffic audio on/off.

TRAFFIC WARNING WINDOW

The Traffic Warning Window is shown when the compatible device issues a traffic advisory (TA). The Traffic Warning Window shows a small pop-up map in the lower left corner. The Range Rings on the pop-up alert are spaced every whole mile/kilometer/ nautical mile. Touch the Traffic Warning Window to acknowledge and remove it.

DISPLAYING TRAFFIC DATA

Traffic is displayed by default on the Map Page and in the Traffic Warning Window. Traffic Symbol and Traffic Label (i.e., relative altitude, altitude trend and absolute motion vectors) settings selects the maximum range at which traffic labels or symbols are shown. Traffic Labels can also be turned off.

Enabling/disabling traffic data on the Map Page:

- 1) From the **Main Menu**, touch **Map > Menu**.
- 2) Touch **Traffic** to enable/disable traffic data on the Map Page.

Or:

- 1) From the **Main Menu**, touch **Map > Menu > Set Up**.
- 2) Touch the Dedicated Page Icon on the Button Bar and touch the **Traffic** group.
- 3) Touch the '**Traffic Data**' **On** or **Off** button.

Customizing the traffic data on the Map Page:

- 1) From the **Main Menu**, touch **Map > Menu > Set Up**.
- 2) Touch the Dedicated Page Icon on the Button Bar and touch the **Traffic** group.
- 3) Touch '**Traffic Symbol**', '**Traffic Label**', or '**Traffic Identifier**' button and touch the desired settings ('**Off**', '**Auto**', or range settings).

Displaying Traffic information using the map pointer:

With traffic displayed on the Navigation Map, touch the desired Traffic symbol on the map to view identification, altitude and altitude trend information.



Traffic Identification

Traffic Data (Navigation Map)

DEDICATED TRAFFIC PAGE



NOTE: Altitude filter settings from the Traffic Page are carried to the Map Page.

Viewing the Traffic Page:

From the **Main Menu**, touch **Traffic**.

Changing the Altitude Filter:

- 1) From the **Main Menu**, touch **Traffic** > **Menu** > **Altitude Filter**.
- 2) Touch the desired setting:
 - **Unrestricted:** All traffic is displayed.
 - **Normal:** Displays non-threat and proximity traffic from 2,700 feet above the aircraft to 2,700 feet below the aircraft. Typically used during enroute phase of flight.
 - **Above:** Displays non-threat and proximity traffic from 9,000 feet above the aircraft to 2,700 feet below the aircraft. Typically used during climb phase of flight.
 - **Below:** Displays non-threat and proximity traffic from 2,700 feet above the aircraft to 9,000 feet below the aircraft. Typically used during descent phase of flight.



Traffic Page

FLIGHT ID DISPLAY

The Flight IDs of other aircraft (when available) can be displayed on the Traffic Page. When a Flight ID or call sign is received, it will appear below the corresponding traffic symbol when enabled.



Example ADS-B Traffic Symbol

Enabling/Disabling Flight ID Display:

From the **Main Menu**, touch **Traffic** > **Menu** > **Target Identifiers**.



WARNING: If the Aircraft Identification is NOT shown with a traffic symbol, the Relative Altitude is operating in a reduced accuracy mode. The Relative Altitude value displayed may differ from the actual Relative Altitude by several hundred feet. In all cases, the pilot must make visual contact when maneuvering to avoid traffic.

MOTION VECTORS

There are two pilot-selectable and mutually exclusive types of motion vectors, Absolute and TargetTrend, which are differentiated by color and function. Absolute vectors are white and indicate ground track as reported by the traffic. TargetTrend vectors are green and indicate the flight path and position, relative to the ownship, at which the traffic will be after the passing of one of four predetermined time intervals. The end of the TargetTrend vector indicates the traffic's predicted location relative to the predicted ownship location at the end of the look-ahead time. For example, if traffic is ahead of the ownship and traveling along the same track but at a slower rate. The motion vector would point opposite of its indicated direction of flight showing the ownship is overtaking the traffic.



TargetTrend

The TargetTrend look-ahead time interval is automatically adjusted from 30 seconds to five minutes and corresponds to the traffic display range setting. The greater the range setting, the longer the time interval and vice versa. Refer to the table below for more details.

Traffic Page Range Ring Settings	TargetTrend Look-ahead
.5nm to 2nm	30 seconds
2nm to 6nm	60 seconds
6nm to 12nm	2 minutes
12nm to 40nm	5 minutes

TargetTrend Look-ahead

Motion vector selection is made from the Traffic Page Menu by enabling/disabling TargetTrend. Absolute vectors are selected by default and are replaced when TargetTrend is enabled.

Enabling/Disabling TargetTrend for Traffic and Map Pages:

From the **Main Menu**, touch **Traffic > Menu > Target Trend**.

Or:

From the **Main Menu**, touch **Map > Menu > Set Up > Traffic**. Select Target Trend 'On' to activate on the Navigation Map.

While TargetTrend is active, the screen will annunciate the current look-ahead time interval in the lower right corner.

TARGETTREND ON MAP

In addition to the Traffic Page, the Map Page can show TargetTrend vectors of nearby traffic. These indications are overlaid on top of regular topographic maps and VFR/IFR charts, showing how nearby traffic relates to surrounding waypoints, airspaces and ground features.



WARNING: The TargetTrend vectors shown on the Map Page represent **relative motion in relation to the aircraft, not absolute motion in relation to the ground.**



TargetTrend Overlaid on Moving Map

Enabling/Disabling TargetTrend Overlay:

- 1) With the Map Page displayed, touch **Menu** > **Set Up** > **Traffic**.
- 2) Touch **On** or **Off**.

Blank Page

SECTION 5 ADDITIONAL FEATURES

5.1 CHARTS



NOTE: The availability of SafeTaxi, ChartView, or FliteCharts in electronic form may not preclude the requirement to carry paper charts aboard the aircraft. See the pertinent manual for more information.



NOTE: Features that are selectable on the Map Page, such as obstacles, airports, airspace, and other waypoint types that are not visible beneath the overlaid chart, remain selectable even when an approach chart is overlaid on the Map Page.



NOTE: Do not use SafeTaxi or Chartview functions as the basis for ground maneuvering. SafeTaxi and Chartview do not comply with the requirements of AC 120-76C and are not qualified to be used as an airport moving map display (AMMD). SafeTaxi and Chartview should only be used by the flight crew to orient themselves on the airport surface.

The Chart Tab on the Waypoint Page will default to the nearest airport if no flight plan or destination airport is present. While you are on the ground, the displayed charts will default to the current airport location regardless of flight plan. The optional ChartView and FliteCharts provide on-board electronic terminal procedures charts. Electronic charts offer the convenience of rapid access to essential information. Either ChartView or FliteCharts may be configured, but not both.

ChartView resembles the paper version of Jeppesen terminal procedures charts. The charts are displayed in full color with high-resolution. The Map depiction shows the aircraft position on the moving map in the plan view of approach charts and on airport diagrams. Airport Hot Spots are outlined in magenta. The ChartView available data includes:

- Arrivals (STAR)
- Airport Diagrams
- Approaches
- Departure Procedures (DP)
- NOTAMs

Viewing a chart from the Waypoint Page:

- 1) From the **Main Menu**, touch **Waypoint** > **Charts** Tab.
- 2) If the desired airport is not displayed, touch the Waypoint Identifier Button.
- 3) Enter the desired airport using the keypad and touch **Enter**.

Or:

- a) Touch **Find**.
- b) Touch the **Search Name** or **Search City** Tab.
- c) Touch the **Search by Facility Name** or **Search by City** button.
- d) Enter the facility name or city using the keypad and touch **Enter**.
- e) Touch the desired airport from the list.

Or:

- a) Touch **Find**.
- b) Touch the **Recent**, **Nearest Airports**, **Flight Plan**, or **User** Tab.
- c) Touch the desired airport from the list.
- 4) Touch  on the Chart Button to display a list of available charts.
- 5) To display INFO (Information) charts (e.g., Airport Diagram, Alternate Minimums, Takeoff Minimums, etc.), touch the desired **INFO** chart from the list.

Or:

To display APR (Approach) charts (e.g., ILS, RNAV, etc.), touch the desired **APR** from the list.

Or:

To display DP (Departure Procedure) charts, touch the desired **DP** chart from the list.

Or:

To display STAR (Arrival Procedure) charts, touch the desired **STAR** chart from the list.

- 6) If desired, touch **Zoom In** or **Zoom Out**.
- 7) If desired, touch **Expand** to declutter the page and view only the chart. Touch **Reduce** or **Back** to return to the normal view.

Waypoint Identifier Button
(Touch to change airport)

Chart Button
(Touch to select chart)



Expand/Reduce Button

Charts Tab

Waypoint Information Page (Charts Tab)

Changing the chart color mode:

- 1) From the **Main Menu**, touch **Tools > Setup > Display**.
- 2) Touch the '**Chart Color Mode**' Data Option Button, and touch the desired option from the list (**Day, Night, or Auto**).

GEO-REFERENCED AIRCRAFT POSITION AND CHART OVERLAY

The geo-referenced aircraft position is placed on the chart when a position is established. On the Map Page, the chart overlay and geo-referenced position are shown when the aircraft is in the air (such as, speed is greater than 30 knots). Typically, SIDs and STARs are not geo-referenced and thus will not typically display the ownship symbol on those charts.

Displaying the chart overlay on the Map Page:

From the **Main Menu**, touch **Map > Menu > Charts**.

Adjusting the chart overlay opacity:

- 1) From the **Main Menu**, touch **Tools > Setup > Map**.
- 2) Touch the '**Chart Overlay Opacity**' Data Option Button, and touch the desired percentage.



Geo-Referenced Aircraft Position and Chart Overlay
(Waypoint Page and Map Page)

5.2 SAFETAXI



NOTE: With the availability of SafeTaxi in electronic form, it is still advisable to carry another source of charts on board the aircraft.

SafeTaxi is an enhanced feature that gives greater map detail when viewing airports at close range. When viewing at ranges close enough to show the airport detail, the map reveals taxiways with identifying letters/numbers, runway incursion "Hot Spot", and airport landmarks including ramps, buildings, control towers, and other prominent features. Resolution is greater at lower map ranges. The SafeTaxi feature can be seen on the Navigation Map or from the Waypoint Information Runway Tab.

Designated Hot Spots are recognized at airports with many intersecting taxiways and runways, and/or complex ramp areas. Airport Hot Spots are outlined to caution pilots of areas on an airport surface where positional awareness confusion or runway incursions happen most often. Hot Spots are defined by a red shaded area.

During ground operations the aircraft's position is displayed in reference to taxiways, runways, and airport features. When panning over the airport, features such as runway holding lines and taxiways are shown at the cursor.

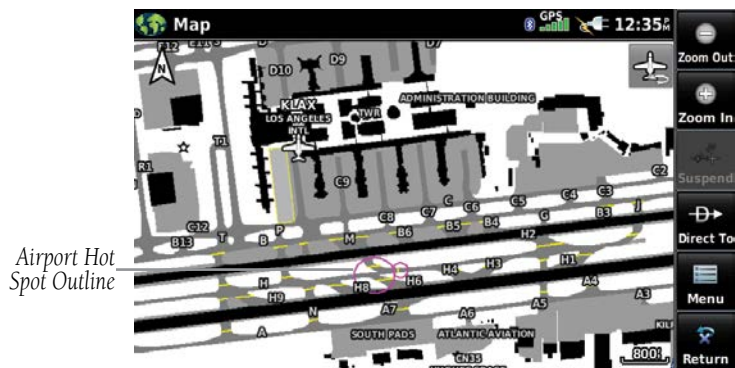

SafeTaxi Depiction

Enabling/disabling SafeTaxi:

- 1) From the **Main Menu**, touch **Map** > **Menu** > **Set Up**.
- 2) Touch the Dedicated Page Icon on the Button Bar and touch the **Airport** Group.
- 3) Touch the '**Safetaxi**' **On** or **Off** Button.

SAFETAXI CYCLE NUMBER AND REVISION

SafeTaxi database is revised every 56 days. SafeTaxi is always available for use after the expiration date. When turning on the aera 760, the database initialization indicates whether the databases are current, out of date, or not available. The database initialization shows the SafeTaxi database is current when the SafeTaxi name and expiration date are shown in white. When the SafeTaxi cycle has expired, the SafeTaxi name and expiration date will appear in yellow.

The SafeTaxi Region, Cycle, Effective date and Expiration date of the database cycle can also be found from the **Main Menu**, by touching the **Tools** > **Database**.

The SafeTaxi database is provided by Garmin. Refer to Appendix C for instructions on updating the SafeTaxi database.

5.3 AIRPORT DIRECTORY DATA

The Airport Directory contains airport statistics such as pattern altitudes, noise abatement information, FBO phone numbers, hours of operation, local attractions, ground transportation, lodging, and services.

The AOPA Airport Directory provides data on airports and heliports throughout the U.S. and it is updated on a 56-day cycle. Detailed information for over 5,300 U.S. airports, along with the names and phone numbers of thousands of FBOs can be viewed. This service allows the pilot to plan an overnight, choose fuel stops, find ground transportation, etc.

Optional airport directory databases such as AC-U-KWIK are also supported. AC-U-KWIK provides complete listings of FBOs, charter companies, fuel suppliers, ground transportation, maintenance and catering services at public airports across the world.

If the AOPA database is in use, the **AOPA** Tab is displayed on the Waypoint Page. If another airport directory database is in use, such as AC-U-KWIK, the **DIRECTORY** Tab is displayed on the Waypoint Page.

Viewing AOPA Airport Directory information:

- 1) From the **Main Menu**, touch **Waypoint** > **AOPA** Tab.
- 2) Touch the Waypoint Identifier Button.
- 3) Enter a waypoint identifier using the keypad and touch **Enter**.

Or:

- a) Touch **Find**.
- b) Touch the **Recent, Nearest Airports, Flight Plan, or User** Tab.
- c) Touch the desired waypoint.

Or:

- a) Touch **Find**.
- b) Touch the **Search Name** Tab.
- c) Touch **Search by Facility Name**.
- d) Enter the desired Facility Name using the keypad.
- e) Touch **Enter**.

Or:



- a) Touch **Find**.
 - b) Touch the **Search City** Tab.
 - c) Touch **Search by City**.
 - d) Enter the desired City using the keypad.
 - e) Touch **Enter**.
- 4) If duplicate entries exist for the entered facility name or location, duplicate waypoints are displayed. Touch the desired waypoint from the list.



Airport Directory Data

Or:

- 1) From any map highlight an airport using the Map Pointer.
- 2) Touch the Map Feature Button.
- 3) Touch the **AOPA** Tab (if necessary).

Icon	Description
	Restaurant on Field
	Self Serve Fuel
	Courtesy Car

Airport Directory Service Icons

FUEL PRICES

Viewing fuel prices on the Navigation Map:

From the Main Menu, touch Map > Menu > Fuel Prices.



Navigation Map Menu



Fuel Prices (Navigation Map)

5.4 SiriusXM® RADIO



NOTE: Refer to the Hazard Avoidance Section for information about SiriusXM Weather products.



NOTE: You **MUST** have a compatible SiriusXM device connected to your aera and a subscription to SiriusXM Radio to use SiriusXM Radio features.



NOTE: Audio interference can occur while using some audio panels. Use of a Ground Loop Isolator can eliminate this interference.

COMPATIBLE SiriusXM DEVICES

Compatible SiriusXM Devices
GDL 51/51R
GDL 52/52R
*Also additional support via Flight Stream

SiriusXM Satellite Radio offers a variety of radio programming over long distances without having to constantly search for new stations. Based on signals from satellites, coverage far exceeds land-based transmissions. SiriusXM Satellite Radio services are subscription-based.

Accessing SiriusXM Radio:

From the **Main Menu**, touch **Tools > SiriusXM Audio**.

ACTIVATING SIRIUSXM SATELLITE RADIO SERVICES

The service is activated by providing SiriusXM Satellite Radio with a coded ID (Radio ID).

SiriusXM Satellite Radio uses the Radio ID to send an activation signal that, when received by the compatible SiriusXM device, allows it to play entertainment programming.

Refer to the compatible SiriusXM device Owner's Manual for more information on activating SiriusXM Satellite Radio.

Accessing the Radio ID:

From the **Main Menu**, touch **Tools > Data Link**.

Or:

The Radio ID is also displayed on channel '0'. Channel '0' is the first channel listed in the '**All Channels**' Category.



Accessing the SiriusXM Radio ID
(Data Link Information)



Accessing the SiriusXM Radio ID
(Channel 0)

USING SiriusXM RADIO

The SiriusXM Radio function provides information and control of the audio entertainment features of the SiriusXM Satellite Radio.

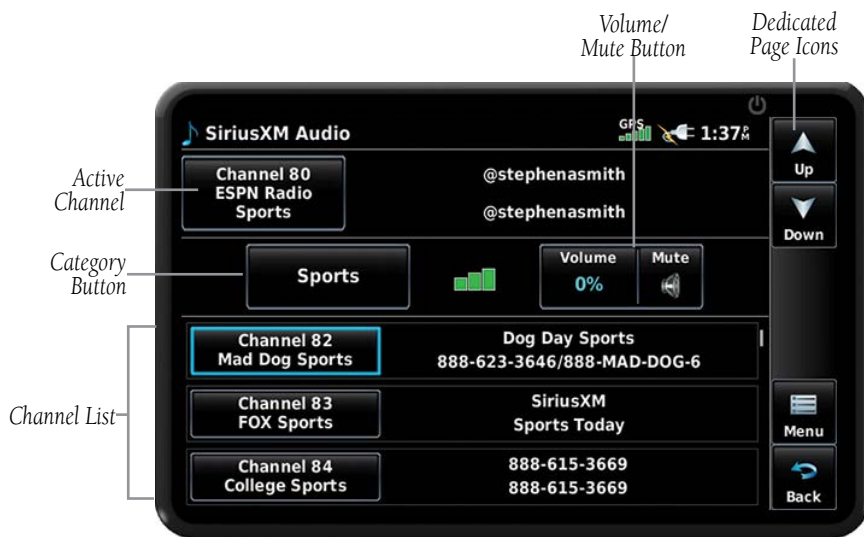

SiriusXM Radio Overview

CATEGORY BUTTON

The Category Button displays a list of categories such as jazz, rock, or news.

Selecting a category:

- 1) From the **Main Menu** touch **Tools** > **SiriusXM Audio**.
- 2) Touch the 'Category' Button.

ACTIVE CHANNEL AND CHANNEL LIST

The Channel List shows a list of the available channels for the selected category. The active channel is outlined blue (in the Channel List).

Selecting a channel from the channel list:

- 1) Scroll through the Channel List by touching and dragging the list up/down or touching the **Up/Down** Buttons.
- 2) Touch the desired channel. The channel is outlined blue to show it is the active channel.

Entering a channel number:

- 1) From the **Main Menu**, touch **Tools > SiriusXM Audio > Menu > Select Channel**.
- 2) Enter the desired channel using the numeric keypad and touch the **Enter** Button.



Channel Number Entry

USING FAVORITES

Favorites is a customized category of up to 30 of your SiriusXM Radio favorites.

To add a channel to Favorites:

- 1) From the **Main Menu** touch **Tools > SiriusXM Audio**.
- 2) Touch and hold the desired channel. A confirmation window is displayed.
- 3) Touch **Yes**.

Selecting Favorites:

- 1) From the **Main Menu** touch **Tools > SiriusXM Audio**.
- 2) Touch the 'Category' Button.
- 3) Touch the **Favorites** Category.

To delete channel(s) from Favorites:

- 1) With the **Favorites** Category displayed (see Selecting Favorites above), touch the desired channel to be removed (unless removing all) and touch the **Menu** Key.
- 2) Touch the '**Remove Favorite**' Menu Option.

Or:

Touch the '**Remove All Favorites**' Menu Option.

- 3) Touch **Yes**. The channel(s) are removed from the **Favorites** Category.

VOLUME**Adjusting SiriusXM volume:**

- 1) From the **Main Menu** touch **Tools** > **SiriusXM Audio**.
- 2) Touch the **Volume** Button.
- 3) Touch the +/- buttons to enter the desired volume.

Muting SiriusXM Audio:

- 1) From the **Main Menu**, touch **Tools** > **SiriusXM Audio**.
- 2) Touch the **Mute**  Icon.

SECTION 6 APPENDICES

APPENDIX A: MESSAGES, ALERTS & DATA FIELD OPTIONS

MISCELLANEOUS MESSAGE ADVISORIES

Message	Comments
Approaching Target Altitude	Within 200 feet of final VNAV target altitude.
Approaching VNAV Profile	The aircraft is within one minute of reaching the initial VNAV decent point.
Arriving at XXX	The aircraft is nearing the destination.
Battery Low	The battery needs to be recharged.
Can't Unlock Maps	No applicable unlock code for one or more maps was found. All MapSource maps are not accessible.
Database Error	Internal problem with the system. Contact a Garmin dealer or Garmin Product Support to have the unit repaired.
Fuel Tank	A reminder for switching fuel tanks. The reminder message repeats at the specified interval after the beginning of each trip.
Lost Satellite Reception	The system is unable to receive satellite signals.
Memory Full	System memory is full, no further data can be saved.
Near Proximity Point	The aircraft has reached the distance set for a proximity waypoint.
Next DTK XXX	The aircraft is nearing a turn in a route.
Proximity Memory Full	No additional proximity waypoints can be saved.
Proximity Radius Overlaps	The radius of two proximity waypoints overlap.
Route Already Exists	A route name that already exists has been entered.

MISCELLANEOUS MESSAGE ADVISORIES (CONT.)

Message	Comments
Route Memory Full	No additional routes can be saved.
Route Truncated	Uploaded route from another device has more than 300 waypoints.
Route Waypoint Memory Full	No additional route waypoints can be saved.
Steep Turn Ahead	Approaching a turn that requires a bank angle in excess of 25 degrees to stay on course.
Track Already Exists	A saved track with the same name already exists.
Track Log Full	The track log is full and track recording was turned off. To record more track points, clear the track log and turn track recording on.
Track Memory Full	No more track data can be stored. Delete the old track data to store the new data.
Track Truncated	A complete uploaded track will not fit in memory. The oldest track log points have been deleted.
VNAV Cancelled	VNAV function has been cancelled due to a change in the active route.
Waypoint Already Exists	A waypoint with the same name already exists.
Waypoint Memory Full	The unit has stored the maximum number of waypoints.

AIRSPACE MESSAGES

Message	Comments
Inside Airspace	Inside the boundaries of the airspace.
Airspace Near and Ahead	Within two nautical miles of an airspace and the current course takes you inside the airspace.
Airspace Ahead, Within 10 Minutes	The projected course takes you inside an airspace within the next 10 minutes or less.
Airspace Near, Within 2 nm	Within two nautical miles of an airspace but not projected to enter it.

DATA FIELD & NUMERIC DATA OPTIONS

Data Field/Numeric Data	Definition
Accuracy	The current accuracy of the GPS determined location.
Altitude	The current altitude in geometric height above Mean Sea Level (MSL).
AGL	<p>Approximate height above ground level, calculated using GPS altitude and terrain database. AGL data will not be displayed if current height above ground relative to GPS vertical position accuracy is insufficient for accurate calculation.</p> <p>The AGL height data field is NOT intended to be used as a primary reference for terrain avoidance and does not relieve the pilot from the responsibility of being aware of surroundings during flight.</p>
Bearing	The compass direction from the present position to a destination waypoint.
Course to Steer	The recommended direction to steer in order to reduce cross-track error and return to the course line.
Crosstrack Error	The distance the aircraft is off a desired course in either direction, left or right.
Desired Track	The desired course between the active "from" and "to" waypoints.
Distance (Destination)	The distance to the destination waypoint in the Active Flight Plan
Distance (Next)	The distance to the next waypoint in the Active Flight Plan.
En Route Safe Altitude	The recommended minimum altitude within ten miles left or right of the desired course on a active flight plan or direct-to.
Flight Timer	Total time in-flight (HH:MM).

Data Field/Numeric Data	Definition
Fuel Timer	Elapsed time since the Fuel Tank Reminder Alarm was last issued (HH:MM).
Glide Ratio	The estimated distance an aircraft will move forward for any given amount of lost altitude.
Ground Speed	The velocity the aircraft is traveling relative to a ground position.
Ground Track	The direction of aircraft movement relative to a ground position.
Minimum Safe Altitude	Uses Grid MORAs to determine a safe altitude within ten miles of the aircraft's present position.
Next Waypoint	The next waypoint in the flight plan or direct-to route.
Sunrise	The time at which the sun rises on this day (current location).
Sunset	The time at which the sun sets on this day (current location).
Estimated Time En Route (Destination)	The estimated time it takes to reach the destination waypoint from the present position, based upon current ground speed.
Estimated Time En Route (Next)	The estimated time it takes to reach the next waypoint from the present position, based upon current ground speed.
Estimated Time of Arrival (Destination)	The estimated time at which the aircraft should reach the destination waypoint, based upon current speed and track.
Estimated Time of Arrival (Next)	The estimated time at which the aircraft should reach the next waypoint, based upon current speed and track.
Estimated Time to VNAV	The estimated time it takes to reach the VNAV waypoint from the present position, based upon current ground speed.

Data Field/Numeric Data	Definition
Time of Day (Local)	The current time and date in 12-hour or 24-hour format.
Time (UTC)	The current time and date in Universal (UTC) time.
Vertical Speed	The rate of climb or descent (GPS-derived).
Vertical Speed Required	The vertical speed necessary to descend/climb from a current position and altitude to the previously selected VNAV position and altitude, based upon current groundspeed.
Weather (Altimeter)	The altimeter setting at the nearest METAR reporting station.
Weather (Dew Point)	The dew point at the nearest weather reporting station.
Weather (Rel. Humidity)	The relative humidity at the nearest weather reporting station.
Weather (Temperature)	The temperature at the nearest weather reporting station.
Weather (Wind)	The wind speed and direction at the nearest weather reporting station.

AURAL ALERTS

TRAFFIC

- “Traffic”—TIS-A/B traffic alert received.
- “Traffic Not Available”—TIS-A/B service is not available or out of range.

TERRAIN

- “Five Hundred”—when the aircraft descends through 500 feet above the destination airport.

The following aural terrain alerts are issued when flight conditions meet parameters that are set within the software algorithms, and are dependant on the sensitivity level set in the Terrain Setup Menu.

Alert Severity	Terrain	Obstacle	Descent Rate
Caution	"caution, terrain" "caution, terrain ahead"	"caution, obstacle" "caution, obstacle ahead"	"caution, sink rate"
Warning	"terrain ahead! pull up!" "terrain! terrain! pull up! pull up!"	"obstacle ahead! pull up!" "obstacle! obstacle! pull up! pull up!"	"sink rate, pull up!" "pull up!"

Aural Alerts

APPENDIX B: ABNORMAL OPERATION

LOSS OF GNSS POSITION

When the aera 760 loses the GNSS signal for any reason, the following will occur:

- A flashing red question mark will appear over the airplane icon on the map.
- The 'Lost Satellite Reception' message will display.
- Any GNSS dependent data fields will not be available.

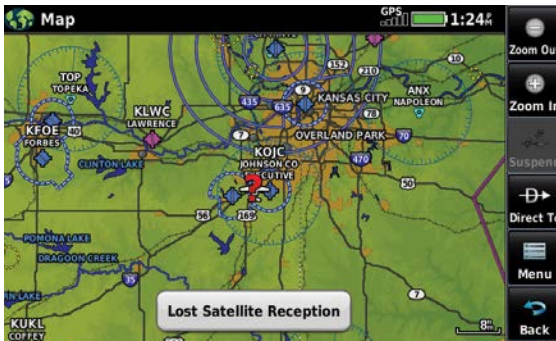

GNSS Signal Lost

HAZARD DISPLAY WITH LOSS OF GNSS POSITION

If the Terrain function doesn't have at least a 3D fix (i.e. altitude unknown), a Red X will be displayed.

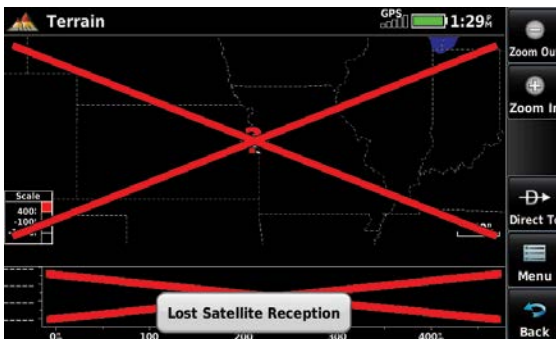

Terrain Red X

Overview

Navigation

Flight Planning

Hazard Avoidance

Additional Features

Appendices

Index

Blank Page

APPENDIX C: MANAGING FILES AND DATABASES

CONNECTING TO A COMPUTER

The aera 760 can be connected to a computer using the included USB-C to PC Interface Cable to connect to a USB data port.



USB-C Connection

Connecting the aera 760 to a computer:

- 1) (Optional Step) Insert a memory card into the memory card slot. Press it in until it clicks.
- 2) Turn the unit on.
- 3) Connect the small end of the USB cable to the connector.
- 4) Connect the larger end of the USB cable to a USB port on the computer. The Mass Storage Icon appears on the screen, along with an icon indicating the usage mode. The aera 760 and memory card appear as removable drives in My Computer in Windows and as mounted volumes on Mac computers.



Mass Storage Icon

Mass Storage Mode**MANAGING FILES**

NOTE: The aera 760 is not compatible with Windows95[®], 98, Me, Windows NT[®], and Mac[®] OS 10.3 and earlier.



NOTE: PDFs must be stored in the "PDF" folder located in the root directory. The user may organize the PDFs inside this folder by creating additional folders.

Files can be stored in the aera 760 internal memory or the optional memory card.

Supported File Types
GPX route files
GPI custom POI files from the POI Loader Application
Maps, routes, trip logs, and waypoints from MapSource [®]
PDFs



aera 760 File Types**MAPSOURCE DETAILED MAPS**

The included USB Interface Cable is used to transfer MapSource[®] CD-ROM data to the aera 760 internal memory or optional MicroSD Card.

For compatible MapSource® products, refer to the Garmin web site at www.garmin.com/cartography.

TRANSFERRING FILES

To transfer files:

- 1) Browse the computer for the file to copy.
- 2) Highlight the file, and select **Edit > Copy**.
- 3) Open the "Garmin" or memory card drive/volume.
- 4) Select **Edit > Paste**. The file appears in the list of files in the aera 760 memory or on the memory card.
- 5) When finished transferring files, click  in the toolbar (system tray), or drag the volume icon to the  trash can on Mac computers.
- 6) Unplug the aera 760 from the computer

MicroSD™ CARD USE (OPTIONAL)

The aera 760 uses an optional MicroSD™ Card for storing data. The maximum recommended size is 32 GB. Note the MicroSD Card must be formatted for 'FAT32'. If a MicroSD Card is installed and an error message is displayed indicating the card is not formatted for FAT32, one of two issues have occurred:

- The card is not formatted for FAT32. Reformat using a computer and specify the FAT32 format.
- The card is formatted for FAT32, but the partitioning is not acceptable for use in the aera 760. Should this be the issue, a different MicroSD Card must be used. It is generally only older and smaller MicroSD Cards which will have unacceptable partitioning.

INSTALLING AND REMOVING MicroSD™ CARDS

Install the MicroSD Card in the slot located on the left side of the unit. Only remove the MicroSD Card when the unit is OFF.

You can load a variety of information to the aera 760 internal memory or MicroSD Card, such as MapSource detailed maps in a MapSource program.



MicroSD™ Slot

MicroSD Card Slot

Installing a MicroSD Card:

- 1) Firmly push the card into the unit. It is not necessary to force the card. The handle is still exposed when it is properly inserted.
- 2) The unit takes a few seconds to read the card. When the data card has been properly installed and accepted, a summary screen noting the card details appears. Touch to acknowledge.

Removing a MicroSD Card:

- 1) With the unit turned 'OFF', push the card into the unit until it stops.
- 2) Release the card. The card should eject for easy removal.
- 3) With the card ejected, pull the card out of the slot.

DATABASE TYPES

The basemap database contains data for the topography and land features, such as rivers, lakes, and towns. It is updated only periodically, with no set schedule. There is no expiration date.

The terrain database contains the terrain mapping data. The database is updated periodically and has no expiration date.

The obstacle database contains data for obstacles, such as towers, that pose a potential hazard to aircraft. Obstacles 200 feet and higher are included in the obstacle database. It is very important to note that not all obstacles are necessarily charted and therefore may not be contained in the obstacle database. This database is updated on a 56-day cycle and does not expire.



NOTE: *The data contained in the terrain and obstacle databases comes from government agencies. Garmin accurately processes and cross-validates the data, but cannot guarantee the accuracy and completeness of the data.*

The Safe Taxi database contains detailed airport diagrams for selected airports. These diagrams aid in following ground control instructions by accurately displaying the aircraft position on the map in relation to taxiways, ramps, runways, terminals, and services. This database is updated on a 56-day cycle and does not expire.

GARMIN AVIATION DATABASES

The Garmin database updates can be obtained via Wi-Fi or by visiting the 'flyGarmin' website (www.flygarmin.com).

After the databases have been updated, check the appropriate databases are initialized and displayed on the start-up screen after applying power.

AIRPORT DIRECTORY DATABASES

The AOPA Airport Directory provides data on airports and heliports throughout the U.S. and it is updated on a 56-day cycle. Detailed information for over 5,300 U.S. airports, along with the names and phone numbers of thousands of FBOs can be viewed. This service allows the pilot to plan an overnight, choose fuel stops, find ground transportation, etc.

Optional airport directory databases such as AC-U-KWIK are also supported. AC-U-KWIK provides complete listings of FBOs, charter companies, fuel suppliers, ground transportation, maintenance and catering services at public airports across the world.

NAVIGATION DATABASE

The aera 760 includes an internal navigation database that provides location and facility information for thousands of airports, VORs, NDBs, and more. There are two navigation database products available: the Garmin Navigation database containing coverage for North America (expanded coverage is planned for the future), and the Jeppesen Navigation database containing coverage for the world, available in regionalized options. Database purchases are available online (www.fly.garmin.com). However, once the databases are purchased, the ability to download and install databases is available from the aera 760 via Wi-Fi.



NOTE: Although the Garmin and Jeppesen Navigation Databases contain much of the same information, pilots may notice differences in behavior, nearest list functionality, airspace display, and map page display details due to data content variations.

The following information is provided from the internal navigation database:

- *Airport—identifier, facility name, city/state/country, latitude/longitude, field elevation, available fuel types, runway designations and layout, runway surface, runway length, runway width, runway lighting, communication frequencies, and published approaches.
 - Weather—frequencies associated with an airport (ASOS, ATIS, and AWOS).
 - *VORs—identifier, facility name, city/state/country, location (latitude/longitude), frequency, service volume (high, low, terminal), and type (such as VOR-DME, TACAN, and VORTAC).
 - *NDBs—identifier, facility name, city/state/country, location (latitude/longitude), and frequency.
 - Intersections—identifier, nearest VOR, radial and distance from nearest VOR, location (latitude/longitude), and region/country.
 - ARTCC—Air Route Traffic Control Centers.
 - Airspace—boundaries (Class B, Class C, Control Zones, SUAs, and MOAs), controlling agency, and vertical boundaries.
 - FSS—Flight Service Stations.
- * Symbology used for NDBs, VORs, and airports is consistent with those used on a sectional chart.



NOTE: After performing a navigation database update, verify all flight plan(s) (routes) are current. If there is an obsolete aviation point in a saved route, the route is locked and unusable. A new route with current navigation database points will need to be created.

DATABASE PURCHASE, INSTALLATION, AND UPDATES

Database purchases are available online (www.flygarmin.com). However, once the databases are purchased online, the ability to download and install databases is available from the aera 760 via Wi-Fi.

Database downloads can be automatically downloaded as updates become available, or be user-initiated.

DATABASE PURCHASE

Purchasing databases:

- 1) If necessary, from www.fly.garmin.com register the unit and purchase the desired databases.
- 2) Connect to a Wi-Fi network on the aera 760:
 - a) From the **Main Menu**, touch **Tools** > **Setup** > **Wi-Fi** > **On**.
 - b) Touch **Add Network**.
 - c) Touch the desired network to add.
 - d) If necessary, enter the password using the keypad and touch **Enter**.

'EASY UPDATE' DATABASE DOWNLOADING AND INSTALLATION (AUTOMATED AND USER-INITIATED)

Enabling automated database downloads:

- 1) If Automatic Database Downloads are currently disabled, from the **Main Menu**, touch **Tools** > **Downloads**.
- 2) Touch **Enable Automatic Downloads** to enable automatic download of updated databases as they become available.

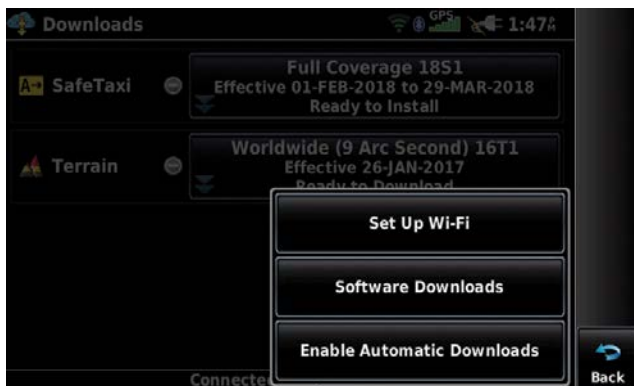

Enabling Automatic Downloads

Automated database download/install:

If Automatic Database Downloads are enabled (refer to previous procedure), a Database Installation window is automatically displayed once a database becomes available to install, and either at least one of the currently installed databases is expired, or if there are no databases currently installed.



Automated Database Installation Window

The Automated Database installation window may indicate, 'Additional selection available' indicating the user is required to select one or more databases for download, if not all of the database downloads were completed automatically.



Automated Database Installation Window - Additional Selection

- 1) Touch **Dismiss** to pause the installation and return to the currently displayed page.
- 2) Touch **View** to display to the Downloads Page.
- 3) Touch **Install** to install the database(s) and reboot the unit. When choosing **Install**, the unit immediately begins database installation and cannot be used until installation is complete and the unit reboots.



Database Downloads Installing

Disabling automated database downloads:

- 1) If Automatic Database Downloads are currently enabled, from the **Main Menu**, touch **Tools > Downloads**.
- 2) Touch **Disable Automatic Downloads** to disable automatic download of updated databases as they become available.

Overview

Navigation

Flight Planning

Hazard Avoidance

Additional Features

Appendices

Index

User-Initiated database download/install:

- 1) From the **Main Menu**, touch **Tools** > **Downloads**.
- 2) Touch **Easy Update** to begin downloading all updated databases. Databases will continue to download even if the **Downloads** page is not displayed.



Database Downloads Page

- 3) If multiple databases of the same type are ready for download and an Easy Update database has not been selected, the user is required to specify which database to install.



Multiple Database Installation - Additional Installation Options

- 4) Once the databases are downloaded, an Easy Database Update window is displayed. The user has 30 seconds to **Install** or **Postpone** immediate installation.

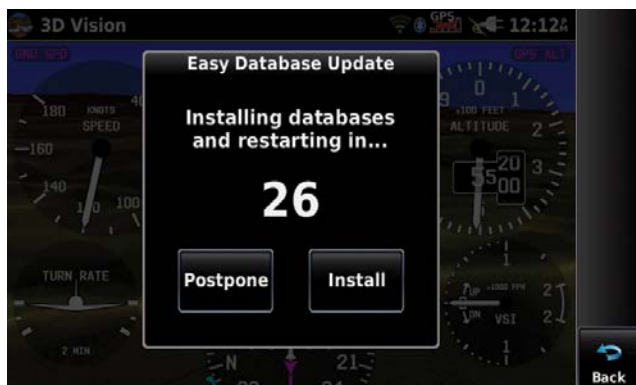

Easy Database Update Window

- a) Touch **Postpone** to exit the installation process and resume at a later time.
- b) Touch **Install** to start the database installation process. The unit reports as the database is "Preparing to Install" and "Installing". The unit automatically reboots when the installation is complete.
- c) Allow the timer to expire to start the database installation process.

SELECTING CHART REGIONS FOR DOWNLOAD

The user is not prompted to select chart regions when downloading charts via Easy Update. Instead, regions are based on the user's previous selections. In order to change the downloaded regions, touch the **Ready to Download** button, then touch **Download** to display the Region Download Selector page.

Some entries in the Downloads page, such as IFR and VFR charts, are categories that group together multiple downloads. Touching a category entry will show a secondary selector screen to select specific content to download. Selector screens display their contents organized as lists and as maps.

For the IFR and VFR Charts category, the selector screen will show a list of regions, such as states for US charts, territories for Canadian charts, etc. Touch a region name to select all charts covering that region; touch selected region names again to deselect them. Region name buttons in List view do not necessarily correlate with specific IFR or VFR charts; instead selecting a region name will select multiple charts on which that region appears. Touching the Map button will switch to map view.

The map view for categories of downloads shows a map of that category's regions, with a grid of chart coverage areas overlaid on it. Touch any of the coverage areas to select that chart for download. Touch a selected coverage area again to deselect it. Touch the Start Download button to start downloading the selected charts.

Selecting/changing chart regions for download:

- 1) From the **Main Menu**, touch **Tools** > **Downloads**.
- 2) Touch the **Ready to Download** button for the desired chart.



Downloads Page

- 3) Touch **Download**.



Downloads Page - Selecting Chart Regions

- 4) Touch the region names to select/deselect.
- 5) Touch **Start Download**.



Region Download Selector - List View

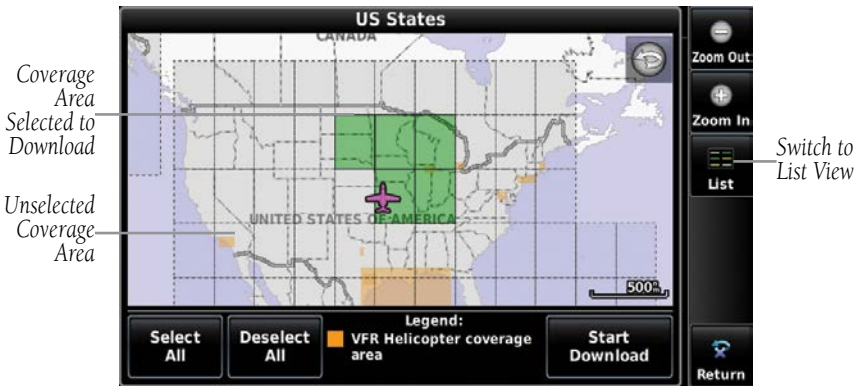

Region Download Selector - Map View

SOFTWARE UPDATES

In addition to databases, the aera 760 will check for software updates when connected to the internet over Wi-Fi. The aera 760 can use Wi-Fi to update its system software, as well as any other software available from Garmin.

Software downloads can be either user-initiated or configured to automatically download as updates become available.

User-Initiated software download/install:

- 1) From the **Main Menu**, touch **Tools** > **Downloads**.
- 2) Touch **Menu** > **Software Downloads**.
- 3) Touch the desired software update and touch **Next**.
- 4) Read the Software License Agreement and touch **Agree and Install**.

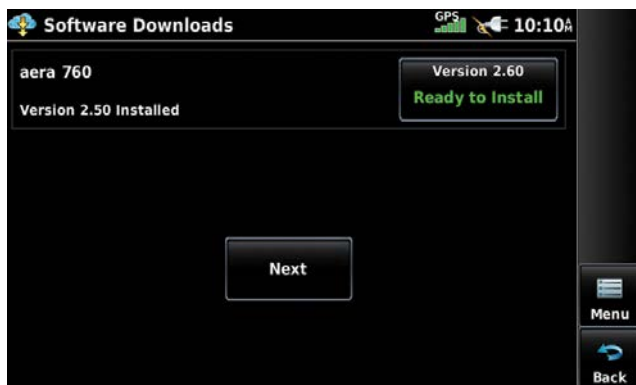

Software Downloads Page

Enabling automated software downloading:

- 1) If Automatic Software Downloading is currently disabled, from the **Main Menu**, touch **Tools** > **Downloads**.
- 2) Touch **Menu** > **Software Downloads** > **Menu**.
- 3) Touch **Yes**.

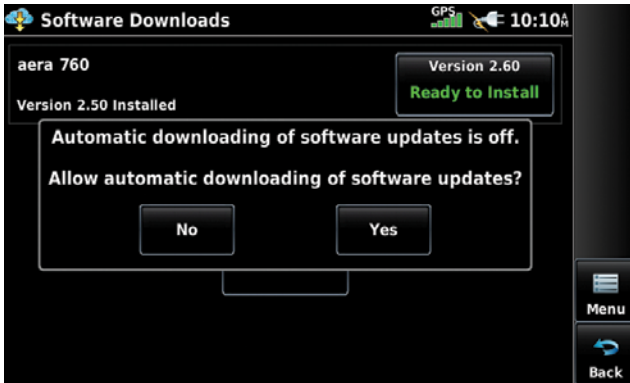

Enabling Automatic Software Downloads

Automated software download/install:

If Automatic Software Downloading is currently enabled (refer to previous procedure), a 'Update Software' window is automatically displayed once a software update becomes available.

- 1) From the 'Update Software' window, touch **Yes** to view the update.
- 2) Touch the desired software update and touch **Next**.
- 3) Read the Software License Agreement and touch **Agree and Install**.



Software Update Notification

Disabling automated software download/install:

- 1) If Automatic Software Downloading is currently enabled, from the **Main Menu**, touch **Tools > Downloads**.
- 2) Touch **Menu > Software Downloads > Menu**.
- 3) Touch **No**.



Disabling Automatic Software Downloads

APPENDIX D: INSTALLATION AND INTERFACING

MOUNTING THE aera 760 IN THE AIRCRAFT

The included aera cradle can be mounted to the optional yoke mount. The yoke mount is designed to fit the majority of conventional aircraft yokes and center column controls. The yoke mount is sold as an optional accessory.

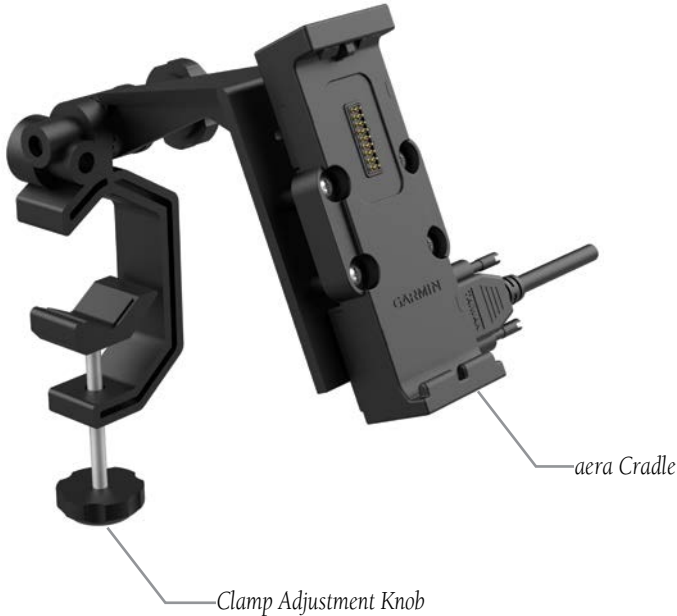

WARNING: It is the sole responsibility of the owner/operator of the aera 760 to place this mount and secure the unit so that it will not interfere with the aircraft's operating controls and safety devices, or cause damage or personal injury in the event of an accident or turbulence. Do not mount the aera 760 where the pilot or passengers are likely to impact it in an accident, collision, or turbulence. The mounting hardware provided by Garmin is not warranted against turbulence, collision damage, or related consequences.



NOTE: After installation, verify flight controls are free and clear per the flight manual of the applicable aircraft and the aera 760 yoke mount and wiring do not cause any interference with the flight controls.



NOTE: *Readjust the position of the aera 760 to provide the best view of the display screen as lighting conditions change.*

Attaching the yoke mount to the yoke shaft or control arm:

- 1) Open the clamp by turning the Clamp Adjustment Knob until it can be easily placed over the yoke shaft or control arm. Install the yoke mount as far from the panel as is practical.
- 2) When in place, tighten the Clamp Adjustment Knob to secure the yoke mount to the yoke shaft or control arm.
- 3) Loosen the Cradle Adjustment Knob, then orient the aera 760 as desired.
- 4) Tighten the Cradle Adjustment Knob to hold the aera 760 in place.
- 5) Connect power/data cables.

Attaching the aera 760 to the yoke mount:

- 1) Fit the bottom of the aera 760 into the cradle.
- 2) Tilt the aera 760 back until it snaps into place.

Removing the aera 760 from the yoke mount:

- 1) Press the Release Button on the side of the mount to release the aera 760.
- 2) Lift out the aera 760.

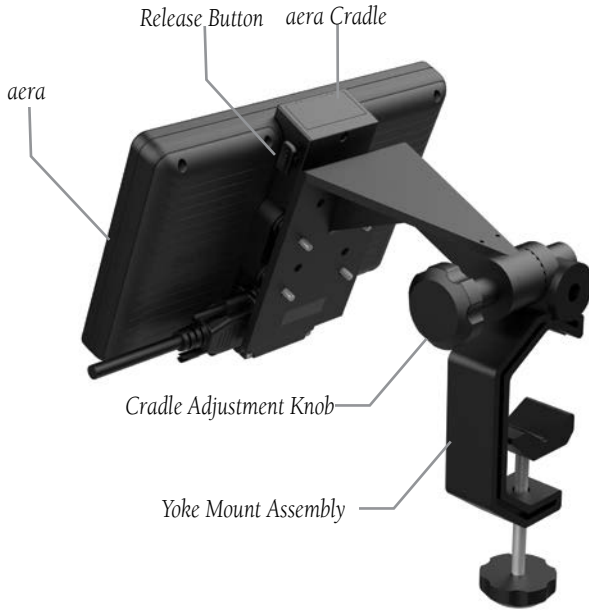

Connecting the cables:

Make all applicable cable connections.

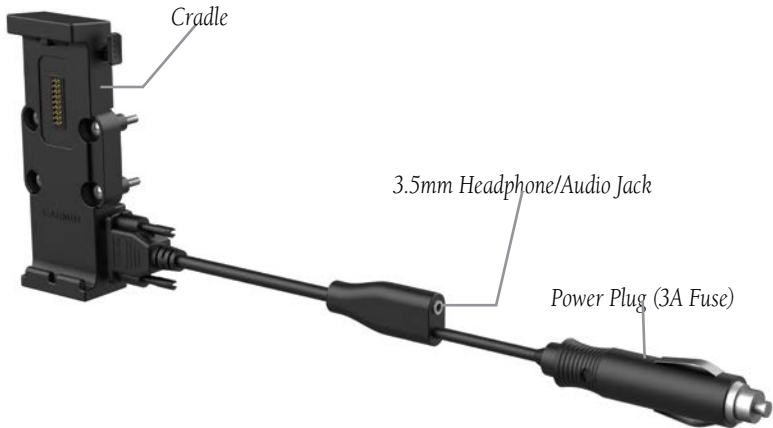

Reconfiguring the yoke mount for center column yokes:

- 1) Loosen and remove the Cradle Adjustment Knob, spacer, and rubber washer.
- 2) Rotate the clamp assembly 90° so the clamp opening faces away from you.
- 3) Secure the clamp assembly to the rest of the yoke mount using the Cradle Adjustment Knob, spacer, and rubber washer. Adjust the clamp angle before fully tightening the Cradle Adjustment Knob.

Yoke Mount in Conventional Configuration

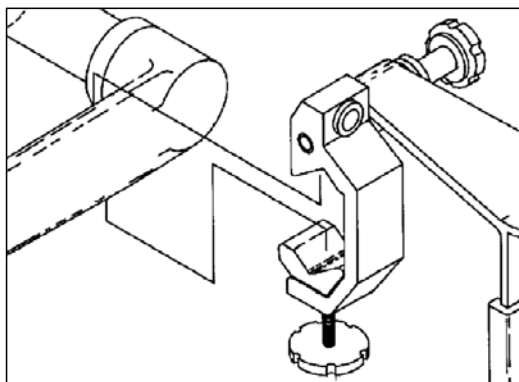
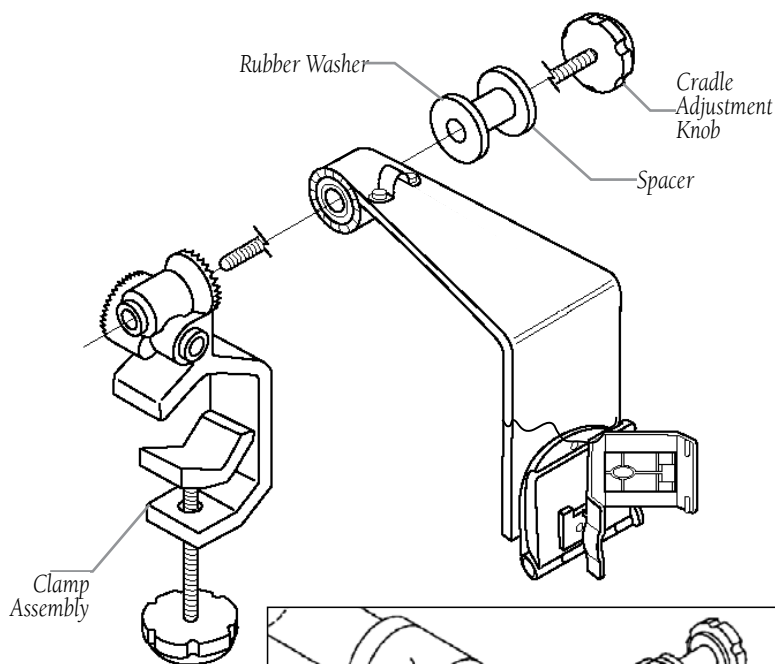

Yoke Mount in Forward-Facing Configuration

Securing the cable on the top of the yoke mount:

- 1) Remove the screws securing the cable clamp.
- 2) Orient the cable and secure the clamp with the screws.

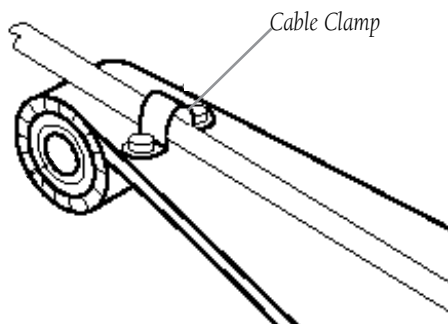

Removing the yoke mount from the yoke shaft (or control arm):

- 1) Disconnect the cable connectors from the aircraft.
- 2) Loosen the clamp by turning the Clamp Adjustment Knob until the clamp assembly can be easily removed from the yoke shaft or control arm.

CONNECTING TO A GARMIN VHF COMM RADIO

The aera 760 can also output frequency data to a Garmin aviation radio. For additional information refer to the applicable installation manual. Currently the following models are supported:

- SL30 NAV/COMM
- SL40 COMM
- GTR 225 COMM
- GNC 255 NAV/COMM
- GTR 200 COMM



NOTE: For additional information refer to the SL30, SL40, GTR 225, GNC 255, or GTR 200 installation manual.



CAUTION: This interface does not have an FAA installation airworthiness approval. If any tuning or operational abnormalities are encountered with the SL30, SL40, GTR 225, GNC 255, or GTR 200, disconnect the aera 760 from the applicable tuning interface.

Outputting frequency data to a SL40, SL30, GTR 200, GTR 225, or GNC 255:

- 1) Connect the aera 760 to the applicable nav/comm radio using the Aviation Bare Wire Connector (optional accessory).



aera 760 Aviation Bare Wire Connector

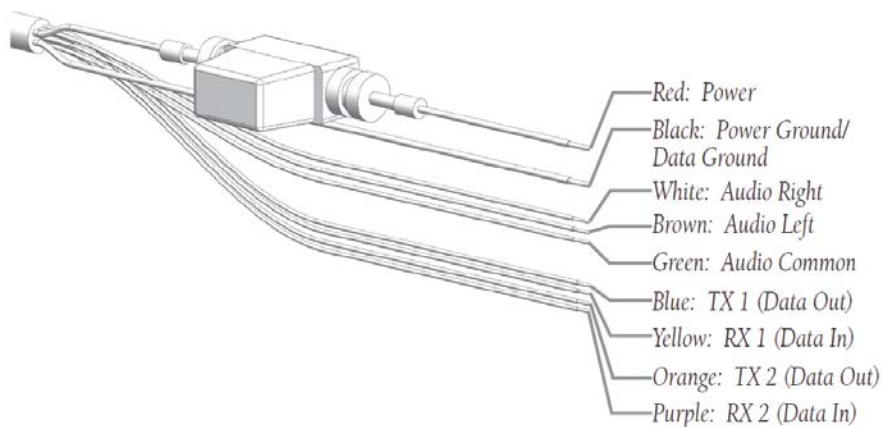

aera 760 Aviation Bare Wire Connections

- 2) From the **Main Menu**, touch **Tools > Setup > Interface**.
- 3) Touch the **Serial Data Format** Button. A vertical list is displayed.
- 4) Touch '**Aviation In/NMEA & VHF Out**' or '**GTX TIS-A In/NMEA & VHF Out**'. These comm modes send both NMEA data and VHF frequency information.

The following features are now available on the radio:

- Remote frequency lists for departure, enroute, and arrival airports.
- Nearest VOR frequencies (SL30 only).

The aera 760 can also directly tune a standby frequency.

Selecting a standby comm frequency:

- 1) From the **Main Menu**, touch **Waypoint > Freq Tab**
- 2) Touch the desired frequency from the list. The frequency is now tuned in standby.

INFORMATION ABOUT USB DRIVERS

When connecting the aera 760 to a USB port, the computer prompts you to locate the destination of the drivers for the device. Only install the drivers once. After the drivers are installed, your computer always detects your aera 760 when it is connected. USB driver updates can be found at www.garmin.com.

INTERFACING

The following formats are supported for connection of external devices: NMEA 0180, 0182, 0183 (versions 1.5, 2.0, 2.3, 3.01), ASCII Text Output, and Garmin proprietary formats for connecting to a Mode S transponder for TIS-A data, and to a Garmin aviation NAV/COM radio.

The following are the Approved Sentences for NMEA 0183, version 3.01 output: GPRMC, GPGGA, GPGSA, GPGSV, GPGLL, GPBOD, GPRTE, and GPWPL. The following are the Proprietary Sentences for NMEA 0183, version 3.01 output: PGRME, PGRMZ, PGRMM, and PGRMH.

Garmin's proprietary communication protocol is available from the Web site (www.garmin.com).

GENERAL INTERFACE SETUP

The Interface Setup controls the input/output format used when connecting the unit to external devices.

Selecting an interface:

- 1) From the **Main Menu**, touch **Tools** > **Setup** > **Interface**.
- 2) Touch **Serial Port 1** or **Serial Port 2**.
- 3) Touch **Serial Data Format**. A vertical list is displayed.
- 4) Touch the desired data format ('**Garmin Data Transfer**', '**NMEA Out**', '**Aviation In**', '**Aviation In/NMEA & VHF Out**', '**GTX TIS-A In**', '**GTX TIS-A In/NMEA & VHF Out**', '**Garmin Data Transfer**', '**MapMX**', or '**None**').

Restoring interface defaults:

From the **Main Menu**, touch **Tools** > **Setup** > **Interface** > **Menu** > **Restore Default**.

SERIAL DATA FORMATS

- **None**: Provides no interfacing capabilities.
- **NMEA Out**: Transmits NMEA position, velocity, and navigation data.
- **Aviation In**: The proprietary format used for connection to a Garmin panel-mounted GPS receiver. This eliminates the need to enter the destination on both units. If the external device supports both the Aviation In and MapMX formats, Garmin recommends using the preferred MapMX format.
- **Aviation In/NMEA & VHF Out**: Receives aviation data and transmits out both NMEA data, at 9600 baud, and VHF frequency tuning information to a Garmin Nav/Comm radio.
- **GTX TIS-A In**: Receives TIS-A data from a Garmin Mode S transponder or other compatible device.
- **GTX TIS-A In/NMEA & VHF Out**: Receives TIS data and transmits out both NMEA data, at 9600 baud, and VHF frequency tuning information to a Garmin Nav/Comm radio.
- **Garmin Data Transfer**: The proprietary format used to exchange data with a PC, weather/traffic device, or another Garmin aera 760.

- **Connex 57600 Baud:** Connex datalink source at 57600 baud. Used to receive ADS-B traffic and weather data if connected to a compatible receiver.
- **MapMX:** Receives flight plan and navigation data from Garmin navigators. When MapMX data is received, a more accurate depiction of the flight plan legs are displayed on the moving map (i.e., holds, procedure turns, etc.). MapMX is the preferred data source when interfacing with Garmin navigators.

ADVANCED NMEA OUTPUT SETUP

If interfacing the aera 760 with another piece of equipment (such as an autopilot), the unit needs to be set to output NMEA data. If the NMEA output mode is set to 'Fast', the unit will output a minimum number of NMEA sentences at 1-second intervals. If the NMEA output is set to 'Normal', the unit will output a greater number NMEA sentences as 2-second intervals.

Setting NMEA output mode:

- 1) From the **Main Menu**, touch **Tools > Setup > Interface**.
- 2) Touch **Serial Data Format**. A vertical list is displayed.
- 3) Touch '**NMEA Out**'.
- 4) Touch **NMEA Output Mode** to toggle between '**Normal**' or '**Fast**'.

NMEA Sentence Output:

- Normal Mode: GPRMB, GPRMC, GPGGA, GPGSA, GPGSV, GPGLL, GPBWC, GPVTG, GPXTE, GPBOD, GPRTE, GPWPL, GPAPB, PGRME, PGRMZ, PGRMM, and PGRMH.
- Fast Mode: GPRMB, GPRMC, PGRMZ, and PGRMH.

CONFIGURING AERA 760 FOR A GDL 39

To receive weather and traffic information from the GDL 39, the GDL 39 must be connected to the aera using the 'GDL 39 Power/Data Cable to aera 760 Series, using a Bluetooth connection, or through a bare wire installation (aera bare wire cable P/N 010-12994-11 to GDL 39 bare wire cable P/N 010-11686-40). The GDL 39 can only be connected to Serial Port 1 on the aera. The aera must also be configured correctly to receive traffic and weather information from the GDL 39 as described below.

Configuring aera for a GDL 39:

- 1) The GDL 39/39R may be connected to either serial (RS-232) port on the aera 760.
- 2) From the **Main Menu**, touch **Tools** > **Setup** > **Interface**.
- 3) Touch the '**Serial Data Format**' field. A vertical list is displayed.
- 4) Touch '**Garmin Data Transfer**'. Garmin Data Transfer is only available on Serial Port 1.
- 5) From the **Main Menu**, touch **Tools** > **Data Link** to view GDL 39 connection status.



CAUTION: Never remove power from the aera or GDL 39 during a software update. Anytime the aera software is updated it may also contain firmware updates for products such as the GDL 39. The aera software will update first, after the unit reboots it will update the firmware of a connected GDL 39. You can view the GDL 39 update progress on the Data Link Information Page.

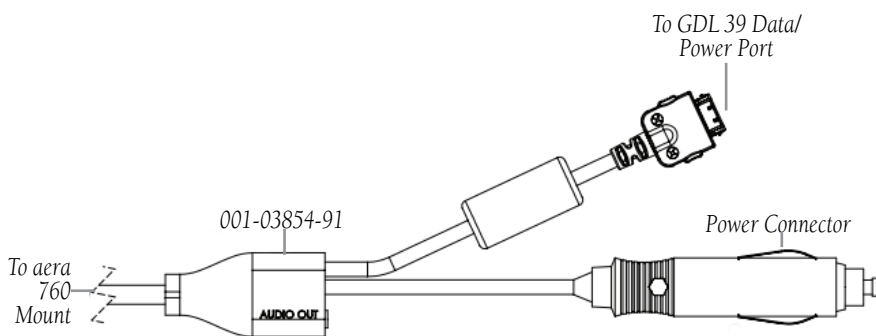

GDL 39 Power/Data Cable to aera

Connection	aera Bare Wire Color	GDL 39 Bare Wire Color
TX1 (Data Out) from aera	TX1 Blue Wire	White/Green Wire
RX1 (Data In) into aera	RX1 Yellow Wire	Green Wire

aera Aviation Bare Wire Connections to GDL 39

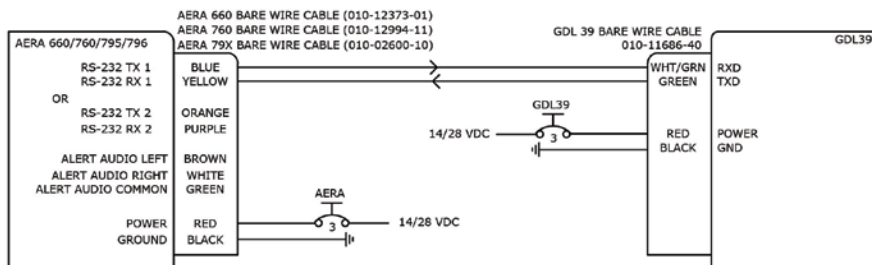

aera 760 Bare Wire Connections to GDL 39

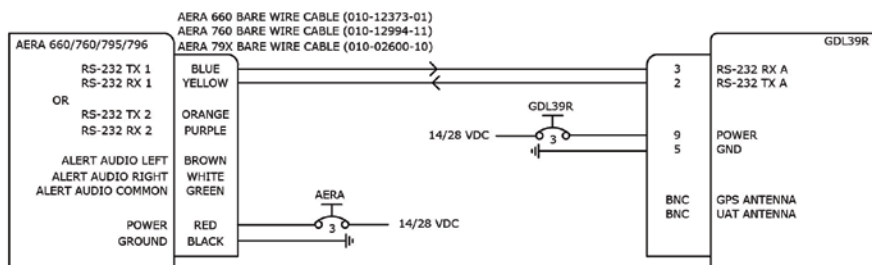

aera 760 Bare Wire Connections to GDL 39R



NOTE: External GPS antenna not required on either GDL 39 or GDL 39R when connected to aera 760.



NOTE: External UAT antenna should be mounted on bottom of aircraft with 1 meter separation from COM and XPDR antennas.

CONFIGURING AERA 760 WITH THE GTX 345

The GTX 345 may be connected to either serial (RS-232) port on the aera 760 and may be connected to any serial port on the GTX 345.

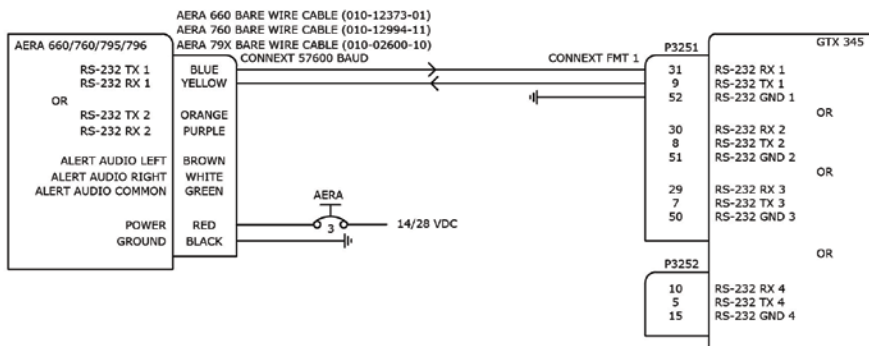

aera 760 Bare Wire Connections to GTX 345

Configuration Guidance:

- aera 760:** From the **Main Menu**, touch **Tools > Setup > Interface**.
- aera 760:** Touch **Serial Port 1** or **Serial Port 2**.
- aera 760:** Touch the '**Serial Data Format**' field. A vertical list is displayed.
- aera 760:** Touch '**Connexxt 57600 Baud**'.
- GTX 345:** Hold '**ON**' and '**ENT**' buttons to enter Setup Mode.
- GTX 345:** Press the **FUNC** Button to display the RS-232 Setup Page.
- GTX 345:** Select RS-232 channel connected to the aera 760.
- GTX 345:** Set input and output format to '**Connexxt FMT 1**'.

CONFIGURING AERA 760 FOR A GDL 50/51/52

To receive weather and traffic information from the GDL 50/51/52, the GDL 50/51/52 must be connected to the aera using the Power/Data Cable (P/N 010-12373-02), using a Bluetooth connection, or through a bare wire installation (aera bare wire cable P/N 010-12994-11). The GDL 50/51/52 may be connected to Serial Port 1 or Serial Port 2 on the aera as long as the respective port is configured appropriately. The aera must also be configured correctly to receive traffic and weather information from the GDL 50/51/52 as described below.

Configuring aera for a GDL 50/51/52:

- 1) Connect the aera to the GDL 50/51/52 through the Power/Data Cable or bare wire installation.
- 2) From the **Main Menu**, touch **Tools > Setup > Interface**.
- 3) Touch **Serial Port 1** or **Serial Port 2**.
- 4) Touch the '**Serial Data Format**' field. A vertical list is displayed.
- 5) Touch '**Connext 57600 Baud**'.
- 6) From the **Main Menu**, touch **Tools > Data Link** to view the GDL 50/51/52 connection status.



CAUTION: *Never remove power from the aera or GDL 50/51/52 during a software update. Anytime the aera software is updated it may also contain firmware updates for products such as the GDL 50/51/52. The aera software will update first, after the unit reboots it will update the firmware of a connected GDL 50/51/52. You can view the GDL 50/51/52 update progress on the Data Link Information Page.*

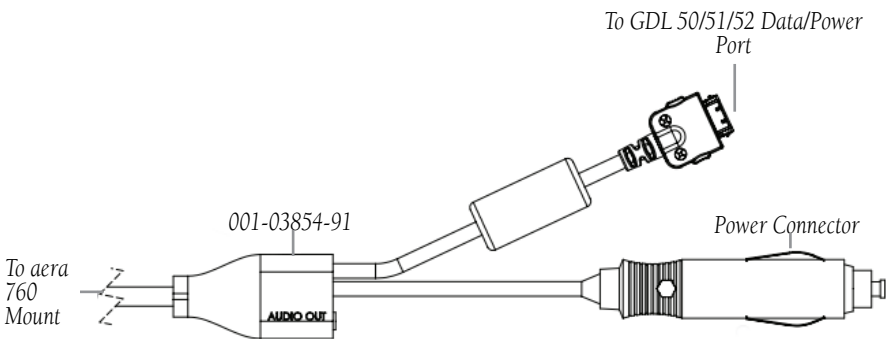

GDL 50/51/52 Power/Data Cable to aera

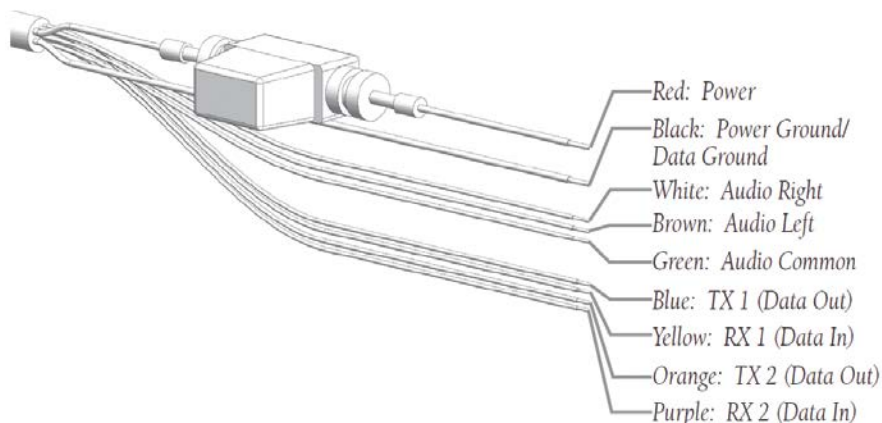

aera 760 Bare Wire Connections

Connection	aera Bare Wire Color	GDL 50/51/52 Bare Wire Color
TX1 (Data Out) from aera	TX1 Blue Wire	White/Green Wire
RX1 (Data In) into aera	RX1 Yellow Wire	Green Wire
TX2 (Data Out) from aera	TX2 Orange Wire	White/Orange Wire
RX2 (Data In) into aera	RX2 Purple Wire	Orange Wire

aera Bare Wire Connections to GDL 50/51/52

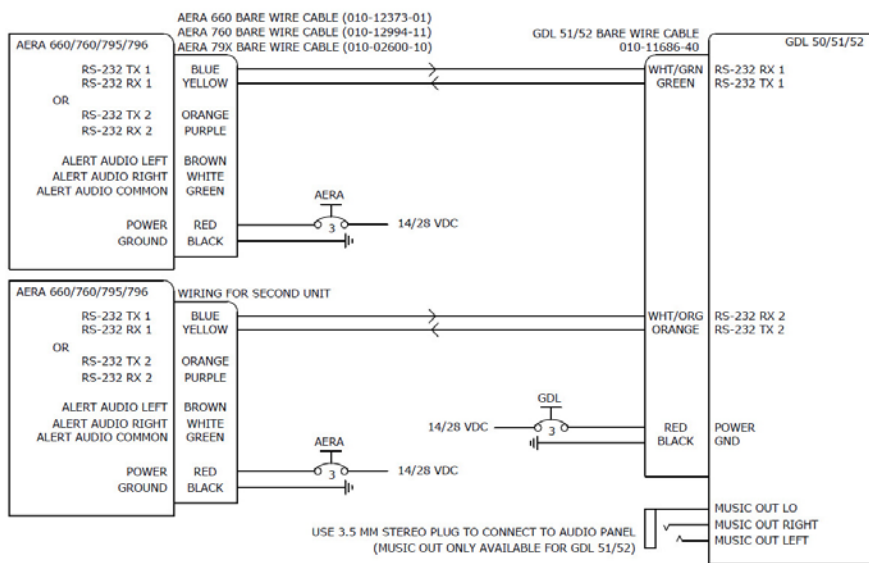

aera 760 Bare Wire Connections to GDL 50/51/52

CONFIGURING AERA 760 FOR A GDL 50R/51R/52R

The GDL 50R/51R/52R may be connected to either serial (RS-232) port on the aera 760.



NOTE: External GPS antenna not required when connected to aera 760.



NOTE: External UAT antenna should be mounted on bottom of aircraft with 1 meter separation from COM and XPDR antennas.



NOTE: SXM antenna should be located on glare shield (GA26XM, GA24TNC) or top of aircraft (GA55/55A/57X).

Configuring aera for a GDL 50R/51R/52R:

- 1) Connect the aera to the GDL 50R/51R/52R through the Power/Data Cable or bare wire installation.
- 2) From the **Main Menu**, touch **Tools > Setup > Interface**.
- 3) Touch **Serial Port 1** or **Serial Port 2**.

- 4) Touch the **'Serial Data Format'** field. A vertical list is displayed.
- 5) Touch **'Connexx 57600 Baud'**.
- 6) From the **Main Menu**, touch **Tools > Data Link** to view the GDL 50R/51R/52R connection status.

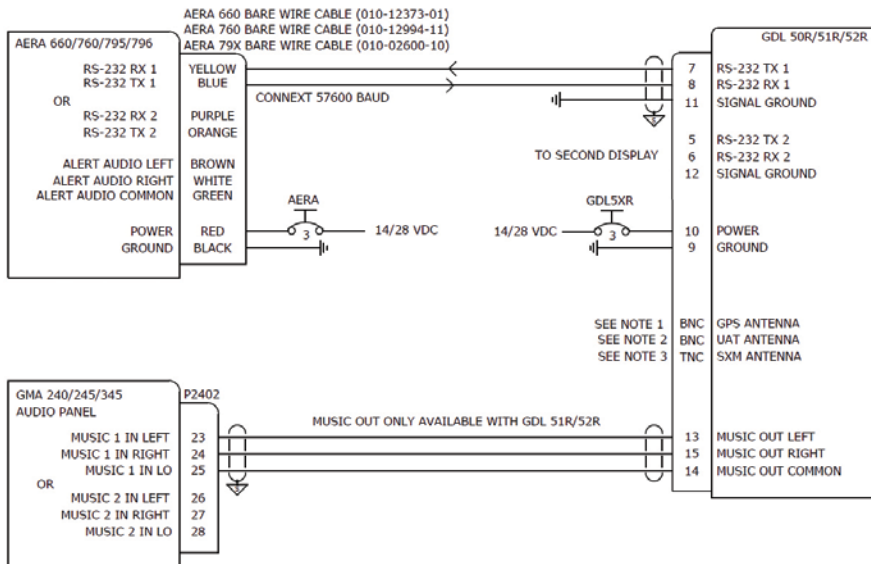

aera 760 Bare Wire Connections to GDL 50R/51R/52R

CONFIGURING AERA 760 WITH THE GNX 375

The GNX 375 may be connected to one or both serial ports on the aera as long as the respective port is configured appropriately. This drawing shows connections for Connex ADs-B traffic/weather and MapMX flight plan data. Both connections are optional.

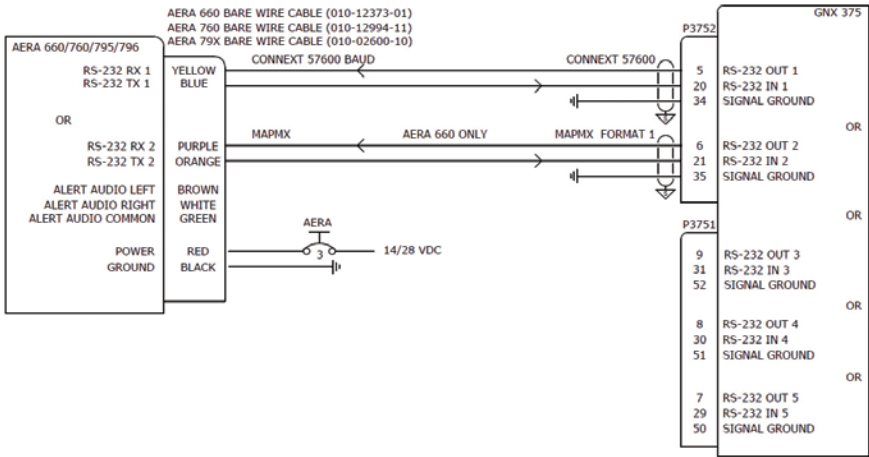

aera 760 Bare Wire Connections to GNX 375

Configuration Guidance:

- aera 760:** From the **Main Menu**, touch **Tools > Setup > Interface**.
- aera 760:** Touch **Serial Port 1** or **Serial Port 2** depending on which serial port is being configured.
- aera 760:** Touch the '**Serial Data Format**' field. A vertical list is displayed.
- aera 760:** Touch '**Connex 57600 Baud**' or '**MapMX**' depending on the connection that is being configured.
- GNX 375:** Select **Setup > Interfaces > RS-232**.
- GNX 375:** Select RS-232 Channel Connected to **aera 760**.
- GNX 375:** Set Input and Output format to '**Connex 57600**' for the traffic/weather data connection or to '**MapMX Format 1**' for the flight plan data connection.
- aera 760:** From the **Main Menu**, touch **Tools > Data Link** to view the GNX 375 connection status.

PAIRING A GDL, GTX, OR NAVIGATOR DEVICE VIA BLUETOOTH

Pairing a GDL, GTX, or Navigator device via Bluetooth:

- 1) From the **Main Menu**, touch **Tools** > **Setup** > **Bluetooth**.
- 2) Touch Bluetooth **On/Off** to turn on the Bluetooth.
- 3) Touch **Not Connected** next to the device name. A Bluetooth Passkey window will open.
- 4) Touch **OK**.
- 5) Touch **Connected** to disconnect.

The Bluetooth Setup Menu provides several options for connecting to Bluetooth devices. **Manage Paired Devices** can enable Automatic Reconnect and remove connections on a per-device basis.

PAIRING THE GDL 51/52 TO AN AUDIO DEVICE

The GDL 51/52 can also be paired using its internal Bluetooth connection to play audio.

Pairing the GDL 51/52 to an audio device:

- 1) From the **Main Menu**, touch **Tools** > **Data Link**.
- 2) Touch **Menu** > **Manage Connex Bluetooth**.
- 3) Touch **Menu**.
 - a) To add a device, touch **Add Audio Devices** > **Pair Device**.
 - b) To remove a device, touch **Remove Paired Devices** and touch the red X to select the desired device.

USING AN EXTERNAL GPS ANTENNA (OPTIONAL)

The optional GA25 external antenna can be used. Connect the antenna to the connector located on the left side of the unit.



External Antenna Connector

Overview

Navigation

Flight Planning

Hazard Avoidance

Additional Features

Appendices

Index

Blank Page

APPENDIX E: BATTERY AND CARE INFORMATION

BATTERY INFORMATION

The aera 760 contains a lithium-ion battery. To maximize the lifetime of the battery, do not leave the aera 760 in direct sunlight, and avoid prolonged exposure to excessive heat.

The  battery icon in the top right of the screen indicates the status of the aera 760 battery. To increase the accuracy of the battery gauge, fully discharge the battery and fully charge it. Do not unplug the aera 760 until it is fully charged.

MAXIMIZING THE BATTERY LIFE

- Turn down the backlight (refer to the 'System Settings' chapter of this section).
- Do not leave the unit in direct sunlight, in a cool (not freezing) place. When storing the unit, store within the following temperature ranges: safe storage -15° to 55° C, or long term storage 0° to 25° C.
- Do not operate the unit outside of the following temperature range: -15° to 55° C.
- Avoid prolonged exposure to excessive heat.

CHANGING THE FUSE

If the unit does not charge, the fuse may need to be replaced.

- 1) Unscrew the round end piece, and remove it.
- 2) Remove the fuse (glass and silver cylinder), and replace with a 3A fast-blow fuse.
- 3) Ensure the silver tip is placed in the end piece. Screw on the end piece.

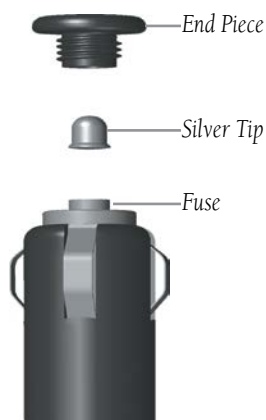

CLEANING THE CASING

The aera 760 is constructed of high-quality materials and does not require user maintenance other than cleaning. Clean the outer casing (not the touchscreen) using a cloth dampened with a mild detergent solution, and then wipe dry. Avoid chemical cleaners and solvents that can damage plastic components.

CLEANING THE TOUCHSCREEN

The aera 760 display uses a lens coated with a special coating that is very sensitive to abrasive cleaners. **AVOID CHEMICAL CLEANERS AND SOLVENTS THAT WILL HARM THE SPECIAL COATING.** It is very important when cleaning the touchscreen to use a clean, lint-free cloth (lightly dampened with water, if necessary).

PROTECTING THE UNIT

- Do not store the aera 760 where prolonged exposure to extreme temperature can occur.
- Though a PDA stylus can be used to operate the touchscreen, never attempt this while operating an aircraft. Never use a hard or sharp object to operate the touchscreen.

APPENDIX F: GENERAL TIS-A INFORMATION



NOTE: Aircraft without an operational transponder are invisible to TIS-A.



WARNING: Do not rely solely upon the display of traffic information for collision avoidance maneuvering. The traffic display does not provide collision avoidance resolution advisories and does not, under any circumstances or conditions, relieve the pilot's responsibility to see and avoid other aircraft.



WARNING: Do not rely solely upon the display of traffic information to accurately depict all of the traffic within range of the aircraft. Due to lack of equipment, poor signal reception, and/or inaccurate information from aircraft or ground stations, traffic may be present that is not represented on the display.

The Traffic Information Service (TIS-A) provides traffic advisory information to non-TAS/TCAS-equipped aircraft. TIS-A is a ground-based service providing the relative locations of all ATCRBS (Air Traffic Control Radar Beacon System) Mode-A and Mode-C transponder equipped aircraft within a specified service volume. The TIS-A ground sensor uses real-time track reports to generate traffic notification. The aera 760 displays TIS-A traffic information on the Navigation Map. Surveillance data includes all transponder-equipped aircraft within the coverage volume. The aera 760 displays up to eight traffic targets within a 7.5-nm radius, from 3,000 feet below, to 3,500 feet above the requesting aircraft.

TIS-A VS. TAS/TCAS

The main difference between the Traffic Information System (TIS-A) and Traffic Advisory (TAS) or Traffic Collision Avoidance Systems (TCAS) is the source of surveillance data. TAS/TCAS uses an airborne interrogator with a half-second update rate, while TIS-A utilizes the terminal Mode-S ground interrogator and accompanying data link to provide a five-second update rate. TIS-A and TAS/TCAS have similar ranges.

TIS-A LIMITATIONS

TIS-A relies on surveillance of the Mode-S radar system, which is a “secondary surveillance” radar system similar to that used by ATCRBS. Many limitations are inherent in secondary radar surveillance. Information provided by TIS-A is neither better nor more accurate than the information used by ATC. TIS-A is intended only to assist in visual acquisition of other aircraft in visual meteorological conditions (VMC). While TIS-A is a useful aid for visual traffic avoidance, system limitations must be considered to ensure proper use. No recommended avoidance maneuvers are given, nor authorized, as a direct result of a TIS-A intruder display or TIS-A advisory.

- TIS-A operation may be intermittent during turns or other maneuvering.
- TIS-A is dependent on two-way, line-of-sight communications between the aircraft and the Mode-S radar antenna. Whenever the structure of the aircraft comes between the transponder antenna and the ground-based radar antenna, the signal may be temporarily interrupted.



NOTE: Refer to the TIS-A Limitations section of the Aeronautical Information Manual (AIM) for a more comprehensive explanation of limitations and anomalies associated with TIS-A.



NOTE: TIS-A is unavailable at low altitudes in many areas of the United States. This is often the case in mountainous regions.



NOTE: Garmin is not responsible for Mode S geographical coverage. Operation of the ground stations is the responsibility of the FAA. Refer to the AIM for a Terminal Mode S radar site map.

TIS-A information is collected during a single radar sweep. Collected information is then sent through the Mode S uplink on the next radar sweep. Because of this, the surveillance information is approximately five seconds old. TIS-A ground station tracking software uses prediction algorithms to compensate for this delay. These algorithms use track history data to calculate expected intruder positions consistent with the time of display. Occasionally, aircraft maneuvering may cause variations in this calculation and create slight errors on the Navigation Map which affect relative bearing information and the target track vector and may delay display of the intruder information. However, intruder distance and altitude typically remain relatively accurate and may be used to assist in spotting traffic. The following errors are common examples:

- When the client or intruder aircraft maneuvers excessively or abruptly, the tracking algorithm may report incorrect horizontal position until the maneuvering aircraft stabilizes.
- When a rapidly closing intruder is on a course that intercepts the client aircraft course at a shallow angle (either overtaking or head-on) and either aircraft abruptly changes course within 0.25 nm, TIS-A may display the intruder aircraft on the incorrect side of the client aircraft.

These are rare occurrences and are typically resolved within a few radar sweeps once the client/intruder aircraft course stabilizes.

Pilots using TIS-A can provide valuable assistance in the correction of malfunctions by reporting observations of undesirable performance. Reports should identify the time of observation, location, type and identity of the aircraft, and describe the condition observed. Reports should also include the type of transponder and transponder software version. Since TIS-A performance is monitored by maintenance personnel, not ATC, malfunctions should be reported in the following ways:

- By telephone to the nearest Flight Service Station (FSS) facility
- By FAA Form 8000-7, Safety Improvement Report (postage-paid card can be obtained at FAA FSSs, General Aviation District Offices, Flight Standards District Offices, and General Aviation Fixed Base Operators)

Overview

Navigation

Flight Planning

Hazard Avoidance

Additional Features

Appendices

Index

Blank Page

APPENDIX G: UTILITIES

PDF VIEWER



NOTE: PDFs must be stored in the "PDF" folder located in the root directory. The user may organize the PDFs inside this folder by creating additional folders.

Refer to Appendix C: Managing Files and Databases, for information on how to store documents on the aera 760.

Accessing a PDF Document using the aera 760 PDF Viewer:

- 1) From the **Main Menu**, touch **PDF Viewer**. The PDF Chooser Page is displayed.
- 2) Touch the **Internal** or **SD Card** tab.
- 3) If necessary, touch **Menu > Sort List By > Name Ascending, Name Descending, Size Ascending, or Size Descending**.
- 4) Touch the desired PDF to display.

FLIGHT LOG



NOTE: Deleting the Track Log may prevent the Flight Log from displaying all available data.

The Flight Log shows a list of any recorded flights, including date, route of flight, and flight time. The aera 760 saves up to 50 recorded flights. Entries on this list are automatically created for each flight.

Recording begins when your speed exceeds 30 knots and you gain 250 feet of altitude. If you land and groundspeed drops below 30 knots, the flight entry is saved and a new entry is recorded when you depart the airport. A touch-and-go or brief stop of less than 10 minutes appends to the current flight record, rather than starting a new entry.

VIEWING THE FLIGHT LOG

Select any listed entry in the log to view additional information, including a map displaying the actual path flown (when available).

Viewing details for a flight:

- 1) From the **Main Menu**, touch **Tools** > **Flight Log**.
- 2) Touch the desired flight log. Route, date, hours, distance, and the flight path are displayed.

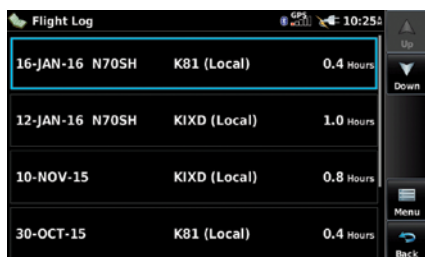

Flight Log

DELETING FLIGHT RECORDS

You can delete the highlighted flight record or delete all flight records from the Flight Log.

Deleting flight records:

- 1) From the **Main Menu**, touch **Tools** > **Flight Log**.
- 2) Touch the desired flight log (if applicable).
- 3) Touch **Menu** > **Delete Flight** > **Yes**.

TRACK LOG

The aera 760 draws an electronic breadcrumb trail or “track log” on the Navigation Map. The track log contains points along its path, including time, and location for each point.

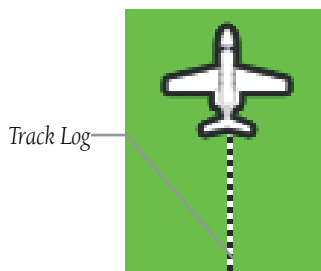

Track Log (Navigation Map)

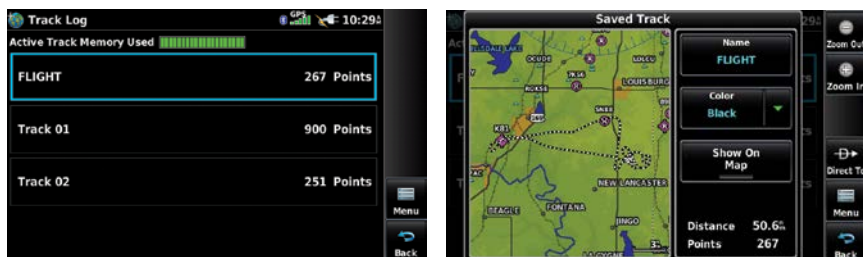

Track Log

The track log starts recording as soon as the aera 760 gets a location fix. For the best results, clear the track log before each flight.

The percentage of memory used by the current track log appears at the top of the Track Log Window. After the track log is cleared, it shows zero percent. When the screen reaches 100%, the most recent track points start to overwrite the least recent track points (if 'Wrap' is selected in the Record Mode Field). To avoid losing track points, save the track log when it approaches the 99% mark.

The Save feature allows storage of up to 15 track logs.

Showing/hiding the track log on the Navigation Map:

- 1) From the **Main Menu**, touch **Map** > **Menu** > **Set Up**.
- 2) Touch the Dedicated Page Icon on the Button Bar and touch the **Line** Group.
- 3) Touch **Track Log** button and touch **Show** or **Hide**.

Changing track log settings:

- 1) From the **Main Menu**, touch **Map > Menu > Set Up**.
- 2) Touch the Dedicated Page Icon on the Button Bar and touch the **Line Group**.
- 3) Touch the **Track Log Record Mode** button and touch **Off, Fill, or Wrap**.
- 4) Touch the **Track Log Interval** button and touch **Auto, Distance, or Time**.
- 5) Touch the **Track Log Color** button and touch the desired color from the list.

Track Log settings are also available from the Track Log Option Menu

- Track Log—Select '**Show**' or '**Hide**' to display/remove the track log on the map.
- Track Record Mode—'**Off**' disables track log recording. '**Fill**' records a track log until the track log is full (100%). '**Wrap**' records over the oldest tracks when the track log reaches 100%.
- Track Interval—'**Distance**' records track points after a specified distance has been traveled. '**Time**' creates track points after a specified time has elapsed. '**Automatic**' saves points that occur after changes in navigation.
- Track Color—Select a color for the track when it appears on the map.

Clearing the track log:

- 1) From the **Main Menu**, touch **Tools > Track Log**.
- 2) Touch the desired track log (if applicable).
- 3) Touch **Menu**.
- 4) Touch **Clear Active Track** or **Delete All Saved Tracks**.
- 5) Touch **Yes**.

Saving a track log:

- 1) From the **Main Menu**, touch **Tools > Track Log > Menu > Save Active Track**.
- 2) Touch the **Save** button and touch '**Entire Active Track**', '**Past 24 Hours**', '**Past 7 Days**', '**Selected Flight**', or '**Specific Dates**'.
- 3) Enter the Selected Flight or Specified Dates (if applicable) and touch **OK**.

Editing a track log:

- 1) From the **Main Menu**, touch **Tools > Track Log**.
- 2) Touch the desired track log.
- 3) Touch desired field to edit (**Track Name**, **Show On Map**, or **Color**).

TRACK VECTOR

The aera 760 draws an electronic "Track Vector" on the Navigation Map. The Track Vector can be set to time or distance.

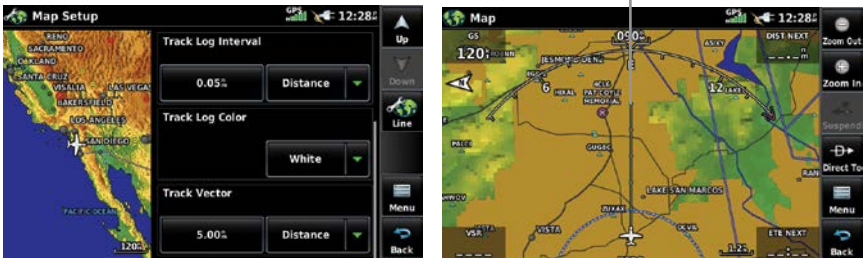

Track Vector Setup

Changing the track vector settings on the Navigation Map:

- 1) From the **Main Menu**, touch **Map > Menu > Set Up**.
- 2) Touch the Dedicated Page Icon on the Button Bar and touch the 'Line' Group.
- 3) Touch the **Track Vector** button and touch **Off**, **Distance**, or **Time**.
- 4) If **Distance** is selected, use the keypad to enter the desired distance and touch **Enter**.
- 5) If **Time** is selected, use the + / - buttons to select the desired time.

E6B CALCULATOR

The E6B Calculator calculates Density Altitude, True Airspeed, Tail Wind, Wind From, and Wind Speed, based on information entered.

Accessing the E6B calculator:

From the **Main Menu**, touch **Tools > E6B**.

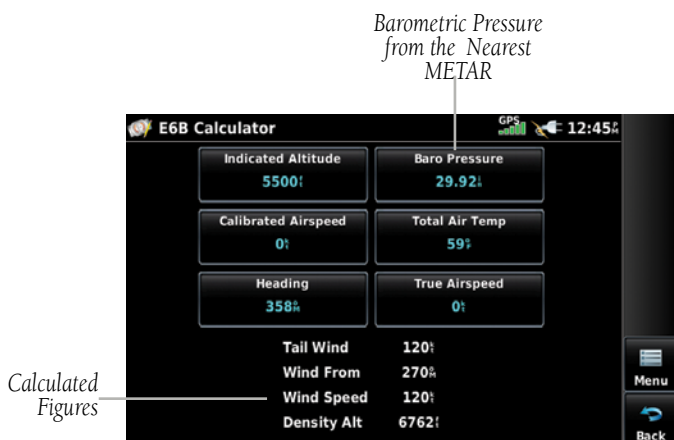

E6B Calculator

- **Indicated Altitude**—required entry for density altitude/true airspeed calculation. Enter the aircraft’s altimeter reading.
- **Baro Pressure**—enter the current barometric pressure.
- **Calibrated Airspeed**— required entry for density altitude/true airspeed calculation. Enter the aircraft’s airspeed indicator value.
- **Total Air Temp**— required entry for density altitude/true airspeed calculation. Total Air Temperature (TAT) is the temperature of the air including the heating effect caused by speed. The temperature reading on a standard outside air temperature gauge found on most piston aircraft is TAT.
- **Heading**— required entry for winds aloft calculation. Use heading from the aircraft’s heading indicator or directional gyro.
- **True Airspeed**— (calculated or user-entered figure) determined from entry of calibrated airspeed, barometric pressure, and total air temperature. This can also be entered directly for winds aloft calculations.
- **Tail Wind**— (calculated figure) determined from entry of heading and true airspeed.
- **Wind From**—(calculated figure) determined from entry of heading and true airspeed.
- **Wind Speed**—(calculated figure) determined from entry of heading and true airspeed.

- **Density Altitude**— (calculated figure) determined from entry of indicated altitude, barometric pressure and total air temperature.

Calculating true airspeed and density altitude:

- 1) From the **Main Menu**, touch **Tools > E6B**, enter the altitude shown on the altimeter into the 'Indicated Altitude' field.
- 2) Repeat for 'Calibrated Airspeed', 'Baro Pressure', and 'Total Air Temperature' fields. (For Calibrated Airspeed, use the speed shown on the airspeed indicator. Use the current altimeter setting for Baro Pressure. Total Air Temperature is the temperature of the outside air including the heating effect caused by speed. For most aircraft, this is the temperature reading on a standard outside air temperature gauge.) The calculated figures for True Airspeed and Density Altitude are shown in the designated fields.

Calculating winds aloft:

- 1) From the **Main Menu**, touch **Tools > E6B**, calculate or enter the true airspeed into the 'True Airspeed' field.
- 2) Enter the aircraft heading shown on the directional gyro or compass into the 'Heading' field. Tail Wind, Wind From, and Wind Speed are calculated.



NOTE: If True North is selected as the heading reference, a heading referenced to True North must be used to calculate winds accurately.

Restoring E6B calculator defaults:

From the **Main Menu**, touch **Tools > E6B > Menu > Restore Default**.

AIRCRAFT PROFILE

The Aircraft Profile allows the pilot to select cruising speed, maximum speed, fuel flow, and map symbol. These values will be saved in the aera 760 unit even while powered off. The unit can save up to 10 aircraft profiles.

The maximum speed is used to define the range for airspeed on the 3D Vision Page and is automatically updated if you exceed this figure.

Accessing the aircraft profile:

From the **Main Menu**, touch **Tools > Profile**



Aircraft Profile

Entering an aircraft profile:

- 1) From the **Main Menu**, touch **Tools** > **Profile**
- 2) Touch the Aircraft Name Button to access a vertical list of saved profiles.
- 3) Touch the **Map Symbol** button and touch the desired symbol from the list.
- 4) Touch the **Aircraft Fuel Type** button and touch the desired fuel type from the list.
- 5) Touch the **Flight Planning Fuel Flow** button and enter the fuel flow using the keypad. Touch **Enter**.
- 6) Touch the **Flight Planning Cruise Speed** button and enter the cruise speed using the keypad. Touch **Enter**.
- 7) Touch the **Maximum Aircraft Speed** button and enter the max speed using the keypad. Touch **Enter**.



NOTE: The identifier is optional, and aircraft parameters can be changed without specifying an identifier. However, in order to add additional aircraft profiles, an identifier for the default aircraft must be specified first.

Renaming a saved aircraft profile:

- 1) From the **Main Menu**, touch **Tools > Profile**.
- 2) Touch the Aircraft Name Button to access a vertical list of saved profiles.
- 3) Touch the desired profile from the list.
- 4) Touch **Menu > Rename**.
- 5) Enter the new Aircraft Name using the keypad, and touch **OK**.

Deleting a saved aircraft profile:

- 1) From the **Main Menu**, touch **Tools > Profile**.
- 2) Touch the Aircraft Name Button to access a vertical list of saved profiles.
- 3) Touch the desired profile from the list.
- 4) Touch **Menu > Delete**.
- 5) Touch **Yes**.

WEIGHT & BALANCE

Weight & Balance may be used during pre-flight preparations to verify the weight and balance conditions of the aircraft. By entering the weight and arm values, the aera 760 can calculate the total weight, moment, and center of gravity (CG).

Before entering the various figures, the empty weight of the airplane and the arm (or "station") for each weight should be determined. These figures should be determined using the pilot's operating handbook for the airplane, which also notes the weight limitations and fore/aft CG limits. Compare those figures to the values calculated by the aera 760.

Fuel units specified in an Aircraft Profile will carry over to the Weight & Balance page. Once the Weight & Balance page is set to use the same fuel units as in the current Aircraft Profile, the Weight & Balance page will inherit the setting from the Profile.

To perform weight and balance calculations:

- 1) From the **Main Menu**, touch **Tools** > **Weight & Balance**
- 2) Touch the fields to enter the desired weights and arms (or “stations”). The calculated moment, weight, and CG figures appear at the bottom of the screen. Keep in mind the “Aircraft” (empty weight/arm) figures must be entered as a reference to calculate a valid moment, weight, and CG.
- 3) To empty the aircraft, touch **Menu** > **Empty Aircraft**.



NOTE: This information is only for flight planning purposes. Consult the aircraft’s pilot operating handbook for the official weight and balance data.

	Weight	Units	Arm
Aircraft	1151	lb	+30.00
Usable Fuel	147	gal avgas	0.00
Pilot	180	lb	+39.00
Moment	48570		
Weight	2393	lb	
Center of Gravity	20.30		

Weight & Balance

PROXIMITY WAYPOINTS

The Proximity Waypoints allows the pilot to define an alarm circle around a waypoint location.



Proximity Waypoints

Defining proximity waypoints:

- 1) From the **Main Menu**, touch **Tools > User Waypoint > Proximity Tab > Menu > New Proximity Waypoint**.
- 2) Touch **Use Identifier** or **Use Map**.
- 3) Enter the desired identifier or pan the map.
- 4) Touch the newly created Proximity Waypoint and touch **Edit Radius**.
- 5) Enter the desired radius using the keypad and touch **Enter**.

Setting up and customizing proximity waypoints for the Navigation Map:

From the **Main Menu**, touch **Tools > User Waypoint > Proximity Tab > Menu > Enable/Disable Proximity Alarms**.

Or:

- 1) From the **Main Menu**, touch **Map > Menu > Set Up**.
- 2) Touch the Dedicated Page Icon on the Button Bar and touch the **Point Group**.
- 3) Touch the **Proximity Circle** button and touch the desired settings ('Off', 'Auto', or Range Settings).

Deleting proximity waypoints:

- 1) From the **Main Menu**, touch **Tools** > **User Waypoint** > **Proximity** Tab.
 - a) Touch the desired proximity waypoint.
 - b) Touch **Delete Proximity Waypoint**.

Or:

 - a) Touch **Menu**.
 - b) Touch **Delete All**.
- 2) Touch **Yes**.

APPENDIX H: DISPLAY SYMBOLS

Overview

Navigation

Flight Planning











Hazard Avoidance

Additional Features







Appendices

Index









VFR SYMBOLS

Item	Symbol
Unknown	
Non-towered, Non-serviced	
Towered, Non-serviced	
Non-towered, Serviced	
Towered, Serviced	
Soft Surface, Non-serviced	
Soft Surface, Serviced	
Soft Surface, Private	
Paved, Private	
Seaplane Base	
Heliport	



Americas/Pacific Database Airports

Item	Symbol
Civilian, Non-serviced	
Military, Non-serviced	
Civilian, Serviced	
Military, Serviced	
Civilian, Soft/Unknown Surface, Non-serviced	
Civilian, Soft/Unknown Surface, Serviced	

Atlantic Database Airports



Item	Symbol
Intersection	
Visual Reporting Point	
LOM (compass locator at outer marker)	
NDB (non-directional radio beacon)	
VOR	
VOR/DME	
ILS/DME or DME only	
VORTAC	
TACAN	

Nav aids



Item	Symbol
Interstate Highway	
US Highway	
State Highway	
National Highway	
Small City	
Medium City	
Large City	

Miscellaneous











IFR SYMBOLS

Item	Symbol
VFR, Soft/unknown Surface, Non-serviced	
VFR, Soft/unknown Surface, Serviced	









Atlantic Database Airports

Item	Symbol
Low-Altitude	
High-Altitude	

Airways

Item	Symbol
Unknown	
VFR Airport, Non-serviced	
IFR Airport, Non-serviced	
VFR Airport, Serviced	
IFR Airport, Serviced	
VFR, Soft Surface, Non-serviced	
VFR, Soft Surface, Serviced	
VFR, Soft Surface, Private	
VFR, Paved, Private	
VFR Seaplane Base	
VFR Heliport	

Americas/Pacific Database Airports

Item	Symbol
Intersection	
LOM (compass locator at outer marker)	
NDB (non-directional radio beacon)	
VOR	
VOR/DME	
ILS/DME or DME Only	
VORTAC	
TACAN	

Nav aids



AIRSPACE SYMBOLS

Item	Symbol
Class B, Class E, CTA	
Class A, Class C, TMA	
Class D	
Mode C Veil	
TRSA	
MOA	
Danger, Alert, or Training Area	
Restricted, Prohibited, or Warning Area	
Radar Area	
ATZ, TIZ	
MATZ	
ADIZ	
Parachute	
Misc/Unknown	

VFR

Item	Symbol
Class B, Class E, CTA	
Class A, Class C, TMA, TRSA	
Class D, MATZ	
MOA	
Danger, Alert, or Training Area	
Restricted, Prohibited, or Warning Area	
Radar Area	
ATZ, TIZ	
Mode C Veil	
ADIZ	
Parachute	
Misc/Unknown	

IFR

Item	Symbol
Danger or Alert Area	
Restricted or Prohibited Area	
Training Area	

VFR Exceptions with European Navigation Feature Style

Item	Symbol
Training Area	

IFR Exceptions with European Navigation Feature Style

Overview

Navigation

Flight Planning

Hazard Avoidance

Additional Features

Appendices

Index

Blank Page

APPENDIX I: MAP DATUM AND LOCATION FORMATS

MAP DATUMS

A datum is a mathematical model of the Earth that approximates the shape of the Earth and enables calculations to be carried out in a consistent and accurate manner. The datum is physically represented by a framework of ground monuments (such as trig. stations) whose locations have been accurately measured and calculated on this reference surface. Lines of latitude and longitude on a chart are referenced to a specific map datum. Every chart has a map datum reference and the aera 760 can be set to match most of those commonly used.

LOCATION FORMATS

Your current location can be viewed on the GPS in the form of coordinates. Since different charts use different location formats, Garmin GPS units allow you to choose the correct coordinate system for the type of chart you are using. The most common format is latitude and longitude, which is used by all Garmin units. You can change the location format to use with other coordinate systems. Several other grids, including a user-definable grid (for the advanced user), are available.

Overview

Navigation

Flight Planning

Hazard Avoidance

Additional Features

Appendices

Index

Blank Page

APPENDIX J: GLOSSARY

ADIZ	Air Defense Identification Zone
ADS-B	Automatic Dependant Surveillance -Broadcast
ADS-B In	Ability to receive ADS-B information from other aircraft and Ground Based Transceivers (GBTs)
ADS-B Out	Ability to transmit ADS-B data on 1090 ES or 978 MHz
ADS-B Participating Aircraft	An aircraft that has both ADS-B In and ADS-B Out capabilities.
ADS-R	Automatic Dependent Surveillance-Rebroadcast
AGL	Above Ground Level
AIRMET	Airman's Meteorological Information
ARTCC	Air Route Traffic Control Center
ASOS	Automated Surface Observing System
ATC	Air Traffic Control
ATIS	Automatic Terminal Information Service
AWOS	Automated Weather Observing System
Bearing	The compass direction from the present position to a destination waypoint.
°C	degrees Celsius
Calibrated Airspeed	Indicated airspeed corrected for installation and instrument errors.
cm	centimeter
COM	communication radio
Course	The line between two points to be followed by the aircraft.
Course to Steer	The recommended direction to steer in order to reduce course error or stay on course. Provides the most efficient heading to get back to the desired course and proceed along the flight plan.

Crosstrack Error The distance the aircraft is off a desired course in either direction, left or right.

dBZ decibels 'Z' (radar return)

deg degree

Desired Track The desired course between the active "from" and "to" waypoints.

DIS distance

Distance The 'great circle' distance from the present position to a destination waypoint.

DME Distance Measuring Equipment

DTK Desired Track

Enroute Safe Altitude The recommended minimum altitude within ten miles left or right of the desired course on an active flight plan or direct-to.

ESA Enroute Safe Altitude

Estimated Time of Arrival The estimated time at which the aircraft should reach the destination waypoint, based upon current speed and track.

Estimated Time Enroute The estimated time it takes to reach the destination waypoint from the present position, based upon current ground speed.

ETA Estimated Time of Arrival

ETE Estimated Time Enroute

°F degrees Fahrenheit

FAA Federal Aviation Administration

FAF Final Approach Fix

FCC Federal Communication Commission

FIS-B Flight Information Service-Broadcast

fpm feet per minute

FSS	Flight Service Station
ft	foot/feet
gal	gallon(s)
Glide Ratio, G/R	The estimated distance an aircraft will move forward for any given amount of lost altitude.
gph	gallons per hour
GPS	Global Positioning System
Grid MORA	Grid Minimum Off-Route Altitude; one degree latitude by one degree longitude in size and clears the highest elevation reference point in the grid by 1000 feet for all areas of the grid
Ground-Based Transceiver	Provides ADS-R, TIS-B and FIS-B broadcasts to ADS-B participating aircraft.
Groundspeed	The velocity the aircraft is travelling relative to a ground position.
Ground Track	see Track
GS	Ground speed
Heading	The direction an aircraft is pointed, based upon indications from a magnetic compass or a properly set directional gyro.
Hg	mercury
hPa	hectopascal
hr	hour
HSI	Horizontal Situation Indicator
Hz	Hertz
IAF	Initial Approach Fix
IAT	Indicated Air Temperature
ICAO	International Civil Aviation Organization
IFR	Instrument Flight Rules

Overview

ILS	Instrument Landing System
IMC	Instrument Meteorological Conditions
in	inch
Indicated	Information provided by properly calibrated and set instrumentation on the aircraft panel.

Navigation

in HG inches of mercury

kg kilogram

kHz kilohertz

km kilometer

kt knot

Flight Planning

LAT latitude

lb pound

Leg The portion of a flight plan between two waypoints.

LOC localizer

LON longitude

Hazard Avoidance

Additional Features

m meter

MAP Missed Approach Point

METAR Meteorological Aviation Routine

MHz megahertz

Minimum Safe Altitude Uses Grid MORAs to determine a safe altitude within ten miles of the aircraft present position.

MOA Military Operations Area

MSA Minimum Safe Altitude

MSL Mean Sea Level

Appendices

Index

NAVAID NAVigation AID

NDB Non-directional Beacon

NEXRAD	Next Generation Radar
nm	nautical mile(s)
OAT	Outside Air Temperature
OBS	Omni Bearing Selector
psi	pounds per square inch
QTY	quantity
rpm	revolutions per minute
SBAS	Satellite-Based Augmentation System
SD	Secure Digital
sec	second(s)
SIGMET	Significant Meteorological Information
TA	Traffic Advisory
TACAN	Tactical Air Navigation System
TAF	Terminal Aerodrome Forecast
TAS	True Airspeed
TCAS	Traffic Collision Avoidance System
TFR	Temporary Flight Restriction
TIS-A	Traffic Information Service
TIS-B	Traffic Information Service-Broadcast
Track	Direction of aircraft movement relative to a ground position; also 'Ground Track'
TRSA	Terminal Radar Service Area

Overview

Navigation

Flight Planning

Hazard Avoidance

Additional Features

Appendices

Index

Overview

UTC Coordinated Universal Time

VFR Visual Flight Rules

VHF Very High Frequency

VNAV vertical navigation

VOR VHF Omni-directional Range

VORTAC very high frequency omnidirectional range station and tactical air navigation

VSI Vertical Speed Indicator

VSR Vertical Speed Required

VTF vector to final

Flight Planning

WAAS Wide Area Augmentation System

WX weather

Hazard Avoidance

Additional Features

Appendices

Index

APPENDIX K: WARRANTY AND COMPLIANCE

CONTACT GARMIN

Contact Garmin Product Support at flygarmin.com

WARRANTY

For warranty information, visit: <https://www.garmin.com/en-US/legal/aviation-limited-warranty>

AOPA AIRPORT DIRECTORY NOTICE

AOPA MEMBERSHIP PUBLICATIONS, INC. AND ITS RELATED ORGANIZATIONS (HEREINAFTER COLLECTIVELY "AOPA") EXPRESSLY DISCLAIM ALL WARRANTIES, WITH RESPECT TO THE AOPA INFORMATION INCLUDED IN THIS DATA, EXPRESS OR IMPLIED, INCLUDING, BUT NOT LIMITED TO, THE IMPLIED WARRANTIES OF MERCHANTABILITY AND FITNESS FOR A PARTICULAR PURPOSE. THE INFORMATION IS PROVIDED "AS IS" AND AOPA DOES NOT WARRANT OR MAKE ANY REPRESENTATIONS REGARDING ITS ACCURACY, RELIABILITY, OR OTHERWISE. UNDER NO CIRCUMSTANCES INCLUDING NEGLIGENCE, SHALL AOPA BE LIABLE FOR ANY INCIDENTAL, SPECIAL OR CONSEQUENTIAL DAMAGES THAT RESULT FROM THE USE OR INABILITY TO USE THE SOFTWARE OR RELATED DOCUMENTATION, EVEN IF AOPA OR AN AOPA AUTHORIZED REPRESENTATIVE HAS BEEN ADVISED OF THE POSSIBILITY OF SUCH DAMAGES. USER AGREES NOT TO SUE AOPA AND, TO THE MAXIMUM EXTENT ALLOWED BY LAW, TO RELEASE AND HOLD HARMLESS AOPA FROM ANY CAUSES OF ACTION, CLAIMS OR LOSSES RELATED TO ANY ACTUAL OR ALLEGED INACCURACIES IN THE INFORMATION ARISING OUT OF GARMIN'S USE OF THE INFORMATION IN THE DATASETS. SOME JURISDICTIONS DO NOT ALLOW THE LIMITATION OR EXCLUSION OF IMPLIED WARRANTIES OR LIABILITY FOR INCIDENTAL OR CONSEQUENTIAL DAMAGES SO THE ABOVE LIMITATIONS OR EXCLUSIONS MAY NOT APPLY TO YOU.

AC-U-KWIK LICENSE AGREEMENT

AC-U-KWIK AND ITS RELATED ORGANIZATIONS (HEREINAFTER COLLECTIVELY "AC-U-KWIK ORGANIZATIONS") EXPRESSLY DISCLAIM ALL WARRANTIES WITH RESPECT TO THE AC-U-KWIK INFORMATION INCLUDED IN THIS DATA, EXPRESS OR IMPLIED, INCLUDING, BUT NOT LIMITED TO, THE IMPLIED WARRANTIES OF MERCHANTABILITY AND FITNESS FOR A PARTICULAR PURPOSE. THE INFORMATION IS PROVIDED "AS IS" AND AC-U-KWIK ORGANIZATIONS DO NOT WARRANT OR MAKE ANY REPRESENTATIONS REGARDING ITS ACCURACY, RELIABILITY, OR OTHERWISE. LICENSEE AGREES NOT TO SUE AC-U-KWIK ORGANIZATIONS AND, TO THE MAXIMUM EXTENT ALLOWED BY LAW, TO RELEASE AND HOLD HARMLESS AC-U-KWIK ORGANIZATIONS FROM ANY CAUSES OF ACTION, CLAIMS OR LOSSES RELATED TO ANY ACTUAL OR ALLEGED INACCURACIES IN THE INFORMATION ARISING OUT OF GARMIN'S USE OF THE INFORMATION IN THE DATASETS. SOME JURISDICTIONS DO NOT ALLOW THE LIMITATION OR EXCLUSION OF IMPLIED WARRANTIES OR LIABILITY FOR INCIDENTAL OR CONSEQUENTIAL DAMAGES SO THE ABOVE LIMITATIONS OR EXCLUSIONS MAY NOT APPLY TO LICENSEE.

FCC COMPLIANCE

This device complies with part 15 of the FCC Rules. Operation is subject to the following two conditions: (1) this device may not cause harmful interference, and (2) this device must accept any interference received, including interference that may cause undesired operation.

This equipment has been tested and found to comply with the limits for a Class B digital device, pursuant to part 15 of the FCC rules. These limits are designed to provide reasonable protection against harmful interference in a residential installation. This equipment generates, uses, and can radiate radio frequency energy and may cause harmful interference to radio communications if not installed and used in accordance with the instructions. However, there is no guarantee that interference will not occur in a particular installation. If this equipment does cause harmful interference to radio or television reception, which can be determined by turning the equipment off and on, the user is encouraged to try to correct the interference by one of the following measures:

- Reorient or relocate the receiving antenna.
- Increase the separation between the equipment and the receiver.
- Connect the equipment into an outlet that is on a different circuit from the GPS unit.
- Consult the dealer or an experienced radio/TV technician for help.

This product does not contain any user-serviceable parts. Repairs should only be made by an authorized Garmin service center. Unauthorized repairs or modifications could result in permanent damage to the equipment, and void your warranty and your authority to operate this device under Part 15 regulations.

INNOVATION, SCIENCE, AND ECONOMIC DEVELOPMENT COMPLIANCE

This device complies with Innovation, Science and Economic Development Canada license-exempt RSS standard(s). Operation is subject to the following two conditions: (1) this device may not cause interference, and (2) this device must accept any interference, including interference that may cause undesired operation of the device

RADIATION EXPOSURE STATEMENT

This equipment complies with FCC RF and IC RSS-102 radiation exposure limits set forth for an uncontrolled environment. This equipment should be installed and operated with a minimum distance of 20 centimeters between the radiator and your body.

This transmitter must not be co-located or operating in conjunction with any other antenna or transmitter.

A

- Abnormal Operation 171
- Acquiring Satellites 4
- AC-U-KWIK 158, 177
- Additional Features 153
- ADS-B 149
- Aircraft Profile 221
- AIRMETs 109, 122
- Airspace 69
 - Alert Messages 69
 - Smart 70
- Airways 52, 79
- Alerts 165
 - Terrain 135
- AOPA 158, 177
- AOPA Data 43, 158
- ARTCC 68
- Aural Alerts 136, 169
- Autolocate 4
- Autozoom 21

B

- Backlight 27
- Baro Pressure 220
- Battery
 - Charging 2
 - Information 209
 - Life 209
- BKSP 15
- Bluetooth 30, 31, 32, 179, 206
- Bug Indicator 46

C

- Calibrated Airspeed 220
- Category 162
- CDI Scale 46
- Channel List 162

- Charge Mode 2
- Charging, the battery 2
- Charts 153
- ChartView 153
- Cities 67
- Cloud Tops 104
- Compass Arc 42
- Computer, connecting to 173
- Connecting, cables 191
- Copying, Flight Plans 87
- Course, setting 46
- Current Icing Product (CIP) 112

D

- Databases 173
- Data Entry 15
 - Alphanumeric Data 16
 - Predetermined Data Option 17
- Data Field
 - Options 41
- Data Field Options 165
- Data Fields 40
- Declutter 25
- Direct-to 72
 - Cancelling 74
- Display
 - Backlight Intensity 27
 - Backlight Timeout 27

E

- Echo Tops 104
- external GPS Antenna 207

F

- Favorites 163
- Files, managing 174
- Flight Log 215

Flight Plan

- Activation 85
- Active 76
- Copying 87
- Creation 76
- Data Fields 75
- Deleting 87
- Fuel Flow 86
- Inverting 88

- Forecast 113
- Freezing Levels 111
- FSS 68
- Fuel Flow 86
- Fuse, changing 209

G

- GDL 39 30, 114
- Geo-reference 155
- GPS Navigation 39
- GPS Receiver Status 4

H

- Hazard Display 171
- Heading Line 219

I

- Icing Forecast 112, 126
- Indicated Altitude 220
- Interfacing 207
- Intersections 61
- Inverting, flight plans 88

L

- Location Formats 233
- Loss of GPS Position 171
- Lost Satellite Reception 4

M

- Managing Files 174
- Map
 - Autozoom 21
 - Declutter 25
 - Display Setup 51
 - Orientation 51
 - Overlays 25
 - Panning 22
 - Range 21
 - Symbols 25, 227
- Map Datum 233
- Map Feature
 - Button 23
 - Information 24
- Messages 165
- METARs 107, 121, 129, 131
- MicroSD Card 175
 - Installing 176, 179, 184
- Mounting, in aircraft 189

N

- NDBs 62
- Nearest 12, 57
 - Airport Criteria 58
- Nearest Airport Criteria 35
 - Entering 35
- Nearest Type, Changing 36
- NEXRAD 103, 118, 129
- NMEA 197
- Numeric Data Options 167

O

- Obstacle
 - Color Code 134
- Obstacles 132

Option Menu 14, 18, 20
Orientation, map 51
Overlays
 Displaying/removing 25

P

Panning 7
PIREPs 110, 124
POWER Button 3
Present Position 36, 37
Proximity Waypoints 225

R

Red X 171
Runways 55

S

SafeTaxi 153, 156
Satellite Information 5
Scrolling 7
SD Card 173
Searching the Sky 4
Settings 26
SIGMETs 109, 123
Smart Airspace 70
Sound
 Adjusting 28
 Muting 29
STAR 91
Storm Cells 107
Surface Pressure 113
System Settings
 Display 26, 29, 30

T

TAFs 107, 121, 129
Temperatures Aloft 106, 120

Terrain 131
 Alerts 135
 Audio 137
 Aural Alerts 136
 Views 134
Tools 11
Touchscreen 7
Touchscreen, cleaning 210
Track Log 216
Traffic Data 139
Traffic Ground Track 139
Traffic Information Service (TIS)
 Configuring 198, 200, 201, 203, 205
Traffic Information Service (TIS-A)
 Alerts 138
traffic warning window 146
Transferring Files 175
Turbulence Forecast 112, 125

U

USB Drivers 195
User Waypoints 63
 Creating 64
 Deleting 66
Utilities 215

V

Vectors-to-Final 96
Vertical Navigation (VNAV) 48
 Profile 49
VHF Comm Radio 193
VORs 62

W

Warranty 241
Waypoints 53
 Proximity 225

User 63
Weather 59
Weather Products 102
Weight & Balance 223
WiFi Setup 32
Winds Aloft 105, 119, 120

X

XM
 Activating 101
 Animating 100
 Radio 160
 Radio ID 101
 Weather Products 102

Y

Yoke Mount 190

Z

Zooming 8



Garmin International, Inc.
1200 East 151st Street
Olathe, Kansas 66062, U.S.A.

Garmin AT, Inc.
2345 Turner Road SE
Salem, OR 97302, U.S.A.

Garmin (Europe) Ltd.
Liberty House, Hounsdown Business Park
Southampton, Hampshire SO40 9LR U.K.

Garmin Corporation
No. 68, Zhangshu 2nd Road
Xizhi District, New Taipei City, Taiwan

flygarmin.com