

Watts NFPA 13D Residential Fire RF PEX™ Multipurpose Piping

Installation Guidelines



For maintenance purposes, please leave this Guide with the occupant and property owner.
Date Left With Homeowner _____

WATTS®

WARNING

FAILURE TO COMPLY WITH PROPER INSTALLATION INSTRUCTIONS COULD RESULT IN DAMAGE TO THE MULTIPURPOSE PIPING SYSTEM INCLUDING, THE FIRE SUPPRESSION SYSTEM, WHICH CAN RESULT IN PROPERTY DAMAGE, PERSONAL INJURY AND/OR DEATH.

THIS GUIDE DOES NOT ADDRESS FIRE PROTECTION DESIGN AND INSTALLATION REQUIREMENTS, NOR DOES IT ADDRESS HYDRAULIC CALCULATIONS, SPRINKLER SELECTION, INSTALLATION, AND/OR PERFORMANCE. YOU ARE REQUIRED TO CONSULT WITH A CERTIFIED FIRE PROTECTION DESIGN PROFESSIONAL, LICENSED RESIDENTIAL FIRE SUPPRESSION SYSTEM INSTALLER, AND THE AUTHORITY HAVING JURISDICTION BEFORE INSTALLING A MULTIPURPOSE SYSTEM. Watts does not provide design or installation services or instructions and shall not be held responsible for system design or installation errors.

The Watts components referenced in this Guide are intended for use with residential multipurpose fire suppression sprinklers in NFPA 13D systems rated at a maximum of 130psi (896 kPa) at 120°F (48.9°C) when used in a multipurpose system. The type of sprinkler for any system shall be limited to that specified and approved by the authority having jurisdiction for the given installation.

DO NOT use this Guide or the offered Watts components for NFPA 13, 13R, or 13D stand-alone systems.

WATTS IS NOT RESPONSIBLE FOR INADEQUATE WATER PRESSURE OR WATER SUPPLY.

Refer to a certified fire protection design professional and/or licensed residential fire suppression system installer to ensure the proper water pressure and supply is available for the application.

In a multipurpose system--where the residential fire PEX tubing (RF PEX™ tubing) serves both fire sprinklers and domestic use--devices that restrict the water flow, decrease the pressure, or automatically shut off the water to the fire suppression system, such as water softeners, filtration systems, and automatic shutoff valves, shall not be added without a review of the fire suppression system by a certified and/or licensed fire protection design professional. Additionally, appropriate signage is required for the end user. Refer to NFPA 13D and/or your design/installation professional for further information.

DO NOT use any damaged products. Before assembling any components, inspect all products for manufacturing defects, cuts, scrapes, gouges, splits, and any other irregularities that may occur during shipping and handling.

In order to ensure proper operation of the multipurpose system, each of the components referenced in this Guide must be Watts UL 1821 listed. The components referenced in this Guide include UL 1821 listed RF PEX™ tubing, residential fire PEX fittings (RF PEX™ fittings), residential fire PEX sprinkler fittings (RF PEX™ sprinkler fittings) and CrimpRing™ connections and these components require protection by any one of the following: (1) 3/8" thick or thicker gypsum wallboard, (2) A suspended membrane ceiling with lay-in panels or tiles having a weight of not less than 0.35 lb/ft² when installed with metallic support grids, or (3) 1/2" plywood or plywood soffits.

DO NOT use air or compressed gas for pressure testing. The use of air or compressed gas can cause system failure and product damage, property damage, personal injury and/or death.

These products are designed for use in environments with ambient temperatures in the range of 40°F to 120°F. DO NOT allow the multipurpose system to freeze. Freezing temperatures can damage component parts causing water damage and can damage the fire suppression system, which can result in property damage, personal injury and/or death.

The components referenced in this Guide are for use with the potable water plumbing system, ONLY. DO NOT use antifreeze. The fire suppression system must be connected to the cold water piping, ONLY.

In order to prevent damage to the Watts components, avoid over torquing when installing a sprinkler head into a multipurpose system. Refer to the sprinkler manufacturer's instructions for proper installation requirements.

Periodic Maintenance is required pursuant to this guide, NFPA 13D and local and national codes.

Table of Contents

Residential Fire Component and Use Overview	
What is Residential Fire (RF) PEX Tubing?	3
Standards and Approvals	3
Pressures and Temperatures.....	4
CrimpRing™ Connection System	5
CrimpRing™ Fittings Advantages:	5
What is a Multipurpose Residential Piping System?	5
Designing Your Own System.....	6
Sprinkler Overview.....	7
Installation Overview.....	9
Making a Good CrimpRing™ Connection	10
Using a CrimpRing™ Tool Correctly.....	10
How to Test a CrimpRing™ Connection	12
Installation Precautions.....	13
Installation Precautions and Handling and Care of RF PEX™.....	16
Installing RF PEX™ Sprinkler Fittings.....	19
System Startup Procedures.....	21
Reference Charts for Residential Fire Tubing and Fittings.....	22
Pressure Loss for RF PEX Tubing.....	22
UL 1821 Residential Fire Products	24
RF PEX™ Sprinkler Fittings.....	24
RF PEX™ Tubing Fittings.....	25

Introduction

The Watts NFPA 13D Residential Fire PEX Multipurpose Piping Guide is intended for certified fire protection design professionals, licensed residential fire suppression system installers, Authorities Having Jurisdiction (AHJ), building officials, engineers, and architects. This instruction Guide outlines Watts Residential Fire Tubing and Fittings in a multipurpose piping system used to support NFPA 13D, which is the standard covering the “Installation of Sprinkler Systems in One- and Two-Family Dwellings and Manufactured Homes”.



IMPORTANT: Watts does not provide design or installation services or instructions and shall not be held responsible for sprinkler system design or installation errors. You are required to consult with a certified fire protection design professional, a licensed residential fire suppression system installer, and the Authority Having Jurisdiction when installing a multipurpose system.

The component parts in this Guide must be installed and maintained pursuant to local and national codes and standards. It is the responsibility of the design and installation professionals to ensure that the product is suitable for the intended use. The information contained herein should be considered as a basis for reference only. **This Guide is not a substitute for proper installer training.**

For Fire Suppression System Design and Fire Suppression Sprinkler Selection, Placement, Installation, and Maintenance refer to a certified fire protection design and installation professional, the local and national codes and standards, and the appropriate Fire Suppression Sprinkler Manufacturer's literature for all requirements, instructions and warnings. **This Guide does not address system design, hydraulic demand calculations, or sprinkler selection, installation and/or performance.**

The Watts components being offered are intended for use with residential fire suppression sprinklers in NFPA 13D multipurpose piping systems rated at maximum 130psi (896 kPa) service pressures at 120°F (48.9°C). **DO NOT USE** this Guide or the offered Watts components for NFPA 13, 13R, or 13D stand-alone systems.

Watts has made a reasonable effort to obtain, prepare and organize correct information for the installation of the Watts products; however, local building or plumbing code enhancements and changes may require modifications not addressed in this Guide. To the extent this Guide is not consistent with local building or plumbing codes, the local codes should be followed.

Watts is not responsible or liable for installation practices that differ from this Guide or are not acceptable mechanical trade practices.

Please call your local Watts representative with any questions concerning this Guide.

Residential Fire Component and Use Overview



The purpose of this Guide is to familiarize building professionals with recommended methods of installing UL 1821 listed Watts Residential Fire PEX Tubing and Fittings with CrimpRing™ connections. All installations should be made by certified and/or licensed professionals in the field and only after carefully reviewing all the design parameters of each project.

Read the entire contents of this Guide before beginning the installation. If you are unsure about a matter related to Watts Residential Fire PEX Tubing and Fittings and need additional assistance, please call us at 978-688-1811.

Installer Tips: Throughout this manual installers share their experience and tips on the most efficient methods of installing Residential Fire PEX Tubing. These tips are displayed in boxes like this.

***The wetted surface of this product contacted by consumable water contains less than one quarter of one percent (0.25%) of lead by weight.**

What is Residential Fire PEX Tubing?

Watts Residential Fire PEX Tubing (referred to as RF PEX™ tubing) is a UL 1821 listed cross-linked polyethylene (PEX) tubing designed for use by professional plumbers and fire sprinkler installers for residential NFPA 13D multipurpose fire suppression piping and potable water plumbing applications. The NFPA 13D standard is applicable for residential sprinkler system installations for One and Two Family Dwellings and Manufactured Homes.

Watts RF PEX™ Tubing is currently available in ¾" and 1" ID sizes in coils ranging from 100' to 1000' in length. It can also be purchased in 10' and 20' straight sticks. It must not be used for transporting petroleum products, natural gas, propane, anhydrous ammonia, or any other fluids. For additional precautions, please refer to page 16.

RF PEX™ Tubing may also be used in certain types of floor heating or snow melting systems. Follow appropriate installation guides for those applications.

Standards and Approvals

RF PEX™ tubing and RF PEX™ fittings are UL 1821 listed by Underwriters Laboratories and are manufactured in accordance with American Standard Testing Methods (ASTM International) F876 and F877 to SDR-9 dimensional standards. RF PEX™ tubing and RF PEX™ fittings are listed by NSF International NSF-61 as lead free for use in potable water systems.

RF PEX™ tubing is also listed by the International Conference of Building Officials (ICBO), the International Association of Plumbing and Mechanical Officials (IAPMO) and carries the Uniform Plumbing Code symbol. RF PEX™ tubing is tested and certified to the Canadian Standards Association (CSA) standard B137.5.



Note: The above listings are solely based upon use of Watts UL 1821 listed RF PEX™ Tubing, RF PEX™ Fittings, RF PEX™ Sprinkler Fittings and CrimpRing™ connections.

Pressures and Temperatures

Watts RF PEX™ Tubing carries the following temperature and pressure ratings:

80 psi (552 kPa) at 200°F (93.3°C) - (If RF PEX™ Tubing is used for Hot Water Lines, Not intended for Sprinkler Use)

100 psi (689 kPa) at 180°F (82.2°C) - (If RF PEX™ Tubing is used for Hot Water Lines, Not intended for Sprinkler Use)

130 psi (896 kPa) at 120°F (48.9°C) - (UL Listed Pressure and Temperature Residential Fire Rating)

160 psi (1103 kPa) at 73.4°F (23°C) - (For reference purposes only, Exceeds NFPA 13D Multipurpose Allowed Maximum Sprinkler System Pressure)

Watts RF PEX™ tubing and RF PEX™ Fittings are listed to both NSF Standard 14 and NSF-61, annex G.

Watts RF PEX™ Tubing and Fittings are UL 1821 listed as long as they are protected by any of the following:

- 1) 3/8" thick or thicker gypsum wallboard
- 2) A suspended membrane ceiling with lay-in panels or tiles having a weight of not less than 0.35 lb/ft² when installed with metallic support grids
- 3) 1/2" plywood or plywood soffits
- 4) When running RF PEX™ Tubing in the attic, adequate insulation shall be provided on the attic side of the plumbing to avoid exposure of the piping to temperatures above or below its rated temperature. Insulation shall follow the guidelines of the insulation manufacturer and must adhere to local codes.

The products used for the Watts Residential Fire Multipurpose Piping consist of RF PEX™ Tubing, RF PEX™ Fittings and RF PEX™ Sprinkler Fittings. A detailed list of these items can be found at the end of this Guide.

RF PEX™ Tubing



RF PEX™ Fittings



RF PEX™ Sprinkler Fittings

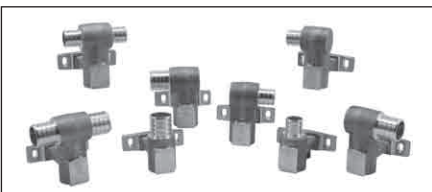

CrimpRing™ Connection System

RF PEX™ tubing is joined to system components using the CrimpRing™ system, which is the same CrimpRing™ system offered with our WaterPEX® potable water products. The CrimpRing™ system is manufactured to the SDR-9 standard. The RF PEX™ tubing and CrimpRing™ system is one of the simplest joining systems available and offers many advantages not found elsewhere.

CrimpRing™ Fittings Advantages:

The Dry-fit Advantage

Using the CrimpRing™ system, the entire multipurpose piping system can be “Roughed in” before final assembly and crimping. This allows the installer to check for appearance and identify routing issues before making final connections. If problems are found, components such as fittings do not have to be cut out and exposed to possible damage.

Quick and Reliable Connections:

CrimpRing™ connections are NSF-listed brass inserts with pure copper fastening rings. When crimped with a simple hand tool, these connections form a fast, reliable, and permanent seal.

Immediate Pressure Testing:

After crimping, you can immediately hydro test each fitting to 100 psi (689 kPa) and a maximum 130 psi. There is no need to wait hours for connections to set and seal.

No Gluing or Adhesives Needed

The CrimpRing™ system only uses the fitting and a copper crimp ring. This eliminates fumes created by glues and adhesives and eliminates the possibility of glues contaminating surrounding products.

No Welding

Fire hazards created during welding are also eliminated. To compress the copper ring, the installer only needs to use a simple crimping tool.

Standard Crimping Tools

Most current Watts WaterPEX® installers already have the standard PEX crimping tool. This eliminates the need for multiple and expensive tools.

What is a Multipurpose Residential Piping System?

The multipurpose residential piping system is a cost efficient system that combines a home's potable water plumbing system and the fire suppression system. With this system, the home's potable plumbing system will be used to supply water to fixtures, lavatories, washing machines, sinks and the fire sprinklers. The multipurpose system has many advantages over stand-alone systems that include:

- Since the fire suppression system and plumbing system are now combined, they can often be installed at the same time by the same licensed professional.
- Stagnant water in the fire suppression system is reduced due to potable water running through fire suppression lines as the potable water system is used.
- Can reduce installation cost since main lines are shared by multiple systems.

The diagrams below show the difference between a multipurpose system and a traditional stand-alone fire suppression system.

Stand-Alone Fire Suppression System Diagram

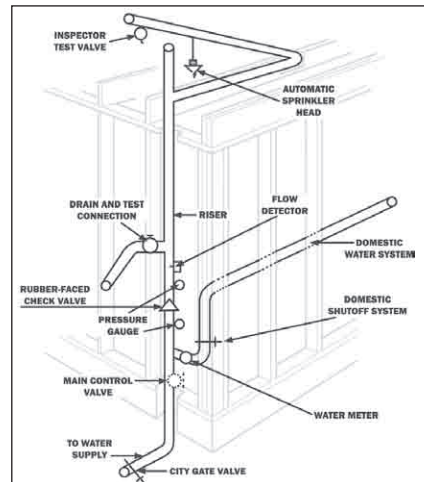

In the above diagram, notice that the fire suppression system is independent of the potable water system. In a stand-alone residential fire suppression system separate pipes containing standing water or antifreeze would feed the fire suppression systems.

RF PEX™ Multipurpose Piping System Diagram

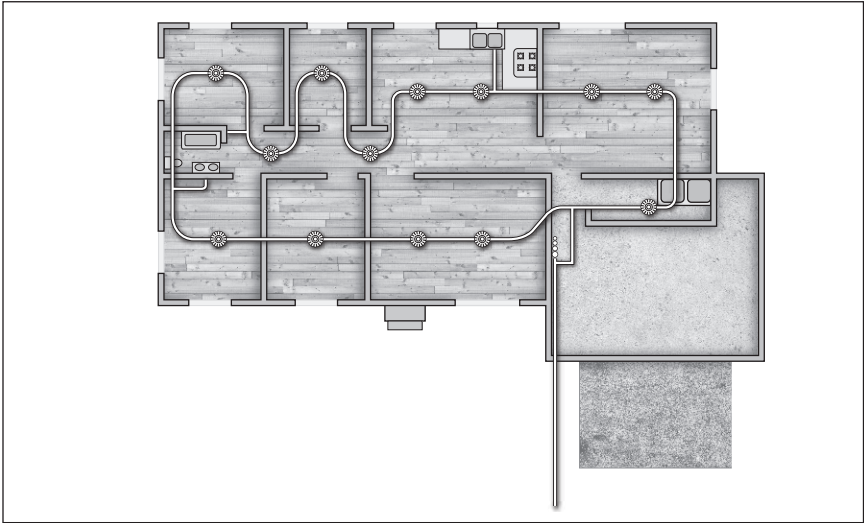

NOTE: All branches supplying a fire suppression sprinkler must be connected to the cold water piping only. Do not use anti-freeze.

RF PEX™ Tubing and Fittings can be used for hot water lines; however, the hot water system cannot be used to supply the fire suppression sprinklers.

Designing Your System

Watts can supply you with all the components needed for your system; however, Watts does NOT design fire suppression systems. Fire suppression system design is left to certified fire protection design professionals who have specialized training in this area. Training for these design professionals are provided by various industry groups. A list of these providers along with website links can be found at watts.com/resfire.

NOTE: Selecting a certified fire protection design and installation professional is up to the customer. Watts does not provide design services. The customer should carefully consider qualifications, knowledge and experience when selecting a provider. The list of offered providers is for reference only, and the parties are not endorsed or warranted by Watts.

Sprinkler Overview

Only NSF and UL listed residential sprinklers are allowed for use in the multipurpose system. Multipurpose system sprinkler heads must be NSF approved because they are now part of the overall potable water system. All sprinklers installed in a multi-



purpose system must be UL listed residential sprinklers pursuant to NFPA 13D.

Watts does not provide design or installation services. The following information is for reference only.

NOTE: For Fire Suppression System Design, Fire Suppression Sprinkler Selection, Placement, Installation, and Maintenance refer to a certified fire protection design and installation professional, the local and national codes and standards, and the appropriate Fire Suppression Sprinkler Manufacturer's literature for all requirements, instructions, and warnings. This Guide does not address system design, hydraulic demand calculations, and sprinkler selection, installation and/or performance.

Residential sprinklers of different styles and flow patterns are available for ceiling and wall mounted applications. The type of sprinkler for any system shall be limited to that specified and approved by the AHJ for the given installation. The Watts RF PEX™ components being offered are intended for use with residential fire suppression sprinklers in NFPA 13D multipurpose piping systems rated at a maximum 130psi (896 kPa) service pressure at 120°F (48.9°C) and Watts RF PEX™ Sprinkler Fittings are designed to fit most listed residential sprinklers with 1/2" NPT threads.

Different sprinkler styles and flow patterns are available for ceiling and wall mounted applications. Each type of sprinkler head is for a specific set of circumstances such as room size, heat sensitivity and aesthetics.

These sprinklers usually



consist of a glass bulb or fusible link that activate when exposed to a predetermined temperature. This heat either expands a bubble inside a glass bulb thus breaking the glass bulb or causes the fusible link to separate. Once this event occurs, the sprinkler is no longer able to hold back water in the system. This allows water to begin dispersing out of the sprinkler head.

NOTE: Water cannot be turned off at the sprinkler head. Once the glass bulb is broken or the fusible link has been damaged; water will continue to flow from the sprinkler.

Extreme care must be taken not to damage this bulb, fusible link or any other part of the sprinkler during installation. Do not attempt to repair or modify a sprinkler that has been activated or if suspicion of damage has occurred. If a damaged or activated sprinkler is found, it should be permanently disposed of.



Recessed Sprinklers

Recessed sprinklers normally protrude past the surface of the drywall. These sprinkler heads are always visible and are not covered by a cover plate.

To enhance the appearance of the sprinkler, a trim piece called an escutcheon is used. This escutcheon hides the hole cut in the drywall occupied by the recessed sprinkler.

Concealed Sprinklers

Concealed sprinkler heads operate the same way as the recessed sprinkler heads; however they have a flat cover rather than an escutcheon.

The base sprinkler can come in various forms and still use the same concealed cover plate.



Sprinkler Overview, cont.

In this case, the deflector shield is on legs allowing the deflector to extend after activation.

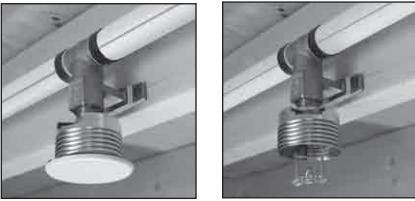

The cover is designed to drop off the sprinkler at a lower temperature than that of the actual sprinkler head rated temperature.

Sprinkler Temperature Ratings

Residential sprinklers have been specifically developed to address the types of fires that occur in residential occupancies. They are also designed and tested to maintain life safety conditions in the room of fire origin. For residential uses, sprinklers are classified as ordinary or intermediate.

The intent of NFPA 13D is to use “ordinary” temperature sprinklers in areas not subject to unusually high ambient temperatures. Ordinary temperature rated sprinklers can be installed where maximum ambient ceiling temperatures do not exceed 100°F (38°C).

In certain instances such as near skylights or under uninsulated roofs, ambient temperatures may exceed this threshold. For this reason, intermediate temperature rated sprinklers are available. Intermediate temperature rated sprinklers are designed for use where maximum ambient ceiling temperatures are between 101°F and 150°F (39°C and 66°C). However, ambient ceiling temperatures should not exceed 120°F (49°C) to be in accordance with the UL and C-UL listing.

Do not exceed ambient ceiling temperatures of 120°F (49°C).

NFPA 13D also establishes minimum distances between sprinkler heads and various heat sources such as fireplaces, kitchen ranges, light fixtures, heat ducts, exhaust fans and numerous other heat creating objects. Consult the detailed approved sprinkler layout plan and NFPA 13D for more details covering this topic.

Orifice Size (K-factor)

Your fire suppression system design should specify the specific fire sprinkler type including temperature and K-factor. The K-factor relates to the size of the opening in the sprinkler through which water passes when the sprinkler is activated. The size of this opening significantly impacts the sprinkler spray patterns and the amount of coverage.

NOTE: There are specific handling instructions for sprinklers. Refer to the appropriate Fire Suppression Sprinkler Manufacturer’s literature for all instructions and warnings.

Following are some of these warnings, however, this does not include a complete list of items required and referenced by NFPA 13D and the appropriate manufacturer:

Inspect each sprinkler for damage and cracked glass bulbs. Dispose of any damaged sprinklers.

Do not expose or store sprinklers in temperatures that exceed 100°F (38°C).

Sprinklers are generally shipped with protective coverings that protect the heat sensing element from damage. Leave the protective cover in place for all phases of installation and construction. Remove all protective covers before placing the system in service.

Do not paint any sprinkler head or the cover. This may interfere with the heat sensitivity of the head or cover causing the head not to function properly.

Sprinkler Installation Tools

Special wrenches and tools will be required for proper sprinkler installation. These wrenches are essential for proper installation to improve leverage, minimize slippage and help protect the sprinkler from damage during installation. Refer to the Sprinkler Manufacturer for further information.



Sprinkler Overview, cont.

Spare Sprinkler Heads

Since sprinkler heads are a one-time device, NFPA13D requires that each sprinkler head used in the dwelling must have an equivalent spare head available on the construction site, stored in an appropriate cabinet designed for this application. All K-factors, temperature ratings and style combinations used in the dwelling must be duplicated in the cabinet. Correct installation wrenches must also be available to remove and replace all heads that have been activated or damaged.

Local requirements may differ from those outlined in NFPA 13D. Consult your local AHJ and NFPA 13D for applicable requirements and spare quantities.

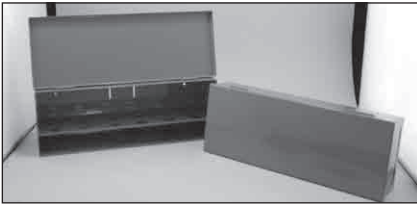

Installation Overview

Design Verification

The first step in installing the multipurpose system is to make sure that all fire suppression plans have been created by a certified fire protection design professional and approved by the AHJ (Design Plan). Local jurisdictions may require that the Design Plan be approved by the local building inspector or fire marshal BEFORE the installation occurs. Please consult your local AHJ for specific laws in your area.

Component Approvals and Interchangeability

Verify that all system components are UL 1821 listed for your correct application. Take notice that many UL 1821 certifications are for groups of products and not just specific components. For example, the Watts UL 1821 certification states that Watts RF PEX™ Tubing must be used in conjunction with Watts UL 1821 listed RF PEX™ Fittings and RF PEX™ Sprinkler Fittings. This combined approval is very common.

Therefore, Watts RF PEX™ Sprinkler Fittings cannot be combined with other manufacturer's tubing.

Verify that the Design Plan matches the current layout of the house.

NOTE: Confirm that the water pressure feeding the multipurpose system matches that required by the approved Design Plan. Lower water pressure may impact hydrostatic calculations and require changes to the multipurpose system design. Pressures exceeding 130 psi exceed the maximum pressure for the Watts PEX components and for NFPA 13D multipurpose piping systems. Follow local and national codes and procedures for verifying water supply for the system design.

Mark All Sprinkler and Fitting Locations and Confirm Tubing Runs

Visually trace where the RF PEX™ Tubing will be run throughout the house. Look for possible issues such as proximity to heat sources. NFPA 13D has specific guidelines concerning distances from various heat sources. Please consult a certified fire protection design professional if any problem areas are found.

Since the multipurpose system will include plumbing fixtures as well as sprinkler fixtures, locate all plumbing stub outs.

Potable plumbing runs for sizes ½" and smaller may not require UL listed RF PEX™ tubing. Standard potable Watts WaterPEX® tubing may be specified for plumbing lines ½" and smaller.

Note: WaterPEX® Tubing can only be used downstream of an RF PEX™ Sprinkler Fitting. DO NOT use WaterPEX® for main water supply or upstream of a RF PEX™ sprinkler fitting.

Installing and Connecting the RF PEX™ Tubing

Run RF PEX™ Tubing and WaterPEX® Tubing according to the approved fire suppression system plan. Once the tubing has been pulled, connect the system using Watts UL 1821 listed RF PEX™ Fittings and CrimpRing™ connections. These connections are made using the same tools and processes used to connect Watts WaterPEX® products with CrimpRing™ connections.

Making a Good CrimpRing™ Connection

1. Cut the tubing to length, making sure that you have a good square cut. A rough, jagged, or uneven cut will result in a weakened joint.
2. Next slide the correctly sized CrimpRing™ over the end of the tubing and down about 2".



3. Then slide the tubing over the fitting until the tubing touches the fitting shoulder.



4. Slide the CrimpRing™ over the end of the tubing until it is 1/8" to 1/4" from the shoulder of the fitting. This positions the ring so that it is directly over the two ribs closest to the end of the fitting.

5. Now position the tool so that it is at a 90° angle to the tubing and its jaws completely cover the ring.

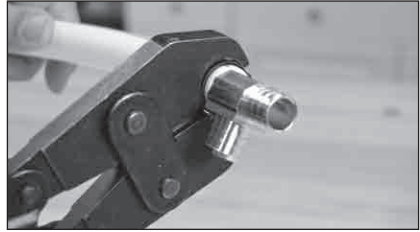
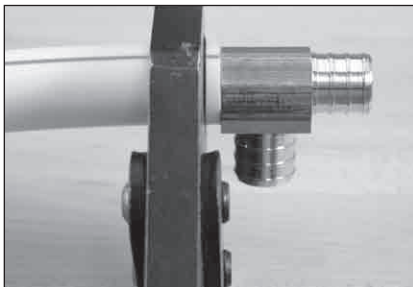

6. Close the jaws completely.



Installer Tip: Slightly squeeze the CrimpRing™ with channel-lock pliers to keep it in place. Then use your crimp tool to make the final connection. This is especially helpful in vertical installations where the crimp ring may slide away before making the final connection.

7. Check to see that the "Go" slot of the Go/No-Go gauge slides across the CrimpRing™. If the CrimpRing™ doesn't fit through the "Go" slot then the ring wasn't compressed sufficiently. Cut out the joint, calibrate the tool, and make a new connection.

Using a CrimpRing™ Tool Correctly

For the crimp tool to work correctly, it must evenly compress the copper CrimpRing™ so that the RF PEX™ Tubing material is evenly forced between the ribs of the fitting. If the ring is not evenly compressed, the joint could leak. For that reason the tool must be correctly adjusted (see following section) and used correctly.

On every joint you must ensure that the tool's jaws are located squarely over the CrimpRing™ and that the tool is positioned at a 90° angle to the fitting.

Using a CrimpRing™ Tool Correctly (cont.)

Using a Cutting Tool and Maintaining Your CrimpRing™ Tools

A quality cutting tool helps ensure quality joints. A good square connection is essential to making good joints. If the tubing is not cut square you won't have enough material to ensure good coverage over the fitting ribs.

The CrimpRing™ tools furnished for use with RF PEX™ tubing are quality precision instruments. They must, like all quality instruments be kept in good adjustment to work properly. Before beginning work on each job we suggest you make a test crimp to ensure that your crimping tool has not been "knocked out" of adjustment while traveling in your truck. Don't adjust the tool unless your points begin failing the "gauge" test. However, if your crimps begin failing the test, the tool can be adjusted to compensate for wear. There are currently four types of CrimpRing™ tools available: CrimpMaster™, RingMaster™, Dual Crimper™, and REMS™ crimper. Each tool has specific guidelines for maintenance included with the tool. Follow these guidelines carefully.

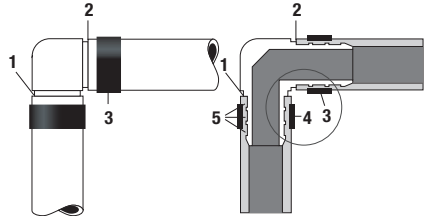

Illustration of a Good CrimpRing™ Connection

1. Fitting Shoulder location.
2. RF PEX™ Tubing is cut square and stops at the fitting shoulder.
3. CrimpRing™ is positioned $\frac{1}{8}$ " to $\frac{1}{4}$ " from end of the tubing directly over two end ribs of fitting.
4. CrimpRing™ is evenly compressed over the tubing, and shows no evidence of uneven distortion.
5. The RF PEX™ Tubing material is uniformly compressed between the brass ribs, resulting in a leak-free, quality joint.

How to Test a CrimpRing™ connection

Using a CrimpRing™ Gauge

Using the CrimpRing™ Gauge (Go/No-Go gauge) helps ensure a quality joint. It has six openings, two for each size of tubing it fits.

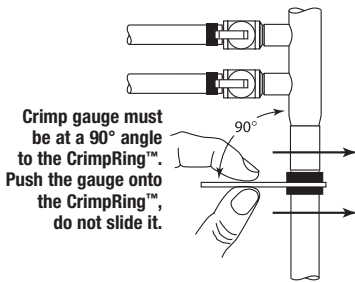
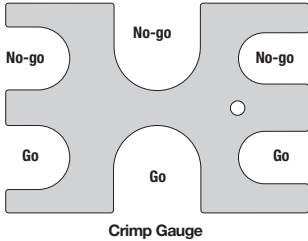

These are for 3/8", 1/2", 3/4" and 1" tubing sizes. See the following illustrations for guidance on how to use this important tool. Always check every joint you make.

1. Check each connection by pushing the crimp gauge onto the crimped copper ring at the appropriate "Go" slot. If it won't fit through, the ring wasn't compressed enough. If the ring fits through the "No-Go" slot, the ring was compressed too much. If your connection fails this test, cut out the bad joint and start over.

Don't try to run it through the crimp tool a second time.

If the gauge "hangs up" where the tool jaws closed (you'll see a small mark there), test the joint at a different point before you fail the connection and make the connection over.

2. You must hold the gauge at a 90° angle to the ring to perform a good test.
 3. Always check to make sure you're using the right size opening in the gauge for the size tubing you're installing.
 4. Push the gauge right onto the crimped ring; don't slide it!
 5. Don't change the gauge opening. It is manufactured to 0.002 tolerances to ensure reliable connections.
- Buy a new gauge if your old one is damaged or suspect.

How to test a CrimpRing™ Connection

Incorrectly compressed fittings can fall into two categories.

Top: The ring has been compressed too much and slides into the NO-Go slot.

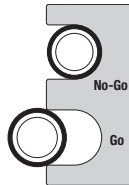

Lower: The ring has not been compressed enough and does not fit in the GO slot.

Correctly compressed fittings will:

Not go into the No-Go slot

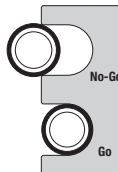

Will go into the Go slot

Installation Precautions

Installer Tip: After crimping a ring onto a fitting, use a magic marker to mark a line across the ring and tubing to keep track of what fittings have been crimped. Make these marks visible to the floor location. To help see the marks from the floor, many contractors carry binoculars so they can see the lines without having to use a ladder.

Avoid These Common CrimpRing™ Problems

(A) The CrimpRing™ was slid past the end of the tube. When the ring was compressed, it did not have enough tubing to “squeeze down on”. Remember to keep the ring $\frac{1}{8}$ " to $\frac{1}{4}$ " from the end of the tube.

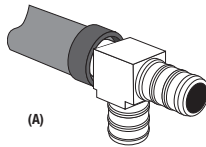

(B) The crimping tool was not held at a 90° degree angle to the tubing when the ring was compressed. The tubing was not evenly compressed onto the ribs.

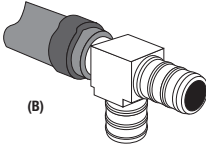

(C) The crimping tool was not centered over the CrimpRing™. The CrimpRing™ is distorted and the joint is of uneven quality.

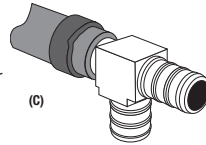

(D) The tube was not cut evenly. The tubing must cover all ribs of the fitting and butt against fitting shoulder.

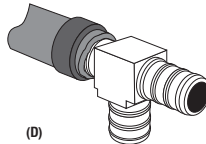

(E) The CrimpRing™ was not slid over the tube far enough to center the ring over the fitting. Therefore, no compression of the PEX into the barbs/ribs occurred.

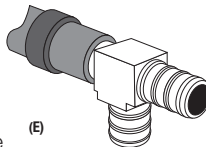

European PEX tubing and fittings.

Most PEX tubing made in Europe, unless specifically stated otherwise, is not made to the SDR-9 standard. It may look the same, but do not use these materials with SDR-9 tubing and fittings. Some older PEX tubing made in North America was also made to this European dimensional standard. Be careful not to mix the two types.

Protect from Physical Damage

Although RF PEX™ Tubing is, in many respects, a durable material, it must be stored, installed, and protected properly to ensure a quality job. See a list of precautions on pages 15 and 16.

Following are some key points to always keep in mind.

Installer Tip: When running PEX tubing through mechanical chases, fasten the tubing away from the ductwork. This prevents abrasion and lessens the noise caused by expansion and contraction.

Installation Precautions (cont.)

Select the Correct RF PEX™ Tube Size

While selecting the correct tubing size for a plumbing system, consider the following:

1. Local codes, customs, and accepted practices.
2. The volume of water required by each sprinkler head and plumbing fixtures.
3. The length of tubing required to service each fixture.
4. The vertical elevation change from the water source to the fixture.
5. The available water pressure at the water source.

For most residential applications, 1" RF PEX™ Tubing is used for main sprinkler supply lines. This will then be reduced to ¾" for sprinkler branches or specific zones. For potable water fixture applications where the tubing is not supplying sprinklers, ½" and ¾" standard WaterPEX® lines can be used.

If installing a "manifold" system, either ¾" or ½" (10 or 15mm) WaterPEX® is installed. These lines can service the potable water system; however, they cannot service the homes fire sprinkler system. There are many advantages of the manifold system (See WaterPEX® Potable Water System Design). Using ¾" (10mm) in lieu of ½" (15mm) offers a few additional advantages:

- Less water in the line means hot water reaches the fixture faster.
- Less water in the line means less cool water is wasted getting hot water to the fixture.

Do Not Exceed the Minimum Bend Radius

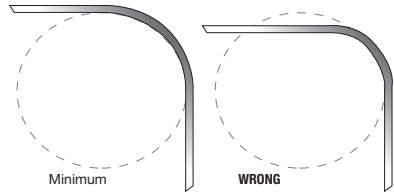

When bend supports are not being utilized, the minimum bend radius shall not be less than 8x the diameter of the tubing.

Without Bend Support (8x diameter)

¾" Tubing minimum bend radius = 7"

1" Tubing minimum bend radius = 9"

For ¾" tubing, the minimum bend radius is allowed to be reduced to 6x the diameter of the tubing (5.25") when using the approved bend supports.



Never bend ¾" tubing in a radius smaller than 6 times the diameter with a bend support or 8 times the diameter without a bend support.

Never bend 1" tubing in a radius smaller than 8 times the diameter.

If bending must be done against the natural curvature of the coil, allow a bending radius of 24 times the diameter of the tubing.

A Bend Radius smaller than recommended may become oval, kink or fail. If RF PEX™ Tubing becomes kinked, do not try to reform it. Instead cut the kink out of the system or replace the section of tubing with new RF PEX™ Tubing.

Installation Precautions, cont.

Support Properly

Although RF PEX™ Tubing is strong, it must be supported against undue stress, strain, and thermal expansion and contraction. We suggest the following guidelines when using RF PEX™ Tubing for potable water supply lines. Plumbing codes require the use of approved fastening devices. It is very important that approved plastic fasteners are used for mounting to wood member studs, joists or plywood. Only use special stand-off type fasteners like WaterPEX® StrapDowns™ and SnapClips™ for mounting to steel framing members.

When strapping down tubing, make sure strap is firm but loose enough to allow pipe to move back and forth during expansions and contractions. The Watts SnapClips™ and StrapDowns™ below are loose enough to allow this movement.

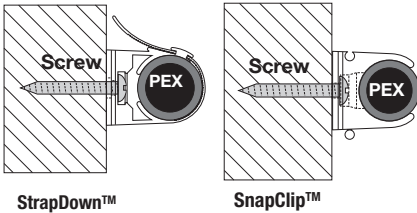

Vertical Runs: Vertical runs must be supported at least at every floor level. We recommend every 30".

Horizontal Runs: Unless continuously supported, hangers should be placed every 30 inches. If it is continuously supported, the tubing can be strapped down every 6'.

Label During Installation



While the tubing is being run to the fixture, label the tubing at both ends to designate the fixture.



Expansion Allowances

RF PEX™ Tubing expands at a rate of 1.1" per 100' of tubing for every 10°F (5.5°C) temperature drop. A line at an ambient temperature of 60°F (16°C) that has water at 160°F (71°C) entering it will expand 11" in a 100' run. And as that tubing cools down from 160°F to 60°F (71°C - 16°C) it will shrink 11". A good way to safely compensate for this expansion and contraction is to incorporate slack along each tubing run. As the tubing heats and cools, the slack will exaggerate or straighten during the temperature cycle.

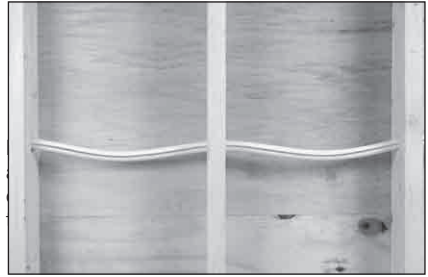

NOTE: Always leave enough excess tubing at the beginning and end of runs to make connections without putting strain on the tubing, and/or CrimpRing™ connection.

Terminate WaterPEX® at Fixture with Care

In most cases, the potable water system will terminate at a fixture using the WaterPEX® product. For the terminal fixturing, there are several options to connect WaterPEX® distribution lines to fixtures. Please see our WaterPEX® System Catalog for various options.

Installation Precautions and Handling and Care of RF PEX™

Trenching Precautions

Where RF PEX™ Tubing is laid in a trench, snake the tubing in with sufficient “waves” in the tubing so that there is sufficient allowance for expansion and contraction with temperature changes in the tubing.

RF PEX™ Tubing can be damaged by abrasion and by contact with abrasive materials, such as fill material with sharp edges. It is essential that the soil in the trench provide stable, continuous support for the tubing. Play it safe by installing polyethylene tubing insulation around the tubing for protection.

Always ensure that the tubing is buried such that any external load, such as the weight of the soil, or vehicular traffic does not cause the vertical dimension of the tubing to flatten by more than 5%. Suggested procedure is to pressurize before backfilling to minimize flattening of the tubing. All installation should be in compliance with local codes.

Additional information on trenching and tubing embedment practices can be obtained from ASTM D2774, Standard Recommended Practice for Underground Installation of Thermoplastic Pressure Piping, or the American Water Works Association (AWWA) report TR31, Underground Installation of Polyolefin Piping.

Protect RF PEX™ Tubing at Expansion Joints

If RF PEX™ Tubing is installed under expansion joints, the piping must be either sleeved with a protective layer of insulation, or the piping must dip under the slab into the underlying base material.

Avoid Bundling Hot and Cold Lines Together

Even though RF PEX™ Tubing has much better insulating values than copper tubing, always run hot and cold lines in separate bundles to avoid heat transfer between hot and cold lines.

Protect From Sharp or Abrasive Hangers

RF PEX™ Tubing can be damaged by metal hangers with sharp or abrasive edges. Don't use them. Don't use hangers, staples or fasteners that crush or pinch RF PEX™ Tubing. Be careful when using hangers or fasteners. Make sure they are not driven in too far and damage the tubing. If you are running bundles of piping, make sure that the entire

bundle is supported by a common strap. Don't use a hook or hanger on just one tub to support the weight of the entire tubing bundle.

Protect from Excessive Heat

RF PEX™ Tubing must be protected against excessive heat. Following are some typical kinds of exposure to excessive heat that you must be careful about.

Soldering

Don't ever solder next to RF PEX™ Tubing. If you are soldering on an RF PEX™ Fitting, make the solder connection first, then make the connection to the RF PEX™ Tubing second.

Water Heaters and Boilers

Use metal tubing to transition between water heaters and RF PEX™ Tubing. Maintain a minimum of 18" separation between the RF PEX™ Tubing and water heaters/gas boilers.

Recessed Light Fixtures

Maintain at least 12" (300mm) of separation between all recessed light fixtures and RF PEX™ Tubing.

Plenums

RF PEX™ Tubing is not approved for use inside plenums.

Air Return Grilles

RF PEX™ Tubing should be installed at least 24 inches (610 mm) from air return grilles or other openings in the ceiling.

Gas Appliance Vents

Maintain at least 6" (150mm) of separation between RF PEX™ Tubing and all gas appliance vents. Maintain at least 18" (450mm) of separation between RF PEX™ Tubing and wood appliance vents.

Protect from Chemicals

Except for short-term superchlorination of potable water lines when a potable water system is being cleaned, do not permit prolonged exposure of free chlorine concentrations in excess of 4 parts per million. Do not expose RF PEX™ Tubing and Fittings to cleaning agents, organic chemicals, strong acids, bug sprays, lubricants, solder fluxes, spray foam or foaming agents (spray foam insulation).

Installation Precautions and Handling and Care of RF PEX™

Standards for Disinfecting Water Mains

Disinfect potable water installations in accordance with the American Water Works Association C651-86, Standard For Disinfecting Water Mains, or follow local codes.

Leak-Testing Agents

Certain kinds of chemicals found in liquid-based leak detectors, especially those containing soap, can cause long term damage to PEX and other types of plastic tubing. The same chemicals used to “lift” dirt from soiled clothes can cause micro-fracturing of PEX tubing and lead to its eventual failure.

Adhesive Tape

RF PEX™ Tubing can also be damaged by some of the adhesives found in adhesive tape. Unless an adhesive tape or label is supplied by a PEX manufacturer do not apply adhesive tape to any RF PEX™.

Pipe Dope, Threading Compound, Mineral or Linseed Oil

RF PEX™ Tubing is damaged by some of the materials found in pipe dope, mineral oil, putty, cutting oil, and similar compounds. Do not expose RF PEX™ Tubing to these materials.

Petroleum Products and Solvent-based Paints

RF PEX™ Tubing is damaged by certain paints and petroleum products, such as gasoline, diesel fuel, cutting oil, brake and transmission fluids, and others. Do not expose RF PEX™ Tubing to these materials. Do not bury RF PEX™ Tubing in soil that is contaminated with these materials. (CMB)

Natural Gas

Do not use RF PEX™ Tubing to convey natural gas, propane, fuel oil, or any other hazardous or volatile fluids.

Electrical Ground

Do not use RF PEX™ Tubing as an electrical ground.

Protect Against Freezing

RF PEX systems shall be protected from freezing. See also NFPA 13D installation requirements.

RF PEX™ Fittings and field connections can be damaged if a plumbing system is allowed to freeze.

Storage of Tubing

Reasonable care and protection must be taken to protect RF PEX™ Tubing from damage, both before and during the construction process.

Do not unwrap tubing from its protective covering until use. The protective covering reduces scratches and UV exposure, which may damage RF PEX™ Tubing.

Sunlight Exposure

Take appropriate measures to protect RF PEX™ Tubing from sunlight exposure. Do not expose RF PEX™ Tubing to more than 30 days of direct sunlight. It will damage the tubing and it will void the warranty.

Temperature Range

Caution should be exercised when installing RF PEX™ at temperatures below freezing. The tubing is more easily damaged and kinked when installed at these temperatures. Best results are observed when the tubing is installed at temperatures above 50°F (10.0°C). In very cold weather you may wish to warm the tubing up in a heated room or truck cab before installing it. RF PEX™ Tubing is most flexible when installed at temperatures above 50°F (10.0°C).

These products are designed for use with temperature ranges between 40°F and 120°F.

Splicing Damaged Pipe

If at all possible, don't make splices in inaccessible locations, such as under slab floors, or behind dry wall.

If it is necessary to make buried splices, wrap the field coupling with insulation to protect the metal components against possible corrosion and mechanical stress.

Pressure Test Splices Before Burying.

Use only genuine RF PEX™ field repair materials when making these field splices. Never use any hose fittings/clamps or non-RF PEX™ fittings/clamps when making splices or connections.

Installation Precautions and Handling and Care of RF PEX™

Final System Inspection Before Covering the Pipe

After the RF PEX™ Tubing is buried or concealed, it is a relatively permanent part of your building. Because of the difficulty in servicing buried or concealed circuits, it is essential that a final inspection be performed to ensure that the piping has not been damaged during construction and that all circuits have been installed according to local codes and according to the building plan.

Look for Concealed Damage

Inspect it for kinks, scrapes, slits, or crush damage. Repair or replace as good practice dictates. Ensure all manifolds are correctly located and that all tubing connections to these manifolds and fittings are tight.

Inspect for Correct Use of Fastener

As you are walking along the RF PEX™ Tubing, make sure that the tubing is properly fastened. It is essential that you maintain correct spacing between fasteners.

Installing RF PEX™ Sprinkler Fittings

The exact placement of the RF PEX™ Sprinkler Fitting on the joist or stud is dependent on the type, design and manufacturer of the sprinkler. For final placement location, please refer to the Design Plan and sprinkler manufacturer's instructions regarding installation and placement needs.

RF PEX™ sprinkler fittings can be installed along ceiling joist for ceiling applications or along a wall stud for horizontal sidewall applications.

For ceiling applications, the RF PEX™ Tubing is run along the joist (normally 2x8). The RF PEX™ Sprinkler Fitting is then attached to the joist with the foot and screw openings



To aid our customers, we are offering the following graphical representation and calculation for a Sprinkler Fitting placement guide. This calculation is only a starting point. The sprinkler manufacturer's instructions provide more detailed and accurate information.

"D" is the distance between the screw holes and the edge of the joist or stud.

"T" is the drywall thickness (typically 1/2")

"L" is the length of the sprinkler.

"Dmin" and "Dmax" are the minimum and maximum distances between the deflector shield and the drywall.

"L", "Dmin" and "Dmax" are all dependent on the sprinkler. Please refer to the sprinkler technical data sheet for sprinkler specifications and placement tolerances. Tolerances and requirements may differ between sprinkler manufacturers. The exact RF PEX™ Sprinkler Fitting location will be determined by the sprinkler head location requirements.



running horizontally as shown.

For horizontal sidewall applications, the RF PEX™ Tubing is run vertically along the stud (normally 2x4). In this application, the RF PEX™ Sprinkler Fitting will then be attached with the foot and screw openings running vertically as shown.

In both cases (ceiling or wall mounted), the exact distance between the RF PEX™ Sprinkler Fitting foot and the edge of the joist or stud depends on the sprinkler design, manufacturer and specifications.

$$D_{min} = L - T - H_{max} - .375.$$

$$D_{max} = L - T - H_{min} - .375.$$

L = Hmin, Hmax should be obtained from the sprinkler manufacturer information.

T = Drywall Thickness

D = Estimated Sprinkler Fitting Hole Location

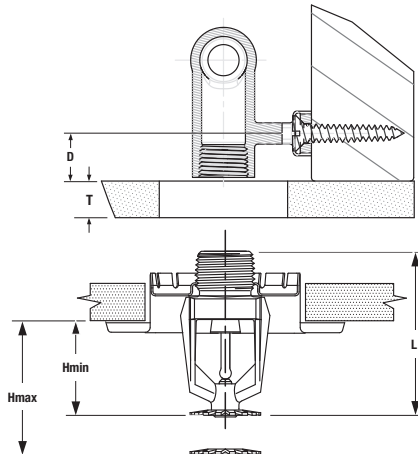

Installing RF PEX™ Sprinkler Fittings (cont.)

Many sprinkler manufacturers identify specific key dimensions on their sprinklers such as Length (L) and the final placement of the deflector from the outer drywall surface. With these dimensions plus the drywall thickness used and the goal sprinkler location, you can calculate the position of the roughed in RF PEX™ Sprinkler Fitting.

Fasten the sprinkler fitting to the structure using #10 x 1 1/2" course thread deck screws. Longer screws may protrude through the back of the joist or stud. The RF PEX™ Sprinkler Fitting is designed with slotted screw-holes to allow for slight depth adjustment. This will help achieve the proper distance between the drywall and the sprinkler head deflector.

NOTE: It is strongly recommended to confirm the sprinkler fitting placement after the first RF PEX™ Sprinkler Fitting has been hung.

After installing the first RF PEX™ Sprinkler Fitting, temporarily install drywall, sprinkler head, escutcheons or cover plates. Verify that the end product will comply with the sprinkler manufacturer instructions. The sprinkler placement instructions take precedent over the above calculations.

NOTE: In order to prevent damage to the Watts components, avoid over torquing when installing the sprinkler head. Refer to the sprinkler manufacturer's instructions for proper installation requirements.

Connecting Final Plumbing Runs

When branching off the main sprinkler lines, all potable water plumbing lines sizes 1/2" and smaller can use WaterPEX® tubing if they are only supplying plumbing fixtures. The fittings used to branch off from the main sprinkler line must be UL 1821 listed Watts RF PEX™ Fittings.

NOTE: WaterPEX® tubing can only be used downstream of a RF PEX™ Sprinkler Fitting. DO NOT use WaterPEX® for main water supply or upstream of a RF PEX™ Sprinkler Fitting.

Once you have branched off from the main sprinkler line, install fixtures as you would normally do with a WaterPEX® potable water system.

Pressure Test the Piping System

Upon completion, testing is required. Follow applicable codes before covering or concealing the tubing. Refer to NFPA 13D and local codes for testing procedures.

NOTE: Prior to any testing, you must ensure that the recommended testing is appropriate for all plumbing components and fixtures attached to the system. DO NOT use air or compressed gas for pressure testing.

Remember that when you pressure test with water, the system may freeze and become damaged if you forget to drain and purge all water from the system.

Depending on the air temperatures and the pressures used, the tubing may expand slightly, or the water/air may contract overnight. Either of these may cause the system pressure to show a slight drop. If you see evidence of a system pressure drop of more than 10% without evidence of a system leak, add more fluid or air. Wait another 24 hours, and check the pressure again.

Flow Testing

Should the multipurpose system be used to provide residential fire suppression, after a successful completion of the pressure test, we recommend that a flow test of the system is performed. Refer to your AHJ or certified fire protection design professional for additional information.

This is to test that the most hydraulically remote sprinkler operates as intended in the Design Plan. The AHJ should be notified of the test and is typically required to witness all tests.

System Startup Procedures

Fill the Piping System

After the system is complete, it is necessary to completely fill all circuits with water. The easiest way to do this is to use line pressure to flush as much air as possible out of the piping.

Open all valves and all fixtures throughout the building. Continue purging until all air is pushed out of all lines and water flows freely through all fixtures.

System Maintenance

Pursuant to NFPA 13D, it is the responsibility of the property owner to understand the system's operation and perform periodic maintenance and inspections.

Maintenance should include the following:

- Monthly inspection of all valves to ensure they are open.
- Monthly inspection of tanks, if present, to ensure they are full.
- Monthly testing of pumps, if present, to ensure they operate properly and do not

trip circuit breakers when starting.

- Testing of all water flow devices, when provided, every 6 months including monitoring service.
- Ongoing visual inspection of all sprinklers to make sure they are not obstructed or decorations are not attached or hung from them.
- Any and all other testing required by the AHJ and local and national codes and standards.
- Whenever painting or home improvements are made in the dwelling unit, special attention should be paid to ensure sprinklers are not painted or obstructed either at the time of installation or during subsequent redecoration. When painting is done in the area, the sprinklers should be protected by covering them with a bag, which should be removed immediately after painting is finished.

Reference Charts for Residential Fire Tubing and Fittings

Fitting Equivalent Length (Feet of RF PEX™ Tubing)

Fitting Configuration	Fitting Size	
	3/4" Fittings	1" Fittings
Coupling	2	1
90 Degree Elbow	4	4
Tee – Run	3	1
Tee – Branch	13	4
Flow-thru Pendent	12	1

Pressure Loss for RF PEX™ Tubing

Watts RF PEX™ tubing has a Hazen-Williams coefficient C-value of 150. Pipe friction loss calculations shall be performed according to the NFPA standards.

3/4" PEX Piping

Initial Static Pressure : 60psig (414kPa)

Water Temperature: 60° F (16°C)

Effective pressure table - Denotes pressure available at end of run based on flow and equivalent feet of tubing.

3/4" PEX Tube Length (feet)											
gpm	25	50	75	100	125	150	175	200	250	300	ft/sec**
1.0	59.9	59.9	59.8	59.7	59.6	59.6	59.5	59.4	59.3	59.1	0.91
1.5	59.8	59.7	59.5	59.4	59.2	59.1	58.9	58.8	58.5	58.2	1.36
2.0	59.7	59.5	59.2	59.0	58.7	58.4	58.2	57.9	57.4	56.9	1.81
2.5	59.6	59.2	58.8	58.4	58.0	57.6	57.3	56.9	56.1	55.3	2.27
3.0	59.5	58.9	58.4	57.8	57.3	56.7	56.2	55.6	54.5	53.4	2.72
3.5	59.3	58.5	57.8	57.1	56.3	55.6	54.9	54.2	52.7	51.2	3.18
4.0	59.1	58.1	57.2	56.3	55.3	54.4	53.5	52.5	50.6	48.8	3.63
4.5	58.8	57.7	56.5	55.3	54.2	53.0	51.9	50.7	48.4	46.0	4.08
5.0	58.6	57.2	55.8	54.3	52.9	51.5	50.1	48.7	45.9	43.0	4.54
5.5	58.3	56.6	54.9	53.3	51.6	49.9	48.2	46.5	43.1	39.8	4.99
6.0	58.0	56.0	54.1	52.1	50.1	48.1	46.1	44.2	40.2	36.2	5.44
6.5	57.7	55.4	53.1	50.8	48.5	46.2	43.9	41.6	37.0	32.4	5.90
7.0	57.4	54.7	52.1	49.5	46.8	44.2	41.6	38.9	33.7	28.4	6.35
7.5	57.0	54.0	51.0	48.0	45.0	42.0	39.1	36.1	30.1	24.1	6.80
8.0	56.6	53.3	49.9	46.5	43.1	39.8	36.4	33.0	26.3	19.5	7.26
8.5	56.2	52.5	48.7	44.9	41.1	37.4	33.6	29.8	22.3	14.7	7.71
9.0	55.8	51.6	47.4	43.2	39.0	34.8	30.7	26.5	18.1	9.7	8.17
9.5	55.4	50.7	46.1	41.5	36.8	32.2	27.6	22.9	13.7	4.4	8.62
10.0	54.9	49.8	44.7	39.6	34.5	29.4	24.3	19.2	9.1	—	9.07
10.5	54.4	48.8	43.3	37.7	32.1	26.5	21.0	15.4	4.2	—	9.53
11.0	53.9	47.8	41.8	35.7	29.6	23.5	17.5	11.4	—	—	9.98
11.5	53.4	46.8	40.2	33.6	27.0	20.4	13.8	7.2	—	—	10.43
12.0	52.9	45.7	38.6	31.4	24.3	17.2	10.0	2.9	—	—	10.89
12.5	52.3	44.6	36.9	29.2	21.5	13.8	6.1	—	—	—	11.34
13.0	51.7	43.4	35.2	26.9	18.6	10.3	2.1	—	—	—	11.79
13.5	51.1	42.2	33.4	24.5	15.6	6.7	—	—	—	—	12.25
14.0	50.5	41.0	31.5	22.0	12.5	3.0	—	—	—	—	12.70
14.5	49.9	39.7	29.6	19.5	9.3	—	—	—	—	—	13.16
15.0	49.2	38.4	27.6	16.9	6.1	—	—	—	—	—	13.61

**ft/sec calculation based on nominal inside diameter of .671" for 3/4" ASTM F876 Tubing

1" PEX Piping

Inlet Pressure : 60psig (414kPa)

Water Temperature: 60° F (16°C)

Effective pressure table - Denotes pressure available at end of run based on flow and equivalent feet of tubing.

1" PEX Tube Length (feet)											
gpm	25	50	75	100	125	150	175	200	250	300	ft/sec**
3.0	59.8	59.7	59.5	59.3	59.2	59.0	58.8	58.7	58.3	58.0	1.65
3.5	59.8	59.6	59.3	59.1	58.9	58.7	58.4	58.2	57.8	57.3	1.92
4.0	59.7	59.4	59.1	58.9	58.6	58.3	58.0	57.7	57.2	56.6	2.20
4.5	59.6	59.3	58.9	58.6	58.2	57.9	57.5	57.2	56.5	55.8	2.47
5.0	59.6	59.1	58.7	58.3	57.9	57.4	57.0	56.6	55.7	54.8	2.75
5.5	59.5	59.0	58.5	57.9	57.4	56.9	56.4	55.9	54.9	53.8	3.02
6.0	59.4	58.8	58.2	57.6	57.0	56.4	55.8	55.2	54.0	52.8	3.30
6.5	59.3	58.6	57.9	57.2	56.5	55.8	55.1	54.4	53.0	51.6	3.57
7.0	59.2	58.4	57.6	56.8	56.0	55.2	54.4	53.6	52.0	50.4	3.85
7.5	59.1	58.2	57.3	56.4	55.5	54.5	53.6	52.7	50.9	49.1	4.12
8.0	59.0	57.9	56.9	55.9	54.9	53.8	52.8	51.8	49.7	47.7	4.40
8.5	58.9	57.7	56.6	55.4	54.3	53.1	52.0	50.8	48.5	46.2	4.67
9.0	58.7	57.5	56.2	54.9	53.6	52.4	51.1	49.8	47.3	44.7	4.95
9.5	58.6	57.2	55.8	54.4	53.0	51.5	50.1	48.7	45.9	43.1	5.22
10.0	58.5	56.9	55.4	53.8	52.3	50.7	49.2	47.6	44.5	41.4	5.50
10.5	58.3	56.6	54.9	53.2	51.5	49.8	48.1	46.4	43.0	39.7	5.77
11.0	58.2	56.3	54.5	52.6	50.8	48.9	47.1	45.2	41.5	37.8	6.05
11.5	58.0	56.0	54.0	52.0	50.0	48.0	46.0	44.0	39.9	35.9	6.32
12.0	57.8	55.7	53.5	51.3	49.1	47.0	44.8	42.6	38.3	34.0	6.60
12.5	57.7	55.3	53.0	50.6	48.3	46.0	43.6	41.3	36.6	31.9	6.87
13.0	57.5	55.0	52.5	49.9	47.4	44.9	42.4	39.9	34.8	29.8	7.15
13.5	57.3	54.6	51.9	49.2	46.5	43.8	41.1	38.4	33.0	27.6	7.42
14.0	57.1	54.2	51.3	48.5	45.6	42.7	39.8	36.9	31.1	25.4	7.70
14.5	56.9	53.8	50.8	47.7	44.6	41.5	38.4	35.4	29.2	23.0	7.97
15.0	56.7	53.4	50.2	46.9	43.6	40.3	37.0	33.8	27.2	20.6	8.25
15.5	56.5	53.0	49.5	46.1	42.6	39.1	35.6	32.1	25.2	18.2	8.52
16.0	56.3	52.6	48.9	45.2	41.5	37.8	34.1	30.4	23.0	15.7	8.80
16.5	56.1	52.2	48.3	44.4	40.4	36.5	32.6	28.7	20.9	13.1	9.07
17.0	55.9	51.7	47.6	43.5	39.3	35.2	31.1	26.9	18.7	10.4	9.35
17.5	55.6	51.3	46.9	42.6	38.2	33.8	29.5	25.1	16.4	7.7	9.62
18.0	55.4	50.8	46.2	41.6	37.0	32.4	27.8	23.2	14.1	4.9	9.90
18.5	55.2	50.3	45.5	40.7	35.8	31.0	26.2	21.3	11.7	2.0	10.17
19.0	54.9	49.8	44.8	39.7	34.6	29.5	24.5	19.4	9.2	—	10.45
19.5	54.7	49.3	44.0	38.7	33.4	28.0	22.7	17.4	6.7	—	10.72
20.0	54.4	48.8	43.2	37.7	32.1	26.5	20.9	15.3	4.2	—	11.00
20.5	54.2	48.3	42.5	36.6	30.8	24.9	19.1	13.2	1.6	—	11.27
21.0	53.9	47.8	41.7	35.6	29.4	23.3	17.2	11.1	—	—	11.55
21.5	53.6	47.2	40.9	34.5	28.1	21.7	15.3	8.9	—	—	11.82
22.0	53.3	46.7	40.0	33.4	26.7	20.0	13.4	6.7	—	—	12.09
22.5	53.1	46.1	39.2	32.2	25.3	18.3	11.4	4.5	—	—	12.37
23.0	52.8	45.5	38.3	31.1	23.8	16.6	9.4	2.1	—	—	12.64
23.5	52.5	45.0	37.4	29.9	22.4	14.9	7.3	—	—	—	12.92
24.0	52.2	44.4	36.5	28.7	20.9	13.1	5.2	—	—	—	13.19
24.5	51.9	43.7	35.6	27.5	19.4	11.2	3.1	—	—	—	13.47
25.0	51.6	43.1	34.7	26.2	17.8	9.4	0.9	—	—	—	13.74
25.5	51.2	42.5	33.7	25.0	16.2	7.5	—	—	—	—	14.02
26.0	50.9	41.9	32.8	23.7	14.6	5.6	—	—	—	—	14.29

**ft/sec calculation based on nominal inside diameter of .862" for 1" ASTM F876 Tubing

UL 1821 Residential Fire Products

Tubing and Fittings Approved for Watts Residential Fire Multipurpose Piping

LEAD FREE*

RF PEX™ Tubing



FPTC12-100W-OS	¾FP-PEX-100ftCoil
FPTC12-250W-OS	¾FP-PEX-250ftCoil
FPTC12-300W-OS	¾FP-PEX-300ftCoil
FPTC12-500W-OS	¾FP-PEX-500ftCoil
FPTC12-1000W-OS	¾FP-PEX-1000ftCoil
FPTS12-25W-OS	¾FP-PEX-20ft-25Sticks
FPTS12-10W-OS	¾FP-PEX-20ft-10Sticks
FPTS12-25W-OS FastPack	¾FP-PEX-10ft-25Sticks
FPTC16-100W-OS	1FP-PEX-100ftCoil
FPTC16-300W-OS	1FP-PEX-300ftCoil
FPTC16-500W-OS	1FP-PEX-500ftCoil
FPTS16-5W-OS	1FP-PEX-20ft-5Sticks

LEAD FREE*

RF PEX™ Sprinkler Fittings

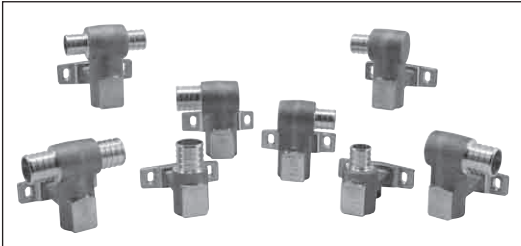

¾ FPSF-2-12	2-Way Tee-Crimp
1 FPSF-2-16	2-Way Tee-Crimp
¾ FPSF-1S-12	1-Way Straight-Crimp
1 FPSF-1S-16	1-Way Straight-Crimp
¾ FPSF-1R-12	1-Way Right-Crimp
1 FPSF-1R-16	1-Way Right-Crimp
¾ FPSF-1L-12	1-Way Left-Crimp
1 FPSF-1L-16	1-Way Left-Crimp

*The wetted surface of this product contacted by consumable water contains less than one quarter of one percent (0.25%) of lead by weight.

LEAD FREE***RF PEX™ Tubing Fittings**

MPT Adapters	3/4"	LFWP12B-1212
MPT Adapters	1"	LFWP12B-1616
MPT Adapters	3/4" x 1"	LFWP12B-1216
MPT Adapters	1" x 3/4"	LFWP12B-1612
FPT Adapters	3/4"	LFWP13B-1212
FPT Adapters	1"	LFWP13B-1616
MS Adapters	3/4"	LFWP10B-1212
MS Adapters	1"	LFWP10B-1616
FS Adapters	3/4"	LFWP11B-1212
FS Adapters	1"	LFWP11B-1616
Couplings	3/4"	LFWP15B-1212
Couplings	1"	LFWP15B-1616
Couplings	1" x 3/4"	LFWP15B-1612
Couplings	3/4" x 1/2"	LFWP15B-1208
Tees	3/4"	LFWP18B-12
Tees	1"	LFWP18B-16
Tees	1 x 3/4 x 3/4"	LFWP18B-161212
Tees	1 x 1 x 3/4"	LFWP18B-161612
Tees	3/4 x 3/4 x 1"	LFWP18B-121216
Tees	3/4 x 3/4 x 1/2"	LFWP18B-121208
Tees	1 x 1 x 1/2"	LFWP18B-161608
Elbows	3/4"	LFWP19B-12
Elbows	1"	LFWP19B-16
Elbows	3/4 x 1/2"	LFWP19B-1208
FS Elbow	3/4"	LFWP21B-12
Plugs & End Caps	3/4"	LFWP24B-12
Plugs & End Caps	1"	LFWP24B-16
Copper PEX CrimpRings	3/4"	WP14C-12
Copper PEX CrimpRings	1"	WP14C-16

For current model numbers and availability, please refer to the Watts Residential Fire Protection Products RF PEX™ catalog or our Watts website.

*The wetted surface of this product contacted by consumable water contains less than one quarter of one percent (0.25%) of lead by weight.

CALIFORNIA PROPOSITION 65 WARNING

WARNING: This product contains chemicals known to the State of California to cause cancer and birth defects or other reproductive harm. (California law requires this warning to be given to customers in the State of California.)

For more information: www.watts.com/prop65

Limited Warranty:

A. Watts Regulator Co. ("Watts") warrants its Residential Fire (RF) PEX cross-linked polyethylene tubing and barbed RF PEX fittings (the "Products") to be free of defects in material and workmanship for a period of twenty-five (25) years from the date of original shipment when used under normal usage in potable water systems and installed in accordance with all Watts published installation instructions.

B. In the event of any such defects during the warranty period, Watts' obligation will be to repair or replace, at its discretion, any Product proven to be defective in material or workmanship. In the event of a system malfunction or leak caused by defective Products within the warranty period (and not by incorrect installation, incorrect handling procedures or by job-site or installation damage), a reasonable pre-approved amount will be allowed for repair materials and repair labor. Note that the Products covered by this warranty are limited to the Watts tubing and fittings described above. Watts does not warrant any fire suppression sprinklers or any products or materials manufactured by any other company. Watts does not warrant the design of or the connections on any installation, as the integrity of the design and connections is subject to the workmanship of the contractor/installer. The design and connections are the sole responsibility of the contractor/ installer.

C. In order to qualify for a warranty remedy under paragraph B, you must contact Watts in advance and receive a written authorization for this remedy from an authorized Watts representative. Repair materials, repair labor and freight expenses not authorized in writing in advance by Watts in this way will not be compensated.

D. To qualify for the warranty described above, you must do the following:

1. Use good construction techniques to install the Products, as specified in our current installation manual and any other guidelines or technical notes published by Watts. This must include field pressure testing our warranted materials before they are covered by concrete or otherwise made inaccessible.
2. Install the Products according to the current installation manual and any other guidelines and technical notes published by Watts.
3. Install the Products in a system that will not operate at temperatures or at pressures that exceed the rating printed on the tubing.
4. The Products must be installed in compliance with local building and plumbing codes.

E. Evidence of tampering, mishandling, neglect, accidental damage, freeze damage or unauthorized repairs that cause damage to the Products will void any warranty coverage. All design and field connections are specifically excluded from the terms of this warranty.

F. Any defects or claims relating to products or materials manufactured by any other company should be reported to that manufacturer for its warranty response.

G. Disclaimer of Warranty. **THE WARRANTY SET FORTH HEREIN IS GIVEN EXPRESSLY AND IS THE ONLY WARRANTY GIVEN BY WATTS WITH RESPECT TO THE PRODUCTS LISTED IN PARAGRAPH A. WATTS MAKES NO OTHER WARRANTIES, EXPRESS OR IMPLIED. WATTS HEREBY SPECIFICALLY DISCLAIMS ALL OTHER WARRANTIES, EXPRESS OR IMPLIED, INCLUDING BUT NOT LIMITED TO THE IMPLIED WARRANTIES OF MERCHANTABILITY AND FITNESS FOR A PARTICULAR PURPOSE.**

H. Limitation of Liability. The remedy described above shall constitute the sole and exclusive remedy for breach of warranty, and, apart from that remedy, Watts shall not be responsible under any legal theory for any incidental, special or consequential damages, including without limitation, lost profits or the cost of repairing or replacing other property which is damaged if these Products do not work properly, other costs resulting from labor charges, delays, vandalism, negligence, fouling caused by foreign material, damage from adverse water conditions, adverse chemical environments, or any other circumstances over which Watts has no control. This Limited Warranty shall be invalidated by any abuse, misuse, misapplication or improper installation of the Products. Some states do not allow limitations on how long an implied warranty lasts, and some states do not allow the exclusion or limitation of incidental or consequential damages. Therefore the above limitations may not apply to you. This Limited Warranty gives you specific legal rights, and you may have other rights that vary from state to state. You should consult applicable state laws to determine your rights. **SO FAR AS IS CONSISTENT WITH APPLICABLE STATE LAW, ANY IMPLIED WARRANTIES THAT MAY NOT BE DISCLAIMED, INCLUDING THE IMPLIED WARRANTIES OF MERCHANTABILITY AND FITNESS FOR A PARTICULAR PURPOSE, ARE LIMITED IN DURATION TO ONE YEAR FROM THE DATE OF ORIGINAL SHIPMENT.**

I. RETURNED GOODS – CREDIT: No material shall be returned without authorization. When credit is issued, it will be at the price originally invoiced, less handling charges, based on the costs of reconditioning, boxing, etc. Products which are obsolete or made to special order are not returnable.

