

SHARP®

DIGITAL FULL COLOUR MULTIFUNCTIONAL SYSTEM

MODEL: BP-10C20
BP-20C20
BP-20C25

User's Manual

Click to jump to the table of contents of the desired chapter.



BEFORE USING THE MACHINE

Functions of the machine and procedures for placing originals and loading paper



COPIER

Using the copy function



PRINTER

Using the printer function



FACSIMILE

Using the fax function



SCANNER

Using the scan function



SYSTEM SETTINGS

Configuring settings to make the machine easier to use



HOW TO USE THIS MANUAL

Click a button below to move to the page that you wish to view.

The following explanation assumes that Adobe Acrobat Reader is being used (Some buttons do not appear in the default state.).

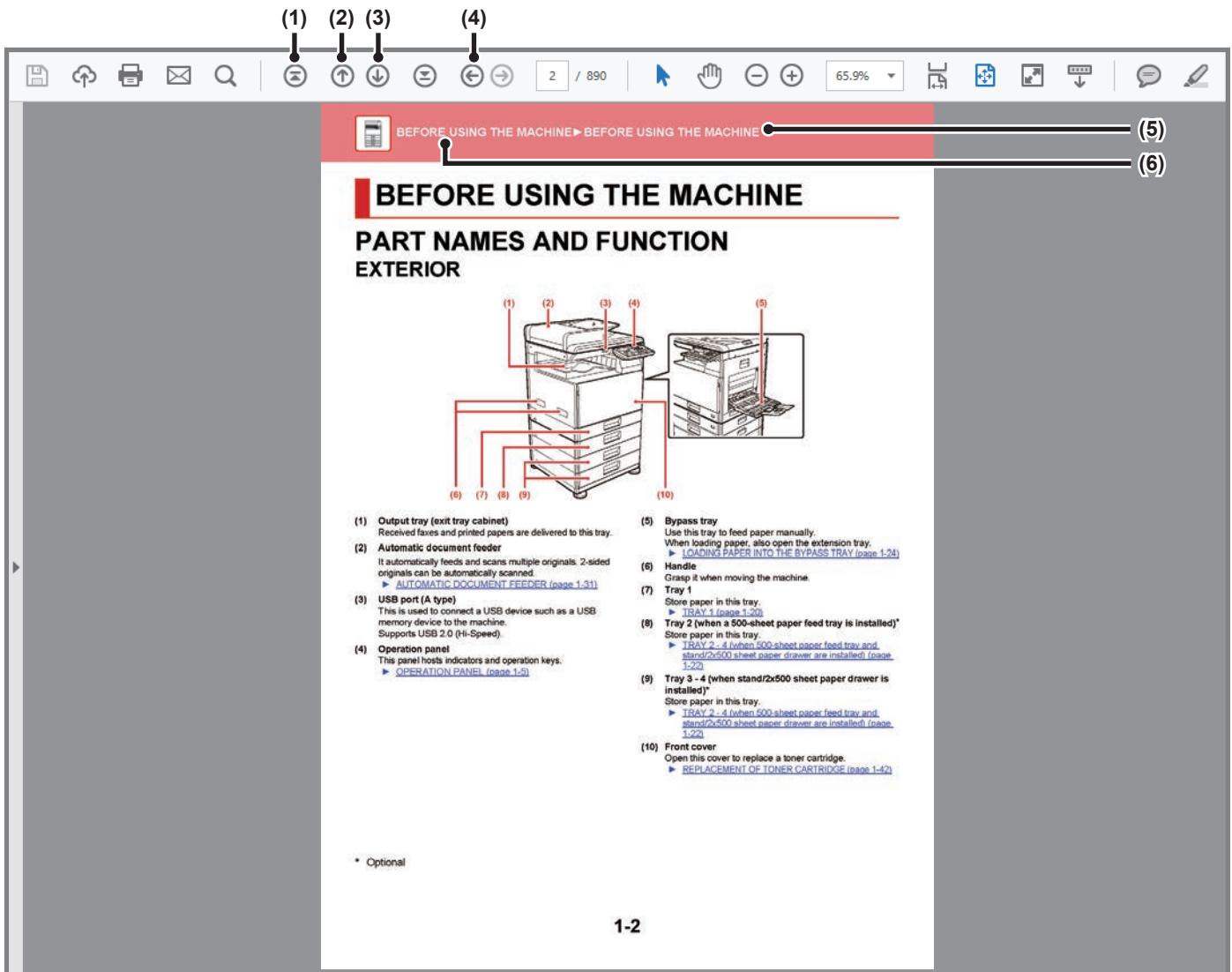

(1) Return to top page button

If an operation does not proceed as expected, click this button to start over again.

(2) Back one page button

Displays the previous page.

(3) Forward one page button

Displays the next page.

(4) Return to previously displayed page button

Displays the page that was displayed before the current page.

(5) Title button

Displays the page of the title indicated by the button.

(6) Contents button

Displays the contents of each chapter.

For example, if the current page is part of the printer chapter, the table of contents of the printer chapter appears.



If a button does not appear, refer to Adobe Reader Help to display the button.

ABOUT OPERATION MANUAL

This manual explains how to use the BP-10C20/BP-20C20/BP-20C25 digital full colour multifunctional system.

Please note

- For information on installing the drivers and software cited in this manual, please refer to the Software Setup Guide.
- For information on your operating system, please refer to your operating system manual or the online Help function.
- The explanations of screens and procedures in a Windows environment are primarily for Windows® 10. The screens may be different depending on the version of the operating system or the software application.
- The explanations of screens and procedures in a Macintosh environment are based on macOS10.12 in the case of macOS. The screens may be different depending on the version of the operating system or the software application.
- Wherever model name xx-xxxx appears in this manual, please substitute your model name.
- This manual contains references to the fax function. However, please note that the fax function is not available in some countries and regions.
- Considerable care has been taken in preparing this manual. If you have any comments or concerns about the manual, please contact your dealer or nearest authorised service representative.
- This product has undergone strict quality control and inspection procedures. In the unlikely event that a defect or other problem is discovered, please contact your dealer or nearest authorised service representative.
- Aside from instances provided for by law, SHARP is not responsible for failures occurring during the use of the product or its options, or failures due to incorrect operation of the product and its options, or other failures, or for any damage that occurs due to use of the product.

Warning

- Reproduction, adaptation or translation of the contents of the manual without prior written permission is prohibited, except as allowed under copyright laws.
- All information in this manual is subject to change without notice.

Illustrations and the operation panel and display shown in this manual





The peripheral devices are generally optional, however, some models include certain peripheral devices as standard equipment. The explanations in this manual assume that 500-sheet paper feed tray and Stand/2x500 sheet paper drawer are installed on the BP-20C25.

For some functions and procedures, the explanations assume that devices other than the above are installed.

The display screens, messages, and key names shown in the manual may differ from those on the actual machine due to product improvements and modifications.

Icons used in the manuals

The icons in the manuals indicate the following types of information:

	This alerts you to a situation that could result in death or serious personal injury. This alerts you to a situation that could result in personal injury or damage to properties.		This explains how to stop or correct an operation.
	This alerts you to a situation where there is a risk of machine damage or failure.		This describes a routine work relevant to setting mode.
	This supplements function or operation procedure.		



BEFORE USING THE MACHINE

BEFORE USING THE MACHINE

PART NAMES AND FUNCTION	1-2
• EXTERIOR	1-2
• INTERIOR, SIDE AND BACK	1-3
• AUTOMATIC DOCUMENT FEEDER AND DOCUMENT GLASS	1-4
• OPERATION PANEL	1-5
PERIPHERAL DEVICES	1-8
DISPLAY	1-9
• LEFT MENU AND RIGHT MENU	1-9
• HOW TO USE THE DISPLAY	1-10
TURNING ON THE POWER	1-12
Eco	1-13
• ECO FUNCTIONS OF THE MACHINE	1-13
• AUTO POWER SHUT-OFF MODE	1-13
• PREHEAT MODE	1-14
• ENTER AUTO POWER SHUT-OFF AFTER THE REMOTE JOB	1-14
USER AUTHENTICATION MODE	1-15
• USING USER AUTHENTICATION MODE	1-15

LOADING PAPER

IMPORTANT POINTS ABOUT PAPER	1-16
• NAMES AND LOCATIONS OF TRAYS	1-16
• THE DEFINITION OF "R" IN PAPER SIZE	1-16
• APPLICABLE PAPER TYPES	1-16
TRAY 1	1-20
TRAY 2 - 4 (when 500-sheet paper feed tray and stand/2x500 sheet paper drawer are installed)	1-22
LOADING PAPER INTO THE BYPASS TRAY	1-24
TRAY SETTINGS	1-29

HOW TO PLACE THE ORIGINAL

SELECTING A PROCEDURE FOR PLACING THE ORIGINAL DEPENDING ON THE TYPE AND STATUS OF THE ORIGINAL	1-31
AUTOMATIC DOCUMENT FEEDER	1-31
DOCUMENT GLASS	1-33

MAINTENANCE

CHECKING THE TOTAL OUTPUT COUNT AND TONER REMAINING	1-34
ADJUSTING THE DISPLAY CONTRAST	1-34
REGULAR MAINTENANCE	1-35
• CLEANING THE DOCUMENT GLASS AND AUTOMATIC DOCUMENT FEEDER	1-35
• CLEANING THE FEED ROLLER OF TRAY 1	1-37
• CLEANING THE BYPASS FEED ROLLER	1-37
• CLEANING THE PAPER FEED ROLLER	1-37
• CLEANING THE LASER UNIT	1-38
REPLACEMENT OF TONER CARTRIDGE	1-42
REPLACING THE WASTE TONER BOX	1-45

CHARACTER ENTRY

CHARACTERS THAT CAN BE ENTERED	1-47
---------------------------------------------	-------------



BEFORE USING THE MACHINE

PART NAMES AND FUNCTION EXTERIOR

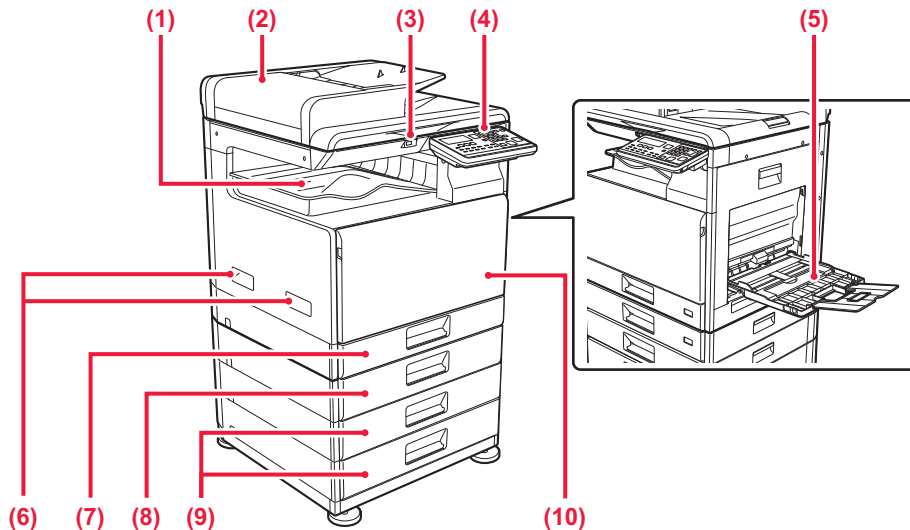

- (1) **Output tray (exit tray cabinet)**
Received faxes and printed papers are delivered to this tray.
- (2) **Automatic document feeder**
It automatically feeds and scans multiple originals. 2-sided originals can be automatically scanned.
► [AUTOMATIC DOCUMENT FEEDER \(page 1-31\)](#)
- (3) **USB port (A type)**
This is used to connect a USB device such as a USB memory device to the machine.
Supports USB 2.0 (Hi-Speed).
- (4) **Operation panel**
This panel hosts indicators and operation keys.
► [OPERATION PANEL \(page 1-5\)](#)
- (5) **Bypass tray**
Use this tray to feed paper manually.
When loading paper, also open the extension tray.
► [LOADING PAPER INTO THE BYPASS TRAY \(page 1-24\)](#)
- (6) **Handle**
Grasp it when moving the machine.
- (7) **Tray 1**
Store paper in this tray.
► [TRAY 1 \(page 1-20\)](#)
- (8) **Tray 2 (when a 500-sheet paper feed tray is installed)***
Store paper in this tray.
► [TRAY 2 - 4 \(when 500-sheet paper feed tray and stand/2x500 sheet paper drawer are installed\) \(page 1-22\)](#)
- (9) **Tray 3 - 4 (when stand/2x500 sheet paper drawer is installed)***
Store paper in this tray.
► [TRAY 2 - 4 \(when 500-sheet paper feed tray and stand/2x500 sheet paper drawer are installed\) \(page 1-22\)](#)
- (10) **Front cover**
Open this cover to replace a toner cartridge.
► [REPLACEMENT OF TONER CARTRIDGE \(page 1-42\)](#)

* Optional



INTERIOR, SIDE AND BACK

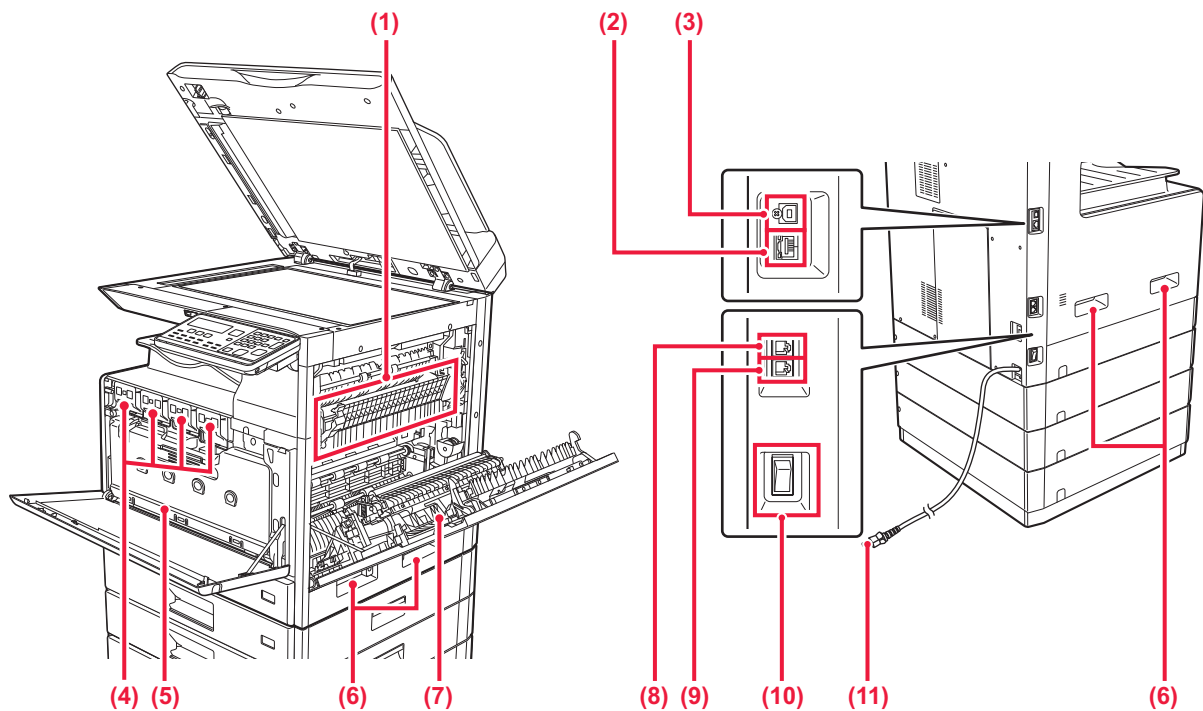

(1) Fusing unit

Heat is applied here to fuse the transferred image onto the paper.



The fusing unit is hot. Take care not to burn yourself when removing a misfeed.

(2) LAN connector

Connect the LAN cable to this connector when the machine is used on a network. Use a shielded LAN cable.

(3) USB port (B type)

The machine does not use this connector.

(4) Toner cartridge

This cartridge contains toner. When the toner in a cartridge runs out, replace with new one.

► [REPLACEMENT OF TONER CARTRIDGE \(page 1-42\)](#)

(5) Waste toner box

This container collects excess toner that remains after printing.

► [REPLACING THE WASTE TONER BOX \(page 1-45\)](#)

(6) Handle

Grasp it when moving the machine.

(7) Side cover

Open this cover to remove a paper misfeed.

(8) Telephone line socket (LINE)

When the fax function of the machine is used, the telephone line is connected to this socket.

(9) Extension phone socket (TEL)

When the fax function of the machine is used, an extension phone can be connected to this socket.

(10) The main power switch

Use this switch to turn on the power for the machine. When using the fax, always keep this switch in the " | " position.

► [TURNING ON THE POWER \(page 1-12\)](#)

(11) Power plug



AUTOMATIC DOCUMENT FEEDER AND DOCUMENT GLASS

BP-10C20

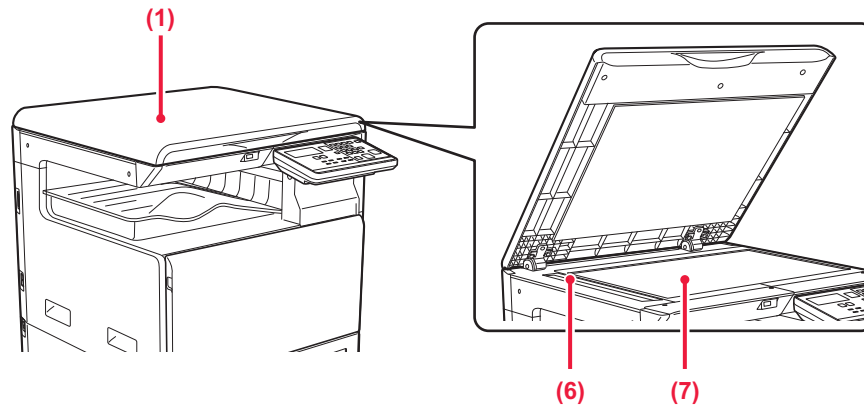

BP-20C20/BP-20C25

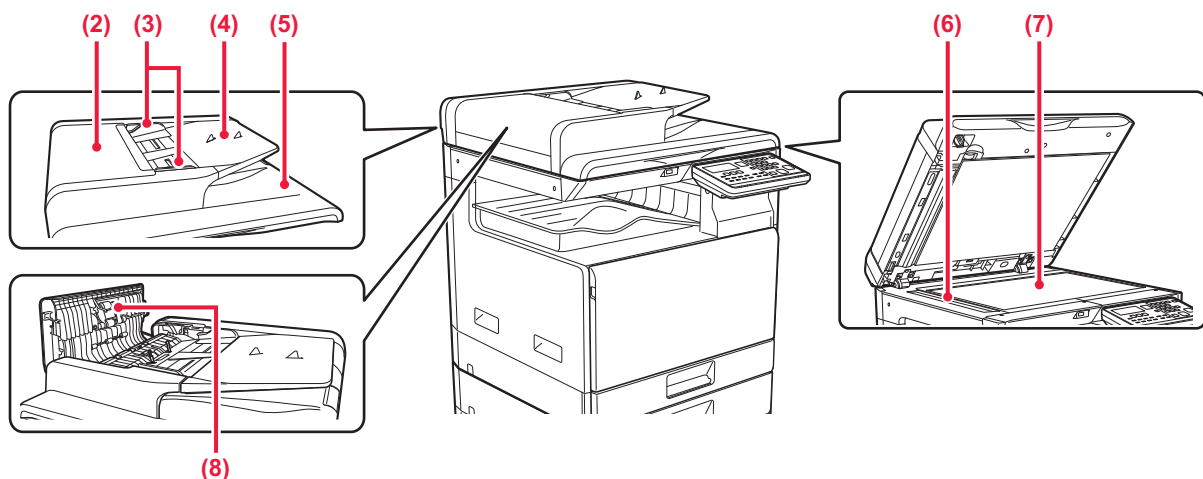

- (1) **Document cover**
Open to make copies from the document glass.
- (2) **Document feeding cover**
Open this cover to remove an original misfeed.
This cover is also opened to clean the paper feed roller.
► [CLEANING THE PAPER FEED ROLLER \(page 1-37\)](#)
- (3) **Original guides**
These guides help ensure that the original is scanned correctly.
Adjust the guides to the width of the original.
- (4) **Document feeder tray**
Place the original.
Place the original with the print side facing up.
► [AUTOMATIC DOCUMENT FEEDER \(page 1-31\)](#)
- (5) **Original exit tray**
The original is discharged to this tray after scanning.
- (6) **Scanning area**
Originals placed in the automatic document feeder are scanned here.
► [CLEANING THE DOCUMENT GLASS AND AUTOMATIC DOCUMENT FEEDER \(page 1-35\)](#)
- (7) **Document glass**
If you want to scan books or other thick originals that cannot be fed through the automatic document feeder, place them on this glass.
► [DOCUMENT GLASS \(page 1-33\)](#)
- (8) **Paper feed roller**
This roller rotates to automatically feed the original.



OPERATION PANEL

This section describes the names and functions of the respective parts of the operation panel.

Depending on the country and region, display on the operation panel is divided into symbol type and English display type.

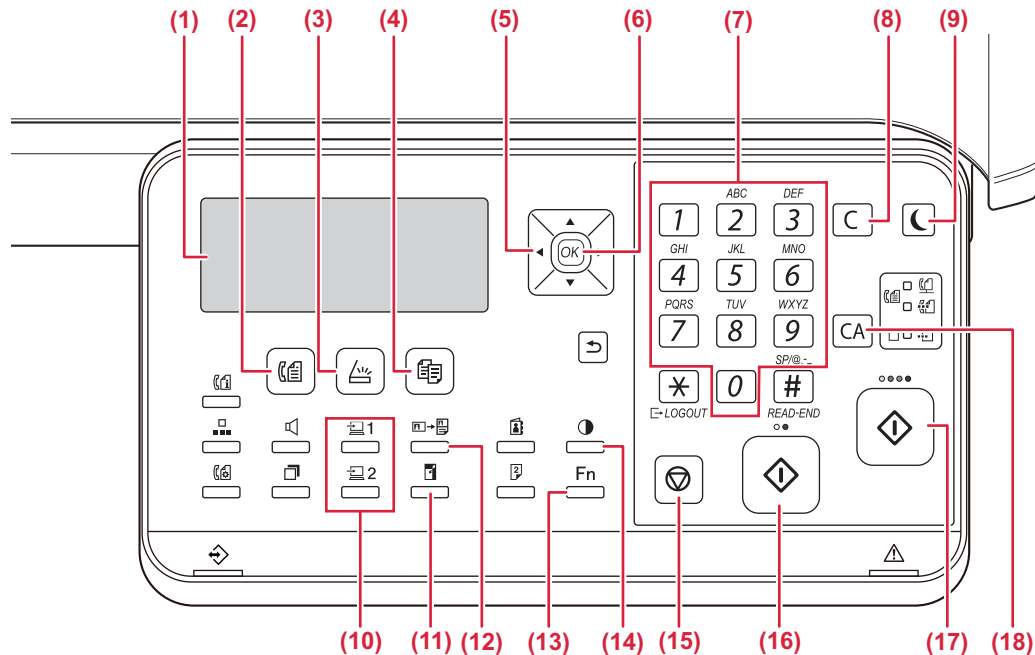

- (1) **Display**
Shows various messages.
► [DISPLAY \(page 1-9\)](#)
- (2) **[FAX] key / indicator** (☎)
Press to select fax mode.
- (3) **[SCAN] key / indicator** (📄)
Press to select scan mode.
- (4) **[COPY] key / indicator** (📄)
Press to select copy mode.
To check the total number of pages output in copy, print, and fax modes hold down the [COPY] key (📄) when the machine is in the standby state. The counts will appear while the key is held down.
The toner level is shown at the bottom of the screen.
- (5) **Arrow keys**
Press to move the highlighting (which indicates that an item is selected) in the display.
- (6) **[OK] key**
Press to enter the selected setting.
- (7) **Numeric keys**
Enter characters/numbers.
- (8) **[C] key**
Press to clear the set number of copies or stop a copy run.
- (9) **[ENERGY SAVE] key / indicator** (☾)
Press to enter the energy save mode.
- (10) **[PROGRAM 1 / PROGRAM 2] key** (📄 1 / 📄 2)
Press to use the scanner settings already stored.
► [USING STORED SETTINGS \(PROGRAM\) \(page 5-20\)](#)
- (11) **[ZOOM] key** (📄)
Press to select a reduction or enlargement copy ratio.
► [ENLARGE/REDUCE \(page 2-10\)](#)
- (12) **[ID CARD COPY] key** (📄 → 📄)
Enable ID Card Copy.
► [ID CARD COPY \(page 2-19\)](#)
- (13) **[SPECIAL FUNCTION] key** (Fn)
Press to select Special Modes.
- (14) **[EXPOSURE] key** (☉)
Use to select the exposure mode.
► [CHANGING THE EXPOSURE AND ORIGINAL IMAGE TYPE \(page 2-8\)](#)
- (15) **[STOP] key** (⏹)
Press this key to stop a copy job or scanning of an original.
- (16) **[B/W START] key / indicator**
Press this key to copy or scan an original in black and white. This key is also used to send a fax in fax mode.
- (17) **[COLOUR START] key / indicator**
Press this key to colour copy or scan an original.
- (18) **[CA] key**
Clears all selected settings and returns the machine to the default settings.

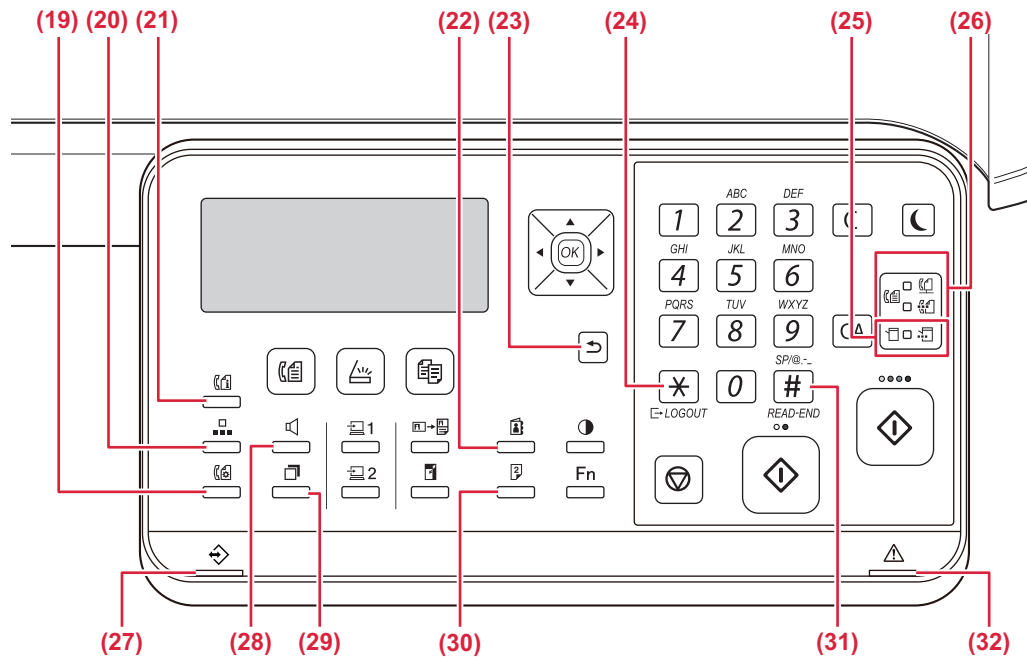
**(19) [COMM. SETTING] key ()***

This is used to switch between memory transmission and direct transmission, and to switch between automatic reception and manual reception.

- [Transmission settings \(memory transmission mode and direct transmission mode\) \(page 4-15\)](#)

(20) [SPEED] key ()*

This is used to dial by Speed dialling.

- [TRANSMISSION BY AUTO-DIALLING \(SPEED DIALLING AND GROUP DIALLING\) \(page 4-12\)](#)

(21) [FAX STATUS] key ()*

This is used to cancel a fax transmission or a stored fax transmission.

- [CANCELLING A FAX TRANSMISSION \(page 4-21\)](#)

(22) [ADDRESS] key ()

Used to search for address, numbers and other contact information stored for auto dialling.

- [SEARCHING FOR A PROGRAMMED DESTINATION \(USING THE \[ADDRESS\] KEY\) \(page 4-13\)](#)

(23) [BACK] key ()

Press to return the display to the previous screen.

(24) [LOGOUT] key ()

Press this key to log out after you have logged in and used the machine. When using the fax function, this key can also be pressed to send tone signals on a pulse dial line.

(25) Printer mode indicators

- **DATA indicator** ()

Blinks when print data is being received. Lights steadily during printing.

(26) FAX mode indicators ()*

- **LINE indicator** ()

Lights up when a fax is being sent or received.

- **DATA indicator** ()

Blinks when a fax cannot be printed because there is no paper or otherwise. Lights steadily when there is an unsent fax.

(27) Data notification indicator

The indicator lights solidly or blinks to indicate the status of a job.

(28) [SPEAKER] key ()*

This is used to dial without lifting an extension phone connected to the machine. (► [page 4-16](#))

(29) [REDIAL/PAUSE] key ()*

This is used to redial the last number dialled, and enter a pause when entering a fax number.

- [CONVENIENT DIALLING METHODS \(AUTO-DIALLING\) \(page 4-6\)](#),

(30) [DUPLEX] key ()

Select the duplex copy/fax/scan mode.

(31) [READ-END] key ()

When copying in sort mode from the document glass, press this key when you have finished scanning the original pages and are ready to start copying.

(32) Error indicator

Lights solidly or blinks to indicate the status of the error.

* The BP-10C20 does not have fax function key or indicators. The fax function key or indicators can be used when a facsimile expansion kit is installed on the BP-20C20/BP-20C25.



You can change the angle of the operation panel.

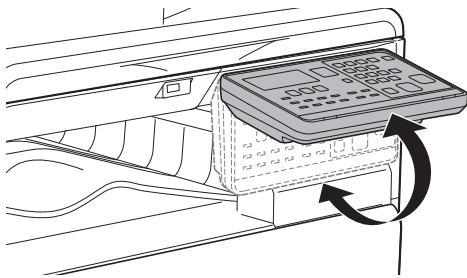



PERIPHERAL DEVICES

Peripheral devices can be installed on the machine to increase its range of functionality.

The peripheral devices are generally optional. However, some models include certain peripheral devices as standard equipment.

(As of May, 2019)

Product name	Product number	Description
500-sheet paper feed tray	BP-CS10	Additional tray. A maximum of 500 sheets of paper can be loaded into the tray. One paper feed tray can be installed.
Stand/2x500 sheet paper drawer	BP-DE10	Additional tray. A maximum of 500 sheets of paper can be loaded into the tray. One paper feed tray can be installed. (when 500-sheet paper feed tray is installed)
High stand	BP-DS10	This is an additional dedicated stand.
Low stand	BP-DS11	
PS3 expansion kit	MX-PK11	Enables the machine to be used as a Postscript compatible printer.
Facsimile expansion kit*	BP-FX10	Enables Fax.
Wireless LAN Adaptor	MX-EB18	You can use this as a work platform, or temporarily place originals or a mobile device.
Sharpdesk 1 license kit	MX-USX1	This software enables integrated management of documents and computer files.
Sharpdesk 5 license kit	MX-USX5	
Sharpdesk 10 license kit	MX-USX10	
Sharpdesk 50 license kit	MX-USX50	
Sharpdesk 100 license kit	MX-USXA0	

* The fax function can be used when a facsimile expansion kit is installed on the BP-20C20/BP-20C25.



Some options may not be available in some countries and regions.



DISPLAY

This section explains how to use the display.

LEFT MENU AND RIGHT MENU

The display on the machine has a right menu containing frequently used settings and a left menu for display of the settings and setting screens of each function.

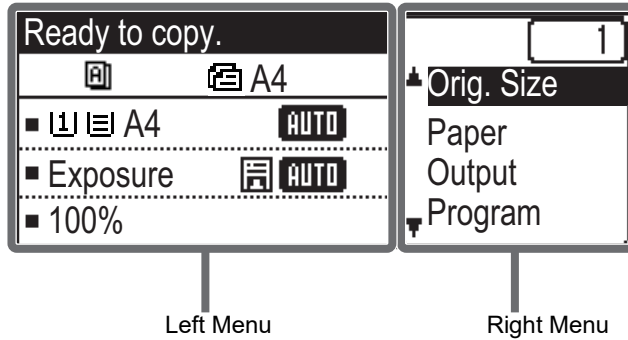

Left Menu (Example: Copy mode)

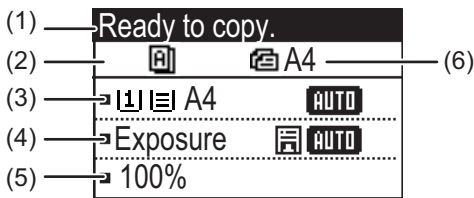

(1) Message display

Messages are displayed regarding machine status and operation.

(2) Special function icon display

Icons of enabled Special Modes will appear.

	1-sided to 2-sided copy		2-Up copy
	2-sided to 2-sided copy		4-Up copy
	2-sided to 1-sided copy		Slow Scan Mode
	Sort		Card shot
	Rotate sort		ID card copy
	Suppress BG		RGB Adjust
			Sharpness

(3) Paper size display

Displays the selected paper size.

(4) Exposure display

Indicates the selected exposure mode.

(5) Copy ratio display

Displays the copy ratio for reduction or enlargement.

(6) Original size display

When the original size is specified in "Orig. Size" in the right menu and the document is loaded in the automatic document feeder, this shows the specified size.

The following icons appear when the original is placed.

None: Document Glass

Automatic document feeder (one-sided scanning).

Automatic document feeder (two-sided scanning)



Right Menu

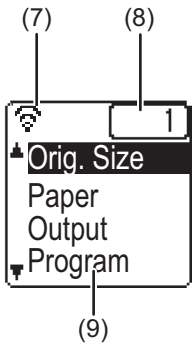

- (7) **Connection status display**
(Models with the wireless LAN function only)
Displayed when wireless LAN is on.

	Wireless infrastructure mode: Connecting
	Wireless infrastructure mode: Not connected
	Wired + wireless access point mode
	Connection failure of wireless LAN device inside machine

- (8) **Number of copies display**
Shows the number of copies set.
- (9) **Function display**
Shows the basic functions of each mode.

HOW TO USE THE DISPLAY

Selecting an item with the arrow keys (up/down)

Use the up/down arrow keys (indicated in this manual by [▼] [▲]) to move to and select (highlight) a setting item in the selection screen. Press the [OK] key to display the screen of the selected setting item. Press [OK] in the setting screen to save your settings.

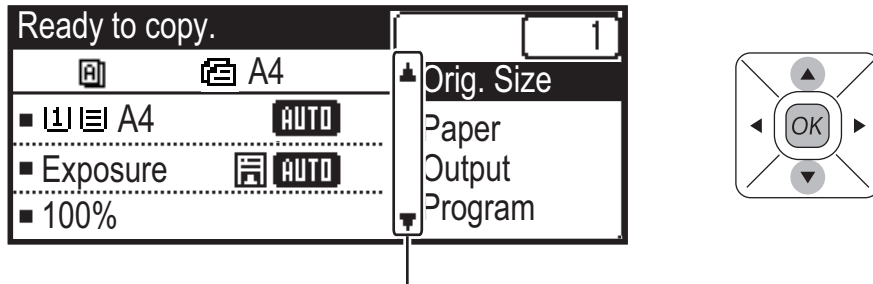

The [▼] [▲] icons appear in the selection screen of settings that use the up/down arrow keys.

Selecting an item with the arrow keys (left/right)

The left/right arrow keys (indicated in this manual by [◀] [▶]) are used to set the exposure and numbers in setting screens. Press the [OK] key to save your settings.

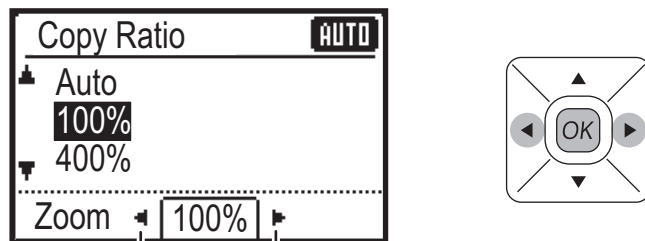

The [◀] [▶] icons appear in setting screens that use the left/right arrow keys.

Use the [BACK] key (↶) to return to the previous setting screen.





Data notification indicator and error indicator

The data notification indicator and the error indicator lights solidly or blinks to indicate the status of the machine.

	Error indicator (red)	Data notification indicator (green)	
		Pattern 1	Pattern 2
Solidly	Errors that do not stop machine operation, such as almost out of toner.	Job in progress, such as paper feeding or output.	Ready state or other state where jobs can be accepted.
Blinks	Errors that stop machine operation, such as misfeeds and out of toner.	A fax is being received (Fax reception hold, print standby, printing a fax)	
On/Blinking Priority	Blinking Priority	Blinking Priority	Blinking Priority



- **To set the status indicated by the data notification indicator**
Select [System Settings] (administrator) → [Device Control] → [Status Light Setting].
- **To set the error indication**
Select [System Settings] (administrator) → [Device Control] → [Error Light Setting].
- **Specify whether or not the data notification indicator blinks while a fax is being received**
Select [System Settings] (administrator) → [Device Control] → [Blink Setting for Received Data].



TURNING ON THE POWER

This section describes how to turn on/off the machine's power and how to restart the machine. The power switch is located on the left side of the machine.

Turning on the power

Turn the main power switch to the " | " position.

Turning off the power

Turn the main power switch to the "○" position.

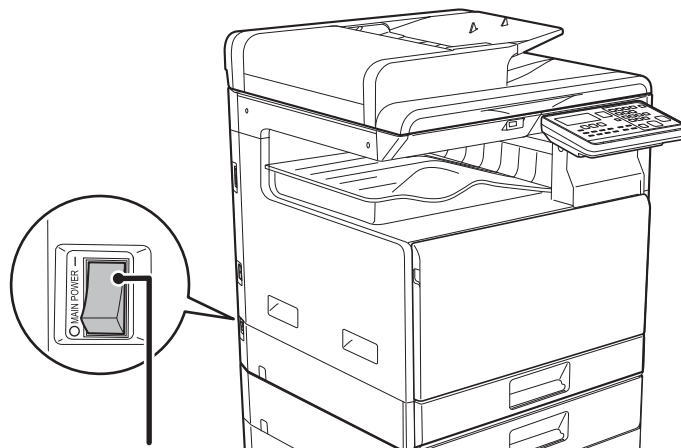

Restart the machine

Turn the main power switch off and then on.



The main power switch

 Turn off the main power switch and unplug the power cord if you suspect a machine failure, if there is a bad thunderstorm nearby, or when you are moving the machine.

-
-  • When using the fax function, always keep the main power switch in the " | " position.
-  • Print and other functions cannot be used during a brief period of time after the power is turned on or after the machine is wakened from sleep mode. This time is required to allow the machine to prepare for normal printing, and is called the warmup time.
-



Eco

ECO FUNCTIONS OF THE MACHINE

These functions help save power consumption by managing operations of sections prone to high power consumption. The machine provides two power-saving modes.

Function	Description	Page
AUTO POWER SHUT-OFF MODE	If no operations take place, this mode will turn off the power to the operation panel and the fusing unit, and makes the machine wait in the lowest power consumption state. Although the power-saving rate is higher, the wakeup time is longer. When " ENTER AUTO POWER SHUT-OFF AFTER THE REMOTE JOB " is enabled, the machine returns to auto power shut-off mode after being wakened from auto power-shut off mode and printing a job.	1-13
PREHEAT MODE	This mode lowers the temperature of the fusing unit and makes the machine wait in low power consumption state. Compared to Auto Power Shut-Off Timer, the power-saving rate is lower, but the wakeup time is shorter.	1-14

AUTO POWER SHUT-OFF MODE

This mode turns off the power to the operation panel and the fusing unit, and makes the machine wait in the lowest power consumption state.

Auto Power Shut-Off Timer will activate when the set duration of time elapses in waiting status without executing a job. Compared to preheat mode, the power-saving rate is considerably higher but the wakeup time is longer.

The [ENERGY SAVE] key (☾) blinks when the machine is in Auto Power Shut-Off Timer.

Auto Power Shut-Off Timer is also activated by pressing the [ENERGY SAVE] key (☾) while the [ENERGY SAVE] key (☾) is not lit.

This mode is cleared when print data is being received, fax data is being output, or when the [ENERGY SAVE] key (☾) is pressed while it is blinking.

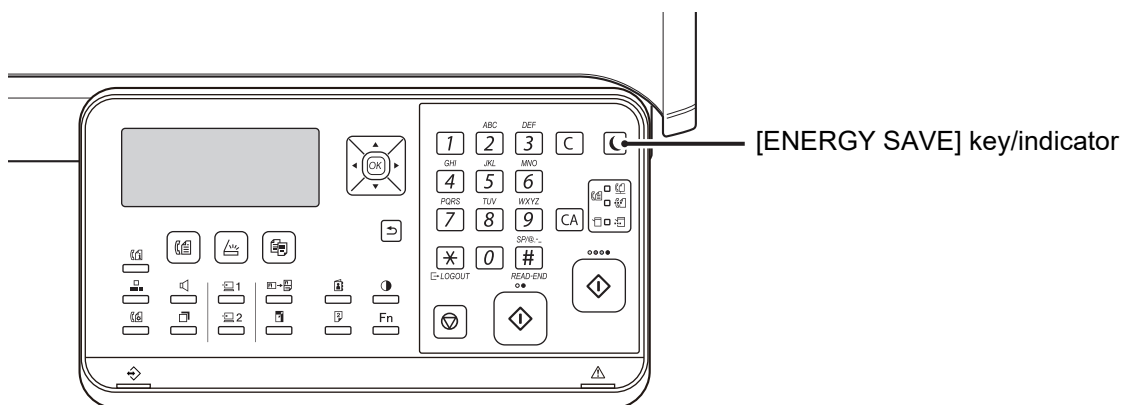

To set Auto Power Shut-Off Timer:

In "System Settings (administrator)", select [Energy Save] → [Auto Power Shut-Off Timer].



PREHEAT MODE

This mode lowers the temperature of the fusing unit and makes the machine wait in low power consumption state. Preheat mode will activate when the set duration of time elapses in waiting status without executing a job. Compared to Auto Power Shut-Off Mode, the amount of energy saved is less and the wakeup time is shorter. In preheat mode the display turns off. Normal operation automatically resumes when a key on the operation panel is pressed, an original is placed, or a print job or fax is received.



To set preheat mode:

In "System Settings (administrator)", select [Energy Save] → [Preheat Mode].

ENTER AUTO POWER SHUT-OFF AFTER THE REMOTE JOB

Printing or outputting received fax data in Auto Power Shut-Off Timer turns on the power, and then the machine returns to Auto Power Shut-Off Mode immediately after completing the print job.

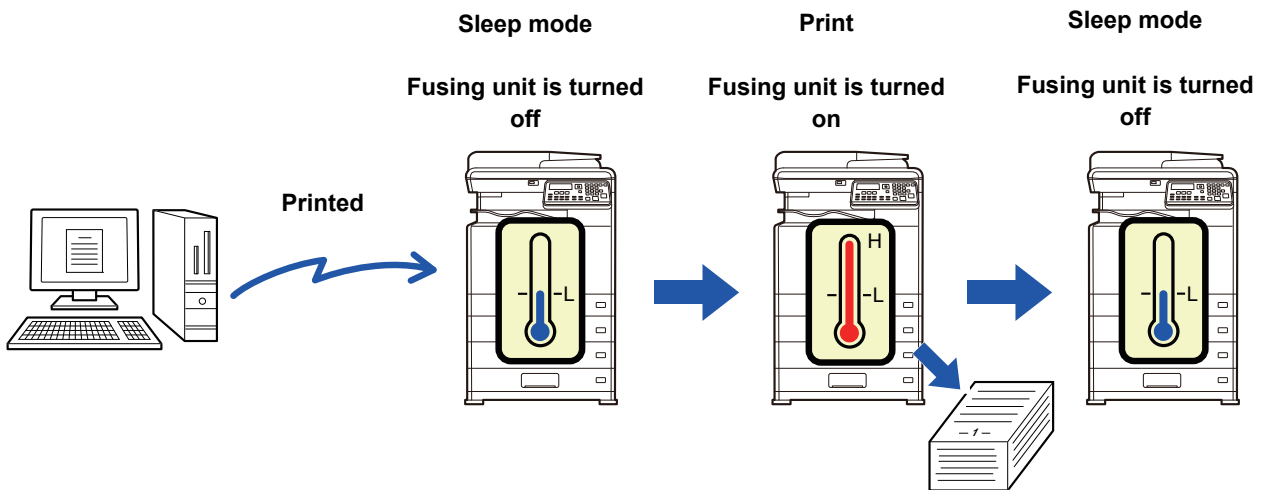

To set "Enter Auto Power Shut-Off after the Remote Job":

In "System Settings (administrator)", select [Energy Save] → [Enter Auto Power Shut-Off after the Remote Job].



USER AUTHENTICATION MODE

When user authentication mode is enabled, a count is kept of the pages printed by each account. The page counts can be viewed in the display. Users that can transmit faxes (up to 30) can be established and transmission time and other information can be tracked for each account. The [User Usage List \(page 6-17\)](#) can be printed out which shows the time used for transmission and pages transmitted by each account.

This function is enabled in the system settings. ([User Authentication \(page 6-12\)](#))

USING USER AUTHENTICATION MODE

When user authentication mode is turned on, the account number entry screen is displayed. Enter your account number (five-digit identification number) as explained below before performing a copy, fax, or scan operation.

Enter your user number.

User #: -----

1

Enter your account number (five digits) with the numeric keys.

As the account number is entered, the hyphens (-) change to asterisks (*). If you enter an incorrect digit, press [C] key and re-enter the correct digit.

2

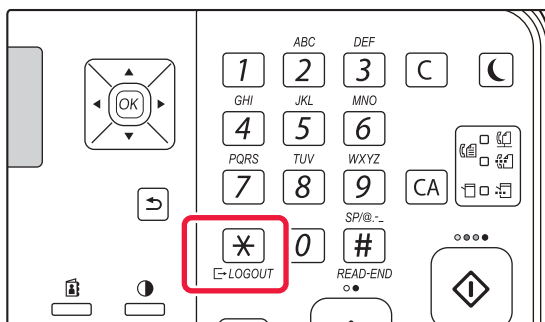

When the copy job is finished, press the [LOGOUT] key (*).



- When a valid account number is entered, the current count of the account will appear in the message display of the base screen. After 6 seconds (factory default setting), the base screen appears. ([page 1-9](#))

* In copy mode, the number of sheets remaining until the limit is reached is also shown if [Function Limit Setting \(page 6-12\)](#) is enabled in the system settings.

- If you enter a user number for copy mode has also been programmed for fax mode, you can change to fax mode after completing the copy operation and continue with the fax operation without re-entering your user number. If you enter a user number for copy mode that has not been programmed for fax mode, enter your user number for fax mode after you press the [FAX] key () to change to fax mode.k
- If an invalid account number is entered in step 1, the account number entry screen reappears.
- When [A Warning when Login Fails \(page 6-12\)](#) in the system settings is enabled, a warning message will appear and operation will not be permitted for 1 minute if an invalid account number is entered 3 times in a row.

Total Count	Copies:	000,000,000
	Remaining:	000,000,222
Total Count	Copies:	000,000,000
	Remaining:	000,000,666



LOADING PAPER

IMPORTANT POINTS ABOUT PAPER

NAMES AND LOCATIONS OF TRAYS

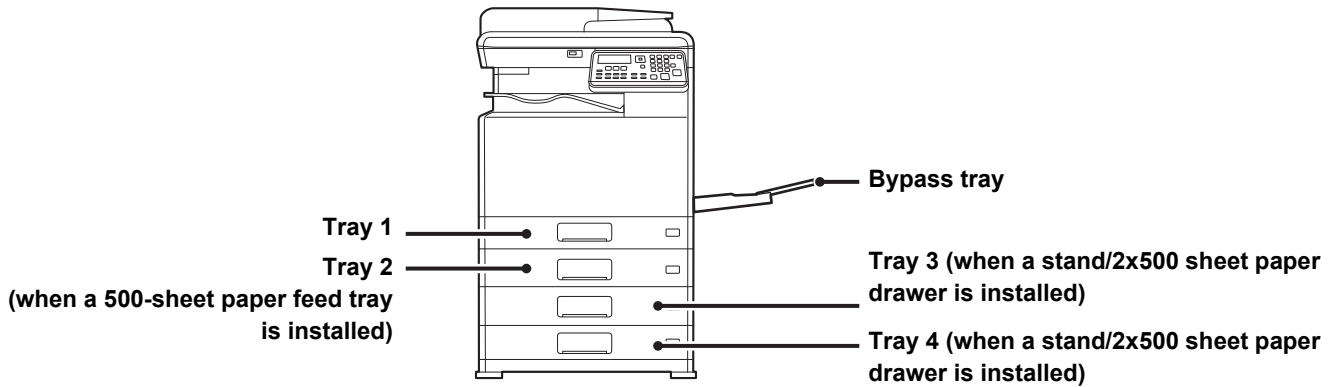

THE DEFINITION OF "R" IN PAPER SIZE

To indicate the landscape setting, "R" is added to the end of the name of a paper size enabled for both landscape and portrait settings.

Paper that can be set either in the portrait or landscape orientation		Paper that can only be set in the landscape orientation
A4, B5, 8-1/2" x 11"		A3W, A3, B4, 12" x 18", 11" x 17", 8-1/2" x 14", 8-1/2" x 13"
Paper set in the landscape orientation 	Paper set in the portrait orientation 	Can be placed only in the landscape orientation

APPLICABLE PAPER TYPES

This section describes paper types that can be used and those that cannot be used. All types of paper other than plain paper are referred to as special media.



- Various types of paper are commercially available, some of which cannot be used on the machine. Before using any paper, consult the dealer or nearest authorised service representative.
- The image quality and toner fusibility of paper may change due to ambient conditions, operating conditions, and paper characteristics, resulting in image quality inferior to that of Sharp standard paper. Before using any paper, consult the dealer or nearest authorised service representative.
- The use of non-recommended or non-usable paper may result in skewed feeding, misfeeds, poor toner fusing (the toner does not adhere to the paper well and can be rubbed off), or machine failure.
- The use of non-recommended paper may result in misfeeds or poor image quality. Before using non-recommended paper, check whether printing can be performed properly.



Useable paper

Specifications of plain paper, heavy paper and thin paper

Plain Paper*	Plain Paper 1	60 g/m ² to 89 g/m ² (16 lbs. bond to 24 lbs. bond)
	Plain Paper 2	90 g/m ² to 105 g/m ² (24 lbs. bond to 28 lbs. bond)
Heavy paper	Heavy paper 1	106 g/m ² to 176 g/m ² (28 lbs. bond to 65 lbs. cover)
	Heavy paper 2	177 g/m ² to 220 g/m ² (65 lbs. cover to 80 lbs. cover)
	Heavy paper 3	221 g/m ² to 256 g/m ² (80 lbs. cover to 140 lbs. index)
Thin paper		55 g/m ² to 59 g/m ² (13 lbs to 16 lbs)

* If the paper that you normally use is Recycled, Pre-Punched, Pre-Printed, Letter Head, or Colour, set an appropriate paper weight in [System Settings (administrator)] → [Device Control] → [Paper Weight].



- The category of "Useable paper" is based on Sharp standard paper.
- If non-recommended paper is used, print quality may be affected even if a paper type setting that accords with the above paper divisions is selected. In that case, try setting the paper type to a type that is slightly heavier or slightly lighter than normal. For details, consult your dealer or nearest authorised service representative.
- For paper specifications, see the specifications in the "Start Guide".
- Recycled paper, coloured paper and pre-punched paper must meet the same specifications as plain paper. Before using any paper, consult the dealer or nearest authorised service representative.
- If the paper that was output is significantly curled, remove the paper from the cassette, turn the paper over so it is face down, and resume use.

Paper that can be used for the fax function

AB type:

A3, B4, A4, A4R, B5, B5R, A5, A5R

Inch type:

8-1/2" x 14", 8-1/2" x 13-1/2", 8-1/2" x 13-2/5", 8-1/2" x 13", 8-1/2" x 11"R, 8-1/2" x 11", 5-1/2" x 8-1/2"R

Specifications of paper that can be used for two-sided printing

Paper Type	Plain, Recycled, Colour, Letter Head, Pre-Printed, Punched
Paper Size	A3, B4, A4, A4R, B5, B5R, A5R, 11" x 17", 8-1/2" x 14", 8-1/2" x 13-1/2", 8-1/2" x 13-2/5", 8-1/2" x 13", 8-1/2" x 11R", 8-1/2" x 11", 5-1/2" x 8-1/2R", 8K, 16K, 16KR



Types of paper that can be set in each tray



- For detailed information on the sizes and types of paper that can be loaded into each tray of the machine, see "SPECIFICATIONS" in the "Start Guide".
- Recycled paper, coloured paper and pre-punched paper must meet the same specifications as plain paper. Before using any paper, consult the dealer or nearest authorised service representative.

	Tray 1	Tray 2 - 4*1	Bypass tray
Plain Paper 1*2	Permitted	Permitted	Permitted
Plain Paper 2*2	Permitted	Permitted	Permitted
Heavy Paper 1*3	-	Permitted	Permitted
Heavy Paper 2*3	-	Permitted	Permitted
Heavy Paper 3*3	-	-	Permitted
Thin Paper	-	-	Permitted
Pre-Printed	Permitted	Permitted	Permitted
Recycle Paper	Permitted	Permitted	Permitted
Letter Head	Permitted	Permitted	Permitted
Pre-Punched	Permitted	Permitted	Permitted
Colour	Permitted	Permitted	Permitted
Labels	-	-	Permitted
Glossy Paper	-	-	Permitted
Transparency	-	-	Permitted
Envelope	-	-	Permitted

*1 when 500-sheet paper feed tray and stand/2x500 sheet paper drawer are installed

*2 "Plain Paper 1" is plain paper 60 to 89 g/m² (16 to 24 lbs. bond), "Plain Paper 2" is plain paper 90 to 105 g/m² (24 to 28 lbs. bond).

*3 "Heavy Paper 1" is heavy paper up to 176 g/m² (65 lbs. cover), "Heavy Paper 2" is heavy paper up to 220 g/m² (80 lbs. cover). "Heavy Paper 3" is heavy paper up to 256 g/m² (140 lbs. index).

Paper size that can be automatically detected

(When 500-sheet paper feed tray and Stand/2x500 sheet paper drawer are installed)

For tray 2 - 4, select "AutoAB" or "AutoIn" in "Paper Size Set", the size of paper is automatically detected.

For detailed procedures for selecting the settings, see "[TRAY SETTINGS \(page 1-29\)](#)"

AutoAB	A3, B4, A4, A4R, B5, 8-1/2" x 13"
AutoIn (Auto-Inch)	11" x 17", 8-1/2" x 14", 8-1/2" x 11", 8-1/2" x 11"R, 7-1/4" x 10-1/2"R



Setting orientation of the print side

The setting orientation varies for the print side of paper, depending on the tray used. For "Letter Head" and "Pre-Printed", set the paper in the reverse orientation.

Place with the print side facing the direction indicated below.

Tray	In normal status	With letter head or pre-printed paper or pre-punched set
Trays 1 - 4	Facing up	Facing down
Bypass	Facing down	Facing up

Paper that cannot be used

- Embossed paper
- Tab paper
- Special media for an ink jet printer
(fine paper, glossy paper, glossy film, etc.)
- Carbon paper or thermal paper
- Pasted paper
- Paper with clips
- Paper with fold marks
- Torn paper
- Oil-feed transparency film
- Thin paper less than 55 g/m² (15 lbs)
- Heavy paper as thick as 257 g/m² (140 lbs. index) over
- Irregularly shaped paper
- Stapled paper
- Damp paper
- Curled paper
- Paper whose print side or reverse side has been already printed on by another printer or multifunction device.
- Paper with a wave-like pattern due to moisture absorption
- Paper with creases
- Paper with dust

Non-recommended paper

- Iron-on transfer paper
- Perforated paper



TRAY 1

A maximum of 250 sheets of paper from size A5R to A3 (5-1/2" x 8-1/2"R to 11" x 17") can be loaded into tray 1.



If you loaded paper of a different type or size from the paper previously loaded, be sure to check the settings in "[TRAY SETTINGS \(page 1-29\)](#)". Incorrect setting affects automatic paper selection action. It may cause print failure, printing on paper of a wrong size or type or paper misfeeds.



Do not place heavy objects on the tray or press down on the tray.



To set the paper type or size

Press the [SPECIAL FUNCTION] key (**Fn**) and set in [Paper Size Set] or [Paper Type Set].

► [TRAY SETTINGS \(page 1-29\)](#)

1

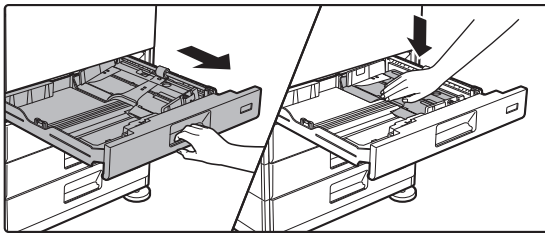

Pull out the paper tray.

Gently pull the tray out until it stops.
Push the centre of the pressure plate down until it locks into place.

2

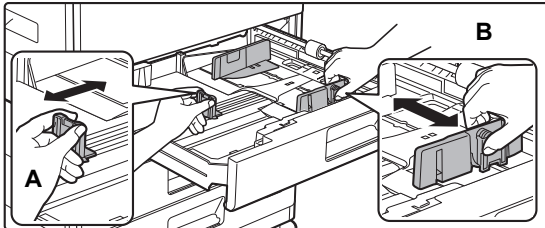

Adjust guide plates A and B to match the longitudinal and transversal dimensions of the paper to be loaded.

The guide plates A and B are slidable. Squeeze the separator plate lever and slide to the desired paper size.

3

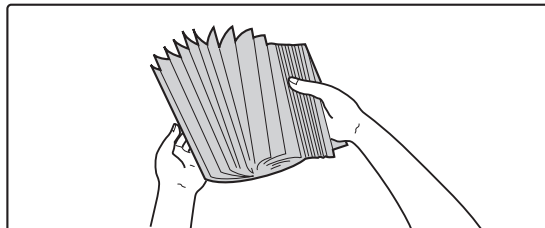

Fan the paper.

Fan the paper well before loading it. If the paper is not fanned, multiple sheets may feed at once and cause a misfeed.



4

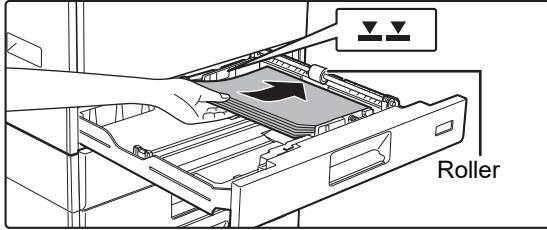

Insert the paper into the tray.

- Load the paper with the print side facing up. Make sure the stack of paper is straight before loading it.
- Place the paper under the roller on the right side of the tray.

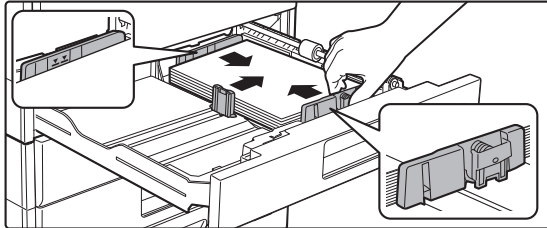

- After loading the paper, close the guides to the paper width not to leave the gap from the guides A and B.
- Do not load the paper as shown below.



To load 11" x 17" paper

Remove the divider plate. Move the divider plate all the way over to the paper feed opening side (right side), and pull up to remove. Insert the removed divider plate into A.

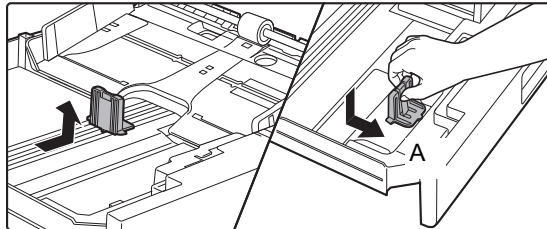

- The stack must not be higher than the indicator line.
- Do not add paper.

5

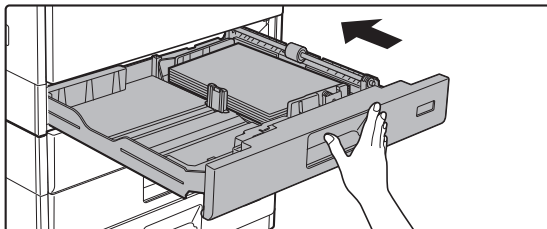

Gently push the paper tray into the machine.

Push the tray firmly all the way into the machine slowly. Forcefully inserting the paper may cause skewed feeding and paper misfeeds.



TRAY 2 - 4 (when 500-sheet paper feed tray and stand/2x500 sheet paper drawer are installed)

A maximum of 500 sheets of paper from size A5R to A3 (5-1/2" x 8-1/2"R to 11" x 17") can be loaded into trays 2 to 4.



If you loaded paper of a different type or size from the paper previously loaded, be sure to check the settings in "[TRAY SETTINGS \(page 1-29\)](#)". Incorrect setting affects automatic paper selection action. It may cause print failure, printing on paper of a wrong size or type or paper misfeeds.



Do not place heavy objects on the tray or press down on the tray.



To set the paper type or size

Press the [SPECIAL FUNCTION] key (Fn) and set in [Paper Size Set] or [Paper Type Set].

► [TRAY SETTINGS \(page 1-29\)](#)

1

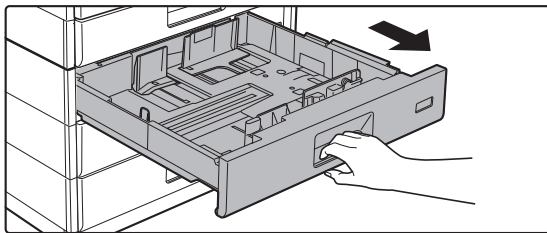

Pull out the paper tray.

Gently pull the tray out until it stops.

To load paper, go to step 3. To load a different size of paper, go to the next step.

2

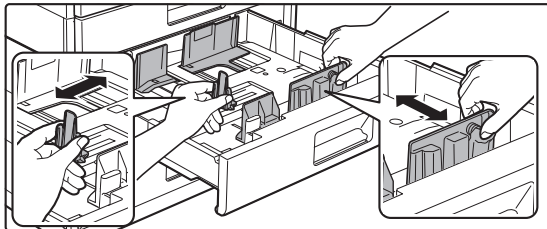

Adjust guide plates A and B to match the longitudinal and transversal dimensions of the paper to be loaded.

The guide plates A and B are slidable. Squeeze the separator plate lever and slide to the desired paper size.

3

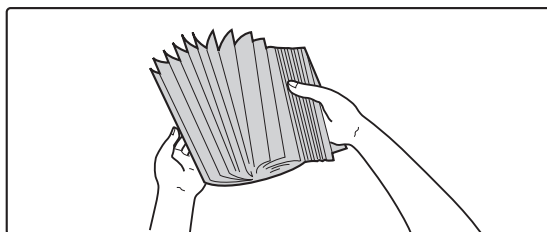

Fan the paper.

Fan the paper well before loading it. If the paper is not fanned, multiple sheets may feed at once and cause a misfeed.



4

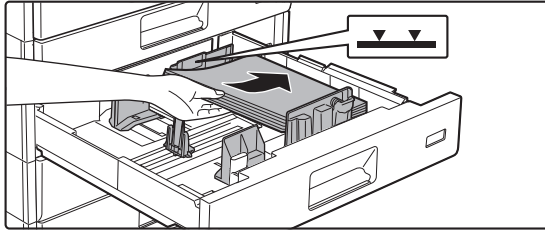

Insert the paper into the tray.

Load the paper with the print side facing up. The stack must not be higher than the indicator line (Maximum of 500 sheets).



- If a paper misfeed occurs, turn the paper over and/or around, and reload.
- If the paper is curled, fix the curl before loading the paper.
- Adjust the divider plate so that there is no gap between the paper and divider plate.
- Do not add paper.
- Do not load the paper as shown below.



5

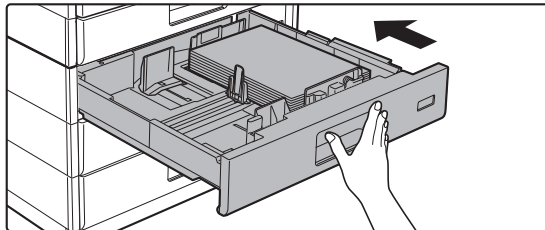

Gently push the paper tray into the machine.

Push the tray firmly all the way into the machine slowly. Forcefully inserting the paper may cause skewed feeding and paper misfeeds.



LOADING PAPER INTO THE BYPASS TRAY

Use the bypass tray for printing on plain paper, envelopes, label sheets, and other special media.

Up to 100 sheets of paper can be loaded (Heavy paper weighing between 106 g/m² to 220 g/m² (28 lbs. cover to 80 lbs. index): 40 sheets, 221 g/m² to 256 g/m² (80 lbs. cover to 140 lbs. index): 20 sheets, and envelope, transparency film: 20 sheets) for continuous printing, just like operation using other trays.



- When using plain paper other than Sharp standard paper or special media other than SHARP-recommended transparency film, glossy paper, or when printing on the reverse side of paper that has been printed on one side, load paper one sheet at a time. Loading more than one sheet at a time will cause misfeeds.
- Before loading paper, straighten any curling in the paper.
- To add paper, press down the pressure plate until it locks, remove any paper remaining in the bypass tray, combine it with the paper to be added, and place in the bypass tray again. If paper is added without removing the remaining paper, a misfeed may result. Loading more sheets than the specified number of sheets or the limit may cause paper misfeeds.
- After loading paper in the bypass tray, always check the paper type and size.

How to place the original

Load paper in landscape orientation.

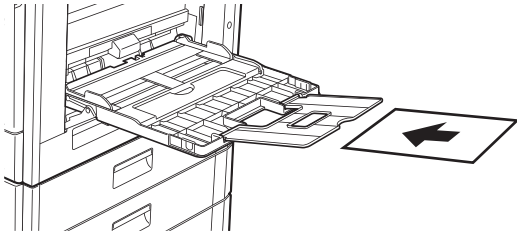

Inserting transparency film



- Use SHARP-recommended transparency film.
- When loading multiple sheets of transparency film into the bypass tray, fan the sheets several times before loading.
- When printing on transparency film, remove each sheet of film as it is printed. If multiple sheets of film are allowed to stack on the output tray, the sheets may stick together or become curled.

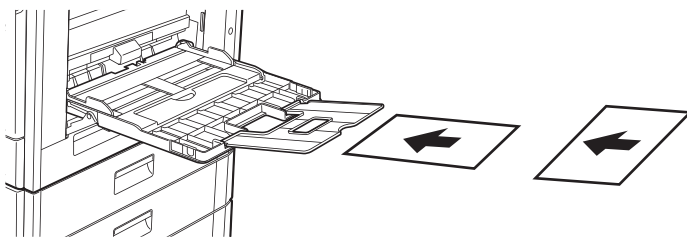



Loading envelopes

When inserting envelopes in the bypass tray, place them aligned to the left side in the orientation shown below. Only the front side of envelopes can be printed or copied on. Place the front side facing down. Fold the flap and make a sharp crease at the fold.

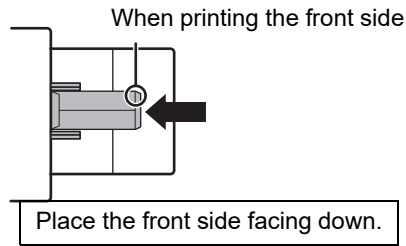
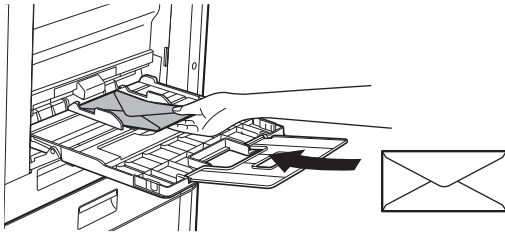

When placing DL

- Open the flap of the envelope.
- Place so that the flap is on the right.



When placing C4, C5, or C6

- Close the flap of the envelope.
- Place so that the flap is on the back side.

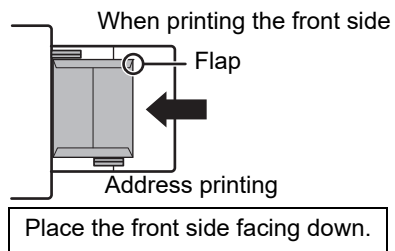
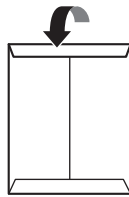
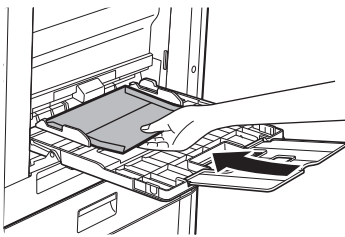



Important points when using envelopes

- Do not print on both sides of an envelope. This may result in misfeeds or poor print quality.
- Restrictions apply to some types of envelopes. For more information, consult a qualified service technician.
- Some operating environments may cause creasing, smudging, misfeeds, poor toner fusing, or machine failure.
- Fold the flap of the envelope and make a sharp crease at the fold. A misfeed may occur if the flap is up.
- Do not use the following envelopes:
 - Those with a metal piece, a plastic hook or a ribbon hook
 - Those with a string for closing
 - Those with a window
 - Those with a lining
 - Those with an uneven surface, finished with titling or emboss
 - Duplex envelopes or those with adhesive or other synthetic material for sealing
 - Hand-made envelopes
 - Those containing air inside
 - Those damaged with a crease, fold mark or tear

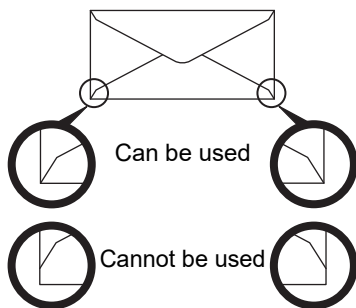

- Envelopes with the corner gluing position on the back not aligned with the corner edge should not be used as it may cause creasing.
- Print quality is not guaranteed in the area 10 mm (13/32") around the edges of the envelope.
- Print quality is not guaranteed on parts of envelopes where there is a large step-like change of thickness, such as on four-layer parts or parts less than three layers.
- Print quality is not guaranteed on envelopes having peel off flaps for sealing the envelopes.

Cautions when placing envelopes

- Removing curling
- Ensure these are flat, containing no air
- Ensure the four folded edges are pressed flat (for items with flaps, three edges)
- Align on a flat surface
- If multiple sheets of film are allowed to stack on the output tray, the sheets may stick together or become curled.



Important points when using label sheets

- For more information, consult the dealer or nearest authorised service representative.
- Some labels may have to be loaded into the bypass tray in the specified orientation. Follow such instructions. If a form is already printed on the labels, and the print images and the preprinted form do not line up, adjust the application or printer driver settings to rotate the print images.
- Do not use the following types of label sheets.
 - Label sheets without an adhesive copy or label copy
 - Label sheets with adhesive exposed
 - Label sheets with a specified feeding direction that is not supported by the machine
 - A label sheet that has already been fed or has some labels removed
 - Label sheets consisting of multiple sheets
 - Label sheets that do not support laser printing
 - Label sheets that cannot withstand heat
 - Label sheets that have perforations in the backing paper
 - Label sheets with slits in the backing paper
 - Non-standard label sheets
 - Label sheets with adhesive that has deteriorated due to prolonged storage or otherwise
 - Label sheets with cutouts that expose the backing paper
 - Curled or otherwise deformed label sheets
 - Torn or creased label sheets
 - Label sheets consisting of three sheets or more.

Loading paper

1

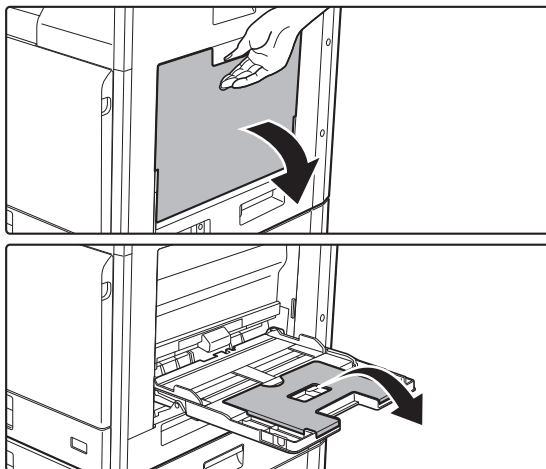

Open the bypass tray.

If you are loading paper of length greater than 250 mm (9-27/32"), open the extension tray.



Do not place heavy objects on the bypass tray or press down on the tray.

2

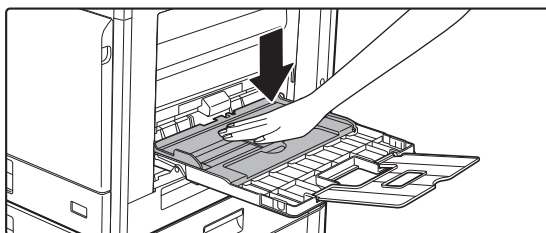

Push the centre of the pressure plate down until it locks into place.



3

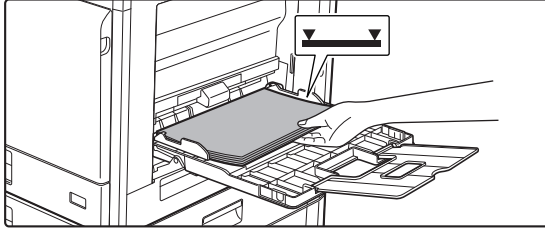

Load the paper with the print side facing down.

Insert the paper along the bypass tray guides all the way into the bypass tray until it stops slowly. Inserting the paper with excessive force may cause the leading edge to fold back. Inserting the paper too loosely may cause skewed feeding or misfeeds.

The paper must not exceed the maximum number of sheets and must not be higher than the indicator line.

4

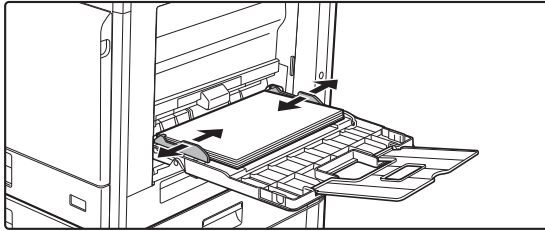

Set the bypass tray guides correctly to the width of the paper.

Adjust the bypass tray guides so that they slightly contact the loaded paper.



- Do not forcefully push in paper that you are loading. This may cause misfeeds.
- If the bypass tray guides are set wider than the paper, move the bypass tray guides in until they correctly fit the width of the paper. If the bypass guides are set too wide, the paper may skew or be creased.
- **How to close the bypass tray.**
Remove any paper remaining in the bypass tray, and press down the centre of the pressure plate until it locks. After you have locked the pressure plate, close the extension tray and then close the bypass tray.



TRAY SETTINGS

These programs are used to change the paper size and type setting of a tray, and auto tray switching.

Changing the paper size setting of a tray

If the size of the loaded paper is different from the size shown in the display, follow the steps below to change the paper size setting of the tray.

The paper size setting cannot be changed during copying, printing, fax printing (when the fax option is installed), or when a misfeed has occurred. However, if the machine is out of paper or out of toner, the paper size setting can be changed during copying, printing, and fax printing.

See [APPLICABLE PAPER TYPES \(page 1-16\)](#) for information on the specifications for the types and sizes of paper that can be loaded in the paper trays.

Press the [SPECIAL FUNCTION] key (Fn), and press the [▼] or [▲] key to select "Paper Size Set".

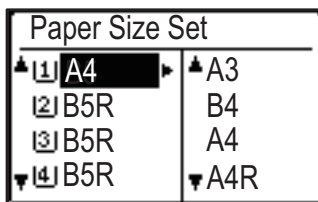

Press the [▼] or [▲] key to select the paper tray for which the paper size is being changed. Press the [▶] key and press the [▼][▲] keys to select the paper size. Press the [OK] key.



- [1]: Shows tray "1".
- [2]: Shows tray "2".
- [3]: Shows tray "3".
- [4]: Shows tray "4".
- [Bypass]: Shows Bypass tray.

For the paper trays and tray numbers, see [Types of paper that can be set in each tray \(page 1-18\)](#).

Disabling (enabling) auto tray switching

When auto tray switching is enabled and paper runs out during copying or printing, the job will continue using paper from a different tray if that tray has the same size of paper in the same type. (This function does not operate when using the bypass tray or when a fax is being printed.)

This function has been enabled at the factory. If you prefer to disable the function, follow the steps below.

Press the [SPECIAL FUNCTION] key (Fn), select "Paper Size Set", and press the [▼] key repeatedly until "Auto Tray Switching" appears.

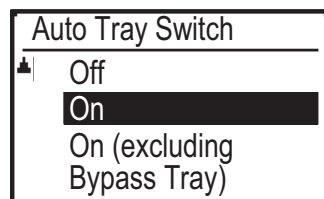
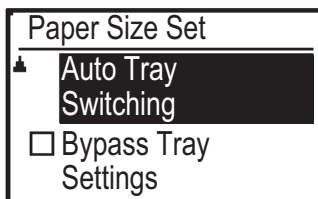

If you select "On (excluding Bypass Tray)", paper in a tray other than the bypass tray will be used.



Changing the paper type of a tray

To change the paper type setting for a tray, follow the steps below.

Press the [SPECIAL FUNCTION] key (**Fn**), select "Paper Type Set", select the tray with the [▼] or [▲] key, and press the [OK] key. Select the desired paper type and press the [OK] key.

See [APPLICABLE PAPER TYPES \(page 1-16\)](#) for information on the specifications for the types and sizes of paper that can be loaded in the paper trays.

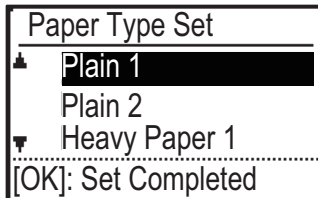



HOW TO PLACE THE ORIGINAL

SELECTING A PROCEDURE FOR PLACING THE ORIGINAL DEPENDING ON THE TYPE AND STATUS OF THE ORIGINAL

Place the original in the automatic document feeder. Depending the type and status of the original, use the document glass. Follow the instructions to select the method for placing the original.

To place it in the automatic document feeder, see "[AUTOMATIC DOCUMENT FEEDER \(page 1-31\)](#)".

AUTOMATIC DOCUMENT FEEDER (BP-20C20/BP-20C25)

This section explains how to place originals in the automatic document feeder.



- Before inserting originals into the document feeder tray, be sure to remove any staples or paper clips.
- If originals have damp spots due to correction fluid, ink or paste up glue, wait until the originals are dry before making copies. Otherwise the interior of the machine or the document glass may be soiled.
- Do not use the following originals. Original misfeeds and smudges may result.
Transparency film or other transparent material for backup copy, tracing paper, carbon paper, thermal paper or originals printed with thermal transfer ink ribbon should not be fed through the document feeder. Originals to be fed through the feeder should not be damaged, crumpled, folded, loosely pasted together, or have cut-out holes. Originals with multiple punched holes other than two-hole or three-hole punched paper may not feed correctly.
- The condition, material, shape, or fabrication method of some business cards may prevent correct feeding or scanning.
- When using originals with two or three holes, place them so that the punched edge is at a position away from the feed slot of the document feeder tray. Specify the orientation of the original using [Original].

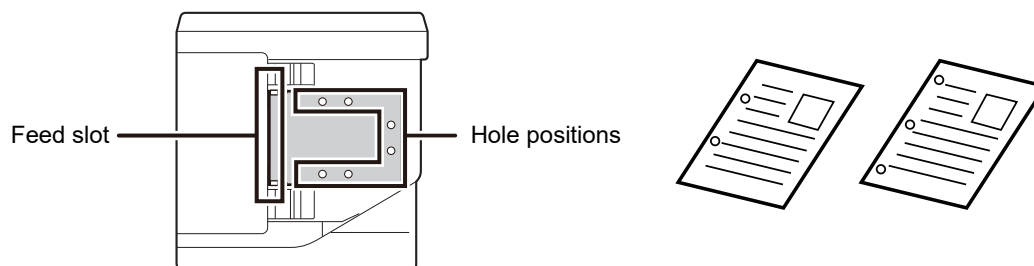



Allowed original sizes

Minimum original size	Maximum original size
<p>Standard size 210 mm (longitudinal) × 148 mm, or A5 5-1/2" (longitudinal) × 8-1/2" (transversal)</p> <p>Non-standard size (Minimum size that can be specified manually) 131 mm (longitudinal) × 140 mm (transversal) 5-1/8" (longitudinal) × 5-1/2" (transversal)</p>	<p>Standard size 297 mm (longitudinal) × 420 mm (transversal) or A3 11" (longitudinal) × 17" (transversal)</p> <p>Non-standard size (Maximum size that can be specified manually) Copy mode/Scanner mode: 297 mm (longitudinal) × 432 mm (transversal) 11-5/8" (longitudinal) × 17" (transversal) Fax mode: 297 mm (longitudinal) × 500 mm (transversal) 11-5/8" (longitudinal) × 19-5/8" (transversal)</p>

When the original is a non-standard size, see the appropriate explanation below for the mode you are using.

- ▶ COPIER: "[SPECIFYING THE SIZE OF THE ORIGINAL \(page 2-12\)](#)"
- ▶ FAX: "[BASIC PROCEDURE FOR SENDING FAXES \(page 4-8\)](#)"
- ▶ SCANNER: "[BASIC TRANSMISSION PROCEDURE \(page 5-5\)](#)"

Allowed original weights

1-sided scanning: 50 to 128 g/m² (13 to 32 lbs Bond)

2-sided scanning: 50 to 105 g/m² (13 to 28 lbs Bond)

Thin paper(1-sided): 35 to 49 g/m² (9 to 13 lbs Bond)

To scan an original from 35 g/m² to 49 g/m², use "Slow Scan Mode" in the Special Modes. Attempting to scan without using "Slow Scan Mode" may result in misfeeding of the original.

2-sided scanning of the original will not take place when "Slow Scan Mode" is enabled.

1

Make sure that there is no original on the document glass.

2

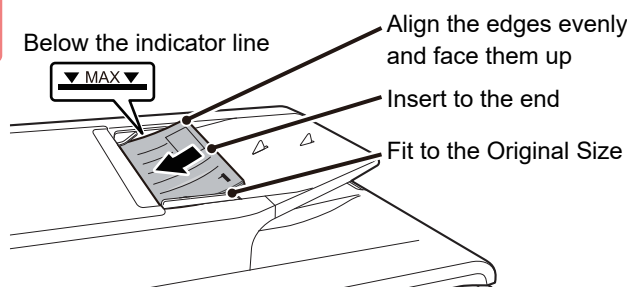

Place the original.

Up to 100 sheets can be inserted.

After scanning is finished on the automatic document feeder, remove originals from the original exit tray.



DOCUMENT GLASS

This section describes the steps for setting the original on the document glass.



- Close the automatic document feeder slowly. Abruptly closing the automatic document feeder may damage it.
- Take care that your fingers are not pinched when closing the automatic document feeder.

Allowed original sizes

Maximum original size

Standard size

297 mm (longitudinal) x 420 mm (transversal) or A3
11" (longitudinal) x 17" (transversal)

Non-standard size

297 mm (longitudinal) x 432 mm (transversal)
11-5/8" (longitudinal) x 17" (transversal)

When the original is a non-standard size, see the appropriate explanation below for the mode you are using.

- COPIER: "[SPECIFYING THE SIZE OF THE ORIGINAL \(page 2-12\)](#)"
- FAX: "[BASIC PROCEDURE FOR SENDING FAXES \(page 4-8\)](#)"
- SCANNER: "[BASIC TRANSMISSION PROCEDURE \(page 5-5\)](#)"

1

Open the automatic document feeder.

2

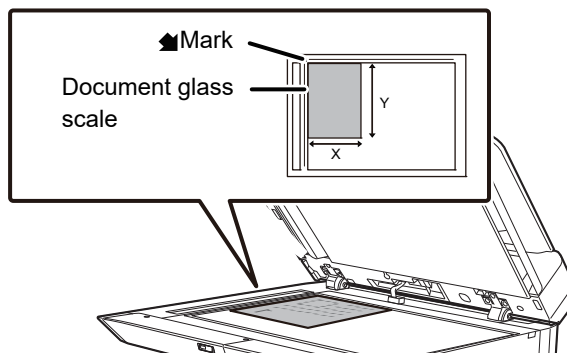

Load the paper with the print side facing down.

Place the original face down and align the top left corner of the original with back left (at the tip of the mark ) of the document glass.

3

Close the automatic document feeder.

After placing the original, close the automatic document feeder. If the unit is left open, parts outside of the original will be copied in black, causing excessive use of toner.



If originals have damp spots due to correction fluid, ink or paste up glue, wait until the originals are dry before making copies. Otherwise the interior of the machine or the document glass may be soiled.







MAINTENANCE

This section explains how to check the total count or toner remaining, adjust the display contrast, clean the machine, and replace the toner cartridge.

CHECKING THE TOTAL OUTPUT COUNT AND TONER REMAINING

To check the total number of pages output in copy, print, and fax modes hold down the [COPY] key () when the machine is in the standby state. The counts will appear while the key is held down. The total output count can be used as a guideline for cleaning. When the total output count exceed "99,999,999", the counts return to "0". The toner level is shown at the bottom of the screen.

Total Count	
57,600	
Toner Remaining (%)	
 100-75	 100-75
 100-75	 100-75



- You can also check by pressing the [SPECIAL FUNCTION] key (Fn) and selecting "Total Count" in the function menu screen.
- Each two-sided sheet that is output is counted as two pages.
- Blank copies and blank prints are included in the count.
- If the last page of a two-sided printing job is blank, it is not included in the count.

ADJUSTING THE DISPLAY CONTRAST

The contrast of the display can be adjusted as explained below.

1

Press the [SPECIAL FUNCTION] key (Fn).

The "Special Function" screen will be appear.

2

Select "Display Contrast" with the [▼] or [▲] key.

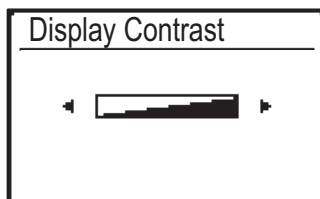
3

Press the [OK] key.

The "Display Contrast" screen will be appear.

4

Adjust the contrast with the [◀] or [▶] key.

To reset the contrast to the default setting, press the [C] key.

5

Press the [SPECIAL FUNCTION] key (Fn).

You will return to the base screen.



REGULAR MAINTENANCE

To ensure that the machine continues to provide top quality performance, periodically clean the machine.



Do not use a flammable spray to clean the machine. If gas from the spray comes in contact with hot electrical components or the fusing unit inside the machine, fire or electrical shock may result.



- Do not use thinner, benzene, or similar volatile cleaning agents to clean the machine. These may degrade or discolour the housing.
- Use a soft cloth to gently wipe off dirt from the area on the operation panel with a mirror-like finish (shown at right). If you use a stiff cloth or rub hard, the surface may be damaged.
The area with a mirror-like finish is the area that is .

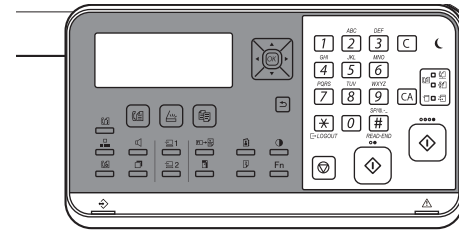

CLEANING THE DOCUMENT GLASS AND AUTOMATIC DOCUMENT FEEDER

If the document glass or document backplate sheet becomes dirty, the dirt will appear as dirty spots, coloured lines, or white lines in the scanned image. Keep these parts clean at all times.

Wipe the parts with a clean, soft cloth.

If necessary, moisten the cloth with water or a small amount of neutral detergent. After that, wipe with a clean dry cloth.

Examples of lines in the image

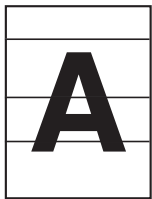

Black lines



White lines

Document glass

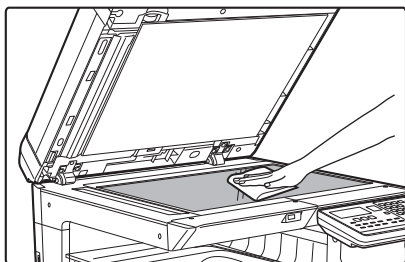

Document backplate sheet

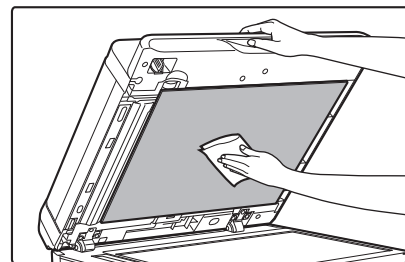



SCANNING AREA

If black lines or white lines appear in images scanned using the automatic document feeder, clean the scanning area (the thin long glass next to the document glass).

When using the BP-20C20/BP-20C25

1

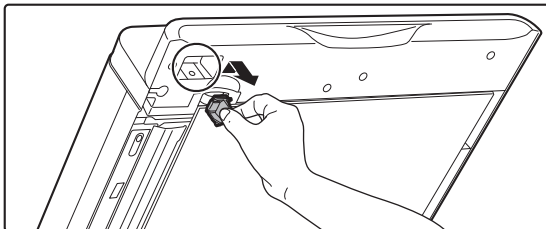

Open the automatic document feeder and remove the glass cleaner.

2

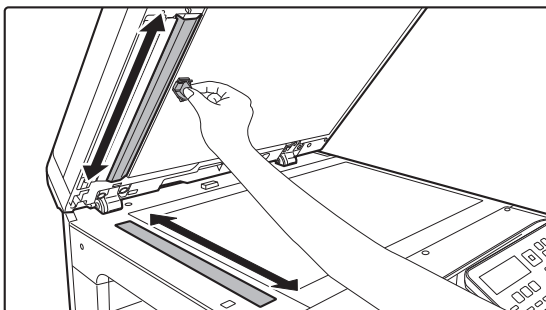

Clean the document scanning area on the document glass with the glass cleaner.

3

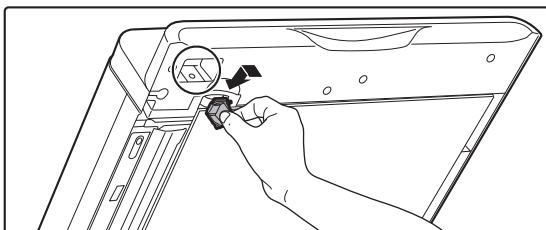

Replace the glass cleaner.



CLEANING THE FEED ROLLER OF TRAY 1

If the paper in tray 1 frequently misfeeds, press down the centre of the pressure plate until it locks, and wipe the surface of the feed roller with a clean, soft cloth moistened with water.

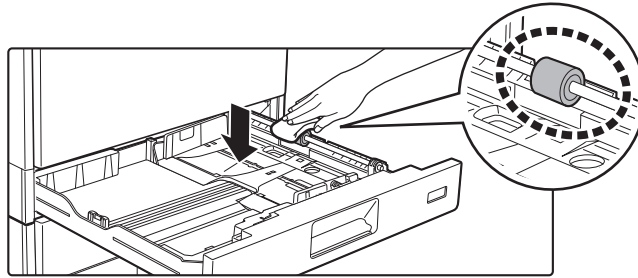

CLEANING THE BYPASS FEED ROLLER

If paper misfeeds frequently occur when feeding envelopes or heavy paper through the bypass tray, wipe the surface of the feed roller with a clean soft cloth moistened with water.

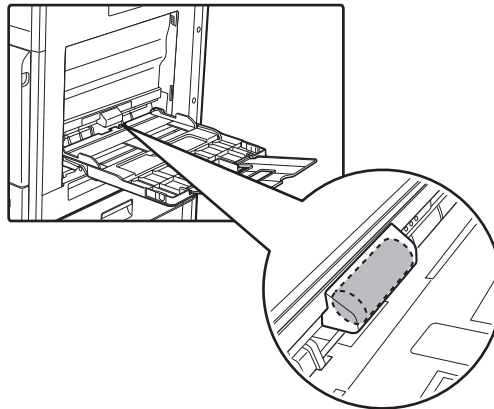

CLEANING THE PAPER FEED ROLLER

If lines or other dirt appear on the scanned original when the automatic document feeder is used, wipe the surface of the roller with a clean soft cloth moistened with water.

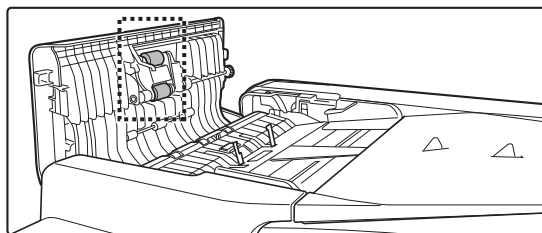



CLEANING THE LASER UNIT

When the laser unit inside the machine becomes dirty, line patterns (coloured lines) may form in the printed image.

Identifying lines (coloured lines) caused by a dirty laser unit

- Coloured lines always appear in the same place. (The lines are never black.)
- Coloured lines appear in parallel with the direction of paper feeding.
- Coloured lines appear not only on output from a copier but also on prints from a computer. (The same lines appear on both copies and print jobs.)

If conditions similar to the above occur, clean the laser unit as explained below.

1

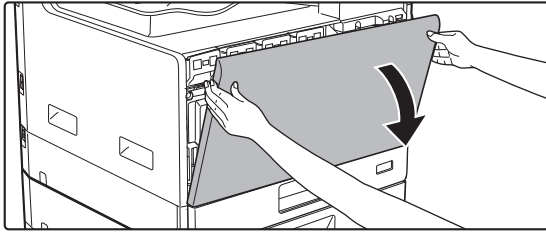

Open the front cover.

2

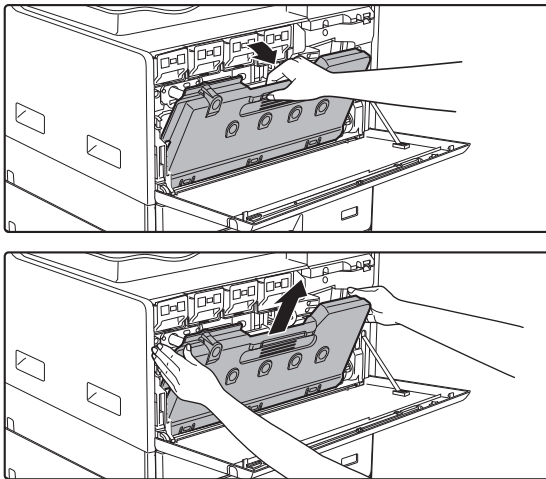

Remove the waste toner box.

Tip the waste toner box forward and down, and slowly pull up.

3

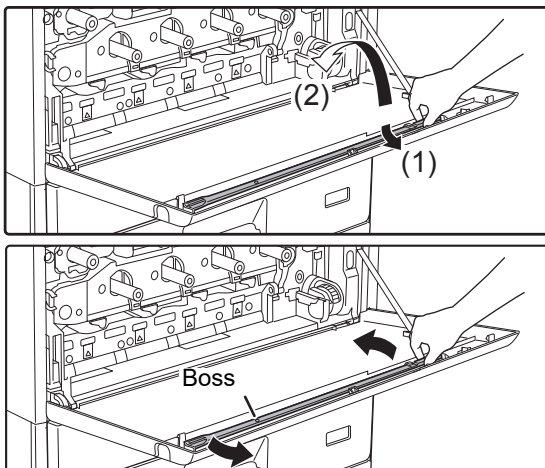

Take out the cleaning tool for the laser unit.

The cleaning tool is attached to the front cover.

- (1) Pull the right-hand side of the cleaning tool to detach it from the hook.
- (2) Put it over the hook to place it on the back side.
- (3) Turn the cleaning tool around the boss to detach it from the left hand hook.



4

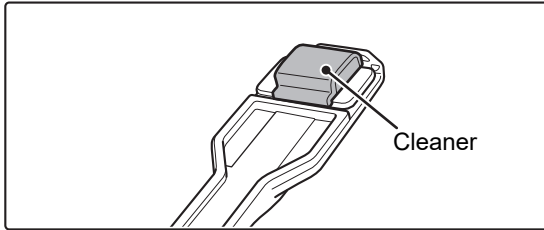

Make sure that the cleaner at the tip of the cleaning tool is not dirty.

If the cleaner is dirty, remove the cleaner from the cleaning tool and replace it with a clean one. For the procedure for replacing the cleaner, see steps 5 through 7. If the cleaner is not dirty, go to step 8.

5

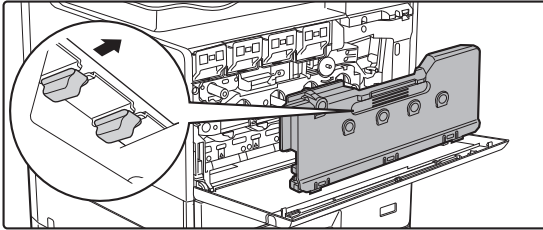

Take out a replacement cleaner from the waste toner box.

Replacement cleaners are stored on the waste toner box. Grasp the end of the cleaner and pull it out of the waste toner box.

6

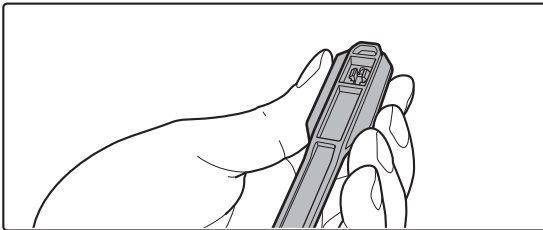

Remove the dirty cleaner from the tip of the cleaning tool.

- (1) Firmly grasp the tool where the cleaner is attached.
- (2) Use your other hand to press down on the hook that secures the cleaner, and remove the cleaner.

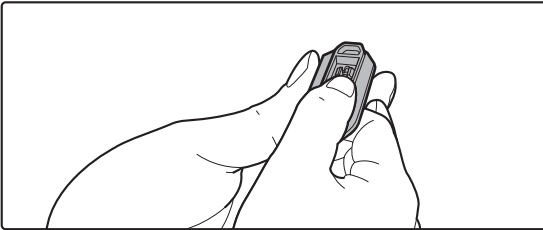

Put the removed cleaner back on the waste toner box.

7

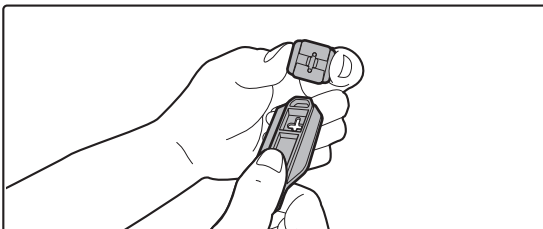

Attach the new cleaner to the cleaning tool.

- (1) Align the cleaner hook with the attachment hole in the cleaning tool.
- (2) Hold the cleaner firmly and push the cleaning tool in.

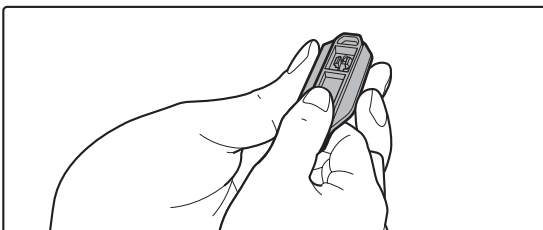



8

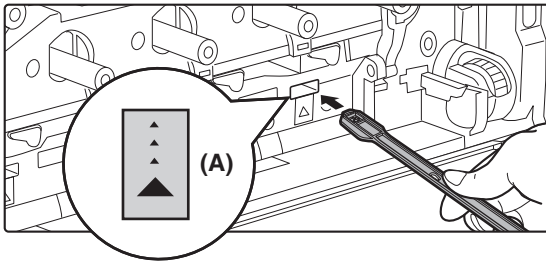

Clean the laser unit.

- (1) **Point the cleaner down and slowly insert the tool into the hole that you wish to clean.**

Be sure to point the cleaner down.
Labels similar to (A) are attached to areas that require cleaning.

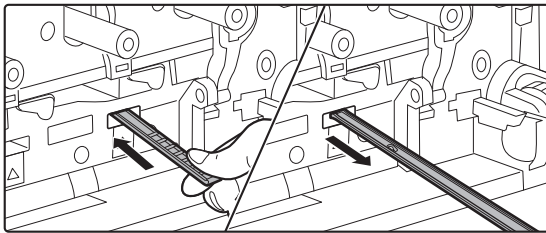

- (2) **Insert the cleaning tool all the way into the hole and then pull it back out.**

Pull the cleaning tool out until you feel the tip of the tool leave the cleaning surface of the laser unit.

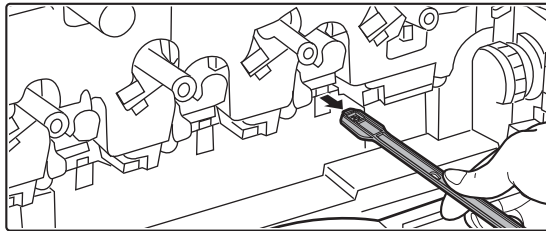

- (3) **Repeat step 2 two or three times and then remove the cleaning tool.**

9

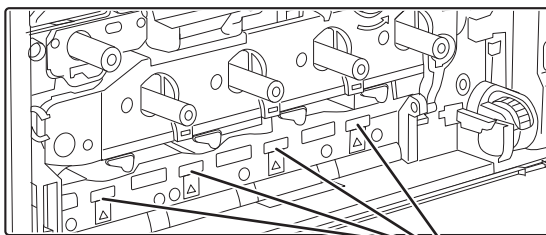

Cleaning locations

Repeat steps 8 to clean all holes (4 holes) in the laser unit.

The laser unit is cleaned in four locations, including the location cleaned in step 8. Clean all holes.

10

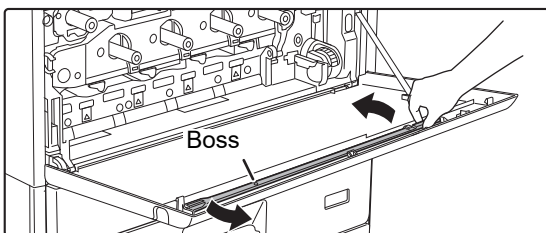

Replace the cleaning tool.

- (1) **Engage the cleaning tool onto the boss and turn it around it, and then put the edge (the cleaner side) on the left hand hook.**

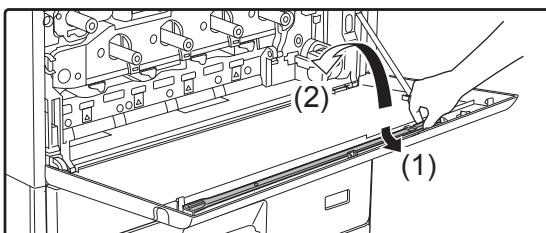

- (2) **Put the right-hand side of the cleaning tool over the hook to place it on the near side.**

- (3) **Turn the cleaning onto hook.**



11

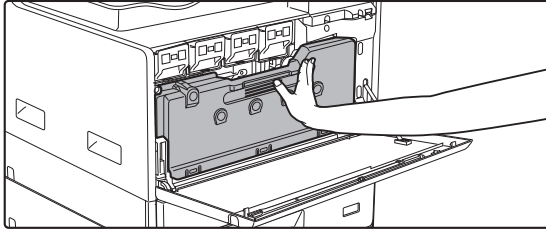

Push the waste toner box into the machine.

Push in until you hear a "click" sound indicating that the left and right locks are engaged.

12

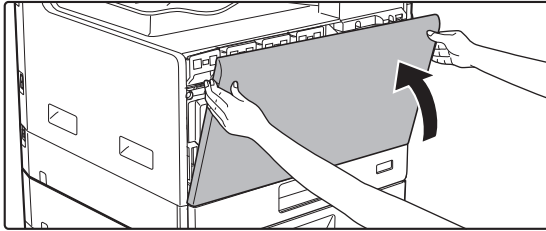

Close the front cover.



REPLACEMENT OF TONER CARTRIDGE

Always replace the toner cartridge after the "Change the toner cartridge." message appears. You should keep one set of replacement toner cartridges on hand so that you can replace a toner cartridge immediately when toner runs out.

Replacement message

Toner Low.
(Do not replace cartridge
until requested.)

Y M C Bk

When this message appears, prepare a toner cartridge for replacement.

Colours that have been prepared are indicated in (□□□□).

Y: Yellow toner, M: Magenta toner, C: Cyan toner, and Bk: Black toner

When you press the any key, the dialog above will be deleted and the screen will change to the following screen.

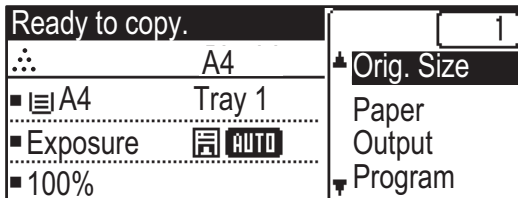

If you continue to use the machine, the following message will appear when the toner runs out.

Colours that have run out of toner are indicated in (□□□□).

Replace the toner cartridge with a one of the relevant colour.

Change the toner
cartridge.

Y M C Bk

1

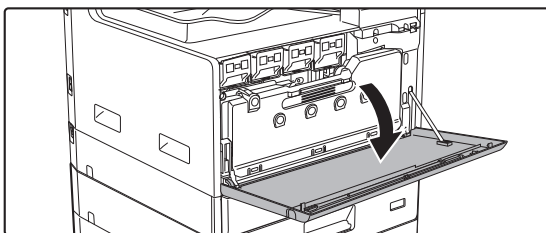

Open the front cover.



2

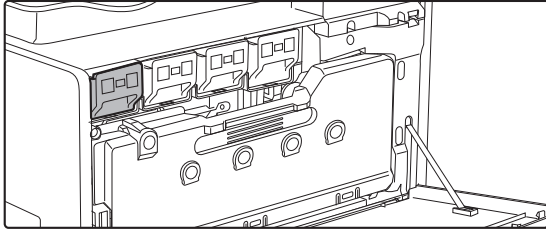

Pull the toner cartridge toward you.

Gently pull out the toner cartridge horizontally.

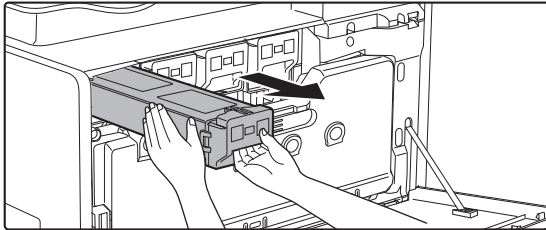

(Example) Replacing the yellow toner cartridge

Hold the toner cartridge with both hands as shown and slowly pull it out of the machine.



If the cartridge is pulled out abruptly, toner may spill out.

3

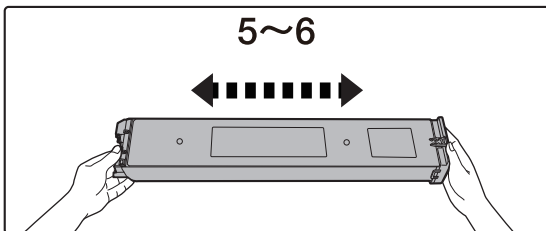

Take out a new toner cartridge from its package and shake it horizontally five or six times.

4

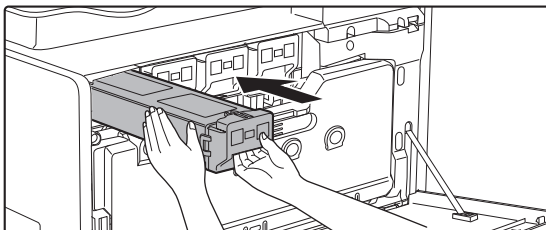

Slowly insert the new toner cartridge on the level.

5

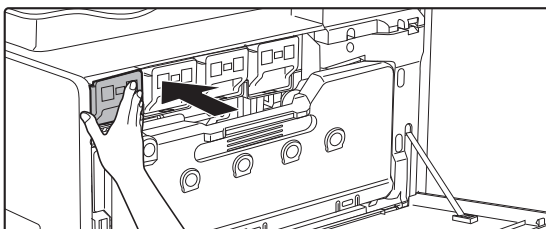

Press in firmly until you hear a "click" sound.



6

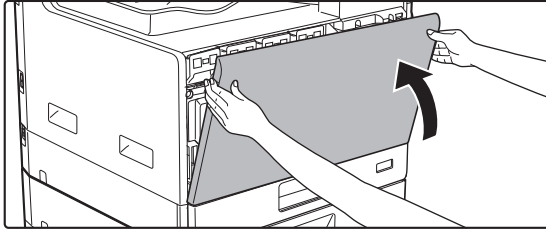

Close the front cover.

After the toner cartridge is replaced, the machine automatically enters image adjustment mode. Do not open the front cover while this is occurring.



- Do not throw a toner cartridge into a fire. Toner may fly and cause burns.
- Store toner cartridges out of reach of small children.
- If a toner cartridge is stored upright, the toner may harden and become unusable. Always store toner cartridges on their side.
- If a toner cartridge other than a SHARP-recommended toner cartridge is used, the machine may not attain full quality and performance and there is a risk of damage to the machine. Be sure to use a SHARP-recommended toner cartridge.



- If any one of the toner colours runs out, colour printing will no longer be possible. If the Y, M, or C toners run out but a quantity of Bk toner still remains, printing is performed in black and white.
- Depending on your conditions of use, the colour may become light or the image blurred.
- Be sure to install four toner cartridges (Y/M/C/Bk).
- Your service technician will collect used toner cartridges.
- To view the approximate amount of toner remaining (indicated in %), hold down the [COPY] key during printing or in standby mode. When the percentage falls to "25-0%", keep a toner cartridge for replacement purposes before toner runs out.



REPLACING THE WASTE TONER BOX

This section explains the procedure for replacing the waste toner box.

The waste toner box collects any excess toner that occurs during printing. When the waste toner box becomes full, the message "Replace waste toner box." will appear.

When this message appears, prepare a new waste toner box and replace. Once this message appears, printing is not possible until the waste toner box is replaced.

To close this screen, press any key.



1

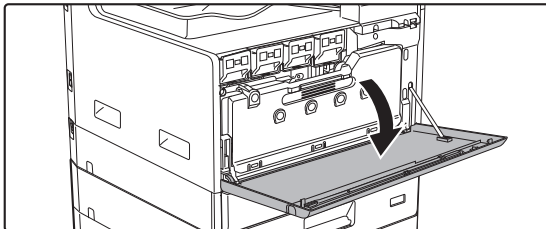

Open the front cover.

2

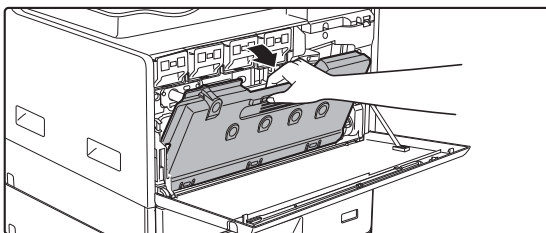

Pull out the waste toner box. Gently pull out the toner cartridge horizontally.

Tip the waste toner box forward and down, and slowly pull up.

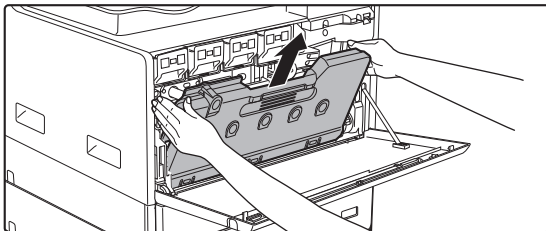

3

Place the waste toner box on a flat surface.

Spread newspaper on the surface before placing the waste toner box.



- Do not tilt the part with the hole down, as waste toner will spill out.
- Do not discard the waste toner box. Place it in a plastic bag and store. Your service technician will collect the waste toner box the next time he comes for maintenance.



4

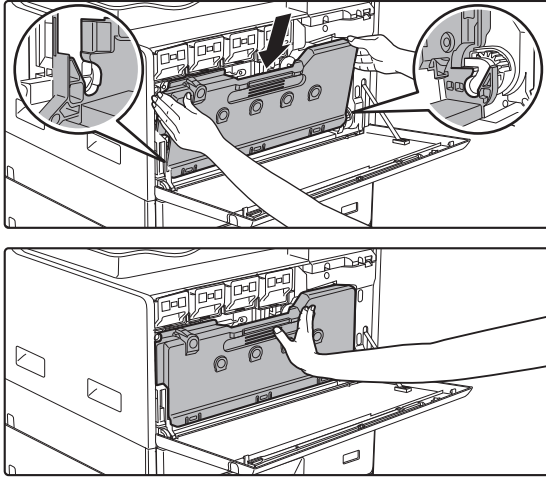

Install a new waste toner box.

Insert the left and right tabs, and push the waste toner box firmly in.

5

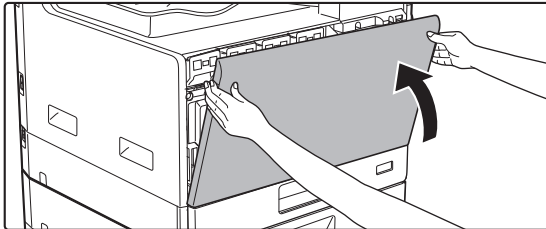

Close the front cover.

You cannot close the front cover when the waste toner box is not attached.



- Do not throw the waste toner box into fire. Toner may fly out and cause burns.
- Store the waste toner box out of the reach of children.



CHARACTER ENTRY

This section explains how to enter and edit characters for names of rapid dial numbers, Speed Dial numbers, and group keys, as well as account names, program names, and search characters for the address list.

CHARACTERS THAT CAN BE ENTERED

Characters that can be entered for names

The following characters can be entered:

- Up to 36 characters can be entered for a name.
However, up to 18 characters can be entered for an account name or sender's name.
- Upper case alphabet, lower case alphabet, numbers, special characters, symbols.

Characters that can be used for search characters

The following characters can be used:

- Up to 10 characters can be entered for search characters.
- Upper case alphabet, lower case alphabet, numbers, special characters.



- Search characters are normally the first 10 characters of the name entered for a destination.
 - Search characters are used when storing and using auto dial keys and numbers.
 - When a destination name includes a symbol, the symbol cannot be stored as a search character.
 - Search characters can be edited.
-



BEFORE USING THE MACHINE ► CHARACTER ENTRY

Characters are entered by pressing the numeric keys on the operation panel. The letters entered with each numeric key are shown below.



Characters that can be entered		
Key	Characters that can be entered for names	Characters that can be used for search characters
1	1 Space	1 Space
2	a b c 2 A B C	a b c 2 A B C
3	d e f 3 D E F	d e f 3 D E F
4	g h i 4 G H I	g h i 4 G H I
5	j k l 5 J K L	j k l 5 J K L
6	m n o 6 M N O	m n o 6 M N O
7	p q r s 7 P Q R S	p q r s 7 P Q R S
8	t u v 8 T U V	t u v 8 T U V
9	w x y z 9 W X Y Z	w x y z 9 W X Y Z
*	*}{[?>=,;:+)'(&%\$"!/_-.@#	
0	0	0
#	Use to enter special characters.	Use to enter special characters.



To enter two characters in succession that require the same key, press the [►] key to move the cursor after entering the first character.

Example: Entering "ab" (when directly entering an e-mail address)

Press the [2] key once, press the [►] key once to move the cursor, and then press the [2] key twice.



COPIER

BEFORE USING THE MACHINE AS A COPIER

COPY MODE	2-2
COPYING SEQUENCE	2-3
SELECTING THE PAPER TRAY FOR COPYING ...	2-4

BASIC PROCEDURE FOR MAKING COPIES

COPYING	2-5
• USING THE AUTOMATIC DOCUMENT FEEDER FOR COPYING	2-5
• USING THE DOCUMENT GLASS FOR COPYING	2-6
• CANCELLING A COPY JOB	2-6
AUTOMATIC DUPLEX COPYING	2-7
CHANGING THE EXPOSURE AND ORIGINAL IMAGE TYPE	2-8
• AUTOMATIC ADJUSTMENT OF EXPOSURE AND ORIGINAL TYPE	2-8
• MANUAL ADJUSTMENT OF EXPOSURE AND ORIGINAL TYPE	2-8
ENLARGE/REDUCE	2-10
SPECIFYING THE SIZE OF THE ORIGINAL	2-12
MAKING COPIES USING THE BYPASS TRAY ...	2-14
• SPECIFYING A TYPE AND SIZE OF PAPER LOADED ON BYPASS TRAY	2-14

CONVENIENT COPY FUNCTIONS

OUTPUT	2-16
• Automatic copy image rotation (Rotation Copy)	2-16
• SORT SETTING	2-17
• ID CARD COPY	2-19
• RESOLUTION SETTINGS	2-20

SPECIAL MODES

COPYING MULTIPLE ORIGINALS ONTO A SINGLE SHEET OF PAPER (2-Up / 4-Up COPY)	2-21
SCANNING THIN ORIGINALS (SLOW SCAN MODE)	2-23
COPYING BOTH SIDES OF A CARD AS A SINGLE PAGE (CARD SHOT)	2-24
ADJUSTING RED/GREEN/BLUE IN COPIES (RGB ADJUST)	2-25
ADJUSTING THE SHARPNESS OF AN IMAGE (SHARPNESS)	2-27
ADJUSTING THE BACKGROUND BY MAKING LIGHT AREAS OF THE ORIGINAL DARKER OR LIGHTER (SUPPRESS BG)	2-28

PROGRAMS

FREQUENTLY USED SETTINGS (PROGRAMS) .	2-29
• STORING A PROGRAM	2-29
• CHANGING A PROGRAM	2-30
• DELETING A PROGRAM	2-31
• USING A PROGRAM	2-31



BEFORE USING THE MACHINE AS A COPIER

COPY MODE

Press the [COPY] key () on the operation panel to change to copy mode.

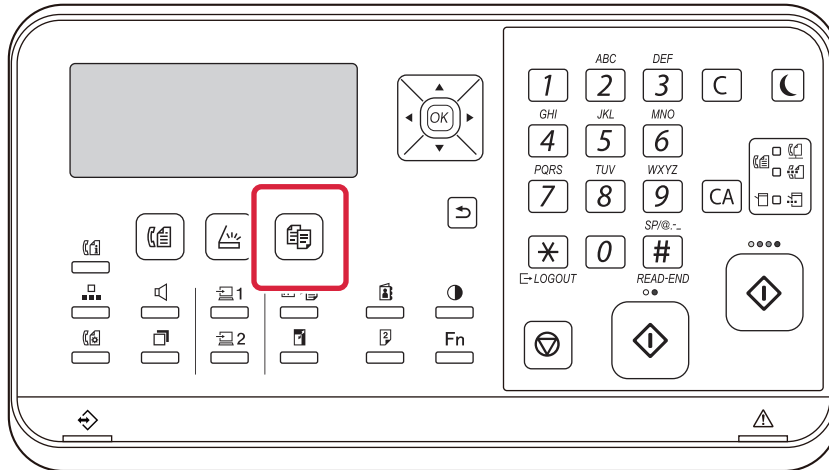



COPYING SEQUENCE

This section explains the basic procedure for copying. Select settings in the order shown below to ensure that the copy operation takes place smoothly.

For detailed procedures for selecting the settings, see the explanation of each setting in this chapter.

1

Switch to copy mode.

- [COPY MODE \(page 2-2\)](#)

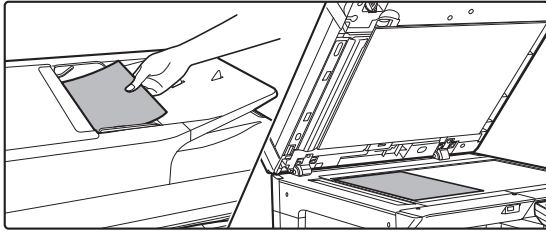
2

Place the original.

Place the original in the document feeder tray of the automatic document feeder, or on the document glass.

- [AUTOMATIC DOCUMENT FEEDER \(page 1-31\)](#)
- [DOCUMENT GLASS \(page 1-33\)](#)

3

Select functions.

Specify the original scan size, exposure, resolution, etc.
If necessary, you can refer to the following functions for the setting.

- Paper Select ► [page 2-4](#)
- 2-Sided Copy ► [page 2-7](#)
- Exposure ► [page 2-8](#)
- Copy Ratio ► [page 2-10](#)
- Original ► [page 2-12](#)
- Output ► [page 2-17](#)
- ID Card Copy ► [page 2-19](#)
- N-Up ► [page 2-21](#)
- Card Shot ► [page 2-24](#)
- RGB Adjust ► [page 2-25](#)
- Sharpness ► [page 2-27](#)
- Suppress BG ► [page 2-28](#)

4

Press the [COLOUR START] or [B/W START] key to start copying.

When making only one set of copies, you do not need to specify the number of copies.



- To cancel all settings, press the [CA] key.
When the [CA] key is pressed, all settings selected to that point are cleared and you will return to the base screen.
- To cancel a copy job, press the [C] key or [CA] key. If you press the [C] key, the copy settings are retained. If you press the [CA] key, the settings are cancelled. If you press the [STOP] key (⏏) while copying is in progress, a confirmation screen appears asking if you want to cancel the copy job.



- **To make two or more sets of copies:**
Press the copies display key to specify the number of copies.



SELECTING THE PAPER TRAY FOR COPYING

To change the tray you want to use in order to use the bypass tray or tray 2 to 4 (if installed), select "Paper Select" in the right menu of the base screen of copy mode, and press the [OK] key.

Press the [▼][▲] keys to select the tray, and press the [OK] key.

For detailed loading paper into the tray, see the [TRAY 1 \(page 1-20\)](#), [LOADING PAPER INTO THE BYPASS TRAY \(page 1-24\)](#).

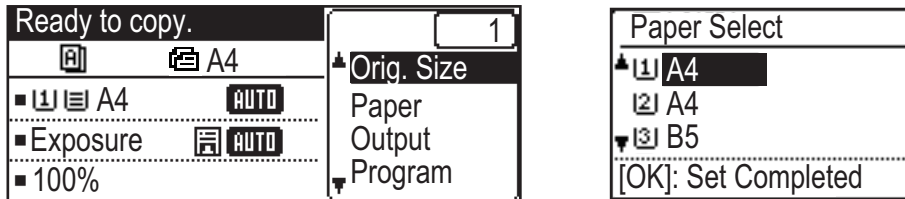

- If the selected tray runs out of paper during a copy job and there is another tray that has the same size and type of paper, that tray will be automatically selected and the copy job will continue.
- **If the "Ready to copy." message does not appear in the base screen of copy mode**
If a list is being printed in the system settings, copying is not possible. Wait until list print finishes and then start copying.



- **Changing the default tray setting**
Change the default tray in [System Settings] → [Default Tray Set].
- **Enabling or disabling auto paper selection**
Select the setting in [System Settings] → [Copier] → [Auto PaperSelect].
When this setting is enabled, a tray with the same size of paper as the original will be automatically selected.



BASIC PROCEDURE FOR MAKING COPIES

COPYING

USING THE AUTOMATIC DOCUMENT FEEDER FOR COPYING

1

Place the original in the document feeder tray of the automatic document feeder.

► [AUTOMATIC DOCUMENT FEEDER \(page 1-31\)](#)



In the automatic document feeder, the size of the placed original is automatically detected.

2

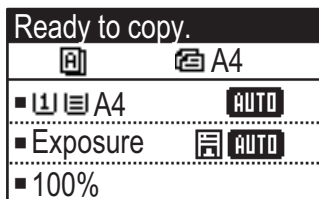

Check the paper (tray) you want to use for copying, and press the keys for any other settings you want to select.

- Paper Select ► [page 2-4](#)
- 2-Sided Copy ► [page 2-7](#)
- Exposure ► [page 2-8](#)
- Copy Ratio ► [page 2-10](#)
- Original ► [page 2-12](#)
- Output ► [page 2-17](#)
- ID Card Copy ► [page 2-19](#)
- N-Up ► [page 2-21](#)
- Card Shot ► [page 2-24](#)
- RGB Adjust ► [page 2-25](#)
- Sharpness ► [page 2-27](#)
- Suppress BG ► [page 2-28](#)

3

Press the [COLOUR START] or [B/W START] key to start copying.

When making only one set of copies, you do not need to specify the number of copies.



To make two or more sets of copies:

Press the number of copies key to specify the number of copies.



USING THE DOCUMENT GLASS FOR COPYING

1**Place the original on the document glass.**► [DOCUMENT GLASS \(page 1-33\)](#)

On the document glass, the size of the placed original is not automatically detected. To make a copy using the document glass, you must manually specify the size of the original.

► [SPECIFYING THE SIZE OF THE ORIGINAL \(page 2-12\)](#)**2**

Ready to copy.

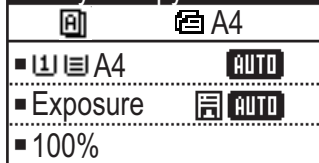
**Check the paper (tray) you want to use for copying, and press the keys for any other settings you want to select.**

- Paper Select ► [page 2-4](#)
- 2-Sided Copy ► [page 2-7](#)
- Exposure ► [page 2-8](#)
- Copy Ratio ► [page 2-10](#)
- Original ► [page 2-12](#)
- Output ► [page 2-17](#)
- ID Card Copy ► [page 2-19](#)
- N-Up ► [page 2-21](#)
- Card Shot ► [page 2-24](#)
- RGB Adjust ► [page 2-25](#)
- Sharpness ► [page 2-27](#)
- Suppress BG ► [page 2-28](#)

3**Press the [COLOUR START] or [B/W START] key to start copying.**

When making only one set of copies, you do not need to specify the number of copies.

**To make two or more sets of copies:**

Press the number of copies key to specify the number of copies.

CANCELLING A COPY JOB



To cancel the copying, press [C] key or [CA] key. When [C] key is pressed the copy settings are maintained and when [CA] key is pressed the copy settings are all deleted.

When [STOP] key (⏏) is pressed while the copy is in process, the confirmation screen whether or not to cancel the copying appears on the display.

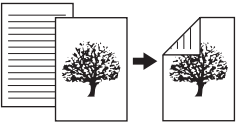
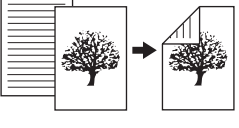

AUTOMATIC DUPLEX COPYING

The machine is capable of performing the following type of auto duplex copying. When copying, the machine will automatically turn over the originals and paper, allowing you to make 2-sided copies with ease.

	Original → Paper			Usable paper
Document glass	One-sided original → Two sides 			A3, B4, A4, A4R, B5, B5R, A5R, 8K, 16K, 16KR (11" x 17", 8-1/2" x 14", 8-1/2" x 13-1/2", 8-1/2" x 13-2/5", 8-1/2" x 13", 8-1/2" x 11", 8-1/2" x 11"R, 5-1/2" x 8-1/2"R)
Document feeder	One-sided original → Two sides 	Duplex original → Two sides 	Duplex original → One side 	A3, B4, A4, A4R, B5, B5R, A5R, 8K, 16K, 16KR (11" x 17", 8-1/2" x 14", 8-1/2" x 13-1/2", 8-1/2" x 13-2/5", 8-1/2" x 13", 8-1/2" x 11", 8-1/2" x 11"R, 5-1/2" x 8-1/2"R)

To change to the 2-sided copy screen, press the [DUPLEX] key () on the operation panel with the base screen of copy mode displayed.

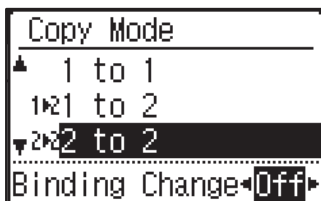

Select "1 to 2", "2 to 2", or "2 to 1" with the [▼][▲] keys and press the [OK] key.

When scanning the original on the document glass, press the [COLOUR START] or [B/W START] key after scanning the front side, turn the original over on the glass, and press the [COLOUR START] or [B/W START] key. Duplex copying starts.

To change the orientation of the copy image on the front and back sides of the paper, set "Binding Change" to "On" with the [◀][▶] keys.

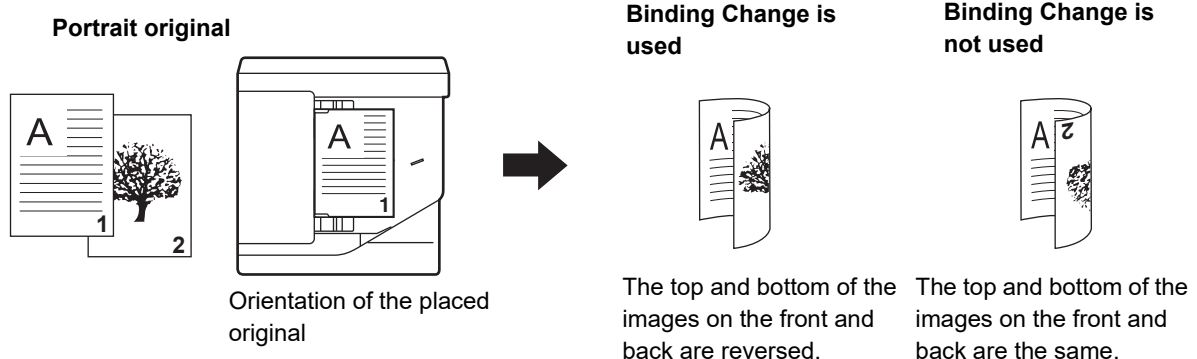



CHANGING THE EXPOSURE AND ORIGINAL IMAGE TYPE

AUTOMATIC ADJUSTMENT OF EXPOSURE AND ORIGINAL TYPE

Automatic exposure adjustment operates by default to automatically adjust the exposure level and original type as appropriate for the original being copied. ([Auto] is displayed.)

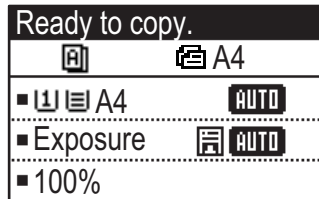

To change the default exposure:

In "System Settings (administrator)", select [Copier] → [Default Exposure].

MANUAL ADJUSTMENT OF EXPOSURE AND ORIGINAL TYPE

This section explains how to select the original type depending on the original to be copied or manually adjust the exposure.



To change the default exposure:

In "System Settings (administrator)", select [Copier] → [Default Exposure].

1

Press the [Exposure] key.

► [COPY MODE \(page 2-2\)](#)

2



Select the original type.

Select the original type with the [▼][▲]keys.

Three exposure modes are available: "Text", "Txt/Prt Photo" and "Photo".

Original image type select keys

- Text Use this mode for regular text documents.
- Txt/Prt Photo This mode provides the best balance for copying an original which contains both text and printed photographs, such as a magazine or catalogue.
- Photo Use this mode to copy photos.



3

Adjust the exposure of the selected original type.

Set "Auto" or "Manual" (5 levels) for the exposure. If needed, adjust the exposure with the [◀][▶] keys.



Guidelines for the exposure level when [Text] is selected for "Exposure/Original Type"

1 to 2: Dark originals such as a newspaper

3: Normal density originals

4 to 5: Originals written in pencil or light coloured text

4

Press the [OK] key.



ENLARGE/REDUCE

Place the original, and press the [ZOOM] key () on the operation panel to change to the ratio selection screen. Specifying a ratio from 25% to 400%: Preset ratios/zoom.

(When the document feeder is being used, the zoom copy ratio range is 25% to 200%.)

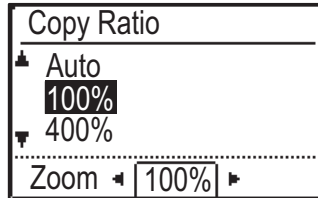
**1**

Press the [ZOOM] key () .

► [COPY MODE \(page 2-2\)](#)

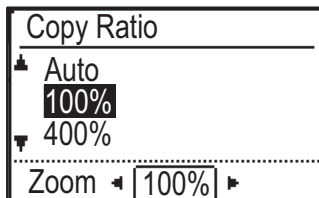
2

Select the ratio.

Select the ratio with the [▼][▲] keys.

3

To set the ratio in increments of 1%, set a numerical value with the [◀][▶] keys.

4

Press the [OK] key.



AUTO RATIO SELECT

This section explains how to automatically select the appropriate ratio to meet the paper size when manually changing the paper tray to make a copy on paper that has a size different from the original.



For a non-standard size original, the size must be entered in order to use Auto Image.



To set Auto ratio select:

In "System Settings (administrator)", select [Copier] → [Auto Image].

1

Manually select the paper tray, and place the original.

Place the original in the document feeder tray of the automatic document feeder, or on the document glass.

- ▶ [SELECTING THE PAPER TRAY FOR COPYING \(page 2-4\)](#)
- ▶ [AUTOMATIC DOCUMENT FEEDER \(page 1-31\)](#)
- ▶ [DOCUMENT GLASS \(page 1-33\)](#)

2

Press the [Copy Ratio] key.

3

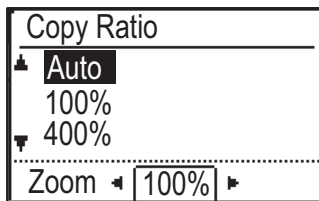

Select "Auto" with the [▼][▲] keys and press the [OK] key.

An enlargement/reduction ratio appropriate for the set original size and selected paper size is automatically selected.

The automatically selected ratio will appear in the ratio display.



SPECIFYING THE SIZE OF THE ORIGINAL

If you want to specify an original size other than the displayed size, select "Orig. Size" from the right menu.



- Set the orientation and size of the original before scanning the original.
- If you want to specify an original size other than the displayed size, select "Orig. Size" from the right menu.
- When "Not Specified" is selected in "Orig. Size Enter" in the system settings, the original is scanned according to the paper size of the selected tray.

Orientation of the original

Place the original as shown below.

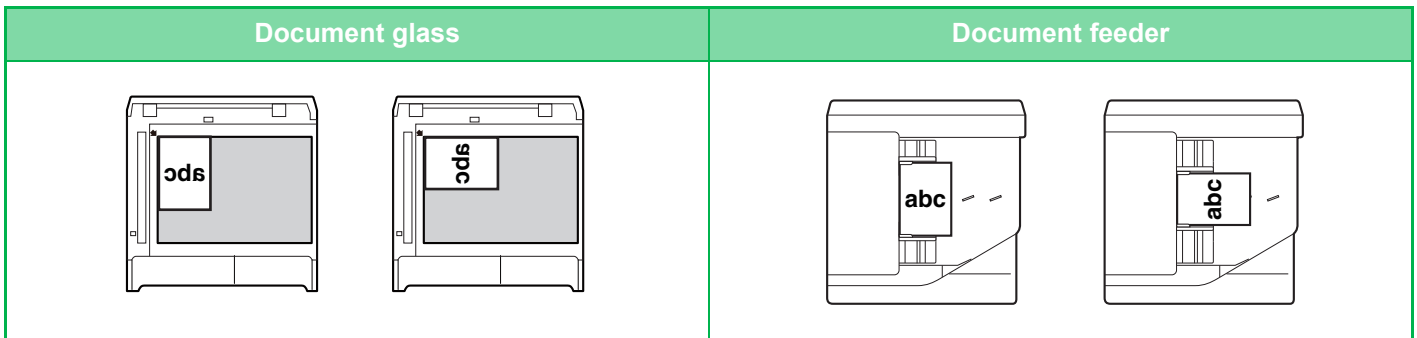

Specifying the size of the original

1

Select "Original Size" in the right menu of the base screen of copy mode and press the [OK] key.

2

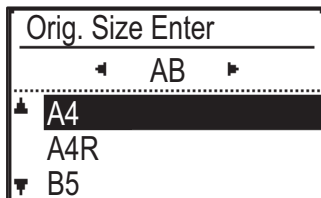

Select Inch or AB with the [◀][▶] keys.

3

Select the size with the [▼][▲] keys.

For a standard original size, select Original Size, press the [OK] key, and specify the original size. The set original size will appear in the Original Size field of the base screen. If you are using a special original size, go to step 4.

4

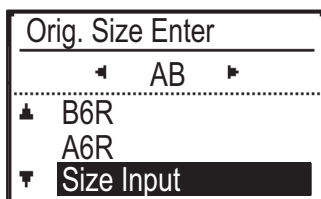

For a special paper size, select "Size Input" and press the [OK] key.



5

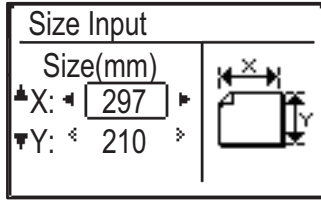

Specify the original size.

- (1) Select "X" (width) with the [▼] or [▲] key .
- (2) Enter the width with the [◀] or [▶] key, then do the same for the length (Y).
- (3) Press the [OK] key.

The original size is set. "Custom" appears in the original size field of the base screen.



MAKING COPIES USING THE BYPASS TRAY

In addition to plain paper, the bypass tray allows you to make copies on transparency film, envelopes, and other special media.



For detailed information on paper that can be loaded into the bypass tray, see "[APPLICABLE PAPER TYPES \(page 1-16\)](#)".
For precautions on loading paper into the bypass tray, see "[LOADING PAPER INTO THE BYPASS TRAY \(page 1-24\)](#)".

SPECIFYING A TYPE AND SIZE OF PAPER LOADED ON BYPASS TRAY

1

Load paper into the bypass tray.

When you load paper in the bypass tray, "Paper Type Set" is displayed.

If paper is already loaded in the bypass tray and you want to change the paper size or paper type, Press the [SPECIAL FUNCTION] key (Fn), select "Paper Size Set" or "Paper Type Set", and press the [OK] key.

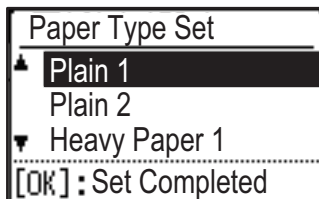

- When "Bypass Tray Settings" in "Paper Size Set" is disabled, "Paper Type Set" is not displayed automatically.
- When "Disable Paper Size Set" is enabled in the system settings, "Paper Size Set" does not appear.

2

Select the type of paper to be used in the bypass tray.

Select the paper type with the [◀][▶] keys. When finished, press the [OK] key.



To use an envelope

Select the envelope size to be used with the [▼][▲] keys, and press the [OK] key.

The envelope size is set. "Envelope" appears in the paper size field of the base screen.

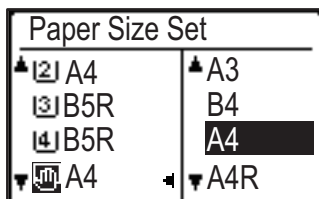
3

Select the paper size used in the bypass tray.

Select the paper size with the [◀][▶] keys. If the paper size is a standard size, select Paper Size, press the [OK] key, and specify the paper size.

The specified paper size appears in the paper size field of the base screen.

When pressing the [SPECIAL FUNCTION] key (Fn) to set "Paper Size Set", the display returns to the base screen by pressing the [OK] key.



To use a special paper size

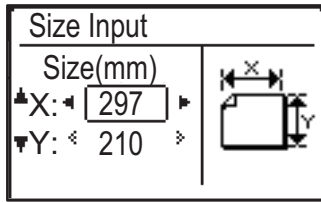

- (1) Select "mm" or "inch" and press the [OK] key.
- (2) Select "X" (horizontal) or "Y" (vertical) with the [▼][▲] keys.
- (3) Specify the size of each with the [◀][▶] keys.

In "mm", you can specify the size in increments of 1 mm. In "inch", you can specify the size in increments of 1/8 inch.

Minimum size:

131 mm (longitudinal) x 140 mm (transversal)

5-1/8" (longitudinal) x 5-1/2" (transversal)

Maximum size:

297 mm (longitudinal) x 432 mm (transversal)

11-5/8" (longitudinal) x 17" (transversal)

- (4) Press the [OK] key.

The paper size is set. "Custom" appears in the paper size field of the base screen.



CONVENIENT COPY FUNCTIONS

OUTPUT

Automatic copy image rotation (Rotation Copy)

If the orientation is different between the original and paper, the original image will be automatically rotated 90 degrees to match the paper.

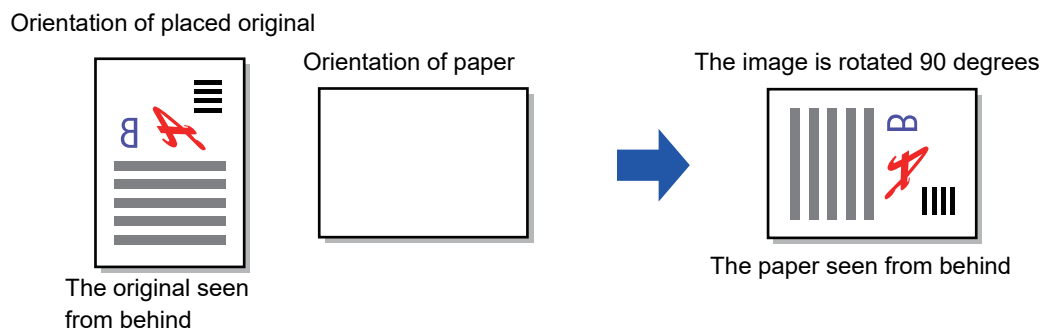

- To use this function, Auto PaperSelect or Auto Image must be enabled.
- This function cannot be used if you directly enter the original size or enable Card Shot.







To cancel Rotation Copy:

In "System Settings (administrator)", select [Copier] → [RotationCopy Set].

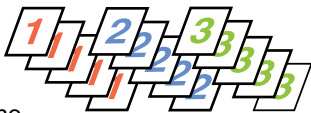

SORT SETTING

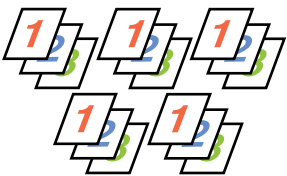
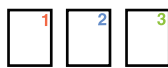
- Groups the scanned original on a page basis, and outputs them. (No Sort)
- Sorts the scanned original on a set basis, and outputs them. (Sort)
- Sorts the scanned originals into sets, and changes the orientation (portrait/landscape). (Rotated Output)

Auto	Enables the sort mode when the original is placed in the automatic document feeder, and enables the group mode when the original is placed on the document glass.	
No Sort	Groups the scanned original on a set basis, and outputs them.	<p>Originals</p>  <p>When 5 is set for the number of copies</p> <p>Finished</p> 
Sort	Sort the scanned original on a page basis, and outputs them.	<p>Originals</p>  <p>When 5 is set for the number of copies</p> <p>Finished</p> 
Rotated Output	Sorts the scanned originals into sets, and changes the orientation (portrait/landscape).	<p>Originals</p>  <p>When 4 is set for the number of copies</p> <p>Finished</p> 

Paper for Rotated Output

Rotated Output can only be selected when the following three conditions are met.

- Load one of the supported paper sizes.
 - *The only paper sizes that can be used for Rotated Output are B5, B5R, A4, A4R, 8-1/2" x 11", 8-1/2" x 11"R.
- Load paper in different orientations (portrait and landscape) in at least two trays. Load the same size of paper.
- Load the same type of paper.

For example, load A4 size plain paper 1 vertically in tray 1, and load A4 size plain paper 1 horizontally in the bypass tray.



1

Select "Output" in the right menu of the base screen of copy mode and press the [OK] key.

2

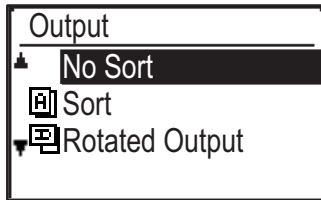

Select "No Sort" or "Sort" or "Rotated Output" with the [▼] [▲] keys

3

Press the [OK] key.



- If the memory becomes full while the originals are being scanned, "Memory is full." will appear in the display. To start copying the originals that have been scanned to that point, press the [COLOUR START] or [B/W START] key. To cancel the copy job, press the [CA] key.
- The auto select setting for the sort function of the automatic document feeder can be changed in "Sort Auto Select" in the system settings ([▶ page 6-19](#)).



ID CARD COPY

You can copy the front and back sides of ID card onto a page through this function.

The layout of the ID card copy, set the "[ID Card Setting \(page 6-19\)](#)" of SYSTEM SETTINGS.

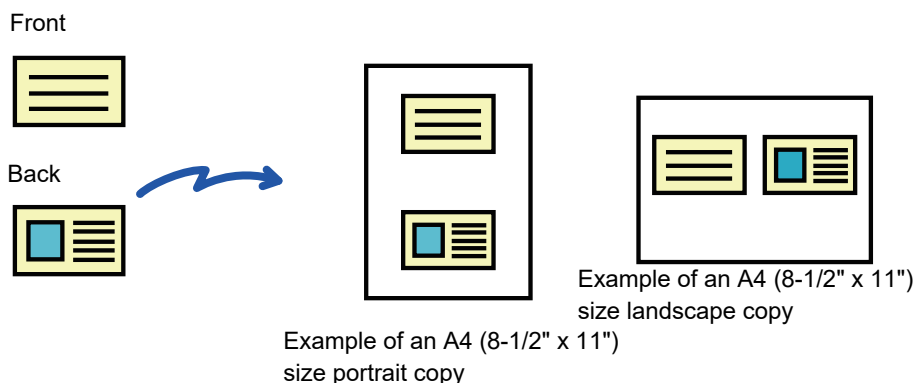
**1**

Press the [ID CARD COPY] key () on the operation panel.

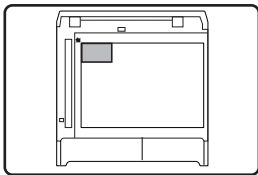
2

Place the ID card on the upper left-hand corner of the document glass, and press the [COLOUR START] or [B/W START] key.

3

Turn the ID card over and press the [COLOUR START] or [B/W START] key.



- The ID card copy function cannot be used at the same time as the 2-sided copy, 2-Up/4-Up copy, sort copy, and card shot functions.
- Paper sizes that can be used with ID Card Copy are standard sizes.
- In ID card copy mode, scan area and scan number (1 page) cannot be changed. Scan area is:
X: 86 + 5 mm (1/4") (margin), Y: 54 + 5mm (1/4") (margin).
- Auto tray switch is invalid in ID card copy mode. Please select paper and tray manually.



RESOLUTION SETTINGS

You can adjust the resolution for scanning an original on the document glass or in the auto document feeder, and select high image quality or high speed as appropriate for your needs.

1

Press the [SPECIAL FUNCTION] key (Fn), select "Resolution" with the [▼][▲] keys, and press the [OK] key.

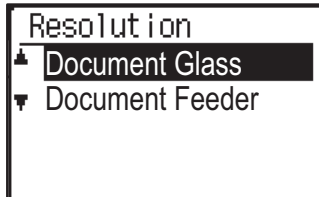
2

Select "Document Glass" or "Document Feeder" with the [▼] [▲] keys and press the [OK] key.

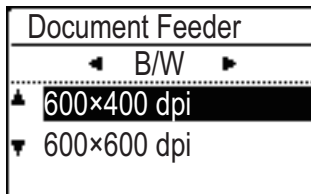
3

Select "B/W" or "Colour" with the [◀] [▶] keys.

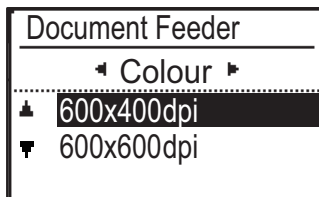
4

Select "600×400dpi" or "600×600dpi" with the [▼] [▲] keys and press the [OK] key.



SPECIAL MODES

To display the Special Modes menu, press the [SPECIAL FUNCTION] key (Fn) with the base copy screen displayed, and press the [▼][▲] keys to select "Special Modes".

COPYING MULTIPLE ORIGINALS ONTO A SINGLE SHEET OF PAPER (2-Up / 4-Up COPY)

Multiple originals can be copied onto a single sheet of paper in a selected layout pattern.

This function is convenient for compiling multi-page reference materials into a compact format, or for providing an overview of all pages of a document on a single page.

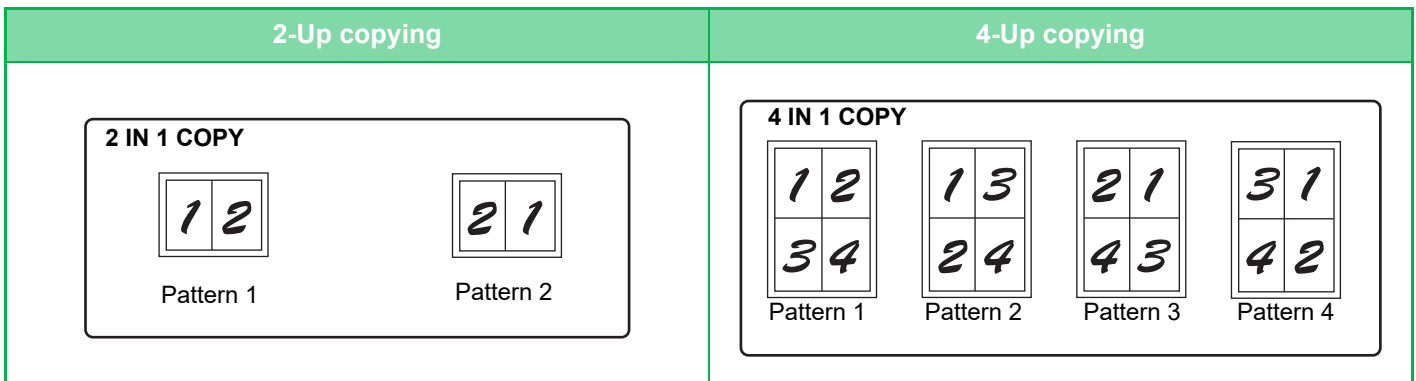

1

Press the [SPECIAL FUNCTION] key (Fn), select "Special Modes" with the [▼][▲] keys, and press the [OK] key.

2

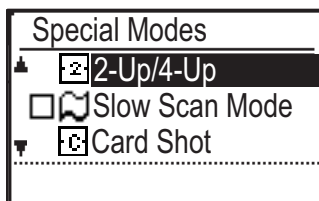

Select "2-Up/4-Up" with the [▼] [▲] keys and press the [OK] key.

3

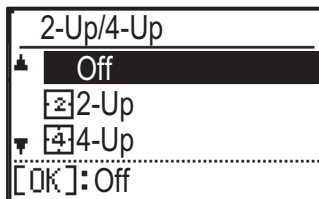

Select "2-Up" or "4-Up" with the [▼] [▲] keys and press the [OK] key.



To cancel 2-Up/4-Up:

Select "OFF" with the [▼] [▲] and press the [OK] key.



4

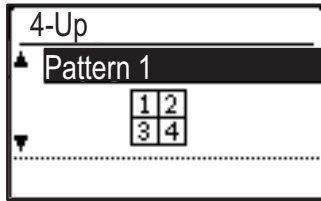

Select the layout with the [▼][▲] keys and press the [OK] key.

See above for the layouts that can be selected.



- 2-Up / 4-Up copy cannot be used in combination with the following functions. The function selected first will take precedence.
Card shot, ID card copy
- If ID card copy is set later, The function will be selected first.
- A special paper size cannot be used for 2-Up / 4-Up copy.
- An appropriate ratio setting will be automatically selected based on the original size, the paper size, and the selected number of images.
Certain combinations of original size, paper size, and number of images may result in images being cut off.
- 2-Up/4-Up copy cannot be used if the original size is not set.



SCANNING THIN ORIGINALS (SLOW SCAN MODE)

When you wish to scan thin originals using the automatic document feeder, you can use this function, which helps prevent thin originals from misfeeding.

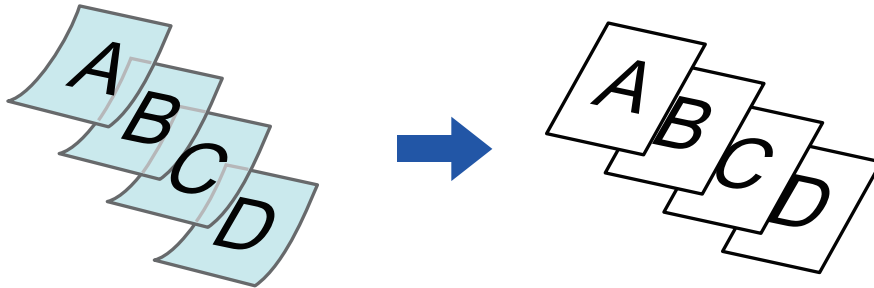

Slow Scan Mode must be specified before scanning the original.



The "2-Sided→2-Sided" and "2-Sided→1-Sided" modes of automatic 2-sided copying cannot be used.

1

Press the [SPECIAL FUNCTION] key (Fn), select "Special Modes" with the [▼][▲] keys, and press the [OK] key.

2

Select "Slow Scan Mode" with the [▼][▲] keys and press the [OK] key.

A checkmark appears on the icon.

After the settings are completed, press the [Back] key.

► [AUTOMATIC DOCUMENT FEEDER \(page 1-31\)](#)



To cancel slow scan mode:

Select "Slow Scan Mode" to clear the checkmark.

3

Place the original in the document feeder tray of the automatic document feeder.

► [AUTOMATIC DOCUMENT FEEDER \(page 1-31\)](#)



If the originals are inserted with too much force, they may crumple and misfeed.

4

Press the [COLOUR START] or [B/W START] key to start copying.



COPYING BOTH SIDES OF A CARD AS A SINGLE PAGE (CARD SHOT)

This function copies the front and reverse sides of a card on one sheet, not on separate sheets. This function is convenient for making copies for identification purposes and helps save paper.

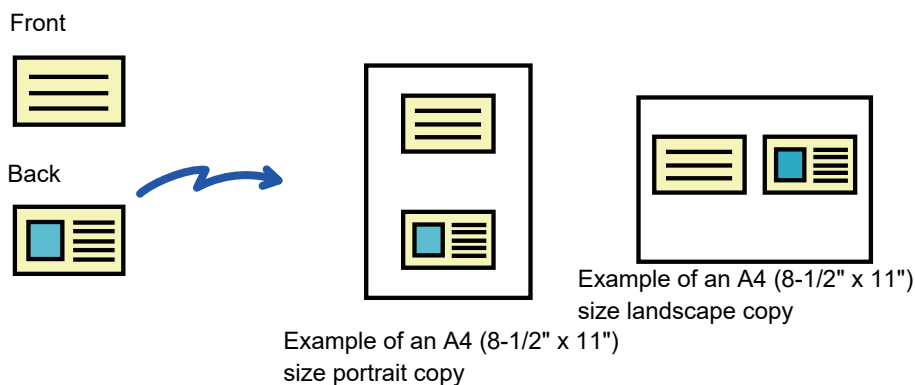

1 Press the [SPECIAL FUNCTION] key (Fn), select "Special Modes" with the [▼][▲] keys, and press the [OK] key.

2 Select "Card Shot" with the [▼] [▲] keys and press the [OK] key.

3

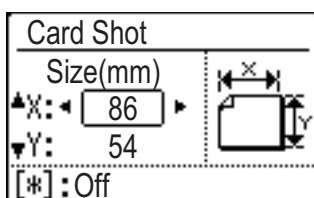

Specify the card size in the Card Shot screen.

Select horizontal (X) or vertical (Y) with the [▼][▲] keys, specify the dimension with the [◀][▶] keys, and press the [OK] key. Repeat for the other dimension.



To cancel Card Shot:
Press the [*] key.



- The horizontal and vertical dimensions can each be set to value from 25 to 210 mm (1" to 8-1/2").
- The card shot function cannot be used in combination with 2-Up / 4-Up copy, and ID card copy.
- The default settings for the horizontal and vertical dimensions in this screen can be set in [Card Shot Default \(page 6-19\)](#) in the system settings.



ADJUSTING RED/GREEN/BLUE IN COPIES (RGB ADJUST)

This function heightens or lightens any one of the three colour components R (red), G (green), and B (blue).

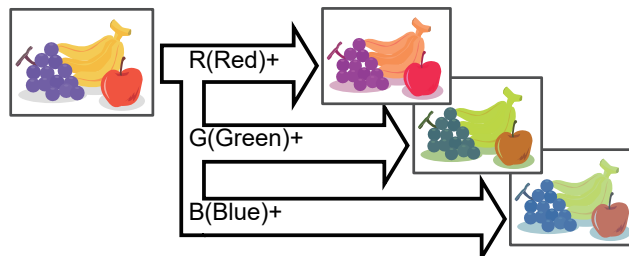

RGB must be specified before scanning the original.

1

Press the [SPECIAL FUNCTION] key (Fn), select "Special Modes" with the [▼][▲] keys, and press the [OK] key.

2

Select "RGB adjust" with the [▼][▲] keys and press the [OK] key.

3

Select the colour you want to adjust with the [▼][▲] keys and press the [OK] key.

4

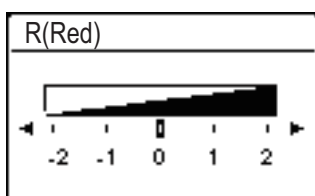

Press [◀] [▶] to adjust the colouring.

After the settings are completed, press the [OK] keys.



- Only one colour can be adjusted. (If you adjust one colour and then select another colour, the adjustment of the first colour is cancelled.)

- **To cancel the RGB adjust:**

Press the [CA] key.

5

Place the original.

Place the original in the document feeder tray of the automatic document feeder, or on the document glass.

- ▶ [AUTOMATIC DOCUMENT FEEDER \(page 1-31\)](#)

- ▶ [DOCUMENT GLASS \(page 1-33\)](#)



To cancel all settings:

Press the [CA] key.



6

Press the [COLOUR START] key to start copying.



ADJUSTING THE SHARPNESS OF AN IMAGE (SHARPNESS)

This function adjusts the sharpness to make a sharper or softer image.

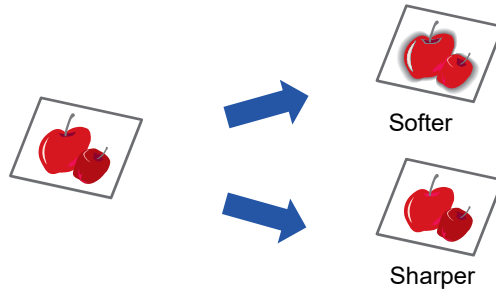

Sharpness must be specified before scanning the original.

1

Press the [SPECIAL FUNCTION] key (Fn), select "Special Modes" with the [▼][▲] keys, and press the [OK] key.

2

Select "Sharpness" with the [▼] [▲] keys and press the [OK] key.

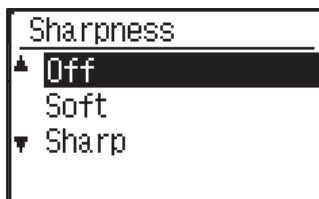
3

Select "Off", "Soft", or "Sharp" with the [▼][▲] keys and press the [OK] key.



To cancel the sharpness setting:

Select "Off" with the [▼][▲] keys and press the [OK] key.



ADJUSTING THE BACKGROUND BY MAKING LIGHT AREAS OF THE ORIGINAL DARKER OR LIGHTER (SUPPRESS BG)

You can adjust the background by making light areas of the original darker or lighter.

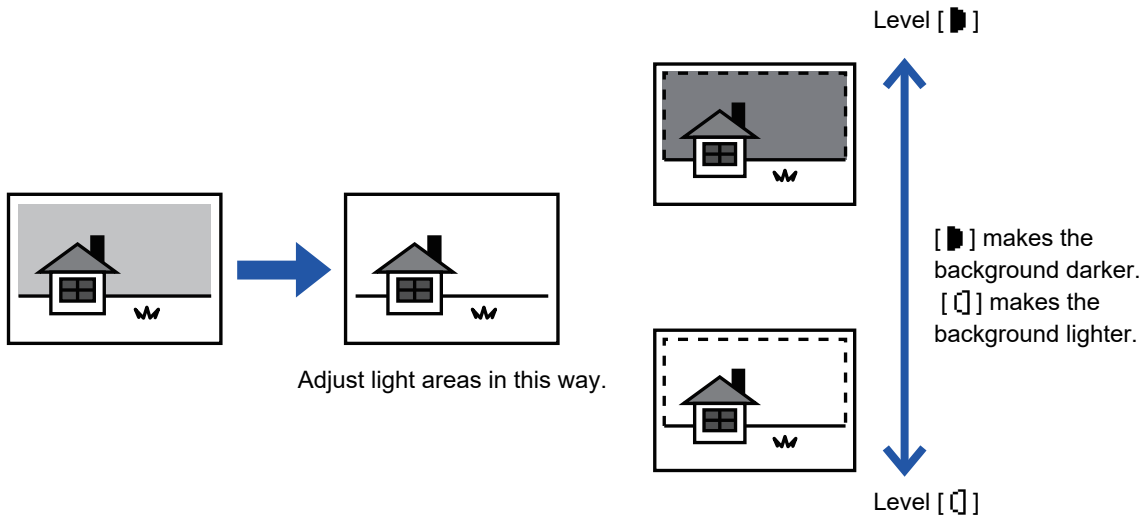

You must select Background Adjustment before scanning the original.

1

Press the [SPECIAL FUNCTION] key (Fn), select "Special Modes" with the [▼][▲] keys, and press the [OK] key.

2

Select "Suppress BG" with the [▼] [▲] keys and press the [OK] key.

3



Select level adjustment with the [▼] [▲] keys, and adjust with the [◀][▶] keys.

To select, change the level (3 levels are available) with the [◀][▶] keys and press the [OK] key.

■ : Only light backgrounds are suppressed.

□ : Light to dark backgrounds are suppressed.



To cancel the Background Adjustment setting:

Select "Off" with the [▼][▲] keys and press the [OK] key.



When Background Adjustment is selected, the copy exposure setting is not applied.

► [CHANGING THE EXPOSURE AND ORIGINAL IMAGE TYPE \(page 2-8\)](#)



PROGRAMS

FREQUENTLY USED SETTINGS (PROGRAMS)

A group of copy settings can be stored together as a program. A stored program can be easily invoked.

STORING A PROGRAM

The following copy settings can be stored:

Duplex, Zoom, Exposure, Resolution, Orig. Size Enter, Paper Select, Sort, 2-Up/4-Up, Slow Scan Mode, Card Shot, RGB Adjust, Sharpness, Background Adjustment

- 1 Press the [SPECIAL FUNCTION] key (Fn), select "Register Program" with the [▼][▲] keys, and press the [OK] key.

2



Select "Enter" with the [▼] [▲] keys and press the [OK] key.

3



Select the number of the program you want to store with the [▼][▲] keys and press the [OK] key.

"No Store" appears in locations where a program has not been stored. "Program 1 - 3" appears in locations where a program is already stored.

4

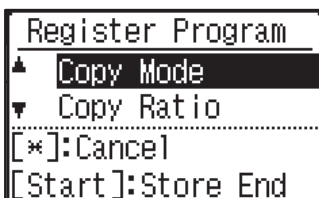

Refer to the copy setting procedures to configure settings for the selected items.

A checkmark appears in front of each setting that you have selected. When you have finished selecting settings, press the [COLOUR START] or [B/W START] key.



If you want to remove an item that has been set (item with a checkmark) from the program, press the [LOGOUT] key (✳).



- Up to three programs can be stored.
- Some setting combinations are not possible.
(For example, 2-Up/4-Up and Card Shot)

CHANGING A PROGRAM

- 1 Press the [SPECIAL FUNCTION] key (Fn), select "Register Program" with the [▼][▲] keys, and press the [OK] key.

2

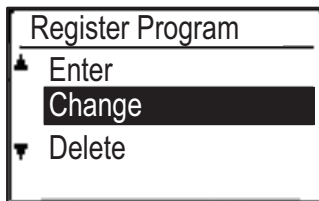

Select "Change" with the [▼] [▲] keys and press the [OK] key.

3

Select the number of the program you want to modify with the [▼] [▲] keys, and press [OK]. Modify the settings as explained in step 4 of [STORING A PROGRAM \(page 2-29\)](#), and resave the program.



DELETING A PROGRAM

- 1 Press the [SPECIAL FUNCTION] key (Fn), select "Register Program" with the [▼][▲] keys, and press the [OK] key.

2

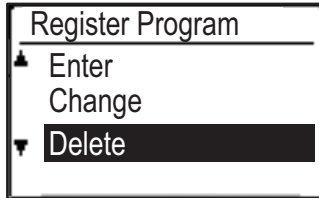

Select "Delete" with the [▼] [▲] keys and press the [OK] key.

3

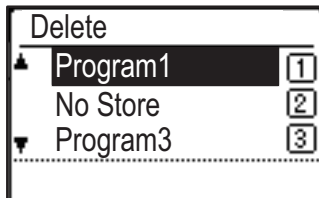

Select the program you want to delete with the [▼][▲] keys and press the [OK] key.

USING A PROGRAM

- 1 Select "Program" in the right menu of the base screen of copy mode and press the [OK] key.

2

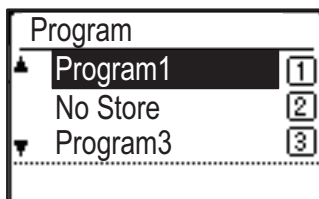

Select the number of the program you want to use with the [▼][▲] keys and press the [OK] key.

The settings in the selected program are applied to the copy job.



PRINTER

The explanations in this chapter are based on American English and the North American version of the software. Software for other countries and regions may vary slightly from the North American version.

PRINTER FUNCTION OF THE MACHINE

PRINTING IN A WINDOWS ENVIRONMENT

BASIC PRINTING PROCEDURE	3-4
• PRINTER DRIVER SETTINGS SCREEN / REFERRING TO HELP	3-6
• SELECTING THE PAPER	3-7
• PRINTING ON ENVELOPES	3-8
PRINTING WHEN THE USER AUTHENTICATION FUNCTION IS ENABLED	3-9
FREQUENTLY USED FUNCTIONS	3-10
• SAVING SETTINGS AT THE TIME OF PRINTING	3-10
• USING SAVED SETTINGS	3-11
• CHANGING THE PRINTER DRIVER DEFAULT SETTINGS	3-11

PRINTING IN A macOS ENVIRONMENT

BASIC PRINTING PROCEDURE	3-13
• SELECTING THE PAPER	3-14
• PRINTING ON ENVELOPES	3-15
PRINTING WHEN THE USER AUTHENTICATION FUNCTION IS ENABLED	3-16

FREQUENTLY USED FUNCTIONS

SELECTING THE COLOR MODE	3-18
SELECTING THE RESOLUTION	3-20
2-SIDED PRINTING	3-21
FITTING THE PRINT IMAGE TO THE PAPER	3-22
PRINTING MULTIPLE PAGES ON ONE PAGE ...	3-24

CONVENIENT PRINTING FUNCTIONS

CONVENIENT FUNCTIONS FOR CREATING PAMPHLETS AND POSTERS	3-26
• CREATE A PAMPHLET (BOOKLET)	3-26
• PRINTING WITH MARGIN SHIFT SETTING (MARGIN)	3-28
• CREATE A LARGE POSTER (POSTER PRINTING)	3-30
FUNCTIONS TO ADJUST THE SIZE AND ORIENTATION OF THE IMAGE	3-31
• ADJUST PRINT POSITION ON ODD AND EVEN PAGES SEPARATELY (PRINT POSITION)	3-31
• ROTATING THE PRINT IMAGE 180 DEGREES (ROTATE 180 DEGREES)	3-32
• ENLARGING/REDUCING THE PRINT IMAGE (ZOOM SETTING/ENLARGE OR REDUCE) ...	3-33
• PRINT A MIRROR-IMAGE (MIRROR-IMAGE REVERSE/VISUAL EFFECTS)	3-35
IMAGE ADJUSTING FUNCTION	3-36
• ADJUST THE BRIGHTNESS AND CONTRAST OF THE IMAGE (COLOR ADJUSTMENT/RGB ADJUSTMENT)	3-36
• PRINTING FAINT TEXT AND LINES IN BLACK (TEXT TO BLACK/VECTOR TO BLACK)	3-37
• SELECTING COLOR SETTINGS TO MATCH THE IMAGE TYPE (ADVANCED COLOR SETTINGS)	3-38
FUNCTIONS TO COMBINE TEXT AND IMAGES ...	3-41
• ADDING A WATERMARK TO PRINTED PAGES (WATERMARK)	3-41
• PRINTING AN IMAGE OVER THE PRINT DATA (IMAGE STAMP)	3-43
• OVERLAY A FIXED FORM ON THE PRINT DATA (OVERLAYS)	3-44





PRINT FUNCTIONS FOR SPECIAL PURPOSES. . . 3-46

- INSERTING COVERS (COVER PAGE) 3-46
- INSERT PRESET DATA BEFORE OR AFTER EACH PAGE (PAGE INTERLEAVE). 3-48
- CHANGING THE RENDERING METHOD AND PRINTING JPEG IMAGES (USE DRIVER TO RENDER JPEGS) 3-49

CONVENIENT PRINTER FUNCTIONS 3-50

- SAVING AND USING PRINT FILES (RETENTION) 3-50

PRINTING WITHOUT THE PRINTER DRIVER

EXTENSION OF PRINTABLE FILES. 3-53

DIRECTLY PRINTING A FILE IN USB MEMORY. . . 3-54

DIRECTLY PRINTING FROM A COMPUTER. 3-56

- FTP PRINT 3-56

APPENDIX

PRINTER DRIVER SPECIFICATIONS LIST 3-57



PRINTER FUNCTION OF THE MACHINE

To enable printing from your computer, a printer driver must be installed.
See the table below to determine which printer driver to use in your environment.

Windows environment

Printer driver type
PCL6 The machine support the Hewlett-Packard PCL6 printer control languages.
PS (On the PS3 expansion kit is required.) <ul style="list-style-type: none">• This printer driver supports the PostScript® 3™ page description language developed by Adobe Systems Incorporated, and enables the machine to be used as a PostScript® 3™ compatible printer.• If it is desired to use the Windows standard PS printer driver, the PPD driver must be used.



- To install the printer driver and configure settings in a Windows environment, see the Software Setup Guide.
- The User's Manual mainly uses PCL6 printer driver screens to explain how to print in a Windows environment. The printer driver screens may differ slightly depending on the printer driver you are using.

macOS Environment

Printer driver type
PS (On the PS3 expansion kit is required.) This printer driver supports the PostScript® 3™ page description language developed by Adobe Systems Incorporated, and enables the machine to be used as a PostScript® 3™ compatible printer.



- To install the printer driver and configure settings in a macOS environment, see the Software Setup Guide.
- The explanations of screens and procedures for use in a macOS environment generally assume that macOS 10.12 is being used and a PPD driver is installed. The screens may be different depending on the version of the operating system or the software application.



PRINTING IN A WINDOWS ENVIRONMENT

BASIC PRINTING PROCEDURE

The following example explains how to print a document from "WordPad", which is a standard accessory application in Windows.



- The menu used to execute printing may vary depending on the application.
- The button that is used to open the printer driver properties window (usually [Property] or [Preferences]) may vary depending on the application.
- The machine name that normally appears in the [Printer] menu is [xx-xxxxx]. ("xxxxx" is a sequence of characters that varies depending on the machine model.)

1

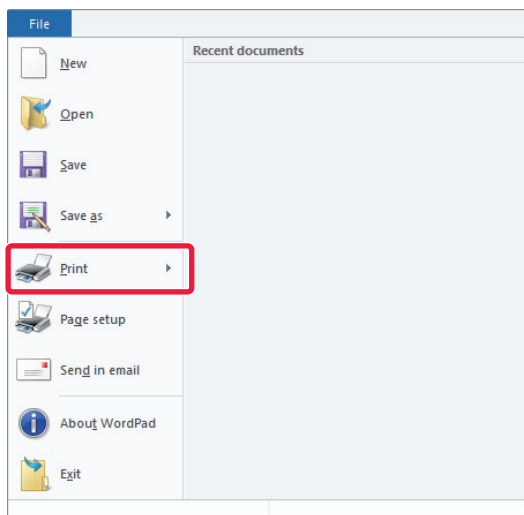

Select [Print] from the [File] menu of WordPad.

2

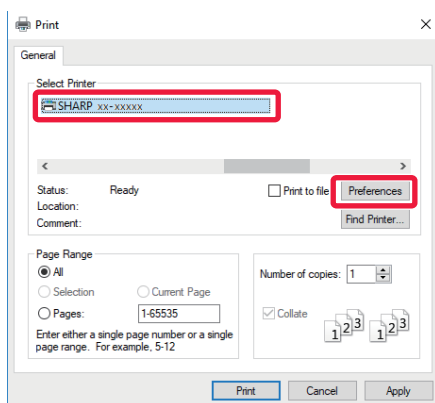

Select the printer driver for the machine and click the [Preferences] button.

The button that is used to open the printer driver properties window (usually [Property] or [Preferences]) may vary depending on the application.



3

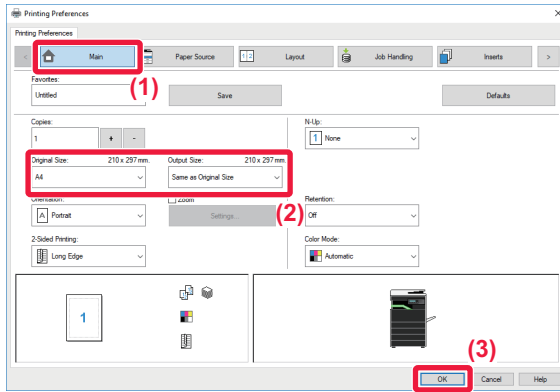

Select print settings.

(1) Click the [Main] tab.

(2) Select the original size.

- You can register up to seven user-defined sizes in the menu. To store an original size, select [Custom Paper] or one of [User1] to [User7] from the menu, and click the [OK] button.
- To select settings on other tabs, click the desired tab and then select the settings.
 - ▶ [PRINTER DRIVER SETTINGS SCREEN / REFERRING TO HELP \(page 3-6\)](#)
- If an original size larger than the largest paper size that the machine supports is set, select the paper size for printing in "Output Size".
- If an "Output Size" different from the "Original Size" is selected, the print image will be adjusted to match the selected paper size.

(3) Click the [OK] button.

4

Click the [Print] button.

Printing begins.



CANCELING A PRINT JOB FROM THE MACHINE

When [STOP] key (⏹) is pressed while showing "Printing" on the display after starting a print job, the confirmation screen whether or not to cancel the print job will appear. Then select "Yes" to cancel the printing.



PRINTER DRIVER SETTINGS SCREEN / REFERRING TO HELP

The printer driver settings screen consists of 8 tabs. Click a tab to select the settings on that tab.

You can check information on each of the settings in the Help screen. Click the [Help] button at the bottom right of the screen.

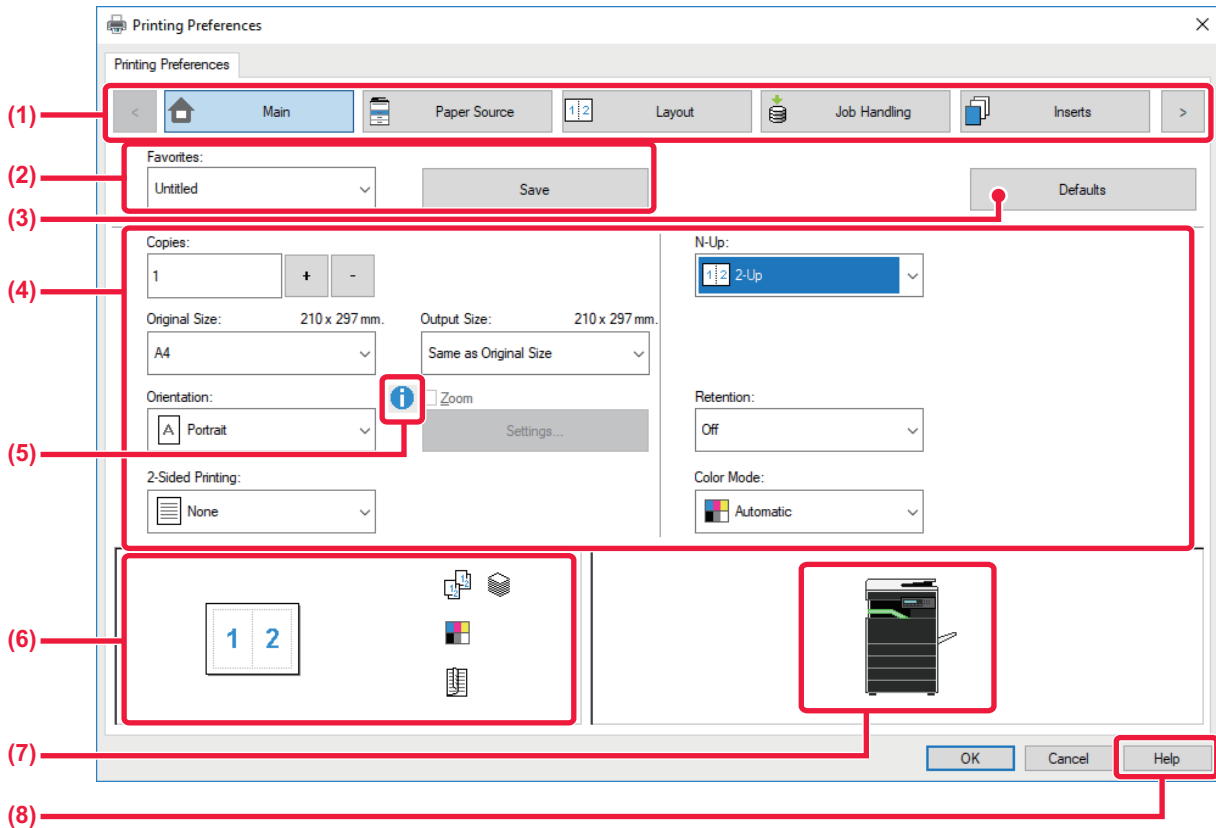

(1) Tabs: Click to change the tabs shown.

- [Main]: Frequently used functions are grouped on this tab. The settings are also on other tabs, and each setting on this tab is linked to the corresponding setting on the other tab.
- [Paper Source]: Set the size and type of paper used for printing, and the paper tray.
- [Layout]: Select functions related to the layout such as two-sided printing and booklet.
- [Job Handling]: Set retention and user authentication.
- [Inserts]: Select cover insertion functions.
- [Stamp]: Select the watermark or stamp function.
- [Image Quality]: Select various image quality settings.
- [Detailed Settings]: Select tandem print and other detailed print settings.

(2) Favorites

Settings configured on each tab at the time of printing can be saved as Favorite.

▶ [FREQUENTLY USED FUNCTIONS \(page 3-10\)](#)

(3) [Defaults]

Return the settings on the currently selected tab to their default state.

(4) Setup Items

Displays the settings on each tab.

(5) Information icon()

Some restrictions exist on the combinations of settings that can be selected in the printer driver properties window. When a restriction exists on a selected setting, an information icon () will appear next to the setting. Click the icon to view an explanation of the restriction.



(6) Print image

This lets you visually check how the current settings affect the print image. Finishing settings is indicated by icons.

(7) Machine image

This shows the options that are installed on the machine, and the paper trays and output trays that are used.

(8) [Help] button

Displays the Help window of the printer driver.



- Help can be displayed for a setting by clicking the setting and pressing the [F1] key.
- You can click the  button in the upper right corner of the settings screen and then click a setting to show Help for that setting in a sub-window.

SELECTING THE PAPER

Before printing, check the paper sizes, paper types, and paper remaining in the machine's trays. To check the most recent tray information, click the [Tray Status] button in the [Paper Source] tab.

The "Output Size" setting and the "Paper Tray" setting are related as follows:

• **When "Paper Tray" is set to [Auto Select]**

The tray that contains paper of the size and type selected in "Output Size" and "Paper Type" is automatically selected.

• **When "Paper Tray" is set to any setting other than [Auto Select]**

The specified tray is used for printing regardless of the "Output Size" setting.

When you have set "Paper Type" to [Bypass Tray], be sure to select "Paper Type". Check the paper type that is set for the bypass tray of the machine, check that paper of that type is actually loaded into the bypass tray, and then select the appropriate paper type.

• **When "Paper Type" is set to [Auto Select]**

A tray with plain paper or recycled paper of the size specified in "Output Size" is automatically selected. (The factory default setting is plain paper only.)

• **When "Paper Type" is set to anything other than [Auto Select]**

A tray with the specified type of paper and the size specified in "Output Size" is used for printing.



Special media such as envelopes can also be placed in the bypass tray.

For the procedure for loading paper in the bypass tray, see "[LOADING PAPER INTO THE BYPASS TRAY \(page 1-24\)](#)".



When [Administrator Settings (administrator)] → [Default Settings] → [Bypass Settings] → [Enable Detected Paper Size in Bypass Tray] (disabled by factory default) or [Enable Selected Paper Type in Bypass Tray] (disabled by factory default) is enabled in "Web page", printing will not take place if the paper size or paper type specified in the printer driver is different from the paper size or paper type specified in the settings of the bypass tray.



PRINTING ON ENVELOPES

The bypass tray can be used for envelope printing.



- For the types of paper that can be used in the bypass tray, see "[APPLICABLE PAPER TYPES \(page 1-16\)](#)".
- For the procedure for loading paper in the bypass tray, see "[LOADING PAPER INTO THE BYPASS TRAY \(page 1-24\)](#)".
- For more information on the procedure for loading paper, see "[SELECTING THE PAPER \(page 3-7\)](#)".
- It is recommended that you carry out a test print to check the print result before using an envelope.
- When using media such as envelopes that can be loaded only in a specific orientation, you can rotate the image 180 degrees. For more information, see "[ROTATING THE PRINT IMAGE 180 DEGREES \(ROTATE 180 DEGREES\) \(page 3-32\)](#)".

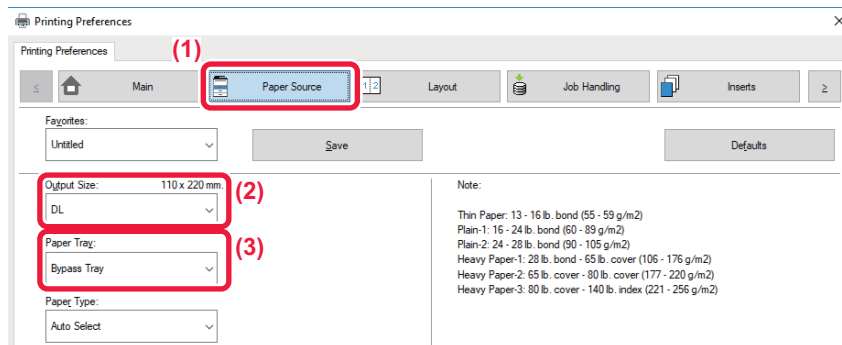

(1) Click the [Paper Source] tab.

(2) Select the envelope size from the "Output Size" menu.

When [Output Size] is set to envelope, [Paper Type] is automatically set to [Envelope].

When "Original Size" is set to envelope on the [Main] tab and "Output Size" is set to [Same as Original Size], "Paper Type" is automatically set to [Envelope].

(3) Select [Bypass Tray] in "Paper Tray".

When [Administrator Settings (administrator)] → [Default Settings] → [Bypass Settings] → [Enable Selected Paper Type in Bypass Tray] (disabled by factory default) is enabled in "Web page", set the paper type of the bypass tray to [Envelope].



PRINTING WHEN THE USER AUTHENTICATION FUNCTION IS ENABLED

Check with the administrator of the machine in advance for the user information (User Number) required to use the machine.



- If you have configured "Printing Policy" on the [Configuration] tab so that user authentication is always performed, users are required to be authenticated for each print job. This is done by entering authentication information in a dialog box that appears each time printing is performed.
- The machine's user authentication function cannot be used when the PPD driver* is installed and the Windows standard PS printer driver is used.
For this reason, the machine can be configured to prohibit users from executing printing unless their user information is stored in the machine.
 - * The PPD driver enables the machine to print using the Windows standard PS printer driver.
(On the PS3 expansion kit is required.)



To prohibit printing by users whose user information is not stored in the machine:
In "System Settings (administrator)", select [User Control] → [Disable Print by Inv. User].

1

In the printer driver properties window of the application, select the printer driver of the machine and click the [Preferences] button.

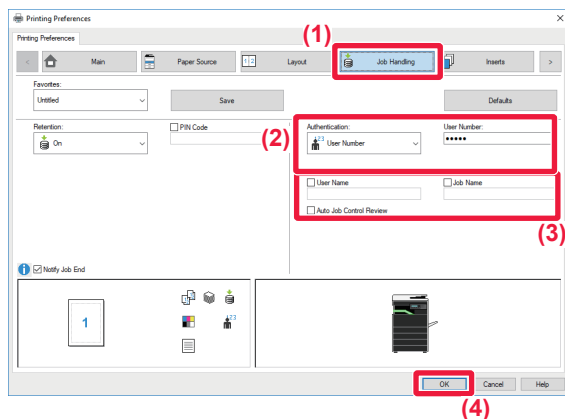

The button that is used to open the printer driver properties window (usually [Property] or [Preferences]) may vary depending on the application.

2

Enter your user information.

(1) Click the [Job Handling] tab.

(2) Enter your user information.

When authentication is performed by user number, select [User Number] and enter your 5 to 8 digit user number.

(3) Enter the user name and job name as necessary.

- Click the [User Name] checkbox, and enter your user name using up to 32 characters. The entered user name will appear on the display of the machine. If you do not enter a user name, your PC login name will appear.
- Click the [Job Name] checkbox, and enter a job name using up to 80 characters. The entered job name will appear as a file name on the display of the machine. If you do not enter a job name, the file name set in the application will appear.
- To have a confirmation window appear before printing starts, select the [Auto Job Control Review] checkbox.

(4) Click the [OK] button to execute printing.



FREQUENTLY USED FUNCTIONS

SAVING SETTINGS AT THE TIME OF PRINTING

Settings configured on each of the tabs at the time of printing can be saved as Favorite. Saving frequently used settings or complex settings under an assigned name makes it easy to select those settings the next time you need to use them. Settings can be saved from any tab of the printer driver properties window. Settings configured on each tab are listed at the time of saving, allowing you to check the settings as you save them.



Deleting saved settings

In step 2 of "[USING SAVED SETTINGS \(page 3-11\)](#)", select the user settings that you want to delete and click the [Delete] button.

1

Select the machine's printer driver from the print window of the application, and click the [Preferences] button.



The button that is used to open the printer driver properties window (usually [Property] or [Preferences]) may vary depending on the application.

2

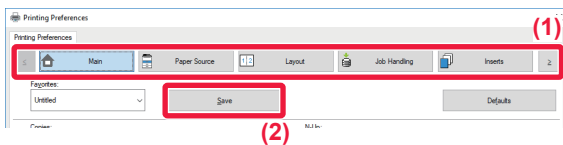

Register Print Settings.

- (1) Configure the print settings on each tab.
- (2) Click the [Save] button.

3

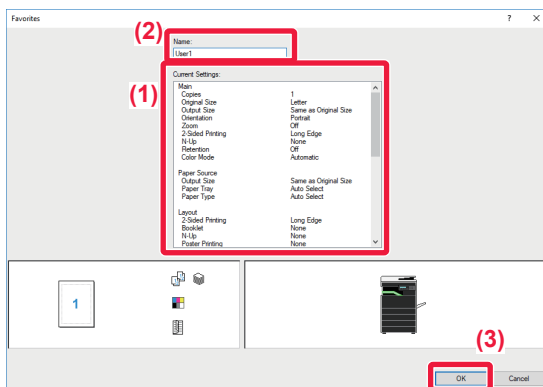

Check and save the settings.

- (1) Check the displayed settings.
- (2) Enter a name for the settings using up to 20 characters.
- (3) Click the [OK] button.



USING SAVED SETTINGS

You can specify the saved favorites through just one click to apply frequently used settings or complicated settings to your printing.

- 1 Select the machine's printer driver from the print window of the application, and click the [Preferences] button.**



The button that is used to open the printer driver properties window (usually [Property] or [Preferences]) may vary depending on the application.

2

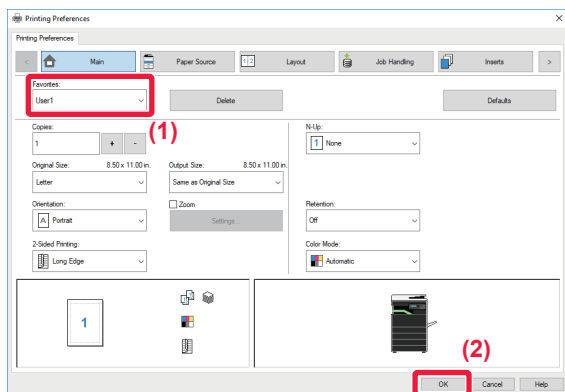

Select favorite settings.

- (1) Select the favorite settings you want to use.**
- (2) Click the [OK] button.**

3

Start printing.

CHANGING THE PRINTER DRIVER DEFAULT SETTINGS

You can change the default settings of the printer driver.

Changes you have made in the printer driver properties window when you execute printing from the application are returned to the default settings specified here when you exit the application.

1

Click the [Start] button, select [Settings] → [Device] → [Devices and Printers].



In Windows 8.1/Windows Server 2012, right-click the [Start] button, select [Control Panel] → [View devices and printers] (or [Devices and Printers]).

In Windows 7/Windows Server 2008, click the [Start] button, select [Devices and Printers].



2

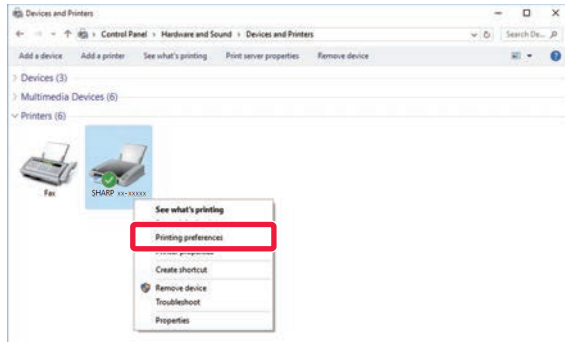

Right-click the printer driver icon of the machine and select [Printing preferences].

3

Configure the settings and click the [OK] button.

For explanations of the settings, see printer driver Help.



PRINTING IN A macOS ENVIRONMENT

BASIC PRINTING PROCEDURE

The following example explains how to print a document from the standard accessory application "TextEdit" in macOS.



- To install the printer driver and configure settings in a macOS environment, see the Software Setup Guide.
- The explanations of screens and procedures for use in a macOS environment generally assume that macOS 10.12 is being used and a PPD driver is installed. The screens may be different depending on the version of the operating system or the software application.
- The menu used to execute printing may vary depending on the application.

1

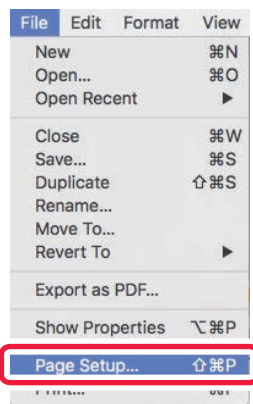

Select [Page Setup] from the [File] menu and select the printer.

If the printer drivers appear as a list, select the name of the printer driver to be used from the list.

2

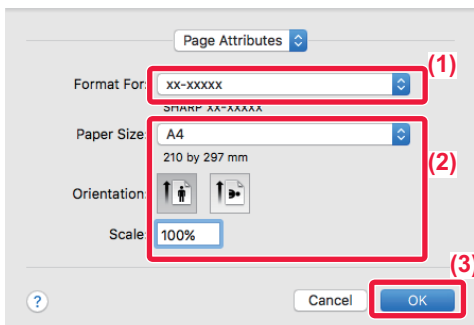

Select paper settings.

- (1) Make sure that the correct printer is selected.
- (2) Select paper settings.
Paper size, paper orientation, and enlarge/reduce settings can be selected.
- (3) Click the [OK] button.

3

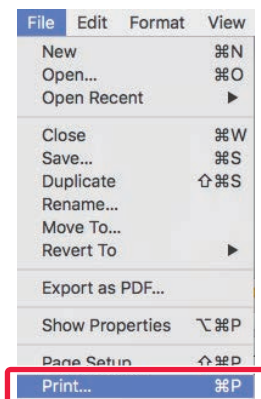

Select [Print] from the [File] menu.



4

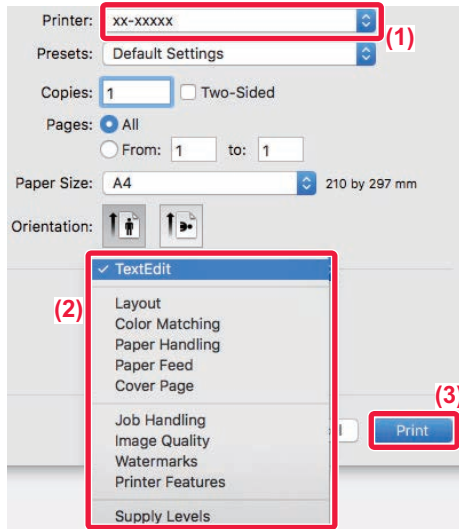

Select print settings.

- (1) Make sure that the correct printer is selected.
- (2) Select an item from the menu and configure the settings as needed.
- (3) Click the [Print] button.



CANCELING A PRINT JOB FROM THE MACHINE

When [STOP] key (⏹) is pressed while showing "Printing" on the display after starting a print job, the confirmation screen whether or not to cancel the print job will appear. Then select "Yes" to cancel the printing.

SELECTING THE PAPER

This section explains the [Paper Feed] settings in the print settings window.

• **When [Auto Select] is selected:**

A tray that is set for plain or recycled paper (only plain paper in the factory default setting) of the size specified in "Paper Size" on the page setup screen is automatically selected.

• **When a paper tray is specified:**

The specified tray is used for printing regardless of the "Paper Size" setting on the page setup screen.

For the bypass tray, also specify the paper type. Check that the paper type that is set for the bypass tray of the machine, check that paper of that type is actually loaded into the bypass tray, and then select the appropriate bypass tray (paper type).

• **When a paper type is specified:**

A tray with the specified type of paper and the size specified in "Paper Size" on the page setup screen is used for printing.



Special media such as envelopes can also be placed in the bypass tray.

For the procedure for loading paper in the bypass tray, see "[LOADING PAPER INTO THE BYPASS TRAY \(page 1-24\)](#)".



When [Administrator Settings (administrator)] → [Default Settings] → [Bypass Settings] → [Enable Detected Paper Size in Bypass Tray] (disabled by factory default) or [Enable Selected Paper Type in Bypass Tray] (disabled by factory default) is enabled in "Web page", printing will not take place if the paper size or paper type specified in the printer driver is different from the paper size or paper type specified in the settings of the bypass tray.



PRINTING ON ENVELOPES

The bypass tray can be used for envelope printing.



- For the types of paper that can be used in the bypass tray, see "[APPLICABLE PAPER TYPES \(page 1-16\)](#)".
- For the procedure for loading paper in the bypass tray, see "[LOADING PAPER INTO THE BYPASS TRAY \(page 1-24\)](#)".
- For more information on the procedure for loading paper, see "[SELECTING THE PAPER \(page 3-14\)](#)".
- When using media such as envelopes that can be loaded only in a specific orientation, you can rotate the image 180 degrees. For more information, see "[ROTATING THE PRINT IMAGE 180 DEGREES \(ROTATE 180 DEGREES\) \(page 3-32\)](#)".
- After printing, there may be creases in the envelope depending on the envelope type and format as well as on the printing environment. Before high-quantity printing, it is recommended that you conduct a test print.

Select the envelope size in the settings of the application ("Page Setup" in many applications) and then perform the following steps.

1

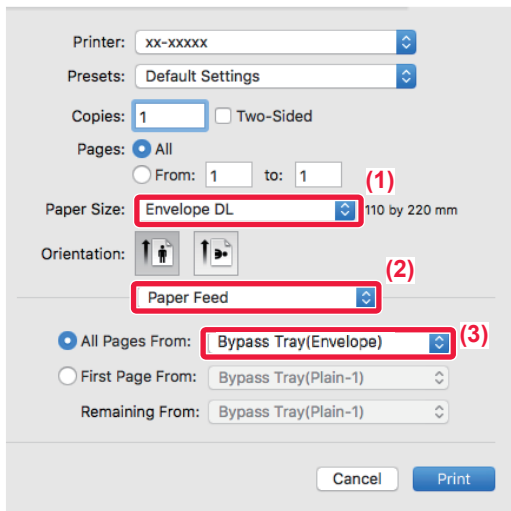

Select print settings.

- (1) Select the envelope size from the "Paper Size" menu.
- (2) Select [Paper Feed].
- (3) Select the [Bypass Tray (Envelope)] from the "All Pages From" menu.



When [Administrator Settings (administrator)] → [Default Settings] → [Bypass Settings] → [Enable Selected Paper Type in Bypass Tray] (disabled by factory default) is enabled in "Web page", set the paper type of the bypass tray to [Envelope].



PRINTING WHEN THE USER AUTHENTICATION FUNCTION IS ENABLED

Check with the administrator of the machine in advance for the user information (User Number) required to use the machine.



The menu used to execute printing may vary depending on the application.



To prohibit printing by users whose user information is not stored in the machine:
In "System Settings (administrator)", select [User Control] → [Disable Print by Inv. User].

1

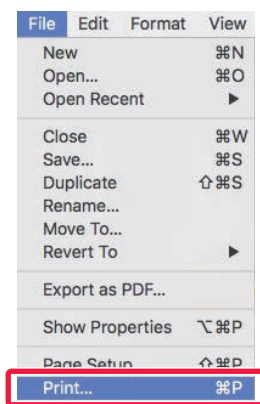

In the application, select [Print] from the [File] menu.



2

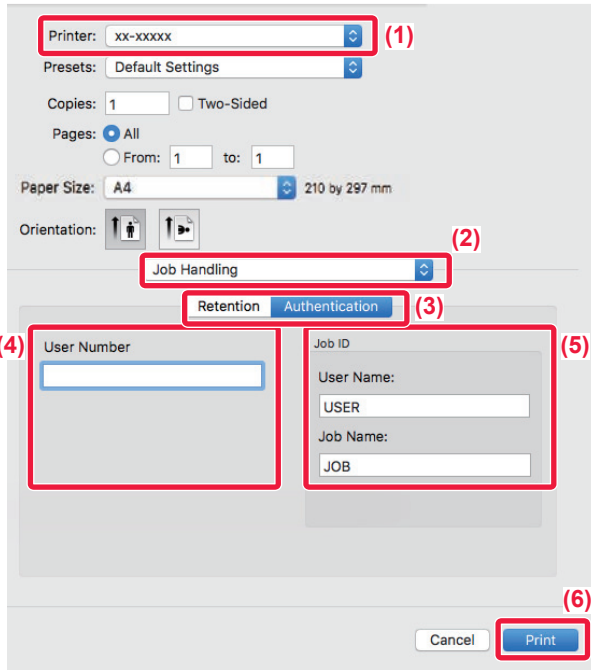

Enter your user information.

(1) **Make sure that the machine's printer name is selected.**

(2) **Select [Job Handling].**

(3) **Click the [Authentication] tab.**

(4) **Enter your user information.**

Enter your user number (5 to 8 digits) in "User Number".

(5) **Enter the user name and job name as necessary.**

- **User Name**
Enter your user name using up to 32 characters. The entered user name will appear on the display of the machine. If you do not enter a user name, your PC login name will appear.
- **Job Name**
Enter a job name using up to 80 characters. The entered job name will appear as a file name on the display of the machine. If you do not enter a job name, the file name set in the application will appear.

(6) **Click the [Print] button.**



FREQUENTLY USED FUNCTIONS

SELECTING THE COLOR MODE

The following three selections are available for the "Color Mode" (a set of colors used for printing):

Automatic	The machine automatically determines whether each page is color or black and white and prints the page accordingly. Pages with colors other than black and white are printed using Y (Yellow), M (Magenta), C (Cyan) and Bk (Black) toner. Pages that are only black and white are printed using Bk (Black) toner only. This is convenient when printing a document that has both color and black and white pages, however, the printing speed is slower.
Color	All pages are printed in color. Both color data and black and white data are printed using Y (Yellow), M (Magenta), C (Cyan) and Bk (Black) toner.
Black and White	All pages are printed in black and white. Color data such as images or materials for a presentation is printed using black toner only. This mode helps conserve color toner when you do not need to print in color, such as when proofreading or checking the layout of a document.



When "Color Mode" is set to [Automatic]:

Even if the print result is black and white, the following types of print jobs will be counted as 4-color (Y (Yellow), M (Magenta), C (Cyan), and Bk (Black)) print jobs.

When you want such jobs to be counted as black and white jobs, select [Black and White].

- When the data is created as color data.
- When the application treats the data as color data even though the data is black and white.
- When an image is hidden under a black and white image.

Windows

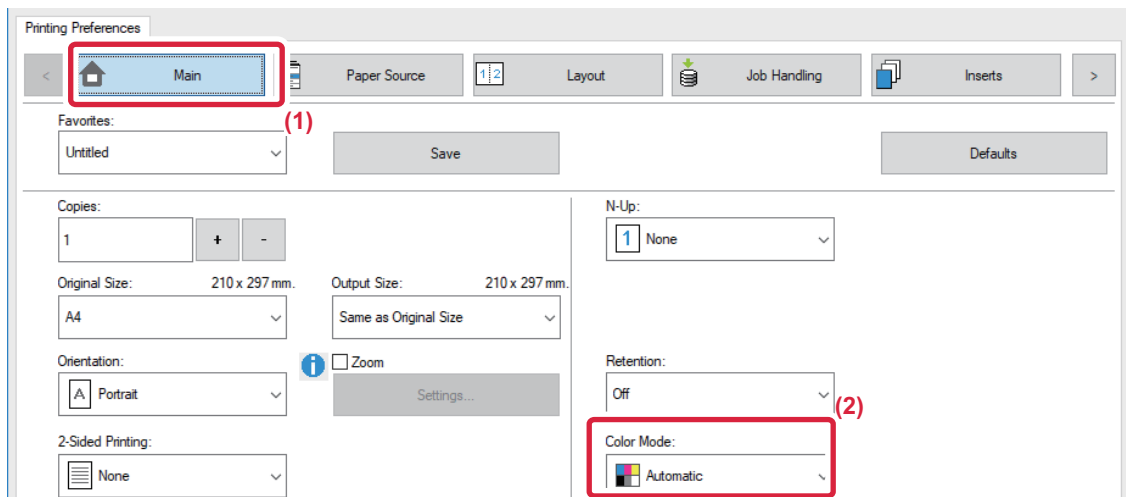

- (1) Click the [Main] tab.
- (2) Select "Color Mode".



In addition to the [Main] tab, [Color Mode] can also be set on the [Image Quality] tab.



macOS

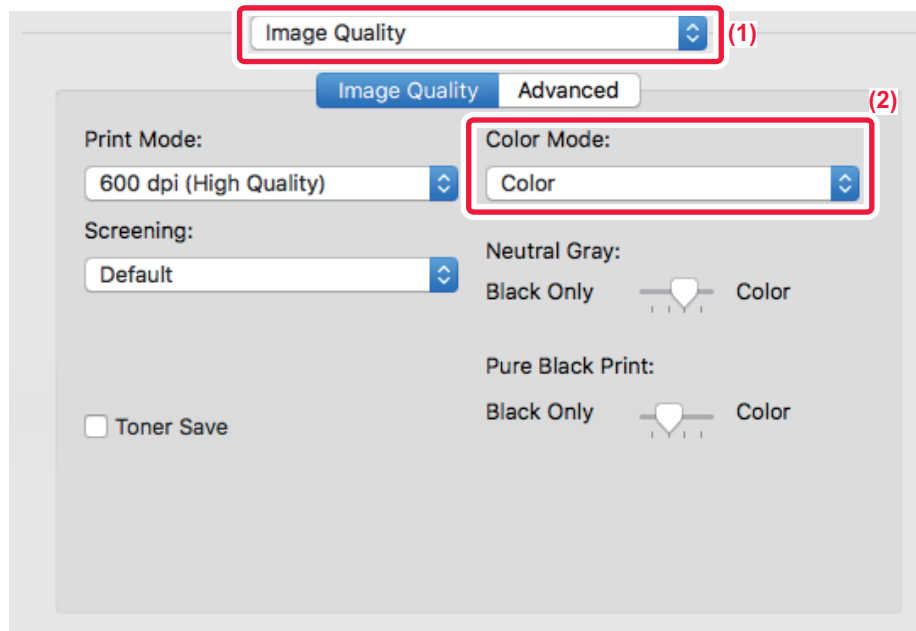

(1) Select [Image Quality].

(2) Select "Color Mode".



SELECTING THE RESOLUTION

The following two selections are available for "Print Mode" (resolution):

600 dpi	This mode is suitable for printing data such as regular text or a table.
600 dpi (High Quality)	The print quality of photos and text are high.

Windows

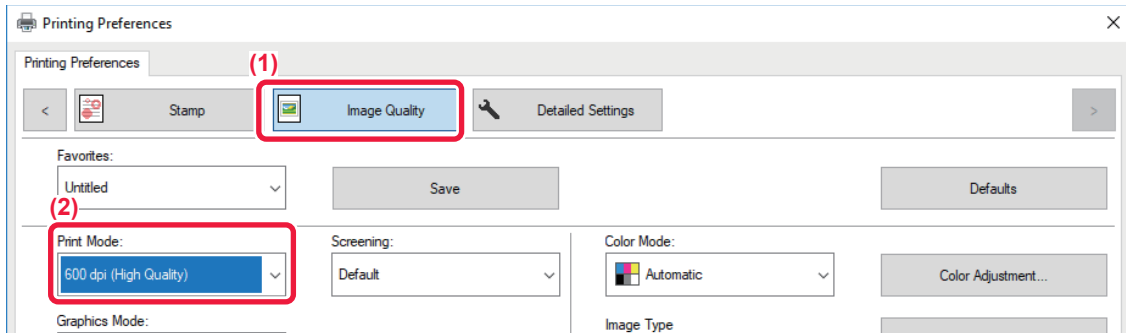

- (1) Click the [Image Quality] tab.
- (2) Select "Print Mode".

macOS

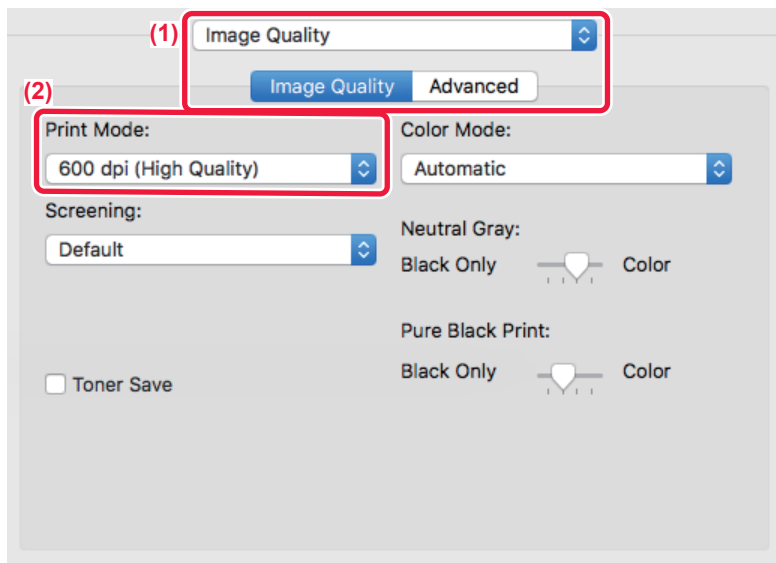



- (1) Select [Image Quality].
- (2) Select "Print Mode".

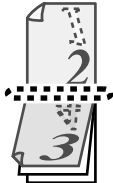

2-SIDED PRINTING

The machine can print on both sides of the paper. This function is useful for many purposes, and is particularly convenient when you want to create a simple pamphlet. 2-sided printing also helps conserve paper.

Paper orientation	Print results	
Portrait	Long Edge 	Short Edge 
	Short Edge 	Long Edge 
	The pages are printed so that they can be bound at the left or right side.	The pages are printed so that they can be bound at the top.

Windows

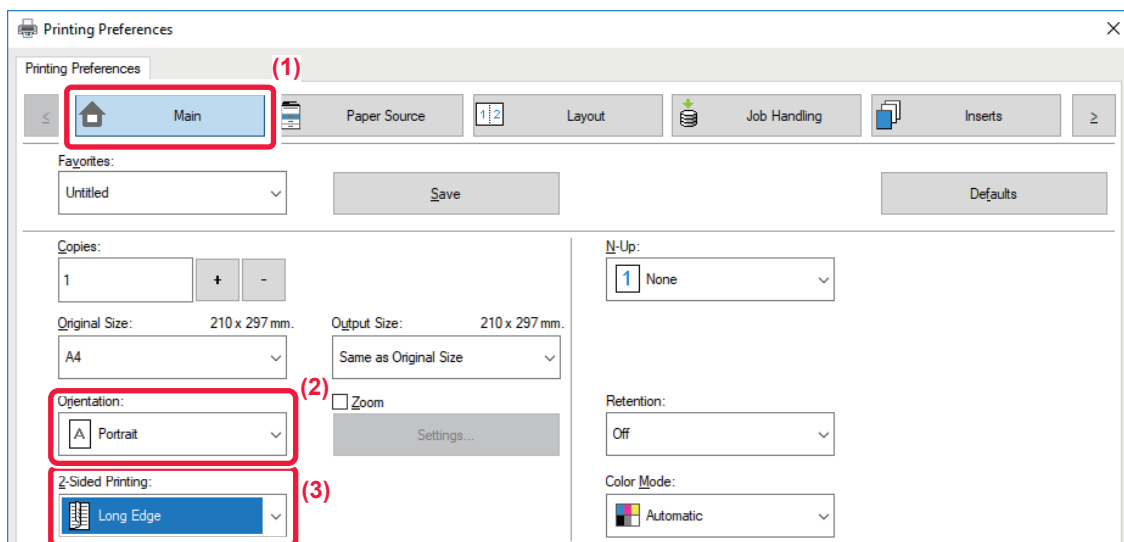

- (1) Click the [Main] tab.
- (2) Select the paper orientation.
- (3) Select [Long Edge] or [Short Edge].



If necessary, you can select the method of implementing 2-sided printing. Click the [Other Settings] button on the [Detailed Settings] tab, and select the mode from "Duplex Style".



macOS

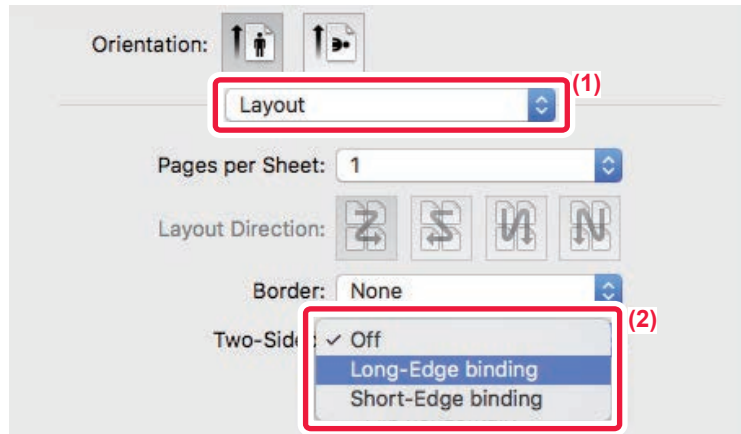

- (1) Select [Layout].
- (2) Select [Long-Edge binding] or [Short-Edge binding].

FITTING THE PRINT IMAGE TO THE PAPER

This function automatically enlarges or reduces the print image to match the size of the paper loaded in the machine. This function is convenient when enlarging an A4 or Letter size document to an A3 or Ledger size to make it easier to view, or when printing a document on paper that is different in size from the original document.

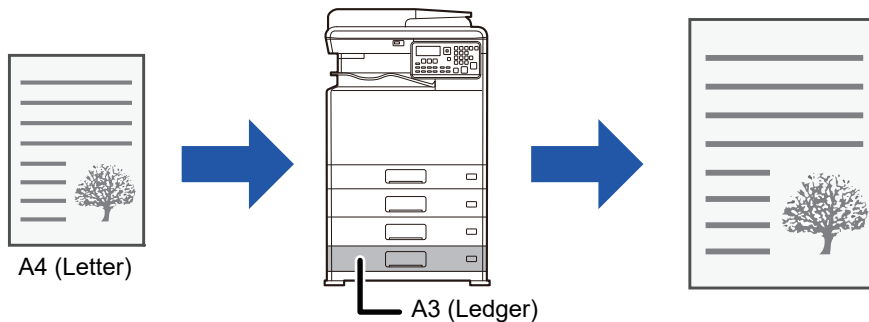

If A0, A1 or A2 size is selected in "Original Size", A4 (or Letter) is automatically selected in "Output Size".

The following example explains how to print an A4 (or Letter) size document on a A3 (or Ledger) size paper.



Windows

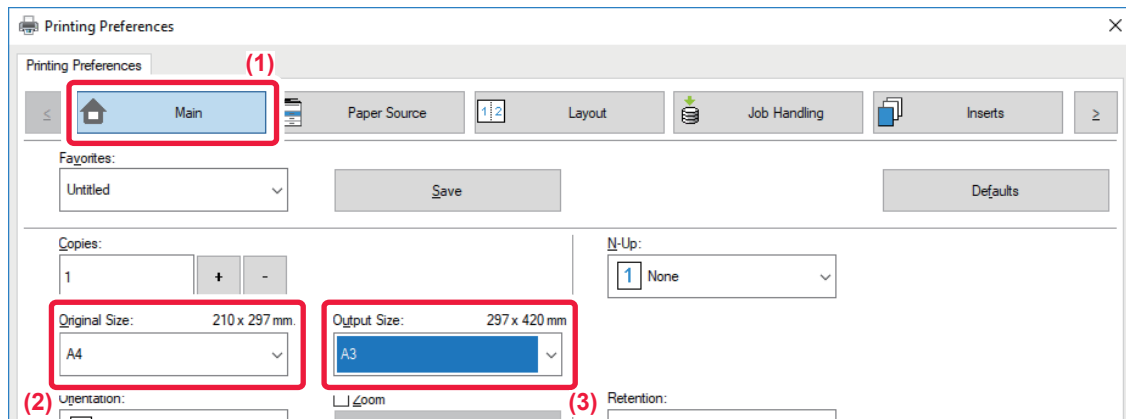

- (1) Click the [Main] tab.
- (2) Select the original size from [Original Size] (for example: A4).
- (3) Select the actual paper size to be used for printing from [Output Size] (for example: A3).
If the output size is larger than the original size, the printed image will be automatically enlarged.

macOS

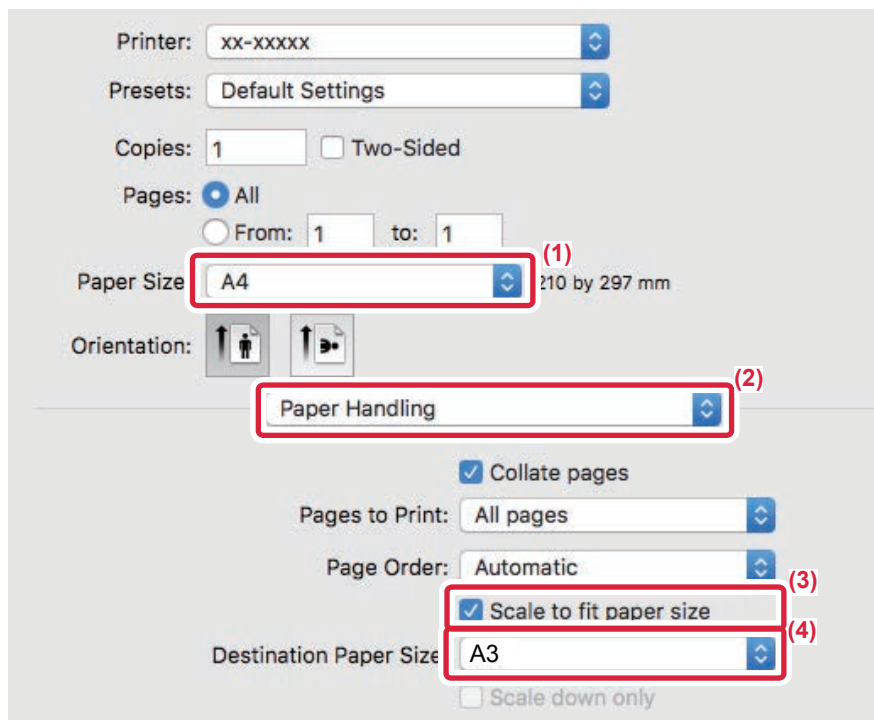

- (1) Check the paper size for the print image (for example: A4).
- (2) Select [Paper Handling].
- (3) Select [Scale to fit paper size].
- (4) Select the actual paper size to be used for printing (for example: A3).



PRINTING MULTIPLE PAGES ON ONE PAGE

This function reduces the print image and prints multiple pages on a single sheet of paper. You can print only the first page in the original size and print multiple reduced pages on the subsequent sheets.

For example, when [2-Up] (2 pages per sheet) or [4-Up] (4 pages per sheet) is selected, the following print results will be obtained, depending on the selected page order.

This is convenient when you want to print multiple images such as photos on a single sheet of paper, and when you want to conserve paper. When used in combination with 2-sided printing, this function saves more paper.

N-Up (Pages per sheet)	Print results		
	Left to Right	Right to Left	Top To Bottom (When the print orientation is landscape)
2-Up (2 pages per sheet)			

N-Up (Pages per sheet)	Right, and Down	Down, and Right	Left, and Down	Down, and Left
4-Up (4 pages per sheet)				



- [N-Up] that can be set on the [Layout] tab can also be set on the [Main] tab. ("Order" can only be set in the [Layout] tab.)
- Note the following when printing multiple pages on one sheet:
 - The page orders for 6-Up, 8-Up, 9-Up, and 16-Up are the same as for 4-Up.
 - In a Windows environment, the page order can be viewed in the print image in the printer driver properties window.
 - In a macOS environment, the page orders are displayed as selections.
 - In a macOS environment, the number of pages that can be printed on a single sheet is 2, 4, 6, 9, or 16. Printing 8 pages on one sheet is not supported.



The function for printing only the first page normally can only be used in the PCL6 printer driver.



Windows

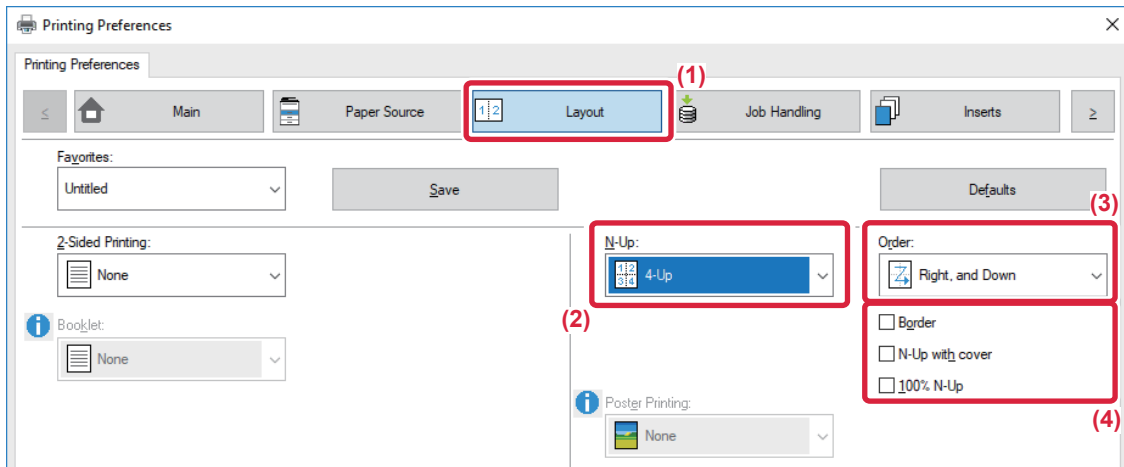

- (1) Click the [Layout] tab.
- (2) Select the number of pages per sheet.
- (3) Select the order of the pages.
- (4) If you wish to print borderlines, click the [Border] checkbox so that the checkmark appears.
 - To print the first page normally (as a cover), select the [N-Up with cover] checkbox (). (PCL6 only)
 - When [100% N-Up] is selected () for jobs such as N-Up copying of two A5 size pages onto one A4 sheet, the pages will be printed at the full size of the original. If you select [Border] at this time, only the border will be printed.

macOS

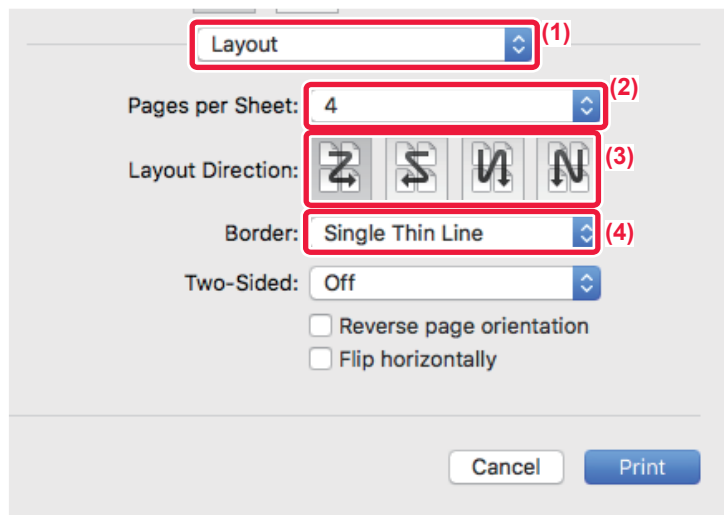

- (1) Select [Layout].
- (2) Select the number of pages per sheet.
- (3) Select the order of the pages.
- (4) If you wish to print borderlines, select the desired type of borderline.



CONVENIENT PRINTING FUNCTIONS

CONVENIENT FUNCTIONS FOR CREATING PAMPHLETS AND POSTERS

CREATE A PAMPHLET (BOOKLET)

The pamphlet function prints on the front and back of each sheet of paper so that the sheets can be folded and bound to create a pamphlet.

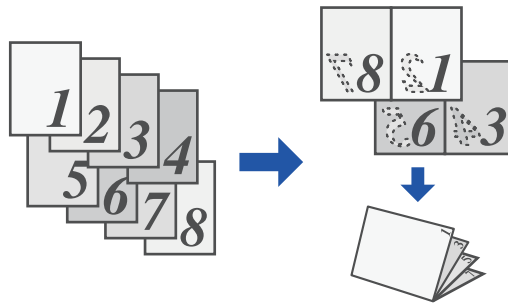

Windows

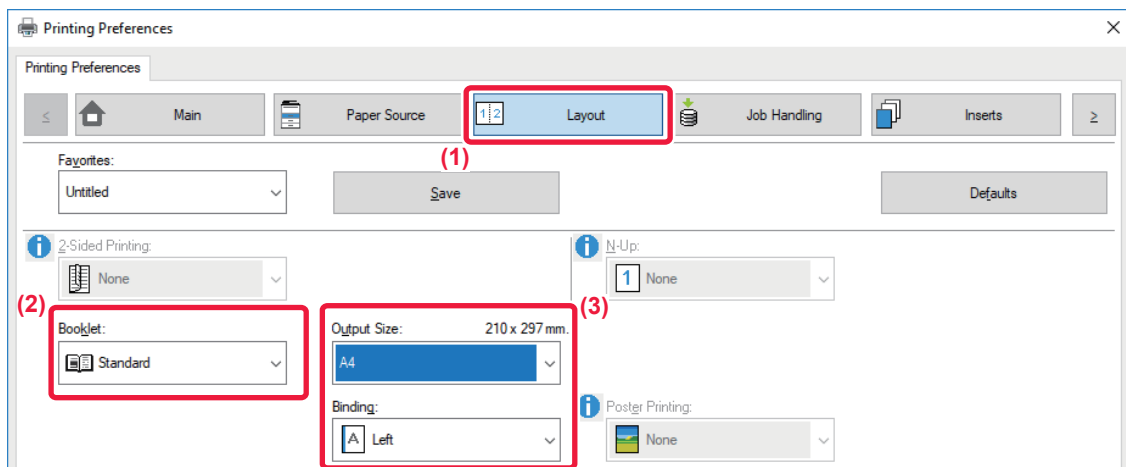

- (1) Click the [Layout] tab.
- (2) Select [Standard] in "Booklet".
The printed image will be enlarged or reduced to fit the paper selected in "Output Size".
- (3) Select the specified output size and the binding edge.



macOS

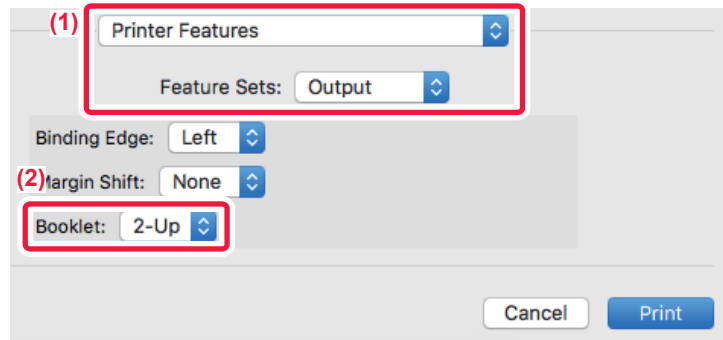

- (1) Select [Printer Features] and then select [Output].
- (2) Select [2-Up] or [Tiled].



PRINTING WITH MARGIN SHIFT SETTING (MARGIN)

This function shifts the print image to increase the margin at the left, the right, or the top of the paper.

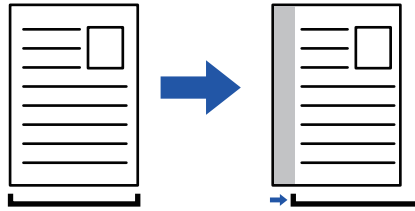

By shifting the image, the part of the image that is outside the print area will not be printed.

Windows

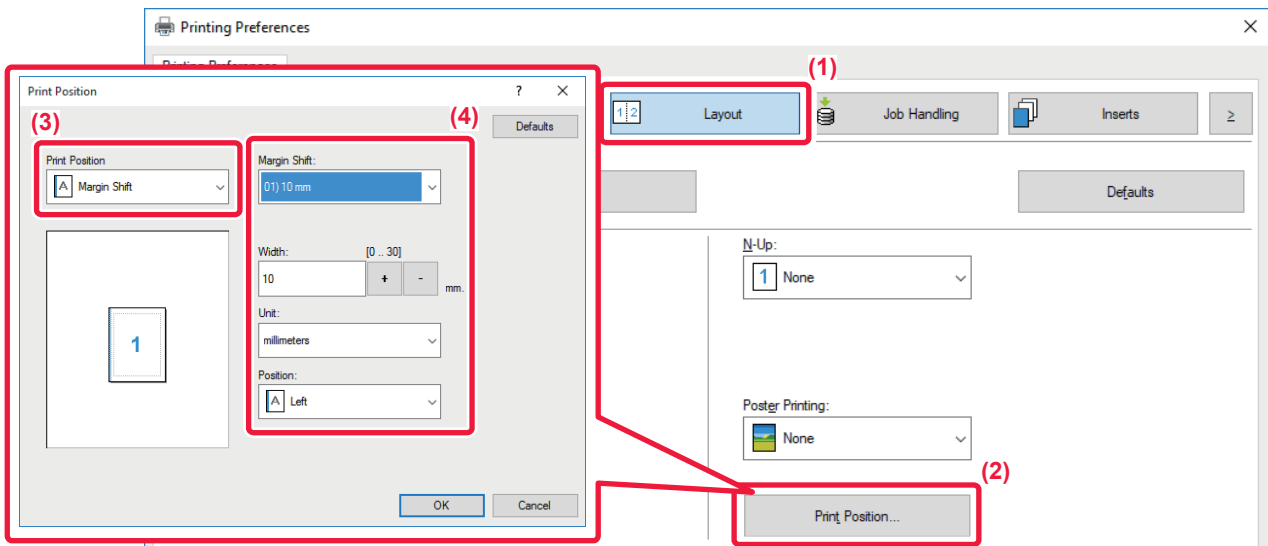

- (1) Click the [Layout] tab.
- (2) Click the [Print Position] button.
- (3) Select [Margin Shift].
- (4) Select the shift width.

Select from the "Margin Shift" menu. If you wish to configure another numeric setting, select the setting and click buttons or directly enter the number.



macOS

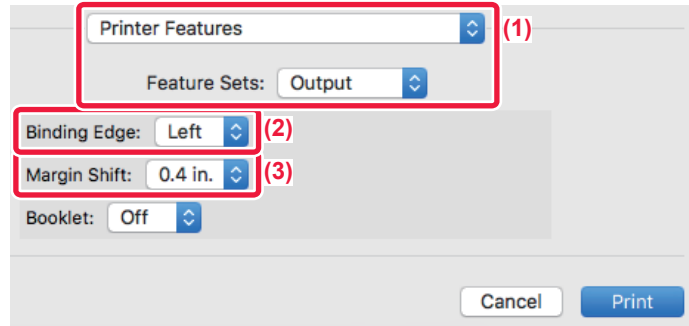

- (1) Select [Printer Features] and then select [Output].
- (2) Select "Binding Edge".
- (3) Select "Margin Shift".



CREATE A LARGE POSTER (POSTER PRINTING)

One page of print data is enlarged and printed using multiple sheets of paper (4 sheets (2 x 2), 9 sheets (3 x 3) or 16 sheets (4 x 4)). The sheets can then be attached together to create a large poster.

To enable precise alignment of the edges of the sheets during attachment, borderlines can be printed or overlapping edges can be created (overlap function).

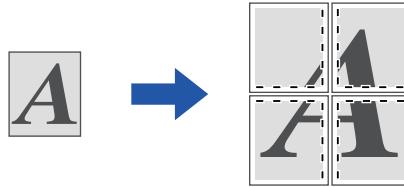

This function is available in a Windows environment.

Windows

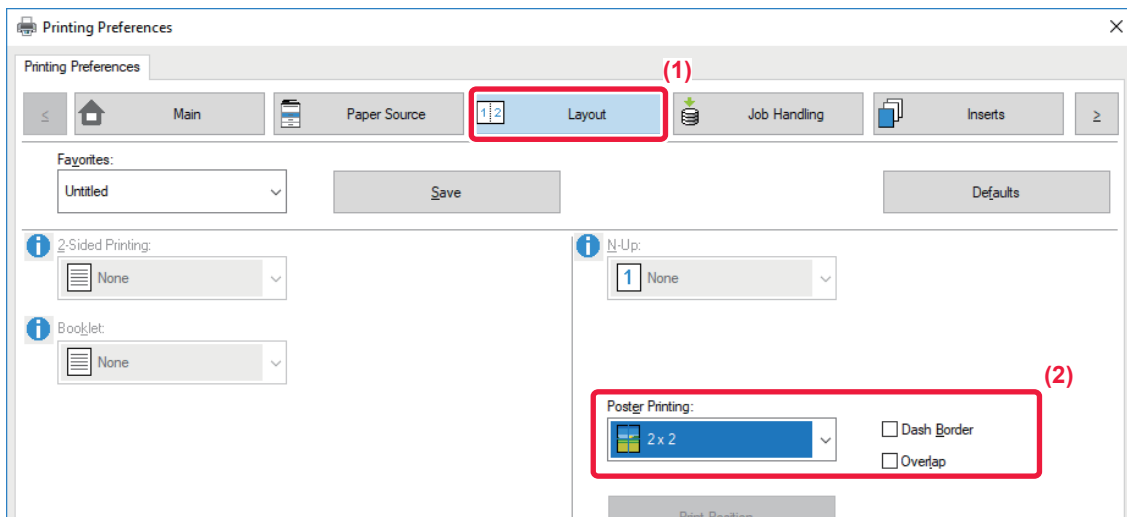

(1) Click the [Layout] tab.

(2) Select the number of sheets to be used in "Poster Printing".

If you wish to print borderlines and/or use the overlap function, click the corresponding checkboxes so that the appears.



FUNCTIONS TO ADJUST THE SIZE AND ORIENTATION OF THE IMAGE

ADJUST PRINT POSITION ON ODD AND EVEN PAGES SEPARATELY (PRINT POSITION)

This function sets different print positions (margins) separately for odd and even pages and prints the pages.



This function is available in a Windows environment.

Windows

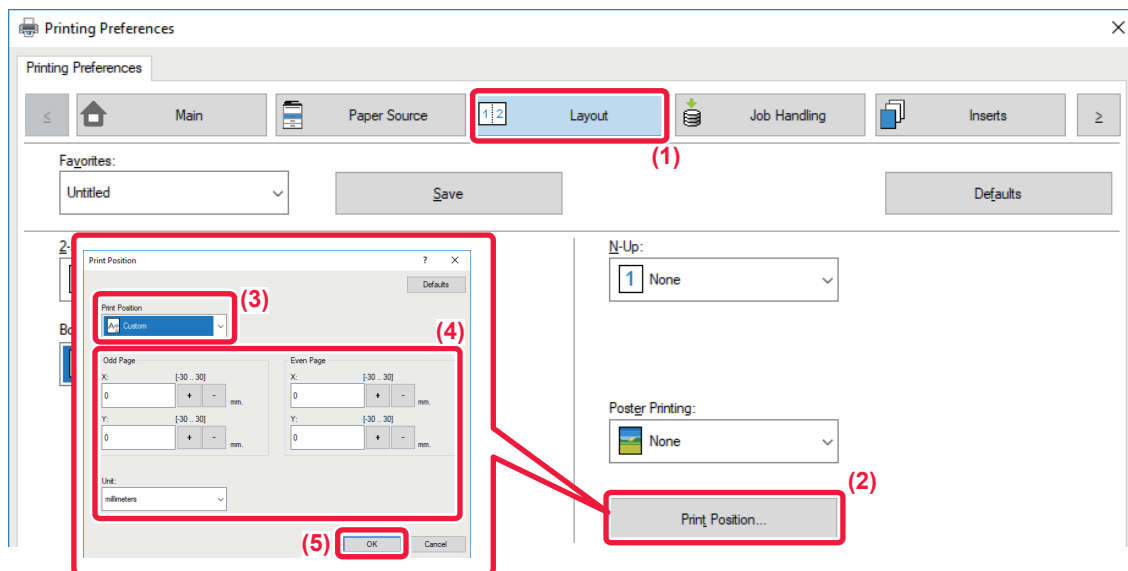

- (1) Click the [Layout] tab.
- (2) Click the [Print Position] button.
- (3) Select [Custom].
- (4) Set the amount of shifting of the print position for odd-numbered pages and even-numbered pages.
- (5) Click the [OK] button.



ROTATING THE PRINT IMAGE 180 DEGREES (ROTATE 180 DEGREES)

This feature rotates the image 180 degrees so that it can be printed correctly on paper that can be loaded in only one orientation (such as envelopes or paper with punch holes).

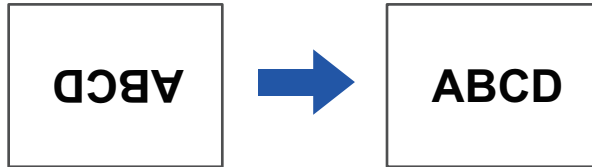

Windows

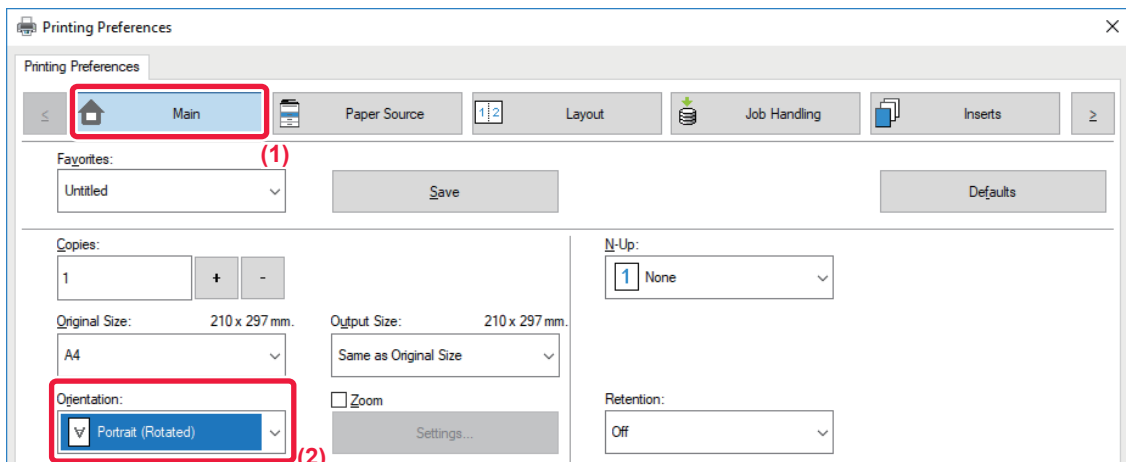

- (1) Click the [Main] tab.
- (2) Select [Portrait (Rotated)] or [Landscape (Rotated)] in "Orientation".

macOS

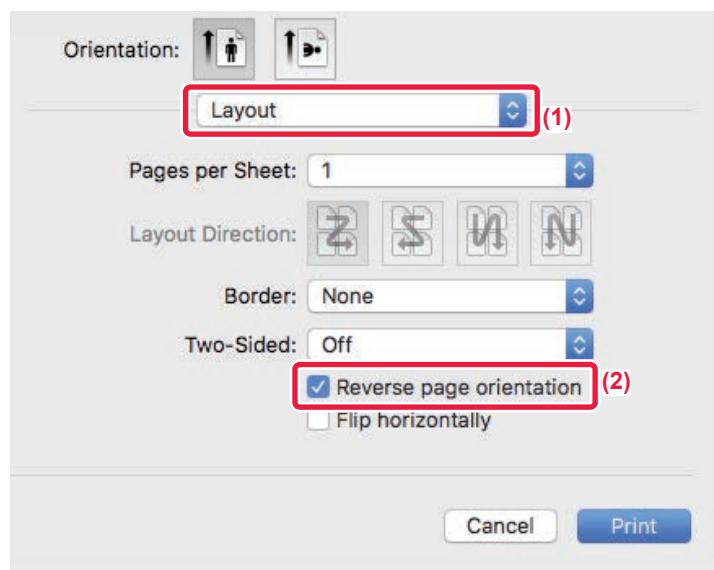

- (1) Select [Layout]
- (2) Select the [Reverse page orientation] checkbox so that appears.



ENLARGING/REDUCING THE PRINT IMAGE (ZOOM SETTING/ENLARGE OR REDUCE)

This function enlarges or reduces the image to a selected percentage.

This allows you to enlarge a small image or add margins to the paper by slightly reducing an image.

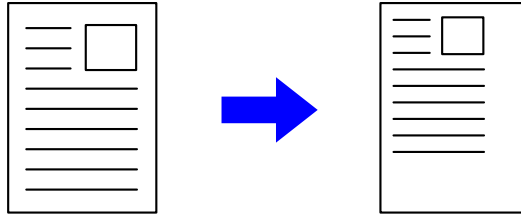

When using the PS printer driver (Windows), you can set the width and length percentages separately to change the proportions of the image. (On the PS3 expansion kit is required.)

Windows

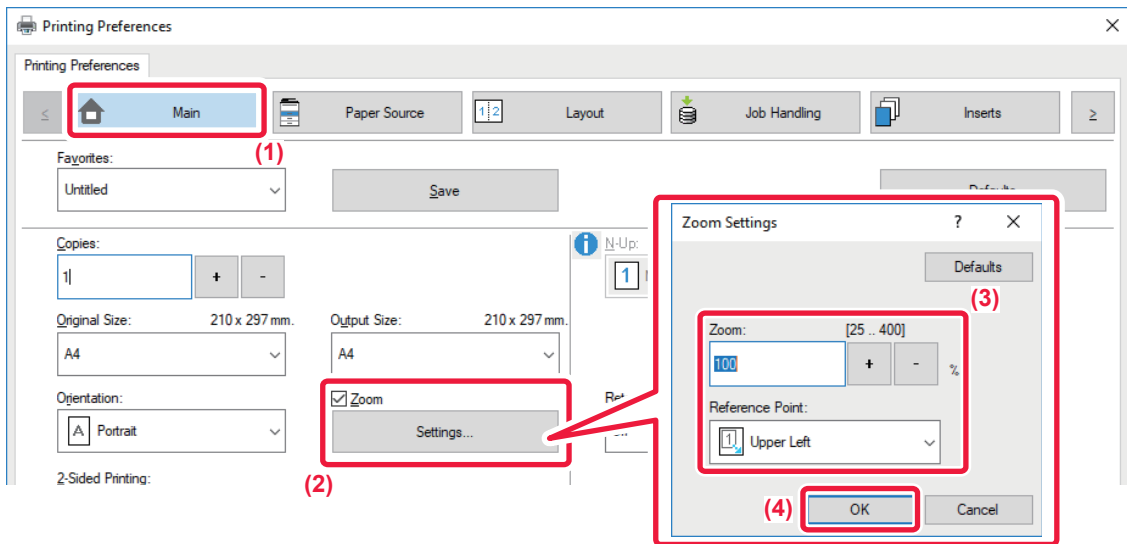

(1) Click the [Main] tab.

(2) Click the [Zoom] checkbox so that appears, and click the [Settings] button.

(3) Enter the percentage.

By clicking the button, you can specify the value in increments of 1%. In addition, select [Upper Left] or [Center] for the base point on the paper.

(4) Click the [OK] button.



macOS

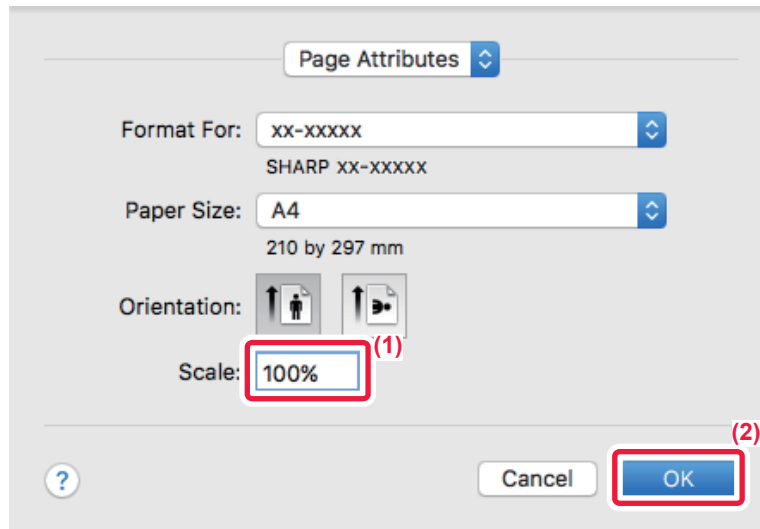

- (1) Select [Page Setup] from the [File] menu and enter the ratio (%).
- (2) Click the [OK] button.



PRINT A MIRROR-IMAGE (MIRROR-IMAGE REVERSE/VISUAL EFFECTS)

The image is reversed to create a mirror image.
This function is conveniently used to print a design for a woodblock print or other printing medium.

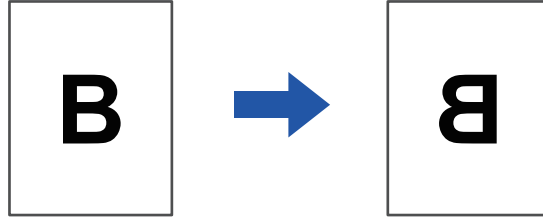

In a Windows environment, this function is only available when using the PS printer driver.
(On the PS3 expansion kit is required.)

Windows

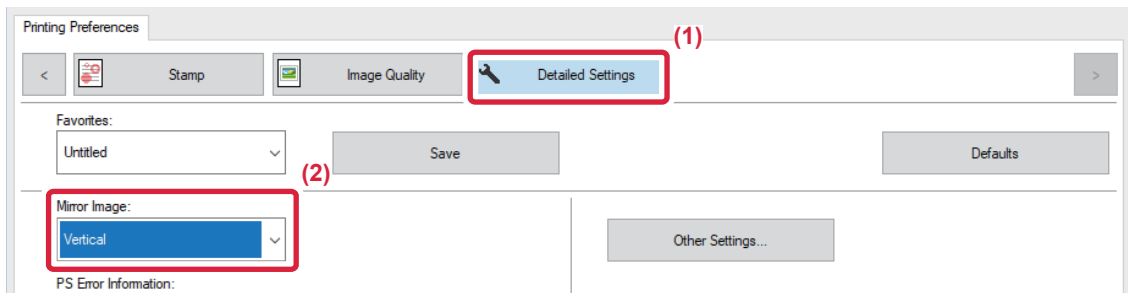

- (1) Click the [Detailed Settings] tab.
- (2) If you wish to reverse the image horizontally, select [Horizontal]. If you wish to reverse the image vertically, select [Vertical].

macOS

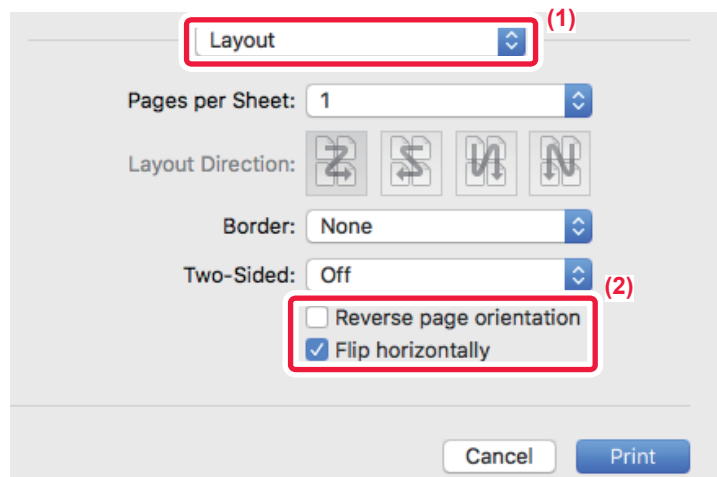

- (1) Select [Layout].
- (2) Select the [Flip horizontally] checkbox ().



IMAGE ADJUSTING FUNCTION

ADJUST THE BRIGHTNESS AND CONTRAST OF THE IMAGE (COLOR ADJUSTMENT/RGB ADJUSTMENT)

This function adjusts the brightness and contrast in the print settings when a photo or other image is printed. This function makes simple corrections even if image editing software is not installed on your computer.



This function is available in a Windows environment.

Windows

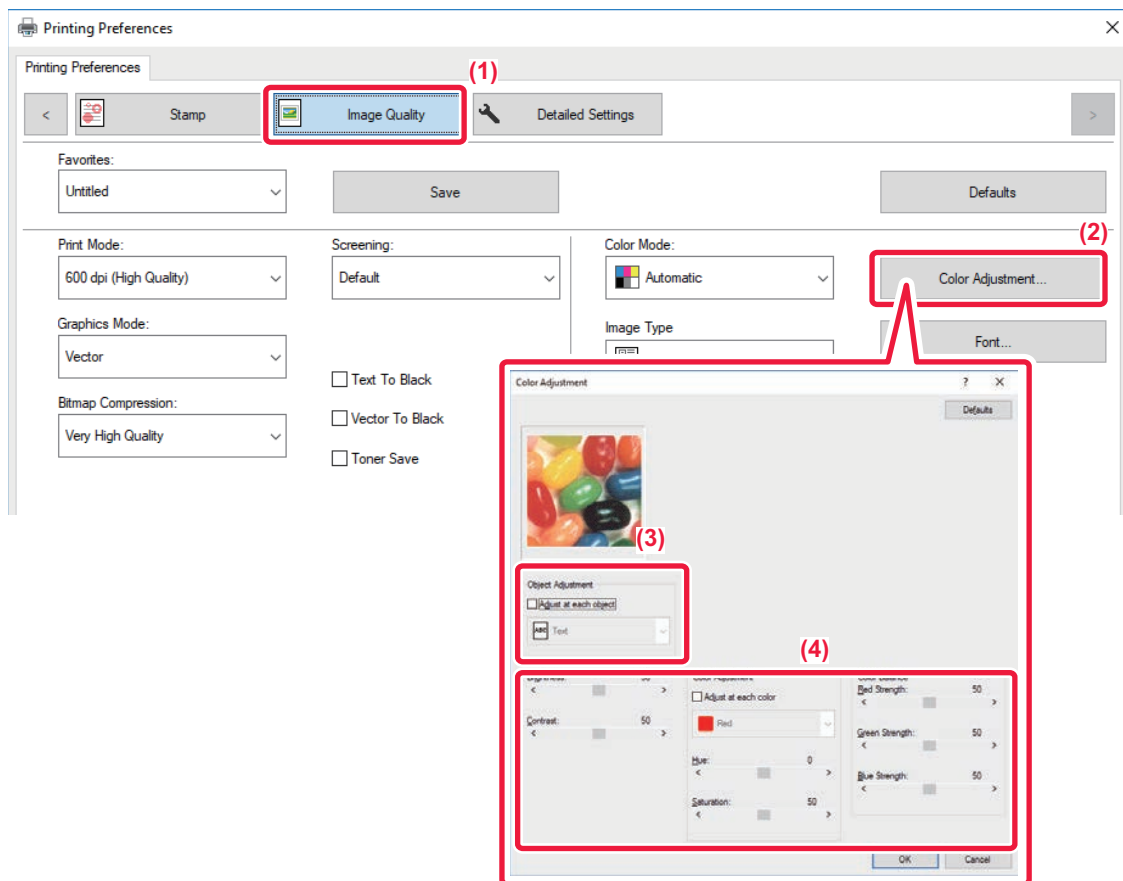

- (1) Click the [Image Quality] tab.
- (2) Click the [Color Adjustment] button.
When using the PS printer driver, click the [RGB Adjustment] button. Proceed to step (4).
- (3) To adjust objects (text, graphics, photos) individually, select the [Adjust at each object] checkbox () and select the object.
- (4) Drag the slide bar or click buttons to adjust the image.



PRINTING FAINT TEXT AND LINES IN BLACK (TEXT TO BLACK/VECTOR TO BLACK)

When printing a color image in grayscale, text and lines that are drawn in faint colors are printed in black. This function allows you to bring out color text and lines that are faint and difficult to see when printed in grayscale.

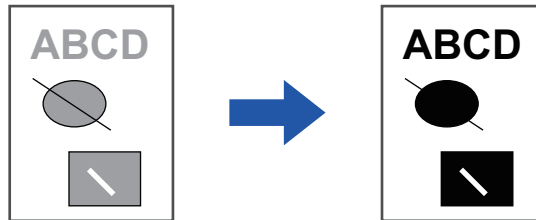

- Raster data such as bitmap images cannot be adjusted.
- This function is available in a Windows environment.

Windows

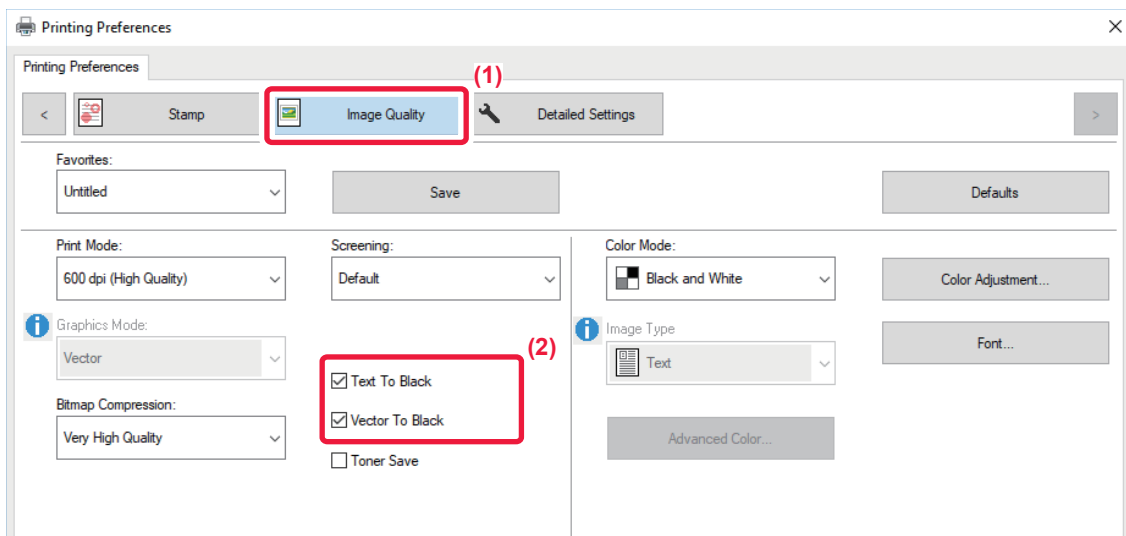

- (1) Click the [Image Quality] tab.
- (2) Select the [Text To Black] checkbox and/or the [Vector To Black] checkbox so that appears.
 - When [Text To Black] is selected, all text other than white text is printed in black.
 - When [Vector To Black] is selected, all vector graphics other than white lines and areas are printed in black.



SELECTING COLOR SETTINGS TO MATCH THE IMAGE TYPE (ADVANCED COLOR SETTINGS)

Preset color settings are available in the machine's printer driver for various uses. These enable printing using the most suitable color settings for the color image type.

Advanced color settings, such as the color management settings and the screening setting for adjusting the color tone expression, are also available for meeting the needs of color image printing.

The following color management settings are available.

Windows ICM	Color management method in a Windows environment
ColorSync	Color management method in a macOS environment
Source Profile	Select a source color profile of color matching.
Rendering Intent	The selections below provide the ability to modify color image processing to suit specific preferences. (Color matching method: Method of color converting RGB colors on the display, etc. into CMYK colors in the printer)
Output Profile	Select a color profile for the image to be printed
CMYK Correction*¹	Correct the image to obtain the optimum printing result when printing a CMYK image.
Screening	Select the screening to modify the image to suit specific preferences, according to the appropriate image processing method.
Neutral Gray	Select a creating method of neutral gray.
Pure Black Print	Select whether you want to print black data area with only black toner.
Black Overprint*²	Prevents whitening of the outline of black text.
CMYK Simulation*²	Adjusts the colors to simulate printing that would be obtained with the process colors used in printing presses.
Simulation Profile*²	Select the simulation target.

*1 Can only be used when using the PCL6 printer driver.

*2 Can only be used when using the PS printer driver (Windows/macOS).



Windows

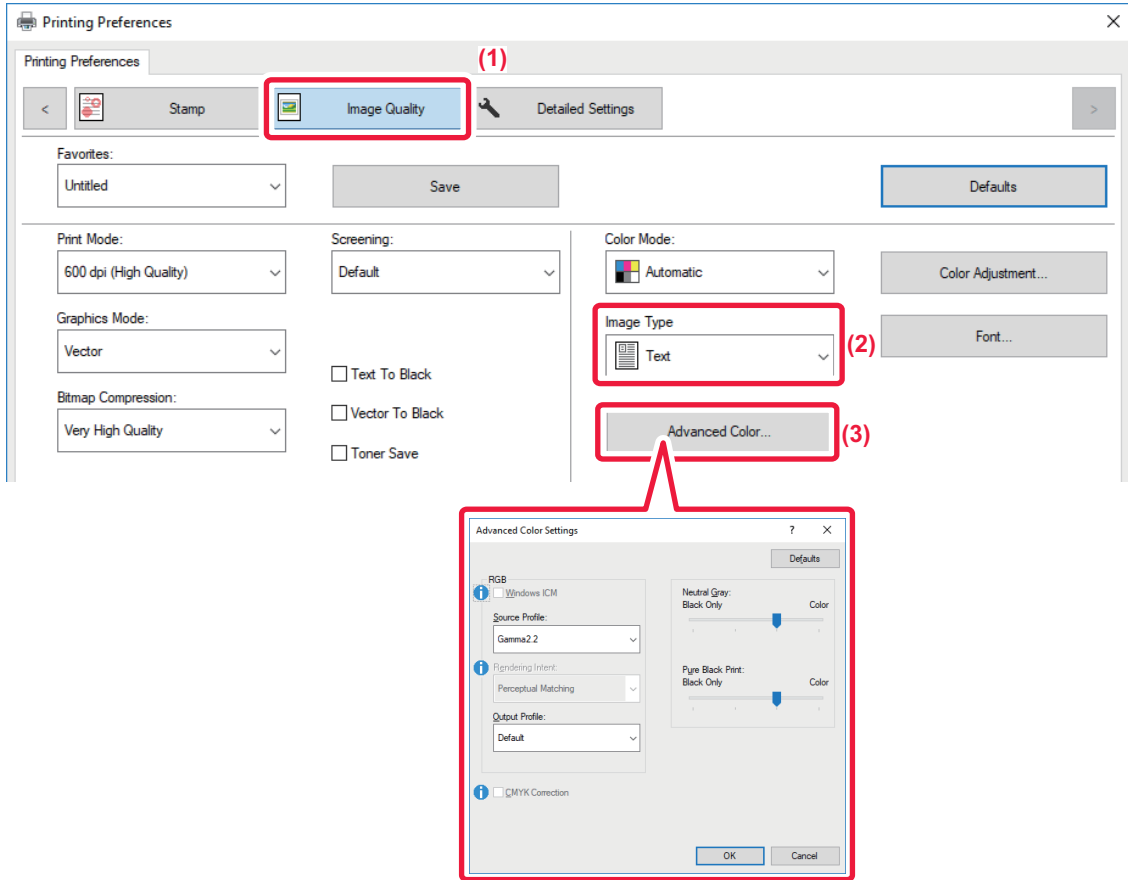

(1) Click the [Image Quality] tab.

(2) Select [Image Type].

- Text: Data consisting mostly of text
- Presentation: Data with many photos or illustrations
- Photo: Photo data or data that uses photos
- CAD: Engineering drawing data
- Scan: Data scanned by a scanner
- Colorimetric: Data to be printed in colors as viewed on the screen
- Custom: Data to be printed with special settings

(3) Click the [Advanced Color] button and specify the settings.

To configure color management using the Windows OS ICM, set "Image Type" to [Custom] in step (2). Then, click the [Windows ICM] checkbox so that the checkmark appears.

To configure "Source Profile" and other detailed color management tasks, select the desired settings from the menus.



macOS

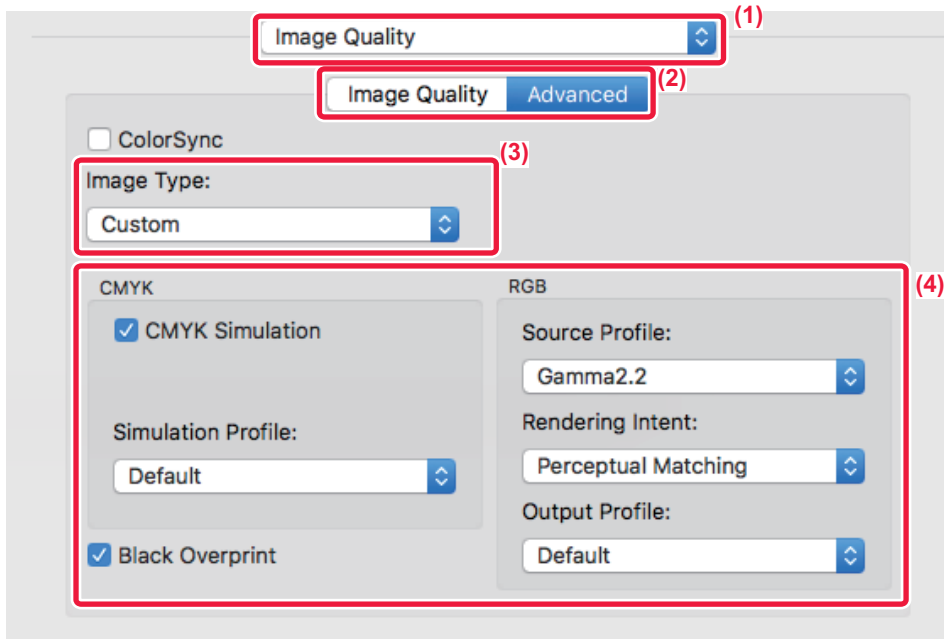

(1) Select [Image Quality].

(2) Click the [Advanced] tab.

To use the macOS color management function, select the [ColorSync] checkbox so that the checkmark appears. In this case, you cannot select "Image Type".

(3) Select [Image Type].

To configure color management settings, select the desired settings from the menus. To select a "CMYK Simulation" setting, select [Custom] in "Image Type", select the [CMYK Simulation] checkbox () , and then select the desired setting.

- Text: Data consisting mostly of text
- Presentation: Data with many photos or illustrations
- Photo: Photo data or data that uses photos
- CAD: Engineering drawing data
- Scan: Data scanned by a scanner
- Colorimetric: Data to be printed in colors as viewed on the screen
- Custom: Data to be printed with special settings

(4) Specify the settings.



FUNCTIONS TO COMBINE TEXT AND IMAGES

ADDING A WATERMARK TO PRINTED PAGES (WATERMARK)

This function adds faint shadow-like text as a watermark in the background of the printed image. The size and angle of the watermark text can be adjusted.

The watermark text can be selected from the previously registered text in the list. When necessary, you can enter text to create an original watermark.

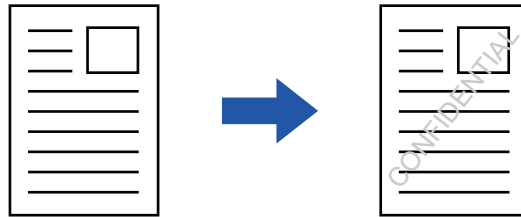

Windows

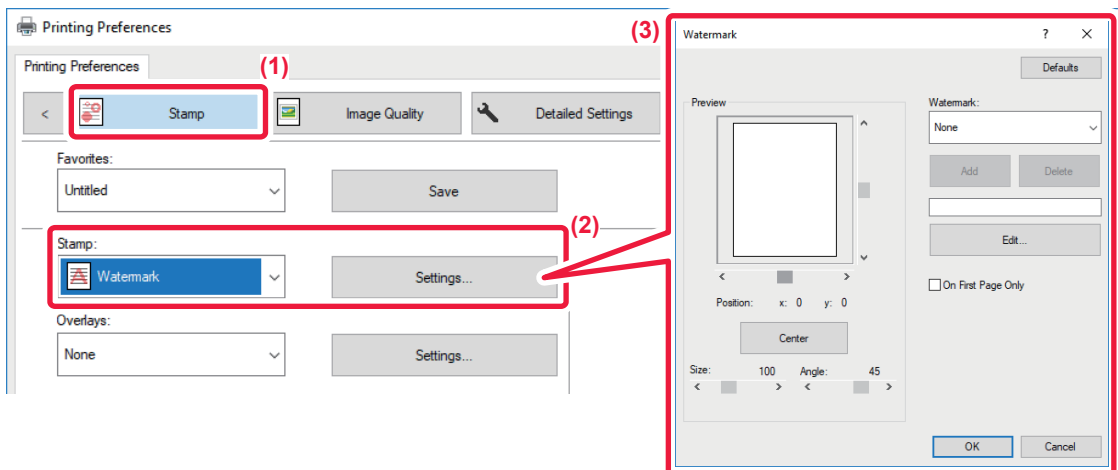

- (1) Click the [Stamp] tab.
- (2) Select [Watermark] from "Stamp" and click the [Settings] button.
- (3) Select the watermark to be used and click the [OK] button.

Click the [Edit] button to edit the font color and select other detailed settings.



If you want to create a new watermark, enter the text of the watermark in the text box and click the [Add] button.



macOS

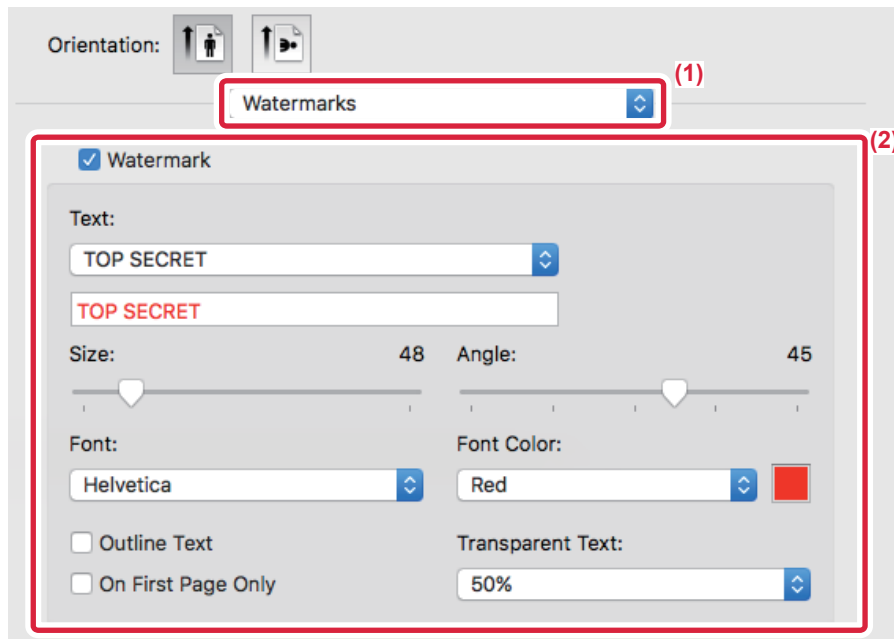

(1) Select [Watermarks].

(2) Click the [Watermark] checkbox and configure watermark settings.

- Configure detailed watermark settings such as selection of the text.
- Adjust the size and angle of the text by dragging the slide bar .



PRINTING AN IMAGE OVER THE PRINT DATA (IMAGE STAMP)

This function prints a bitmap or JPEG image stored on your PC over the print data.

This function prints a frequently used image or an icon of your own creation as if it is stamped on the print data. The size, position, and angle of the image can be adjusted.

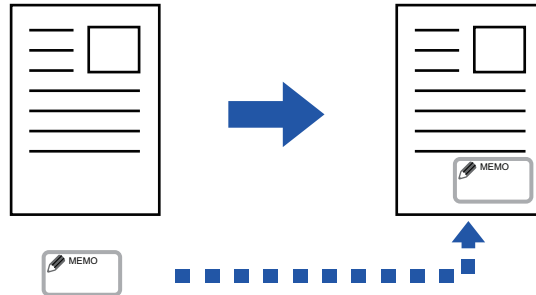

This function is available in a Windows environment.

Windows

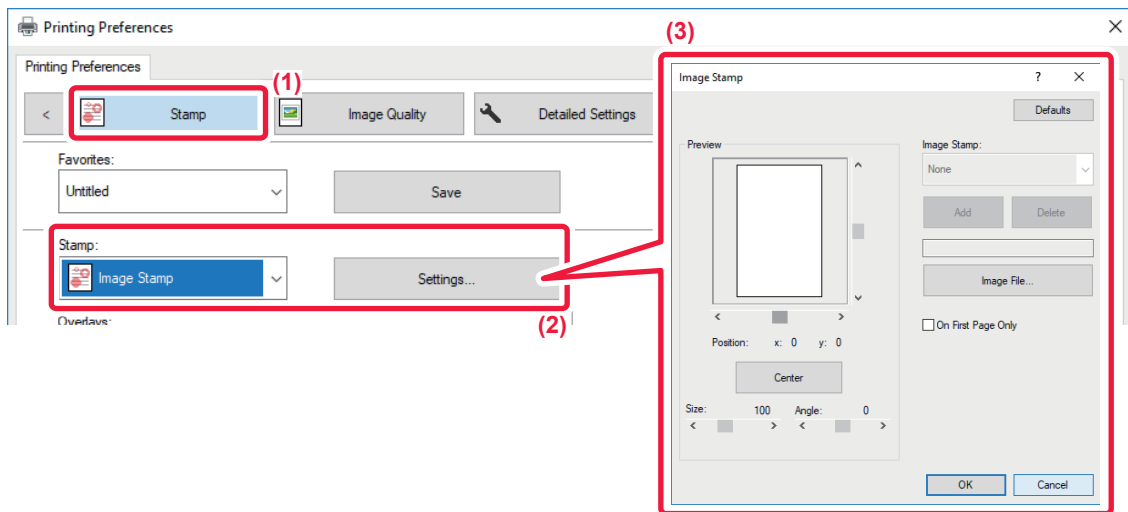

- (1) Click the [Stamp] tab.
- (2) Select [Image Stamp] from "Stamp" and click the [Settings] button.
- (3) Select the image stamp to be used, and click the [OK] button.
 - If an image stamp has already been stored, it can be selected from the menu.
 - If you have not stored an image stamp, click the [Image File], select the file you wish to use for the image stamp, and click the [Add] button.



OVERLAY A FIXED FORM ON THE PRINT DATA (OVERLAYS)

This function overlays data on a fixed form you have prepared.

By creating table rulings or a decorative frame in an application different from that of the text file and registering the data as an overlay file, an attractive print result can be easily obtained without the need for complex manipulations.

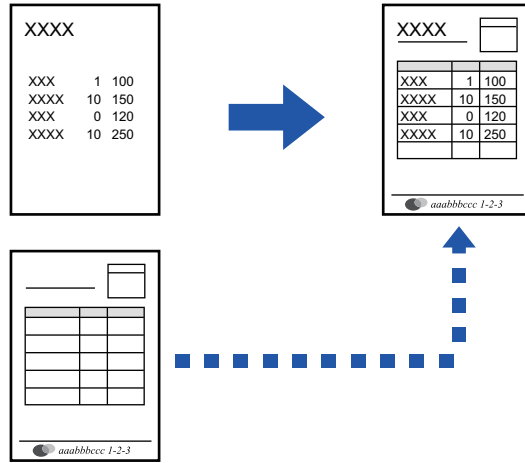

This function is available in a Windows environment.

Windows

Creating an overlay file

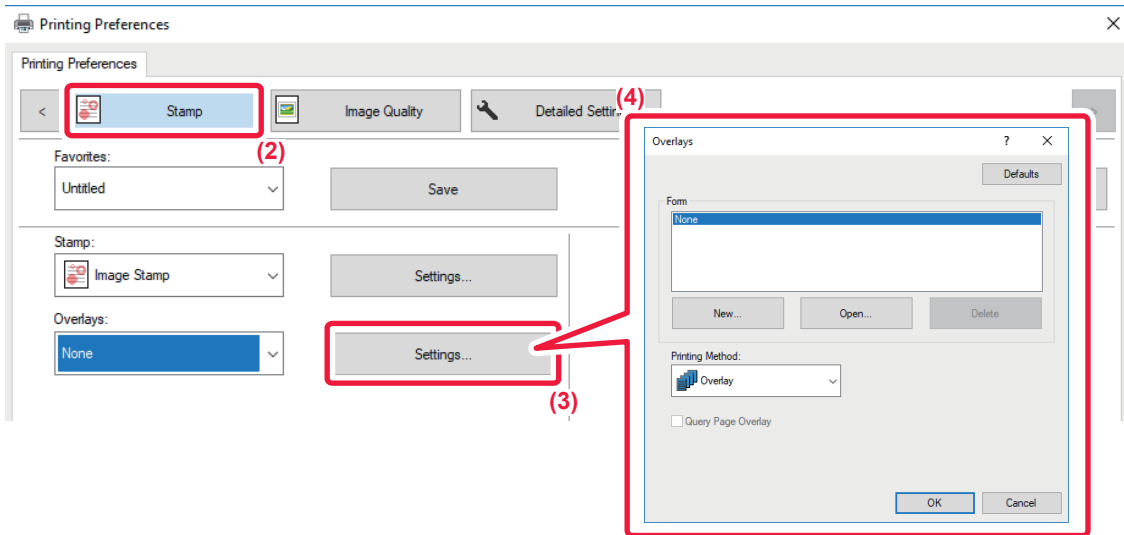

- (1) Open the driver properties window from the application that is used for creating overlay data.
- (2) Click the [Stamp] tab.
- (3) Click the [Settings] button.
- (4) Click the [New] button and specify the name and folder to be used for the overlay file that you wish to create.

The file will be created when the settings are completed and printing is started.



- When printing is started, a confirmation message will appear. The overlay file will not be created until the [Yes] button is clicked.
- When you click the [Open] button, the existing overlay file is registered.

Printing with an overlay file

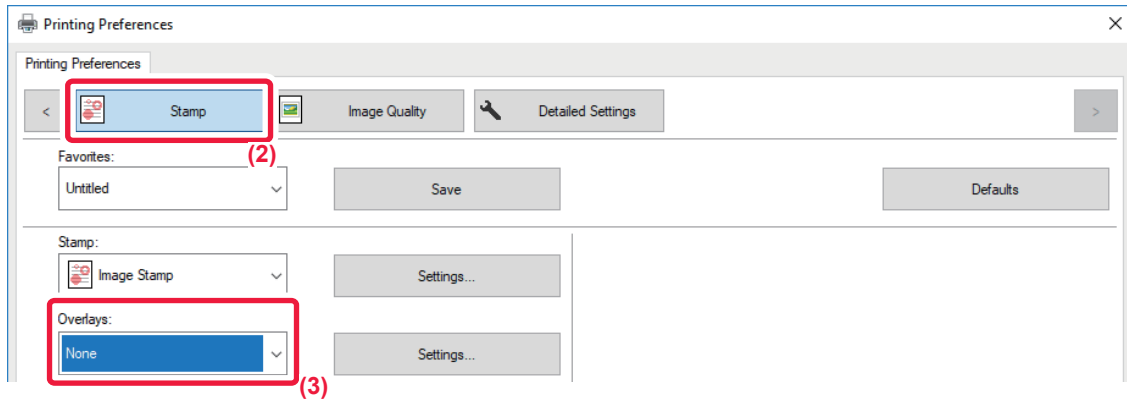

(1) Open the driver properties window from the application that is used for printing with an overlay file.

(2) Click the [Stamp] tab.

(3) Select an overlay file.

A previously created or stored overlay file can be selected from the menu.



PRINT FUNCTIONS FOR SPECIAL PURPOSES

INSERTING COVERS (COVER PAGE)

The front cover of a document is printed on paper that is different from the other pages. Use this function when you wish to print only the front cover on heavy paper.

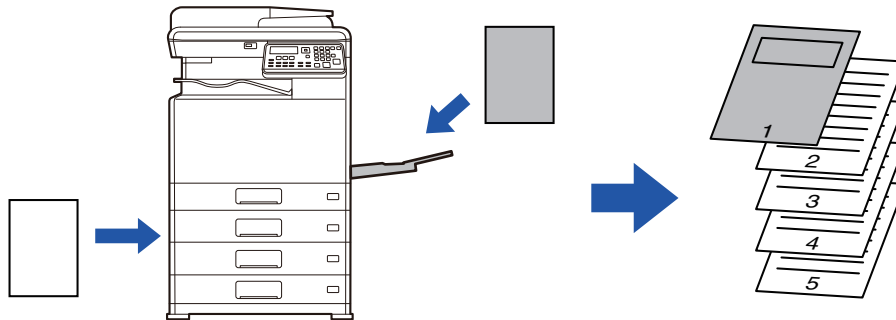

Windows

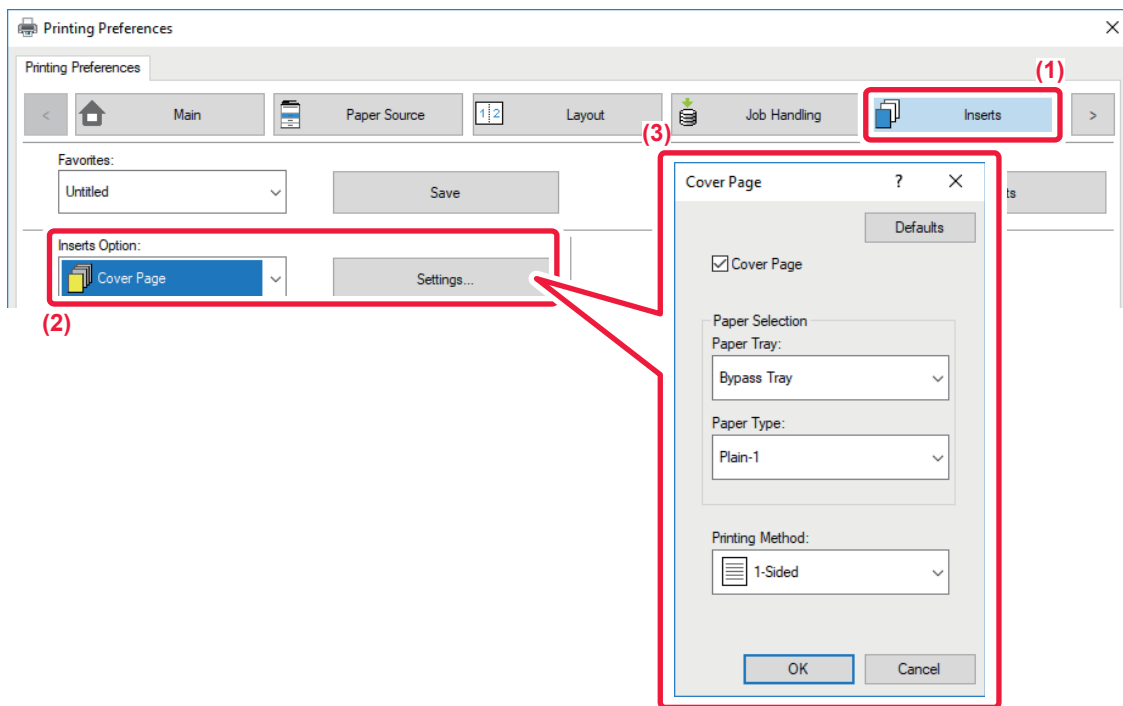

- (1) Click the [Inserts] tab.
- (2) Select [Cover Page] from [Inserts Option], and click the [Settings] button.
- (3) Select the paper insertion settings.
Enable [Cover Page], and select the paper tray and the paper type you will use.



When [Bypass Tray] is selected in "Paper Tray", be sure to select the "Paper Type" and load that type of paper in the bypass tray.



macOS

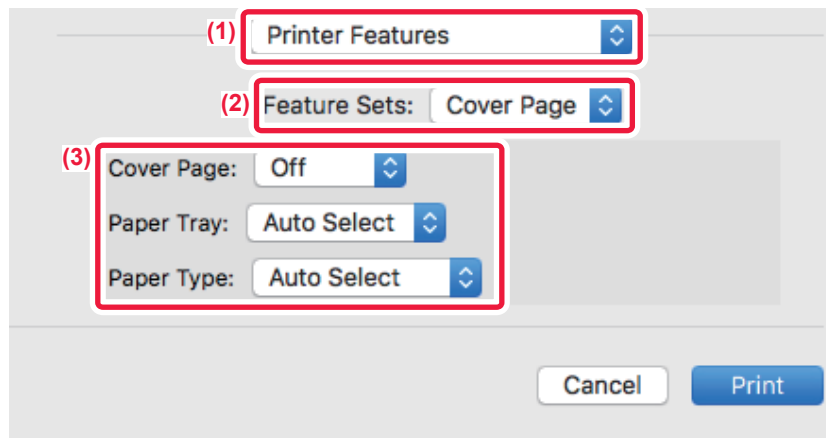

(1) Select [Printer Features].

(2) Select [Cover Page].

(3) Select the cover insertion settings.

Select the print setting, paper tray, and paper type for the front cover.



INSERT PRESET DATA BEFORE OR AFTER EACH PAGE (PAGE INTERLEAVE)

This function inserts a preset data item into every page during printing.

You can easily create documents with opened page spread that is made up of text on the left-hand page and a memo space on the right-hand page.

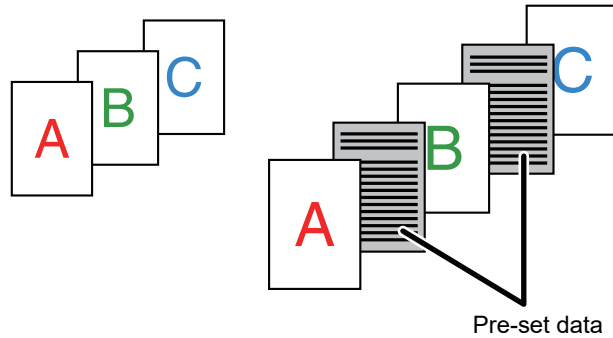

- This function is available in a Windows environment.
- This function can be used when the PCL6 printer driver is used.

Windows



You have to create page data to be inserted in advance.

For the procedure for creating page data, see "[Creating an overlay file \(page 3-44\)](#)" in "[OVERLAY A FIXED FORM ON THE PRINT DATA \(OVERLAYS\) \(page 3-44\)](#)".

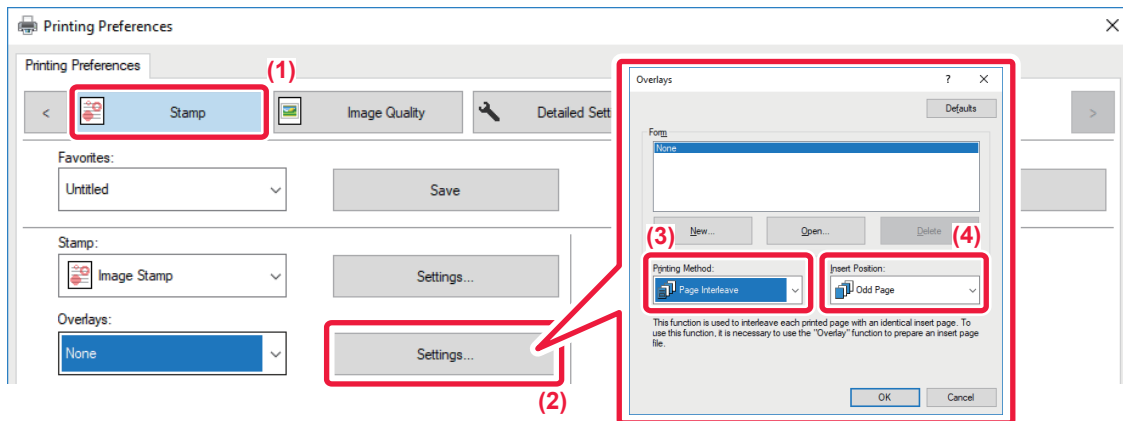

- (1) Click the [Stamp] tab.
- (2) Click the [Settings] button.
- (3) Select [Page Interleave] from the "Printing Method".
- (4) Set the overlay data to be inserted and set its insertion position.



CHANGING THE RENDERING METHOD AND PRINTING JPEG IMAGES (USE DRIVER TO RENDER JPEGS)

In some situations, a document containing a JPEG image may not be printed correctly. This can be solved by changing the way the JPEG image is rendered.

When you print an original containing JPEG images, this function allows you to select whether the images are rendered in the printer driver or the machine.



- This function is available in a Windows environment.
- When images are rendered in the printer driver, it may take time until the printing is completed.

Windows

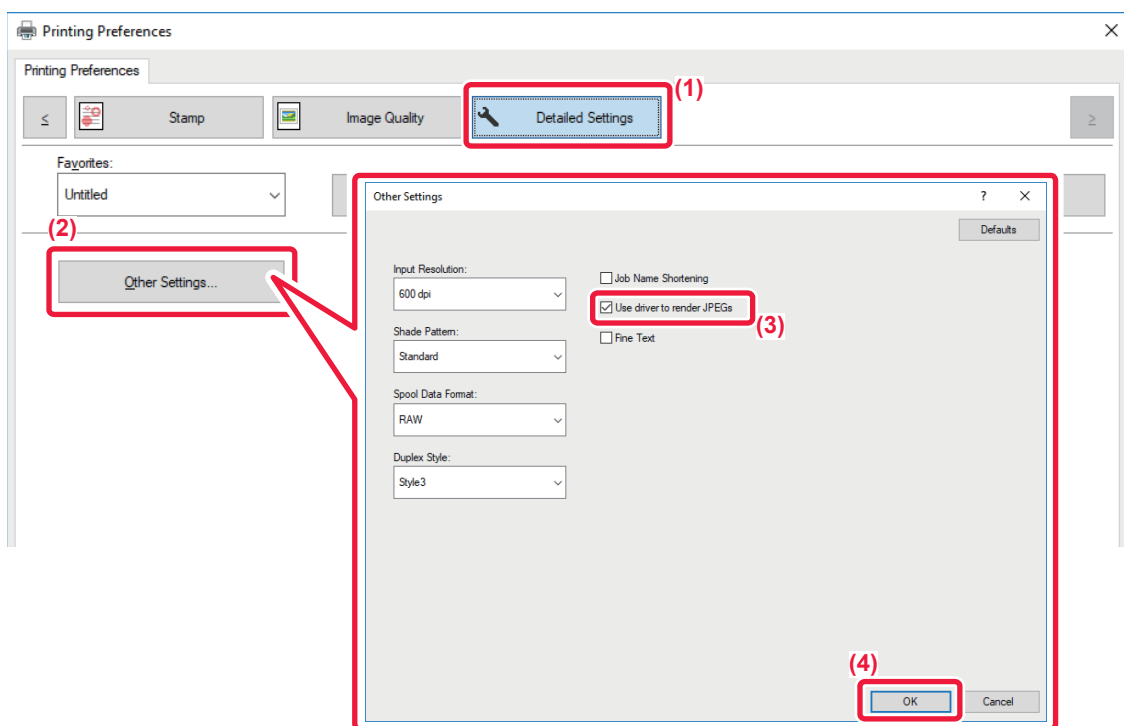

- (1) Click the [Detailed Settings] tab.
- (2) Click the [Other Settings] button.
- (3) Click the [Use driver to render JPEGs] checkbox so that appears.
- (4) Click the [OK] button.



CONVENIENT PRINTER FUNCTIONS

SAVING AND USING PRINT FILES (RETENTION)

This function is used to store a print job as a file on the machine, allowing the job to be printed from the operation panel. When printing from a computer, a PIN code (4 to 8 digits) can be set to maintain the secrecy of information in a stored file.

When a PIN code is set, the PIN code must be entered to print a stored file from the machine.

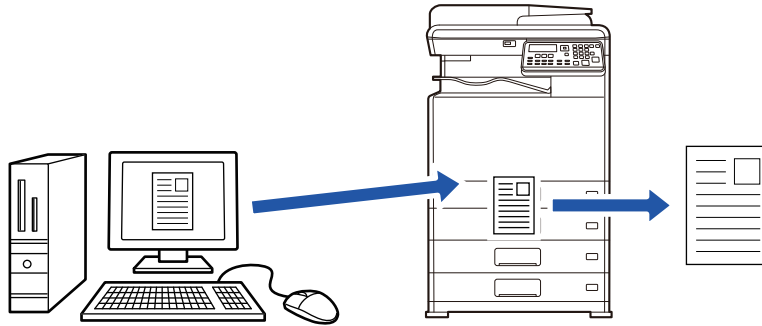

- Print data that exceeds 200 MB cannot be saved.
- A maximum of 30 files can be saved.

Windows

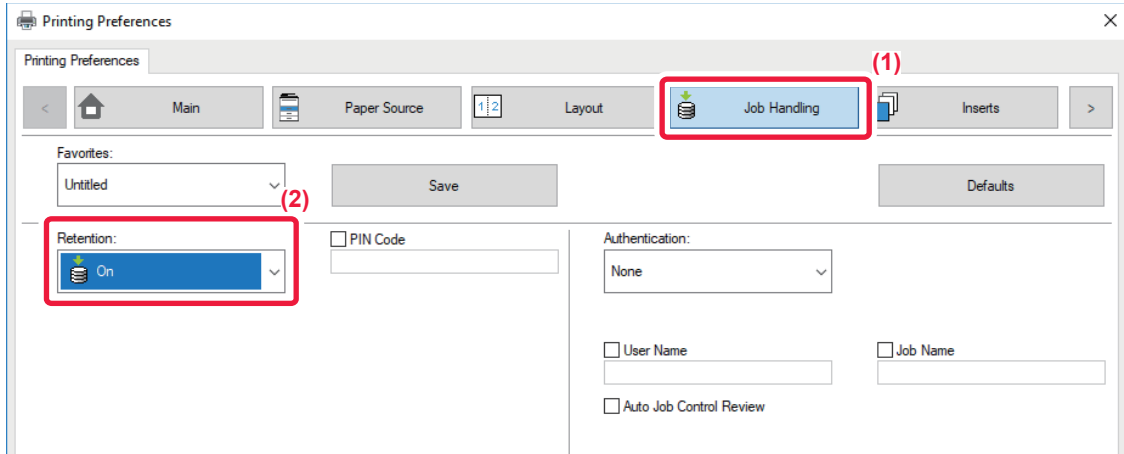

(1) Click the [Job Handling] tab.

(2) Select [On] in "Retention".

To enter a PIN code (4 to 8 digit number), click the [PIN Code] checkbox .



macOS

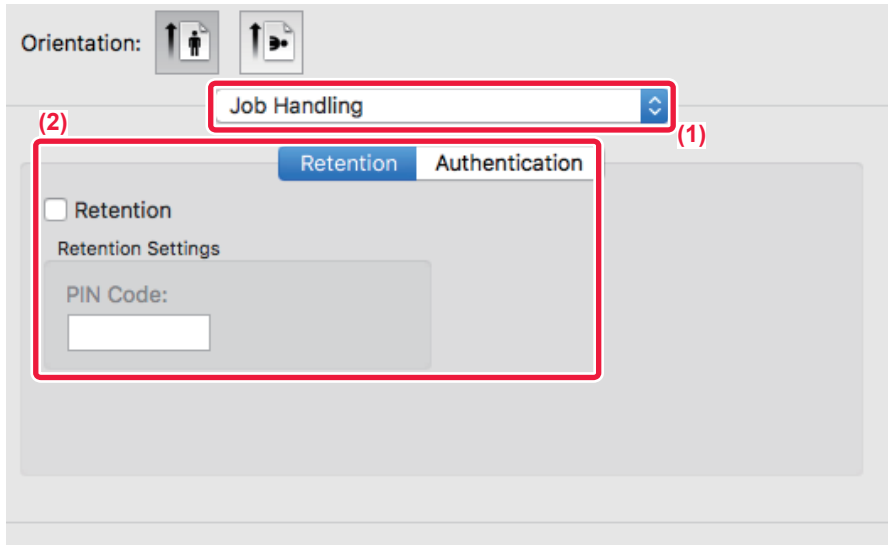

(1) Select [Job Handling].

(2) Select [Retention].

After you have entered a PIN code (a 4 to 8-digit number), click the button to lock the PIN code. This allows you to readily set the same PIN code the next time you use it.

Printing a job stored by retention

When retention is performed, the display appears as follows:

(1) Select the print job with the [▲][▼] keys.

If the screen appears as below, press the [▶] key to display Sort Method Setting.

▶ [Sort Method Setting \(page 3-52\)](#)

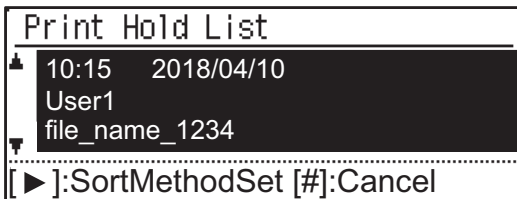

If the screen appears as below, press the [▶] key to display the list of print hold jobs.

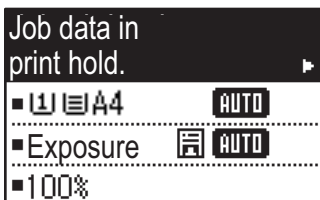

(2) Press the [OK] key.



(3) Print or delete the print job with the [▲] [▼] keys.

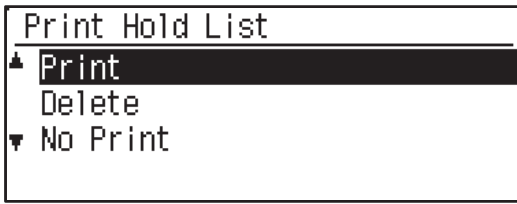

Select "Print" to print the job.
Select "Delete" to delete the job without printing it.
Selecting "No Print" returns you to step 1.

(4) Press the [OK] key.

The print job is printed or deleted. If a pin code is set, the job will be printed or deleted after you enter the pin code with the numeric keys and press the [OK] key.

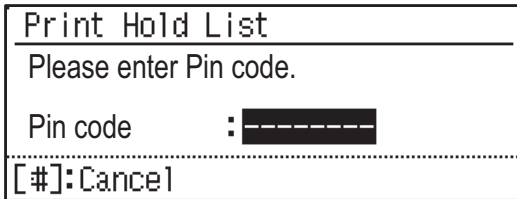

Sort Method Setting

Set the sorting method used for the Print Hold List. Select from "Date (Asc.)", "Date (Dsc.)", "User Name (Asc.)", "User Name (Dsc.)", "File Name (Asc.)", or "File Name (Dsc.)".

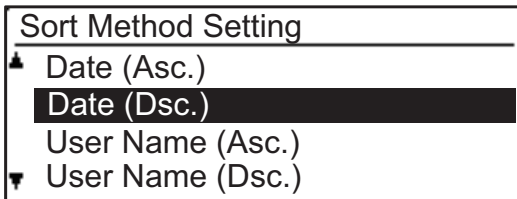



PRINTING WITHOUT THE PRINTER DRIVER

EXTENSION OF PRINTABLE FILES

When you do not have the printer driver installed on your PC, or when the application used to open a file that you wish to print is not available, you can print directly to the machine without using the printer driver.

The file types (and corresponding extensions) that can be printed directly are shown below.

File Type	TIFF	JPEG	PCL	PS*	PDF*, Compact PDF*, PDF/A*, Compact PDF/A*
Extension	tiff, tif	jpeg, jpg, jpe, jfif	pcl, prn, txt	ps, prn	pdf

* On the PS3 expansion kit is required.



- Some files may not print correctly even if shown in the above table.
- A PDF that has a password cannot be printed.



DIRECTLY PRINTING A FILE IN USB MEMORY

Files in a USB memory device connected to the machine are printed from the operation panel of the machine without using the printer driver.

When the printer driver of the machine is not installed on your PC, you can copy a file into a commercially available USB memory device and connect the device to the machine to print the file directly.



Use a FAT32 USB memory device with a capacity of no more than 32 GB.

1

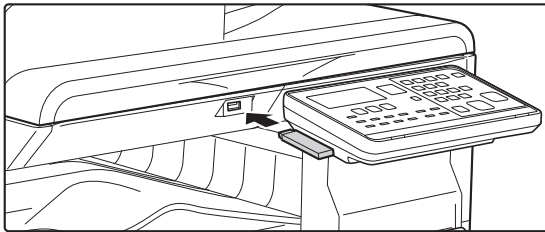

Connect the USB memory device to the machine.

2

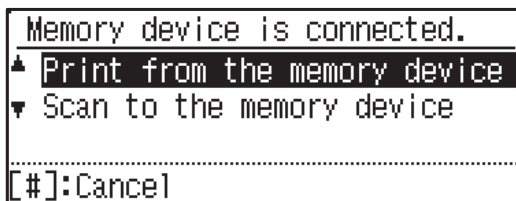

Select "Print from the memory device" with [▲] or [▼] key, and select the file that you wish to print.

A name with "/" to its left is the name of a folder in the USB memory. To display the files and folders in a folder, select the folder and press the [OK] key.



- A total of 100 files and folders can be displayed.
- Press the [READ-END] key (#) to move up one folder level.

3

Press the [OK] key.

4

Select "Print" with the [▲] or [▼] key and then press the [OK] key.

When forwarding of the selected file is completed, printing starts.

Print settings can be selected in the machine's Web page. However, if a file that includes print settings (PCL, PS) is selected, the file's print settings will be applied.



CANCELING A PRINT JOB FROM THE MACHINE

When [STOP] key (⏹) is pressed while showing "Printing" on the display after starting a print job, the confirmation screen whether or not to cancel the print job will appear. Then select "Yes" to cancel the printing.



5

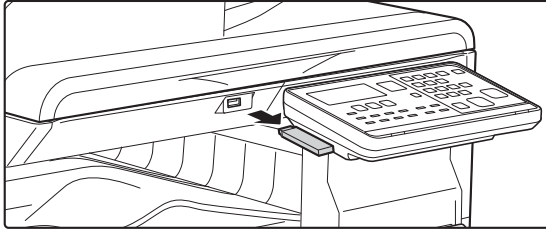

Remove the USB memory device from the machine.



DIRECTLY PRINTING FROM A COMPUTER

FTP PRINT

You can print a file from your PC by simply dragging and dropping the file onto the FTP server of the machine.

Performing FTP print

Type "ftp://" and then the IP address of the machine in the address bar of your PC's Web browser as shown below.

Example: ftp://192.168.1.28

In Windows, enter ftp://<IP address of machine> in Explorer, and drag and drop the file you want to print to that window. Printing will automatically begin.



• CANCELING A PRINT JOB FROM THE MACHINE

When [STOP] key (⏹) is pressed while showing "Printing" on the display after starting a print job, the confirmation screen whether or not to cancel the print job will appear. Then select "Yes" to cancel the printing.

- Print settings can be selected in the machine's Web page. However, if a file that includes print settings (PCL, PS) is selected, the file's print settings will be applied.
 - When user authentication is enabled in the settings of the machine, the print function may be restricted. For more information, ask your administrator.
-



APPENDIX

PRINTER DRIVER SPECIFICATIONS LIST

For information on the setting items, refer to printer driver Help.

► [PRINTER DRIVER SETTINGS SCREEN / REFERRING TO HELP \(page 3-6\)](#)

Function			PCL6	PS	Windows PPD*1	macOS PPD*1
Tab (Windows)	Item	Page				
Main	Copies	-	1 - 999	1 - 999	1 - 999	1 - 999
	Collate	-	Yes	Yes	Yes	Yes
	Original Size	3-4	Yes	Yes	Yes	Yes
	Output Size	3-4	Yes	Yes	No	No
	Orientation	3-32	Yes	Yes	Yes	Yes
	Scale to fit Paper Size	3-22	No	No	Yes	Yes
	Zoom	3-33	Yes*2	Yes	No	No
	2-Sided	3-21	Yes	Yes	Yes	Yes
	N-Up	3-24	2, 4, 6, 8, 9, 16	2, 4, 6, 8, 9, 16	2, 4, 6, 9, 16	2, 4, 6, 9, 16
	Staple	-	No	No	No	No
	Document Filing	-	No	No	No	No
	Retention	3-50	Yes	Yes	No	Yes
Color Mode	3-18	Yes	Yes	Yes	Yes	
Paper Source	Output Size	3-4	Yes	Yes	No	No
	Paper Tray	3-7	Yes	Yes	Yes	Yes
	Paper Type	3-7	Yes	Yes	Yes	Yes
	Tray Status	3-7	Yes	Yes	No	No
Finishing	Staple	-	No	No	No	No
	Punch	-	No	No	No	No
	Fold	-	No	No	No	No
	Offset	-	No	No	No	No
	Output	-	No	No	No	No
	Separator Page	-	No	No	No	No



Function			PCL6	PS	Windows PPD*1	macOS PPD*1	
Tab (Windows)	Item	Page					
Layout	2-Sided		3-21	Yes	Yes	Yes	Yes
	Chapter Inserts		-	No	No	No	No
	Booklet		3-26	Yes	Yes	Yes	Yes
	N-Up	Page No.	3-24	2, 4, 6, 8, 9, 16	2, 4, 6, 8, 9, 16	2, 4, 6, 9, 16	2, 4, 6, 9, 16
		Repeat	-	No	No	No	No
		Order	3-24	Yes	Yes	Yes	Yes
		Border	3-24	Yes	Yes	Yes	Yes
		N-Up with cover	3-24	Yes	No	No	No
		100% N-Up	3-24	Yes	Yes	No	No
	Poster Printing		3-30	Yes	Yes	No	No
	Print Position	Margin Shift	3-28	10mm to 30mm (0 inch to 1.2 inch)	10mm to 30mm (0 inch to 1.2 inch)	Yes	Yes
Tab Shift		-	No	No	No	No	
Custom		3-31	Yes	Yes	No	No	
Job Handling	Print Release		-	No	No	No	No
	Document Filing		-	No	No	No	No
	Create PDF for PC Browsing		-	No	No	No	No
	Print and Send		-	No	No	No	No
	Notify Job End		-	No	No	No	No
	Retention		3-50	Yes	Yes	No	Yes
	Authentication		3-9	Yes	Yes	No	Yes
Inserts	Cover		3-46	Yes	Yes	Yes	Yes
	Transparency Inserts		-	No	No	No	No
	Carbon Copy		-	No	No	No	No
	Tab Paper		-	No	No	No	No
Stamp	Watermark		3-41	Yes	Yes	Yes	Yes
	Image Stamp		3-43	Yes	Yes	No	No
	Overlay		3-44	Yes	Yes	No	No
	Hidden Pattern		-	No	No	No	No
	Copies Stamp		-	No	No	No	No
Image Quality	Print Mode		3-20	Yes	Yes	Yes	Yes
	Graphics Mode		-	Yes	No	No	No
	Bitmap Compression		-	Yes	Yes	No	No
	Sharpness		-	No	No	No	No
	Screening		3-38	Yes	Yes	Yes	Yes
	Smoothing		-	No	No	No	No
	Text To Black		3-37	Yes	Yes	No	No



Function			PCL6	PS	Windows PPD*1	macOS PPD*1	
Tab (Windows)	Item	Page					
Image Quality	Vector To Black	3-37	Yes	Yes	No	No	
	Toner Save *3	-	Yes	Yes	Yes	Yes	
	Color Mode	3-18	Yes	Yes	Yes	Yes	
	Image Type	3-38	Yes	Yes	No	Yes	
	Advanced Color	3-38	Yes	Yes	No	Yes	
	Image Adjustment	3-36	Yes	Yes	No	No	
	Font	-	Yes	Yes	Yes	No	
	Line Width	-	No	No	No	No	
	Boldness Adjustment	-	No	No	No	No	
Detailed Settings	Mirror Image	3-35	No	Yes	Yes	Yes	
	PS Error Information	-	No	Yes	Yes	No	
	PS Pass-Through	-	No	Yes	No	No	
	Job Compression	-	No	Yes	No	No	
	Tandem Print	-	No	No	No	No	
	Disable Blank Page Print	-	No	No	No	No	
	Custom Image Registration	-	No	No	No	No	
	Other Settings						
	• Input Resolution	-	Yes	Yes	No	No	
	• Shade Pattern	-	Yes	No	No	No	
	• Spool Data Format	-	Yes	Yes	No	No	
	• Printable Area	-	No	No	No	No	
	• Rip Style	-	No	No	No	No	
	• Duplex Style	3-21	Yes	Yes	No	No	
	• CMYK Image Enhancement	-	No	No	No	No	
	• Job Name Shortening	-	Yes	Yes	No	No	
	• Use driver to render JPEGs	3-49	Yes	Yes	No	No	
	• Thicken Fine Lines	-	No	No	No	No	
	• Fine Text	-	Yes	Yes	Yes	Yes	
	• Fine Edge	-	No	No	No	No	
• Text/Line control	-	No	No	No	No		
• Text/Line knockout control	-	No	No	No	No		
• Photo Image	-	No	No	No	No		
• Image Enhancement	-	No	No	No	No		

*1 The specifications of each function in Windows PPD and macOS PPD vary depending on the operating system version and the application.

*2 The horizontal and vertical proportion cannot be set separately.

*3 This setting may not operate in some applications and operating systems.



FACSIMILE

BEFORE USING THE MACHINE AS A FAX

TO USE THIS PRODUCT CORRECTLY AS A FACSIMILE	4-2
POINTS TO CHECK AND PROGRAM AFTER INSTALLATION	4-3

BASIC TRANSMISSION METHODS

FAX MODE (BASE SCREEN)	4-4
ORIGINALS	4-5
• ORIGINALS THAT CAN BE FAXED	4-5
• ORIGINAL ORIENTATION	4-5
CONVENIENT DIALLING METHODS (AUTO-DIALLING)	4-6
FAX TRANSMISSION METHODS	4-7
• ADDRESS REVIEW FUNCTION	4-7
SENDING A FAX	4-8
• BASIC PROCEDURE FOR SENDING FAXES	4-8
• TRANSMISSION BY AUTO-DIALLING (SPEED DIALLING AND GROUP DIALLING)	4-12
• SEARCHING FOR A PROGRAMMED DESTINATION (USING THE [ADDRESS] KEY)	4-13
• FAXING A TWO-SIDED ORIGINAL	4-14
• HOW TO SELECT THE RESOLUTION	4-19
• CHANGING THE EXPOSURE	4-20
• CANCELLING A FAX TRANSMISSION	4-21

FAX RECEPTION

RECEIVING FAXES	4-25
• RECEIVING A FAX	4-25
• MANUAL FAX RECEPTION	4-27

CONVENIENT FAX FUNCTIONS

FUNCTION KEY	4-28
• FAX PRINT HOLD FUNCTION	4-28
• SENDING A THIN ORIGINAL (SLOW SCAN MODE)	4-29
• AUTOMATIC TRANSMISSION AT A SPECIFIED TIME	4-30

• SENDING THE SAME DOCUMENT TO MULTIPLE DESTINATIONS IN A SINGLE OPERATION	4-31
• SENDING OPTIONS	4-33
• POLLING MEMORY	4-35
• STORING, EDITING, AND DELETING AUTO-DIAL NUMBERS (SPEED DIAL NUMBERS, AND GROUP DIALS)	4-38
• STORING, EDITING AND DELETING PROGRAMS	4-44

PRINTING LISTS OF PROGRAMMED INFORMATION AND SETTINGS

• INCLUDING SENDER INFORMATION ON FAXES (OWN NUMBER SENDING)	4-47
• FORWARDING FUNCTION	4-48

USING SETTINGS STORED AS A PROGRAM

• USING A PROGRAM	4-50
-------------------------	------

FORWARDING RECEIVED DATA TO A NETWORK ADDRESS (INBOUND ROUTING SETTINGS)

• CONFIGURING THE BASIC SETTINGS	4-51
• SETTINGS THE DESTINATION	4-53

SENDING A FAX DIRECTLY FROM A COMPUTER (PC-Fax)

.....	4-55
-------	-------------

USING AN EXTENSION PHONE

CONNECTING AN EXTENSION PHONE	4-56
• CONNECTING AN EXTENSION PHONE	4-56
• USING AN EXTENSION PHONE	4-57

OTHER FUNCTIONS

WHEN A TRANSACTION REPORT IS PRINTED	4-59
• INFORMATION APPEARING IN THE TYPE/NOTE COLUMN	4-59

REPORT AT REGULAR INTERVALS (COMMUNICATION ACTIVITY REPORT)

.....	4-61
-------	-------------

WHEN AN ALARM SOUNDS AND A WARNING MESSAGE IS DISPLAYED

• SELF-DIAGNOSTIC FUNCTION	4-61
• MESSAGES DURING NORMAL OPERATION	4-62



BEFORE USING THE MACHINE AS A FAX



- The fax function cannot be used on some models and in some regions.
- The fax function can be used when a facsimile expansion kit is installed on the BP-20C20/BP-20C25.

TO USE THIS PRODUCT CORRECTLY AS A FACSIMILE

Several points must be kept in mind when using this product as a facsimile. Please note the following.

Line connection

Be sure to use the provided telephone line cord to connect the machine to a telephone line socket. Insert one end of the telephone line cord into the LINE socket on the left side of the machine as shown. Insert the other end of the telephone line cord into a telephone line socket.

Insert the plug firmly until you hear a "click".

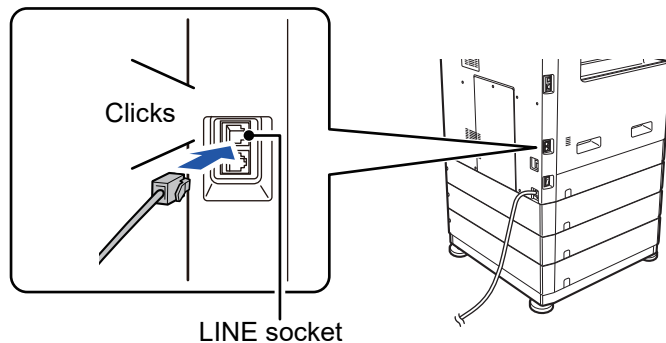

In some countries, an adapter is required to connect the telephone line cable to the wall telephone socket, as shown in the illustration.

For United Kingdom

For Australia

For New Zealand

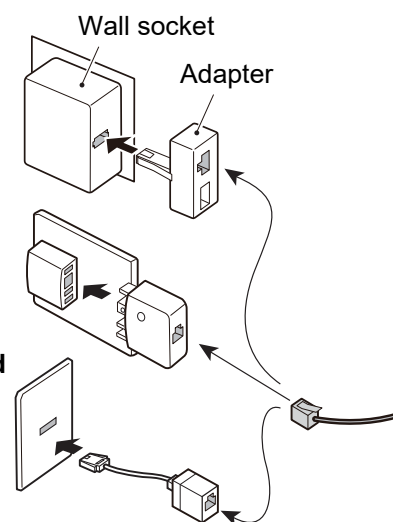

Setting the date and time and programming your sender's name and number

Before using the fax function, you must set the date and time and program your sender's name and number in the machine. This procedure is explained in [POINTS TO CHECK AND PROGRAM AFTER INSTALLATION \(page 4-3\)](#) of this manual.

Lithium battery

The date and time are protected by a lithium battery in the machine.

- When the battery dies, please contact your local Sharp dealer or authorised service representative for assistance in disposing of this battery. The machine will not operate once the battery dies.

Please note

In the event of a thunderstorm, remove the power cord from the power outlet to ensure safety. Information will be retained in memory even if the power cord is unplugged.



POINTS TO CHECK AND PROGRAM AFTER INSTALLATION

After installing the machine and before using it as a fax machine, check the following points and program the required information.

Set the date and time

The machine has an internal clock. It is important to set the correct date and time because they are used for such features as Timer Transmission. ([► page 4-30](#))

The date and time are set in the system settings. ([► page 6-10](#))

The date and time appear in the display. Make sure the correct date and time appear. If the date and time are wrong, please correct them.

Program the sender's name and sender's number

The name and fax number of the user of the machine is programmed in [Own Passcode Set \(page 6-21\)](#) in the system settings. (Only one name and number can be programmed.)

The programmed name and number are printed at the top of each transmitted fax page. The sender's number is also used as an identification number when you use the Polling function to request transmission from another fax machine (see [SENDING OPTIONS \(page 4-33\)](#)).



You can check your programmed name and number by printing out the "Administrator Settings List" in the system settings.

► [List Setting \(page 6-20\)](#)

Paper sizes that can be used for fax mode

For printing, the machine can use paper sizes

AB type:

A3, B4, A4, A4R, B5, B5R, A5, A5R, 8-1/2" x 13", 8-1/2" x 13-1/2", 8-1/2" x 13-2/5", 8-1/2" x 11", 8-1/2" x 11"R

Inch type:

11" x 17", 8-1/2" x 14", 8-1/2" x 13", 8-1/2" x 13-2/5", 8-1/2" x 11", 8-1/2" x 11"R, 5-1/2" x 8-1/2", A4, A4R

For this reason, if only paper sizes that can be used in other modes but not in fax mode are loaded in the machine, received faxes cannot be printed.

(For other points regarding fax reception, see [RECEIVING FAXES \(page 4-25\)](#).)



For the procedures for loading paper in the trays, [LOADING PAPER \(page 1-16\)](#).



BASIC TRANSMISSION METHODS

FAX MODE (BASE SCREEN)

The base screen of fax mode is displayed by pressing the [FAX] key () when the copy mode, or scan mode screen appears.

The base screen of fax mode

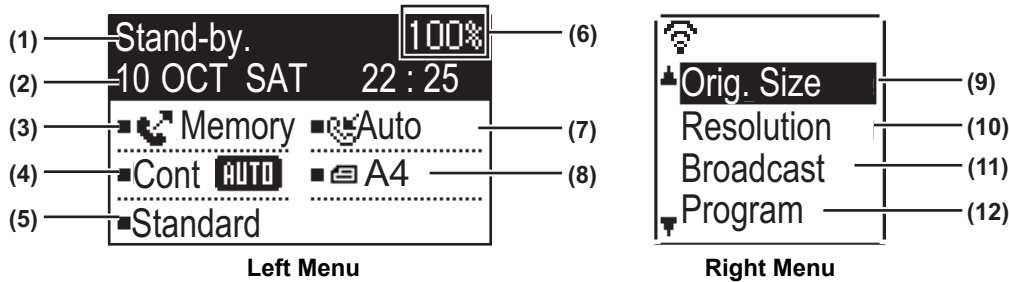

(1) Message display

Messages appear here to indicate the current status of the machine.

(2) Date and time display

This shows the date and time.

(3) Transmission mode display [► page 4-15](#)

There are three transmission modes: memory transmission, direct transmission, and manual transmission. This shows the currently selected transmission mode.

(4) Exposure display

This shows the exposure for scanning the original.

(5) Resolution display

This shows the resolution for scanning the original.

(6) Free memory display

This shows the percentage of fax memory that is free.

(7) Reception mode display

There are two modes for receiving faxes: automatic reception and manual reception. This shows the currently selected reception mode.

(8) Original display

This displays an icon to indicate the original scanning mode when an original has been placed.

 : No document is detected in the document feeder and an original size has been set in the system settings or right menu.

 : One-sided original scanning in the document feeder.

 : Two-sided original scanning in the document feeder.

None: An original has been placed on the document glass, or Orig. Size Enter has not been set in the system settings or right menu.

This also shows the currently selected original scanning size.

(9) Original Size [► page 4-8](#)

This is used to set the original scanning size.

(10) Resolution [► page 4-19](#)

This menu is used to select resolution settings.

(11) Broadcast [page 4-31](#)

This is used to perform a broadcast transmission.

(12) Program [► page 4-44](#)

Select this menu to use a program.

The following functions also operate when a mode other than fax mode is selected:



- Automatic reception
- Manual reception
- Timer Transmission
- Transmission of stored memory transmission jobs
- Voice calls (when the extension phone is installed)
- Remote reception



ORIGINALS

ORIGINALS THAT CAN BE FAXED

For originals that can be set, see [HOW TO PLACE THE ORIGINAL \(page 1-31\)](#).



* Long originals



Depending on the resolution setting and the width of the original, there may not be sufficient space in memory to hold a long original. When a long original cannot be entirely scanned, use direct transmission or manual transmission (on-hook dialling).



Originals of length 297 mm (11-45/64") and width up to 500 mm (19-11/16") can be placed in the automatic document feeder.

ORIGINAL ORIENTATION

When an A4 (8-1/2" x 11") original is placed in vertical orientation (), the image is automatically rotated 90 degrees and transmitted in horizontal orientation () (Rotation Sending).

If the original is placed in horizontal orientation (), it is transmitted in that orientation () without being rotated.

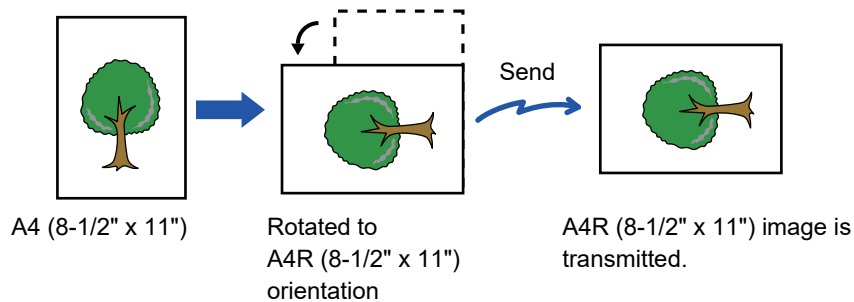

Rotation sending is not available for originals with A4R, B5, or A5 (8-1/2" x 11" or 5-1/2" x 8-1/2") size.



To cancel the rotation sending setting:

In "System Settings (administrator)", select [Fax] → [Sending Function] → [Rotate TX].

If this setting is disabled, the original will be transmitted in the orientation in which it is placed.

Because of this, some receiving machines may reduce the received data.







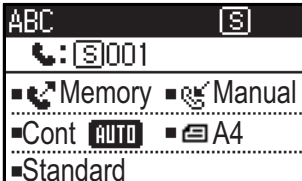

CONVENIENT DIALLING METHODS (AUTO-DIALLING)

The fax function includes a convenient auto dial feature (Speed dialling and group dialling). By programming frequently dialled numbers, you can call and send faxes to these locations by means of a simple dialling operation.

► [TRANSMISSION BY AUTO-DIALLING \(SPEED DIALLING AND GROUP DIALLING\) \(page 4-12\)](#)

There are two types of auto-dialling: Speed dialling, and group dialling. To program auto-dial numbers, see [STORING, EDITING, AND DELETING AUTO-DIAL NUMBERS \(SPEED DIAL NUMBERS, AND GROUP DIALS\) \(page 4-38\)](#).

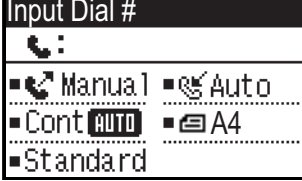
<ul style="list-style-type: none"> • Speed dialling (300 stations) A stored destination can be dialled by pressing the [SPEED] key (), entering a 3-digit number (000 to 299), and pressing the [B/W START] key. A name (maximum 36 characters) can be stored for each destination. 	
<ul style="list-style-type: none"> • Group dialling Multiple numbers can be stored in a Speed Dial number. This is convenient for communicating with a group of other fax machines. 	
<ul style="list-style-type: none"> • Redialling The machine retains the last fax or phone number dialled. This number can be redialled by simply pressing the [REDIAL/PAUSE] key () and then the [B/W START] key. <ul style="list-style-type: none"> • If you pressed a numeric key during the previous call, the [REDIAL/PAUSE] key () may not dial the correct number. • Redialling is not possible to broadcast transmission (► page 4-31), serial polling (► page 4-33), timer transmission (► page 4-30) or group dialling (► page 4-12) destinations. 	
<ul style="list-style-type: none"> • On-hook dialling This feature allows you to dial without lifting an extension phone connected to the machine. Press the [SPEAKER] key (), listen for the dial tone through the speaker, and then dial. <ul style="list-style-type: none"> • Faxes must be sent manually when using on-hook dialling. (► page 4-16) 	



- Up to 100 destinations can be stored in each group dial number, and a combined total of 300 Speed Dial and group dial numbers can be stored.
- Stored Group dialling and Speed dial destinations can be called up using a search name entered when the key or destination was stored.
 - [TRANSMISSION BY AUTO-DIALLING \(SPEED DIALLING AND GROUP DIALLING\) \(page 4-12\)](#)
- To prevent dialling a wrong number and sending a fax to an incorrect destination, check the message display carefully when you store the number. You can also check stored numbers by printing out the programmed information after storing the number.
 - [PRINTING LISTS OF PROGRAMMED INFORMATION AND SETTINGS \(page 4-46\)](#)



FAX TRANSMISSION METHODS

There are three basic methods for fax transmission: memory transmission, direct transmission, and manual transmission. When memory transmission is used, the document is temporarily stored in memory before being transmitted. When direct transmission or manual transmission is used, the document is transmitted without being stored in memory.

The default transmission setting can be set to "Memory TX" or "Direct TX" using "Send Mode" ([▶ page 6-22](#)) in the system settings.

To manually switch between "Memory TX" and "Direct TX", use the [COMM. SETTING] key () . (See [Faxing by direct transmission \(page 4-15\)](#).)

The following explanations generally assume that memory transmission is being used.



ADDRESS REVIEW FUNCTION

The Address Review function allows you to check fax destinations to prevent transmission to an incorrect destination. When a fax number is entered with the numeric keys or selected with the [REDIAL] key, a screen appears after you enter the number prompting you to reenter the number for confirmation.

- When a Speed Dial number ([▶ page 4-12](#)) is used for transmission, a screen appears for confirmation of the stored name and number.
- When a group dial number ([▶ page 4-12](#)) is used for transmission, a screen appears for confirmation of all numbers stored in the group.

This function can be set in "Address Review" in the system settings ([▶ page 6-23](#)).



- When the Address Review function is turned on, the [SPEAKER] key () can only be used for manual reception ([▶ page 4-16](#)). If you press the [SPEAKER] key () when the machine rings to signal an incoming call, a screen appears to confirm whether you want to start reception. The speaker key on a connected extension phone can be used.
- If the "Only apply to direct entry" checkbox is selected when the Address Review function is turned on, the Address Review screen only appears when a number is entered with the numeric keys or the [REDIAL] key.



SENDING A FAX

BASIC PROCEDURE FOR SENDING FAXES

Using the document feeder

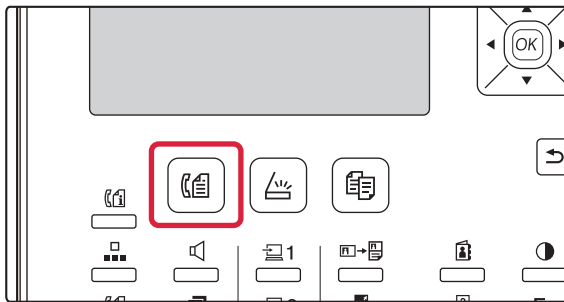
1

Make sure that the machine is in fax mode.

The FAX indicator is lit when the machine is in fax mode. If the indicator is not lit, press the [FAX] key (.

If user authentication has been enabled for the fax function in the system settings, a message will appear prompting you to enter your user number when you switch to fax mode.

Enter your account number (5 digits) with the numeric keys.

► [User Authentication \(page 6-12\)](#)

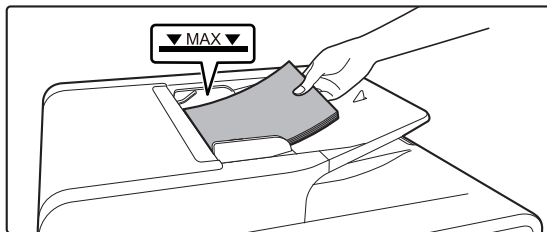
2

Place the original.

Place the original in the document feeder tray of the automatic document feeder.

► [AUTOMATIC DOCUMENT FEEDER \(page 1-31\)](#)



This is a single transmission operation, and therefore originals cannot be scanned in succession from both the document feeder and the document glass.

3

Specify the original size.

One-side scanning

When the original is placed in the automatic document feeder, the detected original size is shown.

Two-side scanning

For the procedure for specifying the original size see [FAXING A TWO-SIDED ORIGINAL \(page 4-14\)](#).

 One-sided scanning in the document feeder.

 Two-sided scanning in the document feeder.

None Document glass



To use a long original, select "Long".

4

If needed, adjust the resolution and exposure settings.



5

Dial the fax number.

- The entered number appears in the message display. Up to 50 digits can be entered. If you make a mistake, press the [C] key and then enter the correct number.
- Redialling and automatic dialling can also be used ([► page 4-6](#), [► page 4-12](#)).
- To enter a pause, see [Entering a pause \(page 4-11\)](#).

6

Press the [OK] key.

7

When the reenter screen appears, reenter the fax number.

- [ADDRESS REVIEW FUNCTION \(page 4-7\)](#)

8

Press the [OK] key.

9

Press the [B/W START] key.

Scanning begins.

If scanning is completed normally, the display returns to the base screen.

- If the line is free, the machine will dial the receiving machine and begin transmission as soon as the first page is scanned.
 - [Quick On-line \(page 4-17\)](#)
- If there is a previously stored job or a job is in progress, or if the line is being used, all pages of the original are scanned into memory and stored as a transmission job. (This is called memory transmission: the destination is automatically called and the document transmitted after previously stored jobs are completed.)



Using the document glass

1

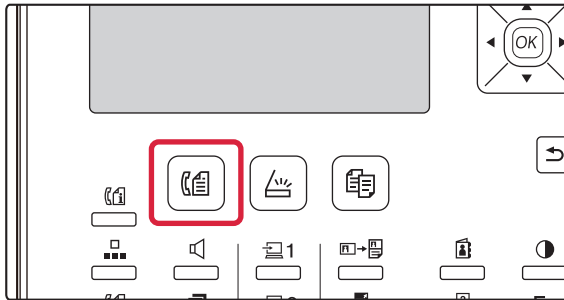

Make sure that the machine is in fax mode.

The FAX indicator is lit when the machine is in fax mode. If the indicator is not lit, press the [FAX] key ().

If user authentication has been enabled for the fax function in the system settings, a message will appear prompting you to enter your user number when you switch to fax mode. Enter your account number (5 digits) with the numeric keys.

► [User Authentication \(page 6-12\)](#)

2

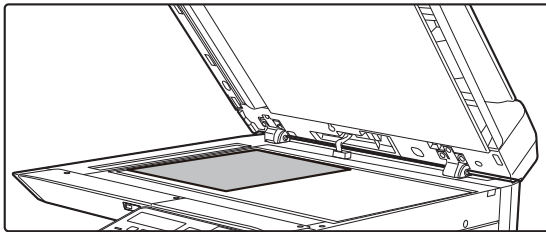

Place the original.

Place the original on the document glass.

► [DOCUMENT GLASS \(page 1-33\)](#)



This is a single transmission operation, and therefore originals cannot be scanned in succession from both the document feeder and the document glass.

3

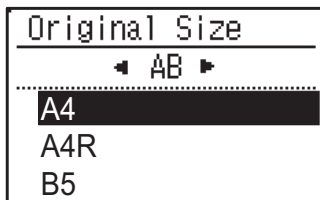

Specify the original size.

Select the "Orig. Size" on the right menu.

The paper size can be selected

AB type:

A3, B4, A4, A4R, A5, A5R, B5, B5R

Inch type:

11" x 17", 8-1/2" x 14", 8-1/2" x 13-1/2", 8-1/2" x 13-2/5",
8-1/2" x 13", 8-1/2" x 11"R, 8-1/2" x 11", 5-1/2" x 8-1/2"R,
5-1/2" x 8-1/2"



Specify a frequently used original size.

Select the setting in [System Settings] → [Fax] → [Sending Function] → [Orig. Size Enter].

4

If needed, adjust the resolution and exposure settings.

5

Dial the fax number.



- The entered number appears in the message display. Up to 50 digits can be entered. If you make a mistake, press the [C] key and then enter the correct number.
- Redialling and automatic dialling can also be used (► [page 4-6](#), ► [page 4-12](#)).
- To enter a pause, see [Entering a pause \(page 4-11\)](#).



6

Press the [OK] key.

7

When the reenter screen appears, reenter the fax number.

► [ADDRESS REVIEW FUNCTION \(page 4-7\)](#)

8

Press the [OK] key.

9

Press the [B/W START] key.

Scanning begins.

10

If you have another page to scan, change pages and then press the [B/W START] key.

- Repeat this sequence until all pages have been scanned.
- You can change the resolution and exposure settings as needed for each.

11

After the last page is scanned, press the [READ-END] key (#).

Open the document feeder and remove the original. When the original is removed or any key operation is performed, the display returns to the base screen.

The destination is automatically called and the document transmitted after any previously stored jobs are completed.



To cancel transmission

To cancel transmission while "Reading" appears or before the [READ-END] key (#) is pressed, press the [C] or [CA] key. To cancel a transmission job that is already stored, press the [FAX STATUS] key () and cancel the job as explained on [page 4-21](#).

- A job number (3 digits) appears in the display with "Read End" when memory transmission is performed. If you make a note of this number after performing a broadcast transmission, you can use the number to check the results of the transmission in the transaction report or activity report.
- If the power is turned off or a power failure occurs while an original is being scanned in the document feeder, the machine will stop and an original misfeed will occur. After power is restored, refer to Troubleshooting to remove the original.

Entering a pause

If a pause is necessary when dialling an international number, press the [PAUSE] key. (This key functions as a [PAUSE] key when entering a number.)

If you press the [PAUSE] key once, a hyphen ("-") appears and a 2-second pause* is inserted.

After entering a number, you can also press the [PAUSE] key to enter a hyphen and then enter another number using the numeric keys. (This connects the numbers together, and is called Chain dialling.)

* The duration of each pause can be changed in the system settings. (See [Pause Time \(page 6-21\)](#).)



Group dials cannot be used for chain dialling.



TRANSMISSION BY AUTO-DIALLING (SPEED DIALLING AND GROUP DIALLING)

Instead of entering a full fax number with the numeric keys, you can send a fax by pressing the [SPEED] key () and entering a 3-digit number. To use an automatic dialling, the 3-digit number and name and fax number of the destination must first be stored. See [CONVENIENT DIALLING METHODS \(AUTO-DIALLING\) \(page 4-6\)](#) for information on auto-dialling and [STORING, EDITING, AND DELETING AUTO-DIAL NUMBERS \(SPEED DIAL NUMBERS, AND GROUP DIALS\) \(page 4-38\)](#) for information on programming auto-dial destinations.

1

Enter the 3-digit number with numeric keys.

- Enter the 3-digit number entered when the Speed Dial number or Group Dial was programmed.
- If you make a mistake, press the [C] key and then enter the correct number. If you enter a 3-digit number that is not programmed in the machine, press the [C] key and then enter the correct number. If you do not know the Speed Dial number, print out the "Speed # List" or "Group List".
 - ▶ [PRINTING LISTS OF PROGRAMMED INFORMATION AND SETTINGS \(page 4-46\)](#).



2

Press the [OK] key.

Check the destination. If correct, press the [OK] key again.



To cancel transmission

To cancel transmission while "Reading" appears or before the [READ-END] key () is pressed, press the [C] or [CA] key. To cancel a transmission job that is already stored, press the [FAX STATUS] key () and cancel the job as explained on [Cancelling a fax transmission \(page 4-21\)](#).

- A job number (3 digits) appears in the display with "Read End" when transmission is performed. If you make a note of this number after performing a broadcast transmission, you can use the number to check the results of the transmission in the transaction report or activity report.



SEARCHING FOR A PROGRAMMED DESTINATION (USING THE [ADDRESS] KEY)

At the time of dialling, you can enter letters to search for a destination stored in a Speed Dial number, or Group dial.

1

Key Words
±
.....

Press the [ADDRESS] key () and enter the search letters (you can also skip entry of search letters and go directly to the next step to display the first destination in the address list).

Up to 10 of the following types of characters can be entered.

Upper case letters, lower case letters, numbers, special characters.



► [CHARACTER ENTRY \(page 1-47\)](#)

2

Press the [OK] key and select the desired destination with the [▼] or [▲] key.

- The search results appear in the following order: upper case letters, lower case letters, special characters, and numbers.
- If not all letters of the destination name appear, press the [READ END] key to display the full name. Press the [READ END] key once again to return to the original screen.



- To cancel transmission while "Reading" appears or before the [READ-END] key () is pressed, press the [C] or [CA] key. To cancel a transmission job that is already stored, press the [FAX STATUS] key () and cancel the job as explained on [Cancelling a fax transmission \(page 4-21\)](#).
- A job number (3 digits) appears in the display with "Read End" when transmission is performed. If you make a note of this number after performing a broadcast transmission, you can use the number to check the results of the transmission in the transaction report or activity report.



FAXING A TWO-SIDED ORIGINAL

Follow the steps below to automatically transmit both sides of a two-sided original.

1

Press the [DUPLEX] key () on the operation panel, select "2-Sided" with the [▼] or [▲] key, and press the [OK] key.

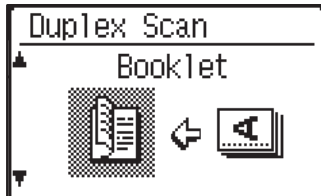
2

Select "Portrait-Booklet", "Portrait-Tablet", "Landscape-Booklet", and "Landscape-Tablet" with the [▼] or [▲] key.



- Booklets and tablets Two-sided originals that are bound at the side are booklets, and two-sided originals that are bound at the top are tablets.
- Duplex scanning is cancelled when the transmission is completed, or when the [CA] key is pressed.
- Duplex scanning of two-sided originals is only possible when a Document feeder is used. Automatic scanning of both sides of an original is not possible when the document glass is used.
- The image of the back side of the original is rotated 180 degrees if needed at the time of transmission, and thus there is no need to change the orientation at the receiving machine.
- To cancel duplex scanning, select "1-Sided" in step 1 and then press the [OK] key.
- Do not use a non-standard document size. This may cause a scanning error or image cutoff. For the paper sizes that can be used with the machine, refer to [Paper sizes that can be used for fax mode \(page 4-3\)](#).

BOOKLET

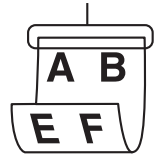

TABLET

**3**

Press [OK] key.



Transmission settings (memory transmission mode and direct transmission mode)

Transmission modes include memory transmission, where the original is temporarily scanned into memory before transmission, and direct transmission, where the original is transmitted directly without being scanned into memory. There are two types of memory transmission: [Storing transmission jobs \(memory transmission\) \(page 4-17\)](#), where all pages of the original are scanned into memory before transmission begins, and [Quick On-line \(page 4-17\)](#), where the destination is dialled after the first page is scanned and the remaining pages are transmitted as they are scanned. During a memory transmission, it may happen that the memory becomes full while the originals are being scanned. See [If the memory becomes full during transmission of a stored transmission job \(page 4-17\)](#), and see [If the memory becomes full during a quick online transmission \(page 4-17\)](#).

If there are too many pages and memory transmission is not possible, you can press the [COMM. SETTING] key () to switch from memory transmission to direct transmission. When direct transmission is used, transmission begins after the current job is completed, allowing you to give priority to a transmission job. As such, direct transmission is a convenient means of performing an interrupt transmission when there are a large number of stored transmission jobs. To switch between memory transmission and direct transmission, see the following "[Faxing by direct transmission](#)".



When transmission is performed manually using an extension phone connected to the machine or using on-hook dialling, direct transmission is automatically selected. (Memory transmission is not possible.)

Faxing by direct transmission

1**Press the [COMM.SETTING] key.**

The communication settings screen appears.

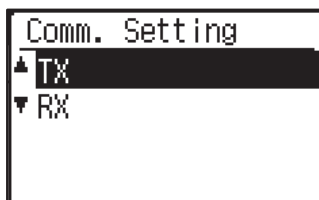
2**Select "TX" with the [▼] or [▲] key.**

The communication settings screen can also be displayed from the function selection screen.

Press the [SPECIAL FUNCTION] key (Fn) to display the special function selection screen, select "Comm. Setting" with the [▼] or [▲] key, and press the [OK] key.

3**Select "Direct TX" with the [▼] or [▲] key and press the [OK] key.****4****Dial the fax number and press the [B/W START] key.**

When using the document glass, multiple original pages cannot be transmitted in a single transmission.

For the basic procedure for sending faxes, refer to "[BASIC PROCEDURE FOR SENDING FAXES \(page 4-8\)](#)".



- To change from "Direct Transmission" back to "Memory Transmission", select "Memory TX" in step 3.
- To cancel a direct transmission, press the [C] key.



Faxing by manual transmission (using the [SPEAKER] key ())

1

Press the [SPEAKER] key ().



When this key is pressed, a message regarding volume adjustment will appear briefly followed by the dial entry screen. You can adjust the speaker volume (high, middle, or low) by pressing the [▼] or [▲] key. Note that this will not change the volume setting in the system settings. Ringing will be heard from the speaker on the rear side of the machine when the [SPEAKER] key () is used for dialling.

2

Dial the fax number and press the [B/W START] key.

For the basic procedure for sending faxes, refer to "[BASIC PROCEDURE FOR SENDING FAXES \(page 4-8\)](#)".

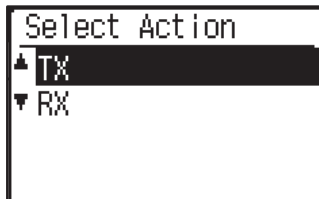

- When the [Address Review \(page 6-23\)](#) function is turned on, the [SPEAKER] key () cannot be used for transmission.
- To cancel dialling using the [SPEAKER] key () when you need to redial the number or because transmission was interrupted, press the [SPEAKER] key () once again.
- As the original is not stored in memory when direct transmission and manual transmission are used, the following functions cannot be used. Broadcast transmission [SENDING THE SAME DOCUMENT TO MULTIPLE DESTINATIONS IN A SINGLE OPERATION \(page 4-31\)](#), [AUTOMATIC TRANSMISSION AT A SPECIFIED TIME \(page 4-30\)](#), [Recall Setting \(Busy\) \(page 6-24\)](#), duplex scanning, Address Review, and others.
- When a fax is sent by direct transmission or manual transmission, the fax is sent after the connection with the receiving machine is established.

3

Select "TX" and press the [OK] key.



Storing transmission jobs (memory transmission)

When the line is in use, the transmission job is temporarily stored in memory. When the current job and any previously stored jobs are completed, transmission begins automatically. (This is called memory transmission.)

This means that transmission jobs can be stored in memory by performing a transmission operation while the machine is occupied with another transmission/reception operation. A combined total of 50 memory transmission and timer transmission jobs ([▶ page 4-30](#)) can be stored at once. After transmission, the scanned document data is cleared from memory.

You can check transmission jobs stored in memory in the fax job status screen. ([▶ page 4-21](#))

Note that depending on the number of pages stored in memory and the transmission settings, it may not be possible to store 50 jobs in memory.

- The procedure for storing a transmission job is the same as the procedure in [BASIC PROCEDURE FOR SENDING FAXES \(page 4-8\)](#).
- If you have not yet pressed the [B/W START] key, you can cancel a transmission job by pressing the [C] key.
- If you have already pressed the [B/W START] key, see [Cancelling a fax transmission \(page 4-21\)](#).
If the original is still being scanned after the [B/W START] key is pressed, you can press the [C] key to cancel the transmission.
- If you store a transmission job in direct transmission mode, you will not be able to store any further transmission jobs. After transmission, the scanned document data is cleared from memory. You can check transmission jobs stored in memory in the fax job status screen. ([▶ page 4-21](#))

If the memory becomes full during transmission of a stored transmission job

If the memory becomes full while scanning the first page of a document, the transmission job is automatically cancelled. If the memory becomes full while scanning the second page or a following page, scanning stops. In this case, you can either press the [C] key to cancel the transmission, or press the [OK] key to transmit only those pages which were completely scanned.

Quick On-line

When you use the document feeder to send a multi-page document and there are no previously stored jobs waiting or in progress (and the line is not being used), the machine dials the destination after the first page is scanned and begins transmitting scanned pages while the remaining pages are being scanned. This transmission method is called Quick On-line. When a quick online transmission is being performed, the message display shows "Reading" - "Dialling" - "Comm." - "Sending" in that order until scanning of the remaining pages is completed. When all pages have been scanned, "Read End" appears before the above messages appear.

If the receiving party is busy, the quick online transmission will change into a stored transmission job (memory transmission).

- ▶ [Storing transmission jobs \(memory transmission\) \(page 4-17\)](#)

If the memory becomes full during a quick online transmission

If the memory becomes full while scanning the first page of a document, the transmission job is automatically cancelled. If the memory becomes full while scanning the second page or a following page, those pages which were completely scanned will be transmitted.



The machine is initially set (factory setting) to perform Quick On-line transmission. If desired, you can disable this function in the system settings. (See [Quick On Line TX \(page 6-23\)](#).) When an original is transmitted using the following methods, the job will be stored in memory. (Quick On-line transmission will not be performed.)

- Sending a fax from the document glass.
- [SENDING THE SAME DOCUMENT TO MULTIPLE DESTINATIONS IN A SINGLE OPERATION \(page 4-31\)](#)
- [AUTOMATIC TRANSMISSION AT A SPECIFIED TIME \(page 4-30\)](#)



If the receiving party is busy

If the receiving party is busy, the transmission is temporarily cancelled and then automatically re-attempted after a brief interval. (Two attempts are made at an interval of 3 minutes.*1)

If you do not want the machine to re-attempt the transmission, press the [FAX STATUS] key () and cancel the job.

[▶ page 4-21](#)

*1 The settings can be changed in the system settings. (See [Recall Setting \(Busy\) \(page 6-24\)](#))

If an error occurs that prevents transmission

If an error occurs that prevents transmission or the receiving machine does not answer the call within 45 seconds*2, the transmission is stopped and then automatically re-attempted later. One attempt is made at an interval of 1 minute.*2) If you do not want the machine to re-attempt the transmission, press the [FAX STATUS] key () and cancel the job.

[▶ page 4-21](#) This machine also supports error correction mode (ECM) and is set to automatically resend any part of a fax that is distorted due to noise on the line.*3

*2 The settings can be changed in the system settings. (See [Ring Timeout In Auto TX \(page 6-25\)](#) and [Recall Set \(Err\) \(page 6-24\)](#).)

*3 If the other fax machine does not support ECM or ECM is not operating, error correction will not take place.



HOW TO SELECT THE RESOLUTION

The resolution can be changed to match the text size of the original, and the original type, such as a photo. Select "Resolution" in the right menu of the base screen of fax mode and press the [OK] key.

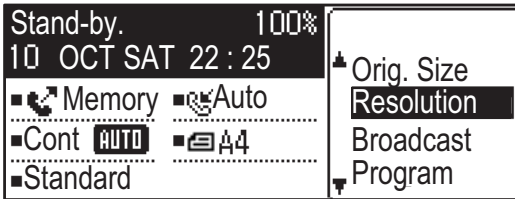

Standard	Select for an original with normal size text.
Fine	Select for an original with small text or detailed diagrams. The original will be scanned at twice the density of "Standard".
Super Fine	Select for an original with intricate pictures or diagrams. A higher-quality image will be produced than with the "Fine" setting.
Ultra Fine	Select for an original with intricate pictures or diagrams. Transmits the clearest image. Requires slightly more time for transmission than the other resolutions.
Fine/Half Tone S-Fine/Half Tone U-Fine/Half Tone	Use for photo or shaded colour originals (colour documents, etc.). Transmits a clearer image than with "Fine", "Super Fine" or "Ultra Fine" alone. The transmission time is slightly longer when halftone is selected.



- The factory default settings for the resolution and contrast are "Standard" and "Auto", respectively. The default settings for the resolution and contrast can be changed in the system settings [Set Res. Con. \(page 6-22\)](#). When using the document glass to scan multiple original pages, you can change the resolution and contrast each time you change pages. When using the auto document feeder, you cannot change the resolution and contrast after scanning has started.
- Even if you send a fax at "Fine", "Super Fine" or "Ultra Fine", the receiving fax may not be capable of receiving and printing the fax at that resolution.
- To cancel a resolution setting, press the [CA] key.



CHANGING THE EXPOSURE

The exposure can be changed to match the darkness of the original.

1

Select the [EXPOSURE] key (ⓘ).

2



Adjust the exposure.

(1) **Adjust the exposure with the [◀] or [▶] key.**

To dark the exposure, select the [▶] key, and to lighten the exposure, select the [◀] key.

(2) **Select the [OK] key.**



CANCELLING A FAX TRANSMISSION

To cancel a transmission that is in progress or a stored transmission job, follow the steps below. A transmission in progress or a stored transmission job is cancelled from the fax status screen. (Printing of a received fax cannot be cancelled.)



To cancel a transmission while the original is being scanned ("Reading" appears in the message display) or before the key is pressed ([READ-END] key (#) when scanning the original from the document glass), the [C] or [CA] key can be pressed.

Cancelling a fax transmission

1

Press the [FAX STATUS] key (☎).

When a transmission is in progress, the job being transmitted is displayed.

If the displayed job is not the job that you wish to cancel, it is likely that the job to be cancelled is a stored job waiting for transmission. Press the [BACK] key (⏪) to display the fax status selection screen and then follow the procedure in "Cancelling a stored transmission job" on [Cancelling a stored transmission job \(page 4-23\)](#) to cancel the job.

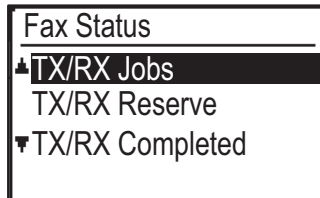

When a transmission is not in progress, the following fax status selection screen appears.

**2**

Press the [C] key.

3

Select "Yes" with the [▼] or [▲] key.

4

Press the [OK] key.

The transmission is cancelled.



- If you do not wish to cancel the transmission, press the [▼] or [▲] key in the screen of step 3, select "No", and press the [OK] key.
- You can check cancelled operations in the Activity Report. "Cancel" will appear in the "Type/Note" column of the report. Additional information on the display during transmission.

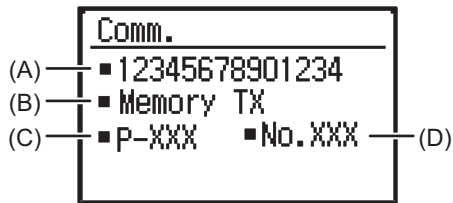

- (A) Destination name
The name of the destination appears if programmed.
- (B) Transmission method name
In the case of a timer transmission, the timer icon "⌚" appears at the beginning of the transmission method name.
- (C) Number of pages currently transmitted
- (D) Document number
The document number assigned at the time of scanning in memory transmission mode appears.



Cancelling a stored transmission job

If you do not wish to cancel a stored transmission job and only wish to check its status, press the [BACK] key (↩) instead of the [C] key in step 4 to exit.

1**Press the [FAX STATUS] key (☎).**

The fax job status screen is displayed.

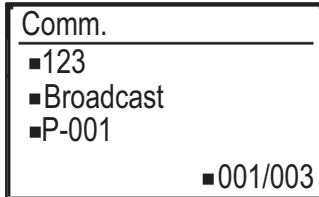

When a transmission is in progress, the job being transmitted is displayed. Press the [BACK] key (↩) to display the fax status selection screen.

**2****Select "TX/RX Reserve" with the [▼] or [▲] key.****3****Press the [OK] key.**

The first stored transmission job appears.

Press the [▼] or [▲] key until the transmission job that you wish to cancel appears.

4**Press the [C] key.**

The transmission cancel confirmation screen appears.

5**Select "Yes" with the [▼] or [▲] key.****6****Press the [OK] key.**

The selected transmission job is cancelled.

If you wish to cancel another transmission job, repeat steps 1 through 6.



You can check cancelled recall mode jobs in the Activity Report. "Cancel" will appear in the "Type/Note" column of the report.



Contents of the stored job screen (screen of step 3)

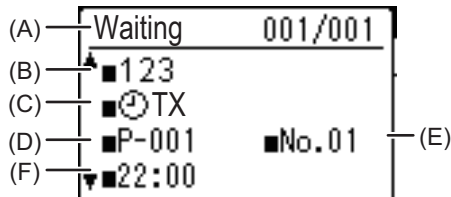

- (A) Current status
"Waiting" will appear next to stored transmission jobs and timer transmission jobs. "Recall" will appear next to recall mode jobs.
- (B) Destination
The name of the destination appears if programmed.
- (C) Transmission method name
In the case of a timer transmission, the timer icon "⌚" appears at the beginning of the transmission method name.
- (D) Number of pages stored
In the case of a stored transmission job, the document number assigned at the time of scanning appears.
- (E) In the case of a timer transmission, the timer job number appears.
- (F) In the case of a timer transmission, the specified reservation time appears. "Prepared" will appear for a stored transmission job.

Status of completed jobs

To check the status of completed jobs, select "TX/RX Completed" in step 2 and press the [OK] key in step 3.



FAX RECEPTION

RECEIVING FAXES

When another fax machine sends a fax to your machine, your machine will ring*, automatically receive the fax, and begin printing. (This is called automatic reception.)

If you do not wish to have received faxes printed immediately, use the print hold function to hold received faxes in memory for printing at your convenience (all received faxes will be printed at once). To enable this function and print received faxes, see [FAX PRINT HOLD FUNCTION \(page 4-28\)](#).



- You can store a transmission job while fax reception is in progress. (See [Storing transmission jobs \(memory transmission\) \(page 4-17\)](#))
- You can connect your telephone to receive a fax after talking, or automatically switch between phone and fax depending on the type of call that is received. ([page 4-57](#) to [page 4-58](#))
- To print received fax pages on both sides of the paper, enable [Duplex Reception \(page 6-26\)](#) in the system settings.
- If an extension phone is not connected to the machine, use automatic reception.
- If the [Duplex Reception \(page 6-26\)](#) function is on, you can press the [SPEAKER] key () when the machine rings to select whether the fax will be received. Select "Yes" to receive the fax or "No" to reject the fax with [▼] [▲], and press the [OK] key.
- In order to receive faxes, paper must be loaded in the paper tray. See [LOADING PAPER \(page 1-16\)](#) to load appropriate paper.

RECEIVING A FAX

1

The machine will ring* and reception will automatically begin.

The LINE indicator () lights up.



If an extension phone is connected and the other party is sending a fax by manual transmission ([▶ page 4-58](#)), you can lift the handset before fax reception starts and speak to the other party.

* Number of rings

The machine has been set to ring twice before beginning automatic reception. You can change the number of rings to any number from 0 to 15 in the system settings.

▶ [#Of Rings At. RX \(page 6-25\)](#)

If the number of rings is set to 0, the machine will receive faxes without ringing.

2

Reception ends.

- When reception ends, the machine sounds a beep.
- Received faxes are output to the output tray.



When approximately 150 sheets accumulate in a tray, a message appears in the display and fax printing stops. If this happens, remove the sheets. Printing will resume momentarily.



Fax Reception / Data lamp

When a fax is received in memory, or the machine is starting to print a received fax, the Fax Reception / Data lamp blinks.

The timing at which this lamp starts blinking depends on the system settings. (See [Blink Setting for Received Data \(page 6-14\)](#))

If received data cannot be printed

If the machine runs out of paper or toner, or a paper misfeed occurs, or if the machine is printing a print or copy job, received faxes will be held in memory until printing becomes possible. The received faxes are automatically printed when printing is possible. When received faxes are held in memory, the FAX [DATA] light blinks. You can also use the forwarding function to have another fax machine print the received faxes.

► [FORWARDING FUNCTION \(page 4-48\)](#)



In order to receive faxes, paper must be loaded in the paper tray. Load appropriate paper as explained in [LOADING PAPER \(page 1-16\)](#).

- If you receive a fax that is larger than the loaded paper, the system setting uses [Received Data Print Condition \(page 6-25\)](#) to print it out in the following manner:
 - If "Reduction" is set up, the image is automatically reduced before printing.*1
 - If "Division" is set up, the image is split onto multiple sheets of paper and printed on them at actual size.*1
 - If "Actual Size" is set up, the image is printed at actual size without being split.*2
- *1 If the loaded paper is of the B5 size or less, the received image may not be printed depending upon the width and length of the image data.
- *2 The received image won't be printed until you load the paper larger than the actual size.
- In fax mode, for printing, the machine can use paper sizes
 - AB type:
A3, B4, A4, A4R, B5, B5R, A5, A5R, 8-1/2" x 13", 8-1/2" x 13-1/2", 8-1/2" x 13-2/5", 8-1/2" x 11", 8-1/2" x 11"R
 - Inch type:
11" x 17", 8-1/2" x 14", 8-1/2" x 13", 8-1/2" x 13-2/5", 8-1/2" x 11", 8-1/2" x 11"R, 5-1/2" x 8-1/2", A4, A4R
- If the paper runs out while a fax is being printed, printing will automatically continue using the closest size of paper in another tray.
- If you change the size of paper loaded in a tray, change the tray's paper size setting.
- Faxes cannot be printed correctly if the actual paper size is different from the paper size setting. Be sure to set the tray's paper size setting to the same paper size as the paper loaded in the tray. For example, if you receive a B4 (11" x 17") size fax when A4 (8-1/2" x 14") paper is loaded in the tray and the tray's paper size setting is B4 (11" x 17"), the fax will be printed on A4 (8-1/2" x 14") paper and part of the image may be cut off. If the paper loaded in the tray is larger than the paper size setting, paper larger than the recognized fax size will be used. (A message prompting you to check the tray's paper size setting will appear.)
- Received faxes cannot be printed on paper inserted in the bypass tray.
- Received data cannot be printed while the transmission original being scanned. It will be printed automatically after the scanning is finished.



MANUAL FAX RECEPTION

You can decide whether to receive a fax (this is called "manual reception" in this manual).

Setting the reception mode

1

Press the [COMM. SETTING] key () in the initial state of Fax mode.



The communication setting screen can also be displayed from the function selection screen. Press the [SPECIAL FUNCTION] key (**Fn**) to display the function selection screen, select "Comm. Setting" with the [▼] [▲] keys, and press the [OK] key.

2

Select "Manual" and press the [OK] key.



To return to auto reception, select "Auto" in step 1 above.

Manually receiving a fax

To receive the fax, press the [B/W START] key and select "RX".



CONVENIENT FAX FUNCTIONS

FUNCTION KEY

This is the initial setting that appears when the [SPECIAL FUNCTION] key (Fn) is pressed in fax mode.



FAX PRINT HOLD FUNCTION

Faxes are normally printed as soon as they are received.

This function is used to hold received faxes in memory rather than printing them as they are received.

Faxes held in memory are printed manually all at once.



- When fax print hold is enabled and received faxes are held in memory, the DATA indicator () above the [FAX] key () on the operation panel blinks and a message appears in the display. (When the received faxes are printed, the indicator stops blinking and the message no longer appears.)
- If the remaining free memory reaches 0%, fax reception will no longer be possible. For this reason, it is important to constantly make sure that sufficient free memory remains and frequently print received faxes. The percentage of free memory remaining appears in the base screen of fax mode. ([▶ page 4-4](#))

Select the "Fax Print Hold" function.

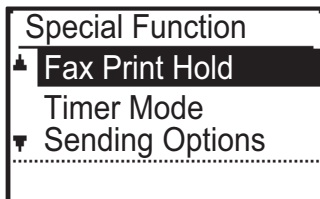

Enabling fax print hold



If fax print hold is prohibited using [Disable Fax Print Hold \(page 6-22\)](#) in the system settings, it will not be possible to enable it.

Select "Setting", and then select "On".

To disable fax print hold, select "Off".

Printing received faxes held in memory

Select "Fax print hold", and then select "Print".



SENDING A THIN ORIGINAL (SLOW SCAN MODE)

Use this function when you wish to scan thin originals using the automatic document feeder. This function helps prevent thin originals from misfeeding.

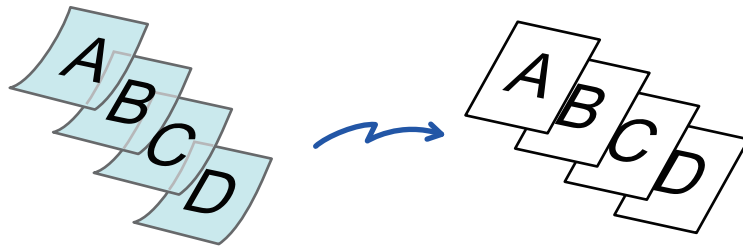

When slow scan mode is selected, 2-sided scanning and Polling is not possible.

1



Select "Slow Scan Mode" with the [▼][▲] keys and press the [OK] key.

A checkmark appears on the icon.

After the settings are completed, press the [BACK] key (↩).



To cancel the slow scan mode setting

Select "Slow Scan Mode" to uncheck it.

2

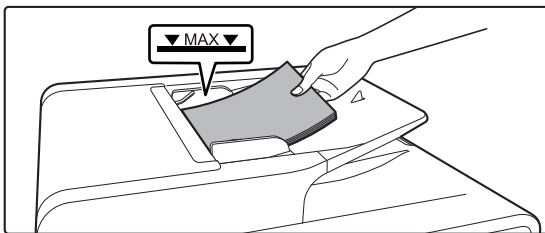

Place the original in the document feeder tray of the automatic document feeder.

► [AUTOMATIC DOCUMENT FEEDER \(page 1-31\)](#)

Adjust the original guides slowly.



If the originals are inserted with too much force, they may crumple and misfeed.

3

Enter the destination fax number.

4

Press the [B/W START] key to start scanning of the original.

A beep will sound to indicate that scanning and transmission have ended.



AUTOMATIC TRANSMISSION AT A SPECIFIED TIME

This feature enables you to set up a transmission or polling operation to be performed automatically at a specified time up to a week in advance. This is convenient when you will be out of the office or for transmission at off-peak nighttime rates. A combined total of 50 timer transmission and memory transmission jobs can be stored.



- After a timer transmission is performed, the information (image, destination, etc.) is automatically cleared from memory.
- To perform a timer transmission, the original must be scanned into memory. It is not possible to leave the original in the document feeder or on the document glass and have it scanned at the specified time of transmission.
- The date and time is set in the machine using the system settings.
(See [Date & Time Set \(page 6-10\)](#).)
- Only one polling timer operation can be set up at a time. If you wish to set up multiple timer polling operations, combine the machines to be polled into one serial polling operation with a timer setting (see [Serial polling mode \(page 4-34\)](#)).

1

Select "Timer Mode" and press the [OK] key.

If a time has been specified, a checkmark appears in front of "Timer Mode". To cancel a specified time, press the [LOGOUT] key (✕) in the above display with "Timer Mode" highlighted.

The current time appears in the screen. If the current time is not correct, press the [CA] key to cancel the operation and see [Date & Time Set \(page 6-10\)](#) to correct the time setting.

2

Select the day of the week with the [▼] or [▲] key.

The selected day is highlighted. If you select "No Select Days", the transmission will be performed as soon as the specified time arrives. To return to the "Time Setting" display, press the [BACK] key (↩).



- To cancel a timer operation after the above procedure has been completed, follow the procedure in [CANCELLING A FAX TRANSMISSION \(page 4-21\)](#).
- A timer job number is automatically assigned to the operation. This number can be used to cancel a stored job. (See the note [Cancelling a stored transmission job](#) screen (screen of step 3) on [page 4-23](#).)
- Other operations can be performed after a timer operation is set up. If another operation is in progress when the specified time arrives, the timer transmission will begin when the job in progress is completed.



SENDING THE SAME DOCUMENT TO MULTIPLE DESTINATIONS IN A SINGLE OPERATION

This feature is used to send a fax to multiple destinations in a single operation. The original to be transmitted is scanned into memory and then successively transmitted to the selected destinations. This feature is convenient for such purposes as distributing a report to company branches. Up to 100 destinations can be selected.

When transmission to all destinations has been completed, the document is automatically cleared from memory.

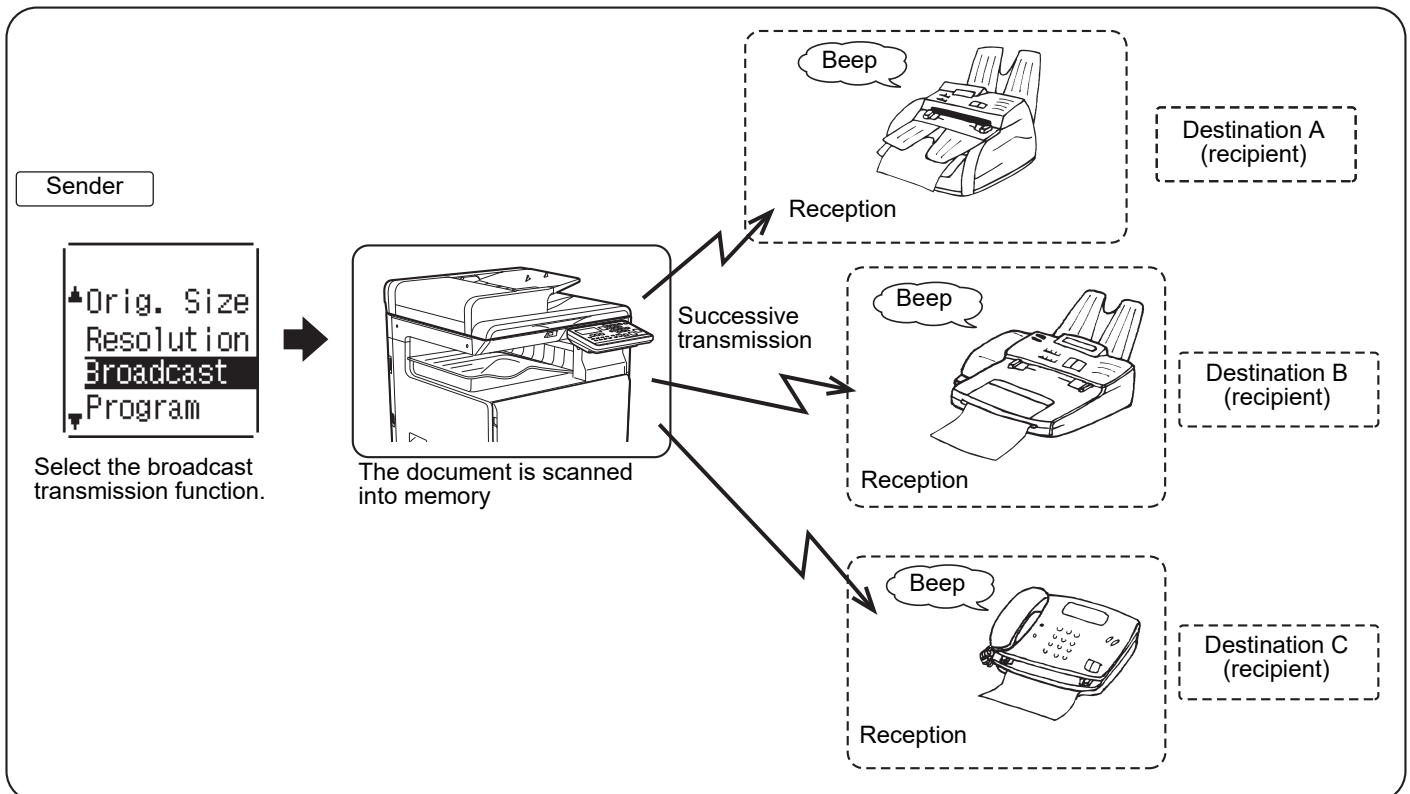

- If you frequently use broadcasting to send faxes to the same group of destinations, it is convenient to program those destinations into a group dial. The procedure for programming group dials is explained on [page 4-38](#).
- When a group dial is used to send a fax, the fax is broadcast (transmitted) to the destinations programmed in the group dial. For example, if five destinations are programmed in a group dial and the key is pressed for a broadcast transmission, the broadcast transmission will have five destinations.

**1**

Enter a full fax number with the numeric keys or press an auto-dial key (Speed Dial number, or group key) to select the first destination.

► [TRANSMISSION BY AUTO-DIALLING \(SPEED DIALLING AND GROUP DIALLING\)](#) (page 4-12)

The destination selection screen appears. To clear a mistake when entering a full number with the numeric keys, press the [C] key to clear one digit at a time. A destination selected with a Speed Dial number, or group dial is indicated by an icon and a number. To clear an entry, press the [C] key.

2

Press the [OK] key and then select the next destination by entering a full fax number or pressing an auto-dial key.

After entering a full number with the numeric keys, press the [OK] key to complete the entry. If you pressed an auto-dial key in step 1, it is not necessary to press the [OK] key. You can immediately press another auto-dial key for the next destination. Repeat steps 1 and 2 to select the remaining destinations.



- If you need to delete a number for which entry has already been completed by pressing the [OK] key, use the [◀] or [▶] key to select the number and then press the [C] key.
- If the selected destinations exceed the display range of the message screen, press the [◀] or [▶] key to scroll through and check the destinations.
- Destinations can also be selected using the address directory and the [REDIAL] key.
Note, however, that the [REDIAL] key can only be used to select the first destination (it must be used before any other destinations are selected).
- If you use two group dials that have 50 stations each, the total number of destinations entered will be 100.

3**Continue from step 7 of [BASIC PROCEDURE FOR SENDING FAXES \(page 4-8\)](#).**

After entering a full number with the numeric keys, press the [OK] key to complete the entry. If you pressed an auto-dial key in step 1, it is not necessary to press the [OK] key. You can immediately press another auto-dial key for the next destination. Repeat steps 1 and 2 to select the remaining destinations.

**To cancel a broadcast transmission**

To cancel a broadcast transmission when selecting destinations, press the [CA] key. To cancel transmission after the transmission procedure has been completed, follow the procedure in [CANCELLING A FAX TRANSMISSION \(page 4-21\)](#).



SENDING OPTIONS

This function allows your machine to call another fax machine and initiate reception of a document in that machine. A timer setting can also be specified to have the operation take place at night or at another specified time.

(See [AUTOMATIC TRANSMISSION AT A SPECIFIED TIME \(page 4-30\)](#).)

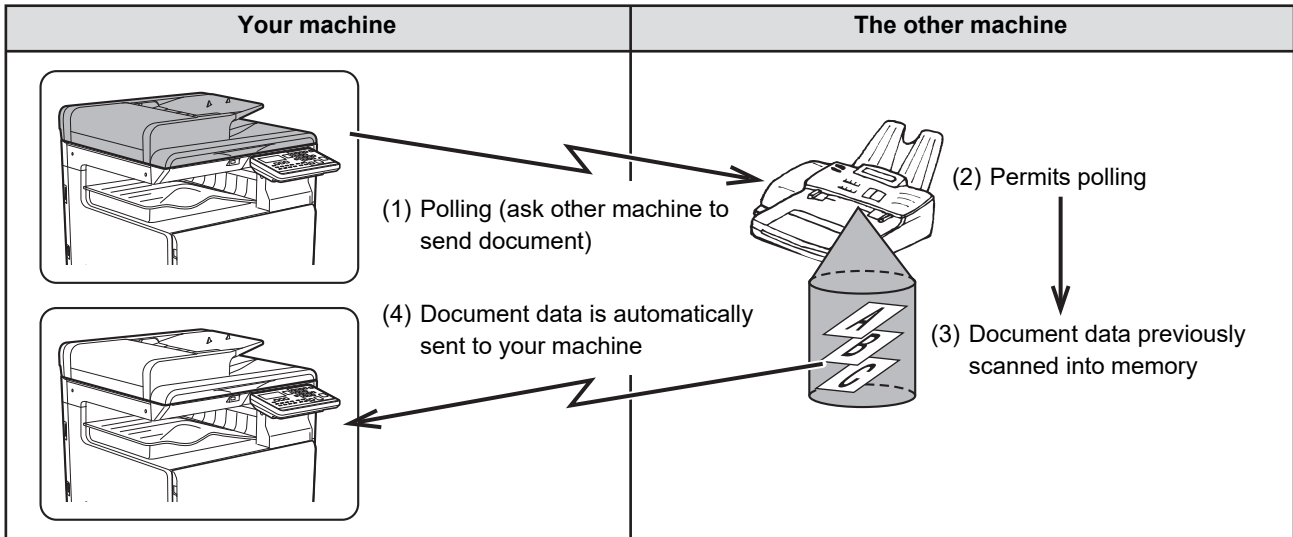

Group dials and the [SENDING THE SAME DOCUMENT TO MULTIPLE DESTINATIONS IN A SINGLE OPERATION \(page 4-31\)](#) can be used to successively poll multiple fax machines in a single operation (this is called "serial polling"). Up to 100 machines can be polled.

In this case, the sequence of operations in the above diagram is successively repeated for each sending machine selected.

When using the Public Box function, do not set the fax reception mode to "Manual". (See [MANUAL FAX RECEPTION \(page 4-27\)](#).)



If the other machine is using polling security (see [Restricting polling access \(polling security\) \(page 4-37\)](#)), your fax number (sender's number) must be programmed in the system settings (see [Own Passcode Set \(page 6-21\)](#)) and your number must also be programmed in the other machine.

1

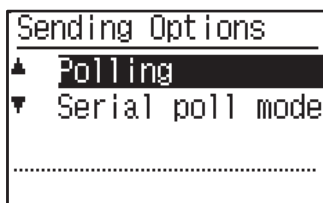

Select "Sending Options".

2

Select "Polling".

3

Press the [OK] key and enter the fax number of the other machine with the numeric keys specify a Speed Dial number (a group dial cannot be used).



4

Press the [OK] key. Press the [B/W START] key.

"Polling reservation has been set." appears in the screen. After communicating with the other machine, your machine prints the received fax.

For the basic procedure for sending faxes, refer to "[BASIC PROCEDURE FOR SENDING FAXES \(page 4-8\)](#)".

**To cancel the operation**

During communication: Cancel as explained in [Cancelling a fax transmission \(page 4-21\)](#).

While the job is stored: Cancel as explained in [Cancelling a stored transmission job \(page 4-23\)](#).

Serial polling mode

Setting for polling reception from multiple fax machines.

Select "Serial polling" steps 1 to 2 of the polling procedure [SENDING OPTIONS \(page 4-33\)](#).

Before pressing the [B/W START] key in step 3, repeat steps 1 and 2 for each machine that you wish to poll.



The receiving machine bears the expense (phone charges) of polling transmission.

This function can only be used when the other machine is Super G3 or G3 compatible and has a polling function.



POLLING MEMORY

This feature allows your machine to automatically send a document previously scanned into memory when another machine calls and polls your machine.

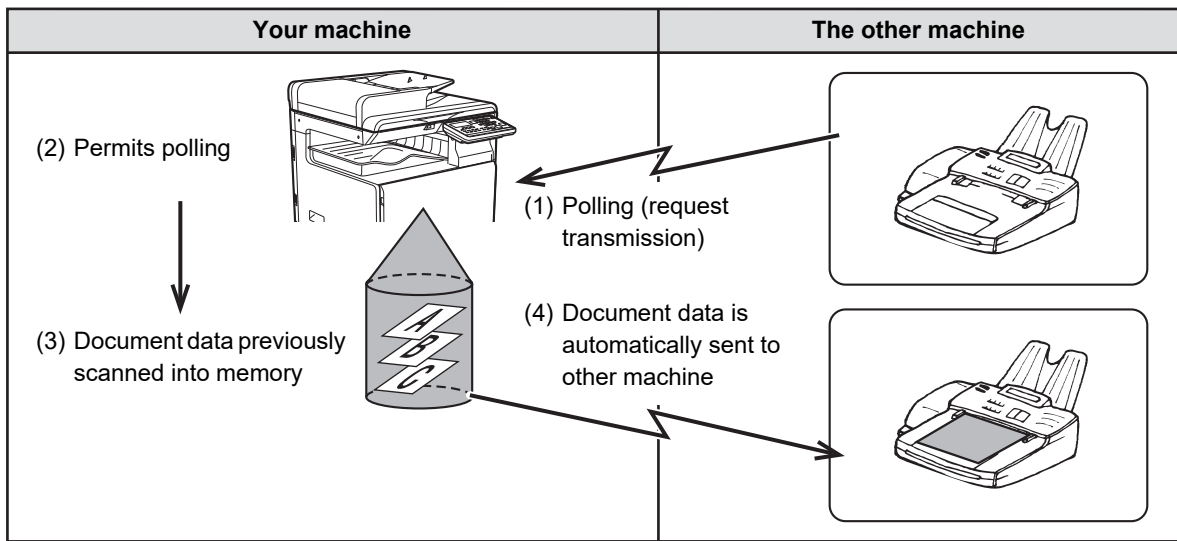

The machine that requests transmission bears the expense (phone charges) of the call.



When using the Public Box function, do not set the fax reception mode to "Manual". (See [MANUAL FAX RECEPTION \(page 4-27\)](#).)

Scanning a document into polling memory

This section explains how to scan a document into the polling memory. If other documents have already been stored in the polling memory, the new document will be appended to those documents. If the previous documents are no longer needed, they can be replaced.

1

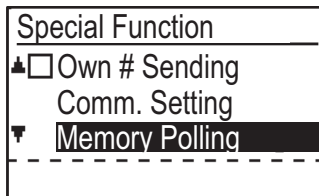

Select "Memory Polling".

2

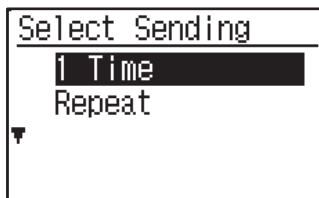

Press the [OK] key and select "1 Time" or "Repeat".

If you select "1 Time", the document data is automatically cleared from memory after your machine is polled once. If you select "Repeat", the document data in memory can be used repeatedly.

- If there are no previously stored documents in the polling memory, the above screen appears.
- If there are previously stored documents in the polling memory, a screen will appear to let you select what action to take.

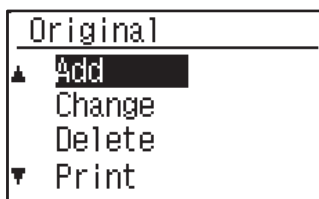

- (1) If you wish to append the new document, select "Add" with the [▼] or [▲] key, press the [OK] key, and then go to step 2.
- (2) If you wish to replace the previous document with the new document, select "Change" with the [▼] or [▲] key, press the [OK] key, and then go to step 2.



3

Press the [OK] key and press the [B/W START] key.

- Scanning begins.
- If you are scanning from the document glass and have another page to scan, change pages and press the [B/W START] key. Repeat until all pages have been scanned and then press the [READ-END] key (#).
- For the basic procedure for sending faxes, refer to "[BASIC PROCEDURE FOR SENDING FAXES \(page 4-8\)](#)".

4

Make sure that the reception mode is set to auto reception. ([Setting the reception mode \(page 4-27\)](#))

Transmission begins when the other machine calls and polls your machine.



To cancel scanning

To cancel scanning of a document while scanning is in progress, press the [CA] key. To erase the documents in the Public Box, follow the procedure in [Deleting documents from the polling memory \(page 4-37\)](#).



Printing documents in the polling memory

To check the document that is stored in the public box, follow these steps to print it out.

1

Follow steps 1 of [Scanning a document into polling memory \(page 4-35\)](#) and then follow the steps below.

2

Select "Print" with the [▼] or [▲] key and press the [OK] key.

Printing begins automatically.

Deleting documents from the polling memory

This procedure is used to delete documents from the polling memory when they are no longer needed.

1

Select "Delete".

2

Press the [OK] key.

A screen appears asking you to confirm the deletion.

3

Select "Yes" with the [▼] or [▲] key and press the [OK] key.

The documents are deleted from the polling memory.



Deletion is not possible while the polling memory is being used.

Restricting polling access (polling security)

If you wish to prevent unauthorised fax machines from polling your machine, enable the polling security function. When this function is enabled, polling permission will only be granted if the fax number of the polling machine (programmed in that machine as the sender's number) matches one of the fax numbers you have programmed in your machine as passcode numbers. Up to 10 fax numbers can be programmed as passcode numbers.

To enable the polling security function and program passcode numbers, see [Polling Passcode # Mode \(page 6-27\)](#) in the system settings.



- If you do not use the polling security function, the document will be sent to any fax machine that polls you.
- To use polling memory with polling security enabled, the sender's number of the polling machine must be programmed in that machine and in your machine.



STORING, EDITING, AND DELETING AUTO-DIAL NUMBERS (SPEED DIAL NUMBERS, AND GROUP DIALS)

Auto dial numbers are stored in the auto dial storing screen. Follow the steps below to display the auto dial storing screen, and then store an auto dial number.

1

Select "Entry" and press the [OK] key.

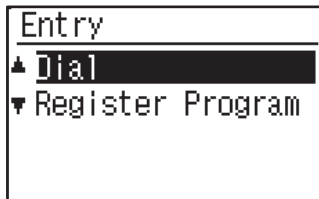
2

Select "Dial" with the [▼] or [▲] key and press the [OK] key.

3

Select "Speed", "Group", or "Change/Delete" with the [▼] or [▲] key.

4

Press the [SPEED] key () and enter the fax number of the destination with the numeric keys.

- Enter the desired Speed Dial number (000 to 299) with the numeric keys.
- Up to 50 digits can be entered for the fax number. If you need to insert a pause between any of the digits, press the [REDIAL/PAUSE] key (). The pause appears as a hyphen (-). To set the duration of the pause, see [Pause Time \(page 6-21\)](#).

5

Enter search characters (see [CHARACTER ENTRY \(page 1-47\)](#)).

6

To finish the storing procedure, press the [B/W START] key. If you wish to program an option such as chain dialling, transmission speed, or international transmission mode, press the [OK] key.

- If you pressed the [B/W START] key, you will return to step 3. If you wish to store another or Speed Dial number, repeat steps 3 to 6. If you have finished storing auto-dial numbers, press the [BACK] key ().
- If you pressed the [OK] key, go to the appropriate page for the option that you wish to program.
- To select "CHAIN DIAL", go to [Chain Dialling \(page 4-39\)](#).
- To set the "TRANSMISSION SPEED", go to [Transmission speed setting \(page 4-39\)](#).
- To set the "INTERNATIONAL TRANSMISSION MODE", go to [International transmission mode setting \(page 4-40\)](#).

**About the setting options**

When storing and editing and Speed Dial numbers, you can also select the setting options below. Chain dialling cannot be combined with any of the other setting options.

When you select a setting option, a checkmark appears in the setting option screen.

- Chain Dialling You can enable or disable Chain Dialling for a Rapid key or Speed Dial number. ([▶ page 4-39](#))
- Transmission speed You can set the transmission speed to 33,600 bps (maximum speed), 14,400 bps (high speed), 9600 bps (middle speed), or 4800 bps (low speed). The initial setting is 33,600 bps (maximum speed). ([▶ page 4-39](#))
- International transmission mode The international transmission mode can be set to "Off" or one of modes 1 to 3. The initial setting is "Off". ([▶ page 4-40](#))

Chain Dialling

To set an auto-dial number as a Chain Dial number, complete [Editing and deleting auto-dial numbers \(page 4-42\)](#).



When a number is set as a Chain Dial number, the destination fax number can be up to 48 digits long.

1

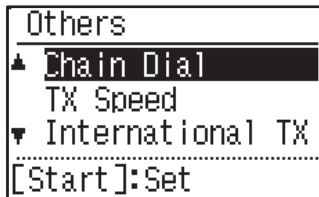

Select "Chain Dial" with the [▼] or [▲] key and press the [OK] key.

- If checkmark appears to the left of "Chain Dial", it is already selected.
- To exit, press the [B/W START] key.

2

Select "On" or "Off" with the [▼] or [▲] key.

Transmission speed setting

To set the transmission speed, complete [Editing and deleting auto-dial numbers \(page 4-42\)](#).



Set the transmission speed only when you know what speed is most suitable, such as when you are sending a fax to a foreign country and telephone line conditions are bad. If you do not know the line conditions, do not change this setting.

1

Select "TX Speed" with the [▼] or [▲] key and press the [OK] key.

2

Select the desired transmission speed with the [▼] or [▲] key.



If you select a speed other than 33,600 bps (maximum speed), a checkmark will appear next to "TX Speed" when you return to the option setting screen. This setting is not effective for polling transmission. To remove the checkmark and return the transmission speed setting to "33,600 bps (maximum speed)", press the [LOGOUT] key (✖).

International transmission mode setting

To set the international transmission mode, complete [Editing and deleting auto-dial numbers \(page 4-42\)](#).



- When sending a fax to a foreign country, telephone line conditions can sometimes distort the fax or interrupt the transmission. Selecting the right international transmission mode can help alleviate these problems.
- If errors frequently occur when sending a fax to a foreign country, try each of modes 1 to 3 and select the mode that enables the best transmission.

1

Select "International TX" with the [▼] or [▲] key press the [OK] key.

2

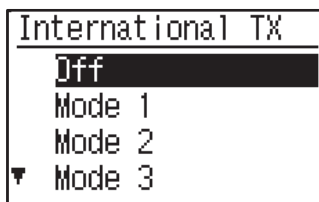

Select the desired mode with the [▼] or [▲] key.



If you select a setting other than "Off", a checkmark will appear next to "International TX" when you return to the option setting screen. To remove the checkmark and return the international transmission mode to "Off", press the [LOGOUT] key (✖).



Storing a group dial

To store a group dial number, perform the steps below in the auto dial storing screen.

1

Press the [SPEED] key ().

Enter the desired Group Dial number (000 to 299) with the numeric keys.

If you press a number that has already been stored, a warning message will appear.





Group key dialling is an automatic dialling function where by multiple destinations are programmed into a Rapid key. If you frequently send faxes to the same group of destinations using broadcast transmission, which is used to send the same document to multiple destinations in a single operation ([▶ page 4-31](#)), it is convenient to program those destinations into a group key.

2

Enter a group name (see [CHARACTER ENTRY \(page 1-47\)](#)).

3

Store the destinations using Speed Dial numbers, and the numeric keys.

- To store a Speed Dial number, press the [SPEED] key () and then enter the desired Speed Dial number (000 to 299) with the numeric keys. If you press an incorrect key, press the [C] key and then press the correct key.
- Chain dialling, transmission speed, and international transmission mode options cannot be selected. If you need to select an option for the destination, store the destination in Speed Dial number and then store the destination in the group dial. Up to 50 digits can be entered for the fax number. If you need to insert a pause between any of the digits, press the [REDIAL/PAUSE] key () to enter a pause. The pause appears as a hyphen (-). To set the duration of the pause, see [Pause Time \(page 6-21\)](#). When you have finished entering the fax number, press the [OK] key.

4

Repeat step 3 for all of the destinations that you wish to store in the group dial, and press the [B/W START] key.

Up to 100 destinations can be stored in a group dial.



Editing and deleting auto-dial numbers

To edit or delete a stored number, perform the steps below in the auto dial storing screen.



The Speed Dial number is being used in a transmission in progress or in a stored transmission, a Speed Dial number cannot be edited or cleared.

Editing a Speed Dial number

1

Select "Speed" with the [▼] or [▲] key and Select "Change" with the [▼] or [▲] key.

2

Press the [SPEED] key () and edit the destination fax number with the numeric keys.

- Press the [SPEED] key () and then enter the Speed Dial number (000 to 299) that you wish to edit with the numeric keys.
- Move the cursor to the digit(s) that you wish to edit with the [◀] or [▶] key, and then enter the correct digit(s) with the numeric keys.
- To delete a digit, move the cursor to the digit that you wish to delete with the [◀] or [▶] key and then press the [C] key.

3

To finish the storing procedure, press the [B/W START] key. If you wish to program an option such as chain dialling, transmission speed, or international transmission mode, press the [OK] key. (see [CHARACTER ENTRY \(page 1-47\)](#))

Deleting a Speed Dial number

1

Select "Delete" and press the [SPEED] key ().

Press the [SPEED] key () and then enter the Speed Dial number (000 to 299) that you wish to delete with the numeric keys.

2

Select "Delete" with the [▼] or [▲] key.



If you select "No Delete", you can press the key to check the destination name. If you are deleting the destination, check the destination name and then delete the destination.



Editing and deleting group dials

To edit or delete a group dial, follow steps 1 through 3 on pages [STORING, EDITING, AND DELETING AUTO-DIAL NUMBERS \(SPEED DIAL NUMBERS, AND GROUP DIALS\)](#) (page 4-38) and then follow the steps below.



A group dial cannot be edited or deleted in the following cases.

- The group dial is stored in a program

Editing a group dial

1

Select "Group" with the [▼] or [▲] key and Select "Change" with the [▼] or [▲] key.

2

Press the group dial number that you wish to edit, and edit the group name, the search characters. (see [CHARACTER ENTRY](#) (page 1-47))

3

When you have finished editing the destinations, press the [B/W START] key.

Deleting a group dial

1

Select "Delete" with the [▼] or [▲] key and press the group that you wish to edit.

2

Select "Delete" with the [▼] or [▲] key.



If you select "No Delete", you can press the key to check the destination name. If you are deleting the destination, check the destination name and then delete the destination.



STORING, EDITING AND DELETING PROGRAMS

You can store a address setting, transmission method*, original size enter, duplex scanning, resolution and exposure, Slow Scan Mode, own number sending, transmission settings.

This will allow you to use the settings for a transmission by means of a simple operation (see [USING SETTINGS STORED AS A PROGRAM \(page 4-50\)](#)).

* Transmission methods: normal transmission, broadcast transmission, polling, serial polling.



A screen setting and timer transmission setting cannot be stored in a program.

To register a program, perform the steps below in the auto dial storing screen.

1

Select "Entry" and select "Register Program" with the [▼] or [▲] key.

2

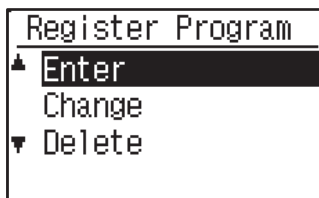

Select "Enter", "Change", or "Delete" with the [▼] or [▲] key.

- To store a program, select "Enter" and press the [OK] key. Continue from step 3 of [Storing a program \(page 4-44\)](#).
- To edit a program, select "Change" and press the [OK] key. Next, follow the steps in [Editing programs \(page 4-45\)](#).
- To delete a program, select "Delete" and press the [OK] key. Next, follow the steps in [Deleting programs \(page 4-45\)](#).

Storing a program

3

Select the program that you wish to store with the [▼] or [▲] key, and enter the program name. (see [CHARACTER ENTRY \(page 1-47\)](#))

If you select a program that has already been stored, a message appears. Select a program that has not been stored, or clear the program ([▶ page 4-45](#)) and then select it.

4

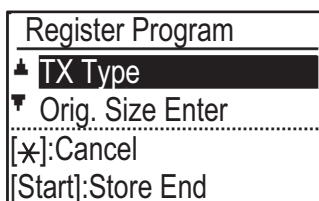

Select the item that you wish to store in the program with the [▼] or [▲] key.

- A transmission method, original size enter, dual pages, resolution/exposure settings, Slow Scan Mode, sender's name, and transmission settings can be stored.
- A transmission method must be stored. The storing procedure cannot be completed unless a transmission method is stored.
- For the procedures for selecting each of the settings, refer to the explanations of the settings.
- To cancel a setting selection, select the setting that you wish to cancel and then press the [x] key.
- Some settings cannot be used in combination with others. If you select a prohibited combination of settings, a message will appear in the display.



Editing programs

If you need to edit a previously stored program, follow these steps.

3

Select the program that you wish to edit with the [▼] or [▲] key.

4

Edit the program name (see [CHARACTER ENTRY \(page 1-47\)](#)).

- See step 3 of [Storing a program \(page 4-44\)](#).
- If you do not wish to edit the program name, go to the next step.

5

Select the stored setting that you wish to edit with the [▼] or [▲] key.

- See steps 4 of [Storing a program \(page 4-44\)](#).
 - If you do not wish to edit the stored settings, press the [B/W START] key and then press the [BACK] key (↵) to exit.
-

Deleting programs

Before deleting a program, print the "Program List" to check the contents. ([▶ page 4-46](#))

To delete a previously stored program, follow these steps.

3

Select the program that you wish to delete with the [▼] or [▲] key.

4

Select "Delete" with the [▼] or [▲] key.



PRINTING LISTS OF PROGRAMMED INFORMATION AND SETTINGS

You can print lists showing programmed information and settings.

The following lists can be printed.

- Destination Lists: Shows the destinations stored in auto dial numbers in the order of their search characters.
- Group List: Shows the destinations stored in each group dial number.
- Program List: Shows the operations stored in each program.
- Timer List: Shows timer transmissions and recall transmissions.
- Mem. Polling List: Shows the documents stored for memory polling.

For other lists that can be printed, refer to [List Print \(page 6-17\)](#).

1

Press the [SPECIAL FUNCTION] key (Fn).

2

Select "Data List Print" and select "Fax" with the [▼] or [▲] key.

3

Select the list that you wish to print with the [▼] or [▲] key.

See the explanation of the lists that can be printed above.



INCLUDING SENDER INFORMATION ON FAXES (OWN NUMBER SENDING)

This function prints the date, time, your programmed name, your programmed fax number, and the transmitted page number at the top centre of each page that you fax. All pages that you fax include this information.

Example of fax page printed out by the receiving machine



- (1) Date and time: programmed in the system settings (see [Date & Time Set \(page 6-10\)](#)).
- (2) Sender's name: programmed in the system settings (see [Own Passcode Set \(page 6-21\)](#)).
- (3) Sender's number: programmed in the system settings (see [Own Passcode Set \(page 6-21\)](#)).
- (4) Transmitted page number: 3-digit number appearing in the format, "page number/total pages".
(Only the page number appears if you use manual transmission, direct transmission, or quick on-line transmission.)

Position of sender information

You can select whether the sender information is added outside the document data or inside the document data in the system settings (see [Print Station # In Rcvd Data \(page 6-23\)](#)). The factory default setting is outside the document data.

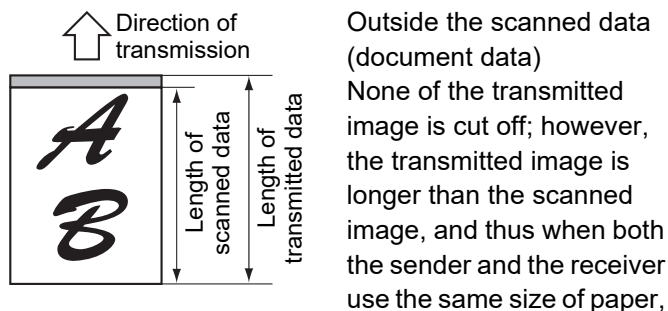

the printed fax may either be reduced or split up and printed on two pages.

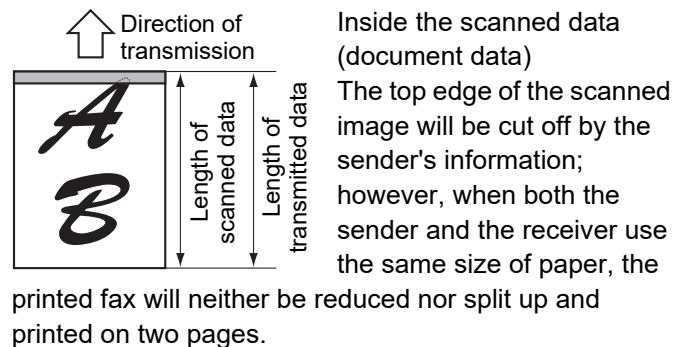

printed fax will neither be reduced nor split up and printed on two pages.

Sending without sender information

You can select whether or not sender information is added each time you send a fax. The procedure for sending one fax without sender information when the system settings are set to add sender information to each fax transmission (factory default setting) is explained here. (When performing a Broadcast Transmission ([▶ page 4-31](#)) after configuring this setting, the fax will be sent to all destinations without sender information.)

1

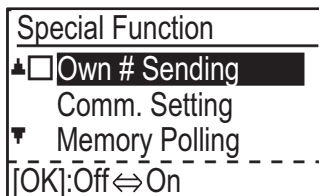

Select "Own # Sending" with the [▼] or [▲] key and press the [OK] key.

When a checkmark appears in the "Own # Sending" checkbox, this function is enabled. If you press [OK] with a checkmark in the checkbox, the function will be disabled.



FORWARDING FUNCTION

When printing is not possible because of a paper, toner, or other problem, you can forward received faxes to another fax machine if that machine has been appropriately programmed in your machine. This function can be conveniently used in an office or other workplace where there is another fax machine connected to a different phone line. When a fax has been received to memory, the FAX [DATA] light blinks (see [If received data cannot be printed \(page 4-26\)](#)).

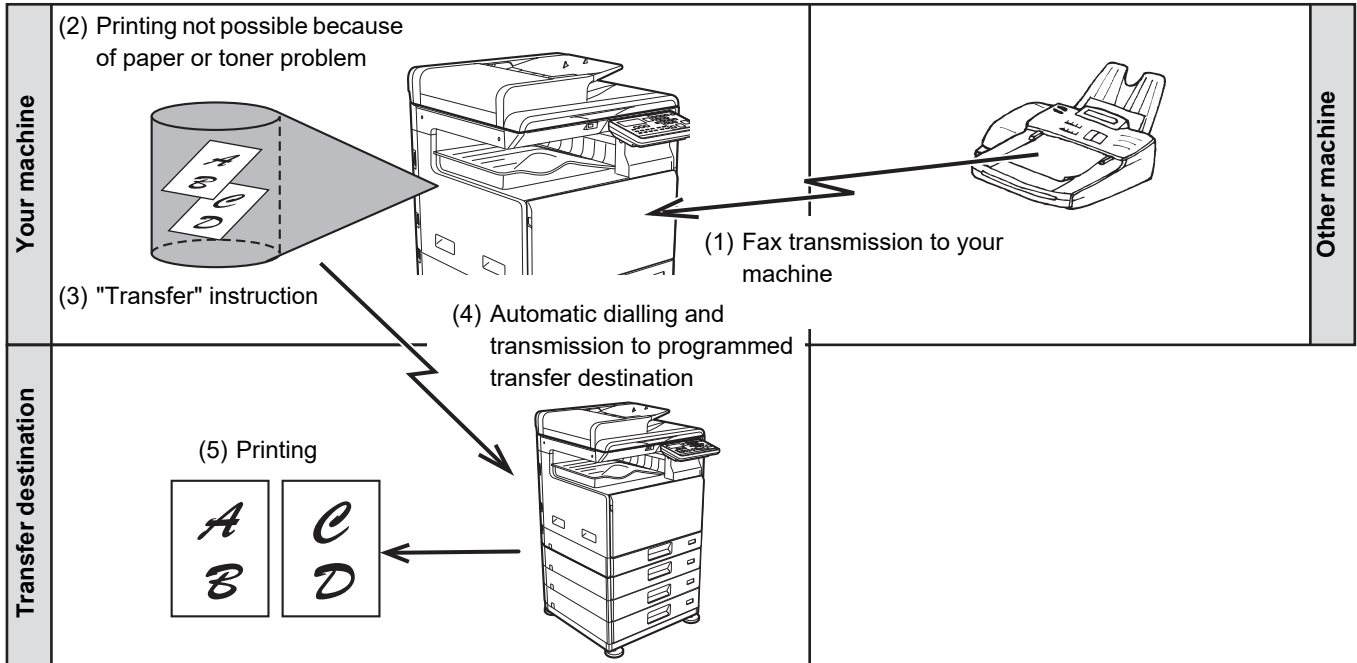

- All received faxes are forwarded; a particular fax cannot be selected for forwarding.
- Faxes that have been received to memory by the fax print hold function ([▶ page 4-28](#)) are also forwarded.
- The result of forwarding is indicated in the activity report (see [REPORT AT REGULAR INTERVALS \(COMMUNICATION ACTIVITY REPORT\) \(page 4-61\)](#)).



USING THE FORWARDING FUNCTION

Programming the fax number of the forwarding destination

The number of the forwarding destination is programmed in the system settings (see [Received Data FW. Station Set \(page 6-26\)](#)). Only one fax number can be programmed. The forwarding function cannot be used unless a number is programmed.

Forwarding received faxes

1

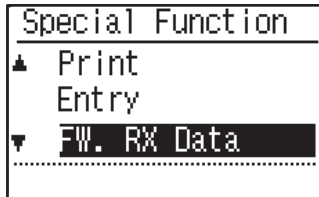

Select "FW. RX Data" with the [▼] or [▲] key and press the [OK] key.

2

Select "Transfer" with the [▼] or [▲] key and press the [OK] key.



To cancel a forwarding operation

- Press the [FAX STATUS] key () and then cancel forwarding in the same way as a regular fax transmission. (See [CANCELLING A FAX TRANSMISSION \(page 4-21\)](#).)
The fax(es) that was going to be forwarded will return to print standby status in your machine.
- If forwarding is not possible because the other machine is busy or a transmission error occurs, recall attempts will be made according to the recall times setting. If forwarding is still not successful after the set number of recall attempts are made, the fax(es) will return to print standby status in your machine.
- When forwarding is performed, all faxes that have been received in memory to that point are forwarded.
The page that was being printed when the problem occurred and all following pages will be forwarded.
- After a fax is forwarded, the fax data is automatically cleared from memory.



USING SETTINGS STORED AS A PROGRAM

This function allows you to store the steps of an operation, including the destination and scanning settings, into a program. This function is convenient when you frequently send documents, such as a daily report, to the same destination. Up to 9 programs for fax transmission can be stored.

When storing a program, a name (maximum 36 letters) can be assigned to the program.

For information on storing, editing, and deleting programs, see [STORING, EDITING AND DELETING PROGRAMS \(page 4-44\)](#).

The following settings can be stored in a program:

- | | |
|----------------------------------------------------------------------------------------------------------------------------------------------------------------------------------------|-------------------------------------------------------|
| (1) Address setting | (4) Duplex Scanning |
| (2) Transmission method | (5) Resolution and exposure |
| Normal transmission ► page 4-4 , broadcast transmission ► page 4-31 , polling ► page 4-33 , serial polling ► page 4-34 | (6) Own number sendings ► page 4-47 |
| (3) Original Size Enter | (7) Transmission settings ► page 4-15 |

When storing a broadcast transmission or serial polling operation in a program, up to 200 destination fax numbers can be stored.



- A program differs from a timer transmission ([► page 4-30](#)) in that it is not cleared from memory after transmission takes place. A program thus allows you to repeatedly perform the same type of transmission. Note, however, that programs do not allow you to establish a timer setting for transmission.
- A setting that can be stored in a program cannot be changed at the time that a program is used for a transmission even if the setting is not stored in the program.
- The only settings that can be selected when using a program are the original size enter, duplex scanning, and a timer setting.

USING A PROGRAM

1

In fax mode, place the original and select "Program" with the [▼] or [▲] key.

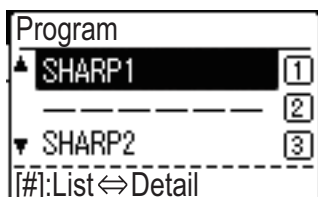
2

Select the program that you wish to use.

If not all letters of the program name appear, press the [READ-END] key (#) to display all letters. Press the [READ-END] key (#) once again to return to the original screen.

3

If needed, select the original size and other settings, and then press the [B/W START] key.

- Transmission takes place according to the program.
- If you selected a program that does not include a transmission method, set the transmission method and the destinations to be dialed before pressing the [B/W START] key.



Select settings that cannot be stored in a program before you press the [B/W START] key in step 3. These settings include the original size (see [BASIC PROCEDURE FOR SENDING FAXES \(page 4-8\)](#)), duplex scanning (see [FAXING A TWO-SIDED ORIGINAL \(page 4-14\)](#)), and a timer setting (see [AUTOMATIC TRANSMISSION AT A SPECIFIED TIME \(page 4-30\)](#)).



FORWARDING RECEIVED DATA TO A NETWORK ADDRESS (INBOUND ROUTING SETTINGS)

You can have received faxes automatically forwarded to a specified E-mail address or shared folder. As an example, this function can be used to route received faxes to a specified E-mail address or a specified folder without printing the faxes.

All Inbound Routing settings are configured in the Web page.

The following explanation assumes that the Web page has been accessed with administrator rights.

For the procedure for accessing the Web pages, see User's Manual (Web Page Settings).

To activate Inbound Routing, configure the basic settings before specifying the destination.

In the menu frame, click [Inbound Routing Settings]. Click the [Submit] button after settings

CONFIGURING THE BASIC SETTINGS

Configure the basic settings of Inbound Routing.

Enabling the Inbound Routing function

Select [Enable] in [Inbound Routing].

Changing the print style of received data

Select a print style in [Print Style Setting].

Item	Settings	Description
Inbound Routing	Enable, Disable	Enable or disable the Inbound Routing function.
Print Style Setting	Always Print , Print at Error	Select a print style of received data.



Set a file name for forwarding received data

Select from the pull-down menu of items used for the file name.

To add a desired text string, select the "Characters" and enter the string in "Preset of Character" using up to 64 characters.

Select the item to be used as the file name in "File Name Setting".

Item	Description
Serial Number	Selecting Serial Number adds the unit serial number to the file name.
Sender Name	Selecting Sender Name adds the sender name to the file name.
Date & Time	Selecting Date & Time adds the date and time to the file name.
Session Page Counter	Selecting Session Page Counter adds the counter to the file name.
Unique Identifier	Selecting Unique Identifier adds the unique identifier to the file name.
Characters	To add a character string to the file name, select this checkbox and enter the text string in "Preset of Character" using up to 64 characters.
Preset of Character	Enter a text string to be used in "Characters" using up to 64 characters.

Setting whether to print the transaction report

Select whether to print the transaction report when forwarding received data.

Specify the print condition in "Transaction Report Print Select Setting".

Item	Settings	Description
Transaction Report Print Select Setting	Always Print, Print at Error , Do not Print	Select a print style of the transaction report.



SETTINGS THE DESTINATION

Specify a sending source of received data and forwarding destination E-mail address, FTP, Desktop or network folder to configure a forwarding table.

Up to 10 forwarding tables can be configured.

For each forwarding table, set the following items:

- Forward Condition (enabling/disabling forwarding, and the conditions to determine forwarding)
- Sender number (fax number)
- Forwarding destinations (network folder)
- FTP
- Desktop
- Forwarding destinations (E-mail address)



- The names of the destination number (Forward destination 1 to 10) cannot be changed.
- The E-mail address, FTP, Desktop or network folder can be specified for a forwarding destination. Scan to FTP, Scan to Desktop, and fax number cannot be specified.

Viewing the destination list

1**Click [Destination].**

The destination list appears.

Item	Description
Inbound Routing	Displays whether Inbound Routing function is enabled.
Number	Displays the forwarding destination number (Forward Destination 1 to 10). Each of setup menu is displayed by clicking each number.
Forward Condition	Displays the forward condition of the destination (enabling/disabling and determining the destination setting).
[Delete] button	To delete the forwarding condition stored in a destination number, select the "Number" checkbox of the destination number and click the [Delete] button.
[Clear Checked] button	Clicking this clears all "Number" checkboxes.

Settings the destination

1**Click [Destination] and click the destination number to be set.****2****Select [Enable] in "Forward Condition" and select the determining condition for forwarding.**

Select [Forward (All)] or [Forward (Sender)].

3**If you wish to forward received data from a specific sender, enter the sender's fax number in "Sender Number".**

Enter the fax number using up to 20 digits. To enter the fax number from the fax addresses stored in the machine, click the [Select from Address Book] button. The "Fax Destination" screen appears, and you can select the sender's number from the fax address list.



4

Enter the destination E-mail address, FTP, Desktop or network folder in "Forward Destination (Max.10)".

Up to ten E-mail address, FTP, Desktop or network folder can be specified as the destination.

Two types of methods are available for entering the destination. The set E-mail address, FTP, Desktop or network folder are displayed in "Forwarding Destination Settings".

- Entering an E-mail address or network folder directly
Click the [Direct Entry] button. When the "Forwarding Destination Settings (Direct Entry)" appears, enter an E-mail address, FTP, Desktop or network folder information ("Hostname or IP Address", "User Name", "Password", "E-mail", "E-mail address"), and click the [Submit] button.
- Selecting an E-mail address, FTP, Desktop or network folder from the address book
Click the [Select From Address Book] button. The "Destination List" screen appears, and you can select an E-mail address, FTP, Desktop or network folder from the list.



To delete a set E-mail address, FTP, Desktop or network folder, select the checkbox at the left of the E-mail address, FTP, Desktop or network folder you wish to delete, and then click the [Delete] button.

Forward Condition

Item	Settings	Description
Forward Condition	Enable, Disable	Enable or disable the destination to be set in this screen.
	Forward (All) , Forward (Sender)	Select the determination condition for forwarding the received FAX data.

Sender Number

Item	Description
Fax No.	Enter the sender's fax number if you have selected "Forward (Sender)" in "Forward Conditions" setting. Up to 20 digits can be entered.
[Select From Address Book] button	Click this button to select the fax number from the fax addresses stored in this machine.

Forward Destination (Max. 10)

Item	Description
Forwarding Destination Settings	Displays the stored destinations. If no destination is stored, "Not Set" appears.
[Delete] button	Deletes the selected destination.
[Direct Entry] button	Click this button to enter an E-mail address, FTP, Desktop or network folder directly.
[Select From Address Book] button	Click this button to select an E-mail address, FTP, Desktop or network folder from the address list stored in the machine.



SENDING A FAX DIRECTLY FROM A COMPUTER (PC-Fax)

A document in a computer can be transmitted via the machine as a fax. Faxes are sent using the PC-Fax function in the same way as documents are printed. Select the PC-Fax driver as the printer driver on your computer and then select the Print command in the software application. Image data for transmission will be created and sent as a fax.

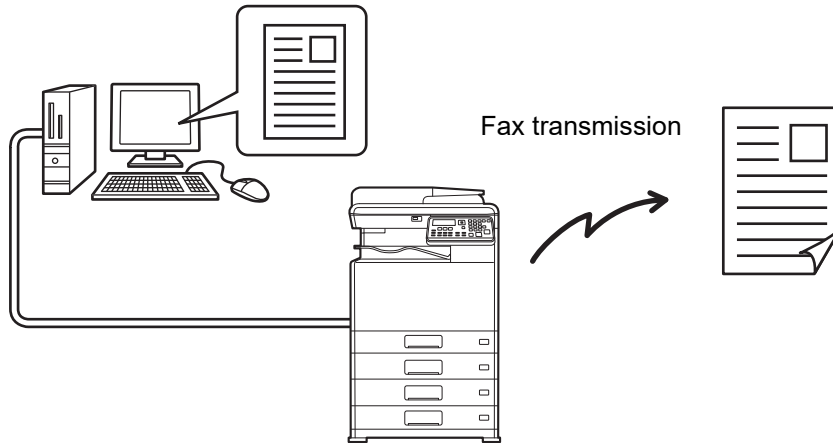

- To use the PC-Fax function, the PC-Fax driver must be installed. For more information, see the Software Setup Guide
- This function can only be used on a Windows computer.
- This function can only be used for transmission. Faxes cannot be received to your computer.



USING AN EXTENSION PHONE

CONNECTING AN EXTENSION PHONE

You can connect a telephone to the machine and use it as an extension phone to place and receive calls like any normal phone. Fax reception can also be activated from an extension phone connected to the machine. (remote operation)

CONNECTING AN EXTENSION PHONE

Insert the end of the extension phone cord into the extension phone socket on the left side of the machine.

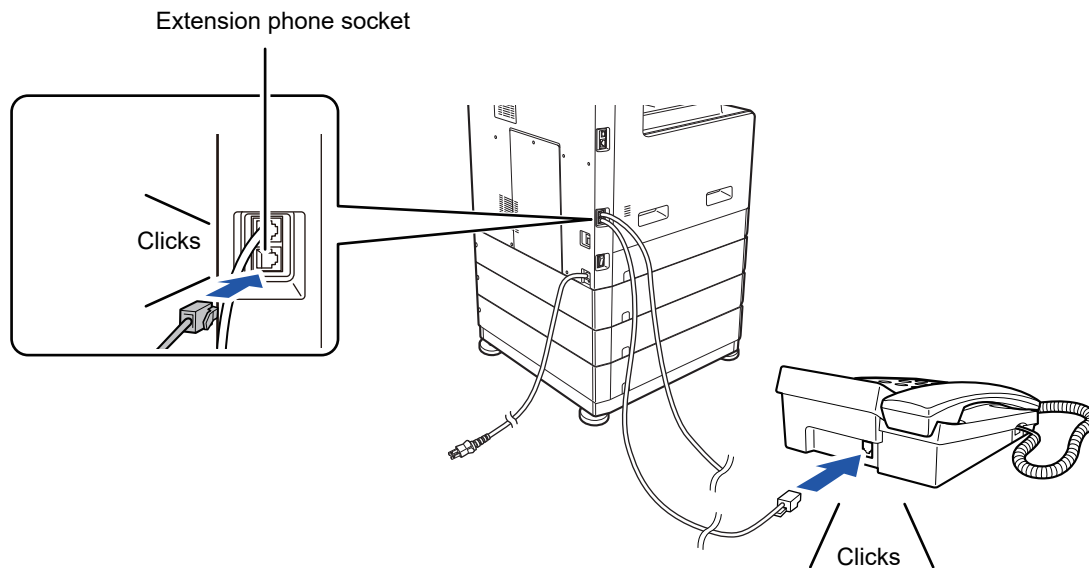

Make sure you hear a "click" sound indicating that the cord is securely connected.



Only use an extension telephone that can be connected to a modular socket.

If the shape of the cord plug is not compatible with the socket, consult your dealer or nearest Sharp customer service centre.



USING AN EXTENSION PHONE

Using an extension phone for voice calls

An extension phone connected to the machine can be used to place and receive voice calls just like a normal phone. An extension phone can be used while another mode is being used (copying, etc.).



- It may not be possible to make a call on your line during a power outage. This depends on the type of line (optical line, etc.).
- If the fax reception mode is set to auto reception, you must lift the phone to answer a call before the machine automatically begins reception. The machine is initially set to answer calls on two rings. The number of rings can be changed to any number from 0 to 15 in the system settings.
 - ▶ [#Of Rings Man.RX \(page 6-25\)](#)
- A call cannot be placed on hold.

Activating fax reception from an extension phone (remote reception)

After receiving a call on the extension phone, you can activate fax reception from the extension phone. This is called "remote reception". After speaking, or when you hear a fax tone through the extension phone, perform the following procedure with the extension phone still lifted. (If you made the call, remote reception will not be possible.)



The following procedure is not possible if you are on a pulse dial line and your extension phone cannot produce tone signals. To find out whether your extension phone can produce tone signals, refer to the manual for your extension phone.

1

If you are on a pulse dial line, set your phone to issue tone signals.

Refer to your phone's manual to set the phone to issue tone signals. If your phone is already set to issue tone signals, proceed to the next step.

2

Press the **5** key once and the ***** key twice on the extension phone.

Fax reception is activated.

3

Replace the extension phone.



The one-digit number that is used to activate fax reception from an extension phone (initially set to "5") is called the "remote reception number". You can change this number to any number from 0 to 9 in the system settings.

- ▶ [Remote Reception \(page 6-22\)](#)



Sending a fax after talking on the phone (Manual transmission)

If the other fax machine is set to manual reception, you can talk to the other party and then send a fax without breaking the connection.



Automatic redialling ([► page 4-18](#)) will not take place if the line is busy.

1

Follow steps 1 to 4 of [BASIC PROCEDURE FOR SENDING FAXES \(page 4-8\)](#) and then follow the steps below.

2

Lift the extension phone.

3

Dial the number of the other party.

4

Speak to the other party when they answer.

5

After the other party switches to fax reception, press your [B/W START] key.

Transmission begins.



If you have loaded the original on the document glass, you can only send one page by manual transmission.



Cancelling a fax transmission...

Press the [C] key. A screen appears asking you to cancel a fax transmission. Select "Yes" with the [▼] [▲] keys, and press the [OK] key.

6

Replace the extension phone.

Receiving a fax after talking (Manual reception)

When an extension phone is connected to the machine and you have set the reception mode to Manual ([► page 4-27](#)), you can talk to a person sending a fax manually and then begin fax reception without breaking the connection.



OTHER FUNCTIONS

WHEN A TRANSACTION REPORT IS PRINTED

The machine has been set to automatically print a transaction report to notify you of the result when a transmission is not successful or when the Broadcast transmission function is used.

When transmission is not successful and a transaction report similar to the following is printed, "FOLLOWING DATA CANNOT BE SENT. PLEASE HAND THIS REPORT TO XXX.", read the report and take appropriate action.

The transaction report is set at the factory to print at the times indicated in grey below, however, the times at which the report is printed can be changed in the system settings.

► [List Setting \(page 6-20\)](#)

- **Normal transmission:** ALWAYS PRINTS / ERROR ONLY / NEVER PRINTS
- **Broadcast transmission:** ALWAYS PRINTS / ERROR ONLY / NEVER PRINTS
- **Original image print setting*:** ALWAYS PRINTS / ERROR ONLY / NEVER PRINTS
- **Reception:** ALWAYS PRINTS / ERROR ONLY / NEVER PRINTS

The Transaction Report shows the date of transmission, the time transmission began, the other party's name, the duration of the operation, the number of pages, the type of transmission, the result, the department, and other information.

* You can select whether or not part of the transmitted original is printed with transaction reports that are printed for normal transmissions and broadcast transmissions.



The list count appears in the "#" column of the Transaction Report and a serial number appears in the FILE column. (These numbers are not related to the transaction.)

INFORMATION APPEARING IN THE TYPE/NOTE COLUMN

Information such as the type of transmission and type of error appears in the TYPE/NOTE column of the [REPORT AT REGULAR INTERVALS \(COMMUNICATION ACTIVITY REPORT\) \(page 4-61\)](#).

The following notes may appear.

Sending result	Explanation
OK	Transmission was completed successfully.
BUSY	Transmission was not successful because the line was busy.
CANCEL	A transmission was cancelled while in progress or a stored transmission job was cancelled.
P. FAIL	The power was turned off or a power failure occurred.
NO RX POLL	A polling request was denied because the polling machine did not have its own fax number programmed.
PASS CODE # ERR	A polling request was denied because the other machine's fax number had not been stored as a polling passcode in your machine.
ORIG ERROR	When you attempted to send a fax from the document feeder in direct transmission mode, a misfeed occurred.



Sending result	Explanation
ERRORXXXXXX First two digits Last four digits	Line conditions prevented the transmission from taking place normally. A code used by service technicians appears.
XX-XX OK	When group dialling or broadcast transmission was performed, xxx- : Indicates total number of transmissions. xxx OK: Indicates completed transmissions.

Reception result	Explanation
OK	Reception was completed successfully
P. FAIL	The power was turned off or a power failure occurred.
MEMORY FULL	The image memory became full during substitute reception to memory.
LENGTH OVER	The transmitted document was over 800 mm long and therefore could not be received.
NO RX POLL	When polling was attempted, Your fax number (sender's number) was not programmed in your machine. Your fax number was not programmed as a polling passcode number in the other machine.
RX NO POLL	When polling was attempted, The other machine did not have a polling function. The other machine did not have a document stored in polling memory.
ERRORXXXXXX First two digits Last four digits	Line conditions prevented the reception from taking place normally. A code used by service technicians appears.
XX-XX OK	When serial polling ended normally, xxx- : Indicates total number of transmissions. xxx OK: Indicates completed transmissions.
JUNK FAX ERR	Fax reception was denied by the reception denial function.



REPORT AT REGULAR INTERVALS (COMMUNICATION ACTIVITY REPORT)

Your machine keeps a record of the most recent 50 transactions (both transmissions and receptions) that were performed. The record includes the date of the transaction, the other party's name, the duration, and result. You can have the report automatically printed when the number of transactions exceeds 50, or at a specified time. This allows you to check the machine's activity at regular intervals.

The machine is initially set (factory default setting) to not print the report. To have the report printed, change the setting in the system settings.

► [List Setting \(page 6-20\)](#)



- Refer to the table on [WHEN A TRANSACTION REPORT IS PRINTED \(page 4-59\)](#) for the notes that appear in the TYPE/NOTE column.
- The activity report can also be printed out on demand.
► [PRINTING LISTS OF PROGRAMMED INFORMATION AND SETTINGS \(page 4-46\)](#)

WHEN AN ALARM SOUNDS AND A WARNING MESSAGE IS DISPLAYED

When an error occurs during a transaction, an alarm will sound and a message will appear in the display.

If one of the following messages appears, follow the instructions in the table.

If another messages appears, see Troubleshooting.

Message (alarm sounds)	Meaning of message	Solution	Page
XXXXXX Line error.	An error prevented completion of the transaction.	Try the transaction again.	–

SELF-DIAGNOSTIC FUNCTION

The machine has a self-diagnostic function that automatically stops operation if a problem occurs in the machine. If a problem occurs in fax mode, the following display appears.

Message display	Action
⚠ Call for service. code:xx xx. Main code Sub code	Turn off the power and then turn it back on. If the error is not cleared, note the 2-digit main code and the 2-digit sub-code and then contact your dealer.



MESSAGES DURING NORMAL OPERATION

Message		Meaning of message
SENT No.001	xx% P-xxx	This appears when a direct transmission ends ("xx" indicates the number of pages).
READING No.001	xx% P-xxx	The original is being scanned into memory (during memory transmission).
Stand-by. 22 AUG FRI 10:25	100%	The machine is in the standby state.
ENTER DIAL #		This appears when the [SPEAKER] key () has been pressed.



SCANNER

BEFORE USING THE MACHINE AS A NETWORK SCANNER

ABOUT THE SCANNER FUNCTIONS 5-2

SCANNER SEQUENCE

THE BASE SCREEN OF SCANNER MODE 5-4

SENDING AN IMAGE 5-5

- BASIC TRANSMISSION PROCEDURE 5-5
- SELECTING A DESTINATION (USING THE [ADDRESS] KEY) 5-9
- TRANSMITTING A TWO-SIDED ORIGINAL 5-11

STORING SCANNING SETTINGS 5-12

- SETTING THE SCANNING SIZE 5-12
- SELECTING THE RESOLUTION 5-13
- SELECTING THE FILE FORMAT 5-14
- SELECTING THE Mono2/Greyscale 5-14
- ADJUSTING THE SCANNING EXPOSURE 5-15
- ENABLING SCANNING MARGINS (VOID AREA) 5-15
- SCANNING A THIN ORIGINAL (SLOW SCAN MODE) 5-16
- ADJUSTING THE BACKGROUND BY MAKING LIGHT AREAS OF THE ORIGINAL DARKER OR LIGHTER (SUPPRESS BG) 5-18
- ADJUSTING THE SHARPNESS OF AN IMAGE (SHARPNESS) 5-19
- STORING AND EDITING/DELETING A PROGRAM 5-20
- USING STORED SETTINGS (PROGRAM) 5-20

SCANNING FROM YOUR COMPUTER (PC SCAN)

SCANNING FROM A TWAIN-COMPLIANT APPLICATION 5-21

SAVING IN USB MEMORY DEVICE

USB MEMORY SCAN 5-25

- USING THE USB MEMORY SCAN FUNCTION 5-25



BEFORE USING THE MACHINE AS A NETWORK SCANNER

ABOUT THE SCANNER FUNCTIONS

With this machine a document or photo can be scanned into an image file. You can then send the data file to the file server or your computer using the inter-corporate network (Intranet) or the Internet. To send originals using the scanner function, specify the stored destination (delivery address information name) from the operation panel (display) of the machine.

1. Scanning from a TWAIN-compliant application

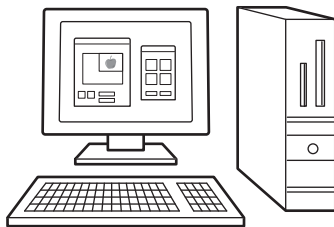

2. Storing the scanned image to a USB flash memory



4. Sending the scanned data to a computer connected to the same network

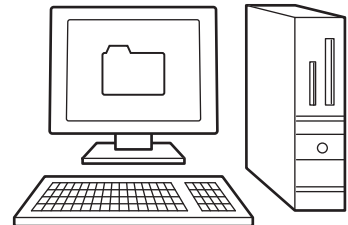

3. Sending the scanned data to FTP server

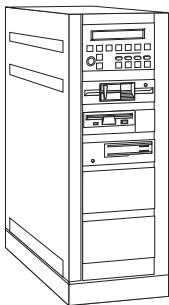

5. Sending the scanned data by E-mail

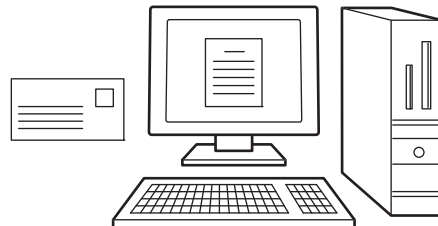



Scanning from a TWAIN-compliant application

A TWAIN-compliant application on a computer connected to the same network as the machine is used to scan a document or image.

To use PC Scan, the scanner driver must be installed from the "Software CD-ROM" that accompanies the machine. For more information on scanning from a TWAIN-compliant application, see [SCANNING FROM YOUR COMPUTER \(PC SCAN\) \(page 5-21\)](#).

Storing the scanned image to a USB flash memory

The scanned image can be stored to a USB flash memory installed on the machine. This is called "USB Memory Scan" in this manual. For more information on USB Memory Scan, see [USB MEMORY SCAN \(page 5-25\)](#).

Sending the scanned data to FTP server

The scanned image can be sent to a memory storage device on a network (a designated directory on an FTP server). (This is called "Scan to FTP" in this manual.)

Sending the scanned data to a computer connected to the same network

The scanned file is sent to a shared folder on a Windows computer on the same network as the machine. (This is called "Scan to Network Folder" in this manual.)

The scanned file is sent to a specified folder on your computer. (This is called "Scan to Desktop" in this manual.) For information on Scan to Desktop, which is used to send a scanned file to a specified folder of your computer, consult your dealer.

Sending the scanned data by E-mail

The scanned image can be sent to an e-mail recipient. (This is called "Scan to E-mail" in this manual.)



SCANNER SEQUENCE

THE BASE SCREEN OF SCANNER MODE

The base screen of scan mode is displayed by pressing the [SCAN] key () from the base screen of copy mode or fax mode.

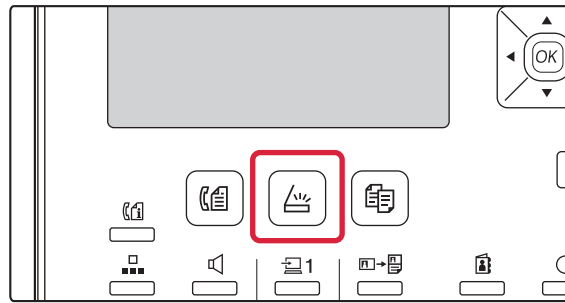

If a screen appears asking you what type of connection you are using after you press the [SCAN] key (), select "Network" with the [▼] or [▲] key and press the [OK] key.

Base screen of scan mode

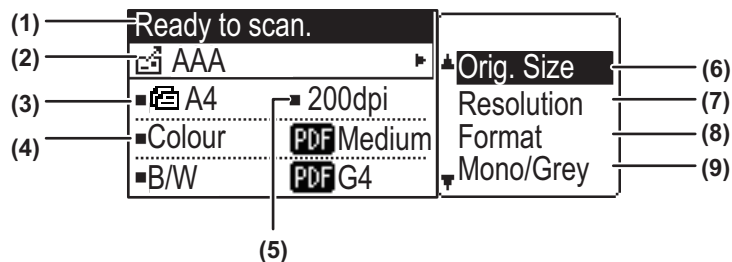

(1) Message display

Messages appear here to indicate the current status of the machine.

(2) Destination display

This shows the selected destination.

There are scanner transmission modes:

Scan to E-mail, Scan to Network Folder, Scan to FTP, Scan to Desktop, and USB Memory Scan.

This shows the currently selected destination and transmission mode.

(3) Original scanning mode / Original size display

Shows the currently selected original scanning mode and scanning size.

 : The document feeder has detected that an original has been placed (one-sided scanning in the document feeder)

 : Two-sided scanning in the document feeder.

None: Document glass

(4) File format display

This shows the image data file type and file method to be created.

(5) Resolution display

This shows the scanning resolution.

(6) Original size [▶ page 5-12](#)

This is used to set the size of the original to be transmitted.

(7) Resolution [▶ page 5-13](#)

This is used to select the scanning resolution.

(8) Format [▶ page 5-13](#)

This is used to select the image data file type and file method to be created.

(9) Mono2/Greyscale [▶ page 5-14](#)

After pressing the [B/W START] key, select whether you want to scan the image in "Mono2" or "Greyscale".



SENDING AN IMAGE

BASIC TRANSMISSION PROCEDURE



Scanner transmission job cannot be accepted while printing a fax receiving data. Start scanning after the fax data printing is finished.

Using the document feeder

1**Make sure the machine is in scan mode.**

When the SCAN indicator is lit, the machine is in scan mode. If the indicator is not lit, press the [SCAN] key (). If auditing mode has been enabled for the scan function in the system settings, a message will appear prompting you to enter your account number when you switch to scan mode. Enter your account number (five digits) with the numeric keys.

► [User Authentication \(page 6-12\)](#)

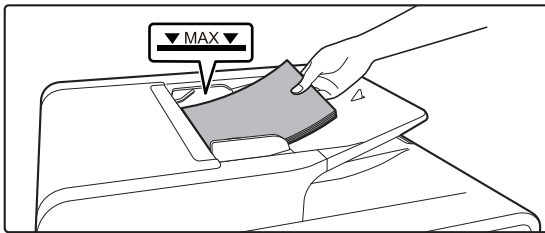
2**Place the original.**

Place the original in the document feeder tray of the automatic document feeder.

► [AUTOMATIC DOCUMENT FEEDER \(page 1-31\)](#)

3**Check the original size.**

To change the original size, change as explained in [STORING SCANNING SETTINGS \(page 5-12\)](#).

4**If needed, select the resolution setting.**

► [SELECTING THE RESOLUTION \(page 5-13\)](#)

The initial factory setting is [200dpi].

5**If needed, select the format.**

► [SELECTING THE FILE FORMAT \(page 5-14\)](#)

The initial factory setting

- Colour / Greyscale : PDF M
- B/W : PDF G4

6**If needed, select "Mono/Grey".**

► [SELECTING THE Mono2/Greyscale \(page 5-14\)](#)

7**Press the [ADDRESS] key ().**



8

Select the destination selection method.

► [SELECTING A DESTINATION \(USING THE \[ADDRESS\] KEY\) \(page 5-9\)](#)

Select from the following three destination selection methods:

- [Address book \(page 5-9\)](#)
Select one of the stored destinations directly from the operation panel.
- [Address entry \(page 5-9\)](#)
Directly enter the e-mail address. (Only for Scan to E-mail.)
- [Address search \(page 5-10\)](#)
Access a directory data base on the Internet or your intranet and search for a destination e-mail address. During a global address search, multiple addresses can be entered to perform a broadcast transmission. When you have finished searching for the destination, you will return to the following base screen.



- Information on the destination can be stored in the Web page.
- The sender name is normally set to the name stored in "Reply E-mail Address" in "SMTP Setup" in the Web page.

9

Press the [COLOUR START] or [B/W START] key.

Scanning begins.

If scanning is completed normally, the following screen is appears briefly and then the display returns to the base screen.



Cancelling transmission

► [Cancelling transmission \(page 5-8\)](#)



If a misfeed occurs during scanning in scan mode, scanning will be cancelled and the data scanned will be deleted. Remove the misfed original and reload the originals from the beginning.

Using the document glass

1

Make sure the machine is in scan mode.

When the SCAN indicator is lit, the machine is in scan mode. If the indicator is not lit, press the [SCAN] key (). If auditing mode has been enabled for the scan function in the system settings, a message will appear prompting you to enter your account number when you switch to scan mode. Enter your account number (five digits) with the numeric keys.

► [User Authentication \(page 6-12\)](#)

2

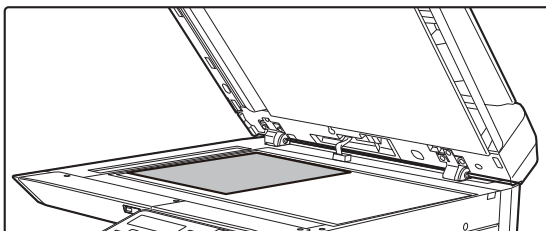
**Place the original.**

Place the original on the document glass.

► [DOCUMENT GLASS \(page 1-33\)](#)

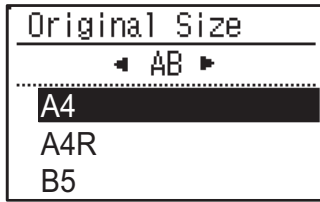

3

**Specify the original size.**

Select the "Original Size" on the right menu.

The paper size can be selected

AB type:

A3, B4, A4, A4R, B5, B5R, A5, A5R, B6R, A6R, Not Specified

Inch type:

11" x 17" , 8-1/2" x 14" , 8-1/2" x 13-1/2" , 8-1/2" x 13-2/5" ,
8-1/2" x 13" , 8-1/2" x 11" , 8-1/2" x 11"R, 5-1/2" x 8-1/2" ,
5-1/2"x8-1/2"R, Not Specified

**Specify a frequently used original size.**

Select the setting in [System Settings] → [Scanner] → [New Default] → [Orig. Size Enter].

4

If needed, select the resolution setting.

► [SELECTING THE RESOLUTION \(page 5-13\)](#)

The initial factory setting is [200dpi].

5

If needed, select the format.

► [SELECTING THE FILE FORMAT \(page 5-14\)](#)

The initial factory setting

- Colour / Greyscale : PDF M
- B/W : PDF G4

6

If needed, select "Mono/Grey".

► [SELECTING THE Mono2/Greyscale \(page 5-14\)](#)

7

Press the [ADDRESS] key (🔑).

8

Select the destination selection method.

► [SELECTING A DESTINATION \(USING THE \[ADDRESS\] KEY\) \(page 5-9\)](#)

Select from the following three destination selection methods:

- [Address book \(page 5-9\)](#)
Select one of the stored destinations directly from the operation panel.
- [Address entry \(page 5-9\)](#)
Directly enter the e-mail address. (Only for Scan to E-mail.)
- [Address search \(page 5-10\)](#)
Access a directory data base on the Internet or your intranet and search for a destination e-mail address.
During a global address search, multiple addresses can be entered to perform a broadcast transmission.
When you have finished searching for the destination, you will return to the following base screen.



- Information on the destination can be stored in the Web page.
- The sender name is normally set to the name stored in "Reply E-mail Address" in "SMTP Setup" in the Web page.



9

Press the [COLOUR START] or [B/W START] key.

Scanning begins.

10

If you have another page to scan, change pages and then press [COLOUR START] or [B/W START] key.

- Repeat this sequence until all pages have been scanned.
- If no action is taken for one minute (the [COLOUR START] or [B/W START] key is not pressed), scanning automatically ends and transmission begins.

11

When the final original page has been scanned, press the [READ-END] key (#).

Open the document feeder and remove the document. When the original is removed or any key operation is performed, the display returns to the base screen.

**Cancelling transmission**

- [Cancelling transmission \(page 5-8\)](#)

Cancelling transmission

- To cancel the transmission while "Reading" appears or before the [READ-END] key (#) is pressed, press the [C] or [CA] key.
- If the power is turned off or a power failure occurs while a document is being scanned in the document feeder, the machine will stop and a document misfeed will occur. After power is restored, refer to Troubleshooting to remove the original.
- When performing a Scan to E-mail transmission, note the following points:
Be careful not to send image data files that are too large. Your mail server's system administrator may have placed a limit on the amount of data that can be sent in one e-mail transmission. If this limit is exceeded, the e-mail will not be delivered to the recipient. Even if there is no limit and your e-mail is successfully delivered, a large data file may take a long time to be received and place a heavy burden on the recipient's network, depending on the recipient's network (Internet) environment. If large image data files are repeatedly sent, the resulting burden on the network may slow down the speed of other, unrelated data transmissions and in some cases, may even cause the mail server or network to go down. In cases where you need to send a large file or multiple images, try lowering the resolution or reducing the scanned original size.



SELECTING A DESTINATION (USING THE [ADDRESS] KEY)

A destination can be selected using one of three methods: Selecting from "ADDRESS BOOK", using "ADDRESS ENTRY", or "ADDRESS SEARCH".



- Multiple destination scan can be selected for a Scan to E-mail transmission. (E-mail and Group (E-mail) destinations can be selected at the maximum of 20 destinations, which will consequently allow broadcasting up to 300 individual destinations in total.)
- Only one destination can be selected for a Scan to Network, Scan to FTP or Scan to Desktop transmission.

Address book

1

Press the [ADDRESS] key () , and select the "Address Book".

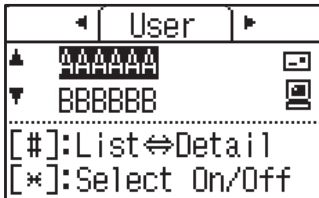
2

Change tabs as needed with the [◀] or [▶] key and select the desired destination with the [▼] or [▲] key.

You can switch between information on the selected destination and the destination list by pressing the [READ-END] key (#).

3

Press the [READ-END] key (#).

A checkmark appears by the selected destination. To cancel the selection, press the [READ-END] key (#) once again to remove the checkmark. To select multiple destinations, repeat steps.

Address entry

1

Press the [ADDRESS] key () , and select "Address Entry" with the [▼] key, and press the [OK] key.

2

Enter the destination address.

3

Press the [OK] key.



Address search

1 Press the [ADDRESS] key () , and select "Global Address Search" with the [▼] key, and press the [OK] key.

2 Enter the search characters.

3 Select the desired destination with the [▼] or [▲] key.

4 Press the [OK] key.



TRANSMITTING A TWO-SIDED ORIGINAL

The original field of the display shows the original scanning size.
The current original scan mode setting is indicated by an icon.

- : One-sided scanning in the document feeder.
 : Two-sided scanning in the document feeder.
 None: Document glass

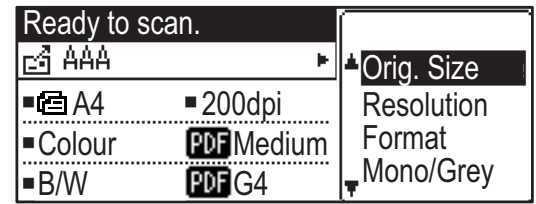

Follow these steps to automatically transmit a two-sided original.



Only the following two-sided document sizes can be used:

Standard sizes

AB Type:

A3, B4, A4, A4R, B5, B5R, A5, A5R, 8K, 16K, 16KR

Inch Type:

11" x 17", 8-1/2" x 14", 8-1/2" x 13-1/2", 8-1/2" x 13-2/5", 8-1/2" x 13", 8-1/2" x 11", 8-1/2" x 11"R, 5-1/2" x 8-1/2", 5-1/2" x 8-1/2"R

Non-standard sizes

AB sizes X: 140 to 432mm, Y: 131 to 297mm

Inch sizes X: 5-1/2 to 17 inches, Y: 5-1/8 to 11-5/8 inches

1

Place the original(s) in the document feeder tray, and check the original size.

For information on placing an original, see [HOW TO PLACE THE ORIGINAL \(page 1-31\)](#).

2

Press the [DUPLEX] key (), and Select "2-Sided" with the [▼] or [▲] key, and press the [OK] key.

3

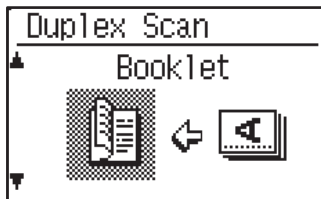

Select "Portrait-Booklet", "Portrait-Tablet", "Landscape-Booklet", "Landscape-Tablet" with the [▼] or [▲] key, and press the [OK] key.

4

Press the [OK] key.



- Booklets and tablets Two-sided originals that are bound at the side are booklets, and two-sided originals that are bound at the top are tablets.
- Duplex scanning is cancelled when the transmission is completed, or when the [CA] key is pressed.
- Duplex scanning of two-sided originals is only possible when a Document feeder is used. Automatic scanning of both sides of an original is not possible when the document glass is used.
- The image of the back side of the original is rotated 180 degrees if needed at the time of transmission, and thus there is no need to change the orientation at the receiving machine.
- To cancel duplex scanning, select "1-Sided" in step 1 and then press the [OK] key.

BOOKLET



TABLET

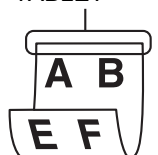



STORING SCANNING SETTINGS

Sets of scanning settings (scan size, resolution, file type, etc.) can be changed for use in various scanning applications.

SETTING THE SCANNING SIZE

If you change the original size, follow the steps below to change the setting after you have placed the original in the document feeder or on the document glass ([▶ page 1-31](#)).

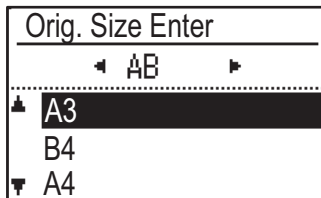
1

Select "Original Size" with the [▼] or [▲] key, and then select the original size.

To select an inch size, press the [▶] key.

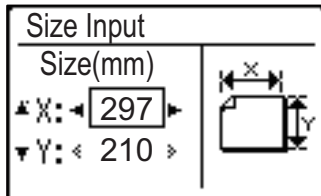

The original scanning size can be set manually.

In the Inch original size selection screen, select [Size Input] and press the [OK] key to display the screen below.

Select the width (X) or the length (Y) with [▼] or [▲] key, and adjust in increments of 1 mm or 1/8" with [◀] or [▶] key.

Input range

X: 140 to 432 mm / 5-1/2" to 17"*

Y: 131 to 297 mm / 5-1/8" to 11-5/8"

* X: 25 to 432 mm / 1" to 17"

Y: 25 to 297 mm / 1" to 11-5/8" when the document glass is used



To cancel a manual original size setting, press the [CA] key.

If it is not possible to select the actual original size, select a size that is larger than the actual original size.

If a smaller size is selected, part of the original will not be transmitted.



SELECTING THE RESOLUTION

The scanning resolution can be selected. After selecting scan mode and placing the original (steps 1 to 3 on [page 5-5](#)), perform the procedure below.

The factory default setting for the resolution is "200dpi".

If you need to change the resolution, follow these steps.

1

Select "Resolution" with the [▼] or [▲] key, and then select the resolution.

2

Press the [OK] key.



Resolution

- The default resolution setting is 200 dpi. For typical text documents, a resolution of 200 dpi or 300 dpi produces sufficiently legible image data. (A resolution of 200 dpi corresponds to the generally used "Fine" in fax mode.) For this reason, the 600 dpi setting should only be used in cases where high-clarity image reproduction is required, such as an original that includes photographs or illustrations.
 - The default setting can be changed in the system settings. ([▶ page 6-28](#))
-



SELECTING THE FILE FORMAT

After selecting scan mode and placing the original (steps 1 to 3 on [page 5-5](#)), perform the procedure below.

The factory default settings are "PDF" for the file type and "Multi" for the file creation method (multiple scanned images are combined into one file).

If you need to change the file format, follow these steps.

- 1 Select "Format" with the [▼] or [▲] key, and select "Colour / Greyscale" or "Mono2", and press the [OK] key.

2

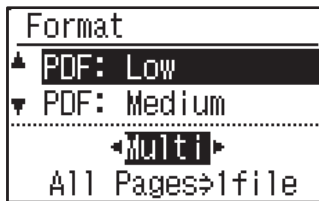

- 2 Select the file type with the [▼] or [▲] key, and select the file creation method.

When "Single" is selected, a one-page file is created for the scanned image.

When "Multi" is selected, all scanned images can be combined into a single file.

3

- 3 Press the [OK] key.



- When the file type is set to "TIFF", the file creation method can only be select.
- To open the scanned image without using the software program in the accompanied CD-ROM, the recipient must have a viewer program that can open the image format (file type) that was selected as explained above. If the recipient cannot open the image, try sending the image in a different format.

SELECTING THE Mono2/Greyscale

After pressing the [B/W START] key, select whether you want to scan the image in "Mono2" or "Greyscale".

The factory default setting for the colour mode is "Mono2".

Mono2

Colours in the original are scanned as black or white.

Greyscale

The colours in the original are scanned in black and white as shades of grey (greyscale).

1

- 1 Select "Mono/Grey" with the [▼] or [▲] key.

2

- 2 Select "Greyscale", or "Mono2", and press the [OK] key.



ADJUSTING THE SCANNING EXPOSURE

The exposure for an image can be adjusted. The larger the value, the darker the image. Select scan mode, place the original (steps 1 to 3 on [page 5-5](#)), and then follow the procedure below. The scanning exposure is set to "Txt/Prt Photo Auto" by factory default.

- 1 Press [EXPOSURE] key (ⓘ), and select "Text", "Txt/Prt Photo", or "Photo" for the original type with the [▼] or [▲] key.

- 2

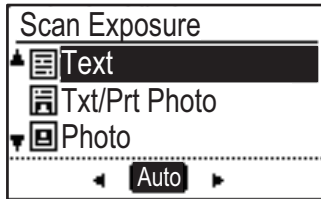

- 2 Select, change the level (5 levels are available) with the [◀] [▶] keys.

- 3

- 3 Press the [OK] key.

ENABLING SCANNING MARGINS (VOID AREA)

When this function is enabled, margins (void areas that are not scanned) are created around the edges of the machine's maximum scanning area.

Select scan mode, place the original (steps 1 to 3 on [page 5-5](#)), and then follow the procedure below.

The factory default setting for the void area is "Off" (disabled).

If you need to change the void area setting, follow these steps.

Void area: 2.5 mm (7/64") from the top and bottom edges
3.0 mm (1/8") from the left and right edges

- 1

- 1 Press the [SPECIAL FUNCTION] key (Fn) to select "Void Area" with the [▼] or [▲] key and press the [OK] key.

- 2

- 2 Select "On" or "Off" with the [▼] or [▲] key.

- 3

- 3 Press the [OK] key.



SCANNING A THIN ORIGINAL (SLOW SCAN MODE)

Use this function when you wish to scan thin originals using the automatic document feeder. This function helps prevent thin originals from misfeeding.

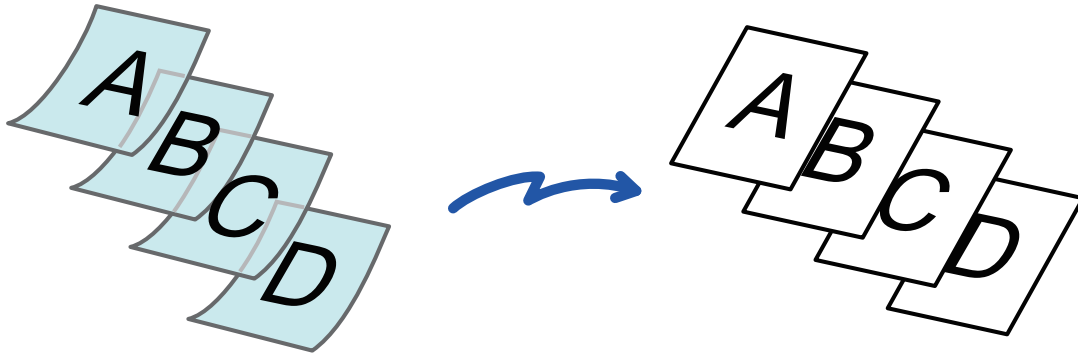

When slow scan mode is selected, 2-sided scanning is not possible.

1

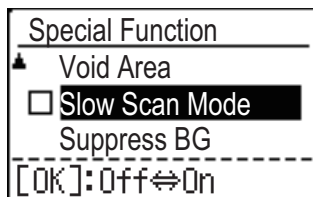

Press the [SPECIAL FUNCTION] key (Fn), select "Slow Scan Mode" with the [▼][▲] keys and press the [OK] key.

A checkmark appears on the icon.

After the settings are completed, press the [BACK] key (↵).



To cancel the slow scan Mode setting

Select "Slow Scan Mode" to uncheck it.

2

Place the original in the document feeder tray of the automatic document feeder.

Adjust the original guides slowly.

► [AUTOMATIC DOCUMENT FEEDER \(page 1-31\)](#)



If the originals are inserted with too much force, they may crumple and misfeed.

3

Specify the destination.



4

Press the [COLOUR START] or [B/W START] key to start scanning of the original.

A beep will sound to indicate that scanning and transmission have ended.



ADJUSTING THE BACKGROUND BY MAKING LIGHT AREAS OF THE ORIGINAL DARKER OR LIGHTER (SUPPRESS BG)

You can adjust the background by making light areas of the original darker or lighter.

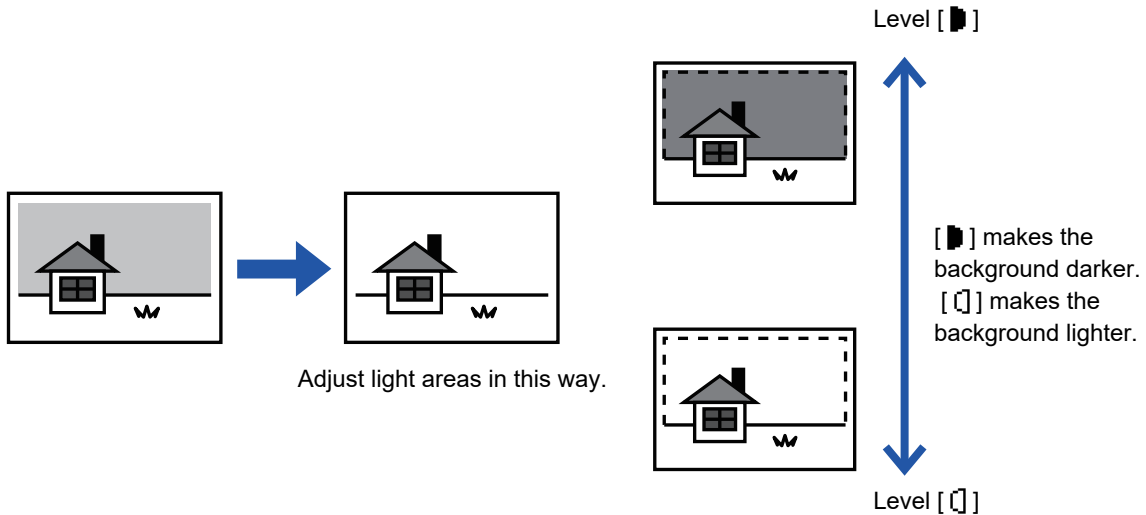

You must select Background Adjustment before scanning the original.

1

Press the [SPECIAL FUNCTION] key (Fn), select "Special Modes" with the [▼][▲] keys, and press the [OK] key.

2

Select "Suppress BG" with the [▼] [▲] keys and press the [OK] key.

3

Select level adjustment with the [▼] [▲] keys, and adjust with the [◀][▶] keys.

To select, change the level (3 levels are available) with the [◀][▶] keys and press the [OK] key.

■ : Only light backgrounds are suppressed.

□ : Light to dark backgrounds are suppressed.



To cancel the Background Adjustment setting:

Select "Off" with the [▼][▲] keys and press the [OK] key.



ADJUSTING THE SHARPNESS OF AN IMAGE (SHARPNESS)

This function adjusts the sharpness to make a sharper or softer image.

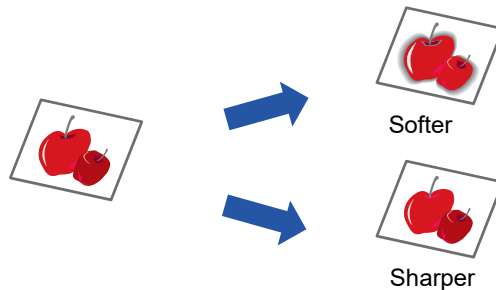

Sharpness must be specified before scanning the original.

1

Press the [SPECIAL FUNCTION] key (Fn), select "Special Modes" with the [▼][▲] keys, and press the [OK] key.

2

Select "Sharpness" with the [▼] [▲] keys and press the [OK] key.

3

Select "Off", "Soft", or "Sharp" with the [▼][▲] keys and press the [OK] key.



To cancel the sharpness setting:

Select "Off" with the [▼][▲] keys and press the [OK] key.



STORING AND EDITING/DELETING A PROGRAM

This function lets you store a transmission address and scanning settings. The address and settings can be called up when you scan a document, saving you the trouble of selecting the address and settings. Up to two programs can be stored for scanning.

• Address Setting • Original Size • Resolution • Format • Exposure • Original scanning mode • Slow Scan Mode can be stored in a program.

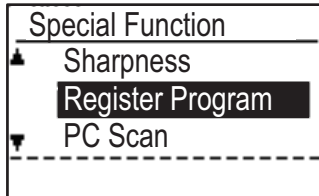
1

Press the [SPECIAL FUNCTION] key (F_n) and select "Register Program" with the [▼] or [▲] key, and press the [OK] key.

The original size is set to business card size (custom).

2

Select "Enter", "Change", "Delete", and press the [OK] key.

- Register program

- (1) Select "No Store", and press the [OK] key.

- (2) Select the program you want to store with the [▼] or [▲] key, and press the [OK] key.

Setting each screen will be displayed.

- (3) Press the [OK] key to perform the required settings.

Return to step 2.

- (4) Press the [COLOUR START] or [B/W START] key.

Programs are stored.

- Change program

- (1) Select the program you want to change, and press the [OK] key.



Change the settings same operation as for registration.

- Delete program

- (1) Select the program you want to delete, and press the [OK] key.

- (2) Select "Delete", and press the [OK] key.

USING STORED SETTINGS (PROGRAM)

Press the [Program 1] or [Program 2] key ( 1 /  2). See [BASIC TRANSMISSION PROCEDURE \(page 5-5\)](#).



SCANNING FROM YOUR COMPUTER (PC SCAN)

SCANNING FROM A TWAIN-COMPLIANT APPLICATION

The machine supports the TWAIN standard, making it possible to scan from TWAIN-compliant applications. Scanning in PC scan mode is only possible when the scanner driver has been installed from the "Software CD-ROM" using the integrated installer. For the procedures for installing the scanner driver and configuring settings, see the Software Setup Guide.

1

```
PC Scan
Do not remove the original.
IP Address: 000.000.000.000
.....
[Back]: Exit
```

Place the original(s) that you wish to scan on the document glass/document feeder. Press the [SPECIAL FUNCTION] key (Fn), select "PC SCAN", and press the [OK] key.

2

After starting TWAIN-compliant application, click the "File" menu and select a menu to scan.



The method for accessing the menu to select the scanner depends upon the application. For more information, refer to the manual or the help file of your application.

3

Select "SHARP MFP TWAIN K", and click the "Select" button.



Depending on your system, "SHARP MFP TWAIN K 1.0 (32-32)" may appear in the above "Select Source" screen.

4

Select the menu to acquire an image from the application's "File" menu.

The scanner driver setup screen will appear.

► [Scanner driver settings \(page 5-23\)](#)



5



In the "Scanning Source" menu, select the location where you placed the original in Step 1.

If you placed a two-sided original in the document feeder, select "SPF (Duplex-Book)" or "SPF (Duplex-Tablet)" according to the binding position of the original.



If you selected "SPF (Duplex-Book)" or "SPF (Duplex-Tablet)" in the "Scanning Source" menu, select whether the orientation of the placed original is "Left edge is fed first" or "Top edge is fed first".

6

Click the "Preview" button.

The preview image will appear.



- If the angle of the image is not correct, reset the original, and click the "Preview" button again.
- If the preview image is not oriented correctly, click the "Rotate" button in the preview screen. This rotates the preview image 90 degrees clockwise, allowing you to correct the orientation without resetting the original.
 - ▶ [Preview screen \(page 5-24\)](#)
- If you set multiple pages in the document feeder, the machine previews only the top page of the originals, and then sends it to the original exit area. Return the previewed original to the document feeder before starting the scanning job.

7

Specify the scanning area and set the scan preferences.

For information on specifying the scan area and setting the scan preferences, see scanner driver Help.

- ▶ [Scanner driver settings \(page 5-23\)](#)



Scanning a large area at high resolution results in a large quantity of data and a prolonged scanning time. It is recommended that you set appropriate scanning preferences for the type of original being scanned, i.e., Web page (monitor), Photo, FAX, or OCR.

8

When you are ready to begin scanning, click the "Scan" button.

Scanning begins and the image is acquired into the application that you are using. In the application, assign a file name and save the file.



To cancel a scanning job after the "Scan" button has been clicked, press the [Esc] key on your keyboard or the [C] key or [CA] key on the operation panel.

9

Press the [BACK] key (↵) on the operation panel.



Scanner driver settings

The scanner driver setup screen consists of the "Set-up screen", which lets you select scan settings, and the "Preview screen", which shows the scanned image. For details on the scan settings, click the "Help" button in the preview screen to display Help.

Set-up screen

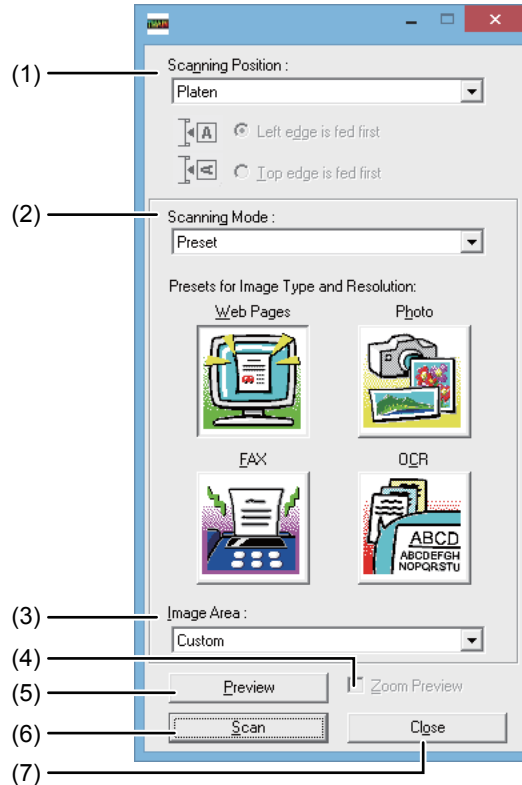

(1) "Scanning Position" menu

("Scanning Source" in some regions)

Select the location where the original is placed. Selections are "Platen" (document glass), "SPF (Simplex)", "SPF (Duplex-Book)" or "SPF (Duplex-Tablet)".

► [SCANNING FROM A TWAIN-COMPLIANT APPLICATION \(page 5-21\)](#)

(2) "Scanning Mode" menu

Select "Preset" or "Custom Settings" ("Standard" or "Professional" in some regions) for the scanning mode. The "Preset (or Standard)" screen lets you select the original type as well as monitor, photo, fax, or OCR according to the purpose of scanning.

If you wish to change the default settings for these four buttons, or select custom settings such as the image type and resolution before scanning, switch to the "Custom Settings (or Professional)" screen.

For details on the settings, click the "Help" button in the preview screen to display Help.

(3) "Image Area" menu

Set the scanning area. To scan the original size detected by the machine, select "Auto".

The scanning area can also be specified as desired in the preview window.

(4) "Zoom Preview" checkbox

When this is selected, the selected part of the preview image will be enlarged when the "Preview" button is clicked.

To return to the regular view, remove the checkmark. [Zoom Preview] cannot be used when [SPF] is selected in the "Scanning Position" menu.

(5) "Preview" button

Previews the document.

If [Preview] is cancelled by immediately pressing the [Esc] key on your keyboard, nothing will appear in the preview screen.

(6) "Scan" button ("Scanning" in some regions)

Click to scan an original using the selected settings.

Before clicking the "Scan" button, make sure the settings are correct.

To cancel a scanning job after the "Scan" button is clicked, press the [Esc] key on your keyboard.

(7) "Close" button

Click to close the scanner driver setup screen.



Preview screen

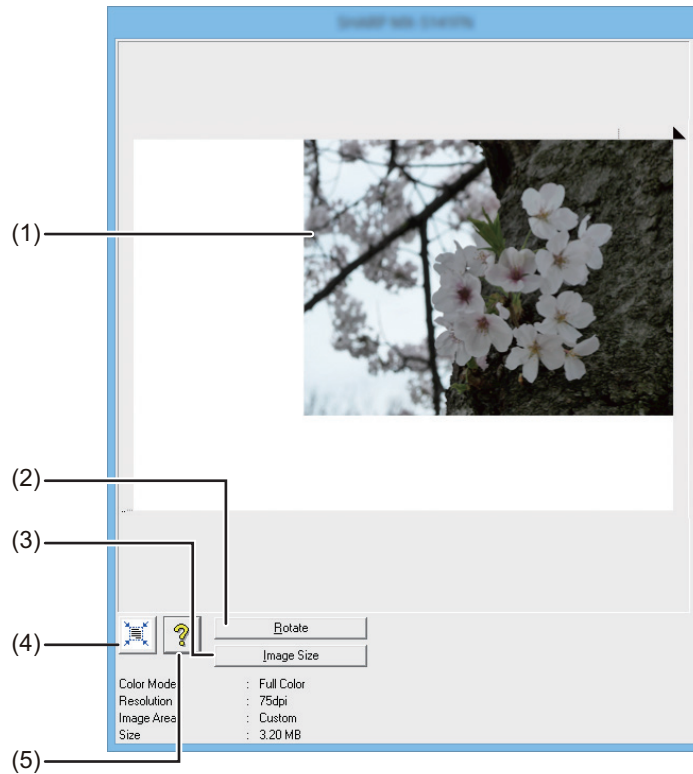

(1) Preview screen

Click the "Preview" button in the Set-up screen to display the scanned image. You can specify the scanning area by dragging the mouse inside the window. The inside of the frame that is created when you drag the mouse will be the scanning area. To cancel a specified scanning area and clear the frame, click anywhere outside the frame.

(2) "Rotate" button

Click to rotate the preview image 90 degrees clockwise. This allows the orientation to be corrected without resetting the original. Upon scanning, the image file is created in the orientation shown in the preview screen.

(3) "Image Size" button

Click to open a dialog box that allows you to specify the scanning area by entering numbers. Pixels, mm, or inches can be selected for the units of the numbers. By initially specifying a scanning area, numbers can be entered to change that area relative to the top left corner as a fixed origin.

(4) "Auto Scan Area Judgement" button

Click when the preview screen is displayed to automatically set the scanning area to the entire preview image.

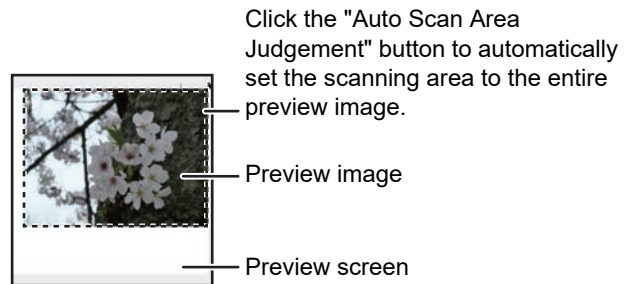

(5) "Help" button

Click to display the help file for the scanner driver.



SAVING IN USB MEMORY DEVICE

USB MEMORY SCAN

USING THE USB MEMORY SCAN FUNCTION

A scanned image can be sent (save) to a commercially available USB flash memory that has been connected to the machine.

Using the document feeder

1**Make sure the machine is in scan mode.**

When the SCAN indicator is lit, the machine is in scan mode. If the indicator is not lit, press the [SCAN] key (). If auditing mode has been enabled for the scan function in the system settings, a message will appear prompting you to enter your account number when you switch to scan mode. Enter your account number (five digits) with the numeric keys.

► [User Authentication \(page 6-12\)](#)

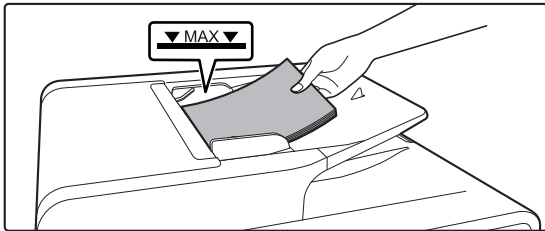
2**Place the original.**

Place the original in the document feeder tray of the automatic document feeder.

► [AUTOMATIC DOCUMENT FEEDER \(page 1-31\)](#)

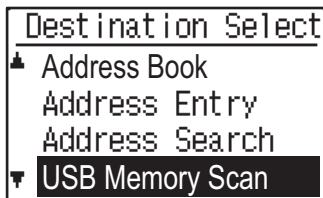

You cannot place originals in both the document feeder tray and on the document glass and send them in a single transmission.

3**Press the [ADDRESS] key ().****4**

Select "USB Memory Scan" using the [▼] key, press the [OK] key.



5

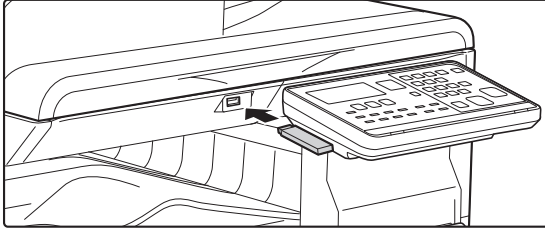

Connect the USB flash memory to the machine.



If a USB flash memory is inserted into the machine prior to step 4, the following screen will appear.

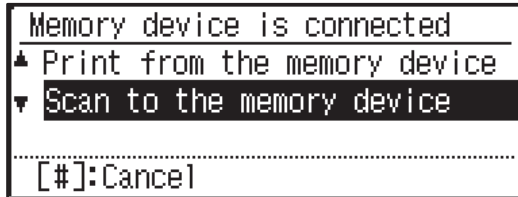

Instead of performing steps 3 and 4, you can select "Scan to the memory device" with the [▼] or [▲] key in the above screen and press the [OK] key to select the USB flash memory as the destination.

6

Press the [COLOUR START] or [B/W START] key.

Scanning begins.

If scanning is completed normally, "Complete." is appears briefly and then the display returns to the base screen.

Using the document glass

1

Make sure the machine is in scan mode.

When the SCAN indicator is lit, the machine is in scan mode. If the indicator is not lit, press the [SCAN] key ().

If auditing mode has been enabled for the scan function in the system settings, a message will appear prompting you to enter your account number when you switch to scan mode. Enter your account number (five digits) with the numeric keys.

► [User Authentication \(page 6-12\)](#)

2

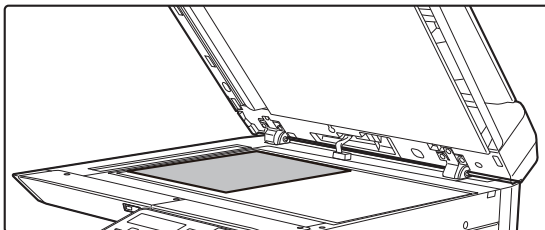

Place the original.

Place the original on the document glass.

► [DOCUMENT GLASS \(page 1-33\)](#)

3

Check the original size.

To change the original size, change as explained in [STORING SCANNING SETTINGS \(page 5-12\)](#).



You cannot place originals in both the document feeder tray and on the document glass and send them in a single transmission.



4

Press the [ADDRESS] key (📄).

5

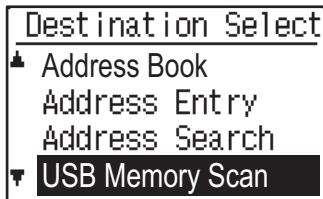

Select "USB Memory Scan" using the [▼] key, press the [OK] key.

6

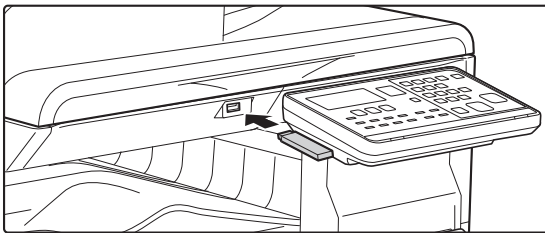

Connect the USB flash memory to the machine.



If a USB flash memory is inserted into the machine prior to step 4, the following screen will appear.

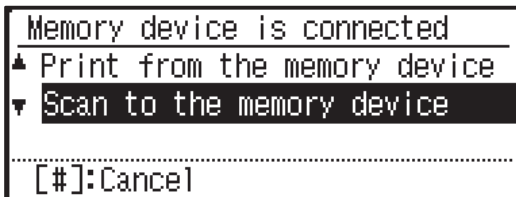

Instead of performing steps 3 and 4, you can select "Scan to the memory device" with the [▼] or [▲] key in the above screen and press the [OK] key to select the USB flash memory as the destination.

7

Press the [COLOUR START] or [B/W START] key.

Scanning begins.

8

If you have another page to scan, change pages and then press the [COLOUR START] or [B/W START] key.

- Repeat this sequence until all pages have been scanned.
- If no action is taken for one minute (the [COLOUR START] or [B/W START] key is not pressed), scanning automatically ends and transmission begins.

9

When the final original page has been scanned, press the [READ-END] key (#).

Open the document feeder and remove the document. When the original is removed or any key operation is performed, the display returns to the base screen.



SYSTEM SETTINGS

PURPOSE OF THE SYSTEM SETTINGS

PROGRAMS RELATED TO ALL FUNCTIONS OF THE MACHINE	6-2
PROGRAMMING AN ADMINISTRATOR PIN CODE	6-2
• PROGRAMMING AN ADMINISTRATOR PIN CODE	6-2

SYSTEM SETTINGS LIST

USING THE SYSTEM SETTINGS

SYSTEM SETTINGS

• Change Admin PIN	6-10
• Initial Setting	6-10
• Network	6-10
• User Control	6-12
• Device Control	6-13
• Operation Setting	6-15
• Energy Save	6-16
• List Print	6-17
• Auto Calibration	6-17
• Security Settings	6-18
• Copier	6-19
• Printer	6-20
• Fax	6-20
• Scanner	6-28



PURPOSE OF THE SYSTEM SETTINGS

The system settings are used by the administrator of the machine to enable or disable functions to suit the needs of your workplace.

PROGRAMS RELATED TO ALL FUNCTIONS OF THE MACHINE

These programs are used to enable user authentication mode, adjust power consumption, and manage peripheral devices.

When user authentication mode is enabled for a function, a valid account number must be entered in order to use the function. (If a valid account number is not entered, the function cannot be used.)

When user authentication mode is enabled for the printer function, an account number must be entered at the user's computer when the print command is selected. (Depending on the system settings, a job may be printed even if an incorrect account number is entered, and thus care must be taken when managing printer page counts.) If "Disable Print by Inv. User" is enabled in the system settings, printing will be prohibited if an invalid account number is entered.)

PROGRAMMING AN ADMINISTRATOR PIN CODE

The administrator PIN code is a 5-digit number that must be entered in order to access the system settings. The administrator (administrator of the machine) should change the default administrator PIN code that was set at the factory to a new 5-digit number. Be sure to remember the new administrator PIN code, as it must be entered each time the system settings are subsequently used. (Only one administrator PIN code can be programmed.)

Refer to the Start Guide for the factory default administrator PIN code.

To change the administrator PIN code, see "[PROGRAMMING AN ADMINISTRATOR PIN CODE \(page 6-2\)](#)".

PROGRAMMING AN ADMINISTRATOR PIN CODE

1

Press the [SPECIAL FUNCTION] key (Fn).

The special function screen will appear.

2

Select "System Settings" with the [▼] or [▲] key.

3

Press the [OK] key.

The administrator PIN code entry screen appears.



4

Use the numeric keys to enter the five-digit administrator PIN code.

- If this is the first time you are programming the administrator PIN code, enter the factory default code. (Refer to the Start Guide)
- "✖" appears for each digit that you enter.
- The special modes screen will appear with "Change Admin PIN" selected.

5

Press the [OK] key.

The administrator PIN code change screen appears.

6

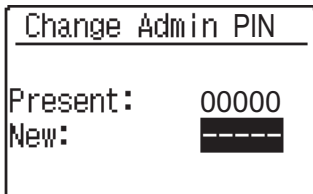

Enter the new 5-digit administrator PIN code with the numeric keys.

Any 5 digits can be used for the administrator PIN code.

7

Press the [OK] key.

- The previously programmed administrator PIN code is replaced by the new administrator PIN code.
- Press the [CA] key to return to the base screen.



SYSTEM SETTINGS LIST

Programs for general use of the machine

Program name	Page
Change Admin PIN	
Change Admin PIN	6-10
Initial Setting	
Date & Time Set	6-10
Daylight Saving Time	6-10
Network	
Confirmation of Network	6-10
Connection Type	6-10
Wired settings	6-10
Wireless (Infrastructure)	6-11
Wireless (Access Point)	6-11
User Control	
User Authentication	6-12
User Registration	6-12
Function Limit Setting	6-12
Account Limit Setting	6-12
User Count Display	6-12
User Count Reset	6-12
A Warning when Login Fails	6-12
Disable Print by Inv. User	6-12
Device Control	
Document Feeder Detect Settings (BP-20C20/BP-20C25)	6-13
Original Size Display Setting (BP-10C20)	6-13
Paper Weight	6-14
Fusing Cleaning	6-14
Reg. Adjustment	6-14
Plain Paper Settings	6-14
Status Light Setting	6-14
Error Light Setting	6-14
Blink Setting for Received Data	6-14
Operation Setting	
Auto Clear	6-15
Disable Display Timeout	6-15
Language Setting	6-15
Message Time	6-15
Key Touch Sound	6-15
Keys Touch Sound At Initial Point	6-15
Key Press Time	6-15
Disable Auto Key Repeat	6-15
Disable Paper Size Set	6-16

Program name	Page
Energy Save	
Auto Power Shut-Off	6-16
Auto Power Shut-Off Timer	6-16
Preheat Mode	6-16
Enter Auto Power Shut-Off after the Remote Job	6-16
Toner Save Mode (Copy)	6-16
Toner Save Mode (Print)	6-16
Eco Scan Setting	6-16
List Print	
Fax Settings	6-17
Inbound Routing	6-17
User Usage List	6-17
Activity Report	6-17
Allow/Reject Number List	6-17
User Info. Print	6-17
Auto Calibration	
Auto Calibration	6-17
Security Settings	
IPsec Settings	6-18
Enable Filter	6-18
Initialize Private Data and Data in Machine	6-18

Programs for Copy Mode

Program name	Page
Copier	
ID Card Setting	6-19
Card Shot Default	6-19
Orig. Size Enter	6-19
Default Tray Set	6-19
AutoSelect Tray Paper Supplied	6-19
Auto PaperSelect	6-19
Paper Type of Auto PaperSelect	6-19
Default Exposure	6-19
RotationCopy Set	6-19
Sort Auto Select	6-19
Auto Image	6-19
Limit Of Copies	6-19



Programs for Printer Mode

Program name	Page
Printer	
Notice Page	6-20
Delete All Print Hold Data	6-20

Programs for Fax Mode

Program name	Page
Fax	
List Setting	
Print Selection	6-20
Auto Listing	6-21
Initial Setting	
Dial Mode	6-21
Pause Time	6-21
Own Passcode Set	6-21
Set Volume	6-21
TX/RX End Sound	6-22
TX/RX End Sound Length	6-22
Distinctive Ring	6-22
Remote Reception	6-22
PBX Setting Mode	6-22
Disable Fax Print Hold	6-22
Sending Function	
Orig. Size Enter	6-22
Set Res. Con.	6-22
Auto Reduce TX	6-22
Rotate TX	6-22
Send Mode	6-22
Quick On Line TX	6-23
Print Station # In Rcvd Data	6-23
Address Review	6-23
Recall Setting (Busy)	6-24
Recall Set (Err)	6-24
Ring Timeout In Auto TX	6-25
Rcv. Function	
#Of Rings At. RX	6-25
#Of Rings Man. RX	6-25
Tray Selection	6-25
Received Data Print Condition	6-25
Auto Rcv Reduce To Regular Size	6-26
Duplex Reception	6-26
8-1/2x11 RX Reduce Print	6-26
A3 RX Reduce	6-26

Program name	Page
FW. RX Data	6-26
Received Data FW. Station Set	6-26
Allow/Reject Set	6-27
Num Allow/Reject	6-27
Polling Security	
Polling Security	6-27
Polling Passcode # Mode	6-27

Programs for Scanner Mode

Program name	Page
Scanner	
Disable USB Scan	6-28
New Default	
Orig. Size Enter	6-28
Resolution	6-28
Format	6-28
Mono2/Greyscale	6-28



Administrator settings menu

The system settings are accessed via the following menu structure.

Refer to this menu when enabling or disabling the settings that are explained beginning on [SYSTEM SETTINGS \(page 6-10\)](#). Some settings contain an additional level of settings (a settings screen).

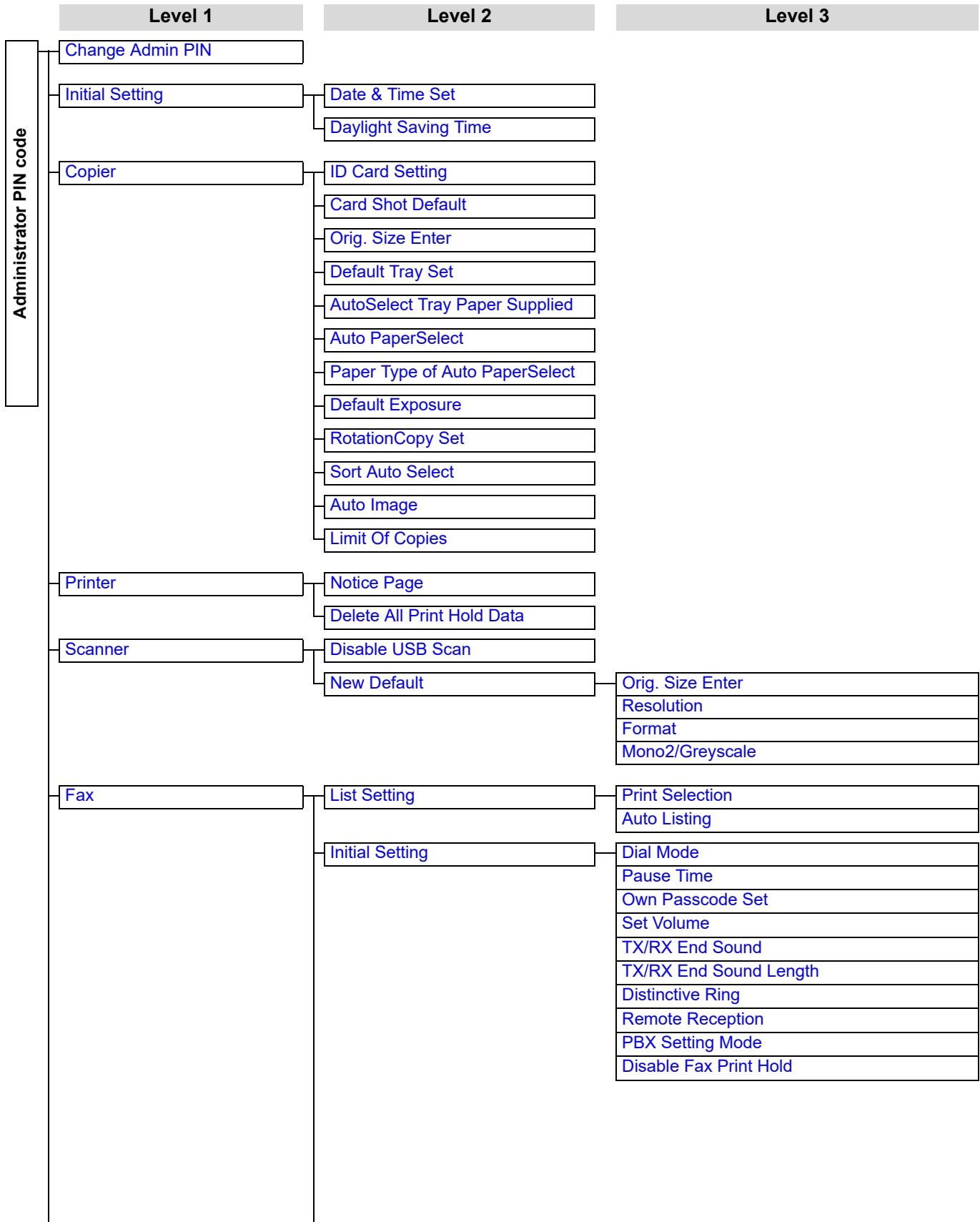



Level 1	Level 2	Level 3	
	Sending Function	Orig. Size Enter Set Res. Con. Auto Reduce TX Rotate TX Send Mode Quick On Line TX Print Station # In Rcvd Data Address Review Recall Setting (Busy) Recall Set (Err) Ring Timeout In Auto TX	
	Rcv. Function	#Of Rings At. RX #Of Rings Man.RX Tray Selection Received Data Print Condition Auto Rcv Reduce To Regular Size Duplex Reception 8-1/2x11 RX Reduce Print A3 RX Reduce FW. RX Data Received Data FW. Station Set Allow/Reject Set Num Allow/Reject	
	Polling Security	Polling Security Polling Passcode # Mode	
	Network	Confirmation of Network	
		Connection Type	Wired Wireless Infrastructure Wired + Wireless AP
		Wired settings	IPv4 Settings IPv6 Settings
		Wireless (Infrastructure)	Manual Input of SSID
		Wireless (Access Point)	Setting of SSID Security Settings Device IP Address Settings Channel Settings Sending Output Settings Bandwidth Settings IP Addr. Distribution Range
	User Control	User Authentication	
	User Registration		
	Function Limit Setting		
	Account Limit Setting		
	User Count Display		
	User Count Reset		
	A Warning when Login Fails		
	Disable Print by Inv. User		



Level 1	Level 2	Level 3
Device Control	Document Feeder Detect Settings (BP-20C20/BP-20C25)	
	Original Size Display Setting (BP-10C20)	
	Paper Weight	
	Fusing Cleaning	
	Reg. Adjustment	
	Plain Paper Settings	
	Status Light Setting	
	Error Light Setting	
	Blink Setting for Received Data	
	Operation Setting	Auto Clear
Disable Display Timeout		
Language Setting		
Message Time		
Key Touch Sound		
Keys Touch Sound At Initial Point		
Key Press Time		
Disable Auto Key Repeat		
Disable Paper Size Set		
Energy Save		Auto Power Shut-Off
	Auto Power Shut-Off Timer	
	Preheat Mode	
	Enter Auto Power Shut-Off after the Remote Job	
	Toner Save Mode (Copy)	
	Toner Save Mode (Print)	
	Eco Scan Setting	
List Print	Fax Settings	
	Inbound Routing	
	User Usage List	
	Activity Report	
	Allow/Reject Number List	
	User Info. Print	
Auto Calibration		
Security Settings	IPsec Settings	
	Enable Filter	
	Initialize Private Data and Data in Machine	



USING THE SYSTEM SETTINGS

1 Press the [SPECIAL FUNCTION] key (Fn).

2 Select "System Settings" with the [▼] or [▲] key and press the [OK] key.

3 Enter admin
PIN Code.

Admin PIN Code:

Enter the administrator PIN code with the numeric keys.

- "X" appears for each digit that you enter.
- The mode selection screen appears.

4 Mode Select
▲ Change Admin PIN
Initial Setting
Copier
▼ Printer

Select the desired mode with the [▼] or [▲] key.

5 Press the [OK] key.

6 Select the desired setting with the [▼] or [▲] key.

7 Press the [OK] key and follow the instructions in the setting screen.

Several settings will have checkboxes in front of them. To enable a function (make a checkmark appear), press the [OK] key. To disable the setting, press the [OK] once again to remove the checkmark. To configure a setting that has a checkbox, go to step 8.

8 To use another setting for the same mode, select the desired setting with the [▼] or [▲] key.

To use a setting for a different mode, press the [BACK] key (↩) and select the desired mode. To exit the system settings, press the [CA] key.



SYSTEM SETTINGS

Change Admin PIN

Use this function to change administrator PIN code. To change the administrator PIN code, see "[PROGRAMMING AN ADMINISTRATOR PIN CODE \(page 6-2\)](#)".

Initial Setting

The default settings for operation of the machine can be configured. Select the [Initial Setting] to configure the settings.

Date & Time Set

Use this to set the date and time in the machine's built-in clock.

Daylight Saving Time

Enable daylight saving time.

Network

Network settings are described below. Select the [Network] to configure the settings.

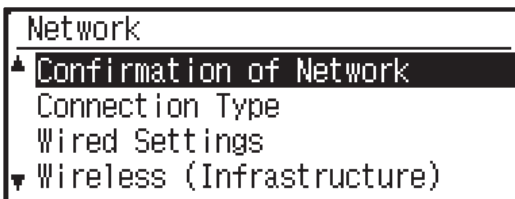

Confirmation of Network

Confirm network settings.

Connection Type

You can change the machine's network connection type.

Wired settings

IPv4 Settings

When using the machine on a TCP/IP (IPv4) network, use this setting to configure the IP address of the machine. The settings are shown below.

Enable DHCP

Use this setting to have the IP address obtained automatically using DHCP (Dynamic Host Configuration Protocol). When this setting is enabled, it is not necessary to manually enter an IP address.

IPv4 Address

Enter the IP address of the machine.

Subnetmask

Enter the Subnetmask

Default Gateway

Enter the Default Gateway.

IPv6 Settings

When using the machine on a TCP/IP (IPv6) network, use this setting to configure the IP address of the machine.

The settings are shown below.

Enable IPv6 Protocol

Enable this setting.

Enable DHCPv6

Use this setting to have the IP address obtained automatically using DHCP (Dynamic Host Configuration Protocol). When this setting is enabled, it is not necessary to manually enter an IP address.

Manual Address

Enter the IP address of the machine.

Prefix Length

Enter the prefix length (0 to 128).

Default Gateway

Enter the IP Gateway address.



- If DHCP is used, the IP address assigned to the machine may change automatically. If the IP address changes, printing will not be possible.
- In an IPv6 environment, the machine can use LPD, Raw(9100), and IPP protocol.



Wireless (Infrastructure)

(This setting appears when a wireless LAN adaptor is installed.)

This sets connection using wireless infrastructure mode.

Manual Input of SSID

Enter up to 32 half-width characters for the SSID.

• Setting of Security Type

Select the security type.

(None, WEP, WPA/WPA2-mixed Personal, WPA2 Personal)

• Setting of Encrypt

Select the encryption method based on the "Setting of Security Type" setting.

(None, WEP, AES/TKIP, AES)

• Security Key Settings

Set the security key used for wireless connection.

WEP	5 half-width numeric digits, 10 hexadecimal (64 bit) digits, 13 half-width numeric digits, or 26 hexadecimal (128 bit) digits
WPA/WPA2 -mixed Personal	8 to 63 half-width numeric digits or 64 hexadecimal digits
WPA2 Personal	

Wireless (Access Point)

(This setting appears when a wireless LAN adaptor is installed.)

This sets connection using wireless access point mode.

Setting of SSID

Enter up to 32 half-width characters for the SSID.

Security Settings

• Setting of Security Type

Select the security type.

(None, WEP, WPA/WPA2-mixed Personal, WPA2 Personal)

• Setting of Encrypt

Select the encryption method based on the "Setting of Security Type" setting.

(None, WEP, AES/TKIP, AES)

• Security Key Settings

Set the security key used for wireless connection.

WEP	5 half-width numeric digits, 10 hexadecimal (64 bit) digits, 13 half-width numeric digits, or 26 hexadecimal (128 bit) digits
WPA/WPA2 -mixed Personal	8 to 63 half-width numeric digits or 64 hexadecimal digits
WPA2 Personal	

Device IP Address Settings

Set the IP address of the access point.

Channel Settings

Set the channel used for the access point.

Sending Output Settings

Set the transmission output of the access point.

Bandwidth Settings

Set the frequency band of the access point.

IP Addr. Distribution Range

Set the lease range and lease period of the IP address used for the access point.



User Control

User Control is used to configure settings for user authentication. Select the [User Control] to configure the settings.

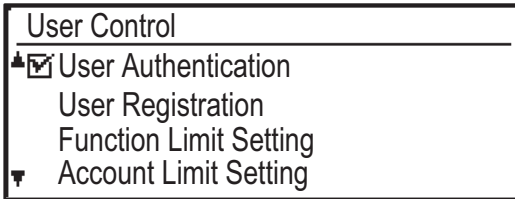

User Authentication

These settings enable or disable user authentication and specify the authentication method.

When user authentication is enabled, each user of the machine is registered. When a user logs in, settings for that user are applied.

User Registration

Users can be added, deleted, and changed.



- When entering a user number, the [OK] key is not enabled until 5 digits have been entered.
- If the [C] key is pressed during entry of a user number, the displayed user number changes to "-----".

Function Limit Setting

Set functions that all users or a specific user can use.

- Copies(Colour/B/W)
- (Colour/B/W/USB Memory Direct Print)
- Scanner
- Fax

Account Limit Setting

Copying and printing paper limits can be set for all users or specific users.

- Copies(Colour)
- Copies(B/W)
- Printer(Colour)
- Printer(B/W)

Set the paper limits for copying and printing.

User Count Display

This setting is used to display the page counts of each account in copy, print, and scan modes, and the usage limits for copy and print modes. Misfed pages are not included in the page counts.

For the network scanner function, the number of transmitted pages is displayed.

Switch to the page counts in other modes for the same account, as well as the page limits, with the [◀] or [▶] key.

To change to a different account number, press the [▼] or [▲] key.

User Count Reset

This setting is used to reset the copy, print, and scan page counts of an individual account, or all accounts, to zero.

A Warning when Login Fails

When this setting is enabled, the machine will not allow operation for one minute if an incorrect account number is entered three times in a row. During this time, "This operation is disabled. Please contact your administrator." will appear in the display.

This setting is only effective when "User Authentication" has been enabled for print mode.

Disable Print by Inv. User

When enabled, this setting cancels a print job if no account number is entered or an invalid account number is entered. This setting is only effective when "User Authentication" has been enabled for print mode. The function is initially enabled (factory default setting).



Pages printed by invalid account numbers are added to the page count of "Others" (account number).



Device Control

These settings are used to configure settings for hardware functions of the machine. To access one of these settings, select "Device Control" in the mode selection screen, select the desired setting in the device control screen, and press the [OK] key.

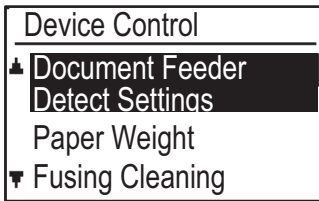

Document Feeder Detect Settings (BP-20C20/BP-20C25)

One of the 8 groups of standard original sizes shown below can be selected for detection by the original size detection function.

Selections	Detectable original sizes
AB-1	11" x 17", 8-1/2" x 14", 8-1/2" x 11", A3, A4, A4R, A5, B4, B5, B5R
AB-2	A3, A4, A4R, A5, B4, B5, B5R, 11"x17", 8-1/2"x11", 216 mm x 330 mm (8-1/2"x13")
AB-3	A3, A4, A4R, A5, B4, 11"x17", 8-1/2"x11", 216 mm x 330 mm (8-1/2"x13"), 8K, 16K, 16KR
AB-4	A3, A4, A4R, A5, B4, B5, B5R, 11"x17", 8-1/2"x11", 216 mm x 340 mm (8-1/2"x13-2/5")
AB-5	A3, A4, A4R, A5, B4, B5, B5R, 11"x17", 8-1/2"x11", 216 mm x 343 mm (8-1/2"x13-1/2")
Inch-1	11" x 17", 8-1/2" x 14", 8-1/2" x 11", 8-1/2" x 11"R, 5-1/2" x 8-1/2", A3, A4
Inch-2	11"x17", 216 mm x 330 mm (8-1/2"x13"), 8-1/2"x11", 8-1/2"x11"R, 5-1/2"x8-1/2", A3, A4
Inch-3	11"x17", 8-1/2"x13-2/5 (216 mm x 340 mm), 8-1/2"x11", 8-1/2"x11"R, 5-1/2"x8-1/2", A3, A4

Original Size Display Setting (BP-10C20)

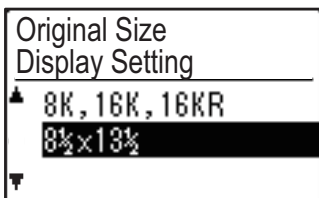

Set the original sizes that appear in the original size specification screen.



Paper Weight

The temperature of toner fusing is controlled according to the weight of the paper that is used.

Apply this setting to plain, recycled, punched, pre-printed, letter head, and colour.

Select from 60g/m² - 79g/m² and 80g/m² - 105g/m².



- Be sure to use only paper that is in the same weight range as the weight range set here. Do not mix in other standard paper that differs from the set range.
- When settings are changed, the changes will take effect after the machine is restarted. To restart the machine, see [TURNING ON THE POWER \(page 1-12\)](#).

Fusing Cleaning

Use this function to clean the machine's fusing unit when dots or other dirt appear on the printed side of the paper.

When this function is executed, "V" printed paper is output and the fusing unit is cleaned.



- If improvement is not noticed after the first time you use the function, try executing the function again.

Reg. Adjustment

If the printed colours shift out of position when you print by Colour printing, you can adjust the print position of each colour to reduce colour shifting.

Plain Paper Settings

In this machine, paper type is divided between plain paper 1 and plain paper 2.

When printing on plain paper with a printer driver that is not compatible with plain paper 1 and plain paper 2, you can set which paper type to use for printing

Status Light Setting

Set the operation of the data notification indicator on the machine. Select from "Pattern 1", "Pattern 2", or "Not Use". For explanations of the patterns, refer to [Data notification indicator and error indicator \(page 1-11\)](#).

Error Light Setting

Set the operation of the error indicator when an error occurs on the machine. Select whether the indicator lights or blinks depending on the error status, only blinks, or is not used.

Blink Setting for Received Data

Set whether the data notification indicator blinks when fax data has been received or received data is held.



Operation Setting

These settings are used to configure various settings related to the operation panel. To access one of these programs, select "Operation Setting" in the mode selection screen, select the desired setting in the operation setting screen, and press the [OK] key.

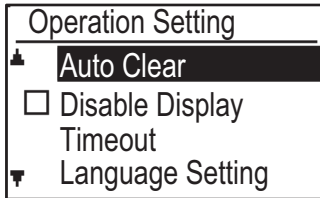

Auto Clear

This function returns the copy settings to the default settings if the operation panel is not used for the duration of time set with this setting following the end of a copy job. Time selections are "0 sec.", "10 sec.", "20 sec.", "60 sec.", "90 sec." and "120 sec."

The factory default setting is 60 seconds. Select "Auto Clear" and press the [OK] key.

Select the desired time with the [◀] or [▶] key. If you do not want auto clear to operate, select "0".



The Auto Clear function is disabled when scanned data is stored under the following status: When the last page has not been scanned during the 2-Up or 4-Up copy process (one page has been scanned for a two-page set or three pages have been scanned in a four-page set), or only one side has been scanned in the ID card copy process.

Disable Display Timeout

This setting is used to select whether or not the display will automatically return to the base screen if no keys are pressed on the operation panel for the time set in the above "Auto Clear" function setting in scan or fax mode. The factory default setting is automatic return to the base screen.

Language Setting

This setting is used to select the display language.

Message Time

This setting is used to set the length of time that messages appear in the display (this applies to messages that appear for a certain length of time and then automatically disappear.)

Select from "Short (3 sec.)", "Normal (6 sec.)", or "Long (9 sec.)".

The factory default setting is "Normal (6 sec.)".

Key Touch Sound

This setting is used to set the length of the key touch sound that is heard each time a key is pressed.

The initial factory setting is "Short".

Select the desired length with the [▼] or [▲] key.

To turn the key touch sound off, select "Off".

Keys Touch Sound At Initial Point

This setting is used to select whether or not a beep will sound at preset base settings as you press a key to select a setting.

The factory default setting is no beep.

Key Press Time

This setting is used to set the duration of time that a key must be pressed to take effect.

A longer setting can be selected to prevent keys pressed accidentally from taking effect. Keep in mind, however, that when a longer setting is selected more care is required when pressing keys to ensure that the key input is registered.

The initial factory setting is "Minimum".

Disable Auto Key Repeat

This setting is used to stop a setting from changing continuously when the [▼] or [▲] key is held down, such as when setting the zoom ratio or the original size (auto key repeat will not operate). When this setting is enabled, a key must be pressed repeatedly instead of holding it down.

Auto key repeat is initially set to operate (factory default setting).



Disable Paper Size Set

This setting is used to disable "Paper Size Set" in the Special Modes menu. When disabled, "Paper Size Set" cannot be used when the [SPECIAL FUNCTION] key (Fn) is pressed, which prevents users other than the administrator from easily changing the paper size setting.

"Disable Paper Size Set" is initially disabled (factory default setting).

Energy Save

These settings are used to configure energy saving settings. To access one of these settings, select "Energy Save" in the mode selection screen, and select the desired setting in the energy save screen, and then press the [OK] key.

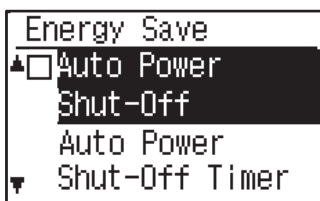

Auto Power Shut-Off

(Except for Europe)

This setting is used to enable auto power shut-off mode, which automatically turns off the power to the fusing unit if the operation panel is not used for a certain duration of time.

Enabling auto power shut-off mode helps conserve energy, preserve natural resources, and reduce environmental pollution.

The function is initially enabled.



Rather than disabling the auto power shut-off feature, it is recommended that you first try lengthening the time set in "Auto Power Shut-Off Timer" (see below). In most cases a suitable timer setting will allow work to proceed with minimal delay and still enable you to enjoy the benefits of power conservation.

Auto Power Shut-Off Timer

This setting is used to set the duration of time until auto power shut-off mode activates when the operation panel is not used. Using this function helps conserve energy, preserve natural resources, and reduce environmental pollution.

"1 to 60min." can be selected for the duration of time.

Select a setting that suits your work conditions.

The factory default setting is "11 min." (for Europe)/"1 min." (Except for Europe).

Preheat Mode

This setting is used to set the duration of time until preheat mode, which automatically lowers the fusing unit temperature, activates when the operation panel is not used. Using this function helps conserve energy, preserve natural resources, and reduce environmental pollution. "1 to 60min." can be selected for the duration of time. Select a setting that suits your work conditions. The factory default setting is "1 min."

Enter Auto Power Shut-Off after the Remote Job

This function works in Auto Power Shut-Off mode. When the machine completes a print job received from the PC or outputs received fax data, the machine immediately returns to the Auto Power Shut-Off mode.

Toner Save Mode (Copy)

Toner Save Mode (Print)

You can reduce the amount of toner used for copying/printing.



Toner Save Mode (Print) is only effective when the machine's printer driver is not used. When the printer driver is used, the printer driver setting takes precedence.

This function may not operate in some applications and operating systems.

Eco Scan Setting

This setting keeps the fusing unit off when you perform an operation that does not involve printing, such as sending a scanned document.

Copy (factory default setting: Disabled)

Scanner transmission (factory default setting: Enabled)

Fax transmission (factory default setting: Enabled)



List Print

This is used to print lists and reports that are only for use by the administrator of the machine.

Select [List Print] to choose the list and the report you want to print.

Fax Settings	Shows the current state of the system settings, as well as the sender name, sender number, polling passcode numbers, and forwarding numbers.
Inbound Routing	Shows the inbound routing settings for routing received faxes on your network.
User Usage List	Shows the communication time and number of pages transmitted by each user.
Activity Report	Shows a log of past communication performed on the machine (date of communication, name of other party, time required, result, etc.).
Allow/Reject Number List	Shows the stored fax numbers from which reception in Allow/Reject Set (page 6-27) is allowed or blocked.
User Info. Print	The user name, user number, paper used, paper limits, and function permission settings can be printed for each user.

Auto Calibration

If the print tones are off, you can correct the tones. By scanning the printed test pattern, tones can be automatically corrected.

After the [OK] is selected and a test patch is printed, a message appears prompting you to begin automatic calibration. Place the test patch on the document glass as shown below.

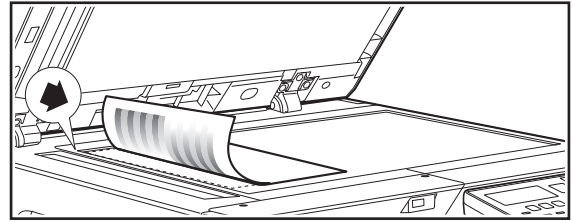

Align the upper left corner of the original with the mark.

Lay copy paper (about five sheets) that is the same size as the test patch on top of the placed test patch, gently close the automatic document feeder, and select the [OK].



If the tones are still off after "Auto Calibration" is performed, repeating Auto Calibration may provide improvement.



Security Settings

The following settings are related to security.
Select the [Security Settings] to configure the settings.

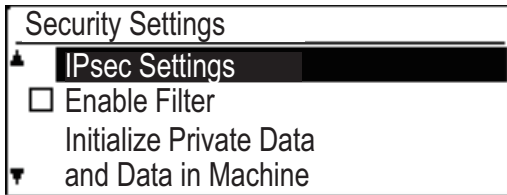

IPsec Settings

IPsec can be used for data transmission/reception on a network.

Enable IPsec

Specify whether or not IPsec is used for transmission.

IKEv1 Settings

Configure the IKEv1 settings.

Pre-Shared Key

Enter the Pre-Shared Key to be used for IKEv1.

SA Lifetime (time)

Set the SA lifetime.

IKE Lifetime

Set the IKE lifetime.

Enable Filter

Enable the IP address filter or Mac address filter that is set in "Filter" in the Web pages.

When this setting is enabled on the machine, the setting in the device Web pages is also enabled.

The factory default setting is "Disabled".

Initialize Private Data and Data in Machine

The system-set values can be restored to the factory default state after eliminating the data stored in the machine.

- All information displayed in the fax status
- Image data in memory boxes
- Unsent fax data
- Print Hold Data
- Current values set for system settings
- Current values set for network settings
- User information > User registration information
- User information > Paper limits
- User information > Function usage restrictions
- User information > User counts
(Excluding default users)
- Fax / scanner addresses
- Groups
- User index (scanner)
- Programs
- Auto forwarding of received faxes
- Public box data
- Sender information
- Allow/Reject Number List
- Forwarding information
- Product key



Copier

These settings are used to enable various copy functions. To access one of these programs, select "Copier" in the mode selection screen, select the desired setting in the copy settings screen, and press the [OK] key.

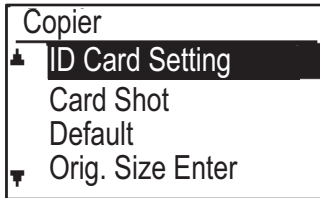

ID Card Setting

The layout pattern for copying of the ID card can be changed during the ID card copy process.

Refer to the illustration in [ID CARD COPY \(page 2-19\)](#) for the available layout patterns.

Card Shot Default

This setting is used to set the default dimensions that appear when the card shot size entry screen is displayed.

The factory default settings are 86 mm (3-3/8") for the width (X) and 54 mm (2-1/8") for the length (Y).

Select X or Y and adjust the corresponding default value with the [◀] or [▶] key.

Orig. Size Enter

Set the default original size for the document glass.

The paper size can be selected

AB type:

A3, B4, A4, A4R, B5, B5R, A5, A5R, B6R, A6R, Not Specified

Inch type:

11" x 17", 8-1/2" x 14", 8-1/2" x 13-1/2", 8-1/2" x 13-2/5", 8-1/2" x 13", 8-1/2" x 11", 8-1/2" x 11"R, 5-1/2" x 8-1/2", 5-1/2"x8-1/2"R, Not Specified

The factory default setting is "A4".

Default Tray Set

This setting is used to set which tray is selected by default.

Trays that appear for selection will vary depending on the optional trays that have been installed.

The factory default setting is "Tray 1".

AutoSelect Tray Paper Supplied

This setting automatically selects the tray in which paper was added.

The factory default setting is "Disabled".

Auto PaperSelect

Select the auto paper selection setting.

When [On] is set, auto paper selection applies to all trays. When [On (excluding Bypass Tray)] is set, auto paper selection applies to all trays except the bypass tray.

The factory default setting is "On".

Paper Type of Auto PaperSelect

Set the paper types to which auto paper selection applies.

- Plain paper 1 (factory default setting: enabled)
- Plain paper 2 (factory default setting: enabled)
- Recycled paper (factory default setting: disabled)

Default Exposure

This setting is used to select the original type and exposure mode that is initially selected when the [EXPOSURE] key is pressed.

Three exposure modes are available: "Text", "Txt/Prt Photo" and "Photo".

Depending on the settings, set "Auto" or one of five levels for the exposure.

Select the original type with the [▼][▲] keys, adjust the exposure if needed with the [◀][▶] keys, and press the [OK] key.

RotationCopy Set

Set whether or not Rotation Copy is used.

The factory default setting is "ON".

Sort Auto Select

This setting is used to select the default output mode when the document feeder is used for copying.

The initial factory setting is "Sort".

Auto Image

Set whether or not Auto Image is performed when the paper tray (paper size) is manually selected.

The factory default setting is "Disabled".

Limit Of Copies

This setting is used to set the limit for the number of copies that can be set (and that can appear in the display) for one copy job.

The factory default setting is "999 copies".



Printer

Settings related to the printer function can be configured. Select the [Printer] to configure the settings.

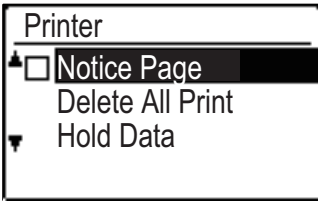

Notice Page

Set whether a notice page is printed when printing does not take place due to an error such as memory full.

Delete All Print Hold Data

This function deletes all print hold data that is held in the machine.

The following data is excluded:

- A job that is currently being printed
- Print hold data that is in the process of being saved

Fax

System settings for the fax function are explained below.

List Setting

This setting is used to print lists showing current system settings and other programmed information. Select the [List Setting] to configure the settings.

Print Selection

This setting is used to select the conditions for printing out transaction reports for normal transmission, broadcast transmission, original print and reception.

Transmission	Broadcast	Original Image Print Setting
<input type="checkbox"/> Always Prints	<input checked="" type="checkbox"/> Always Prints	<input type="checkbox"/> Always Prints
<input checked="" type="checkbox"/> Error Only	<input type="checkbox"/> Error Only	<input checked="" type="checkbox"/> Error Only
<input type="checkbox"/> Never Prints	<input type="checkbox"/> Never Prints	<input type="checkbox"/> Never Prints
Reception		
<input type="checkbox"/> Always Prints		
<input type="checkbox"/> Error Only		
<input checked="" type="checkbox"/> Never Prints		

Normally the settings indicated by shading  above are selected.

"Transmission", "Broadcast", "Original Image Print Setting", or "Reception" can be selected.

- If you selected "Transmission", select "Always Prints", "Error Only", or "Never Prints".
- If you selected "Broadcast", select "Always Prints", "Error Only", or "Never Prints".
- If you selected "Original Image Print Setting", select "Always Prints", "Error Only", or "Never Prints".
- If you selected "Reception", select "Always Prints", "Error Only", or "Never Prints".



"Original Image Print Setting" is used to have part of the first page of the transmitted document printed on the transaction report. This setting is not effective when the transaction report is set to not print out.



Auto Listing

This setting is used to have the activity report that is stored in the machine's memory printed out at regular intervals.

You can choose to have the report automatically printed each time the number of stored transactions exceeds 50, or have the report printed at a specified time every day (only once per day). You can also enable both print methods.

The report is normally set to not print out. To have the report automatically printed when the number of stored transactions (the combined total of transmissions and receptions) exceeds 50, select "Auto Print Rept At Limit(50)".

To have the report printed at a specified time, enable "Print Time Set" and enter the desired time.

- The setting is enabled and a checkmark appears in the checkbox.
- If this procedure is performed when the setting is enabled, the checkmark will be cleared and the setting disabled.



- To cancel a "Print Time Set" setting, select "Cancel":
- Select "Cancel" with the [▼] or [▲] key and then press the [OK] key.
- If "Auto Print Rept At Limit(50)" is not enabled and the number of recorded transactions exceeds 50, each new transaction will delete the oldest transaction.
- The activity report can also be printed out on demand. (See [PRINTING LISTS OF PROGRAMMED INFORMATION AND SETTINGS \(page 4-46\)](#).)

Initial Setting

These settings are used to change the default settings (initially set at the factory) for the various fax functions to settings that better meet your needs.

Select the [Initial Setting] to configure the settings.

Dial Mode

(Varies depending on country and region)

This setting is used to set the appropriate dial mode for the line connected to the machine. Select tone for a tone dial line or pulse for a pulse dial line.

Pause Time

This setting is used to select the duration of pauses that are inserted in destination fax numbers.

Normally the setting is 2 seconds, which means that each time the [PAUSE] key is pressed when dialling or storing a fax number, a pause of 2 seconds (Except for South Africa) is inserted. In South Africa, the factory default setting is "4 seconds".

The pause time can be set to any number of seconds from 1 to 15.

Own Passcode Set

Use this setting to setting the fax number of the machine and the name of the user. The programmed name and number are printed at the top of each fax page you send. The number is also used as a passcode when performing polling reception [SENDING OPTIONS \(page 4-33\)](#).

You can check your programmed name and number by printing out the [List Print \(page 6-17\)](#)

A maximum of 20 digits can be stored for the fax number.

A maximum of 18 letters can be stored for the name.



- To clear the programmed fax number and name, follow these steps:
- (1) Select "Delete" and then press the [OK] key.
 - (2) Select "Delete" with the [▼] or [▲] key and then press the [OK] key.

Set Volume

This setting is used to adjust the on-hook volume, the ringing volume, the line monitor volume, the TX/RX end sound volume and the original scanning end sound volume.

- "High", "Middle" or "Low" can be selected for the on hook volume.
- "High", "Middle", "Low" or "Off" can be selected for volumes other than the on hook volume.

Item	Factory default setting
On Hook Volume	Middle
Ringer Volume	Low
Line Monitor Vol	Off
TX/RX End Volume	Low
Scan End Volume	Middle



TX/RX End Sound

This setting is used to select the beep pattern that signals the end of transmission or reception. "Pattern 1", "Pattern 2" or "Pattern 3" can be selected. Before pressing the [OK] key to store your selection, you can press the  key to listen to the selected pattern.

TX/RX End Sound Length

This setting is used to select the length of the end sound in seconds. Selections are "2.0 sec", "2.5 sec", "3.0 sec", "3.5 sec", and "4.0 sec". "3.0 sec" is normally selected.

Distinctive Ring

(Varies depending on country and region)

If multiple telephone numbers have been assigned to your telephone line, the number called can be identified by its ringing pattern. By using one number for voice calls and another number for faxes, you can tell which type of call you are receiving by the ringing pattern. You can set your machine to automatically receive faxes when your fax number is called by setting the pattern that corresponds to your fax number. Normally "Off" is selected.

Remote Reception

(Only when an extension phone is connected)

When a call is received on an extension phone connected to the machine, fax reception can be activated by entering a 1-digit number and pressing  twice on the phone's keypad. This 1-digit number is called the remote reception number, and you can set it to any number from "0" to "9". Normally the remote reception number is set to "5".



If a remote number has been previously stored, the newly entered remote number overwrites the old number.

PBX Setting Mode

(Varies depending on country and region)

Enable/disable connection to a PBX line, and set whether Flash or ID is used to dial out when connected to a PBX. FLASH or ID can only be selected when PBX is enabled. ID Code Set is required when ID is selected.

Disable Fax Print Hold

This setting is used to disable the fax print hold function, which holds received faxes in memory instead of printing them as they are received. ([▶ page 4-28](#))

Normally the fax print hold function is disabled.

- The setting (which disables fax print hold) is enabled and a checkmark appears in the checkbox.
- If this procedure is performed when the setting is enabled, the checkmark will be cleared and the setting disabled (fax print hold is enabled).

Sending Function

These settings are used to change the default settings (initially set at the factory) for the various fax transmission functions to settings that better meet your needs.

Select the [Sending Function] to configure the settings.

Orig. Size Enter

Set the size of originals scanned on the document glass. The paper size can be selected

AB type:

A3, B4, A4, A4R, B5, B5R, A5, A5R, Not Specified

Inch type:

11" x 17", 8"-1/2 x 14", 8-1/2" x 13-1/2", 8-1/2" x 13-2/5", 8-1/2" x 13", 8-1/2" x 11", 8-1/2" x 11"R, 5-1/2" x 8-1/2", 5-1/2" x 8-1/2"R, Not Specified

The factory default setting for the Orig. Size Enter is "Not Specified".

Set Res. Con.

This setting is used to adjust the resolution and the exposure level when scanning an original to be faxed. The initial setting is standard resolution and auto exposure mode.

Auto Reduce TX

Set whether or not the transmission image is reduced to match the size of the paper in the receiving fax machine. Normally "ON" is selected.

Rotate TX

Set whether or not the transmission image is rotated to reduce misrecognition of the paper size, such as printing a transmitted A4 size image on A3 paper in the receiving machine.

Send Mode

This setting is used to select whether the default mode for sending faxes is memory transmission or direct transmission.

The initial setting is "Memory TX".



Quick On Line TX

This setting is used to select whether or not quick on-line transmission (transmission while original pages are being scanned into memory) takes place when a memory transmission is performed.

If quick on-line transmission is disabled, transmission will not begin until all original pages have been scanned into memory.

Normally quick on-line transmission is enabled.

When this function is disabled, transmission will not begin until all pages of the document have been scanned. Note that this setting does not apply to manual transmission. (See [Storing transmission jobs \(memory transmission\) \(page 4-17\)](#).)

- Quick on-line is enabled and a checkmark appears in the checkbox.
- If this procedure is performed when quick on-line is enabled, the checkmark will be cleared and quick on-line disabled.

Print Station # In Rcvd Data

This setting lets you select the position (inside or outside the original image) of the date and sender's information that are printed at the top of each fax page you send.

Normally outside the original image is selected. To have your name and number printed inside the original image, select "In Data".

For more detailed information on the position of each setting, see [INCLUDING SENDER INFORMATION ON FAXES \(OWN NUMBER SENDING\) \(page 4-47\)](#).

Address Review

You can specify whether a screen appears for confirmation of the destination when sending a fax.



When the "Only apply to direct entry" checkbox is selected, the Address Review screen only appears when the fax number is entered with the numeric keys or the [REDIAL] key.



Recall Setting (Busy)

This setting is used to set the number of recall attempts and the interval between recall attempts when a transmission is not successful due to the line being busy or other reason.

Country Differentiation Table

	The number of recall attempts	The interval between attempts
United Kingdom, France, Germany, Sweden, Italy, Spain, Netherlands, Denmark, Norway, Finland, Portugal, Belgium, Luxembourg, Switzerland, Saudi Arabia, South Africa, Hungary, Czech Republic, Slovakia, Poland, Greece, Russia, Vietnam	0 to 10 (default: 2)	any number of minutes from 1 to 15 (default: 3)
Canada, Korea	0 to 14 (default: 2)	
Australia, New Zealand, Singapore, Thailand, Malaysia, India, Brazil	0 to 9 (default: 2)	
China, Hong Kong	0 to 3 (default: 2)	
Taiwan	0 to 15 (default: 2)	any number of minutes from 4 to 15 (default: 4)



Even if this setting is enabled, the machine will not re-attempt the call when a fax is sent by manual transmission.

Recall Set (Err)

When sending a fax, this setting is used to select whether or not the machine will automatically re-attempt the call if the transmission fails due to a line error.

Country Differentiation Table

	The number of recall attempts	The interval between attempts
United Kingdom, France, Germany, Sweden, Italy, Spain, Netherlands, Denmark, Norway, Finland, Portugal, Belgium, Luxembourg, Switzerland, Saudi Arabia, South Africa, Hungary, Czech Republic, Slovakia, Poland, Greece, Russia, Vietnam	0 to 5 (default: 1)	any number of minutes from 0 to 15 (default: 1)
Australia, Canada, Korea	0 to 1 (default: 1)	any number of minutes from 0 to 15 (default: 3)
New Zealand	0 to 1 (default: 1)	any number of minutes from 1 to 15 (default: 3)
Singapore, Brazil	0 to 9 (default: 2)	any number of minutes from 0 to 15 (default: 1)
Malaysia, Thailand, India	0 to 9 (default: 2)	any number of minutes from 1 to 15 (default: 1)
China, Hong Kong	0 to 3 (default: 2)	any number of minutes from 0 to 15 (default: 1)
Taiwan	0 to 15 (default: 2)	any number of minutes from 4 to 15 (default: 4)



- If the recall interval is set to "0", the machine will immediately call again after the connection is broken due to the line error.
- Even if this setting is enabled, the machine will not re-attempt the call when a fax is sent by manual transmission.



Ring Timeout In Auto TX

When sending a fax by automatic transmission (see [Storing transmission jobs \(memory transmission\) \(page 4-17\)](#)), this setting lets you select the amount of time that the machine waits before breaking the connection when the other machine does not answer your machine's call. If the other machine does not respond within this set time, your machine will automatically break the connection.

Time selections are "30 sec.", "45 sec." and "60 sec.".

Normally "45 sec." is selected.

The contents that can be set are different depending on the country and region.

Rcv. Function

These settings are used to change the default settings (initially set at the factory) for the various fax reception functions to settings that better meet your needs.

Select the [Rcv. Function] to configure the settings.

#Of Rings At. RX

When the reception mode is set to auto, this setting is used to select the number of rings on which the machine automatically receives a call and begins fax reception.

(See [RECEIVING FAXES \(page 4-25\)](#).)

- Any number of rings from 0 to 15 can be selected. The "#Of Rings At. RX" that can be set in each country are shown in the following table.

Item	The number of rings
United Kingdom, France, Germany, Sweden, Italy, Spain, Netherlands, Thailand, Hong Kong, Saudi Arabia, South Africa, Hungary, Czech Republic, Slovakia, Poland, Greece, Russia, Philippines, Indonesia	0 to 9
Australia, New Zealand	2 to 4
Singapore	0 to 3
Malaysia, India, Canada, Taiwan	0 to 15

- If you make a mistake, move the cursor to the mistake with the [◀] [▶] keys and reenter.



- If the number of rings is set to 0, the machine will receive faxes without ringing.
- When the number of rings is set to 14 or 15, reception may not be possible depending on the functions and settings of the other machine.

#Of Rings Man.RX

(This function may not be available in some regions)

You can set the number of rings on which the machine changes to auto reception when there is an incoming fax call in manual reception mode.

Tray Selection

This setting is used to select which output trays can be used for received faxes. All output trays are initially enabled.

- The selected tray is enabled and a checkmark appears in the checkbox.
- If this procedure is performed when the tray is enabled, the checkmark will be cleared and the tray disabled.



- The trays that can be enabled will vary depending on the options that are installed.
- The trays cannot all be disabled.

Received Data Print Condition

This setting determines the selection condition for paper when printing received documents. Select one of the three conditions below. "Reduction" is normally selected.

- Reduction**
Each received image is printed at actual size when possible. When not possible, the image is automatically reduced before printing.
- Division**
Each received image is printed at actual size. If necessary, the image is split onto multiple sheets of paper.
- Actual Size**
The received fax image is printed at its actual size (without dividing it onto multiple sheets of paper). If the same size of paper or larger paper is not loaded, the fax will be received in memory and will not be printed until a suitable size of paper is loaded.



Auto Rcv Reduce To Regular Size

When you receive a fax that includes the sender's name and number, the received image is slightly larger than the standard size*. This setting lets you select whether or not the received image is automatically reduced before printing to fit the standard size. Normally this setting is enabled.

* Standard sizes are sizes such as A4 and B5 (8-1/2" x 11" and 5-1/2" x 8-1/2").



- If this setting is disabled (no reduction) and the received data print condition is set to division, the image may be clipped.
- If auto receive reduce is disabled, an image larger than the standard size will be cut off. However, the image will be clearer because it will be printed at the same size as the original.

Duplex Reception

This setting is used to select whether or not received faxes are printed on both sides of the paper. When two-sided printing is enabled and a fax that is two pages or longer is received (the pages must be the same size), the fax will be printed on both sides of the paper. Even if the pages are in different orientations, the pages are rotated appropriately to enable printing on both sides of the paper.

- The setting is enabled (two-sided printing will take place) and a checkmark appears in the checkbox.
- If the procedure is performed when the setting is enabled, the checkmark will be cleared and the setting disabled.

8-1/2x11 RX Reduce Print

(This may not be available for some region.)

This setting is used to select whether received 8-1/2" x 11"-size faxes are reduced. When an 8-1/2" x 11" fax is received, part of the document is normally cut off. This setting can be turned on to have 8-1/2" x 11" faxes reduced to fit on A4 paper.

The setting is initially turned off.

- The setting is turned on and a checkmark appears in the checkbox.
- If this procedure is performed when the setting is turned on, the checkmark is cleared and the setting turned off.



If this setting is turned off, part of the image may be cut off. The trays cannot all be disabled.

A3 RX Reduce

When an A3 size fax is received, this function reduces the fax to ledger (11" x 17") size.



When this setting is enabled, ledger (11" x 17") size faxes are also reduced.

FW. RX Data

This setting is used to select whether or not received faxes are forwarded to a fax machine programmed as explained in [Received Data FW. Station Set \(page 6-26\)](#) in the event that the machine cannot print the faxes. The setting is initially disabled.

- The setting is enabled and a checkmark appears in the checkbox.
- If the procedure is performed when the setting is enabled, the checkmark will be cleared and the setting disabled.



This setting only operates when the fax number of the machine that is to receive the forwarded faxes is programmed.

Received Data FW. Station Set

When a problem prevents the machine from printing a received fax, the fax forwarding function ([page 4-48](#)) can be used to forward the received fax to another fax machine. Use this setting to setting the fax number of the destination fax machine. Only one fax number can be programmed (maximum of 50 digits).



To delete the number, follow these steps:

- (1) Select "Delete" and then press the [OK] key.
- (2) Select "Delete" with the [▼] or [▲] key and then press the [OK] key.



Allow/Reject Set

When this setting is enabled, reception from fax numbers programmed using the "[Num Allow/Reject \(page 6-27\)](#)" setting will be blocked.

This setting is normally set to "All Invalid", so that all faxes are received regardless of whether the sending fax number is programmed in allow/reject fax number.

- By setting to "Allow Reception", you can receive faxes only from numbers programmed in allow/reject fax number. Faxes from all other numbers will be rejected. This setting cannot be used if no allow/reject fax numbers are programmed.
- By setting to "Reject Reception", faxes from fax numbers programmed in allow/reject fax number will be rejected, and all other faxes will be received.

Num Allow/Reject

Program fax numbers to be used with Allow/Reject Set. Depending on Allow/Reject Set, you can receive only faxes from, or reject faxes from, the numbers programmed here. Up to 50 fax numbers can be stored (maximum of 20 digits each).



To delete a number, follow these steps: Before deleting a number, use the [List Setting \(page 6-20\)](#) to check the control number that identifies the fax number (01 to 50) that you wish to delete. The control number must be entered to delete the fax number. (The fax number will not appear in the display. If the wrong control number is accidentally entered, a fax number other than the fax number that you wish to delete will be deleted.)

- (1) Select "Delete" and then press the [OK] key.
- (2) Select the 2-digit control number (01 to 50) that identifies the fax number that you wish to delete with the [▼] or [▲] key and then press the [OK] key.
- (3) Select "Delete" with the [▼] or [▲] key and then press the [OK] key.

Polling Security

These settings are used for the public box. Select the [Polling Security] to configure the settings.

Polling Security

When performing polling memory (see [Restricting polling access \(polling security\) \(page 4-37\)](#)), this setting is used to select whether any machine will be allowed to poll your machine, or only machines that have been programmed in your machine. Normally this setting is enabled.

- The setting is enabled and a checkmark appears in the checkbox.
- If this procedure is performed when the setting is enabled, the checkmark will be cleared and the setting disabled.

Polling Passcode # Mode

When "Polling Security" is enabled, use this setting to program (or delete) the fax numbers of the machines that are allowed to poll your machine. Programmed fax numbers are called passcodes. Up to 10 fax numbers can be programmed. To check the programmed numbers, print the [List Print \(page 6-17\)](#).

If you make a mistake, move the cursor to the mistake with the [◀] or [▶] keys and enter the correct number.



- To clear a passcode number, follow these steps:
- (1) Select "Delete" and then press the [OK] key.
 - (2) Enter the control number that identifies the number you wish to clear, and then press the [OK] key.
 - (3) Select "Delete" with the [▼] or [▲] key and then press the [OK] key.



Scanner

System settings for the scanner function are explained below.

Select the [Scanner] to configure the settings.

Disable USB Scan

Select whether or not scanning from a computer and scanning from the machine are disabled when a USB connection is used.

Default setting is "No" (disabled).

New Default

This is used to change the default settings for the original size, resolution, Mono2/Greyscale, and format.

Orig. Size Enter

The paper size can be selected

AB type:

A3, B4, A4, A4R, B5, B5R, A5, A5R, B6R, A6R, Not Specified

Inch type:

11" x 17", 8-1/2" x 14", 8-1/2" x 13-1/2", 8-1/2" x 13-2/5", 8-1/2" x 13", 8-1/2" x 11", 8-1/2" x 11"R, 5-1/2" x 8-1/2", 5-1/2"x8-1/2"R, Not Specified

The factory default setting for the Orig. Size Enter is "Not Specified".

Resolution

The scanning resolution can be selected.

The factory default setting for the resolution is "200dpi".

Format

Set the default transmission format.

The factory default setting is "PDF Medium" for colour/greyscale, and "PDF G4" for black and white.

Mono2/Greyscale

After pressing the [B/W START] key, select whether you want to scan the image in "Mono2" or "Greyscale".

The factory default setting for the colour mode is "Mono2".

LICENSE INFORMATION

Information on the Software License for This Product

Software composition

The software included in this product is comprised of various software components whose individual copyrights are held by SHARP or by third parties.

Software developed by SHARP and open source software

The copyrights for the software components and various relevant documents included with this product that were developed or written by SHARP are owned by SHARP and are protected by the Copyright Act, international treaties, and other relevant laws. This product also makes use of freely distributed software and software components whose copyrights are held by third parties. These include software components covered by a GNU General Public License (hereafter GPL), a GNU Lesser General Public License (hereafter LGPL) or other license agreement.

Obtaining source code

Some of the open source software licensors require the distributor to provide the source code with the executable software components. GPL and LGPL include similar requirements. For information on obtaining the source code for the open source software and for obtaining the GPL, LGPL, and other license agreement information, visit the following website:

<http://sharp-world.com/products/copier/source/download/index.html>

We are unable to answer any questions about the source code for the open source software. The source code for the software components whose copyrights are held by SHARP is not distributed.

Software Copyrights

Copyright (c) 2000 Carnegie Mellon University. All rights reserved.

Redistribution and use in source and binary forms, with or without modification, are permitted provided that the following conditions are met:

- 1.Redistributions of source code must retain the above copyright notice, this list of conditions and the following disclaimer.
- 2.Redistributions in binary form must reproduce the above copyright notice, this list of conditions and the following disclaimer in the documentation and/or other materials provided with the distribution.
- 3.The name "Carnegie Mellon University" must not be used to endorse or promote products derived from this software without prior written permission. For permission or any other legal details, please contact
Office of Technology Transfer Carnegie Mellon University 5000 Forbes Avenue Pittsburgh, PA 15213-3890
(412) 268-4387, fax: (412) 268-7395
tech-transfer@andrew.cmu.edu
- 4.Redistributions of any form whatsoever must retain the following acknowledgment:
"This product includes software developed by Computing Services at Carnegie Mellon University
(<http://www.cmu.edu/computing/>)."

CARNEGIE MELLON UNIVERSITY DISCLAIMS ALL WARRANTIES WITH REGARD TO THIS SOFTWARE, INCLUDING ALL IMPLIED WARRANTIES OF MERCHANTABILITY AND FITNESS, IN NO EVENT SHALL CARNEGIE MELLON UNIVERSITY BE LIABLE FOR ANY SPECIAL, INDIRECT OR CONSEQUENTIAL DAMAGES OR ANY DAMAGES WHATSOEVER RESULTING FROM LOSS OF USE, DATA OR PROFITS, WHETHER IN AN ACTION OF CONTRACT, NEGLIGENCE OR OTHER TORTIOUS ACTION, ARISING OUT OF OR IN CONNECTION WITH THE USE OR PERFORMANCE OF THIS SOFTWARE.

Copyright (c) 1995 - 2008 Kungliga Tekniska Högskolan (Royal Institute of Technology, Stockholm, Sweden). All rights reserved.

All rights reserved. Export of this software from the United States of America may require a specific license from the United States Government. It is the responsibility of any person or organization contemplating export to obtain such a license before exporting.

WITHIN THAT CONSTRAINT, permission to use, copy, modify, and distribute this software and its documentation for any purpose and without fee is hereby granted, provided that the above copyright notice appear in all copies and that both that copyright notice and this permission notice appear in supporting documentation, and that the name of M.I.T. not be used in advertising or publicity pertaining to distribution of the software without specific, written prior permission. Furthermore if you modify this software you must label your software as modified software and not distribute it in such a fashion that it might be confused with the original MIT software. M.I.T. makes no representations about the suitability of this software for any purpose. It is provided "as is" without express or implied warranty.

THIS SOFTWARE IS PROVIDED "**AS IS**" AND WITHOUT ANY EXPRESS OR IMPLIED WARRANTIES, INCLUDING, WITHOUT LIMITATION, THE IMPLIED WARRANTIES OF MERCHANTABILITY AND FITNESS FOR A PARTICULAR PURPOSE.

Individual source code files are copyright MIT, Cygnus Support, OpenVision, Oracle, Sun Soft, FundsXpress, and others.

Project Athena, Athena, Athena MUSE, Discuss, Hesiod, Kerberos, Moira, and Zephyr are trademarks of the Massachusetts Institute of Technology (MIT). No commercial use of these trademarks may be made without prior written permission of MIT.

"Commercial use" means use of a name in a product or other for-profit manner. It does NOT prevent a commercial firm from referring to the MIT trademarks in order to convey information (although in doing so, recognition of their trademark status should be given).

OpenSSL License

Copyright (c) 1998-2004 The OpenSSL Project. All rights reserved.

Redistribution and use in source and binary forms, with or without modification, are permitted provided that the following conditions are met:

- 1.Redistributions of source code must retain the above copyright notice, this list of conditions and the following disclaimer.
- 2.Redistributions in binary form must reproduce the above copyright notice, this list of conditions and the following disclaimer in the documentation and/or other materials provided with the distribution.
- 3.All advertising materials mentioning features or use of this software must display the following acknowledgment: "This product includes software developed by the OpenSSL Project for use in the OpenSSL Toolkit. (<http://www.openssl.org/>)"
- 4.The names "OpenSSL Toolkit" and "OpenSSL Project" must not be used to endorse or promote products derived from this software without prior written permission. For written permission, please contact openssl-core@openssl.org.
- 5.Products derived from this software may not be called "OpenSSL" nor may "OpenSSL" appear in their names without prior written permission of the OpenSSL Project.
- 6.Redistributions of any form whatsoever must retain the following acknowledgment: "This product includes software developed by the OpenSSL Project for use in the OpenSSL Toolkit. (<http://www.openssl.org/>)"

THIS SOFTWARE IS PROVIDED BY THE OpenSSL PROJECT "AS IS" AND ANY EXPRESSED OR IMPLIED WARRANTIES, INCLUDING, BUT NOT LIMITED TO, THE IMPLIED WARRANTIES OF MERCHANTABILITY AND FITNESS FOR A PARTICULAR PURPOSE ARE DISCLAIMED. IN NO EVENT SHALL THE OpenSSL PROJECT OR ITS CONTRIBUTORS BE LIABLE FOR ANY DIRECT, INDIRECT, INCIDENTAL, SPECIAL, EXEMPLARY, OR CONSEQUENTIAL DAMAGES (INCLUDING, BUT NOT LIMITED TO, PROCUREMENT OF SUBSTITUTE GOODS OR SERVICES; LOSS OF USE, DATA, OR PROFITS; OR BUSINESS INTERRUPTION) HOWEVER CAUSED AND ON ANY THEORY OF LIABILITY, WHETHER IN CONTRACT, STRICT LIABILITY, OR TORT (INCLUDING NEGLIGENCE OR OTHERWISE) ARISING IN ANY WAY OUT OF THE USE OF THIS SOFTWARE, EVEN IF ADVISED OF THE POSSIBILITY OF SUCH DAMAGE.

This product includes cryptographic software written by Eric Young (eay@cryptsoft.com). This product includes software written by Tim Hudson (tjh@cryptsoft.com).

Original SSLeay License

Copyright (C) 1995-1998 Eric Young (eay@cryptsoft.com) All rights reserved.

This package is an SSL implementation written by Eric Young (eay@cryptsoft.com). The implementation was written so as to conform with Netscape's SSL.

This library is free for commercial and non-commercial use as long as the following conditions are adhered to. The following conditions apply to all code found in this distribution, be it the RC4, RSA, lhash, DES, etc., code; not just the SSL code. The SSL documentation included with this distribution is covered by the same copyright terms except that the holder is Tim Hudson (tjh@cryptsoft.com).

Copyright remains Eric Young's, and as such any Copyright notices in the code are not to be removed. If this package is used in a product, Eric Young should be given attribution as the author of the parts of the library used. This can be in the form of a textual message at program startup or in documentation (online or textual) provided with the package.

Redistribution and use in source and binary forms, with or without modification, are permitted provided that the following conditions are met:

1. Redistributions of source code must retain the copyright notice, this list of conditions and the following disclaimer.
2. Redistributions in binary form must reproduce the above copyright notice, this list of conditions and the following disclaimer in the documentation and/or other materials provided with the distribution.
3. All advertising materials mentioning features or use of this software must display the following acknowledgement:
"This product includes cryptographic software written by Eric Young (eay@cryptsoft.com)" The word 'cryptographic' can be left out if the routines from the library being used are not cryptographic related :-).
4. If you include any Windows specific code (or a derivative thereof) from the apps directory (application code) you must include an acknowledgement: "This product includes software written by Tim Hudson (tjh@cryptsoft.com)"

THIS SOFTWARE IS PROVIDED BY ERIC YOUNG "AS IS" AND ANY EXPRESS OR IMPLIED WARRANTIES, INCLUDING, BUT NOT LIMITED TO, THE IMPLIED WARRANTIES OF MERCHANTABILITY AND FITNESS FOR A PARTICULAR PURPOSE ARE DISCLAIMED. IN NO EVENT SHALL THE AUTHOR OR CONTRIBUTORS BE LIABLE FOR ANY DIRECT, INDIRECT, INCIDENTAL, SPECIAL, EXEMPLARY, OR CONSEQUENTIAL DAMAGES (INCLUDING, BUT NOT LIMITED TO, PROCUREMENT OF SUBSTITUTE GOODS OR SERVICES; LOSS OF USE, DATA, OR PROFITS; OR BUSINESS INTERRUPTION) HOWEVER CAUSED AND ON ANY THEORY OF LIABILITY, WHETHER IN CONTRACT, STRICT LIABILITY, OR TORT (INCLUDING NEGLIGENCE OR OTHERWISE) ARISING IN ANY WAY OUT OF THE USE OF THIS SOFTWARE, EVEN IF ADVISED OF THE POSSIBILITY OF SUCH DAMAGE.

The licence and distribution terms for any publically available version orderivative of this code cannot be changed. i.e. this code cannot simply becoped and put under another distribution licence [including the GNU Public Licence.]

D3DES License

Copyright (c) 1988,1989,1990,1991,1992 by Richard Outerbridge. (GENie : OUTER; CIS : [71755,204]) Graven Imagery, 1992.

GNU GENERAL PUBLIC LICENSE Version 2, June 1991

Copyright (C) 1989, 1991 Free Software Foundation, Inc., 51 Franklin Street, Fifth Floor, Boston, MA 02110-1301 USA Everyone is permitted to copy and distribute verbatim copies of this license document, but changing it is not allowed.

Preamble

The licenses for most software are designed to take away your freedom to share and change it. By contrast, the GNU General Public License is intended to guarantee your freedom to share and change free software--to make sure the software is free for all its users. This General Public License applies to most of the Free Software Foundation's software and to any other program whose authors commit to using it. (Some other Free Software Foundation software is covered by the GNU Lesser General Public License instead.) You can apply it to your programs, too.

When we speak of free software, we are referring to freedom, not price. Our General Public Licenses are designed to make sure that you have the freedom to distribute copies of free software (and charge for this service if you wish), that you receive source code or can get it if you want it, that you can change the software or use pieces of it in new free programs; and that you know you can do these things.

To protect your rights, we need to make restrictions that forbid anyone to deny you these rights or to ask you to surrender the rights. These restrictions translate to certain responsibilities for you if you distribute copies of the software, or if you modify it.

For example, if you distribute copies of such a program, whether gratis or for a fee, you must give the recipients all the rights that you have. You must make sure that they, too, receive or can get the source code. And you must show them these terms so they know their rights.

We protect your rights with two steps: (1) copyright the software, and (2) offer you this license which gives you legal permission to copy, distribute and/or modify the software.

Also, for each author's protection and ours, we want to make certain that everyone understands that there is no warranty for this free software. If the software is modified by someone else and passed on, we want its recipients to know that what they have is not the original, so that any problems introduced by others will not reflect on the original authors' reputations.

Finally, any free program is threatened constantly by software patents. We wish to avoid the danger that redistributors of a free program will individually obtain patent licenses, in effect making the program proprietary. To prevent this, we have made it clear that any patent must be licensed for everyone's free use or not licensed at all.

The precise terms and conditions for copying, distribution and modification follow.

GNU GENERAL PUBLIC LICENSE TERMS AND CONDITIONS FOR COPYING, DISTRIBUTION AND MODIFICATION

0. This License applies to any program or other work which contains a notice placed by the copyright holder saying it may be distributed under the terms of this General Public License. The "Program", below, refers to any such program or work, and a "work based on the Program" means either the Program or any derivative work under copyright law: that is to say, a work containing the Program or a portion of it, either verbatim or with modifications and/or translated into another language. (Hereinafter, translation is included without limitation in the term "modification".) Each licensee is addressed as "you".

Activities other than copying, distribution and modification are not covered by this License; they are outside its scope. The act of running the Program is not restricted, and the output from the Program is covered only if its contents constitute a work based on the Program (independent of having been made by running the Program). Whether that is true depends on what the Program does.

1. You may copy and distribute verbatim copies of the Program's source code as you receive it, in any medium, provided that you conspicuously and appropriately publish on each copy an appropriate copyright notice and disclaimer of warranty; keep intact all the notices that refer to this License and to the absence of any warranty; and give any other recipients of the Program a copy of this License along with the Program.

You may charge a fee for the physical act of transferring a copy, and you may at your option offer warranty protection in exchange for a fee.

2. You may modify your copy or copies of the Program or any portion of it, thus forming a work based on the Program, and copy and distribute such modifications or work under the terms of Section 1 above, provided that you also meet all of these conditions:

- a) You must cause the modified files to carry prominent notices stating that you changed the files and the date of any change.
- b) You must cause any work that you distribute or publish, that in whole or in part contains or is derived from the Program or any part thereof, to be licensed as a whole at no charge to all third parties under the terms of this License.
- c) If the modified program normally reads commands interactively when run, you must cause it, when started running for such interactive use in the most ordinary way, to print or display an announcement including an appropriate copyright notice and a notice that there is no warranty (or else, saying that you provide a warranty) and that users may redistribute the program under these conditions, and telling the user how to view a copy of this License. (Exception: if the Program itself is interactive but does not normally print such an announcement, your work based on the Program is not required to print an announcement.)

These requirements apply to the modified work as a whole. If identifiable sections of that work are not derived from the Program, and can be reasonably considered independent and separate works in themselves, then this License, and its terms, do not apply to those sections when you distribute them as separate works. But when you distribute the same

sections as part of a whole which is a work based on the Program, the distribution of the whole must be on the terms of this License, whose permissions for other licensees extend to the entire whole, and thus to each and every part regardless of who wrote it.

Thus, it is not the intent of this section to claim rights or contest your rights to work written entirely by you; rather, the intent is to exercise the right to control the distribution of derivative or collective works based on the Program.

In addition, mere aggregation of another work not based on the Program with the Program (or with a work based on the Program) on a volume of a storage or distribution medium does not bring the other work under the scope of this License.

3. You may copy and distribute the Program (or a work based on it, under Section 2) in object code or executable form under the terms of Sections 1 and 2 above provided that you also do one of the following:

- a) Accompany it with the complete corresponding machine-readable source code, which must be distributed under the terms of Sections 1 and 2 above on a medium customarily used for software interchange; or,
- b) Accompany it with a written offer, valid for at least three years, to give any third party, for a charge no more than your cost of physically performing source distribution, a complete machine-readable copy of the corresponding source code, to be distributed under the terms of Sections 1 and 2 above on a medium customarily used for software interchange; or,
- c) Accompany it with the information you received as to the offer to distribute corresponding source code. (This alternative is allowed only for noncommercial distribution and only if you received the program in object code or executable form with such an offer, in accord with Subsection b above.)

The source code for a work means the preferred form of the work for making modifications to it. For an executable work, complete source code means all the source code for all modules it contains, plus any associated interface definition files, plus the scripts used to control compilation and installation of the executable. However, as a special exception, the source code distributed need not include anything that is normally distributed (in either source or binary form) with the major components (compiler, kernel, and so on) of the operating system on which the executable runs, unless that component itself accompanies the executable.

If distribution of executable or object code is made by offering access to copy from a designated place, then offering equivalent access to copy the source code from the same place counts as distribution of the source code, even though third parties are not compelled to copy the source along with the object code.

4. You may not copy, modify, sublicense, or distribute the Program except as expressly provided under this License. Any attempt otherwise to copy, modify, sublicense or distribute the Program is void, and will automatically terminate your rights under this License. However, parties who have received copies, or rights, from you under this License will not have their licenses terminated so long as such parties remain in full compliance.

5. You are not required to accept this License, since you have not signed it. However, nothing else grants you permission to modify or distribute the Program or its derivative works. These actions are prohibited by law if you do not accept this License. Therefore, by modifying or distributing the Program (or any work based on the Program), you indicate your acceptance of this License to do so, and all its terms and conditions for copying, distributing or modifying the Program or works based on it.

6. Each time you redistribute the Program (or any work based on the Program), the recipient automatically receives a license from the original licensor to copy, distribute or modify the Program subject to these terms and conditions. You

may not impose any further restrictions on the recipients' exercise of the rights granted herein. You are not responsible for enforcing compliance by third parties to this License.

7. If, as a consequence of a court judgment or allegation of patent infringement or for any other reason (not limited to patent issues), conditions are imposed on you (whether by court order, agreement or otherwise) that contradict the conditions of this License, they do not excuse you from the conditions of this License. If you cannot distribute so as to satisfy simultaneously your obligations under this License and any other pertinent obligations, then as a consequence you may not distribute the Program at all. For example, if a patent license would not permit royalty-free redistribution of the Program by all those who receive copies directly or indirectly through you, then the only way you could satisfy both it and this License would be to refrain entirely from distribution of the Program.

If any portion of this section is held invalid or unenforceable under any particular circumstance, the balance of the section is intended to apply and the section as a whole is intended to apply in other circumstances.

It is not the purpose of this section to induce you to infringe any patents or other property right claims or to contest validity of any such claims; this section has the sole purpose of protecting the integrity of the free software distribution system, which is implemented by public license practices. Many people have made generous contributions to the wide range of software distributed through that system in reliance on consistent application of that system; it is up to the author/donor to decide if he or she is willing to distribute software through any other system and a licensee cannot impose that choice.

This section is intended to make thoroughly clear what is believed to be a consequence of the rest of this License.

8. If the distribution and/or use of the Program is restricted in certain countries either by patents or by copyrighted interfaces, the original copyright holder who places the Program under this License may add an explicit geographical distribution limitation excluding those countries, so that distribution is permitted only in or among countries not thus excluded. In such case, this License incorporates the limitation as if written in the body of this License.

9. The Free Software Foundation may publish revised and/or new versions of the General Public License from time to time. Such new versions will be similar in spirit to the present version, but may differ in detail to address new problems or concerns.

Each version is given a distinguishing version number. If the Program specifies a version number of this License which applies to it and "any later version", you have the option of following the terms and conditions either of that version or of any later version published by the Free Software Foundation. If the Program does not specify a version number of this License, you may choose any version ever published by the Free Software Foundation.

10. If you wish to incorporate parts of the Program into other free programs whose distribution conditions are different, write to the author to ask for permission. For software which is copyrighted by the Free Software Foundation, write to the Free Software Foundation; we sometimes make exceptions for this. Our decision will be guided by the two goals of preserving the free status of all derivatives of our free software and of promoting the sharing and reuse of software generally.

NO WARRANTY

11. BECAUSE THE PROGRAM IS LICENSED FREE OF CHARGE, THERE IS NO WARRANTY FOR THE PROGRAM, TO THE EXTENT PERMITTED BY APPLICABLE LAW. EXCEPT WHEN OTHERWISE STATED IN WRITING THE COPYRIGHT HOLDERS AND/OR OTHER PARTIES PROVIDE THE PROGRAM "AS IS" WITHOUT WARRANTY OF ANY KIND, EITHER EXPRESSED OR IMPLIED, INCLUDING, BUT NOT LIMITED TO, THE IMPLIED WARRANTIES OF MERCHANTABILITY AND FITNESS FOR A PARTICULAR PURPOSE. THE ENTIRE RISK AS TO

THE QUALITY AND PERFORMANCE OF THE PROGRAM IS WITH YOU. SHOULD THE PROGRAM PROVE DEFECTIVE, YOU ASSUME THE COST OF ALL NECESSARY SERVICING, REPAIR OR CORRECTION.

12. IN NO EVENT UNLESS REQUIRED BY APPLICABLE LAW OR AGREED TO IN WRITING WILL ANY COPYRIGHT HOLDER, OR ANY OTHER PARTY WHO MAY MODIFY AND/OR REDISTRIBUTE THE PROGRAM AS PERMITTED ABOVE, BE LIABLE TO YOU FOR DAMAGES, INCLUDING ANY GENERAL, SPECIAL, INCIDENTAL OR CONSEQUENTIAL DAMAGES ARISING OUT OF THE USE OR INABILITY TO USE THE PROGRAM (INCLUDING BUT NOT LIMITED TO LOSS OF DATA OR DATA BEING RENDERED INACCURATE OR LOSSES SUSTAINED BY YOU OR THIRD PARTIES OR A FAILURE OF THE PROGRAM TO OPERATE WITH ANY OTHER PROGRAMS), EVEN IF SUCH HOLDER OR OTHER PARTY HAS BEEN ADVISED OF THE POSSIBILITY OF SUCH DAMAGES.

END OF TERMS AND CONDITIONS

How to Apply These Terms to Your New Programs

If you develop a new program, and you want it to be of the greatest possible use to the public, the best way to achieve this is to make it free software which everyone can redistribute and change under these terms.

To do so, attach the following notices to the program. It is safest to attach them to the start of each source file to most effectively convey the exclusion of warranty; and each file should have at least the "copyright" line and a pointer to where the full notice is found.

<one line to give the program's name and a brief idea of what it does.> Copyright (C) <year> <name of author>

This program is free software; you can redistribute it and/or modify it under the terms of the GNU General Public License as published by the Free Software Foundation; either version 2 of the License, or (at your option) any later version.

This program is distributed in the hope that it will be useful, but WITHOUT ANY WARRANTY; without even the implied warranty of MERCHANTABILITY or FITNESS FOR A PARTICULAR PURPOSE. See the GNU General Public License for more details.

You should have received a copy of the GNU General Public License along with this program; if not, write to the Free Software Foundation, Inc., 51 Franklin Street, Fifth Floor, Boston, MA 02110-1301 USA.

Also add information on how to contact you by electronic and paper mail.

If the program is interactive, make it output a short notice like this when it starts in an interactive mode:

Gnomovision version 69, Copyright (C) year name of author Gnomovision comes with ABSOLUTELY NO WARRANTY; for details type `show w'. This is free software, and you are welcome to redistribute it under certain conditions; type `show c' for details.

The hypothetical commands `show w' and `show c' should show the appropriate parts of the General Public License. Of course, the commands you use may be called something other than `show w' and `show c'; they could even be mouse-clicks or menu items--whatever suits your program.

You should also get your employer (if you work as a programmer) or your school, if any, to sign a "copyright disclaimer" for the program, if necessary. Here is a sample; alter the names:

Yoyodyne, Inc., hereby disclaims all copyright interest in the program `Gnomovision' (which makes passes at compilers) written by James Hacker.

<signature of Ty Coon>, 1 April 1989
Ty Coon, President of Vice

This General Public License does not permit incorporating your program into proprietary programs. If your program is a subroutine library, you may consider it more useful to permit linking proprietary applications with the library. If this is what you want to do, use the GNU Lesser General Public License instead of this License.

GNU LESSER GENERAL PUBLIC LICENSE

Version 2.1, February 1999

Copyright (C) 1991, 1999 Free Software Foundation, Inc. 51 Franklin Street, Fifth Floor, Boston, MA 02110-1301 USA Everyone is permitted to copy and distribute verbatim copies of this license document, but changing it is not allowed.

[This is the first released version of the Lesser GPL. It also counts as the successor of the GNU Library Public License, version 2, hence the version number 2.1.]

Preamble

The licenses for most software are designed to take away your freedom to share and change it. By contrast, the GNU General Public Licenses are intended to guarantee your freedom to share and change free software--to make sure the software is free for all its users.

This license, the Lesser General Public License, applies to some specially designated software packages--typically libraries--of the Free Software Foundation and other authors who decide to use it. You can use it too, but we suggest you first think carefully about whether this license or the ordinary General Public License is the better strategy to use in any particular case, based on the explanations below.

When we speak of free software, we are referring to freedom of use, not price. Our General Public Licenses are designed to make sure that you have the freedom to distribute copies of free software (and charge for this service if you wish); that you receive source code or can get it if you want it; that you can change the software and use pieces of it in new free programs; and that you are informed that you can do these things.

To protect your rights, we need to make restrictions that forbid distributors to deny you these rights or to ask you to surrender these rights. These restrictions translate to certain responsibilities for you if you distribute copies of the library or if you modify it.

For example, if you distribute copies of the library, whether gratis or for a fee, you must give the recipients all the rights that we gave you. You must make sure that they, too, receive or can get the source code. If you link other code with the

library, you must provide complete object files to the recipients, so that they can relink them with the library after making changes to the library and recompiling it. And you must show them these terms so they know their rights.

We protect your rights with a two-step method: (1) we copyright the library, and (2) we offer you this license, which gives you legal permission to copy, distribute and/or modify the library.

To protect each distributor, we want to make it very clear that there is no warranty for the free library. Also, if the library is modified by someone else and passed on, the recipients should know that what they have is not the original version, so that the original author's reputation will not be affected by problems that might be introduced by others.

Finally, software patents pose a constant threat to the existence of any free program. We wish to make sure that a company cannot effectively restrict the users of a free program by obtaining a restrictive license from a patent holder. Therefore, we insist that any patent license obtained for a version of the library must be consistent with the full freedom of use specified in this license.

Most GNU software, including some libraries, is covered by the ordinary GNU General Public License. This license, the GNU Lesser General Public License, applies to certain designated libraries, and is quite different from the ordinary General Public License. We use this license for certain libraries in order to permit linking those libraries into non-free programs.

When a program is linked with a library, whether statically or using a shared library, the combination of the two is legally speaking a combined work, a derivative of the original library. The ordinary General Public License therefore permits such linking only if the entire combination fits its criteria of freedom. The Lesser General Public License permits more lax criteria for linking other code with the library.

We call this license the "Lesser" General Public License because it does Less to protect the user's freedom than the ordinary General Public License. It also provides other free software developers Less of an advantage over competing non-free programs. These disadvantages are the reason we use the ordinary General Public License for many libraries. However, the Lesser license provides advantages in certain special circumstances.

For example, on rare occasions, there may be a special need to encourage the widest possible use of a certain library, so that it becomes a de-facto standard. To achieve this, non-free programs must be allowed to use the library. A more frequent case is that a free library does the same job as widely used non-free libraries. In this case, there is little to gain by limiting the free library to free software only, so we use the Lesser General Public License.

In other cases, permission to use a particular library in non-free programs enables a greater number of people to use a large body of free software. For example, permission to use the GNU C Library in non-free programs enables many more people to use the whole GNU operating system, as well as its variant, the GNU/Linux operating system.

Although the Lesser General Public License is Less protective of the users' freedom, it does ensure that the user of a program that is linked with the Library has the freedom and the wherewithal to run that program using a modified version of the Library.

The precise terms and conditions for copying, distribution and modification follow. Pay close attention to the difference between a "work based on the library" and a "work that uses the library". The former contains code derived from the library, whereas the latter must be combined with the library in order to run.

GNU LESSER GENERAL PUBLIC LICENSE TERMS AND CONDITIONS FOR COPYING, DISTRIBUTION AND MODIFICATION

0. This License Agreement applies to any software library or other program which contains a notice placed by the copyright holder or other authorized party saying it may be distributed under the terms of this Lesser General Public License (also called "this License"). Each licensee is addressed as "you".

A "library" means a collection of software functions and/or data prepared so as to be conveniently linked with application programs (which use some of those functions and data) to form executables.

The "Library", below, refers to any such software library or work which has been distributed under these terms. A "work based on the Library" means either the Library or any derivative work under copyright law: that is to say, a work containing the Library or a portion of it, either verbatim or with modifications and/or translated straightforwardly into another language. (Hereinafter, translation is included without limitation in the term "modification".)

"Source code" for a work means the preferred form of the work for making modifications to it. For a library, complete source code means all the source code for all modules it contains, plus any associated interface definition files, plus the scripts used to control compilation and installation of the library.

Activities other than copying, distribution and modification are not covered by this License; they are outside its scope. The act of running a program using the Library is not restricted, and output from such a program is covered only if its contents constitute a work based on the Library (independent of the use of the Library in a tool for writing it). Whether that is true depends on what the Library does and what the program that uses the Library does.

1. You may copy and distribute verbatim copies of the Library's complete source code as you receive it, in any medium, provided that you conspicuously and appropriately publish on each copy an appropriate copyright notice and disclaimer of warranty; keep intact all the notices that refer to this License and to the absence of any warranty; and distribute a copy of this License along with the Library.

You may charge a fee for the physical act of transferring a copy, and you may at your option offer warranty protection in exchange for a fee.

2. You may modify your copy or copies of the Library or any portion of it, thus forming a work based on the Library, and copy and distribute such modifications or work under the terms of Section 1 above, provided that you also meet all of these conditions:

a) The modified work must itself be a software library.

b) You must cause the files modified to carry prominent notices stating that you changed the files and the date of any change.

c) You must cause the whole of the work to be licensed at no charge to all third parties under the terms of this License.

d) If a facility in the modified Library refers to a function or a table of data to be supplied by an application program that uses the facility, other than as an argument passed when the facility is invoked, then you must make a good faith effort to ensure that, in the event an application does not supply such function or table, the facility still operates, and performs whatever part of its purpose remains meaningful.

(For example, a function in a library to compute square roots has a purpose that is entirely well-defined independent of the application. Therefore, Subsection 2d requires that any application-supplied function or table used by this function must be optional: if the application does not supply it, the square root function must still compute square roots.)

These requirements apply to the modified work as a whole. If identifiable sections of that work are not derived from the Library, and can be reasonably considered independent and separate works in themselves, then this License, and its terms, do not apply to those sections when you distribute them as separate works. But when you distribute the same sections as part of a whole which is a work based on the Library, the distribution of the whole must be on the terms of this License, whose permissions for other licensees extend to the entire whole, and thus to each and every part regardless of who wrote it.

Thus, it is not the intent of this section to claim rights or contest your rights to work written entirely by you; rather, the intent is to exercise the right to control the distribution of derivative or collective works based on the Library.

In addition, mere aggregation of another work not based on the Library with the Library (or with a work based on the Library) on a volume of a storage or distribution medium does not bring the other work under the scope of this License.

3. You may opt to apply the terms of the ordinary GNU General Public License instead of this License to a given copy of the Library. To do this, you must alter all the notices that refer to this License, so that they refer to the ordinary GNU General Public License, version 2, instead of to this License. (If a newer version than version 2 of the ordinary GNU General Public License has appeared, then you can specify that version instead if you wish.) Do not make any other change in these notices.

Once this change is made in a given copy, it is irreversible for that copy, so the ordinary GNU General Public License applies to all subsequent copies and derivative works made from that copy.

This option is useful when you wish to copy part of the code of the Library into a program that is not a library.

4. You may copy and distribute the Library (or a portion or derivative of it, under Section 2) in object code or executable form under the terms of Sections 1 and 2 above provided that you accompany it with the complete corresponding machine-readable source code, which must be distributed under the terms of Sections 1 and 2 above on a medium customarily used for software interchange.

If distribution of object code is made by offering access to copy from a designated place, then offering equivalent access to copy the source code from the same place satisfies the requirement to distribute the source code, even though third parties are not compelled to copy the source along with the object code.

5. A program that contains no derivative of any portion of the Library, but is designed to work with the Library by being compiled or linked with it, is called a "work that uses the Library". Such a work, in isolation, is not a derivative work of the Library, and therefore falls outside the scope of this License.

However, linking a "work that uses the Library" with the Library creates an executable that is a derivative of the Library (because it contains portions of the Library), rather than a "work that uses the library". The executable is therefore covered by this License. Section 6 states terms for distribution of such executables.

When a "work that uses the Library" uses material from a header file that is part of the Library, the object code for the work may be a derivative work of the Library even though the source code is not. Whether this is true is especially significant if the work can be linked without the Library, or if the work is itself a library. The threshold for this to be true is not precisely defined by law.

If such an object file uses only numerical parameters, data structure layouts and accessors, and small macros and small inline functions (ten lines or less in length), then the use of the object file is unrestricted, regardless of whether it is legally a derivative work. (Executables containing this object code plus portions of the Library will still fall under Section 6.)

Otherwise, if the work is a derivative of the Library, you may distribute the object code for the work under the terms of Section 6. Any executables containing that work also fall under Section 6, whether or not they are linked directly with the Library itself.

6. As an exception to the Sections above, you may also combine or link a "work that uses the Library" with the Library to produce a work containing portions of the Library, and distribute that work under terms of your choice, provided that the terms permit modification of the work for the customer's own use and reverse engineering for debugging such modifications.

You must give prominent notice with each copy of the work that the Library is used in it and that the Library and its use are covered by this License. You must supply a copy of this License. If the work during execution displays copyright notices, you must include the copyright notice for the Library among them, as well as a reference directing the user to the copy of this License. Also, you must do one of these things:

- a) Accompany the work with the complete corresponding machine-readable source code for the Library including whatever changes were used in the work (which must be distributed under Sections 1 and 2 above); and, if the work is an executable linked with the Library, with the complete machine-readable "work that uses the Library", as object code and/or source code, so that the user can modify the Library and then relink to produce a modified executable containing the modified Library. (It is understood that the user who changes the contents of definitions files in the Library will not necessarily be able to recompile the application to use the modified definitions.)
- b) Use a suitable shared library mechanism for linking with the Library. A suitable mechanism is one that (1) uses at run time a copy of the library already present on the user's computer system, rather than copying library functions into the executable, and (2) will operate properly with a modified version of the library, if the user installs one, as long as the modified version is interface-compatible with the version that the work was made with.
- c) Accompany the work with a written offer, valid for at least three years, to give the same user the materials specified in Subsection 6a, above, for a charge no more than the cost of performing this distribution.
- d) If distribution of the work is made by offering access to copy from a designated place, offer equivalent access to copy the above specified materials from the same place.
- e) Verify that the user has already received a copy of these materials or that you have already sent this user a copy.

For an executable, the required form of the "work that uses the Library" must include any data and utility programs needed for reproducing the executable from it. However, as a special exception, the materials to be distributed need not include anything that is normally distributed (in either source or binary form) with the major components (compiler, kernel, and so on) of the operating system on which the executable runs, unless that component itself accompanies the executable.

It may happen that this requirement contradicts the license restrictions of other proprietary libraries that do not normally accompany the operating system. Such a contradiction means you cannot use both them and the Library together in an executable that you distribute.

7. You may place library facilities that are a work based on the Library side-by-side in a single library together with other library facilities not covered by this License, and distribute such a combined library, provided that the separate distribution of the work based on the Library and of the other library facilities is otherwise permitted, and provided that you do these two things:

a) Accompany the combined library with a copy of the same work based on the Library, uncombined with any other library facilities. This must be distributed under the terms of the Sections above.

b) Give prominent notice with the combined library of the fact that part of it is a work based on the Library, and explaining where to find the accompanying uncombined form of the same work.

8. You may not copy, modify, sublicense, link with, or distribute the Library except as expressly provided under this License. Any attempt otherwise to copy, modify, sublicense, link with, or distribute the Library is void, and will automatically terminate your rights under this License. However, parties who have received copies, or rights, from you under this License will not have their licenses terminated so long as such parties remain in full compliance.

9. You are not required to accept this License, since you have not signed it. However, nothing else grants you permission to modify or distribute the Library or its derivative works. These actions are prohibited by law if you do not accept this License. Therefore, by modifying or distributing the Library (or any work based on the Library), you indicate your acceptance of this License to do so, and all its terms and conditions for copying, distributing or modifying the Library or works based on it.

10. Each time you redistribute the Library (or any work based on the Library), the recipient automatically receives a license from the original licensor to copy, distribute, link with or modify the Library subject to these terms and conditions. You may not impose any further restrictions on the recipients' exercise of the rights granted herein. You are not responsible for enforcing compliance by third parties with this License.

11. If, as a consequence of a court judgment or allegation of patent infringement or for any other reason (not limited to patent issues), conditions are imposed on you (whether by court order, agreement or otherwise) that contradict the conditions of this License, they do not excuse you from the conditions of this License. If you cannot distribute so as to satisfy simultaneously your obligations under this License and any other pertinent obligations, then as a consequence you may not distribute the Library at all. For example, if a patent license would not permit royalty-free redistribution of the Library by all those who receive copies directly or indirectly through you, then the only way you could satisfy both it and this License would be to refrain entirely from distribution of the Library.

If any portion of this section is held invalid or unenforceable under any particular circumstance, the balance of the section is intended to apply, and the section as a whole is intended to apply in other circumstances.

It is not the purpose of this section to induce you to infringe any patents or other property right claims or to contest validity of any such claims; this section has the sole purpose of protecting the integrity of the free software distribution system which is implemented by public license practices. Many people have made generous contributions to the wide range of software distributed through that system in reliance on consistent application of that system; it is up to the author/donor to decide if he or she is willing to distribute software through any other system and a licensee cannot impose that choice.

This section is intended to make thoroughly clear what is believed to be a consequence of the rest of this License.

12. If the distribution and/or use of the Library is restricted in certain countries either by patents or by copyrighted interfaces, the original copyright holder who places the Library under this License may add an explicit geographical distribution limitation excluding those countries, so that distribution is permitted only in or among countries not thus excluded. In such case, this License incorporates the limitation as if written in the body of this License.

13. The Free Software Foundation may publish revised and/or new versions of the Lesser General Public License from time to time. Such new versions will be similar in spirit to the present version, but may differ in detail to address new problems or concerns.

Each version is given a distinguishing version number. If the Library specifies a version number of this License which applies to it and "any later version", you have the option of following the terms and conditions either of that version or of any later version published by the Free Software Foundation. If the Library does not specify a license version number, you may choose any version ever published by the Free Software Foundation.

14. If you wish to incorporate parts of the Library into other free programs whose distribution conditions are incompatible with these, write to the author to ask for permission. For software which is copyrighted by the Free Software Foundation, write to the Free Software Foundation; we sometimes make exceptions for this. Our decision will be guided by the two goals of preserving the free status of all derivatives of our free software and of promoting the sharing and reuse of software generally.

NO WARRANTY

15. BECAUSE THE LIBRARY IS LICENSED FREE OF CHARGE, THERE IS NO WARRANTY FOR THE LIBRARY, TO THE EXTENT PERMITTED BY APPLICABLE LAW. EXCEPT WHEN OTHERWISE STATED IN WRITING THE COPYRIGHT HOLDERS AND/OR OTHER PARTIES PROVIDE THE LIBRARY "AS IS" WITHOUT WARRANTY OF ANY KIND, EITHER EXPRESSED OR IMPLIED, INCLUDING, BUT NOT LIMITED TO, THE IMPLIED WARRANTIES OF MERCHANTABILITY AND FITNESS FOR A PARTICULAR PURPOSE. THE ENTIRE RISK AS TO THE QUALITY AND PERFORMANCE OF THE LIBRARY IS WITH YOU. SHOULD THE LIBRARY PROVE DEFECTIVE, YOU ASSUME THE COST OF ALL NECESSARY SERVICING, REPAIR OR CORRECTION.

16. IN NO EVENT UNLESS REQUIRED BY APPLICABLE LAW OR AGREED TO IN WRITING WILL ANY COPYRIGHT HOLDER, OR ANY OTHER PARTY WHO MAY MODIFY AND/OR REDISTRIBUTE THE LIBRARY AS PERMITTED ABOVE, BE LIABLE TO YOU FOR DAMAGES, INCLUDING ANY GENERAL, SPECIAL, INCIDENTAL OR CONSEQUENTIAL DAMAGES ARISING OUT OF THE USE OR INABILITY TO USE THE LIBRARY (INCLUDING BUT NOT LIMITED TO LOSS OF DATA OR DATA BEING RENDERED INACCURATE OR LOSSES SUSTAINED BY

YOU OR THIRD PARTIES OR A FAILURE OF THE LIBRARY TO OPERATE WITH ANY OTHER SOFTWARE), EVEN IF SUCH HOLDER OR OTHER PARTY HAS BEEN ADVISED OF THE POSSIBILITY OF SUCH DAMAGES.

END OF TERMS AND CONDITIONS

How to Apply These Terms to Your New Libraries

If you develop a new library, and you want it to be of the greatest possible use to the public, we recommend making it free software that everyone can redistribute and change. You can do so by permitting redistribution under these terms (or, alternatively, under the terms of the ordinary General Public License).

To apply these terms, attach the following notices to the library. It is safest to attach them to the start of each source file to most effectively convey the exclusion of warranty; and each file should have at least the "copyright" line and a pointer to where the full notice is found.

<one line to give the library's name and a brief idea of what it does.> Copyright (C) <year> <name of author>

This library is free software; you can redistribute it and/or modify it under the terms of the GNU Lesser General Public License as published by the Free Software Foundation; either version 2.1 of the License, or (at your option) any later version.

This library is distributed in the hope that it will be useful, but WITHOUT ANY WARRANTY; without even the implied warranty of MERCHANTABILITY or FITNESS FOR A PARTICULAR PURPOSE. See the GNU Lesser General Public License for more details.

You should have received a copy of the GNU Lesser General Public License along with this library; if not, write to the Free Software Foundation, Inc., 51 Franklin Street, Fifth Floor, Boston, MA 02110-1301 USA

Also add information on how to contact you by electronic and paper mail.

You should also get your employer (if you work as a programmer) or your school, if any, to sign a "copyright disclaimer" for the library, if necessary. Here is a sample; alter the names:

Yoyodyne, Inc., hereby disclaims all copyright interest in the library `Frob' (a library for tweaking knobs) written by James Random Hacker.

<signature of Ty Coon>, 1 April 1990
Ty Coon, President of Vice

That's all there is to it!

GNU GENERAL PUBLIC LICENSE

Version 3, 29 June 2007

Copyright (C) 2007 Free Software Foundation, Inc. <<http://fsf.org/>>

Everyone is permitted to copy and distribute verbatim copies of this license document, but changing it is not allowed.

Preamble

The GNU General Public License is a free, copyleft license for software and other kinds of works.

The licenses for most software and other practical works are designed to take away your freedom to share and change the works. By contrast, the GNU General Public License is intended to guarantee your freedom to share and change all versions of a program--to make sure it remains free software for all its users. We, the Free Software Foundation, use the GNU General Public License for most of our software; it applies also to any other work released this way by its authors. You can apply it to your programs, too.

When we speak of free software, we are referring to freedom, not price. Our General Public Licenses are designed to make sure that you have the freedom to distribute copies of free software (and charge for them if you wish), that you receive source code or can get it if you want it, that you can change the software or use pieces of it in new free programs, and that you know you can do these things.

To protect your rights, we need to prevent others from denying you these rights or asking you to surrender the rights. Therefore, you have certain responsibilities if you distribute copies of the software, or if you modify it: responsibilities to respect the freedom of others.

For example, if you distribute copies of such a program, whether gratis or for a fee, you must pass on to the recipients the same freedoms that you received. You must make sure that they, too, receive or can get the source code. And you must show them these terms so they know their rights.

Developers that use the GNU GPL protect your rights with two steps:

(1) assert copyright on the software, and (2) offer you this License giving you legal permission to copy, distribute and/or modify it.

For the developers' and authors' protection, the GPL clearly explains that there is no warranty for this free software. For both users' and authors' sake, the GPL requires that modified versions be marked as changed, so that their problems will not be attributed erroneously to authors of previous versions.

Some devices are designed to deny users access to install or run modified versions of the software inside them, although the manufacturer can do so. This is fundamentally incompatible with the aim of protecting users' freedom to change the software. The systematic pattern of such abuse occurs in the area of products for individuals to use, which is precisely where it is most unacceptable. Therefore, we have designed this version of the GPL to prohibit the practice for those products. If such problems arise substantially in other domains, we stand ready to extend this provision to those domains in future versions of the GPL, as needed to protect the freedom of users.

Finally, every program is threatened constantly by software patents. States should not allow patents to restrict development and use of software on general-purpose computers, but in those that do, we wish to avoid the special danger that patents applied to a free program could make it effectively proprietary. To prevent this, the GPL assures that patents cannot be used to render the program non-free.

The precise terms and conditions for copying, distribution and modification follow.

TERMS AND CONDITIONS

0. Definitions.

"This License" refers to version 3 of the GNU General Public License.

"Copyright" also means copyright-like laws that apply to other kinds of works, such as semiconductor masks.

"The Program" refers to any copyrightable work licensed under this License. Each licensee is addressed as "you". "Licensees" and "recipients" may be individuals or organizations.

To "modify" a work means to copy from or adapt all or part of the work in a fashion requiring copyright permission, other than the making of an exact copy. The resulting work is called a "modified version" of the earlier work or a work "based on" the earlier work.

A "covered work" means either the unmodified Program or a work based on the Program.

To "propagate" a work means to do anything with it that, without permission, would make you directly or secondarily liable for infringement under applicable copyright law, except executing it on a computer or modifying a private copy. Propagation includes copying, distribution (with or without modification), making available to the public, and in some countries other activities as well.

To "convey" a work means any kind of propagation that enables other parties to make or receive copies. Mere interaction with a user through a computer network, with no transfer of a copy, is not conveying.

An interactive user interface displays "Appropriate Legal Notices" to the extent that it includes a convenient and prominently visible feature that (1) displays an appropriate copyright notice, and (2) tells the user that there is no warranty for the work (except to the extent that warranties are provided), that licensees may convey the work under this License, and how to view a copy of this License. If the interface presents a list of user commands or options, such as a menu, a prominent item in the list meets this criterion.

1. Source Code.

The "source code" for a work means the preferred form of the work for making modifications to it. "Object code" means any non-source form of a work.

A "Standard Interface" means an interface that either is an official standard defined by a recognized standards body, or, in the case of interfaces specified for a particular programming language, one that is widely used among developers working in that language.

The "System Libraries" of an executable work include anything, other than the work as a whole, that (a) is included in the normal form of packaging a Major Component, but which is not part of that Major Component, and (b) serves only to enable use of the work with that Major Component, or to implement a Standard Interface for which an implementation is available to the public in source code form. A "Major Component", in this context, means a major essential component (kernel, window system, and so on) of the specific operating system (if any) on which the executable work runs, or a compiler used to produce the work, or an object code interpreter used to run it.

The "Corresponding Source" for a work in object code form means all the source code needed to generate, install, and (for an executable work) run the object code and to modify the work, including scripts to control those activities. However, it does not include the work's System Libraries, or general-purpose tools or generally available free programs which are used unmodified in performing those activities but which are not part of the work. For example, Corresponding Source includes interface definition files associated with source files for the work, and the source code for shared libraries and dynamically linked subprograms that the work is specifically designed to require, such as by intimate data communication or control flow between those subprograms and other parts of the work.

The Corresponding Source need not include anything that users can regenerate automatically from other parts of the Corresponding Source.

The Corresponding Source for a work in source code form is that same work.

2. Basic Permissions.

All rights granted under this License are granted for the term of copyright on the Program, and are irrevocable provided the stated conditions are met. This License explicitly affirms your unlimited permission to run the unmodified Program. The output from running a covered work is covered by this License only if the output, given its content, constitutes a covered work. This License acknowledges your rights of fair use or other equivalent, as provided by copyright law.

You may make, run and propagate covered works that you do not convey, without conditions so long as your license otherwise remains in force. You may convey covered works to others for the sole purpose of having them make modifications exclusively for you, or provide you with facilities for running those works, provided that you comply with the terms of this License in conveying all material for which you do not control copyright. Those thus making or running the covered works for you must do so exclusively on your behalf, under your direction and control, on terms that prohibit them from making any copies of your copyrighted material outside their relationship with you.

Conveying under any other circumstances is permitted solely under the conditions stated below. Sublicensing is not allowed; section 10 makes it unnecessary.

3. Protecting Users' Legal Rights From Anti-Circumvention Law.

No covered work shall be deemed part of an effective technological measure under any applicable law fulfilling obligations under article 11 of the WIPO copyright treaty adopted on 20 December 1996, or similar laws prohibiting or restricting circumvention of such measures.

When you convey a covered work, you waive any legal power to forbid circumvention of technological measures to the extent such circumvention is effected by exercising rights under this License with respect to the covered work, and you disclaim any intention to limit operation or modification of the work as a means of enforcing, against the work's users, your or third parties' legal rights to forbid circumvention of technological measures.

4. Conveying Verbatim Copies.

You may convey verbatim copies of the Program's source code as you receive it, in any medium, provided that you conspicuously and appropriately publish on each copy an appropriate copyright notice; keep intact all notices stating that this License and any non-permissive terms added in accord with section 7 apply to the code; keep intact all notices of the absence of any warranty; and give all recipients a copy of this License along with the Program.

You may charge any price or no price for each copy that you convey, and you may offer support or warranty protection for a fee.

5. Conveying Modified Source Versions.

You may convey a work based on the Program, or the modifications to produce it from the Program, in the form of source code under the terms of section 4, provided that you also meet all of these conditions:

a) The work must carry prominent notices stating that you modified it, and giving a relevant date.

b) The work must carry prominent notices stating that it is released under this License and any conditions added under section

7. This requirement modifies the requirement in section 4 to "keep intact all notices".

c) You must license the entire work, as a whole, under this License to anyone who comes into possession of a copy. This License will therefore apply, along with any applicable section 7 additional terms, to the whole of the work, and all its parts, regardless of how they are packaged. This License gives no permission to license the work in any other way, but it does not invalidate such permission if you have separately received it.

d) If the work has interactive user interfaces, each must display Appropriate Legal Notices; however, if the Program has interactive interfaces that do not display Appropriate Legal Notices, your work need not make them do so.

A compilation of a covered work with other separate and independent works, which are not by their nature extensions of the covered work, and which are not combined with it such as to form a larger program, in or on a volume of a storage or distribution medium, is called an "aggregate" if the compilation and its resulting copyright are not used to limit the access or legal rights of the compilation's users beyond what the individual works permit. Inclusion of a covered work in an aggregate does not cause this License to apply to the other parts of the aggregate.

6. Conveying Non-Source Forms.

You may convey a covered work in object code form under the terms of sections 4 and 5, provided that you also convey the machine-readable Corresponding Source under the terms of this License, in one of these ways:

a) Convey the object code in, or embodied in, a physical product (including a physical distribution medium), accompanied by the Corresponding Source fixed on a durable physical medium customarily used for software interchange.

b) Convey the object code in, or embodied in, a physical product (including a physical distribution medium), accompanied by a written offer, valid for at least three years and valid for as long as you offer spare parts or customer support for that product model, to give anyone who possesses the object code either (1) a copy of the Corresponding Source for all the software in the product that is covered by this License, on a durable physical medium customarily used for software interchange, for a price no more than your reasonable cost of physically performing this conveying of source, or (2) access to copy the Corresponding Source from a network server at no charge.

c) Convey individual copies of the object code with a copy of the written offer to provide the Corresponding Source. This alternative is allowed only occasionally and noncommercially, and only if you received the object code with such an offer, in accord with subsection 6b.

d) Convey the object code by offering access from a designated place (gratis or for a charge), and offer equivalent access to the Corresponding Source in the same way through the same place at no further charge. You need not require recipients to copy the Corresponding Source along with the object code. If the place to copy the object code is a network server, the Corresponding Source may be on a different server (operated by you or a third party) that supports equivalent copying facilities, provided you maintain clear directions next to the object code saying where to find the Corresponding Source. Regardless of what server hosts the Corresponding Source, you remain obligated to ensure that it is available for as long as needed to satisfy these requirements.

e) Convey the object code using peer-to-peer transmission, provided you inform other peers where the object code and Corresponding Source of the work are being offered to the general public at no charge under subsection 6d.

A separable portion of the object code, whose source code is excluded from the Corresponding Source as a System Library, need not be included in conveying the object code work.

A "User Product" is either (1) a "consumer product", which means any tangible personal property which is normally used for personal, family, or household purposes, or (2) anything designed or sold for incorporation into a dwelling. In determining whether a product is a consumer product, doubtful cases shall be resolved in favor of coverage. For a particular product received by a particular user, "normally used" refers to a typical or common use of that class of product, regardless of the status of the particular user or of the way in which the particular user actually uses, or expects or is expected to use, the product. A product is a consumer product regardless of whether the product has substantial commercial, industrial or non-consumer uses, unless such uses represent the only significant mode of use of the product.

"Installation Information" for a User Product means any methods, procedures, authorization keys, or other information required to install and execute modified versions of a covered work in that User Product from a modified version of its

Corresponding Source. The information must suffice to ensure that the continued functioning of the modified object code is in no case prevented or interfered with solely because modification has been made.

If you convey an object code work under this section in, or with, or specifically for use in, a User Product, and the conveying occurs as part of a transaction in which the right of possession and use of the User Product is transferred to the recipient in perpetuity or for a fixed term (regardless of how the transaction is characterized), the Corresponding Source conveyed under this section must be accompanied by the Installation Information. But this requirement does not apply if neither you nor any third party retains the ability to install modified object code on the User Product (for example, the work has been installed in ROM).

The requirement to provide Installation Information does not include a requirement to continue to provide support service, warranty, or updates for a work that has been modified or installed by the recipient, or for the User Product in which it has been modified or installed. Access to a network may be denied when the modification itself materially and adversely affects the operation of the network or violates the rules and protocols for communication across the network.

Corresponding Source conveyed, and Installation Information provided, in accord with this section must be in a format that is publicly documented (and with an implementation available to the public in source code form), and must require no special password or key for unpacking, reading or copying.

7. Additional Terms.

"Additional permissions" are terms that supplement the terms of this License by making exceptions from one or more of its conditions. Additional permissions that are applicable to the entire Program shall be treated as though they were included in this License, to the extent that they are valid under applicable law. If additional permissions apply only to part of the Program, that part may be used separately under those permissions, but the entire Program remains governed by this License without regard to the additional permissions.

When you convey a copy of a covered work, you may at your option remove any additional permissions from that copy, or from any part of it. (Additional permissions may be written to require their own removal in certain cases when you modify the work.) You may place additional permissions on material, added by you to a covered work, for which you have or can give appropriate copyright permission.

Notwithstanding any other provision of this License, for material you add to a covered work, you may (if authorized by the copyright holders of that material) supplement the terms of this License with terms:

- a) Disclaiming warranty or limiting liability differently from the terms of sections 15 and 16 of this License; or
- b) Requiring preservation of specified reasonable legal notices or author attributions in that material or in the Appropriate Legal Notices displayed by works containing it; or
- c) Prohibiting misrepresentation of the origin of that material, or requiring that modified versions of such material be marked in reasonable ways as different from the original version; or
- d) Limiting the use for publicity purposes of names of licensors or authors of the material; or
- e) Declining to grant rights under trademark law for use of some trade names, trademarks, or service marks; or
- f) Requiring indemnification of licensors and authors of that material by anyone who conveys the material (or modified versions of it) with contractual assumptions of liability to the recipient, for any liability that these contractual assumptions directly impose on those licensors and authors.

All other non-permissive additional terms are considered "further restrictions" within the meaning of section 10. If the Program as you received it, or any part of it, contains a notice stating that it is governed by this License along with a term that is a further restriction, you may remove that term. If a license document contains a further restriction but permits

relicensing or conveying under this License, you may add to a covered work material governed by the terms of that license document, provided that the further restriction does not survive such relicensing or conveying.

If you add terms to a covered work in accord with this section, you must place, in the relevant source files, a statement of the additional terms that apply to those files, or a notice indicating where to find the applicable terms.

Additional terms, permissive or non-permissive, may be stated in the form of a separately written license, or stated as exceptions; the above requirements apply either way.

8. Termination.

You may not propagate or modify a covered work except as expressly provided under this License. Any attempt otherwise to propagate or modify it is void, and will automatically terminate your rights under this License (including any patent licenses granted under the third paragraph of section 11).

However, if you cease all violation of this License, then your license from a particular copyright holder is reinstated (a) provisionally, unless and until the copyright holder explicitly and finally terminates your license, and (b) permanently, if the copyright holder fails to notify you of the violation by some reasonable means prior to 60 days after the cessation.

Moreover, your license from a particular copyright holder is reinstated permanently if the copyright holder notifies you of the violation by some reasonable means, this is the first time you have received notice of violation of this License (for any work) from that copyright holder, and you cure the violation prior to 30 days after your receipt of the notice.

Termination of your rights under this section does not terminate the licenses of parties who have received copies or rights from you under this License. If your rights have been terminated and not permanently reinstated, you do not qualify to receive new licenses for the same material under section 10.

9. Acceptance Not Required for Having Copies.

You are not required to accept this License in order to receive or run a copy of the Program. Ancillary propagation of a covered work occurring solely as a consequence of using peer-to-peer transmission to receive a copy likewise does not require acceptance. However, nothing other than this License grants you permission to propagate or modify any covered work. These actions infringe copyright if you do not accept this License. Therefore, by modifying or propagating a covered work, you indicate your acceptance of this License to do so.

10. Automatic Licensing of Downstream Recipients.

Each time you convey a covered work, the recipient automatically receives a license from the original licensors, to run, modify and propagate that work, subject to this License. You are not responsible for enforcing compliance by third parties with this License.

An "entity transaction" is a transaction transferring control of an organization, or substantially all assets of one, or subdividing an organization, or merging organizations. If propagation of a covered work results from an entity transaction, each party to that transaction who receives a copy of the work also receives whatever licenses to the work the party's predecessor in interest had or could give under the previous paragraph, plus a right to possession of the Corresponding Source of the work from the predecessor in interest, if the predecessor has it or can get it with reasonable efforts.

You may not impose any further restrictions on the exercise of the rights granted or affirmed under this License. For example, you may not impose a license fee, royalty, or other charge for exercise of rights granted under this License, and you may not initiate litigation (including a cross-claim or counterclaim in a lawsuit) alleging that any patent claim is infringed by making, using, selling, offering for sale, or importing the Program or any portion of it.

11. Patents.

A "contributor" is a copyright holder who authorizes use under this License of the Program or a work on which the Program is based. The work thus licensed is called the contributor's "contributor version".

A contributor's "essential patent claims" are all patent claims owned or controlled by the contributor, whether already acquired or hereafter acquired, that would be infringed by some manner, permitted by this License, of making, using, or selling its contributor version, but do not include claims that would be infringed only as a consequence of further modification of the contributor version. For purposes of this definition, "control" includes the right to grant patent sublicenses in a manner consistent with the requirements of this License.

Each contributor grants you a non-exclusive, worldwide, royalty-free patent license under the contributor's essential patent claims, to make, use, sell, offer for sale, import and otherwise run, modify and propagate the contents of its contributor version.

In the following three paragraphs, a "patent license" is any express agreement or commitment, however denominated, not to enforce a patent (such as an express permission to practice a patent or covenant not to sue for patent infringement). To "grant" such a patent license to a party means to make such an agreement or commitment not to enforce a patent against the party.

If you convey a covered work, knowingly relying on a patent license, and the Corresponding Source of the work is not available for anyone to copy, free of charge and under the terms of this License, through a publicly available network server or other readily accessible means, then you must either (1) cause the Corresponding Source to be so available, or (2) arrange to deprive yourself of the benefit of the patent license for this particular work, or (3) arrange, in a manner consistent with the requirements of this License, to extend the patent license to downstream recipients. "Knowingly relying" means you have actual knowledge that, but for the patent license, your conveying the covered work in a country, or your recipient's use of the covered work in a country, would infringe one or more identifiable patents in that country that you have reason to believe are valid.

If, pursuant to or in connection with a single transaction or arrangement, you convey, or propagate by procuring conveyance of, a covered work, and grant a patent license to some of the parties receiving the covered work authorizing them to use, propagate, modify or convey a specific copy of the covered work, then the patent license you grant is automatically extended to all recipients of the covered work and works based on it.

A patent license is "discriminatory" if it does not include within the scope of its coverage, prohibits the exercise of, or is conditioned on the non-exercise of one or more of the rights that are specifically granted under this License. You may not convey a covered work if you are a party to an arrangement with a third party that is in the business of distributing software, under which you make payment to the third party based on the extent of your activity of conveying the work, and under which the third party grants, to any of the parties who would receive the covered work from you, a discriminatory patent license (a) in connection with copies of the covered work conveyed by you (or copies made from those copies), or (b) primarily for and in connection with specific products or compilations that contain the covered work, unless you entered into that arrangement, or that patent license was granted, prior to 28 March 2007.

Nothing in this License shall be construed as excluding or limiting any implied license or other defenses to infringement that may otherwise be available to you under applicable patent law.

12. No Surrender of Others' Freedom.

If conditions are imposed on you (whether by court order, agreement or otherwise) that contradict the conditions of this License, they do not excuse you from the conditions of this License. If you cannot convey a covered work so as to satisfy simultaneously your obligations under this License and any other pertinent obligations, then as a consequence you may not convey it at all. For example, if you agree to terms that obligate you to collect a royalty for further conveying from those to whom you convey the Program, the only way you could satisfy both those terms and this License would be to refrain entirely from conveying the Program.

13. Use with the GNU Affero General Public License.

Notwithstanding any other provision of this License, you have permission to link or combine any covered work with a work licensed under version 3 of the GNU Affero General Public License into a single combined work, and to convey the resulting work. The terms of this License will continue to apply to the part which is the covered work, but the special requirements of the GNU Affero General Public License, section 13, concerning interaction through a network will apply to the combination as such.

14. Revised Versions of this License.

The Free Software Foundation may publish revised and/or new versions of the GNU General Public License from time to time. Such new versions will be similar in spirit to the present version, but may differ in detail to address new problems or concerns.

Each version is given a distinguishing version number. If the Program specifies that a certain numbered version of the GNU General Public License "or any later version" applies to it, you have the option of following the terms and conditions either of that numbered version or of any later version published by the Free Software Foundation. If the Program does not specify a version number of the GNU General Public License, you may choose any version ever published by the Free Software Foundation.

If the Program specifies that a proxy can decide which future versions of the GNU General Public License can be used, that proxy's public statement of acceptance of a version permanently authorizes you to choose that version for the Program.

Later license versions may give you additional or different permissions. However, no additional obligations are imposed on any author or copyright holder as a result of your choosing to follow a later version.

15. Disclaimer of Warranty.

THERE IS NO WARRANTY FOR THE PROGRAM, TO THE EXTENT PERMITTED BY APPLICABLE LAW. EXCEPT WHEN OTHERWISE STATED IN WRITING THE COPYRIGHT HOLDERS AND/OR OTHER PARTIES PROVIDE THE PROGRAM "AS IS" WITHOUT WARRANTY OF ANY KIND, EITHER EXPRESSED OR IMPLIED, INCLUDING, BUT NOT LIMITED TO, THE IMPLIED WARRANTIES OF MERCHANTABILITY AND FITNESS FOR A PARTICULAR PURPOSE. THE ENTIRE RISK AS TO THE QUALITY AND PERFORMANCE OF THE PROGRAM IS WITH YOU. SHOULD THE PROGRAM PROVE DEFECTIVE, YOU ASSUME THE COST OF ALL NECESSARY SERVICING, REPAIR OR CORRECTION.

16. Limitation of Liability.

IN NO EVENT UNLESS REQUIRED BY APPLICABLE LAW OR AGREED TO IN WRITING WILL ANY COPYRIGHT HOLDER, OR ANY OTHER PARTY WHO MODIFIES AND/OR CONVEYS THE PROGRAM AS PERMITTED ABOVE, BE LIABLE TO YOU FOR DAMAGES, INCLUDING ANY GENERAL, SPECIAL, INCIDENTAL OR CONSEQUENTIAL DAMAGES ARISING OUT OF THE USE OR INABILITY TO USE THE PROGRAM (INCLUDING BUT NOT LIMITED TO LOSS OF DATA OR DATA BEING RENDERED INACCURATE OR LOSSES SUSTAINED BY YOU OR THIRD PARTIES OR A FAILURE OF THE PROGRAM TO OPERATE WITH ANY OTHER PROGRAMS), EVEN IF SUCH HOLDER OR OTHER PARTY HAS BEEN ADVISED OF THE POSSIBILITY OF SUCH DAMAGES.

17. Interpretation of Sections 15 and 16.

If the disclaimer of warranty and limitation of liability provided above cannot be given local legal effect according to their terms, reviewing courts shall apply local law that most closely approximates an absolute waiver of all civil liability in connection with the Program, unless a warranty or assumption of liability accompanies a copy of the Program in return for a fee.

END OF TERMS AND CONDITIONS

How to Apply These Terms to Your New Programs

If you develop a new program, and you want it to be of the greatest possible use to the public, the best way to achieve this is to make it free software which everyone can redistribute and change under these terms.

To do so, attach the following notices to the program. It is safest to attach them to the start of each source file to most effectively state the exclusion of warranty; and each file should have at least the "copyright" line and a pointer to where the full notice is found.

```
<one line to give the program's name and a brief idea of what it does.>  
Copyright (C) <year> <name of author>
```

This program is free software: you can redistribute it and/or modify it under the terms of the GNU General Public License as published by the Free Software Foundation, either version 3 of the License, or (at your option) any later version.

This program is distributed in the hope that it will be useful, but WITHOUT ANY WARRANTY; without even the implied warranty of MERCHANTABILITY or FITNESS FOR A PARTICULAR PURPOSE. See the GNU General Public License for more details.

You should have received a copy of the GNU General Public License along with this program. If not, see <http://www.gnu.org/licenses/>.

Also add information on how to contact you by electronic and paper mail.

If the program does terminal interaction, make it output a short notice like this when it starts in an interactive mode:

```
<program> Copyright (C) <year> <name of author>  
This program comes with ABSOLUTELY NO WARRANTY; for details type `show w'.  
This is free software, and you are welcome to redistribute it under certain conditions; type `show c' for details.
```

The hypothetical commands `show w' and `show c' should show the appropriate parts of the General Public License. Of course, your program's commands might be different; for a GUI interface, you would use an "about box".

You should also get your employer (if you work as a programmer) or school, if any, to sign a "copyright disclaimer" for the program, if necessary.

For more information on this, and how to apply and follow the GNU GPL, see <http://www.gnu.org/licenses/>.

The GNU General Public License does not permit incorporating your program into proprietary programs. If your program is a subroutine library, you may consider it more useful to permit linking proprietary applications with the library. If this is what you want to do, use the GNU Lesser General Public License instead of this License. But first, please read <http://www.gnu.org/philosophy/why-not-lgpl.html>.

-----libtiff-----

Copyright (c) 1988-1997 Sam Leffler
Copyright (c) 1991-1997 Silicon Graphics, Inc.

Permission to use, copy, modify, distribute, and sell this software and its documentation for any purpose is hereby granted without fee, provided that (i) the above copyright notices and this permission notice appear in all copies of the software and related documentation, and (ii) the names of Sam Leffler and Silicon Graphics may not be used in any advertising or publicity relating to the software without the specific, prior written permission of Sam Leffler and Silicon Graphics.

THE SOFTWARE IS PROVIDED "AS-IS" AND WITHOUT WARRANTY OF ANY KIND, EXPRESS, IMPLIED OR OTHERWISE, INCLUDING WITHOUT LIMITATION, ANY WARRANTY OF MERCHANTABILITY OR FITNESS FOR A PARTICULAR PURPOSE.

IN NO EVENT SHALL SAM LEFFLER OR SILICON GRAPHICS BE LIABLE FOR ANY SPECIAL, INCIDENTAL, INDIRECT OR CONSEQUENTIAL DAMAGES OF ANY KIND, OR ANY DAMAGES WHATSOEVER RESULTING FROM LOSS OF USE, DATA OR PROFITS, WHETHER OR NOT ADVISED OF THE POSSIBILITY OF DAMAGE, AND ON ANY THEORY OF LIABILITY, ARISING OUT OF OR IN CONNECTION WITH THE USE OR PERFORMANCE OF THIS SOFTWARE.

-----libjpeg-----

This software is based in part on the work of the Independent JPEG Group.

SOFTWARE LICENSE

PLEASE READ THIS LICENSE CAREFULLY BEFORE USING THE SOFTWARE. BY USING THE SOFTWARE, YOU ARE AGREEING TO BE BOUND BY THE TERMS OF THIS LICENSE.

1. License

The application, demonstration, system and other software accompanying this License, whether on disk, in read only memory, or on any other media (the "Software") and related documentation are licensed to you by SHARP. You own the disk on which the Software is recorded but SHARP and/or SHARP's Licensors retain title to the Software and related documentation. This License allows you to use the Software on one or more computers connected to a single printer and make one copy of the Software in machine-readable form for backup purposes only. You must reproduce on such copy the SHARP copyright notice, the copyright notice of SHARP's Licensors and any other proprietary legends of SHARP and/or its Licensors that were on the original copy of the Software. You may also transfer all your license rights in the Software, the backup copy of the Software, the related documentation and a copy of this License to another party, provided the other party reads and agrees to the terms and conditions of this License.

2. Restrictions

The Software contains copyrighted material, trade secrets and other proprietary material which is owned by SHARP and/or its Licensors and in order to protect them you may not decompile, reverse engineer, disassemble or otherwise reduce the Software to a human-perceivable form. You may not modify, network, rent, lease, loan, distribute or create derivative works based upon the Software in whole or in part. You may not electronically transmit the Software from one computer to another or over a network.

3. Termination

This license is effective until terminated. You may terminate this License at any time by destroying the Software and related documentation and all copies thereof. This License will terminate immediately without notice from SHARP and/or SHARP's Licensors if you fail to comply with any provision of this License. Upon termination you must destroy the Software and related documentation and all copies thereof.

4. Export Law Assurances

You agree and certify that neither the Software nor any other technical data received from SHARP, nor the direct product thereof, will be exported outside the United States except as authorized and as permitted by the laws and regulations of the United States. If the Software has been rightfully obtained by you outside of the United States, you agree that you will not re-export the Software nor any other technical data received from SHARP, nor the direct product thereof, except as permitted by the laws and regulations of the United States and the laws and the regulation of the jurisdiction in which you obtained the Software.

5. Government End Users

If you are acquiring the Software on behalf of any unit or agency of the United States Government, the following provisions apply. The Government agrees:

- (i) if the Software is supplied to the Department of Defense (DoD), the Software is classified as "Commercial Computer Software" and the Government is acquiring only "restricted rights" in the Software and its documentation as that term is defined in Clause 252.227-7013 (c)(1) (Oct., 1988) of the DFARS; and
- (ii) if the Software is supplied to any unit or agency of the United States Government other than DoD, the Software is classified as "Commercial" that term is defined at 48 C.F.R. 2.101 and as "Commercial Computer Software" that term is defined in 48 C.F.R. 12.212, and the Government's rights in the Software and its documentation will be as defined in Clause 52.227-19 (c)(2) of the FAR or, in the case of NASA, in Clause 18-52.227-86 (d) of the NASA Supplement to the FAR.

6. Limited Warranty on Media.

SHARP warrants the disks on which the Software is recorded to be free from defects in materials and workmanship under normal use for a period of ninety (90) days from the date of purchase as evidenced by a copy of the receipt. The entire liability of SHARP and/or its Licensors and your exclusive remedy will be replacement of the disk which fails to meet the limited warranty provided by this Clause 6. A disk will be replaced when it is returned to SHARP or a SHARP authorized representative with a copy of the receipt. SHARP will have no responsibility to replace a disk damaged by accident, abuse or misapplication.

ANY IMPLIED WARRANTIES ON THE DISKS, INCLUDING THE IMPLIED WARRANTIES OF MERCHANTABILITY AND FITNESS FOR A PARTICULAR PURPOSE, ARE LIMITED IN DURATION TO NINETY (90) DAYS FROM THE DATE OF DELIVERY. THIS WARRANTY GIVES YOU SPECIFIC LEGAL RIGHTS, AND YOU MAY ALSO HAVE OTHER RIGHTS WHICH VARY FROM JURISDICTION TO JURISDICTION.

7. Disclaimer of Warranty on Software

You expressly acknowledge and agree that use of the Software is at your sole risk. The Software and related documentation are provided "AS IS" and without warranty of any kind and SHARP and SHARP's Licensor(s) (for the purpose of provisions 6 and 7, SHARP and SHARP's Licensor(s) shall be collectively referred to as "SHARP") EXPRESSLY DISCLAIM ALL WARRANTIES, EXPRESS OR IMPLIED, INCLUDING, BUT NOT LIMITED TO, THE IMPLIED WARRANTIES OF MERCHANTABILITY AND FITNESS FOR A PARTICULAR PURPOSE. SHARP DOES NOT WARRANT THAT THE FUNCTIONS CONTAINED IN THE SOFTWARE WILL MEET YOUR REQUIREMENTS, OR THAT THE OPERATION OF THE SOFTWARE WILL BE UNINTERRUPTED OR ERROR-FREE, OR THAT DEFECTS IN THE SOFTWARE WILL BE CORRECTED. FURTHERMORE, SHARP DOES NOT WARRANT OR MAKE ANY REPRESENTATIONS REGARDING THE USE OR THE RESULTS OF THE USE OF THE SOFTWARE OR RELATED DOCUMENTATION IN TERMS OF THEIR CORRECTNESS, ACCURACY, RELIABILITY, OR OTHERWISE. NO ORAL OR WRITTEN INFORMATION OR ADVICE GIVEN BY SHARP OR A SHARP AUTHORIZED REPRESENTATIVE SHALL CREATE A WARRANTY OR IN ANY WAY INCREASE THE SCOPE OF THIS WARRANTY. SHOULD THE SOFTWARE PROVE DEFECTIVE, YOU (AND NOT SHARP OR A SHARP AUTHORIZED REPRESENTATIVE) ASSUME THE ENTIRE COST OF ALL NECESSARY SERVICING, REPAIR OR CORRECTION, SOME JURISDICTIONS DO NOT ALLOW THE EXCLUSION OF IMPLIED WARRANTIES, SO THE ABOVE EXCLUSION MAY NOT APPLY TO YOU.

8. Limitation of Liability

UNDER NO CIRCUMSTANCES INCLUDING NEGLIGENCE, SHALL SHARP BE LIABLE FOR ANY INCIDENTAL, SPECIAL OR CONSEQUENTIAL DAMAGES THAT RESULT FROM THE USE OR INABILITY TO USE THE SOFTWARE OR RELATED DOCUMENTATION, EVEN IF SHARP OR A SHARP AUTHORIZED REPRESENTATIVE HAS BEEN ADVISED OF THE POSSIBILITY OF SUCH DAMAGES. SOME JURISDICTIONS DO NOT ALLOW THE LIMITATION OR EXCLUSION OF LIABILITY FOR INCIDENTAL OR CONSEQUENTIAL DAMAGES SO THE ABOVE LIMITATION OR EXCLUSION MAY NOT APPLY TO YOU.

In no event shall SHARP's total liability to you for all damages, losses, and causes of action (whether in contract, tort (including negligence) or otherwise) exceed the amount paid by you for the Software.

9. Controlling Law and Severability

For a portion of the Software related with Apple Macintosh and Microsoft Windows, this license shall be governed by and construed in accordance with the laws of the state of California and Washington, respectively. If for any reason a court of competent jurisdiction finds any provision of this License, or portion thereof, to be unenforceable, that provision of the License shall be enforced to the maximum extent permissible so as to effect the intent of the parties, and the remainder of this License shall continue in full force and effect.

10. Complete Agreement

This License constitutes the entire agreement between the parties with respect to the use of the Software and related documentation, and supersedes all prior or contemporaneous understandings or agreements, written or oral, regarding such subject matter. No amendment to or modification of this License will be binding unless in writing and signed by a duly authorized representative of SHARP.

SHARP[®]
SHARP CORPORATION