

LP Gas Grill Users Manual

Table Top Grill

205
FM205

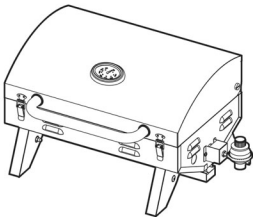

For Outdoor Household Use Only. Not for Commercial Use.

DANGER

If you smell gas:

1. Shut off gas to the appliance.
2. Extinguish any open flame.
3. Open lid.
4. If odor continues, keep away from the appliance and immediately call your gas supplier or your fire department.

Failure to follow these instructions could result in fire or explosion which could cause property damage, personal injury or death.

WARNING

- This instruction manual contains important information necessary for the proper assembly and safe use of this appliance. Failure to follow these instructions could result in death or serious injury from explosion or fire.
- Read and follow all warnings and instructions carefully before assembling or using this appliance.
- Follow all warnings and instructions when using this appliance.
- Keep this manual for future reference. **SAVE THESE INSTRUCTIONS.**

Need Help? Call Outdoor Leisure Products at 1-866-475-5180

⚠ DANGER

CARBON MONOXIDE HAZARD



This appliance can produce carbon monoxide, an odorless toxic gas. Using it in an enclosed space can kill you. Never use this appliance in an enclosed space, such as a camper, tent, car, boat or home. This appliance is not intended for and should never be used as a heater.

⚠ WARNING

To reduce the risk of serious injury or death from fire or explosion:

- Never leave grill unattended
- Never use alcohol, prescription or non-prescription drugs while assembling or safely operating this appliance.
- Keep children and pets away at all times.
- Do not connect to the LP Gas supply until assembly is complete.
- Do not store or use gasoline or other flammable vapors and liquids in the vicinity of this or any other appliance.
- An LP cylinder not connected for use shall not be stored in the vicinity of this or any other appliance.
- Always have a type BC or ABC fire extinguisher readily available.

⚠ CAUTION

To reduce the risk of a laceration hazard, wear protective gloves when handling parts that have sharp edges.

NOTICE

Outdoor Leisure Products strives to be a quality supplier of consumer products. If we omitted any parts needed for assembly, or you need troubleshooting information, please contact us using our toll free number.

It is important to retain your receipt.

1-866-475-5180
8:30am-4:30pm
Central Time
Monday-Friday

Consumer Service Department
Outdoor Leisure Products, Inc.
5400 Doniphan Drive
Neosho, MO 64850

Tools Required for Assembly:



Phillips Screwdriver

Packing List

Grill Body _____
 Regulator Housing Assembly _____
 Igniter Housing Assembly _____
Handle and Bezels _____
 Warming Rack (inside) _____
 Cooking Grid (inside) _____
 Flavor Activator (inside) _____
 Owner's Manual and _____
 Warranty Card (not pictured) _____

Detailed Parts List and Illustrations may be found on pages 19 and 20 .

When ordering parts, it is VERY important to have the complete Model Number to receive the correct replacement parts for your grill. The grill model number and serial number are printed on the label located on the inside surface of the rear leg.

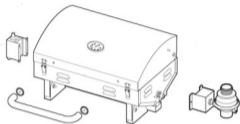

Contents

Packing List	3
Preparation for Assembly	4
Grill Assembly Instructions	
Hood Handle Assembly	4
Regulator-Valve Housing Assembly	5
Igniter Housing Assembly	5
Drip Tray Access	6
Table Top Use	6
Using Gas	
LP Gas Cylinder	7
LP Regulator	7
Connecting LP Gas Cylinder	8
Disconnecting LP Gas Cylinder	8
Before Using Your LP Gas Grill	
Installation Codes	9
Selecting a Location	9
Performing a Leak Test	9
How to Perform a Leak Test	10

Cooking on the Gas Grill	
Grill Cooking (Direct Method)	13
Warming Rack	14
End of Cooking Session	14
Storage and Transportation	14

Care and Maintenance	
Cleaning the Grill	15
How to Clean the Burners	15

Emergencies	17
Troubleshooting	18

Replacement Parts	
Parts Illustration	19
Parts List	20

Limited Warranty	21
-------------------------------	----

Retain your receipt

If you need a replacement part under warranty, a proof of purchase will be necessary.

Lighting the Grill	
Lighting Grill Using the Pulse-Spark Igniter	11
Manually Lighting the Grill	12
Check the Flame	12

Remove grill and all packaging materials from the carton and place on a clean level surface. Some parts are packed inside the grill body. Remove, unpack and inspect these parts as well.

NOTE: Before using your grill, read the instructions and your manual.

For easier set-up and assembly, follow instructions of each step in the order they are written as you look at the diagrams. If accessories mentioned in certain assembly steps do not come with your model, skip that step and proceed to the next step that applies to your model.

If you have any questions or need help, contact **Customer Service at 1-866-475-5180**. Be sure to have the grill model number and serial number printed on the label located on the inside surface of the rear leg. If you need replacement parts, look in the Parts List Section to find the exact parts you need. **If you need a replacement part under warranty, a proof of purchase will be necessary.** You will be asked to forward your proof of purchase. **It is important to retain your receipt.**

Grill Assembly Instructions

Step 1 Hood Handle Assembly

Place a Handle Bezel between each end of the handle and the grill hood then insert a 1/4-20 x .50" Bolt through the inside of the hood into each end of the handle. Tighten the bolts.



1/4-20 x .50" Bolt set
2 pc

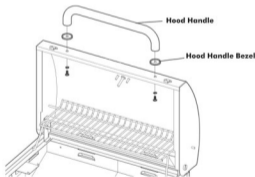

Step 2

Regulator-Valve Housing Assembly

Insert the end of the regulator valve nozzle into the open end of the burner tube (venturi). Align the holes in Regulator Housing with the threaded holes in the grill firebowl and insert two 5/32 x .31" Bolts through the holes in the housing into the threaded holes in the firebox. Tighten the bolts securely.

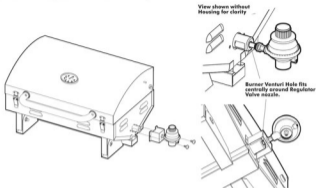

View shown without Housing for clarity

Burner Venturi Hole fits centrally around Regulator Valve nozzle.

Step 3

Igniter Housing Assembly

A. Thread the Electrode Wire through the hole in the Igniter Housing and attach the end onto the pin at the bottom end of the Piezo Igniter.

B. Align the holes in the Igniter Housing with the threaded holes in the firebowl end. Insert Four 5/32 x .31" Bolts through the housing into the threaded holes. When installing the fourth bolt, first insert it through the ring at the end of the Match Holder chain and then through the Housing and into the firebowl end. Tighten the bolts securely.

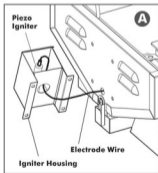

Piezo Igniter

Electrode Wire

Igniter Housing



5/32 x .31" Bolt
4 pcs

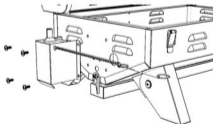

B

⚠ WARNING

To reduce the risk of serious injury or death from fire or explosion:

- Be sure the grill has cooled completely before removing the drip tray.
- Be sure to empty and re-install the drip tray after each use.

⚠ CAUTION

To reduce the risk of a laceration hazard, wear protective gloves when handling parts that have sharp edges.

Drip Tray Access

The Drip Tray is accessed for cleaning by rotating the spring tab and sliding the tray out from under the grill.

Note:
Shown without Igniter
Housing for clarity

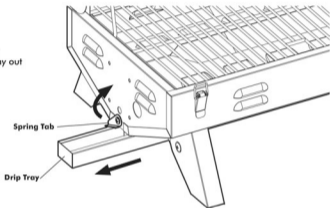

Table Top Use

Unfold the legs, as shown and place grill on a level surface.

When legs are unfolded completely they will snap into the open position. Dimples in the legs help them remain in position. To close, simply apply enough pressure to overcome the friction fit.



LP Gas Cylinder

⚠ DANGER

If you see, smell, or hear the hiss of LP gas escaping from the cylinder:

1. Do not attempt to light appliance.
2. Extinguish any open flame.
3. Disconnect from fuel supply.

Carbon Monoxide Hazard

- This appliance can produce carbon monoxide which has no odor. Using it in an enclosed space can kill you.
- Never use this appliance indoors, on recreational vehicles, or boats.

⚠ WARNING

To reduce the risk of serious injury or death from fire or explosion:

- Use only propane gas with this LP gas grill.
- Do not attempt to convert this LP unit to natural gas.
- Always use a gas appliance outdoors in an open area with good ventilation to avoid breathing toxic fumes from combustion or leaking gas. As with all conventional fuels, the burning process consumes oxygen and produces toxic gases, including carbon monoxide. In addition, the combustion products of such fuels, including liquefied petroleum (LP), contain chemicals known to the state of California and other authorities to cause cancer, birth defects, and other reproductive harm.
- Read and follow all warnings on LP Gas Cylinder.
- Do not operate the LP gas grill without the LP Gas Cylinder oriented as instructed in "Connecting LP Gas Cylinder" on page 7.
- Never connect or disconnect LP Gas Cylinder or fittings while grill is in use or is hot.
- Do not use an LP Gas Cylinder if it has a damaged valve or shows signs of dents, gouges, bulges, fire damage, corrosion, leakage, excessive rust, or other forms of visual external damage; it may be hazardous and should be checked immediately by a liquid propane supplier.
- Do not store a spare LP Gas Cylinder under or near the LP gas grill.
- When grill is not in use, turn off all grill Control Knobs and disconnect LP Gas Cylinder.
- Never fold or transport grill while LP cylinder is attached.
- Never refill a 1 lb. cylinder.

The LP Gas Cylinder, for use with this LP gas grill, must meet the following requirements:

1. 1 lb. capacity
2. Constructed and marked in accordance with Specifications for LP Gas Cylinders of the U.S. Department of Transportation (DOT) or the National Standard of Canada, CAN/CSA-B339, Cylinders, Spheres and Tubes for Transportation of Dangerous Goods; and Commission, as applicable (See collar for marking)
3. Marked "PROPANE."
4. Provided with a cylinder connection device that is compatible with the grill's connection.

LP Regulator

⚠ WARNING

To reduce the risk of serious injury or death from fire or explosion:

- Clean and inspect the gas regulator before each use of the outdoor cooking gas appliance. Replace the gas regulator prior to being used if there is evidence of excessive abrasion or wear.
- Use only the gas regulator assembly that has been supplied with this gas grill. Do not use a regulator from another manufacturer. A replacement gas regulator must be specified by this grill's manufacturer before using.
- Always check for gas leaks (see page 9) when you connect and disconnect the regulator to the LP Gas Cylinder, especially after a period of storage (for example, over winter).

NOTE:

If the regulator assembly is not working properly and you need a replacement, contact:

Customer Service at 1-866-475-5180. Be sure to **have the grill model number and serial number** printed on the label located on the inside surface of the rear leg.

If you need a replacement part under warranty, a proof of purchase will be necessary. You will be asked to forward your proof of purchase. **It is important to retain your receipt.**

Connecting LP Gas Cylinder

1. Purchase 11lb. LP Gas cylinder at your local retailer.
2. Turn the regulator knob to the "Off" position.
3. Remove protective cap from regulator opening. Remove plastic cap from top of propane cylinder. Save cylinder cap for replacement on cylinder if gas remains in cylinder after use.
4. Insert the 11lb. LP Gas cylinder into the threaded hole in the underside of the regulator. Turn the cylinder clockwise until firmly seated. Hand tighten only. (Fig. 1)
5. For optimum performance, allow cylinder to hang vertically off the edge of the table when there is no danger of being bumped or disturbed.

NOTE: NEVER FOLD UP OR TRANSPORT GRILL WITH CYLINDER ATTACHED.

Disconnecting LP Gas Cylinder

1. Turn regulator knob to the "Off" position.
2. Remove the cylinder by turning counterclockwise.
3. Replace the protective cap over the regulator opening. Replace the plastic cap on the top of propane cylinder for storage if not empty.
4. Store cylinder outdoors and away from grill

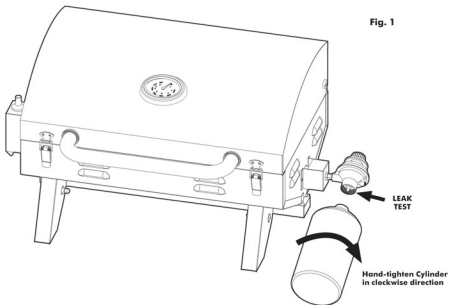

Installation Codes

⚠ WARNING

To reduce the risk of serious bodily injury or death from fire or explosion:

- This installation must conform with local codes or, in the absence of local codes, with either the National Fuel Gas Code, ANSI Z223.1/NFPA 54 Natural Gas and Propane Installation Code, CSA B149.1, or Propane Storage and Handling Code, B149.2 or the Standard for Recreational Vehicles, ANSI A 119.2/NFPA 1192 and CSA Z240 RV Series, recreational Vehicle Code, as applicable.
- If an external electrical source is utilized, the outdoor cooking appliance, when installed, must be electrically grounded in accordance with local codes or, in the absence of local codes, with the National Electrical Codes, ANSI/NFPA 70, or the Canadian Electrical Code CSA C22.1.
- Keep any electrical supply cord and the fuel supply hose away from any heated surfaces.

Selecting a Location

⚠ WARNING

To reduce the risk of serious bodily injury or death from fire or explosion:

- Use this outdoor cooking appliance only outdoors and never in a building, garage, breezeway, carport, porch or in any enclosed area. Locate outdoor cooking appliance in an area with good ventilation on a level stable surface clear of combustible and flammable material.
- Locate your LP gas grill at least 10 feet away from your house or any building.
- Maintain minimum clearances of 10" from back and sides of grill to any combustible construction.
- Do not locate this appliance under overhead, unprotected combustible construction.
- This outdoor cooking appliance is not intended to be used in/on boats or installed in/on recreational vehicles.
- Never use gas grill as a space heater.

⚠ WARNING

Do not use this appliance under extended awnings. Failure to comply could result in a fire or personal injury.

Performing A Leak Test

⚠ WARNING

To reduce the risk of serious bodily injury or death from fire or explosion:

- Perform a leak test before lighting your grill for the first time.
- Perform a leak test if any gas component is changed.
- Perform a leak test after travel, especially over rough or bumpy roads.
- Perform a leak test a minimum of once a season.
- Perform a leak test after a prolonged period of storage or non-use.
- Perform leak tests in a well ventilated area.
- Never use an open flame to test for gas leaks.
- Never smoke near the grill during a leak test.
- Do not perform a leak test on a grill while it is hot or in use.
- Do not use the gas grill if you detect a gas leak that cannot be corrected by using the leak test procedures.

Before using your gas grill, perform a leak test on the Regulator Connection and LP Gas Cylinders described on the next page.

How to Perform A Leak Test - "FIRST TIME USE" and as recommended on previous page

Supplies Needed for a Leak Test:

• Clean paint brush • Water • Dish washing liquid • Empty clean bowl or can for solution

1. Make sure the regulator knob is turned to the "Off" position and verify that the LP Gas Cylinder is tightened securely to the regulator.
2. Mix one part of water with one part of dish washing liquid.
3. Brush mix on Regulator, Propane Cylinder and connection as indicated by the heavy arrows in the figure below . If "growing" bubbles appear, there is a gas leak.
 - a. If leak appears at the regulator/cylinder connection, repeat cylinder installation procedure, but do not over-tighten. (NOTE: Only hand tighten) Repeat Leak Test.
 - b. If the leak is coming from the Gas Cylinder or if the leak cannot be stopped, remove the cylinder and **DO NOT USE THE GRILL**. Call Customer Service at 1-866-475-5180. Be sure to **have the grill model number and serial number** printed on the label, located on the inside of the rear leg. **If you need a replacement part under warranty, a proof of purchase will be necessary.**

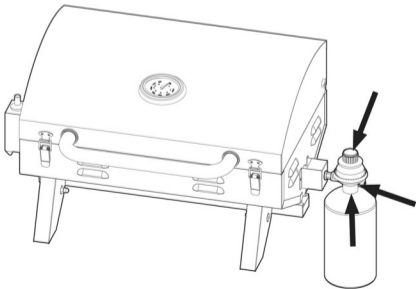

Lighting the Grill

⚠ WARNING

To reduce the risk of serious bodily injury or death from fire or explosion:

- Open Hood before lighting the grill to release trapped gas.
- During failed lighting attempts, or if the Burner goes out during operation, turn Control Knob "Off" to dissipate any accumulated gas. Wait five minutes before repeating lighting procedure.

Lighting Grill Using the Pulse-Spark Ignitor

1. Open the Hood.
2. Push the Regulator Knob in and turn 270 degrees (or 3/4 turn) counterclockwise to the High position (Fig. 2). Note the triangular indicator mark on the silver regulator housing.
3. Push the Igniter Button in repeatedly until the Burner is lit. Listen for the click indicating spark ignition, and look to make sure the Burner is lit.

If the Burner goes out during operation, turn Regulator Knob to the "Off" position. Open Hood and wait five minutes before attempting to relight the grill to allow any accumulated gas to dissipate.

If Burner fails to light after three to four attempts, turn Regulator Knob to the "Off" position and allow any accumulated gas to dissipate. Check for igniter spark by pushing igniter button and looking at the igniter tip. If no spark, adjust gap between electrode tip and burner to 3/16" (Fig. 3). If still no spark, see **Troubleshooting Section**.

Wait five minutes; then repeat the lighting procedures.

The Burner can also be lit manually, see **Manual Lighting of the Grill** on next page.

Should you notice that your Burner is getting hard to light or the flame is not as hot as it once was, refer to the **"How to Clean your Burner"** to remove any possible obstructions.

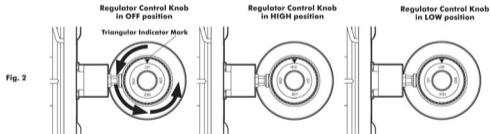

Fig. 2

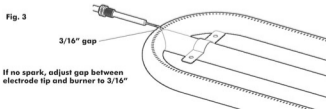

Fig. 3

Manually Lighting the Grill

1. **Open the Hood. IMPORTANT:** Make sure Regulator Knob is turned "Off."
2. While holding a lit match near the burner (Fig. 4), push the Regulator Knob in and turn 270 degrees (or 3/4 turn) counterclockwise to the High position (Fig. 2).

If Burner goes out during operation, turn Regulator Knob to the "Off" position. Open Hood and wait five minutes before attempting to relight the grill to allow any accumulated gas to dissipate.

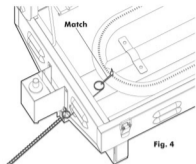

Fig. 4

Check the Flame

WARNING

To reduce the risk of death or serious injury from an explosion or a fire:

- Regularly inspect and clean Burner/Venturi Tube for insects or insect nests, especially after periods of storage. Spiders or small insects can build nests, webs, and lay eggs in the grill's Venturi Tube, obstructing the flow of gas to the Burner. (Fig. 6) The backed-up gas can ignite and cause a fire. This is known as a "flashback."
- Be sure Burner is re-installed properly before using grill.

The Burner has been preset by the manufacturer for optimal flame performance. A blue flame, possibly with a small yellow tip, is the result of the optimal air and gas mixture. (Fig. 5)

Check the flame before each cooking session and throughout the grilling season. Check the flame, especially after long periods of storing the grill. Note that the minimum flame height should be 1/4". If the flame is significantly yellow in color, the appropriate amount of LP gas in the air/LP gas mixture is not correct. This could be due to a blocked Burner from grease drippings or from insects building a nest inside the Burner or Burner opening. Should you notice that your Burner is getting hard to light or the flame is not as hot as it once was, refer to the "How to Clean your Burner" section to remove possible obstructions.

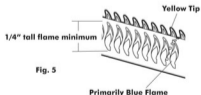

Fig. 5

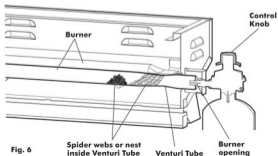

Fig. 6

⚠ WARNING

To reduce the risk of serious injury or death from fire, explosion or burn hazard:

- Never use charcoal or lighter fluid in your gas grill. Keep this outdoor cooking appliance clear and free from combustible materials, gasoline, and other flammable vapors and liquids.
- Keep any electrical supply cord and regulator hose away from any heated surfaces.
- Make sure there are no gas leaks or obstructions to the flow of combustion and ventilation air before each use.
- Always open the Hood before lighting the LP gas grill.
- Do not attempt to extinguish a grease fire with water or other liquids. Have a BC or ABC fire extinguisher readily accessible. Never douse or spray the grill or cooking surfaces with water when hot. Burns from grease or water splatters could occur.
- If your gas grill catches on fire:
 - If the fire is in the grill portion and you can safely reach the Regulator Knob, then turn it to the "Off" position.
 - If the fire involves the LP Gas Cylinder, leave it alone, evacuate the area, and call the Fire Department.
 - If there is any type of fire that threatens either personal safety or endangers property, call the Fire Department.
- Do not use the grill without Drip Tray in place. Check the Drip Tray for build-up. Empty excess grease before each use to reduce the risk of a grease fire in the Drip Tray.
- Do not place containers of oil or grease on or near the grill.
- Do not operate a gas grill if you have knowledge of or suspect a gas leak.
- Do not leave grill unattended.
- Do not wear loose clothing (hanging shirt tails, clothing with frills, etc.) around a gas grill while in use or hot.
- Do not lean your body over the gas grill when lighting it or while it is in use or hot.
- Do not touch hot surfaces. Use heat-resistant gloves, long-handled tongs, or cooking mitts at all times, since the grill will become very hot. Open the Hood carefully when cooking to avoid burns from the hot air and steam trapped inside.
- Do not allow children to operate or play near a gas grill. Keep children, animals and bystanders out of the grill area.
- Do not move an LP gas grill when in use or hot.
- When grill is not in use, turn off all grill Regulator Knob, and disconnect the LP Gas Cylinder..
- Do not cover more than half (50%) of the cooking area if using griddle plates. Full coverage of cooking area will cause overheating below the plates.
- Do not leave any utensils or cookware on a hot cooking surface.

To reduce risk of burn injury from flame rollout or hot air/steam trapped inside grill, open Hood carefully.

Grill Cooking (Direct Method)**Direct Cooking on the Grids:**

Food is cooked directly over the heat source. The Burner heats up the Flavor Activator under the Cooking Grid, which in turn heats the food on the grill. The natural food juices from cooking fall onto the hot Flavor Activator below and vaporize. Rising smoke bastes the food, giving it that unique barbecued flavor.

Use the Direct Cooking method for foods that take less than 25 minutes to cook: steaks, chops, kabobs, sausages, and more. These foods should be turned once halfway through the grilling time.

To sear meats, place them over Direct High heat for 2 to 5 minutes per side. Smaller pieces require less searing time. Hamburgers, steaks, chops, chicken breasts, and larger cuts of meat all benefit from searing. Usually after searing you finish cooking the food at a lower temperature.

For Direct Cooking, preheat the grill for 10 minutes with the Burner on "High." Place food on the Cooking Grid, and then adjust the Burner to the temperature required. Close the Hood and lift it only to turn food or to test for doneness at the end of the recommended cooking time.

Controlling Flare-ups:

Flare-ups are part of cooking meats on a grill. This adds to the unique flavor of barbequed food. However, excessive flare-ups can overcook your food and create a dangerous situation for you and your grill. Excessive flare-ups may result from large amounts of fat on the food being cooked or the build up of grease in the grill. **If excessive flare-ups occur, DO NOT pour water on the flames.** This can cause grease to splatter and could result in serious burns or bodily harm. If a grease fire occurs, turn off the burner until the grease burns out. To prevent or minimize flare-ups, trim all excess fat or skin from meats before grilling and keep the grill and drip tray cleaned of excess grease.

Warming Rack

The Warming Rack is a convenient way to cook food more slowly and further from the heat or to warm items such as bread or rolls. When opening the Hood, be alert for dripping fat from the Warming Rack that could drip onto the back of the grill. Always check that your Warming Rack is properly fitted before use. Using heat resistant gloves, carefully wipe away any dripping grease.

End of Cooking Session

WARNING

To reduce risk of serious injury or death from fire or burn hazard:

- Allow grill and grease in the Drip Tray to completely cool before emptying, cleaning, moving, or storing grill.
 - Empty the Drip Tray after each cooking session so grease does not accumulate.
1. After each cooking session, close the Hood and turn the Burner to the "High" position and burn for five minutes. This will burn off some cooking residue, thus making cleaning easier.
 2. When you have finished using your grill, turn the Regulator Knob clockwise to the "Off" position.
 3. Remove the propane cylinder and replace the protective cap over the regulator opening. Replace the plastic cap on the top of propane cylinder for storage if not empty.
 4. Store cylinder outdoors and away from grill
 5. Wait until the grill is cool to the touch before closing the Hood, cleaning, storing or transporting.
 6. Clean your LP gas grill between uses and after extended storage periods. To maintain the condition and extend the life of your grill, the unit should be covered when stored.

Storage and Transportation

DANGER

Do not put grill in storage or travel mode immediately after use.

Allow grill to cool to touch before moving or storing. Failure to do so could result in fire resulting in property damage, personal injury or death.

1. Disconnect LP Gas Cylinder from grill and store outside, in a dry, well-ventilated area, away from any sources of heat or ignition. Re-cap LP Gas Cylinder valve with the Safety Cap.
2. Cover the regulator opening with the plastic cap supplied with the grill.
3. If storing grill or before an extended period of non-use, remove Burner and wrap with aluminum foil to reduce the risk of insects entering the Burner holes. Cooking Grid and Flavor Activator may be wrapped in foil as well.
4. Store grill indoors only if the LP Gas Cylinder is disconnected from the gas grill and stored outside.
5. Before next use, remove aluminum foil and reinstall Burner, Flavor Activator, and Cooking Grid.
6. Before using the grill after periods of storage or non-use (i.e. over winter), check your LP gas grill for gas leaks, deterioration, proper assembly, and Burner obstructions.
7. Periodically check and tighten all nuts, bolts, and screws on grill.

Cleaning the Grill

⚠ CAUTION

To reduce risk of injury from laceration hazard, wear protective gloves when handling parts with sharp edges.

Drip Tray:

Remove the Drip Tray under the grill bowl after the grill has cooled completely. Scrape away food and fat residue from the Drip Tray. Empty and wash the Drip Tray with hot soapy water and a cloth.

Grill Body:

Remove excess grease and/or fat with a soft plastic or wooden scraper. Do not use steel wool or other abrasive cleaners that can scratch painted, porcelain-coated or stainless steel surfaces. It is not necessary to remove all the grease from the body. When grill is cool, wipe it down with paper towels or soft damp cloth. On painted grills, if rust appears, clean and buff the affected area with steel wool. Touch up bare metal with a high heat paint specified for barbecue grills. Follow paint manufacturer's instructions for use.

Cooking Grid/Warming Rack/Flavor Activator:

Clean the residue off with a baking soda and water solution. For stubborn stains, use a non-abrasive scouring powder. Do not use steel wool or other abrasive cleaners that can scratch the plated, porcelain-coated or stainless steel surfaces. This can cause foods to stick on the Cooking Grids.

All Other Cleaning:

For further cleaning, use hot soapy water and a cloth, or nylon-bristled brush only. Do not immerse the Gas Controls in water. (Avoid getting water in the Burner holes.)

Burner:

Burning off the residue after cooking will keep the Burner clean with normal usage, provided the Burner is operating correctly. Clean the Burner annually, or whenever heavy build-up is found, to ensure that there are no signs of blockage (debris, insects) in the Burner portholes, the primary air inlet, or the neck of the Burner. See **How to Clean the Burner**.

How to Clean the Burners

1. Make sure the Regulator Knob is turned "Off", the grill is completely cooled and the propane cylinder is removed.
2. Carefully remove Cooking Grid and Flavor Activator.
3. To remove the Burner, first remove the Bolts that fasten the Burner to its support bracket (figs. 7).
4. Slide U-Tube burner to the left so that the end of the burner is off of the valve nozzle and inside the firebowl. Lift the venturi end of the burner up first then slide the burner out from under the electrode (Fig. 8).

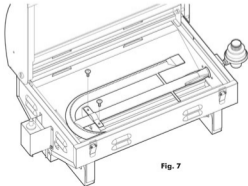

Fig. 7

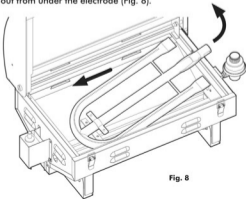
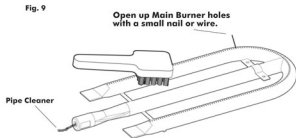

Fig. 8

- Use a pipe cleaner to clear insect nests or debris from the inlet hole of Main Burner (Fig. 9)
- Open up the Burner holes (Fig. 9) with a small nail or wire. Use a **non-metallic brush** to remove food particles and corrosion from the Burner surfaces.



- Check the Electrode to see if it is loose. If so, tighten the screw holding the Electrode to maintain 3/16" gap between Electrode tip and Burner.

NOTE: Before next step, you may wish to clean the rest of the grill. See "**Cleaning the Grill**" section.

- After cleaning, refit the Burner. If the grill is to be stored, the Burners may be wrapped in a protective cover such as aluminum foil or plastic wrap to help keep insects out.

NOTE: When refitting the Burner, be sure the Burner is positioned correctly. The valve nozzle should protrude inside the Venturi end of the Burner. (Fig. 10) Replace the Bolts that fasten the Burner Flange to the burner bracket.

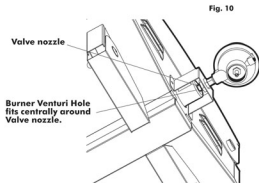

- Perform a Leak Test and check Burner operation after re-assembly.
- Replace Flavor Activator and Cooking Grid.

Emergencies

<u>Problem</u>	<u>Possible Cause</u>	<u>Solution</u>
Gas leaking from LP Gas Cylinder	Mechanical failure due to rust or mishandling	Replace LP Gas Cylinder.
Gas leaking between LP Gas Cylinder and regulator connection	Improper installation, connection not tight, failure of seal on LP Gas Cylinder	Remove LP Gas Cylinder. Re-install correctly and tighten. Replace Cylinder if damaged. See “Leak Test” and “Connecting Regulator to LP Gas Cylinder” sections.
Grease fire or excessive flames above cooking surface	Too much grease build-up in Burner section	Turn off Regulator Knob and remove LP Gas Cylinder. Once fire is out and grill has cooled off, clean residual food particles and excess grease from inside firebox area, grease cup, and other surfaces.
Flashback (Fire in or around Venturi tubes)	Clogged or blocked Venturi tube	If you can safely reach the Regulator Knob, turn it to the “OFF” position, then remove the LP Gas Cylinder. Once grill has cooled, clean Burner and Venturi tubes. See “How to Clean Burners” section.

Troubleshooting

Problem	Possible Cause	Solution
Burners will not light using the ignitor	Burners not assembled correctly	See re-assembly after cleaning in "Care and Maintenance."
	Not pressing igniter in enough for spark.	Push Regulator Knob in and turn counterclockwise to the "High" position. Depress the Igniter Button until a loud click is heard. Repeat until the Burner lights.
	No spark - out of place, loose, or broken.	<ol style="list-style-type: none"> 1. Electrode tip is bent (making too large or small of a gap between the Electrode and burner). Bend electrode tip back to a 3/16" gap to burner. (Page 10) 2. Tighten Electrode mounting screws. 3. Replace Igniter Wire/Electrode assembly. (Call the Customer Service Department)
	LP gas cylinder is empty	Purchase new 1 lb. LP Gas Cylinder.
	LP cylinder is not fully attached to regulator	Tighten cylinder by hand. Do not use tools.
	Obstructions in Burners	See "How to Clean Burners" in Care and Maintenance.
	Wet Electrodes and Burners	Allow electrode to air dry, dry with clean cloth or blow dryer.
	Wire loose or disconnected.	Reconnect the wire.
Wire shorting (sparking between Igniter and Electrode)	Replace Igniter Wire/Electrode assembly. (Call the Customer Service Department)	
Burners will not light using a match	Burners not assembled correctly.	See re-assembly after cleaning in Care and Maintenance.
	LP Gas Cylinder is empty.	Purchase new 1 lb. LP Gas Cylinder.
	LP cylinder is not fully attached to regulator.	Tighten cylinder by hand. Do not use tools.
	Obstructions in Burners.	See "How to Clean Burners" in Care and Maintenance.
Low flame or low heat	LP-gas in LP Gas Cylinder is low.	Purchase new 1 lb. LP Gas Cylinder.
Flames blow out	High or gusting winds.	Turn front of grill away from wind or increase flame height.
	Gas in LP cylinder is low.	Purchase new 1 lb. LP Gas Cylinder.
Flare up	Grease build-up.	Clean grill.
	Excessive fat in meat.	Trim fat from meat before grilling.
Persistent grease fire	Grease trapped around burner system.	Turn Regulator Knob "Off" then remove the LP Gas Cylinder. Open Hood carefully and let fire burn out. After the grill cools, remove and clean all parts.

If your problem is not resolved from the information provided above, please call Customer Service at 1-866-475-5180.

If you need a replacement part under warranty, a proof of purchase will be necessary.

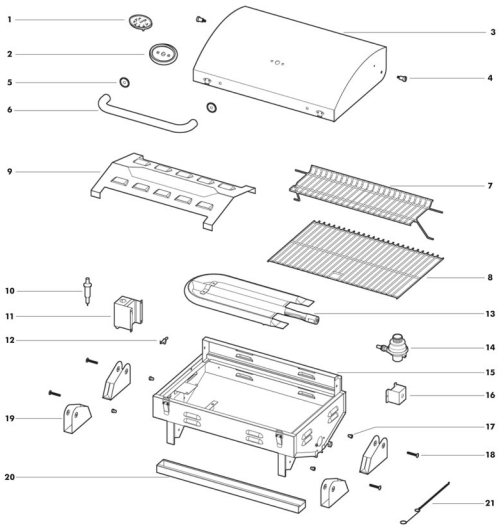

Parts List

Key	Description	Quantity
1	Thermometer	1
2	Thermometer Bezel	1
3	Hood	1
4	Hood Pivot Pin	2
4A	Hood Pivot Pin Nut (not shown)	2
5	Hood Handle Bezel	2
6	Hood Handle	1
7	Warming Rack	1
8	Cooking Grid	1
9	Flavor Activator	1
10	Piezo Igniter	1
11	Igniter Housing	1
12	Electrode (wire not shown)	1
13	Burner	1
14	Regulator/Valve	1
15	Grill Firebowl	1
16	Regulator Housing	1
17	Leg Nut	4
18	Leg Bolt	4
19	Leg	4
20	Drip Tray	1
21	Match Holder	1

If you need replacement parts, refer to the Parts Illustrations to find the exact parts you need.

If you have any questions or need help, contact **Customer Service at 1-866-475-5180**. Be sure to have the grill model number and serial number that are printed on the label located on the inside surface of the rear leg.

If you need a replacement part under warranty, a proof of purchase will be necessary. You will be asked to forward your proof of purchase.

It is important to retain your receipt.

NOTE:

Some illustrations may vary slightly depending on grill Model, however the names are the same.

When ordering parts, it is **VERY important to have the complete Model Number** to receive the correct replacement parts for your grill.



Limited Warranty

This Grill is guaranteed against broken or damaged parts at time of purchase. All parts carry a 1-year limited warranty. Paint is guaranteed to be free of defects for 90 days except for rust, which may appear after repeated use.

This warranty does not cover damage or issues related to neglect, abuse, or modifications to the product. Repair labor is not covered.

All parts that meet the warranty requirements will be shipped at no-charge via the discretion of the Customer Service Department (ground shipments, US Mail, or Parcel Post Only). Any special handling charges (i.e. Second Day, Overnight, etc.) will be the responsibility of the consumer.

All warranty claims apply only to the original purchaser and require a proof of purchase verifying purchase date. Do not return parts to our address without first obtaining a return authorization number from our customer service.

This service is available by calling 866-475-5180, 8:30am to 4:30pm, Central Time, Monday through Friday, or write to Outdoor Leisure Products, Inc. 5400 Doniphan Drive, Neosho, MO 64850.

This warranty may give you specific legal rights that vary by state.

Outdoor Leisure Products, Inc.
5400 Doniphan Drive
Neosho, MO 64850
www.olp-inc.com

©2009 Outdoor Leisure Products, Inc. logo is a trademark and is not to be used without express permission by Outdoor Leisure Products, Inc.

Made by OLPI under License from Meco Corporation