



# ***MULTI V***<sup>TM</sup> **5**

## **OPERATION AND MAINTENANCE MANUAL**

Variable Refrigerant Flow Outdoor Units  
6.0 to 42.0 Tons



## **PROPRIETARY DATA NOTICE**

**This document, as well as all reports, illustrations, data, information, and other materials are the property of LG Electronics U.S.A., Inc., and are disclosed by LG Electronics U.S.A., Inc. only in confidence.**

**⊘ Do not throw away, destroy, or lose this manual.  
Please read carefully and store in a safe place for future reference.  
Content familiarity is required for proper installation.**

The instructions included in this manual must be followed to prevent product malfunction, property damage, injury, or death to the user or other people. Incorrect operation due to ignoring any instructions will cause harm or damage. The level of seriousness is classified by the symbols described by the summary list of safety precautions on page 4.

**For more technical materials such as submittals, catalogs, engineering, owner's, best practices, and service manuals, visit [www.lghvac.com](http://www.lghvac.com).**

For continual product development, LG Electronics U.S.A., Inc. reserves the right to change specifications without notice.

© LG Electronics U.S.A., Inc.

---



---

<b>Safety Precautions</b> .....	<b>4</b>	<b>Maintenance</b> .....	<b>66</b>
<b>Unit Nomenclature</b> .....	<b>8</b>	<i>Preventive Maintenance Schedule</i> .....	66
<i>Outdoor Units and Heat Recovery Units</i> .....	8	<i>LG VRF System Maintenance &amp; Diagnostic Software</i> .....	67
<b>General information</b> .....	<b>9</b>	<i>PCB Self-Diagnostics Check</i> .....	69
<b>Operation</b> .....	<b>12</b>	<i>VRF System Maintenance Self-Diagnostics Test &amp; Report</i> .....	70
<i>About Your LG Outdoor Unit</i> .....	12	<i>Integrated Test Run</i> .....	71
<i>Refrigerant Piping System Insulation</i> .....	16	<i>Adjusting Fan Performance on Ducted IDUs</i> .....	72
<i>Outdoor Unit Micro-Processor Components</i> .....	19	<b>Troubleshooting</b> .....	<b>74</b>
<i>Outdoor Unit - Wiring Terminations</i> .....	20	<i>Error Codes</i> .....	74
<i>Electrical Wiring System</i> .....	21		
<i>Communication Wiring</i> .....	24		
<i>Refrigerant Pipe System Test</i> .....	26		
<i>Setting DIP Switches</i> .....	32		
<i>Assigning Equipment Addresses</i> .....	37		
<i>Assigning Equipment Addresses / Group Controlling Indoor Units</i> .....	42		
<i>Addressing Heat Recovery Units</i> .....	43		
<i>Customizing Operation</i> .....	55		

The instructions below must be followed to prevent product malfunction, property damage, injury or death to the user or other people. Incorrect operation due to ignoring any instructions will cause harm or damage. The level of seriousness is classified by the symbols described below.

## TABLE OF SYMBOLS

<b>DANGER</b>	<i>This symbol indicates an imminently hazardous situation which, if not avoided, will result in death or serious injury.</i>
<b>WARNING</b>	<i>This symbol indicates a potentially hazardous situation which, if not avoided, could result in death or serious injury.</i>
<b>CAUTION</b>	<i>This symbol indicates a potentially hazardous situation which, if not avoided, may result in minor or moderate injury.</i>
<b>Note:</b>	<i>This symbol indicates situations that may result in equipment or property damage accidents only.</i>
	<i>This symbol indicates an action that should not be performed.</i>

## INSTALLATION

### DANGER

Do not store or use flammable gas or combustibles near the unit.  
*There is risk of fire, explosion, and physical injury or death.*

Do not supply power to the unit until all wiring and piping are completed or reconnected and checked.  
*There is risk of physical injury or death due to electric shock.*

### WARNING

Do not install, remove, or re-install the unit by yourself (end user). Ask the dealer or an LG trained technician to install the unit.  
*Improper installation by the user may result in fire, explosion, electric shock, physical injury or death.*

**For replacement of an installed unit, always contact an LG trained service provider.**  
*There is risk of fire, electric shock, explosion, and physical injury or death.*

**Wear protective gloves when handling equipment. Sharp edges may cause personal injury.**

Do not change the settings of the protection devices.  
*If the protection devices have been bypassed or are forced to operate improperly, or parts other than those specified by LG are used, there is risk of fire, electric shock, explosion, and physical injury or death.*

**Replace all control box and panel covers.**  
*If cover panels are not securely installed, dust, water, and animals may enter the outdoor unit, causing fire, electric shock, and physical injury or death.*

**Always check for system refrigerant leaks after the unit has been installed or serviced.**  
*Exposure to high concentration levels of refrigerant gas may lead to illness or death.*

**Periodically check that the outdoor frame is not damaged.**  
*There is a risk of explosion, physical injury, or death.*

**If the air conditioner is installed in a small space, take measures to prevent the refrigerant concentration from exceeding safety limits in the event of a refrigerant leak.**  
*Consult the latest edition of American Society of Heating, Refrigerating, and Air Conditioning Engineers (ASHRAE) Standard 15. If the refrigerant leaks and safety limits are exceeded, it could result in personal injuries or death from oxygen depletion.*

**The heat recovery unit must be installed indoors; do not install the heat recovery unit in a highly humid environment.**  
*There is risk of physical injury or death due to electric shock.*

**Dispose of the packing materials safely.**

- Packing materials, such as nails and other metal or wooden parts, may cause puncture wounds or other injuries.
- Tear apart and throw away plastic packaging bags so that children may not play with them and risk suffocation and death.

**Install the unit considering the potential for strong winds or earthquakes.**  
*Improper installation may cause the unit to fall over, resulting in physical injury or death.*

**Install the unit in a safe location where nobody can step, fall onto it, or place objects on it. Do not install the unit on a defective stand.**  
*It may result in an accident that causes physical injury or death.*

**⚠ WARNING**

**Properly insulate all cold surfaces to prevent “sweating.”**

*Cold surfaces such as uninsulated piping can generate condensate that could drip, causing a slippery surface that creates a risk of slipping, falling, and personal injury.*

**⚠ CAUTION**

**Be very careful when transporting the product. There is a risk of the product falling and causing physical injury.**

- Use appropriate moving equipment to transport each frame; ensure the equipment is capable of supporting the weights listed.
- Some products use polypropylene bands for packaging. Ⓣ Do not use polypropylene bands to lift the unit.
- Suspend the outdoor unit from the base at specified positions (at a minimum of six [6] points) to avoid slippage from rigging apparatus.

**Note:**

LG Electronics U.S.A., Inc., is not responsible for any piping calculations, refrigerant leaks, degradation of performance, or any other potential problems or damages as a result of interconnecting piping, their joint connections, isolation valves, introduced debris inside the piping system, or other problems caused by the interconnecting piping system.

Ⓣ Do not install the product where it is exposed directly to ocean winds.

*Sea salt in the air may cause the product to corrode. Corrosion, particularly on the condenser and evaporator fins, could cause product malfunction or inefficient operation.*

**When installing the outdoor unit in a low-lying area, or a location that is not level, use a raised concrete pad or concrete blocks to provide a solid, level foundation.**

*This prevents water damage and abnormal vibration.*

**Properly insulate all cold surfaces to prevent “sweating.”**

*Cold surfaces such as uninsulated piping can generate condensate that may drip and cause a slippery surface condition and / or water damage to walls.*

**Always check for system refrigerant leaks after the unit has been installed or serviced.**

*Low refrigerant levels may cause product failure.*

Ⓣ Do not make refrigerant substitutions. Use R410A only.

*If a different refrigerant is used, or air mixes with original refrigerant, the unit will malfunction and damage will occur.*

Ⓣ Do not store or use flammable gas / combustibles near the unit.

*There is a risk of product failure.*

Ⓣ Do not use the product for mission critical or special purpose applications such as preserving foods, works of art, or other precision air conditioning applications. The equipment is designed to provide comfort cooling and heating.

*There is risk of property damage.*

**Keep the unit upright during installation to avoid vibration or water leakage.**

**When installing the unit in a hospital, mechanical room, or similar electromagnetic field (EMF) sensitive environment, provide sufficient protection against electrical noise.**

*Inverter equipment, power generators, high-frequency medical equipment or radio communication equipment may cause the air conditioner to operate improperly. The unit may also affect such equipment by creating electrical noise that disturbs medical treatment or image broadcasting.*

**The heat recovery box must be installed indoors; Ⓣ do not install the heat recovery box in a highly humid environment.**

*There is risk of product failure and property damage.*

**When connecting refrigerant piping, remember to allow for pipe expansion.**

*Improper piping installation may cause system malfunction.*

Ⓣ Do not install the outdoor unit or heat recovery unit in a noise-sensitive area.

**Take appropriate actions at the end of HVAC equipment life to recover, recycle, reclaim, or destroy R410A refrigerant according to applicable U.S. Environmental Protection Agency (EPA) rules.**

**Periodically check that the outdoor frame is not damaged.**

*There is a risk of equipment damage.*

**Install the unit in a safe location where no one can step on or fall onto it. Ⓣ Do not install the unit on a defective stand.**

*There is a risk of unit and property damage.*

**Install the drain hose to ensure adequate drainage.**

*There is a risk of water leakage and property damage.*

## WIRING

### **⚠ DANGER**

**High voltage electricity is required to operate this system. Adhere to the U.S. National Electric Codes (NEC) and these instructions when wiring.**

*Improper connections and inadequate grounding can cause accidental injury or death.*

**Always ground the unit following local, state, and NEC codes.**  
*There is risk of fire, electric shock, and physical injury or death.*

**Turn the power off at the nearest disconnect before servicing the equipment.**

*Electrical shock can cause physical injury or death.*

**Properly size all circuit breakers or fuses.**

*There is risk of fire, electric shock, explosion, physical injury or death.*

⊘ **Do not share the electrical circuit with other devices.**

*There is risk of fire, electric shock, and physical injury or death due to heat generation.*

⊘ **Do not use damaged or loose power wiring.** ⊘ **Do not modify or extend the outdoor unit's power wiring. Ensure that the power wiring will not be pulled nor weight be placed on the power wiring during operation.**

*There is risk of fire, electric shock, and physical injury or death.*

### **⚠ WARNING**

**The information contained in this manual is intended for use by an industry-qualified, experienced, trained electrician familiar with the NEC who is equipped with the proper tools and test instruments.**

*Failure to carefully read and follow all instructions in this manual can result in personal injury or death.*

**All electric work must be performed by a licensed electrician and conform to local building codes or, in the absence of local codes, with the NEC, and the instructions given in this manual.**

*If the power source capacity is inadequate or the electric work is not performed properly, it may result in fire, electric shock, physical injury or death.*

**Refer to local, state, and federal codes, and use power wires of sufficient current capacity and rating.**

*Wires that are too small may generate heat and cause a fire, and physical injury or death.*

**Secure all field wiring connections with appropriate wire strain relief.**

*Improperly securing wires will create undue stress on equipment power connections. Inadequate connections may generate heat, cause a fire, and physical injury or death.*

**Ensure the system is connected to a dedicated power source that provides adequate power.**

*If the power source capacity is inadequate or the electric work is not performed properly, it may result in fire, electric shock, physical injury or death.*

**Properly tighten all power connections.**

*Loose wiring may overheat at connection points, causing a fire, physical injury or death.*

⊘ **Do not change the settings of the protection devices.**

*If the protection devices have been bypassed or is forced to operate improperly, or parts other than those specified by LG are used, there is risk of fire, electric shock, explosion, and physical injury or death.*

### **Note:**

⊘ **Do not supply power to the unit until all electrical wiring, controls wiring, piping, installation, and refrigerant system evacuation are completed.**

*The system may malfunction.*

**The information contained in this manual is intended for use by an industry-qualified, experienced, licensed electrician familiar with the NEC who is equipped with the proper tools and test instruments.**

*Failure to carefully read and follow all instructions in this manual can result in equipment malfunction and property damage.*

**OPERATION**

**⚠ DANGER**

⊘ Do not provide power to or operate the unit if it is flooded or submerged.

*There is risk of fire, electric shock, physical injury or death.*

**Use a dedicated breaker for this product.**

*There is risk of fire, electric shock, physical injury or death.*

⊘ Do not operate the disconnect switch with wet hands.

*There is risk of fire, electric shock, physical injury or death.*

**Periodically verify the equipment mounts have not deteriorated.**

*If the base collapses, the unit could fall and cause physical injury or death.*

**Use inert (nitrogen) gas when performing leak tests or air purges.** ⊘ Do not use compressed air, oxygen, or flammable gases.

*Using these substances may cause fire, explosion, and physical injury or death.*

**If refrigerant leaks out, ventilate the area before operating the unit.**

*If the unit is mounted in an enclosed, low-lying, or poorly ventilated area, and the system develops a refrigerant leak, it may cause a fire, electric shock, explosion, physical injury or death.*

**⚠ WARNING**

⊘ Do not allow water, dirt, or animals to enter the unit.

*There is risk of fire, electric shock, physical injury or death.*

⊘ Do not operate the unit with the panel(s) or protective cover(s) removed; keep fingers and clothing away from moving parts.

*The rotating, hot, cold, and high-voltage parts of the unit can cause physical injury or death.*

⊘ Do not touch the refrigerant piping during or after operation.

*It can cause burns or frostbite.*

⊘ Do not open the inlet during operation.

*There is risk of electric shock, physical injury or death.*

**⚠ CAUTION**

**To avoid physical injury, use caution when cleaning or servicing the air conditioner.**

*There is risk of electric shock, physical injury or death.*

**Note:**

**Clean up the site after servicing is finished, and check that no metal scraps, screws, or bits of wiring have been left inside or surrounding the unit.**

⊘ Do not use the product for mission critical or special purpose applications such as preserving food, works of art, or other precision air conditioning applications. The equipment is designed to provide comfort cooling and heating.

*There is risk of property damage.*

⊘ Do not allow water, dirt, or animals to enter the unit.

*There is risk of unit failure.*

⊘ Do not open the inlet during operation.

*There is risk of unit failure.*

⊘ Do not operate the unit with the panel(s) or protective cover(s) removed; keep fingers and clothing away from moving parts.

*Non-secured covers can result in malfunction due to dust or water in the service panel.*

**Periodically verify the equipment mounts have not deteriorated.**

*If the base collapses, the unit could fall and cause property damage or product failure.*

**Use only a soft cloth to clean the air conditioner.** ⊘ Do not use wax, thinner, or strong detergents.

*Strong cleaning products may damage the surface of the air conditioner, or may cause its appearance to deteriorate.*

**Provide power to the outdoor unit to warm the compressor crankcase at least six (6) hours before operation begins.**

*Starting operation with a cold compressor sump(s) may result in severe bearing damage to the compressor(s). Keep the power switch on during the operational season.*

⊘ Do not turn off the main power switch after operation has been stopped.

*Wait at least five (5) minutes before turning off the main power switch, otherwise it may result in product malfunction.*

⊘ Do not block the inlet or outlet.

*Unit may malfunction.*

**Auto-addressing should be performed after connecting the power of all indoor and outdoor units.**

*Auto-addressing should also be performed after servicing an indoor unit.*

# UNIT NOMENCLATURE



## Outdoor Units and Heat Recovery Units

### Outdoor Units (ODU)

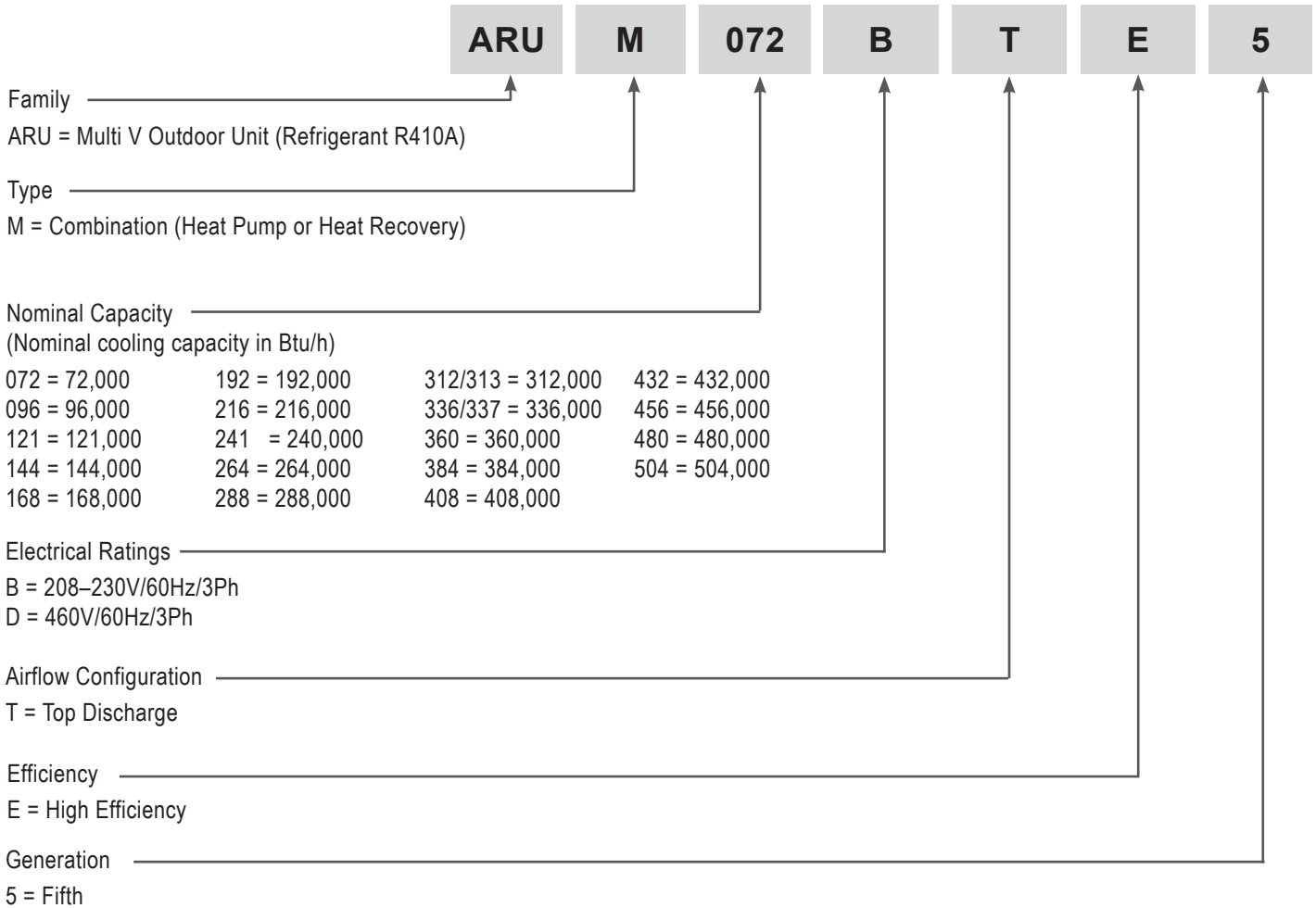

### Heat Recovery Units (HRU)

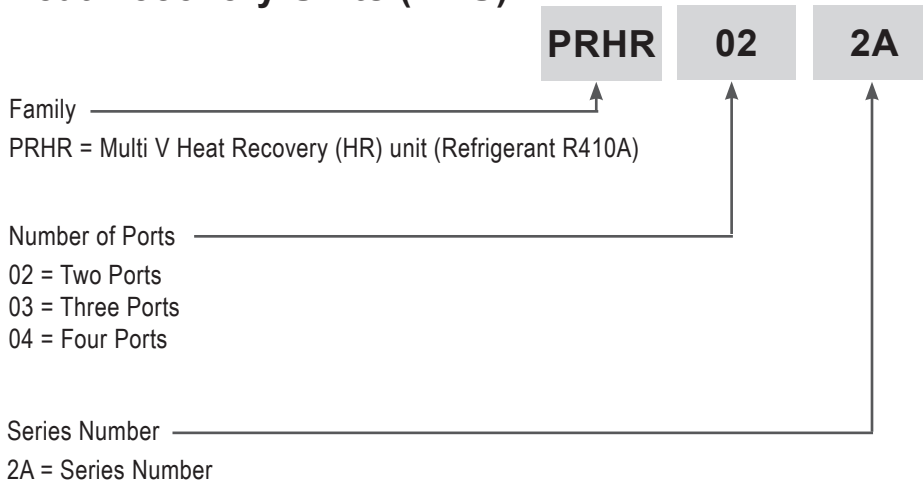



## LG Electronics USA Air Conditioning Technologies

The LG Electronics USA Air Conditioning Technologies business is based in Alpharetta, Georgia. LG is a leading player in the global air conditioning market, manufacturing both commercial and residential air conditioners and providing total sustainability and building management solutions. From consumer and individual units to industrial and specialized air conditioning systems, LG provides a wide range of products for heating, ventilating and air conditioning. For more information, please visit [www.lghvac.com](http://www.lghvac.com).

### LG VRF

A Variable Refrigerant Flow (VRF) system is a single refrigerant circuit that connects many indoor units to one outdoor unit. VRF is a superior way to heat and cool any space, providing improved humidity control, individual set points per indoor unit, and a very quiet comfort experience. In the heat recovery configuration, VRF also allows for heating and cooling simultaneously in different zones, further enhancing energy savings and increasing occupant comfort. Energy efficient and easy to design, install, and maintain, a VRF system has low life cycle cost compared to other systems on the market today.

### Why LG VRF?

The benefits are numerous: less piping for installers, energy efficiency for owners, and modern indoor units that complement every setting. Sound levels of LG VRF products are among the lowest in the industry, so units can be installed where noise is an issue. Inverter scroll compressors manufactured by LG optimize system energy efficiency.

MULTI V™ 5



## 1. High Elevation Piping Distances

NOTE: All piping lengths are equivalent.

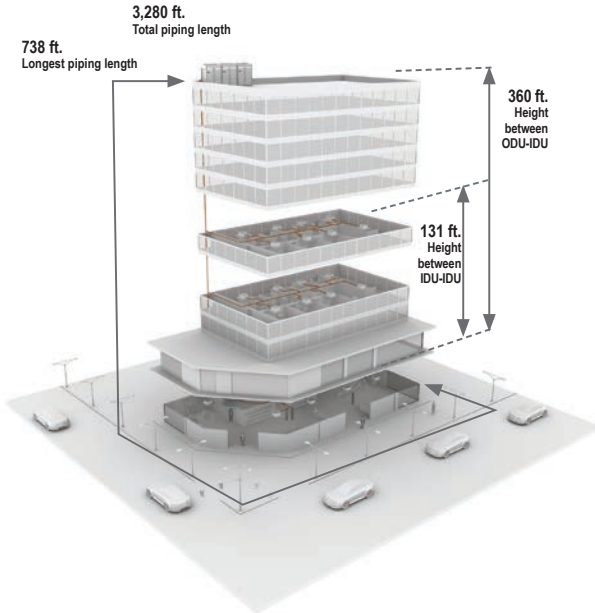

## 2. Optimized Heat Recovery Piping

- Flexible piping layout reduces materials and labor costs during installation
- LG Heat Recovery Unit (HRU) is quiet, compact, lightweight, and does not need condensate drains<sup>1</sup>
- Configured for fully independent heating and cooling, ensuring occupant comfort

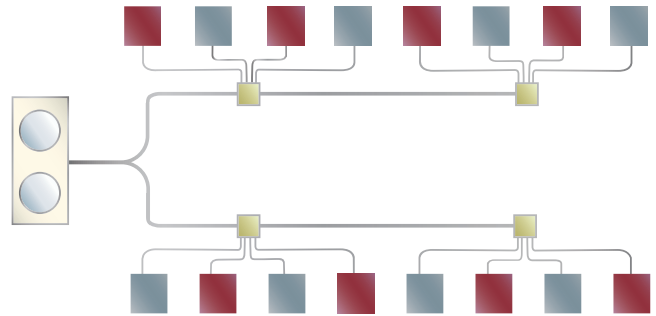

## 3. Quiet Operation

- Quiet indoor unit operation down to 23 dB(A), comparable to the sound of rustling leaves

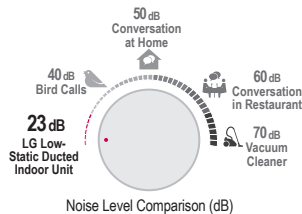

## 4. Operation Range

- Industry-leading operation ranges without additional accessories or performance deficits:
  - Heating: -13°F to 61°F WB
  - Cooling: 5°F to 122°F DB
  - Simultaneous Cooling: 14°F to 81°F

## Efficiency

### Advanced features for superior efficiency

- **Advanced Smart Load Control**  
Automatically adjusts system target pressures based on outdoor temperature and humidity for increased cooling performance.
- **Active Refrigerant Control**  
Depending on the operating mode and conditions, the system refrigerant level is automatically adjusted for increased part load and heating efficiency.
- **Variable Path Heat Exchanger**  
Depending on the operating mode and conditions, both the refrigerant flow path and velocity are adjusted for improved efficiency.
- **Advanced PCB Cooling**  
Improved cooling performance of the inverter PCB by using liquid refrigerant instead of heat sink cooling methods.
- **LG Inverter Scroll**  
Innovative high side-shell design creates a more compact unit providing the same capacity output, with greater reliability in cold climates.

- **HiPOR™ (High-Pressure Oil Return)**  
Oil is returned to the compressor through a separate inlet pipe, ensuring that compressor energy is used to compress refrigerant only.
- **Smart Oil Control**  
Eliminates timed oil-return cycles and takes hours off of the time required to return oil compared to systems that use a timed oil-recovery cycle.
- **Intelligent Heating**  
By monitoring the outdoor humidity, system target pressures can be reduced to extend heating operation, delay defrost operation and reduce power consumption.

1. Down to 35.1 dB(A).

## Design Flexibility

- Higher-Elevation Piping Technology  
More floors with fewer systems. LG Multi V 5 eliminates the need to invest in extra systems and saves on installation. Enjoy no heating capacity losses due to long pipe length.
- Compact & Lightweight  
More indoor zones, less outdoor space. When space or access is at a premium, Multi V 5 offers significant cost advantages on large projects.

## Performance

Expansive operating range in cooling and heating without adding accessories

- LG Multi V 5 uses vapor injection technology for improved heating performance in ambient conditions as low as -13°F.
- Using a variable path heat exchanger, LG Multi V 5 performs in low ambient conditions to provide cooling down to 5°F.

## Comfort

- Quiet Operation  
Multi V indoor units are among the quietest in the industry, with rated sound levels as low as 23dB(A). In addition to temperature, airflow and dehumidification, extremely low sound levels contribute to a relaxing environment.
- Individualized Zone Control  
Multi V systems allow the user to control the space to the exact temperature desired. This further enhances comfort while promoting reduced power consumption.
- Indoor Air Quality  
All Multi V indoor units incorporate a reusable, washable filter. Since distribution and return ducts are not required for this system, dust and duct mold accumulation are reduced, contributing to improved indoor air quality.

## Training

The LG US Air Conditioning division is headquartered near Atlanta in Alpharetta, Georgia, along with a full training academy. Additional training academies are located in California, Texas and New Jersey. Since 2008, our academies have trained thousands on the advantages of LG air conditioning systems, and even more have been trained through LG's online training modules. World class trainers with years of experience teach classes in ductless technology, with topics covering everything from installation to service for the full range of LG air conditioning products. LG also has several strategically placed partner academies throughout the United States that offer a number of LG training classes as well. For HVAC professionals, LG offers online instruction via our Learning Management System and classroom training at our training academies, strategically placed throughout the country. Training is open to all contractors; ask your LG Electronics authorized distributor for details.

## Service Tools

As part of our commitment to innovation, LG has developed innovative ways to enhance the service technician's experience during routine maintenance or service with these tools:

- LG Monitoring View (LGMV) Software and Mobile App both connect to LG Multi V Systems to allow technicians to troubleshoot accurately and evaluate equipment performance by interfacing directly with the unit. The software provides an accurate picture of an operating system without the need to check system temperatures manually, access the refrigerant circuit for system pressures, or perform time-consuming resistance and voltage tests. This service tool provides the most effective troubleshooting method for LG Multi V equipment.
- LG Telepresence connects technicians in the field directly to LG Technical Assistance representatives via a live feed through the technician's smartphone, allowing you to bring LG technical support with you to any jobsite.

## Contact Information

Installation, Startup, Commissioning, Operation & Maintenance Technical Assistance	1-888-865-3026
Freight Damage and Unit Replacements	Your LG Manufacturer Representative
Missing Parts	Your LG Manufacturer Representative
Received Wrong Order Unit Model(s)	Your LG Manufacturer Representative



## About Your LG Outdoor Unit

### Piping Connections for Heat Recovery Operation

Use the correct outdoor unit connections to join the outdoor unit to the branch piping in the indoor unit refrigeration system. The outdoor unit, heat recovery unit, and branch piping require brazed connections; indoor units require flare connections to the refrigerant system.

Multi V 5 outdoor units designed for heat recovery operation use the liquid pipe, high pressure vapor, and low pressure vapor pipe connections as shown in the diagram at right.

#### ⚠ WARNING

*It is imperative that the correct outdoor unit connections be used for the intended system operation (heat pump versus heat recovery). If the wrong connections are used, it may result in refrigerant leaks, which may lead to illness or death.*

#### Note:

*It is imperative that the correct outdoor unit connections be used for the intended system operation (heat pump versus heat recovery). If the wrong connections are used, it may result in refrigerant leaks, which may lead to system malfunction or even failure to work at all.*

### Pipe Routes

Choose from three pipe routes from out of the outdoor unit to the indoor unit refrigerant system:

- Front Pipe Route.
- Left Side Route (Pipes are routed through the bottom of the outdoor unit).
- Right Side Route (Pipes are routed through the bottom of the outdoor unit).

The pipe route chosen depends on the installation area, and is at the discretion of the installer. After the pipe route is chosen, the appropriate outdoor unit access holes must be knocked out (see next page for knock out information).

#### Front Pipe Route.

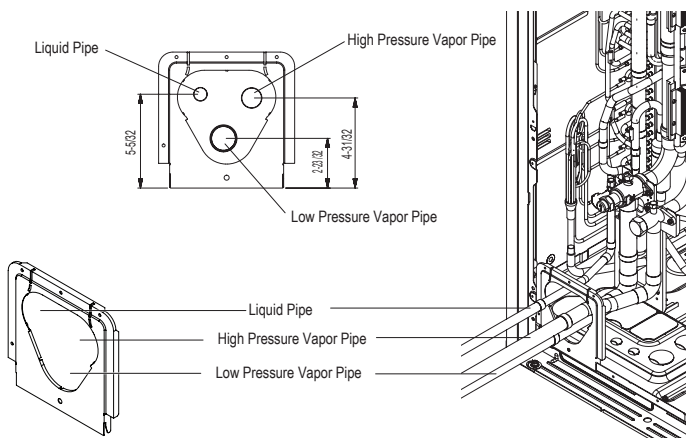

#### Piping Connections for Heat Recovery Operation.

Service Ports for Heat Recovery Operation

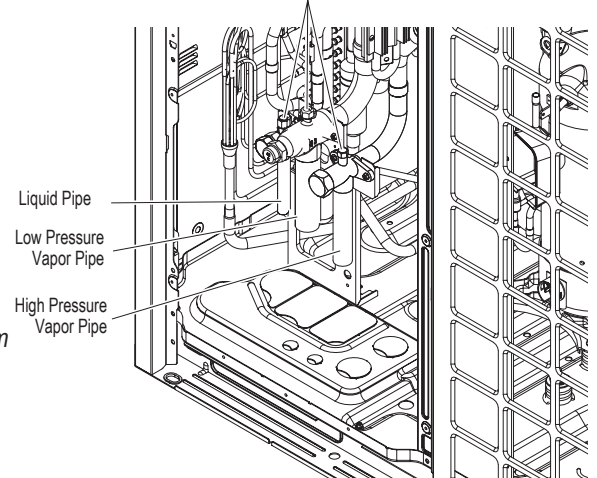

#### Pipe Route Options.

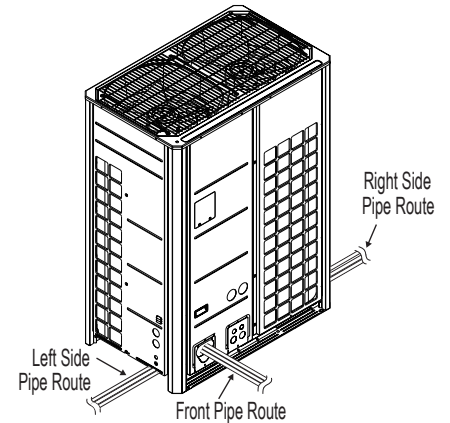

#### Left and Right Side Routes (Pipes are Routed Through the Bottom of the Outdoor Unit).

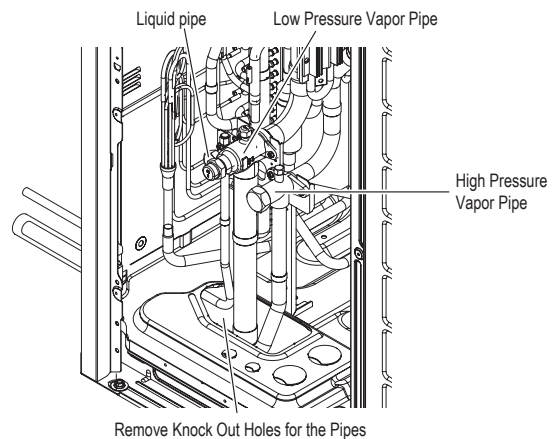

**Knock Outs**

After the pipe route is chosen, installer must prepare the access holes in the front panel (front pipe route) or in the base pan at the bottom of the outdoor unit (for left and right side pipe routes). The access holes for the communication cables and the power supply wiring can also be knocked out at this time. See diagram at right for access hole locations.

Heat Recovery Outdoor Unit Knock Outs.

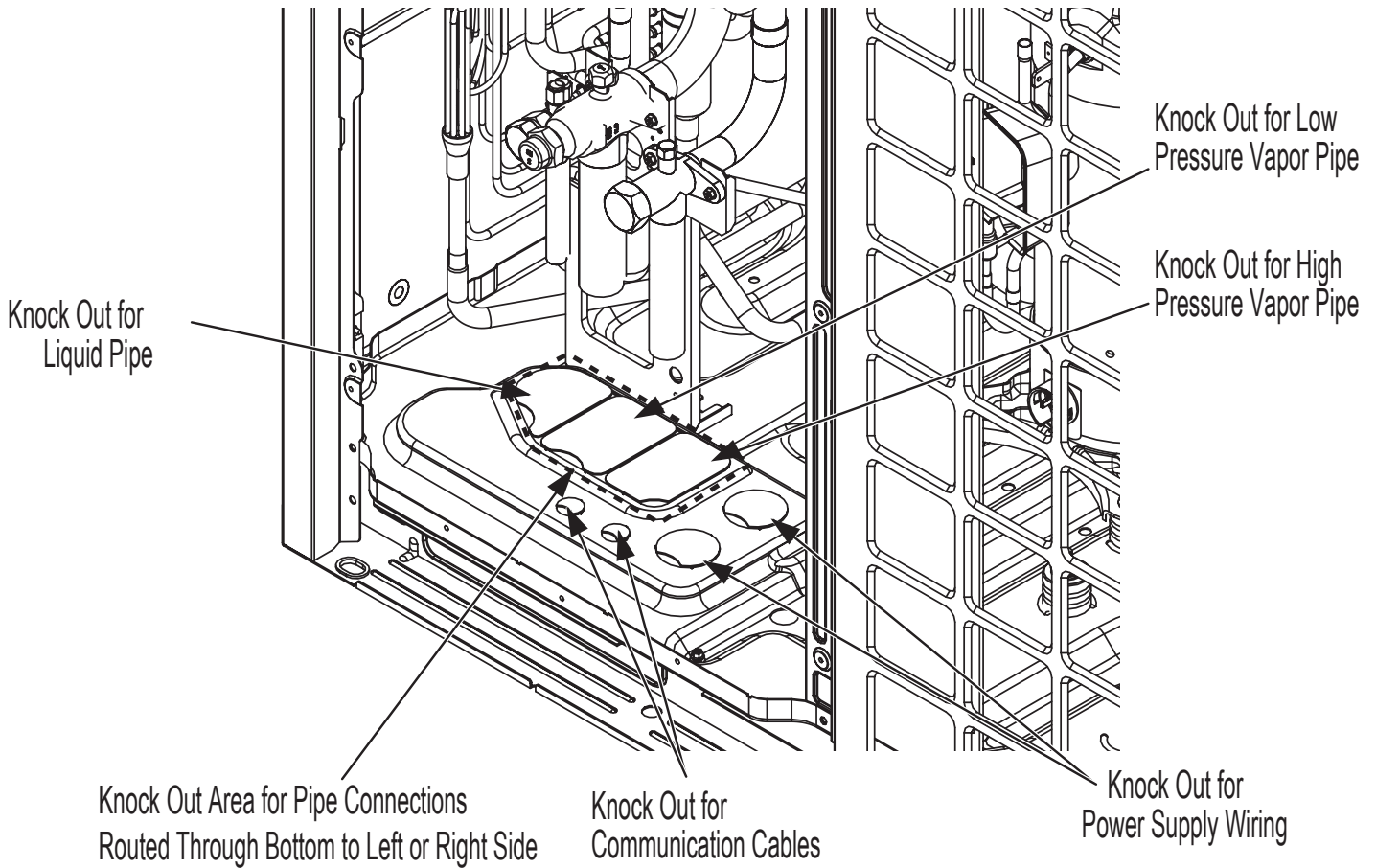

**Note:**

- Do not damage the outdoor unit pipes or the base pan when knocking out the access holes.
- To avoid damaging the piping and power wiring / communication cables, remove any burrs that may have formed during the knock out procedure. Make sure the access holes have smooth edges.
- To avoid damaging the power wiring / communication cables, install sleeves.
- After piping installation is complete, to prevent animals or foreign materials from damaging the outdoor unit cables / wiring, seal any holes in with sealant, plugs, foam, caulk, putty, etc.

**Avoid Pipe Damage**

- When routing field-provided piping inside the outdoor unit frame, avoid causing vibration that will damage the components.
- Correctly route the piping so it does not make contact with the compressor casing, terminal cover, or mounting bolts. Allow room for field installation.
- Properly install and insulate refrigerant pipes separately up to the service valve body inside the confines of the unit frame.

### Removing the Leak Prevention Caps

Before brazing the field-supplied refrigerant piping to the outdoor unit connections, the leak prevention caps MUST be removed from the liquid, high pressure vapor, and low pressure vapor pipe connections.

- Verify that the valve stems in the service ports are closed (see next page).
- Remove the leak prevention caps from the liquid, high pressure vapor, and low pressure vapor pipe outdoor unit connections.
- Use the Schrader valves on the liquid, high pressure vapor, and low pressure vapor pipes to perform the leak / pressure, triple evacuation, and trim charge procedures.

Location of the Leak Prevention Caps.

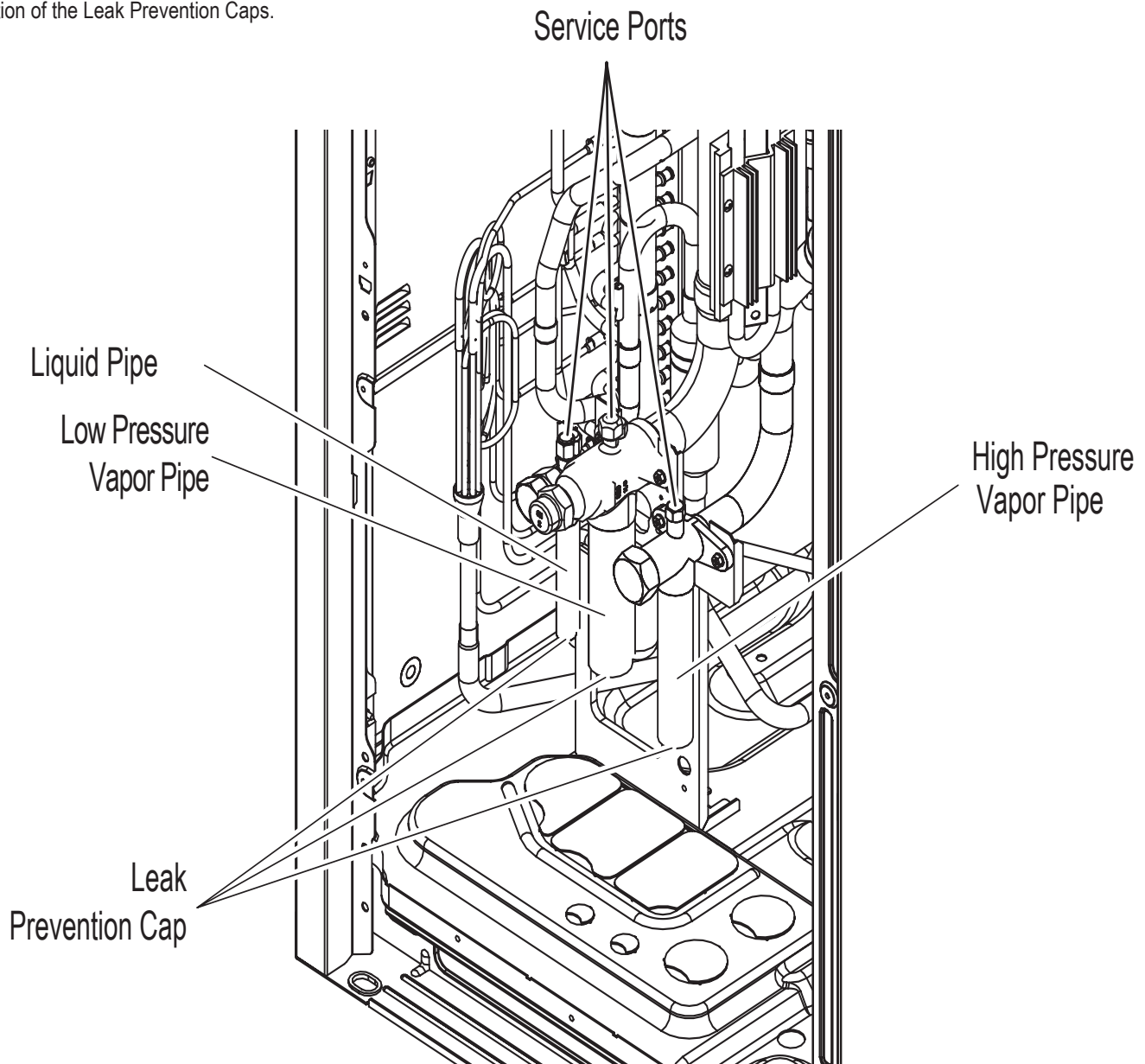

### Note:

Line connection dimensions in the specification tables and in LATS are field piping dimensions, NOT the dimensions on the outdoor unit connections themselves. Adapters may be needed to connect the field piping to the correct outdoor unit connection (adapters are factory supplied with the outdoor unit).

### Heat Recovery Outdoor Unit Service Port Detail

1. Liquid piping service port (back seated type with right hand thread).
2. Low pressure vapor piping service port (back seated type with right hand thread).
3. High pressure vapor piping service port (back seated type with right hand thread).
4. Stem head access with factory-provided cap.
5. Schrader ports with factory-provided cap.
6. Service port piping to connect to field piping.

**Note:**

⊘ Do not expose the outdoor unit service valves to heat. Protect the service valve with a wet towel during brazing.

### Operating the Service Port Components

**Note:**

⊘ Do not apply excessive force to the Schrader and service ports.

#### Opening and Closing the Schrader Ports

1. Loosen the Schrader port caps on the liquid, low pressure vapor, and high pressure vapor service ports.
2. After the leak / pressure, triple evacuation, and trim charge procedures are complete, securely tighten all Schrader port caps.

#### Opening the Service Port

1. After servicing is finished and the system is ready for operation, remove the stem head access caps on the liquid, low pressure vapor, and high pressure vapor piping service ports.
2. Turn the valve stem counterclockwise using a metric sized Allen wrench (4mm to 8mm, depending on the size of the port).
3. Turn until the valve stem is out, stops, and the valve is completely backseated. ⊘ Do not apply excessive force.
4. Securely replace the stem head access caps.

#### Closing the Service Ports

1. If present, remove the stem head access caps on the liquid, low pressure vapor, and high pressure vapor piping service ports.
2. Turn the valve stems clockwise using a metric sized Allen wrench (4mm to 8mm, depending on the size of the port).
3. Securely tighten the valves until the shaft contact the main body seal. ⊘ Do not apply excessive force.
4. Securely replace the stem head access caps.

**⚠ WARNING**

- Outdoor units ship with a factory charge of refrigerant. Always take extreme caution to prevent refrigerant gas (R410A) from leaking during use, around fire or flame, and during brazing. If the refrigerant gas comes in contact with a flame from any source, it may break down and generate a poisonous gas. ⊘ Do not braze in a small room, or a room that is not ventilated.
- After refrigerant piping work is complete, verify that the Schrader port and service port caps are securely tightened to help prevent refrigerant gas from leaking. Verify the system is free of leaks after refrigerant piping installation is complete. Exposure to high concentration levels of refrigerant gas may lead to illness or death.
- ⊘ Do not attempt to remove the service valve stem. Physical injury or death may occur from the uncontrolled rapid release of refrigerant.

**Note:**

- Before connecting the refrigerant piping, make sure the service port valves of the outdoor unit are completely closed (factory setting). ⊘ Do not open the service port valves or attempt to operate the system until the refrigerant pipe system installation has been completed. Never open the valves before a pressure test is performed, a leak test performed, the system is evacuated, and the Commissioning Agent provides authorization to do so. ⊘ Do not use polyolester (POE) or any other type of mineral oil as a thread lubricant. If introduced to the refrigerant circuit, it will create oil sludge leading to system malfunction. Use PVE (polyvinyl ether) type refrigeration oil only.
- Protect the liquid and vapor piping / ports with a wet towel during brazing.
- Use a 15% silver phosphorous copper brazing alloy to avoid overheating and produce good flow. ⊘ Do not use flux, soft solder, or anti-oxidant agents. If the proper material is not used, oxidized film may accumulate and clog or damage the compressors. Flux can harm the copper piping or refrigerant oil.
- When brazing the field-supplied refrigerant piping to the outdoor unit connections, flow 3 psig nitrogen into the piping. If nitrogen was not flowed during brazing, the piping may oxidize and cause membranes to form, which may negatively impact valve and condenser operation.

Heat Recovery Outdoor Unit Service Port Diagram.

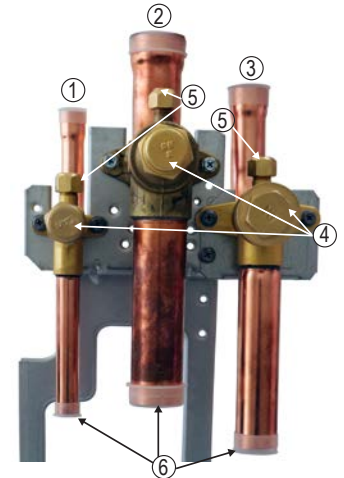

Opening the Service Ports.



## Refrigerant Piping System Insulation

### Note:

For information regarding insulation for underground or penetration situations, see the "General Refrigerant Piping System Information" section.

### Refrigerant Piping System Insulation

All refrigerant piping from the outdoor unit to the indoor units / heat recovery units must be insulated correctly for safety and usage. Y-branch connections, header branch connections, refrigerant piping, field-provided isolation ball valves (if present), service valves, and elbows must be properly and completely insulated using closed cell pipe insulation (up to the indoor unit piping connections). To prevent heat loss / heat gain through the refrigerant piping, all refrigerant piping including liquid lines and vapor lines shall be insulated separately. Insulation shall be a minimum 1/2 inches thick, and thickness may need to be increased based on ambient conditions and local codes. Table on next page lists minimum wall thickness requirements for Ethylene Propylene Diene Methylene (EPDM) insulation.

Typical Pipe Insulation, Power Wire and Communications Cable Arrangement.

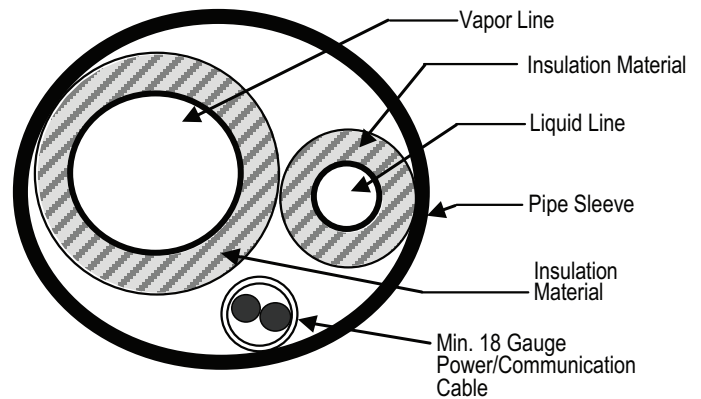

Inside the outdoor unit, maximum pipe temperature is 248°F and minimum pipe temperature is -40°F. For field insulation of refrigerant piping between outdoor units and indoor units, consider the following pipe temperature ranges for an operating heat pump system:

- Heating mode refrigerant temperature ranges: Liquid, 75-118°F; High Pressure Vapor, 95-220°F
- Cooling mode refrigerant temperature ranges: Liquid, 75-118°F; Low Pressure Vapor, 40-90°F

All insulation joints shall be glued with no air gaps. Insulation material shall fit snugly against the refrigeration pipe with no air space between it and the pipe. Insulation passing through pipe hangers, inside conduit, and/or sleeves must not be compressed. Protect insulation inside hangers and supports with a second layer. All pipe insulation exposed to the sun and outdoor elements shall be properly protected with PVC, aluminum vapor barrier, or alternatively placed in a weather-resistant enclosure such as a pipe rack with a top cover; and meet local codes. LG-provided Y-branches are shipped from the factory with pre-formed peel-and-stick foam insulation jackets, with a 1.84 lb./ft.<sup>3</sup> density, 1/2 inch thickness, and meet UL94 MF-1 flammability.

The design engineer should perform calculations to determine if the factory-supplied insulation jackets are sufficient to meet local codes and avoid sweating. Add additional insulation if necessary. Check the fit of the insulation jacket after the header fitting and all run-out pipes are installed. Mark all pipes at the point where the insulation jacket ends. Remove the jacket. Install field provided insulation on the run-out and main trunk pipes first. Install the LG-provided insulation plugs on the ends of all unused header ports. Peel the adhesive glue protector slip from the insulation jacket and install the clam-shell jacket over the fitting.

Typical Insulation Butt-Joint at Indoor Unit Casing.

Typical Refrigerant Flare Fitting Insulation Detail.

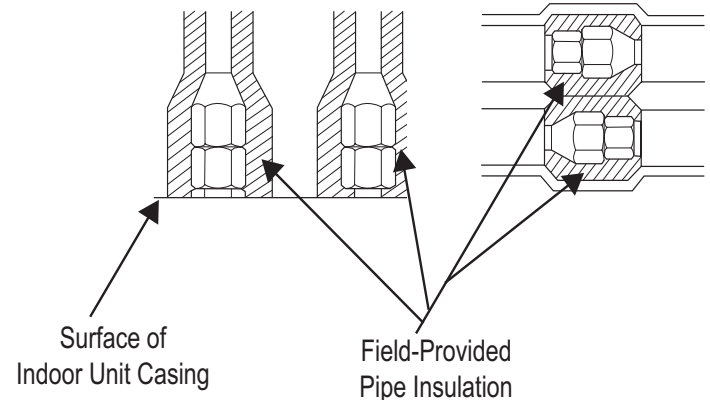

Insulating the Shut Off / Isolation Ball Valve (If Present).

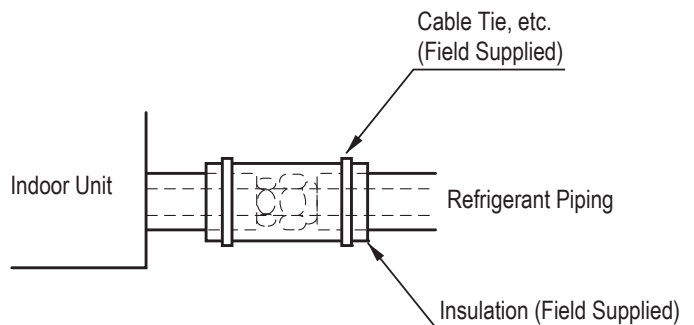



**Note:**

- Do not insulate gas and liquid pipes together as this can result in pipe leakage and malfunction due to extreme temperature fluctuations.
- Always properly insulate the piping. Insufficient insulation will result in condensation, reduced heating/cooling performance, etc. Also, if the pipes aren't insulated properly, condensation could potentially cause damage to building finishes. Pay special attention to insulating the pipes installed in the ceiling plenum.
- Fully insulate the piping connections.
- Follow locals codes and the designer's instructions when selecting ethylene propylene diene methylene (EPDM) insulation wall thickness.

Table 1: Minimum Refrigerant Pipe EPDM Insulation Wall Thickness Requirements.<sup>1</sup>

Classification / Piping O.D.		Air-conditioned location		Non-air conditioned location	
		1. Typical Conditioned Location	2. Special Conditioned Location	3. Typical Unconditioned Location	4. Special Unconditioned Location
Liquid pipe	ø1/4 inches	>1/2 inches	>1/2 inches	>1/2 inches	>1/2 inches
	ø3/8 inches	>1/2 inches	>1/2 inches	>1/2 inches	>1/2 inches
	≥ø1/2 inches	>1/2 inches	>1/2 inches	>1/2 inches	>1/2 inches
Vapor pipe	ø3/8 inches	>1/2 inches	>3/4 inches	>3/4 inches	>1 inch
	ø1/2 inches				
	ø5/8 inches				
	ø3/4 inches				
	ø7/8 inches				
	ø1 inch	>3/4 inches	>1 inch	>1 inch	
	ø1-1/8 inches				
	ø1-1/4 inches				
	ø1-3/8 inches				
	ø1-1/2 inches				
ø1-3/4 inches					

<sup>1</sup>The thickness of the above insulation material is based on heat conductivity of 0.61 Btu/in/h/ft<sup>2</sup>/°F.

**1. Typical Conditioned Location**

A building plenum or space that contains conditioned air that does not exceed 80°F DB.

**2. Special Conditioned Location**

1. When the location is air conditioned, but there is severe temperature/humidity difference due to high ceilings.
  - Church, auditorium, theater, lobby, etc.
2. When the location is air conditioned, but internal temperature/humidity are high.
  - Bathroom, swimming pool, locker room, etc.

**3. Typical Unconditioned Location**

An unconditioned space inside a building.

**4. Special Unconditioned Location: If conditions 1 and 2 below are present.**

1. An unconditioned space or plenum of a building.
2. An area where there is an elevated humidity level.

**5. Additional Insulation for Indoor Units May be Required in Humid Environments.**

The air conditioner factory insulation has been tested according to "ISO Conditions with Mist," and it satisfies the requirements. If the system has been operating for a long time in a high humidity environment (dew point temperature: more than 73°F), condensate is likely to form. If this happens, install 3/8 inch thick EPDM insulation that is plenum-rated with a heat-resistance factor of more than 248°F.

## Insulation

### Applying Insulation to Y-Branch and Header Fittings

LG Y-branches and Headers should be insulated with the clam-shell insulation jacket that is provided with each component. Check the fit of the insulation jacket after all pipes are brazed to fittings. Mark all pipes at the point where the insulation jacket ends. Remove the insulation jacket. Install field-supplied insulation on the pipe segments first, and then install the LG provided insulation plugs on the ends of all unused Header ports. Apply the clam-shell insulation on jackets to Y-branch and Header fittings last. Peel the adhesive glue protector slip from the insulation jacket and install the insulation jacket over the fitting.

Y-branch Insulation.

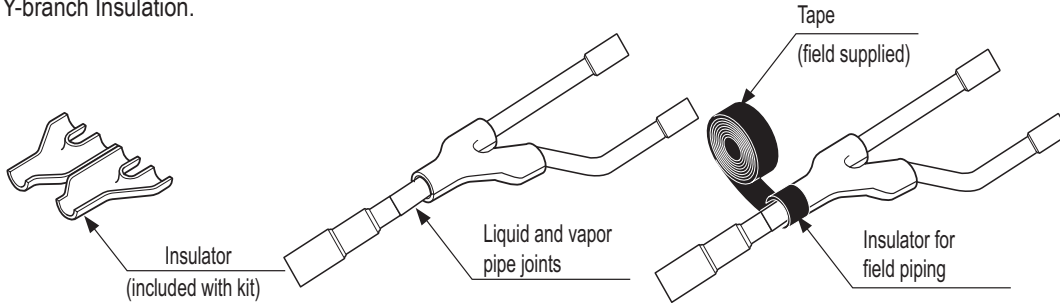

Header Insulation.

Joints between branch and pipe should be sealed with tape included in each kit.

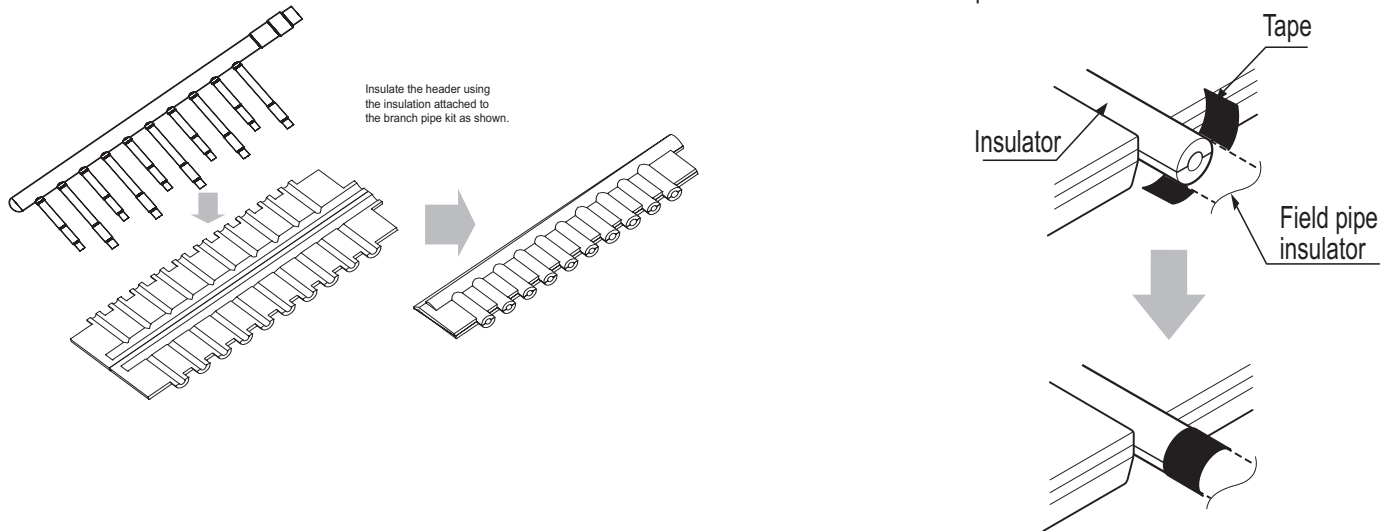

Capped pipes should be insulated using the cap included in each kit, and then taped as shown.

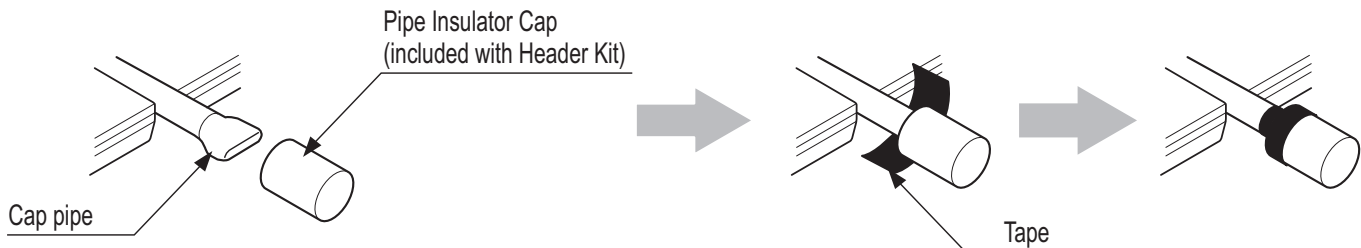

### Note:

**Additional Insulation for Y-Branched and Headers May be Required in Humid Environments.**

If the system has been operating for a long time in a high humidity environment (dew point temperature: more than 73°F), condensate is likely to form. If this happens, install 3/8 inch thick ethylene propylene diene methylene (EPDM) insulation that is plenum-rated with a heat-resistance factor of more than 248°F.

## Location of Outdoor Unit PCBs and Other Electrical Components

Outdoor Unit Electrical Component Locations.

### Large Frame Outdoor Units

### Small Frame Outdoor Units

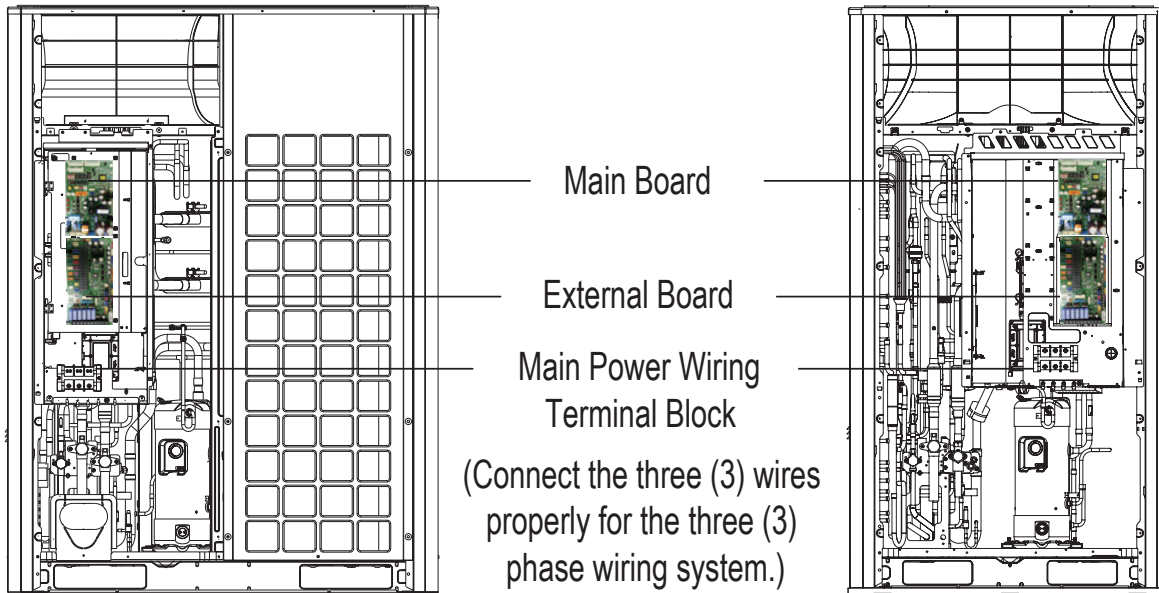

Internal Routing and Terminations in Small Frame Outdoor Units.

#### Power Wiring / Communication Cable Routed Through the Front

#### Power Wiring / Communication Cable Routed Through the Bottom (Left)

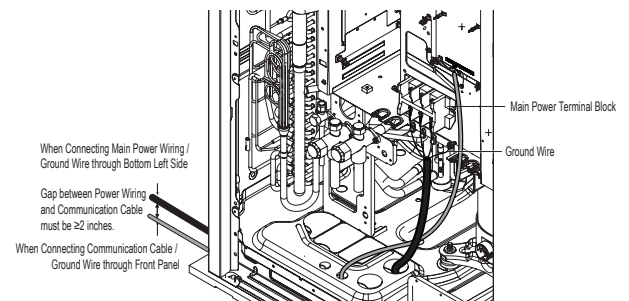
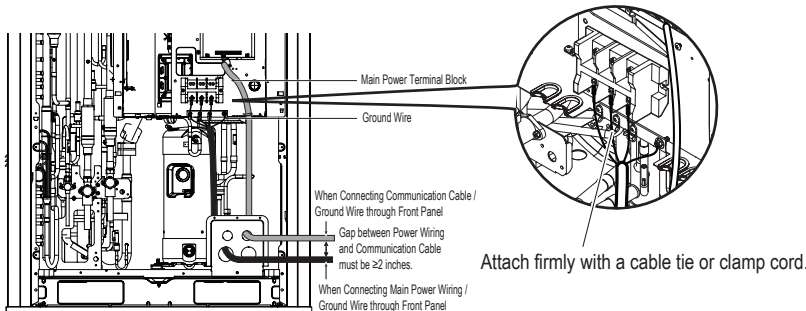

Close Up of Wiring / Cable Connections in Small Frame Outdoor Units.

#### Main Power Wiring Connection

#### Communication Cable / Ground Wiring Connections

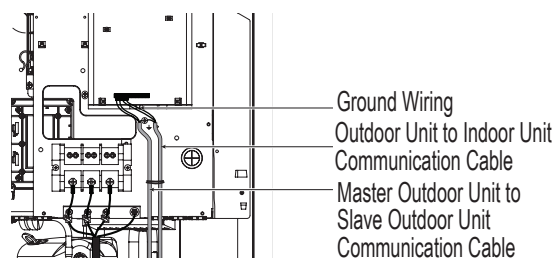
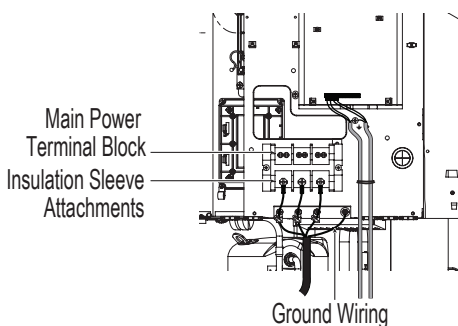

### Note:

Position the power wiring / communication cables so that electromagnetic interference with the oil level sensor is avoided. If the oil sensor is subjected to electromagnetic interference, it may malfunction.

# OPERATION

**MULTI V 5**

## Outdoor Unit - Wiring Terminations

Internal Routing and Terminations in Large Frame Outdoor Units.

Power Wiring / Communication Cable Routed Through the Front

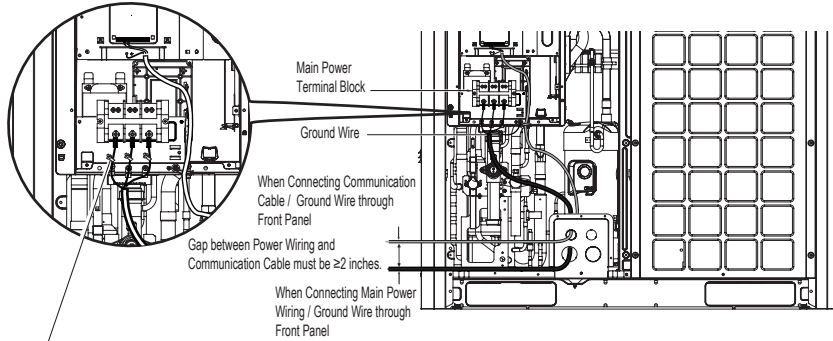

Attach firmly with a cable tie or clamp cord.

Power Wiring / Communication Cable Routed Through the Bottom (Left)

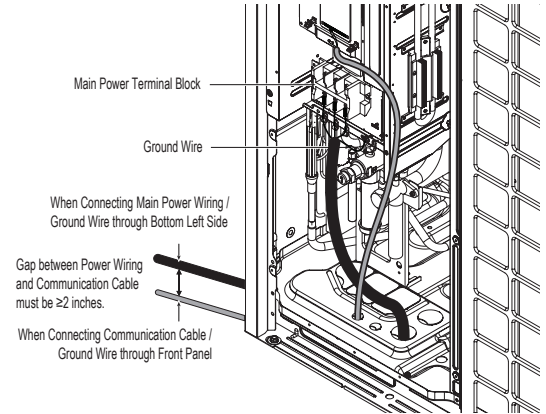

Close Up of Wiring / Cable Connections in Large Frame Outdoor Units.

Main Power Wiring Connection

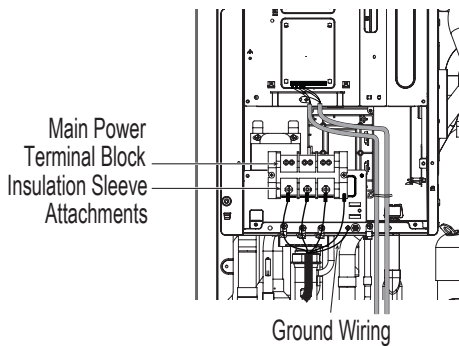

Communication Cable / Ground Wiring Connections

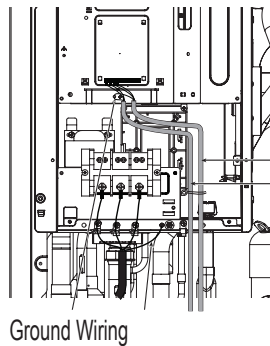

**Note:**

Position the power wiring / communication cables so that electromagnetic interference with the oil level sensor is avoided. If the oil sensor is subjected to electromagnetic interference, it may malfunction.

**⚠ WARNING**

- All power wiring and communication cable installation must be performed by authorized service providers working in accordance with local, state, and National Electrical Code (NEC) regulations related to electrical equipment and wiring, and following the instructions in this manual. Failure to do so may lead to electric shock and bodily injury or death.
- Be sure that main power to the unit is completely off before proceeding. Follow all safety and warning information outlined at the beginning of this manual. Failure to do so may cause electric shock and bodily injury.
- Familiarize yourself with the location of the circuit breaker. Be sure that a circuit breaker or some other emergency power cutoff device is in place before any power wiring is done to the system. Failure to do so may cause bodily injury or death.
- ⓧ Never touch any power lines or live cables before all power is cutoff to the system. To do so, may cause bodily injury or death.
- Undersized wiring may lead to unacceptable voltage at the unit and may cause a fire, which may cause bodily injury or death.
- Properly ground all outdoor units and indoor units. Ground wiring must always be installed by a qualified technician. Ground wiring is required to prevent accidental electrical shock during current leakage, which may cause bodily injury or death.
- The outdoor units are inverter driven. ⓧ Do not install a phase-leading capacitor; if installed, it will deteriorate the power factor improvement effect, cause the capacitor to generate an abnormal amount of heat, which may result in physical injury.
- Install appropriately sized breakers / fuses / overcurrent protection switches and wiring in accordance with local, state, and NEC regulations related to electrical equipment and wiring, and following the instructions in this manual. Generated overcurrent may include some amount of direct current. Using an oversized breaker or fuse may result in electric shock, physical injury or death.
- ⓧ Do not connect ground wire to refrigerant, gas, or water piping; to lightning rods; to telephone ground wiring; or to the building plumbing system. Failure to properly provide a NEC-approved earth ground can result in electric shock, physical injury or death.

**Note:**

- Consider ambient conditions (temperature, direct sunlight, inclement weather, etc.) when selecting, installing, and connecting the power wiring.
- Properly ground all outdoor units and indoor units. Ground wiring must always be installed by a qualified technician. Improperly ground wire can cause communication problems from electrical noise, and motor current leakage.
- If there is a possibility of reversed phase, phase loss, momentary blackout, or the power goes on and off while the system is operating, install a field-supplied phase loss protection circuit. If the system operates in reversed phase, etc., it may damage the compressors and other components.
- Install appropriately sized breakers / fuses / overcurrent protection switches and wiring in accordance with local, state, and NEC regulations related to electrical equipment and wiring, and following the instructions in this manual. Generated overcurrent may include some amount of direct current. Using an oversized breaker or fuse may result in equipment malfunction and property damage.
- ⓧ Do not connect ground wire to refrigerant, gas, or water piping; to lightning rods; to telephone ground wiring; or to the building plumbing system. Failure to properly provide a NEC-approved earth ground can result in property damage and equipment malfunction.
- Verify the power imbalance is no greater than 2% between phases at each outdoor unit frame. Power imbalances may damage the compressors and other components.

### Power Wiring / Communication Cable Connections

Best practice dictates using solderless ring or fork terminals at all power wiring and communication cable terminations. Use copper bearing ring or fork terminals; do not use galvanized or nickle plate over steel. Use appropriate crimping tool to attach the ring or fork terminals at all power wiring and control cable terminations. To install:

- Firmly attach the wire; secure in a way to prevent external forces from being imparted to the terminal block.
- Use an appropriately sized screwdriver for tightening the terminals.
- Do not overtighten the connections; overtightening may damage the terminals.

Close up of a Typical Ring Terminal.

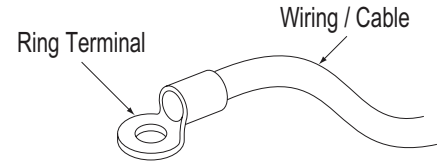

If ring terminals or fork terminals are not available, then:

- Do not terminate different gauge wires to the power terminal block. (Slack in the wiring may generate heat.)
- When terminating wires of the same thickness, follow the instructions demonstrated in the figures below.

Proper and Improper Power Wiring Connections.

:Copper Wire

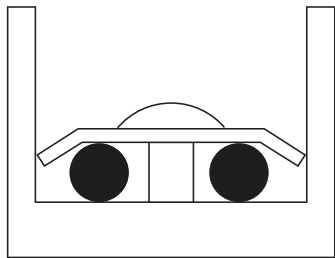

Terminate multiple power wires of the same gauge to both sides.

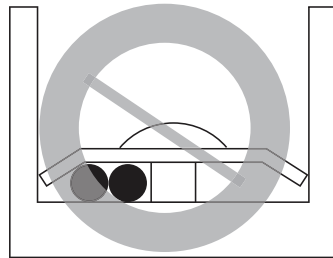

Do not terminate two wires on one side.

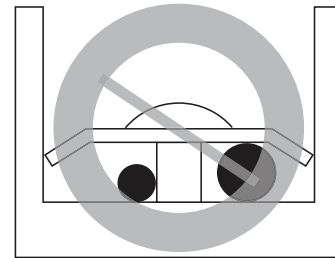

Do not terminate different gauge wires to a terminal block.

### WARNING

If power wires are not properly terminated and firmly attached, there is risk of fire, electric shock, and physical injury or death.

### Note:

- Never apply line voltage power to the communications cable terminal block. If contact is made, the PCBs may be damaged.
- Always include some allowance in the wiring length when terminating. Firmly attach the wiring or cable, but provide some slack to facilitate removing the electrical panels while servicing, and to prevent external forces from damaging the terminal block.

### Terminal Connections

LG uses a "JIS" type of screw for all terminals; use a JIS screwdriver to tighten and loosen these screws and avoid damaging the terminal. Do not overtighten the connections — overtightening may damage the terminals — but firmly and securely attach the wiring in a way to prevent external forces from being imparted to the terminal block.

### Note:

- The terminals labeled "GND" are NOT ground terminals. The terminals labeled ARE ground terminals.
- Polarity matters. Always connect "A" to "A" and "B" to "B."
- Always create a wiring diagram that contains the exact sequence in which all the indoor units and heat recovery units are wired in relation to the outdoor unit.
- Do not include splices or wire nuts in the communication cable.

JIS Screws.

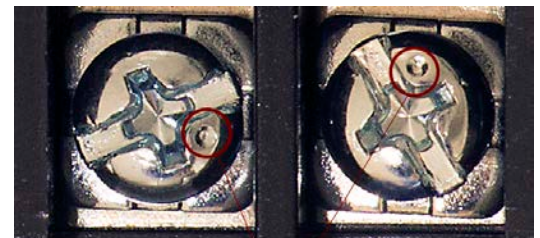

JIS DIMPLES

**Power Supply / Power Wiring Specifications**

Outdoor unit(s) and indoor units must be provided power from separate breakers.

**Outdoor Units**

- Outdoor units are available in both 3Ø, 208-230V, 60Hz, and 3Ø, 460V, 60Hz.
- Power wiring / power wiring gauge to the outdoor unit(s) should be solid or stranded, and must comply with all local and NEC electrical codes.
- Each outdoor unit must be provided a dedicated fused disconnect or breaker. Properly ground each outdoor unit per NEC and local codes.
- Each outdoor unit frame in a multi-frame configuration must be provided a dedicated fused disconnect or breaker. On multi-frame installations, ground each frame separately per NEC and local codes.
- No matter which system is installed, power supply should not decrease or increase more than 10% of the rated voltage.
- Power imbalance between phases cannot be greater than 2% (if it is, the lifespan of the units will be reduced).
- Position the power wiring a minimum of two (2) inches away from the communication cables to avoid operation problems caused by electrical interference.
- ⓧ Do not run both the power wiring and the communication cable in the same conduit.

Outside Power Source to Outdoor Unit Terminal Diagram.

208-230V, 60Hz or 460V, 60Hz  
Use Copper Power Supply Wire

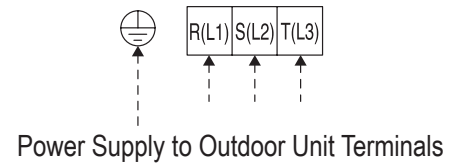

**Indoor Units / Heat Recovery Units**

- Indoor units and heat recovery units require 1Ø, 208-230V, 60Hz power, but each unit draws minimal power.
- Where permitted by NEC and local codes, multiple indoor units and heat recovery units may be powered from a single breaker.
- Service switches typically must be installed for each indoor unit and heat recovery unit.
- Ground each indoor unit and heat recovery unit separately to a solid earth ground source per NEC and local code requirements.

**⚠ WARNING**

- All power wiring installation must be performed by trained service providers working in accordance with local, state, and NEC regulations related to electrical equipment and wiring, and following the instructions in this manual. Failure to do so may lead to electric shock and bodily injury or death.
- Use specified wiring for connections, and ensure that external force is not imparted to terminal connections. If connections firmly attached, it may generate heat and / or cause a fire, resulting in physical injury or death.
- Install appropriately sized breakers / fuses / overcurrent protection switches and wiring in accordance with local, state, and NEC regulations related to electrical equipment and wiring, and following the instructions in this manual. Generated overcurrent may include some amount of direct current. Using an oversized breaker or fuse may result in electric shock, physical injury or death.
- Use the appropriate type of overcurrent protection. Generated overcurrent may include some amount of direct current, and if the appropriate type of overcurrent protection is not installed, there is a risk of fire, electric shock, and physical injury or death.
- Ground wiring is required to prevent accidental electrical shock during current leakage, communication problems from electrical noise, and motor current leakage. ⓧ Do not connect the ground line to the pipes. There is risk of fire, electric shock, explosion, physical injury or death.
- Install a main shutoff switch that interrupts all power sources simultaneously. There is risk of fire, electric shock, explosion, physical injury or death.
- The GND terminal at the main PCB is a negative terminal for dry contact, not a ground. Inadequate connections may generate heat, cause a fire, and physical injury or death.

**Note:**

- If there is a possibility of reversed phase, phase loss, momentary blackout, or the power goes on and off while the system is operating, install a field-supplied phase loss protection circuit. If the system operates in reversed phase, etc., it may damage the compressors and other components.
- Install appropriately sized breakers / fuses / overcurrent protection switches and wiring in accordance with local, state, and NEC regulations related to electrical equipment and wiring, and following the instructions in this manual. Generated overcurrent may include some amount of direct current. Using an oversized breaker or fuse may result in equipment malfunction and property damage.
- ⓧ Do not connect ground wire to refrigerant, gas, or water piping; to lightning rods; to telephone ground wiring; or to the building plumbing system. Failure to properly provide a National Electrical Code-approved earth ground can result in property damage and equipment malfunction.



### From Master Outdoor Unit to Central Controllers

- Communication cable from Master Outdoor Unit to Central Controller is to be 18 AWG, 2-conductor, twisted, stranded, shielded. Ensure the communication cable shield is properly grounded to the Master ODU chassis only. ⚡ Do not ground the communication cable at any other point. Wiring must comply with all applicable local and national codes.
- Connect all central control devices on the same cable if cable requirements are the same.
- Order does not matter, but polarity does. Keep "A" terminals with "A" terminals, and "B" terminals with "B" terminals. Starting at the outdoor unit, terminate the cable on terminals Internet A and Internet B.
- Route the cable as needed between each device.
- Tie shields together at each termination point.
- Add insulation material as recommended by local code.

Cable requirements may differ depending on other installed components:

- Communication cable from Master Outdoor Unit to Mode Selector Switch is to be 18 AWG, 3-conductor, twisted or non-twisted, stranded, shielded. Ensure the communication cable shield is properly grounded to the Master ODU chassis only. ⚡ Do not ground the communication cable at any other point. Wiring must comply with all applicable local and national codes.

### From Indoor Units to Remote Controllers

- Communication cable from Indoor Unit to Remote Controller(s) is to be 22 AWG, 3-conductor, twisted, stranded, unshielded. Wiring must comply with all applicable local and national codes.
- If the length needs to be extended, the LG Extension Kit (sold separately) must be used. A maximum of four (4) kits (up to 165 feet) can be used.
- Remote Controllers have hardwired connections: SIG - 12V - GND (Comm.) terminals.
- Indoor unit controller connections depend on type of indoor unit being installed. Some indoor units use terminal block connections; other indoor units use Molex connections. See diagrams below for the two options. Refer to the wiring diagram schematic found in the indoor unit itself, or to the indoor unit wiring diagrams in the Engineering Manuals for more information.
- ⚡ NEVER splice, cut, or extend cable length with field provided cable. Always include enough cable to cover distance between the indoor unit and the remote controller.
- Set the indoor unit operating parameters using DIP switches, or by setting up the remote controller. Refer to the indoor unit installation manuals for more details.

One Example of Indoor Unit to Zone Controller Connection.

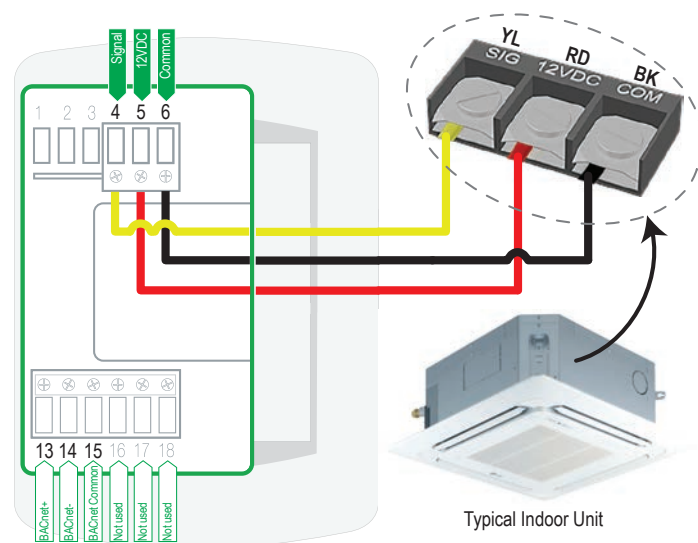

Another Example of Indoor Unit to Zone Controller Connection.

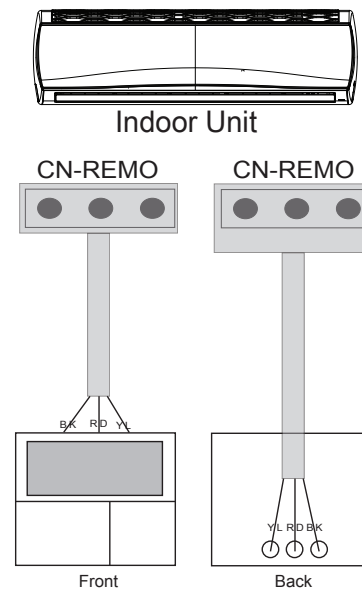

### Note:

Cable connected to Zone Controller is the factory default connection.



**Between Multiple Indoor Units Operating as a Group (Group Control)**

**If any indoor units were specified to operate in unison:**

- Before running cable, decide which indoor unit will be the “Master.” The other indoor units in that group will be designated as “Slave(s).” The zone controller will be connected to the “Master.”
- Set the pertinent DIP switch at each indoor unit to identify the Master and Slave(s). On wall mounted indoor unit models, set the assignment using the handheld remote controller.
- Use a daisy chain configuration and connect all of the group’s indoor units together starting at the “Master” unit.
- ⚠ NEVER splice, cut, or extend cable length with field provided cable. Always include enough cable to cover distance between all components.

**For indoor units with hardwired connections SIG - 12V - GND (Comm.) terminals:**

- From the controller to the master indoor unit, use 22 AWG, 3-conductor, twisted, stranded, unshielded. All wiring must comply with all applicable local and national codes.
- From the master indoor unit to the slave indoor unit(s), daisy chain using 22 AWG, 3-conductor, twisted, stranded, unshielded (⚠ Do not attach wire to 12VDC terminal to the slave indoor units). All wiring must comply with all applicable local and national codes.

**For indoor units with CN-REMO connections:**

Use Group Control Kit (sold separately) containing extension and Y-splitter cables. Use one (1) group control cable kit for each indoor unit in the group except for the last indoor unit.

**Note:**

- Cable connected to zone controller is the factory default connection.
- Indoor unit connections depend on indoor unit type.

Example of Indoor Unit Group to Zone Controller Connections (Sig-12V-GND [Comm.] Terminal).

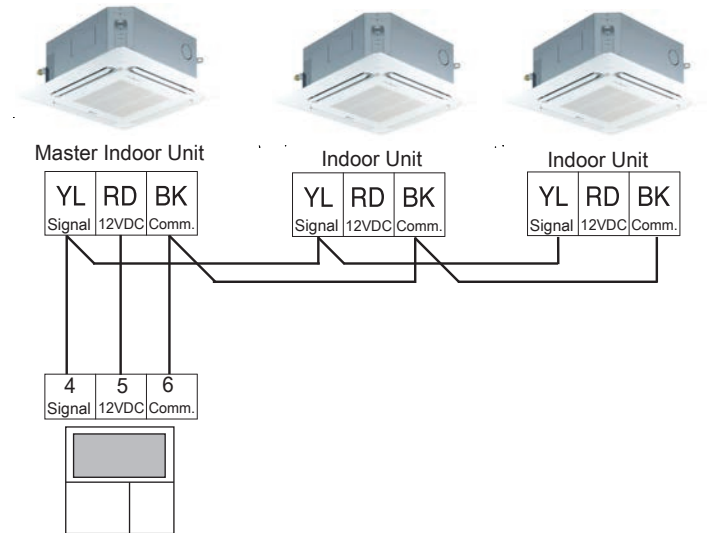

Example of Indoor Unit Group to Zone Controller Connections (CN-REMO).

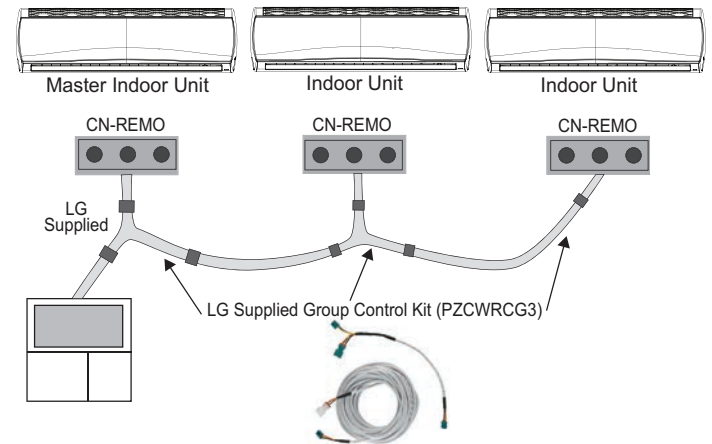

## Refrigerant Pipe System Test

### Triple Leak / Pressure Check

After the refrigerant pipe installation is complete, perform a triple leak / pressure check to check for leaks at any joints or connections within the piping system.

#### **⚠ DANGER**

*Using combustible gases, including oxygen, may result in fire or explosion and result in severe personal injury or death. Use inert gas (medical-grade dry nitrogen) when checking leaks, cleaning, installing/repairing pipes, etc. The use of a 600 psig nitrogen regulator is required for safety.*

#### **Note:**

- **⊘** Do not apply power to the Multi V outdoor unit(s), the indoor units, and the heat recovery units before performing a system leak test. There is a possibility that the EEV valves may close and isolate sections of the piping system, making the test inconclusive. Contact your LG Applied Rep or or service technician for the procedure to reopen the EEV valves before the leak test ONLY if the power has been applied.
- For multi-frame outdoor units, connect the nitrogen cylinder regulator to the gauge manifold, then connect the gauge manifold to the Schrader port of the service port on only one outdoor unit, preferably the slave outdoor unit that is farthest away from the refrigerant piping system and connected indoor units / heat recovery units.
- **⊘** Never perform the leak test using refrigerant.
- To avoid nitrogen entering the refrigerant system in a liquid state, the top of the cylinder must be higher than its bottom (used in a vertical standing position) when the system is pressurized.
- Use only a leak-free gauge manifold set.

### Triple Leak / Pressure Check Procedure Steps

1. After the refrigerant piping installation is complete, open the isolation ball valves, if any, that may have been included in the piping system.
2. Verify that all outdoor unit service ports are closed. For multi-frame outdoor units, verify the service valves on all master and slave outdoor units are closed and the stem head access caps are tight. The leak / pressure check is to be performed to only the refrigerant piping system and connected indoor units / heat recovery units.
  - For systems designed for heat pump operation, verify that the liquid and vapor line service ports (and to the unused service port) are closed, and the stem head access caps are tight.
  - For systems designed for heat recovery operation, verify that the hot gas line (high pressure vapor), liquid line, and suction (low pressure vapor) line service ports are closed, and the stem head access caps are tight.
3. Remove the caps on the Schrader ports. Connect the (medical-grade dry) nitrogen cylinder regulator to a gauge manifold, then connect the gauge manifold to the Schrader ports on the service ports.
  - For systems designed for heat pump operation, connect the nitrogen cylinder regulator to the gauge manifold, then connect the gauge manifold to the Schrader ports on the liquid and vapor line service ports. **⊘** Do not connect to the unused port.
  - For systems designed for heat recovery operation, connect the nitrogen cylinder regulator to the gauge manifold, then connect the gauge manifold to the Schrader ports on the hot gas line (high pressure vapor), liquid line, and suction (low pressure vapor) service ports.

#### **Note:**

*For multi-frame outdoor units, connect the gauge manifold to the Schrader ports on only one outdoor unit, preferably the slave outdoor unit that is farthest away from the refrigerant piping system and connected indoor units / heat recovery units.*

**Triple Leak / Pressure Check Procedure Steps, continued.**

4. Perform the leak / pressure check at 150 psig for five (5) minutes (standing pressure check).
5. Perform the leak / pressure check at 300 psig for fifteen (15) minutes (standing pressure check).
6. Perform the leak / pressure check at 550 psig for 24 hours to make sure the piping system is leak-free. After the gauge reading reaches 550 psig, isolate the system by first closing the gauge manifold, then close the nitrogen cylinder valve. Check the flared and brazed connections for leaks by applying a bubble solution to all joints.

**Note:**

*The bubble solution should be a solution designed for refrigerant leak testing. Common soap solution should never be used on refrigerant piping as those contain chemicals that could corrode copper and brass, and cause product malfunction.*

7. If the pressure does NOT drop for 24 hours, the system passes the test. See how ambient conditions may affect the pressure test below.

**Ambient Conditions and the Leak / Pressure Check**

If the ambient temperature changed between the time when pressure was applied and when the pressure drop was checked, adjust results by factoring in approximately 0.79 psi for each 1°F of temperature difference.

Correction formula: (°F Temperature when pressure was applied - °F Temperature when pressure drop was checked) x 0.79.

Example: When pressure (550 psig) was applied, temperature was 80°F; 24 hours later when pressure drop (540 psig) was checked, temperature was 68°F.

Thus,  $(80^{\circ}\text{F} - 68^{\circ}\text{F}) \times 0.79 = 9.5$  psig.

In this case, the pressure drop of 9.5 psig was due to temperature differences, therefore, there is no leak in the refrigerant piping system.

8. If the pressure drops and it is not due to ambient conditions, there is a leak and it must be found. Remove the bubble solution with a clean cloth, repair the leak(s), and perform the leak / pressure check again.
9. After the system has been thoroughly tested and no leaks are found, depressurize by loosening the charging hose connector at the nitrogen cylinder regulator. When system pressure returns to normal, completely disconnect the charging hose from the cylinder, and release the nitrogen charge from all refrigerant piping. Wipe off any remaining bubble solution with a clean cloth.

# OPERATION

## Refrigerant Pipe System Test

Leak / Pressure Test for Systems Designed for Heat Pump Operation.

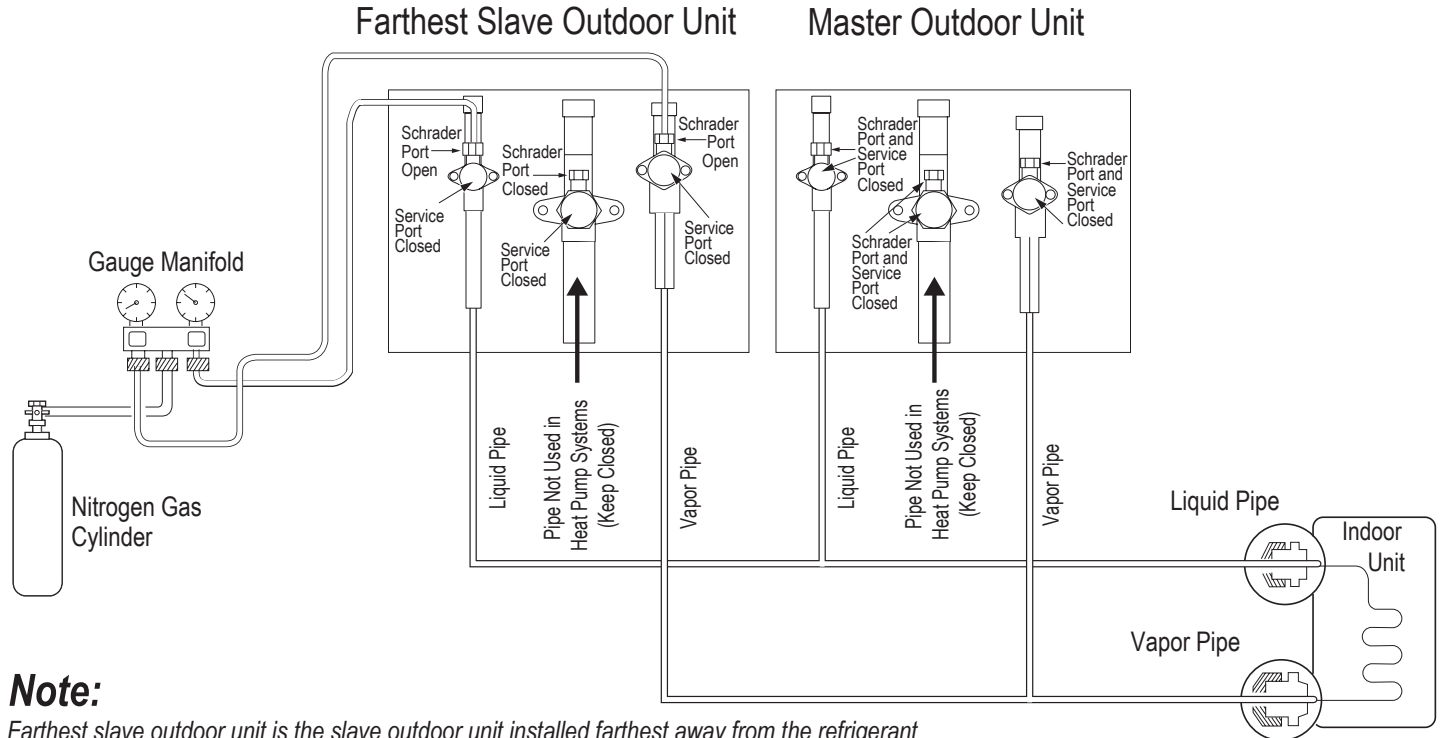

**Note:**

Farthest slave outdoor unit is the slave outdoor unit installed farthest away from the refrigerant piping system / indoor units.

Leak / Pressure Test for Systems Designed for Heat Recovery Operation.

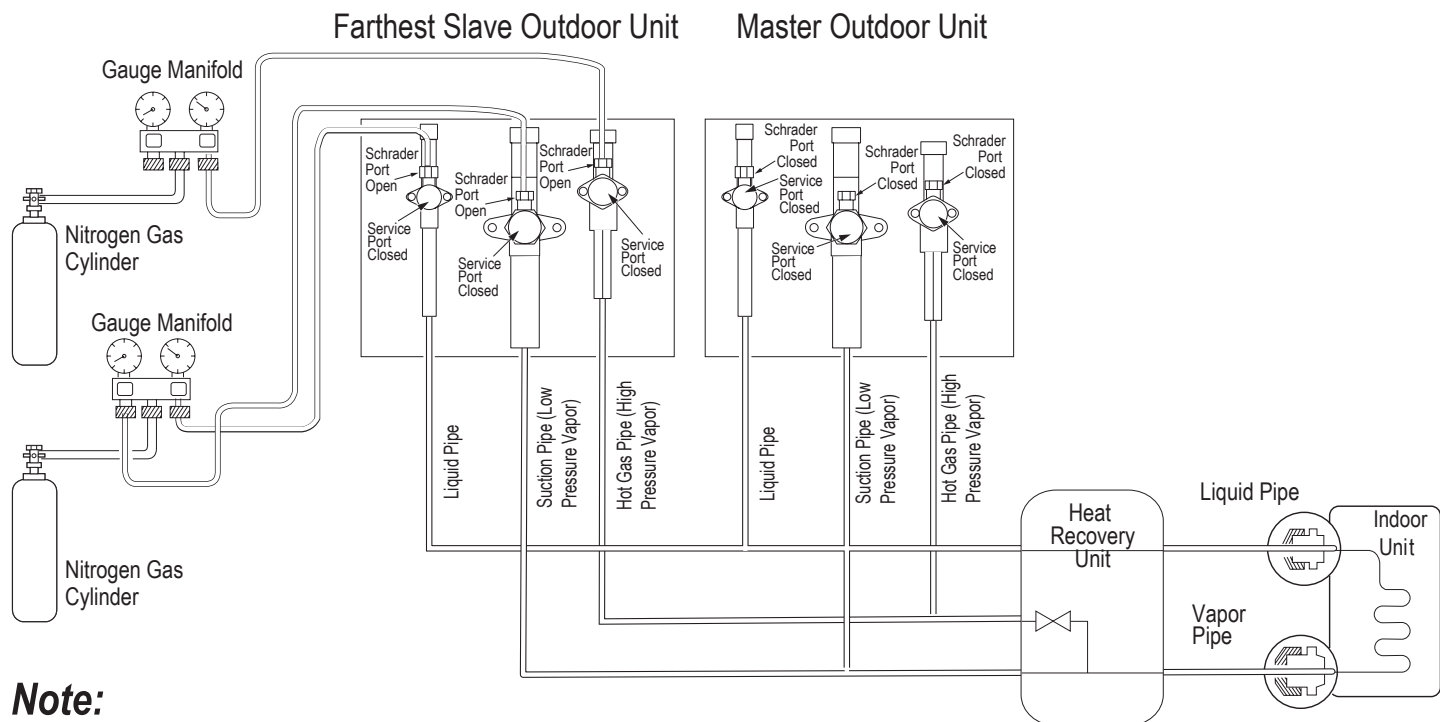

**Note:**

Farthest slave outdoor unit is the slave outdoor unit installed farthest away from the refrigerant piping system / indoor units / heat recovery units.

## Triple Evacuation Procedure

After the leak / pressure check is complete, perform a Triple Evacuation with the entire system. Evacuation should be performed through the Schrader ports on the outdoor unit service ports.

### Note:

*For faster evacuation, the Schrader core can be removed, and an auxiliary service port can be used. Make sure to re-install the original Schrader core before operating the system.*

For Heat Pump systems, evacuate through both the liquid and vapor refrigerant lines. For Heat Recovery systems, evacuate through all three (3) hot gas line (high pressure vapor), liquid line, and suction (low pressure vapor) refrigerant lines.

The outdoor unit service valves should remain closed and the stem head access caps tight. ⚠ Do not open the outdoor unit service valves and release the factory refrigerant charge until the LG trained commissioner authorizes to do so. The system must be left in vacuum until the LG trained commissioner verifies the quality of the evacuation.

Any field-installed ball valves in the refrigerant system (if used) should be open to ensure all piping is free and clear for evacuation on all piping and connected indoor units / heat recovery units.

### Note:

- ⚠ Do not apply power to the Multi V outdoor unit(s), the indoor units, and the heat recovery units before performing a system evacuation. There is a possibility that the EEV valves may close and isolate sections of the pipe system, making the evacuation procedure inconclusive. Contact your LG Applied Rep or service technician for the procedure to reopen the EEV valves before evacuation only if the power has been applied.
- For multi-frame outdoor units, connect the vacuum pump / manifold to the service port Schrader ports (or core) to only one outdoor unit, preferably the slave outdoor unit that is installed farthest away from the refrigerant piping system and connected indoor units / heat recovery units.
- ⚠ Never perform evacuation using refrigerant.
- Use only a vacuum pump that can reach 500 microns, vacuum rated hoses or copper tubing, and a leak-free gauge manifold set.
- Use only new vacuum pump oil from a properly sealed (unopened) container, and change oil in pump before **EVERY** use.
- Subsequent oil changes will be necessary after several hours of continuous operation; have extra oil on hand.
- Use a quality micron gauge in good operating order and install as far away from pump as possible.

## Triple Evacuation Procedure Steps

1. If this procedure is performed shortly after the leak / pressure test, the caps and cores on the Schrader ports should have already been removed, and the manifold should already be connected. If the procedure was not performed shortly after the leak / pressure test, make sure to remove the caps and cores on the Schrader ports. Verify that the service valves on the outdoor unit are closed, and the stem head access caps are tight.

### Note:

*Connect the vacuum pump to the gauge manifold and hoses. Once the vacuum pump is first operated, if hoses, manifold, and vacuum valves are leak free (and oil is not moisture laden), the gauge should read <100 microns within one (1) minute. ⚠ Do not proceed if the gauge does not read <100 microns within one (1) minute. There is a leak in the hose, gauge manifold, or vacuum valve, and the equipment must be replaced.*

2. Connect the gauge manifold along with the vacuum pump to the Schrader ports (with core removed) using vacuum hoses. Open the gauge manifold and the vacuum pump valves.

## Refrigerant Pipe System Test

---

---

3. Operate the vacuum pump and evacuate the system to the 2,000 micron level. Isolate the pump by closing the manifold gauges and the vacuum pump valve, and then watch the micron level. Micron level may rise a bit, but MUST eventually stop rising for fifteen (15) minutes.
  - If the micron level DOES NOT stop rising, there is a leak, and the leak test must be performed again.
  - If the micron level DOES rise above 2,000 micron, re-open the manifold gauges and the vacuum pump valve and continue evacuation back down to 2,000 micron level.
  - If the micron level holds at 2,000 micron, continue to step 4.
4. Break vacuum with 50 psig nitrogen purge for an appropriate amount of time (this is to “sweep” moisture from piping).
5. Purge nitrogen from the system until the pressure drops down to 1 to 3 psig.
6. Evacuate to 1,000 micron level. Isolate the pump by closing the manifold gauges and the vacuum pump valve, and then watch the micron level. Micron level may rise a bit, but MUST eventually stop rising for fifteen (15) minutes.
  - If the micron level DOES NOT stop rising, there is a leak, and the leak test must be performed again.
  - If the micron level DOES rise above 1,000 micron, re-open the manifold gauges and the vacuum pump valve, and continue evacuation back down to 1,000 micron level.
  - If the micron level holds at 1,000 micron, continue to step 7.
7. Break vacuum with 50 psig nitrogen purge for an appropriate amount of time.
8. Purge nitrogen from the system until the pressure drops down to 1 to 3 psig.
9. Evacuate to static micron level  $\leq 500$ .
10. Micron level must remain  $\leq 500$  for 24 hours. If the vacuum gauge rises and stops, the system may contain moisture, therefore, it will be necessary to repeat the steps of vacuum break and drying.
11. After maintaining the system in vacuum for 24 hours, check if the vacuum gauge rises or not. If it doesn't rise, then the system is properly evacuated.
12. Close manifold gauges.
13. Shut the valve before turning off the vacuum pump.

### **Note:**

*If the outdoor unit is moved to and installed in another site, only charge with new refrigerant after successful leak test and triple evacuation procedures have been performed. If a different refrigerant or air is mixed with the original refrigerant, the refrigerant cycle may malfunction and the unit may be damaged.*

Triple Evacuation Diagram for Heat Pump Systems.

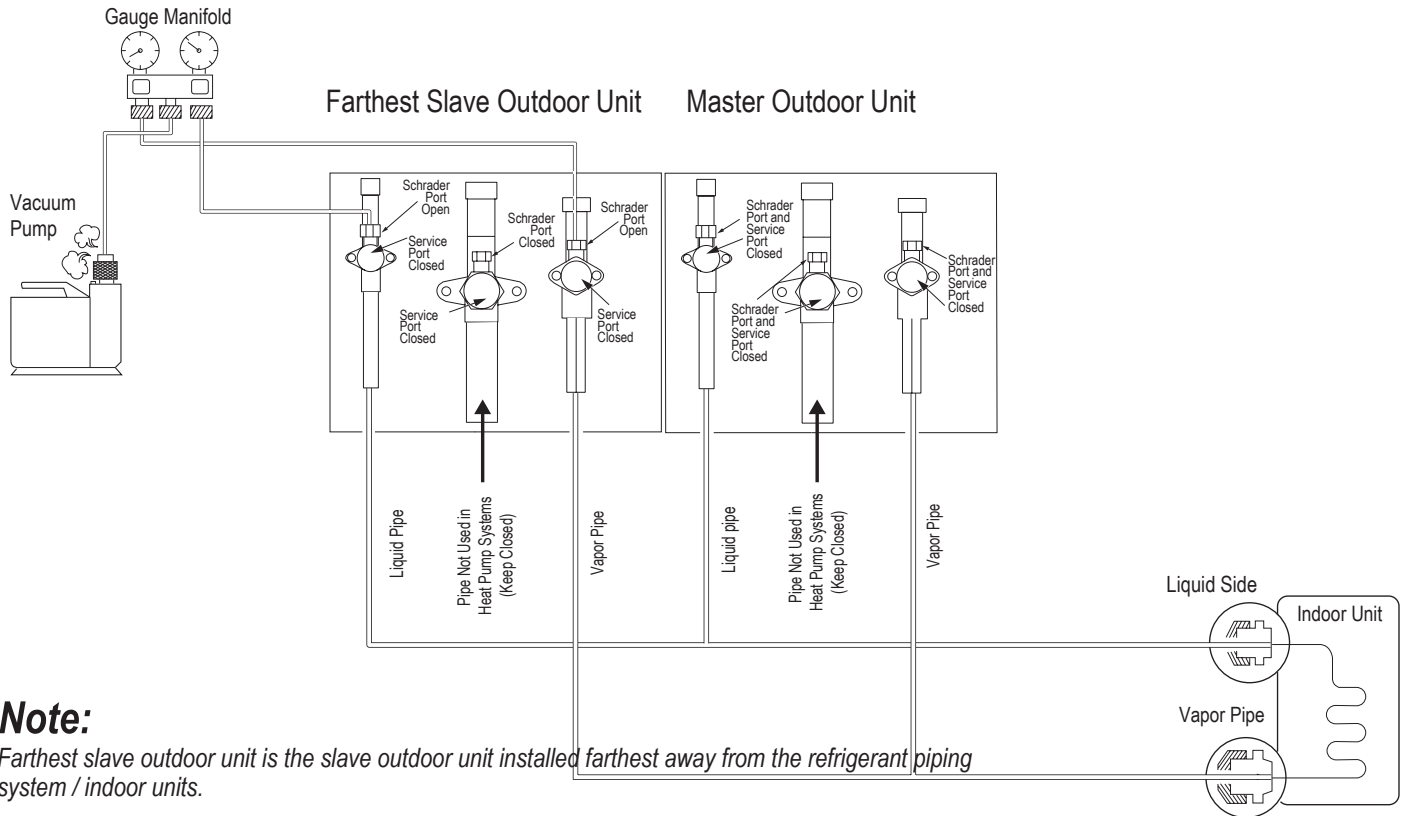

**Note:**

Farthest slave outdoor unit is the slave outdoor unit installed farthest away from the refrigerant piping system / indoor units.

Triple Evacuation Diagram for Heat Recovery Systems.

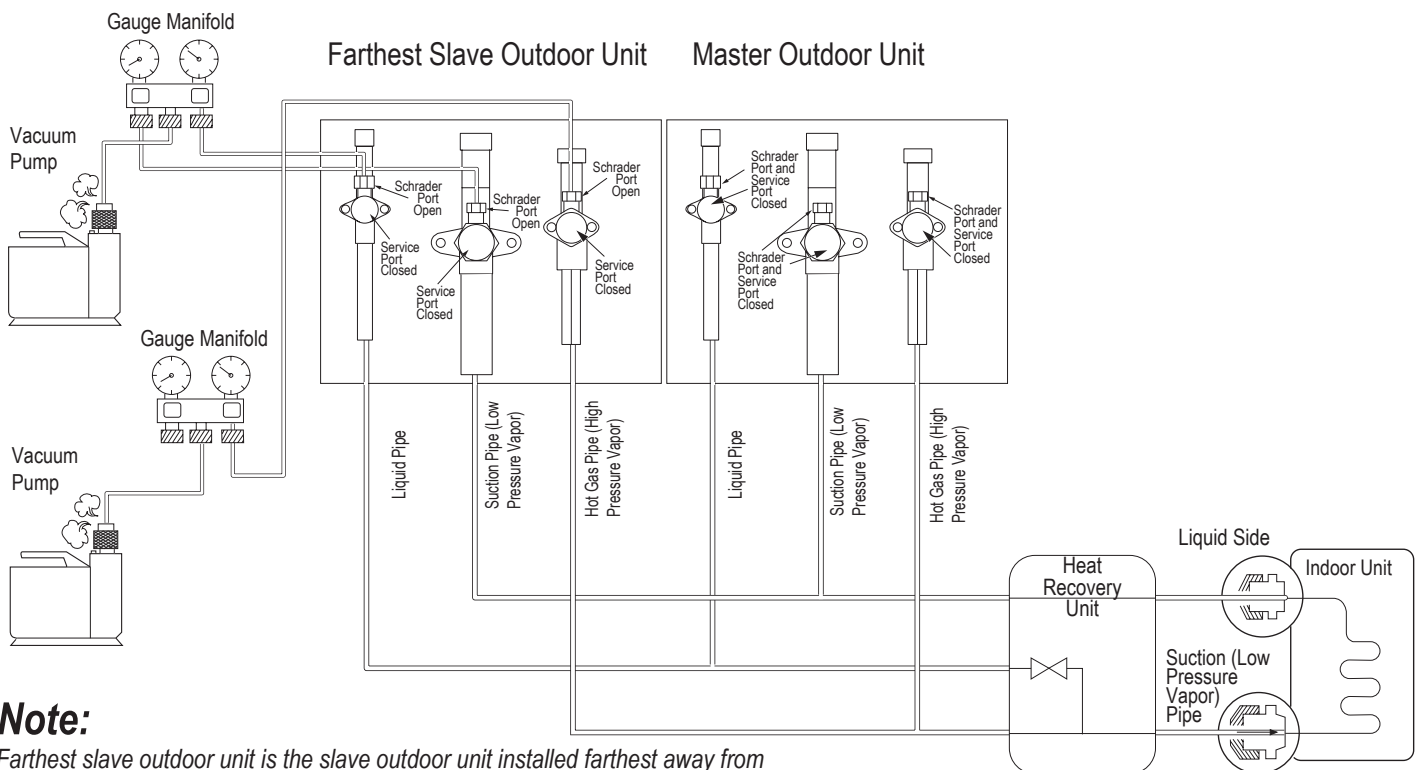

**Note:**

Farthest slave outdoor unit is the slave outdoor unit installed farthest away from the refrigerant piping system / indoor units / heat recovery units.

## Setting DIP Switches

### Vacuum Mode (Option) (Se3)

The vacuum mode can be used as an option for creating vacuum in the system when the outdoor unit is first installed, if power is available, and if the system has already been auto addressed. Vacuum mode enables the system to fully open all valves, and can help speed up the evacuation process.

Vacuum mode can also be used when compressor and / or outdoor unit parts are replaced, or when an indoor unit is added or replaced.

1. Turn No. 5 on the master outdoor unit PCB DIP Switch SW01 to ON.
2. Select the "SvC" mode By using the ► and ◀ buttons, then push the ● button.
3. Select the "Se3" function By using the ► and ◀ Buttons, then push the ● button.
4. Press the SW01D Reset Button one (1) time to reset PCB, and start the vacuum mode "vACC". In vacuum mode, the outdoor unit valve is open, the outdoor unit EEV is open, and the indoor unit(s) EEV(s) is/are open. The heat recovery unit(s) valve(s) and EEVs are open (if system includes heat recovery units).
5. To cancel the vacuum mode, turn No. 5 on the master outdoor unit PCB DIP Switch SW01 to OFF, and push the SW01D reset button on the outdoor unit PCB. On a multi-frame system, push the SW01D reset button on ALL outdoor units.

Vacuum Mode Setting Locations.

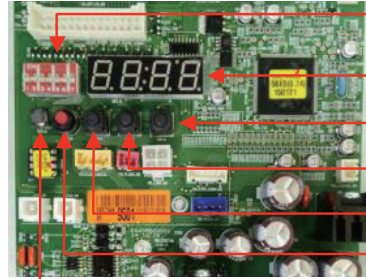

- No. 5 on DIP-SW01
- SSD
- SW04C (X: Cancel)
- SW03C (►: Forward)
- SW02C (◀: Backward)
- SW01C (●: Confirm / Automatic Addressing)
- SW01D (Reset)

No. 5 on DIP-SW01

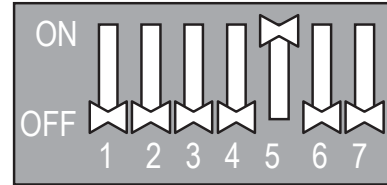

### Setting Vacuum Mode

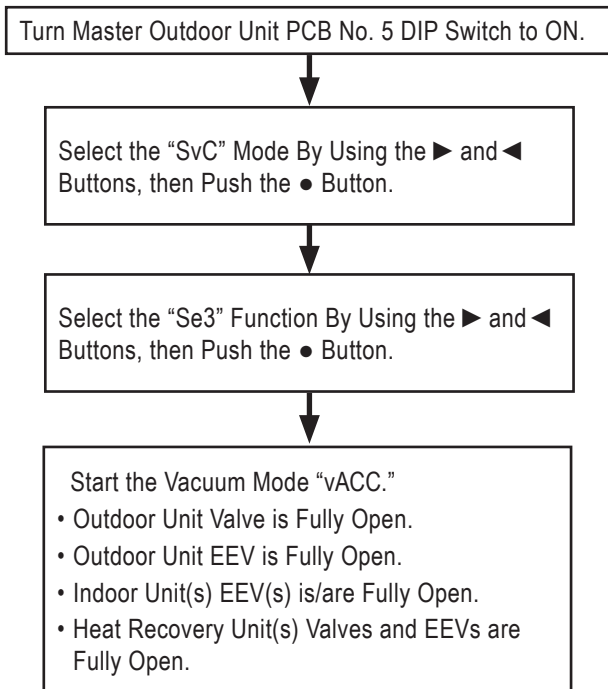

### Canceling Vacuum Mode

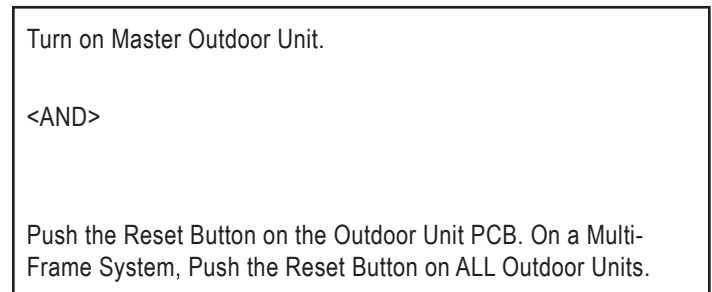

### Note:

- Outdoor unit operation stops during Vacuum Mode, so the compressor cannot operate.
- Limit vacuum mode to less than 48 hours of continuous operation. If vacuum mode is not stopped, the system will continue to operate with all EEVs and valves open on the non-vacuum mode terminated slave outdoor units. The refrigerant will flood back to the compressors on those non-vacuum mode terminated slave outdoor units, which will result in poor operation, equipment malfunction and / or compressor damage.



### Pre-Commissioning Process

After successfully completing the leak / pressure check and triple evacuation procedures, begin the pre-commissioning process. The pre-commissioning process will prepare the system for commissioning in several steps:

1. Verify facility power is correct.
2. Power up the system.
3. Verify power at the system is correct.
4. Run self diagnostics check. (heat recovery systems only).
5. Assign a system address to indoor units.
6. Assign addresses to heat recovery units
7. Assign each central control device an address.

### Prepare the Electrical System

Multi V outdoor units require either 208-230V / 60Hz / 3Ø or 460V / 60Hz / 3Ø power. Verify that the power and phase requirements are correct and all three legs are present. Make sure that the power imbalance ratio between phases is no greater than 2%. If the electrical power is dirty, the unit may shutdown on a compressor safety and/or the lifespan will be reduced.

Multi V outdoor units are inverter driven. ⚠ Do not install a phase-leading capacitor. If one is included, it will deteriorate the power factor improvement effect, and may cause the capacitor to generate an abnormal amount of heat.

1. Verify correct, clean, specified power is at the line side of each system component's disconnect.
2. Note if the green LED light on the component PCB board is illuminated.
3. If an air cleaner is installed on a high static ducted model indoor unit, verify power has been provided to the air cleaner controller. Verify by observing the LED in the center of the disconnect plate is illuminated.
4. If a zone controller (Remote Unit controller on the Hydro Kit) is connected to the component, verify the LCD screen displays current operational characteristics.

### Setting Outdoor Units to Heat Pump or Heat Recovery Systems

Outdoor units are factory set to heat recovery operation—all switches on DIP Switch bank SW01 are set to OFF. **All outdoor unit(s) (master and slave[s]) MUST be manually set to a heat pump system.** To change the factory set heat recovery system to a heat pump system:

- Flip switch No. 4 on the DIP-SW01 bank to ON. Display will show “HR” (heat recovery).
- Push the ► (SW03C) button to change “HR” (heat recovery) to “HP” (heat pump), then press the confirm (SW01C) button.
- Flip switch No. 4 on the DIP-SW01 bank to OFF, and push the reset (SW01D) button to restart the system. If No. 4 on the DIP-SW01 bank is switched to ON again, “HR” (heat recovery) or “HP” (heat pump) can be verified by reading the display later.

Heat Recovery System DIP Switch Setting on Outdoor Units (Factory Set).

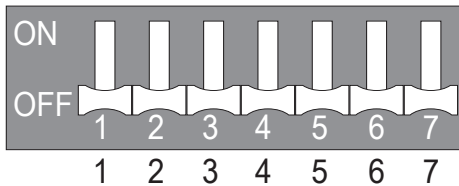

Heat Pump System DIP Switch Setting on Outdoor Units (Manually Set).

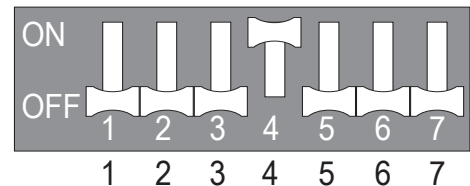

### Setting Outdoor Units in Dual / Triple Frame Systems

On the DIP-SW01 bank (Main PCB), one (1) outdoor unit must be set on DIP-SW01 bank to the Master unit and the other units set to the Slave(s) unit(s) or errors will be generated.

- For the DIP-SW01 bank on the master unit, all DIP switches must be set to off.
- For the DIP-SW01 bank on the slave 1 unit, set only DIP switch 6 to ON.
- For the DIP-SW01 bank on the slave 2 unit, set only DIP switch 7 to ON.

Master, Slave1, and Slave2 DIP Switch Settings.

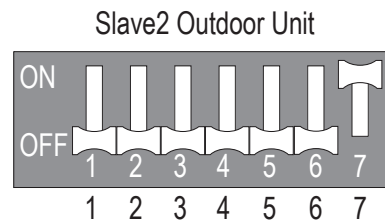
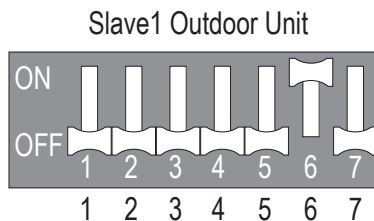
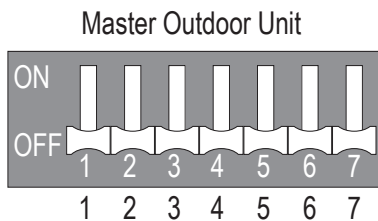

## Setting DIP Switches

### Generation 4 Equipment

The latest versions of LG's indoor units are designated Generation 4 (Gen 4). For Gen 4 indoor units to operate with Gen 4 indoor unit features, the air conditioning system must meet the following requirements:

- All indoor units, heat recovery units, and air / water source units must be Gen 4 or higher.
- All air / water source units must have Gen 4 or higher software installed.
- Air / water source units DIP switch 3 must be set to ON (factory default setting is OFF).
- All controllers must support Gen 4 indoor unit features.

Location and Setting of Outdoor Unit DIP Switch 3.

Air/Water Source Unit DIP Switch No. 3

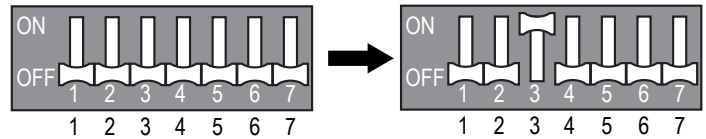
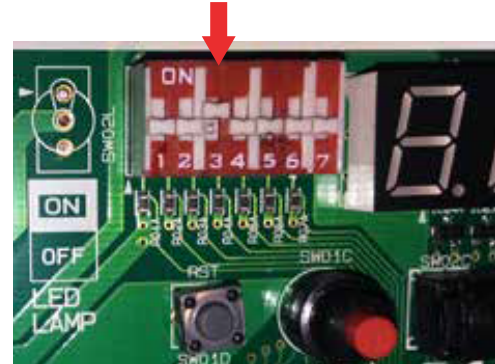

The figure at right shows the outdoor unit DIP switch. The "System Component Combinations and Operation Status" table lists how combining different components will affect system operation. The "Serial Numbers or Air / Water Source Units with Gen 4 or Higher Software" table lists the serial numbers of air and water source units that have Gen 4 or higher software. All air and water source units, indoor units, heat recovery units, and controllers in a system must be Gen 4 compatible or the system will not operate with Gen 4 indoor unit features.

Table 2: System Component Combinations and Operation Status.

Air / Water Source Units*	Indoor Unit(s)**	Heat Recovery Unit(s)	Outdoor Unit DIP Switch No. 3	Operation Status
Gen 4 or Higher	Gen 4 ONLY	Model 2A ONLY	Must be ON	System will operate WITH Gen. 4 indoor unit features.
Gen 4 or Higher	Gen 4 ONLY	Model 2A ONLY	OFF	System will operate but WITHOUT Gen. 4 indoor unit features.
Gen 4 or Higher	Gen 4 ONLY	Any combination of Models 1A, 2A	Must be OFF (factory default)	Does NOT include Gen. 4 features. System will not operate if DIP Switch No. 3 is ON, and an error code will be generated.
Gen 4 or Higher	Any combination of Gen 2 and Gen 4	Model 2A ONLY	Must be OFF (factory default)	
Gen 4 or Higher	Any combination of Gen 2 and Gen 4	Any combination of Models 1A, 2A	Must be OFF (factory default)	
Gen 2	Any combination of Gen 2 and Gen 4	Any combination of Models 0A****, 1A, 2A	N/A***	Does not include Gen. 4 features.

\*Gen 4 or Higher Air / Water Source Units = Multi V 5, Multi V IV or Multi V Water IV with Gen 4 or Higher software (see table below for Gen 4 or higher serial numbers) or Multi V S.

Gen 2 Air / Water Source Units = Multi V II, Multi V III, Multi V IV without Gen. 4 software, Multi V Water II, Multi V Water IV without Gen. 4 software, Multi V Mini, Multi V Water Mini, or Multi V Space II.

\*\*Gen 4 Indoor Units model numbers end in "4"; Gen 2 Indoor Units model numbers end in "2" or an "A", including Hydro Kit.

\*\*\*DIP Switch No. 3 on Gen 2 air / water source units is not related to Gen 4 features as it is with Gen 4 air / water source units.

\*\*\*\*0A Model Heat Recovery units are not for use with Multi V 5, Multi V IV, Multi V Water IV, or Multi V III heat recovery systems.

Table 3: Serial Numbers of Air / Water Source Units with Gen 4 or Higher Software.

Air / Water Source Unit Model Type	Multi V Air Source Heat Pump	Multi V Air Source Heat Recovery	Multi V IV Water Source Heat Pump	Multi V IV Water Source Heat Recovery
Serial Number of Air / Water Source Units with Gen 4 or Higher Software	502***** and Higher	503***** and Higher	504***** and Higher	

## Checking Outdoor Unit Settings

### Initial Display

Outdoor unit settings are sequentially displayed in the SSD five (5) seconds after applying power. All displays are shown on the master outdoor unit.

### DIP Switch Settings

DIP switch settings must be changed with the system power OFF (settings won't be applied). All displays are shown on the master outdoor unit SSD.

## Optional Modes

### Fault Detection and Diagnosis Modes (Fdd, Fd)

LG's LGMV should be used to assist in gauging Multi V system operations. If LGMV is not available, LG has included some onboard service algorithms (Fault Detection and Diagnosis Modes) to help with new installation, or troubleshooting a malfunction on an existing system.

### Note:

*The results provided by running a FDD (Fault Detection and Diagnostics) routine should not be considered definitive proof that a system is properly operating. No "Fd" function code should be left in the "on" position without an LG trained commissioner approving and guiding its use.*

### Function Modes (Func, Fn)

Modify the operation of one (1) or more components of the VRF systems. Setting a Function Mode typically impacts the universal operation of the refrigeration system control.

### Indoor Unit Modes (Idu, Id)

Modify the operation of one (1) or more of the indoor units. Can be used to adjust a localized issue with a single indoor unit or group of indoor units.

### Service Modes (SvC, Se)

Should only be used by LG trained service technicians who have in-depth knowledge and experience working with Multi V systems. Service codes provide manual control of the VRF system component(s) as aides in isolating an operation problem during initial commissioning / start-up, assist with diagnosing an operation problem, or used to modify the operation of the oil return and/or defrost cycles.

## Saving Optional Mode Settings

In general, the main PCB on the master unit must be rebooted if the optional mode changes:

1. Compressor speed operation.
2. Outdoor unit fan speed operation.
3. System target pressure variables.

For specific, more detailed information, see the instructions for each mode on the next few pages. The short list of optional modes in this manual may be useful for installation. For other modes that may be used for service, etc., purposes, see the Multi V 5 Service Manual.

### How to Cycle the Power on the Main PCB:

1. Open the outdoor unit control box (on multi-frame systems, identify which frame is the master outdoor unit).
2. Find the SW01D Reset Button on the PCB.
3. Press the SW01D Reset Button one (1) time.

Checking Outdoor Unit Settings.

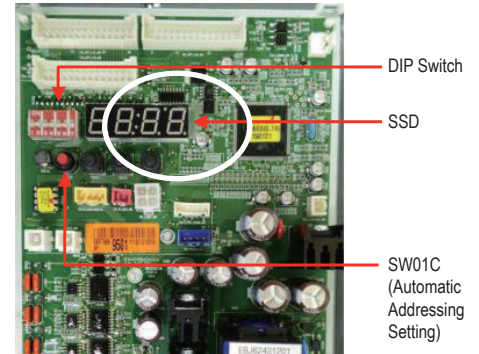

## Setting DIP Switches

### Setting the Optional Modes

To access and set the different modes, first turn No. 5 on the master outdoor unit PCB DIP switch bank SW01 to ON. Then, select the “Func”, “Idu”, or “SvC” mode by using the SW03C forward ► button and the SW02C backward ◀ button, and then press the SW01C confirm ● button.

No. 5 on DIP Switch Bank SW01 ON.

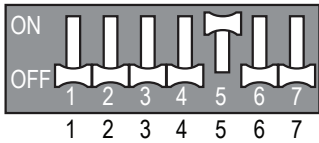

#### Note:

- To set the optional modes / functions, all indoor units must be OFF. Mode / function settings won't save, nor will operate unless all indoor units are OFF.
- If system power was reset, some modes / function settings will be automatically saved in the EPROM. Other modes / functions will re-set when power is cycled off. See next pages for details on specific modes / functions.

Location of DIP Switches and Setting Buttons on the Outdoor Unit PCB.

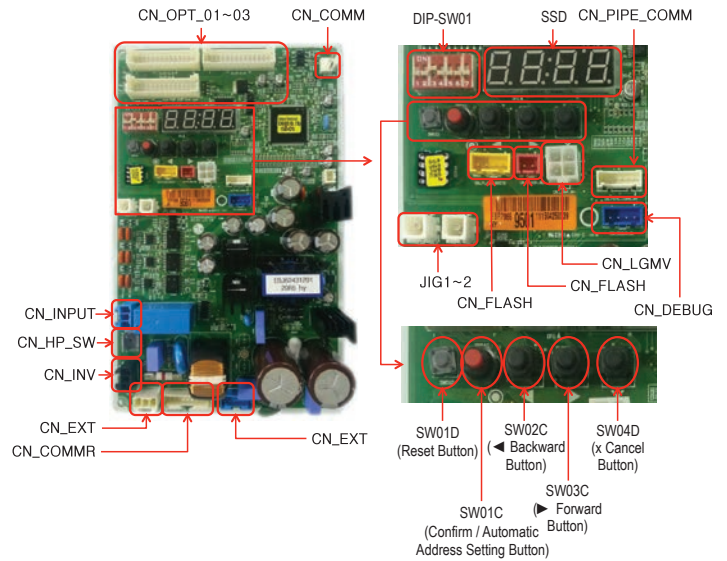

Table 4: Optional Modes.

Mode Selection		Selection		Selection		Notes
Content	Display	Mode / Function Name	Display	Default	Options	
Fault Detection and Diagnostics	Fdd	Integrated Test Run	Fd7	-	-	
Function	Func	Cool / Heat Selector Switch (Installed)	Fn1	oFF	oFF, oP1~oP2	Saved in EPROM; Off = Not Installed
		Static Pressure Compensation	Fn2	oFF	oFF, oP1~oP3	Used for ducted discharge
		Night Low Sound	Fn3	oP10	oP1~oP12	
		Overall Defrost	Fn4	oFF	on, oFF	Off = Split Coil / Frame Allowed
		Outdoor Unit Addressing	Fn5	0	0~254	
		Snow Removal Assist / Rapid Defrost	Fn6	oFF	oFF, oP1~oP3	
		Low Ambient Kit	Fn9	oFF	on, oFF	
		High Efficiency Mode (Cooling Operation)	Fn10	oFF	on, oFF	
		High Efficiency Mode Cooling Operation (Auto Dust Throw)	Fn11	oFF	oFF, oP1~oP5	
		Smart Load Control	Fn14	oFF	oFF, oP1~oP3	Can use in all applications except DOAS. Energy saving feature.
		Humidity Reference	Fn16	oFF	on, oFF	
		Central Control Connection at the Indoor Unit Side	Fn19	oFF	oFF, on	
		Power Consumption Display on Wired Remote Controllers	Fn21	oFF	oFF, Pd10, Pd11	
Overall Defrost Operating in Low Temperature (Heating)	Fn22	oFF	on, oFF			
Base Pan Heater (Optional Accessory)	Fn23	oFF	on, oFF			
User	Idu	Comfort Cooling	Id10	EACH		Saved in EPROM
Service	SvC	Vacuum Mode	Se3	vACC	-	One Time / One Selection

## Central Control

### Central Control Addresses Assignments

Gather any preferences the project may have; if there are no preferences:

- Hex assignments do not have to be assigned in any particular order, or an order defined by the routing of the communications cable between the indoor units. In most cases, Hex addresses can be skipped.
- All members of a Hex Group are not required to be on the same Multi V system.
- Addresses can be assigned at random, not in any particular order, and can be skipped.

### Indoor Unit Central Control Address Assignments

A central control address is made up of two hexadecimal characters.

- The first character in the central control address is the Hex Group Identifier.  
Possible Hex Group Identifiers (in order of lowest to highest) are 0-9 followed by A-F. See complete list on next page.
- The second character in the address is the Hex Member Identifier in a Hex Group.  
Hex Member Identifiers (in order from lowest to highest) are 0-9 followed by A-F. See complete list in table at right.

### Hex Address Assignment Limitations

- There is a limit of 16 Members per Hex Group
- There is a limit of 16 Hex Groups per system.
- There is a limit of 256 possible Member Identifiers per Central Control (See Central Controller Communications Limitations).

### Setting Central Control Addresses

1. Verify power to the whole system, including indoor units and outdoor unit(s), is OFF. If not, turn OFF.
2. If not installed already, connect the communication cable from CEN. A and CEN. B terminals on the master outdoor unit to A and B terminals on the central controller. Polarity matters, so make sure A to A and B to B.
3. Power the whole system ON.
4. Set the group and indoor unit numbers using the wired remote controllers.
5. To control several sets of indoor units as a group, set the group I.D. settings from 0 to F.

Central Control Address Nomenclature.

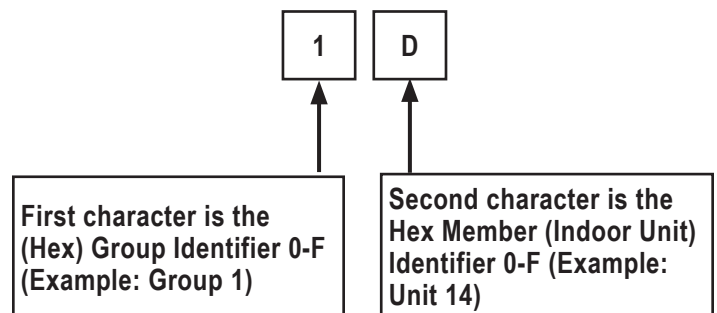

Table 5: Central Control Address Nomenclature List.

Group Control by Central Controller	
No. 0 Group (00 ~ 0F)	
No. 1 Group (10 ~ 1F)	
No. 2 Group (20 ~ 2F)	
No. 3 Group (30 ~ 3F)	
No. 4 Group (40 ~ 4F)	
No. 5 Group (50 ~ 5F)	
No. 6 Group (60 ~ 6F)	
No. 7 Group (70 ~ 7F)	
No. 8 Group (80 ~ 8F)	
No. 9 Group (90 ~ 9F)	
A Group (A0 ~ AF)	
B Group (B0 ~ BF)	
C Group (C0 ~ CF)	
D Group (D0 ~ DF)	
E Group (E0 ~ EF)	
F Group (F0 ~ FF)	

### Outdoor Unit to Central Controller Communication Connections.

Master Outdoor Unit Communication Terminal Block

SODU		IDU		CENT		DRY1	DRY2	GND	12V
B	A	B	A	B	A				

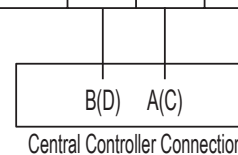

## Assigning Equipment Addresses

### Central Control and Indoor Units Connected to Heat Recovery Units

#### Note:

The heat recovery unit valve address and the central control address of its corresponding indoor unit should be set using the same number (in manual addressing).

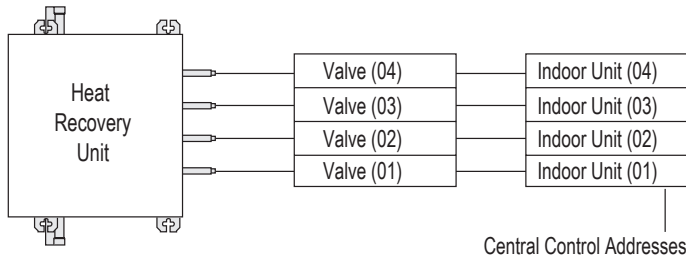

#### Controller Communications Limitations

Each type of Controller device is designed to communicate with a limited quantity of indoor units. The quantity of indoor units that can be connected to a single control communications cable, therefore, will be defined by the control device on that cable with the smallest Maximum Indoor Unit Quantity as shown in the tables at right.

Table 6: Central Controller Indoor Unit Connection Limitations.

Central Control Device	Maximum Indoor Unit Quantity
ACP IV	256
AC SMART IV	128

Table 7: Integration Solutions Indoor Unit Connection Limitations.

Integration Solutions	Maximum Indoor Unit Quantity
MultiSITE™ Communications Manager	128
AC Smart BACnet® Gateway	128
ACP IV BACnet Gateway	256
ACP LonWorks® Gateway	64

BACnet® is a trademark of ASHRAE; LonWorks® is a trademark of Echelon Corporation.

#### Group Number

If the building operator wants to know which indoor units are on each outdoor unit, and multiple systems serve a building:

- Assign a Group Number to each system. If there are more than 16 indoor units on a system, multiple Group Numbers may be necessary.

If the building owner wants to know which indoor units are on each floor:

- Assign a different group number for each floor. If there are more than 16 indoor units on a floor, multiple Group Numbers may be necessary.

#### Member Number

Can be assigned at will or for example, can follow the room layout on each floor.

For each LG Central Controller product provided on the project, devise a central control address schedule and assign a central control address to each indoor unit(s) Hydro Kit(s), and ERV(s) units. Record this central control address for each component in the column provided on the Pre-commissioning Device Configuration Worksheet.

#### Upload Central Control Address to the Indoor Units

For all ducted, vertical and floor standing indoor units, the central control address must be assigned using a wired zone controller. Wall-mount, ceiling cassette, ceiling suspended, and the wall / ceiling convertible indoor units, the central control address can be assigned using a wireless handheld controller or a wired zone controller.

**Note:**

During the following procedure, Ⓞ NEVER PUSH the ON / OFF (Enable operation) Button on the zone controller.

**For Indoor Units That ARE NOT Being Controlled as a Group**

1. Verify the zone controller wiring / cable is connected properly to the indoor unit PCB. For more information on the different connections in LG indoor units, see the Electrical System Installation Section in this manual.
2. Using the controller, go to the setup function 02 (icons are different for each controller. Refer to the controller user's manual for more information.)
3. Type in the Hex Central Control address that has been designated to the unit.
4. Repeat Steps 1 through 3 for each indoor unit in the building.

**For Indoor Units That ARE Being Controlled as a Group****For the Master Indoor Unit in a Group Setting**

1. Identify which unit will be the Master indoor unit and which indoor units are going to be the Slave units.
2. Go to the Master indoor unit and access the PCB.
3. Verify the group control cable / group control wiring is installed into CN-REMO or the SIG - 12V - GND (Comm.) terminal on the Master indoor unit PCB. If it is not, install now.
4. Detach group control cable / wiring.
5. Attach the zone controller to the Master indoor unit.
6. Using the controller, go to the setup function 02 (icons are different for each controller. Refer to the controller user's manual for more information.) Type in the Central Control address designated for the master indoor unit.
7. Disable power to the Master indoor unit. Ⓞ Do not restore power to the Master indoor unit at this time. It will be restored later.
8. If the zone controller and associated communications cable has already been permanently mounted in place, reattach cable / wiring and obtain a loose zone controller with a communications cable to continue programming the Slave indoor units (see procedure below).

**For the Slave Indoor Unit(s) in a Group Setting**

For grouped control indoor units, using DIP Switch No. 3 to set slave units automatically sets these units to Central Control address "FF. If the application calls for central control addresses to all slave units, follow the procedure below.

1. Go to the first Slave indoor unit and disconnect the cable / wiring from CN-REMO or the SIG - 12V - GND (Comm.) terminal.
2. Attach the zone controller communications cable into the Slave indoor unit. Ⓞ Do not push the ON / OFF button or enable indoor unit operation.
3. Using the controller, go to the setup function 02 (icons are different for each controller. Refer to the controller user's manual for more information.) Type in the Hex address assigned to the unit.
4. Change DIP Switch No. 3 on the Slave indoor unit PCB to the "ON" position.
5. Disable power to the Slave indoor unit using the disconnect switch. Wait one (1) minute.
6. While power is off, detach the zone controller cable.
7. Attach the group control cable / wiring to the Slave indoor unit.
8. Restore power to that Slave indoor unit, and go to the next Slave indoor unit.
9. Repeat Steps 1 to 8 for each Slave indoor unit.
10. After all Slave indoor unit have addresses assigned, go back to the Master indoor unit and restore power.

---

---

### Indoor Unit Auto Addressing Procedure

#### **⚠ WARNING**

Disconnects should only be operated by a properly licensed electrician at this time. ⚡ Never look at a disconnect switch when closing. Turn away from the switch when closing. Incorrect wiring could cause the disconnect to explode, physical injury, and / or death.

#### **Note:**

- Supply power to the indoor units. If power is not supplied, an operation error will occur.
- During the pre-commissioning process for systems with Gen 4 indoor units, ⚡ do not change any DIP switch settings except for No. 3 on SW01B, which should be ON to enable Gen. 4 features. All other combinations of switches (one [1] through seven [7]) should be left in the OFF position on the outdoor unit DIP switch bank SW01B. Refer to System Combinations and Outdoor Unit Operation Settings for proper setting of No. 3 on SW01B.
- If the Auto Address Procedure has never been successfully completed for the system, the compressor(s) will not start when power is applied to the unit.
- Auto addressing is only possible on the main PCB of the outdoor unit (master unit if dual / triple frame system).
- If an indoor unit PCB has been replaced, the auto addressing procedure must be performed again.

1. Verify all that all indoor units connected to the system have power to the PCB board AND all wired controller system start buttons are OFF.
2. Remove the maintenance access panel and unit control box cover from the outdoor unit. Place panels and screws in a secure area.
3. Verify that the communications cable between the indoor units and the outdoor unit is terminated at the outdoor unit terminals IDU(A) and IDU (B).
4. Verify the shield on the communications cable is grounded at the outdoor unit.
5. If installing a dual- or triple-frame system, verify which outdoor unit will be the "Master" unit, the Slave1 unit, and the Slave2 unit; check if the DIP switches on DIP-SW01 are set properly. (See "Setting Outdoor Units in Dual / Triple Frame Systems" under "Pre-Commissioning / Outdoor Unit DIP Switch Settings" earlier in this section.)
6. Cycle power on the outdoor units, indoor units, etc., and wait three (3) minutes while the outdoor unit sequences through the self-diagnostics check, and to improve indoor unit communication when initial power is supplied. Leave disconnect in the "ON" position.
7. Check the outdoor unit(s) current configuration code(s). Observe the unit setup codes using the SSD display found on the outdoor units PCB.

#### **Note:**

After the self-diagnostics check is complete, the SSD should be clear and nothing displayed. Diagnostic process should take from three (3) to seven (7) minutes.

8. Know how many indoor units are connected to the system.
9. Press and hold the red SW01C button for about five (5) seconds. Release when "88" appears on the SSD of the master outdoor unit PCB. After three (3) to seven (7) minutes, the display will flash a number for about thirty (30) seconds, indicating how many total indoor units the system successfully communicated with.
10. This number should match the known installed number of indoor units if the auto addressing procedure was successful. If using LGMV, read the address of each indoor unit. The address of each indoor unit is also indicated on wired remote control displays.
11. Upon completion of the auto addressing routine, the display will be blank and the system will be in standby waiting for another command.
12. Upon successful completion of the auto address procedure, record the system address assigned to each indoor unit by the auto address procedure in the column provided on the Pre-Commissioning Device Configuration Worksheet.



**Indoor Unit Auto Addressing Procedure, continued.**

13. After recording the system addresses assigned to each device, open the outdoor unit disconnect. Remove the outdoor unit to indoor unit communications cable from terminals IDU(A) and IDU(B). Protect conductors by placing electrical tape over the bare ends.
14. Close the disconnect to reapply power to the outdoor unit and energize the compressor crankcase heater. Once again, verify that the outdoor unit to indoor unit(s) communications cable is not connected to terminals IDU(A) and IDU(B) of the outdoor unit.
15. Replace the control panel door.

**⚠ WARNING**

Upon successful completion of the auto addressing function, an unintentional compressor start can occur unless the communications cable to the indoor units is removed from the outdoor unit terminals IDU(A) and IDU(B). **⊘ Do NOT open the service valves or attempt to start outdoor unit compressors or until directed by the LG trained commissioner. Major damage to the unit piping and compressors will occur, and there is a risk of explosion, suffocation, physical injury, and / or death.**

**Auto Addressing Flowchart.**

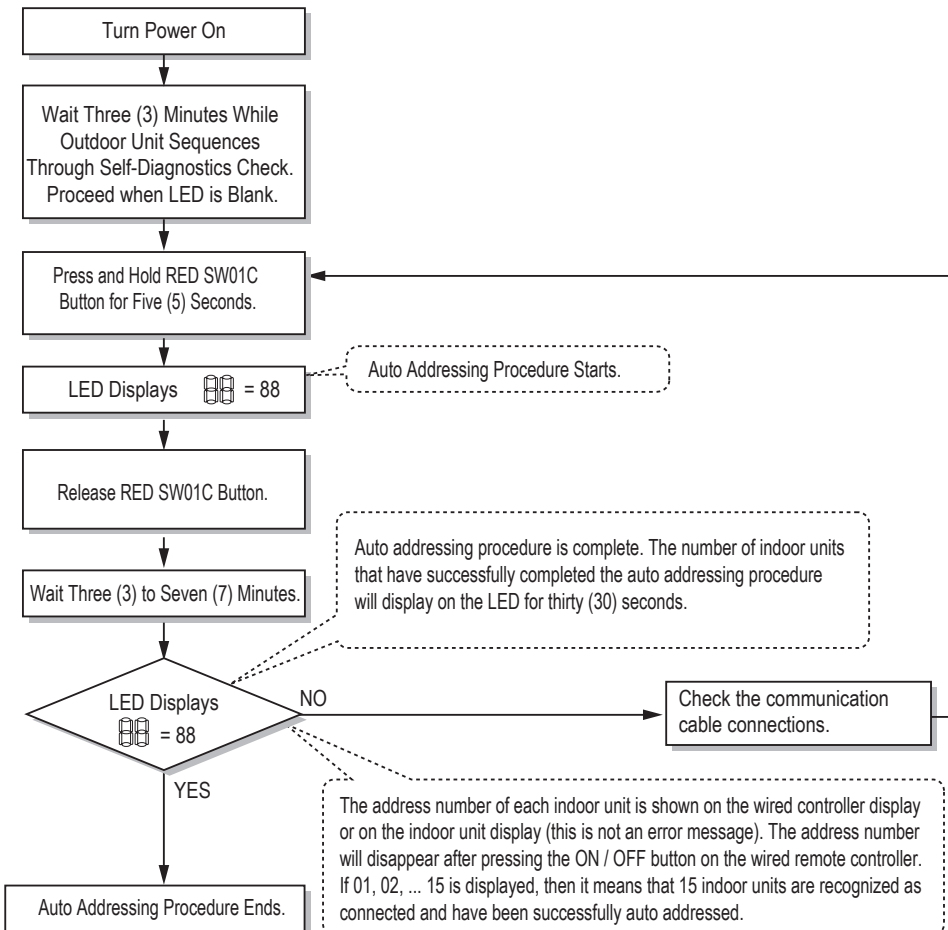

Auto Addressing Button Location on Outdoor Unit PCB.

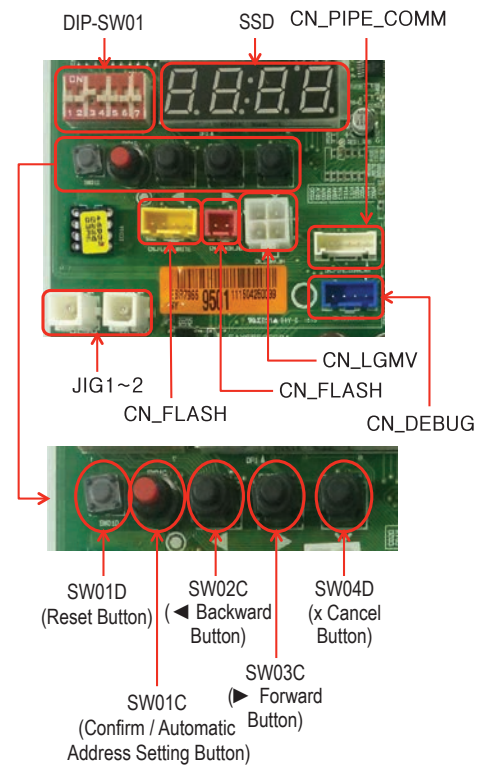

---

---

### Troubleshooting a Failed Indoor Unit Auto Addressing Procedure

If the quantity of indoor units the auto addressing procedure found is incorrect, or the "88" never disappears from the display for the seven (7) minutes, the auto address procedure has failed and a communications problem exists. If the Auto Address Procedure failed:

1. Verify ALL indoor unit ON/OFF buttons are in the OFF position (i.e., ON / OFF button NOT illuminated).
2. Check the terminations, polarity, and continuity of each conductor on the communications cable between the outdoor unit and the indoor units. Verify the indoor unit to outdoor unit communications cable is wired correctly.
  - Verify the conductor connected to the "3" (or "5" in the case of cassette frame codes TP, TN, TM) terminals on all indoor units and is terminated on the outdoor unit terminal tagged IDU(A).
  - In a similar fashion, verify the conductor connected to all indoor units on the "4" (or "6" in the case of cassette chassis codes TP, TN, TM) terminals and is terminated on the outdoor unit terminal tagged IDU(B).
3. Verify the shield of the communications cable is grounded at the outdoor unit only. All segment shields should be spliced together at each indoor unit and NOT grounded.
4. After repairing the communications cable, go to Step 9 of the Auto Addressing Procedure and repeat the process until successful: Press and hold the red SW01C button for about five (5) seconds. Release when "88" appears on the SSD. After three (3) to seven (7) minutes, the display will flash a number for about thirty (30) seconds indicating how many total indoor units the system successfully communicated with.
5. This number should match the known installed number of indoor units if the auto addressing procedure was successful.
6. Upon completion of the auto addressing routine, the display will be blank and the system will be in standby waiting for another command.
7. Record the system address the outdoor unit assigned to each indoor unit by the auto address procedure in the column provided on the Pre-commissioning Device Configuration Worksheet.
8. After recording the system addresses assigned to each device, open the outdoor unit disconnect. Remove the outdoor unit to indoor unit communications cable from terminals IDU(A) and IDU(B). Protect conductors by placing electrical tape over the bare ends to prevent an accidental compressor start from occurring before the LG trained commissioner arrives.
9. Close the disconnect to reapply power to the outdoor unit and energize the compressor crankcase heater. Once again, verify the outdoor unit to indoor unit(s) communications cable is not connected to terminals IDU(A) and IDU(B) of the outdoor unit.
10. Replace the control panel cover.

### Group Controlling Indoor Units

If any of the indoor units were specified to operate in unison, create a group control communications circuit between the indoor units using field wiring (with indoor units that have SIG - 12V - GND [Comm.] terminals), or a group control cable kit (with indoor units that have CN-REMO).

1. Before proceeding with group control cable terminations, verify power is OFF at all applicable indoor units.
2. Identify which indoor unit will be the "Master" unit of the group. If not already recorded, record the "Master" and the "Slave" identity assignment to each indoor unit in the group on the Pre-commissioning Device Configuration Worksheet.
3. SIG - 12V - GND [Comm.] Terminal Procedure
  - From the controller to the master indoor unit, use 22 AWG, 3-conductor, twisted, stranded, unshielded.
  - From the master indoor unit to the slave indoor unit(s), daisy chain using 22 AWG, 3-conductor, twisted, stranded, unshielded (⊘ Do not attach wire to 12VDC terminal to the slave indoor units). All wiring must comply with all applicable local and national codes.
  - All wiring must comply with all applicable local and national codes.
4. CN-REMO Termination Procedure:
  - Starting with the master indoor unit, plug in the male end of the pigtail cable into the CN-REMO socket. At the last slave indoor unit in the group, a pigtail cable is not required. Plug the male end of the extension cable coming from the previous indoor unit into the CN-REMO socket.
  - Plug the Y-cable into the pigtail at each indoor unit except for the last slave indoor unit in the group where no Y-cable cable will be needed.
  - Connect two extension cable segments to each "Y" cable except for the "Y" cable connected to the master indoor unit. At the master indoor unit, connect one extension cable and the communications cable from the zone controller to the Y-cable.

## Addressing with Heat Recovery Units (For Heat Recovery Systems Only)

### General

Each heat recovery unit will have a unique address assign so the outdoor unit will be able distinguish it from other heat recovery units. Upon completion of the heat recovery unit address, the heat recovery unit operating parameters will be set by adjusting the positions DIP switches on SW02M and SW01M.

### Procedure

Before beginning the physical process of assigning heat recovery addresses, map out the address assignments using a copy of the LATS tree mode diagram.

### Guidelines

1. Addresses must be sequential and cannot be skipped.
2. Assign the lowest address to the heat recovery unit that has the largest capacity indoor unit connected to port number 1. If the capacity of all indoor units connected to port number 1 of each heat recovery unit is the same, assign address "0" to the heat recovery unit farthest away from the outdoor unit. Assign the next address to the next farthest away and so on until all heat recovery units have an address. The heat recovery unit with the highest address should be the one closest to the outdoor unit. Up to 16 heat recovery units can be on a single system.

Possible settings in order of lowest to highest are: 0,1,2,3,4,5,6,7,8,9,A,B,C,D,E,F.

### Note:

Addressing must be performed following the detailed steps above because port number 1 on the heat recovery unit addressed "0" will remain open during the auto pipe detect procedure. If the indoor unit capacity connected to the port is relatively small compared with other units on the system, the outdoor unit high head pressure safety will trip and shut down the unit during the procedure.

3. Record the address assigned to each heat recovery unit in the pertinent column on the Pre-Commissioning Device Configuration Worksheet.

Heat Recovery Unit Main PCB.

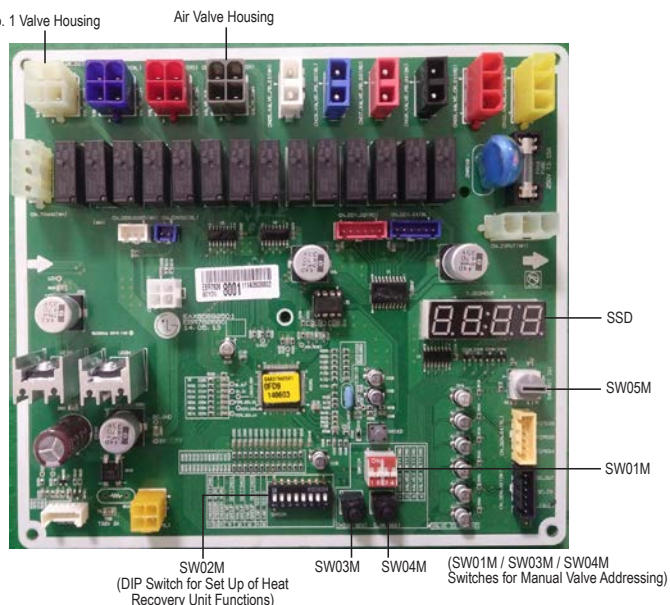

## Addressing Heat Recovery Units

Close Up of DIP Switches and Rotary Dial on the Heat Recovery Unit Main PCB.

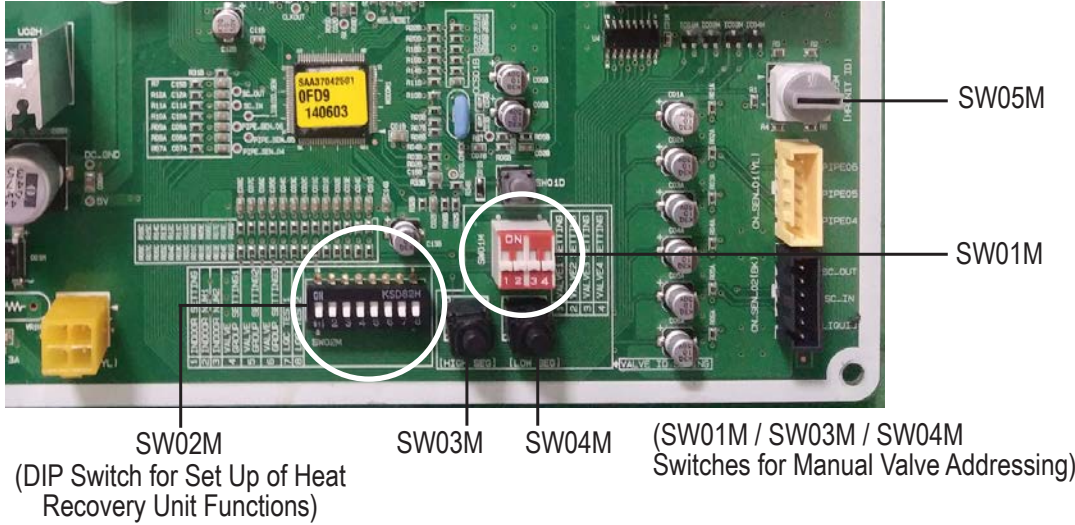

### 1. Main Function of SW02M.

ON / SW	Selection	
	No. 1	Method for addressing the heat recovery control valves (Auto / Manual)
No. 2	Model of heat recovery unit	
No. 3	Model of heat recovery unit	
No. 4	Valve group setting	
No. 5	Valve group setting	
No. 6	Valve group setting	
No. 7	Used only in factory production (preset to "OFF")	Zone setting ("ON")
No. 8	Used only in factory production (preset to "OFF")	

### Selecting the Heat Recovery Unit Valve Addressing Method (Pipe Detection) (Auto / Manual).

Auto (Switch No. 1 on SW02M OFF)

Manual (Switch No. 1 on SW02M ON)

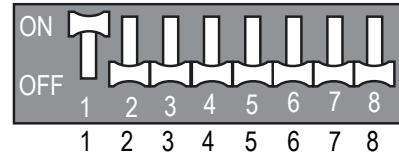
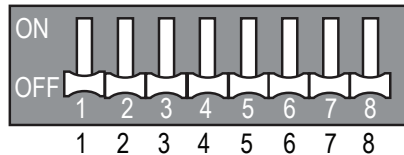

### Zone Control Setting.

	DIP Switch Settings	
Normal Control	<p>SW02M</p>	<p>SW01M</p>
Zone Control	<p>SW02M</p>	<p>SW01M</p> <p>Turn the DIP Switch of the zoned branch to ON. Example: Branches one (1) and two (2) are set to zone control.</p>

### Select the Heat Recovery Unit Model.

1. Identify how many ports are connected (see table below).
2. Group ports if necessary. If any connected indoor units are "large" capacity models (indoor units with >54,000 Btu/h capacity) two heat recovery ports must be "grouped" to serve a large capacity indoor using an inverted 'Y' branch.
3. Set switches on SW02M as outlined in the table below and on the next page.

Table 8: Selecting the Heat Recovery Unit Model.

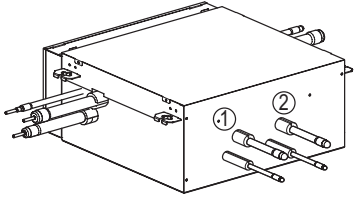
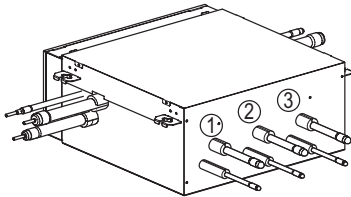
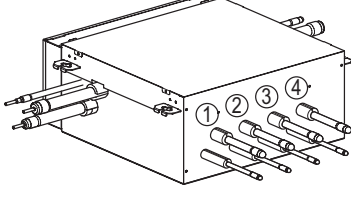
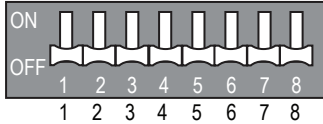
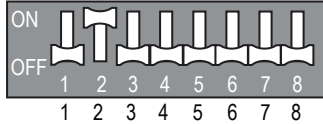
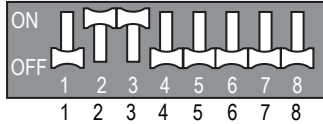
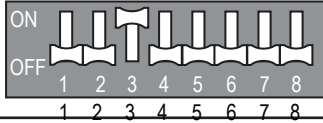
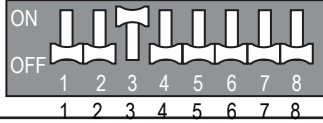
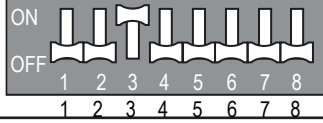
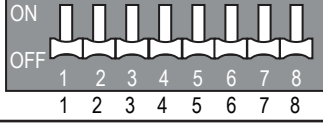
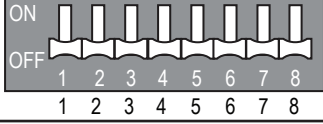
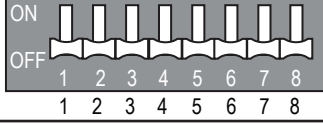
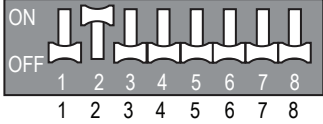
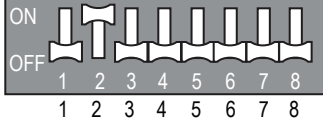
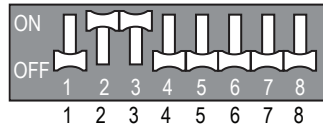
	 PRHR022A (Two [2] ports)	 PRHR032A (Three [3] ports)	 PRHR042A (Four [4] ports)
<b>Factory Setting</b>			
<b>One port connected</b>			
<b>Two ports connected</b>			
<b>Three ports connected</b>			
<b>Four ports connected</b>			

### Note:

Each heat recovery unit has switches No. 2 and No. 3 (on SW02M) factory set as shown above in initial setting.

- To use a PRHR022A for one port, cap off the second pipe, and set the DIP switches on the heat recovery unit for "one port connected" as shown in the table above.
- To use a PRHR032A for two ports, cap off the third port, and set the DIP switches on the heat recovery unit for "two ports connected" as shown in the table above.
- To use a PRHR042A for three ports, cap off the fourth port, and set the DIP switches on the heat recovery unit for "three ports connected" as shown in the table above.
- To use a PRHR042A for two ports, cap off the third and fourth ports, and set the DIP switches on the heat recovery unit for "two ports connected" as shown in the table above.
- Any unused port must be sealed with a brazed copper cap, not with a plastic cap.

# OPERATION

## Addressing Heat Recovery Units

### Select the Valve Group.

Table 9: SW02M Valve Group Settings.

	DIP Switch Setting	Example
No Valve Group Control		<p>Indoor unit Indoor unit Indoor unit Indoor unit</p>
No. 1, 2 Valve Control		<p>Indoor unit Indoor unit Large capacity indoor unit</p>
No. 2, 3 Valve Control		<p>Indoor unit Large capacity indoor unit Indoor unit</p>
No. 3, 4 Valve Control		<p>Large capacity indoor unit Indoor unit Indoor unit</p>
No. 1, 2 Valve Control No. 3, 4 Valve Control		<p>Large capacity indoor unit Large capacity indoor unit</p>

## 2. SW05M Function (Rotary Switch for Addressing Heat Recovery Units).

- Rotary switch SW05M must be set to "0" when installing only one heat recovery unit.

Adjusting the Heat Recovery Unit Addresses.

- When installing multiple heat recovery units, address each unit with sequentially increasing numbers starting from "0".

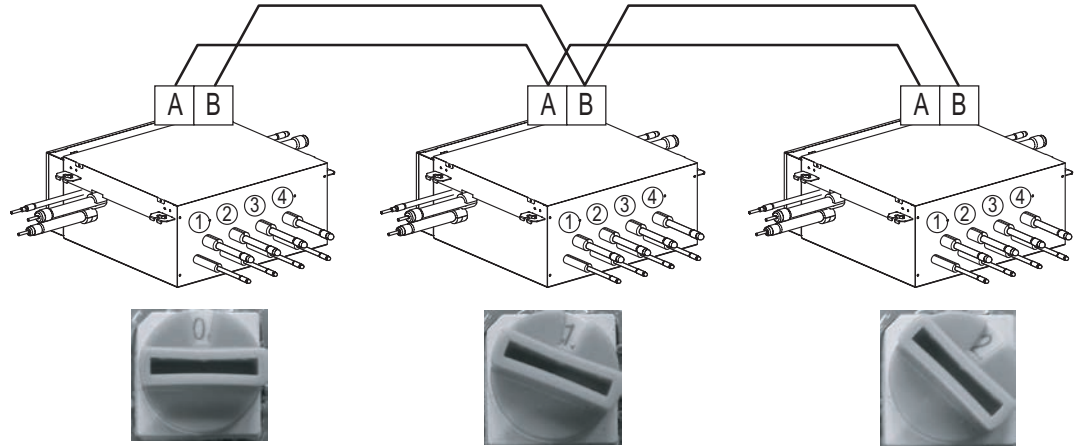

## 3. SW01M / SW03M / SW04M (DIP and Tact Switches) for Manual Valve Addressing

### Non-zoning (Normal Setting).

- Set the address of the heat recovery unit valve to the central control address of the connected indoor unit.
- SW01M: Select the valve to address.
- SW03M: Increases the valve address by ten (10).
- SW04M: Increases the valve address by one (1).

### Note:

Each indoor unit must have a unique, preset central control address (using its wired controller) before manual valve addressing can occur.

Table 10: Settings for Manual Valve Addressing, Non-Zoning.

PCB Component	S/W No.	Set Up
	No. 1	Manual Addressing Valve No. 1
	No. 2	Manual Addressing Valve No. 2
	No. 3	Manual Addressing Valve No. 3
	No. 4	Manual Addressing Valve No. 4
	SW03M	Increases the Valve Address by Ten (10)
	SW04M	Increases the Valve Address by One (1)

## Addressing Heat Recovery Units

### 3. SW01M / SW03M / SW04M (DIP and Tact Switches) for Manual Valve Addressing, continued.





#### Zoning

- Set the address of the heat recovery unit valve to the central control address of the connected indoor unit.
- SW01M: Select the valve to address.
- SW03M: Increases the valve address by ten (10).
- SW04M: Increases the valve address by one (1).
- SW05M: Rotary switch

#### Note:

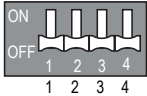
Each indoor unit must have a unique, preset central control address (using its wired controller) before manual valve addressing can occur.

Table 11: Settings for Manual Valve Addressing, Zoning.

PCB Component	S/W No.	Set Up
	No. 1	Manual Addressing Valve No. 1
	No. 2	Manual Addressing Valve No. 2
	No. 3	Manual Addressing Valve No. 3
	No. 4	Manual Addressing Valve No. 4
	SW03M	Increases the Valve Address by Ten (10)
	SW04M	Increases the Valve Address by One (1)
	SW05M	Manual Addressing of Zoned Indoor Units



## Auto Addressing for Pipe Detection

Auto addressing for pipe detection function sets the connection relationship automatically between the indoor units and the heat recovery units.

1. Turn No.1 of SW02M on the heat recovery unit PCB to OFF.
2. Confirm that the setting of Nos. 2, 3 of SW02M corresponds with the number ports used.
3. Reset the power of heat recovery unit PCB.  
Turn master outdoor unit PCB No. 5 DIP switch to ON.
4. Select the "Idu" mode using ► and ◀, then push the ● button.
5. Select the "Id 5" "Ath" or "Atc" function using ► and ◀, then push the ● button. If outdoor temperature is >59°F, use "Ath". If that does not work, use "Atc." If outdoor temperature is <59°F, use "Atc". If that does not work, use "Ath."

### Note:

*Atc = "At-cold outside", and Ath = "At-hot outside". Select accordingly.*

6. Select the "Idu" mode using ► and ◀, then push the ● button.
7. Select the "Id 6 StA" function using ► and ◀, then push the ● button.
8. The number "88" should display on the SSD of the outdoor unit main PCB.
9. The automatic pipe detection procedure starts.
10. The procedure may run from five (5) to sixty (60) minutes, depending on the number of connected indoor units, and the ambient outdoor temperature.
11. The number of indoor units detected is displayed for thirty (30) seconds to one (1) minute on the outdoor unit PCB after the outdoor unit stops.
  - The number of indoor units connected to each heat recovery unit will be displayed.
  - If there is an auto pipe detection error, "200" will be displayed.
  - If there are no auto pipe detection errors, the number "88" displays on the SSD of the outdoor unit main PCB. After "88" disappears, the auto detection error is complete.

### Note:

- Run the auto addressing and auto pipe detection procedures again whenever an indoor unit PCB and / or and heat recovery unit PCB are replaced. Apply power to the indoor units and heat recovery units after the repair is complete, otherwise operation errors will occur.
- Error No. 200 occurs if the number of actual connected indoor units and the number of detected indoor units are different.
- If the auto pipe detection procedure fails, perform the manual pipe detection procedure. (If the auto pipe detection procedure is successful, the manual pipe detection procedure is not required.)
- The auto pipe detection procedure can be run again after a failed auto pipe detection procedure attempt; just reset the outdoor unit first.
- ⓧ Do not turn off the main unit PCB for at least five (5) minutes after the auto pipe detection procedure is complete; allow time for the outdoor unit to automatically save auto pipe detection results.

## Addressing Heat Recovery Units

Auto Addressing for Pipe Detection Procedure Flowchart.

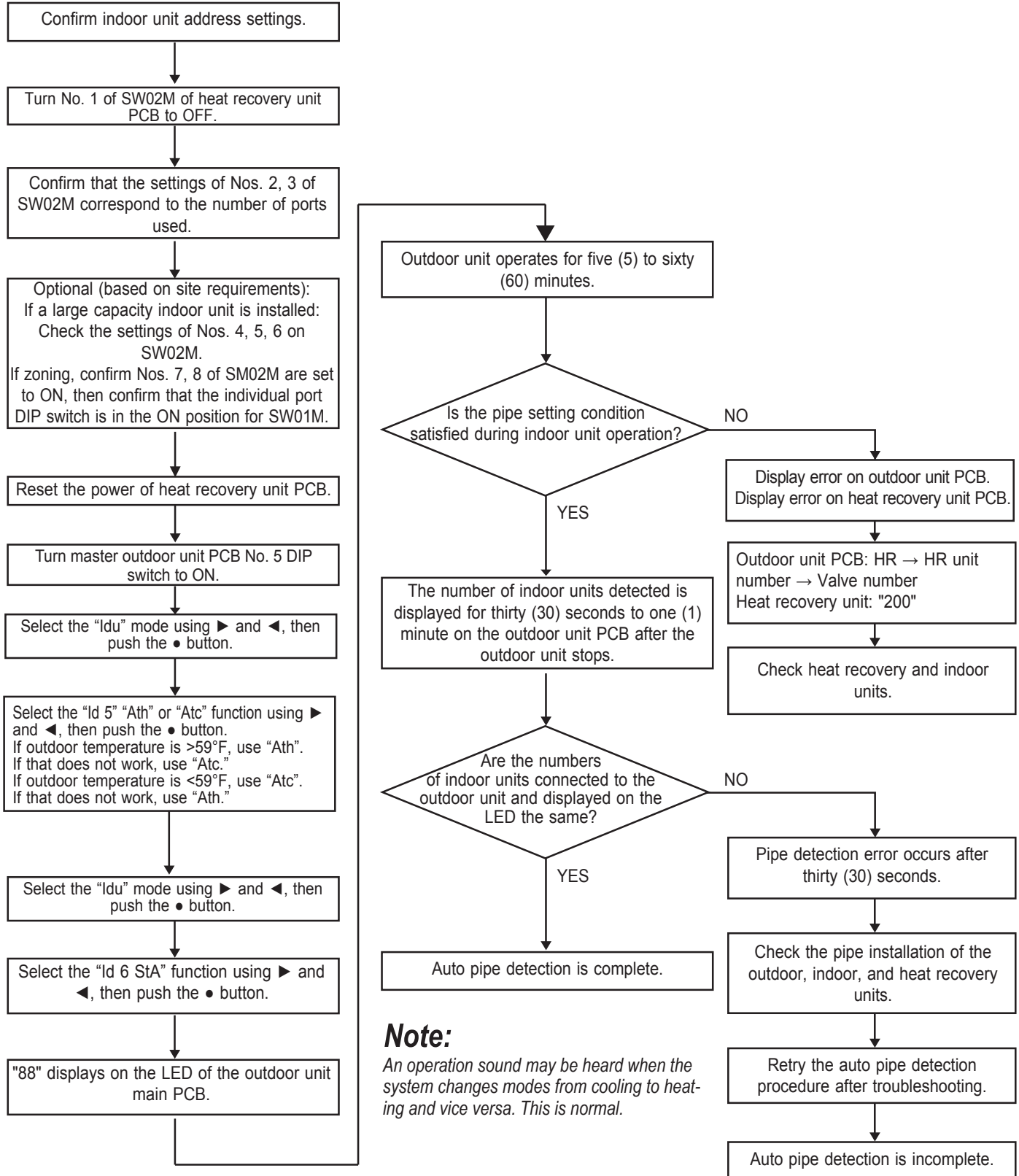

### Note:

An operation sound may be heard when the system changes modes from cooling to heating and vice versa. This is normal.

## Manual Addressing for Pipe Detection

1. Enter the central control address into each indoor unit using its wired remote control.
2. Turn No. 1 of DIP switch bank SW02M of the heat recovery unit PCB ON.
3. Reset the power of the heat recovery unit PCB.
4. Through the heat recovery unit PCB, manually set address of each heat recovery unit valve to the central control address of the indoor unit connected to that valve.
5. Reset the power to the outdoor unit PCB.
6. The number of the indoor unit installed will be displayed after about five (5) minutes. (Example: Heat Recovery Unit to the Number of the Indoor Unit.)
7. Reset the power of the outdoor unit PCB and the heat recovery unit.
8. Manual pipe detection addressing is complete.

Location of DIP Switch SW02M on the Heat Recovery Unit Main PCB.

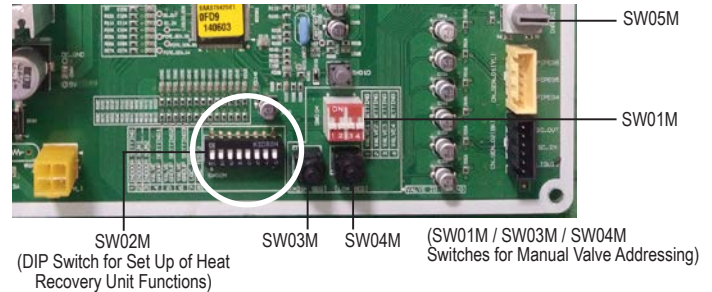

### Manual Addressing for Pipe Detection Flowchart.

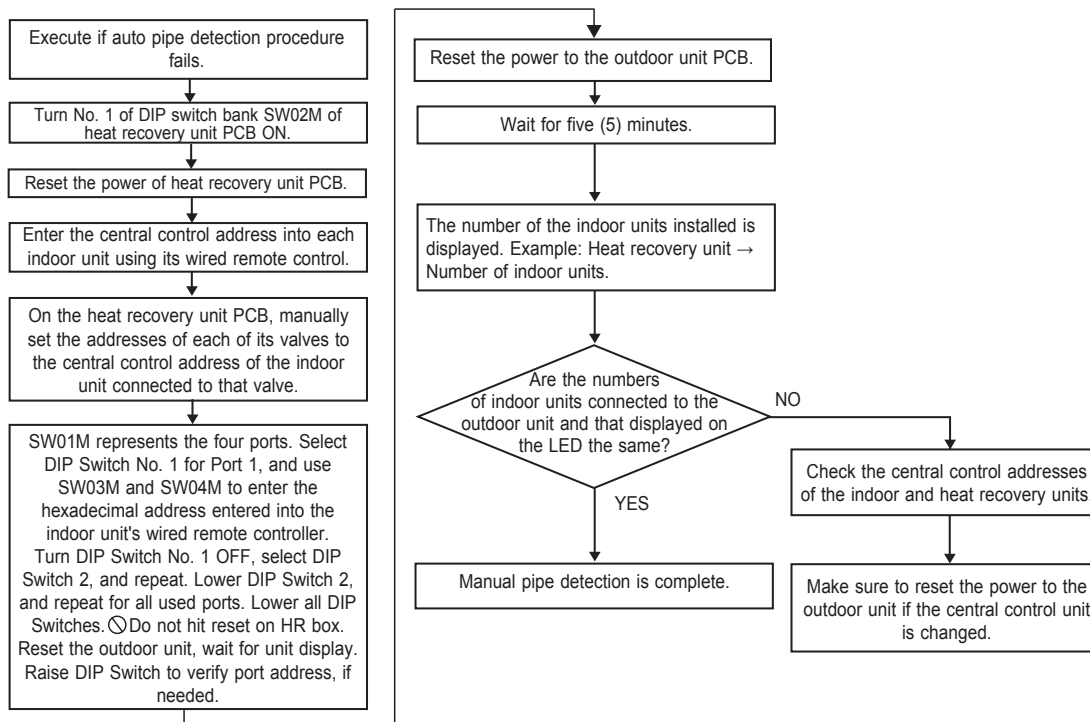

### Note:











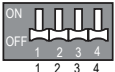



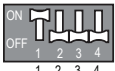

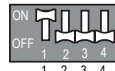

1. If a central controller is not installed yet, leave the address data alone until the installer adds the central controller, and sets the central control address as desired.
2. If a central controller is already installed, the wired remote controller of the indoor units will provide the central control addresses. (In this case, manually set the heat recovery unit pipe address following the central control address of the indoor unit.)
3. Central controller addresses must be set manually at each individual controller.
4. A pipe that does not have an indoor unit connected to it should be set with a different address than a pipe that does have an indoor unit connected to it. (If addresses are the same, the valves will not operate.)
5. Change the manual pipe settings using the heat recovery unit PCB.
6. An error indicates that the manual pipe detection procedure was not completed properly.
7. To save the pipe detection procedure results automatically, ⏻ do not turn off the main outdoor unit PCB for five (5) minutes after the procedure has finished.

## Addressing Heat Recovery Units

### Manual Addressing for Pipe Detection Example (Non-Zone Setting)

Before performing manual pipe addressing, input a different central control address to every indoor unit through either a wired or a wireless controller (depending on indoor unit type).

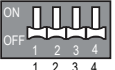
Example: An indoor unit with a central control address of "11" is connected to valve "1" of a heat recovery unit.

No.	Display / Setup	Description
1	 SSD  SW01M  SW03M  SW04M	Operation: None Display: None
2	 SSD  SW01M  SW03M  SW04M	Operation: Turn DIP switch No. 1 on to address valve No. 1 (SW01M). Display: Existing value saved in EPROM is displayed on SSD.
3	 SSD  SW01M  SW03M  SW04M	<ul style="list-style-type: none"> <li>Operation: Set the "10" digit of the Group High data number of the wired remote control connected to the corresponding indoor unit to the valve No. 1 by pressing left tact switch (SW03M).</li> <li>Display: Digit increases with the number of times the tact switch is pressed, shown on the SSD.</li> </ul>
4	 SSD  SW01M  SW03M  SW04M	<ul style="list-style-type: none"> <li>Operation: Set the "1" digit of the Group Low data number of the wired remote control connected to the corresponding indoor unit to the valve No. 1 by pressing right tact switch (SW04M).</li> <li>Display: Digit increases with the number of times the tact switch is pressed; shown on right SSD numeral.</li> </ul>
5	 SSD  SW01M  SW03M  SW04M	<ul style="list-style-type: none"> <li>Operation: Turn DIP switch No. 1 off to save the address of valve No. 1 (SW01M).</li> <li>Display: "11" displayed on SSD disappears.</li> </ul>

### Note:











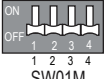



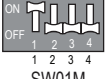



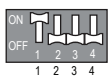



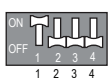



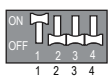

- The procedure described above must be performed for all heat recovery unit valves.
- Valves that do not have indoor units connected to them should be addressed with a number that has not been used. (Valves will not work if the address numbers are the same.)

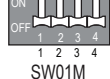
**Manual Addressing for Pipe Detection Example (Zone Setting)**

Zone control is when two (2) or more indoor units are connected to one (1) valve of the heat recovery unit. For this application, set the controls with the multiple indoor connections using the rotary switch; i.e., only the rotary switch changes the same valve set condition and set indoor units connection.

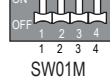
1. Set the DIP switch on the corresponding valves and the rotary switch to "0".
2. Set the number using the tact switches.
3. If additional indoor units are connected to one heat recovery unit valve, increase the rotary switch setting by one (1) and set the number using the tact switches.
4. To verify the number of the corresponding valve, turn the DIP switch to ON and set the number on the rotary switch.
5. One heat recovery unit valve can support up to eight (8) indoor units (rotary switch settings 0~7). An error will display if more than eight (8) indoor units per heat recovery valve are set with the rotary switch.
6. Return the rotary switch to its original setting (heat recovery unit number settings) after all pipe settings are complete.
7. The rotary switch setting value of the number of indoor units connected to "FF" prevents a malfunction. Example: Where three (3) indoor units are connected to valve 1; rotary switch settings are 0,1,2 and 3,4,5,6,7 with "FF". (Prerequisite for manual pipe detection: The central control address of each indoor unit must be preset differently using its wired remote control.)

Example: An indoor unit with a central control address of "11" is connected to valve no. "1" of an heat recovery unit.

No.	Display / Setup	Description
1	 LED  SW01M  SW03M  SW04M  SW05M	Operation: None Display: None
2	 SSD  SW01M  SW03M  SW04M  SW05M	Operation: Turn DIP switch No. 1 on to address valve No. 1. Display: Existing value saved in EPROM is displayed on SSD.
3	 SSD  SW01M  SW03M  SW04M  SW05M	<ul style="list-style-type: none"> <li>• Operation: Set the "10" digit to the number in Group High data of the wired remote control connected to the corresponding indoor unit with the valve No. 1 by pressing left tact switch.</li> <li>• Display: Digit increases with the number of times the tact switch is pressed, shown on left SSD.</li> </ul>
4	 SSD  SW01M  SW03M  SW04M  SW05M	<ul style="list-style-type: none"> <li>• Operation: Set SW05M to "1".</li> <li>• Display: Former set value is shown on SSD.</li> </ul>
5	 SSD  SW01M  SW03M  SW04M  SW05M	<ul style="list-style-type: none"> <li>• Operation: Set SW03M, SW04M, and SW05M to "1".</li> <li>• Display: Set value is shown on SSD.</li> </ul>
6	 SSD  SW01M  SW03M  SW04M  SW05M	<ul style="list-style-type: none"> <li>• Operation: Turn DIP switch No.1 to off to save the address of valve No. 1.</li> <li>• Display : Set value from previous step disappears; SSD is blank.</li> </ul>
7	 SSD  SW01M  SW03M  SW04M  SW05M	<ul style="list-style-type: none"> <li>• Operation: Addressing the return valve of the heat recovery unit.</li> <li>• Display: SSD is blank.</li> </ul>

**Note:**

- The procedure described above must be performed for all heat recovery unit valves.
- Valves that do not have connected indoor units should be addressed with a number that has not been used. (Valves will not work if the address numbers are the same.)

## Addressing Heat Recovery Units

### Example of Checking the Valve Address

Example: An indoor unit with a central control address of "11" is connected to heat recovery unit valve No. 1.

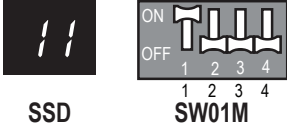
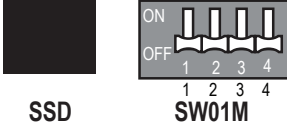
No.	Display / Setup	Description
1	 <p>SSD</p> <p>SW01M</p>	<ul style="list-style-type: none"> <li>• Operation: Turn DIP switch No. 1 to ON.</li> <li>• Display: "11" displays on SSD.</li> </ul>
2	 <p>SSD</p> <p>SW01M</p>	<ul style="list-style-type: none"> <li>• Operation: Turn DIP switch No. 1 to OFF.</li> <li>• Display: SSD is blank.</li> </ul>

### Identifying the Manual Valve Address

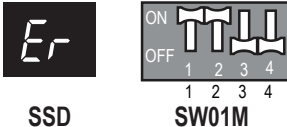
No.	Display / Setup	Description
1	 <p>SSD</p> <p>SW01M</p>	<ul style="list-style-type: none"> <li>• Operation: More than two (2) DIP switches turned ON.</li> <li>• Display: SSD displays "Er."</li> </ul>

#### Note:

- Wait for eighty (80) seconds after power is turned ON.
- Zoning and master indoor unit information are removed from EPROM after auto addressing.
- If a central control is installed, it is impossible to set the master indoor unit in zoning.

**Cool / Heat Selector (Fn1)**

The setting communicates to the outdoor unit that the optional LG Cool / Heat Selector is connected. The Cool / Heat Selector is field-wired to the “Dry 1” and “Dry 2” terminals located on the master outdoor unit main PCB.

Use the Cool / Heat Selector in heat pump systems (when all indoor units have to be in the same mode) to set the system mode for all cooling operation, all heating operation, or fan operation.

Recommended for use in heat pump systems only.

Setting the Cool / Heat Selector Function.

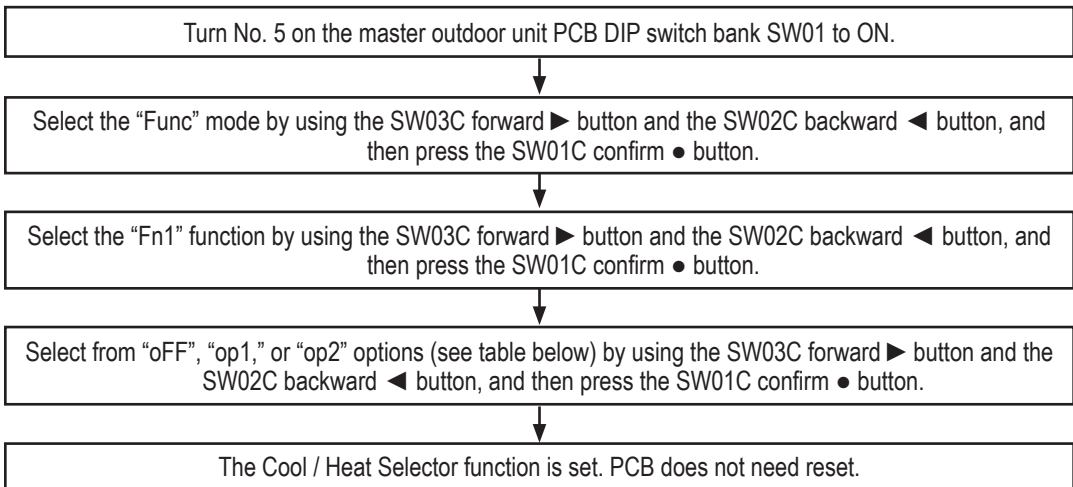

Cool / Heat Selector.

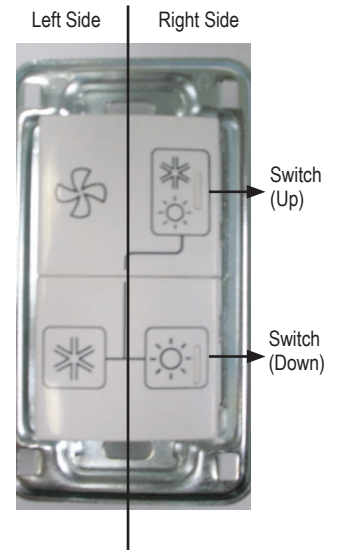

Table 12: Cool / Heat Selector Function Settings.

Switch Control		Function		
Switch (Up)	Switch (Down)	oFF	op1 (Mode)	op2 (Mode)
Right Side (On)	Left Side (On)	Not Operating	Cooling	Cooling
Right Side (On)	Right Side (On)	Not Operating	Heating	Heating
Left Side (Off)	-	Not Operating	Fan Mode	Off

**Note:**

- The Cool / Heat Selector must be installed first before setting the cool / heat operation function.
- A trained LG service provider must set this function during system installation.
- If cool or heat function is not used, set to OFF.
- Cool / Heat Selector is not for use with central control.

### Static Pressure Compensation Function (Fn2)

Static Pressure Compensation function modifies the maximum outdoor unit fan speed during normal system operation. Use to raise the maximum outdoor unit fan speed to compensate for an obstruction (duct) in airflow.

The default outdoor fan external static pressure rating for Multi V 5 Outdoor Units is 0.16 in-wg. Selecting “op3” raises the fan speed to produce the same airflow at 0.32 in-wg.

Refer to the Multi V Engineering Manuals for the default static pressure rating, and the maximum static pressure rating with this function engaged.

For use on both heat pump and heat recovery systems.

#### Note:

- Ask a trained LG service provider to set this function during system installation.
- If the outdoor unit RPM is changed, cooling capacity may be reduced.

Setting the Static Pressure Compensation Function.

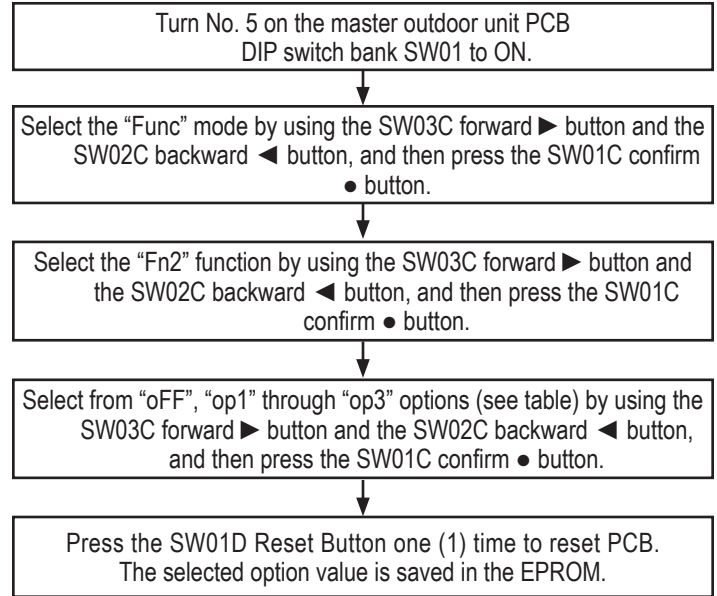

Table 13: Setting Static Pressure Compensation Function.

Settings	Nominal 6 Ton (RPM)	ESP (in-wg)	Nominal 8 to 20 Ton (RPM)	ESP (in-wg)
oFF (Default)	880	0.16	1,000	0.16
op1	910	0.231	1,040	0.25*
op2	930	0.271	1,070	0.27*
op3	950	0.32	1,100	0.32

\*Settings “op1” and “op2” are interpolated external static pressure values given the values for “oFF” and “op3”.



### Night Low Sound Function (Fn3)

The Night Low Sound Function reduces the operating speed of the outdoor unit fans (according to the input signal) when in cooling mode. Operating at a low RPM reduces the fan sound levels of the outdoor unit at night, which usually has a low cooling load.

On a rolling 24 hour basis, an internal timer begins counting hours after the start time (delay set after peak cooling recorded operation), switching to restricted fan speed duration operation, following whatever settings have been chosen.

For use on both heat pump and heat recovery systems.

Setting the Night Low Sound Function.

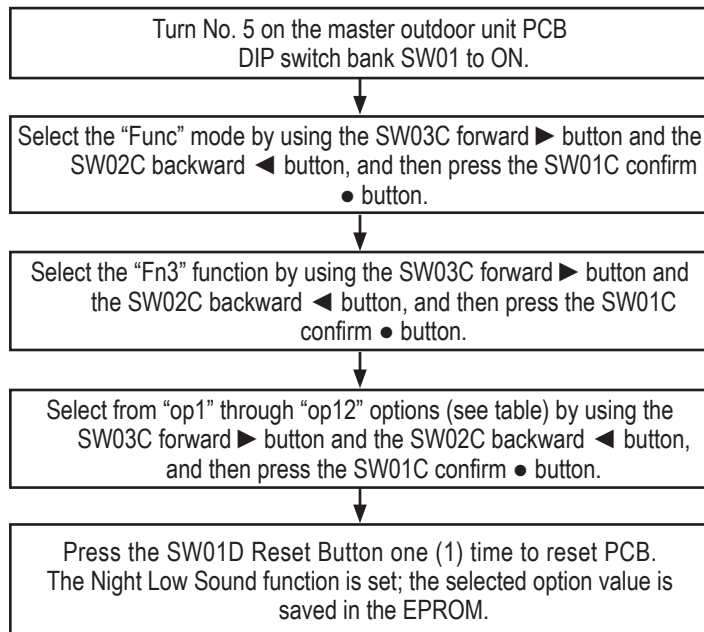

Table 14: Setting the Time and Related Sound Level.

Settings	Start Time (Delay after Peak Cooling Recorded) (Hour)*	Restricted Fan Speed Duration (Hour)	Approximate Noise Level dB(A)	
			6 Ton	8 to 20 Ton
op1	8.0	9.0	55	59
op2	6.5	10.5	55	59
op3	5.0	12.0	55	59
op4	8.0	9.0	52	56
op5	6.5	10.5	52	56
op6	5.0	12.0	52	56
op7	8.0	9.0	49	53
op8	6.5	10.5	49	53
op9	5.0	12.0	49	53
op10 (Default)	0.0 (Continuous Operation)	24.0	55	59
op11	0.0 (Continuous Operation)	24.0	52	56
op12	0.0 (Continuous Operation)	24.0	49	53

\*The system measures ambient temperature (minimum and maximum) in "Wait Time" to help determine when the system can start operating in Night Low Sound.

### (Overall) Defrost Function (Fn4)

Overall Defrost Function allows the outdoor unit to operate in either full frame (overall) defrost or in partial defrost (or partial frame defrost in multi-frame systems). Overall defrost is when the entire coil is in defrost per cycle. Partial defrost is when half the coil (or one frame in a multi-frame system) is in defrost first, then the other half of the coil (or another frame in a multi-frame system) is in defrost next, then the first half of the coil is in defrost again, per cycle. Use in locations where relative humidity remains high during the heating season, or in applications where it has proven that operating all the outdoor units in defrost at the same time saves energy, and / or shortens the defrost time without impacting comfort levels.

Can also be used with Fn6 - Rapid Defrost, and Fn22 - Overall Defrost Operating in Low Temperatures (Heating).

For use on both heat pump and heat recovery systems.

Table 15: Setting the Overall Defrost Function.

Options	Function
on	System Operates in Full Frame (Overall) Defrost
oFF	System Operates in Partial Defrost (or Partial Frame Defrost in Multi-Frame Systems)

### Outdoor Unit Addressing Function (Fn5)

Use this function to set the system address of the outdoor unit when a central controller has been installed. If multiple systems (master units) are wired to the central control bus, each system is assigned to a unique outdoor unit address. If not properly addressed, a communication error could occur or one (1) or more of the systems.

For use on both heat pump and heat recovery systems.

#### Note:

- The central controller must be installed first before setting the outdoor unit address.
- A trained LG service provider must set this function during system installation.

Setting the Overall Function.

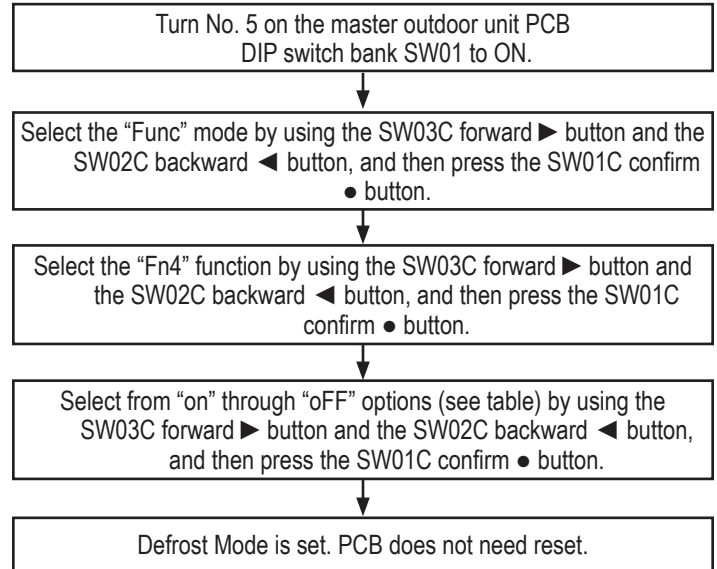

#### Note:

A trained LG service provider must set this function during system installation.

Setting the Outdoor Unit Address Function.

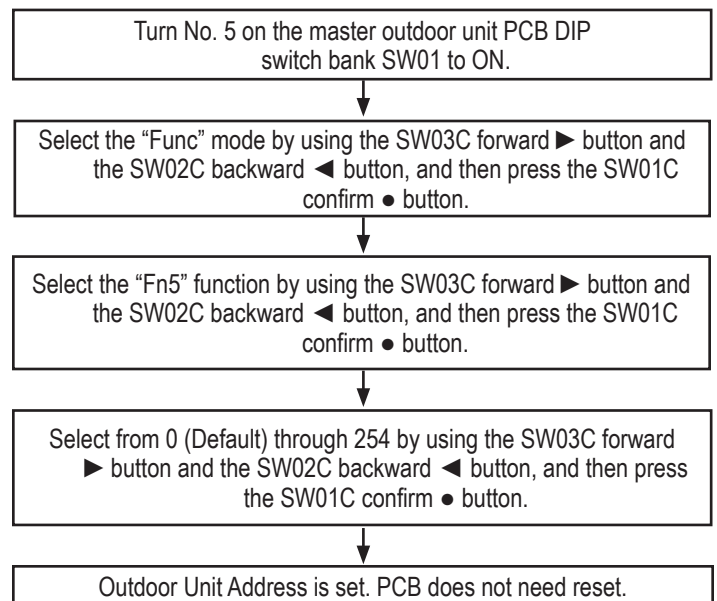

## Snow Removal Assist / Rapid Defrost Function (Fn6)

### Snow Removal Assist

Snow removal assist function allows the outdoor unit(s) fans to operate at regular intervals, for two (2) minutes, at specified speeds below to remove snow.

The function will only operate when the system has not called for a compressor start (no demand for heating or cooling) for thirty (30) minutes, and the outdoor air temperature is <37°F.

### Rapid Defrost

Rapid defrost function puts the entire system in defrost at the same time, and limits the amount of frost and ice allowed to build on the coil between defrost cycles. System pressure is monitored, and when system performance is reduced, the defrost cycle is initiated.

Snow removal assist / rapid defrost can also be used with Fn4 - Overall Defrost, and Fn22 - Overall Defrost Operating in Low Temperatures (Heating).

Snow Removal Assist and Rapid Defrost can be used on both heat pump and heat recovery systems.

Setting the Snow Removal / Rapid Defrost Function.

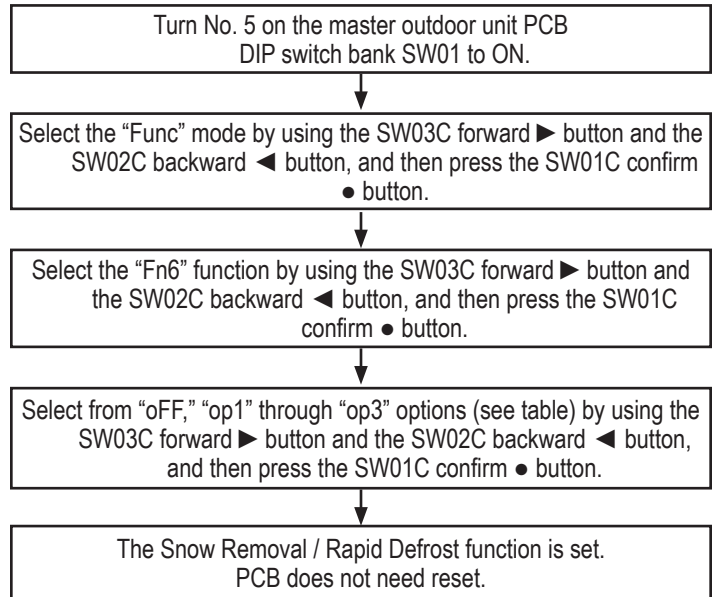

### Note:

- A trained LG service provider must set this function during system installation.
- If the snow removal / rapid defrost mode is not used, set to OFF.

Table 16: Setting the Snow Removal / Rapid Defrost Function.

Settings	Details	Fan Speed During Snow Throw (RPM)	
		6 Ton	8 to 20 Ton
oFF (Default)	Mode Is Not Set	-	-
op1	Snow Removal Assist Mode	670	850
op2	Rapid Defrost Mode	-	-
op3	Snow Removal Assist Mode and Rapid Defrost Mode	670	850

## Customizing Operation

### Low Ambient Kit Function (Fn9)

The function notifies the outdoor unit that a low ambient kit is installed. Use in zones that will need cooling when outdoor ambient temperatures fall below 5°F.

For use on both heat pump and heat recovery systems. Optional low ambient baffle kits allow for Multi V 5 outdoor unit operation down to -9.9°F. When used with heat recovery operation, low ambient cooling to -9.9°F is possible only when all indoor units are operating in cooling mode. The low ambient wind baffle kit does not impact synchronous operating range.

**Note:**

See the *Low Ambient Kit Installation Manual* on [www.lghvac.com](http://www.lghvac.com) for installation, etc., information.

Table 17: Setting the Low Ambient Kit Function.

Settings	Function
on	Low Ambient Kit is Installed
oFF	Default - Low Ambient Kit is Not Installed

### High Efficiency Function (Cooling Operation) (Fn10)

High Efficiency Function (Cooling Option) increases compressor capability, while reducing the target low pressure, to cool at high ambient temperatures. The function increases compressor operation, so energy use may also rise. Use for cooling dominant installations, and on both heat pump and heat recovery systems.

**Note:**

Always verify the refrigerant charge is correct before using this function.

Table 18: Setting the High Efficiency Function (Cooling Operation).

Settings	Function
on	High Efficiency Function (Cooling Operation) Selected
oFF	Default

#### Setting the Low Ambient Kit Function.

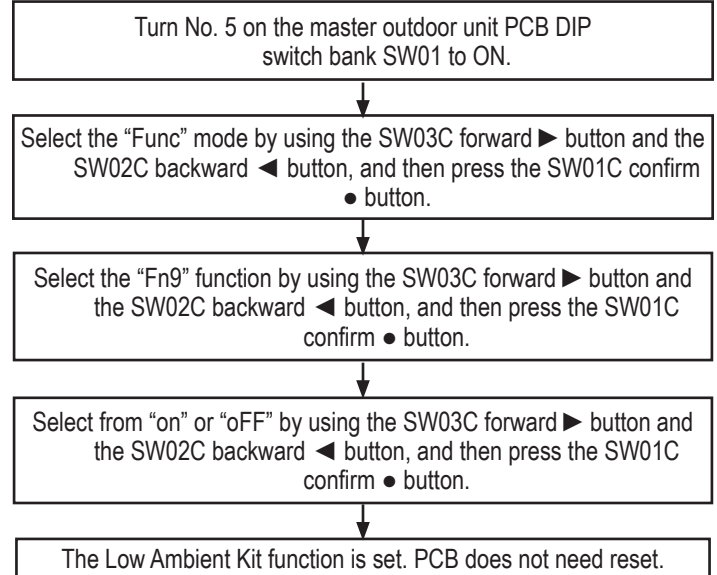

#### Setting the High Efficiency Function (Cooling Operation).

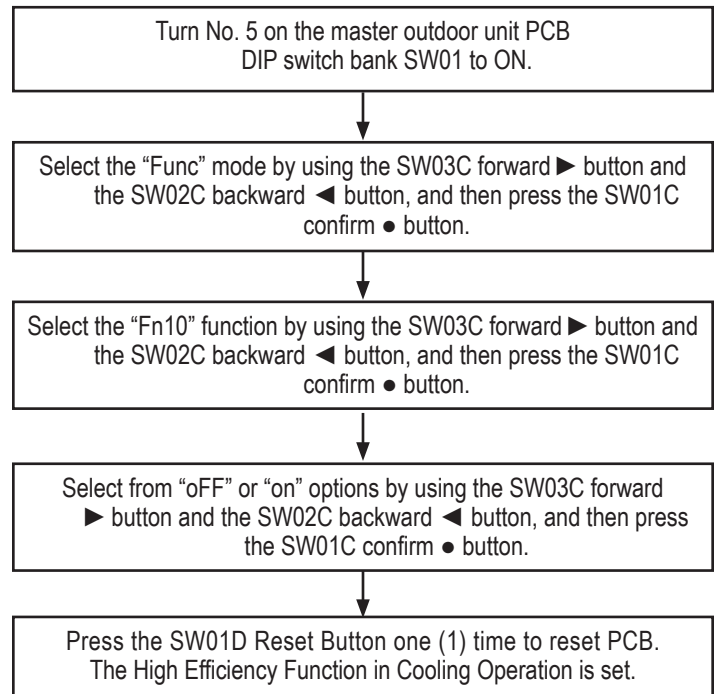

### High Efficiency Function Cooling Operation (Auto Dust Mode) (Fn11)

High Efficiency Function (Auto Dust Mode) attempts to remove sand / debris that may have collected on the outdoor unit coil. After the cooling, heating, etc., mode is satisfied, this function will start the fan motors, operating them at full speed and in the reverse direction. Air is drawn in through the top of the outdoor unit, and passes through the coil to help dislodge any loose debris.

The op3 setting requires an LG I / O Module to be installed in the master outdoor unit. If a binary signal is sent to the outdoor unit via a third party source, normal VRF system operation can be interrupted, and the Auto Dust Throw function can be performed. All other settings will not interrupt the Multi V system operation

Use on both heat pump and heat recovery systems.

**Note:**

The Auto Dust Mode function is not a substitute for coil cleaning and does not clear the coil of all debris. A coil cleaning procedure should be included when performing regular preventative maintenance.

Setting the High Efficiency Function (Auto Dust Mode).

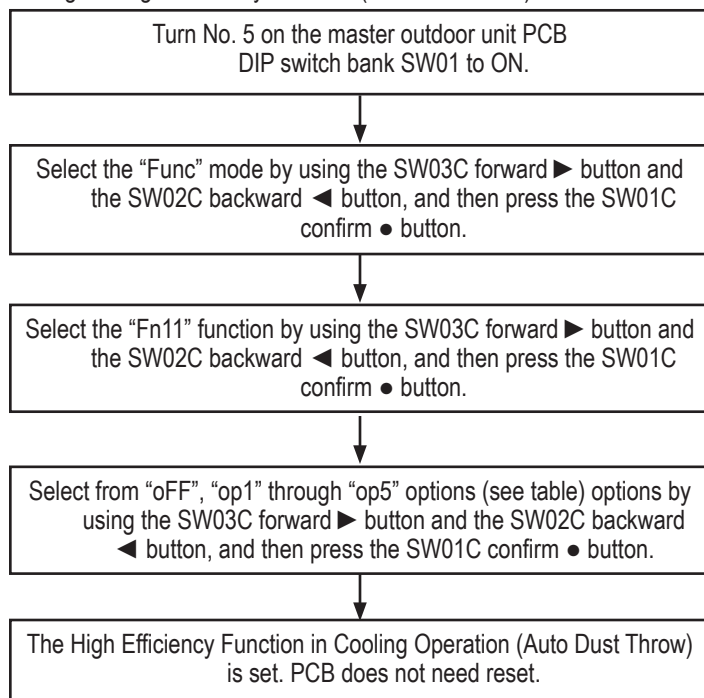

Table 19: Setting the High Efficiency Function (Auto Dust Mode).

Settings	Reverse Cycle Fan Runtime (Minutes)	Time Delay Between Cycles	Number of Cycles
Off (Default)	-	-	-
op1	5	2 Hours	No Limit
op2	5	2 Hours	2
op3*	3	5 Minutes Following Compressor Shutdown	1
op4	1	-	1
op5	1	1 Hour	2

\*op3 requires LG's I / O Module.

### Smart Load Control (SLC) Function (Fn14)

Smart Load Control Function may assist in reducing energy by lowering compressor lift during off-peak hours and shoulder seasons. The function adjusts compressor lift by reading outdoor ambient temperature, humidity (if FN16 is set to on), and current heating or cooling demand in real time.

#### Smart Load Control Options:

- Smooth Mode (oP1): Maximize energy savings; rate of temperature change less important.
- Normal Mode (oP2): Balance the rate of temperature change with energy consumed.
- Peak Mode (oP3): Quickly cool / heat the building; energy consumption less important.

All three (3) options only run for twenty (20) minutes of operation following a compressor start. Following the twenty (20) minute morning warm-up (or cool-down period), Smart Load Control will then use the same algorithm irrelevant of which Smart Load Control option selected.

Smart Load can be used in almost every application except those where the outdoor unit is serving a Dedicated Outdoor Air System (contact an LG representative for information).

Use on both heat pump and heat recovery systems.

### Humidity Reference (Fn16)

When humidity reference is selected (on), the master outdoor unit microprocessor considers the outdoor ambient humidity condition when making adjustments to the control values of the refrigeration cycle.

The Humidity Reference function is used by Smart Load Control (FN14), Comfort Cooling (ID10 [see Multi V 5 Service Manual]), and core logic Intelligent Defrost – Smart Heating algorithms to prepare the system for changes in the building load.

For use on both heat pump and heat recovery systems.

Table 21: Setting the Humidity Reference.

Settings	Function
oFF (Default)	Mode Not Set; Disabled
on	Humidity Reference On

#### Note:

- When using the Smart Load Control in cooling mode, the Humidity Reference function may assist in improving energy savings because the evaporation temperature decreases.
- If high humidity conditions exist when the system is operating in heating mode, defrost mode will be delayed because target high / low pressure will be changed (Intelligent Defrost - Smart Heating).
- If Comfort Cooling is selected for one (1) or more indoor units, then the superheat reset will be delayed or will not reset at all under humid outdoor conditions. See the Multi V 5 Service Manual.

Setting the Smart Load Control Functional.

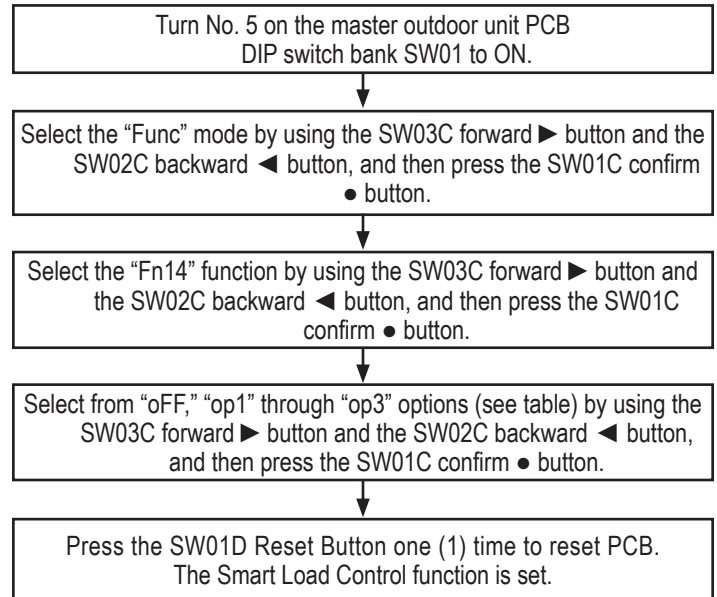
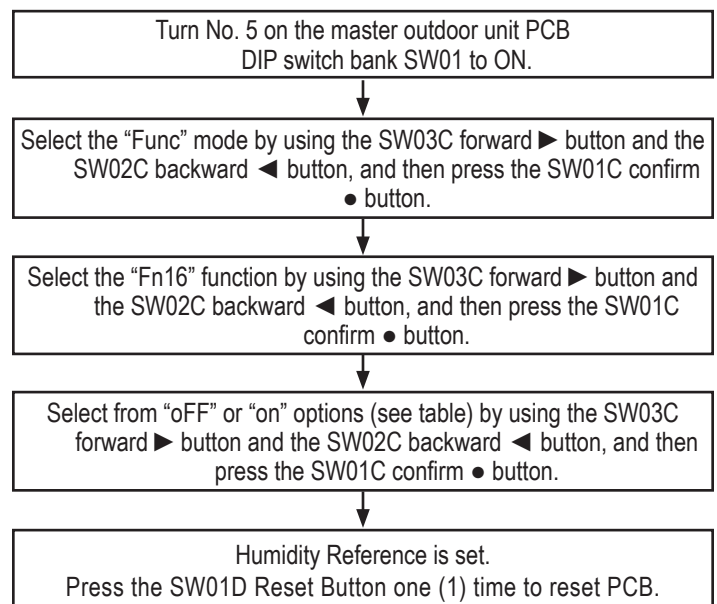

Table 20: Setting the Smart Load Control Function.

Settings	Mode	Details (First Twenty [20] Minutes)
oFF (Default)	Not Selected	-
oP1	Smooth	Maximize Energy Savings
oP2	Normal	Balance the Temperature Rate of Change with Energy Consumed
oP3	Peak	Quickly Change the Temperature.

Setting the Humidity Reference Function.



**Central Control Connection at the Indoor Units (Fn19)**

Central Control Connection function allows the field connection of the LG AC EZ central controller to the indoor unit communications bus on Multi V 5 systems.

For use on both heat pump and heat recovery systems.

**Note:**

AC EZ controller was discontinued in the U.S. market January 2016.

Table 23: Setting the Central Control Connection Function.

Settings	Connecting Central Control at IDU Terminals
oFF (Default)	Not Allowed
on	AC EZ Connected to the Indoor Unit Communications Bus

**Power Consumption Display (Fn21)**

The function tells the outdoor unit (master outdoor unit if a multi-frame system) that power consumption should be monitored. The function also communicates to the outdoor unit if it will be responsible for reporting the data to the central control device(s), or if an (optional) LG Power Distribution Integrator (PDI) will be responsible for reporting.

When the optional PDI is installed, the PDI will monitor outdoor unit power consumption. PDI allocates outdoor unit power consumed to indoor units based on the volume of refrigerant flow through each indoor unit during the billing period.

Power consumption data can then be viewed using an LG ACP or AC Smart central controller, LG MultiSite Communications Manager, and LG zone controllers. For installations where a third-party BMS system is present, consumption data is also made available for through LG's BACnet Gateway.

For use on both heat pump and heat recovery systems.

Table 22: Setting the Power Consumption Function.

Settings	Power Monitoring
oFF (Default)	No Power Monitoring
Pd10	Outdoor Unit Assigned Reporting Duty
Pd11	PDI Installed and Assigned Reporting Duty

Setting the Central Control Connection at the Indoor Units.

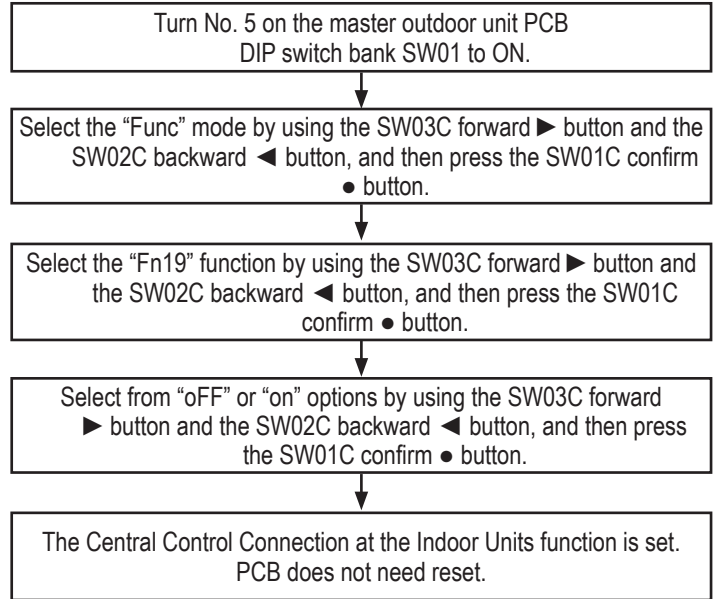

Setting the Power Consumption Display Function.

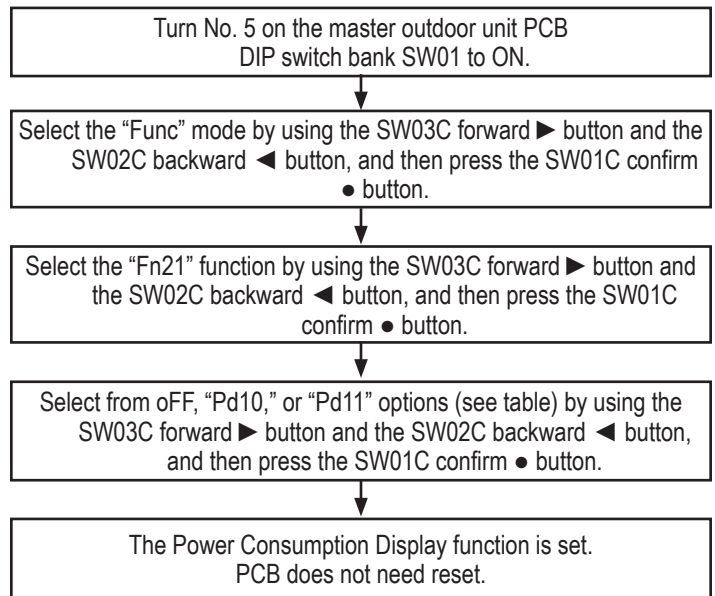

### Overall Defrost Operating in Low Temperatures (Heating) (Fn22)

The Overall Defrost Operating in Low Temperatures function overrides LG's Intelligent Defrost algorithm, and defrosts first the lower half of the coil, then followed by a full coil defrost. On multi-frame systems, all frames are in defrost simultaneously. Defrost operation occurs every three (3) hours, irrespective of need, whenever the outdoor air temperature is <14°F.

Used in locations where heavy snow fall is prevalent, or when a small amount of ice build-up on the coil has a noticeable impact on building comfort.

Overall Defrost Operating in Low Temperatures can also be used with Fn4 - Overall Defrost, and Fn6 - Snow Removal Assist / Rapid Defrost.

For use on both heat pump and heat recovery systems.

Table 24: Setting the Overall Defrost Operating in Low Temperatures (Heating).

Settings	Overall Entrance for Low Ambient Defrost
oFF (Default)	No
Setting	Yes

### Base Pan Heater (Optional) Function (Fn23)

Informs the master outdoor unit microprocessor an optional field-installed base pan heater (sold separately) is installed in the outdoor unit. Selecting to engage this option should only be done if a properly sized third-party heater is in place to keep the bottom surface of the outdoor unit >32°F.

The microprocessor will power outdoor unit PCB terminal "CN25\_Basepan Heater" when at least one (1) compressor in the frame is operating, the outdoor air temperature is <39°F, and either the following conditions occur:

1. Outdoor unit is operating in heating.
2. Outdoor unit is in defrost.

The controller will shut off base pan heating operation when the outdoor air temperature rises >39°F, or when all compressors stop operating.

For use on both heat pump and heat recovery systems.

#### Note:

On multi-frame systems, it is possible for one (1) or more frame(s) to be operating in heating, and have another frame operating in cooling.

#### Setting the Low Temperatures Defrost Function (Heating).

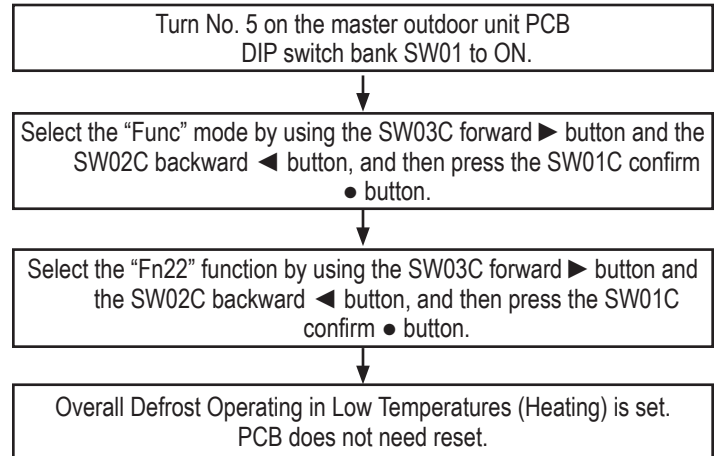

#### Setting the Base Pan Heater Function.

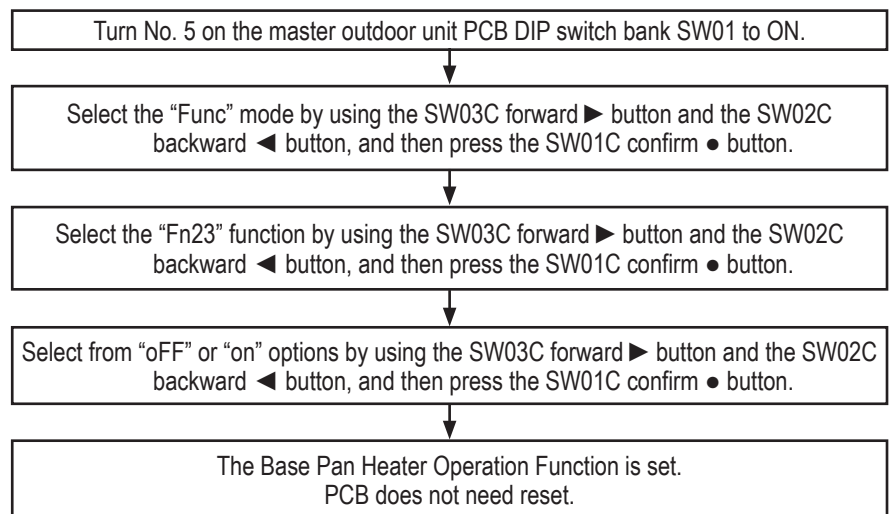

Table 25: Setting the Base Pan Heater Function.

Settings	Base Pan Heater Kit Installed
oFF (Default)	No
on	Yes



**Comfort Cooling (Id10)**

When comfort cooling is on, the indoor unit cooling coil target superheat value is raised in steps as the space temperature approaches the setpoint temperature. This results in warmer chilled air coming from the indoor unit. Comfort Cooling must be set on an indoor unit to indoor unit basis unless the apply to all option is selected.

Table 26: Setting Comfort Cooling Operation.

Settings	Function
00	OFF, Do Not Use Comfort Cooling on the Selected Indoor Unit.
01	4°C (7.2°F)
02	2°C (3.6°F)
03	1°C (1.8°F)

Setting the Comfort Cooling Operation Mode.

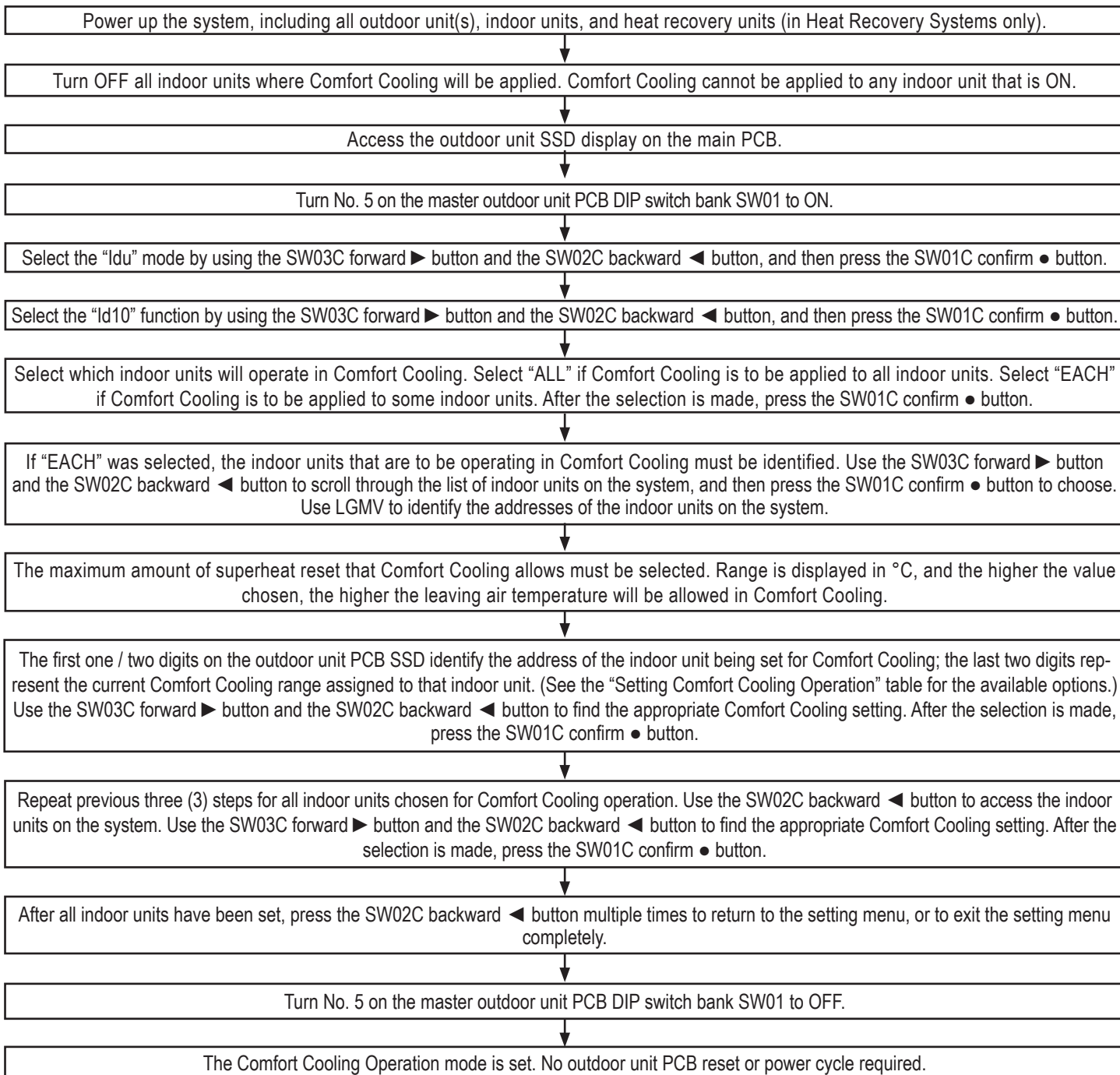

# MAINTENANCE



## Preventive Maintenance Schedule

Category.	Item	Weekly Check	Monthly Check	Semi-Annual Check	Annual Check
General Cleaning	Grilles	—	0	0	0
	Filter	—	0	0	0
	PCB Check for Corrosiion	—	—	0	0
	Drain Pan (disassembled)	—	—	0	0
	Fan Blade Inspection	—	0	0	0
	High Pressure Cleaning of HEX	—	—	—	0
	Plasma Filters (if present)	—	—	—	0
	Bacteria cleaning	—	—	—	0
Outdoor Units	Refrigerant Pressure (LGMV)	—	0	0	0
	Compressor Noise (level and quality)	—	0	0	0
	Fan Noise (IPM and condenser)	—	0	0	0
	Inspect/Clean ODU Coil Fins	—	0	0	0
	PCB Status (dust, etc.)	—	0	0	0
Indoor Units	Fan Noise Status	0	0	0	0
	Dust Buildup – IDU Panels	0	0	0	0
	Check Controller	0	0	0	0
	Check Discharge Temperature	0	0	0	0
	Drain Pump	—	—	0	0
	Check/Clean Drain Pan	—	—	0	0
	Check Piping/Insulation	—	—	—	0
	PCB Status (dust, etc.)	—	—	—	0
	Inspect Indoor Coil Fins	—	—	—	0

0 : Recommended to perform

— : Not Required

### Note:

It is also recommended to monitor system operation using LGMV Software at least once a year.

## LG Monitoring View (LGMV) Diagnostic Software

LG Monitoring View (LGMV) software allows real-time monitoring of Multi V system operating parameters, and can be used to commission new systems. LGMV software can also help the service technician or LG trained commissioner to troubleshoot existing system operation issues by displaying error codes. Also, LGMV data can be recorded to a .csv file and emailed to an LG representative to assist with diagnostic evaluations.

LGMV is available in different formats, including Mobile LGMV, which is an app for use on wireless devices. Contact your LG Sales Representative for more information, including recommended PC or mobile device configurations.

LGMV Monitoring Screen.

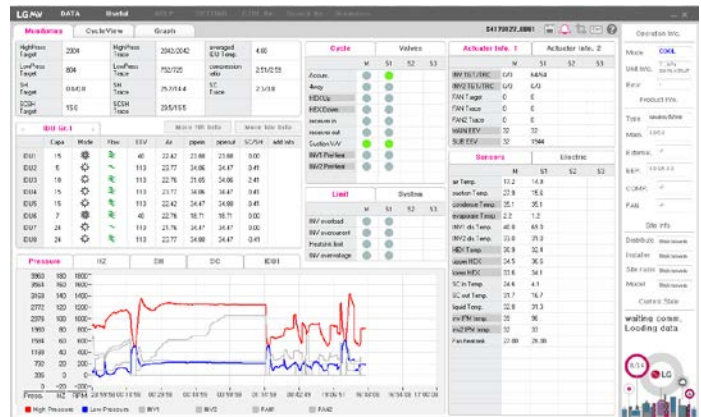

### Note:

Images on these pages are examples of LGMV screenshots. Actual images may differ depending on the version of the software and the units installed.

### LGMV Display

LGMV displays the following real-time data:

- Actual inverter compressor speed
- Target inverter compressor speed
- Actual outdoor fan speed
- Target outdoor unit fan speed
- Actual superheat
- Target superheat
- Actual subcooler circuit superheat
- Target subcooler circuit superheat
- Main EEV position
- Subcooling EEV position
- Inverter compressor current transducer value
- Outdoor air temperature
- Actual high pressure/saturation temperature
- Actual low pressure/saturation temperature
- Suction temperature
- Inverter compressor discharge temperature
- Constant speed compressor discharge temperature
- Front outdoor coil pipe temperature
- Back outdoor coil pipe temperature
- Liquid line pipe temperature
- Subcooler inlet temperature
- Subcooler outlet temperature
- Average indoor unit (IDU) pipe temperature
- Inverter compressor operation indicator light
- Four-way reversing valve operation indicator light
- Pressure graph showing actual low pressure and actual high pressure levels
- Error code display
- Operating mode indicator
- Target high pressure
- Target low pressure
- PCB (printed circuit board) version
- Software version
- Installer name
- Model no. of outdoor units
- Site name
- Total number of connected indoor units
- Communication indicator lights
- Indoor unit capacity
- Indoor unit operating mode
- Indoor unit fan speed
- Indoor unit EEV position
- Indoor unit room temperature
- Indoor unit inlet pipe temperature
- Indoor unit outlet pipe temperature
- Indoor unit error code

Additional screens can be accessed by tabs on the main screen. Additional screens include:

1. Cycleview: Graphic of internal components including:
  - Compressors showing actual speeds
  - EEVs
  - Indoor units
  - Liquid injection valves
  - Temperature and pressure sensors
  - Four-way reversing valve
  - Outdoor fans showing status and speeds

LGMV Cycleview Screen.

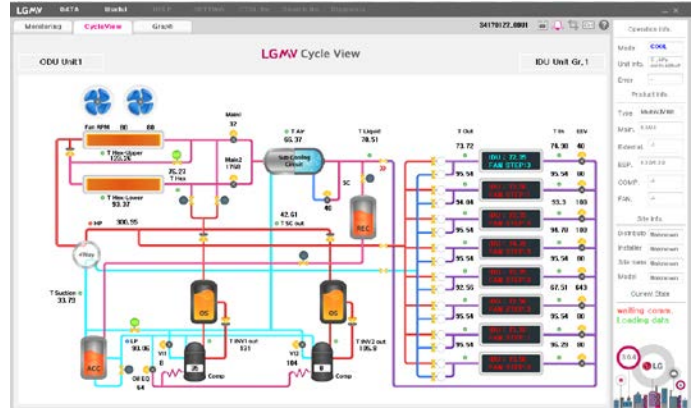

2. Graph: Full screen graph of actual high and low pressures and high and low pressure limits. A sliding bar allows viewing of previously recorded data.

LGMV Graph Screen.

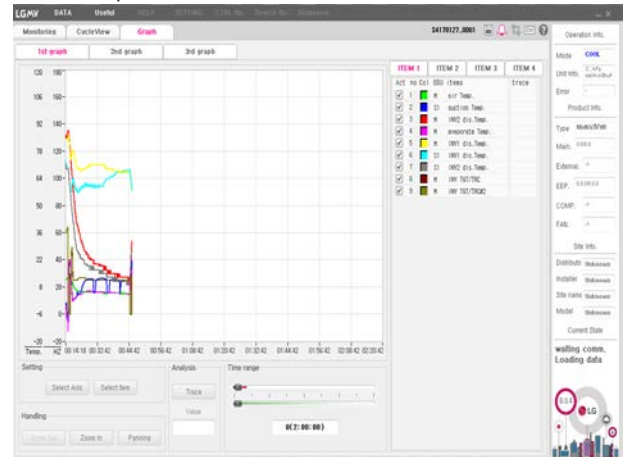

3. Control IDU: Enables user to turn on IDU's default setpoints of 86°F in heat mode or 64°F in cool mode.

4. Setting: Converts metric values to imperial values.

5. Making Data: Recording of real time data to a separate file created to be stored on the user's computer.

6. Loading Data: Recorded data from a saved ".CSV" file can be loaded to create an LGMV session.

7. Electrical Data: The Electric tab on the main screen is changed to show the following:

- Inverter compressor
  - Amps
  - Volts
  - Power Hz
  - Inverter control board fan Hz
- Constant compressor
  - Current transducer value
  - Phase

### Note:

Images on these pages are examples of LGMV screenshots. Actual images may differ depending on the version of the software and the units installed.

### Self Diagnostics Check

All switches on outdoor unit PCB DIP Switch bank SW01 are factory set to OFF. To prepare for the self diagnostics check:

1. Verify that all indoor unit models are Gen 4. (See “DIP Switch Settings for Use With GEN 4 Indoor Units” earlier in this section.)
2. Flip No. 3 on DIP Switch bank SW01 to ON.
3. Push the reset SW01D button.

### Run Self Diagnostics Check

#### Note:

If the indoor units have already been successfully assigned a system address, skip this step and go to “Assign Addresses to the Heat Recovery Units.”

1. Power all indoor units.
2. Power all heat recovery units in conjunction with powering indoor units (heat recovery systems only).
3. Verify the outdoor units to indoor units / heat recovery units communications cable is installed and terminated correctly.
4. Verify the communications cable between outdoor unit frames is installed and terminated correctly. Inspect terminals (SODU [B] and SODU [A]) at each outdoor unit.
5. Verify that DIP Switches 6 and / or 7 on the slave outdoor unit(s) were properly adjusted for the job site configuration.
6. Power all outdoor units. Order does not matter on multi-frame installation.
7. As the power is provided to the main printed circuit board (PCB) on the Master outdoor unit, observe the SSD.
  - Wait. The perimeter segments will flash in sequence for 45 seconds.
  - Verify the microprocessor’s outdoor unit configuration agrees with the submittal information approved the design engineer (see Tables below).
  - Confirm that this step has been completed by checking the box provided on the Record following the information as it is provided. The date is provided in sequence, and segment of the sequence will remain lit for two (2) seconds.

Location of SW01 and SW01D.

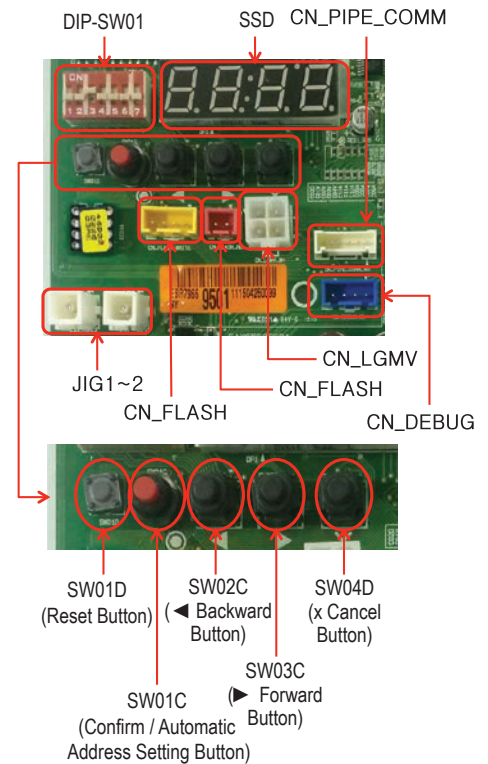

DIP Switch Bank SW01 Settings.

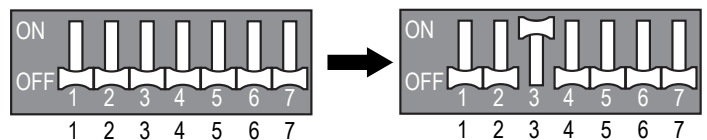

Table 27: Display Code Definitions—Outdoor Unit Nominal Capacity.

Display Code	8	10	12	14	18	20	22	24	26	28	32	34	36	38	40	42
Nominal Mb/h	6	8	10	12	14	16	18	20	22	24	26	28	30	32	34	36

Table 28: Display Code Definitions—Voltage.

Outdoor Unit Code	22	46
Electrical Requirements	208-230V / 60Hz / 3Ø	460V / 60Hz / 3Ø

Table 29: Segment Display Sequence (Two [2] seconds per segment following a forty-five [45] second wait).

Sequence	Description	Code(s)	
1	Master Outdoor Unit Nominal Capacity	8 - 14*	
2	Slave1 Outdoor Unit Nominal Capacity	8 - 24*	
3	Slave2 Outdoor Unit Nominal Capacity	8 - ~*	
4	Total Nominal Capacity of System	8 - ~ *	
5	Unit Type	Heat Pump	2
		Heat Recovery	3
6	Unit Voltage	208-230V / 60Hz / 3Ø	22
		460V / 60Hz / 3Ø	46
7	Efficiency Level	1 or 2	

\*See Tables above for code definitions.

### Integrated Test Run (ITR) (Fd7)

The algorithm tests the operation of all components and system functions. Using a batch file concept, the routine begins by asking the technician to enter the total refrigerant charge in kilograms.

#### Note:

Unlike previous versions of Multi V where the user selected heating or cooling mode for the Integrated Test Run function, Multi V 5 automatically selects which mode to use based on outside air temperature.

#### Procedure

1. Connect a computer with LGMV software to the Master ODU.
2. Start the LGMV software.
3. Select ID7 on the Master outdoor unit seven segment display (SSD).
4. "INIT ITR" will be displayed (Initiate Integrated Test Run)
5. Use the SSD and the control buttons below it to enter the system refrigerant charge by weight in kilograms. The system refrigerant charge is the sum of the field provided refrigerant charge and the factory refrigerant charge shipped with each outdoor unit.

#### Note:

See the specification tables in the Product Data section for the factory refrigerant charge in pounds.

#### Example:

ARUM432BTE5

- Consisting of (2) ARUM121BTE5 + (1) ARUM192BTE5
- Factory charge ARUM121BTE5 = 23.2 lbs each
- Factory charge ARUM192BTE5 = 30.9 lbs
- Field trim charge : 10.5 lbs

System refrigerant charge = (Factory charge of frame 1 + Frame 2 + Frame 3)+(Field-supplied Refrigerant)

System refrigerant charge = (23.2 + 23.2 + 30.9) + 10.5 = 87.8 lbs.

To convert the refrigerant charge from pounds to kilograms:

Kilograms refrigerant = pounds refrigerant x 0.453592

Kilograms refrigerant = 87.8 x 0.453592  
= 3.983 kilograms

6. Press the confirm/accept button on the ODU under the SSD.
7. Observe the SSD displays "88" to confirm the ITR is running. The ITR will run for approximately 5 to 30 minutes. When "88" is no longer displayed, the ITR has successfully completed.
8. If more than 30 minutes pass and "88" is still displayed, the ITR has failed. Contact your LG representative for technical assistance.
9. After a successful ITR, you can go to the LGMV Diagnostics tab, select Test Report, and save the .html data file. The report on the next page is a sample ITR report.

#### Note:

If an error occurs with an indoor unit, operate that indoor unit in fan mode, but make sure the auto address number of that indoor unit does not display.

### Multi V ITR Result Report

Follow the Procedure:

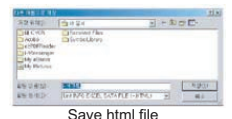

**VRF System Maintenance Self-Diagnostics Test & Report, Continued.**

Start up Confirmation													
Model type	Multi V 5 HR			Model Name	model na			The date of print	May 23, 2017 5:35:47 AM				
Installation Information													
	Name			Company Name & Address				Product					
Installation								ODU	1 EA (1.8.0)				
CIQ								IDU	4 EA				
Supervisor								HRU	1 EA				
Site								Total refrigerant	10.5 Kg				
*Please check the installation information with the actual products.													
ITR Conditions													
	Air Temperature			Standard				Status of ITR					
Indoor	74.1 °F			Cooling: 50.0°F ≤ Indoor air ≤ 95.0°F Heating: 41.0°F ≤ Indoor air ≤ 89.6°F				Operating Mode	ITR(Cooling)				
Outdoor	72.3 °F			Cooling: 23.0°F ≤ Outdoor air ≤ 113.0°F Heating: 5.0°F ≤ Outdoor air ≤ 95.0°F				ITR Error Information	-				
ITR Result													
Refrigerant				ODU EEV				IDU EEV					
CompletedRefrigerant : -3.1kg				-				Okay					
*Each Result is affected by the results of other items. After modifying the problem , please recheck.													
Cycle Summary													
Item	ODU1				ODU2				ODU3				Criterion For Judgment
	Minimum	Maximum	Average	Judgment	Minimum	Maximum	Average	Judgment	Minimum	Maximum	Average	Judgment	
High Pressure (kPa)	2729	2729	2729		0	0	0		0	0	0		2000~3500kPa (Cool/Heat)
Low Pressure (kPa)	1092	1092	1092		0	0	0		0	0	0		650~1200kPa (Cool) 200~1000kPa (Heat)
ODU EEV pulse	32	32	32		0	0	0		0	0	0		-
Discharg SH (°F)	-	-	40.3		-	-	0.0		-	-	0.0		18.0~90.0°F
Suction SH (°F)	-	-	11.7		-	-	0.0		-	-	0.0		0.9~54.0°F
Subcool (°F)	-	-	5.9		-	-	0.0		-	-	0.0		0.9~36.0°F
INV1 Discharge (°F)	-	-	158.0		-	-	572.0		-	-	572.0		122.0~212.0°F
INV2 Discharge (°F)	-	-	572.0		-	-	572.0		-	-	572.0		122.0~212.0°F
Input Voltage (V)	205	205	205		0	0	0		0	0	0		345~456V
Input Current (A)	10.2	10.2	10.2		0	0	0		0	0	0		20A↓
INV1 phase Current (A)	-	-	29.6		-	-	0		-	-	0		24A↓
INV2 phase Current (A)	-	-	0		-	-	0		-	-	0		24A↓
*Criterion for judgment stands for the boundaries to decide error condition for normal operating conditons. Therefore, even if it display error signal, it is recommended to re-confirm the results based on the physical behavior of air-conditioning and refrigeration system.													

## Adjusting Fan Performance on Ducted IDUs

---

---

### Setting External Static Pressure

Ducted units will need the fan speed adjusted to deliver the required airflow at the external static pressure (ESP) of the duct system. Settings are made using a wired remote controller and the air flow information found in the specific indoor unit's engineering manual. For instructions on how to set the ESP through the wired remote controller, consult the user's, owner's, and / or installation manual for that particular controller.

#### **Note:**

*It is always best if the air balance is completed prior to a request for an LG trained commissioner. If the air balancing contractor has not completed the work before commissioning, the LG trained commissioner is not responsible for setting the indoor unit air flow rates, fan speeds, or ensuring the air volume delivered at each indoor unit is per project specifications. Excessive or restricted airflow may impact the ability of the LG trained commissioner to successfully complete system commissioning. If any problems exist, request verification from the Test and Balance contractor. If necessary, provide instruction to the air balance technician on how to adjust the indoor unit fan setting value.*

#### Summary of External Static Pressure Procedure

1. Request / review the final air balance report (that includes the actual measured ESP[s] and required air flow rate[s]).
2. Note all required fan setting value changes.
3. Perform all required ESP (fan) setting value changes. A separate ESP (fan) setting value should be selected for each available indoor unit fan speed.
4. Check all fan setting values on zone controllers to verify adjustments were made.
5. Record the values on the Pre-Commissioning Device Configuration Worksheet.



Adjusting Fan Performance on Ducted IDUs

**Determining External Static Pressure and Setting the Values**

1. For ducted indoor units, the Engineering Manual includes tables listing setting values as they relate to ESP and airflow. The installer can use the available range of ESP settings to adjust for ductwork in the system. See table below for an example.

**Note:**

The indoor unit fan(s) cannot be allowed to operate outside manufacturer's parameters. Extended operation in these conditions will result in

- Fan surge (noisy & slow pulsating airflow), and / or
- Fan motor failure

Table 31: BR Unit External Static Pressure and Air Flow Table from Ducted Indoor Unit Engineering Manual.

Set Value	Static Pressure (in. wg)										
	0.19	0.23	0.31	0.39	0.47	0.55	0.59	0.62	0.66	0.70	0.78
91	1,642	1,543	1,349	1,105	819	494	317	130	-	-	-
96	1,762	1,628	1,518	1,183	1,098	649	483	317	91	-	-
101	1,839	1,772	1,691	1,395	1,320	964	889	628	314	215	-
106	1,815	1,808	1,779	1,568	1,522	1,176	1,133	1,020	741	632	293
111	1,892	1,896	1,868	1,762	1,705	1,433	1,419	1,158	1,112	960	618
116	-	-	-	1,967	1,794	1,582	1,504	1,416	1,327	1,147	974
121	-	-	-	-	1,843	1,794	1,776	1,613	1,575	1,370	1,137
126	-	-	-	-	-	-	1,921	1,808	1,779	1,624	1,536

2. The table below presents the ESP settings that the unit comes with from the factory, plus an additional "standard" setting.

Table 30: Example of BR Unit External Static Pressure and Air Flow (with Settings) from Ducted Indoor Unit Engineering Manual.

Model	Capacity (MBh)	Mode	Setting Value	Standard ESP (in. wg)	CFM	Min. ESP (in. wg)	Max. ESP (in. wg)
ARNU483BRA4	48.1	High (Factory Set)	High	116	1,582	0.39	0.78
			Mid	111			
			Low	106			
		Standard	High	106	1,568	0.27	0.55
			Mid	102			
			Low	95			

3. Once the available system static pressure requirements and the desired airflow rate are known, select the required ESP (fan) setting value(s). A separate ESP (fan) setting value should be selected for each available indoor unit fan speed.

**Note:**

Fan RPM = fan setting value x 10.

4. Record the values on the Pre-Commissioning Device Configuration Worksheet. If the fan setting value was left at the factory default, insert "000" in the blank.

## Error Codes

**⚠ WARNING** Please refer to the Safety Precautions on pages 4-7 for more detail to prevent injury or death regarding the operation and service troubleshooting of the Multi V product.

---

---

### General Information

LG VRF system's core logic uses error codes to indicate that an abnormal operation occurred. Error codes help guide a trained service technician identify why and what caused the error to display, and help track the frequency of malfunction occurrences.

There are four (4) levels of error code responses; the system responds accordingly, depending on the severity of the malfunction assigned to the malfunction. The level of responses range from "notify and keep operating" (Level 4), to "immediate system shutdown" (Level 1).

All error codes can be viewed at the outdoor unit seven segment display (SSD) and with LGMV software. If an error codes shows on one (1) or more indoor unit zone controllers, it will display on LGMV, central controllers, BMS, or any other LG device connected to Comm bus - Internet A/B. Indoor unit error code notifications will display differently based on location of the problem.

#### Level 4 Responses

Level 4 responses display the error code, but the system continues to operate (operate indefinitely). When the malfunction is fixed, the error code remains until the master outdoor unit's microprocessor is reset, and operation has resumed for 130 minutes without the malfunction reoccurring.

#### Level 3 Responses

Level 3 responses display the error code on all zone controllers, central controllers, and on BMS systems. For Level 3 responses, the Multi V system will shut down for three (3) minutes, and then the master microprocessor in the outdoor unit will automatically restart the system.

If the malfunction reoccurs up to a total of nine (9) times within one (1) hour, the system will display the error code, shut down, and restart again each time. If the malfunction occurs a tenth (10th) time within the same one (1) hour, the system shuts down permanently, assigning the error to a Level 1 response that requires a manual restart. The error code displays on the zone controllers and central controllers until the malfunction is fixed.

#### Level 2 Responses

Level 2 responses are communications related errors only. Level 2 responses activate after ten (10) attempts to communicate have occurred. After communications have been re-established, the error codes display for one (1) minute. If the communications are restored, then the error code disappears. If the communication is lost within one (1) minute, the error code remains.

Error codes for Level 2 responses stop appearing on the zone and central controllers as soon as communications are restored, without the need to reset power at the Master outdoor unit or to restart the entire system.

Multi V 5 error codes for Level 2 responses appear where the problem occurs, and time limits differ depending on type:

1. Communications lost between outdoor unit PCBs – no time delay.
2. Communications lost between the indoor unit and the outdoor unit for three (3) minutes.
3. Communications lost between the indoor unit and heat recovery unit for ten (10) seconds.
4. Communications lost between outdoor unit external PCBs for ten (10) seconds.

#### Level 1 Responses

Level 1 responses call for an immediate system shutdown, and only occur after the algorithm monitoring system verifies that the malfunction is real (to avoid nuisance alarms and false positives). Level 1 responses are displayed at zone controllers, central controllers, BMS, LGMV, and the outdoor unit SSD. They cannot be cleared until the problem that caused it is fixed.

Before a Level 1 response is assigned, the Multi V algorithm initially assigns a Level 3 response to any system malfunction that is not communications related. The system follows Level 3 protocol until the tenth (10th) time a malfunction occurs, at which time the system shuts down, the malfunction changes from Level 3 to Level 1, and a manual restart is required. The entire Level 3 auto restart to Level 1 shut down sequence will repeat until the malfunction is fixed.

### Note:

For more information on Multi V Levels and error codes, contact an LG trained technician.

For detailed information on how to troubleshoot each error, see the Multi V Service Manual on [www.lghvac.com](http://www.lghvac.com).

**⚠ WARNING** Please refer to the Safety Precautions on pages 4-7 for more detail to prevent injury or death regarding the operation and service troubleshooting of the Multi V product.

**Error Code Display**

The seven segment display on the main board displays error codes. Error codes are 3 or 4 digit numbers. The rightmost number designates the ODU frame (1=Master; 2=Slave1; 3=Slave2). The other two or three digits indicate the error.

Examples: 211 = Error No. 21 on master unit; 212 = Error No. 21 on slave 1 unit; 213 = Error No. 21 on slave2 unit, 1051 = Error No. 105 on master unit.

- If two or more errors occur simultaneously, the lower error code number is displayed first.
- After error is resolved, the error code disappears.

Example of an Error Code.

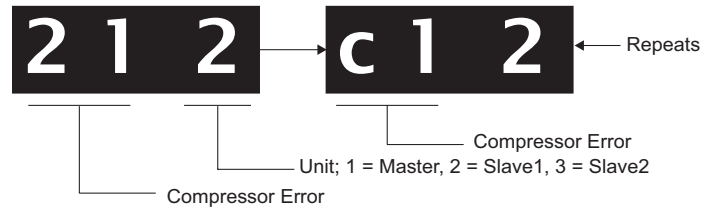

**Nomenclature Definitions**

- MICOM: Non-volatile memory chip where unit setup information is stored.
- EPROM: Non-volatile memory chip where device identification, size, and factory defined default component operating parameters are stored.

The error code tables below and on the following pages list the error codes used for Multi V systems. For detailed information on how to troubleshoot each error, see the Multi V 5 Service Manual on [www.lghvac.com](http://www.lghvac.com).

Table 32: Error Codes.

Error Code			Description	Details	
Indoor Unit	0	1	-	Indoor unit return air or optional remote wall temperature sensor communications error.	Indoor unit air temperature sensor disconnected or shorted. (Check the wiring, connection on the indoor unit PCB, then check the thermistor.)
	0	2	-	Indoor unit inlet pipe temperature sensor communication error.	Indoor unit inlet pipe temperature sensor is disconnected or shorted. (Check the connection on the indoor unit PCB, then check the thermistor.)
	0	3	-	Communication error between zone controller and indoor unit.	Indoor unit PCB is not receiving communications signal from zone controller.
	0	4	-	Indoor unit drain pump error.	Drain pump and/or flow switch is/are malfunctioning. Also check drain line for obstructions.
	0	5	-	<ul style="list-style-type: none"> <li>• Communication error between indoor unit communication PCB and indoor unit.</li> <li>• Communication error between outdoor unit and indoor unit.</li> </ul>	<ul style="list-style-type: none"> <li>• Indoor unit PCB is not receiving signal from indoor unit communications PCB for &gt;3 consecutive minutes. Check PCBs for issues.</li> <li>• Indoor unit PCB is not receiving communications signal from outdoor unit. Check indoor unit to outdoor unit communication cable connections for issues.</li> </ul>
	0	6	-	Indoor unit or hydro kit outlet pipe temperature sensor error.	<ul style="list-style-type: none"> <li>• Indoor unit outlet pipe temperature sensor is disconnected or shorted. (Check the connection on the indoor unit PCB, then check the thermistor.)</li> <li>• Hydro kit liquid side temperature sensor is disconnected or shorted. Values read less than -43°C or greater than +96°C (less than -45.4°F or greater than +204.8°F).</li> </ul>
	0	7	-	Indoor units are not operating in the same mode. (Heat pump applications only)	Different operation mode between indoor units.
	0	8	-	Hydro kit hot water storage tank temperature sensor error.	Pipe temperature sensor disconnected or shorted.
	0	9	-	Indoor unit EPROM error.	<ul style="list-style-type: none"> <li>• Communication error between the indoor unit PCB board and its option card. (The option card is about 1' x 1' and is plugged into the indoor unit PCB board. Check connection between the two.)</li> <li>• Communication error between EPROM on indoor unit main PCB.</li> <li>• Indoor unit EPROM data is not available.</li> </ul>

For detailed information on how to troubleshoot each error, see the Multi V Service Manual on [www.lghvac.com](http://www.lghvac.com).

# TROUBLESHOOTING

## Error Codes

**⚠ WARNING** Please refer to the Safety Precautions on pages 4-7 for more detail to prevent injury or death regarding the operation and service troubleshooting of the Multi V product.

Table 33: Error Codes, continued.

Error Code			Description	Details
1	0	-	Indoor unit BLDC fan motor communications error.	<ul style="list-style-type: none"> <li>Fan motor has been removed or is defective. Refer to the resistance and voltage check charts in the product service manual.</li> <li>The system has detected the fan motor is not spinning.</li> <li>On new installs, verify installation manual and paperwork were removed from fan discharge shroud during installation.</li> <li>Check the wiring plug and connections (if applicable).</li> </ul>
1	1	-	Communication error between hydro kit and inverter compressor PCB.	Hydro kit is not receiving communications signal from inverter compressor PCB.
1	2	-	Hydro kit inverter compressor PCB error.	Hydro kit inverter compressor PCB error.
1	3	-	Hydro kit solar heat pipe temperature sensor error.	Solar heat pipe temperature sensor disconnected or shorted.
1	4	-	Hydro kit flow switch error.	Flow switch failed to close.
1	5	-	Hydro Kit leaving water temperature has exceeded 185°F (85°C).	Temperature sensor is defective or there is hot water inflow.
1	6	-	Hydro kit indoor unit water pipe temperature and ambient temperature sensor communication error.	Water inlet and outlet pipe temperature sensor disconnected or shorted.
1	7	-	Hydro kit inlet pipe temperature sensor communication error. Outside air duct inlet pipe temperature sensor communication error.	<ul style="list-style-type: none"> <li>Water inlet temperature sensor disconnected or shorted. Values read less than -43°C or greater than +96°C (less than -45.4°F or greater than +204.8°F).</li> <li>Temperature sensor disconnected or shorted.</li> </ul>
1	8	-	Hydro kit outlet pipe temperature sensor communication error.	Outlet pipe temperature sensor disconnected or short circuited.
2	3	0	Refrigerant leak sensor error.	<ul style="list-style-type: none"> <li>Refrigerant leak sensor error; sensor is malfunctioning.</li> <li>Refrigerant leak is detected when &gt;6,000 ppm.</li> <li>Enable the function through the function code on the remote controller.</li> </ul> <ol style="list-style-type: none"> <li>Operation stop.</li> <li>Solenoid valve closes on the indoor unit side.</li> <li>CH230 is displayed. If the communication baud is 1,200 bps, then only the zone controller can display the CH230; central controller cannot display the error due to lack of information.</li> <li>Buzzer rings 2 long buzzes every 1 second. Ringing stops when there is an input from the controller. (If there is a hard lock, then only the controller can make the hard lock to stop buzzing. If leak sensor measures under 1.5V, then it is considered normal and the buzzing stops.</li> <li>To release the error, power needs reset.</li> </ol>
2	3	7	Communication error between indoor unit communications PCB and outdoor unit PCB.	Indoor unit communications PCB is not receiving signal from outdoor unit communication PCB for >3 consecutive minutes. Check PCBs for issues.
2	3	8	Communication error between outdoor unit communications PCB and outdoor unit.	Outdoor unit communications PCB is not receiving signal from outdoor unit for >3 consecutive minutes. Check PCB for issues.

For detailed information on how to troubleshoot each error, see the Multi V Service Manual on [www.lghvac.com](http://www.lghvac.com).



Please refer to the Safety Precautions on pages 4-7 for more detail to prevent injury or death regarding the operation and service troubleshooting of the Multi V product.

Table 34: Error Codes, continued.

Error Code			Description	Details	
Outdoor Unit	2	1	1	Master outdoor unit inverter board IPM fault error; Inverter driver detects overcurrent; Error code is determined by overcurrent in any one phase of compressor.	<ul style="list-style-type: none"> <li>Detected by the CT sensor on the IGBTM PC board.</li> <li>Overcurrent in compressor UVW phases.</li> </ul>
	2	1	2	Slave1 outdoor unit inverter board IPM fault error; Inverter driver detects overcurrent; Error code is determined by overcurrent in any one phase of compressor.	<ul style="list-style-type: none"> <li>Damaged compressor.</li> <li>Damaged IPM on inverter board.</li> <li>Compressor disconnected.</li> </ul>
	2	1	3	Slave2 outdoor unit inverter board IPM fault error; Inverter driver detects overcurrent; Error code is determined by overcurrent in any one phase of compressor.	<ul style="list-style-type: none"> <li>Damaged inverter board – input voltage too low. For 208-230V: 143A for minimum of 3μs; For 460V: 80A for minimum of 3μs.</li> </ul>
	2	2	1	Master outdoor unit inverter PCB input overcurrent (RMS) error.	<ul style="list-style-type: none"> <li>Overcurrent of outdoor unit inverter board PCB.</li> </ul>
	2	2	2	Slave1 outdoor unit inverter PCB input overcurrent (RMS) error.	<ul style="list-style-type: none"> <li>Under voltage.</li> <li>Refrigerant flow restriction from defective EEV.</li> </ul>
	2	2	3	Slave2 outdoor unit inverter PCB input overcurrent (RMS) error.	<ul style="list-style-type: none"> <li>Refrigerant charge is too high (overcharged).</li> </ul>
	2	3	1	Low or high DC voltage sensed at the master outdoor unit inverter compressor DC link.	<p>There is a capacitor that is not working properly, or the voltage at the capacitor is out of range. System shut off because outdoor unit inverter compressor DC link voltage fell below 50V (for both 208-230V and 460V units), or exceeded 550V (for 208-230V units) or 1,000V (for 460V units) for a minimum of 250μs.</p> <ul style="list-style-type: none"> <li>No DC voltage charge on inverter PCB, when over 1,000V DC.</li> <li>Over 780V DC voltage was applied to inverter PCB.</li> <li>Improper wiring at DC link terminal or disconnected contact.</li> <li>Damaged electrical condenser component (serving capacitor) on inverter driver board.</li> <li>Improper input voltage (R,S,T,N) or power wiring (no N phase).</li> </ul>
	2	3	2	Low or high DC voltage to the slave1 outdoor unit inverter compressor DC link.	
	2	3	3	Low or high DC voltage to the slave2 outdoor unit inverter compressor DC link.	
	2	4	1	Master outdoor unit high pressure switch error.	System has been turned off by the master outdoor unit high pressure switch.
	2	4	2	Slave1 outdoor unit high pressure switch error.	System has been turned off by the slave1 outdoor unit high pressure switch.
	2	4	3	Slave2 outdoor unit high pressure switch error.	System has been turned off by the slave2 outdoor unit high pressure switch.
	2	5	1	Input voltage to the master outdoor unit is too high or too low.	Master outdoor unit has an input voltage of ≤140V or ≥300V (for 208-230V units), or an input voltage of ≤414V or ≥528V (for 460V units).
	2	5	2	Input voltage to the slave1 outdoor unit is too high or too low.	Slave1 outdoor unit has an input voltage of ≤140V or ≥300V (for 208-230V units), or an input voltage of ≤414V or ≥528V (for 460V units).
	2	5	3	Input voltage to the slave2 outdoor unit is too high or too low.	Slave2 outdoor unit has an input voltage of ≤140V or ≥300V (for 208-230V units), or an input voltage of ≤414V or ≥528V (for 460V units).
	2	6	1	Master outdoor unit inverter compressor operation error.	Inverter compressor failed to start.
	2	6	2	Slave1 outdoor unit inverter compressor operation error.	
	2	6	3	Slave2 outdoor unit inverter compressor operation error.	
	2	9	1	Master outdoor unit inverter compressor overcurrent error.	<ul style="list-style-type: none"> <li>Outdoor unit inverter compressor current draw is too high.</li> <li>Compressor defect and restriction in refrigerant piping are possible causes.</li> </ul>
	2	9	2	Slave1 outdoor unit inverter compressor overcurrent error.	
2	9	3	Slave2 outdoor unit inverter compressor overcurrent error.		

For detailed information on how to troubleshoot each error, see the Multi V Service Manual on [www.lghvac.com](http://www.lghvac.com).

# TROUBLESHOOTING

## Error Codes

**⚠ WARNING** Please refer to the Safety Precautions on pages 4-7 for more detail to prevent injury or death regarding the operation and service troubleshooting of the Multi V product.

Table 35: Error Codes, continued.

Error Code			Description	Details	
Outdoor Unit	3	2	1	Excessive increase in master outdoor unit inverter compressor1 gas discharge temperature.	<ul style="list-style-type: none"> <li>System shutdown happens when discharge pipe temperature rises &gt;115°C (239°F) for 10 seconds, or compressor dome temperature equals 105°C (221°F) for 10 seconds.</li> <li>Check the inverter compressor discharge pipe temperature sensor.</li> <li>Check for low refrigerant / leaks.</li> <li>Check for a defective EEV.</li> <li>Check for a defective liquid spray valve.</li> </ul>
	3	2	2	Excessive increase in slave1 outdoor unit inverter compressor1 gas discharge temperature.	
	3	2	3	Excessive increase in slave2 outdoor unit inverter compressor1 gas discharge temperature.	
	3	3	1	Excessive increase in master outdoor unit inverter compressor2 gas discharge temperature.	
	3	3	2	Excessive increase in slave1 outdoor unit inverter compressor2 gas discharge temperature.	
	3	3	3	Excessive increase in slave2 outdoor unit inverter compressor2 gas discharge temperature.	
	3	4	1	Master outdoor unit compressor high pressure safety tripped.	<ul style="list-style-type: none"> <li>Shutdown due to one (1) compressor operating at ≥30Hz, or if high pressure is &gt;4,000 kPa (580 psi) for ten (10) seconds.</li> <li>Check the high pressure sensor, indoor unit or outdoor unit fan(s), refrigerant, EEV, service valve (may be clogged); check for defective outdoor unit PCB, indoor unit pipe temperature sensor, or hot gas valve. Also, outdoor unit may not have enough clearance (cooling operation), or indoor unit filter may be clogged (heating operation).</li> </ul>
	3	4	2	Slave1 outdoor unit compressor high pressure safety tripped.	
	3	4	3	Slave2 outdoor unit compressor high pressure safety tripped.	
	3	5	1	Master outdoor unit low side pressure below allowable limits.	<ul style="list-style-type: none"> <li>System will shut down when an abnormal low pressure condition occurs.</li> <li>Shut down occurs when the sum of all compressors inverter frequency &lt;30Hz = low &lt;110 kPa for 1 minute.</li> <li>When operating in cooling mode: Low side pressure &lt;400 kPa for 1 minute; High side pressure is &lt;2,200 kPa. Check for refrigerant leaks (low refrigerant charge), or a defective indoor unit EEV.</li> <li>When operating in heating mode: Low side pressure &lt;230 kPa for 1 minute; High side pressure is &lt;1,800 kPa. Check for refrigerant leaks (low refrigerant charge), or a defective outdoor unit EEV.</li> </ul>
	3	5	2	Slave1 outdoor unit low side pressure below allowable limits.	
	3	5	3	Slave1 outdoor unit low side pressure below allowable limits.	
	3	6	1	Master outdoor unit inverter 1 or inverter 2 low compression ratio.	<ul style="list-style-type: none"> <li>Outdoor unit is experiencing a problem developing compressor lift. Error is calling out low compression ratio. System will shut down and display error code "CH36*".</li> <li>During ongoing operation, if the compression ratio is &lt;1.6 for 2 to 5 minutes following a change in position of the reversing valve (either direction). If compression ratio is &lt;1.6, delay 5 minutes for condition to correct itself before raising the error.</li> <li>During low ambient cooling operation following an initial compressor start, if compression ratio is &lt;1.1 for 2 minutes, if compression ratio is &lt;1.3 for 3 minutes.</li> </ul>
	3	6	2	Slave1 outdoor unit inverter 1 or inverter 2 low compression ratio.	
	3	6	3	Slave2 outdoor unit inverter 1 or inverter 2 low compression ratio.	
	4	0	1	Master outdoor unit inverter compressor current transducer (CT) sensor error.	Master outdoor unit inverter compressor current transducer (CT) detection sensor disconnected or shorted.
	4	0	2	Slave1 outdoor unit inverter compressor current transducer (CT) sensor error.	Slave1 outdoor unit inverter compressor current transducer (CT) detection sensor disconnected or shorted.
	4	0	3	Slave2 outdoor unit inverter compressor current transducer (CT) sensor error.	Slave2 outdoor unit inverter compressor current transducer (CT) detection sensor disconnected or shorted.
4	1	1	Master outdoor unit inverter compressor1 discharge pipe temperature sensor error.	<ul style="list-style-type: none"> <li>Check the connection on the outdoor unit PCB.</li> <li>Thermistor disconnected or shorted.</li> </ul>	
4	1	2	Slave1 outdoor unit inverter compressor1 discharge pipe temperature sensor error.		
4	1	3	Slave2 outdoor unit inverter compressor1 discharge pipe temperature sensor error.		

For detailed information on how to troubleshoot each error, see the Multi V Service Manual on [www.lghvac.com](http://www.lghvac.com).

**⚠ WARNING** Please refer to the Safety Precautions on pages 4-7 for more detail to prevent injury or death regarding the operation and service troubleshooting of the Multi V product.

Table 36: Error Codes, continued.

Error Code				Description	Details
Outdoor Unit	4	2	1	Master outdoor unit low pressure sensor error.	<ul style="list-style-type: none"> <li>• Check the connection on the outdoor unit PCB.</li> <li>• Sensor disconnected or shorted.</li> </ul>
	4	2	2	Slave1 outdoor unit low pressure sensor error.	
	4	2	3	Slave2 outdoor unit low pressure sensor error.	
	4	3	1	Master outdoor unit high pressure sensor error.	<ul style="list-style-type: none"> <li>• Check the connection on the outdoor unit PCB.</li> <li>• Sensor disconnected or shorted.</li> </ul>
	4	3	2	Slave1 outdoor unit high pressure sensor error.	
	4	3	3	Slave2 outdoor unit high pressure sensor error.	
	4	4	1	Master outdoor unit ambient temperature sensor error.	<ul style="list-style-type: none"> <li>• Check the connection on the outdoor unit PCB.</li> <li>• Thermistor disconnected or shorted.</li> </ul>
	4	4	2	Slave1 outdoor unit ambient temperature sensor error.	
	4	4	3	Slave2 outdoor unit ambient temperature sensor error.	
	4	5	1	Master outdoor unit heat exchanger pipe temperature sensor.	<ul style="list-style-type: none"> <li>• Check suction sensor in cooling mode; check hot gas sensor located near the heat exchanger in heating mode.</li> <li>• Check the connection on the outdoor unit PCB, then check if thermistor is open or shorted.</li> <li>• Thermistor disconnected or shorted.</li> </ul>
	4	5	2	Slave1 outdoor unit heat exchanger pipe temperature sensor.	
	4	5	3	Slave2 outdoor unit heat exchanger pipe temperature sensor.	
	4	6	1	Master outdoor unit suction pipe temperature sensor error.	<ul style="list-style-type: none"> <li>• Check the connection on the outdoor unit PCB.</li> <li>• Thermistor disconnected or shorted.</li> </ul>
	4	6	2	Slave1 outdoor unit suction pipe temperature sensor error.	
	4	6	3	Slave2 outdoor unit suction pipe temperature sensor error.	
	4	7	1	Master outdoor unit inverter compressor2 discharge temperature sensor error.	Master outdoor unit inverter compressor2 discharge temperature sensor disconnected or shorted.
	4	7	2	Slave1 outdoor unit inverter compressor2 discharge temperature sensor error.	Slave1 outdoor unit inverter compressor2 discharge temperature sensor disconnected or shorted.
	4	7	3	Slave2 outdoor unit inverter compressor2 discharge temperature sensor error.	Slave2 outdoor unit inverter compressor2 discharge temperature sensor disconnected or shorted.
	4	9	1	Master outdoor unit IPM temperature sensor error.	Master outdoor unit IPM temperature sensor disconnected or shorted.
	4	9	2	Slave1 outdoor unit IPM temperature sensor error.	Slave1 outdoor unit IPM temperature sensor disconnected or shorted.
4	9	3	Slave2 outdoor unit IPM temperature sensor error.	Slave2 outdoor unit IPM temperature sensor disconnected or shorted.	
5	0	1	Master outdoor unit three-phase power is not connected properly.	One or more of R(L1), S(L2), T(L3) input power line connections is / are missing for the master outdoor unit.	
5	0	2	Slave1 outdoor unit three-phase power is not connected properly.	One or more of R(L1), S(L2), T(L3) input power line connections is / are missing for the slave1 outdoor unit.	
5	0	3	Slave2 outdoor unit three-phase power is not connected properly.	One or more of R(L1), S(L2), T(L3) input power line connections is / are missing for the slave2 outdoor unit.	
5	1	1	Combination ratio is out of range.	The total of the nominal indoor unit capacity is less than 50% or more than 130% of the nominal outdoor unit capacity.	
5	1	2	Total indoor unit capacity exceeds allowable heat recovery unit branch capacity. (Heat Recovery Systems only.)	Value of total indoor unit capacity exceeds allowable heat recovery unit branch capacity specifications. After auto-pipe detection is complete, wait 5 minutes, then verify connected capacity. System will display error if: <ul style="list-style-type: none"> <li>• The heat recovery unit port addresses are all unique, but &gt;54 Mbh single indoor unit connected; &gt;54 Mbh total of multiple IDUs connected.</li> <li>• If 2 heat recovery unit port addresses are the same and the ports are twinned; &gt;108 Mbh total of multiple indoor units are connected.</li> <li>• If 3 heat recovery unit port addresses are the same and the ports are all connected, or &gt;162 Mbh total of multiple indoor units connected.</li> <li>• If the total connected IDU nominal capacity exceeds 192 Mbh for a single heat recovery unit.</li> </ul>	

For detailed information on how to troubleshoot each error, see the Multi V Service Manual on [www.lghvac.com](http://www.lghvac.com).

# TROUBLESHOOTING

## Error Codes

**⚠ WARNING** Please refer to the Safety Precautions on pages 4-7 for more detail to prevent injury or death regarding the operation and service troubleshooting of the Multi V product.

Table 37: Error Codes, continued.

Error Code			Description	Details	
Outdoor Unit	5	2	1	Communication error between master outdoor unit main PCB and inverter PCB.	<ul style="list-style-type: none"> <li>• Communication error between main PCB (CN-29) and inverter PCB CN-MAIN (COM/RD).</li> <li>• Check connections at both sockets.</li> <li>• Inspect interconnecting cable for wear.</li> </ul>
	5	2	2	Communication error between slave1 outdoor unit main PCB and inverter PCB.	
	5	2	3	Communication error between slave2 outdoor unit main PCB and inverter PCB.	
	5	3	1	Communication error between outdoor unit main PCB and indoor unit(s) PCB.	<ul style="list-style-type: none"> <li>• Check if outdoor unit to indoor unit(s) communications cable disconnected or shorted.</li> <li>• Check A terminals are connected to indoor unit A(3) (5 on 3 x 3 cassette) terminals; B(4) (6 on 3 x 3 cassette) terminals.</li> </ul>
	5	7	1	Master outdoor unit main PCB and inverter PCB communication error.	Master outdoor unit inverter PCB is not receiving signal from main PCB.
	5	7	2	Slave1 outdoor unit main PCB and inverter PCB communication error.	Slave1 outdoor unit inverter PCB is not receiving signal from main PCB.
	5	7	3	Slave2 outdoor unit main PCB and inverter PCB communication error.	Slave2 outdoor unit inverter PCB is not receiving signal from main PCB.
	6	0	1	Master outdoor unit inverter PCB EPROM error.	<ul style="list-style-type: none"> <li>• Verify the EPROM is present and in the socket correctly.</li> <li>• Check if all pins are in and are not bent.</li> <li>• Check if notch in the chip lines up with the arrow on the socket.</li> </ul>
	6	0	2	Slave1 outdoor unit inverter PCB EPROM error.	
	6	0	3	Slave2 outdoor unit inverter PCB EPROM error.	
	6	2	1	High temperature at the master outdoor unit inverter heatsink.	System shut off because of high temperatures at the master outdoor unit inverter heatsink.
	6	2	2	High temperature at the slave1 outdoor unit inverter heatsink.	System shut off because of high temperatures at the slave1 outdoor unit inverter heatsink.
	6	2	3	High temperature at the slave2 outdoor unit inverter heatsink.	System shut off because of high temperatures at the slave2 outdoor unit inverter heatsink.
	6	5	1	Master outdoor unit inverter heatsink temperature sensor error.	Master outdoor unit inverter heatsink temperature sensor disconnected or shorted.
	6	5	2	Slave1 outdoor unit inverter heatsink temperature sensor error.	Slave1 outdoor unit inverter heatsink temperature sensor disconnected or shorted.
	6	5	3	Slave2 outdoor unit inverter heatsink temperature sensor error.	Slave2 outdoor unit inverter heatsink temperature sensor disconnected or shorted.
	6	7	1	Master outdoor unit fan has locked up.	No airflow.
	6	7	2	Slave1 outdoor unit fan has locked up.	
	6	7	3	Slave2 outdoor unit fan has locked up.	
	7	1	1	Master outdoor unit inverter CT sensor error.	Master outdoor unit is restricted.
7	1	2	Slave1 outdoor unit inverter CT sensor error.	Slave1 outdoor unit is restricted.	
7	1	3	Slave2 outdoor unit inverter CT sensor error.	Slave2 outdoor unit is restricted.	
7	5	1	Master outdoor unit fan CT sensor error.	Master outdoor unit fan current detection (CT) sensor disconnected or shorted.	
7	5	2	Slave1 outdoor unit fan CT sensor error.	Slave1 outdoor unit fan current detection (CT) sensor disconnected or shorted.	
7	5	3	Slave2 outdoor unit fan CT sensor error.	Slave2 outdoor unit fan current detection (CT) sensor disconnected or shorted.	

For detailed information on how to troubleshoot each error, see the Multi V Service Manual on [www.lghvac.com](http://www.lghvac.com).



**WARNING** Please refer to the Safety Precautions on pages 4-7 for more detail to prevent injury or death regarding the operation and service troubleshooting of the Multi V product.

Table 38: Error Codes, continued.

Error Code				Description	Details	
Outdoor Unit	7	7	1	Master outdoor unit fan overcurrent error.	Outdoor unit fan current is >10A (for 208-230V units) or 5A (for 460V units).	
	7	7	2	Slave1 outdoor unit fan overcurrent error.	Slave1 outdoor unit fan current is >10A (for 208-230V units) or 5A (for 460V units).	
	7	7	3	Slave2 outdoor unit fan overcurrent error.	Slave2 outdoor unit fan current is >10A (for 208-230V units) or 5A (for 460V units).	
	7	9	1	Master outdoor unit fan operation failure error.	Master outdoor unit fan is experiencing first position sensor failure.	
	7	9	2	Slave1 outdoor unit fan operation failure error.	Slave1 outdoor unit fan is experiencing first position sensor failure.	
	7	9	3	Slave2 outdoor unit fan operation failure error.	Slave2 outdoor unit fan is experiencing first position sensor failure.	
	8	6	1	Master outdoor unit main PCB onboard EPROM error.	<ul style="list-style-type: none"> <li>Verify the EPROM is present and in the socket correctly.</li> <li>Check if all pins are in and are not bent.</li> <li>Check if notch in the chip lines up with the arrow on the socket.</li> </ul>	
	8	6	2	Slave1 outdoor unit main PCB onboard EPROM error.		
	8	6	3	Slave2 outdoor unit main PCB onboard EPROM error.		
	8	7	1	Master outdoor unit fan PCB EPROM error.	<ul style="list-style-type: none"> <li>Communication error between master outdoor unit fan MICOM and EPROM.</li> <li>Verify EPROM is present and in the socket correctly.</li> </ul>	
	8	7	2	Slave1 outdoor unit fan PCB EPROM error.	<ul style="list-style-type: none"> <li>Communication error between slave1 outdoor unit fan MICOM and EPROM.</li> <li>Verify EPROM is present and in the socket correctly.</li> </ul>	
	8	7	3	Slave2 outdoor unit fan PCB EPROM error.	<ul style="list-style-type: none"> <li>Communication error between slave2 outdoor unit fan MICOM and EPROM.</li> <li>Verify EPROM is present and in the socket correctly.</li> </ul>	
	1	0	4	1	Communication error between master outdoor unit and slave outdoor units.	Master outdoor unit main PCB is not receiving signals from slave outdoor units.
	1	0	4	2	Communication error between slave1 outdoor unit and master and slave2 outdoor units.	Slave1 outdoor unit main PCB is not receiving signals from master and slave2 outdoor units.
	1	0	4	3	Communication error between slave2 outdoor unit and master and slave1 outdoor units.	Slave2 outdoor unit main PCB is not receiving signals from master and slave1 outdoor units.
	1	0	5	1	Master outdoor unit fan PCB communication error.	Master outdoor unit main PCB is not receiving a signal from the fan.
	1	0	5	2	Slave1 outdoor unit fan PCB communication error.	Slave1 outdoor unit main PCB is not receiving a signal from the fan.
	1	0	5	3	Slave2 outdoor unit fan PCB communication error.	Slave2 outdoor unit main PCB is not receiving a signal from the fan.
	1	0	6	1	Master outdoor unit fan IPM error.	Instant overcurrent (peak) of master outdoor unit fan IPM.
	1	0	6	2	Slave1 outdoor unit fan IPM error.	Instant overcurrent (peak) of slave1 outdoor unit fan IPM.
1	0	6	3	Slave2 outdoor unit fan IPM error.	Instant overcurrent (peak) of slave2 outdoor unit fan IPM.	
1	0	7	1	Master outdoor unit fan DC link low voltage error.	<p>A capacitor that is serving the ODU fan inverter is not working properly, or the voltage at the capacitor is out of range (low).</p> <ul style="list-style-type: none"> <li>Outdoor unit fan DC link voltage is &lt;50V for a minimum of 250µs (for both 208-230V and 460V units).</li> <li>Disconnected DC link.</li> <li>Damaged electrical condenser component (serving capacitor) on inverter driver board.</li> </ul>	
1	0	7	2	Slave1 outdoor unit fan DC link low voltage error.		
1	0	7	3	Slave2 outdoor unit fan DC link low voltage error.		

For detailed information on how to troubleshoot each error, see the Multi V Service Manual on [www.lghvac.com](http://www.lghvac.com).

# TROUBLESHOOTING

## Error Codes

**⚠ WARNING** Please refer to the Safety Precautions on pages 4-7 for more detail to prevent injury or death regarding the operation and service troubleshooting of the Multi V product.

Table 39: Error Codes, continued.

Error Code				Description	Details	
Outdoor Unit	1	1	3	1	Master outdoor unit liquid pipe temperature sensor error.	<ul style="list-style-type: none"> <li>• Check the connection on the outdoor unit PCB.</li> <li>• Thermistor disconnected or shorted.</li> </ul>
	1	1	3	2	Slave1 outdoor unit liquid pipe temperature sensor error.	
	1	1	3	3	Slave2 outdoor unit liquid pipe temperature sensor error.	
	1	1	4	1	Master outdoor unit subcooling inlet temperature sensor error.	<ul style="list-style-type: none"> <li>• Check the connection on the outdoor unit PCB.</li> <li>• Thermistor disconnected or shorted.</li> </ul>
	1	1	4	2	Slave1 outdoor unit subcooling inlet temperature sensor error.	
	1	1	4	2	Slave2 outdoor unit subcooling inlet temperature sensor error.	
	1	1	5	1	Master outdoor unit subcooling outlet temperature sensor error.	<ul style="list-style-type: none"> <li>• Check the connection on the outdoor unit PCB.</li> <li>• Thermistor disconnected or shorted.</li> </ul>
	1	1	5	2	Slave1 outdoor unit subcooling outlet temperature sensor error.	
	1	1	5	3	Slave2 outdoor unit subcooling outlet temperature sensor error.	
	1	1	6	1	Master outdoor unit low oil level or oil level sensor error.	<ul style="list-style-type: none"> <li>• Master outdoor unit may have low oil levels.</li> <li>• Master outdoor unit oil level sensor disconnected or shorted.</li> </ul>
	1	1	6	2	Slave1 outdoor unit oil level sensor error.	<ul style="list-style-type: none"> <li>• Slave1 outdoor unit may have low oil levels.</li> <li>• Slave1 outdoor unit oil level sensor disconnected or shorted.</li> </ul>
	1	1	6	3	Slave2 outdoor unit oil level sensor error.	<ul style="list-style-type: none"> <li>• Slave2 outdoor unit may have low oil levels.</li> <li>• Slave2 outdoor unit oil level sensor disconnected or shorted.</li> </ul>
	1	4	5	1	Communication error between master outdoor unit main board and external board.	Master outdoor unit main board to external board communication failure.
	1	4	5	2	Communication error between slave1 outdoor unit main board and external board.	Slave1 outdoor unit main board to external board communication failure.
	1	4	5	3	Communication error between slave2 outdoor unit main board and external board.	Slave2 outdoor unit main board to external board communication failure.
	1	5	0	1	Master outdoor unit compressor discharge superheat not satisfied.	<ul style="list-style-type: none"> <li>• Outdoor unit compressor discharge superheat not satisfied for ≥5 minutes.</li> <li>• Code can only occur when the outdoor is operating in cooling mode (all indoor units must be in cooling mode; error cannot occur during simultaneous operation).</li> </ul>
	1	5	0	2	Slave1 outdoor unit compressor discharge superheat not satisfied.	<ul style="list-style-type: none"> <li>• After at least 10 minutes of compressor operation, the master outdoor unit microprocessor will calculate the system's compressor superheat. If at any time during compressor operation where all indoor units in thermal on are in cooling mode and the compressor superheat falls &lt;3°C for ≥5 minutes, there is a high probability that liquid could flood back to the inlet of the compressor scroll, resulting in compressor damage.</li> </ul>
	1	5	0	3	Slave2 outdoor unit compressor discharge superheat not satisfied.	<ul style="list-style-type: none"> <li>• If error occurs 3 times within any 1 hour period of compressor operation, the system will shut down and remain off. A manual restart will be necessary.</li> </ul>
1	5	1	1	Master outdoor unit operation mode conversion error.	Pressure imbalance between outdoor units.	
1	5	1	2	Slave1 outdoor unit operation mode conversion error.		
1	5	1	3	Slave2 outdoor unit operation mode conversion error.		

For detailed information on how to troubleshoot each error, see the Multi V Service Manual on [www.lghvac.com](http://www.lghvac.com).

**⚠ WARNING** Please refer to the Safety Precautions on pages 4-7 for more detail to prevent injury or death regarding the operation and service troubleshooting of the Multi V product.

Table 40: Error Codes, continued.

Error Code				Description	Details		
1	5	3	1	Master outdoor unit upper heat exchanger temperature sensor error.	<ul style="list-style-type: none"> <li>• Check the connection on the outdoor unit PCB.</li> <li>• Thermistor is disconnected or shorted.</li> </ul>		
			2	Slave1 outdoor unit upper heat exchanger temperature sensor error.			
			3	Slave2 outdoor unit upper heat exchanger temperature sensor error.			
1	5	4	1	Master outdoor unit lower heat exchanger temperature sensor error.	<ul style="list-style-type: none"> <li>• Check the connection on the outdoor unit PCB.</li> <li>• Thermistor disconnected or shorted.</li> </ul>		
			2	Slave1 outdoor unit lower heat exchanger temperature sensor error.			
			3	Slave2 outdoor unit lower heat exchanger temperature sensor error.			
1	8	2	1	Communication error between master outdoor unit external board main and sub MICOMs.	Master outdoor unit external board main to sub MICOMs communication failure.		
			2	Communication error between slave1 outdoor unit external board main and sub MICOMs.	Slave1 outdoor unit external board main to sub MICOMs communication failure.		
			3	Communication error between slave2 outdoor unit external board main and sub MICOMs.	Slave2 outdoor unit external board main to sub MICOMs communication failure.		
1	9	3	1	Hydro kit P, HEX error (P equals prevents from freezing).	<ul style="list-style-type: none"> <li>• Water outlet temperature sensor is disconnected or shorted. Values read less than -43°C or greater than +96°C (less than -45.4°F or greater than +204.8°F).</li> <li>• Prevents HEX from bursting when operating. Does not protect HEX if the glycol is inadequate, nor if the hydro kit is off and not operating.</li> </ul> <p>Outdoor unit compressor ramps up, and hydro kit operates. One (1) minute later, pipe temperature at mid-temperature hot water supply (inlet or outlet water) is &lt;0°C (32°F), and mid-temperature hot water supply (inlet or outlet water) is ≤4°C (39.2°F) for ten (10) seconds.</p>		
					2	Excessive increase in slave1 outdoor unit fan heatsink temperature.	System has shut off because slave1 outdoor unit fan heatsink temperature is >203°F.
					3	Excessive increase in slave2 outdoor unit fan heatsink temperature.	System has shut off because slave1 outdoor unit fan heatsink temperature is >203°F.
					4	Master outdoor unit fan heatsink temperature sensor error.	Disconnection or short circuit of master outdoor unit fan heatsink temperature sensor.
					2	Slave1 outdoor unit fan heatsink temperature sensor error.	Disconnection or short circuit of slave1 outdoor unit fan heatsink temperature sensor.
					3	Slave2 outdoor unit fan heatsink temperature sensor error.	Disconnection or short circuit of slave2 outdoor unit fan heatsink temperature sensor.
					1	Excessive increase in master outdoor unit fan heatsink temperature.	System has shut off because master outdoor unit fan heatsink temperature is >203°F.

For detailed information on how to troubleshoot each error, see the Multi V Service Manual on [www.lghvac.com](http://www.lghvac.com).

# TROUBLESHOOTING



## Error Codes

**⚠ WARNING** Please refer to the Safety Precautions on pages 4-7 for more detail to prevent injury or death regarding the operation and service troubleshooting of the Multi V product.

Table 41: Error Codes, continued.

Error Code				Description	Details	
Heat Recovery Unit	-	5	1	C + No. of HR Unit Capacity of indoor units connected to the heat recovery unit exceeds allowable limits.	The amount of nominal cooling capacity of indoor units connected to a heat recovery unit, or a heat recovery unit port, or capacity of grouped heat recovery unit port is excessive. After auto-pipe detection is complete, wait 5 minutes, then verify connected capacity. System will display error if: <ul style="list-style-type: none"> <li>• The heat recovery unit port addresses are all unique, but &gt;54 Mbh single indoor unit connected; &gt;54 Mbh total of multiple indoor units connected.</li> <li>• If 2 heat recovery unit port addresses are the same and the ports are twinned; &gt;108 Mbh total of multiple indoor units are connected.</li> <li>• If 3 heat recovery unit port addresses are the same and the ports are all connected, or &gt;162 Mbh total of multiple indoor units connected.</li> <li>• If the total connected indoor unit nominal capacity exceeds 192 Mbh for a single heat recovery unit.</li> <li>• Error code displays on the outdoor unit SSD, the heat recovery unit SSD, or in LGMV.</li> </ul>	
	2	0	0	1	Auto pipe search failure.	Auto piping procedure did not complete properly.
	2	0	1	C + No. of HR Unit	Heat recovery unit liquid sensor error. (C = Heat recovery unit + Heat recovery unit number).	Disconnection or short circuit of heat recovery unit liquid pipe sensor.
	2	0	2		Heat recovery unit subcooling pipe inlet sensor error. (C = Heat recovery unit + Heat recovery unit number).	Disconnection or short circuit of heat recovery unit subcooling pipe inlet sensor.
	2	0	3		Heat recovery unit subcooling pipe outlet sensor error. (C = Heat recovery unit + Heat recovery unit number).	Disconnection or short circuit of heat recovery unit subcooling pipe outlet sensor.
	2	0	4		Communication error between outdoor unit and heat recovery unit. (C = Heat recovery unit + Heat recovery unit number)	Outdoor unit does not receive signal from heat recovery unit.
	2	0	5		Communication error between heat recovery unit (2A Series) and the 485 modem. The 2A Series heat recovery unit applies only to heat recovery systems communicating at a baud rate of 9,600 bps. <ul style="list-style-type: none"> <li>• The 485 modem is the communications style on the bus that is 1e outdoor unit to many indoor units.</li> </ul>	<ul style="list-style-type: none"> <li>• Communication problem occurred between the heat recovery unit PCB and the connection to the communications bus.</li> <li>• Error displays if the outdoor unit signal is not received for three (3) minutes. The error clears after the signal is received from the modem. (2A Series Heat Recovery Units.)</li> </ul>
2	0	6	Duplicate address error of the heat recovery unit (2A Series). <ul style="list-style-type: none"> <li>• The 2A Series heat recovery unit applies only to heat recovery systems communicating at a baud rate of 9,600 bps.</li> <li>• The 485 modem is the communications style on the bus that is 1e outdoor unit to many indoor units.</li> </ul>		<ul style="list-style-type: none"> <li>• A heat recovery unit address is duplicated for 485 communication.</li> <li>• There are two heat recovery units with one or more HEX addresses that are the same.</li> <li>• Adjust the hex address dial found on the heat recovery units.</li> </ul>	
Network	2	4	2	*	Network error of central controller.	Inability of the central controller to receive information from the outdoor unit.

For detailed information on how to troubleshoot each error, see the Multi V Service Manual on [www.lghvac.com](http://www.lghvac.com).

# LG Multi V Pre-Commissioning Device Configuration Worksheet

<b>Project Name:</b> _____	<b>Building ID</b> _____
<b>Date:</b> _____	<b>System ID</b> _____
Mech Contractor Company Name _____ Pre-Com Tech Name/Ph#/email _____	MEP Project Mngr Name _____ Ph# / Email _____
	<b>Page #</b> _____

## IDU's

Unit Tag	Building Floor	Room ID	Type	Model	Serial #	Adjusted Fan Setting Value			System Address	Central Control Address	Group member ID or N/A if not in a group	Group Function M=Master S=Slave	Sensor Strategy (RA/ZC/Both)
						Low	Medium	High					



**To access additional technical documentation such as submittals, indoor unit engineering manuals, installation, service, product data performance, general best practice, and building ventilation manuals, as well as white papers, catalogs, LATS software programs, and more, log in to [www.lghvac.com](http://www.lghvac.com).**

*Inverter*



LG Electronics, U.S.A., Inc.  
Commercial Air Conditioning Division  
4300 North Point Parkway  
Alpharetta, Georgia 30022  
www.lg-vrf.com

LG Customer Information Center, Commercial Products  
1-888-865-3026 USA  
Follow the prompts for commercial A/C products.

New Issue: OM\_MultiV\_5\_OutdoorUnits\_08\_17