



US009721566B2

(12) **United States Patent**
Newendorp et al.

(10) **Patent No.:** **US 9,721,566 B2**

(45) **Date of Patent:** **Aug. 1, 2017**

(54) **COMPETING DEVICES RESPONDING TO VOICE TRIGGERS**

(56) **References Cited**

(71) Applicant: **Apple Inc.**, Cupertino, CA (US)

(72) Inventors: **Brandon J. Newendorp**, Cupertino, CA (US); **Evan S. Dibiase**, Pittsburgh, PA (US)

(73) Assignee: **Apple Inc.**, Cupertino, CA (US)

(*) Notice: Subject to any disclaimer, the term of this patent is extended or adjusted under 35 U.S.C. 154(b) by 0 days.

(21) Appl. No.: **14/841,379**

(22) Filed: **Aug. 31, 2015**

(65) **Prior Publication Data**

US 2016/0260431 A1 Sep. 8, 2016

Related U.S. Application Data

(60) Provisional application No. 62/129,922, filed on Mar. 8, 2015.

(51) **Int. Cl.**

G10L 15/32 (2013.01)
G10L 15/22 (2006.01)
G06F 3/16 (2006.01)
G10L 15/08 (2006.01)

(52) **U.S. Cl.**

CPC **G10L 15/22** (2013.01); **G06F 3/167** (2013.01); **G10L 15/32** (2013.01); **G10L 2015/088** (2013.01)

(58) **Field of Classification Search**

CPC **G10L 17/22**; **G10L 17/24**; **G06F 3/167**
See application file for complete search history.

U.S. PATENT DOCUMENTS

1,559,320 A 10/1925 Hirsh
2,180,522 A 11/1939 Henne
2,495,222 A 1/1950 Bierig
3,704,345 A 11/1972 Coker et al.
(Continued)

FOREIGN PATENT DOCUMENTS

CA 2666438 C 6/2013
CH 681573 A5 4/1993
(Continued)

OTHER PUBLICATIONS

“Interactive Voice”, available at <<http://www.helloivee.com/company/>>, retrieved on Feb. 10, 2014, 2 pages.

(Continued)

Primary Examiner — Douglas Godbold

(74) *Attorney, Agent, or Firm* — Morrison & Foerster LLP

(57)

ABSTRACT

At a first electronic device with a display and a microphone: sampling audio input using the first microphone; in accordance with the sampling of audio input using the first microphone, sending stop instructions to a second electronic device with a second microphone, the second electronic device external to the first electronic device, wherein the second electronic device is configured to respond to audio input received using the second microphone, and wherein the stop instructions instruct the second electronic device to forgo responding to audio input received using the second microphone, wherein responding to audio input received using the second microphone comprises providing perceptible output.

22 Claims, 22 Drawing Sheets

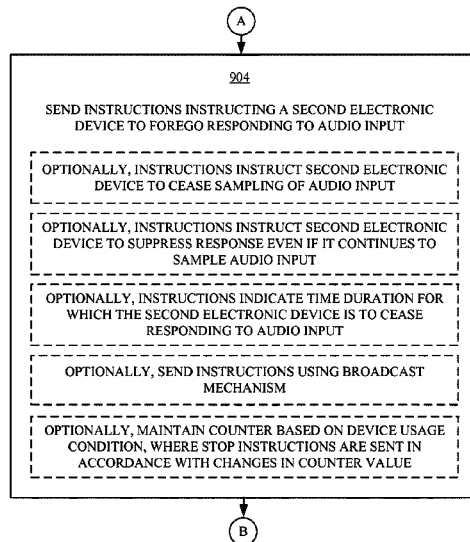

(56)

References Cited

U.S. PATENT DOCUMENTS

3,710,321	A	1/1973	Rubenstein	4,831,551	A	5/1989	Schalk et al.
3,787,542	A	1/1974	Gallagher et al.	4,833,712	A	5/1989	Bahl et al.
3,828,132	A	8/1974	Flanagan et al.	4,833,718	A	5/1989	Sprague
3,979,557	A	9/1976	Schulman et al.	4,837,798	A	6/1989	Cohen et al.
4,013,085	A	3/1977	Wright	4,837,831	A	6/1989	Gillick et al.
4,081,631	A	3/1978	Feder	4,839,853	A	6/1989	Deerwester et al.
4,090,216	A	5/1978	Constable	4,852,168	A	7/1989	Sprague
4,107,784	A	8/1978	Van Bemmelen	4,862,504	A	8/1989	Nomura
4,108,211	A	8/1978	Tanaka	4,875,187	A	10/1989	Smith
4,159,536	A	6/1979	Kehoe et al.	4,878,230	A	10/1989	Murakami et al.
4,181,821	A	1/1980	Pirz et al.	4,887,212	A	12/1989	Zamora et al.
4,204,089	A	5/1980	Key et al.	4,896,359	A	1/1990	Yamamoto et al.
4,241,286	A	12/1980	Gordon	4,903,305	A	2/1990	Gillick et al.
4,253,477	A	3/1981	Eichman	4,905,163	A	2/1990	Garber et al.
4,278,838	A	7/1981	Antonov	4,908,867	A	3/1990	Silverman
4,282,405	A	8/1981	Taguchi	4,914,586	A	4/1990	Swinehart et al.
4,310,721	A	1/1982	Manley et al.	4,914,590	A	4/1990	Loatman et al.
4,332,464	A	6/1982	Bartulis et al.	4,918,723	A	4/1990	Iggulden et al.
4,348,553	A	9/1982	Baker et al.	4,926,491	A	5/1990	Maeda et al.
4,384,169	A	5/1983	Mozer et al.	4,928,307	A	5/1990	Lynn
4,386,345	A	5/1983	Narveson et al.	4,931,783	A	6/1990	Atkinson
4,433,377	A	2/1984	Eustis et al.	4,935,954	A	6/1990	Thompson et al.
4,451,849	A	5/1984	Fuhrer	4,939,639	A	7/1990	Lee et al.
4,485,439	A	11/1984	Rothstein	4,941,488	A	7/1990	Marxer et al.
4,495,644	A	1/1985	Parks et al.	4,944,013	A	7/1990	Gouvianakis et al.
4,513,379	A	4/1985	Wilson et al.	4,945,504	A	7/1990	Nakama et al.
4,513,435	A	4/1985	Sakoe et al.	4,953,106	A	8/1990	Gansner et al.
4,555,775	A	11/1985	Pike	4,955,047	A	9/1990	Morganstein et al.
4,577,343	A	3/1986	Oura	4,965,763	A	10/1990	Zamora
4,586,158	A	4/1986	Brandle	4,972,462	A	11/1990	Shibata
4,587,670	A	5/1986	Levinson et al.	4,974,191	A	11/1990	Amirghodsi et al.
4,589,022	A	5/1986	Prince et al.	4,975,975	A	12/1990	Filipski
4,611,346	A	9/1986	Bednar et al.	4,977,598	A	12/1990	Doddington et al.
4,615,081	A	10/1986	Lindahl	4,980,916	A	12/1990	Zinser
4,618,984	A	10/1986	Das et al.	4,985,924	A	1/1991	Matsuura
4,642,790	A	2/1987	Minshull et al.	4,992,972	A	2/1991	Brooks et al.
4,653,021	A	3/1987	Takagi	4,994,966	A	2/1991	Hutchins
4,654,875	A	3/1987	Srihari et al.	4,994,983	A	2/1991	Landell et al.
4,655,233	A	4/1987	Laughlin	5,001,774	A	3/1991	Lee
4,658,425	A	4/1987	Julstrom	5,003,577	A	3/1991	Ertz et al.
4,670,848	A	6/1987	Schramm	5,007,095	A	4/1991	Nara et al.
4,677,570	A	6/1987	Taki	5,007,098	A	4/1991	Kumagai
4,680,429	A	7/1987	Murdock et al.	5,010,574	A	4/1991	Wang
4,680,805	A	7/1987	Scott	5,016,002	A	5/1991	Levanto
4,686,522	A	8/1987	Hernandez et al.	5,020,112	A	5/1991	Chou
4,688,195	A	8/1987	Thompson et al.	5,021,971	A	6/1991	Lindsay
4,692,941	A	9/1987	Jacks et al.	5,022,081	A	6/1991	Hirose et al.
4,698,625	A	10/1987	McCaskill et al.	5,027,110	A	6/1991	Chang et al.
4,709,390	A	11/1987	Atal et al.	5,027,406	A	6/1991	Roberts et al.
4,713,775	A	12/1987	Scott et al.	5,027,408	A	6/1991	Kroeker et al.
4,718,094	A	1/1988	Bahl et al.	5,029,211	A	7/1991	Ozawa
4,724,542	A	2/1988	Williford	5,031,217	A	7/1991	Nishimura
4,726,065	A	2/1988	Froessler	5,032,989	A	7/1991	Tornetta
4,727,354	A	2/1988	Lindsay	5,033,087	A	7/1991	Bahl et al.
RE32,632	E	3/1988	Atkinson	5,040,218	A	8/1991	Vitale et al.
4,736,296	A	4/1988	Katayama et al.	5,046,099	A	9/1991	Nishimura
4,750,122	A	6/1988	Kaji et al.	5,047,614	A	9/1991	Bianco
4,754,489	A	6/1988	Bokser	5,047,617	A	9/1991	Shepard et al.
4,755,811	A	7/1988	Slavin et al.	5,050,215	A	9/1991	Nishimura
4,776,016	A	10/1988	Hansen	5,053,758	A	10/1991	Cornett et al.
4,783,804	A	11/1988	Juang et al.	5,054,084	A	10/1991	Tanaka et al.
4,783,807	A	11/1988	Marley	5,057,915	A	10/1991	Von Kohorn
4,785,413	A	11/1988	Atsumi	5,067,158	A	11/1991	Arjmand
4,790,028	A	12/1988	Ramage	5,067,503	A	11/1991	Stile
4,797,930	A	1/1989	Goudie	5,072,452	A	12/1991	Brown et al.
4,802,223	A	1/1989	Lin et al.	5,075,896	A	12/1991	Wilcox et al.
4,803,729	A	2/1989	Baker	5,079,723	A	1/1992	Herceg et al.
4,807,752	A	2/1989	Chodorow	5,083,119	A	1/1992	Trevett et al.
4,811,243	A	3/1989	Racine	5,083,268	A	1/1992	Hemphill et al.
4,813,074	A	3/1989	Marcus	5,086,792	A	2/1992	Chodorow
4,819,271	A	4/1989	Bahl et al.	5,090,012	A	2/1992	Kajiyama et al.
4,827,518	A	5/1989	Feustel et al.	5,091,790	A	2/1992	Silverberg
4,827,520	A	5/1989	Zeinstra	5,091,945	A	2/1992	Kleijn
4,829,576	A	5/1989	Porter	5,103,498	A	4/1992	Lanier et al.
4,829,583	A	5/1989	Monroe et al.	5,109,509	A	4/1992	Katayama et al.
				5,111,423	A	5/1992	Kopec, Jr. et al.
				5,119,079	A	6/1992	Hube et al.
				5,122,951	A	6/1992	Kamiya
				5,123,103	A	6/1992	Ohtaki et al.

(56)

References Cited

U.S. PATENT DOCUMENTS

5,125,022	A	6/1992	Hunt et al.	5,301,109	A	4/1994	Landauer et al.
5,125,030	A	6/1992	Nomura et al.	5,303,406	A	4/1994	Hansen et al.
5,127,043	A	6/1992	Hunt et al.	5,305,205	A	4/1994	Weber et al.
5,127,053	A	6/1992	Koch	5,305,421	A	4/1994	Li
5,127,055	A	6/1992	Larkey	5,305,768	A	4/1994	Gross et al.
5,128,672	A	7/1992	Kaehler	5,309,359	A	5/1994	Katz et al.
5,133,011	A	7/1992	McKiel, Jr.	5,315,689	A	5/1994	Kanazawa et al.
5,133,023	A	7/1992	Bokser	5,317,507	A	5/1994	Gallant
5,142,584	A	8/1992	Ozawa	5,317,647	A	5/1994	Pagallo
5,144,875	A	9/1992	Nakada	5,325,297	A	6/1994	Bird et al.
5,148,541	A	9/1992	Lee et al.	5,325,298	A	6/1994	Gallant
5,153,913	A	10/1992	Kandefer et al.	5,325,462	A	6/1994	Farrett
5,157,610	A	10/1992	Asano et al.	5,326,270	A	7/1994	Ostby et al.
5,157,779	A	10/1992	Washburn et al.	5,327,342	A	7/1994	Roy
5,161,102	A	11/1992	Griffin et al.	5,327,498	A	7/1994	Hamon
5,163,809	A	11/1992	Akgun et al.	5,329,608	A	7/1994	Bocchieri et al.
5,164,900	A	11/1992	Bernath	5,333,236	A	7/1994	Bahl et al.
5,164,982	A	11/1992	Davis	5,333,266	A	7/1994	Boaz et al.
5,165,007	A	11/1992	Bahl et al.	5,333,275	A	7/1994	Wheatley et al.
5,167,004	A	11/1992	Netsch et al.	5,335,011	A	8/1994	Addeo et al.
5,175,536	A	12/1992	Aschliman et al.	5,335,276	A	8/1994	Thompson et al.
5,175,803	A	12/1992	Yeh	5,341,293	A	8/1994	Vertelney et al.
5,175,814	A	12/1992	Anick et al.	5,341,466	A	8/1994	Perlin et al.
5,179,627	A	1/1993	Sweet et al.	5,345,536	A	9/1994	Hoshimi et al.
5,179,652	A	1/1993	Rozmanith et al.	5,349,645	A	9/1994	Zhao
5,194,950	A	3/1993	Murakami et al.	5,353,374	A	10/1994	Wilson et al.
5,195,034	A	3/1993	Garneau et al.	5,353,376	A	10/1994	Oh et al.
5,195,167	A	3/1993	Bahl et al.	5,353,377	A	10/1994	Kuroda et al.
5,197,005	A	3/1993	Shwartz et al.	5,353,408	A	10/1994	Kato et al.
5,199,077	A	3/1993	Wilcox et al.	5,353,432	A	10/1994	Richek et al.
5,201,034	A	4/1993	Matsuura et al.	5,357,431	A	10/1994	Nakada et al.
5,202,952	A	4/1993	Gillick et al.	5,367,640	A	11/1994	Hamilton et al.
5,208,862	A	5/1993	Ozawa	5,369,575	A	11/1994	Lamberti et al.
5,210,689	A	5/1993	Baker et al.	5,369,577	A	11/1994	Kadashevich et al.
5,212,638	A	5/1993	Bernath	5,371,853	A	12/1994	Kao et al.
5,212,821	A	5/1993	Gorin et al.	5,371,901	A	12/1994	Reed et al.
5,216,747	A	6/1993	Hardwick et al.	5,373,566	A	12/1994	Murdock
5,218,700	A	6/1993	Beechick	5,377,103	A	12/1994	Lamberti et al.
5,220,629	A	6/1993	Kosaka et al.	5,377,301	A	12/1994	Rosenberg et al.
5,220,639	A	6/1993	Lee	5,377,303	A	12/1994	Firman
5,220,657	A	6/1993	Bly et al.	5,384,671	A	1/1995	Fisher
5,222,146	A	6/1993	Bahl et al.	5,384,892	A	1/1995	Strong
5,230,036	A	7/1993	Akamine et al.	5,384,893	A	1/1995	Hutchins
5,231,670	A	7/1993	Goldhor et al.	5,386,494	A	1/1995	White
5,235,680	A	8/1993	Bijnagte	5,386,556	A	1/1995	Hedin et al.
5,237,502	A	8/1993	White et al.	5,390,236	A	2/1995	Klausner et al.
5,241,619	A	8/1993	Schwartz et al.	5,390,279	A	2/1995	Strong
5,252,951	A	10/1993	Tannenbaum et al.	5,390,281	A	2/1995	Luciw et al.
5,253,325	A	10/1993	Clark	5,392,419	A	2/1995	Walton
5,255,386	A	10/1993	Prager	5,396,625	A	3/1995	Parkes
5,257,387	A	10/1993	Richek et al.	5,400,434	A	3/1995	Pearson
5,260,697	A	11/1993	Barrett et al.	5,404,295	A	4/1995	Katz et al.
5,266,931	A	11/1993	Tanaka	5,406,305	A	4/1995	Shimomura et al.
5,266,949	A	11/1993	Rossi	5,408,060	A	4/1995	Muurinen
5,267,345	A	11/1993	Brown et al.	5,412,756	A	5/1995	Bauman et al.
5,268,990	A	12/1993	Cohen et al.	5,412,804	A	5/1995	Krishna
5,274,771	A	12/1993	Hamilton et al.	5,412,806	A	5/1995	Du et al.
5,274,818	A	12/1993	Vasilevsky et al.	5,418,951	A	5/1995	Damashek
5,276,616	A	1/1994	Kuga et al.	5,422,656	A	6/1995	Allard et al.
5,276,794	A	1/1994	Lamb, Jr.	5,424,947	A	6/1995	Nagao et al.
5,278,980	A	1/1994	Pedersen et al.	5,425,108	A	6/1995	Hwang et al.
5,282,265	A	1/1994	Suda et al.	5,428,731	A	6/1995	Powers, III
5,283,818	A	2/1994	Klausner et al.	5,434,777	A	7/1995	Luciw
5,287,448	A	2/1994	Nicol et al.	5,440,615	A	8/1995	Caccuro et al.
5,289,562	A	2/1994	Mizuta et al.	5,442,598	A	8/1995	Haikawa et al.
RE34,562	E	3/1994	Murakami et al.	5,442,780	A	8/1995	Takanashi et al.
5,291,286	A	3/1994	Murakami et al.	5,444,823	A	8/1995	Nguyen
5,293,254	A	3/1994	Eschbach	5,449,368	A	9/1995	Kuzmak
5,293,448	A	3/1994	Honda	5,450,523	A	9/1995	Zhao
5,293,452	A	3/1994	Picone et al.	5,455,888	A	10/1995	Iyengar et al.
5,296,642	A	3/1994	Konishi	5,457,768	A	10/1995	Tsuboi et al.
5,297,170	A	3/1994	Eyuboglu et al.	5,459,488	A	10/1995	Geiser
5,297,194	A	3/1994	Hunt et al.	5,463,696	A	10/1995	Beernink et al.
5,299,125	A	3/1994	Baker et al.	5,463,725	A	10/1995	Henckel et al.
5,299,284	A	3/1994	Roy	5,465,401	A	11/1995	Thompson
				5,469,529	A	11/1995	Bimbot et al.
				5,471,611	A	11/1995	McGregor
				5,473,728	A	12/1995	Luginbuhl et al.
				5,475,587	A	12/1995	Anick et al.

(56)

References Cited

U.S. PATENT DOCUMENTS

5,475,796	A	12/1995	Iwata	5,617,539	A	4/1997	Ludwig et al.
5,477,447	A	12/1995	Luciw et al.	5,619,583	A	4/1997	Page et al.
5,477,448	A	12/1995	Golding et al.	5,619,694	A	4/1997	Shimazu
5,477,451	A	12/1995	Brown et al.	5,621,859	A	4/1997	Schwartz et al.
5,479,488	A	12/1995	Lennig et al.	5,621,903	A	4/1997	Luciw et al.
5,481,739	A	1/1996	Staats	5,627,939	A	5/1997	Huang et al.
5,483,261	A	1/1996	Yasutake	5,634,084	A	5/1997	Malsheen et al.
5,485,372	A	1/1996	Golding et al.	5,636,325	A	6/1997	Farrett
5,485,543	A	1/1996	Aso	5,638,425	A	6/1997	Meador, III et al.
5,488,204	A	1/1996	Mead et al.	5,638,489	A	6/1997	Tsuboka
5,488,727	A	1/1996	Agrawal et al.	5,638,523	A	6/1997	Mullet et al.
5,490,234	A	2/1996	Narayan	5,640,487	A	6/1997	Lau et al.
5,491,758	A	2/1996	Bellegarda et al.	5,642,464	A	6/1997	Yue et al.
5,491,772	A	2/1996	Hardwick et al.	5,642,466	A	6/1997	Narayan
5,493,677	A	2/1996	Balogh et al.	5,642,519	A	6/1997	Martin
5,495,604	A	2/1996	Harding et al.	5,644,656	A	7/1997	Akra et al.
5,497,319	A	3/1996	Chong et al.	5,644,727	A	7/1997	Atkins
5,500,903	A	3/1996	Gulli	5,644,735	A	7/1997	Luciw et al.
5,500,905	A	3/1996	Martin et al.	5,649,060	A	7/1997	Ellozy et al.
5,500,937	A	3/1996	Thompson-Rohrlich	5,652,828	A	7/1997	Silverman
5,502,774	A	3/1996	Bellegarda et al.	5,652,884	A	7/1997	Palevich
5,502,790	A	3/1996	Yi	5,652,897	A	7/1997	Linebarger et al.
5,502,791	A	3/1996	Nishimura et al.	5,661,787	A	8/1997	Pocock
5,515,475	A	5/1996	Gupta et al.	5,664,055	A	9/1997	Kroon
5,521,816	A	5/1996	Roche et al.	5,664,206	A	9/1997	Murow et al.
5,524,140	A	6/1996	Klausner et al.	5,670,985	A	9/1997	Cappels, Sr. et al.
5,533,182	A	7/1996	Bates et al.	5,675,819	A	10/1997	Schuetze
5,535,121	A	7/1996	Roche et al.	5,678,039	A	10/1997	Hinks et al.
5,536,902	A	7/1996	Serra et al.	5,682,475	A	10/1997	Johnson et al.
5,537,317	A	7/1996	Schabes et al.	5,682,539	A	10/1997	Conrad et al.
5,537,618	A	7/1996	Boulton et al.	5,684,513	A	11/1997	Decker
5,537,647	A	7/1996	Hermansky et al.	5,687,077	A	11/1997	Gough, Jr.
5,543,588	A	8/1996	Bisset et al.	5,689,287	A	11/1997	Mackinlay et al.
5,543,897	A	8/1996	Altrieth, III	5,689,616	A	11/1997	Li
5,544,264	A	8/1996	Bellegarda et al.	5,689,618	A	11/1997	Gaspar et al.
5,548,507	A	8/1996	Martino et al.	5,692,205	A	11/1997	Berry et al.
5,555,343	A	9/1996	Luther	5,696,962	A	12/1997	Kupiec
5,555,344	A	9/1996	Zunkler	5,699,082	A	12/1997	Marks et al.
5,559,301	A	9/1996	Bryan, Jr. et al.	5,701,400	A	12/1997	Amado
5,559,945	A	9/1996	Beaudet et al.	5,706,442	A	1/1998	Anderson et al.
5,564,446	A	10/1996	Wiltshire	5,708,659	A	1/1998	Rostoker et al.
5,565,888	A	10/1996	Selker	5,708,822	A	1/1998	Wical
5,568,536	A	10/1996	Tiller et al.	5,710,886	A	1/1998	Christensen et al.
5,568,540	A	10/1996	Greco et al.	5,710,922	A	1/1998	Alley et al.
5,570,324	A	10/1996	Geil	5,712,949	A	1/1998	Kato et al.
5,572,576	A	11/1996	Klausner et al.	5,712,957	A	1/1998	Waibel et al.
5,574,823	A	11/1996	Hassanein et al.	5,715,468	A	2/1998	Budzinski
5,574,824	A	11/1996	Slyh et al.	5,717,877	A	2/1998	Orton et al.
5,577,135	A	11/1996	Grajski et al.	5,721,827	A	2/1998	Logan et al.
5,577,164	A	11/1996	Kaneko et al.	5,721,949	A	2/1998	Smith et al.
5,577,241	A	11/1996	Spencer	5,724,406	A	3/1998	Juster
5,578,808	A	11/1996	Taylor	5,724,985	A	3/1998	Snell et al.
5,579,037	A	11/1996	Tahara et al.	5,726,672	A	3/1998	Hernandez et al.
5,579,436	A	11/1996	Chou et al.	5,727,950	A	3/1998	Cook et al.
5,581,484	A	12/1996	Prince	5,729,694	A	3/1998	Holzrichter et al.
5,581,652	A	12/1996	Abe et al.	5,729,704	A	3/1998	Stone et al.
5,581,655	A	12/1996	Cohen et al.	5,732,216	A	3/1998	Logan et al.
5,583,993	A	12/1996	Foster et al.	5,732,390	A	3/1998	Katayanagi et al.
5,584,024	A	12/1996	Shwartz	5,732,395	A	3/1998	Silverman
5,586,540	A	12/1996	Marzec et al.	5,734,750	A	3/1998	Arai et al.
5,594,641	A	1/1997	Kaplan et al.	5,734,791	A	3/1998	Acero et al.
5,596,260	A	1/1997	Moravec et al.	5,736,974	A	4/1998	Selker
5,596,676	A	1/1997	Swaminathan et al.	5,737,487	A	4/1998	Bellegarda et al.
5,596,994	A	1/1997	Bro	5,737,609	A	4/1998	Reed et al.
5,608,624	A	3/1997	Luciw	5,737,734	A	4/1998	Schultz
5,608,698	A	3/1997	Yamanoi et al.	5,739,451	A	4/1998	Winsky et al.
5,608,841	A	3/1997	Tsuboka	5,740,143	A	4/1998	Suetomi
5,610,812	A	3/1997	Schabes et al.	5,742,705	A	4/1998	Parthasarathy
5,613,036	A	3/1997	Strong	5,742,736	A	4/1998	Haddock
5,613,122	A	3/1997	Burnard et al.	5,745,116	A	4/1998	Pisutha-Armond
5,615,378	A	3/1997	Nishino et al.	5,745,843	A	4/1998	Wetters et al.
5,615,384	A	3/1997	Allard et al.	5,745,873	A	4/1998	Braida et al.
5,616,876	A	4/1997	Cluts	5,748,512	A	5/1998	Vargas
5,617,386	A	4/1997	Choi	5,748,974	A	5/1998	Johnson
5,617,507	A	4/1997	Lee et al.	5,749,071	A	5/1998	Silverman
				5,749,081	A	5/1998	Whiteis
				5,751,906	A	5/1998	Silverman
				5,757,358	A	5/1998	Osga
				5,757,979	A	5/1998	Hongo et al.

(56)

References Cited

U.S. PATENT DOCUMENTS

5,758,079	A	5/1998	Ludwig et al.	5,875,427	A	2/1999	Yamazaki
5,758,083	A	5/1998	Singh et al.	5,875,429	A	2/1999	Douglas
5,758,314	A	5/1998	McKenna	5,875,437	A	2/1999	Atkins
5,759,101	A	6/1998	Von Kohorn	5,876,396	A	3/1999	Lo et al.
5,761,640	A	6/1998	Kalyanswamy et al.	5,877,751	A	3/1999	Kanemitsu et al.
5,765,131	A	6/1998	Stentiford et al.	5,877,757	A	3/1999	Baldwin et al.
5,765,168	A	6/1998	Burrows	5,878,393	A	3/1999	Hata et al.
5,771,276	A	6/1998	Wolf	5,878,394	A	3/1999	Muhling
5,774,834	A	6/1998	Visser	5,878,396	A	3/1999	Henton
5,774,855	A	6/1998	Foti et al.	5,880,411	A	3/1999	Gillespie et al.
5,774,859	A	6/1998	Houser et al.	5,880,731	A	3/1999	Liles et al.
5,777,614	A	7/1998	Ando et al.	5,884,039	A	3/1999	Ludwig et al.
5,778,405	A	7/1998	Ogawa	5,884,323	A	3/1999	Hawkins et al.
5,790,978	A	8/1998	Olive et al.	5,890,117	A	3/1999	Silverman
5,794,050	A	8/1998	Dahlgren et al.	5,890,122	A	3/1999	Van et al.
5,794,182	A	8/1998	Manduchi et al.	5,891,180	A	4/1999	Greeninger et al.
5,794,207	A	8/1998	Walker et al.	5,893,126	A	4/1999	Drews et al.
5,794,237	A	8/1998	Gore, Jr.	5,893,132	A	4/1999	Huffman et al.
5,797,008	A	8/1998	Burrows	5,895,448	A	4/1999	Vysotsky et al.
5,799,268	A	8/1998	Boguraev	5,895,464	A	4/1999	Bhandari et al.
5,799,269	A	8/1998	Schabes et al.	5,895,466	A	4/1999	Goldberg et al.
5,799,276	A	8/1998	Komissarchik et al.	5,896,321	A	4/1999	Miller et al.
5,801,692	A	9/1998	Muzio et al.	5,896,500	A	4/1999	Ludwig et al.
5,802,466	A	9/1998	Gallant et al.	5,899,972	A	5/1999	Miyazawa et al.
5,802,526	A	9/1998	Fawcett et al.	5,905,498	A	5/1999	Diamant et al.
5,812,697	A	9/1998	Sakai et al.	5,909,666	A	6/1999	Gould et al.
5,812,698	A	9/1998	Platt et al.	5,912,951	A	6/1999	Checchio et al.
5,815,142	A	9/1998	Allard et al.	5,912,952	A	6/1999	Brendzel
5,815,225	A	9/1998	Nelson	5,913,193	A	6/1999	Huang et al.
5,818,142	A	10/1998	Edleblute et al.	5,915,001	A	6/1999	Uppaluru et al.
5,818,451	A	10/1998	Bertram et al.	5,915,236	A	6/1999	Gould et al.
5,818,924	A	10/1998	King et al.	5,915,238	A	6/1999	Tjaden
5,822,288	A	10/1998	Shinada	5,915,249	A	6/1999	Spencer
5,822,720	A	10/1998	Bookman et al.	5,917,487	A	6/1999	Ulrich
5,822,730	A	10/1998	Roth et al.	5,918,303	A	6/1999	Yamaura et al.
5,822,743	A	10/1998	Gupta et al.	5,920,327	A	7/1999	Seidensticker, Jr.
5,825,349	A	10/1998	Meier et al.	5,920,836	A	7/1999	Gould et al.
5,825,352	A	10/1998	Bisset et al.	5,920,837	A	7/1999	Gould et al.
5,825,881	A	10/1998	Colvin, Sr.	5,923,757	A	7/1999	Hocker et al.
5,826,261	A	10/1998	Spencer	5,924,068	A	7/1999	Richard et al.
5,828,768	A	10/1998	Eatwell et al.	5,926,769	A	7/1999	Valimaa et al.
5,828,999	A	10/1998	Bellegarda et al.	5,926,789	A	7/1999	Barbara et al.
5,832,433	A	11/1998	Yashchin et al.	5,930,408	A	7/1999	Seto
5,832,435	A	11/1998	Silverman	5,930,751	A	7/1999	Cohrs et al.
5,833,134	A	11/1998	Ho et al.	5,930,754	A	7/1999	Karaali et al.
5,835,077	A	11/1998	Dao et al.	5,930,769	A	7/1999	Rose
5,835,079	A	11/1998	Shieh	5,930,783	A	7/1999	Li et al.
5,835,721	A	11/1998	Donahue et al.	5,933,477	A	8/1999	Wu
5,835,732	A	11/1998	Kikinis et al.	5,933,806	A	8/1999	Beyerlein et al.
5,835,893	A	11/1998	Ushioda	5,933,822	A	8/1999	Braden-Harder et al.
5,839,106	A	11/1998	Bellegarda	5,936,926	A	8/1999	Yokouchi et al.
5,841,902	A	11/1998	Tu	5,937,163	A	8/1999	Lee et al.
5,842,165	A	11/1998	Raman et al.	5,940,811	A	8/1999	Norris
5,845,255	A	12/1998	Mayaud	5,940,841	A	8/1999	Schmuck et al.
5,848,410	A	12/1998	Walls et al.	5,941,944	A	8/1999	Messerly
5,850,480	A	12/1998	Scanlon	5,943,043	A	8/1999	Furuhata et al.
5,850,629	A	12/1998	Holm et al.	5,943,049	A	8/1999	Matsubara et al.
5,854,893	A	12/1998	Ludwig et al.	5,943,052	A	8/1999	Allen et al.
5,855,000	A	12/1998	Waibel et al.	5,943,429	A	8/1999	Handel
5,857,184	A	1/1999	Lynch	5,943,443	A	8/1999	Itonori et al.
5,859,636	A	1/1999	Pandit	5,943,670	A	8/1999	Prager
5,860,063	A	1/1999	Gorin et al.	5,946,647	A	8/1999	Miller et al.
5,860,064	A	1/1999	Henton	5,948,040	A	9/1999	DeLorme et al.
5,860,075	A	1/1999	Hashizume et al.	5,949,961	A	9/1999	Sharman
5,862,223	A	1/1999	Walker et al.	5,950,123	A	9/1999	Schwelb et al.
5,862,233	A	1/1999	Poletti	5,952,992	A	9/1999	Helms
5,864,806	A	1/1999	Mokbel et al.	5,953,541	A	9/1999	King et al.
5,864,815	A	1/1999	Rozak et al.	5,956,021	A	9/1999	Kubota et al.
5,864,844	A	1/1999	James et al.	5,956,699	A	9/1999	Wong et al.
5,864,855	A	1/1999	Ruocco et al.	5,960,394	A	9/1999	Gould et al.
5,864,868	A	1/1999	Contois	5,960,422	A	9/1999	Prasad
5,867,799	A	2/1999	Lang et al.	5,963,208	A	10/1999	Dolan et al.
5,870,710	A	2/1999	Ozawa et al.	5,963,924	A	10/1999	Williams et al.
5,873,056	A	2/1999	Liddy et al.	5,963,964	A	10/1999	Nielsen
5,873,064	A	2/1999	De et al.	5,966,126	A	10/1999	Szabo
				5,970,446	A	10/1999	Goldberg et al.
				5,970,474	A	10/1999	LeRoy et al.
				5,973,612	A	10/1999	Deo et al.
				5,973,676	A	10/1999	Kawakura

(56)

References Cited

U.S. PATENT DOCUMENTS

5,974,146	A	10/1999	Randle et al.	6,085,204	A	7/2000	Chijiwa et al.
5,977,950	A	11/1999	Rhyne	6,088,671	A	7/2000	Gould et al.
5,982,352	A	11/1999	Pryor	6,088,731	A	7/2000	Kiraly et al.
5,982,891	A	11/1999	Ginter et al.	6,092,036	A	7/2000	Hamann et al.
5,982,902	A	11/1999	Terano	6,092,043	A	7/2000	Squires et al.
5,983,179	A	11/1999	Gould et al.	6,094,649	A	7/2000	Bowen et al.
5,983,216	A	11/1999	Kirsch et al.	6,097,391	A	8/2000	Wilcox
5,987,132	A	11/1999	Rowney	6,101,468	A	8/2000	Gould et al.
5,987,140	A	11/1999	Rowney et al.	6,101,470	A	8/2000	Eide et al.
5,987,401	A	11/1999	Trudeau	6,105,865	A	8/2000	Hardesty
5,987,404	A	11/1999	Della Pietra et al.	6,108,627	A	8/2000	Sabourin
5,987,440	A	11/1999	O'Neil et al.	6,108,640	A	8/2000	Slotznick
5,990,887	A	11/1999	Redpath et al.	6,111,562	A	8/2000	Downs et al.
5,991,441	A	11/1999	Jourjine	6,111,572	A	8/2000	Blair et al.
5,995,460	A	11/1999	Takagi et al.	6,115,686	A	9/2000	Chung et al.
5,995,590	A	11/1999	Brunet et al.	6,116,907	A	9/2000	Baker et al.
5,998,972	A	12/1999	Gong	6,119,101	A	9/2000	Peckover
5,999,169	A	12/1999	Lee	6,121,960	A	9/2000	Carroll et al.
5,999,895	A	12/1999	Forest	6,122,340	A	9/2000	Darley et al.
5,999,908	A	12/1999	Abelow	6,122,614	A	9/2000	Kahn et al.
5,999,927	A	12/1999	Tukey et al.	6,122,616	A	9/2000	Henton
6,006,274	A	12/1999	Hawkins et al.	6,122,647	A	9/2000	Horowitz et al.
6,009,237	A	12/1999	Hirabayashi et al.	6,125,284	A	9/2000	Moore et al.
6,011,585	A	1/2000	Anderson	6,125,346	A	9/2000	Nishimura et al.
6,014,428	A	1/2000	Wolf	6,125,356	A	9/2000	Brockman et al.
6,016,471	A	1/2000	Kuhn et al.	6,129,582	A	10/2000	Wilhite et al.
6,017,219	A	1/2000	Adams, Jr. et al.	6,138,098	A	10/2000	Shieber et al.
6,018,705	A	1/2000	Gaudet	6,138,158	A	10/2000	Boyle et al.
6,018,711	A	1/2000	French-St. George et al.	6,141,642	A	10/2000	Oh
6,020,881	A	2/2000	Naughton et al.	6,141,644	A	10/2000	Kuhn et al.
6,023,536	A	2/2000	Visser	6,144,377	A	11/2000	Oppermann et al.
6,023,676	A	2/2000	Erell	6,144,380	A	11/2000	Shwartz et al.
6,023,684	A	2/2000	Pearson	6,144,938	A	11/2000	Surace et al.
6,024,288	A	2/2000	Gottlich et al.	6,144,939	A	11/2000	Pearson et al.
6,026,345	A	2/2000	Shah et al.	6,151,401	A	11/2000	Annaratone
6,026,375	A	2/2000	Hall et al.	6,154,551	A	11/2000	Frenkel
6,026,388	A	2/2000	Liddy et al.	6,154,720	A	11/2000	Onishi et al.
6,026,393	A	2/2000	Gupta et al.	6,157,935	A	12/2000	Tran et al.
6,029,132	A	2/2000	Kuhn et al.	6,161,084	A	12/2000	Messerly et al.
6,029,135	A	2/2000	Krasle	6,161,087	A	12/2000	Wightman et al.
6,035,267	A	3/2000	Watanabe et al.	6,161,944	A	12/2000	Leman
6,035,303	A	3/2000	Baer et al.	6,163,769	A	12/2000	Acerio et al.
6,035,336	A	3/2000	Lu et al.	6,163,809	A	12/2000	Buckley
6,038,533	A	3/2000	Buchsbaum et al.	6,167,369	A	12/2000	Schulze
6,040,824	A	3/2000	Maekawa et al.	6,169,538	B1	1/2001	Nowlan et al.
6,041,023	A	3/2000	Lakhansingh	6,172,948	B1	1/2001	Keller et al.
6,047,255	A	4/2000	Williamson	6,173,194	B1	1/2001	Vanttila
6,047,300	A	4/2000	Walfish et al.	6,173,251	B1	1/2001	Ito et al.
6,052,654	A	4/2000	Gaudet et al.	6,173,261	B1	1/2001	Arai et al.
6,052,656	A	4/2000	Suda et al.	6,173,263	B1	1/2001	Conkie
6,054,990	A	4/2000	Tran	6,173,279	B1	1/2001	Levin et al.
6,055,514	A	4/2000	Wren	6,177,905	B1	1/2001	Welch
6,055,531	A	4/2000	Bennett et al.	6,177,931	B1	1/2001	Alexander et al.
6,064,767	A	5/2000	Muir et al.	6,179,432	B1	1/2001	Zhang et al.
6,064,951	A	5/2000	Park et al.	6,182,028	B1	1/2001	Karaali et al.
6,064,959	A	5/2000	Young et al.	6,185,533	B1	2/2001	Holm et al.
6,064,960	A	5/2000	Bellegarda et al.	6,188,391	B1	2/2001	Seely et al.
6,064,963	A	5/2000	Gainsboro	6,188,967	B1	2/2001	Kurtzberg et al.
6,067,519	A	5/2000	Lowry	6,188,999	B1	2/2001	Moody
6,069,648	A	5/2000	Suso et al.	6,191,939	B1	2/2001	Burnett
6,070,138	A	5/2000	Iwata	6,192,253	B1	2/2001	Charlier et al.
6,070,139	A	5/2000	Miyazawa et al.	6,192,340	B1	2/2001	Abecassis
6,070,140	A	5/2000	Tran	6,195,641	B1	2/2001	Loring et al.
6,070,147	A	5/2000	Harms et al.	6,199,076	B1	3/2001	Logan et al.
6,073,033	A	6/2000	Campo	6,205,456	B1	3/2001	Nakao
6,073,036	A	6/2000	Heikkinen et al.	6,208,044	B1	3/2001	Viswanadham et al.
6,073,097	A	6/2000	Gould et al.	6,208,932	B1	3/2001	Ohmura et al.
6,076,051	A	6/2000	Messerly et al.	6,208,956	B1	3/2001	Motoyama
6,076,060	A	6/2000	Lin et al.	6,208,964	B1	3/2001	Sabourin
6,076,088	A	6/2000	Paik et al.	6,208,967	B1	3/2001	Pauws et al.
6,078,885	A	6/2000	Beutnagel	6,208,971	B1	3/2001	Bellegarda et al.
6,078,914	A	6/2000	Redfern	6,212,564	B1	4/2001	Harter et al.
6,081,750	A	6/2000	Hoffberg et al.	6,216,102	B1	4/2001	Martino et al.
6,081,774	A	6/2000	de Hita et al.	6,216,131	B1	4/2001	Liu et al.
6,081,780	A	6/2000	Lumelsky	6,217,183	B1	4/2001	Shipman
				6,222,347	B1	4/2001	Gong
				6,226,403	B1	5/2001	Parthasarathy
				6,226,533	B1	5/2001	Akahane
				6,226,614	B1	5/2001	Mizuno et al.

(56)

References Cited

U.S. PATENT DOCUMENTS

6,226,655	B1	5/2001	Borman et al.	6,345,250	B1	2/2002	Martin
6,230,322	B1	5/2001	Saib et al.	6,351,522	B1	2/2002	Vitikainen
6,232,539	B1	5/2001	Looney et al.	6,351,762	B1	2/2002	Ludwig et al.
6,232,966	B1	5/2001	Kurlander	6,353,442	B1	3/2002	Masui
6,233,545	B1	5/2001	Datig	6,353,794	B1	3/2002	Davis et al.
6,233,547	B1	5/2001	Denber et al.	6,356,287	B1	3/2002	Rubery et al.
6,233,559	B1	5/2001	Balakrishnan	6,356,854	B1	3/2002	Schubert et al.
6,233,578	B1	5/2001	Machihara et al.	6,356,864	B1	3/2002	Foltz et al.
6,237,025	B1	5/2001	Ludwig et al.	6,356,905	B1	3/2002	Gershman et al.
6,240,303	B1	5/2001	Katzur	6,357,147	B1	3/2002	Darley et al.
6,243,681	B1	6/2001	Guji et al.	6,359,572	B1	3/2002	Vale
6,246,981	B1	6/2001	Papineni et al.	6,359,970	B1	3/2002	Burgess
6,248,946	B1	6/2001	Dwek	6,360,227	B1	3/2002	Aggarwal et al.
6,249,606	B1	6/2001	Kiraly et al.	6,360,237	B1	3/2002	Schulz et al.
6,259,436	B1	7/2001	Moon et al.	6,363,348	B1	3/2002	Besling et al.
6,259,826	B1	7/2001	Pollard et al.	6,366,883	B1	4/2002	Campbell et al.
6,260,011	B1	7/2001	Heckerman et al.	6,366,884	B1	4/2002	Bellegarda et al.
6,260,013	B1	7/2001	Sejnova	6,374,217	B1	4/2002	Bellegarda
6,260,016	B1	7/2001	Holm et al.	6,377,530	B1	4/2002	Burrows
6,260,024	B1	7/2001	Shkedy	6,377,925	B1	4/2002	Greene, Jr. et al.
6,266,098	B1	7/2001	Cove et al.	6,377,928	B1	4/2002	Saxena et al.
6,266,637	B1	7/2001	Donovan et al.	6,381,593	B1	4/2002	Yano et al.
6,268,859	B1	7/2001	Andresen et al.	6,385,586	B1	5/2002	Dietz
6,269,712	B1	8/2001	Zentmyer	6,385,662	B1	5/2002	Moon et al.
6,271,835	B1	8/2001	Hoeksma	6,389,114	B1	5/2002	Dowens et al.
6,272,456	B1	8/2001	De Campos	6,397,183	B1	5/2002	Baba et al.
6,272,464	B1	8/2001	Kiraz et al.	6,397,186	B1	5/2002	Bush et al.
6,275,795	B1	8/2001	Tzirkel-Hancock	6,400,806	B1	6/2002	Uppaluru
6,275,824	B1	8/2001	O'Flaherty et al.	6,401,065	B1	6/2002	Kanevsky et al.
6,278,443	B1	8/2001	Amro et al.	6,405,169	B1	6/2002	Kondo et al.
6,278,970	B1	8/2001	Milner	6,405,238	B1	6/2002	Votipka
6,282,507	B1	8/2001	Horiguchi et al.	6,408,272	B1	6/2002	White et al.
6,285,785	B1	9/2001	Bellegarda et al.	6,411,924	B1	6/2002	De Hita et al.
6,285,786	B1	9/2001	Seni et al.	6,411,932	B1	6/2002	Molnar et al.
6,289,085	B1	9/2001	Miyashita et al.	6,415,250	B1	7/2002	Van Den Akker
6,289,124	B1	9/2001	Okamoto	6,417,873	B1	7/2002	Fletcher et al.
6,289,301	B1	9/2001	Higginbotham et al.	6,421,305	B1	7/2002	Gioscia et al.
6,289,353	B1	9/2001	Hazlehurst et al.	6,421,672	B1	7/2002	McAllister et al.
6,292,772	B1	9/2001	Kantrowitz	6,421,707	B1	7/2002	Miller et al.
6,292,778	B1	9/2001	Sukkar	6,424,944	B1	7/2002	Hikawa
6,295,390	B1	9/2001	Kobayashi et al.	6,430,551	B1	8/2002	Thelen et al.
6,295,541	B1	9/2001	Bodnar et al.	6,434,522	B1	8/2002	Tsuboka
6,297,818	B1	10/2001	Ulrich et al.	6,434,524	B1	8/2002	Weber
6,298,314	B1	10/2001	Blackadar et al.	6,434,604	B1	8/2002	Harada et al.
6,298,321	B1	10/2001	Karlov et al.	6,437,818	B1	8/2002	Ludwig et al.
6,300,947	B1	10/2001	Kanevsky	6,438,523	B1	8/2002	Oberteuffer et al.
6,304,844	B1	10/2001	Pan et al.	6,442,518	B1	8/2002	Van Thong et al.
6,304,846	B1	10/2001	George et al.	6,442,523	B1	8/2002	Siegel
6,307,548	B1	10/2001	Flinchem et al.	6,446,076	B1	9/2002	Burkey et al.
6,308,149	B1	10/2001	Gaussier et al.	6,448,485	B1	9/2002	Barile
6,310,610	B1	10/2001	Beaton et al.	6,448,986	B1	9/2002	Smith
6,311,157	B1	10/2001	Strong	6,449,620	B1	9/2002	Draper et al.
6,311,189	B1	10/2001	deVries et al.	6,453,281	B1	9/2002	Walters et al.
6,317,237	B1	11/2001	Nakao et al.	6,453,292	B2	9/2002	Ramaswamy et al.
6,317,594	B1	11/2001	Gossman et al.	6,453,315	B1	9/2002	Weissman et al.
6,317,707	B1	11/2001	Bangalore et al.	6,456,616	B1	9/2002	Rantanen
6,317,831	B1	11/2001	King	6,456,972	B1	9/2002	Gladstein et al.
6,321,092	B1	11/2001	Fitch et al.	6,460,015	B1	10/2002	Hetherington et al.
6,321,179	B1	11/2001	Glance et al.	6,460,029	B1	10/2002	Fries et al.
6,323,846	B1	11/2001	Westerman et al.	6,462,778	B1	10/2002	Abram et al.
6,324,499	B1	11/2001	Lewis et al.	6,463,128	B1	10/2002	Elwin
6,324,502	B1	11/2001	Handel et al.	6,466,654	B1	10/2002	Cooper et al.
6,324,512	B1	11/2001	Junqua et al.	6,467,924	B2	10/2002	Shipman
6,324,514	B2	11/2001	Matulich et al.	6,469,712	B1	10/2002	Hilpert, Jr. et al.
6,330,538	B1	12/2001	Breen	6,469,722	B1	10/2002	Kinoe et al.
6,331,867	B1	12/2001	Eberhard et al.	6,469,732	B1	10/2002	Chang et al.
6,332,175	B1	12/2001	Birrell et al.	6,470,347	B1	10/2002	Gillam
6,334,103	B1	12/2001	Surace et al.	6,473,630	B1	10/2002	Baranowski et al.
6,335,722	B1	1/2002	Tani et al.	6,477,488	B1	11/2002	Bellegarda
6,336,365	B1	1/2002	Blackadar et al.	6,477,494	B2	11/2002	Hyde-Thomson et al.
6,336,727	B1	1/2002	Kim	6,487,533	B2	11/2002	Hyde-Thomson et al.
6,340,937	B1	1/2002	Stepita-Klauco	6,487,534	B1	11/2002	Thelen et al.
6,341,316	B1	1/2002	Kloba et al.	6,487,663	B1	11/2002	Jaisimha et al.
6,343,267	B1	1/2002	Kuhn et al.	6,489,951	B1	12/2002	Wong et al.
6,345,240	B1	2/2002	Havens	6,490,560	B1	12/2002	Ramaswamy et al.
				6,493,006	B1	12/2002	Gourdol et al.
				6,493,428	B1	12/2002	Hillier
				6,493,652	B1	12/2002	Ohlenbusch et al.
				6,493,667	B1	12/2002	De Souza et al.

(56)

References Cited

U.S. PATENT DOCUMENTS

6,499,013	B1	12/2002	Weber	6,622,136	B2	9/2003	Russell
6,499,014	B1	12/2002	Chihara	6,623,529	B1	9/2003	Lakritz
6,499,016	B1	12/2002	Anderson	6,625,583	B1	9/2003	Silverman et al.
6,501,937	B1	12/2002	Ho et al.	6,628,808	B1	9/2003	Bach et al.
6,502,194	B1	12/2002	Berman et al.	6,631,186	B1	10/2003	Adams et al.
6,505,158	B1	1/2003	Conkie	6,631,346	B1	10/2003	Karaorman et al.
6,505,175	B1	1/2003	Silverman et al.	6,633,741	B1	10/2003	Posa et al.
6,505,183	B1	1/2003	Loofbourrow et al.	6,633,846	B1	10/2003	Bennett et al.
6,507,829	B1	1/2003	Richards et al.	6,633,932	B1	10/2003	Bork et al.
6,510,406	B1	1/2003	Marchisio	6,642,940	B1	11/2003	Dakss et al.
6,510,417	B1	1/2003	Woods et al.	6,643,401	B1	11/2003	Kashioka et al.
6,513,008	B2	1/2003	Pearson et al.	6,643,824	B1	11/2003	Bates et al.
6,513,063	B1	1/2003	Julia et al.	6,647,260	B2	11/2003	Dusse et al.
6,519,565	B1	2/2003	Clements et al.	6,650,735	B2	11/2003	Burton et al.
6,519,566	B1	2/2003	Boyer et al.	6,651,042	B1	11/2003	Field et al.
6,523,026	B1	2/2003	Gillis	6,651,218	B1	11/2003	Adler et al.
6,523,061	B1	2/2003	Halverson et al.	6,654,740	B2	11/2003	Tokuda et al.
6,523,172	B1	2/2003	Martinez-Guerra et al.	6,658,389	B1	12/2003	Alpdemir
6,526,351	B2	2/2003	Whitham	6,658,408	B2	12/2003	Yano et al.
6,526,382	B1	2/2003	Yuschik	6,658,577	B2	12/2003	Huppi et al.
6,526,395	B1	2/2003	Morris	6,661,438	B1	12/2003	Shiraishi et al.
6,529,592	B1	3/2003	Khan	6,662,023	B1	12/2003	Helle
6,529,608	B2	3/2003	Gersabeck et al.	6,665,639	B2	12/2003	Mozer et al.
6,532,444	B1	3/2003	Weber	6,665,640	B1	12/2003	Bennett et al.
6,532,446	B1	3/2003	King	6,665,641	B1	12/2003	Coorman et al.
6,535,610	B1	3/2003	Stewart	6,671,672	B1	12/2003	Heck
6,535,852	B2	3/2003	Eide	6,671,683	B2	12/2003	Kanno
6,535,983	B1	3/2003	McCormack et al.	6,671,856	B1	12/2003	Gillam
6,536,139	B2	3/2003	Darley et al.	6,675,169	B1	1/2004	Bennett et al.
6,538,665	B2	3/2003	Crow et al.	6,675,233	B1	1/2004	Du et al.
6,542,171	B1	4/2003	Satou et al.	6,677,932	B1	1/2004	Westerman
6,542,584	B1	4/2003	Sherwood et al.	6,680,675	B1	1/2004	Suzuki
6,546,262	B1	4/2003	Freadman	6,684,187	B1	1/2004	Conkie
6,546,367	B2	4/2003	Otsuka	6,684,376	B1	1/2004	Kerzman et al.
6,546,388	B1	4/2003	Edlund et al.	6,690,387	B2	2/2004	Zimmerman et al.
6,549,497	B2	4/2003	Miyamoto et al.	6,690,800	B2	2/2004	Resnick
6,553,343	B1	4/2003	Kagoshima et al.	6,690,828	B2	2/2004	Meyers
6,553,344	B2	4/2003	Bellegarda et al.	6,691,064	B2	2/2004	Vroman
6,556,971	B1	4/2003	Rigsby et al.	6,691,090	B1	2/2004	Laurila et al.
6,556,983	B1	4/2003	Altschuler et al.	6,691,111	B2	2/2004	Lazaridis et al.
6,560,903	B1	5/2003	Darley	6,691,151	B1	2/2004	Cheyer et al.
6,563,769	B1	5/2003	Van Der Meulen	6,694,295	B2	2/2004	Lindholm et al.
6,564,186	B1	5/2003	Kiraly et al.	6,694,297	B2	2/2004	Sato
6,567,549	B1	5/2003	Marianetti, II et al.	6,697,780	B1	2/2004	Beutnagel et al.
6,570,557	B1	5/2003	Westerman et al.	6,697,824	B1	2/2004	Bowman-Amuah
6,570,596	B2	5/2003	Frederiksen	6,701,294	B1	3/2004	Ball et al.
6,582,342	B2	6/2003	Kaufman	6,701,305	B1	3/2004	Holt et al.
6,583,806	B2	6/2003	Ludwig et al.	6,701,318	B2	3/2004	Fox et al.
6,584,464	B1	6/2003	Warthen	6,704,015	B1	3/2004	Bovarnick et al.
6,587,403	B1	7/2003	Keller et al.	6,704,034	B1	3/2004	Rodriguez et al.
6,587,404	B1	7/2003	Keller et al.	6,704,698	B1	3/2004	Paulsen, Jr. et al.
6,590,303	B1	7/2003	Austin et al.	6,704,710	B2	3/2004	Strong
6,591,379	B1	7/2003	LeVine et al.	6,708,153	B2	3/2004	Brittan et al.
6,594,673	B1	7/2003	Smith et al.	6,711,585	B1	3/2004	Copperman et al.
6,594,688	B2	7/2003	Ludwig et al.	6,714,221	B1	3/2004	Christie et al.
6,597,345	B2	7/2003	Hirshberg	6,716,139	B1	4/2004	Hosseinzadeh-Dolkhani et al.
6,598,021	B1	7/2003	Shambaugh et al.	6,718,324	B2	4/2004	Edlund et al.
6,598,022	B2	7/2003	Yuschik	6,718,331	B2	4/2004	Davis et al.
6,598,039	B1	7/2003	Livowsky	6,720,980	B1	4/2004	Lui et al.
6,598,054	B2	7/2003	Schuetze et al.	6,721,728	B2	4/2004	McGreevy
6,601,026	B2	7/2003	Appelt et al.	6,721,734	B1	4/2004	Subasic et al.
6,601,234	B1	7/2003	Bowman-Amuah	6,724,370	B2	4/2004	Dutta et al.
6,603,837	B1	8/2003	Kesanupalli et al.	6,725,197	B1	4/2004	Wuppermann et al.
6,604,059	B2	8/2003	Strubbe et al.	6,728,675	B1	4/2004	Maddalozzo, Jr. et al.
6,606,101	B1	8/2003	Malamud et al.	6,728,681	B2	4/2004	Whitham
6,606,388	B1	8/2003	Townsend et al.	6,728,729	B1	4/2004	Jawa et al.
6,606,632	B1	8/2003	Saulpaugh et al.	6,731,312	B2	5/2004	Robbin
6,611,789	B1	8/2003	Darley	6,732,142	B1	5/2004	Bates et al.
6,615,172	B1	9/2003	Bennett et al.	6,735,632	B1	5/2004	Kiraly et al.
6,615,175	B1	9/2003	Gazdzinski	6,738,738	B2	5/2004	Henton
6,615,176	B2	9/2003	Lewis et al.	6,741,264	B1	5/2004	Lesser
6,615,220	B1	9/2003	Austin et al.	6,742,021	B1	5/2004	Halverson et al.
6,621,768	B1	9/2003	Keller et al.	6,751,592	B1	6/2004	Shiga
6,621,892	B1	9/2003	Banister et al.	6,751,595	B2	6/2004	Busayapongchai et al.
6,622,121	B1	9/2003	Crepy et al.	6,751,621	B1	6/2004	Calistri-Yeh et al.
				6,754,504	B1	6/2004	Reed
				6,757,362	B1	6/2004	Cooper et al.
				6,757,365	B1	6/2004	Bogard
				6,757,646	B2	6/2004	Marchisio

(56)

References Cited

U.S. PATENT DOCUMENTS

6,757,653 B2	6/2004	Buth et al.	6,879,957 B1	4/2005	Pechter et al.
6,757,718 B1	6/2004	Halverson et al.	6,882,335 B2	4/2005	Saarinen
6,760,412 B1	7/2004	Loucks	6,882,337 B2	4/2005	Shetter
6,760,700 B2	7/2004	Lewis et al.	6,882,747 B2	4/2005	Thawonmas et al.
6,760,754 B1	7/2004	Isaacs et al.	6,882,955 B1	4/2005	Ohlenbusch et al.
6,762,741 B2	7/2004	Weindorf	6,882,971 B2	4/2005	Craner
6,762,777 B2	7/2004	Carroll	6,885,734 B1	4/2005	Eberle et al.
6,763,089 B2	7/2004	Feigenbaum	6,889,361 B1	5/2005	Bates et al.
6,766,294 B2	7/2004	MacGinite et al.	6,895,084 B1	5/2005	Saylor et al.
6,766,320 B1	7/2004	Wang et al.	6,895,257 B2	5/2005	Boman et al.
6,766,324 B2	7/2004	Carlson et al.	6,895,380 B2	5/2005	Sepe, Jr.
6,768,979 B1	7/2004	Menendez-Pidal et al.	6,895,558 B1	5/2005	Loveland
6,772,123 B2	8/2004	Cooklev et al.	6,898,550 B1	5/2005	Blackadar et al.
6,772,195 B1	8/2004	Hatlelid et al.	6,901,364 B2	5/2005	Nguyen et al.
6,772,394 B1	8/2004	Kamada	6,901,399 B1	5/2005	Corston et al.
6,775,358 B1	8/2004	Breitenbach et al.	6,904,405 B2	6/2005	Suominen
6,778,951 B1	8/2004	Contractor	6,907,112 B1	6/2005	Guedalia et al.
6,778,952 B2	8/2004	Bellegarda	6,907,140 B2	6/2005	Matsugu et al.
6,778,962 B1	8/2004	Kasai et al.	6,910,004 B2	6/2005	Tarbouriech et al.
6,778,970 B2	8/2004	Au	6,910,007 B2	6/2005	Stylianou et al.
6,778,979 B2	8/2004	Grefenstette et al.	6,910,186 B2	6/2005	Kim
6,782,510 B1	8/2004	Gross et al.	6,911,971 B2	6/2005	Suzuki et al.
6,784,901 B1	8/2004	Harvey et al.	6,912,407 B1	6/2005	Clarke et al.
6,789,094 B2	9/2004	Rudoff et al.	6,912,498 B2	6/2005	Stevens et al.
6,789,231 B1	9/2004	Reynar et al.	6,912,499 B1	6/2005	Sabourin et al.
6,790,704 B2	9/2004	Doyle et al.	6,915,138 B2	7/2005	Kraft
6,792,082 B1	9/2004	Levine	6,915,246 B2	7/2005	Gusler et al.
6,792,086 B1	9/2004	Saylor et al.	6,915,294 B1	7/2005	Singh et al.
6,792,407 B2	9/2004	Kibre et al.	6,917,373 B2	7/2005	Vong et al.
6,794,566 B2	9/2004	Pachet	6,918,677 B2	7/2005	Shipman
6,795,059 B2	9/2004	Endo	6,924,828 B1	8/2005	Hirsch
6,799,226 B1	9/2004	Robbin et al.	6,925,438 B2	8/2005	Mohamed et al.
6,801,604 B2	10/2004	Maes et al.	6,928,149 B1	8/2005	Panjwani et al.
6,801,964 B1	10/2004	Mahdavi	6,928,614 B1	8/2005	Everhart
6,803,905 B1	10/2004	Capps et al.	6,931,255 B2	8/2005	Mekuria
6,804,649 B2	10/2004	Miranda	6,931,384 B1	8/2005	Horvitz et al.
6,804,677 B2	10/2004	Shadmon et al.	6,932,708 B2	8/2005	Yamashita et al.
6,807,536 B2	10/2004	Achlioptas et al.	6,934,394 B1	8/2005	Anderson
6,807,574 B1	10/2004	Partovi et al.	6,934,684 B2	8/2005	Alpdemir et al.
6,809,724 B1	10/2004	Shiraishi et al.	6,934,756 B2	8/2005	Maes
6,810,379 B1	10/2004	Vermeulen et al.	6,934,812 B1	8/2005	Robbin et al.
6,813,218 B1	11/2004	Antonelli et al.	6,937,975 B1	8/2005	Elworthy
6,813,491 B1	11/2004	McKinney	6,937,986 B2	8/2005	Denenberg et al.
6,813,607 B1	11/2004	Faruquie et al.	6,944,593 B2	9/2005	Kuzunuki et al.
6,816,578 B1	11/2004	Kredo et al.	6,948,094 B2	9/2005	Schultz et al.
6,820,055 B2	11/2004	Saindon et al.	6,950,087 B2	9/2005	Knox et al.
6,829,018 B2	12/2004	Lin et al.	6,950,502 B1	9/2005	Jenkins
6,829,603 B1	12/2004	Wolf et al.	6,952,799 B2	10/2005	Edwards et al.
6,832,194 B1	12/2004	Mozer et al.	6,954,755 B2	10/2005	Reisman
6,832,381 B1	12/2004	Mathur et al.	6,954,899 B1	10/2005	Anderson
6,836,651 B2	12/2004	Segal et al.	6,956,845 B2	10/2005	Baker et al.
6,836,760 B1	12/2004	Silverman et al.	6,957,076 B2	10/2005	Hunzinger
6,839,464 B2	1/2005	Hawkins et al.	6,957,183 B2	10/2005	Malayath et al.
6,839,669 B1	1/2005	Gould et al.	6,960,734 B1	11/2005	Park
6,839,670 B1	1/2005	Stammler et al.	6,961,699 B1	11/2005	Kahn et al.
6,839,742 B1	1/2005	Dyer et al.	6,961,912 B2	11/2005	Aoki et al.
6,842,767 B1	1/2005	Partovi et al.	6,963,841 B2	11/2005	Handal et al.
6,847,966 B1	1/2005	Sommer et al.	6,964,023 B2	11/2005	Maes et al.
6,847,979 B2	1/2005	Allemang et al.	6,965,376 B2	11/2005	Tani et al.
6,850,775 B1	2/2005	Berg	6,968,311 B2	11/2005	Knockeart et al.
6,850,887 B2	2/2005	Epstein et al.	6,970,820 B2	11/2005	Junqua et al.
6,851,115 B1	2/2005	Cheyet et al.	6,970,881 B1	11/2005	Mohan et al.
6,856,259 B1	2/2005	Sharp	6,970,915 B1	11/2005	Partovi et al.
6,857,800 B2	2/2005	Zhang et al.	6,970,935 B1	11/2005	Maes
6,859,931 B1	2/2005	Cheyet et al.	6,976,090 B2	12/2005	Ben-Shaul et al.
6,862,568 B2	3/2005	Case	6,978,127 B1	12/2005	Bulthuis et al.
6,862,710 B1	3/2005	Marchisio	6,978,239 B2	12/2005	Chu et al.
6,865,533 B2	3/2005	Addison et al.	6,980,949 B2	12/2005	Ford
6,868,045 B1	3/2005	Schroder	6,980,955 B2	12/2005	Okutani et al.
6,868,385 B1	3/2005	Gerson	6,983,251 B1	1/2006	Umemoto et al.
6,870,529 B1	3/2005	Davis	6,985,858 B2	1/2006	Frey et al.
6,871,346 B1	3/2005	Kumbalimutt et al.	6,985,865 B1	1/2006	Packingham et al.
6,873,986 B2	3/2005	McConnell et al.	6,985,958 B2	1/2006	Lucovsky et al.
6,876,947 B1	4/2005	Darley et al.	6,988,071 B1	1/2006	Gazdzinski
6,877,003 B2	4/2005	Ho et al.	6,990,450 B2	1/2006	Case et al.
			6,996,520 B2	2/2006	Levin
			6,996,531 B2	2/2006	Korall et al.
			6,996,575 B2	2/2006	Cox et al.
			6,999,066 B2	2/2006	Litwiller

(56)

References Cited

U.S. PATENT DOCUMENTS

6,999,914	B1	2/2006	Boerner et al.	7,095,733	B1	8/2006	Yarlagadda et al.
6,999,925	B2	2/2006	Fischer et al.	7,096,183	B2	8/2006	Junqua
6,999,927	B2	2/2006	Mozer et al.	7,100,117	B1	8/2006	Chwa et al.
7,000,189	B2	2/2006	Dutta et al.	7,103,548	B2	9/2006	Squibbs et al.
7,002,556	B2	2/2006	Tsukada et al.	7,107,204	B1	9/2006	Liu et al.
7,003,099	B1	2/2006	Zhang et al.	7,111,248	B2	9/2006	Mulvey et al.
7,003,463	B1	2/2006	Maes et al.	7,111,774	B2	9/2006	Song
7,003,522	B1	2/2006	Reynar et al.	7,113,803	B2	9/2006	Dehlin
7,006,969	B2	2/2006	Atal	7,113,943	B2	9/2006	Bradford et al.
7,007,026	B2	2/2006	Wilkinson et al.	7,115,035	B2	10/2006	Tanaka
7,007,239	B1	2/2006	Hawkins et al.	7,117,231	B2	10/2006	Fischer et al.
7,010,581	B2	3/2006	Brown et al.	7,123,696	B2	10/2006	Lowe
7,013,289	B2	3/2006	Horn et al.	7,124,081	B1	10/2006	Bellegarda
7,013,308	B1	3/2006	Tunstall-Pedoe	7,124,082	B2	10/2006	Freedman
7,013,429	B2	3/2006	Fujimoto et al.	7,124,164	B1	10/2006	Chemtob
7,015,894	B2	3/2006	Morohoshi	7,127,046	B1	10/2006	Smith et al.
7,020,685	B1	3/2006	Chen et al.	7,127,394	B2	10/2006	Strong
7,024,363	B1	4/2006	Comerford et al.	7,127,396	B2	10/2006	Chu et al.
7,024,364	B2	4/2006	Guerra et al.	7,127,403	B1	10/2006	Saylor et al.
7,024,366	B1	4/2006	Deyoe et al.	7,133,900	B1	11/2006	Szeto
7,024,460	B2	4/2006	Koopmas et al.	7,136,710	B1	11/2006	Hoffberg et al.
7,027,568	B1	4/2006	Simpson et al.	7,136,818	B1	11/2006	Cosatto et al.
7,027,974	B1	4/2006	Busch et al.	7,137,126	B1	11/2006	Coffman et al.
7,027,990	B2	4/2006	Sussman	7,139,697	B2	11/2006	Häkkinen et al.
7,028,252	B1	4/2006	Baru et al.	7,139,714	B2	11/2006	Bennett et al.
7,030,861	B1	4/2006	Westerman et al.	7,139,722	B2	11/2006	Perrella et al.
7,031,530	B2	4/2006	Driggs et al.	7,143,028	B2	11/2006	Hillis et al.
7,031,909	B2	4/2006	Mao et al.	7,143,038	B2	11/2006	Katae
7,035,794	B2	4/2006	Sirivara	7,143,040	B2	11/2006	Durston et al.
7,035,801	B2	4/2006	Jimenez-Feltstrom	7,146,319	B2	12/2006	Hunt
7,035,807	B1	4/2006	Brittain et al.	7,146,437	B2	12/2006	Robbin et al.
7,036,128	B1	4/2006	Julia et al.	7,149,319	B2	12/2006	Roeck
7,036,681	B2	5/2006	Suda et al.	7,149,695	B1	12/2006	Bellegarda
7,038,659	B2	5/2006	Rajkowski	7,149,964	B1	12/2006	Cottrille et al.
7,039,588	B2	5/2006	Okutani et al.	7,152,070	B1	12/2006	Musick et al.
7,043,420	B2	5/2006	Ratnaparkhi	7,152,093	B2	12/2006	Ludwig et al.
7,043,422	B2	5/2006	Gao et al.	7,154,526	B2	12/2006	Foote et al.
7,046,230	B2	5/2006	Zadesky et al.	7,155,668	B2	12/2006	Holland et al.
7,046,850	B2	5/2006	Braspenning et al.	7,158,647	B2	1/2007	Azima et al.
7,047,193	B1	5/2006	Bellegarda	7,159,174	B2	1/2007	Johnson et al.
7,050,550	B2	5/2006	Steinbiss et al.	7,162,412	B2	1/2007	Yamada et al.
7,050,976	B1	5/2006	Packingham	7,162,482	B1	1/2007	Dunning
7,050,977	B1	5/2006	Bennett	7,165,073	B2	1/2007	Vandersluis
7,051,096	B1	5/2006	Krawiec et al.	7,166,791	B2	1/2007	Robbin et al.
7,054,419	B2	5/2006	Culliss	7,171,350	B2	1/2007	Lin et al.
7,054,888	B2	5/2006	LaChapelle et al.	7,171,360	B2	1/2007	Huang et al.
7,057,607	B2	6/2006	Mayoraz et al.	7,174,042	B1	2/2007	Simmons et al.
7,058,569	B2	6/2006	Coorman et al.	7,174,295	B1	2/2007	Kivimaki
7,058,888	B1	6/2006	Gjerstad et al.	7,174,297	B2	2/2007	Guerra et al.
7,058,889	B2	6/2006	Trovato et al.	7,174,298	B2	2/2007	Sharma
7,062,223	B2	6/2006	Gerber et al.	7,177,794	B2	2/2007	Mani et al.
7,062,225	B2	6/2006	White	7,177,798	B2	2/2007	Hsu et al.
7,062,428	B2	6/2006	Hogenhout et al.	7,177,817	B1	2/2007	Khosla et al.
7,062,438	B2	6/2006	Kobayashi et al.	7,181,386	B2	2/2007	Mohri et al.
7,065,185	B1	6/2006	Koch	7,181,388	B2	2/2007	Tian
7,065,485	B1	6/2006	Chong-White et al.	7,184,064	B2	2/2007	Zimmerman et al.
7,069,213	B2	6/2006	Thompson	7,185,276	B2	2/2007	Keswa
7,069,220	B2	6/2006	Coffman et al.	7,188,085	B2	3/2007	Pelletier
7,069,560	B1	6/2006	Cheyser et al.	7,190,351	B1	3/2007	Goren
7,072,686	B1	7/2006	Schrager	7,190,794	B2	3/2007	Hinde
7,072,941	B2	7/2006	Griffin et al.	7,191,118	B2	3/2007	Bellegarda
7,076,527	B2	7/2006	Bellegarda et al.	7,191,131	B1	3/2007	Nagao
7,079,713	B2	7/2006	Simmons	7,193,615	B2	3/2007	Kim et al.
7,082,322	B2	7/2006	Harano	7,194,186	B1	3/2007	Strub et al.
7,084,758	B1	8/2006	Cole	7,194,413	B2	3/2007	Mahoney et al.
7,084,856	B2	8/2006	Huppi	7,194,471	B1	3/2007	Nagatsuka et al.
7,085,723	B2	8/2006	Ross et al.	7,194,611	B2	3/2007	Bear et al.
7,085,960	B2	8/2006	Bouat et al.	7,194,699	B2	3/2007	Thomson et al.
7,088,345	B2	8/2006	Robinson et al.	7,197,120	B2	3/2007	Luehrig et al.
7,089,292	B1	8/2006	Roderick et al.	7,197,460	B1	3/2007	Gupta et al.
7,092,370	B2	8/2006	Jiang et al.	7,200,550	B2	4/2007	Menezes et al.
7,092,887	B2	8/2006	Mozer et al.	7,200,558	B2	4/2007	Kato et al.
7,092,928	B1	8/2006	Elad et al.	7,200,559	B2	4/2007	Wang
7,092,950	B2	8/2006	Wong et al.	7,203,646	B2	4/2007	Bennett
7,093,693	B1	8/2006	Gazdzinski	7,206,809	B2	4/2007	Ludwig et al.
				7,216,008	B2	5/2007	Sakata
				7,216,073	B2	5/2007	Lavi et al.
				7,216,080	B2	5/2007	Tsiao et al.
				7,218,920	B2	5/2007	Hyon

(56)

References Cited

U.S. PATENT DOCUMENTS

7,218,943	B2	5/2007	Klassen et al.	7,376,645	B2	5/2008	Bernard
7,219,063	B2	5/2007	Schalk et al.	7,378,963	B1	5/2008	Begault et al.
7,219,123	B1	5/2007	Fiechter et al.	7,379,874	B2	5/2008	Schmid et al.
7,225,125	B2	5/2007	Bennett et al.	7,380,203	B2	5/2008	Keely et al.
7,228,278	B2	6/2007	Nguyen et al.	7,383,170	B2	6/2008	Mills et al.
7,231,343	B1	6/2007	Treadgold et al.	7,386,438	B1	6/2008	Franz et al.
7,231,597	B1	6/2007	Braun et al.	7,386,449	B2	6/2008	Sun et al.
7,233,790	B2	6/2007	Kjellberg et al.	7,386,799	B1	6/2008	Clanton et al.
7,233,904	B2	6/2007	Luisi	7,389,224	B1	6/2008	Elworthy
7,234,026	B2	6/2007	Robbin et al.	7,389,225	B1	6/2008	Jensen et al.
7,236,932	B1	6/2007	Grajski	7,392,185	B2	6/2008	Bennett
7,240,002	B2	7/2007	Minamino et al.	7,394,947	B2	7/2008	Li et al.
7,243,130	B2	7/2007	Horvitz et al.	7,398,209	B2	7/2008	Kennewick et al.
7,243,305	B2	7/2007	Schabes et al.	7,401,300	B2	7/2008	Nurmi
7,246,118	B2	7/2007	Chastain et al.	7,403,938	B2	7/2008	Harrison et al.
7,246,151	B2	7/2007	Isaacs et al.	7,403,941	B2	7/2008	Bedworth et al.
7,248,900	B2	7/2007	Deeds et al.	7,404,143	B2	7/2008	Frelander et al.
7,251,454	B2	7/2007	White	7,409,337	B1	8/2008	Potter et al.
7,254,773	B2	8/2007	Bates et al.	7,409,347	B1	8/2008	Bellegarda
7,257,537	B2	8/2007	Ross et al.	7,412,389	B2	8/2008	Yang
7,259,752	B1	8/2007	Simmons	7,412,470	B2	8/2008	Masuno et al.
7,260,529	B1	8/2007	Lengen	7,415,100	B2	8/2008	Cooper et al.
7,263,373	B2	8/2007	Mattisson	7,415,469	B2	8/2008	Singh et al.
7,266,189	B1	9/2007	Day	7,418,389	B2	8/2008	Chu et al.
7,266,495	B1	9/2007	Beaufays et al.	7,418,392	B1	8/2008	Mozer et al.
7,266,496	B2	9/2007	Wang et al.	7,426,467	B2	9/2008	Nashida et al.
7,266,499	B2	9/2007	Surace et al.	7,426,468	B2	9/2008	Coifman et al.
7,269,544	B2	9/2007	Simske	7,427,024	B1	9/2008	Gazdzinski et al.
7,269,556	B2	9/2007	Kiss et al.	7,428,541	B2	9/2008	Houle
7,272,224	B1	9/2007	Normile et al.	7,433,869	B2	10/2008	Gollapudi
7,275,063	B2	9/2007	Horn	7,433,921	B2	10/2008	Ludwig et al.
7,277,088	B2	10/2007	Robinson et al.	7,441,184	B2	10/2008	Frerebeau et al.
7,277,854	B2	10/2007	Bennett et al.	7,443,316	B2	10/2008	Lim
7,277,855	B1	10/2007	Acker et al.	7,444,589	B2	10/2008	Zellner
7,280,958	B2	10/2007	Pavlov et al.	7,447,360	B2	11/2008	Li et al.
7,283,072	B1	10/2007	Plachta et al.	7,447,624	B2	11/2008	Fuhrmann et al.
7,289,102	B2	10/2007	Hinckley et al.	7,447,635	B1	11/2008	Konopka et al.
7,290,039	B1	10/2007	Lisitsa et al.	7,451,081	B1	11/2008	Gajic et al.
7,292,579	B2	11/2007	Morris	7,454,351	B2	11/2008	Jeschke et al.
7,292,979	B2	11/2007	Karas et al.	7,460,652	B2	12/2008	Chang
7,296,230	B2	11/2007	Fukatsu et al.	7,461,043	B2	12/2008	Hess
7,299,033	B2	11/2007	Kjellberg et al.	7,467,087	B1	12/2008	Gillick et al.
7,302,392	B1	11/2007	Thenthiruperai et al.	7,467,164	B2	12/2008	Marsh
7,302,394	B1	11/2007	Baray et al.	7,472,061	B1	12/2008	Alewine et al.
7,302,686	B2	11/2007	Togawa	7,472,065	B2	12/2008	Aaron et al.
7,308,404	B2	12/2007	Venkataraman et al.	7,475,010	B2	1/2009	Chao
7,308,408	B1	12/2007	Stifelman et al.	7,475,063	B2	1/2009	Datta et al.
7,310,329	B2	12/2007	Vieri et al.	7,477,238	B2	1/2009	Fux et al.
7,310,600	B1	12/2007	Garner et al.	7,477,240	B2	1/2009	Yanagisawa
7,310,605	B2	12/2007	Janakiraman et al.	7,478,037	B2	1/2009	Strong
7,313,523	B1	12/2007	Bellegarda et al.	7,478,091	B2	1/2009	Mojsilovic et al.
7,315,809	B2	1/2008	Xun	7,478,129	B1	1/2009	Chemtob
7,315,818	B2	1/2008	Stevens et al.	7,479,948	B2	1/2009	Kim et al.
7,319,957	B2	1/2008	Robinson et al.	7,479,949	B2	1/2009	Jobs et al.
7,321,783	B2	1/2008	Kim	7,483,832	B2	1/2009	Tischer
7,322,023	B2	1/2008	Shulman et al.	7,483,894	B2	1/2009	Cao
7,324,833	B2	1/2008	White et al.	7,487,089	B2	2/2009	Mozer
7,324,947	B2	1/2008	Jordan et al.	7,487,093	B2	2/2009	Mutsuno et al.
7,328,155	B2	2/2008	Endo et al.	7,490,034	B2	2/2009	Finnigan et al.
7,345,670	B2	3/2008	Armstrong	7,490,039	B1	2/2009	Shaffer et al.
7,345,671	B2	3/2008	Robbin et al.	7,493,560	B1	2/2009	Kipnes et al.
7,349,953	B2	3/2008	Lisitsa et al.	7,496,498	B2	2/2009	Chu et al.
7,353,139	B1	4/2008	Burrell et al.	7,496,512	B2	2/2009	Zhao et al.
7,359,493	B1	4/2008	Wang et al.	7,499,923	B2	3/2009	Kawatani
7,359,671	B2	4/2008	Richenstein et al.	7,502,738	B2	3/2009	Kennewick et al.
7,359,851	B2	4/2008	Tong et al.	7,505,795	B1	3/2009	Lim et al.
7,360,158	B1	4/2008	Beeman	7,508,324	B2	3/2009	Suraqui
7,362,738	B2	4/2008	Taube et al.	7,508,373	B2	3/2009	Lin et al.
7,363,227	B2	4/2008	Mapes-Riordan et al.	7,516,123	B2	4/2009	Betz et al.
7,363,586	B1	4/2008	Briggs et al.	7,519,327	B2	4/2009	White
7,365,260	B2	4/2008	Kawashima	7,522,927	B2	4/2009	Fitch et al.
7,366,461	B1	4/2008	Brown	7,523,036	B2	4/2009	Akabane et al.
7,373,612	B2	5/2008	Risch et al.	7,523,108	B2	4/2009	Cao
7,376,556	B2	5/2008	Bennett	7,526,466	B2	4/2009	Au
7,376,632	B1	5/2008	Sadek et al.	7,526,738	B2	4/2009	Ording et al.
				7,528,713	B2	5/2009	Singh et al.
				7,529,671	B2	5/2009	Rockenbeck et al.
				7,529,676	B2	5/2009	Koyama
				7,535,997	B1	5/2009	McQuaide, Jr. et al.

(56)

References Cited

U.S. PATENT DOCUMENTS

7,536,029	B2	5/2009	Choi et al.	7,673,340	B1	3/2010	Cohen et al.
7,536,565	B2	5/2009	Girish et al.	7,676,026	B1	3/2010	Baxter, Jr.
7,538,685	B1	5/2009	Cooper et al.	7,676,365	B2	3/2010	Hwang et al.
7,539,619	B1	5/2009	Seligman et al.	7,676,463	B2	3/2010	Thompson et al.
7,539,656	B2	5/2009	Fratkina et al.	7,679,534	B2	3/2010	Kay et al.
7,541,940	B2	6/2009	Upton	7,680,649	B2	3/2010	Park
7,542,967	B2	6/2009	Hurst-Hiller et al.	7,681,126	B2	3/2010	Roose
7,542,971	B2	6/2009	Thione et al.	7,683,886	B2	3/2010	Willey
7,543,232	B2	6/2009	Easton, Jr. et al.	7,683,893	B2	3/2010	Kim
7,546,382	B2	6/2009	Healey et al.	7,684,985	B2	3/2010	Dominach et al.
7,546,529	B2	6/2009	Reynar et al.	7,684,990	B2	3/2010	Caskey et al.
7,548,895	B2	6/2009	Pulsipher	7,684,991	B2	3/2010	Stohr et al.
7,552,045	B2	6/2009	Barliga et al.	7,689,245	B2	3/2010	Cox et al.
7,552,055	B2	6/2009	Lecoecuche	7,689,408	B2	3/2010	Chen et al.
7,555,431	B2	6/2009	Bennett	7,689,409	B2	3/2010	Heinecke
7,555,496	B1	6/2009	Lantrip et al.	7,689,421	B2	3/2010	Li et al.
7,558,381	B1	7/2009	Ali et al.	7,693,715	B2	4/2010	Hwang et al.
7,558,730	B2	7/2009	Davis et al.	7,693,717	B2	4/2010	Kahn et al.
7,559,026	B2	7/2009	Girish et al.	7,693,719	B2	4/2010	Chu et al.
7,561,069	B2	7/2009	Horstemeyer	7,693,720	B2	4/2010	Kennewick et al.
7,562,007	B2	7/2009	Hwang	7,698,131	B2	4/2010	Bennett
7,562,032	B2	7/2009	Abbosh et al.	7,702,500	B2	4/2010	Blaedow
7,565,104	B1	7/2009	Brown et al.	7,702,508	B2	4/2010	Bennett
7,565,380	B1	7/2009	Venkatachary	7,706,510	B2	4/2010	Ng
7,571,106	B2	8/2009	Cao et al.	7,707,026	B2	4/2010	Liu
7,577,522	B2	8/2009	Rosenberg	7,707,027	B2	4/2010	Balchandran et al.
7,580,551	B1	8/2009	Srihari et al.	7,707,032	B2	4/2010	Wang et al.
7,580,576	B2	8/2009	Wang et al.	7,707,221	B1	4/2010	Dunning et al.
7,580,839	B2	8/2009	Tamura et al.	7,707,267	B2	4/2010	Lisitsa et al.
7,584,093	B2	9/2009	Potter et al.	7,710,262	B2	5/2010	Ruha
7,584,278	B2	9/2009	Rajarajan et al.	7,711,129	B2	5/2010	Lindahl et al.
7,584,429	B2	9/2009	Fabritius	7,711,550	B1	5/2010	Feinberg et al.
7,593,868	B2	9/2009	Margiloff et al.	7,711,565	B1	5/2010	Gazdzinski
7,596,269	B2	9/2009	King et al.	7,711,672	B2	5/2010	Au
7,596,499	B2	9/2009	Anguera Miro et al.	7,712,053	B2	5/2010	Bradford et al.
7,596,606	B2	9/2009	Codignotto	7,716,056	B2	5/2010	Weng et al.
7,596,765	B2	9/2009	Almas	7,716,216	B1	5/2010	Harik et al.
7,599,918	B2	10/2009	Shen et al.	7,720,674	B2	5/2010	Kaiser et al.
7,603,381	B2	10/2009	Burke et al.	7,720,683	B1	5/2010	Vermeulen et al.
7,606,444	B1	10/2009	Erol et al.	7,721,226	B2	5/2010	Barabe et al.
7,609,179	B2	10/2009	Diaz-Gutierrez et al.	7,721,301	B2	5/2010	Wong et al.
7,610,258	B2	10/2009	Yuknewicz et al.	7,724,242	B2	5/2010	Hillis et al.
7,613,264	B2	11/2009	Wells et al.	7,725,307	B2	5/2010	Bennett
7,614,008	B2	11/2009	Ording	7,725,318	B2	5/2010	Gavalda et al.
7,617,094	B2	11/2009	Aoki et al.	7,725,320	B2	5/2010	Bennett
7,620,407	B1	11/2009	Donald et al.	7,725,321	B2	5/2010	Bennett
7,620,549	B2	11/2009	Di Cristo et al.	7,725,838	B2	5/2010	Williams
7,623,119	B2	11/2009	Autio et al.	7,729,904	B2	6/2010	Bennett
7,624,007	B2	11/2009	Bennett	7,729,916	B2	6/2010	Coffman et al.
7,627,481	B1	12/2009	Kuo et al.	7,734,461	B2	6/2010	Kwak et al.
7,630,901	B2	12/2009	Omi	7,735,012	B2	6/2010	Naik
7,633,076	B2	12/2009	Huppi et al.	7,739,588	B2	6/2010	Reynar et al.
7,634,409	B2	12/2009	Kennewick et al.	7,742,953	B2	6/2010	King et al.
7,634,413	B1	12/2009	Kuo et al.	7,743,188	B2	6/2010	Haitani et al.
7,634,718	B2	12/2009	Nakajima	7,747,616	B2	6/2010	Yamada et al.
7,634,732	B1	12/2009	Blagsvedt et al.	7,752,152	B2	7/2010	Paek et al.
7,636,657	B2	12/2009	Ju et al.	7,756,868	B2	7/2010	Lee
7,640,158	B2	12/2009	Detlef et al.	7,756,871	B2	7/2010	Yacoub et al.
7,640,160	B2	12/2009	Di Cristo et al.	7,757,173	B2	7/2010	Beaman
7,643,990	B1	1/2010	Bellegarda	7,757,182	B2	7/2010	Elliott et al.
7,647,225	B2	1/2010	Bennett et al.	7,761,296	B1	7/2010	Bakis et al.
7,649,454	B2	1/2010	Singh et al.	7,763,842	B2	7/2010	Hsu et al.
7,649,877	B2	1/2010	Vieri et al.	7,774,204	B2	8/2010	Mozer et al.
7,653,883	B2	1/2010	Hotelling et al.	7,774,388	B1	8/2010	Runchey
7,656,393	B2	2/2010	King et al.	7,777,717	B2	8/2010	Fux et al.
7,657,424	B2	2/2010	Bennett	7,778,432	B2	8/2010	Larsen
7,657,844	B2	2/2010	Gibson et al.	7,778,595	B2	8/2010	White et al.
7,657,849	B2	2/2010	Chaudhri et al.	7,778,632	B2	8/2010	Kurlander et al.
7,663,607	B2	2/2010	Hotelling et al.	7,779,353	B2	8/2010	Grigoriu et al.
7,664,558	B2	2/2010	Lindahl et al.	7,779,356	B2	8/2010	Griesmer
7,664,638	B2	2/2010	Cooper et al.	7,779,357	B2	8/2010	Naik
7,669,134	B1	2/2010	Christie et al.	7,783,283	B2	8/2010	Kuusinen et al.
7,672,841	B2	3/2010	Bennett	7,783,486	B2	8/2010	Rosser et al.
7,672,952	B2	3/2010	Isaacson et al.	7,788,590	B2	8/2010	Taboada et al.
7,673,238	B2	3/2010	Girish et al.	7,797,265	B2	9/2010	Brinker et al.
				7,797,269	B2	9/2010	Rieman et al.
				7,797,331	B2	9/2010	Theimer et al.
				7,797,629	B2	9/2010	Fux et al.
				7,801,721	B2	9/2010	Rosart et al.

(56)

References Cited

U.S. PATENT DOCUMENTS

7,801,728 B2	9/2010	Ben-David et al.	7,949,534 B2	5/2011	Davis et al.
7,801,729 B2	9/2010	Mozer	7,953,679 B2	5/2011	Chidlovskii et al.
7,805,299 B2	9/2010	Coifman	7,957,975 B2	6/2011	Burns et al.
7,809,565 B2	10/2010	Coifman	7,962,179 B2	6/2011	Huang
7,809,569 B2	10/2010	Attwater et al.	7,974,844 B2	7/2011	Sumita
7,809,570 B2	10/2010	Kennewick et al.	7,974,972 B2	7/2011	Cao
7,809,610 B2	10/2010	Cao	7,975,216 B2	7/2011	Woolf et al.
7,809,744 B2	10/2010	Nevidomski et al.	7,983,478 B2	7/2011	Liu et al.
7,818,165 B2	10/2010	Carlgren et al.	7,983,915 B2	7/2011	Knight et al.
7,818,176 B2	10/2010	Freeman et al.	7,983,917 B2	7/2011	Kennewick et al.
7,818,215 B2	10/2010	King et al.	7,983,919 B2	7/2011	Conkie
7,818,291 B2	10/2010	Ferguson et al.	7,983,997 B2	7/2011	Allen et al.
7,818,672 B2	10/2010	McCormack et al.	7,984,062 B2	7/2011	Dunning et al.
7,822,608 B2	10/2010	Cross, Jr. et al.	7,986,431 B2	7/2011	Emori et al.
7,823,123 B2	10/2010	Sabbouh	7,987,151 B2	7/2011	Schott et al.
7,826,945 B2	11/2010	Zhang et al.	7,987,244 B1	7/2011	Lewis et al.
7,827,047 B2	11/2010	Anderson et al.	7,991,614 B2	8/2011	Washio et al.
7,831,423 B2	11/2010	Schubert	7,992,085 B2	8/2011	Wang-Aryattanwanich et al.
7,831,426 B2	11/2010	Bennett	7,996,228 B2	8/2011	Miller et al.
7,831,432 B2	11/2010	Bodin et al.	7,996,589 B2	8/2011	Schultz et al.
7,836,437 B2	11/2010	Kacmarcik et al.	7,996,769 B2	8/2011	Fux et al.
7,840,400 B2	11/2010	Lavi et al.	7,996,792 B2	8/2011	Anzures et al.
7,840,447 B2	11/2010	Kleinrock et al.	7,999,669 B2	8/2011	Singh et al.
7,840,581 B2	11/2010	Ross et al.	8,000,453 B2	8/2011	Cooper et al.
7,840,912 B2	11/2010	Elias et al.	8,005,664 B2	8/2011	Hanumanthappa
7,848,924 B2	12/2010	Nurminen et al.	8,005,679 B2	8/2011	Jordan et al.
7,848,926 B2	12/2010	Goto et al.	8,006,180 B2	8/2011	Tunning et al.
7,853,444 B2	12/2010	Wang et al.	8,014,308 B2	9/2011	Gates, III et al.
7,853,445 B2	12/2010	Bachenko et al.	8,015,006 B2	9/2011	Kennewick et al.
7,853,574 B2	12/2010	Kraenzel et al.	8,015,011 B2	9/2011	Nagano et al.
7,853,577 B2	12/2010	Sundaresan et al.	8,015,144 B2	9/2011	Zheng et al.
7,853,664 B1	12/2010	Wang et al.	8,018,431 B1	9/2011	Zehr et al.
7,853,900 B2	12/2010	Nguyen et al.	8,019,271 B1	9/2011	Izdepski
7,865,817 B2	1/2011	Ryan et al.	8,024,195 B2	9/2011	Mozer et al.
7,869,999 B2	1/2011	Amato et al.	8,027,836 B2	9/2011	Baker et al.
7,870,118 B2	1/2011	Jiang et al.	8,031,943 B2	10/2011	Chen et al.
7,870,133 B2	1/2011	Krishnamoorthy et al.	8,032,383 B1	10/2011	Bhardwaj et al.
7,873,519 B2	1/2011	Bennett	8,036,901 B2	10/2011	Mozer
7,873,654 B2	1/2011	Bernard	8,037,034 B2	10/2011	Plachta et al.
7,877,705 B2	1/2011	Chambers et al.	8,041,557 B2	10/2011	Liu
7,880,730 B2	2/2011	Robinson et al.	8,041,570 B2	10/2011	Mirkovic et al.
7,881,283 B2	2/2011	Cormier et al.	8,041,611 B2	10/2011	Kleinrock et al.
7,881,936 B2	2/2011	Longe et al.	8,042,053 B2	10/2011	Darwish et al.
7,885,844 B1	2/2011	Cohen et al.	8,046,363 B2	10/2011	Cha et al.
7,886,233 B2	2/2011	Rainisto et al.	8,046,374 B1	10/2011	Bromwich
7,889,184 B2	2/2011	Blumenberg et al.	8,050,500 B1	11/2011	Batty et al.
7,889,185 B2	2/2011	Blumenberg et al.	8,055,502 B2	11/2011	Clark et al.
7,890,330 B2	2/2011	Ozkaragoz et al.	8,055,708 B2	11/2011	Chitsaz et al.
7,890,652 B2	2/2011	Bull et al.	8,060,824 B2	11/2011	Brownrigg, Jr. et al.
7,895,531 B2	2/2011	Radtke et al.	8,064,753 B2	11/2011	Freeman
7,899,666 B2	3/2011	Varone	8,065,143 B2	11/2011	Yanagihara
7,908,287 B1	3/2011	Katragadda	8,065,155 B1	11/2011	Gazdzinski
7,912,289 B2	3/2011	Kansal et al.	8,065,156 B2	11/2011	Gazdzinski
7,912,699 B1	3/2011	Saraclar et al.	8,068,604 B2	11/2011	Leeds et al.
7,912,702 B2	3/2011	Bennett	8,069,046 B2	11/2011	Kennewick et al.
7,912,720 B1	3/2011	Hakkani-Tur et al.	8,069,422 B2	11/2011	Sheshagiri et al.
7,912,828 B2	3/2011	Bonnet et al.	8,073,681 B2	12/2011	Baldwin et al.
7,913,185 B1	3/2011	Benson et al.	8,077,153 B2	12/2011	Benko et al.
7,916,979 B2	3/2011	Simmons	8,078,473 B1	12/2011	Gazdzinski
7,917,367 B2	3/2011	Di Cristo et al.	8,082,153 B2	12/2011	Coffman et al.
7,917,497 B2	3/2011	Harrison et al.	8,082,498 B2	12/2011	Salamon et al.
7,920,678 B2	4/2011	Cooper et al.	8,090,571 B2	1/2012	Elshishiny et al.
7,920,682 B2	4/2011	Byrne et al.	8,095,364 B2	1/2012	Longe et al.
7,920,857 B2	4/2011	Lau et al.	8,099,289 B2	1/2012	Mozer et al.
7,925,525 B2	4/2011	Chin	8,099,395 B2	1/2012	Pabla et al.
7,925,610 B2	4/2011	Elbaz et al.	8,099,418 B2	1/2012	Inoue et al.
7,929,805 B2	4/2011	Wang et al.	8,103,510 B2	1/2012	Sato
7,930,168 B2	4/2011	Weng et al.	8,107,401 B2	1/2012	John et al.
7,930,183 B2	4/2011	Odell et al.	8,112,275 B2	2/2012	Kennewick et al.
7,930,197 B2	4/2011	Ozzie et al.	8,112,280 B2	2/2012	Lu
7,936,339 B2	5/2011	Marggraff et al.	8,117,037 B2	2/2012	Gazdzinski
7,936,861 B2	5/2011	Knott et al.	8,117,542 B2	2/2012	Radtke et al.
7,941,009 B2	5/2011	Li et al.	8,121,413 B2	2/2012	Hwang et al.
7,945,470 B1	5/2011	Cohen et al.	8,121,837 B2	2/2012	Agapi et al.
7,949,529 B2	5/2011	Weider et al.	8,122,094 B1	2/2012	Kotab
			8,122,353 B2	2/2012	Bouta
			8,131,557 B2	3/2012	Davis et al.
			8,135,115 B1	3/2012	Hogg, Jr. et al.
			8,138,912 B2	3/2012	Singh et al.

(56)

References Cited

U.S. PATENT DOCUMENTS

8,140,335 B2	3/2012	Kennewick et al.	8,489,599 B2	7/2013	Bellotti
8,140,567 B2	3/2012	Padovitz et al.	8,498,857 B2	7/2013	Kopparapu et al.
8,150,694 B2	4/2012	Kennewick et al.	8,521,513 B2	8/2013	Millett et al.
8,150,700 B2	4/2012	Shin et al.	8,560,229 B1	10/2013	Park et al.
8,155,956 B2	4/2012	Cho et al.	8,583,416 B2	11/2013	Huang et al.
8,156,005 B2	4/2012	Vieri	8,589,869 B2	11/2013	Wolfram
8,160,883 B2	4/2012	Lecoeuche	8,595,004 B2	11/2013	Koshinaka
8,165,321 B2	4/2012	Paquier et al.	8,620,659 B2	12/2013	Di Cristo et al.
8,165,886 B1	4/2012	Gagnon et al.	8,626,681 B1	1/2014	Jurca et al.
8,166,019 B1	4/2012	Lee et al.	8,645,137 B2	2/2014	Bellegarda et al.
8,166,032 B2	4/2012	Sommer et al.	8,654,936 B1	2/2014	Eslambolchi et al.
8,170,790 B2	5/2012	Lee et al.	8,655,901 B1	2/2014	Li et al.
8,179,370 B1	5/2012	Yamasani et al.	8,660,849 B2	2/2014	Gruber et al.
8,188,856 B2	5/2012	Singh et al.	8,660,970 B1	2/2014	Fiedorowicz
8,190,359 B2	5/2012	Bourne	8,661,112 B2	2/2014	Creamer et al.
8,195,467 B2	6/2012	Mozer et al.	8,675,084 B2	3/2014	Bolton et al.
8,195,468 B2	6/2012	Kennewick et al.	8,677,377 B2	3/2014	Cheyer et al.
8,200,495 B2	6/2012	Braho et al.	8,682,667 B2	3/2014	Haughay
8,201,109 B2	6/2012	Van Os et al.	8,688,446 B2	4/2014	Yanagihara
8,204,238 B2	6/2012	Mozer	8,706,472 B2	4/2014	Ramerth et al.
8,205,788 B1	6/2012	Gazdzinski et al.	8,719,006 B2	5/2014	Bellegarda
8,209,183 B1	6/2012	Patel et al.	8,719,014 B2	5/2014	Wagner
8,219,115 B1	7/2012	Nelissen	8,731,610 B2	5/2014	Appaji
8,219,406 B2	7/2012	Yu et al.	8,744,852 B1	6/2014	Seymour et al.
8,219,407 B1	7/2012	Roy et al.	8,760,537 B2	6/2014	Johnson et al.
8,219,608 B2	7/2012	alSafadi et al.	8,762,145 B2	6/2014	Ouchi et al.
8,224,649 B2	7/2012	Chaudhari et al.	8,768,693 B2	7/2014	Lempel et al.
8,239,207 B2	8/2012	Seligman et al.	8,768,702 B2	7/2014	Mason et al.
8,244,712 B2	8/2012	Serlet et al.	8,775,931 B2	7/2014	Fux et al.
8,255,217 B2	8/2012	Stent et al.	8,798,995 B1	8/2014	Edara et al.
8,275,621 B2	9/2012	Alewine et al.	8,838,457 B2	9/2014	Cerra et al.
8,285,546 B2	10/2012	Reich	8,880,405 B2	11/2014	Cerra et al.
8,285,551 B2	10/2012	Gazdzinski	8,886,540 B2	11/2014	Cerra et al.
8,285,553 B2	10/2012	Gazdzinski	8,930,191 B2	1/2015	Gruber et al.
8,290,777 B1	10/2012	Nguyen et al.	8,943,423 B2	1/2015	Merrill et al.
8,290,778 B2	10/2012	Gazdzinski	8,972,878 B2	3/2015	Mohler et al.
8,290,781 B2	10/2012	Gazdzinski	8,983,383 B1	3/2015	Haskin
8,296,145 B2	10/2012	Clark et al.	8,996,381 B2	3/2015	Mozer et al.
8,296,146 B2	10/2012	Gazdzinski	9,098,467 B1	8/2015	Blanksteen et al.
8,296,153 B2	10/2012	Gazdzinski	2001/0005859 A1	6/2001	Okuyama et al.
8,296,380 B1	10/2012	Kelly et al.	2001/0020259 A1	9/2001	Sekiguchi et al.
8,296,383 B2	10/2012	Lindahl	2001/0027396 A1	10/2001	Sato
8,300,801 B2	10/2012	Sweeney et al.	2001/0029455 A1	10/2001	Chin et al.
8,301,456 B2	10/2012	Gazdzinski	2001/0030660 A1	10/2001	Zainoulline
8,311,834 B1	11/2012	Gazdzinski	2001/0032080 A1	10/2001	Fukada
8,311,838 B2	11/2012	Lindahl et al.	2001/0041021 A1	11/2001	Boyle et al.
8,312,017 B2	11/2012	Martin et al.	2001/0042107 A1	11/2001	Palm
8,321,786 B2	11/2012	Lunati et al.	2001/0044724 A1	11/2001	Hon et al.
8,332,224 B2	12/2012	Di Cristo et al.	2001/0047264 A1	11/2001	Roundtree
8,332,748 B1	12/2012	Karam	2001/0056342 A1	12/2001	Piehn et al.
8,340,975 B1	12/2012	Rosenberger	2001/0056347 A1	12/2001	Chazan et al.
8,345,665 B2	1/2013	Vieri et al.	2002/0001395 A1	1/2002	Davis et al.
8,352,183 B2	1/2013	Thota et al.	2002/0002039 A1	1/2002	Qureshey et al.
8,352,268 B2	1/2013	Naik et al.	2002/0002413 A1	1/2002	Tokue
8,352,272 B2	1/2013	Rogers et al.	2002/0002461 A1	1/2002	Tetsumoto
8,355,919 B2	1/2013	Silverman et al.	2002/0004703 A1	1/2002	Gaspard, II
8,359,234 B2	1/2013	Vieri	2002/0010581 A1	1/2002	Euler et al.
8,370,158 B2	2/2013	Gazdzinski	2002/0010584 A1	1/2002	Schultz et al.
8,371,503 B2	2/2013	Gazdzinski	2002/0010726 A1	1/2002	Rogson
8,374,871 B2	2/2013	Ehsani et al.	2002/0010798 A1	1/2002	Ben-Shaul et al.
8,375,320 B2	2/2013	Kotler et al.	2002/0013707 A1	1/2002	Shaw et al.
8,380,504 B1	2/2013	Peden et al.	2002/0013784 A1	1/2002	Swanson
8,380,507 B2	2/2013	Herman et al.	2002/0013852 A1	1/2002	Janik
8,381,107 B2	2/2013	Rottler et al.	2002/0015024 A1	2/2002	Westerman et al.
8,381,135 B2	2/2013	Hotelling et al.	2002/0015064 A1	2/2002	Robotham et al.
8,386,485 B2	2/2013	Kerschberg et al.	2002/0021278 A1	2/2002	Hinckley et al.
8,391,844 B2	3/2013	Novick et al.	2002/0026315 A1	2/2002	Miranda
8,396,714 B2	3/2013	Rogers et al.	2002/0026456 A1	2/2002	Bradford
8,423,288 B2	4/2013	Stahl et al.	2002/0031254 A1	3/2002	Lantrip et al.
8,428,758 B2	4/2013	Naik et al.	2002/0031262 A1	3/2002	Imagawa et al.
8,447,612 B2	5/2013	Gazdzinski	2002/0032048 A1	3/2002	Kitao et al.
8,452,597 B2	5/2013	Bringert et al.	2002/0032564 A1	3/2002	Ehsani et al.
8,458,115 B2	6/2013	Cai et al.	2002/0032591 A1	3/2002	Mahaffy et al.
8,458,278 B2	6/2013	Christie et al.	2002/0032751 A1	3/2002	Bharadwaj
8,479,122 B2	7/2013	Hotelling et al.	2002/0035467 A1	3/2002	Morimoto et al.
			2002/0035469 A1	3/2002	Holzapfel
			2002/0035474 A1	3/2002	Alpdemir
			2002/0040359 A1	4/2002	Green et al.
			2002/0042707 A1	4/2002	Zhao et al.

(56)

References Cited

U.S. PATENT DOCUMENTS

2002/0045438	A1	4/2002	Tagawa et al.	2002/0163544	A1	11/2002	Baker et al.
2002/0045961	A1	4/2002	Gibbs et al.	2002/0164000	A1	11/2002	Cohen et al.
2002/0046025	A1	4/2002	Hain	2002/0165918	A1	11/2002	Bettis
2002/0046315	A1	4/2002	Miller et al.	2002/0167534	A1	11/2002	Burke
2002/0052730	A1	5/2002	Nakao	2002/0169592	A1	11/2002	Aityan
2002/0052740	A1	5/2002	Charlesworth et al.	2002/0169605	A1	11/2002	Damiba et al.
2002/0052747	A1	5/2002	Sarukkai	2002/0173273	A1	11/2002	Spurgat et al.
2002/0052913	A1	5/2002	Yamada et al.	2002/0173889	A1	11/2002	Odinak et al.
2002/0054094	A1	5/2002	Matsuda	2002/0173961	A1	11/2002	Guerra
2002/0055844	A1	5/2002	L'Esperance et al.	2002/0173962	A1	11/2002	Tang et al.
2002/0055934	A1	5/2002	Lipscomb et al.	2002/0173966	A1	11/2002	Henton
2002/0059066	A1	5/2002	O'hagan	2002/0177993	A1	11/2002	Veditz et al.
2002/0059068	A1	5/2002	Rose et al.	2002/0184015	A1	12/2002	Li et al.
2002/0065659	A1	5/2002	Isono et al.	2002/0184027	A1	12/2002	Brittan et al.
2002/0065797	A1	5/2002	Meidan et al.	2002/0184189	A1	12/2002	Hay et al.
2002/0067308	A1	6/2002	Robertson	2002/0189426	A1	12/2002	Hirade et al.
2002/0069063	A1	6/2002	Buchner et al.	2002/0191029	A1	12/2002	Gillespie et al.
2002/0069071	A1	6/2002	Knockeart et al.	2002/0193996	A1	12/2002	Squibbs et al.
2002/0069220	A1	6/2002	Tran	2002/0198714	A1	12/2002	Zhou
2002/0072816	A1	6/2002	Shdema et al.	2002/0198715	A1	12/2002	Belrose
2002/0072908	A1	6/2002	Case et al.	2003/0001881	A1	1/2003	Mannheimer et al.
2002/0072914	A1	6/2002	Alshawi et al.	2003/0002632	A1	1/2003	Bhogal et al.
2002/0077082	A1	6/2002	Cruickshank	2003/0003897	A1	1/2003	Hyon
2002/0077817	A1	6/2002	Atal	2003/0013483	A1	1/2003	Ausems et al.
2002/0078041	A1	6/2002	Wu	2003/0016770	A1	1/2003	Trans et al.
2002/0080163	A1	6/2002	Morey	2003/0018475	A1	1/2003	Basu et al.
2002/0083068	A1	6/2002	Quass et al.	2003/0020760	A1	1/2003	Takatsu et al.
2002/0085037	A1	7/2002	Leavitt et al.	2003/0026402	A1	2/2003	Clapper
2002/0087508	A1	7/2002	Hull et al.	2003/0028380	A1	2/2003	Freeland et al.
2002/0091511	A1	7/2002	Hellwig et al.	2003/0033148	A1	2/2003	Silverman et al.
2002/0091529	A1	7/2002	Whitham	2003/0033153	A1	2/2003	Olson et al.
2002/0095286	A1	7/2002	Ross et al.	2003/0033214	A1	2/2003	Mikkelsen et al.
2002/0095290	A1	7/2002	Kahn et al.	2003/0037073	A1	2/2003	Tokuda et al.
2002/0099547	A1	7/2002	Chu et al.	2003/0037254	A1	2/2003	Fischer et al.
2002/0099552	A1	7/2002	Rubin et al.	2003/0040908	A1	2/2003	Yang et al.
2002/0101447	A1	8/2002	Carro	2003/0046075	A1	3/2003	Stone
2002/0103641	A1	8/2002	Kuo et al.	2003/0046401	A1	3/2003	Abbott et al.
2002/0103644	A1	8/2002	Brocius et al.	2003/0046434	A1	3/2003	Flanagin et al.
2002/0103646	A1	8/2002	Kochanski et al.	2003/0050781	A1	3/2003	Tamura et al.
2002/0107684	A1	8/2002	Gao	2003/0051136	A1	3/2003	Curtis et al.
2002/0109709	A1	8/2002	Sagar	2003/0055537	A1	3/2003	Odinak et al.
2002/0110248	A1	8/2002	Kovales et al.	2003/0061317	A1	3/2003	Brown et al.
2002/0111198	A1	8/2002	Heie et al.	2003/0061570	A1	3/2003	Hatori et al.
2002/0111810	A1	8/2002	Khan et al.	2003/0063073	A1	4/2003	Geaghan et al.
2002/0116082	A1	8/2002	Gudorf	2003/0074195	A1	4/2003	Bartosik et al.
2002/0116171	A1	8/2002	Russell	2003/0074198	A1	4/2003	Sussman
2002/0116185	A1	8/2002	Cooper et al.	2003/0074457	A1	4/2003	Kluth
2002/0116189	A1	8/2002	Yeh et al.	2003/0076301	A1	4/2003	Tsuk et al.
2002/0116420	A1	8/2002	Allam et al.	2003/0078766	A1	4/2003	Appelt et al.
2002/0120697	A1	8/2002	Generous et al.	2003/0078780	A1	4/2003	Kochanski et al.
2002/0120925	A1	8/2002	Logan	2003/0078969	A1	4/2003	Sprague et al.
2002/0122053	A1	9/2002	Dutta et al.	2003/0079024	A1	4/2003	Hough et al.
2002/0123894	A1	9/2002	Woodward	2003/0079038	A1	4/2003	Robbin et al.
2002/0126097	A1	9/2002	Savolainen	2003/0080991	A1	5/2003	Crow et al.
2002/0128827	A1	9/2002	Bu et al.	2003/0083113	A1	5/2003	Chua et al.
2002/0128840	A1	9/2002	Hinde et al.	2003/0083878	A1	5/2003	Lee et al.
2002/0129057	A1	9/2002	Spielberg	2003/0083884	A1	5/2003	Odinak et al.
2002/0133347	A1	9/2002	Schoneburg et al.	2003/0084350	A1	5/2003	Eibach et al.
2002/0133348	A1	9/2002	Pearson et al.	2003/0085870	A1	5/2003	Hinckley
2002/0135565	A1	9/2002	Gordon et al.	2003/0086699	A1	5/2003	Benyamin et al.
2002/0135618	A1	9/2002	Maes et al.	2003/0088414	A1	5/2003	Huang et al.
2002/0138254	A1	9/2002	Isaka et al.	2003/0088421	A1	5/2003	Maes et al.
2002/0138265	A1	9/2002	Stevens et al.	2003/0090467	A1	5/2003	Hohl et al.
2002/0138270	A1	9/2002	Bellegarda et al.	2003/0090474	A1	5/2003	Schaefer
2002/0138616	A1	9/2002	Basson et al.	2003/0095096	A1	5/2003	Robbin et al.
2002/0140679	A1	10/2002	Wen	2003/0097210	A1	5/2003	Horst et al.
2002/0143533	A1	10/2002	Lucas et al.	2003/0097379	A1	5/2003	Ireton
2002/0143542	A1	10/2002	Eide	2003/0097408	A1	5/2003	Kageyama et al.
2002/0143551	A1	10/2002	Sharma et al.	2003/0098892	A1	5/2003	Hiipakka
2002/0143826	A1	10/2002	Day et al.	2003/0099335	A1	5/2003	Tanaka et al.
2002/0151297	A1	10/2002	Remboski et al.	2003/0101045	A1	5/2003	Moffatt et al.
2002/0152045	A1	10/2002	Dowling et al.	2003/0115060	A1	6/2003	Junqua et al.
2002/0152255	A1	10/2002	Smith et al.	2003/0115064	A1	6/2003	Gusler et al.
2002/0154160	A1	10/2002	Hosokawa	2003/0115186	A1	6/2003	Wilkinson et al.
2002/0161865	A1	10/2002	Nguyen	2003/0115552	A1	6/2003	Jahnke et al.
				2003/0117365	A1	6/2003	Shteyn
				2003/0120494	A1	6/2003	Jost et al.
				2003/0122652	A1	7/2003	Himmelstein
				2003/0122787	A1	7/2003	Zimmerman et al.

(56)

References Cited

U.S. PATENT DOCUMENTS

2003/0125927	A1	7/2003	Seme	2004/0023643	A1	2/2004	Vander Veen et al.
2003/0125955	A1	7/2003	Arnold et al.	2004/0030554	A1	2/2004	Boxberger-Oberoi et al.
2003/0126559	A1	7/2003	Fuhrmann	2004/0030556	A1	2/2004	Bennett
2003/0128819	A1	7/2003	Lee et al.	2004/0030559	A1	2/2004	Payne et al.
2003/0130847	A1	7/2003	Case et al.	2004/0030996	A1	2/2004	Van Liempd et al.
2003/0133694	A1	7/2003	Yeo	2004/0036715	A1	2/2004	Warren
2003/0134678	A1	7/2003	Tanaka	2004/0048627	A1	3/2004	Olvera-Hernandez
2003/0135501	A1	7/2003	Frerebeau et al.	2004/0049388	A1	3/2004	Roth et al.
2003/0135740	A1	7/2003	Talmor et al.	2004/0049391	A1	3/2004	Polanyi et al.
2003/0140088	A1	7/2003	Robinson et al.	2004/0051729	A1	3/2004	Borden, IV
2003/0144846	A1	7/2003	Denenberge et al.	2004/0052338	A1	3/2004	Celi, Jr. et al.
2003/0145285	A1	7/2003	Miyahira et al.	2004/0054530	A1	3/2004	Davis et al.
2003/0147512	A1	8/2003	Abhuri	2004/0054533	A1	3/2004	Bellegarda
2003/0149557	A1	8/2003	Cox et al.	2004/0054534	A1	3/2004	Junqua
2003/0149567	A1	8/2003	Schmitz et al.	2004/0054535	A1	3/2004	Mackie et al.
2003/0149978	A1	8/2003	Plotnick	2004/0054541	A1	3/2004	Kryze et al.
2003/0152203	A1	8/2003	Berger et al.	2004/0054690	A1	3/2004	Hillerbrand et al.
2003/0152894	A1	8/2003	Townshend	2004/0055446	A1	3/2004	Robbin et al.
2003/0154081	A1	8/2003	Chu et al.	2004/0056899	A1	3/2004	Sinclair, II et al.
2003/0157968	A1	8/2003	Boman et al.	2004/0059577	A1	3/2004	Pickering
2003/0158735	A1	8/2003	Yamada et al.	2004/0059790	A1	3/2004	Austin-Lane et al.
2003/0158737	A1	8/2003	Csicsatka	2004/0061717	A1	4/2004	Menon et al.
2003/0160702	A1	8/2003	Tanaka	2004/0062367	A1	4/2004	Fellenstein et al.
2003/0160830	A1	8/2003	DeGross	2004/0064593	A1	4/2004	Sinclair et al.
2003/0163316	A1	8/2003	Addison et al.	2004/0069122	A1	4/2004	Wilson
2003/0164848	A1	9/2003	Dutta et al.	2004/0070567	A1	4/2004	Longe et al.
2003/0167167	A1	9/2003	Gong	2004/0070612	A1	4/2004	Sinclair et al.
2003/0167318	A1	9/2003	Robbin et al.	2004/0073427	A1	4/2004	Moore
2003/0167335	A1	9/2003	Alexander	2004/0073428	A1	4/2004	Zlokarnik et al.
2003/0171928	A1	9/2003	Falcon et al.	2004/0076086	A1	4/2004	Keller et al.
2003/0171936	A1	9/2003	Sall et al.	2004/0078382	A1	4/2004	Mercer et al.
2003/0174830	A1	9/2003	Boyer et al.	2004/0085162	A1	5/2004	Agarwal et al.
2003/0177046	A1	9/2003	Socha-Leialoha et al.	2004/0085368	A1	5/2004	Johnson, Jr. et al.
2003/0179222	A1	9/2003	Noma et al.	2004/0086120	A1	5/2004	Akins, III et al.
2003/0182115	A1	9/2003	Malayath et al.	2004/0093213	A1	5/2004	Conkie
2003/0182131	A1	9/2003	Arnold et al.	2004/0093215	A1	5/2004	Gupta et al.
2003/0187655	A1	10/2003	Dunsmuir	2004/0093328	A1	5/2004	Damle
2003/0187659	A1	10/2003	Cho et al.	2004/0094018	A1	5/2004	Ueshima et al.
2003/0187844	A1	10/2003	Li et al.	2004/0096105	A1	5/2004	Holtsberg
2003/0187925	A1	10/2003	Inala et al.	2004/0098250	A1	5/2004	Kimchi et al.
2003/0188005	A1	10/2003	Yoneda et al.	2004/0100479	A1	5/2004	Nakano et al.
2003/0188192	A1	10/2003	Tang et al.	2004/0106432	A1	6/2004	Kanamori et al.
2003/0190074	A1	10/2003	Loudon et al.	2004/0107169	A1	6/2004	Lowe
2003/0191645	A1	10/2003	Zhou	2004/0111266	A1	6/2004	Coorman et al.
2003/0193481	A1	10/2003	Sokolsky	2004/0111332	A1	6/2004	Baar et al.
2003/0194080	A1	10/2003	Michaelis et al.	2004/0114731	A1	6/2004	Gillett et al.
2003/0195741	A1	10/2003	Mani et al.	2004/0122656	A1	6/2004	Abir
2003/0197736	A1	10/2003	Murphy	2004/0122664	A1	6/2004	Lorenzo et al.
2003/0197744	A1	10/2003	Irvine	2004/0124583	A1	7/2004	Landis
2003/0200858	A1	10/2003	Xie	2004/0125088	A1	7/2004	Zimmerman et al.
2003/0202697	A1	10/2003	Simard et al.	2004/0125922	A1	7/2004	Specht
2003/0204392	A1	10/2003	Finnigan et al.	2004/0127198	A1	7/2004	Roskind et al.
2003/0204492	A1	10/2003	Wolf et al.	2004/0127241	A1	7/2004	Shostak
2003/0208756	A1	11/2003	Macrae et al.	2004/0128137	A1	7/2004	Bush et al.
2003/0210266	A1	11/2003	Cragun et al.	2004/0128614	A1	7/2004	Andrews et al.
2003/0212961	A1	11/2003	Soin et al.	2004/0133817	A1	7/2004	Choi
2003/0214519	A1	11/2003	Smith et al.	2004/0135701	A1	7/2004	Yasuda et al.
2003/0221198	A1	11/2003	Sloo et al.	2004/0135774	A1	7/2004	La Monica
2003/0224760	A1	12/2003	Day	2004/0136510	A1	7/2004	Vander Veen
2003/0228863	A1	12/2003	Vander Veen et al.	2004/0138869	A1	7/2004	Heinecke
2003/0228909	A1	12/2003	Tanaka et al.	2004/0145607	A1	7/2004	Alderson
2003/0229490	A1	12/2003	Etter	2004/0153306	A1	8/2004	Tanner et al.
2003/0229616	A1	12/2003	Wong	2004/0160419	A1	8/2004	Padgitt
2003/0233230	A1	12/2003	Ammicht et al.	2004/0162741	A1	8/2004	Flaxer et al.
2003/0233237	A1	12/2003	Garside et al.	2004/0174399	A1	9/2004	Wu et al.
2003/0233240	A1	12/2003	Kaatrasalo	2004/0174434	A1	9/2004	Walker et al.
2003/0234824	A1	12/2003	Litwiller	2004/0176958	A1	9/2004	Salmenkaita et al.
2003/0236663	A1	12/2003	Dimitrova et al.	2004/0177319	A1	9/2004	Horn
2004/0001396	A1	1/2004	Keller et al.	2004/0178994	A1	9/2004	Kairls, Jr.
2004/0006467	A1	1/2004	Anisimovich et al.	2004/0183833	A1	9/2004	Chua
2004/0010484	A1	1/2004	Foulger et al.	2004/0186713	A1	9/2004	Gomas et al.
2004/0012556	A1	1/2004	Yong et al.	2004/0186714	A1	9/2004	Baker
2004/0013252	A1	1/2004	Craner	2004/0186777	A1	9/2004	Margiloff et al.
2004/0021676	A1	2/2004	Chen et al.	2004/0186857	A1	9/2004	Serlet et al.
2004/0022373	A1	2/2004	Suder et al.	2004/0193398	A1	9/2004	Chu et al.
				2004/0193420	A1	9/2004	Kennewick et al.
				2004/0193421	A1	9/2004	Blass
				2004/0193426	A1	9/2004	Maddux et al.
				2004/0196256	A1	10/2004	Wobbrock et al.

(56)

References Cited

U.S. PATENT DOCUMENTS

2004/0198436	A1	10/2004	Alden	2005/0080613	A1	4/2005	Colledge et al.
2004/0199375	A1	10/2004	Ehsani et al.	2005/0080620	A1	4/2005	Rao et al.
2004/0199387	A1	10/2004	Wang et al.	2005/0080625	A1	4/2005	Bennett et al.
2004/0199663	A1	10/2004	Horvitz et al.	2005/0080632	A1	4/2005	Endo et al.
2004/0203520	A1	10/2004	Schirtzinger et al.	2005/0080780	A1	4/2005	Colledge et al.
2004/0205151	A1	10/2004	Sprigg et al.	2005/0086059	A1	4/2005	Bennett
2004/0205671	A1	10/2004	Sukehiro et al.	2005/0086255	A1	4/2005	Schran et al.
2004/0208302	A1	10/2004	Urban et al.	2005/0086605	A1	4/2005	Ferrer et al.
2004/0210442	A1	10/2004	Glynn et al.	2005/0091118	A1	4/2005	Fano
2004/0210634	A1	10/2004	Ferrer et al.	2005/0094475	A1	5/2005	Naoi
2004/0213419	A1	10/2004	Varma et al.	2005/0099398	A1	5/2005	Garside et al.
2004/0215731	A1	10/2004	Tzann-en Szeto	2005/0100214	A1	5/2005	Zhang et al.
2004/0216049	A1	10/2004	Lewis et al.	2005/0102144	A1	5/2005	Rapoport
2004/0218451	A1	11/2004	Said et al.	2005/0102614	A1	5/2005	Brockett et al.
2004/0220798	A1	11/2004	Chi et al.	2005/0102625	A1	5/2005	Lee et al.
2004/0223485	A1	11/2004	Arellano et al.	2005/0105712	A1	5/2005	Williams et al.
2004/0223599	A1	11/2004	Bear et al.	2005/0108001	A1	5/2005	Aarskog
2004/0224638	A1	11/2004	Fadell et al.	2005/0108017	A1	5/2005	Esser et al.
2004/0225501	A1	11/2004	Cutaia et al.	2005/0108074	A1	5/2005	Bloechl et al.
2004/0225650	A1	11/2004	Cooper et al.	2005/0108338	A1	5/2005	Simske et al.
2004/0225746	A1	11/2004	Niell et al.	2005/0108344	A1	5/2005	Tafoya et al.
2004/0230637	A1	11/2004	Lecoeuche et al.	2005/0108642	A1	5/2005	Sinclair
2004/0236778	A1	11/2004	Junqua et al.	2005/0114124	A1	5/2005	Liu et al.
2004/0242286	A1	12/2004	Benco et al.	2005/0114140	A1	5/2005	Brackett et al.
2004/0243412	A1	12/2004	Gupta et al.	2005/0114306	A1	5/2005	Shu et al.
2004/0243419	A1	12/2004	Wang	2005/0114791	A1	5/2005	Bollenbacher et al.
2004/0249629	A1	12/2004	Webster	2005/0119890	A1	6/2005	Hirose
2004/0249637	A1	12/2004	Baker	2005/0119897	A1	6/2005	Bennett et al.
2004/0249667	A1	12/2004	Oon	2005/0125216	A1	6/2005	Chitrapura et al.
2004/0252119	A1	12/2004	Hunleth et al.	2005/0125235	A1	6/2005	Lazay et al.
2004/0252604	A1	12/2004	Johnson et al.	2005/0131951	A1	6/2005	Zhang et al.
2004/0252966	A1	12/2004	Holloway et al.	2005/0132301	A1	6/2005	Ikeda
2004/0254791	A1	12/2004	Coifman et al.	2005/0136949	A1	6/2005	Barnes
2004/0254792	A1	12/2004	Busayapongchai et al.	2005/0138305	A1	6/2005	Zellner
2004/0257432	A1	12/2004	Girish et al.	2005/0140504	A1	6/2005	Marshall et al.
2004/0259536	A1	12/2004	Keskar et al.	2005/0143972	A1	6/2005	Gopalakrishnan et al.
2004/0260438	A1	12/2004	Chernetsky et al.	2005/0144003	A1	6/2005	Iso-Sipila
2004/0260718	A1	12/2004	Fedorov et al.	2005/0144070	A1	6/2005	Cheshire
2004/0261023	A1	12/2004	Bier	2005/0144568	A1	6/2005	Gruen et al.
2004/0262051	A1	12/2004	Carro	2005/0148356	A1	7/2005	Ferguson et al.
2004/0263636	A1	12/2004	Cutler et al.	2005/0149214	A1	7/2005	Yoo et al.
2004/0267825	A1	12/2004	Novak et al.	2005/0149330	A1	7/2005	Katae
2004/0268253	A1	12/2004	Demello et al.	2005/0149332	A1	7/2005	Kuzunuki et al.
2004/0268262	A1	12/2004	Gupta et al.	2005/0149510	A1	7/2005	Shafir
2005/0002507	A1	1/2005	Timmins et al.	2005/0152558	A1	7/2005	Van Tassel
2005/0010409	A1	1/2005	Hull et al.	2005/0152602	A1	7/2005	Chen et al.
2005/0012723	A1	1/2005	Pallakoff	2005/0154578	A1	7/2005	Tong et al.
2005/0015254	A1	1/2005	Beaman	2005/0154591	A1	7/2005	Lecoeuche
2005/0015772	A1	1/2005	Saare et al.	2005/0159939	A1	7/2005	Mohler et al.
2005/0021330	A1	1/2005	Mano	2005/0159957	A1	7/2005	Roth et al.
2005/0022114	A1	1/2005	Shanahan et al.	2005/0162395	A1	7/2005	Unruh
2005/0024341	A1	2/2005	Gillespie et al.	2005/0165015	A1	7/2005	Ncube et al.
2005/0024345	A1	2/2005	Easty et al.	2005/0165607	A1	7/2005	Di Fabrizio et al.
2005/0027385	A1	2/2005	Yueh	2005/0166153	A1	7/2005	Eytchison et al.
2005/0030175	A1	2/2005	Wolfe	2005/0177445	A1	8/2005	Church
2005/0031106	A1	2/2005	Henderson	2005/0181770	A1	8/2005	Helferich
2005/0033582	A1	2/2005	Gadd et al.	2005/0182616	A1	8/2005	Kotipalli
2005/0033771	A1	2/2005	Schmitter et al.	2005/0182627	A1	8/2005	Tanaka et al.
2005/0034164	A1	2/2005	Sano et al.	2005/0182628	A1	8/2005	Choi
2005/0038657	A1	2/2005	Roth et al.	2005/0182629	A1	8/2005	Coorman et al.
2005/0039141	A1	2/2005	Burke et al.	2005/0182630	A1	8/2005	Miro et al.
2005/0042591	A1	2/2005	Bloom et al.	2005/0182765	A1	8/2005	Liddy
2005/0043946	A1	2/2005	Ueyama et al.	2005/0187773	A1	8/2005	Filoché et al.
2005/0043949	A1	2/2005	Roth et al.	2005/0190970	A1	9/2005	Griffin
2005/0044569	A1	2/2005	Marcus	2005/0192801	A1	9/2005	Lewis et al.
2005/0045373	A1	3/2005	Born	2005/0192812	A1	9/2005	Buchholz et al.
2005/0049880	A1	3/2005	Roth et al.	2005/0195077	A1	9/2005	Mcculloch et al.
2005/0055212	A1	3/2005	Nagao	2005/0195429	A1	9/2005	Archbold
2005/0055403	A1	3/2005	Brittan	2005/0196733	A1	9/2005	Budra et al.
2005/0058438	A1	3/2005	Hayashi	2005/0201572	A1	9/2005	Lindahl et al.
2005/0060155	A1	3/2005	Chu et al.	2005/0202854	A1	9/2005	Kortum et al.
2005/0071165	A1	3/2005	Hofstader et al.	2005/0203747	A1	9/2005	Lecoeuche
2005/0071332	A1	3/2005	Ortega et al.	2005/0203991	A1	9/2005	Kawamura et al.
2005/0071437	A1	3/2005	Bear et al.	2005/0209848	A1	9/2005	Ishii
2005/0074113	A1	4/2005	Mathew et al.	2005/0210394	A1	9/2005	Crandall et al.
				2005/0216331	A1	9/2005	Ahrens et al.
				2005/0222843	A1	10/2005	Kahn et al.
				2005/0222973	A1	10/2005	Kaiser
				2005/0228665	A1	10/2005	Kobayashi et al.

(56)

References Cited

U.S. PATENT DOCUMENTS

2005/0245243	A1	11/2005	Zuniga	2006/0100849	A1	5/2006	Chan
2005/0246350	A1	11/2005	Canaran	2006/0101354	A1	5/2006	Hashimoto et al.
2005/0246365	A1	11/2005	Lowles et al.	2006/0103633	A1	5/2006	Gioeli
2005/0246726	A1	11/2005	Labrou et al.	2006/0106592	A1	5/2006	Brockett et al.
2005/0262440	A1	11/2005	Stanciu et al.	2006/0106594	A1	5/2006	Brockett et al.
2005/0267738	A1	12/2005	Wilkinson et al.	2006/0106595	A1	5/2006	Brockett et al.
2005/0267757	A1	12/2005	Iso-Sipila et al.	2006/0111906	A1	5/2006	Cross et al.
2005/0271216	A1	12/2005	Lashkari	2006/0111909	A1	5/2006	Maes et al.
2005/0273337	A1	12/2005	Erell et al.	2006/0116874	A1	6/2006	Samuelsson et al.
2005/0273626	A1	12/2005	Pearson et al.	2006/0116877	A1	6/2006	Pickering et al.
2005/0278297	A1	12/2005	Nelson	2006/0117002	A1	6/2006	Swen
2005/0278643	A1	12/2005	Ukai et al.	2006/0119582	A1	6/2006	Ng et al.
2005/0278647	A1	12/2005	Leavitt et al.	2006/0122834	A1	6/2006	Bennett
2005/0283364	A1	12/2005	Longe et al.	2006/0122836	A1	6/2006	Cross et al.
2005/0283726	A1	12/2005	Lunati	2006/0129929	A1	6/2006	Weber et al.
2005/0283729	A1	12/2005	Morris et al.	2006/0132812	A1	6/2006	Barnes et al.
2005/0288934	A1	12/2005	Omi	2006/0136213	A1	6/2006	Hirose et al.
2005/0288936	A1	12/2005	Busayapongchai et al.	2006/0136352	A1	6/2006	Brun et al.
2005/0289463	A1	12/2005	Wu et al.	2006/0141990	A1	6/2006	Zak et al.
2006/0001652	A1	1/2006	Chiu et al.	2006/0142576	A1	6/2006	Meng et al.
2006/0004570	A1	1/2006	Ju et al.	2006/0143007	A1	6/2006	Koh et al.
2006/0004744	A1	1/2006	Nevidomski et al.	2006/0143576	A1	6/2006	Gupta et al.
2006/0007174	A1	1/2006	Shen	2006/0148520	A1	7/2006	Baker et al.
2006/0009973	A1	1/2006	Nguyen et al.	2006/0149557	A1	7/2006	Kaneko et al.
2006/0013414	A1	1/2006	Shih	2006/0150087	A1	7/2006	Cronenberger et al.
2006/0015341	A1	1/2006	Baker	2006/0152496	A1	7/2006	Knaven
2006/0015819	A1	1/2006	Hawkins et al.	2006/0153040	A1	7/2006	Girish et al.
2006/0018446	A1	1/2006	Schmandt et al.	2006/0156252	A1	7/2006	Sheshagiri et al.
2006/0018492	A1	1/2006	Chiu et al.	2006/0156307	A1	7/2006	Kunjithapatham et al.
2006/0020890	A1	1/2006	Kroll et al.	2006/0161870	A1	7/2006	Hotelling et al.
2006/0025999	A1	2/2006	Feng et al.	2006/0161871	A1	7/2006	Hotelling et al.
2006/0026233	A1	2/2006	Tenembaum et al.	2006/0161872	A1	7/2006	Rytivaara et al.
2006/0026521	A1	2/2006	Hotelling et al.	2006/0165105	A1	7/2006	Shenfield et al.
2006/0026535	A1	2/2006	Hotelling et al.	2006/0167676	A1	7/2006	Plumb
2006/0026536	A1	2/2006	Hotelling et al.	2006/0168150	A1	7/2006	Naik et al.
2006/0033724	A1	2/2006	Chaudhri et al.	2006/0168507	A1	7/2006	Hansen
2006/0035632	A1	2/2006	Sorvari et al.	2006/0168539	A1	7/2006	Hawkins et al.
2006/0036946	A1	2/2006	Radtke et al.	2006/0172720	A1	8/2006	Islam et al.
2006/0041424	A1	2/2006	Todhunter et al.	2006/0173683	A1	8/2006	Roth et al.
2006/0041431	A1	2/2006	Maes	2006/0174207	A1	8/2006	Deshpande
2006/0041590	A1	2/2006	King et al.	2006/0178868	A1	8/2006	Billerey-Mosier
2006/0047632	A1	3/2006	Zhang	2006/0181519	A1	8/2006	Vernier et al.
2006/0050865	A1	3/2006	Kortum et al.	2006/0183466	A1	8/2006	Lee et al.
2006/0052141	A1	3/2006	Suzuki	2006/0184886	A1	8/2006	Chung et al.
2006/0053007	A1	3/2006	Niemisto	2006/0187073	A1	8/2006	Lin et al.
2006/0053365	A1	3/2006	Hollander et al.	2006/0190269	A1	8/2006	Tessel et al.
2006/0053379	A1	3/2006	Henderson et al.	2006/0190577	A1	8/2006	Yamada
2006/0053387	A1	3/2006	Ording	2006/0193518	A1	8/2006	Dong
2006/0058999	A1	3/2006	Barker et al.	2006/0195206	A1	8/2006	Moon et al.
2006/0059437	A1	3/2006	Conklin	2006/0195323	A1	8/2006	Monne et al.
2006/0060762	A1	3/2006	Chan et al.	2006/0197753	A1	9/2006	Hotelling
2006/0061488	A1	3/2006	Dunton	2006/0197755	A1	9/2006	Bawany
2006/0067535	A1	3/2006	Culbert et al.	2006/0200253	A1	9/2006	Hofberg et al.
2006/0067536	A1	3/2006	Culbert et al.	2006/0200342	A1	9/2006	Corston-Oliver et al.
2006/0069567	A1	3/2006	Tischer et al.	2006/0200347	A1	9/2006	Kim et al.
2006/0069664	A1	3/2006	Ling et al.	2006/0205432	A1	9/2006	Hawkins et al.
2006/0072248	A1	4/2006	Watanabe et al.	2006/0206454	A1	9/2006	Forstall et al.
2006/0072716	A1	4/2006	Pham	2006/0212415	A1	9/2006	Backer et al.
2006/0074628	A1	4/2006	Elbaz et al.	2006/0217967	A1	9/2006	Goertzen et al.
2006/0074660	A1	4/2006	Waters et al.	2006/0221738	A1	10/2006	Park et al.
2006/0074674	A1	4/2006	Zhang et al.	2006/0221788	A1	10/2006	Lindahl et al.
2006/0074750	A1	4/2006	Clark et al.	2006/0224570	A1	10/2006	Quiroga et al.
2006/0074898	A1	4/2006	Gavalda et al.	2006/0229802	A1	10/2006	Vertelney et al.
2006/0075429	A1	4/2006	Istvan et al.	2006/0229870	A1	10/2006	Kobal
2006/0077055	A1	4/2006	Basir	2006/0229876	A1	10/2006	Aaron et al.
2006/0080098	A1	4/2006	Campbell	2006/0230410	A1	10/2006	Kurganov et al.
2006/0085187	A1	4/2006	Barquilla	2006/0234680	A1	10/2006	Doulton
2006/0085465	A1	4/2006	Nori et al.	2006/0235550	A1	10/2006	Csicsatka et al.
2006/0085757	A1	4/2006	Andre et al.	2006/0235700	A1	10/2006	Wong et al.
2006/0095265	A1	5/2006	Chu et al.	2006/0235841	A1	10/2006	Betz et al.
2006/0095790	A1	5/2006	Nguyen et al.	2006/0236262	A1	10/2006	Bathiche et al.
2006/0095846	A1	5/2006	Nurmi	2006/0239419	A1	10/2006	Joseph et al.
2006/0095848	A1	5/2006	Naik	2006/0239471	A1	10/2006	Mao et al.
2006/0097991	A1	5/2006	Hotelling et al.	2006/0240866	A1	10/2006	Eilts
2006/0100848	A1	5/2006	Cozzi et al.	2006/0242190	A1	10/2006	Wnek
				2006/0246955	A1	11/2006	Nirhamo et al.
				2006/0247931	A1	11/2006	Caskey et al.
				2006/0252457	A1	11/2006	Schrager
				2006/0253210	A1	11/2006	Rosenberg

(56)

References Cited

U.S. PATENT DOCUMENTS

2006/0253787	A1	11/2006	Fogg	2007/0098195	A1	5/2007	Holmes
2006/0256934	A1	11/2006	Mazor	2007/0100206	A1	5/2007	Lin et al.
2006/0262876	A1	11/2006	LaDue	2007/0100602	A1	5/2007	Kim
2006/0265208	A1	11/2006	Assadollahi	2007/0100619	A1	5/2007	Purho
2006/0265503	A1	11/2006	Jones et al.	2007/0100635	A1	5/2007	Mahajan et al.
2006/0265648	A1	11/2006	Rainisto et al.	2007/0100709	A1	5/2007	Lee et al.
2006/0271627	A1	11/2006	Szczepanek	2007/0100790	A1	5/2007	Cheyser et al.
2006/0274051	A1	12/2006	Longé et al.	2007/0100883	A1	5/2007	Rose et al.
2006/0274905	A1	12/2006	Lindahl et al.	2007/0106512	A1	5/2007	Acerio et al.
2006/0277058	A1	12/2006	J'maev et al.	2007/0106513	A1	5/2007	Boillot et al.
2006/0282264	A1	12/2006	Denny et al.	2007/0106674	A1	5/2007	Agrawal et al.
2006/0282415	A1	12/2006	Shibata et al.	2007/0116195	A1	5/2007	Thompson et al.
2006/0286527	A1	12/2006	Morel	2007/0118377	A1	5/2007	Badino et al.
2006/0288024	A1	12/2006	Braica	2007/0118378	A1	5/2007	Skuratovsky
2006/0291666	A1	12/2006	Ball et al.	2007/0121846	A1	5/2007	Altberg et al.
2006/0293876	A1	12/2006	Kamatani et al.	2007/0124132	A1	5/2007	Takeuchi
2006/0293880	A1	12/2006	Elshishiny et al.	2007/0124149	A1	5/2007	Shen et al.
2006/0293886	A1	12/2006	Odell et al.	2007/0124676	A1	5/2007	Amundsen et al.
2007/0003026	A1	1/2007	Hodge et al.	2007/0127888	A1	6/2007	Hayashi et al.
2007/0004451	A1	1/2007	Anderson	2007/0128777	A1	6/2007	Yin et al.
2007/0005849	A1	1/2007	Oliver	2007/0129059	A1	6/2007	Nadarajah et al.
2007/0006098	A1	1/2007	Krumm et al.	2007/0130014	A1	6/2007	Altberg et al.
2007/0011154	A1	1/2007	Musgrove et al.	2007/0130128	A1	6/2007	Garg et al.
2007/0014280	A1	1/2007	Cormier et al.	2007/0132738	A1	6/2007	Lowles et al.
2007/0016563	A1	1/2007	Omoigui	2007/0133771	A1	6/2007	Stifelman et al.
2007/0016865	A1	1/2007	Johnson et al.	2007/0135949	A1	6/2007	Snover et al.
2007/0021956	A1	1/2007	Qu et al.	2007/0136064	A1	6/2007	Carroll
2007/0022380	A1	1/2007	Swartz et al.	2007/0136778	A1	6/2007	Birger et al.
2007/0025704	A1	2/2007	Tsukazaki et al.	2007/0143163	A1	6/2007	Weiss et al.
2007/0026852	A1	2/2007	Logan et al.	2007/0149252	A1	6/2007	Jobs et al.
2007/0027732	A1	2/2007	Hudgens	2007/0150842	A1	6/2007	Chaudhri et al.
2007/0028009	A1	2/2007	Robbin et al.	2007/0152978	A1	7/2007	Kocienda et al.
2007/0032247	A1	2/2007	Shaffer et al.	2007/0152980	A1	7/2007	Kocienda et al.
2007/0033003	A1	2/2007	Morris	2007/0155346	A1	7/2007	Mijatovic et al.
2007/0033026	A1	2/2007	Bartosik et al.	2007/0156410	A1	7/2007	Stohr et al.
2007/0036117	A1	2/2007	Taube et al.	2007/0156627	A1	7/2007	D'Alicandro
2007/0036286	A1	2/2007	Champlin et al.	2007/0157089	A1	7/2007	Van Os et al.
2007/0038436	A1	2/2007	Cristo et al.	2007/0157268	A1	7/2007	Girish et al.
2007/0038609	A1	2/2007	Wu	2007/0162274	A1	7/2007	Ruiz et al.
2007/0040813	A1	2/2007	Kushler et al.	2007/0162296	A1	7/2007	Altberg et al.
2007/0041361	A1	2/2007	Iso-Sipila	2007/0162414	A1	7/2007	Horowitz et al.
2007/0043568	A1	2/2007	Dhanakshirur et al.	2007/0168922	A1	7/2007	Kaiser et al.
2007/0044038	A1	2/2007	Horentrup et al.	2007/0173233	A1	7/2007	Vander Veen et al.
2007/0046641	A1	3/2007	Lim	2007/0173267	A1	7/2007	Klassen et al.
2007/0047719	A1	3/2007	Dhawan et al.	2007/0174188	A1	7/2007	Fish
2007/0050184	A1	3/2007	Drucker et al.	2007/0174396	A1	7/2007	Kumar et al.
2007/0050191	A1	3/2007	Weider et al.	2007/0179776	A1	8/2007	Segond et al.
2007/0050393	A1	3/2007	Vogel et al.	2007/0179778	A1	8/2007	Gong et al.
2007/0050712	A1	3/2007	Hull et al.	2007/0180383	A1	8/2007	Naik
2007/0052586	A1	3/2007	Horstemeyer	2007/0182595	A1	8/2007	Ghasabian
2007/0055493	A1	3/2007	Lee	2007/0185551	A1	8/2007	Meadows et al.
2007/0055508	A1	3/2007	Zhao et al.	2007/0185754	A1	8/2007	Schmidt
2007/0055514	A1	3/2007	Beattie et al.	2007/0185831	A1	8/2007	Churchar
2007/0055525	A1	3/2007	Kennewick et al.	2007/0185917	A1	8/2007	Prahlad et al.
2007/0055529	A1	3/2007	Kanevsky et al.	2007/0188901	A1	8/2007	Heckerman et al.
2007/0058832	A1	3/2007	Hug et al.	2007/0192026	A1	8/2007	Lee et al.
2007/0060107	A1	3/2007	Day	2007/0192027	A1	8/2007	Lee et al.
2007/0061487	A1	3/2007	Moore et al.	2007/0192105	A1	8/2007	Neeracher et al.
2007/0061712	A1	3/2007	Bodin et al.	2007/0192179	A1	8/2007	Van et al.
2007/0061754	A1	3/2007	Ardhanari et al.	2007/0192293	A1	8/2007	Swen
2007/0067173	A1	3/2007	Bellegarda	2007/0192403	A1	8/2007	Heine et al.
2007/0067272	A1	3/2007	Flynt et al.	2007/0192744	A1	8/2007	Reponen
2007/0073540	A1	3/2007	Hirakawa et al.	2007/0198267	A1	8/2007	Jones et al.
2007/0073541	A1	3/2007	Tian	2007/0198269	A1	8/2007	Braho et al.
2007/0073745	A1	3/2007	Scott et al.	2007/0198273	A1	8/2007	Hennecke
2007/0075965	A1	4/2007	Huppi et al.	2007/0198566	A1	8/2007	Sustik
2007/0079027	A1	4/2007	Marriott et al.	2007/0203955	A1	8/2007	Pomerantz
2007/0080936	A1	4/2007	Tsuk et al.	2007/0207785	A1	9/2007	Chatterjee et al.
2007/0083467	A1	4/2007	Lindahl et al.	2007/0208569	A1	9/2007	Subramanian et al.
2007/0083623	A1	4/2007	Nishimura et al.	2007/0208579	A1	9/2007	Peterson
2007/0088556	A1	4/2007	Andrew	2007/0208726	A1	9/2007	Krishnaprasad et al.
2007/0089132	A1	4/2007	Qureshey et al.	2007/0211071	A1	9/2007	Slotznick et al.
2007/0089135	A1	4/2007	Qureshey et al.	2007/0213099	A1	9/2007	Bast
2007/0093277	A1	4/2007	Cavacuiti et al.	2007/0213857	A1	9/2007	Bodin et al.
2007/0094026	A1	4/2007	Ativanichayaphong et al.	2007/0219645	A1	9/2007	Thomas et al.
				2007/0219777	A1	9/2007	Chu et al.
				2007/0219803	A1	9/2007	Chiu et al.
				2007/0219983	A1	9/2007	Fish
				2007/0225980	A1	9/2007	Sumita

(56)

References Cited

U.S. PATENT DOCUMENTS

2007/0225984	A1	9/2007	Milstein et al.	2008/0059190	A1	3/2008	Chu et al.
2007/0226652	A1	9/2007	Kikuchi et al.	2008/0059200	A1	3/2008	Puli
2007/0229323	A1	10/2007	Plachta et al.	2008/0059876	A1	3/2008	Hantler et al.
2007/0230729	A1	10/2007	Naylor et al.	2008/0062141	A1	3/2008	Chandhri
2007/0233484	A1	10/2007	Coelho	2008/0065382	A1	3/2008	Gerl et al.
2007/0233490	A1	10/2007	Yao	2008/0065387	A1	3/2008	Cross et al.
2007/0233497	A1	10/2007	Paek et al.	2008/0071529	A1	3/2008	Silverman et al.
2007/0233692	A1	10/2007	Lisa et al.	2008/0071544	A1	3/2008	Beaufays et al.
2007/0233725	A1	10/2007	Michmerhuizen et al.	2008/0075296	A1	3/2008	Lindahl et al.
2007/0238488	A1	10/2007	Scott	2008/0076972	A1	3/2008	Dorogusker et al.
2007/0238489	A1	10/2007	Scott	2008/0077310	A1	3/2008	Murlidar et al.
2007/0238520	A1	10/2007	Kacmarcik	2008/0077384	A1	3/2008	Agapi et al.
2007/0239429	A1	10/2007	Johnson et al.	2008/0077386	A1	3/2008	Gao et al.
2007/0240043	A1	10/2007	Fux et al.	2008/0077391	A1	3/2008	Chino et al.
2007/0240044	A1	10/2007	Fux et al.	2008/0077393	A1	3/2008	Gao et al.
2007/0240045	A1	10/2007	Fux et al.	2008/0077406	A1	3/2008	Ganong, III
2007/0241885	A1	10/2007	Clipsham	2008/0077859	A1	3/2008	Schabes et al.
2007/0244702	A1	10/2007	Kahn et al.	2008/0079566	A1	4/2008	Singh et al.
2007/0247441	A1	10/2007	Kim et al.	2008/0082332	A1	4/2008	Mallett et al.
2007/0255435	A1	11/2007	Cohen et al.	2008/0082338	A1	4/2008	O'Neil et al.
2007/0255979	A1	11/2007	Deily et al.	2008/0082390	A1	4/2008	Hawkins et al.
2007/0257890	A1	11/2007	Hotelling et al.	2008/0082576	A1	4/2008	Bodin et al.
2007/0258642	A1	11/2007	Thota	2008/0082651	A1	4/2008	Singh et al.
2007/0260460	A1	11/2007	Hyatt	2008/0084974	A1	4/2008	Dhanakshirur
2007/0260595	A1	11/2007	Beatty et al.	2008/0091406	A1	4/2008	Baldwin et al.
2007/0260822	A1	11/2007	Adams	2008/0091426	A1	4/2008	Rempel et al.
2007/0261080	A1	11/2007	Saetti	2008/0091443	A1	4/2008	Strope et al.
2007/0265831	A1	11/2007	Dinur et al.	2008/0096531	A1	4/2008	McQuaide et al.
2007/0271104	A1	11/2007	McKay	2008/0096726	A1	4/2008	Riley et al.
2007/0271510	A1	11/2007	Grigoriu et al.	2008/0097937	A1	4/2008	Hadjarian
2007/0274468	A1	11/2007	Cai	2008/0098302	A1	4/2008	Roose
2007/0276651	A1	11/2007	Bliss et al.	2008/0098480	A1	4/2008	Henry et al.
2007/0276714	A1	11/2007	Beringer	2008/0100579	A1	5/2008	Robinson et al.
2007/0276810	A1	11/2007	Rosen	2008/0101584	A1	5/2008	Gray et al.
2007/0277088	A1	11/2007	Bodin et al.	2008/0109222	A1	5/2008	Liu
2007/0282595	A1	12/2007	Tunning et al.	2008/0109402	A1	5/2008	Wang et al.
2007/0285958	A1	12/2007	Platchta et al.	2008/0114480	A1	5/2008	Harb
2007/0286363	A1	12/2007	Burg et al.	2008/0114598	A1	5/2008	Prieto et al.
2007/0288241	A1	12/2007	Cross et al.	2008/0114604	A1	5/2008	Wei et al.
2007/0288449	A1	12/2007	Datta et al.	2008/0114841	A1	5/2008	Lambert
2007/0291108	A1	12/2007	Huber et al.	2008/0115084	A1	5/2008	Scott
2007/0294077	A1	12/2007	Narayanan et al.	2008/0118143	A1	5/2008	Gordon et al.
2007/0294263	A1	12/2007	Punj et al.	2008/0120102	A1	5/2008	Rao
2007/0299664	A1	12/2007	Peters et al.	2008/0120112	A1	5/2008	Jordan et al.
2007/0299831	A1	12/2007	Williams et al.	2008/0120342	A1	5/2008	Reed et al.
2007/0300140	A1	12/2007	Makela et al.	2008/0122796	A1	5/2008	Jobs et al.
2008/0010355	A1	1/2008	Vieri et al.	2008/0126077	A1	5/2008	Thorn
2008/0012950	A1	1/2008	Lee et al.	2008/0126091	A1	5/2008	Clark et al.
2008/0013751	A1	1/2008	Hiselius	2008/0126093	A1	5/2008	Sivadas
2008/0015863	A1	1/2008	Agapi et al.	2008/0126100	A1	5/2008	Grost et al.
2008/0015864	A1	1/2008	Ross et al.	2008/0126491	A1	5/2008	Portele et al.
2008/0016575	A1	1/2008	Vincent et al.	2008/0129520	A1	6/2008	Lee
2008/0021708	A1	1/2008	Bennett et al.	2008/0130867	A1	6/2008	Bowen
2008/0022208	A1	1/2008	Morse	2008/0131006	A1	6/2008	Oliver
2008/0031475	A1	2/2008	Goldstein	2008/0132221	A1	6/2008	Willey
2008/0034032	A1	2/2008	Healey et al.	2008/0133215	A1	6/2008	Sarukkai
2008/0034044	A1	2/2008	Bhakta et al.	2008/0133228	A1	6/2008	Rao
2008/0036743	A1	2/2008	Westerman et al.	2008/0133241	A1	6/2008	Baker et al.
2008/0040339	A1	2/2008	Zhou et al.	2008/0133956	A1	6/2008	Fadell
2008/0042970	A1	2/2008	Liang et al.	2008/0140413	A1	6/2008	Millman et al.
2008/0043936	A1	2/2008	Liebermann	2008/0140416	A1	6/2008	Shostak
2008/0043943	A1	2/2008	Sipher et al.	2008/0140652	A1	6/2008	Millman et al.
2008/0046239	A1	2/2008	Boo	2008/0140657	A1	6/2008	Azvine et al.
2008/0046250	A1	2/2008	Agapi et al.	2008/0140702	A1	6/2008	Reed et al.
2008/0046422	A1	2/2008	Lee et al.	2008/0141125	A1	6/2008	Ghassabian et al.
2008/0046820	A1	2/2008	Lee et al.	2008/0141180	A1	6/2008	Reed et al.
2008/0046948	A1	2/2008	Verosub	2008/0141182	A1	6/2008	Barsness et al.
2008/0048908	A1	2/2008	Sato	2008/0146245	A1	6/2008	Appaji
2008/0052063	A1	2/2008	Bennett et al.	2008/0146290	A1	6/2008	Sreeram et al.
2008/0052073	A1	2/2008	Goto et al.	2008/0147408	A1	6/2008	Da Palma et al.
2008/0052077	A1	2/2008	Bennett et al.	2008/0147411	A1	6/2008	Dames et al.
2008/0052080	A1	2/2008	Narayanan	2008/0147874	A1	6/2008	Yoneda et al.
2008/0056459	A1	3/2008	Vallier et al.	2008/0150900	A1	6/2008	Han
2008/0056579	A1	3/2008	Guha	2008/0154600	A1	6/2008	Tian et al.
2008/0057922	A1	3/2008	Kokes et al.	2008/0154612	A1	6/2008	Evermann et al.
				2008/0154828	A1	6/2008	Antebi et al.
				2008/0157867	A1	7/2008	Krah
				2008/0163119	A1	7/2008	Kim et al.
				2008/0163131	A1	7/2008	Hirai et al.

(56)

References Cited

U.S. PATENT DOCUMENTS

2008/0165144	A1	7/2008	Forstall et al.	2008/0319753	A1	12/2008	Hancock
2008/0165980	A1	7/2008	Pavlovic et al.	2008/0319763	A1	12/2008	Di Fabrizio et al.
2008/0165994	A1	7/2008	Caren et al.	2009/0003115	A1	1/2009	Lindahl et al.
2008/0167013	A1	7/2008	Novick et al.	2009/0005012	A1	1/2009	Van Heugten
2008/0167858	A1	7/2008	Christie et al.	2009/0005891	A1	1/2009	Batson et al.
2008/0168366	A1	7/2008	Kocienda et al.	2009/0006097	A1	1/2009	Etezadi et al.
2008/0183473	A1	7/2008	Nagano et al.	2009/0006099	A1	1/2009	Sharpe et al.
2008/0189099	A1	8/2008	Friedman et al.	2009/0006100	A1	1/2009	Badger et al.
2008/0189106	A1	8/2008	Low et al.	2009/0006343	A1	1/2009	Platt et al.
2008/0189110	A1	8/2008	Freeman et al.	2009/0006345	A1	1/2009	Platt et al.
2008/0189114	A1	8/2008	Fail et al.	2009/0006488	A1	1/2009	Lindahl et al.
2008/0189606	A1	8/2008	Rybak	2009/0006671	A1	1/2009	Batson et al.
2008/0195312	A1	8/2008	Aaron et al.	2009/0007001	A1	1/2009	Morin et al.
2008/0195601	A1	8/2008	Ntoulas et al.	2009/0011709	A1	1/2009	Akasaka et al.
2008/0195630	A1	8/2008	Exartier et al.	2009/0012748	A1	1/2009	Beish et al.
2008/0195940	A1	8/2008	Gail et al.	2009/0012775	A1	1/2009	El Hady et al.
2008/0200142	A1	8/2008	Abdel-Kader et al.	2009/0018828	A1	1/2009	Nakadai et al.
2008/0201306	A1	8/2008	Cooper et al.	2009/0018834	A1	1/2009	Cooper et al.
2008/0201375	A1	8/2008	Khedouri et al.	2009/0018835	A1	1/2009	Cooper et al.
2008/0204379	A1	8/2008	Perez-Noguera	2009/0018839	A1	1/2009	Cooper et al.
2008/0207176	A1	8/2008	Brackbill et al.	2009/0018840	A1	1/2009	Lutz et al.
2008/0208585	A1	8/2008	Ativanichayaphong et al.	2009/0022329	A1	1/2009	Mahowald
2008/0208587	A1	8/2008	Ben-David et al.	2009/0028435	A1	1/2009	Wu et al.
2008/0212796	A1	9/2008	Denda	2009/0030800	A1	1/2009	Grois
2008/0219641	A1	9/2008	Sandrew et al.	2009/0030978	A1	1/2009	Johnson et al.
2008/0221866	A1	9/2008	Katragadda et al.	2009/0043580	A1	2/2009	Mozer et al.
2008/0221879	A1	9/2008	Cerra et al.	2009/0043583	A1	2/2009	Agapi et al.
2008/0221880	A1	9/2008	Cerra et al.	2009/0043763	A1	2/2009	Peng
2008/0221889	A1	9/2008	Cerra et al.	2009/0048821	A1	2/2009	Yam et al.
2008/0221903	A1	9/2008	Kanevsky et al.	2009/0048845	A1	2/2009	Burckart et al.
2008/0222118	A1	9/2008	Scian et al.	2009/0049067	A1	2/2009	Murray
2008/0228463	A1	9/2008	Mori et al.	2009/0055179	A1	2/2009	Cho et al.
2008/0228485	A1	9/2008	Owen	2009/0055186	A1	2/2009	Lance et al.
2008/0228490	A1	9/2008	Fischer et al.	2009/0058823	A1	3/2009	Kocienda
2008/0228495	A1	9/2008	Cross et al.	2009/0058860	A1	3/2009	Fong et al.
2008/0228496	A1	9/2008	Yu et al.	2009/0060472	A1	3/2009	Bull et al.
2008/0228928	A1	9/2008	Donelli et al.	2009/0063974	A1	3/2009	Bull et al.
2008/0229185	A1	9/2008	Lynch	2009/0064031	A1	3/2009	Bull et al.
2008/0229218	A1	9/2008	Maeng	2009/0070097	A1	3/2009	Wu et al.
2008/0235017	A1	9/2008	Satomura et al.	2009/0070102	A1	3/2009	Maegawa
2008/0235024	A1	9/2008	Goldberg et al.	2009/0070114	A1	3/2009	Staszak
2008/0235027	A1	9/2008	Cross	2009/0074214	A1	3/2009	Bradford et al.
2008/0240569	A1	10/2008	Tonouchi	2009/0076792	A1	3/2009	Lawson-Tancred
2008/0242280	A1	10/2008	Shapiro et al.	2009/0076796	A1	3/2009	Daraselina
2008/0244390	A1	10/2008	Fux et al.	2009/0076819	A1	3/2009	Wouters et al.
2008/0244446	A1	10/2008	Lefevre et al.	2009/0076821	A1	3/2009	Brenner et al.
2008/0247519	A1	10/2008	Abella et al.	2009/0076825	A1	3/2009	Bradford et al.
2008/0248797	A1	10/2008	Freeman et al.	2009/0077165	A1	3/2009	Rhodes et al.
2008/0249770	A1	10/2008	Kim et al.	2009/0083034	A1	3/2009	Hernandez et al.
2008/0253577	A1	10/2008	Eppolito	2009/0083035	A1	3/2009	Huang et al.
2008/0255837	A1	10/2008	Kahn et al.	2009/0083036	A1	3/2009	Zhao et al.
2008/0255845	A1	10/2008	Bennett	2009/0083037	A1	3/2009	Gleason et al.
2008/0256613	A1	10/2008	Grover	2009/0083047	A1	3/2009	Lindahl et al.
2008/0259022	A1	10/2008	Mansfield et al.	2009/0089058	A1	4/2009	Bellegarda
2008/0262838	A1	10/2008	Nurminen et al.	2009/0092260	A1	4/2009	Powers
2008/0262846	A1	10/2008	Burns et al.	2009/0092261	A1	4/2009	Bard
2008/0270118	A1	10/2008	Kuo et al.	2009/0092262	A1	4/2009	Costa et al.
2008/0270138	A1	10/2008	Knight et al.	2009/0094029	A1	4/2009	Koch et al.
2008/0270139	A1	10/2008	Shi et al.	2009/0094033	A1	4/2009	Mozer et al.
2008/0270140	A1	10/2008	Hertz et al.	2009/0097634	A1	4/2009	Nambiar et al.
2008/0270151	A1	10/2008	Mahoney et al.	2009/0097637	A1	4/2009	Boscher et al.
2008/0277473	A1	11/2008	Kotlarsky et al.	2009/0100049	A1	4/2009	Cao
2008/0281510	A1	11/2008	Shahine	2009/0100454	A1	4/2009	Weber
2008/0292112	A1	11/2008	Valenzuela et al.	2009/0104898	A1	4/2009	Harris
2008/0294418	A1	11/2008	Cleary et al.	2009/0106026	A1	4/2009	Ferrieux
2008/0294651	A1	11/2008	Masuyama et al.	2009/0106376	A1	4/2009	Tom et al.
2008/0294981	A1	11/2008	Balzano et al.	2009/0106397	A1	4/2009	O'Keefe
2008/0298766	A1	12/2008	Wen et al.	2009/0112572	A1	4/2009	Thorn
2008/0299523	A1	12/2008	Chai et al.	2009/0112592	A1	4/2009	Candelore et al.
2008/0300871	A1	12/2008	Gilbert	2009/0112677	A1	4/2009	Rhett
2008/0300878	A1	12/2008	Bennett	2009/0112892	A1	4/2009	Cardie et al.
2008/0306727	A1	12/2008	Thurmair et al.	2009/0119587	A1	5/2009	Allen et al.
2008/0312909	A1	12/2008	Hermansen et al.	2009/0123021	A1	5/2009	Jung et al.
2008/0313335	A1	12/2008	Jung et al.	2009/0123071	A1	5/2009	Iwasaki
2008/0316183	A1	12/2008	Westerman et al.	2009/0125477	A1	5/2009	Lu et al.
				2009/0128505	A1	5/2009	Partridge et al.
				2009/0137286	A1	5/2009	Luke et al.
				2009/0138736	A1	5/2009	Chin
				2009/0138828	A1	5/2009	Schultz et al.

(56)

References Cited

U.S. PATENT DOCUMENTS

2009/0144049	A1	6/2009	Haddad et al.	2009/0292987	A1	11/2009	Sorenson
2009/0144428	A1	6/2009	Bowater et al.	2009/0296552	A1	12/2009	Hicks et al.
2009/0144609	A1	6/2009	Liang et al.	2009/0298474	A1	12/2009	George
2009/0146848	A1	6/2009	Ghassabian	2009/0299745	A1	12/2009	Kennewick et al.
2009/0150147	A1	6/2009	Jacoby et al.	2009/0299849	A1	12/2009	Cao et al.
2009/0150156	A1	6/2009	Kennewick et al.	2009/0300391	A1	12/2009	Jessup et al.
2009/0152349	A1	6/2009	Bonev et al.	2009/0300488	A1	12/2009	Salamon et al.
2009/0153288	A1	6/2009	Hope et al.	2009/0304198	A1	12/2009	Herre et al.
2009/0154669	A1	6/2009	Wood et al.	2009/0306967	A1	12/2009	Nicolov et al.
2009/0157382	A1	6/2009	Bar	2009/0306969	A1	12/2009	Goud et al.
2009/0157384	A1	6/2009	Toutanova et al.	2009/0306979	A1	12/2009	Jaiswal et al.
2009/0157401	A1	6/2009	Bennett	2009/0306980	A1	12/2009	Shin
2009/0158423	A1	6/2009	Orlassino et al.	2009/0306981	A1	12/2009	Cromack et al.
2009/0160803	A1	6/2009	Hashimoto	2009/0306985	A1	12/2009	Roberts et al.
2009/0164441	A1	6/2009	Cheyser	2009/0306988	A1	12/2009	Chen et al.
2009/0164655	A1	6/2009	Pettersson et al.	2009/0306989	A1	12/2009	Kaji
2009/0164937	A1	6/2009	Alviar et al.	2009/0307162	A1	12/2009	Bui et al.
2009/0167508	A1	7/2009	Fadell et al.	2009/0307201	A1	12/2009	Dunning et al.
2009/0167509	A1	7/2009	Fadell et al.	2009/0307584	A1	12/2009	Davidson et al.
2009/0171578	A1	7/2009	Kim et al.	2009/0313023	A1	12/2009	Jones
2009/0171664	A1	7/2009	Kennewick et al.	2009/0313026	A1	12/2009	Coffman et al.
2009/0172108	A1	7/2009	Singh	2009/0313544	A1	12/2009	Wood et al.
2009/0172542	A1	7/2009	Girish et al.	2009/0313564	A1	12/2009	Rottler et al.
2009/0174667	A1	7/2009	Kocienda et al.	2009/0316943	A1	12/2009	Frigola Munoz et al.
2009/0174677	A1	7/2009	Gehani et al.	2009/0318119	A1	12/2009	Basir et al.
2009/0177300	A1	7/2009	Lee	2009/0318198	A1	12/2009	Carroll
2009/0177461	A1	7/2009	Ehsani et al.	2009/0319266	A1	12/2009	Brown et al.
2009/0182445	A1	7/2009	Girish et al.	2009/0326936	A1	12/2009	Nagashima
2009/0187402	A1	7/2009	Scholl	2009/0326938	A1	12/2009	Marila et al.
2009/0187577	A1	7/2009	Reznik et al.	2009/0326949	A1	12/2009	Douthitt et al.
2009/0191895	A1	7/2009	Singh et al.	2009/0327977	A1	12/2009	Bachfischer et al.
2009/0192782	A1	7/2009	Drewes	2010/0004931	A1	1/2010	Ma et al.
2009/0198497	A1	8/2009	Kwon	2010/0005081	A1	1/2010	Bennett
2009/0204409	A1	8/2009	Mozer et al.	2010/0013796	A1	1/2010	Abileah et al.
2009/0204596	A1	8/2009	Brun et al.	2010/0019834	A1	1/2010	Zerbe et al.
2009/0204620	A1	8/2009	Thione et al.	2010/0023318	A1	1/2010	Lemoine
2009/0210232	A1	8/2009	Sanchez	2010/0023320	A1	1/2010	Di Cristo et al.
2009/0213134	A1	8/2009	Stephanick et al.	2010/0030928	A1	2/2010	Conroy et al.
2009/0215503	A1	8/2009	Zhang et al.	2010/0031143	A1	2/2010	Rao et al.
2009/0216540	A1	8/2009	Tessel et al.	2010/0036655	A1	2/2010	Cecil et al.
2009/0216704	A1	8/2009	Zheng et al.	2010/0036660	A1	2/2010	Bennett
2009/0222270	A2	9/2009	Likens et al.	2010/0037183	A1	2/2010	Miyashita et al.
2009/0222488	A1	9/2009	Boerries et al.	2010/0042400	A1	2/2010	Block et al.
2009/0228126	A1	9/2009	Spielberg et al.	2010/0046842	A1	2/2010	Conwell
2009/0228273	A1	9/2009	Wang et al.	2010/0049514	A1	2/2010	Kennewick et al.
2009/0228281	A1	9/2009	Singleton et al.	2010/0050064	A1	2/2010	Liu et al.
2009/0228792	A1	9/2009	Van Os et al.	2010/0054512	A1	3/2010	Solum
2009/0228842	A1	9/2009	Westerman et al.	2010/0057457	A1	3/2010	Ogata et al.
2009/0234655	A1	9/2009	Kwon	2010/0057643	A1	3/2010	Yang
2009/0239202	A1	9/2009	Stone	2010/0060646	A1	3/2010	Unsal et al.
2009/0239552	A1	9/2009	Churchill et al.	2010/0063804	A1	3/2010	Sato et al.
2009/0240485	A1	9/2009	Dalal et al.	2010/0063825	A1	3/2010	Williams et al.
2009/0241054	A1	9/2009	Hendricks	2010/0063961	A1	3/2010	Guiheneuf et al.
2009/0241760	A1	10/2009	Georges	2010/0064113	A1	3/2010	Lindahl et al.
2009/0247237	A1	10/2009	Mittleman et al.	2010/0064218	A1	3/2010	Bull et al.
2009/0248182	A1	10/2009	Logan et al.	2010/0067723	A1	3/2010	Bergmann et al.
2009/0248420	A1	10/2009	Basir et al.	2010/0067867	A1	3/2010	Lin
2009/0249198	A1	10/2009	Davis et al.	2010/0070281	A1	3/2010	Conkie et al.
2009/0252350	A1	10/2009	Seguin	2010/0070899	A1	3/2010	Hunt et al.
2009/0253457	A1	10/2009	Seguin	2010/0076760	A1	3/2010	Kraenzel et al.
2009/0253463	A1	10/2009	Shin et al.	2010/0077350	A1	3/2010	Lim et al.
2009/0254339	A1	10/2009	Seguin	2010/0079501	A1	4/2010	Ikeda et al.
2009/0254345	A1	10/2009	Fleizach et al.	2010/0080398	A1	4/2010	Waldmann
2009/0259969	A1	10/2009	Pallakoff	2010/0080470	A1	4/2010	Deluca et al.
2009/0265368	A1	10/2009	Crider et al.	2010/0081456	A1	4/2010	Singh et al.
2009/0271109	A1	10/2009	Lee et al.	2010/0081487	A1	4/2010	Chen et al.
2009/0271175	A1	10/2009	Bodin et al.	2010/0082327	A1	4/2010	Rogers et al.
2009/0271176	A1	10/2009	Bodin et al.	2010/0082328	A1	4/2010	Rogers et al.
2009/0271178	A1	10/2009	Bodin et al.	2010/0082329	A1	4/2010	Silverman et al.
2009/0274315	A1	11/2009	Carnes et al.	2010/0082346	A1	4/2010	Rogers et al.
2009/0281789	A1	11/2009	Waibel et al.	2010/0082347	A1	4/2010	Rogers et al.
2009/0284482	A1	11/2009	Chin	2010/0082348	A1	4/2010	Silverman et al.
2009/0286514	A1	11/2009	Lichorowic et al.	2010/0082349	A1	4/2010	Bellegarda et al.
2009/0287583	A1	11/2009	Holmes	2010/0082970	A1	4/2010	Lindahl et al.
2009/0290718	A1	11/2009	Kahn et al.	2010/0086152	A1	4/2010	Rank et al.
				2010/0086153	A1	4/2010	Hagen et al.
				2010/0086156	A1	4/2010	Rank et al.
				2010/0088020	A1	4/2010	Sano et al.
				2010/0088093	A1	4/2010	Lee et al.

(56)

References Cited

U.S. PATENT DOCUMENTS

2010/0088100	A1	4/2010	Lindahl	2010/0318576	A1	12/2010	Kim
2010/0100212	A1	4/2010	Lindahl et al.	2010/0322438	A1	12/2010	Siotis
2010/0100384	A1	4/2010	Ju et al.	2010/0324895	A1	12/2010	Kurzweil et al.
2010/0103776	A1	4/2010	Chan	2010/0324905	A1	12/2010	Kurzweil et al.
2010/0106500	A1	4/2010	McKee et al.	2010/0325573	A1	12/2010	Estrada et al.
2010/0114856	A1	5/2010	Kuboyama	2010/0325588	A1	12/2010	Reddy et al.
2010/0121637	A1	5/2010	Roy et al.	2010/0332224	A1	12/2010	Mäkelä et al.
2010/0125460	A1	5/2010	Mellott et al.	2010/0332235	A1	12/2010	David
2010/0125811	A1	5/2010	Moore et al.	2010/0332280	A1	12/2010	Bradley et al.
2010/0131273	A1	5/2010	Aley-Raz et al.	2010/0332348	A1	12/2010	Cao
2010/0131498	A1	5/2010	Linthicum et al.	2010/0332428	A1	12/2010	Mchenry et al.
2010/0131899	A1	5/2010	Hubert	2010/0332976	A1	12/2010	Fux et al.
2010/0138215	A1	6/2010	Williams	2010/0333030	A1	12/2010	Johns
2010/0138224	A1	6/2010	Bedingfield, Sr.	2011/0002487	A1	1/2011	Panther et al.
2010/0138416	A1	6/2010	Bellotti	2011/0010178	A1	1/2011	Lee et al.
2010/0142740	A1	6/2010	Roerup	2011/0010644	A1	1/2011	Merrill et al.
2010/0145694	A1	6/2010	Ju et al.	2011/0016150	A1	1/2011	Engstrom et al.
2010/0145700	A1	6/2010	Kennewick et al.	2011/0018695	A1	1/2011	Bells et al.
2010/0146442	A1	6/2010	Nagasaka et al.	2011/0021213	A1	1/2011	Carr
2010/0153115	A1	6/2010	Klee et al.	2011/0022292	A1	1/2011	Shen et al.
2010/0161313	A1	6/2010	Karttunen	2011/0022394	A1	1/2011	Wide
2010/0161554	A1	6/2010	Datuashvili et al.	2011/0022472	A1	1/2011	Zon
2010/0164897	A1	7/2010	Morin et al.	2011/0022952	A1	1/2011	Wu et al.
2010/0169075	A1	7/2010	Raffa et al.	2011/0029616	A1	2/2011	Wang et al.
2010/0169097	A1	7/2010	Nachman et al.	2011/0033064	A1	2/2011	Johnson et al.
2010/0171713	A1	7/2010	Kwok et al.	2011/0038489	A1	2/2011	Visser et al.
2010/0174544	A1	7/2010	Heifets	2011/0047072	A1	2/2011	Ciurea
2010/0175066	A1*	7/2010	Paik	2011/0047161	A1	2/2011	Myaeng et al.
			G06F 1/3203	2011/0050591	A1	3/2011	Kim et al.
			718/102	2011/0054894	A1	3/2011	Phillips et al.
				2011/0054901	A1	3/2011	Qin et al.
2010/0179932	A1	7/2010	Yoon et al.	2011/0055256	A1	3/2011	Phillips et al.
2010/0179991	A1	7/2010	Lorch et al.	2011/0060584	A1	3/2011	Ferrucci et al.
2010/0185448	A1	7/2010	Meisel	2011/0060587	A1	3/2011	Phillips et al.
2010/0185949	A1	7/2010	Jaeger	2011/0060589	A1	3/2011	Weinberg et al.
2010/0197359	A1	8/2010	Harris	2011/0060807	A1	3/2011	Martin et al.
2010/0199215	A1	8/2010	Seymour et al.	2011/0066468	A1	3/2011	Huang et al.
2010/0204986	A1	8/2010	Kennewick et al.	2011/0072492	A1	3/2011	Mohler et al.
2010/0211199	A1	8/2010	Naik et al.	2011/0076994	A1	3/2011	Kim et al.
2010/0217604	A1	8/2010	Baldwin et al.	2011/0082688	A1	4/2011	Kim et al.
2010/0222033	A1	9/2010	Scott et al.	2011/0083079	A1	4/2011	Farrell et al.
2010/0222098	A1	9/2010	Garg	2011/0087491	A1	4/2011	Wittenstein et al.
2010/0223055	A1	9/2010	Mclean	2011/0090078	A1	4/2011	Kim et al.
2010/0223056	A1	9/2010	Kadiramanathan	2011/0093261	A1	4/2011	Angott
2010/0223131	A1	9/2010	Scott et al.	2011/0093265	A1	4/2011	Stent et al.
2010/0228540	A1	9/2010	Bennett	2011/0093271	A1	4/2011	Bernard et al.
2010/0228691	A1	9/2010	Yang et al.	2011/0099000	A1	4/2011	Rai et al.
2010/0229082	A1	9/2010	Karmarkar et al.	2011/0103682	A1	5/2011	Chidlovskii et al.
2010/0231474	A1	9/2010	Yamagajo et al.	2011/0106736	A1	5/2011	Aharonson et al.
2010/0235167	A1	9/2010	Bourdon	2011/0110502	A1	5/2011	Daye et al.
2010/0235341	A1	9/2010	Bennett	2011/0112827	A1	5/2011	Kennewick et al.
2010/0235729	A1	9/2010	Kocienda et al.	2011/0112837	A1	5/2011	Kurki-Suonio et al.
2010/0235770	A1	9/2010	Ording et al.	2011/0112921	A1	5/2011	Kennewick et al.
2010/0250542	A1	9/2010	Fujimaki	2011/0116610	A1	5/2011	Shaw et al.
2010/0250599	A1	9/2010	Schmidt et al.	2011/0119049	A1	5/2011	Ylonen
2010/0257160	A1	10/2010	Cao	2011/0119051	A1	5/2011	Li et al.
2010/0257478	A1	10/2010	Longe et al.	2011/0125540	A1	5/2011	Jang et al.
2010/0262599	A1	10/2010	Nitz	2011/0130958	A1	6/2011	Stahl et al.
2010/0268539	A1	10/2010	Xu et al.	2011/0131036	A1	6/2011	DiCristo et al.
2010/0274753	A1	10/2010	Liberty et al.	2011/0131038	A1	6/2011	Oyaizu et al.
2010/0277579	A1	11/2010	Cho et al.	2011/0131045	A1	6/2011	Cristo et al.
2010/0278320	A1	11/2010	Arsenault et al.	2011/0141141	A1	6/2011	Kankainen
2010/0278453	A1	11/2010	King	2011/0143811	A1	6/2011	Rodriguez
2010/0280983	A1	11/2010	Cho et al.	2011/0144973	A1	6/2011	Bocchieri et al.
2010/0281034	A1	11/2010	Petrou et al.	2011/0144999	A1	6/2011	Jang et al.
2010/0286985	A1	11/2010	Kennewick et al.	2011/0145718	A1	6/2011	Ketola et al.
2010/0287514	A1	11/2010	Cragun et al.	2011/0151830	A1	6/2011	Blanda et al.
2010/0293460	A1	11/2010	Budelli	2011/0153209	A1	6/2011	Geelen
2010/0299133	A1	11/2010	Kopparapu et al.	2011/0153330	A1	6/2011	Yazdani et al.
2010/0299138	A1	11/2010	Kim	2011/0153373	A1	6/2011	Dantzig et al.
2010/0299142	A1	11/2010	Freeman et al.	2011/0157029	A1	6/2011	Tseng
2010/0302056	A1	12/2010	Dutton et al.	2011/0161076	A1	6/2011	Davis et al.
2010/0304705	A1	12/2010	Hursey	2011/0161079	A1	6/2011	Gruhn et al.
2010/0305807	A1	12/2010	Basir et al.	2011/0161309	A1	6/2011	Lung et al.
2010/0305947	A1	12/2010	Schwarz et al.	2011/0161852	A1	6/2011	Vainio et al.
2010/0312547	A1	12/2010	Van Os et al.	2011/0167350	A1	7/2011	Hoellwarth
2010/0312566	A1	12/2010	Odinak et al.	2011/0175810	A1	7/2011	Markovic et al.
				2011/0179002	A1	7/2011	Dumitru et al.
				2011/0179372	A1	7/2011	Moore et al.

(56)

References Cited

U.S. PATENT DOCUMENTS

2011/0183650	A1	7/2011	Mckee	2012/0136572	A1	5/2012	Norton
2011/0184721	A1	7/2011	Subramanian et al.	2012/0136985	A1	5/2012	Popescu et al.
2011/0184730	A1	7/2011	LeBeau et al.	2012/0137367	A1	5/2012	Dupont et al.
2011/0191271	A1	8/2011	Baker et al.	2012/0149394	A1	6/2012	Singh et al.
2011/0191344	A1	8/2011	Jin et al.	2012/0150580	A1	6/2012	Norton
2011/0195758	A1	8/2011	Damale et al.	2012/0158293	A1	6/2012	Burnham
2011/0201385	A1	8/2011	Higginbotham	2012/0158422	A1	6/2012	Burnham et al.
2011/0201387	A1	8/2011	Paek et al.	2012/0159380	A1	6/2012	Kocienda et al.
2011/0202526	A1	8/2011	Lee et al.	2012/0163710	A1	6/2012	Skaff et al.
2011/0205149	A1	8/2011	Tom et al.	2012/0173464	A1	7/2012	Tur et al.
2011/0209088	A1	8/2011	Hinckley et al.	2012/0174121	A1	7/2012	Treat et al.
2011/0212717	A1	9/2011	Rhoads et al.	2012/0185237	A1	7/2012	Gajic et al.
2011/0218855	A1	9/2011	Cao et al.	2012/0197743	A1	8/2012	Grigg et al.
2011/0219018	A1	9/2011	Bailey et al.	2012/0197995	A1	8/2012	Caruso
2011/0224972	A1	9/2011	Millett et al.	2012/0197998	A1	8/2012	Kessel et al.
2011/0231182	A1	9/2011	Weider et al.	2012/0201362	A1	8/2012	Crossan et al.
2011/0231188	A1	9/2011	Kennewick et al.	2012/0209853	A1	8/2012	Desai et al.
2011/0231474	A1	9/2011	Locker et al.	2012/0214141	A1	8/2012	Raya et al.
2011/0238407	A1	9/2011	Kent	2012/0214517	A1	8/2012	Singh et al.
2011/0238408	A1	9/2011	Larcheveque et al.	2012/0221339	A1	8/2012	Wang et al.
2011/0238676	A1	9/2011	Liu et al.	2012/0221552	A1	8/2012	Reponen et al.
2011/0242007	A1	10/2011	Gray et al.	2012/0223936	A1	9/2012	Aughey et al.
2011/0249144	A1	10/2011	Chang	2012/0232886	A1	9/2012	Capuozzo et al.
2011/0250570	A1	10/2011	Mack et al.	2012/0232906	A1	9/2012	Lindahl
2011/0258188	A1	10/2011	Abdalmageed et al.	2012/0242482	A1	9/2012	Elumalai et al.
2011/0260861	A1	10/2011	Singh et al.	2012/0245719	A1	9/2012	Story, Jr. et al.
2011/0264643	A1	10/2011	Cao	2012/0245941	A1	9/2012	Cheyer
2011/0274303	A1	11/2011	Filson et al.	2012/0245944	A1	9/2012	Gruber et al.
2011/0276598	A1	11/2011	Kozempel	2012/0252367	A1	10/2012	Gaglio et al.
2011/0279368	A1	11/2011	Klein et al.	2012/0254143	A1	10/2012	Varma et al.
2011/0282888	A1	11/2011	Koperski et al.	2012/0254152	A1	10/2012	Park et al.
2011/0288861	A1	11/2011	Kurzweil et al.	2012/0265528	A1	10/2012	Gruber et al.
2011/0298585	A1	12/2011	Barry	2012/0265535	A1	10/2012	Bryant-Rich et al.
2011/0302162	A1	12/2011	Xiao et al.	2012/0271625	A1	10/2012	Bernard
2011/0306426	A1	12/2011	Novak et al.	2012/0271635	A1	10/2012	Ljolje
2011/0307491	A1	12/2011	Fisk et al.	2012/0271640	A1	10/2012	Basir
2011/0307810	A1	12/2011	Hilerio et al.	2012/0271676	A1	10/2012	Aravamudan et al.
2011/0313775	A1	12/2011	Laligand et al.	2012/0284027	A1	11/2012	Mallett et al.
2011/0314032	A1	12/2011	Bennett et al.	2012/0290300	A1	11/2012	Lee et al.
2011/0314404	A1	12/2011	Kotler et al.	2012/0295708	A1	11/2012	Hernandez-Abrego et al.
2012/0002820	A1	1/2012	Leichter	2012/0296649	A1	11/2012	Bansal et al.
2012/0008754	A1	1/2012	Mukherjee et al.	2012/0296891	A1	11/2012	Rangan
2012/0011138	A1	1/2012	Dunning et al.	2012/0304124	A1	11/2012	Chen et al.
2012/0013609	A1	1/2012	Reponen et al.	2012/0309363	A1	12/2012	Gruber et al.
2012/0015629	A1	1/2012	Olsen et al.	2012/0310642	A1	12/2012	Cao et al.
2012/0016678	A1	1/2012	Gruber et al.	2012/0310649	A1	12/2012	Cannistraro et al.
2012/0020490	A1	1/2012	Leichter	2012/0310652	A1	12/2012	O'Sullivan
2012/0022787	A1	1/2012	LeBeau et al.	2012/0311478	A1	12/2012	Van Os et al.
2012/0022857	A1	1/2012	Baldwin et al.	2012/0311583	A1	12/2012	Gruber et al.
2012/0022860	A1	1/2012	Lloyd et al.	2012/0311584	A1	12/2012	Gruber et al.
2012/0022868	A1	1/2012	LeBeau et al.	2012/0311585	A1	12/2012	Gruber et al.
2012/0022869	A1	1/2012	Lloyd et al.	2012/0317498	A1	12/2012	Logan et al.
2012/0022870	A1	1/2012	Kristjansson et al.	2012/0330660	A1	12/2012	Jaiswal
2012/0022872	A1	1/2012	Gruber et al.	2012/0330661	A1	12/2012	Lindahl
2012/0022874	A1	1/2012	Lloyd et al.	2013/0005405	A1	1/2013	Prociw
2012/0022876	A1	1/2012	LeBeau et al.	2013/0006633	A1	1/2013	Grokop et al.
2012/0023088	A1	1/2012	Cheng et al.	2013/0006638	A1	1/2013	Lindahl
2012/0034904	A1	2/2012	LeBeau et al.	2013/0007648	A1	1/2013	Gamon et al.
2012/0035907	A1	2/2012	Lebeau et al.	2013/0041968	A1	2/2013	Cohen et al.
2012/0035908	A1	2/2012	Lebeau et al.	2013/0054706	A1	2/2013	Graham et al.
2012/0035924	A1	2/2012	Jitkoff et al.	2013/0055099	A1	2/2013	Yao et al.
2012/0035925	A1	2/2012	Friend et al.	2013/0073286	A1	3/2013	Bastea-Forte et al.
2012/0035931	A1	2/2012	LeBeau et al.	2013/0080167	A1	3/2013	Mozer
2012/0035932	A1	2/2012	Jitkoff et al.	2013/0080177	A1	3/2013	Chen
2012/0036556	A1	2/2012	LeBeau et al.	2013/0085761	A1	4/2013	Bringert et al.
2012/0042343	A1	2/2012	Laligand et al.	2013/0091090	A1	4/2013	Spivack et al.
2012/0053815	A1	3/2012	Montanari et al.	2013/0097566	A1	4/2013	Berglund
2012/0053945	A1	3/2012	Gupta et al.	2013/0110505	A1	5/2013	Gruber et al.
2012/0056815	A1	3/2012	Mehra	2013/0110515	A1	5/2013	Guzzoni et al.
2012/0078627	A1	3/2012	Wagner	2013/0110518	A1	5/2013	Gruber et al.
2012/0082317	A1	4/2012	Pance et al.	2013/0110519	A1	5/2013	Cheyer et al.
2012/0084086	A1	4/2012	Gilbert et al.	2013/0110520	A1	5/2013	Cheyer et al.
2012/0108221	A1	5/2012	Thomas et al.	2013/0111348	A1	5/2013	Gruber et al.
2012/0116770	A1	5/2012	Chen et al.	2013/0111487	A1	5/2013	Cheyer et al.
2012/0124126	A1	5/2012	Alcazar et al.	2013/0111487	A1	5/2013	Cheyer et al.
				2013/0115927	A1	5/2013	Gruber et al.
				2013/0117022	A1	5/2013	Chen et al.
				2013/0144616	A1	6/2013	Bangalore
				2013/0170738	A1	7/2013	Capuozzo et al.
				2013/0185074	A1	7/2013	Gruber et al.

(56)

References Cited

U.S. PATENT DOCUMENTS

2013/0185081 A1 7/2013 Cheyer et al.
 2013/0191117 A1 7/2013 Atti et al.
 2013/0218560 A1 8/2013 Hsiao et al.
 2013/0225128 A1 8/2013 Gomar
 2013/0238647 A1 9/2013 Thompson
 2013/0244615 A1 9/2013 Miller
 2013/0275117 A1 10/2013 Winer
 2013/0275875 A1* 10/2013 Gruber G10L 15/22
 715/728
 2013/0289991 A1 10/2013 Eshwar et al.
 2013/0289994 A1 10/2013 Newman et al.
 2013/0304479 A1 11/2013 Teller et al.
 2013/0304758 A1 11/2013 Gruber et al.
 2013/0325443 A1 12/2013 Begeja et al.
 2013/0325484 A1* 12/2013 Chakladar G10L 15/26
 704/275
 2013/0325979 A1 12/2013 Mansfield et al.
 2013/0346068 A1 12/2013 Solem et al.
 2014/0028735 A1 1/2014 Williams et al.
 2014/0068751 A1 3/2014 Last
 2014/0080428 A1 3/2014 Rhoads et al.
 2014/0086458 A1 3/2014 Rogers et al.
 2014/0098247 A1 4/2014 Rao et al.
 2014/0122086 A1 5/2014 Kapur et al.
 2014/0136195 A1 5/2014 Abdossalami et al.
 2014/0152577 A1 6/2014 Yuen et al.
 2014/0155031 A1 6/2014 Lee et al.
 2014/0195251 A1 7/2014 Zeinstra et al.
 2014/0244258 A1 8/2014 Song et al.
 2014/0274211 A1* 9/2014 Sejnoha H04M 1/72519
 455/563
 2014/0278435 A1 9/2014 Ganong et al.
 2014/0281983 A1* 9/2014 Xian G06F 3/167
 715/716
 2015/0370531 A1* 12/2015 Faaborg G06F 3/167
 704/275
 2016/0189717 A1* 6/2016 Kannan G10L 17/22
 704/275

FOREIGN PATENT DOCUMENTS

CN 1263385 A 8/2000
 CN 1369858 A 9/2002
 CN 1494695 A 5/2004
 CN 1673939 A 9/2005
 CN 1864204 A 11/2006
 CN 1959628 A 5/2007
 CN 1975715 A 6/2007
 CN 1995917 A 7/2007
 CN 101162153 A 4/2008
 CN 101183525 A 5/2008
 CN 101297541 A 10/2008
 CN 101535983 A 9/2009
 CN 101636736 A 1/2010
 CN 101939740 A 1/2011
 DE 3837590 A1 5/1990
 DE 4126902 A1 2/1992
 DE 4334773 A1 4/1994
 DE 4445023 A1 6/1996
 DE 10-2004-029203 A1 12/2005
 DE 19841541 B4 12/2007
 EP 0030390 A1 6/1981
 EP 0057514 A1 8/1982
 EP 0509880 A2 9/1982
 EP 0138061 A1 4/1985
 EP 0140777 A1 5/1985
 EP 0218859 A2 4/1987
 EP 0262938 A1 4/1988
 EP 0138061 B1 6/1988
 EP 0283995 A2 9/1988
 EP 0293259 A2 11/1988
 EP 0299572 A2 1/1989
 EP 0313975 A2 5/1989
 EP 0314908 A2 5/1989

EP 0327408 A2 8/1989
 EP 0389271 A2 9/1990
 EP 0411675 A2 2/1991
 EP 0441089 A2 8/1991
 EP 0464712 A2 1/1992
 EP 0476972 A2 3/1992
 EP 0534410 A2 3/1993
 EP 0558312 A1 9/1993
 EP 0559349 A1 9/1993
 EP 0570660 A1 11/1993
 EP 0575146 A2 12/1993
 EP 0578604 A1 1/1994
 EP 0586996 A2 3/1994
 EP 0609030 A1 8/1994
 EP 0651543 A2 5/1995
 EP 0679005 A1 10/1995
 EP 0795811 A1 9/1997
 EP 0476972 B1 5/1998
 EP 0845894 A2 6/1998
 EP 0863453 A1 9/1998
 EP 0863469 A2 9/1998
 EP 0867860 A2 9/1998
 EP 0869697 A2 10/1998
 EP 0559349 B1 1/1999
 EP 0889626 A1 1/1999
 EP 0917077 A2 5/1999
 EP 0691023 B1 9/1999
 EP 0946032 A2 9/1999
 EP 0981236 A1 2/2000
 EP 0982732 A1 3/2000
 EP 0984430 A2 3/2000
 EP 1001588 A2 5/2000
 EP 1014277 A1 6/2000
 EP 1028425 A2 8/2000
 EP 1028426 A2 8/2000
 EP 1047251 A2 10/2000
 EP 1052566 A1 11/2000
 EP 1076302 A1 2/2001
 EP 1091615 A1 4/2001
 EP 1094406 A2 4/2001
 EP 1107229 A2 6/2001
 EP 1229496 A2 8/2002
 EP 1233600 A2 8/2002
 EP 1245023 A1 10/2002
 EP 1246075 A2 10/2002
 EP 1280326 A1 1/2003
 EP 1291848 A2 3/2003
 EP 1311102 A1 5/2003
 EP 1315084 A1 5/2003
 EP 1315086 A1 5/2003
 EP 1347361 A1 9/2003
 EP 1368961 A2 12/2003
 EP 1379061 A2 1/2004
 EP 1432219 A1 6/2004
 EP 1435620 A1 7/2004
 EP 1480421 A1 11/2004
 EP 1517228 A2 3/2005
 EP 1536612 A1 6/2005
 EP 1566948 A1 8/2005
 EP 1650938 A1 4/2006
 EP 1693829 A1 8/2006
 EP 1739546 A2 1/2007
 EP 1181802 B1 2/2007
 EP 1818786 A1 8/2007
 EP 1892700 A1 2/2008
 EP 1912205 A2 4/2008
 EP 1939860 A1 7/2008
 EP 651543 B1 9/2008
 EP 1909263 B1 1/2009
 EP 1335620 B1 3/2009
 EP 2069895 A1 6/2009
 EP 2094032 A1 8/2009
 EP 2109295 A1 10/2009
 EP 1720375 B1 7/2010
 EP 2205010 A1 7/2010
 EP 2309491 A1 4/2011
 EP 2400373 A1 12/2011
 EP 2431842 A2 3/2012
 EP 2551784 A1 1/2013

(56)

References Cited

FOREIGN PATENT DOCUMENTS

EP	2575128	A2	4/2013	JP	2004-86356	A	3/2004
EP	2733598	A2	5/2014	JP	2004-152063	A	5/2004
GB	2293667	A	4/1996	JP	2005-070645	A	3/2005
GB	2310559	A	8/1997	JP	2005-86624	A	3/2005
GB	2342802	A	4/2000	JP	2005-506602	A	3/2005
GB	2343285	A	5/2000	JP	2005-92441	A	4/2005
GB	2346500	A	8/2000	JP	2005-149481	A	6/2005
GB	2352377	A	1/2001	JP	2005-181386	A	7/2005
GB	2384399	A	7/2003	JP	2005-189454	A	7/2005
GB	2402855	A	12/2004	JP	2005-221678	A	8/2005
GB	2445436	A	7/2008	JP	2005-283843	A	10/2005
IT	FI20010199	A1	4/2003	JP	2005-311864	A	11/2005
JP	55-80084	A	6/1980	JP	2005-332212	A	12/2005
JP	57-41731	A	3/1982	JP	2006-023860	A	1/2006
JP	59-57336	A	4/1984	JP	2006-031092	A	2/2006
JP	62-153326	A	7/1987	JP	2006-080617	A	3/2006
JP	1-254742	A	10/1989	JP	2006-107438	A	4/2006
JP	2-86397	A	3/1990	JP	2006-146008	A	6/2006
JP	2-153415	A	6/1990	JP	2006-195637	A	7/2006
JP	3-113578	A	5/1991	JP	2007-4633	A	1/2007
JP	4-236624	A	8/1992	JP	2007-053796	A	3/2007
JP	5-79951	A	3/1993	JP	2007-079690	A	3/2007
JP	5-165459	A	7/1993	JP	2007-193794	A	8/2007
JP	5-293126	A	11/1993	JP	2007-206317	A	8/2007
JP	6-19965	A	1/1994	JP	2007-299352	A	11/2007
JP	6-69954	A	3/1994	JP	2008-26381	A	2/2008
JP	6-274586	A	9/1994	JP	2008-39928	A	2/2008
JP	6-332617	A	12/1994	JP	2008-90545	A	4/2008
JP	7-199379	A	8/1995	JP	2008-97003	A	4/2008
JP	7-320051	A	12/1995	JP	2008-134949	A	6/2008
JP	7-320079	A	12/1995	JP	2008-526101	A	7/2008
JP	8-63330	A	3/1996	JP	2008-198022	A	8/2008
JP	8-185265	A	7/1996	JP	2008-217468	A	9/2008
JP	08-223281	A	8/1996	JP	2008-233678	A	10/2008
JP	8-227341	A	9/1996	JP	2008-236448	A	10/2008
JP	9-18585	A	1/1997	JP	2008-271481	A	11/2008
JP	9-55792	A	2/1997	JP	2009-503623	A	1/2009
JP	9-259063	A	10/1997	JP	2009-036999	A	2/2009
JP	9-265457	A	10/1997	JP	2009-47920	A	3/2009
JP	10-31497	A	2/1998	JP	2009-98490	A	5/2009
JP	10-105324	A	4/1998	JP	2009-186989	A	8/2009
JP	11-6743	A	1/1999	JP	2009-205367	A	9/2009
JP	11-45241	A	2/1999	JP	2009-294913	A	12/2009
JP	11-265400	A	9/1999	JP	2009-294946	A	12/2009
JP	2000-90119	A	3/2000	JP	2010-78979	A	4/2010
JP	2000-99225	A	4/2000	JP	2010-518526	A	5/2010
JP	2000-134407	A	5/2000	JP	2010-157207	A	7/2010
JP	2000-163031	A	6/2000	JP	2010-535377	A	11/2010
JP	2000-207167	A	7/2000	JP	2010-287063	A	12/2010
JP	2000-224663	A	8/2000	JP	2011-041026	A	2/2011
JP	2000-272349	A	10/2000	JP	2011-059659	A	3/2011
JP	2000-331004	A	11/2000	JP	2013-511214	A	3/2013
JP	2000-339137	A	12/2000	JP	2013-517566	A	5/2013
JP	2001-034290	A	2/2001	KR	10-1999-0073234	A	10/1999
JP	2001-56233	A	2/2001	KR	11-2002-0013984	A	2/2002
JP	2001-125896	A	5/2001	KR	10-2002-0057262	A	7/2002
JP	2001-148899	A	5/2001	KR	10-2002-0064149	A	8/2002
JP	2002-14954	A	1/2002	KR	10-2002-0069952	A	9/2002
JP	2002-024212	A	1/2002	KR	10-2003-0016993	A	3/2003
JP	2002-041624	A	2/2002	KR	10-2004-0044632	A	5/2004
JP	2002-082748	A	3/2002	KR	10-2005-0083561	A	8/2005
JP	2002-82893	A	3/2002	KR	10-2005-0090568	A	9/2005
JP	2002-342033	A	11/2002	KR	10-2006-0011603	A	2/2006
JP	2002-344880	A	11/2002	KR	10-2006-0012730	A	2/2006
JP	2002-542501	A	12/2002	KR	10-2006-0073574	A	6/2006
JP	2003-44091	A	2/2003	KR	10-2006-0091469	A	8/2006
JP	2003-84877	A	3/2003	KR	10-2007-0024262	A	3/2007
JP	2003-517158	A	5/2003	KR	10-2007-0071675	A	7/2007
JP	2003-233568	A	8/2003	KR	10-0757496	B1	9/2007
JP	2003-244317	A	8/2003	KR	10-2007-0100837	A	10/2007
JP	2003-288356	A	10/2003	KR	10-0776800	B1	11/2007
JP	2004-48804	A	2/2004	KR	10-0801227	B1	2/2008
JP	2004-054080	A	2/2004	KR	10-0810500	B1	3/2008
JP	2004-505322	A	2/2004	KR	10-2008-0049647	A	6/2008
JP	2004-505525	A	2/2004	KR	10-2008-0109322	A	12/2008
				KR	10-2009-0001716	A	1/2009
				KR	10-2009-0086805	A	8/2009
				KR	10-0920267	B1	10/2009
				KR	10-2009-0122944	A	12/2009

(56)

References Cited

FOREIGN PATENT DOCUMENTS

KR	10-2010-0119519	A	11/2010	WO	2005/031737	A1	4/2005
KR	10-1032792	B1	5/2011	WO	2005/034085	A1	4/2005
KR	10-2011-0113414	A	10/2011	WO	2005/041455	A1	5/2005
KR	10-1193668	B1	12/2012	WO	2005/059895	A1	6/2005
NL	1014847	C1	10/2001	WO	2005/069171	A1	7/2005
RU	2273106	C2	3/2006	WO	2005/101176	A2	10/2005
RU	2349970	C2	3/2009	WO	2006/020305	A2	2/2006
RU	2353068	C2	4/2009	WO	2006/037545	A2	4/2006
TW	200643744	A	12/2006	WO	2006/054724	A1	5/2006
TW	200801988	A	1/2008	WO	2006/056822	A1	6/2006
TW	201227715	A	7/2012	WO	2006/078246	A1	7/2006
WO	93/20640	A1	10/1993	WO	2006/6084144	A2	8/2006
WO	94/16434	A1	7/1994	WO	2006/101649	A2	9/2006
WO	94/29788	A1	12/1994	WO	2006/129967	A1	12/2006
WO	95/02221	A1	1/1995	WO	2006/133571	A1	12/2006
WO	95/16950	A1	6/1995	WO	2007/002753	A2	1/2007
WO	95/17746	A1	6/1995	WO	2007/080559	A2	7/2007
WO	97/10586	A1	3/1997	WO	2007/083894	A1	7/2007
WO	97/26612	A1	7/1997	WO	2008/030970	A2	3/2008
WO	97/29614	A1	8/1997	WO	2008/071231	A1	6/2008
WO	97/38488	A1	10/1997	WO	2008/085742	A2	7/2008
WO	97/49044	A1	12/1997	WO	2008/098900	A2	8/2008
WO	98/09270	A1	3/1998	WO	2008/109835	A2	9/2008
WO	98/33111	A1	7/1998	WO	2008/120036	A1	10/2008
WO	98/41956	A1	9/1998	WO	2008/130095	A1	10/2008
WO	99/01834	A1	1/1999	WO	2008/140236	A1	11/2008
WO	99/08238	A1	2/1999	WO	2008/142472	A1	11/2008
WO	99/16181	A1	4/1999	WO	2008/153639	A1	12/2008
WO	99/56227	A1	11/1999	WO	2009/009240	A2	1/2009
WO	00/19697	A1	4/2000	WO	2009/016631	A2	2/2009
WO	00/22820	A1	4/2000	WO	2009/017280	A1	2/2009
WO	00/29964	A1	5/2000	WO	2009/104126	A1	8/2009
WO	00/30070	A2	5/2000	WO	2009/156438	A1	12/2009
WO	00/38041	A1	6/2000	WO	2009/156978	A1	12/2009
WO	00/44173	A1	7/2000	WO	2010/075623	A1	7/2010
WO	00/60435	A2	10/2000	WO	2011/057346	A1	5/2011
WO	00/63766	A1	10/2000	WO	2011/060106	A1	5/2011
WO	00/68936	A1	11/2000	WO	2011/088053	A2	7/2011
WO	01/06489	A1	1/2001	WO	2011/116309	A1	9/2011
WO	01/30046	A2	4/2001	WO	2011/133543	A1	10/2011
WO	01/30047	A2	4/2001	WO	2011/150730	A1	12/2011
WO	01/60435	A3	4/2001	WO	2011/163350	A1	12/2011
WO	01/33569	A1	5/2001	WO	2012/154317	A1	11/2012
WO	01/35391	A1	5/2001	WO	2012/155079	A2	11/2012
WO	01/46946	A1	6/2001	WO	2012/167168	A2	12/2012
WO	01/65413	A1	9/2001	WO	2013/048880	A1	4/2013
WO	01/67753	A1	9/2001	WO	2013/169842	A2	11/2013
WO	2002/010900	A2	2/2002	WO	2014/028797	A1	2/2014
WO	02/25610	A1	3/2002	WO	2014/031505	A1	2/2014
WO	02/31814	A1	4/2002	WO	2014/078965	A1	5/2014
WO	02/37469	A2	5/2002	WO	2014/143959	A2	9/2014
WO	02/071259	A1	9/2002	WO	2014/143959	A2	9/2014
WO	02/073603	A1	9/2002	WO	2015/084659	A1	6/2015
WO	03/003152	A2	1/2003				
WO	03/003765	A1	1/2003				
WO	03/023786	A2	3/2003				
WO	03/041364	A2	5/2003				
WO	03/049494	A1	6/2003				
WO	03/056789	A1	7/2003				
WO	03/067202	A2	8/2003				
WO	03/084196	A1	10/2003				
WO	03/094489	A1	11/2003				
WO	2004/008801	A1	1/2004				
WO	2004/025938	A1	3/2004				
WO	2004/047415	A1	6/2004				
WO	2004/055637	A2	7/2004				
WO	2004/057486	A1	7/2004				
WO	2004/061850	A1	7/2004				
WO	2004/084413	A2	9/2004				
WO	2005/003920	A2	1/2005				
WO	2005/008505	A1	1/2005				
WO	2005/008899	A1	1/2005				
WO	2005/010725	A2	2/2005				
WO	2005/027472	A2	3/2005				
WO	2005/027485	A1	3/2005				

OTHER PUBLICATIONS

“Meet Ivey, Your Wi-Fi Voice Activated Assistant”, available at <<http://www.helloivee.com/>>, retrieved on Feb. 10, 2014, 8 pages.
 “Speaker Recognition”, Wikipedia, The Free Encyclopedia, Nov. 2, 2010, 4 pages.

International Preliminary Report on Patentability received for PCT Patent Application No. PCT/US2012/029810, mailed on Oct. 3, 2013, 9 pages.

International Search Report and Written Opinion received for PCT Patent Application No. PCT/US2012/029810, mailed on Aug. 17, 2012, 11 pages.

Extended European Search Report and Search Opinion received for European Patent Application No. 12185276.8, mailed on Dec. 18, 2012, 4 pages.

Extended European Search Report received for European Patent Application No. 12186663.6, mailed on Jul. 16, 2013, 6 pages.

Apple Computer, “Knowledge Navigator”, published by Apple Computer no later than 2008, as depicted in Exemplary Screenshots from video entitled ‘Knowledge Navigator’, 2008, 7 pages.

Applebaum et al., “Enhancing the Discrimination of Speaker Independent Hidden Markov Models with Corrective Training”, International Conference on Acoustics, Speech, and Signal Processing, May 23, 1989, pp. 302-305.

(56)

References Cited

OTHER PUBLICATIONS

- Bellegarda, Jerome R. "Latent Semantic Mapping", IEEE Signal Processing Magazine, vol. 22, No. 5, Sep. 2005, pp. 70-80.
- Bellegarda et al., "Tied Mixture Continuous Parameter Modeling for Speech Recognition", IEEE Transactions on Acoustics, Speech and Signal Processing, vol. 38, No. 12, Dec. 1990, pp. 2033-2045.
- Chang et al., "Discriminative Training of Dynamic Programming based Speech Recognizers", IEEE Transactions on Speech and Audio Processing, vol. 1, No. 2, Apr. 1993, pp. 135-143.
- Cheyser et al., "Demonstration Video of Multimodal Maps Using an Agent Architecture", published by SRI International no later than 1996, as depicted in Exemplary Screenshots from video entitled Demonstration Video of Multimodal Maps Using an Agent Architecture, 1996, 6 pages.
- Cheyser et al., "Demonstration Video of Multimodal Maps Using an Open-Agent Architecture", published by SRI International no later than 1996, as depicted in Exemplary Screenshots from video entitled Demonstration Video of Multimodal Maps Using an Open-Agent Architecture, 6 pages.
- Cheyser, A., "Demonstration Video of Vanguard Mobile Portal", published by SRI International no later than 2004, as depicted in Exemplary Screenshots from video entitled Demonstration Video of Vanguard Mobile Portal, 2004, 10 pages.
- Choi et al., "Acoustic and Visual Signal based Context Awareness System for Mobile Application", IEEE Transactions on Consumer Electronics, vol. 57, No. 2, May 2011, pp. 738-746.
- Kickstarter, "Ivee Sleek: Wi-Fi Voice-Activated Assistant", available at <<https://www.kickstarter.com/projects/ivee/ivee-sleek-wi-fi-voice-activated-assistant>>, retrieved on Feb. 10, 2014, 13 pages.
- Navigli, Roberto, "Word Sense Disambiguation: A Survey", ACM Computing Surveys, vol. 41, No. 2, Feb. 2009, 70 pages.
- International Search Report and Written Opinion received for PCT Patent Application No. PCT/US2014/015418, mailed on Aug. 26, 2014, 17 pages.
- Guim, Mark, "How to Set a Person-Based Reminder with Cortana", available at <<http://www.wpcentral.com/how-to-person-based-reminder-cortana>>, Apr. 26, 2014, 15 pages.
- Miller, Chance, "Google Keyboard Updated with New Personalized Suggestions Feature", available at <<http://9to5google.com/2014/03/19/google-keyboard-updated-with-new-personalized-suggestions-feature/>>, Mar. 19, 2014, 4 pages.
- Roddy et al., "Interface Issues in Text Based Chat Rooms", SIGCHI Bulletin, vol. 30, No. 2, Apr. 1998, pp. 119-123.
- Viegas et al., "Chat Circles", SIGCHI Conference on Human Factors in Computing Systems, May 15-20, 1999, pp. 9-16.
- Davis et al., "A Personal Handheld Multi-Modal Shopping Assistant", International Conference on Networking and Services, IEEE, 2006, 9 pages.
- SRI, "SRI Speech: Products: Software Development Kits: EduSpeak", available at <<http://web.archive.org/web/20090828084033/http://www.speechsri.com/products/eduspeak.shtml>>, retrieved on Jun. 20, 2013, 2 pages.
- "Mel Scale", Wikipedia the Free Encyclopedia, Last modified on Oct. 13, 2009 and retrieved on Jul. 28, 2010, available at <http://en.wikipedia.org/wiki/Mel_scale>, 2 pages.
- "Minimum Phase", Wikipedia the free Encyclopedia, Last modified on Jan. 12, 2010 and retrieved on Jul. 28, 2010, available at <http://en.wikipedia.org/wiki/Minimum_phase>, 8 pages.
- Acero et al., "Environmental Robustness in Automatic Speech Recognition", International Conference on Acoustics, Speech and Signal Processing (ICASSP'90), Apr. 1990, 4 pages.
- Acero et al., "Robust Speech Recognition by Normalization of the Acoustic Space", International Conference on Acoustics, Speech and Signal Processing, 1991, 4 pages.
- Agnas et al., "Spoken Language Translator: First-Year Report", SICS (ISSN 0283-3638), SRI and Telia Research AB, Jan. 1994, 161 pages.
- Ahlbom et al., Modeling Spectral Speech Transitions Using Temporal Decomposition Techniques, IEEE International Conference of Acoustics, Speech and Signaling Processing (ICASSP'87), vol. 12, Apr. 1987, 4 pages.
- Alfred App, "Alfred", available at <<http://www.alfredapp.com/>>, retrieved on Feb. 8, 2012, 5 pages.
- Allen, J., "Natural Language Understanding", 2nd Edition, The Benjamin/Cummings Publishing Company, Inc., 1995, 671 pages.
- Alshawi et al., "CLARE: A Contextual Reasoning and Co-operative Response Framework for the Core Language Engine", SRI International, Cambridge Computer Science Research Centre, Cambridge, Dec. 1992, 273 pages.
- Alshawi et al., "Declarative Derivation of Database Queries from Meaning Representations", Proceedings of the BANKAI Workshop on Intelligent Information Access, Oct. 1991, 12 pages.
- Alshawi et al., "Logical Forms in the Core Language Engine", Proceedings of the 27th Annual Meeting of the Association for Computational Linguistics, 1989, pp. 25-32.
- Alshawi et al., "Overview of the Core Language Engine", Proceedings of Future Generation Computing Systems, Tokyo, 13 pages.
- Alshawi, H., "Translation and Monotonic Interpretation/Generation", SRI International, Cambridge Computer Science Research Centre, Cambridge, available at <<http://www.cam.sri.com/tr/crc024/paper.ps.Z1992>>, Jul. 1992, 18 pages.
- Ambite et al., "Design and Implementation of the CALO Query Manager", American Association for Artificial Intelligence, 2006, 8 pages.
- Ambite et al., "Integration of Heterogeneous Knowledge Sources in the CALO Query Manager", The 4th International Conference on Ontologies, Databases and Applications of Semantics (ODBASE), 2005, 18 pages.
- Anastasakos et al., "Duration Modeling in Large Vocabulary Speech Recognition", International Conference on Acoustics, Speech and Signal Processing (ICASSP'95), May 1995, pp. 628-631.
- Anderson et al., "Syntax-Directed Recognition of Hand-Printed Two-Dimensional Mathematics", Proceedings of Symposium on Interactive Systems for Experimental Applied Mathematics: Proceedings of the Association for Computing Machinery Inc. Symposium, 1967, 12 pages.
- Ansari et al., "Pitch Modification of Speech using a Low-Sensitivity Inverse Filter Approach", IEEE Signal Processing Letters, vol. 5, No. 3, Mar. 1998, pp. 60-62.
- Anthony et al., "Supervised Adaption for Signature Verification System", IBM Technical Disclosure, Jun. 1, 1978, 3 pages.
- Appelt et al., "Fastus: A Finite-State Processor for Information Extraction from Real-world Text", Proceedings of IJCAI, 1993, 8 pages.
- Appelt et al., "SRI International Fastus System MUC-6 Test Results and Analysis", SRI International, Menlo Park, California, 1995, 12 pages.
- Apple Computer, "Guide Maker User's Guide", Apple Computer, Inc., Apr. 27, 1994, 8 pages.
- Apple Computer, "Introduction to Apple Guide", Apple Computer, Inc., Apr. 28, 1994, 20 pages.
- Archbold et al., "A Team User's Guide", SRI International, Dec. 21, 1981, 70 pages.
- Asanovic et al., "Experimental Determination of Precision Requirements for Back-Propagation Training of Artificial Neural Networks", Proceedings of the 2nd International Conference of Microelectronics for Neural Networks, 1991, www.ICSI.Berkeley.EDU, 1991, 7 pages.
- Atal et al., "Efficient Coding of LPC Parameters by Temporal Decomposition", IEEE International Conference on Acoustics, Speech and Signal Processing (ICASSP'83), Apr. 1983, 4 pages.
- Bahl et al., "A Maximum Likelihood Approach to Continuous Speech Recognition", IEEE Transaction on Pattern Analysis and Machine Intelligence, vol. PAMI-5, No. 2, Mar. 1983, 13 pages.
- Bahl et al., "A Tree-Based Statistical Language Model for Natural Language Speech Recognition", IEEE Transactions on Acoustics, Speech and Signal Processing, vol. 37, No. 7, Jul. 1989, 8 pages.

(56)

References Cited

OTHER PUBLICATIONS

- Bahl et al., "Acoustic Markov Models Used in the Tangora Speech Recognition System", Proceeding of International Conference on Acoustics, Speech and Signal Processing (ICASSP'88), vol. 1, Apr. 1988, 4 pages.
- Bahl et al., "Large Vocabulary Natural Language Continuous Speech Recognition", Proceedings of 1989 International Conference on Acoustics, Speech and Signal Processing, vol. 1, May 1989, 6 pages.
- Bahl et al., "Multitonic Markov Word Models for Large Vocabulary Continuous Speech Recognition", IEEE Transactions on Speech and Audio Processing, vol. 1, No. 3, Jul. 1993, 11 pages.
- Bahl et al., "Speech Recognition with Continuous-Parameter Hidden Markov Models", Proceeding of International Conference on Acoustics, Speech and Signal Processing (ICASSP'88), vol. 1, Apr. 1988, 8 pages.
- Banbrook, M., "Nonlinear Analysis of Speech from a Synthesis Perspective", A Thesis Submitted for the Degree of Doctor of Philosophy, The University of Edinburgh, Oct. 15, 1996, 35 pages.
- Bear et al., "A System for Labeling Self-Repairs in Speech", SRI International, Feb. 22, 1993, 9 pages.
- Bear et al., "Detection and Correction of Repairs in Human-Computer Dialog", SRI International, May 1992, 11 pages.
- Bear et al., "Integrating Multiple Knowledge Sources for Detection and Correction of Repairs in Human-Computer Dialog", Proceedings of the 30th Annual Meeting on Association for Computational Linguistics (ACL), 1992, 8 pages.
- Bear et al., "Using Information Extraction to Improve Document Retrieval", SRI International, Menlo Park, California, 1998, 11 pages.
- Belaïd et al., "A Syntactic Approach for Handwritten Mathematical Formula Recognition", IEEE Transactions on Pattern Analysis and Machine Intelligence, vol. PAMI-6, No. 1, Jan. 1984, 7 pages.
- Bellegarda et al., "A Latent Semantic Analysis Framework for Large-Span Language Modeling", 5th European Conference on Speech, Communication and Technology (EUROSPEECH'97), Sep. 1997, 4 pages.
- Bellegarda et al., "A Multispan Language Modeling Framework for Large Vocabulary Speech Recognition", IEEE Transactions on Speech and Audio Processing, vol. 6, No. 5, Sep. 1998, 12 pages.
- Bellegarda et al., "A Novel Word Clustering Algorithm Based on Latent Semantic Analysis", Proceedings of the IEEE International Conference on Acoustics, Speech and Signal Processing (ICASSP'96), vol. 1, 1996, 4 pages.
- Bellegarda et al., "Experiments Using Data Augmentation for Speaker Adaptation", International Conference on Acoustics, Speech and Signal Processing (ICASSP'95), May 1995, 4 pages.
- Bellegarda, Jerome R., "Exploiting Latent Semantic Information in Statistical Language Modeling", Proceedings of the IEEE, vol. 88, No. 8, Aug. 2000, 18 pages.
- Bellegarda, Jerome R., "Interaction-Driven Speech Input-A Data-Driven Approach to the Capture of both Local and Global Language Constraints", available at <<http://old.sig.chi.ora/bulletin/1998.2/bellegarda.html>>, 1992, 7 pages.
- Bellegarda, Jerome R., "Large Vocabulary Speech Recognition with Multispan Statistical Language Models", IEEE Transactions on Speech and Audio Processing, vol. 8, No. 1, Jan. 2000, 9 pages.
- Bellegarda et al., "On-Line Handwriting Recognition using Statistical Mixtures", Advances in Handwriting and Drawings: A Multidisciplinary Approach, Europia, 6th International IGS Conference on Handwriting and Drawing, Paris, France, Jul. 1993, 11 pages.
- Appelt et al., "SRI: Description of the JV-FASTUS System used for MUC-5", SRI International, Artificial Intelligence Center, 1993, 19 pages.
- Bellegarda, Jerome R., "Exploiting both Local and Global Constraints for Multi-Span Statistical Language Modeling", Proceeding of the 1998 IEEE International Conference on Acoustics, Speech and Signal Processing (ICASSP'98), vol. 2, May 1998, 5 pages.
- "Top 10 Best Practices for Voice User Interface Design" available at <<http://www.developer.com/voice/article.php/1567051/Top-10-Best-Practices-for-Voice-UserInterface-Design.html>>, Nov. 1, 2002, 4 pages.
- Combined Search Report and Examination Report under Sections 17 and 18(3) received for GB Patent Application No. 1009318.5, mailed on Oct. 8, 2010, 5 pages.
- Combined Search Report and Examination Report under Sections 17 and 18(3) received for GB Patent Application No. 1217449.6, mailed on Jan. 17, 2013, 6 pages.
- Aikawa et al., "Speech Recognition Using Time-Warping Neural Networks", Proceedings of the 1991, IEEE Workshop on Neural Networks for Signal Processing, 1991, 10 pages.
- Bellegarda et al., "Performance of the IBM Large Vocabulary Continuous Speech Recognition System on the ARPA Wall Street Journal Task", Signal Processing VII: Theories and Applications, European Association for Signal Processing, 1994, 4 pages.
- Bellegarda et al., "The Metamorphic Algorithm: A Speaker Mapping Approach to Data Augmentation", IEEE Transactions on Speech and Audio Processing, vol. 2, No. 3, Jul. 1994, 8 pages.
- Belvin et al., "Development of the HRL Route Navigation Dialogue System", Proceedings of the First International Conference on Human Language Technology Research, Paper, 2001, 5 pages.
- Berry et al., "PTIME: Personalized Assistance for Calendaring", ACM Transactions on Intelligent Systems and Technology, vol. 2, No. 4, Article 40, Jul. 2011, pp. 1-22.
- Berry et al., "Task Management under Change and Uncertainty Constraint Solving Experience with the CALO Project", Proceedings of CP'05 Workshop on Constraint Solving under Change, 2005, 5 pages.
- Black et al., "Automatically Clustering Similar Units for Unit Selection in Speech Synthesis", Proceedings of Eurospeech, vol. 2, 1997, 4 pages.
- Blair et al., "An Evaluation of Retrieval Effectiveness for a Full-Text Document-Retrieval System", Communications of the ACM, vol. 28, No. 3, Mar. 1985, 11 pages.
- Bobrow et al., "Knowledge Representation for Syntactic/Semantic Processing", From: AAA-80 Proceedings, Copyright 1980, AAAI, 1980, 8 pages.
- Bouchou et al., "Using Transducers in Natural Language Database Query", Proceedings of 4th International Conference on Applications of Natural Language to Information Systems, Austria, Jun. 1999, 17 pages.
- Bratt et al., "The SRI Telephone-Based ATIS System", Proceedings of ARPA Workshop on Spoken Language Technology, 1995, 3 pages.
- Briner, L. L., "Identifying Keywords in Text Data Processing", In Zelkowitz, Marvin V., ED, Directions and Challenges, 15th Annual Technical Symposium, Gaithersbury, Maryland, Jun. 17, 1976, 7 pages.
- Bulyko et al., "Error-Correction Detection and Response Generation in a Spoken Dialogue System", Speech Communication, vol. 45, 2005, pp. 271-288.
- Bulyko et al., "Joint Prosody Prediction and Unit Selection for Concatenative Speech Synthesis", Electrical Engineering Department, University of Washington, Seattle, 2001, 4 pages.
- Burke et al., "Question Answering from Frequently Asked Question Files", AI Magazine, vol. 18, No. 2, 1997, 10 pages.
- Burns et al., "Development of a Web-Based Intelligent Agent for the Fashion Selection and Purchasing Process via Electronic Commerce", Proceedings of the Americas Conference on Information System (AMCIS), Dec. 31, 1998, 4 pages.
- Bussey, et al., "Service Architecture, Prototype Description and Network Implications of a Personalized Information Grazing Service", INFOCOM'90, Ninth Annual Joint Conference of the IEEE Computer and Communication Societies, Available at <<http://slohall.com/ublications/>>, Jun. 1990, 8 pages.
- Bussler et al., "Web Service Execution Environment (WSMX)", retrieved from Internet on Sep. 17, 2012, available at <<http://www.w3.org/Submission/WSMX/>>, Jun. 3, 2005, 29 pages.
- Butcher, Mike, "EVI Arrives in Town to go Toe-to-Toe with Siri", TechCrunch, Jan. 23, 2012, 2 pages.

(56)

References Cited

OTHER PUBLICATIONS

- Buzo et al., "Speech Coding Based Upon Vector Quantization", IEEE Transactions on Acoustics, Speech and Signal Processing, vol. Assp-28, No. 5, Oct. 1980, 13 pages.
- Caminero-Gil et al., "Data-Driven Discourse Modeling for Semantic Interpretation", Proceedings of the IEEE International Conference on Acoustics, Speech and Signal Processing, May 1996, 6 pages.
- Car Working Group, "Hands-Free Profile 1.5 HF1.5_SPEC", Bluetooth Doc, available at <www.bluetooth.org>, Nov. 25, 2005, 93 pages.
- Carter, D., "Lexical Acquisition in the Core Language Engine", Proceedings of the Fourth Conference of the European Chapter of the Association for Computational Linguistics, 1989, 8 pages.
- Carter et al., "The Speech-Language Interface in the Spoken Language Translator", SRI International, Nov. 23, 1994, 9 pages.
- Cawley, Gavin C. "The Application of Neural Networks to Phonetic Modelling", PhD. Thesis, University of Essex, Mar. 1996, 13 pages.
- Chai et al., "Comparative Evaluation of a Natural Language Dialog Based System and a Menu Driven System for Information Access: A Case Study", Proceedings of the International Conference on Multimedia Information Retrieval (RIAO), Paris, Apr. 2000, 11 pages.
- Chang et al., "A Segment-Based Speech Recognition System for Isolated Mandarin Syllables", Proceedings TEN CON '93, IEEE Region 10 Conference on Computer, Communication, Control and Power Engineering, vol. 3, Oct. 1993, 6 pages.
- Chen, Yi, "Multimedia Siri Finds and Plays Whatever You Ask for", PSFK Report, Feb. 9, 2012, 9 pages.
- Cheyner, Adam, "A Perspective on AI & Agent Technologies for SCM", VerticalNet Presentation, 2001, 22 pages.
- Cheyner, Adam, "About Adam Cheyner", available at <<http://www.adam.cheyner.com/about.html>>, retrieved on Sep. 17, 2012, 2 pages.
- Cheyner et al., "Multimodal Maps: An Agent-Based Approach", International Conference on Co-operative Multimodal Communication, 1995, 15 pages.
- Cheyner et al., "Spoken Language and Multimodal Applications for Electronic Realities", Virtual Reality, vol. 3, 1999, pp. 1-15.
- Cheyner et al., "The Open Agent Architecture", Autonomous Agents and Multi-Agent Systems, vol. 4, Mar. 1, 2001, 6 pages.
- Cheyner et al., "The Open Agent Architecture: Building Communities of Distributed Software Agents", Artificial Intelligence Center, SRI International, Power Point Presentation, Available online at <<http://www.ai.sri.com/oaa/>>, retrieved on Feb. 21, 1998, 25 pages.
- Codd, E. F., "Databases: Improving Usability and Responsiveness—How About Recently", Copyright 1978, Academic Press, Inc., 1978, 28 pages.
- Cohen et al., "An Open Agent Architecture", available at <<http://citeseerx.ist.psu.edu/viewdoc/summary?doi=10.1.1.30.480>>, 1994, 8 pages.
- Cohen et al., "Voice User Interface Design.", Excerpts from Chapter 1 and Chapter 10, 2004, 36 pages.
- Coles et al., "Chemistry Question-Answering", SRI International, Jun. 1969, 15 pages.
- Coles et al., "Techniques for Information Retrieval Using an Inferential Question-Answering System with Natural-Language Input", SRI International, Nov. 1972, 198 Pages.
- Coles et al., "The Application of Theorem Proving to Information Retrieval", SRI International, Jan. 1971, 21 pages.
- Conklin, Jeff, "Hypertext: An Introduction and Survey", Computer Magazine, Sep. 1987, 25 pages.
- Connolly et al., "Fast Algorithms for Complex Matrix Multiplication Using Surrogates", IEEE Transactions on Acoustics, Speech and Signal Processing, vol. 37, No. 6, Jun. 1989, 13 pages.
- Constantinides et al., "A Schema Based Approach to Dialog Control", Proceedings of the International Conference on Spoken Language Processing, 1998, 4 pages.
- Cox et al., "Speech and Language Processing for Next-Millennium Communications Services", Proceedings of the IEEE, vol. 88, No. 8, Aug. 2000, 24 pages.
- Craig et al., "Deacon: Direct English Access and Control", AFIPS Conference Proceedings, vol. 19, San Francisco, Nov. 1966, 18 pages.
- Cutkosky et al., "PACT: An Experiment in Integrating Concurrent Engineering Systems", Journal & Magazines, Computer, vol. 26, No. 1, Jan. 1993, 14 pages.
- Dar et al., "DTL's DataSpot: Database Exploration Using Plain Language", Proceedings of the 24th VLDB Conference, New York, 1998, 5 pages.
- Decker et al., "Designing Behaviors for Information Agents", The Robotics Institute, Carnegie-Mellon University, Paper, Jul. 1996, 15 pages.
- Decker et al., "Matchmaking and Brokering", The Robotics Institute, Carnegie-Mellon University, Paper, May 1996, 19 pages.
- Deerwester et al., "Indexing by Latent Semantic Analysis", Journal of the American Society for Information Science, vol. 41, No. 6, Sep. 1990, 19 pages.
- Deller, Jr. et al., "Discrete-Time Processing of Speech Signals", Prentice Hall, ISBN: 0-02-328301-7, 1987, 14 pages.
- Digital Equipment Corporation, "Open VMS Software Overview", Software Manual, Dec. 1995, 159 pages.
- Domingue et al., "Web Service Modeling Ontology (WSMO)-An Ontology for Semantic Web Services", Position Paper at the W3C Workshop on Frameworks for Semantics in Web Services, Innsbruck, Austria, Jun. 2005, 6 pages.
- Donovan, R. E., "A New Distance Measure for Costing Spectral Discontinuities in Concatenative Speech Synthesizers", available at <<http://citeseerx.ist.osu.edu/viewdoc/summary?doi=10.1.1.1.21.6398>>, 2001, 4 pages.
- Dowding et al., "Gemini: A Natural Language System for Spoken-Language Understanding", Proceedings of the Thirty-First Annual Meeting of the Association for Computational Linguistics, 1993, 8 pages.
- Dowding et al., "Interleaving Syntax and Semantics in an Efficient Bottom-Up Parser", Proceedings of the 32nd Annual Meeting of the Association for Computational Linguistics, 1994, 7 pages.
- Elio et al., "On Abstract Task Models and Conversation Policies", Proc. Workshop on Specifying and Implementing Conversation Policies, Autonomous Agents'99 Conference, 1999, pp. 1-10.
- Epstein et al., "Natural Language Access to a Melanoma Data Base", SRI International, Sep. 1978, 7 pages.
- Ericsson et al., "Software Illustrating a Unified Approach to Multimodality and Multilinguality in the In-Home Domain", Talk and Look: Tools for Ambient Linguistic Knowledge, Dec. 2006, 127 pages.
- Evi, "Meet Evi: The One Mobile Application that Provides Solutions for your Everyday Problems", Feb. 2012, 3 pages.
- Exhibit 1, "Natural Language Interface Using Constrained Intermediate Dictionary of Results", List of Publications Manually Reviewed for the Search of U.S. Pat. No. 7,177,798, Mar. 22, 2013, 1 page.
- Feigenbaum et al., "Computer-Assisted Semantic Annotation of Scientific Life Works", Oct. 15, 2007, 22 pages.
- Ferguson et al., "TRIPS: An Integrated Intelligent Problem-Solving Assistant", Proceedings of the Fifteenth National Conference on Artificial Intelligence (AAAI-98) and Tenth Conference on Innovative Applications of Artificial Intelligence (IAAI-98), 1998, 7 pages.
- Fikes et al., "A Network-Based Knowledge Representation and its Natural Deduction System", SRI International, Jul. 1977, 43 pages.
- Frisse, M. E., "Searching for Information in a Hypertext Medical Handbook", Communications of the ACM, vol. 31, No. 7, Jul. 1988, 8 pages.
- Gamback et al., "The Swedish Core Language Engine", NOTEX Conference, 1992, 17 pages.
- Gannes, Liz, "Alfred App Gives Personalized Restaurant Recommendations", AllThingsD, Jul. 18, 2011, pp. 1-3.
- Gautier et al., "Generating Explanations of Device Behavior Using Compositional Modeling and Causal Ordering", CiteSeerx, 1993, pp. 89-97.

(56)

References Cited

OTHER PUBLICATIONS

- Gervasio et al., "Active Preference Learning for Personalized Calendar Scheduling Assistance", CiteSeerx, Proceedings of IUI'05, Jan. 2005, pp. 90-97.
- Glass, Alyssa, "Explaining Preference Learning", CiteSeerx, 2006, pp. 1-5.
- Glass et al., "Multilingual Language Generation Across Multiple Domains", International Conference on Spoken Language Processing, Japan, Sep. 1994, 5 pages.
- Glass et al., "Multilingual Spoken-Language Understanding in the Mit Voyager System", Available online at <<http://groups.csail.mit.edu/sls/publications/1995/speechcomm95-voyager.pdf>>, Aug. 1995, 29 pages.
- Goddeau et al., "A Form-Based Dialogue Manager for Spoken Language Applications", Available online at <<http://phasedance.com/pdf/icslp96.pdf>>, Oct. 1996, 4 pages.
- Goddeau et al., "Galaxy: A Human-Language Interface to On-Line Travel Information", International Conference on Spoken Language Processing, Yokohama, 1994, pp. 707-710.
- Goldberg et al., "Using Collaborative Filtering to Weave an Information Tapestry", Communications of the ACM, vol. 35, No. 12, Dec. 1992, 10 pages.
- Gong et al., "Guidelines for Handheld Mobile Device Interface Design", Proceedings of DSI 2004 Annual Meeting, 2004, pp. 3751-3756.
- Gorin et al., "On Adaptive Acquisition of Language", International Conference on Acoustics, Speech and Signal Processing (ICASSP'90), vol. 1, Apr. 1990, 5 pages.
- Gotoh et al., "Document Space Models Using Latent Semantic Analysis", In Proceedings of Eurospeech, 1997, 4 pages.
- Gray, R. M., "Vector Quantization", IEEE ASSP Magazine, Apr. 1984, 26 pages.
- Green, C., "The Application of Theorem Proving to Question-Answering Systems", SRI Stanford Research Institute, Artificial Intelligence Group, Jun. 1969, 169 pages.
- Gregg et al., "DSS Access on the WWW: An Intelligent Agent Prototype", Proceedings of the Americas Conference on Information Systems, Association for Information Systems, 1998, 3 pages.
- Grishman et al., "Computational Linguistics: An Introduction", Cambridge University Press, 1986, 172 pages.
- Grosz et al., "Dialogic: A Core Natural-Language Processing System", SRI International, Nov. 1982, 17 pages.
- Grosz et al., "Research on Natural-Language Processing at SRI", SRI International, Nov. 1981, 21 pages.
- Grosz, B., "Team: A Transportable Natural-Language Interface System", Proceedings of the First Conference on Applied Natural Language Processing, 1983, 7 pages.
- Grosz et al., "TEAM: An Experiment in the Design of Transportable Natural-Language Interfaces", Artificial Intelligence, vol. 32, 1987, 71 pages.
- Gruber, Tom, "(Avoiding) The Travesty of the Commons", Presentation at NPUC, New Paradigms for User Computing, IBM Almaden Research Center, Jul. 24, 2006, 52 pages.
- Gruber, Thomas R., "A Translation Approach to Portable Ontology Specifications", Knowledge Acquisition, vol. 5, No. 2, Jun. 1993, pp. 199-220.
- Gruber et al., "An Ontology for Engineering Mathematics", Fourth International Conference on Principles of Knowledge Representation and Reasoning, Available online at <<http://www-ksl.stanford.edu/knowledge-sharing/papers/engmath.html>>, 1994, pp. 1-22.
- Gruber, Thomas R., "Automated Knowledge Acquisition for Strategic Knowledge", Machine Learning, vol. 4, 1989, pp. 293-336.
- Gruber, Tom, "Big Think Small Screen: How Semantic Computing in the Cloud will Revolutionize the Consumer Experience on the Phone", Keynote Presentation at Web 3.0 Conference, Jan. 2010, 41 pages.
- Gruber et al., "Generative Design Rationale: Beyond the Record and Replay Paradigm", Knowledge Systems Laboratory, Technical Report KSL 92-59, Dec. 1991, Updated Feb. 1993, 24 pages.
- Gruber, Thomas R., "Interactive Acquisition of Justifications: Learning "Why" by Being Told "What"", Knowledge Systems Laboratory, Technical Report KSL 91-17, Original Oct. 1990, Revised Feb. 1991, 24 pages.
- Gruber et al., "Machine-Generated Explanations of Engineering Models: A Compositional Modeling Approach", Proceedings of International Joint Conference on Artificial Intelligence, 1993, 7 pages.
- Gruber et al., "NIKE: A National Infrastructure for Knowledge Exchange", A Whitepaper Advocating and ATP Initiative on Technologies for Lifelong Learning, Oct. 1994, pp. 1-10.
- Gruber et al., "Toward a Knowledge Medium for Collaborative Product Development", Proceedings of the Second International Conference on Artificial Intelligence in Design, Jun. 1992, pp. 1-19.
- Gruber, Thomas R., "Toward Principles for the Design of Ontologies used for Knowledge Sharing", International Journal of Human-Computer Studies, vol. 43, No. 5-6, Nov. 1995, pp. 907-928.
- Gruber, Tom, "2021: Mass Collaboration and the Really New Economy", TINTY Futures, vol. 1, No. 6, Available online at <<http://tomgruber.org/writing/tnty2001.htm>>, Aug. 2001, 5 pages.
- Gruber, Tom, "Collaborating Around Shared Content on the WWW, W3C Workshop on WWW and Collaboration", available at <<http://www.w3.org/Collaboration/Workshop/Proceedings/P9.html>>, Sep. 1995, 1 page.
- Gruber, Tom, "Collective Knowledge Systems: Where the Social Web Meets the Semantic Web", Web Semantics: Science, Services and Agents on the World Wide Web, 2007, pp. 1-19.
- Gruber, Tom, "Despite Our Best Efforts, Ontologies are not the Problem", AAAI Spring Symposium, Available online at <<http://tomgruber.org/writing/aaai-ss08.htm>>, Mar. 2008, pp. 1-40.
- Gruber, Tom, "Enterprise Collaboration Management with Intraspect", Intraspect Technical White Paper, Jul. 2001, pp. 1-24.
- Gruber, Tom, "Every Ontology is a Treaty-A Social Agreement-Among People with Some Common Motive in Sharing", Official Quarterly Bulletin of AIS Special Interest Group on Semantic Web and Information Systems, vol. 1, No. 3, 2004, pp. 1-5.
- Gruber, Tom, "Helping Organizations Collaborate, Communicate, and Learn", Presentation to NASA Ames Research, Available online at <<http://tomgruber.org/writing/organizational-intelligence-talk.htm>>, Mar.-Oct. 2003, 30 pages.
- Gruber, Tom, "Intelligence at the Interface: Semantic Technology and the Consumer Internet Experience", Presentation at Semantic Technologies Conference, Available online at <<http://tomgruber.org/writing/semtech08.htm>>, May 20, 2008, pp. 1-40.
- Gruber, Tom, "It Is What It Does: The Pragmatics of Ontology for Knowledge Sharing", Proceedings of the International CIDOC CRM Symposium, Available online at <<http://tomgruber.org/writing/cidoc-ontology.htm>>, Mar. 26, 2003, 21 pages.
- Gruber, Tom, "Ontologies, Web 2.0 and Beyond", Ontology Summit, Available online at <<http://tomgruber.org/writing/ontology-social-web-keynote.htm>>, Apr. 2007, 17 pages.
- Gruber, Tom, "Ontology of Folksonomy: A Mash-Up of Apples and Oranges", Int'l Journal on Semantic Web & Information Systems, vol. 3, No. 2, 2007, 7 pages.
- Gruber, Tom, "Siri, A Virtual Personal Assistant-Bringing Intelligence to the Interface", Semantic Technologies Conference, Jun. 16, 2009, 21 pages.
- Gruber, Tom, "TagOntology", Presentation to Tag Camp, Oct. 29, 2005, 20 pages.
- Gruber, Tom, "Where the Social Web Meets the Semantic Web", Presentation at the 5th International Semantic Web Conference, Nov. 2006, 38 pages.
- Guida et al., "NLI: A Robust Interface for Natural Language Person-Machine Communication", International Journal of Man-Machine Studies, vol. 17, 1982, 17 pages.
- Guzzoni et al., "A Unified Platform for Building Intelligent Web Interaction Assistants", Proceedings of the 2006 IEEE/WIC/ACM International Conference on Web Intelligence and Intelligent Agent Technology, Computer Society, 2006, 4 pages.
- Guzzoni et al., "Active, A Platform for Building Intelligent Operating Rooms", Surgetica 2007 Computer-Aided Medical Interventions: Tools and Applications, 2007, pp. 191-198.

(56)

References Cited

OTHER PUBLICATIONS

- Guzzoni et al., "Active, A platform for Building Intelligent Software", Computational Intelligence, available at <<http://www.informatik.uni-trier.de/~ley/pers/hd/g/Guzzoni:Didier>>, 2006, 5 pages.
- Guzzoni et al., "Active, A Tool for Building Intelligent User Interfaces", ASC 2007, Palma de Mallorca, Aug. 2007, 6 pages.
- Guzzoni, D., "Active: A Unified Platform for Building Intelligent Assistant Applications", Oct. 25, 2007, 262 pages.
- Guzzoni et al., "Many Robots Make Short Work", AAAI Robot Contest, SRI International, 1996, 9 pages.
- Guzzoni et al., "Modeling Human-Agent Interaction with Active Ontologies", AAAI Spring Symposium, Interaction Challenges for Intelligent Assistants, Stanford University, Palo Alto, California, 2007, 8 pages.
- Haas et al., "An Approach to Acquiring and Applying Knowledge", SRI international, Nov. 1980, 22 pages.
- Hadidi et al., "Students Acceptance of Web-Based Course Offerings: An Empirical Assessment", Proceedings of the Americas Conference on Information Systems(AMCIS), 1998, 4 pages.
- Hardwar, Devindra, "Driving App Waze Builds its own Siri for Hands-Free Voice Control", Available online at <<http://venturebeat.com/2012/02/09/driving-app-waze-builds-its-own-siri-for-hands-free-voice-control/>>, retrieved on Feb. 9, 2012, 4 pages.
- Harris, F. J., "On the Use of Windows for Harmonic Analysis with the Discrete Fourier Transform", In Proceedings of the IEEE, vol. 66, No. 1, Jan. 1978, 34 pages.
- Hawkins et al., "Hierarchical Temporal Memory: Concepts, Theory and Terminology", Numenta, Inc., Mar. 27, 2007, 20 pages.
- He et al., "Personal Security Agent: KQML-Based PKI", The Robotics Institute, Carnegie-Mellon University, Paper, 1997, 14 pages.
- Helm et al., "Building Visual Language Parsers", Proceedings of CHI'91, Proceedings of the SIGCHI Conference on Human Factors in Computing Systems, 1991, 8 pages.
- Hendrix et al., "Developing a Natural Language Interface to Complex Data", ACM Transactions on Database Systems, vol. 3, No. 2, Jun. 1978, pp. 105-147.
- Hendrix, Gary G., "Human Engineering for Applied Natural Language Processing", SRI International, Technical Note 139, Feb. 1977, 27 pages.
- Hendrix, Gary G., "Klaus: A System for Managing Information and Computational Resources", SRI International, Technical Note 230, Oct. 1980, 34 pages.
- Hendrix, Gary G., "Lifer: A Natural Language Interface Facility", SRI Stanford Research Institute, Technical Note 135, Dec. 1976, 9 pages.
- Hendrix, Gary G., "Natural-Language Interface", American Journal of Computational Linguistics, vol. 8, No. 2, Apr.-Jun. 1982, pp. 56-61.
- Hendrix, Gary G., "The Lifer Manual: A Guide to Building Practical Natural Language Interfaces", SRI International, Technical Note 138, Feb. 1977, 76 pages.
- Hendrix et al., "Transportable Natural-Language Interfaces to Databases", SRI International, Technical Note 228, Apr. 30, 1981, 18 pages.
- Hermansky, H., "Perceptual Linear Predictive (PLP) Analysis of Speech", Journal of the Acoustical Society of America, vol. 87, No. 4, Apr. 1990, 15 pages.
- Hermansky, H., "Recognition of Speech in Additive and Convolutional Noise Based on Rasta Spectral Processing", Proceedings of IEEE International Conference on Acoustics, Speech and Signal Processing (ICASSP'93), Apr. 1993, 4 pages.
- Hirschman et al., "Multi-Site Data Collection and Evaluation in Spoken Language Understanding", Proceedings of the Workshop on Human Language Technology, 1993, pp. 19-24.
- Hobbs et al., "Fastus: A System for Extracting Information from Natural-Language Text", SRI International, Technical Note 519, Nov. 19, 1992, 26 pages.
- Hobbs et al., "Fastus: Extracting Information from Natural-Language Texts", SRI International, 1992, pp. 1-22.
- Hobbs, Jerry R., "Sublanguage and Knowledge", SRI International, Technical Note 329, Jun. 1984, 30 pages.
- Hodjat et al., "Iterative Statistical Language Model Generation for use with an Agent-Oriented Natural Language Interface", Proceedings of HCI International, vol. 4, 2003, pp. 1422-1426.
- Hochfeld et al., "Learning with Limited Numerical Precision Using the Cascade-Correlation Algorithm", IEEE Transactions on Neural Networks, vol. 3, No. 4, Jul. 1992, 18 pages.
- Holmes, J. N., "Speech Synthesis and Recognition-Stochastic Models for Word Recognition", Published by Chapman & Hall, London, ISBN 0 412 534304, 1998, 7 pages.
- Hon et al., "CMU Robust Vocabulary-Independent Speech Recognition System", IEEE International Conference on Acoustics, Speech and Signal Processing (ICASSP-91), Apr. 1991, 4 pages.
- Horvitz et al., "Handsfree Decision Support: Toward a Non-invasive Human-Computer Interface", Proceedings of the Symposium on Computer Applications in Medical Care, IEEE Computer Society Press, 1995, p. 955.
- Horvitz et al., "In Pursuit of Effective Handsfree Decision Support: Coupling Bayesian Inference, Speech Understanding, and User Models", 1995, 8 pages.
- Huang et al., "The SPHINX-II Speech Recognition System: An Overview", Computer, Speech and Language, vol. 7, No. 2, 1993, 14 pages.
- IBM, "Speech Editor", IBM Technical Disclosure Bulletin, vol. 29, No. 10, Mar. 10, 1987, 3 pages.
- IBM, "Integrated Audio-Graphics User Interface", IBM Technical Disclosure Bulletin, vol. 33, No. 11, Apr. 1991, 4 pages.
- IBM, "Speech Recognition with Hidden Markov Models of Speech Waveforms", IBM Technical Disclosure Bulletin, vol. 34, No. 1, Jun. 1991, 10 pages.
- Intraspect Software, "The Intraspect Knowledge Management Solution: Technical Overview", available at <<http://tomgruber.org/writing/intraspect-whitepaper-1998.pdf>>, 1998, 18 pages.
- Iowegian International, "FIR Filter Properties, DSPGuru, Digital Signal Processing Central", available at <<http://www.dspguru.com/dsp/faq/fir/properties>> retrieved on Jul. 28, 2010, 6 pages.
- Issar et al., "CMU's Robust Spoken Language Understanding System", Proceedings of Eurospeech, 1993, 4 pages.
- Issar, Sunil, "Estimation of Language Models for New Spoken Language Applications", Proceedings of 4th International Conference on Spoken language Processing, Oct. 1996, 4 pages.
- Jacobs et al., "Scisor: Extracting Information from On-Line News", Communications of the ACM, vol. 33, No. 11, Nov. 1990, 10 pages.
- Janas, Jurgen M., "The Semantics-Based Natural Language Interface to Relational Databases", Chapter 6, Cooperative Interfaces to Information Systems, 1986, pp. 143-188.
- Jelinek, F., "Self-Organized Language Modeling for Speech Recognition", Readings in Speech Recognition, Edited by Alex Waibel and Kai-Fu Lee, Morgan Kaufmann Publishers, Inc., ISBN: 1-55860-124-4, 1990, 63 pages.
- Jennings et al., "A Personal News Service Based on a User Model Neural Network", IEICE Transactions on Information and Systems, vol. E75-D, No. 2, Mar. 1992, 12 pages.
- Ji et al., "A Method for Chinese Syllables Recognition Based upon Sub-syllable Hidden Markov Model", 1994 International Symposium on Speech, Image Processing and Neural Networks, Hong Kong, Apr. 1994, 4 pages.
- Johnson, Julia Ann., "A Data Management Strategy for Transportable Natural Language Interfaces", Doctoral Thesis Submitted to the Department of Computer Science, University of British Columbia, Canada, Jun. 1989, 285 pages.
- Jones, J., "Speech Recognition for Cyclone", Apple Computer, Inc., E.R.S. Revision 2.9, Sep. 10, 1992, 93 pages.
- Julia et al., "<http://www.speech.sri.com/demos/atis.html>", Proceedings of AAAI, Spring Symposium, 1997, 5 pages.
- Julia et al., "Un Editeur Interactif De Tableaux Dessines a Main Levee (An Interactive Editor for Hand-Sketched Tables)", Traitement du Signal, vol. 12, No. 6, 1995, pp. 619-626.
- Kahn et al., "CoABS Grid Scalability Experiments", Autonomous Agents and Multi-Agent Systems, vol. 7, 2003, pp. 171-178.

(56)

References Cited

OTHER PUBLICATIONS

- Kamel et al., "A Graph Based Knowledge Retrieval System", IEEE International Conference on Systems, Man and Cybernetics, 1990, pp. 269-275.
- Karp, P. D., "A Generic Knowledge-Base Access Protocol", Available online at <<http://lecture.cs.buu.ac.th/~f50353/Document/gfp.pdf>>, May 12, 1994, 66 pages.
- Katz, Boris, "A Three-Step Procedure for Language Generation", Massachusetts Institute of Technology, A.I. Memo No. 599, Dec. 1980, pp. 1-40.
- Katz, Boris, "Annotating the World Wide Web Using Natural Language", Proceedings of the 5th RIAO Conference on Computer Assisted Information Searching on the Internet, 1997, 7 pages.
- Katz, S. M., "Estimation of Probabilities from Sparse Data for the Language Model Component of a Speech Recognizer", IEEE Transactions on Acoustics, Speech and Signal Processing, vol. ASSP-35, No. 3, Mar. 1987, 3 pages.
- Katz et al., "Exploiting Lexical Regularities in Designing Natural Language Systems", Proceedings of the 12th International Conference on Computational Linguistics, 1998, pp. 1-22.
- Katz et al., "REXTOR: A System for Generating Relations from Natural Language", Proceedings of the ACL Workshop on Natural Language Processing and Information Retrieval (NLP&IR), Oct. 2000, 11 pages.
- Katz, Boris, "Using English for Indexing and Retrieving", Proceedings of the 1st RIAO Conference on User-Oriented Content-Based Text and Image Handling, 1988, pp. 314-332.
- Kitano, H., "PhiDM-Dialog, An Experimental Speech-to-Speech Dialog Translation System", Computer, vol. 24, No. 6, Jun. 1991, 13 pages.
- Klabbers et al., "Reducing Audible Spectral Discontinuities", IEEE Transactions on Speech and Audio Processing, vol. 9, No. 1, Jan. 2001, 13 pages.
- Klatt et al., "Linguistic Uses of Segmental Duration in English: Acoustic and Perpetual Evidence", Journal of the Acoustical Society of America, vol. 59, No. 5, May 1976, 16 pages.
- Knownav, "Knowledge Navigator", YouTube Video available at <http://www.youtube.com/watch?v=QRH8eimU_20>, Apr. 29, 2008, 1 page.
- Kominek et al., "Impact of Durational Outlier Removal from Unit Selection Catalogs", 5th ISCA Speech Synthesis Workshop, Jun. 14-16, 2004, 6 pages.
- Konolige, Kurt, "A Framework for a Portable Natural-Language Interface to Large Data Bases", SRI International, Technical Note 197, Oct. 12, 1979, 54 pages.
- Kubala et al., "Speaker Adaptation from a Speaker-Independent Training Corpus", International Conference on Acoustics, Speech and Signal Processing (ICASSP'90), Apr. 1990, 4 pages.
- Kubala et al., "The Hub and Spoke Paradigm for CSR Evaluation", Proceedings of the Spoken Language Technology Workshop, Mar. 1994, 9 pages.
- Laird et al., "SOAR: An Architecture for General Intelligence", Artificial Intelligence, vol. 33, 1987, pp. 1-64.
- Langley et al., "A Design for the ICARUS Architecture", SIGART Bulletin, vol. 2, No. 4, 1991, pp. 104-109.
- Larks, "Intelligent Software Agents", available at <<http://www.cs.cmu.edu/~softagents/larks.html>> retrieved on Mar. 15, 2013, 2 pages.
- Lee et al., "A Real-Time Mandarin Dictation Machine for Chinese Language with Unlimited Texts and Very Large Vocabulary", International Conference on Acoustics, Speech and Signal Processing, vol. 1, Apr. 1990, 5 pages.
- Lee et al., "Golden Mandarin (II)—An Improved Single-Chip Real-Time Mandarin Dictation Machine for Chinese Language with Very Large Vocabulary", IEEE International Conference of Acoustics, Speech and Signal Processing, vol. 2, 1993, 4 pages.
- Lee et al., "Golden Mandarin (II)—An Intelligent Mandarin Dictation Machine for Chinese Character Input with Adaptation/Learning Functions", International Symposium on Speech, Image Processing and Neural Networks, Hong Kong, Apr. 1994, 5 pages.
- Lee, K. F., "Large-Vocabulary Speaker-Independent Continuous Speech Recognition: The SPHINX System", Partial Fulfillment of the Requirements for the Degree of Doctor of Philosophy, Computer Science Department, Carnegie Mellon University, Apr. 1988, 195 pages.
- Lee et al., "System Description of Golden Mandarin (I) Voice Input for Unlimited Chinese Characters", International Conference on Computer Processing of Chinese & Oriental Languages, vol. 5, No. 3 & 4, Nov. 1991, 16 pages.
- Lemon et al., "Multithreaded Context for Robust Conversational Interfaces: Context-Sensitive Speech Recognition and Interpretation of Corrective Fragments", ACM Transactions on Computer-Human Interaction, vol. 11, No. 3, Sep. 2004, pp. 241-267.
- Leong et al., "CASIS: A Context-Aware Speech Interface System", Proceedings of the 10th International Conference on Intelligent User Interfaces, Jan. 2005, pp. 231-238.
- Lieberman et al., "Out of Context: Computer Systems that Adapt to, and Learn from, Context", IBM Systems Journal, vol. 39, No. 3 & 4, 2000, pp. 617-632.
- Lin et al., "A Distributed Architecture for Cooperative Spoken Dialogue Agents with Coherent Dialogue State and History", Available online at <<http://citeseerx.ist.psu.edu/viewdoc/summary?doi=10.1.1.42.272>>, 1999, 4 pages.
- Lin et al., "A New Framework for Recognition of Mandarin Syllables with Tones Using Sub-syllabic Unites", IEEE International Conference on Acoustics, Speech and Signal Processing (ICASSP-93), Apr. 1993, 4 pages.
- Linde et al., "An Algorithm for Vector Quantizer Design", IEEE Transactions on Communications, vol. 28, No. 1, Jan. 1980, 12 pages.
- Liu et al., "Efficient Joint Compensation of Speech for the Effects of Additive Noise and Linear Filtering", IEEE International Conference of Acoustics, Speech and Signal Processing, ICASSP-92, Mar. 1992, 4 pages.
- Logan et al., "Mel Frequency Cepstral Co-efficients for Music Modeling", International Symposium on Music Information Retrieval, 2000, 2 pages.
- Lowerre, B. T., "The-Harpy Speech Recognition System", Doctoral Dissertation, Department of Computer Science, Carnegie Mellon University, Apr. 1976, 20 pages.
- Maghbouleh, Arman, "An Empirical Comparison of Automatic Decision Tree and Linear Regression Models for Vowel Durations", Revised Version of a Paper Presented at the Computational Phonology in Speech Technology Workshop, 1996 Annual Meeting of the Association for Computational Linguistics in Santa Cruz, California, 7 pages.
- Markel et al., "Linear Prediction of Speech", Springer-Verlag, Berlin, Heidelberg, New York, 1976, 12 pages.
- Martin et al., "Building and Using Practical Agent Applications", SRI International, PAAM Tutorial, 1998, 78 pages.
- Martin et al., "Building Distributed Software Systems with the Open Agent Architecture", Proceedings of the Third International Conference on the Practical Application of Intelligent Agents and Multi-Agent Technology, Mar. 1998, pp. 355-376.
- Martin et al., "Development Tools for the Open Agent Architecture", Proceedings of the International Conference on the Practical Application of Intelligent Agents and Multi-Agent Technology, Apr. 1996, pp. 1-17.
- Martin et al., "Information Brokering in an Agent Architecture", Proceedings of the Second International Conference on the Practical Application of Intelligent Agents and Multi-Agent Technology, Apr. 1997, pp. 1-20.
- Martin et al., "Transportability and Generality in a Natural-Language Interface System", Proceedings of the Eighth International Joint Conference on Artificial Intelligence, Technical Note 293, Aug. 1983, 21 pages.
- Martin et al., "The Open Agent Architecture: A Framework for Building Distributed Software Systems", Applied Artificial Intelligence: An International Journal, vol. 13, No. 1-2, available at <<http://adam.cheyer.com/papers/oa.pdf>>, retrieved from internet on Jan.-Mar. 1999.

(56)

References Cited

OTHER PUBLICATIONS

- Matiasek et al., "Tamic-P: A System for NL Access to Social Insurance Database", 4th International Conference on Applications of Natural Language to Information Systems, Jun. 1999, 7 pages.
- McGuire et al., "SHADE: Technology for Knowledge-Based Collaborative Engineering", Journal of Concurrent Engineering Applications and Research (CERA), 1993, 18 pages.
- Meng et al., "Wheels: A Conversational System in the Automobile Classified Domain", Proceedings of Fourth International Conference on Spoken Language, ICSLP 96, vol. 1, Oct. 1996, 4 pages.
- Michos et al., "Towards an Adaptive Natural Language Interface to Command Languages", Natural Language Engineering, vol. 2, No. 3, 1996, pp. 191-209.
- Milstead et al., "Metadata: Cataloging by Any Other Name", available at <http://www.iicm.tugraz.at/thesis/cguetl_diss/literatur/Kapitel06/References/Milstead_et_al_1999/metadata.html>, Jan. 1999, 18 pages.
- Milward et al., "D2.2: Dynamic Multimodal Interface Reconfiguration, Talk and Look: Tools for Ambient Linguistic Knowledge", available at <<http://www.ihmc.us/users/nblaylock!Pubs/Files/talkd2.2.pdf>>, Aug. 8, 2006, 69 pages.
- Minker et al., "Hidden Understanding Models for Machine Translation", Proceedings of ETRW on Interactive Dialogue in Multimodal Systems, Jun. 1999, pp. 1-4.
- Mitra et al., "A Graph-Oriented Model for Articulation of Ontology Interdependencies", Advances in Database Technology, Lecture Notes in Computer Science, vol. 1777, 2000, pp. 1-15.
- Modi et al., "CMRadar: A Personal Assistant Agent for Calendar Management", AAAI, Intelligent Systems Demonstrations, 2004, pp. 1020-1021.
- Moore et al., "Combining Linguistic and Statistical Knowledge Sources in Natural-Language Processing for ATIS", SRI International, Artificial Intelligence Center, 1995, 4 pages.
- Moore, Robert C., "Handling Complex Queries in a Distributed Data Base", SRI International, Technical Note 170, Oct. 8, 1979, 38 pages.
- Moore, Robert C., "Practical Natural-Language Processing by Computer", SRI International, Technical Note 251, Oct. 1981, 34 pages.
- Moore et al., "SRI's Experience with the ATIS Evaluation", Proceedings of the Workshop on Speech and Natural Language, Jun. 1990, pp. 147-148.
- Moore et al., "The Information Warfare Advisor: an Architecture for Interacting with Intelligent Agents Across the Web", Proceedings of Americas Conference on Information Systems (AMCIS), Dec. 31, 1998, pp. 186-188.
- Moore, Robert C., "The Role of Logic in Knowledge Representation and Commonsense Reasoning", SRI International, Technical Note 264, Jun. 1982, 19 pages.
- Moore, Robert C., "Using Natural-Language Knowledge Sources in Speech Recognition", SRI International, Artificial Intelligence Center, Jan. 1999, pp. 1-24.
- Moran et al., "Intelligent Agent-Based User Interfaces", Proceedings of International Workshop on Human Interface Technology, Oct. 1995, pp. 1-4.
- Moran et al., "Multimodal User Interfaces in the Open Agent Architecture", International Conference on Intelligent User Interfaces (IUI97), 1997, 8 pages.
- Moran, Douglas B., "Quantifier Scoping in the Sri Core Language Engine", Proceedings of the 26th Annual Meeting on Association for Computational Linguistics, 1988, pp. 33-40.
- Morgan, B., "Business Objects (Business Objects for Windows) Business Objects Inc.", DBMS, vol. 5, No. 10, Sep. 1992, 3 pages.
- Motro, Amihai, "Flex: A Tolerant and Cooperative User Interface to Databases", IEEE Transactions on Knowledge and Data Engineering, vol. 2, No. 2, Jun. 1990, pp. 231-246.
- Mountford et al., "Talking and Listening to Computers", The Art of Human-Computer Interface Design, Apple Computer, Inc., Addison-Wesley Publishing Company, Inc., 1990, 17 pages.
- Mozer, Michael C., "An Intelligent Environment must be Adaptive", IEEE Intelligent Systems, 1999, pp. 11-13.
- Murty et al., "Combining Evidence from Residual Phase and MFCC Features for Speaker Recognition", IEEE Signal Processing Letters, vol. 13, No. 1, Jan. 2006, 4 pages.
- Murveit et al., "Integrating Natural Language Constraints into Hmm-Based Speech Recognition", International Conference on Acoustics, Speech and Signal Processing, Apr. 1990, 5 pages.
- Murveit et al., "Speech Recognition in Sri's Resource Management and ATIS Systems", Proceedings of the Workshop on Speech and Natural Language, 1991, pp. 94-100.
- Nakagawa et al., "Speaker Recognition by Combining MFCC and Phase Information", IEEE International Conference on Acoustics, Speech and Signal Processing (ICASSP), Mar. 2010, 4 pages.
- Naone, Erica, "TR10: Intelligent Software Assistant", Technology Review, Mar.-Apr. 2009, 2 pages.
- Neches et al., "Enabling Technology for Knowledge Sharing", Fall, 1991, pp. 37-56.
- Niesler et al., "A Variable-Length Category-Based N-Gram Language Model", IEEE International Conference on Acoustics, Speech and Signal Processing (ICASSP'96), vol. 1, May 1996, 6 pages.
- Noth et al., "Verbmobil: the Use of Prosody in the Linguistic Components of a Speech Understanding System", IEEE Transactions on Speech and Audio Processing, vol. 8, No. 5, Sep. 2000, pp. 519-532.
- Odubiyi et al., "Saire-A Scalable Agent-Based Information Retrieval Engine", Proceedings of the First International Conference on Autonomous Agents, 1997, 12 pages.
- Owei et al., "Natural Language Query Filtration in the Conceptual Query Language", IEEE, 1997, pp. 539-549.
- Pannu et al., "A Learning Personal Agent for Text Filtering and Notification", Proceedings of the International Conference of Knowledge Based Systems, 1996, pp. 1-11.
- Papadimitriou et al., "Latent Semantic Indexing: a Probabilistic Analysis", Available online at <<http://citeseerx.ist.psu.edu/messages/downloadsexceeded.html>>, Nov. 14, 1997, 21 pages.
- Parson, T. W., "Voice and Speech Processing", Pitch and Formant Estimation, McGraw-Hill, Inc., ISBN: 0-07-0485541-0, 1987, 15 pages.
- Parsons, T. W., "Voice and Speech Processing", Linguistics and Technical Fundamentals, Articulatory Phonetics and Phonemics, McGraw-Hill, Inc., ISBN: 0-07-0485541-0, 1987, 5 pages.
- International Preliminary Report on Patentability received for PCT Patent Application No. PCT/US1993/012637, issued on Apr. 10, 1995, 7 pp.
- International Preliminary Report on Patentability received for PCT Patent Application No. PCT/US1993/012666, issued on Mar. 1, 1995, 5 pages.
- International Search Report received for PCT Patent Application No. PCT/US1993/012666, mailed on Nov. 9, 1994, 8 pages.
- International Preliminary Report on Patentability received for PCT Patent Application No. PCT/US1994/011011, issued on Feb. 28, 1996, 4 pages.
- International Search Report and Written Opinion received for PCT Patent Application No. PCT/US1994/11011, mailed on Feb. 8, 1995, 7 pages.
- Shimazu et al., "Capit: Natural Language Interface Design Tool with Keyword Analyzer and Case-Based Parser", NEG Research & Development, vol. 33, No. 4, Oct. 1992, 11 pages.
- Shinkle, L., "Team User's Guide", SRI International, Artificial Intelligence Center, Nov. 1984, 78 pages.
- Shklar et al., "InfoHarness: Use of Automatically Generated Metadata for Search and Retrieval of Heterogeneous Information", Proceedings of CAISE'95, Finland, 1995, 14 pages.
- Sigurdsson et al., "Mel Frequency Cepstral Co-efficients: an Evaluation of Robustness of MP3 Encoded Music", Proceedings of the 7th International Conference on Music Information Retrieval, 2006, 4 pages.
- Silverman et al., "Using a Sigmoid Transformation for Improved Modeling of Phoneme Duration", Proceedings of the IEEE International Conference on Acoustics, Speech and Signal Processing, Mar. 1999, 5 pages.

(56)

References Cited

OTHER PUBLICATIONS

- Simonite, Tom, "One Easy Way to Make Siri Smarter", *Technology Review*, Oct. 18, 2011, 2 pages.
- Singh, N., "Unifying Heterogeneous Information Models", *Communications of the ACM*, 1998, 13 pages.
- SRI International, "The Open Agent Architecture TM 1.0 Distribution", *Open Agent Architecture (OAA)*, 1999, 2 pages.
- Starr et al., "Knowledge-Intensive Query Processing", *Proceedings of the 5th KRDB Workshop*, Seattle, May 31, 1998, 6 pages.
- Stent et al., "The CommandTalk Spoken Dialogue System", *SRI International*, 1999, pp. 183-190.
- Stern et al., "Multiple Approaches to Robust Speech Recognition", *Proceedings of Speech and Natural Language Workshop*, 1992, 6 pages.
- Stickel, Mark E., "A Nonclausal Connection-Graph Resolution Theorem-Proving Program", *Proceedings of AAAI'82*, 1982, 5 pages.
- Sugumaran, V., "A Distributed Intelligent Agent-Based Spatial Decision Support System", *Proceedings of the Americas Conference on Information Systems (AMCIS)*, Dec. 31, 1998, 4 pages.
- Sycara et al., "Coordination of Multiple Intelligent Software Agents", *International Journal of Cooperative Information Systems (IJCIS)*, vol. 5, No. 2 & 3, 1996, 31 pages.
- Sycara et al., "Distributed Intelligent Agents", *IEEE Expert*, vol. 11, No. 6, Dec. 1996, 32 pages.
- Sycara et al., "Dynamic Service Matchmaking among Agents in Open Information Environments", *SIGMOD Record*, 1999, 7 pages.
- Sycara et al., "The RETSINA MAS Infrastructure", *Autonomous Agents and Multi-Agent Systems*, vol. 7, 2003, 20 pages.
- Tenenbaum et al., "Data Structure Using Pascal", *Prentice-Hall, Inc.*, 1981, 34 pages.
- Textndrive, "Text'nDrive App Demo-Listen and Reply to your Messages by Voice while driving!", *YouTube Video* available at <<http://www.youtube.com/watch?v=WaGfzoHsAMw>>, Apr. 27, 2010, 1 page.
- Tofel, Kevin C., "SpeakTolt: a Personal Assistant for Older iPhones, iPads", *Apple News, Tips and Reviews*, Feb. 9, 2012, 7 pages.
- Tsai et al., "Attributed Grammar-A Tool for Combining Syntactic and Statistical Approaches to Pattern Recognition", *IEEE Transactions on Systems, Man and Cybernetics*, vol. SMC-10, No. 12, Dec. 1980, 13 pages.
- Tucker, Joshua, "Too Lazy to Grab Your Tv Remote? Use Siri Instead", *Engadget*, Nov. 30, 2011, 8 pages.
- Tur et al., "The CALO Meeting Assistant System", *IEEE Transactions on Audio, Speech and Language Processing*, vol. 18, No. 6, Aug. 2010, pp. 1601-1611.
- Tur et al., "The CALO Meeting Speech Recognition and Understanding System", *Proc. IEEE Spoken Language Technology Workshop*, 2008, 4 pages.
- Tyson et al., "Domain-Independent Task Specification in the Tacitus Natural Language System", *SRI International, Artificial Intelligence Center*, May 1990, 16 pages.
- Udell, J., "Computer Telephony", *BYTE*, vol. 19, No. 7, Jul. 1994, 9 pages.
- Van Santen, J. P.H., "Contextual Effects on Vowel Duration", *Journal Speech Communication*, vol. 11, No. 6, Dec. 1992, pp. 513-546.
- Vepa et al., "New Objective Distance Measures for Spectral Discontinuities in Concatenative Speech Synthesis", *Proceedings of the IEEE 2002 Workshop on Speech Synthesis*, 2002, 4 pages.
- Verschelde, Jan, "MATLAB Lecture 8. Special Matrices in MATLAB", *UIC, Dept. of Math, Stat. & CS, MCS 320, Introduction to Symbolic Computation*, 2007, 4 pages.
- Vingron, Martin, "Near-Optimal Sequence Alignment", *Current Opinion in Structural Biology*, vol. 6, No. 3, 1996, pp. 346-352.
- Vlingo, "Vlingo Launches Voice Enablement Application on Apple App Store", *Press Release*, Dec. 3, 2008, 2 pages.
- Vlingo Incar, "Distraction Driving Solution with Vlingo InCar", *YouTube Video*, Available online at <<http://www.youtube.com/watch?v=Vqs8XfXgz4>>, Oct. 2010, 2 pages.
- Voiceassist, "Send Text, Listen to and Send E-Mail by Voice", *YouTube Video*, Available online at <<http://www.youtube.com/watch?v=0tEU6lnHHA4>>, Jul. 30, 2009, 1 page.
- Voiceonthego, "Voice on the Go (BlackBerry)", *YouTube Video*, available online at <<http://www.youtube.com/watch?v=pJqpWgQS98w>>, Jul. 27, 2009, 1 page.
- Wahlster et al., "Smartkom: Multimodal Communication with a Life-Like Character", *Eurospeech-Scandinavia, 7th European Conference on Speech Communication and Technology*, 2001, 5 pages.
- Waldinger et al., "Deductive Question Answering from Multiple Resources", *New Directions in Question Answering*, Published by AAAI, Menlo Park, 2003, 22 pages.
- Walker et al., "Natural Language Access to Medical Text", *SRI International, Artificial Intelligence Center*, Mar. 1981, 23 pages.
- Waltz, D., "An English Language Question Answering System for a Large Relational Database", *ACM*, vol. 21, No. 7, 1978, 14 pages.
- Ward et al., "A Class Based Language Model for Speech Recognition", *IEEE*, 1996, 3 pages.
- Ward et al., "Recent Improvements in the CMU Spoken Language Understanding System", *ARPA Human Language Technology Workshop*, 1994, 4 pages.
- Ward, Wayne, "The Cmu Air Travel Information Service: Understanding Spontaneous Speech", *Proceedings of the Workshop on Speech and Natural Language, HLT '90*, 1990, pp. 127-129.
- Warren et al., "An Efficient Easily Adaptable System for Interpreting Natural Language Queries", *American Journal of Computational Linguistics*, vol. 8, No. 3-4, 1982, 11 pages.
- Weizenbaum, J., "ELIZA—A Computer Program for the Study of Natural Language Communication Between Man and Machine", *Communications of the ACM*, vol. 9, No. 1, Jan. 1966, 10 pages.
- Werner et al., "Prosodic Aspects of Speech, Universite de Lausanne", *Fundamentals of Speech Synthesis and Speech Recognition: Basic Concepts, State of the Art and Future Challenges*, 1994, 18 pages.
- Winiwarter et al., "Adaptive Natural Language Interfaces to FAQ Knowledge Bases", *Proceedings of 4th International Conference on Applications of Natural Language to Information Systems*, Austria, Jun. 1999, 22 pages.
- Wolff, M., "Post Structuralism and the Artful Database: Some Theoretical Considerations", *Information Technology and Libraries*, vol. 13, No. 1, Mar. 1994, 10 pages.
- Wu, M., "Digital Speech Processing and Coding", *Multimedia Signal Processing, Lecture-2 Course Presentation*, University of Maryland, College Park, 2003, 8 pages.
- Wu et al., "KDA: A Knowledge-Based Database Assistant", *Proceeding of the Fifth International Conference on Engineering (IEEE Cat. No. 89CH2695-5)*, 1989, 8 pages.
- Wu, M., "Speech Recognition, Synthesis, and H.C.I.", *Multimedia Signal Processing, Lecture-3 Course Presentation*, University of Maryland, College Park, 2003, 11 pages.
- Wyle, M. F., "A Wide Area Network Information Filter", *Proceedings of First International Conference on Artificial Intelligence on Wall Street*, Oct. 1991, 6 pages.
- International Preliminary Report on Patentability received for PCT Patent Application No. PCT/US1995/008369, issued on Oct. 09, 1996, 4 pp.
- International Search Report received for PCT Patent Application No. PCT/US1995/008369, mailed on Nov. 8, 1995, 6 pages.
- International Search Report and Written Opinion received for PCT Patent Application No. PCT/US2010/037378, mailed on Aug. 25, 2010, 14 pages.
- International Search Report and Written Opinion received for PCT Patent Application No. PCT/US2011/020861, mailed on Nov. 29, 2011, 12 pages.
- International Search Report and Written Opinion received for PCT Patent Application No. PCT/US2012/040571, mailed on Nov. 16, 2012, 14 pages.
- International Search Report and Written Opinion received for PCT Patent Application No. PCT/US2012/056382, mailed on Dec. 20, 2012, 11 pages.
- Pereira, Fernando, "Logic for Natural Language Analysis", *SRI International, Technical Note 275*, Jan. 1983, 194 pages.

(56)

References Cited

OTHER PUBLICATIONS

- Perrault et al., "Natural-Language Interfaces", SRI International, Technical Note 393, Aug. 22, 1986, 48 pages.
- Phoenix Solutions, Inc., "Declaration of Christopher Schmandt Regarding the MIT Galaxy System", West Interactive Corp., A Delaware Corporation, Document 40, Jul. 2, 2010, 162 pages.
- Picone, J., "Continuous Speech Recognition using Hidden Markov Models", IEEE ASSP Magazine, vol. 7, No. 3, Jul. 1990, 16 pages.
- Pulman et al., "Clare: A Combined Language and Reasoning Engine", Proceedings of JFIT Conference, available at <<http://www.cam.sri.com/tr/crc042/paper.ps.Z>>, 1993, 8 pages.
- Rabiner et al., "Fundamental of Speech Recognition", AT&T, Published by Prentice-Hall, Inc., ISBN: 0-13-285826-6, 1993, 17 pages.
- Rabiner et al., "Note on the Properties of a Vector Quantizer for LPC Coefficients", Bell System Technical Journal, vol. 62, No. 8, Oct. 1983, 9 pages.
- Ratcliffe, M., "ClearAccess 2.0 Allows Sql Searches Off-Line (Structured Query Language) (ClearAccess Corp. Preparing New Version of Data-Access Application with Simplified User Interface, New Features) (Product Announcement)", MacWeek, vol. 6, No. 41, Nov. 16, 1992, 2 pages.
- Ravishankar, Mosur K., "Efficient Algorithms for Speech Recognition", Doctoral Thesis Submitted to School of Computer Science, Computer Science Division, Carnegie Mellon University, Pittsburgh, May 15, 1996, 146 pages.
- Rayner, M., "Abductive Equivocal Translation and its Application to Natural Language Database Interfacing", Dissertation Paper, SRI International, Sep. 1993, 162 pages.
- Rayner et al., "Adapting the Core Language Engine to French and Spanish", Cornell University Library, available at <<http://arxiv.org/abs/cmp-lg/9605015>>, May 10, 1996, 9 pages.
- Rayner et al., "Deriving Database Queries from Logical Forms by Abductive Definition Expansion", Proceedings of the Third Conference on Applied Natural Language Processing, ANLC, 1992, 8 pages.
- Rayner, Manny, "Linguistic Domain Theories: Natural-Language Database Interfacing from First Principles", Sri International, Cambridge, 1993, 11 pages.
- Rayner et al., "Spoken Language Translation with Mid-90's Technology: A Case Study", Eurospeech, ISCA, Available online at <<http://citeseerx.ist.psu.edu/viewdoc/summary?doi=10.1.1.54.8608>>, 1993, 4 pages.
- Remde et al., "SuperBook: An Automatic Tool for Information Exploration-Hypertext?", In Proceedings of Hypertext, 87 Papers, Nov. 1987, 14 pages.
- Reynolds, C. F., "On-Line Reviews: A New Application of the HICOM Conferencing System", IEEE Colloquium on Human Factors in Electronic Mail and Conferencing Systems, Feb. 3, 1989, 4 pages.
- Rice et al., "Monthly Program: Nov. 14, 1995", The San Francisco Bay Area Chapter of ACM SIGCHI, available at <<http://www.baychi.org/calendar/19951114>>, Nov. 14, 1995, 2 pages.
- Rice et al., "Using the Web Instead of a Window System", Proceedings of the SIGCHI Conference on Human Factors in Computing Systems, CHI'96, 1996, pp. 1-14.
- Rigoll, G., "Speaker Adaptation for Large Vocabulary Speech Recognition Systems Using Speaker Markov Models", International Conference on Acoustics, Speech and Signal Processing (ICASSP'89), May 1989, 4 pages.
- Riley, M. D., "Tree-Based Modelling of Segmental Durations", Talking Machines Theories, Models and Designs, Elsevier Science Publishers B.V., North-Holland, ISBN: 08-444-89115.3, 1992, 15 pages.
- Rivlin et al., "Maestro: Conductor of Multimedia Analysis Technologies", SRI International, 1999, 7 pages.
- Rivoira et al., "Syntax and Semantics in a Word-Sequence Recognition System", IEEE International Conference on Acoustics, Speech and Signal Processing (ICASSP'79), Apr. 1979, 5 pages.
- Roddy et al., "Communication and Collaboration in a Landscape of B2B eMarketplaces", VerticalNet Solutions, White Paper, Jun. 15, 2000, 23 pages.
- Rosenfeld, R., "A Maximum Entropy Approach to Adaptive Statistical Language Modelling", Computer Speech and Language, vol. 10, No. 3, Jul. 1996, 25 pages.
- Roszkiewicz, A., "Extending your Apple", Back Talk-Lip Service, A+ Magazine, The Independent Guide for Apple Computing, vol. 2, No. 2, Feb. 1984, 5 pages.
- Rudnicki et al., "Creating Natural Dialogs in the Carnegie Mellon Communicator System", Proceedings of Eurospeech, vol. 4, 1999, pp. 1531-1534.
- Russell et al., "Artificial Intelligence, A Modern Approach", Prentice Hall, Inc., 1995, 121 pages.
- Sacerdoti et al., "A Ladder User's Guide (Revised)", SRI International Artificial Intelligence Center, Mar. 1980, 39 pages.
- Sagalowicz, D., "AD-Ladder User's Guide", SRI International, Sep. 1980, 42 pages.
- Sakoe et al., "Dynamic Programming Algorithm Optimization for Spoken Word Recognition", IEEE Transactions on Acoustics, Speech and Signal Processing, vol. ASSP-26, No. 1, Feb. 1978, 8 pages.
- Salton et al., "On the Application of Syntactic Methodologies in Automatic Text Analysis", Information Processing and Management, vol. 26, No. 1, Great Britain, 1990, 22 pages.
- Sameshima et al., "Authorization with Security Attributes and Privilege Delegation Access control beyond the ACL", Computer Communications, vol. 20, 1997, 9 pages.
- San-Segundo et al., "Confidence Measures for Dialogue Management in the CU Communicator System", Proceedings of Acoustics, Speech and Signal Processing (ICASSP'00), Jun. 2000, 4 pages.
- Sato, H., "A Data Model, Knowledge Base and Natural Language Processing for Sharing a Large Statistical Database", Statistical and Scientific Database Management, Lecture Notes in Computer Science, vol. 339, 1989, 20 pages.
- Savoy, J., "Searching Information in Hypertext Systems Using Multiple Sources of Evidence", International Journal of Man-Machine Studies, vol. 38, No. 6, Jun. 1996, 15 pages.
- Scagliola, C., "Language Models and Search Algorithms for Real-Time Speech Recognition", International Journal of Man-Machine Studies, vol. 22, No. 5, 1985, 25 pages.
- Schmandt et al., "Augmenting a Window System with Speech Input", IEEE Computer Society, Computer, vol. 23, No. 8, Aug. 1990, 8 pages.
- Schnelle, Dirk, "Context Aware Voice User Interfaces for Workflow Support", Dissertation paper, Aug. 27, 2007, 254 pages.
- Schütze, H., "Dimensions of Meaning", Proceedings of Supercomputing'92 Conference, Nov. 1992, 10 pages.
- Seneff et al., "A New Restaurant Guide Conversational System: Issues in Rapid Prototyping for Specialized Domains", Proceedings of Fourth International Conference on Spoken Language, vol. 2, 1996, 4 pages.
- Sharoff et al., "Register-Domain Separation as a Methodology for Development of Natural Language Interfaces to Databases", Proceedings of Human-Computer Interaction (INTERACT'99), 1999, 7 pages.
- Sheth et al., "Evolving Agents for Personalized Information Filtering", Proceedings of the Ninth Conference on Artificial Intelligence for Applications, Mar. 1993, 9 pages.
- Sheth et al., "Relationships at the Heart of Semantic Web: Modeling, Discovering, and Exploiting Complex Semantic Relationships", Enhancing the Power of the Internet: Studies in Fuzziness and Soft Computing, Oct. 13, 2002, pp. 1-38.
- Shikano et al., "Speaker Adaptation through Vector Quantization", IEEE International Conference on Acoustics, Speech and Signal Processing (ICASSP'86), vol. 11, Apr. 1986, 4 pages.
- Apple Computer, Inc., "iTunes 2: Specification Sheet", 2001, 2 pages.
- Apple Computer, Inc., "iTunes, Playlist Related Help Screens", iTunes v1.0, 2000-2001, 8 pages.
- Apple Computer, Inc., "QuickTime Movie Playback Programming Guide", Aug. 11, 2005, pp. 1-58.

(56)

References Cited

OTHER PUBLICATIONS

- Apple Computer, Inc., "QuickTime Overview", Aug. 11, 2005, pp. 1-34.
- Apple Computer, Inc., "Welcome to Tiger", available at <http://www.maths.dundee.ac.uk/software/Welcome_to_Mac_OS_X_v10.4_Tiger.pdf>, 2005, pp. 1-32.
- "Corporate Ladder", BLOC Publishing Corporation, 1991, 1 page.
- Arango et al., "Touring Machine: A Software Platform for Distributed Multimedia Applications", 1992 IFIP International Conference on Upper Layer Protocols, Architectures, and Applications, May 1992, pp. 1-11.
- Arons, Barry M., "The Audio-Graphical Interface to a Personal Integrated Telecommunications System", Thesis Submitted to the Department of Architecture at the Massachusetts Institute of Technology, Jun. 1984, 88 pages.
- Badino et al., "Language Independent Phoneme Mapping for Foreign TTS", 5th ISCA Speech Synthesis Workshop, Pittsburgh, PA, Jun. 14-16, 2004, 2 pages.
- Baechtle et al., "Adjustable Audio Indicator", IBM Technical Disclosure Bulletin, Jul. 1, 1984, 2 pages.
- Baeza-Yates, Ricardo, "Visualization of Large Answers in Text Databases", AVI '96 Proceedings of the Workshop on Advanced Visual Interfaces, 1996, pp. 101-107.
- Bahl et al., "Recognition of a Continuously Read Natural Corpus", IEEE International Conference on Acoustics, Speech, and Signal Processing, vol. 3, Apr. 1978, pp. 422-424.
- Bajarin, Tim, "With Low End Launched, Apple Turns to Portable Future", PC Week, vol. 7, Oct. 1990, p. 153(1).
- Barthel, B., "Information Access for Visually Impaired Persons: Do We Still Keep a 'Document' in 'Documentation'?", Professional Communication Conference, Sep. 1995, pp. 62-66.
- Baudel et al., "2 Techniques for Improved HC Interaction: Toolglass & Magic Lenses: The See-Through Interface", Apple Inc., Video Clip, CHI'94 Video Program on a CD, 1994.
- Beck et al., "Integrating Natural Language, Query Processing, and Semantic Data Models", COMCON Spring '90. IEEE Computer Society International Conference, 1990, Feb. 26-Mar. 2, 1990, pp. 538-543.
- Bederson et al., "Pad++: A Zooming Graphical Interface for Exploring Alternate Interface Physics", UIST '94 Proceedings of the 7th Annual ACM symposium on User Interface Software and Technology, Nov. 1994, pp. 17-26.
- Bederson et al., "The Craft of Information Visualization", Elsevier Science, Inc., 2003, 435 pages.
- "Diagrammaker", Action Software, 1989.
- "Diagram-Master", Ashton-Tate, 1989.
- Benel et al., "Optimal Size and Spacing of Touchscreen Input Areas", Human-Computer Interaction—Interact, 1987, pp. 581-585.
- Beringer et al., "Operator Behavioral Biases Using High-Resolution Touch Input Devices", Proceedings of the Human Factors and Ergonomics Society 33rd Annual Meeting, 1989, 3 pages.
- Beringer, Dennis B., "Target Size, Location, Sampling Point and Instruction Set: More Effects on Touch Panel Operation", Proceedings of the Human Factors and Ergonomics Society 34th Annual Meeting, 1990, 5 pages.
- Bernabei et al., "Graphical I/O Devices for Medical Users", 14th Annual International Conference of the IEEE on Engineering in Medicine and Biology Society, vol. 3, 1992, pp. 834-836.
- Bernstein, Macrophone, "Speech Corpus", IEEE/ICASSP, Apr. 22, 1994, pp. 1-81 to 1-84.
- Berry et al., "Symantec", New version of MORE.™, Apr. 10, 1990, 1 page.
- Best Buy, "When it Comes to Selecting a Projection TV, Toshiba Makes Everything Perfectly Clear", Previews of New Releases, available at <<http://www.bestbuy.com/HomeAudioVideo/Specials/ToshibaTVFeatures.asp>>, retrieved on Jan. 23, 2003, 5 pages.
- Betts et al., "Goals and Objectives for User Interface Software", Computer Graphics, vol. 21, No. 2, Apr. 1987, pp. 73-78.
- Biemann, Chris, "Unsupervised Part-of-Speech Tagging Employing Efficient Graph Clustering", Proceeding Coling ACL '06 Proceedings of the 21st International Conference on computational Linguistics and 44th Annual Meeting of the Association for Computational Linguistics: Student Research Workshop, 2006, pp. 7-12.
- Bier et al., "Toolglass and Magic Lenses: The See-Through Interface", Computer Graphics (SIGGRAPH '93 Proceedings), vol. 27, 1993, pp. 73-80.
- Birrell, Andrew, "Personal Jukebox (PJB)", available at <<http://birrell.org/andrew/talks/pjb-overview.ppt>>, Oct. 13, 2000, 6 pages.
- Black et al., "Multilingual Text-to-Speech Synthesis", Acoustics, Speech and Signal Processing (ICASSP'04) Proceedings of the IEEE International Conference, vol. 3, May 17-21, 2004, 4 pages.
- Bleher et al., "A Graphic Interactive Application Monitor", IBM Systems Journal, vol. 19, No. 3, Sep. 1980, pp. 382-402.
- Bluetooth PC Headsets, "'Connecting' Your Bluetooth Headset with Your Computer", Enjoy Wireless VoIP Conversations, available at <<http://www.bluetoothpcheadsets.com/connect.htm>>, retrieved on Apr. 29, 2006, 4 pages.
- Bocchieri et al., "Use of Geographical Meta-Data in ASR Language and Acoustic Models", IEEE International Conference on Acoustics and Signal Processing, 2010, pp. 5118-5121.
- Bociurkiw, Michael, "Product Guide: Vanessa Matz", available at <http://www.forbes.com/asap/2000/1127/vmartz_print.html>, retrieved on Jan. 23, 2003, 2 pages.
- "Glossary of Adaptive Technologies: Word Prediction", available at <<http://www.utoronto.ca/atrc/reference/techwordpred.html>>, retrieved on Dec. 6, 2005, 5 pages.
- Borenstein, Nathaniel S., "Cooperative Work in the Andrew Message System", Information Technology Center and Computer Science Department, Carnegie Mellon University; Thyberg, Chris A. Academic Computing, Carnegie Mellon University, 1988, pp. 306-323.
- Boy, Guy A., "Intelligent Assistant Systems", Harcourt Brace Jovanovicy, 1991, 1 page.
- "iAP Sports Lingo 0x33 09 Protocol V1.00", May 1, 2006, 17 pages.
- Brown et al., "Browsing Graphs Using a Fisheye View", Apple Inc., Video Clip, Systems Research Center, CHI '92 Continued Proceedings on a CD, 1992.
- Brown et al., "Browsing Graphs Using a Fisheye View", CHI '93 Proceedings of the INTERACT '93 and Chi '93 Conference on Human Factors in Computing Systems, 1993, p. 516.
- Burger, D., "Improved Access to Computers for the Visually Handicapped: New Prospects and Principles", IEEE Transactions on Rehabilitation Engineering, vol. 2, No. 3, Sep. 1994, pp. 111-118.
- "IEEE 1394 (Redirected from Firewire)", Wikipedia, The Free Encyclopedia, available at <<http://www.wikipedia.org/wiki/Firewire>>, retrieved on Jun. 8, 2003, 2 pages.
- Butler, Travis, "Archos Jukebox 6000 Challenges Nomad Jukebox", available at <<http://tidbits.com/article/6521>>, Aug. 13, 2001, 5 pages.
- Butler, Travis, "Portable MP3: The Nomad Jukebox", available at <<http://tidbits.com/article/6261>>, Jan. 8, 2001, 4 pages.
- Buxton et al., "EuroPARC's Integrated Interactive Intermedia Facility (IIIF): Early Experiences", Proceedings of the IFIP WG 8.4 Conference on Multi-User Interfaces and Applications, 1990, pp. 11-34.
- Call Centre, "Word Prediction", The CALL Centre & Scottish Executive Education Dept., 1999, pp. 63-73.
- Campbell et al., "An Expandable Error-Protected 4800 BPS CELP Coder (U.S. Federal Standard 4800 BPS Voice Coder)", (Proceedings of IEEE Int'l Acoustics, Speech, and Signal Processing Conference, May 1983), as reprinted in Vector Quantization (IEEE Press, 1990), 1990, pp. 328-330.
- Card et al., "Readings in Information Visualization Using Vision to Think", Interactive Technologies, 1999, 712 pages.
- Carpendale et al., "3-Dimensional Pliable Surfaces: For the Effective Presentation of Visual Information", UIST '95 Proceedings of the 8th Annual ACM Symposium on User Interface and Software Technology, Nov. 14-17, 1995, pp. 217-226.
- Carpendale et al., "Extending Distortion Viewing from 2D to 3D", IEEE Computer Graphics and Applications, Jul./Aug. 1997, pp. 42-51.

(56)

References Cited

OTHER PUBLICATIONS

- Carpendale et al., "Making Distortions Comprehensible", IEEE Proceedings of Symposium on Visual Languages, 1997, 10 pages.
- Casner et al., "N-Way Conferencing with Packet Video", The Third International Workshop on Packet Video, Mar. 22-23, 1990, pp. 1-6.
- Chakarova et al., "Digital Still Cameras—Downloading Images to a Computer", Multimedia Reporting and Convergence, available at <<http://journalism.berkeley.edu/multimedia/tutorials/stillcams/downloading.html>>, retrieved on May 9, 2005, 2 pages.
- Chartier, David, "Using Multi-Network Meebo Chat Service on Your iPhone", available at <<http://www.tuaw.com/2007/07/04/using-multi-network-meebo-chat-service-on-your-iphone/>>, Jul. 4, 2007, 5 pages.
- Extended European Search Report (includes European Search Report and European Search Opinion) received for European Patent Application No. 06256215.2, mailed on Feb. 20, 2007, 6 pages.
- Extended European Search Report (includes Supplementary European Search Report and Search Opinion) received for European Patent Application No. 07863218.9, mailed on Dec. 9, 2010, 7 pages.
- Extended European Search Report (includes European Search Report and European Search Opinion) received for European Patent Application No. 12186113.2, mailed on Apr. 28, 2014, 14 pages.
- Abcom Pty. Ltd. "12.1" 925 Candela Mobile PC", LCDHardware.com, available at <http://www.lcdhardware.com/panel/12_1_panel/default.asp>, retrieved on Dec. 19, 2002, 2 pages.
- Cisco Systems, Inc., "Cisco Unity Unified Messaging User Guide", Release 4.0(5), Apr. 14, 2005, 152 pages.
- Cisco Systems, Inc., "Installation Guide for Cisco Unity Unified Messaging with Microsoft Exchange 2003/2000 (With Failover Configured)", Release 4.0(5), Apr. 14, 2005, 152 pages.
- Cisco Systems, Inc., "Operations Manager Tutorial, Cisco's IPC Management Solution", 2006, 256 pages.
- Coleman, David W., "Meridian Mail Voice Mail System Integrates Voice Processing and Personal Computing", Speech Technology, vol. 4, No. 2, Mar./Apr. 1998, pp. 84-87.
- Compaq, "Personal Jukebox", available at <<http://research.compaq.com/SRC/pjb/>>, 2001, 3 pages.
- Compaq Inspiration Technology, "Personal Jukebox (PJB)—Systems Research Center and PAAD", Oct. 13, 2000, 25 pages.
- Conkie et al., "Preselection of Candidate Units in a Unit Selection-Based Text-to-Speech Synthesis System", ISCA, 2000, 4 pages.
- Conklin, Jeffrey, "A Survey of Hypertext", MCC Software Technology Program, Dec. 1987, 40 pages.
- Copperi et al., "CELP Coding for High Quality Speech at 8 kbits/s", Proceedings of IEEE International Acoustics, Speech and Signal Processing Conference, Apr. 1986), as reprinted in Vector Quantization (IEEE Press), 1990, pp. 324-327.
- Corr, Paul, "Macintosh Utilities for Special Needs Users", available at <<http://homepage.mac.com/corr/macsup/columns/specneeds.html>>, Feb. 1994 (content updated Sep. 19, 1999), 4 pages.
- Creative, "Creative NOMAD MuVo", available at <<http://web.archive.org/web/20041024075901/www.creative.com/products/product.asp?category=213&subcategory=216&product=4983>>, retrieved on Jun. 7, 2006, 1 page.
- Creative, "Creative NOMAD MuVo TX", available at <<http://web.archive.org/web/20041024175952/www.creative.com/products/pfriendly.asp?product=9672>>, retrieved on Jun. 6, 2006, 1 page.
- Creative, "Digital MP3 Player", available at <<http://web.archive.org/web/20041024074823/www.creative.com/products/product.asp?category=213&subcategory=216&product=4983>>, 2004, 1 page.
- Creative Technology Ltd., "Creative NOMAD®: Digital Audio Player: User Guide (On-Line Version)", available at <<http://ec1.images-amazon.com/media/i3d/01/A/man-migrate/MANUAL000010757.pdf>>, Jun. 1999, 40 pages.
- Creative Technology Ltd., "Creative NOMAD® II: Getting Started—User Guide (on Line Version)", available at <<http://ec1.images-amazon.com/media/i3d/01/A/man-migrate/MANUAL000026434.pdf>>, Apr. 2000, 46 pages.
- Creative Technology Ltd., "Nomad Jukebox", User Guide, Version 1.0, Aug. 2000, 52 pages.
- Croft et al., "Task Support in an Office System", Proceedings of the Second ACM-SIGOA Conference on Office Information Systems, 1984, pp. 22-24.
- Crowley et al., "MMConf: An Infrastructure for Building Shared Multimedia Applications", CSCW 90 Proceedings, Oct. 1990, pp. 329-342.
- Cuperman et al., "Vector Predictive Coding of Speech at 16 kbit s/s", (IEEE Transactions on Communications, Jul. 1985), as reprinted in Vector Quantization (IEEE Press, 1990), 1990, pp. 300-311.
- ABF Software, "Lens-Magnifying Glass 1.5", available at <<http://download.com/3000-2437-10262078.html?tag=1st-0-1>>, retrieved on Feb. 11, 2004, 1 page.
- Davis et al., "Stone Soup Translation", Department of Linguistics, Ohio State University, 2001, 11 pages.
- De Herrera, Chris, "Microsoft ActiveSync 3.1", Version 1.02, available at <<http://www.cewindows.net/wce/activesync3.1.htm>>, Oct. 13, 2000, 8 pages.
- Degani et al., "'Soft' Controls for Hard Displays: Still a Challenge", Proceedings of the 36th Annual Meeting of the Human Factors Society, 1992, pp. 52-56.
- Del Strother, Jonathan, "Coverflow", available at <<http://www.steelskies.com/coverflow>>, retrieved on Jun. 15, 2006, 14 pages.
- Diamond Multimedia Systems, Inc., "Rio PMP300: User's Guide", available at <<http://ec1.images-amazon.com/media/i3d/01/A/man-migrate/MANUAL000022854.pdf>>, 1998, 28 pages.
- Dickinson et al., "Palmtips: Tiny Containers for All Your Data", PC Magazine, vol. 9, Mar. 1990, p. 218(3).
- Digital Equipment Corporation, "OpenVMS RTL DECtalk (DTKS) Manual", May 1993, 56 pages.
- Donahue et al., "Whiteboards: A Graphical Database Tool", ACM Transactions on Office Information Systems, vol. 4, No. 1, Jan. 1986, pp. 24-41.
- Dourish et al., "Portholes: Supporting Awareness in a Distributed Work Group", CHI 1992, May 1992, pp. 541-547.
- Abut et al., "Low-Rate Speech Encoding Using Vector Quantization and Subband Coding", (Proceedings of the IEEE International Acoustics, Speech and Signal Processing Conference, Apr. 1986), as reprinted in Vector Quantization IEEE Press, 1990, pp. 312-315.
- dyslexic.com, "AlphaSmart 3000 with CoWriter SmartApplet: Don Johnston Special Needs", available at <<http://www.dyslexic.com/procuts.php?catid=2&pid=465&PHPSID=2511b80000f7da>>, retrieved on Dec. 6, 2005, 13 pages.
- Edwards, John R., "Q&A: Integrated Software with Macros and an Intelligent Assistant", Byte Magazine, vol. 11, No. 1, Jan. 1986, pp. 120-122.
- Egido, Carmen, "Video Conferencing as a Technology to Support Group Work: A Review of its Failures", Bell Communications Research, 1988, pp. 13-24.
- Elliot, Chip, "High-Quality Multimedia Conferencing Through a Long-Haul Packet Network", BBN Systems and Technologies, 1993, pp. 91-98.
- Elliott et al., "Annotation Suggestion and Search for Personal Multimedia Objects on the Web", CIVR, Jul. 7-9, 2008, pp. 75-84.
- Elofson et al., "Delegation Technologies: Environmental Scanning with Intelligent Agents", Jour. of Management Info. Systems, Summer 1991, vol. 8, No. 1, 1991, pp. 37-62.
- Eluminox, "Illuminated Keyboard", available at <<http://www.eluminox.com/>>, retrieved on Dec. 19, 2002, 1 page.
- Engst, Adam C., "SoundJam Keeps on Jammin'", available at <<http://db.tidbits.com/getbits.acgi?tbart=05988>>, Jun. 19, 2000, 3 pages.
- Ericsson Inc., "Cellular Phone with Integrated MP3 Player", Research Disclosure Journal No. 41815, Feb. 1999, 2 pages.
- Eslambolchilar et al., "Making Sense of Fisheye Views", Second Dynamics and Interaction Workshop at University of Glasgow, Aug. 2005, 6 pages.
- Eslambolchilar et al., "Multimodal Feedback for Tilt Controlled Speed Dependent Automatic Zooming", UIST'04, Oct. 24-27, 2004, 2 pages.

(56)

References Cited

OTHER PUBLICATIONS

- Fanty et al., "A Comparison of DFT, PLP and Cochleagram for Alphabet Recognition", IEEE, Nov. 1991.
- Findlater et al., "Beyond QWERTY: Augmenting Touch-Screen Keyboards with Multi-Touch Gestures for Non-Alphanumeric Input", CHI '12, Austin, Texas, USA, May 5-10, 2012, 4 pages.
- Fisher et al., "Virtual Environment Display System", Interactive 3D Graphics, Oct. 23-24, 1986, pp. 77-87.
- Forsdick, Harry, "Explorations into Real-Time Multimedia Conferencing", Proceedings of the 16th International Symposium on Computer Message Systems, 1986, 331 pages.
- Furnas et al., "Space-Scale Diagrams: Understanding Multiscale Interfaces", CHI '95 Proceedings of the SIGCHI Conference on Human Factors in Computing Systems, 1995, pp. 234-241.
- Furnas, George W., "Effective View Navigation", Proceedings of the ACM SIGCHI Conference on Human Factors in Computing Systems, Mar. 1997, pp. 367-374.
- Furnas, George W., "Generalized Fisheye Views", CHI '86 Proceedings of the SIGCHI Conference on Human Factors in Computing Systems, vol. 17, No. 4, Apr. 1986, pp. 16-23.
- Furnas, George W., "The Fisheye Calendar System", Bellcore Technical Memorandum, Nov. 19, 1991.
- Gardner, Jr., P. C., "A System for the Automated Office Environment", IBM Systems Journal, vol. 20, No. 3, 1981, pp. 321-345.
- Garretson, R., "IBM Adds 'Drawing Assistant' Design Tool to Graphic Series", PC Week, vol. 2, No. 32, Aug. 13, 1985, 1 page.
- Gaver et al., "One Is Not Enough: Multiple Views in a Media Space", INTERCHI, Apr. 24-29, 1993, pp. 335-341.
- Gaver et al., "Realizing a Video Environment: EuroPARC's RAVE System", Rank Xerox Cambridge EuroPARC, 1992, pp. 27-35.
- Giachin et al., "Word Juncture Modeling Using Inter-Word Context-Dependent Phone-Like Units", Csel Technical Reports, vol. 20, No. 1, Mar. 1992, pp. 43-47.
- Gillespie, Kelly, "Adventures in Integration", Data Based Advisor, vol. 9, No. 9, Sep. 1991, pp. 90-92.
- Gillespie, Kelly, "Internationalize Your Applications with Unicode", Data Based Advisor, vol. 10, No. 10, Oct. 1992, pp. 136-137.
- Gilloire et al., "Innovative Speech Processing for Mobile Terminals: An Annotated Bibliography", Signal Processing, vol. 80, No. 7, Jul. 2000, pp. 1149-1166.
- Glinert-Stevens, Susan, "Microsoft Publisher: Desktop Wizardry", PC Sources, vol. 3, No. 2, Feb. 1992, 1 page.
- Gmail, "About Group Chat", available at <<http://mail.google.com/support/bin/answer.py?answer=81090>>, Nov. 26, 2007, 2 pages.
- Goldberg, Cheryl, "IBM Drawing Assistant: Graphics for the EGA", PC Magazine, vol. 4, No. 26, Dec. 24, 1985, 1 page.
- Good et al., "Building a User-Derived Interface", Communications of the ACM, (Oct. 1984) vol. 27, No. 10, Oct. 1984, pp. 1032-1043.
- Gray et al., "Rate Distortion Speech Coding with a Minimum Discrimination Information Distortion Measure", (IEEE Transactions on Information Theory, Nov. 1981), as reprinted in Vector Quantization (IEEE Press), 1990, pp. 208-221.
- Greenberg, Saul, "A Fisheye Text Editor for Relaxed-WYSIWIS Groupware", CHI '96 Companion, Vancouver, Canada, Apr. 13-18, 1996, 2 pages.
- Griffin et al., "Signal Estimation From Modified Short-Time Fourier Transform", IEEE Transactions on Acoustics, Speech and Signal Processing, vol. ASSP-32, No. 2, Apr. 1984, pp. 236-243.
- Gruhn et al., "A Research Perspective on Computer-Assisted Office Work", IBM Systems Journal, vol. 18, No. 3, 1979, pp. 432-456.
- Hain et al., "The Papageno TTS System", Siemens AG, Corporate Technology, Munich, Germany TC-STAR Workshop, 2006, 6 pages.
- Halbert, D. C., "Programming by Example", Dept. Electrical Engineering and Comp. Sciences, University of California, Berkeley, Nov. 1984, pp. 1-76.
- Hall, William S., "Adapt Your Program for Worldwide Use with Windows™. Internationalization Support", Microsoft Systems Journal, vol. 6, No. 6, Nov./Dec. 1991, pp. 29-58.
- Haoui et al., "Embedded Coding of Speech: A Vector Quantization Approach", (Proceedings of the IEEE International Acoustics, Speech and Signal Processing Conference, Mar. 1985), as reprinted in Vector Quantization (IEEE Press, 1990), 1990, pp. 297-299.
- Hartson et al., "Advances in Human-Computer Interaction", Chapters 1, 5, and 6, vol. 3, 1992, 121 pages.
- Heger et al., "KNOWBOT: An Adaptive Data Base Interface", Nuclear Science and Engineering, V. 107, No. 2, Feb. 1991, pp. 142-157.
- Hendrix et al., "The Intelligent Assistant: Technical Considerations Involved in Designing Q&A's Natural-Language Interface", Byte Magazine, Issue 14, Dec. 1987, 1 page.
- Heyer et al., "Exploring Expression Data: Identification and Analysis of Coexpressed Genes", Genome Research, vol. 9, 1999, pp. 1106-1115.
- Hill, R. D., "Some Important Features and Issues in User Interface Management System", Dynamic Graphics Project, University of Toronto, CSRI, vol. 21, No. 2, Apr. 1987, pp. 116-120.
- Hinckley et al., "A Survey of Design Issues in Spatial Input", UIST '94 Proceedings of the 7th Annual ACM Symposium on User Interface Software and Technology, 1994, pp. 213-222.
- Hiroshi, "TeamWork Station: Towards a Seamless Shared Workspace", NTT Human Interface Laboratories, CSCW 90 Proceedings, Oct. 1990, pp. 13-26.
- Holmes, "Speech System and Research", 1955, pp. 129-135, 152-153.
- Hon et al., "Towards Large Vocabulary Mandarin Chinese Speech Recognition", Conference on Acoustics, Speech, and Signal Processing, ICASSP-94, IEEE International, vol. 1, Apr. 1994, pp. 545-548.
- Hopper, Andy, "Pandora—An Experimental System for Multimedia Applications", Olivetti Research Laboratory, Apr. 1990, pp. 19-34.
- Howard, John H., "(Abstract) An Overview of the Andrew File System", Information Technology Center, Carnegie Mellon University; (CMU-ITC-88-062) to Appear in a future issue of the ACM Transactions on Computer Systems, 1988, pp. 1-6.
- Huang et al., "Real-Time Software-Based Video Coder for Multimedia Communication Systems", Department of Computer Science and Information Engineering, 1993, 10 pages.
- Hukin, R. W., "Testing an Auditory Model by Resynthesis", European Conference on Speech Communication and Technology, Sep. 26-29, 1989, pp. 243-246.
- Hunt, "Unit Selection in a Concatenative Speech Synthesis System Using a Large Speech Database", Copyright 1996 IEEE. "To appear in Proc. ICASSP-96, May 7-10, Atlanta, GA" ATR Interpreting Telecommunications Research Labs, Kyoto Japan, 1996, pp. 373-376.
- IBM, "Why Buy: ThinkPad", available at <<http://www.pc.ibm.com/us/thinkpad/easeofuse.html>>, retrieved on Dec. 19, 2002, 2 pages.
- IBM Corporation, "Simon Says Here's How", Users Manual, 1994, 3 pages.
- ichat AV, "Video Conferencing for the Rest of Us", Apple—Mac OS X—iChat AV, available at <<http://www.apple.com/macosx/features/ichat/>>, retrieved on Apr. 13, 2006, 3 pages.
- iphone Hacks, "Native iPhone MMS Application Released", available at <<http://www.iphonemods.com/2007/12/iphone-mms-app.html>>, retrieved on Dec. 25, 2007, 5 pages.
- iphonechat, "iChat for iPhone in JavaScript", available at <<http://www.publicity.com/iPhoneChat/>>, retrieved on Dec. 25, 2007, 2 pages.
- Jabra, "Bluetooth Headset: User Manual", 2005, 17 pages.
- Jabra, "Bluetooth Introduction", 2004, 15 pages.
- Jabra Corporation, "FreeSpeak: BT200 User Manual", 2002, 42 pages.
- Jaybird, "Everything Wrong with AIM: Because We've All Thought About It", available at <<http://www.psychnoble.com/archives/articles/82.html>>, May 24, 2006, 3 pages.
- Jeffay et al., "Kernel Support for Live Digital Audio and Video", In Proc. of the Second Intl. Workshop on Network and Operating System Support for Digital Audio and Video, vol. 614, Nov. 1991, pp. 10-21.

(56)

References Cited

OTHER PUBLICATIONS

- Jelinek et al., "Interpolated Estimation of Markov Source Parameters from Sparse Data", In Proceedings of the Workshop on Pattern Recognition in Practice, May 1980, pp. 381-397.
- Johnson, Jeff A., "A Comparison of User Interfaces for Panning on a Touch-Controlled Display", CHI '95 Proceedings, 1995, 8 pages.
- Kaappner et al., "Architecture of HeiPhone: A Testbed for Audio/Video Teleconferencing", IBM European Networking Center, 1993.
- Kamba et al., "Using Small Screen Space More Efficiently", CHI '96 Proceedings of the SIGCHI Conference on Human Factors in Computing Systems, Apr. 13-18, 1996, pp. 383-390.
- Kang et al., "Quality Improvement of LPC-Processed Noisy Speech by Using Spectral Subtraction", IEEE Transactions on Acoustics, Speech and Signal Processing, vol. 37, No. 6, Jun. 1989, pp. 939-942.
- Keahey et al., "Non-Linear Image Magnification", Apr. 24, 1996, 11 pages.
- Keahey et al., "Nonlinear Magnification Fields", Proceedings of the 1997 IEEE Symposium on Information Visualization, 1997, 12 pages.
- Keahey et al., "Techniques for Non-Linear Magnification Transformations", IEEE Proceedings of Symposium on Information Visualization, Oct. 1996, pp. 38-45.
- Keahey et al., "Viewing Text With Non-Linear Magnification: An Experimental Study", Department of Computer Science, Indiana University, Apr. 24, 1996, pp. 1-9.
- Kennedy, P. J., "Digital Data Storage Using Video Disc", IBM Technical Disclosure Bulletin, vol. 24, No. 2, Jul. 1981, p. 1171.
- Kerr, "An Incremental String Search in C: This Data Matching Algorithm Narrows the Search Space with each Keystroke", Computer Language, vol. 6, No. 12, Dec. 1989, pp. 35-39.
- Abut et al., "Vector Quantization of Speech and Speech-Like Waveforms", (IEEE Transactions on Acoustics, Speech, and Signal Processing, Jun. 1982), as reprinted in Vector Quantization (IEEE Press, 1990), 1990, pp. 258-270.
- Kim, E.A. S., "The Structure and Processing of Fundamental Frequency Contours", University of Cambridge, Doctoral Thesis, Apr. 1987, 378 pages.
- Kirstein et al., "Piloting of Multimedia Integrated Communications for European Researchers", Proc. INET '93, 1993, pp. 1-12.
- Kjelldahl et al., "Multimedia—Principles, Systems, and Applications", Proceedings of the 1991 Eurographics Workshop on Multimedia Systems, Applications, and Interaction, Apr. 1991.
- Kline et al., "Improving GUI Accessibility for People with Low Vision", CHI '95 Proceedings of the SIGCHI Conference on Human Factors in Computing Systems, May 7-11, 1995, pp. 114-121.
- Kline et al., "UnWindows 1.0: X Windows Tools for Low Vision Users", ACM SIGCAPH Computers and the Physically Handicapped, No. 49, Mar. 1994, pp. 1-5.
- Knight et al., "Heuristic Search", Production Systems, Artificial Intelligence, 2nd ed., McGraw-Hill, Inc., 1983-1991.
- Kroon et al., "Quantization Procedures for the Excitation in CELP Coders", (Proceedings of IEEE International Acoustics, Speech, and Signal Processing Conference, Apr. 1987), as reprinted in Vector Quantization (IEEE Press, 1990), 1990, pp. 320-323.
- Kuo et al., "A Radical-Partitioned coded Block Adaptive Neural Network Structure for Large-Volume Chinese Characters Recognition", International Joint Conference on Neural Networks, vol. 3, Jun. 1992, pp. 597-601.
- Kuo et al., "A Radical-Partitioned Neural Network System Using a Modified Sigmoid Function and a Weight-Dotted Radical Selector for Large-Volume Chinese Character Recognition VLSI", IEEE Int. Symp. Circuits and Systems, Jun. 1994, pp. 3862-3865.
- Kurlander et al., "Comic Chat", [Online], 1996 [Retrieved on: Feb. 4, 2013], SIGGRAPH '96 Proceedings of the 23rd annual conference on Computer graphics and interactive techniques, [Retrieved from: <http://delivery.acm.org/10.1145/240000/237260/p225-kurlander.pdf>], 1996, pp. 225-236.
- Laface et al., "A Fast Segmental Viterbi Algorithm for Large Vocabulary Recognition", International Conference on Acoustics, Speech, and Signal Processing, vol. 1, May 1995, pp. 560-563.
- Lafferty et al., "Conditional Random Fields: Probabilistic Models for Segmenting and Labeling Sequence Data", Proceedings of the 18th International Conference on Machine Learning, 2001, 9 pages.
- Adium, "AboutAdium—Adium X—Trac", available at <<http://web.archive.org/web/20070819113247/http://trac.adiumx.com/wiki/AboutAdium>>, retrieved on Nov. 25, 2011, 2 pages.
- Lamping et al., "Laying Out and Visualizing Large Trees Using a Hyperbolic Space", Proceedings of the ACM Symposium on User Interface Software and Technology, Nov. 1994, pp. 13-14.
- Lamping et al., "Visualizing Large Trees Using the Hyperbolic Browser", Apple Inc., Video Clip, MIT Media Library, on a CD, 1995.
- Lantz et al., "Towards a Universal Directory Service", Departments of Computer Science and Electrical Engineering, Stanford University, 1985, pp. 250-260.
- Lantz, Keith, "An Experiment in Integrated Multimedia Conferencing", 1986, pp. 267-275.
- Lauwers et al., "Collaboration Awareness in Support of Collaboration Transparency: Requirements for the Next Generation of Shared Window Systems", CHI'90 Proceedings, 1990, pp. 303-311.
- Lauwers et al., "Replicated Architectures for Shared Window Systems: A Critique", COCS '90 Proceedings of the ACM SIGOIS and IEEE CS TC-OA conference on Office information systems, ACM SIGOIS Bulletin, 1990, pp. 249-260.
- Lazzaro, Joseph J., "Adapting Desktop Computers to Meet the Needs of Disabled Workers is Easier Than You Might Think", Computers for the Disabled, BYTE Magazine, Jun. 1993, 4 pages.
- Leahy et al., "Effect of Touch Screen Target Location on User Accuracy", Proceedings of the Human Factors Society 34th Annual Meeting, 1990, 5 pages.
- Lee, Kai-Fu, "Automatic Speech Recognition", 1989, 14 pages (Table of Contents).
- Leung et al., "A Review and Taxonomy of Distortion-Oriented Presentation Techniques", ACM Transactions on Computer-Human Interaction (TOCHI), vol. 1, No. 2, Jun. 1994, pp. 126-160.
- Levinson et al., "Speech synthesis in telecommunications", IEEE Communications Magazine, vol. 31, No. 11, Nov. 1993, pp. 46-53.
- Lewis, "Speech synthesis in a computer aided learning environment", UK IT, Mar. 19-22, 1990, pp. 294-298.
- Lewis, Peter, "Two New Ways to Buy Your Bits", CNN Money, available at <<http://money.cnn.com/2003/12/30/commentary/ontechnology/download/>>, Dec. 31, 2003, 4 pages.
- Lieberman, Henry, "A Multi-Scale, Multi-Layer, Translucent Virtual Space", Proceedings of IEEE Conference on Information Visualization, Aug. 1997, pp. 124-131.
- Lieberman, Henry, "Powers of Ten Thousand: Navigating in Large Information Spaces", Proceedings of the ACM Symposium on User Interface Software and Technology, Nov. 1994, pp. 1-2.
- Lyon, R., "A Computational Model of Binaural Localization and Separation", Proceedings of IEEE International Conference on Acoustics, Speech and Signal Processing, Apr. 1983, pp. 1148-1151.
- Ahlberg et al., "The Alphaslider: A Compact and Rapid Selector", CHI '94 Proceedings of the SIGCHI Conference on Human Factors in Computing Systems, Apr. 1994, pp. 365-371.
- Lyons, Richard F., "CCD Correlators for Auditory Models", Proceedings of the Twenty-Fifth Asilomar Conference on Signals, Systems and Computers, Nov. 4-6, 1991, pp. 785-789.
- MacKenzie et al., "Alphanumeric Entry on Pen-Based Computers", International Journal of Human-Computer Studies, vol. 41, 1994, pp. 775-792.
- MacKinlay et al., "The Perspective Wall: Detail and Context Smoothly Integrated", ACM, 1991, pp. 173-179.
- Ahlberg et al., "Visual Information Seeking: Tight Coupling of Dynamic Query Filters with Starfield Displays", Proceedings of the SIGCHI Conference on Human Factors in Computing Systems, Apr. 24-28, 1994, pp. 313-317.
- Mactech, "KeyStrokes 3.5 for Mac OS X Boosts Word Prediction", available at <<http://www.mactech.com/news/?p=1007129>>, retrieved on Jan. 7, 2008, 3 pages.

(56)

References Cited

OTHER PUBLICATIONS

- Mahedero et al., "Natural Language Processing of Lyrics", In Proceedings of the 13th Annual ACM International Conference on Multimedia, ACM, Nov. 6-11, 2005, 4 pages.
- Marcus et al., "Building a Large Annotated Corpus of English: The Penn Treebank", Computational Linguistics, vol. 19, No. 2, 1993, pp. 313-330.
- Markel et al., "Linear Production of Speech", Reviews, 1976, pp. xii, 288.
- Masui, Toshiyuki, "POBox: An Efficient Text Input Method for Handheld and Ubiquitous Computers", Proceedings of the 1st International Symposium on Handheld and Ubiquitous Computing, 1999, 12 pages.
- Matsui et al., "Speaker Adaptation of Tied-Mixture-Based Phoneme Models for Text-Prompted Speaker Recognition", 1994 IEEE International Conference on Acoustics, Speech and Signal Processing, Apr. 19-22, 1994, 1-125-1-128.
- Matsuzawa, A., "Low-Voltage and Low-Power Circuit Design for Mixed Analog/Digital Systems in Portable Equipment", IEEE Journal of Solid-State Circuits, vol. 29, No. 4, 1994, pp. 470-480.
- Mellinger, David K., "Feature-Map Methods for Extracting Sound Frequency Modulation", IEEE Computer Society Press, 1991, pp. 795-799.
- Menico, Costas, "Faster String Searches", Dr. Dobb's Journal, vol. 14, No. 7, Jul. 1989, pp. 74-77.
- Menta, Richard, "1200 Song MP3 Portable is a Milestone Player", available at <<http://www.mp3newswire.net/stories/personaljuke.html>>, Jan. 11, 2000, 4 pages.
- Meyer, Mike, "A Shell for Modern Personal Computers", University of California, Aug. 1987, pp. 13-19.
- Meyrowitz et al., "Bruwin: An Adaptable Design Strategy for Window Manager/Virtual Terminal Systems", Department of Computer Science, Brown University, 1981, pp. 180-189.
- Miastkowski, Stan, "paperWorks Makes Paper Intelligent", Byte Magazine, Jun. 1992.
- Microsoft, "Turn On and Use Magnifier", available at <<http://www.microsoft.com/windowsxp/using/accessibility/magnifierturnon.mspx>>, retrieved on Jun. 6, 2009.
- Microsoft Corporation, Microsoft Office Word 2003 (SP2), Microsoft Corporation, SP3 as of 2005, pages MSWord 2003 Figures 1-5, 1983-2003.
- Microsoft Corporation, "Microsoft MS-DOS Operating System User's Guide", Microsoft Corporation, 1982, pp. 4-1 to 4-16, 5-1 to 5-19.
- Microsoft Press, "Microsoft Windows User's Guide for the Windows Graphical Environment", version 3.0, 1985-1990, pp. 33-41 & 70-74.
- Microsoft Windows XP, "Magnifier Utility", Oct. 25, 2001, 2 pages.
- Microsoft Word 2000 Microsoft Corporation, pages MSWord Figures 1-5, 1999.
- Microsoft/Ford, "Basic Sync Commands", www.SyncMyRide.com, Sep. 14, 2007, 1 page.
- Milner, N. P., "A Review of Human Performance and Preferences with Different Input Devices to Computer Systems", Proceedings of the Fourth Conference of the British Computer Society on People and Computers, Sep. 5-9, 1988, pp. 341-352.
- Miniman, Jared, "Applian Software's Replay Radio and Player v1.02", <<http://www.pocketnow.com/reviews/replay/replay.htm>>, Jul. 31, 2001, 16 pages.
- Moberg et al., "Cross-Lingual Phoneme Mapping for Multilingual Synthesis Systems", Proceedings of the 8th International Conference on Spoken Language Processing, Jeju Island, Korea, Interspeech 2004, Oct. 4-8, 2004, 4 pages.
- Moberg, M., "Contributions to Multilingual Low-Footprint TTS System for Hand-Held Devices", Doctoral Thesis, Tampere University of Technology, Aug. 17, 2007, 82 pages.
- Mobile Tech News, "T9 Text Input Software Updated", available at <<http://www.mobiletechnews.com/info/2004/11/23/122155.html>>, Nov. 23, 2004, 4 pages.
- Mok et al., "Media Searching on Mobile Devices", IEEE EIT 2007 Proceedings, 2007, pp. 126-129.
- Morland, D. V., "Human Factors Guidelines for Terminal Interface Design", Communications of the ACM vol. 26, No. 7, Jul. 1983, pp. 484-494.
- Morris et al., "Andrew: A Distributed Personal Computing Environment", Communications of the ACM, (Mar. 1986); vol. 29 No. 3., Mar. 1986, pp. 184-201.
- Muller et al., "CSCW'92 Demonstrations", 1992, pp. 11-14.
- Musicmatch, "Musicmatch and Xing Technology Introduce Musicmatch Jukebox", Press Releases, available at <<http://www.musicmatch.com/info/company/press/releases/?year=1998&release=2>>, May 18, 1998, 2 pages.
- Muthesamy et al., "Speaker-Independent Vowel Recognition: Spectrograms versus Cochleagrams", IEEE, Apr. 1990.
- My Cool Aids, "What's New", available at <<http://www.mycoolaids.com/>>, 2012, 1 page.
- Myers, Brad A., "Shortcutter for Palm", available at <<http://www.cs.cmu.edu/~pebbles/v5/shortcutter/palm/index.html>>, retrieved on Jun. 18, 2014, 10 pages.
- Nadoli et al., "Intelligent Agents in the Simulation of Manufacturing Systems", Proceedings of the SCS Multiconference on AI and Simulation, 1989, 1 page.
- Nakagawa et al., "Unknown Word Guessing and Part-of-Speech Tagging Using Support Vector Machines", Proceedings of the 6th NLPSP, 2001, pp. 325-331.
- Ahlstrom et al., "Overcoming Touchscreen User Fatigue by Workplace Design", CHI '92 Posters and Short Talks of the 1992 SIGCHI Conference on Human Factors in Computing Systems, 1992, pp. 101-102.
- NCIP, "NCIP Library: Word Prediction Collection", available at <<http://www2.edc.org/ncip/library/wp/toc.htm>>, 1998, 4 pages.
- NCIP, "What is Word Prediction?", available at <http://www2.edc.org/NCIP/library/wp/what_is.htm>, 1998, 2 pages.
- NCIP Staff, "Magnification Technology", available at <<http://www2.edc.org/ncip/library/vi/magnifi.htm>>, 1994, 6 pages.
- Newton, Harry, "Newton's Telecom Dictionary", Mar. 1998, pp. 62, 155, 610-611, 771.
- Nguyen et al., "Generic Manager for Spoken Dialogue Systems", In DiaBruck: 7th Workshop on the Semantics and Pragmatics of Dialogue, Proceedings, 2003, 2 pages.
- Nilsson, B. A., "Microsoft Publisher is an Honorable Start for DTP Beginners", Computer Shopper, Feb. 1, 1992, 2 pages.
- Noik, Emanuel G., "Layout-Independent Fisheye Views of Nested Graphs", IEEE Proceedings of Symposium on Visual Languages, 1993, 6 pages.
- Nonhoff-Arps et al., "StraBenmusik: Portable MP3-Spieler mit USB Anschluss", CT Magazin Fuer Computer Technik, Verlag Heinz Heise GmbH, Hannover DD, No. 25, 2000, pp. 166-175.
- Northern Telecom, "Meridian Mail PC User Guide", 1988, 17 Pages.
- Notenboom, Leo A., "Can I Retrieve Old MSN Messenger Conversations?", available at <http://ask-leo.com/can_i_retrieve_old_msn_messenger_conversations.html>, Mar. 11, 2004, 23 pages.
- O'Connor, Rory J., "Apple Banking on Newton's Brain", San Jose Mercury News, Apr. 22, 1991.
- Ohsawa et al., "A computational Model of an Intelligent Agent Who Talks with a Person", Research Reports on Information Sciences, Series C, No. 92, Apr. 1989, pp. 1-18.
- Ohtomo et al., "Two-Stage Recognition Method of Hand-Written Chinese Characters Using an Integrated Neural Network Model", Denshi Jooohoo Tsuushin Gakkai Ronbunshi, D-II, vol. J74, Feb. 1991, pp. 158-165.
- Okazaki et al., "Multi-Fisheye Transformation Method for Large-Scale Network Maps", IEEE Japan, vol. 44, No. 6, 1995, pp. 495-500.
- Omologo et al., "Microphone Array Based Speech Recognition with Different Talker-Array Positions", IEEE International Conference on Acoustics, Speech, and Signal Processing, vol. 1, Apr. 21-24, 1997, pp. 227-230.

(56)

References Cited

OTHER PUBLICATIONS

- Oregon Scientific, "512MB Waterproof MP3 Player with FM Radio & Built-in Pedometer", available at <<http://www2.oregonscientific.com/shop/product.asp?cid=4&scid=11&pid=581>>, retrieved on Jul. 31, 2006, 2 pages.
- Oregon Scientific, "Waterproof Music Player with FM Radio and Pedometer (MP121)—User Manual", 2005, 24 pages.
- Padilla, Alfredo, "Palm Treo 750 Cell Phone Review—Messaging", available at <<http://www.wirelessinfo.com/content/palm-Treo-750-Cell-Phone-Review/Messaging.htm>>, Mar. 17, 2007, 6 pages.
- Palay et al., "The Andrew Toolkit: An Overview", Information Technology Center, Carnegie-Mellon University, 1988, pp. 1-15.
- Palm, Inc., "User Guide : Your Palm® Treo.™. 755p Smartphone", 2005-2007, 304 pages.
- Panasonic, "Toughbook 28: Powerful, Rugged and Wireless", Panasonic: Toughbook Models, available at <http://www.panasonic.com/computer/notebook/html/01a_s8.htm>, retrieved on Dec. 19, 2002, 3 pages.
- Parks et al., "Classification of Whale and Ice Sounds with a cochlear Model", IEEE, Mar. 1992.
- Patterson et al., "Rendezvous: An Architecture for Synchronous Multi-User Applications", CSCW '90 Proceedings, 1990, pp. 317-328.
- International Search Report received for PCT Patent Application No. PCT/US2002/033330, mailed on Feb. 4, 2003, 6 pages.
- Ahmed et al., "Intelligent Natural Language Query Processor", TENCON '89, Fourth IEEE Region 10 International Conference, Nov. 22-24, 1989, pp. 47-49.
- Ahuja et al., "A Comparison of Application Sharing Mechanisms in Real-Time Desktop Conferencing Systems", At&T Bell Laboratories, 1990, pp. 238-248.
- International Search Report and Written Opinion received for PCT Patent Application No. PCT/US2005/038819, mailed on Apr. 5, 2006, 12 pages.
- International Search Report received for PCT Patent Application No. PCT/US2005/046797, mailed on Nov. 24, 2006, 6 pages.
- Invitation to Pay Additional Fees and Partial Search Report received for PCT Application No. PCT/US2005/046797, mailed on Jul. 3, 2006, 6 pages.
- Written Opinion received for PCT Patent Application No. PCT/US2005/046797, mailed on Nov. 24, 2006, 9 pages.
- International Search Report and Written Opinion received for PCT Patent Application No. PCT/US2006/048669, mailed on Jul. 2, 2007, 12 pages.
- International Search Report and Written Opinion received for PCT Patent Application No. PCT/US2006/048670, mailed on May 21, 2007, 11 pages.
- Invitation to Pay Addition Fees and Partial International Search Report received for PCT Patent Application No. PCT/US2006/048738, mailed on Jul. 10, 2007, 4 pages.
- International Search Report and Written Opinion received for PCT Patent Application No. PCT/US2006/048753, mailed on Jun. 19, 2007, 15 pages.
- International Search Report and Written Opinion received for PCT Patent Application No. PCT/US2007/026243, mailed on Mar. 31, 2008, 10 pages.
- International Search Report and Written Opinion received for PCT Patent Application No. PCT/US2007/088872, mailed on May 8, 2008, 8 pages.
- International Search Report and Written Opinion received for PCT Patent Application No. PCT/US2007/088873, mailed on May 8, 2008, 7 pages.
- International Search Report and Written Opinion received for PCT Patent Application No. PCT/US2008/000032, mailed on Jun. 12, 2008, 7 pages.
- International Search Report and Written Opinion received for PCT Patent Application No. PCT/US2008/000042, mailed on May 21, 2008, 7 pages.
- International Search Report and Written Opinion received for PCT Patent Application No. PCT/US2008/000043, mailed on Oct. 10, 2008, 12 pages.
- Invitation to Pay Additional Fees received for PCT Patent Application No. PCT/US2008/000043, mailed on Jun. 27, 2008, 4 pages.
- International Search Report and Written Opinion received for PCT Patent Application No. PCT/US2008/000045, mailed on Jun. 12, 2008, 7 pages.
- International Search Report and Written Opinion received for PCT Patent Application No. PCT/US2008/000047, mailed on Sep. 11, 2008, 12 pages.
- Invitation to Pay Additional Fees received for PCT Patent Application No. PCT/US2008/000047, mailed on Jul. 4, 2008, 4 pages.
- International Search Report and Written Opinion received for PCT Patent Application No. PCT/US2008/000059, mailed on Sep. 19, 2008, 18 pages.
- International Search Report and Written Opinion received for PCT Patent Application No. PCT/US2008/000061, mailed on Jul. 1, 2008, 13 pages.
- International Search Report and Written Opinion received for PCT Patent Application No. PCT/US2011/020350, mailed on Jun. 30, 2011, 17 pages.
- Invitation to Pay Additional Fees and Partial International Search Report received for PCT Patent Application No. PCT/US2011/020350, mailed on Apr. 14, 2011, 5 pages.
- International Preliminary Report on Patentability received for PCT Patent Application No. PCT/US2011/020861, mailed on Aug. 2, 2012, 11 pages.
- Aikawa, K. "Time-Warping Neural Network for Phoneme Recognition", IEEE International Joint Conference on Neural Networks, vol. 3, Nov. 18-21, 1991, pp. 2122-2127.
- Allen et al., "Automated Natural Spoken Dialog", Computer, vol. 35, No. 4, Apr. 2002, pp. 51-56.
- Alleva et al., "Applying Sphinx-II to DARPA Wall Street Journal CSR Task", Proceedings of Speech and Natural Language Workshop, Feb. 1992, pp. 393-398.
- Amrel Corporation, "Rocky Matrix BackLit Keyboard", available at <http://www.amrel.com/asi_matrixkeyboard.html>, retrieved on Dec. 19, 2002, 1 page.
- International Search Report and Written Opinion received for PCT Patent Application No. PCT/US2012/034028, mailed on Jun. 11, 2012, 9 pages.
- International Search Report and Written Opinion received for PCT Patent Application No. PCT/US2012/040931, mailed on Feb. 1, 2013, 4 pages (International Search Report only).
- Apple, "VoiceOver", available at <<http://www.apple.com/accessibility/voiceover/>>, Feb. 2009, 5 pages.
- Apple Computer, Inc., "Apple—iPod—Technical Specifications, iPod 20GB and 60GB Mac + PC", available at <<http://www.apple.com/ipod/color/specs.html>>, 2005, 3 pages.
- International Search Report and Written Opinion received for PCT Patent Application No. PCT/US2013/041225, mailed on Aug. 23, 2013, 3 pages (International Search Report only).
- Invitation to Pay Additional Fees received for PCT Patent Application No. PCT/US2013/047659, mailed on Feb. 27, 2014, 7 pages.
- Invitation to Pay Additional Fees received for PCT Application No. PCT/US2013/052558, mailed on Nov. 7, 2013, 6 pages.
- Pearl, Amy, "System Support for Integrated Desktop Video Conferencing", Sunmicrosystems Laboratories, Dec. 1992, pp. 1-15.
- Penn et al., "Ale for Speech: A Translation Prototype", Bell Laboratories, 1999, 4 pages.
- Phillipps, Ben, "Touchscreens are Changing the Face of Computers—Today's Users Have Five Types of Touchscreens to Choose from, Each with its Own Unique Characteristics", Electronic Products, Nov. 1994, pp. 63-70.
- Phillips, Dick, "The Multi-Media Workstation", SIGGRAPH '89 Panel Proceedings, 1989, pp. 93-109.
- Pickering, J. A., "Touch-Sensitive Screens: The Technologies and Their Application", International Journal of Man-Machine Studies, vol. 25, No. 3, Sep. 1986, pp. 249-269.
- Pingali et al., "Audio-Visual Tracking for Natural Interactivity", ACM Multimedia, Oct. 1999, pp. 373-382.

(56)

References Cited

OTHER PUBLICATIONS

- Plaisant et al., "Touchscreen Interfaces for Alphanumeric Data Entry", Proceedings of the Human Factors and Ergonomics Society 36th Annual Meeting, 1992, pp. 293-297.
- Plaisant et al., "Touchscreen Toggle Design", CHI'92, May 3-7, 1992, pp. 667-668.
- Poly-Optical Products, Inc., "Poly-Optical Fiber Optic Membrane Switch Backlighting", available at <http://www.poly-optical.com/membrane_switches.html>, retrieved on Dec. 19, 2002, 3 pages.
- Poor, Alfred, "Microsoft Publisher", PC Magazine, vol. 10, No. 20, Nov. 26, 1991, 1 page.
- Potter et al., "An Experimental Evaluation of Three Touch Screen Strategies within a Hypertext Database", International Journal of Human-Computer Interaction, vol. 1, No. 1, 1989, pp. 41-52.
- Potter et al., "Improving the Accuracy of Touch Screens: An Experimental Evaluation of Three Strategies", CHI '88 ACM, 1988, pp. 27-32.
- Public Safety Technologies, "Tracer 2000 Computer", available at <<http://www.pst911.com/tracer.html>>, retrieved on Dec. 19, 2002, 3 pages.
- Apple Computer, Inc., "Apple Announces iTunes 2", Press Release, Oct. 23, 2001, 2 pages.
- Rabiner et al., "Digital Processing of Speech Signals", Prentice Hall, 1978, pp. 274-277.
- Rampe et al., "SmartForm Designer and SmartForm Assistant", News release, Claris Corp., Jan. 9, 1989, 1 page.
- Rao et al., "Exploring Large Tables with the Table Lens", Apple Inc., Video Clip, Xerox Corp., on a CD, 1994.
- Rao et al., "Exploring Large Tables with the Table Lens", CHI'95 Mosaic of Creativity, ACM, May 7-11, 1995, pp. 403-404.
- Rao et al., "The Table Lens: Merging Graphical and Symbolic Representations in an Interactive Focus+Context Visualization for Tabular Information", Proceedings of the ACM SIGCHI Conference on Human Factors in Computing Systems, Apr. 1994, pp. 1-7.
- Raper, Larry K., "The C-MU PC Server Project", (CMU-ITC-86-051), Dec. 1986, pp. 1-30.
- Ratcliffe et al., "Intelligent Agents Take U.S. Bows", MacWeek, vol. 6, No. 9, Mar. 2, 1992, 1 page.
- Reddy, D. R., "Speech Recognition by Machine: A Review", Proceedings of the IEEE, Apr. 1976, pp. 501-531.
- Reininger et al., "Speech and Speaker Independent Codebook Design in VQ Coding Schemes", (Proceedings of the IEEE International Acoustics, Speech and Signal Processing Conference, Mar. 1985), as reprinted in Vector Quantization (IEEE Press, 1990), 1990, pp. 271-273.
- Ren et al., "Efficient Strategies for Selecting Small Targets on Pen-Based Systems: An Evaluation Experiment for Selection Strategies and Strategy Classifications", Proceedings of the IFIP TC2/TC13 WG2.7/WG13.4 Seventh Working Conference on Engineering for Human-Computer Interaction, vol. 150, 1998, pp. 19-37.
- Ren et al., "Improving Selection Performance on Pen-Based Systems: A Study of Pen-Based Interaction for Selection Tasks", ACM Transactions on Computer-Human Interaction, vol. 7, No. 3, Sep. 2000, pp. 384-416.
- Ren et al., "The Best among Six Strategies for Selecting a Minute Target and the Determination of the Minute Maximum Size of the Targets on a Pen-Based Computer", Human-Computer Interaction INTERACT, 1997, pp. 85-92.
- Apple Computer, Inc., "Apple Introduces iTunes—World's Best and Easiest to Use Jukebox Software", Macworld Expo, Jan. 9, 2001, 2 pages.
- Riecken, R. D., "Adaptive Direct Manipulation", IEEE Xplore, 1991, pp. 1115-1120.
- Rioport, "Rio 500: Getting Started Guide", available at <<http://ec1.images-amazon.com/media/i3d/01/A/man-migrate/MANUAL000023453.pdf>>, 1999, 2 pages.
- Robbin et al., "MP3 Player and Encoder for Macintosh!", SoundJam MP Plus, Version 2.0, 2000, 76 pages.
- Robertson et al., "Information Visualization Using 3D Interactive Animation", Communications of the ACM, vol. 36, No. 4, Apr. 1993, pp. 57-71.
- Robertson et al., "The Document Lens", UIST '93, Nov. 3-5, 1993, pp. 101-108.
- Root, Robert, "Design of a Multi-Media Vehicle for Social Browsing", Bell Communications Research, 1988, pp. 25-38.
- Roseberry, Catherine, "How to Pair a Bluetooth Headset & Cell Phone", available at <http://mobileoffice.about.com/od/usingyourphone/ht/blueheadset_p.htm>, retrieved on Apr. 29, 2006, 2 pages.
- Rosenberg et al., "An Overview of the Andrew Message System", Information Technology Center Carnegie-Mellon University, Jul. 1987, pp. 99-108.
- Rosner et al., "In Touch: A Graphical User Interface Development Tool", IEEE Colloquium on Software Tools for Interface Design, Nov. 8, 1990, pp. 12/1-12/7.
- Rossfrank, "Konstenlose Sprachmittelungens Festnetz", XP002234425, Dec. 10, 2000, pp. 1-4.
- Roucos et al., "A Segment Vocoder at 150 B/S", (Proceedings of the IEEE International Acoustics, Speech and Signal Processing Conference, Apr. 1983), as reprinted in Vector Quantization (IEEE Press, 1990), 1990, pp. 246-249.
- Roucos et al., "High Quality Time-Scale Modification for Speech", Proceedings of the 1985 IEEE Conference on Acoustics, Speech and Signal Processing, 1985, pp. 493-496.
- Sabin et al., "Product Code Vector Quantizers for Waveform and Voice Coding", (IEEE Transactions on Acoustics, Speech and Signal Processing, Jun. 1984), as reprinted in Vector Quantization (IEEE Press, 1990), 1990, pp. 274-288.
- Apple Computer, Inc., "Apple's iPod Available in Stores Tomorrow", Press Release, Nov. 9, 2001, 1 page.
- Santen, Jan P., "Assignment of Segmental Duration in Text-to-Speech Synthesis", Computer Speech and Language, vol. 8, No. 2, Apr. 1994, pp. 95-128.
- Sarawagi, Sunita, "CRF Package Page", available at <<http://crf.sourceforge.net/>>, retrieved on Apr. 6, 2011, 2 pages.
- Sarkar et al., "Graphical Fisheye Views", Communications of the ACM, vol. 37, No. 12, Dec. 1994, pp. 73-83.
- Sarkar et al., "Graphical Fisheye Views of Graphs", Systems Research Center, Digital Equipment Corporation Mar. 17, 1992, 31 pages.
- Sarkar et al., "Graphical Fisheye Views of Graphs", CHI '92 Proceedings of the SIGCHI Conference on Human Factors in Computing Systems, May 3-7, 1992, pp. 83-91.
- Sarkar et al., "Stretching the Rubber Sheet: A Metaphor for Viewing Large Layouts on Small Screens", UIST'93, ACM, Nov. 3-5, 1993, pp. 81-91.
- Sastry, Ravindra W., "A Need for Speed: A New Speedometer for Runners", submitted to the Department of Electrical Engineering and Computer Science at the Massachusetts Institute of Technology, 1999, pp. 1-42.
- Schafer et al., "Digital Representations of Speech Signals", Proceedings of the IEEE, vol. 63, No. 4, Apr. 1975, pp. 662-677.
- Schaffer et al., "Navigating Hierarchically Clustered Networks through Fisheye and Full-Zoom Methods", ACM Transactions on Computer-Human Interaction, vol. 3, No. 2, Jun. 1996, pp. 162-188.
- Scheifler, R. W., "The X Window System", MIT Laboratory for Computer Science and Gettys, Jim Digital Equipment Corporation and MIT Project Athena; ACM Transactions on Graphics, vol. 5, No. 2, Apr. 1986, pp. 79-109.
- Schluter et al., "Using Phase Spectrum Information for Improved Speech Recognition Performance", IEEE International Conference on Acoustics, Speech, and Signal Processing, 2001, pp. 133-136.
- Schmandt et al., "A Conversational Telephone Messaging System", IEEE Transactions on Consumer Electronics, vol. CE-30, Aug. 1984, pp. xxi-xxiv.
- Schmandt et al., "Phone Slave: A Graphical Telecommunications Interface", Society for Information Display, International Symposium Digest of Technical Papers, Jun. 1984, 4 pages.
- Schmandt et al., "Phone Slave: A Graphical Telecommunications Interface", Proceedings of the SID, vol. 26, No. 1, 1985, pp. 79-82.

(56)

References Cited

OTHER PUBLICATIONS

- Schmid, H., "Part-of-speech tagging with neural networks", COLING '94 Proceedings of the 15th conference on Computational linguistics—vol. 1, 1994, pp. 172-176.
- Schooler et al., "A Packet-switched Multimedia Conferencing System", by Eve Schooler, et al; ACM SIGOIS Bulletin, vol. I, No. 1, Jan. 1989, pp. 12-22.
- Schooler et al., "An Architecture for Multimedia Connection Management", Proceedings IEEE 4th Comsoc International Workshop on Multimedia Communications, Apr. 1992, pp. 271-274.
- Schooler et al., "Multimedia Conferencing: Has it Come of Age?", Proceedings 24th Hawaii International Conference on System Sciences, vol. 3, Jan. 1991, pp. 707-716.
- Schooler et al., "The Connection Control Protocol: Architecture Overview", USC/Information Sciences Institute, Jan. 28, 1992, pp. 1-6.
- Schooler, Eve, "A Distributed Architecture for Multimedia Conference Control", ISI Research Report, Nov. 1991, pp. 1-18.
- Schooler, Eve M., "Case Study: Multimedia Conference Control in a Packet-Switched Teleconferencing System", Journal of Internetworking: Research and Experience, vol. 4, No. 2, Jun. 1993, pp. 99-120.
- Schooler, Eve M., "The Impact of Scaling on a Multimedia Connection Architecture", Multimedia Systems, vol. 1, No. 1, 1993, pp. 2-9.
- Schütze, H., "Distributional part-of-speech tagging", EACL '95 Proceedings of the seventh conference on European chapter of the Association for Computational Linguistics, 1995, pp. 141-148.
- Schütze, Hinrich, "Part-of-speech induction from scratch", ACL '93 Proceedings of the 31st annual meeting on Association for Computational Linguistics, 1993, pp. 251-258.
- Schwartz et al., "Context-Dependent Modeling for Acoustic-Phonetic Recognition of Continuous Speech", IEEE International Conference on Acoustics, Speech, and Signal Processing, vol. 10, Apr. 1985, pp. 1205-1208.
- Schwartz et al., "Improved Hidden Markov Modeling of Phonemes for Continuous Speech Recognition", IEEE International Conference on Acoustics, Speech, and Signal Processing, vol. 9, 1984, pp. 21-24.
- Schwartz et al., "The N-Best Algorithm: An Efficient and Exact Procedure for Finding the N Most Likely Sentence Hypotheses", IEEE, 1990, pp. 81-84.
- Scott et al., "Designing Touch Screen Numeric Keypads: Effects of Finger Size, Key Size, and Key Spacing", Proceedings of the Human Factors and Ergonomics Society 41st Annual Meeting, Oct. 1997, pp. 360-364.
- Seagrave, Jim, "A Faster Way to Search Text", EXE, vol. 5, No. 3, Aug. 1990, pp. 50-52.
- Sears et al., "High Precision Touchscreens: Design Strategies and Comparisons with a Mouse", International Journal of Man-Machine Studies, vol. 34, No. 4, Apr. 1991, pp. 593-613.
- Sears et al., "Investigating Touchscreen Typing: The Effect of Keyboard Size on Typing Speed", Behavior & Information Technology, vol. 12, No. 1, 1993, pp. 17-22.
- Sears et al., "Touchscreen Keyboards", Apple Inc., Video Clip, Human-Computer Interaction Laboratory, on a CD, Apr. 1991.
- Seide et al., "Improving Speech Understanding by Incorporating Database Constraints and Dialogue History", Proceedings of Fourth International Conference on Philadelphia., 1996, pp. 1017-1020.
- Shiraki et al., "LPC Speech Coding Based on Variable-Length Segment Quantization", (IEEE Transactions on Acoustics, Speech and Signal Processing, Sep. 1988), as reprinted in Vector Quantization (IEEE Press, 1990), 1990, pp. 250-257.
- Shneiderman, Ben, "Designing the User Interface: Strategies for Effective Human-Computer Interaction", Second Edition, 1992, 599 pages.
- Shneiderman, Ben, "Designing the User Interface: Strategies for Effective Human-Computer Interaction", Third Edition, 1998, 669 pages.
- Shneiderman, Ben, "Direct Manipulation for Comprehensible, Predictable and Controllable User Interfaces", Proceedings of the 2nd International Conference on Intelligent User Interfaces, 1997, pp. 33-39.
- Shneiderman, Ben, "Sparks of Innovation in Human-Computer Interaction", 1993, (Table of Contents, Title Page, Ch. 4, Ch. 6 and List of References).
- Shneiderman, Ben, "The Eyes Have It: A Task by Data Type Taxonomy for Information Visualizations", IEEE Proceedings of Symposium on Visual Languages, 1996, pp. 336-343.
- Shneiderman, Ben, "Touch Screens Now Offer Compelling Uses", IEEE Software, Mar. 1991, pp. 93-94.
- Shoham et al., "Efficient Bit and Allocation for an Arbitrary Set of Quantizers", (IEEE Transactions on Acoustics, Speech, and Signal Processing, Sep. 1988) as reprinted in Vector Quantization (IEEE Press, 1990), 1990, pp. 289-296.
- Simkovitz, Daniel, "LP-DOS Magnifies the PC Screen", IEEE, 1992, pp. 203-204.
- Singh et al., "Automatic Generation of Phone Sets and Lexical Transcriptions", Acoustics, Speech and Signal Processing (ICASSP'00), 2000, 1 page.
- Sinitzyn, Alexander, "A Synchronization Framework for Personal Mobile Servers", Proceedings of the Second IEEE Annual Conference on Pervasive Computing and Communications Workshops, Piscataway, 2004, pp. 1, 3 and 5.
- Slaney et al., "On the Importance of Time—A Temporal Representation of Sound", Visual Representation of Speech Signals, 1993, pp. 95-116.
- Smeaton, Alan F., "Natural Language Processing and Information Retrieval", Information Processing and Management, vol. 26, No. 1, 1990, pp. 19-20.
- Smith et al., "Guidelines for Designing User Interface Software", User Lab, Inc., Aug. 1986, pp. 1-384.
- Smith et al., "Relating Distortion to Performance in Distortion Oriented Displays", Proceedings of Sixth Australian Conference on Computer-Human Interaction, Nov. 1996, pp. 6-11.
- Sony Eicicsson Corporate, "Sony Ericsson to introduce Auto pairing.™ to Improve Bluetooth.™. Connectivity Between Headsets and Phones", Press Release, available at <http://www.sonyericsson.com/spg.jsp?cc=global&lc=en&ver=4001&template=pc3_1_1&z...>, Sep. 28, 2005, 2 pages.
- Soong et al., "A High Quality Subband Speech Coder with Backward Adaptive Predictor and Optimal Time-Frequency Bit Assignment", (Proceedings of the IEEE International Acoustics, Speech, and Signal Processing Conference, Apr. 1986), as reprinted in Vector Quantization (IEEE Press, 1990), 1990, pp. 316-319.
- Spiller, Karen, "Low-Decibel Earbuds Keep Noise at a Reasonable Level", available at <<http://www.nashuatelegraph.com/apps/pbcs.dll/article?Date=20060813&Cate...>>, Aug. 13, 2006. 3 pages.
- Apple Computer, Inc., "Inside Macintosh", vol. VI, 1985.
- Srinivas et al., "Monet: A Multi-Media System for Conferencing and Application Sharing in Distributed Systems", CERC Technical Report Series Research Note, Feb. 1992.
- Stealth Computer Corporation, "Peripherals for Industrial Keyboards & Pointing Devices", available at <http://www.stealthcomputer.com/peripherals_oem.htm>, retrieved on Dec. 19, 2002, 6 pages.
- Steinberg, Gene, "Sonicblue Rio Car (10 GB, Reviewed: 6 GB)", available at <<http://electronics.cnet.com/electronics/0-6342420-1304-4098389.html>>, Dec. 12, 2000, 2 pages.
- Stent et al., "Geo-Centric Language Models for Local Business Voice Search", AT&T Labs—Research, 2009, pp. 389-396.
- Stone et al., "The Movable Filter as a User Interface Tool", CHI '94 Human Factors in Computing Systems, 1994, pp. 306-312.
- Su et al., "A Review of ZoomText Xtra Screen Magnification Program for Windows 95", Journal of Visual Impairment & Blindness, Feb. 1998, pp. 116-119.
- Su, Joseph C., "A Review of Telesensory's Vista PCI Screen Magnification System", Journal of Visual Impairment & Blindness, Oct. 1998, pp. 705, 707-710.

(56)

References Cited

OTHER PUBLICATIONS

- Sullivan, Danny, "How Google Instant's Autocomplete Suggestions Work", available at <<http://searchengineland.com/how-google-instant-autocomplete-suggestions-work-62592>>, Apr. 6, 2011, 12 pages.
- Summerfield et al., "ASIC Implementation of the Lyon Cochlea Model", Proceedings of the 1992 International Conference on Acoustics, Speech and Signal Processing, IEEE, vol. V, 1992, pp. 673-676.
- T3 Magazine, "Creative MuVo TX 256MB", available at <http://www.t3.co.uk/reviews/entertainment/mp3_player/creative_muvo_tx_256mb>, Aug. 17, 2004, 1 page.
- Taos, "Taos, Inc. Announces Industry's First Ambient Light Sensor to Convert Light Intensity to Digital Signals", News Release, available at <http://www.taosinc.com/pressrelease_090902.htm>, Sep. 16, 2002, 3 pages.
- Apple Computer, Inc., "iTunes 2, Playlist Related Help Screens", iTunes v2.0, 2000-2001, 8 pages.
- Tello, Ernest R., "Natural-Language Systems", Mastering AI Tools and Techniques, Howard W. Sams & Company, 1988.
- TG3 Electronics, Inc., "BL82 Series Backlit Keyboards", available at <<http://www.tg3electronics.com/products/backlit/backlit.htm>>, retrieved on Dec. 19, 2002, 2 pages.
- The HP 150, "Hardware: Compact, Powerful, and Innovative", vol. 8, No. 10, Oct. 1983, pp. 36-50.
- Tidwell, Jenifer, "Animated Transition", Designing Interfaces, Patterns for effective Interaction Design, Nov. 2005, First Edition, 4 pages.
- Touch, Joseph, "Zoned Analog Personal Teleconferencing", USC / Information Sciences Institute, 1993, pp. 1-19.
- Toutanova et al., "Feature-Rich Part-of-Speech Tagging with a Cyclic Dependency Network", Computer Science Dept., Stanford University, Stanford CA 94306-9040, 2003, 8 pages.
- Trigg et al., "Hypertext Habitats: Experiences of Writers in NoteCards", Hypertext'87 Papers; Intelligent Systems Laboratory, Xerox Palo Alto Research Center, 1987, pp. 89-108.
- Trowbridge, David, "Using Andrew for Development of Educational Applications", Center for Design of Educational Computing, Carnegie-Mellon University (CMU-ITC-85-065), Jun. 2, 1985, pp. 1-6.
- Tsao et al., "Matrix Quantizer Design for LPC Speech Using the Generalized Lloyd Algorithm", (IEEE Transactions on Acoustics, Speech and Signal Processing, Jun. 1985), as reprinted in Vector Quantization (IEEE Press, 1990), 1990, pp. 237-245.
- Turletti, Thierry, "The INRIA Videoconferencing System (IVS)", Oct. 1994, pp. 1-7.
- Uslan et al., "A Review of Henter-Joyce's MAGic for Windows NT", Journal of Visual Impairment and Blindness, Dec. 1999, pp. 666-668.
- Uslan et al., "A Review of Supernova Screen Magnification Program for Windows", Journal of Visual Impairment & Blindness, Feb. 1999, pp. 108-110.
- Uslan et al., "A Review of Two Screen Magnification Programs for Windows 95: Magnum 95 and LP-Windows", Journal of Visual Impairment & Blindness, Sep.-Oct. 1997, pp. 9-13.
- Veiga, Alex, "AT&T Wireless Launching Music Service", available at <http://bizyahoo.com/ap/041005/at_t_mobile_music_5.html?printer=1>, Oct. 5, 2004, 2 pages.
- Vogel et al., "Shift: A Technique for Operating Pen-Based Interfaces Using Touch", CHI '07 Proceedings, Mobile Interaction Techniques I, Apr. 28-May 3, 2007, pp. 657-666.
- W3C Working Draft, "Speech Synthesis Markup Language Specification for the Speech Interface Framework", available at <<http://www.w3.org/TR/speech-synthesis>>, retrieved on Dec. 14, 2000, 42 pages.
- Wadlow, M. G., "The Role of Human Interface Guidelines in the Design of Multimedia Applications", Carnegie Mellon University (To be Published in Current Psychology: Research and Reviews, Summer 1990 (CMU-ITC-91-101), 1990, pp. 1-22.
- Walker et al., "The LOCUS Distributed Operating System 1", University of California Los Angeles, 1983, pp. 49-70.
- Wang et al., "An Initial Study on Large Vocabulary Continuous Mandarin Speech Recognition with Limited Training Data Based on Sub-Syllabic Models", International Computer Symposium, vol. 2, 1994, pp. 1140-1145.
- Wang et al., "Tone Recognition of Continuous Mandarin Speech Based on Hidden Markov Model", International Journal of Pattern Recognition and Artificial Intelligence, vol. 8, 1994, pp. 233-245.
- Ware et al., "The DragMag Image Magnifier", CHI '95 Mosaic of Creativity, May 7-11, 1995, pp. 407-408.
- Ware et al., "The DragMag Image Magnifier Prototype I", Apple Inc., Video Clip, Marlon, on a CD, Applicant is not Certain about the Date for the Video Clip., 1995.
- Watabe et al., "Distributed Multiparty Desktop Conferencing System: MERMAID", CSCW 90 Proceedings, Oct. 1990, pp. 27-38.
- White, George M., "Speech Recognition, Neural Nets, and Brains", Jan. 1992, pp. 1-48.
- Wikipedia, "Acoustic Model", available at <<http://en.wikipedia.org/wiki/AcousticModel>>, retrieved on Sep. 14, 2011, 2 pages.
- Wikipedia, "Language Model", available at <http://en.wikipedia.org/wiki/Language_model>, retrieved on Sep. 14, 2011, 3 pages.
- Wikipedia, "Speech Recognition", available at <http://en.wikipedia.org/wiki/Speech_recognition>, retrieved on Sep. 14, 2011, 10 pages.
- Wilensky et al., "Talking to UNIX in English: An Overview of UC", Communications of the ACM, vol. 27, No. 6, Jun. 1984, pp. 574-593.
- Wilson, Mark, "New iPod Shuffle Moves Buttons to Headphones, Adds Text to Speech", available at <<http://gizmodo.com/5167946/new-ipod-shuffle-moves-buttons-to-headphones-adds-text-to-speech>>, Mar. 11, 2009, 13 pages.
- Wirelessinfo, "SMS/MMS Ease of Use (8.0)", available at <<http://www.wirelessinfo.com/content/palm-Treo-750-Cell-Phone-Review/Messaging.htm>>, Mar. 2007, 3 pages.
- Wong et al., "An 800 Bit/s Vector Quantization LPC Vocoder", (IEEE Transactions on Acoustics, Speech and Signal Processing, Oct. 1982), as reprinted in Vector Quantization (IEEE Press, 1990), 1990, pp. 222-232.
- Wong et al., "Very Low Data Rate Speech Compression with LPC Vector and Matrix Quantization", (Proceedings of the IEEE Int'l Acoustics, Speech and Signal Processing Conference, Apr. 1983), as reprinted in Vector Quantization (IEEE Press, 1990), 1990, pp. 233-236.
- Wu et al., "Automatic Generation of Synthesis Units and Prosodic Information for Chinese Concatenative Synthesis", Speech Communication, vol. 35, No. 3-4, Oct. 2001, pp. 219-237.
- Yang et al., "Auditory Representations of Acoustic Signals", IEEE Transactions of Information Theory, vol. 38, No. 2, Mar. 1992, pp. 824-839.
- Yang et al., "Hidden Markov Model for Mandarin Lexical Tone Recognition", IEEE Transactions on Acoustics, Speech and Signal Processing, vol. 36, No. 7, Jul. 1998, pp. 988-992.
- Yiourgalis et al., "Text-to-Speech system for Greek", ICASSP 91, vol. 1, May 14-17, 1991., pp. 525-528.
- Zainab, "Google Input Tools Shows Onscreen Keyboard in Multiple Languages [Chrome]", available at <<http://www.addictivetips.com/internet-tips/google-input-tools-shows-multiple-language-onscreen-keyboards-chrome/>>, Jan. 3, 2012, 3 pages.
- Zelig, "A Review of the Palm Treo 750v", available at <<http://www.mtekk.com.au/Articles/tabid/54/articleType/ArticleView/articleId/769/A-Review-of-the-Palm-Treo-750v.aspx>>, Feb. 5, 2007, 3 pages.
- Zhang et al., "Research of Text Classification Model Based on Latent Semantic Analysis and Improved HS-SVM", Intelligent Systems and Applications (ISA), 2010 2nd International Workshop, May 22-23, 2010, 5 pages.
- Ziegler, K., "A Distributed Information System Study", IBM Systems Journal, vol. 18, No. 3, 1979, pp. 374-401.
- Zipnick et al., "U.S. Appl. No. 10/859,661, filed Jun. 2, 2004".
- "2004 Chrysler Pacifica: U-Connect Hands-Free Communication System", The Best and Brightest of 2004, Brief Article, Automotive Industries, Sep. 2003, 1 page.

(56)

References Cited

OTHER PUBLICATIONS

- "2007 Lexus GS 450h 4dr Sedan (3.5L 6cyl Gas/Electric Hybrid CVT)", available at <http://review.cnet.com/4505-10865_16-31833144.html>, retrieved on Aug. 3, 2006, 10 pages.
- "All Music Website", available at <<http://www.allmusic.com/>>, retrieved on Mar. 19, 2007, 2 pages.
- "BluePhoneElite: About", available at <<http://www.reelintelligence.com/BluePhoneElite>>, retrieved on Sep. 25, 2006, 2 pages.
- "BluePhoneElite: Features", available at <<http://www.reelintelligence.com/BluePhoneElite/features.shtml>>, retrieved on Sep. 25, 2006, 2 pages.
- "Digital Audio in the New Era", Electronic Design and Application, No. 6, Jun. 30, 2003, 3 pages.
- "Mobile Speech Solutions, Mobile Accessibility", SVOX AG Product Information Sheet, available at <<http://www.svox.com/site/bra840604/con782768/mob965831936.aSQ?osLang=1>>, Sep. 27, 2012, 1 page.
- "N200 Hands-Free Bluetooth Car Kit", available at <www.wirelessground.com>, retrieved on Mar. 19, 2007, 3 pages.
- "PhatNoise", Voice Index on Tap, Kenwood Music Keg, available at <<http://www.phatnoise.com/kenwood/kenwoodssamail.html>>, retrieved on Jul. 13, 2006, 1 page.
- "What is Fuzzy Logic?", available at <<http://www.cs.cmu.edu>>, retrieved on Apr. 15, 1993, 5 pages.
- "Windows XP: A Big Surprise!—Experiencing Amazement from Windows XP", New Computer, No. 2, Feb. 28, 2002, 8 pages.
- Aikawa et al., "Generation for Multilingual MT", available at <<http://mtarchive.info/MTS-2001-Aikawa.pdf>>, retrieved on Sep. 18, 2001, 6 pages.
- Anhui USCT IFL YTEK Co. Ltd., "Flytek Research Center Information Datasheet", available at <<http://www.ifltek.com/english/Research.htm>>, retrieved on Oct. 15, 2004, 3 pages.
- Borden IV, G.R., "An Aural User Interface for Ubiquitous Computing", Proceedings of the 6th International Symposium on Wearable Computers, IEEE, 2002, 2 pages.
- Brain, Marshall, "How MP3 Files Work", available at <<http://www.howstuffworks.com>>, retrieved on Mar. 19, 2007, 4 pages.
- Busemann et al., "Natural Language Dialogue Service for Appointment Scheduling Agents", Technical Report RR-97-02, Deutsches Forschungszentrum für Künstliche Intelligenz GmbH, 1997, 8 pages.
- Dusan et al., "Multimodal Interaction on PDA's Integrating Speech and Pen Inputs", Eurospeech Geneva, 2003, 4 pages.
- Lamel et al., "Generation and synthesis of Broadcast Messages", Proceedings of ESCA-NATO Workshop: Applications of Speech Technology, Sep. 1, 1993, 4 pages.
- Lyons et al., "Augmenting Conversations Using Dual-Purpose Speech", Proceedings of the 17th Annual ACM Symposium on User Interface Software and Technology, 2004, 10 pages.
- Macsimum News, "Apple Files Patent for an Audio Interface for the iPod", available at <http://www.macsimumnews.com/index.php/archive/apple_files_patent_for_an_audi_o_interface_for_the_ipod>, retrieved on Jul. 13, 2006, 8 pages.
- International Search Report and Written Opinion received for PCT Patent Application No. PCT/US2004/016519, mailed on Nov. 3, 2005, 6 pages.
- Invitation to Pay Additional Fees and Partial International Search Report received for PCT Patent Application No. PCT/US2004/016519, mailed on Aug. 4, 2005, 6 pages.
- International Search Report received for PCT Patent Application No. PCT/US2011/037014, mailed on Oct. 4, 2011, 6 pages.
- Invitation to Pay Additional Search Fees received for PCT Application No. PCT/US2011/037014, mailed on Aug. 2, 2011, 6 pages.
- International Search Report and Written Opinion received for PCT Patent Application No. PCT/US2012/043098, mailed on Nov. 14, 2012, 9 pages.
- International Search Report and Written Opinion received for PCT Patent Application No. PCT/US2013/040971, mailed on Nov. 12, 2013, 11 pages.
- Quazza et al., "Actor: A Multilingual Unit-Selection Speech Synthesis System", Proceedings of 4th ISCA Tutorial and Research Workshop on Speech Synthesis, Jan. 1, 2001, 6 pages.
- Ricker, Thomas, "Apple Patents Audio User Interface", Engadget, available at <<http://www.engadget.com/2006/05/04/apple-patents-audio-user-interface/>>, May 4, 2006, 6 pages.
- Santaholma, Marianne E., "Grammar Sharing Techniques for Rule-based Multilingual NLP Systems", Proceedings of the 16th Nordic Conference of Computational Linguistics, NODALIDA 2007, May 25, 2007, 8 pages.
- Taylor et al., "Speech Synthesis by Phonological Structure Matching", International Speech Communication Association, vol. 2, Section 3, 1999, 4 pages.
- Xu et al., "Speech-Based Interactive Games for Language Learning: Reading, Translation, and Question-Answering", Computational Linguistics and Chinese Language Processing, vol. 14, No. 2, Jun. 2009, pp. 133-160.
- Yunker, John, "Beyond Borders: Web Globalization Strategies", New Riders, Aug. 22, 2002, 11 pages.
- Yang et al., "Smart Sight: A Tourist Assistant System", Proceedings of Third International Symposium on Wearable Computers, 1999, 6 pages.
- Yankelovich et al., "Intermedia: The Concept and the Construction of a Seamless Information Environment", Computer Magazine, IEEE, Jan. 1988, 16 pages.
- Yoon et al., "Letter-to-Sound Rules for Korean", Department of Linguistics, The Ohio State University, 2002, 4 pages.
- Zeng et al., "Cooperative Intelligent Software Agents", The Robotics Institute, Carnegie-Mellon University, Mar. 1995, 13 pages.
- Zhao, Y., "An Acoustic-Phonetic-Based Speaker Adaptation Technique for Improving Speaker-Independent Continuous Speech Recognition", IEEE Transactions on Speech and Audio Processing, vol. 2, No. 3, Jul. 1994, pp. 380-394.
- Zhao et al., "Intelligent Agents for Flexible Workflow Systems", Proceedings of the Americas Conference on Information Systems (AMCIS), Oct. 1998, 4 pages.
- Zovato et al., "Towards Emotional Speech Synthesis: A Rule based Approach", Proceedings of 5th ISCA Speech Synthesis Workshop-Pittsburgh, 2004, pp. 219-220.
- Zue, Victor, "Conversational Interfaces: Advances and Challenges", Spoken Language System Group, Sep. 1997, 10 pages.
- Zue et al., "From Interface to Content: Translingual Access and Delivery of On-Line Information", Eurospeech, 1997, 4 pages.
- Zue et al., "Jupiter: A Telephone-Based Conversational Interface for Weather Information", IEEE Transactions on Speech and Audio Processing, Jan. 2000, 13 pages.
- Zue et al., "Pegasus: A Spoken Dialogue Interface for On-Line Air Travel Planning", Speech Communication, vol. 15, 1994, 10 pages.
- Zue et al., "The Voyager Speech Understanding System: Preliminary Development and Evaluation", Proceedings of IEEE, International Conference on Acoustics, Speech and Signal Processing, 1990, 4 pages.
- Zue, Victor W., "Toward Systems that Understand Spoken Language", ARPA Strategic Computing Institute, Feb. 1994, 9 pages.
- International Search Report received for PCT Patent Application No. PCT/GB2009/051684, mailed on Mar. 12, 2010, 4 pages.
- International Preliminary Report on Patentability received for PCT Patent Application No. PCT/GB2009/051684, mailed on Jun. 23, 2011, 10 pages.
- Cucerzan et al., "Bootstrapping a Multilingual Part-of-Speech Tagger in One Person-Day", In Proceedings of the 6th Conference on Natural Language Learning, vol. 20, 2002, pp. 1-7.
- Schone et al., "Knowledge-Free Induction of Morphology Using Latent Semantic Analysis", Proceedings of the 2nd Workshop on Learning Language in Logic and the 4th Conference on Computational Natural Language Learning, vol. 7, 2000, pp. 67-72.
- International Preliminary Report on Patentability received for PCT Patent Application No. PCT/US2005/030234, issued on Mar. 20, 2007, 9 pages.
- International Search Report and Written Opinion received for PCT Patent Application No. PCT/US2005/030234, mailed on Mar. 17, 2006, 11 pages.

(56)

References Cited

OTHER PUBLICATIONS

- International Preliminary Report on Patentability received for PCT Patent Application No. PCT/US2012/040801, mailed on Dec. 19, 2013, 16 pages.
- International Search Report and Written Opinion received for PCT Patent Application No. PCT/US2012/040801, mailed on Oct. 22, 2012, 20 pages.
- International Search Report & Written Opinion received for PCT Patent Application No. PCT/US2013/028412, mailed on Sep. 26, 2013, 17 pages.
- International Search Report and Written Opinion received for PCT Patent Application No. PCT/US2013/028920, mailed on Jun. 27, 2013, 14 pages.
- International Search Report and Written Opinion received for PCT Patent Application No. PCT/US2013/029156, mailed on Jul. 15, 2013, 9 pages.
- International Search Report and Written Opinion received for PCT Patent Application No. PCT/US2013/058916, mailed on Sep. 8, 2014, 10 pages.
- International Search Report and Written Opinion received for PCT Patent Application No. PCT/US2014/029050, mailed on Jul. 31, 2014, 9 pages.
- International Search Report and Written Opinion received for PCT Patent Application No. PCT/US2014/029562, mailed on Sep. 18, 2014, 21 pages.
- International Search Report and Written Opinion received for PCT Patent Application No. PCT/US2014/040401, mailed on Sep. 4, 2014, 10 pages.
- International Search Report and Written Opinion received for PCT Patent Application No. PCT/US2014/040403, mailed on Sep. 23, 2014, 9 pages.
- International Search Report and Written Opinion received for PCT Patent Application No. PCT/US2014/041159, mailed on Sep. 26, 2014, 10 pages.
- International Search Report and Written Opinion received for PCT Patent Application No. PCT/US2014/041173, mailed on Sep. 10, 2014, 11 pages.
- International Search Report and Written Opinion received for PCT Patent Application No. PCT/US2014/23822, mailed on Sep. 25, 2014, 14 pages.
- International Preliminary Report on Patentability received for PCT Patent Application No. PCT/US2012/056382, mailed on Apr. 10, 2014, 9 pages.
- International Preliminary Report on Patentability received for PCT Patent Application No. PCT/US2013/028412, mailed on Sep. 12, 2014, 12 pages.
- International Preliminary Report on Patentability received for PCT Patent Application No. PCT/US2013/028920, mailed on Sep. 18, 2014, 11 pages.
- International Preliminary Report on Patentability received for PCT Patent Application No. PCT/US2013/029156, mailed on Sep. 9, 2014, 7 pages.
- Biemann et al., "Disentangling from Babylonian Confusion—Un-supervised Language Identification", CICLing'05 Proceedings of the 6th international conference on Computational Linguistics and Intelligent Text Processing, vol. 3406, Feb. 2005, pp. 773-784.
- Choularton et al., "User Responses to Speech Recognition Errors: Consistency of Behaviour Across Domains", Proceedings of the 10th Australian International Conference on Speech Science & Technology, Dec. 8-10, 2004, pp. 457-462.
- Jiang et al., "A Syllable-based Name Transliteration System", Proc. of the 2009 Named Entities Workshop, Aug. 7, 2009, pp. 96-99.
- Kazemzadeh et al., "Acoustic Correlates of User Response to Error in Human-Computer Dialogues", Automatic Speech Recognition and Understanding, 2003, pp. 215-220.
- Kikui, Gen-Itiro, "Identifying the Coding System and Language of On-Line Documents on the Internet", International Conference on Computational, Aug. 1996, pp. 652-657.
- Meng et al., "Generating Phonetic Cognates to Handle Named Entities in English-Chinese Cross-Language Spoken Document Retrieval", Automatic Speech Recognition and Understanding, Dec. 2001, pp. 311-314.
- Russo et al., "Urgency is a Non-Monotonic Function of Pulse Rate", Journal of the Acoustical Society of America, vol. 122, No. 5, 2007, 6 pages.
- Sethy et al., "A Syllable Based Approach for Improved Recognition of Spoken Names", ITRW on Pronunciation Modeling and Lexicon Adaptation for Spoken language Technology (PMLA2002), Sep. 14-15, 2002, pp. 30-35.
- Strom et al., "Intelligent Barge-In in Conversational Systems", MIT laboratory for Computer Science, 2000, 4 pages.
- Henrich et al., "Language Identification for the Automatic Grapheme-To-Phoneme Conversion of Foreign Words in a German Text-To-Speech System", Proceedings of the European Conference on Speech Communication and Technology, vol. 2, Sep. 1989, pp. 220-223.
- International Preliminary Report on Patentability received for PCT Patent Application No. PCT/US2012/040571, mailed on Dec. 19, 2013, 10 pages.
- International Preliminary Report on Patentability received for PCT Patent Application No. PCT/US2013/041233, issued on Nov. 18, 2014, 8 pages.
- International Search Report received for PCT Patent Application No. PCT/US2013/041233, mailed on Nov. 22, 2013, 3 pages.
- International Search Report and Written Opinion received for PCT Patent Application No. PCT/US2014/028785, mailed on Oct. 17, 2014, 23 pages.
- International Search Report and Written Opinion received for PCT Patent Application No. PCT/US2014/049568, mailed on Nov. 14, 2014, 12 pages.
- Extended European Search Report (includes Supplementary European Search Report and Search Opinion) received for European Patent Application No. 12727027.0 mailed on Sep. 26, 2014, 7 pages.
- Guay, Matthew, "Location-Driven Productivity with Task Ave", available at <<http://iphone.appstorm.net/reviews/productivity/location-driven-productivity-with-task-ave/>>, Feb. 19, 2011, 7 pages.
- Waibel, Alex, "Interactive Translation of Conversational Speech", Computer, vol. 29, No. 7, Jul. 1996, pp. 41-48.
- Amano et al., "A User-friendly Multimedia Book Authoring System", The Institute of Electronics, Information and Communication Engineers Technical Report, vol. 103, No. 416, Nov. 2003, pp. 33-40.
- AppleEvent Manager, which is described in the publication Inside Macintosh vol. VI, available from Addison-Wesley Publishing Company, 1985.
- Dual Rate Speech Coder for Multimedia Communications Transmitting at 5.3 and 6.3 kbit/s, International Telecommunication Union Recommendation G.723, 7 pages.
- Quick Search Algorithm, Communications of the ACM, 33(8), 1990, pp. 132-142.
- Worldwide Character Encoding, Version 2.0, vols. 1,2 by Unicode, Inc., 12 pages.
- Extended European Search Report (includes Partial European Search Report and European Search Opinion) received for European Patent Application No. 13169672.6, mailed on Aug. 14, 2013, 11 pages.
- Barrett et al., "How to Personalize the Web", 1997 in proceedings of the ACM SIGCHI Conference on Human Factors in Computer Systems, Mar. 22-27, 1997, pp. 75-82.
- Boyer et al., "A Fast String Searching Algorithm", Communications of the ACM, vol. 20, 1977, pp. 762-772.
- Cao et al., "Adapting Ranking SVM to Document Retrieval", SIGIR '06, Seattle, WA, Aug. 6-11, 2006, 8 pages.
- Chomsky et al., "The Sound Pattern of English", New York, Harper and Row, 1968, 242 pages.
- Church, Kenneth W., "Phonological Parsing in Speech Recognition", Kluwer Academic Publishers, 1987.
- Erol et al., "Multimedia Clip Generation From Documents for Browsing on Mobile Devices", IEEE Transactions on Multimedia, vol. 10, No. 5, Aug. 2008, 13 pages.

(56)

References Cited

OTHER PUBLICATIONS

- Evermann et al., "Posterior Probability Decoding, Confidence Estimation and System Combination", Proceedings Speech Transcription Workshop, 2000, 4 pages.
- Fiscus, J. G., "A Post-Processing System to Yield Reduced Word Error Rates: Recognizer Output Voting Error Reduction (Rover)", IEEE Proceedings, Automatic Speech Recognition and Understanding, Dec. 14-17, 1997, pp. 347-354.
- Gonnet et al., "Handbook of Algorithms and Data Structures: in Pascal and C. (2nd ed.)", Addison-Wesley Longman Publishing Co., 1991, 17 pages.
- Gruber, Thomas R., et al., U.S. Appl. No. 61/186,414, filed Jun. 12, 2009 titled "System and Method for Semantic Auto-Completion" 13 pages.
- Gruber, Thomas R., et al., U.S. Appl. No. 61/493,201, filed Jun. 3, 2011 titled "Generating and Processing Data Items That Represent Tasks to Perform", 68 pages.
- Gruber, Thomas R., et al., U.S. Appl. No. 61/657,744, filed Jun. 9, 2012 titled "Automatically Adapting User Interfaces for Hands-Free Interaction", 40 pages.
- Gruber, Thomas R., et al., U.S. Appl. No. 07/976,970, filed Nov. 16, 1992 titled "Status Bar for Application Windows".
- Haitisma et al., "A Highly Robust Audio Fingerprinting System", In Proceedings of the International Symposium on Music Information Retrieval (ISMIR), 2002, 9 pages.
- Hendrickson, Bruce, "Latent Semantic Analysis and Fiedler Retrieval", Discrete Algorithms and Mathematics Department, Sandia National Labs, Albuquerque, NM, Sep. 21, 2006, 12 pages. id3.org, "id3v2.4.0-Frames", available at <<http://id3.org/id3v2.4.0-frames?action=print>>, retrieved on Jan. 22, 2015, 41 pages.
- Jawaid et al., "Machine Translation with Significant Word Reordering and Rich Target-Side Morphology", WDS'11 Proceedings of Contributed Papers, Part I, 2011, pp. 161-166.
- Kane et al., "Slide Rule: Making Mobile Touch Screens Accessible to Blind People Using Multi-Touch Interaction Techniques", ASSETS, Oct. 13-15, 2008, pp. 73-80.
- Kohler, Joachim, "Multilingual Phone Models for Vocabulary-Independent Speech Recognition Tasks", Speech Communication, vol. 35, No. 1-2, Aug. 2001, pp. 21-30.
- Kroon et al., "Pitch Predictors with High Temporal Resolution", IEEE, vol. 2, 1990, pp. 661-664.
- Ladefoged, Peter, "A Course in Phonetics", New York, Harcourt, Brace, Jovanovich, Second Edition, 1982.
- Lau et al., "Trigger-Based Language Models: A Maximum Entropy Approach", ICASSP'93 Proceedings of the 1993 IEEE international conference on Acoustics, speech, and signal processing: speech processing—vol. II, 1993, pp. 45-48.
- Lee et al., "On URL Normalization", Proceedings of the International Conference on Computational Science and its Applications, ICCSA 2005, pp. 1076-1085.
- Levesque et al., "A Fundamental Tradeoff in Knowledge Representation and Reasoning", Readings in Knowledge Representation, 1985, 30 pages.
- Mangu et al., "Finding Consensus in Speech Recognition: Word Error Minimization and Other Applications of Confusion Networks", Computer Speech and Language, vol. 14, No. 4, 2000, pp. 291-294.
- Manning et al., "Foundations of Statistical Natural Language Processing", The MIT Press, Cambridge Massachusetts, 1999, pp. 10-11.
- International Preliminary Examination Report on received for PCT Patent Application No. PCT/US1993/12637, mailed on Apr. 10, 1995, 7 pages.
- International Preliminary Report on Patentability received for PCT Patent Application No. PCT/US2009/051954, issued on Mar. 24, 2011, 8 pages.
- International Search Report and Written Opinion received for PCT Patent Application No. PCT/US2009/051954, mailed on Oct. 30, 2009, 10 pages.
- International Search Report and Written Opinion received for PCT Patent Application No. PCT/US2012/043100, mailed on Nov. 15, 2012, 8 pages.
- Reddi, "The Parser".
- Rose et al., "Inside Macintosh", vols. I, II, and III, Addison-Wesley Publishing Company, Inc., Jul. 1988, 1284 pages.
- Sankar, Ananth, "Bayesian Model Combination (BAYCOM) for Improved Recognition", IEEE International Conference on Acoustics, Speech, and Signal Processing (ICASSP), Mar. 18-23, 2005, pp. 845-848.
- Stifleman, L., "Not Just Another Voice Mail System", Proceedings of 1991 Conference, American Voice, Atlanta GA, Sep. 24-26, 1991, pp. 21-26.
- Stuker et al., "Cross-System Adaptation and Combination for Continuous Speech Recognition: The Influence of Phoneme Set and Acoustic Front-End", Influence of Phoneme Set and Acoustic Front-End, Interspeech, Sep. 17-21, 2006, pp. 521-524.
- Sundaram et al., "Latent Perceptual Mapping with Data-Driven Variable-Length Acoustic Units for Template-Based Speech Recognition", ICASSP 2012, Mar. 2012, pp. 4125-4128.
- Wang et al., "An Industrial-Strength Audio Search Algorithm", In Proceedings of the International Conference on Music Information Retrieval (ISMIR), 2003, 7 pages.
- Young, S. J., "The HTK Book", Available on <<http://htk.eng.cam.ac.uk>>, 4 pages.
- Amano, Junko, "A User-Friendly Authoring System for Digital Talking Books", IEICE Technical Report, The Institute of Electronics, Information and Communication Engineers, vol. 103 No. 418, Nov. 6, 2003, pp. 33-40.
- Extended European Search Report (inclusive of the Partial European Search Report and European Search Opinion) received for European Patent Application No. 12729332.2, mailed on Oct. 31, 2014, 6 pages.
- adobe.com, "Reading PDF Documents with Adobe Reader 6.0—A Guide for People with Disabilities", Available online at "https://www.adobe.com/enterprise/accessibility/pdfs/acro6_cg_ue.pdf", Jan. 2004, 76 pages.
- Bertulucci, Jeff, "Google Adds Voice Search to Chrome Browser", PC World, Jun. 14, 2011.
- Dobrissek et al., "Evolution of the Information-Retrieval System for Blind and Visually-Impaired People", International Journal of Speech Technology, Kluwer Academic Publishers, Bo, vol. 6, No. 3, pp. 301-309.
- Lee et al., "A Multi-Touch Three Dimensional Touch-Sensitive Tablet", CHI '85 Proceedings of the SIGCHI Conference on Human Factors in Computing Systems, Apr. 1985, pp. 21-25.
- Martins et al., "Extracting and Exploring the Geo-Temporal Semantics of Textual Resources", Semantic Computing, IEEE International Conference, 2008, pp. 1-9.
- International Preliminary Report on Patentability received for PCT Patent Application No. PCT/US2009/055577, completed on Aug. 6, 2010, 12 pages.
- International Search Report and Written Opinion received for PCT Patent Application No. PCT/US2009/055577, mailed on Jan. 26, 2010, 9 pages.
- International Preliminary Report on Patentability received for PCT Patent Application No. PCT/US2013/041225, mailed on Nov. 27, 2014, 9 pages.
- International Preliminary Report on Patentability received for PCT Patent Application No. PCT/US2013/047668, mailed on Jan. 8, 2015, 13 pages.
- International Preliminary Report on Patentability received for PCT Patent Application No. PCT/US2013/052558, mailed on Feb. 12, 2015, 12 pages.
- International Preliminary Report on Patentability received for PCT Patent Application No. PCT/US2013/058916, mailed on Mar. 19, 2015, 8 pages.
- International Search Report and Written Opinion received for PCT Patent Application No. PCT/US2013/060121, mailed on Apr. 2, 2015, 6 pages.
- Rubine, Dean Harris, "Combining Gestures and Direct Manipulation", CHI '92, May 3-7, 1992, pp. 659-660.

(56)

References Cited

OTHER PUBLICATIONS

- Rubine, Dean Harris, "The Automatic Recognition of Gestures", CMU-CS-91-202, Thesis Submitted in Partial Fulfillment of the Requirements for the Degree of Doctor of Philosophy in Computer Science at Carnegie Mellon University, Dec. 1991, 285 pages.
- Sen et al., "Indian Accent Text-to-Speech System for Web Browsing", *Sadhana*, vol. 27, No. 1, Feb. 2002, pp. 113-126.
- Tombros et al., "Users' Perception of Relevance of Spoken Documents", *Journal of the American Society for Information Science*, New York, Aug. 2000, pp. 929-939.
- Westerman, Wayne, "Hand Tracking, Finger Identification and Chordic Manipulation on a Multi-Touch Surface", Doctoral Dissertation, 1999, 363 Pages.
- Youtube, "New bar search for Facebook", Available at <<https://www.youtube.com/watch?v=vwgn1WbvCas>>, 1 page.
- International Search Report and Written Opinion received for PCT Patent Application No. PCT/US2013/047668, mailed on Feb. 13, 2014, 17 pages.
- International Search Report and Written Opinion received for PCT Patent Application No. PCT/US2013/052558, mailed on Jan. 30, 2014, 15 pages.
- International Search Report and Written Opinion received for PCT Patent Application No. PCT/US2013/060121, mailed on Dec. 6, 2013, 8 pages.
- International Search Report and Written Opinion received for PCT Patent Application No. PCT/US2014/040961, mailed on Mar. 10, 2015, 5 pages.
- Invitation to Pay Additional Fees received for PCT Application No. PCT/US2014/040961, mailed on Jan. 14, 2015, 3 pages.
- Invitation to Pay Additional Fees and Partial Search Report received for PCT Patent Application No. PCT/US2015/023089, mailed on Jun. 17, 2015, 7 pages.
- Chen et al., "An Improved Method for Image Retrieval Using Speech Annotation", The 9th International Conference on Multi-Media Modeling, Jan. 2003, pp. 1-17.
- Haga et al., "A Usability Survey of a Contents-Based Video Retrieval System by Combining Digital Video and an Electronic Bulletin Board", *The Internet and Higher Education*, vol. 8, No. 3, 2005, pp. 251-262.
- Jouvet et al., "Evaluating Grapheme-to-phoneme Converters in Automatic Speech Recognition Context", *IEEE*, 2012 pp. 4821-4824.
- Kazmucha, Allyson, "How to Send Map Locations Using iMessage", *iMore.com*, Available at <<http://www.imore.com/how-use-imeessage-share-your-location-your-iphone>>, Aug. 2, 2012, 6 pages.
- Lewis, Cameron, "Task Ave for iPhone Review", *Mac Life*, Available at <http://www.maclife.com/article/reviews/task_ave_iphone_review>, Mar. 3, 2011, 5 pages.
- Ng, Simon, "Google's Task List Now Comes to iPhone", *SimonBlog*, Available at <<http://www.simonblog.com/2009/02/04/googles-task-list-now-comes-to-iphone/>>, Feb. 4, 2009, 33 pages.
- Osxdaily, "Get a List of Siri Commands Directly from Siri", Available at <<http://osxdaily.com/2013/02/05/list-siri-commands/>>, Feb. 5, 2013, 15 pages.
- Extended European Search Report (includes Partial European Search Report and European Search Opinion) received for European Patent Application No. 15169349.6, mailed on Jul. 28, 2015, 8 pages.
- International Search Report and Written Opinion received for PCT Patent Application No. PCT/US2013/044574, mailed on Sep. 27, 2013, 12 pages.
- International Preliminary Report on Patentability received for PCT Patent Application No. PCT/US2013/044834, issued on Dec. 9, 2014, 9 pages.
- International Search Report and Written Opinion received for PCT Patent Application No. PCT/US2013/044834, mailed on Dec. 20, 2013, 13 pages.
- International Search Report and Written Opinion received for PCT Patent Application No. PCT/US2013/047659, mailed on Jul. 7, 2014, 25 pages.
- International Search Report and Written Opinion received for PCT Patent Application No. PCT/US2014/023826, mailed on Oct. 9, 2014, 13 pages.
- International Search Report and Written Opinion received for PCT Patent Application No. PCT/US2014/026871, mailed on Jul. 23, 2014, 9 pages.
- International Search Report and Written Opinion received for PCT Patent Application No. PCT/US2014/026873, mailed on Jan. 5, 2015, 11 pages.
- International Search Report and Written Opinion received for PCT Patent Application No. PCT/US2014/028950, mailed on Nov. 25, 2014, 10 pages.
- International Search Report and Written Opinion received for PCT Patent Application No. PCT/US2014/040393, mailed on Dec. 8, 2014, 23 pages.
- International Search Report and Written Opinion received for PCT Patent Application No. PCT/US2014/040394, mailed on Aug. 8, 2014, 11 pages.
- International Search Report and Written Opinion received for PCT Patent Application No. PCT/US2014/040397, mailed on Aug. 27, 2014, 12 pages.
- International Search Report and Written Opinion received for PCT Patent Application No. PCT/US2015/023097, mailed on Jul. 7, 2015, 15 pages.
- Sarvas et al., "Metadata Creation System for Mobile Images", *Conference Proceedings, The Second International Conference on Mobile Systems, Applications and Services*, Jun. 6, 2004, pp. 36-48.
- Srihari, R. K., "Use of Multimedia Input in Automated Image Annotation and Content-based Retrieval", *Proceedings of Spie, International Society for Optical Engineering*, vol. 2420, Feb. 9, 1995., pp. 249-260.
- Timothy et al., "Speech-Based Annotation and Retrieval of Digital Photographs", *Interspeech. 8th Annual Conference of the International Speech Communication Association*, Aug. 27, 2007, pp. 2165-2168.
- Viikki et al., "Speaker- and Language-Independent Speech Recognition in Mobile Communication Systems", *IEEE*, vol. 1, 2001, pp. 5-8.
- Xiang et al., "Correcting Phoneme Recognition Errors in Learning Word Pronunciation through Speech Interaction", *Speech Communication*, vol. 55, No. 1, Jan. 1, 2013, pp. 190-203.
- Database WPI Section Ch, Week 8733, Derwent Publications Ltd., London, GB; Class A17, AN 87-230826 & JP,A,62 153 326 (SANWA KAKO KK (SANS) SANWA KAKO CO), Jul. 8, 1987.
- Database WPI Section Ch, Week 8947, Derwent Publications Ltd., London, GB; Class A17, AN 89-343299 & JP,A,1 254 742 (Sekisui Plastics KK), Oct. 11, 1989.
- Dragon NaturallySpeaking Version 11 Users Guide, Nuance Communications, Inc., Copyright @2002-2010, 132 pages.
- Headset Button Controller v7.3 APK Full APP Download for Android, Blackberry, iPhone, 11 pages.
- Patent Abstracts of Japan, vol. 014, No. 273 (E-0940) Jun. 13, 1990—& JP 02 086057 A (Japan Storage Battery Co Ltd), Mar. 27, 1990.
- European Search Report received for European Patent Application No. 01201774.5, mailed on Sep. 14, 2001, 3 pages.
- Extended European Search Report received for European Patent Application No. 11159884.3, mailed on May 20, 2011, 8 pages.
- European Search Report received for European Patent Application No. 99107544.1, mailed on Jul. 8, 1999, 4 pages.
- European Search Report received for European Patent Application No. 99107545.8, mailed on Jul. 1, 1999, 3 pages.
- api.ai, "Android App Review—Speaktoit Assistant", Available at <<https://www.youtube.com/watch?v=myE498nyfGw>>, Mar. 30, 2011, 3 pages.
- Apple, "iPhone User's Guide", Available at <<http://mesnotices.20minutes.fr/manuel-notice-mode-emploi/APPLE/IPHONE%2D%5FE#>>, Retrieved on Mar. 27, 2008, Jun. 2007, 137 pages.
- Bergmann et al., "An adaptable man-machine interface using connected-word recognition", *2nd European Conference on Speech Communication and Technology (Eurospeech 91)*, vol. 2, XP002176387, Sep. 24-26, 1991, pp. 467-470.

(56)

References Cited

OTHER PUBLICATIONS

Chamberlain, Kim, "Quick Start Guide Natural Reader", available online at <http://atrc.colostate.edu/files/quickstarts/Natural_Reader_Quick_Start_Guide>, Apr. 2008, 5 pages.

Colt, Sam, "Here's One Way Apple's Smartwatch Could Be Better Than Anything Else", Business Insider, Aug. 21, 2014, pp. 1-4.

Dittenbach et al., "A Natural Language Query Interface for Tourism Information", In: Information and Communication Technologies in Tourism 2003, XP055114393, Feb. 14, 2003, pp. 152-162.

Fuji Film, "Taking Pictures Remotely : Free iPhone/Android App Fuji Film Camera Remote", Available at <http://app.fujifilm-dsc.com/en/camera_remote/guide05.html>, Apr. 22, 2014, 3 pages.

Gurevych et al., "Semantic Coherence Scoring Using an Ontology", North American Chapter of the Association for Computational Linguistics Archive, Proceedings of the 2003 Conference of the North American Chapter of the Association for Computational Linguistics on Human Language Technology, May 27, 2003, 8 pages.

Morton, Philip, "Checking If an Element Is Hidden", StackOverflow, Available at <<http://stackoverflow.com/questions/178325/checking-if-an-element-is-hidden>>, Oct. 7, 2008, 12 pages.

NDTV, "Sony SmartWatch 2 Launched in India for Rs. 14,990", available at <<http://gadgets.ndtv.com/others/news/sony-smartwatch-2-launched-in-india-for-rs-14990-420319>>, Sep. 18, 2013, 4 pages.

Pan et al., "Natural Language Aided Visual Query Building for Complex Data Access", In proceeding of: Proceedings of the Twenty-Second Conference on Innovative Applications of Artificial Intelligence, XP055114607, Jul. 11, 2010.

International Search Report received for PCT Application No. PCT/US1994/000687, mailed on Jun. 3, 1994, 1 page.

International Search Report received for PCT Application No. PCT/US1994/00077, mailed on May 25, 1994, 2 pages.

International Preliminary Report on Patentability received for PCT Patent Application No. PCT/US1994/11011, issued on Feb. 28, 1996, 4 pages.

International Search Report received for PCT Application No. PCT/US1995/013076, mailed on Feb. 2, 1996, 1 page.

International Search Report received for PCT Application No. PCT/US1996/01002, mailed on Oct. 30, 1996, 4 pages.

International Search Report received for PCT Application No. PCT/US2002/024669, mailed on Nov. 5, 2002, 3 pages.

International Search Report received for PCT Application No. PCT/US2002/024670, mailed on Sep. 26, 2002, 3 pages.

International Preliminary Report on Patentability received for PCT Application No. PCT/US2004/002873, dated Feb. 1, 2006, 5 pages.

International Search Report received and written opinion for PCT Application No. PCT/US2004/002873, mailed on Oct. 13, 2005, 7 pages.

International Preliminary report on Patentability received for PCT Application No. PCT/US2004/016519, issued on Jan. 23, 2006, 12 pages.

International Preliminary Report on Patentability received for PCT Application No. PCT/US2008/000042, issued on Jul. 7, 2009, 6 pages.

International Preliminary Report on Patentability received for PCT Application No. PCT/US2008/000043, issued on Jul. 7, 2009, 8 pages.

International Preliminary Report on Patentability received for PCT Application No. PCT/US2008/000047, issued on Jul. 7, 2009, 8 pages.

International Preliminary Report on Patentability received for PCT Application No. PCT/US2010/037378, issued on Dec. 6, 2011, 9 pages.

International Preliminary Report on Patentability received for PCT Application No. PCT/US2011/020350, issued on Jul. 17, 2012, 12 pages.

International Preliminary Report on Patentability received for PCT Application No. PCT/US2011/020825, dated Jan. 13, 2012, 17 pages.

International Search Report and Written Opinion received for PCT Application No. PCT/US2011/020825, mailed on Mar. 18, 2011.

International Preliminary Report on Patentability received for PCT Application No. PCT/US2011/037014, mailed on Dec. 13, 2012, 10 pages.

International Preliminary Report on Patentability received for PCT Application No. PCT/US2012/034028, mailed on Oct. 31, 2013, 7 pages.

International Preliminary Report on Patentability received for PCT Application No. PCT/US2012/040931, mailed on Dec. 18, 2014, 9 pages.

International Preliminary Report on Patentability received for PCT Application No. PCT/US2012/043098, mailed on Jan. 9, 2014, 8 pages.

International Preliminary Report on Patentability received for PCT Application No. PCT/US2012/043100, mailed on Jan. 9, 2014, 7 pages.

International Preliminary Report on Patentability received for PCT/US2013/047659, issued on Dec. 31, 2014, 15 pages.

International Preliminary Report on Patentability received for PCT Patent Application No. PCT/US2014/015418, mailed on Aug. 20, 2015, 12 pages.

International Preliminary Report on Patentability received for PCT Application No. PCT/US2014/016988, mailed on Sep. 3, 2015, 8 pages.

International Search Report and Written Opinion received for PCT Application No. PCT/US2014/016988, mailed on Apr. 29, 2014, 10 pages.

International Preliminary Report on Patentability received for PCT Patent Application No. PCT/US2014/023822, mailed on Sep. 24, 2015, 12 pages.

International Preliminary Report on Patentability received for PCT Patent Application No. PCT/US2014/026871, mailed on Sep. 24, 2015, 7 pages.

International Preliminary Report on Patentability received for PCT Patent Application No. PCT/US2014/026873, mailed on Sep. 24, 2015, 9 pages.

International Preliminary Report on Patentability received for PCT Patent Application No. PCT/US2014/028785, mailed on Sep. 24, 2015, 15 pages.

International Preliminary Report on Patentability received for PCT Patent Application No. PCT/US2014/028950, mailed on Sep. 24, 2015, 8 pages.

International Preliminary Report on Patentability received for PCT Patent Application No. PCT/US2014/029562, mailed on Sep. 24, 2015, 16 pages.

International Search Report and Written Opinion received for PCT Patent Application No. PCT/US2014/053951, mailed on Dec. 8, 2014, 11 pages.

International Search Report and Written Opinion received for PCT Patent Application No. PCT/US2014/053957, mailed on Feb. 19, 2015, 11 pages.

International Search Report and Written Opinion received for PCT Patent Application No. PCT/US2014/053958, mailed on Feb. 19, 2015, 10 pages.

International Search Report and Written Opinion received for PCT Patent Application No. PCT/US2015/019298, mailed on Jul. 13, 2015, 17 pages.

International Search Report and Written Opinion received for PCT Patent Application No. PCT/US2015/019320, mailed on Jul 2, 2015, 14 pages.

International Search Report and Written Opinion received for PCT Patent Application No. PCT/US2015/019321, mailed on Jun. 3, 2015, 11 pages.

International Search Report and Written Opinion received for PCT Patent Application No. PCT/US2015/019322, mailed on Jun. 18, 2015, 16 pages.

International Search Report and Written Opinion received for PCT Patent Application No. PCT/US2015/023593, mailed on Aug. 14, 2015, 16 pages.

International Search Report and Written Opinion received for PCT Patent Application No. PCT/US2015/025188, mailed on Jun. 23, 2015, 11 pages.

(56)

References Cited

OTHER PUBLICATIONS

International Search Report and Written Opinion received for PCT Patent Application No. PCT/US2015/032724, mailed on Jul. 27, 2015, 11 pages.

International Search Report and Written Opinion received for PCT Patent Application No. PCT/US2015/033051, mailed on Aug. 5, 2015, 14 pages.

Playmemories Camera Apps, “PlayMemories Camera Apps Help Guide”, Available at <https://www.playmemoriescameraapps.com/portal/manual/IS9104-NPIA09014_00-F00002/en/index.html>, 2012, 3 pages.

Techsmith, “Snagit 11—Snagit 11.4 Help”, Available at <http://assets.techsmith.com/Downloads/ua-tutorials-snagit-11/Snagit_11.pdf>, Jan. 2014, 146 pages.

Xperia Blog, “Action Camera Extension Gives Smartwatch/Smartband Owners Ability to Control Sony Wireless Cameras”, Available at <<http://www.xperiablog.net/2014/06/13/action-camera-extension-gives-smartwatchsmartband-owners-ability-to-control-sony-wireless-cameras/>>, Jun. 13, 2014, 10 pages.

Zhong et al., “JustSpeak: Enabling Universal Voice Control on Android”, W4A’14, Proceedings of the 11th Web for All Conference, No. 36, Apr. 7-9, 2014, 4 pages.

International Search Report and Written opinion received for PCT Patent Application No. PCT/US2016/021409, mailed on May 26, 2016, 22 pages.

* cited by examiner

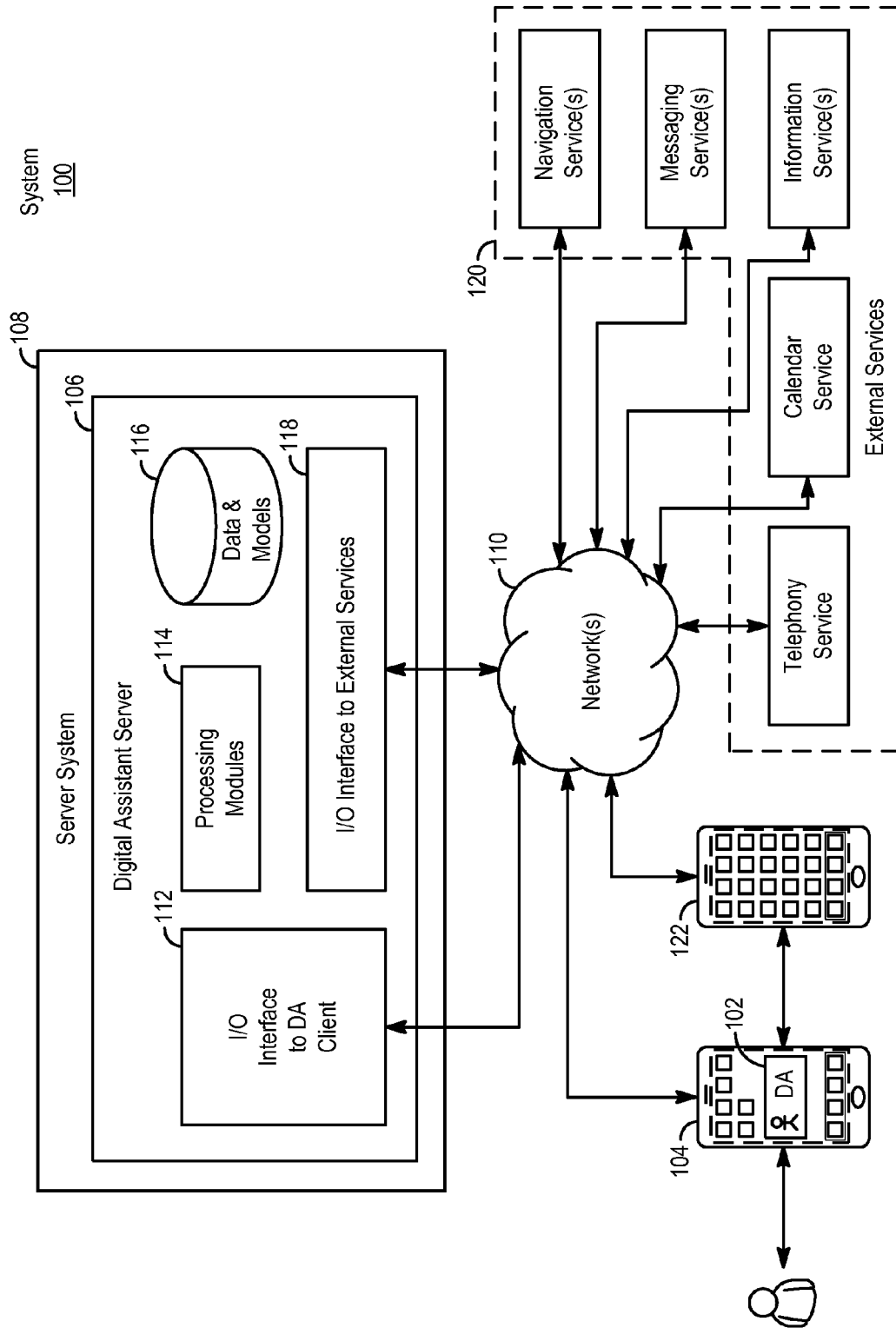

FIG. 1

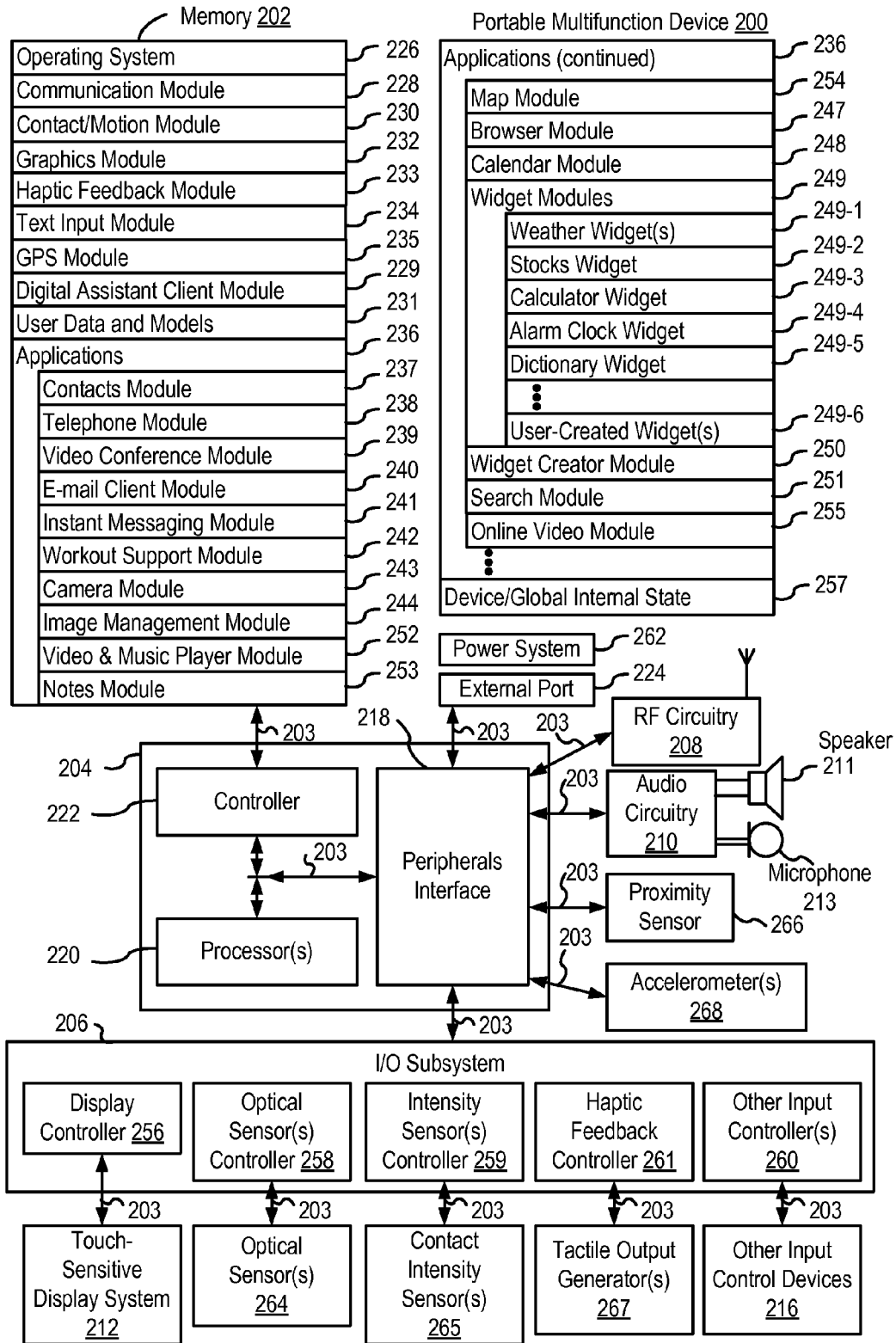

FIG. 2A

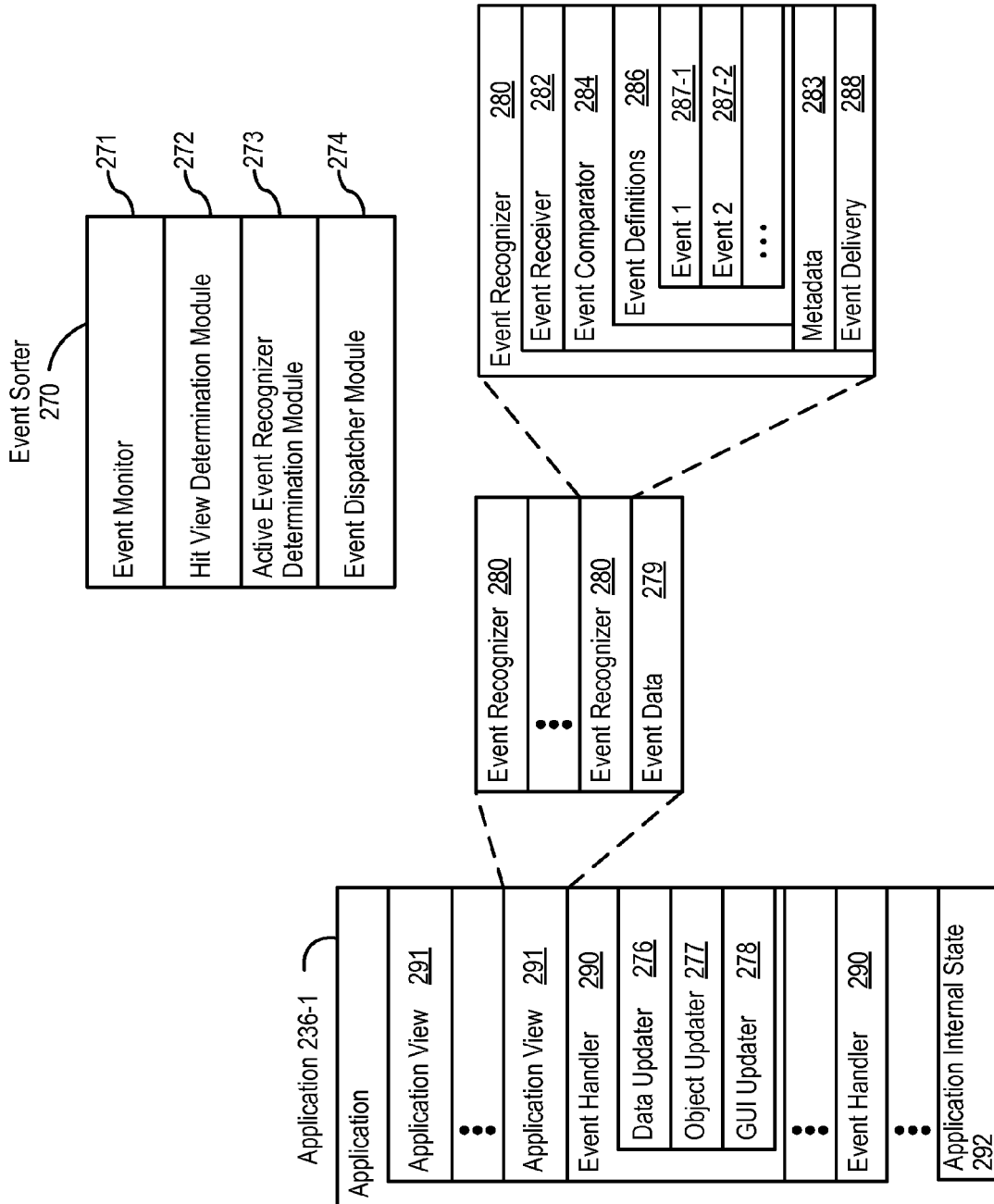

FIG. 2B

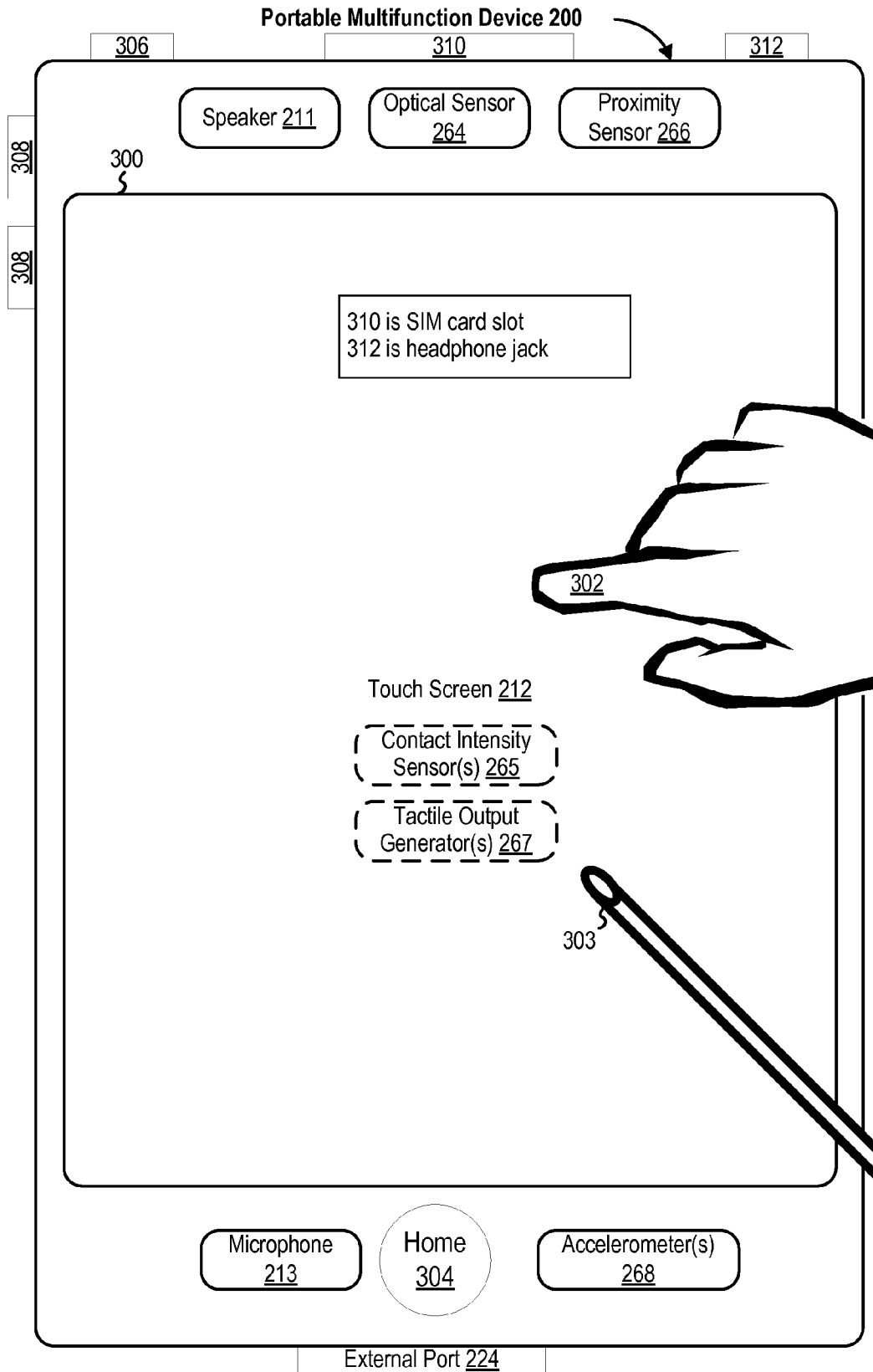

FIG. 3

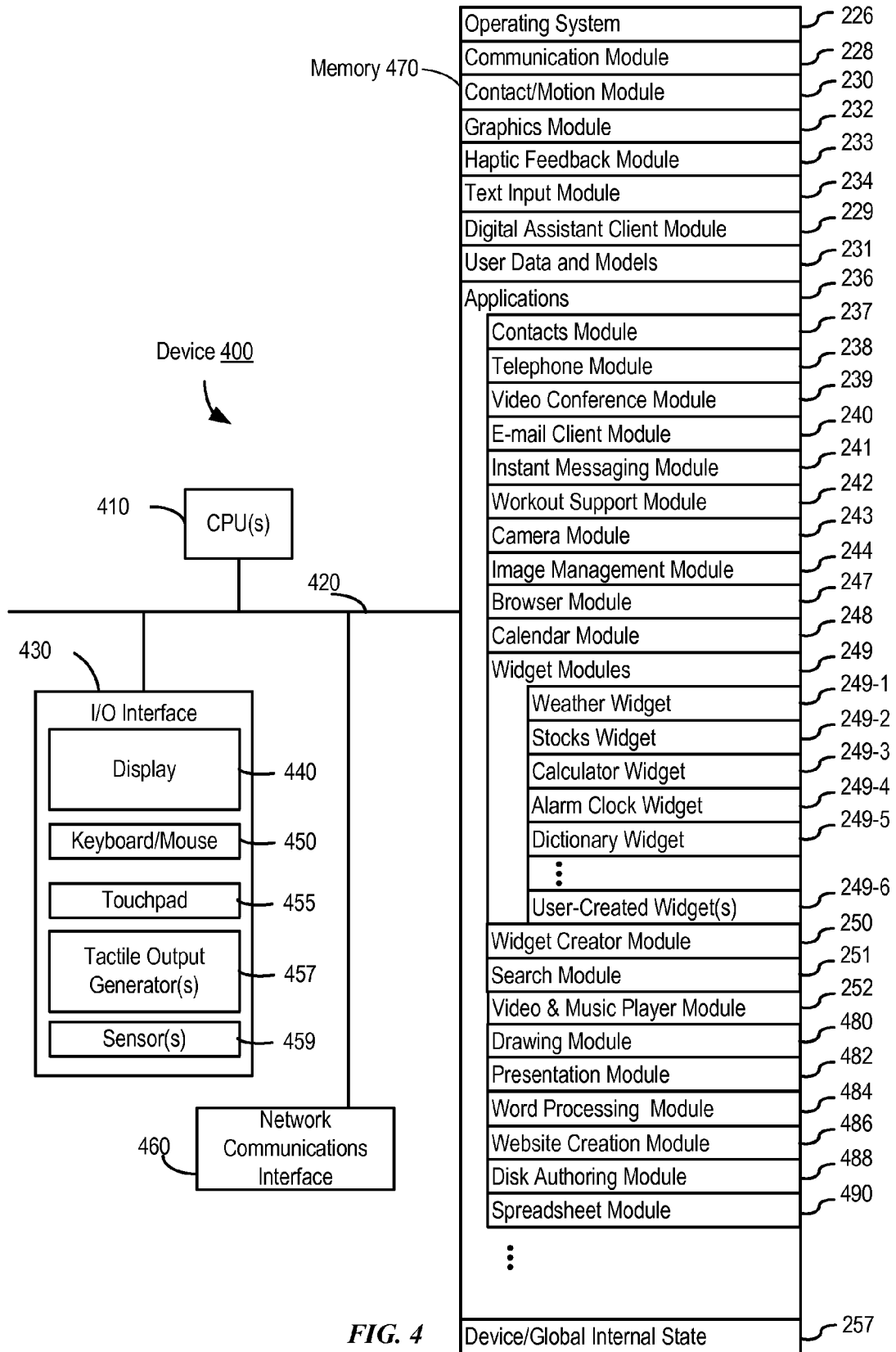

FIG. 4

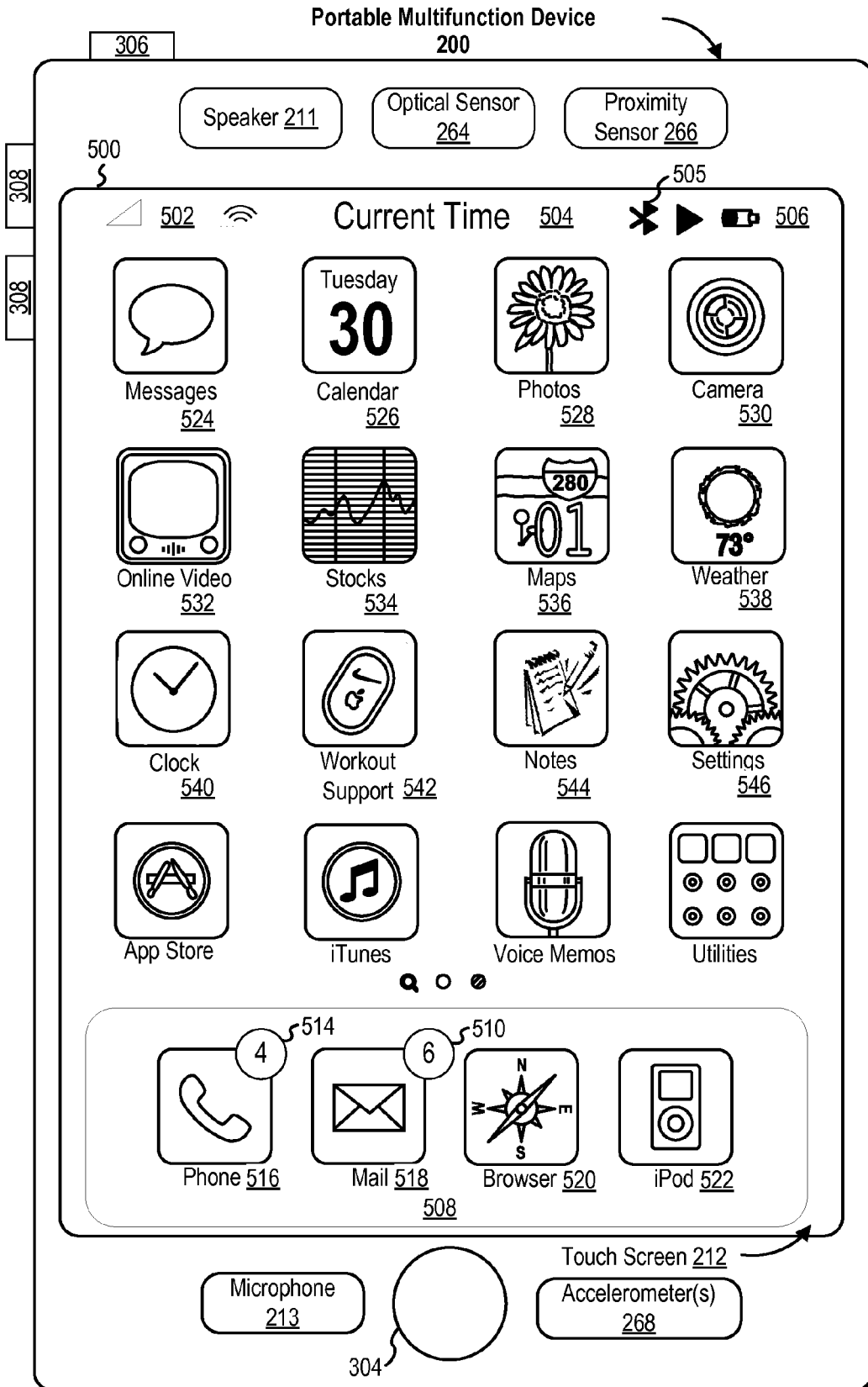

FIG. 5A

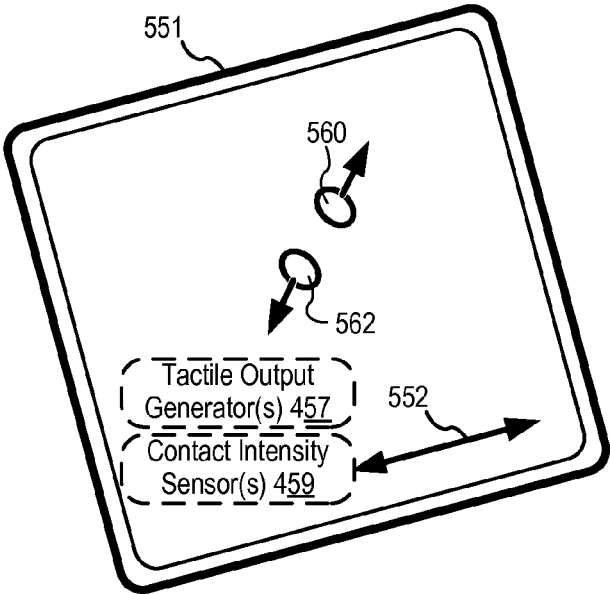
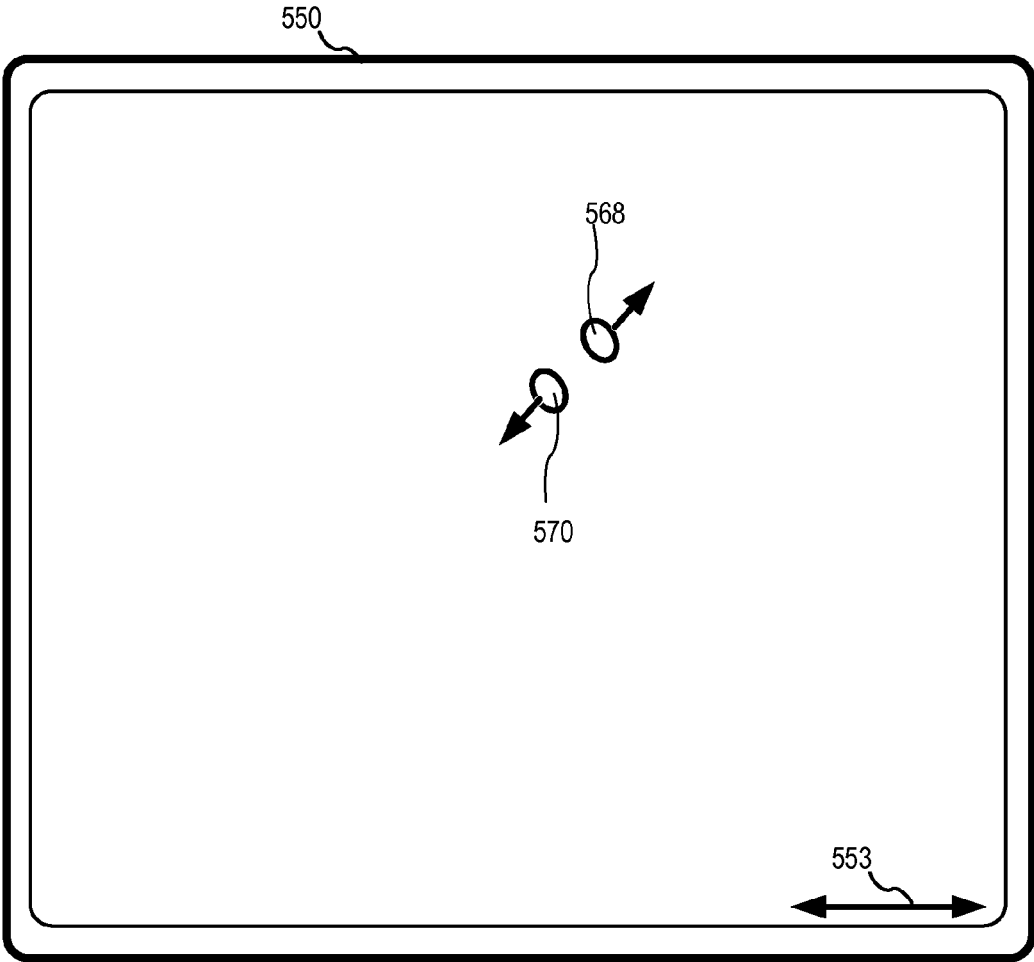

FIG. 5B

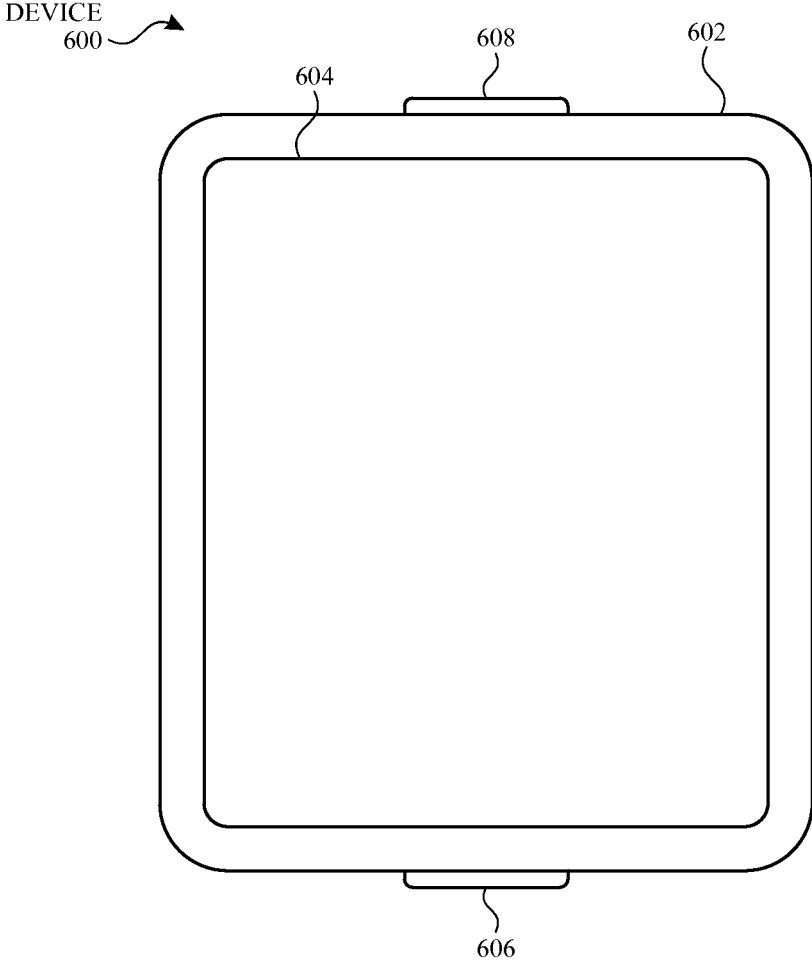

FIG. 6A

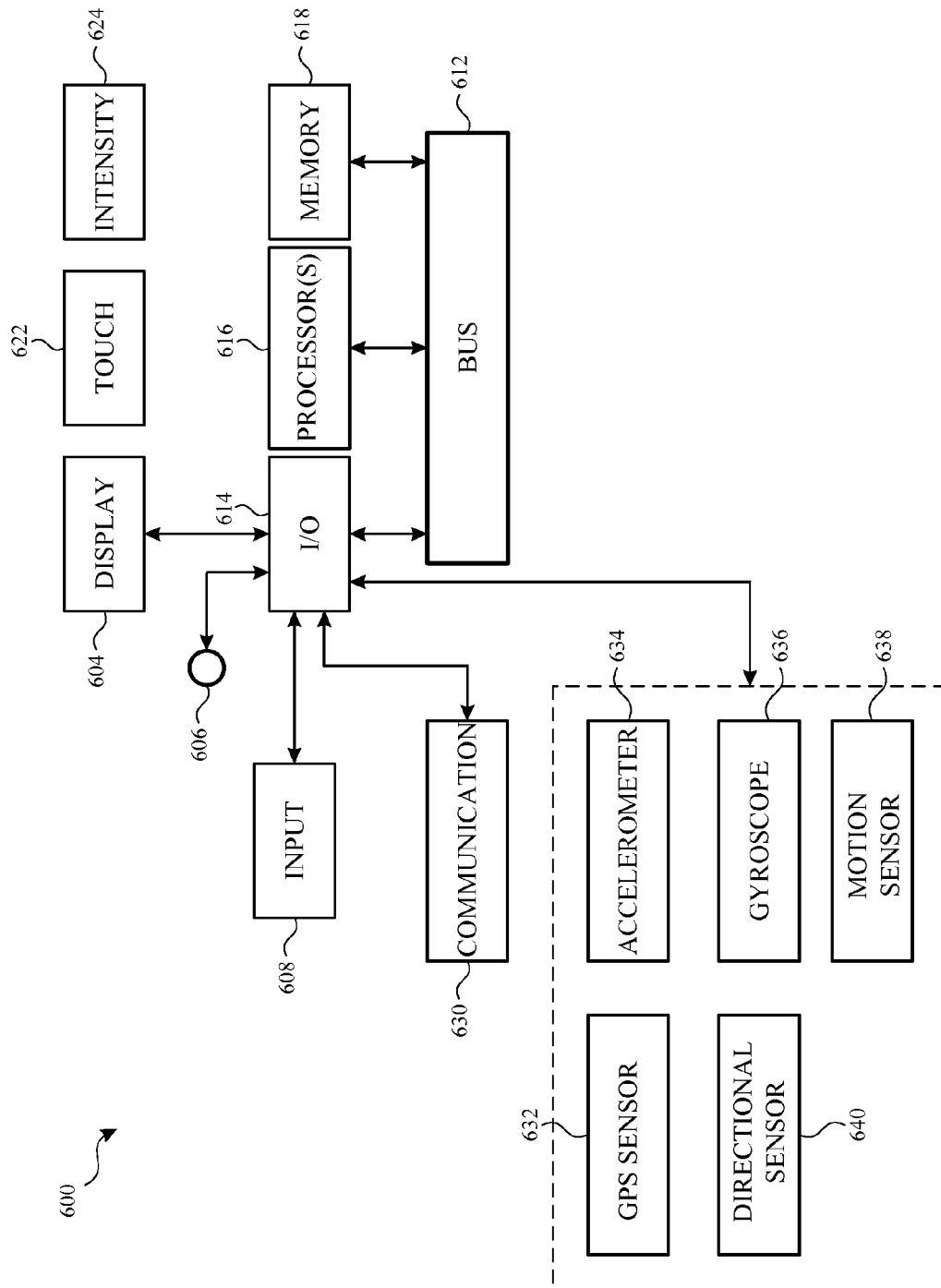

FIG. 6B

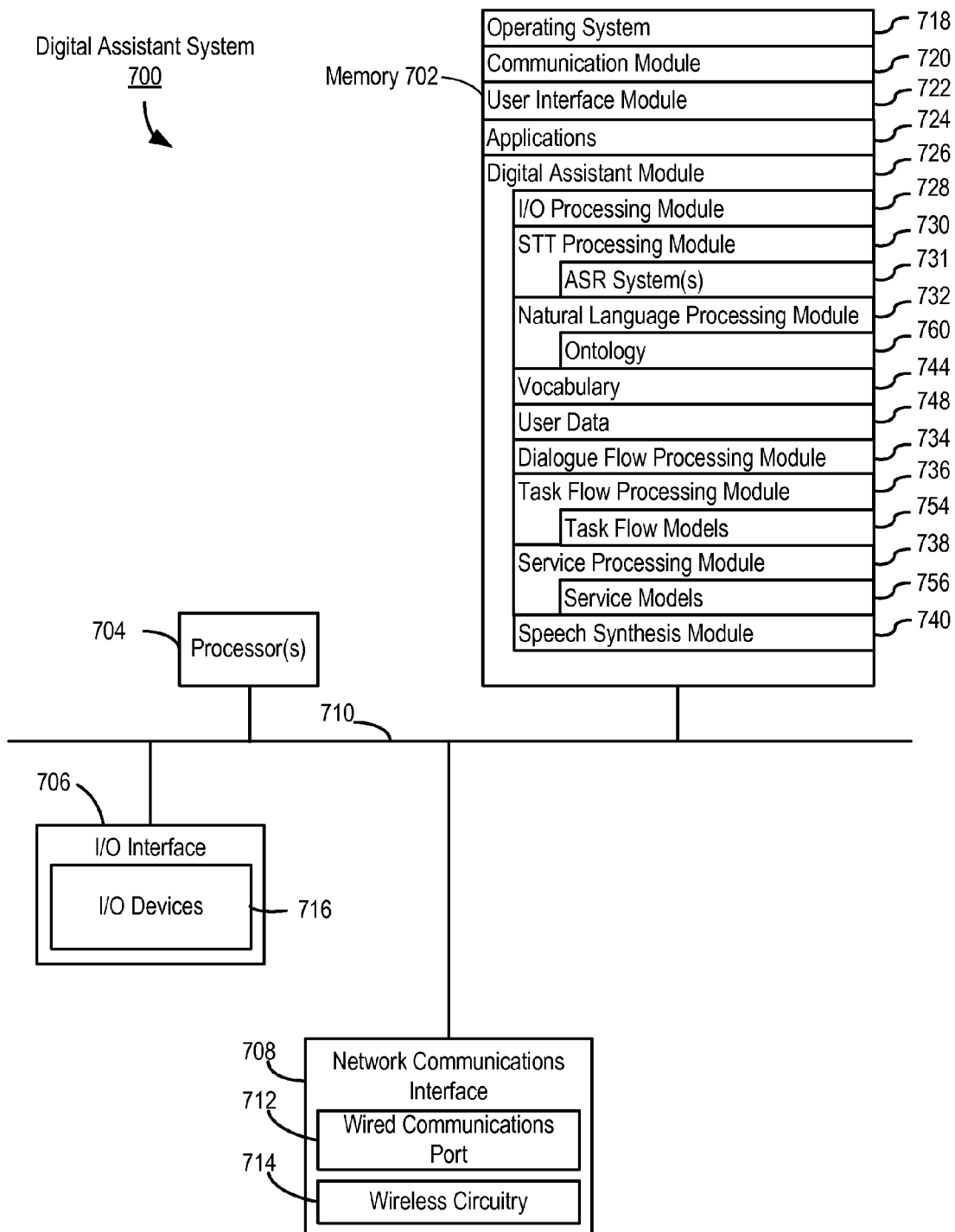

FIG. 7A

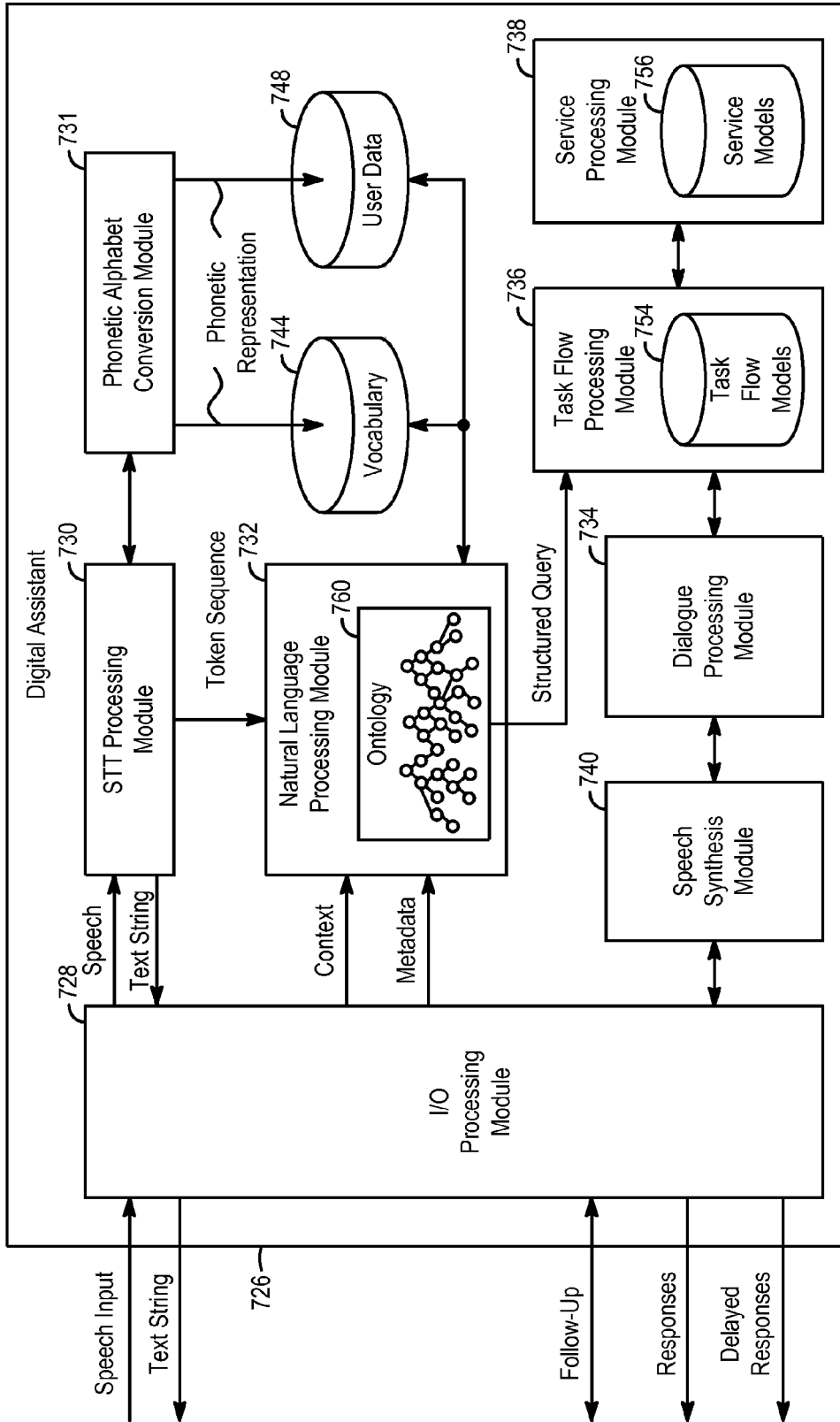

FIG. 7B

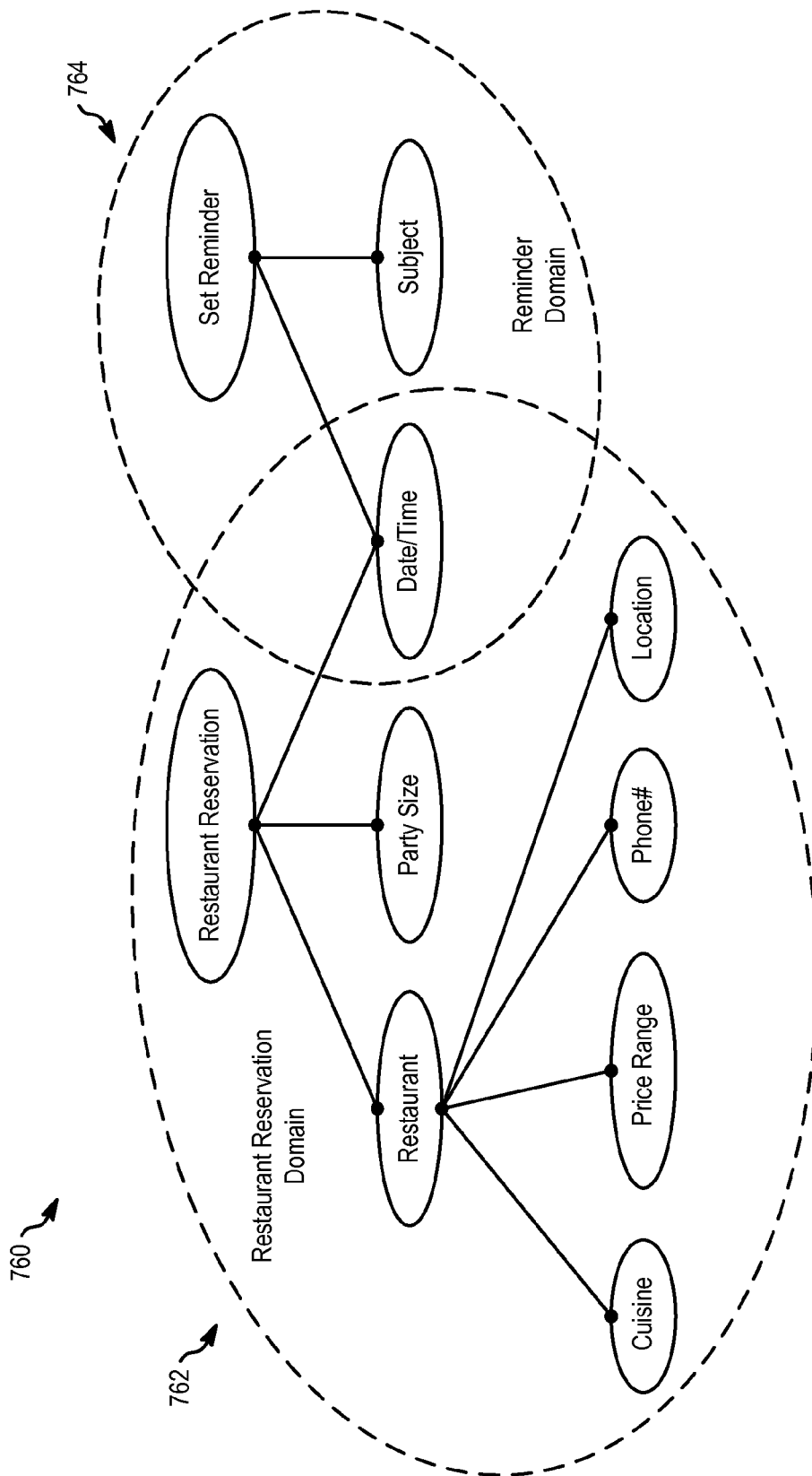

FIG. 7C

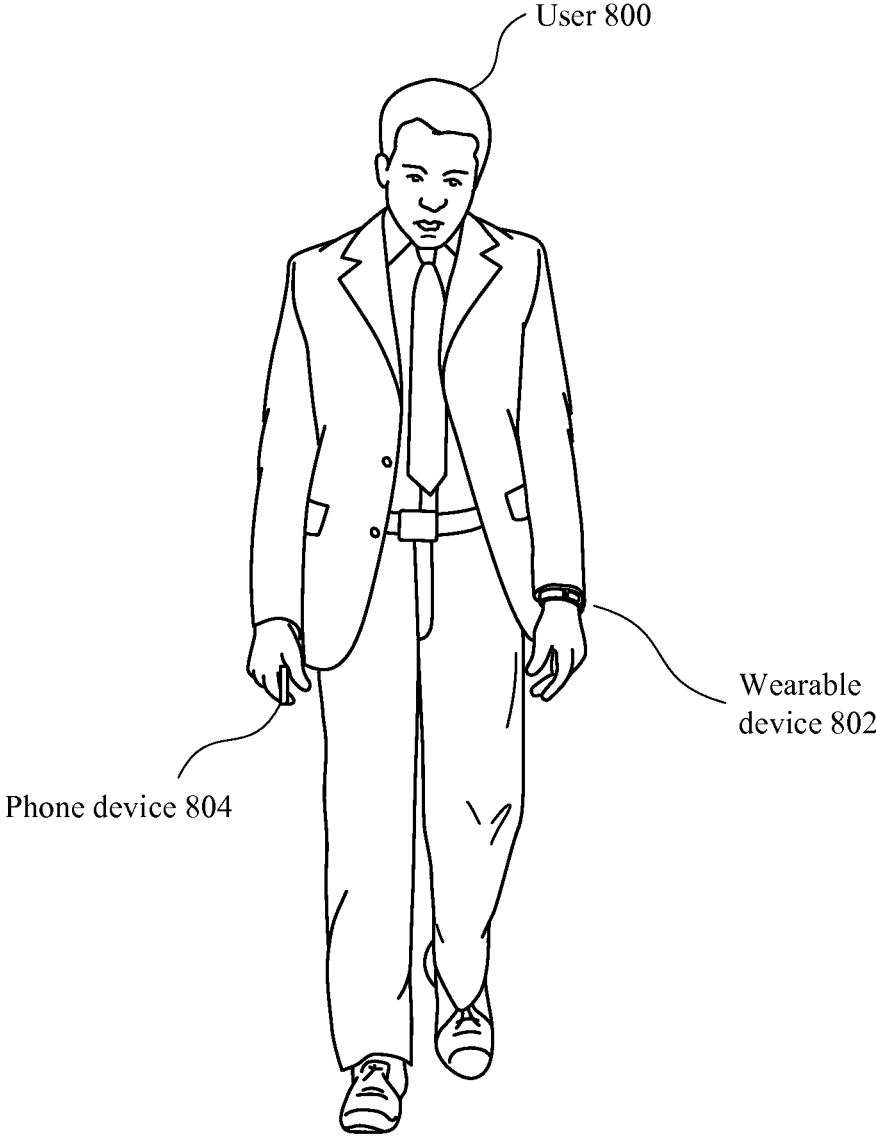

FIG. 8A

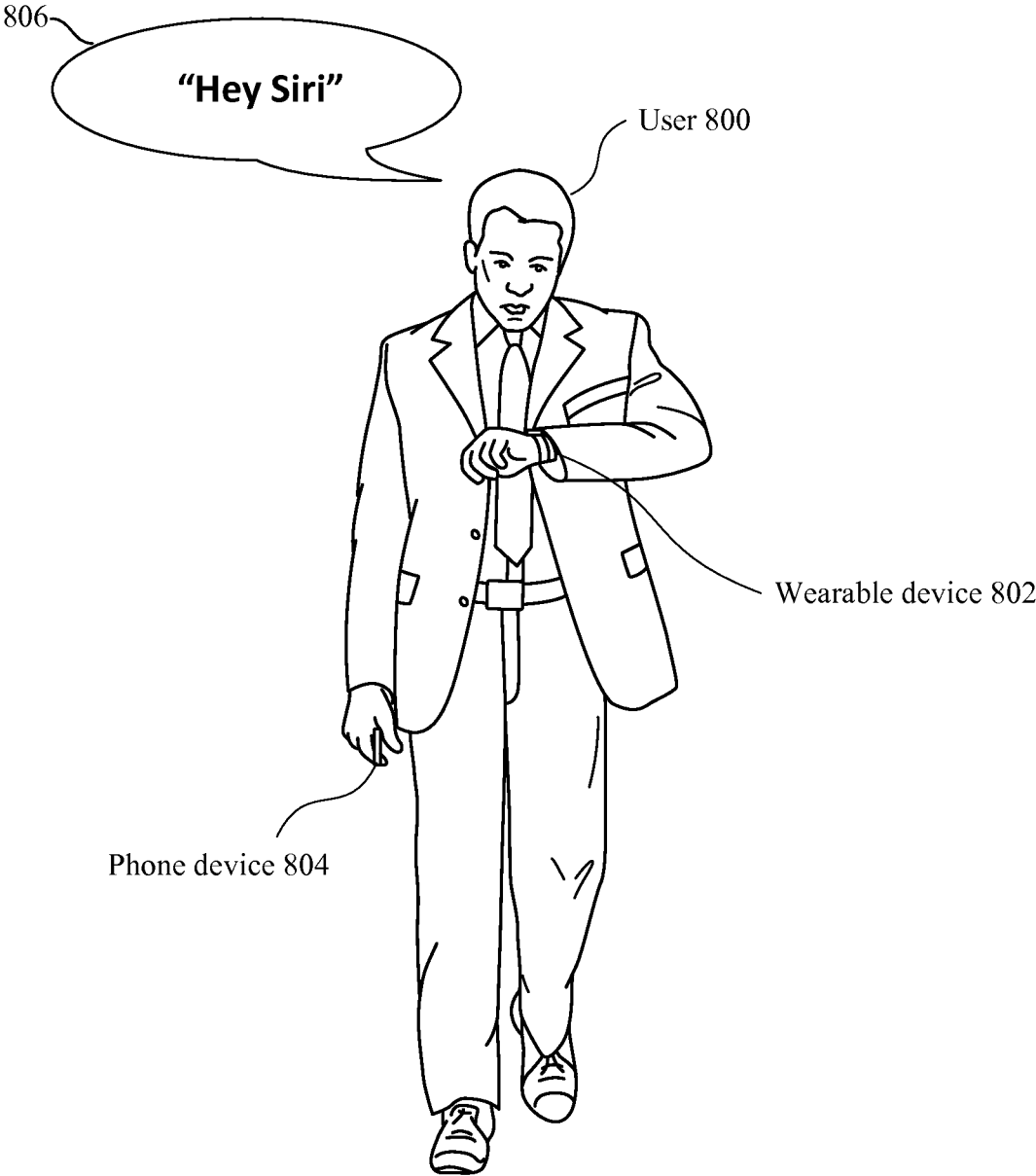

FIG. 8B

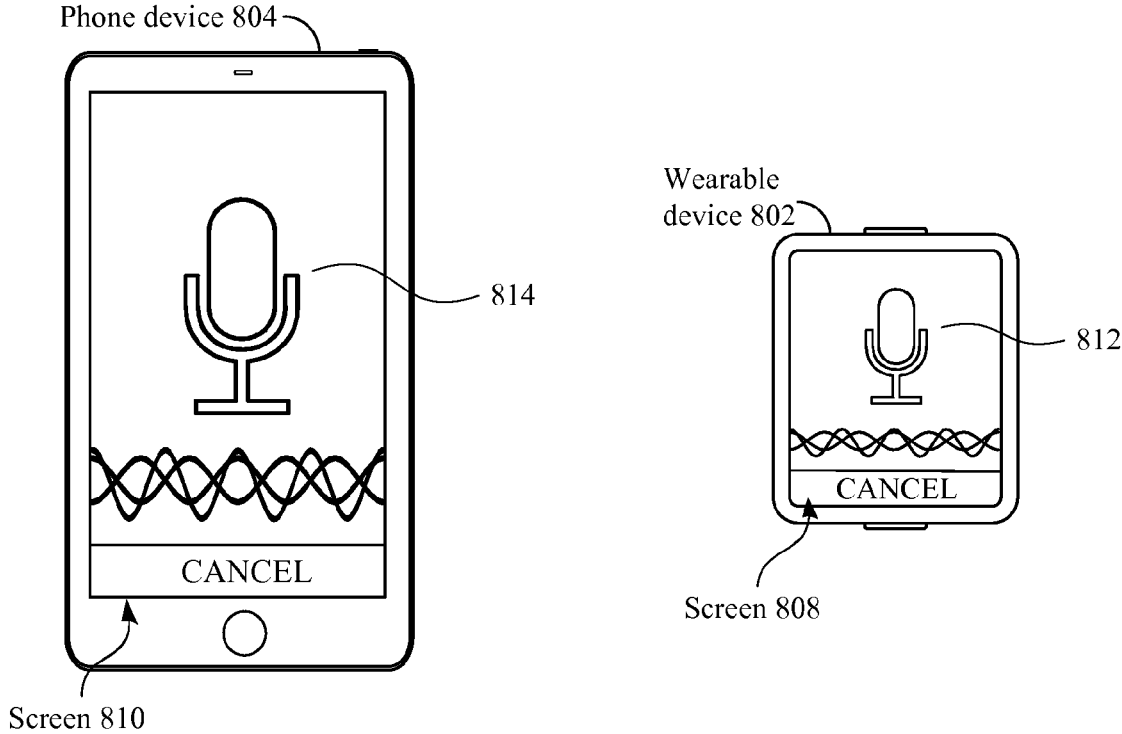

FIG. 8C

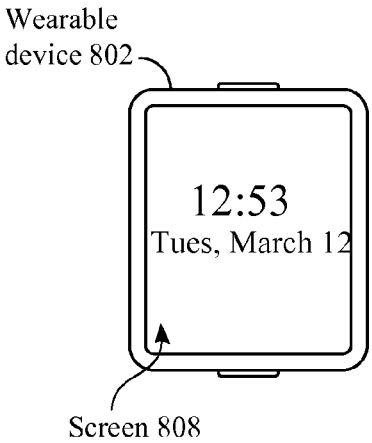
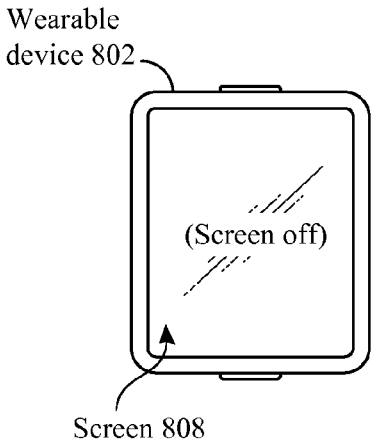
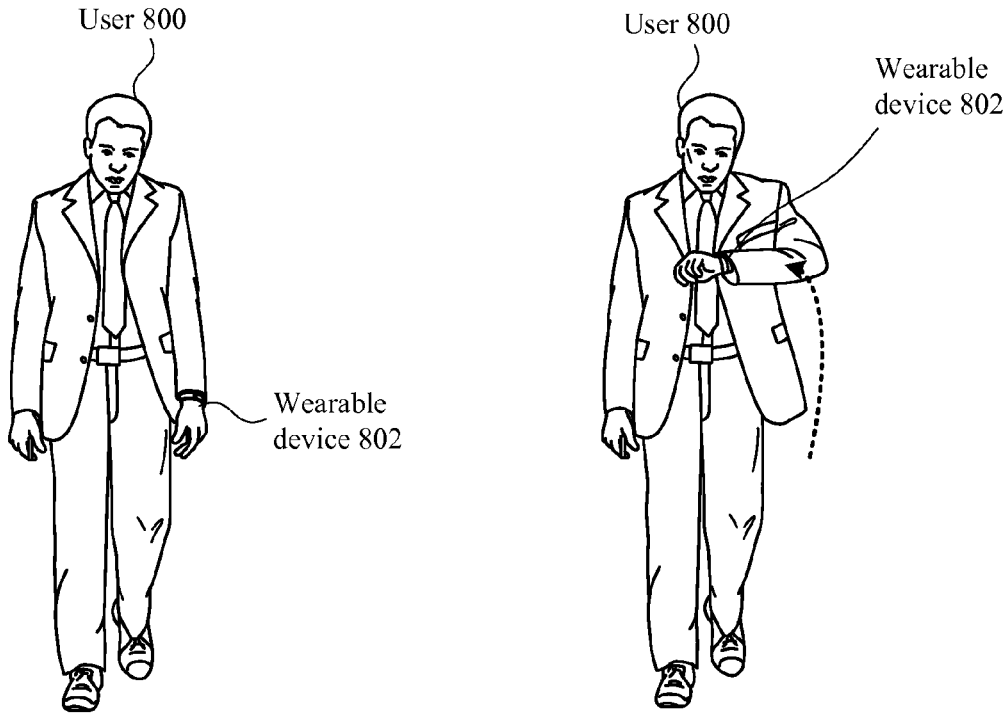

FIG. 8D

820

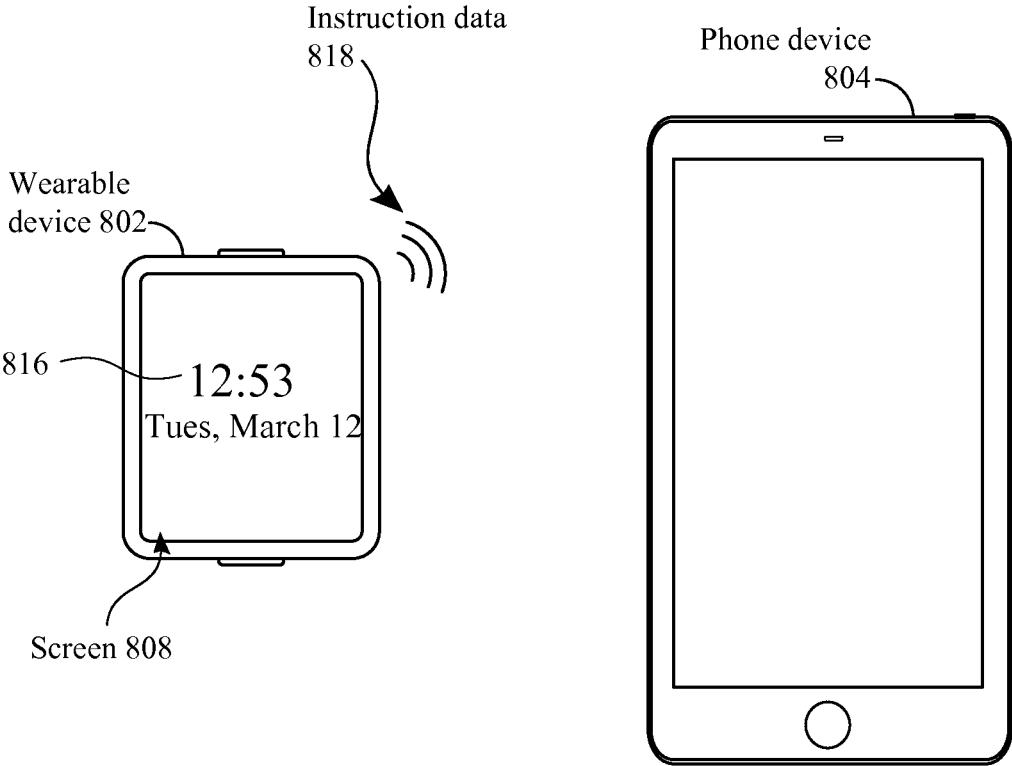

FIG. 8E

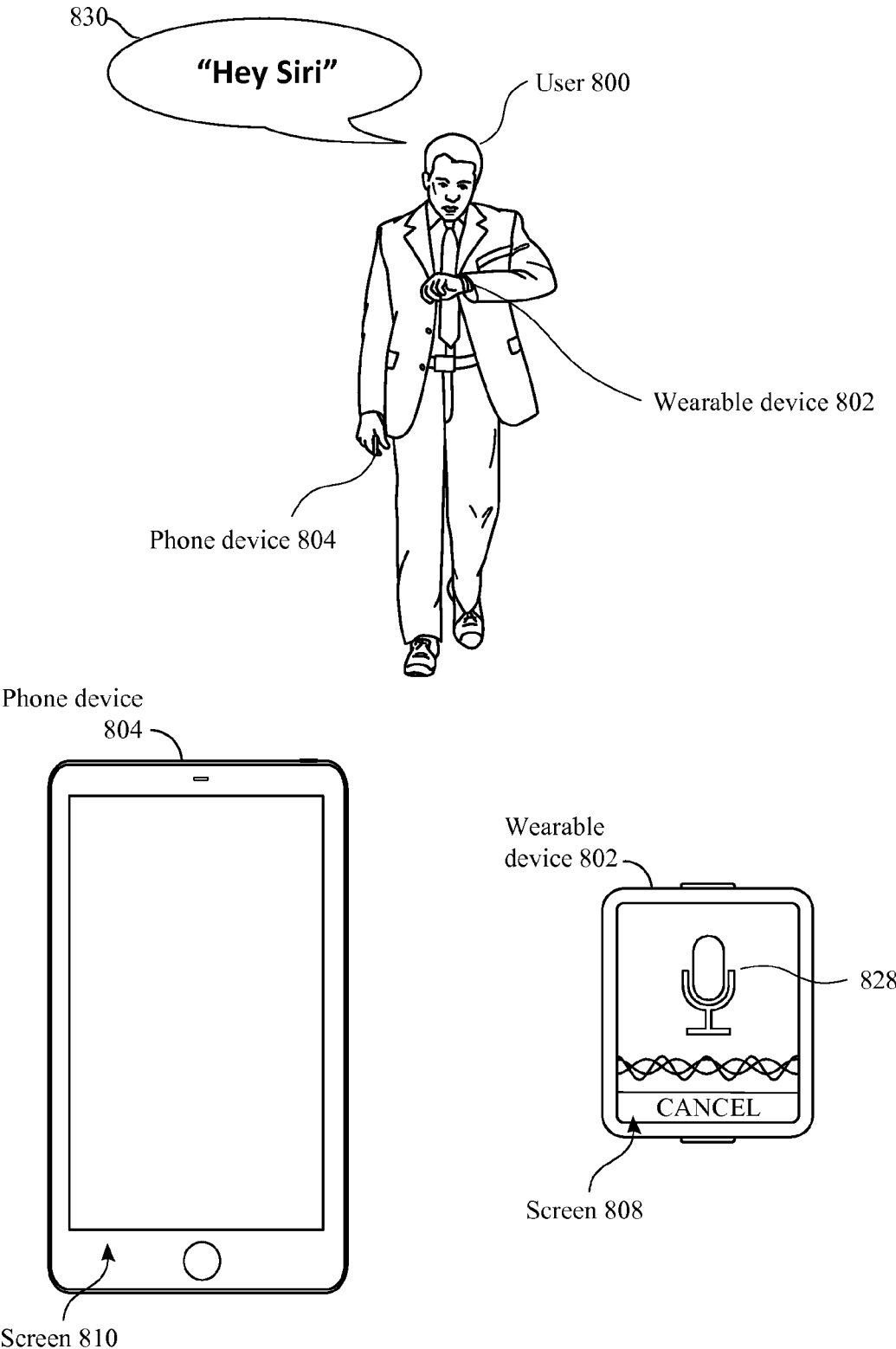

FIG. 8F

900

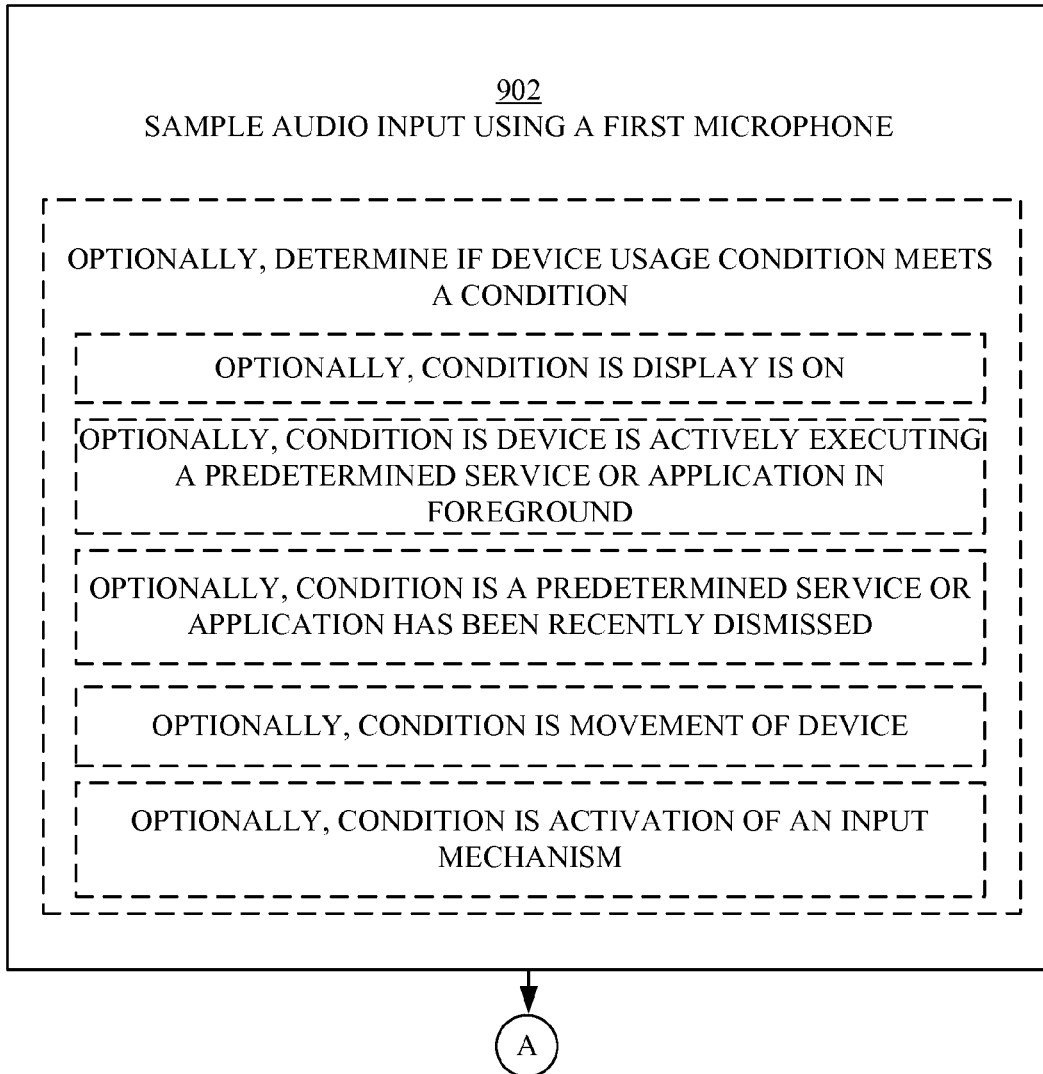

FIG. 9A

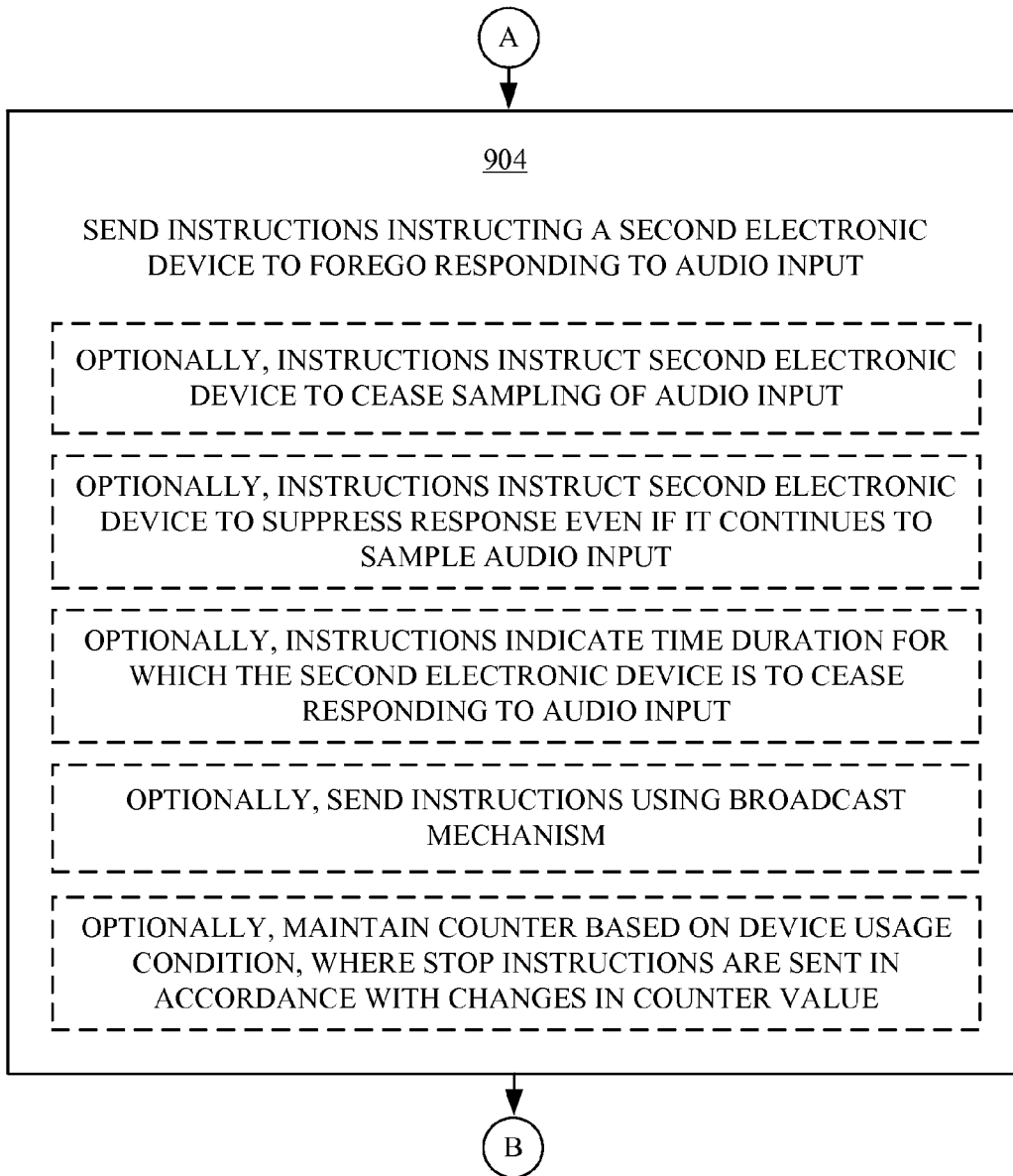

FIG. 9B

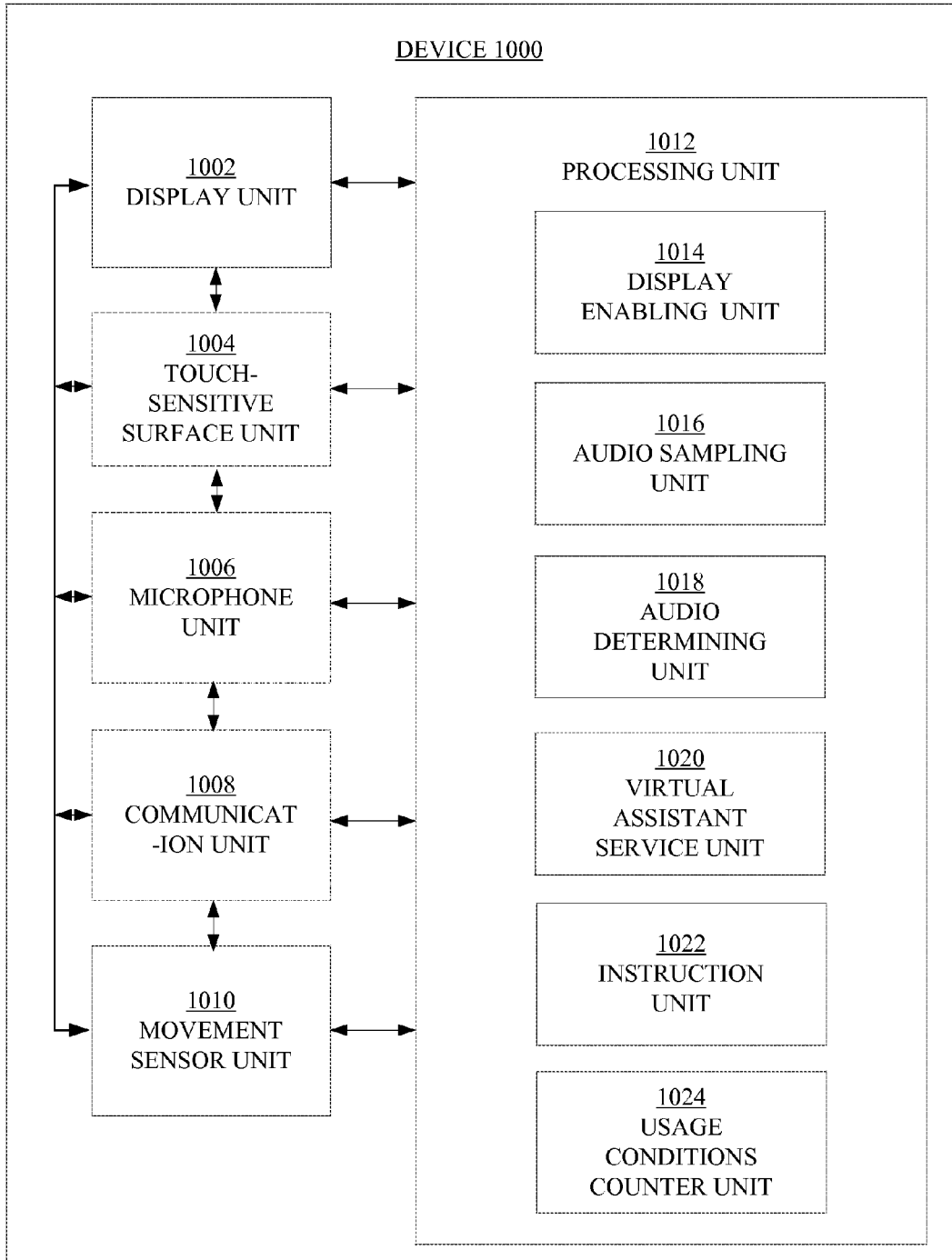

FIG. 10

COMPETING DEVICES RESPONDING TO VOICE TRIGGERS

CROSS-REFERENCE TO RELATED APPLICATIONS

This application claims the benefit of priority of U.S. Provisional Patent Application Ser. No. 62/129,922, titled "COMPETING DEVICES RESPONDING TO VOICE TRIGGERS," filed Mar. 8, 2015, the content of which is hereby incorporated by reference in its entirety.

This application relates to the following provisional applications: U.S. patent application Ser. No. 12/987,982, titled "INTELLIGENT AUTOMATED ASSISTANT," filed Jan. 10, 2011; and U.S. Provisional Patent Application Ser. No. 62/026,532, titled "RAISE GESTURE DETECTION IN A DEVICE," filed Jul. 18, 2014. The content of these applications is hereby incorporated by reference in its entirety.

BACKGROUND

1. Field

The present disclosure relates generally to computer user interfaces, and more specifically to techniques for triggering services and/or applications on electronic devices using spoken input.

2. Description of Related Art

Intelligent automated assistants (or virtual assistants) provide beneficial interfaces between human users and electronic devices. Exemplary virtual assistants allow users to interact with devices or systems using natural language in spoken and/or text forms. For instance, a user can provide a natural language input containing a user request to an electronic device. The virtual assistant of the device interprets the user's intent from the input and operationalizes the user's intent into one or more tasks.

Some electronic devices are configured to trigger a virtual assistant by sampling audio input and determining whether the sampled audio includes a trigger phrase. When multiple devices providing this feature are in proximity to a user, a single spoken utterance of the trigger phrase by the user may cause multiple devices to respond. This outcome may be sub-optimal as the user, who is likely expecting one device to respond, would be overwhelmed by the multiple responses.

BRIEF SUMMARY

It would be helpful for nearby devices to communicate with one another such that some devices refrain from responding to a user's spoken input. For example, one device can respond to the user's audio input while the other devices refrain from doing so temporarily.

In accordance with some embodiments, a method comprises: at a first electronic device with a display and a microphone: sampling audio input using the first microphone; in accordance with the sampling of audio input using the first microphone, sending stop instructions to a second electronic device with a second microphone, the second electronic device external to the first electronic device, wherein the second electronic device is configured to respond to audio input received using the second microphone, and wherein the stop instructions instruct the second electronic device to forgo responding to audio input received using the second microphone, wherein responding to audio input received using the second microphone comprises providing perceptible output.

In accordance with some embodiments, a non-transitory computer readable storage medium storing one or more programs, the one or more programs comprising instructions, which when executed by a first electronic device with a display, a first microphone, cause the first electronic device to: sample audio input using the first microphone; in accordance with the sampling of audio input using the first microphone, send stop instructions to a second electronic device with a second microphone, the second electronic device external to the first electronic device, wherein the second electronic device is configured to respond to audio input received using the second microphone, and wherein the stop instructions instruct the second electronic device to forgo responding to audio input received using the second microphone, wherein responding to audio input received using the second microphone comprises providing perceptible output.

In accordance with some embodiments, an electronic device comprises: a display; one or more processors; a memory; a first microphone; and one or more programs, wherein the one or more programs are stored in memory and configured to be executed by the one or more processors, the one or more programs including instructions for: sampling audio input using the first microphone; in accordance with the sampling of audio input using the first microphone, sending stop instructions to a second electronic device with a second microphone, the second electronic device external to the first electronic device, wherein the second electronic device is configured to respond to audio input received using the second microphone, and wherein the stop instructions instruct the second electronic device to forgo responding to audio input received using the second microphone, wherein responding to audio input received using the second microphone comprises providing perceptible output.

In accordance with some embodiments, an electronic device comprises: means for sampling audio input using the first microphone; means for, in accordance with the sampling of audio input using the first microphone, sending stop instructions to a second electronic device with a second microphone, the second electronic device external to the first electronic device, wherein the second electronic device is configured to respond to audio input received using the second microphone, and wherein the stop instructions instruct the second electronic device to forgo responding to audio input received using the second microphone, wherein responding to audio input received using the second microphone comprises providing perceptible output.

In accordance with some embodiments, an electronic device comprises: a display; a first microphone; and a processing unit coupled to the display, the first microphone, wherein the processing unit is configured to: sample audio input using the first microphone; in accordance with the sampling of audio input using the first microphone, send stop instructions to a second electronic device with a second microphone, the second electronic device external to the electronic device, wherein the second electronic device is configured to respond to audio input received using the second microphone, and wherein the stop instructions instruct the second electronic device to forgo responding to audio input received using the second microphone, wherein responding to audio input received using the second microphone comprises providing perceptible output.

In accordance with some embodiments, a transitory computer readable storage medium storing one or more programs, the one or more programs comprising instructions, which when executed by a first electronic device with a display, a first microphone, cause the first electronic device

to: sample audio input using the first microphone; in accordance with the sampling of audio input using the first microphone, send stop instructions to a second electronic device with a second microphone, the second electronic device external to the first electronic device, wherein the second electronic device is configured to respond to audio input received using the second microphone, and wherein the stop instructions instruct the second electronic device to forgo responding to audio input received using the second microphone, wherein responding to audio input received using the second microphone comprises providing perceptible output.

Executable instructions for performing these functions are, optionally, included in a non-transitory computer-readable storage medium or other computer program product configured for execution by one or more processors. Executable instructions for performing these functions are, optionally, included in a transitory computer-readable storage medium or other computer program product configured for execution by one or more processors.

BRIEF DESCRIPTION OF THE FIGURES

For a better understanding of the various described embodiments, reference should be made to the Description of Embodiments below, in conjunction with the following drawings in which like reference numerals refer to corresponding parts throughout the figures.

FIG. 1 illustrates a system and environment for implementing a digital assistant in accordance with some embodiments.

FIG. 2A illustrates a user device for implementing the client-side portion of a digital assistant in accordance with some embodiments.

FIG. 2B is a block diagram illustrating exemplary components for event handling in accordance with some embodiments.

FIG. 3 illustrates a portable multifunction device implementing the client-side portion of a digital assistant in accordance with some embodiments.

FIG. 4 is a block diagram of an exemplary multifunction device with a display and a touch-sensitive surface in accordance with some embodiments.

FIG. 5A illustrates an exemplary user interface for a menu of applications on a portable multifunction device in accordance with some embodiments.

FIG. 5B illustrates an exemplary user interface for a multifunction device with a touch-sensitive surface that is separate from the display in accordance with some embodiments.

FIG. 6A illustrates a personal electronic device in accordance with some embodiments.

FIG. 6B is a block diagram illustrating a personal electronic device in accordance with some embodiments.

FIG. 7A illustrates a digital assistant system or a server portion thereof in accordance with some embodiments.

FIG. 7B illustrates the functions of the digital assistant shown in FIG. 7A in accordance with some embodiments.

FIG. 7C illustrates a portion of an ontology in accordance with some embodiments.

FIGS. 8A-8F illustrate exemplary techniques for transitioning between electronic devices in accordance with some embodiments.

FIGS. 9A-9C are flow diagrams illustrating a process for transitioning between electronic devices in accordance with some embodiments.

FIG. 10 is a functional block diagram of an electronic device in accordance with some embodiments.

DESCRIPTION OF EMBODIMENTS

In the following description of the disclosure and embodiments, reference is made to the accompanying drawings in which it is shown by way of illustration of specific embodiments that can be practiced. It is to be understood that other embodiments and examples can be practiced and changes can be made without departing from the scope of the disclosure.

Techniques for avoiding simultaneous responses from multiple electronic devices due to a user's utterance of a spoken trigger are desirable. These techniques help prevent a user from being inundated with user interface outputs, and generally lends to a higher-quality user experience. In addition, by avoiding redundant output across multiple devices, processor and battery power otherwise wasted can be conserved.

Below, FIGS. 1, 2, 7A-7B, and 10 describe exemplary computing devices that are adapted to control their output responsive to spoken input to avoid simultaneous responses. FIGS. 8A-8F illustrate exemplary techniques and user interfaces for transitioning between computing devices. The user interfaces in the figures are also used to illustrate the processes described below, including the process in FIGS. 9A-9C.

Although the following description uses terms "first," "second," etc. to describe various elements, these elements should not be limited by the terms. These terms are only used to distinguish one element from another. For example, a first input could be termed a second input, and, similarly, a second input could be termed a first input, without departing from the scope of the various described examples. The first input and the second input can both be outputs and, in some cases, can be separate and different inputs.

The terminology used in the description of the various described examples herein is for the purpose of describing particular examples only and is not intended to be limiting. As used in the description of the various described examples and the appended claims, the singular forms "a," "an," and "the" are intended to include the plural forms as well, unless the context clearly indicates otherwise. It will also be understood that the term "and/or" as used herein refers to and encompasses any and all possible combinations of one or more of the associated listed items. It will be further understood that the terms "includes," "including," "comprises," and/or "comprising," when used in this specification, specify the presence of stated features, integers, steps, operations, elements, and/or components, but do not preclude the presence or addition of one or more other features, integers, steps, operations, elements, components, and/or groups thereof.

The term "if" is, optionally, construed to mean "when" or "upon" or "in response to determining" or "in response to detecting," depending on the context. Similarly, the phrase "if it is determined" or "if [a stated condition or event] is detected" is, optionally, construed to mean "upon determining" or "in response to determining" or "upon detecting [the stated condition or event]" or "in response to detecting [the stated condition or event]," depending on the context.

1. System and Environment

FIG. 1 illustrates a block diagram of system 100 according to various examples. In some examples, system 100 can implement a digital assistant. The terms "digital assistant," "virtual assistant," "intelligent automated assistant," or

“automatic digital assistant” can refer to any information processing system that interprets natural language input in spoken and/or textual form to infer user intent, and performs actions based on the inferred user intent. For example, to act on an inferred user intent, the system can perform one or more of the following: identifying a task flow with steps and parameters designed to accomplish the inferred user intent, inputting specific requirements from the inferred user intent into the task flow; executing the task flow by invoking programs, methods, services, APIs, or the like; and generating output responses to the user in an audible (e.g., speech) and/or visual form.

Specifically, a digital assistant can be capable of accepting a user request at least partially in the form of a natural language command, request, statement, narrative, and/or inquiry. Typically, the user request can seek either an informational answer or performance of a task by the digital assistant. A satisfactory response to the user request can be a provision of the requested informational answer, a performance of the requested task, or a combination of the two. For example, a user can ask the digital assistant a question, such as “Where am I right now?” Based on the user’s current location, the digital assistant can answer, “You are in Central Park near the west gate.” The user can also request the performance of a task, for example, “Please invite my friends to my girlfriend’s birthday party next week.” In response, the digital assistant can acknowledge the request by saying “Yes, right away,” and then send a suitable calendar invite on behalf of the user to each of the user’s friends listed in the user’s electronic address book. During performance of a requested task, the digital assistant can sometimes interact with the user in a continuous dialogue involving multiple exchanges of information over an extended period of time. There are numerous other ways of interacting with a digital assistant to request information or performance of various tasks. In addition to providing verbal responses and taking programmed actions, the digital assistant can also provide responses in other visual or audio forms, e.g., as text, alerts, music, videos, animations, etc.

As shown in FIG. 1, in some examples, a digital assistant can be implemented according to a client-server model. The digital assistant can include client-side portion **102** (hereafter “DA client **102**”) executed on user device **104** and server-side portion **106** (hereafter “DA server **106**”) executed on server system **108**. DA client **102** can communicate with DA server **106** through one or more networks **110**. DA client **102** can provide client-side functionalities such as user-facing input and output processing and communication with DA server **106**. DA server **106** can provide server-side functionalities for any number of DA clients **102** each residing on a respective user device **104**.

In some examples, DA server **106** can include client-facing I/O interface **112**, one or more processing modules **114**, data and models **116**, and I/O interface to external services **118**. The client-facing I/O interface **112** can facilitate the client-facing input and output processing for DA server **106**. One or more processing modules **114** can utilize data and models **116** to process speech input and determine the user’s intent based on natural language input. Further, one or more processing modules **114** perform task execution based on inferred user intent. In some examples, DA server **106** can communicate with external services **120** through network(s) **110** for task completion or information acquisition. I/O interface to external services **118** can facilitate such communications.

User device **104** can be any suitable electronic device. For example, user devices can be a portable multifunctional

device (e.g., device **200**, described below with reference to FIG. 2A), a multifunctional device (e.g., device **400**, described below with reference to FIG. 4), or a personal electronic device (e.g., device **600**, described below with reference to FIG. 6A-B.) A portable multifunctional device can be, for example, a mobile telephone that also contains other functions, such as PDA and/or music player functions. Specific examples of portable multifunction devices can include the iPhone®, iPod Touch®, and iPad® devices from Apple Inc. of Cupertino, Calif. Other examples of portable multifunction devices can include, without limitation, laptop or tablet computers. Further, in some examples, user device **104** can be a non-portable multifunctional device. In particular, user device **104** can be a desktop computer, a game console, a television, or a television set-top box. In some examples, user device **104** can include a touch-sensitive surface (e.g., touch screen displays and/or touchpads). Further, user device **104** can optionally include one or more other physical user-interface devices, such as a physical keyboard, a mouse, and/or a joystick. Various examples of electronic devices, such as multifunctional devices, are described below in greater detail.

Examples of communication network(s) **110** can include local area networks (LAN) and wide area networks (WAN), e.g., the Internet. Communication network(s) **110** can be implemented using any known network protocol, including various wired or wireless protocols, such as, for example, Ethernet, Universal Serial Bus (USB), FIREWIRE, Global System for Mobile Communications (GSM), Enhanced Data GSM Environment (EDGE), code division multiple access (CDMA), time division multiple access (TDMA), Bluetooth, Wi-Fi, voice over Internet Protocol (VoIP), Wi-MAX, or any other suitable communication protocol.

Server system **108** can be implemented on one or more standalone data processing apparatus or a distributed network of computers. In some examples, server system **108** can also employ various virtual devices and/or services of third-party service providers (e.g., third-party cloud service providers) to provide the underlying computing resources and/or infrastructure resources of server system **108**.

In some examples, user device **104** can communicate with DA server **106** via second user device **122**. Second user device **122** can be similar or identical to user device **104**. For example, second user device **122** can be similar to any one of devices **200**, **400**, or **600**, described below with reference to FIGS. 2A, 4, and 6A-B, respectively. User device **104** can be configured to communicatively couple to second user device **122** via a direct communication connection, such as Bluetooth, NFC, BTLE, or the like, or via a wired or wireless network, such as a local Wi-Fi network. In some examples, second user device **122** can be configured to act as a proxy between user device **104** and DA server **106**. For example, DA client **102** of user device **104** can be configured to transmit information (e.g., a user request received at user device **104**) to DA server **106** via second user device **122**. DA server **106** can process the information and return relevant data (e.g., data content responsive to the user request) to user device **104** via second user device **122**.

In some examples, user device **104** can be configured to communicate abbreviated requests for data to second user device **122** to reduce the amount of information transmitted from user device **104**. Second user device **122** can be configured to determine supplemental information to add to the abbreviated request to generate a complete request to transmit to DA server **106**. This system architecture can advantageously allow user device **104** having limited communication capabilities and/or limited battery power (e.g., a

watch or a similar compact electronic device) to access services provided by DA server **106** by using second user device **122**, having greater communication capabilities and/or battery power (e.g., a mobile phone, laptop computer, tablet computer, or the like), as a proxy to DA server **106**. While only two user devices **104** and **122** are shown in FIG. 1, it should be appreciated that system **100** can include any number and type of user devices configured in this proxy configuration to communicate with DA server system **106**.

Although the digital assistant shown in FIG. 1 can include both a client-side portion (e.g., DA client **102**) and a server-side portion (e.g., DA server **106**), in some examples, the functions of a digital assistant can be implemented as a standalone application installed on a user device. In addition, the divisions of functionalities between the client and server portions of the digital assistant can vary in different implementations. For instance, in some examples, the DA client can be a thin-client that provides only user-facing input and output processing functions, and delegates all other functionalities of the digital assistant to a backend server.

2. Electronic Devices

Attention is now directed toward embodiments of electronic devices for implementing the client-side portion of a digital assistant. FIG. 2A is a block diagram illustrating portable multifunction device **200** with touch-sensitive display system **212** in accordance with some embodiments. Touch-sensitive display **212** is sometimes called a “touch screen” for convenience and is sometimes known as or called a “touch-sensitive display system.” Device **200** includes memory **202** (which optionally includes one or more computer-readable storage mediums), memory controller **222**, one or more processing units (CPUs) **220**, peripherals interface **218**, RF circuitry **208**, audio circuitry **210**, speaker **211**, microphone **213**, input/output (I/O) subsystem **206**, other input control devices **216**, and external port **224**. Device **200** optionally includes one or more optical sensors **264**. Device **200** optionally includes one or more contact intensity sensors **265** for detecting intensity of contacts on device **200** (e.g., a touch-sensitive surface such as touch-sensitive display system **212** of device **200**). Device **200** optionally includes one or more tactile output generators **267** for generating tactile outputs on device **200** (e.g., generating tactile outputs on a touch-sensitive surface such as touch-sensitive display system **212** of device **200** or touchpad **455** of device **400**). These components optionally communicate over one or more communication buses or signal lines **203**.

As used in the specification and claims, the term “intensity” of a contact on a touch-sensitive surface refers to the force or pressure (force per unit area) of a contact (e.g., a finger contact) on the touch-sensitive surface, or to a substitute (proxy) for the force or pressure of a contact on the touch-sensitive surface. The intensity of a contact has a range of values that includes at least four distinct values and more typically includes hundreds of distinct values (e.g., at least 256). Intensity of a contact is, optionally, determined (or measured) using various approaches and various sensors or combinations of sensors. For example, one or more force sensors underneath or adjacent to the touch-sensitive surface are, optionally, used to measure force at various points on the touch-sensitive surface. In some implementations, force measurements from multiple force sensors are combined (e.g., a weighted average) to determine an estimated force of a contact. Similarly, a pressure-sensitive tip of a stylus is, optionally, used to determine a pressure of the stylus on the touch-sensitive surface. Alternatively, the size of the contact

area detected on the touch-sensitive surface and/or changes thereto, the capacitance of the touch-sensitive surface proximate to the contact and/or changes thereto, and/or the resistance of the touch-sensitive surface proximate to the contact and/or changes thereto are, optionally, used as a substitute for the force or pressure of the contact on the touch-sensitive surface. In some implementations, the substitute measurements for contact force or pressure are used directly to determine whether an intensity threshold has been exceeded (e.g., the intensity threshold is a pressure threshold corresponding to the substitute measurements). In some implementations, the substitute measurements for contact force or pressure are converted to an estimated force or pressure, and the estimated force or pressure is used to determine whether an intensity threshold has been exceeded (e.g., the intensity threshold is a pressure threshold measured in units of pressure). Using the intensity of a contact as an attribute of a user input allows for user access to additional device functionality that may otherwise not be accessible by the user on a reduced-size device with limited real estate for displaying affordances (e.g., on a touch-sensitive display) and/or receiving user input (e.g., via a touch-sensitive display, a touch-sensitive surface, or a physical/mechanical control such as a knob or a button).

As used in the specification and claims, the term “tactile output” refers to physical displacement of a device relative to a previous position of the device, physical displacement of a component (e.g., a touch-sensitive surface) of a device relative to another component (e.g., housing) of the device, or displacement of the component relative to a center of mass of the device that will be detected by a user with the user’s sense of touch. For example, in situations where the device or the component of the device is in contact with a surface of a user that is sensitive to touch (e.g., a finger, palm, or other part of a user’s hand), the tactile output generated by the physical displacement will be interpreted by the user as a tactile sensation corresponding to a perceived change in physical characteristics of the device or the component of the device. For example, movement of a touch-sensitive surface (e.g., a touch-sensitive display or trackpad) is, optionally, interpreted by the user as a “down click” or “up click” of a physical actuator button. In some cases, a user will feel a tactile sensation such as an “down click” or “up click” even when there is no movement of a physical actuator button associated with the touch-sensitive surface that is physically pressed (e.g., displaced) by the user’s movements. As another example, movement of the touch-sensitive surface is, optionally, interpreted or sensed by the user as “roughness” of the touch-sensitive surface, even when there is no change in smoothness of the touch-sensitive surface. While such interpretations of touch by a user will be subject to the individualized sensory perceptions of the user, there are many sensory perceptions of touch that are common to a large majority of users. Thus, when a tactile output is described as corresponding to a particular sensory perception of a user (e.g., an “up click,” a “down click,” “roughness”), unless otherwise stated, the generated tactile output corresponds to physical displacement of the device or a component thereof that will generate the described sensory perception for a typical (or average) user.

It should be appreciated that device **200** is only one example of a portable multifunction device, and that device **200** optionally has more or fewer components than shown, optionally combines two or more components, or optionally has a different configuration or arrangement of the components. The various components shown in FIG. 2A are implemented in hardware, software, or a combination of

both hardware and software, including one or more signal processing and/or application-specific integrated circuits.

Memory **202** optionally includes one or more computer-readable storage mediums. The computer-readable storage mediums is, optionally, tangible and non-transitory. Memory **202** optionally includes high-speed random access memory and optionally includes non-volatile memory, such as one or more magnetic disk storage devices, flash memory devices, or other non-volatile solid-state memory devices. Memory controller **222** optionally controls access to memory **202** by other components of device **200**.

In some examples, a non-transitory computer-readable storage medium of memory **202** can be used to store instructions (e.g., for performing aspects of process **900** (FIG. 9), described below) for use by or in connection with an instruction execution system, apparatus, or device, such as a computer-based system, processor-containing system, or other system that can fetch the instructions from the instruction execution system, apparatus, or device and execute the instructions. In other examples, the instructions (e.g., for performing aspects of process **900** (FIG. 9), described below) can be stored on a non-transitory computer-readable storage medium (not shown) of the server system **108** or can be divided between the non-transitory computer-readable storage medium of memory **202** and the non-transitory computer-readable storage medium of server system **108**. In the context of this document, a “non-transitory computer-readable storage medium” can be any medium that can contain or store the program for use by or in connection with the instruction execution system, apparatus, or device.

Peripherals interface **218** can be used to couple input and output peripherals of the device to CPU **220** and memory **202**. The one or more processors **220** run or execute various software programs and/or sets of instructions stored in memory **202** to perform various functions for device **200** and to process data. In some embodiments, peripherals interface **218**, CPU **220**, and memory controller **222** is, optionally, implemented on a single chip, such as chip **204**. In some other embodiments, they are, optionally, be implemented on separate chips.

RF (radio frequency) circuitry **208** receives and sends RF signals, also called electromagnetic signals. RF circuitry **208** converts electrical signals to/from electromagnetic signals and communicates with communications networks and other communications devices via the electromagnetic signals. RF circuitry **208** optionally includes well-known circuitry for performing these functions, including but not limited to an antenna system, an RF transceiver, one or more amplifiers, a tuner, one or more oscillators, a digital signal processor, a CODEC chipset, a subscriber identity module (SIM) card, memory, and so forth. RF circuitry **208** optionally communicates with networks, such as the Internet, also referred to as the World Wide Web (WWW), an intranet and/or a wireless network, such as a cellular telephone network, a wireless local area network (LAN) and/or a metropolitan area network (MAN), and other devices by wireless communication. The RF circuitry **208** optionally includes well-known circuitry for detecting near field communication (NFC) fields, such as by a short-range communication radio. The wireless communication optionally uses any of a plurality of communications standards, protocols, and technologies, including but not limited to Global System for Mobile Communications (GSM), Enhanced Data GSM Environment (EDGE), high-speed downlink packet access (HSDPA), high-speed uplink packet access (HSUPA), Evolution, Data-Only (EV-DO), HSPA, HSPA+, Dual-Cell HSPA

(DC-HSPDA), long term evolution (LTE), near field communication (NFC), wideband code division multiple access (W-CDMA), code division multiple access (CDMA), time division multiple access (TDMA), Bluetooth, Bluetooth Low Energy (BTLE), Wireless Fidelity (Wi-Fi) (e.g., IEEE 802.11a, IEEE 802.11b, IEEE 802.11g, IEEE 802.11n, and/or IEEE 802.11ac), voice over Internet Protocol (VoIP), Wi-MAX, a protocol for e mail (e.g., Internet message access protocol (IMAP) and/or post office protocol (POP)), instant messaging (e.g., extensible messaging and presence protocol (XMPP), Session Initiation Protocol for Instant Messaging and Presence Leveraging Extensions (SIMPLE), Instant Messaging and Presence Service (IMPS)), and/or Short Message Service (SMS), or any other suitable communication protocol, including communication protocols not yet developed as of the filing date of this document.

Audio circuitry **210**, speaker **211**, and microphone **213** provide an audio interface between a user and device **200**. Audio circuitry **210** receives audio data from peripherals interface **218**, converts the audio data to an electrical signal, and transmits the electrical signal to speaker **211**. Speaker **211** converts the electrical signal to human-audible sound waves. Audio circuitry **210** also receives electrical signals converted by microphone **213** from sound waves. Audio circuitry **210** converts the electrical signal to audio data and transmits the audio data to peripherals interface **218** for processing. Audio data is, optionally, retrieved from and/or transmitted to memory **202** and/or RF circuitry **208** by peripherals interface **218**. In some embodiments, audio circuitry **210** also includes a headset jack (e.g., **312**, FIG. 3). The headset jack provides an interface between audio circuitry **210** and removable audio input/output peripherals, such as output-only headphones or a headset with both output (e.g., a headphone for one or both ears) and input (e.g., a microphone).

I/O subsystem **206** couples input/output peripherals on device **200**, such as touch screen **212** and other input control devices **216**, to peripherals interface **218**. I/O subsystem **206** optionally includes display controller **256**, optical sensor controller **258**, intensity sensor controller **259**, haptic feedback controller **261**, and one or more input controllers **260** for other input or control devices. The one or more input controllers **260** receive/send electrical signals from/to other input control devices **216**. The other input control devices **216** optionally include physical buttons (e.g., push buttons, rocker buttons, etc.), dials, slider switches, joysticks, click wheels, and so forth. In some alternate embodiments, input controller(s) **260** are, optionally, coupled to any (or none) of the following: a keyboard, an infrared port, a USB port, and a pointer device such as a mouse. The one or more buttons (e.g., **308**, FIG. 3) optionally include an up/down button for volume control of speaker **211** and/or microphone **213**. The one or more buttons optionally include a push button (e.g., **306**, FIG. 3).

A quick press of the push button optionally disengages a lock of touch screen **212** or begin a process that uses gestures on the touch screen to unlock the device, as described in U.S. patent application Ser. No. 11/322,549, “Unlocking a Device by Performing Gestures on an Unlock Image,” filed Dec. 23, 2005, U.S. Pat. No. 7,657,849, which is hereby incorporated by reference in its entirety. A longer press of the push button (e.g., **306**) optionally turns power to device **200** on or off. The functionality of one or more of the buttons are, optionally, user customizable. Touch screen **212** is used to implement virtual or soft buttons and one or more soft keyboards.

Touch-sensitive display **212** provides an input interface and an output interface between the device and a user. Display controller **256** receives and/or sends electrical signals from/to touch screen **212**. Touch screen **212** displays visual output to the user. The visual output optionally includes graphics, text, icons, video, and any combination thereof (collectively termed “graphics”). In some embodiments, some or all of the visual output optionally correspond to user-interface objects.

Touch screen **212** has a touch-sensitive surface, sensor, or set of sensors that accepts input from the user based on haptic and/or tactile contact. Touch screen **212** and display controller **256** (along with any associated modules and/or sets of instructions in memory **202**) detect contact (and any movement or breaking of the contact) on touch screen **212** and convert the detected contact into interaction with user-interface objects (e.g., one or more soft keys, icons, web pages, or images) that are displayed on touch screen **212**. In an exemplary embodiment, a point of contact between touch screen **212** and the user corresponds to a finger of the user.

Touch screen **212** optionally uses LCD (liquid crystal display) technology, LPD (light emitting polymer display) technology, or LED (light emitting diode) technology, although other display technologies are used in other embodiments. Touch screen **212** and display controller **256** optionally detect contact and any movement or breaking thereof using any of a plurality of touch sensing technologies now known or later developed, including but not limited to capacitive, resistive, infrared, and surface acoustic wave technologies, as well as other proximity sensor arrays or other elements for determining one or more points of contact with touch screen **212**. In an exemplary embodiment, projected mutual capacitance sensing technology is used, such as that found in the iPhone® and iPod Touch® from Apple Inc. of Cupertino, Calif.

A touch-sensitive display in some embodiments of touch screen **212** is, optionally, analogous to the multi-touch sensitive touchpads described in the following U.S. Pat. No. 6,323,846 (Westerman et al.), U.S. Pat. No. 6,570,557 (Westerman et al.), and/or U.S. Pat. No. 6,677,932 (Westerman), and/or U.S. Patent Publication 2002/0015024A1, each of which is hereby incorporated by reference in its entirety. However, touch screen **212** displays visual output from device **200**, whereas touch-sensitive touchpads do not provide visual output.

A touch-sensitive display in some embodiments of touch screen **212** is described in the following applications: (1) U.S. patent application Ser. No. 11/381,313, “Multipoint Touch Surface Controller,” filed May 2, 2006; (2) U.S. patent application Ser. No. 10/840,862, “Multipoint Touchscreen,” filed May 6, 2004; (3) U.S. patent application Ser. No. 10/903,964, “Gestures For Touch Sensitive Input Devices,” filed Jul. 30, 2004; (4) U.S. patent application Ser. No. 11/048,264, “Gestures For Touch Sensitive Input Devices,” filed Jan. 31, 2005; (5) U.S. patent application Ser. No. 11/038,590, “Mode-Based Graphical User Interfaces For Touch Sensitive Input Devices,” filed Jan. 18, 2005; (6) U.S. patent application Ser. No. 11/228,758, “Virtual Input Device Placement On A Touch Screen User Interface,” filed Sep. 16, 2005; (7) U.S. patent application Ser. No. 11/228,700, “Operation Of A Computer With A Touch Screen Interface,” filed Sep. 16, 2005; (8) U.S. patent application Ser. No. 11/228,737, “Activating Virtual Keys Of A Touch-Screen Virtual Keyboard,” filed Sep. 16, 2005; and (9) U.S. patent application Ser. No. 11/367,749, “Multi-Functional Hand-Held Device,” filed Mar. 3, 2006. All of these applications are incorporated by reference herein in their entirety.

Touch screen **212** optionally has a video resolution in excess of 100 dpi. In some embodiments, the touch screen has a video resolution of approximately 160 dpi. The user optionally makes contact with touch screen **212** using any suitable object or appendage, such as a stylus, a finger, and so forth. In some embodiments, the user interface is designed to work primarily with finger-based contacts and gestures, which can be less precise than stylus-based input due to the larger area of contact of a finger on the touch screen. In some embodiments, the device translates the rough finger-based input into a precise pointer/cursor position or command for performing the actions desired by the user.

In some embodiments, in addition to the touch screen, device **200** optionally includes a touchpad (not shown) for activating or deactivating particular functions. In some embodiments, the touchpad is a touch-sensitive area of the device that, unlike the touch screen, does not display visual output. The touchpad is, optionally, a touch-sensitive surface that is separate from touch screen **212** or an extension of the touch-sensitive surface formed by the touch screen.

Device **200** also includes power system **262** for powering the various components. Power system **262** optionally includes a power management system, one or more power sources (e.g., battery, alternating current (AC)), a recharging system, a power failure detection circuit, a power converter or inverter, a power status indicator (e.g., a light-emitting diode (LED)) and any other components associated with the generation, management and distribution of power in portable devices.

Device **200** optionally also include one or more optical sensors **264**. FIG. 2A shows an optical sensor coupled to optical sensor controller **258** in I/O subsystem **206**. Optical sensor **264** optionally includes charge-coupled device (CCD) or complementary metal-oxide semiconductor (CMOS) phototransistors. Optical sensor **264** receives light from the environment, projected through one or more lenses, and converts the light to data representing an image. In conjunction with imaging module **243** (also called a camera module), optical sensor **264** optionally captures still images or video. In some embodiments, an optical sensor is located on the back of device **200**, opposite touch screen display **212** on the front of the device so that the touch screen display is enabled for use as a viewfinder for still and/or video image acquisition. In some embodiments, an optical sensor is located on the front of the device so that the user’s image is, optionally, obtained for video conferencing while the user views the other video conference participants on the touch screen display. In some embodiments, the position of optical sensor **264** can be changed by the user (e.g., by rotating the lens and the sensor in the device housing) so that a single optical sensor **264** is, optionally, used along with the touch screen display for both video conferencing and still and/or video image acquisition.

Device **200** optionally also includes one or more contact intensity sensors **265**. FIG. 2A shows a contact intensity sensor coupled to intensity sensor controller **259** in I/O subsystem **206**. Contact intensity sensor **265** optionally includes one or more piezoresistive strain gauges, capacitive force sensors, electric force sensors, piezoelectric force sensors, optical force sensors, capacitive touch-sensitive surfaces, or other intensity sensors (e.g., sensors used to measure the force (or pressure) of a contact on a touch-sensitive surface). Contact intensity sensor **265** receives contact intensity information (e.g., pressure information or a proxy for pressure information) from the environment. In some embodiments, at least one contact intensity sensor is

collocated with, or proximate to, a touch-sensitive surface (e.g., touch-sensitive display system 212). In some embodiments, at least one contact intensity sensor is located on the back of device 200, opposite touch screen display 212, which is located on the front of device 200.

Device 200 optionally also includes one or more proximity sensors 266. FIG. 2A shows proximity sensor 266 coupled to peripherals interface 218. Alternately, proximity sensor 266 is, optionally, coupled to input controller 260 in I/O subsystem 206. Proximity sensor 266 optionally performs as described in U.S. patent application Ser. No. 11/241,839, "Proximity Detector In Handheld Device"; Ser. No. 11/240,788, "Proximity Detector In Handheld Device"; Ser. No. 11/620,702, "Using Ambient Light Sensor To Augment Proximity Sensor Output"; Ser. No. 11/586,862, "Automated Response To And Sensing Of User Activity In Portable Devices"; and Ser. No. 11/638,251, "Methods And Systems For Automatic Configuration Of Peripherals," which are hereby incorporated by reference in their entirety. In some embodiments, the proximity sensor turns off and disables touch screen 212 when the multifunction device is placed near the user's ear (e.g., when the user is making a phone call).

Device 200 optionally also includes one or more tactile output generators 267. FIG. 2A shows a tactile output generator coupled to haptic feedback controller 261 in I/O subsystem 206. Tactile output generator 267 optionally includes one or more electroacoustic devices such as speakers or other audio components and/or electromechanical devices that convert energy into linear motion such as a motor, solenoid, electroactive polymer, piezoelectric actuator, electrostatic actuator, or other tactile output generating component (e.g., a component that converts electrical signals into tactile outputs on the device). Contact intensity sensor 265 receives tactile feedback generation instructions from haptic feedback module 233 and generates tactile outputs on device 200 that are capable of being sensed by a user of device 200. In some embodiments, at least one tactile output generator is collocated with, or proximate to, a touch-sensitive surface (e.g., touch-sensitive display system 212) and, optionally, generates a tactile output by moving the touch-sensitive surface vertically (e.g., in/out of a surface of device 200) or laterally (e.g., back and forth in the same plane as a surface of device 200). In some embodiments, at least one tactile output generator sensor is located on the back of device 200, opposite touch screen display 212, which is located on the front of device 200.

Device 200 optionally also includes one or more accelerometers 268. FIG. 2A shows accelerometer 268 coupled to peripherals interface 218. Alternately, accelerometer 268 is, optionally, coupled to an input controller 260 in I/O subsystem 206. Accelerometer 268 optionally performs as described in U.S. Patent Publication No. 20050190059, "Acceleration-based Theft Detection System for Portable Electronic Devices," and U.S. Patent Publication No. 20060017692, "Methods And Apparatuses For Operating A Portable Device Based On An Accelerometer," both of which are incorporated by reference herein in their entirety. In some embodiments, information is displayed on the touch screen display in a portrait view or a landscape view based on an analysis of data received from the one or more accelerometers. Device 200 optionally includes, in addition to accelerometer(s) 268, a magnetometer (not shown) and a GPS (or GLONASS or other global navigation system) receiver (not shown) for obtaining information concerning the location and orientation (e.g., portrait or landscape) of device 200.

In some embodiments, the software components stored in memory 202 include operating system 226, communication module (or set of instructions) 228, contact/motion module (or set of instructions) 230, graphics module (or set of instructions) 232, text input module (or set of instructions) 234, Global Positioning System (GPS) module (or set of instructions) 235, Digital Assistant Client Module 229, and applications (or sets of instructions) 236. Further, memory 202 can store data and models, such as user data and models 231. Furthermore, in some embodiments, memory 202 (FIG. 2A) or 470 (FIG. 4) stores device/global internal state 257, as shown in FIGS. 2A and 4. Device/global internal state 257 includes one or more of: active application state, indicating which applications, if any, are currently active; display state, indicating what applications, views or other information occupy various regions of touch screen display 212; sensor state, including information obtained from the device's various sensors and input control devices 216; and location information concerning the device's location and/or attitude.

Operating system 226 (e.g., Darwin, RTXC, LINUX, UNIX, OS X, iOS, WINDOWS, or an embedded operating system such as VxWorks) includes various software components and/or drivers for controlling and managing general system tasks (e.g., memory management, storage device control, power management, etc.) and facilitates communication between various hardware and software components.

Communication module 228 facilitates communication with other devices over one or more external ports 224 and also includes various software components for handling data received by RF circuitry 208 and/or external port 224. External port 224 (e.g., Universal Serial Bus (USB), FIREWIRE, etc.) is adapted for coupling directly to other devices or indirectly over a network (e.g., the Internet, wireless LAN, etc.). In some embodiments, the external port is a multi-pin (e.g., 30-pin) connector that is the same as, or similar to and/or compatible with, the 30-pin connector used on iPod® (trademark of Apple Inc.) devices.

Contact/motion module 230 optionally detects contact with touch screen 212 (in conjunction with display controller 256) and other touch-sensitive devices (e.g., a touchpad or physical click wheel). Contact/motion module 230 includes various software components for performing various operations related to detection of contact, such as determining if contact has occurred (e.g., detecting a finger-down event), determining an intensity of the contact (e.g., the force or pressure of the contact or a substitute for the force or pressure of the contact), determining if there is movement of the contact and tracking the movement across the touch-sensitive surface (e.g., detecting one or more finger-dragging events), and determining if the contact has ceased (e.g., detecting a finger-up event or a break in contact). Contact/motion module 230 receives contact data from the touch-sensitive surface. Determining movement of the point of contact, which is represented by a series of contact data, optionally includes determining speed (magnitude), velocity (magnitude and direction), and/or an acceleration (a change in magnitude and/or direction) of the point of contact. These operations are, optionally, applied to single contacts (e.g., one finger contacts) or to multiple simultaneous contacts (e.g., "multitouch"/multiple finger contacts). In some embodiments, contact/motion module 230 and display controller 256 detect contact on a touchpad.

In some embodiments, contact/motion module 230 uses a set of one or more intensity thresholds to determine whether an operation has been performed by a user (e.g., to determine whether a user has "clicked" on an icon). In some embodiments, at least a subset of the intensity thresholds are

determined in accordance with software parameters (e.g., the intensity thresholds are not determined by the activation thresholds of particular physical actuators and can be adjusted without changing the physical hardware of device 200). For example, a mouse “click” threshold of a trackpad or touch screen display can be set to any of a large range of predefined threshold values without changing the trackpad or touch screen display hardware. Additionally, in some implementations, a user of the device is provided with software settings for adjusting one or more of the set of intensity thresholds (e.g., by adjusting individual intensity thresholds and/or by adjusting a plurality of intensity thresholds at once with a system-level click “intensity” parameter).

Contact/motion module 230 optionally detects a gesture input by a user. Different gestures on the touch-sensitive surface have different contact patterns (e.g., different motions, timings, and/or intensities of detected contacts). Thus, a gesture is, optionally, detected by detecting a particular contact pattern. For example, detecting a finger tap gesture includes detecting a finger-down event followed by detecting a finger-up (liftoff) event at the same position (or substantially the same position) as the finger-down event (e.g., at the position of an icon). As another example, detecting a finger swipe gesture on the touch-sensitive surface includes detecting a finger-down event followed by detecting one or more finger-dragging events, and subsequently followed by detecting a finger-up (liftoff) event.

Graphics module 232 includes various known software components for rendering and displaying graphics on touch screen 212 or other display, including components for changing the visual impact (e.g., brightness, transparency, saturation, contrast, or other visual property) of graphics that are displayed. As used herein, the term “graphics” includes any object that can be displayed to a user, including, without limitation, text, web pages, icons (such as user-interface objects including soft keys), digital images, videos, animations, and the like.

In some embodiments, graphics module 232 stores data representing graphics to be used. Each graphic is, optionally, assigned a corresponding code. Graphics module 232 receives, from applications etc., one or more codes specifying graphics to be displayed along with, if necessary, coordinate data and other graphic property data, and then generates screen image data to output to display controller 256.

Haptic feedback module 233 includes various software components for generating instructions used by tactile output generator(s) 267 to produce tactile outputs at one or more locations on device 200 in response to user interactions with device 200. In some embodiments, event monitor 271 sends requests to the peripherals interface 218 at predetermined intervals. In response, peripherals interface 218 transmits event information. In other embodiments, peripherals interface 218 transmits event information only when there is a significant event (e.g., receiving an input above a predetermined noise threshold and/or for more than a predetermined duration).

Text input module 234, which is, optionally, a component of graphics module 232, provides soft keyboards for entering text in various applications (e.g., contacts 237, e mail 240, IM 241, browser 247, and any other application that needs text input).

GPS module 235 determines the location of the device and provides this information for use in various applications (e.g., to telephone 238 for use in location-based dialing; to camera 243 as picture/video metadata; and to applications

that provide location-based services such as weather widgets, local yellow page widgets, and map/navigation widgets).

Digital assistant client module 229 can include various client-side digital assistant instructions to provide the client-side functionalities of the digital assistant. For example, digital assistant client module 229 can be capable of accepting voice input (e.g., speech input), text input, touch input, and/or gestural input through various user interfaces (e.g., microphone 213, accelerometer(s) 268, touch-sensitive display system 212, optical sensor(s) 229, other input control devices 216, etc.) of portable multifunction device 200. Digital assistant client module 229 can also be capable of providing output in audio (e.g., speech output), visual, and/or tactile forms through various output interfaces (e.g., speaker 211, touch-sensitive display system 212, tactile output generator(s) 267, etc.) of portable multifunction device 200. For example, output can be provided as voice, sound, alerts, text messages, menus, graphics, videos, animations, vibrations, and/or combinations of two or more of the above. During operation, digital assistant client module 229 can communicate with DA server 106 using RF circuitry 208.

User data and models 231 can include various data associated with the user (e.g., user-specific vocabulary data, user preference data, user-specified name pronunciations, data from the user’s electronic address book, to-do lists, shopping lists, etc.) to provide the client-side functionalities of the digital assistant. Further, user data and models 231 can include various models (e.g., speech recognition models, statistical language models, natural language processing models, ontology, task flow models, service models, etc.) for processing user input and determining user intent.

In some examples, digital assistant client module 229 can utilize the various sensors, subsystems, and peripheral devices of portable multifunction device 200 to gather additional information from the surrounding environment of the portable multifunction device 200 to establish a context associated with a user, the current user interaction, and/or the current user input. In some examples, digital assistant client module 229 can provide the contextual information or a subset thereof with the user input to DA server 106 to help infer the user’s intent. In some examples, the digital assistant can also use the contextual information to determine how to prepare and deliver outputs to the user. Contextual information can be referred to as context data.

In some examples, the contextual information that accompanies the user input can include sensor information, e.g., lighting, ambient noise, ambient temperature, images or videos of the surrounding environment, etc. In some examples, the contextual information can also include the physical state of the device, e.g., device orientation, device location, device temperature, power level, speed, acceleration, motion patterns, cellular signals strength, etc. In some examples, information related to the software state of DA server 106, e.g., running processes, installed programs, past and present network activities, background services, error logs, resources usage, etc., and of portable multifunction device 200 can be provided to DA server 106 as contextual information associated with a user input.

In some examples, the digital assistant client module 229 can selectively provide information (e.g., user data 231) stored on the portable multifunction device 200 in response to requests from DA server 106. In some examples, digital assistant client module 229 can also elicit additional input from the user via a natural language dialogue or other user interfaces upon request by DA server 106. Digital assistant

client module 229 can pass the additional input to DA server 106 to help DA server 106 in intent deduction and/or fulfillment of the user's intent expressed in the user request.

A more detailed description of a digital assistant is described below with reference to FIGS. 7A-C. It should be recognized that digital assistant client module 229 can include any number of the sub-modules of digital assistant module 726 described below.

Applications 236 optionally include the following modules (or sets of instructions), or a subset or superset thereof:

Contacts module 237 (sometimes called an address book or contact list);

Telephone module 238;

Video conference module 239;

E-mail client module 240;

Instant messaging (IM) module 241;

Workout support module 242;

Camera module 243 for still and/or video images;

Image management module 244;

Video player module;

Music player module;

Browser module 247;

Calendar module 248;

Widget modules 249, which optionally include one or more of: weather widget 249-1, stocks widget 249-2, calculator widget 249-3, alarm clock widget 249-4, dictionary widget 249-5, and other widgets obtained by the user, as well as user-created widgets 249-6;

Widget creator module 250 for making user-created widgets 249-6;

Search module 251;

Video and music player module 252, which merges video player module and music player module;

Notes module 253;

Map module 254; and/or

Online video module 255.

Examples of other applications 236 that are, optionally, stored in memory 202 include other word processing applications, other image editing applications, drawing applications, presentation applications, JAVA-enabled applications, encryption, digital rights management, voice recognition, and voice replication.

In conjunction with touch screen 212, display controller 256, contact/motion module 230, graphics module 232, and text input module 234, contacts module 237 are, optionally, used to manage an address book or contact list (e.g., stored in application internal state 292 of contacts module 237 in memory 202 or memory 470), including: adding name(s) to the address book; deleting name(s) from the address book; associating telephone number(s), e-mail address(es), physical address(es) or other information with a name; associating an image with a name; categorizing and sorting names; providing telephone numbers or e-mail addresses to initiate and/or facilitate communications by telephone 238, video conference module 239, e-mail 240, or IM 241; and so forth.

In conjunction with RF circuitry 208, audio circuitry 210, speaker 211, microphone 213, touch screen 212, display controller 256, contact/motion module 230, graphics module 232, and text input module 234, telephone module 238 are, optionally, used to enter a sequence of characters corresponding to a telephone number, access one or more telephone numbers in contacts module 237, modify a telephone number that has been entered, dial a respective telephone number, conduct a conversation, and disconnect or hang up when the conversation is completed. As noted above, the

wireless communication optionally uses any of a plurality of communications standards, protocols, and technologies.

In conjunction with RF circuitry 208, audio circuitry 210, speaker 211, microphone 213, touch screen 212, display controller 256, optical sensor 264, optical sensor controller 258, contact/motion module 230, graphics module 232, text input module 234, contacts module 237, and telephone module 238, video conference module 239 includes executable instructions to initiate, conduct, and terminate a video conference between a user and one or more other participants in accordance with user instructions.

In conjunction with RF circuitry 208, touch screen 212, display controller 256, contact/motion module 230, graphics module 232, and text input module 234, e-mail client module 240 includes executable instructions to create, send, receive, and manage e-mail in response to user instructions. In conjunction with image management module 244, e-mail client module 240 makes it very easy to create and send e-mails with still or video images taken with camera module 243.

In conjunction with RF circuitry 208, touch screen 212, display controller 256, contact/motion module 230, graphics module 232, and text input module 234, the instant messaging module 241 includes executable instructions to enter a sequence of characters corresponding to an instant message, to modify previously entered characters, to transmit a respective instant message (for example, using a Short Message Service (SMS) or Multimedia Message Service (MMS) protocol for telephony-based instant messages or using XMPP, SIMPLE, or IMPS for Internet-based instant messages), to receive instant messages, and to view received instant messages. In some embodiments, transmitted and/or received instant messages optionally include graphics, photos, audio files, video files and/or other attachments as are supported in an MMS and/or an Enhanced Messaging Service (EMS). As used herein, "instant messaging" refers to both telephony-based messages (e.g., messages sent using SMS or MMS) and Internet-based messages (e.g., messages sent using XMPP, SIMPLE, or IMPS).

In conjunction with RF circuitry 208, touch screen 212, display controller 256, contact/motion module 230, graphics module 232, text input module 234, GPS module 235, map module 254, and music player module, workout support module 242 includes executable instructions to create workouts (e.g., with time, distance, and/or calorie burning goals); communicate with workout sensors (sports devices); receive workout sensor data; calibrate sensors used to monitor a workout; select and play music for a workout; and display, store, and transmit workout data.

In conjunction with touch screen 212, display controller 256, optical sensor(s) 264, optical sensor controller 258, contact/motion module 230, graphics module 232, and image management module 244, camera module 243 includes executable instructions to capture still images or video (including a video stream) and store them into memory 202, modify characteristics of a still image or video, or delete a still image or video from memory 202.

In conjunction with touch screen 212, display controller 256, contact/motion module 230, graphics module 232, text input module 234, and camera module 243, image management module 244 includes executable instructions to arrange, modify (e.g., edit), or otherwise manipulate, label, delete, present (e.g., in a digital slide show or album), and store still and/or video images.

In conjunction with RF circuitry 208, touch screen 212, display controller 256, contact/motion module 230, graphics module 232, and text input module 234, browser module

247 includes executable instructions to browse the Internet in accordance with user instructions, including searching, linking to, receiving, and displaying web pages or portions thereof, as well as attachments and other files linked to web pages.

In conjunction with RF circuitry 208, touch screen 212, display controller 256, contact/motion module 230, graphics module 232, text input module 234, e-mail client module 240, and browser module 247, calendar module 248 includes executable instructions to create, display, modify, and store calendars and data associated with calendars (e.g., calendar entries, to-do lists, etc.) in accordance with user instructions.

In conjunction with RF circuitry 208, touch screen 212, display controller 256, contact/motion module 230, graphics module 232, text input module 234, and browser module 247, widget modules 249 are mini-applications that are, optionally, downloaded and used by a user (e.g., weather widget 249-1, stocks widget 249-2, calculator widget 249-3, alarm clock widget 249-4, and dictionary widget 249-5) or created by the user (e.g., user-created widget 249-6). In some embodiments, a widget includes an HTML (Hypertext Markup Language) file, a CSS (Cascading Style Sheets) file, and a JavaScript file. In some embodiments, a widget includes an XML (Extensible Markup Language) file and a JavaScript file (e.g., Yahoo! Widgets).

In conjunction with RF circuitry 208, touch screen 212, display controller 256, contact/motion module 230, graphics module 232, text input module 234, and browser module 247, the widget creator module 250 are, optionally, used by a user to create widgets (e.g., turning a user-specified portion of a web page into a widget).

In conjunction with touch screen 212, display controller 256, contact/motion module 230, graphics module 232, and text input module 234, search module 251 includes executable instructions to search for text, music, sound, image, video, and/or other files in memory 202 that match one or more search criteria (e.g., one or more user-specified search terms) in accordance with user instructions.

In conjunction with touch screen 212, display controller 256, contact/motion module 230, graphics module 232, audio circuitry 210, speaker 211, RF circuitry 208, and browser module 247, video and music player module 252 includes executable instructions that allow the user to download and play back recorded music and other sound files stored in one or more file formats, such as MP3 or AAC files, and executable instructions to display, present, or otherwise play back videos (e.g., on touch screen 212 or on an external, connected display via external port 224). In some embodiments, device 200 optionally includes the functionality of an MP3 player, such as an iPod (trademark of Apple Inc.).

In conjunction with touch screen 212, display controller 256, contact/motion module 230, graphics module 232, and text input module 234, notes module 253 includes executable instructions to create and manage notes, to-do lists, and the like in accordance with user instructions.

In conjunction with RF circuitry 208, touch screen 212, display controller 256, contact/motion module 230, graphics module 232, text input module 234, GPS module 235, and browser module 247, map module 254 are, optionally, used to receive, display, modify, and store maps and data associated with maps (e.g., driving directions, data on stores and other points of interest at or near a particular location, and other location-based data) in accordance with user instructions.

In conjunction with touch screen 212, display controller 256, contact/motion module 230, graphics module 232, audio circuitry 210, speaker 211, RF circuitry 208, text input

module 234, e-mail client module 240, and browser module 247, online video module 255 includes instructions that allow the user to access, browse, receive (e.g., by streaming and/or download), play back (e.g., on the touch screen or on an external, connected display via external port 224), send an e-mail with a link to a particular online video, and otherwise manage online videos in one or more file formats, such as H.264. In some embodiments, instant messaging module 241, rather than e-mail client module 240, is used to send a link to a particular online video. Additional description of the online video application can be found in U.S. Provisional Patent Application No. 60/936,562, "Portable Multifunction Device, Method, and Graphical User Interface for Playing Online Videos," filed Jun. 20, 2007, and U.S. patent application Ser. No. 11/968,067, "Portable Multifunction Device, Method, and Graphical User Interface for Playing Online Videos," filed Dec. 31, 2007, the contents of which are hereby incorporated by reference in their entirety.

Each of the above-identified modules and applications corresponds to a set of executable instructions for performing one or more functions described above and the methods described in this application (e.g., the computer-implemented methods and other information processing methods described herein). These modules (e.g., sets of instructions) need not be implemented as separate software programs, procedures, or modules, and thus various subsets of these modules are, optionally, combined or otherwise rearranged in various embodiments. For example, video player module are, optionally, combined with music player module into a single module (e.g., video and music player module 252, FIG. 2A). In some embodiments, memory 202 optionally stores a subset of the modules and data structures identified above. Furthermore, memory 202 optionally stores additional modules and data structures not described above.

In some embodiments, device 200 is a device where operation of a predefined set of functions on the device is performed exclusively through a touch screen and/or a touchpad. By using a touch screen and/or a touchpad as the primary input control device for operation of device 200, the number of physical input control devices (such as push buttons, dials, and the like) on device 200 is, optionally, reduced.

The predefined set of functions that are performed exclusively through a touch screen and/or a touchpad optionally include navigation between user interfaces. In some embodiments, the touchpad, when touched by the user, navigates device 200 to a main, home, or root menu from any user interface that is displayed on device 200. In such embodiments, a "menu button" is implemented using a touchpad. In some other embodiments, the menu button is a physical push button or other physical input control device instead of a touchpad.

FIG. 2B is a block diagram illustrating exemplary components for event handling in accordance with some embodiments. In some embodiments, memory 202 (FIG. 2A) or 470 (FIG. 4) includes event sorter 270 (e.g., in operating system 226) and a respective application 236-1 (e.g., any of the aforementioned applications 237-251, 255, 480-490).

Event sorter 270 receives event information and determines the application 236-1 and application view 291 of application 236-1 to which to deliver the event information. Event sorter 270 includes event monitor 271 and event dispatcher module 274. In some embodiments, application 236-1 includes application internal state 292, which indicates the current application view(s) displayed on touch-sensitive display 212 when the application is active or

21

executing. In some embodiments, device/global internal state 257 is used by event sorter 270 to determine which application(s) is (are) currently active, and application internal state 292 is used by event sorter 270 to determine application views 291 to which to deliver event information.

In some embodiments, application internal state 292 includes additional information, such as one or more of: resume information to be used when application 236-1 resumes execution, user interface state information that indicates information being displayed or that is ready for display by application 236-1, a state queue for enabling the user to go back to a prior state or view of application 236-1, and a redo/undo queue of previous actions taken by the user.

Event monitor 271 receives event information from peripherals interface 218. Event information includes information about a sub-event (e.g., a user touch on touch-sensitive display 212, as part of a multi-touch gesture). Peripherals interface 218 transmits information it receives from I/O subsystem 206 or a sensor, such as proximity sensor 266, accelerometer(s) 268, and/or microphone 213 (through audio circuitry 210). Information that peripherals interface 218 receives from I/O subsystem 206 includes information from touch-sensitive display 212 or a touch-sensitive surface.

In some embodiments, event sorter 270 also includes a hit view determination module 272 and/or an active event recognizer determination module 273.

Hit view determination module 272 provides software procedures for determining where a sub-event has taken place within one or more views when touch-sensitive display 212 displays more than one view. Views are made up of controls and other elements that a user can see on the display.

Another aspect of the user interface associated with an application is a set of views, sometimes herein called application views or user interface windows, in which information is displayed and touch-based gestures occur. The application views (of a respective application) in which a touch is detected optionally correspond to programmatic levels within a programmatic or view hierarchy of the application. For example, the lowest level view in which a touch is detected is, optionally, called the hit view, and the set of events that are recognized as proper inputs are, optionally, determined based, at least in part, on the hit view of the initial touch that begins a touch-based gesture.

Hit view determination module 272 receives information related to sub events of a touch-based gesture. When an application has multiple views organized in a hierarchy, hit view determination module 272 identifies a hit view as the lowest view in the hierarchy which should handle the sub-event. In most circumstances, the hit view is the lowest level view in which an initiating sub-event occurs (e.g., the first sub-event in the sequence of sub-events that form an event or potential event). Once the hit view is identified by the hit view determination module 272, the hit view typically receives all sub-events related to the same touch or input source for which it was identified as the hit view.

Active event recognizer determination module 273 determines which view or views within a view hierarchy should receive a particular sequence of sub-events. In some embodiments, active event recognizer determination module 273 determines that only the hit view should receive a particular sequence of sub-events. In other embodiments, active event recognizer determination module 273 determines that all views that include the physical location of a sub-event are actively involved views, and therefore determines that all actively involved views should receive a

22

particular sequence of sub-events. In other embodiments, even if touch sub-events were entirely confined to the area associated with one particular view, views higher in the hierarchy would still remain as actively involved views.

Event dispatcher module 274 dispatches the event information to an event recognizer (e.g., event recognizer 280). In embodiments including active event recognizer determination module 273, event dispatcher module 274 delivers the event information to an event recognizer determined by active event recognizer determination module 273. In some embodiments, event dispatcher module 274 stores in an event queue the event information, which is retrieved by a respective event receiver 282.

In some embodiments, operating system 226 includes event sorter 270. Alternatively, application 236-1 includes event sorter 270. In yet other embodiments, event sorter 270 is a stand-alone module, or a part of another module stored in memory 202, such as contact/motion module 230.

In some embodiments, application 236-1 includes a plurality of event handlers 290 and one or more application views 291, each of which includes instructions for handling touch events that occur within a respective view of the application's user interface. Each application view 291 of the application 236-1 includes one or more event recognizers 280. Typically, a respective application view 291 includes a plurality of event recognizers 280. In other embodiments, one or more of event recognizers 280 are part of a separate module, such as a user interface kit (not shown) or a higher level object from which application 236-1 inherits methods and other properties. In some embodiments, a respective event handler 290 includes one or more of: data updater 276, object updater 277, GUI updater 278, and/or event data 279 received from event sorter 270. Event handler 290 optionally utilizes or calls data updater 276, object updater 277, or GUI updater 278 to update the application internal state 292. Alternatively, one or more of the application views 291 include one or more respective event handlers 290. Also, in some embodiments, one or more of data updater 276, object updater 277, and GUI updater 278 are included in a respective application view 291.

A respective event recognizer 280 receives event information (e.g., event data 279) from event sorter 270 and identifies an event from the event information. Event recognizer 280 includes event receiver 282 and event comparator 284. In some embodiments, event recognizer 280 also includes at least a subset of: metadata 283, and event delivery instructions 288 (which optionally include sub-event delivery instructions).

Event receiver 282 receives event information from event sorter 270. The event information includes information about a sub-event, for example, a touch or a touch movement. Depending on the sub-event, the event information also includes additional information, such as location of the sub-event. When the sub-event concerns motion of a touch, the event information optionally also includes speed and direction of the sub-event. In some embodiments, events include rotation of the device from one orientation to another (e.g., from a portrait orientation to a landscape orientation, or vice versa), and the event information includes corresponding information about the current orientation (also called device attitude) of the device.

Event comparator 284 compares the event information to predefined event or sub-event definitions and, based on the comparison, determines an event or sub event, or determines or updates the state of an event or sub-event. In some embodiments, event comparator 284 includes event defini-

tions **286**. Event definitions **286** contain definitions of events (e.g., predefined sequences of sub-events), for example, event **1** (**287-1**), event **2** (**287-2**), and others. In some embodiments, sub-events in an event (**287**) include, for example, touch begin, touch end, touch movement, touch cancellation, and multiple touching. In one example, the definition for event **1** (**287-1**) is a double tap on a displayed object. The double tap, for example, comprises a first touch (touch begin) on the displayed object for a predetermined phase, a first liftoff (touch end) for a predetermined phase, a second touch (touch begin) on the displayed object for a predetermined phase, and a second liftoff (touch end) for a predetermined phase. In another example, the definition for event **2** (**287-2**) is a dragging on a displayed object. The dragging, for example, comprises a touch (or contact) on the displayed object for a predetermined phase, a movement of the touch across touch-sensitive display **212**, and liftoff of the touch (touch end). In some embodiments, the event also includes information for one or more associated event handlers **290**.

In some embodiments, event definition **287** includes a definition of an event for a respective user-interface object. In some embodiments, event comparator **284** performs a hit test to determine which user-interface object is associated with a sub-event. For example, in an application view in which three user-interface objects are displayed on touch-sensitive display **212**, when a touch is detected on touch-sensitive display **212**, event comparator **284** performs a hit test to determine which of the three user-interface objects is associated with the touch (sub-event). If each displayed object is associated with a respective event handler **290**, the event comparator uses the result of the hit test to determine which event handler **290** should be activated. For example, event comparator **284** selects an event handler associated with the sub-event and the object triggering the hit test.

In some embodiments, the definition for a respective event (**287**) also includes delayed actions that delay delivery of the event information until after it has been determined whether the sequence of sub-events does or does not correspond to the event recognizer's event type.

When a respective event recognizer **280** determines that the series of sub-events do not match any of the events in event definitions **286**, the respective event recognizer **280** enters an event impossible, event failed, or event ended state, after which it disregards subsequent sub-events of the touch-based gesture. In this situation, other event recognizers, if any, that remain active for the hit view continue to track and process sub-events of an ongoing touch-based gesture.

In some embodiments, a respective event recognizer **280** includes metadata **283** with configurable properties, flags, and/or lists that indicate how the event delivery system should perform sub-event delivery to actively involved event recognizers. In some embodiments, metadata **283** includes configurable properties, flags, and/or lists that indicate how event recognizers optionally interact, or are optionally enabled to interact, with one another. In some embodiments, metadata **283** includes configurable properties, flags, and/or lists that indicate whether sub-events are delivered to varying levels in the view or programmatic hierarchy.

In some embodiments, a respective event recognizer **280** activates event handler **290** associated with an event when one or more particular sub-events of an event are recognized. In some embodiments, a respective event recognizer **280** delivers event information associated with the event to event handler **290**. Activating an event handler **290** is distinct from sending (and deferred sending) sub-events to a

respective hit view. In some embodiments, event recognizer **280** throws a flag associated with the recognized event, and event handler **290** associated with the flag catches the flag and performs a predefined process.

In some embodiments, event delivery instructions **288** include sub-event delivery instructions that deliver event information about a sub-event without activating an event handler. Instead, the sub-event delivery instructions deliver event information to event handlers associated with the series of sub-events or to actively involved views. Event handlers associated with the series of sub-events or with actively involved views receive the event information and perform a predetermined process.

In some embodiments, data updater **276** creates and updates data used in application **236-1**. For example, data updater **276** updates the telephone number used in contacts module **237**, or stores a video file used in video player module. In some embodiments, object updater **277** creates and updates objects used in application **236-1**. For example, object updater **277** creates a new user-interface object or updates the position of a user-interface object. GUI updater **278** updates the GUI. For example, GUI updater **278** prepares display information and sends it to graphics module **232** for display on a touch-sensitive display.

In some embodiments, event handler(s) **290** includes or has access to data updater **276**, object updater **277**, and GUI updater **278**. In some embodiments, data updater **276**, object updater **277**, and GUI updater **278** are included in a single module of a respective application **236-1** or application view **291**. In other embodiments, they are included in two or more software modules.

It shall be understood that the foregoing discussion regarding event handling of user touches on touch-sensitive displays also applies to other forms of user inputs to operate multifunction devices **200** with input devices, not all of which are initiated on touch screens. For example, mouse movement and mouse button presses, optionally coordinated with single or multiple keyboard presses or holds; contact movements such as taps, drags, scrolls, etc. on touchpads; pen stylus inputs; movement of the device; oral instructions; detected eye movements; biometric inputs; and/or any combination thereof are optionally utilized as inputs corresponding to sub-events which define an event to be recognized.

FIG. **3** illustrates a portable multifunction device **200** having a touch screen **212** in accordance with some embodiments. The touch screen optionally displays one or more graphics within user interface (UI) **300**. In this embodiment, as well as others described below, a user is enabled to select one or more of the graphics by making a gesture on the graphics, for example, with one or more fingers **302** (not drawn to scale in the figure) or one or more styluses **303** (not drawn to scale in the figure). In some embodiments, selection of one or more graphics occurs when the user breaks contact with the one or more graphics. In some embodiments, the gesture optionally includes one or more taps, one or more swipes (from left to right, right to left, upward and/or downward), and/or a rolling of a finger (from right to left, left to right, upward and/or downward) that has made contact with device **200**. In some implementations or circumstances, inadvertent contact with a graphic does not select the graphic. For example, a swipe gesture that sweeps over an application icon optionally does not select the corresponding application when the gesture corresponding to selection is a tap.

Device **200** also optionally includes one or more physical buttons, such as "home" or menu button **304**. As described previously, menu button **304** is, optionally, used to navigate

25

to any application 236 in a set of applications that are, optionally, executed on device 200. Alternatively, in some embodiments, the menu button is implemented as a soft key in a GUI displayed on touch screen 212.

In some embodiments, device 200 includes touch screen 212, menu button 304, push button 306 for powering the device on/off and locking the device, volume adjustment button(s) 308, subscriber identity module (SIM) card slot 310, headset jack 312, and docking/charging external port 224. Push button 306 is, optionally, used to turn the power on/off on the device by depressing the button and holding the button in the depressed state for a predefined time interval; to lock the device by depressing the button and releasing the button before the predefined time interval has elapsed; and/or to unlock the device or initiate an unlock process. In an alternative embodiment, device 200 also accepts verbal input for activation or deactivation of some functions through microphone 213. Device 200 also, optionally, includes one or more contact intensity sensors 265 for detecting intensity of contacts on touch screen 212 and/or one or more tactile output generators 267 for generating tactile outputs for a user of device 200.

FIG. 4 is a block diagram of an exemplary multifunction device with a display and a touch-sensitive surface in accordance with some embodiments. Device 400 need not be portable. In some embodiments, device 400 is a laptop computer, a desktop computer, a tablet computer, a multimedia player device, a navigation device, an educational device (such as a child's learning toy), a gaming system, or a control device (e.g., a home or industrial controller). Device 400 typically includes one or more processing units (CPUs) 410, one or more network or other communications interfaces 460, memory 470, and one or more communication buses 420 for interconnecting these components. Communication buses 420 optionally include circuitry (sometimes called a chipset) that interconnects and controls communications between system components. Device 400 includes input/output (I/O) interface 430 comprising display 440, which is typically a touch screen display. I/O interface 430 also optionally includes a keyboard and/or mouse (or other pointing device) 450 and touchpad 455, tactile output generator 457 for generating tactile outputs on device 400 (e.g., similar to tactile output generator(s) 267 described above with reference to FIG. 2A), sensors 459 (e.g., optical, acceleration, proximity, touch-sensitive, and/or contact intensity sensors similar to contact intensity sensor(s) 265 described above with reference to FIG. 2A). Memory 470 includes high-speed random access memory, such as DRAM, SRAM, DDR RAM, or other random access solid state memory devices; and optionally includes non-volatile memory, such as one or more magnetic disk storage devices, optical disk storage devices, flash memory devices, or other non-volatile solid state storage devices. Memory 470 optionally includes one or more storage devices remotely located from CPU(s) 410. In some embodiments, memory 470 stores programs, modules, and data structures analogous to the programs, modules, and data structures stored in memory 202 of portable multifunction device 200 (FIG. 2A), or a subset thereof. Furthermore, memory 470 optionally stores additional programs, modules, and data structures not present in memory 202 of portable multifunction device 200. For example, memory 470 of device 400 optionally stores drawing module 480, presentation module 482, word processing module 484, website creation module 486, disk authoring module 488, and/or spreadsheet module 490, while memory 202 of portable multifunction device 200 (FIG. 2A) optionally does not store these modules.

26

Each of the above-identified elements in FIG. 4 are, optionally, stored in one or more of the previously mentioned memory devices. Each of the above-identified modules corresponds to a set of instructions for performing a function described above. The above-identified modules or programs (e.g., sets of instructions) need not be implemented as separate software programs, procedures, or modules, and thus various subsets of these modules are, optionally, combined or otherwise rearranged in various embodiments. In some embodiments, memory 470 optionally stores a subset of the modules and data structures identified above. Furthermore, memory 470 optionally stores additional modules and data structures not described above.

Attention is now directed towards embodiments of user interfaces that is, optionally, implemented on, for example, portable multifunction device 200.

FIG. 5A illustrates an exemplary user interface for a menu of applications on portable multifunction device 200 in accordance with some embodiments. Similar user interfaces is, optionally, implemented on device 400. In some embodiments, user interface 500 includes the following elements, or a subset or superset thereof:

Signal strength indicator(s) 502 for wireless communication(s), such as cellular and Wi-Fi signals;

Time 504;

Bluetooth indicator 505;

Battery status indicator 506;

Tray 508 with icons for frequently used applications, such as:

Icon 516 for telephone module 238, labeled "Phone," which optionally includes an indicator 514 of the number of missed calls or voicemail messages;

Icon 518 for e-mail client module 240, labeled "Mail," which optionally includes an indicator 510 of the number of unread e-mails;

Icon 520 for browser module 247, labeled "Browser;" and

Icon 522 for video and music player module 252, also referred to as iPod (trademark of Apple Inc.) module 252, labeled "iPod;" and

Icons for other applications, such as:

Icon 524 for IM module 241, labeled "Messages;"

Icon 526 for calendar module 248, labeled "Calendar;"

Icon 528 for image management module 244, labeled "Photos;"

Icon 530 for camera module 243, labeled "Camera;"

Icon 532 for online video module 255, labeled "Online Video;"

Icon 534 for stocks widget 249-2, labeled "Stocks;"

Icon 536 for map module 254, labeled "Maps;"

Icon 538 for weather widget 249-1, labeled "Weather;"

Icon 540 for alarm clock widget 249-4, labeled "Clock;"

Icon 542 for workout support module 242, labeled "Workout Support;"

Icon 544 for notes module 253, labeled "Notes;" and

Icon 546 for a settings application or module, labeled "Settings," which provides access to settings for device 200 and its various applications 236.

It should be noted that the icon labels illustrated in FIG. 5A are merely exemplary. For example, icon 522 for video and music player module 252 are labeled "Music" or "Music Player." Other labels are, optionally, used for various application icons. In some embodiments, a label for a respective application icon includes a name of an application corresponding to the respective application icon. In some

embodiments, a label for a particular application icon is distinct from a name of an application corresponding to the particular application icon.

FIG. 5B illustrates an exemplary user interface on a device (e.g., device 400, FIG. 4) with a touch-sensitive surface 551 (e.g., a tablet or touchpad 455, FIG. 4) that is separate from the display 550 (e.g., touch screen display 212). Device 400 also, optionally, includes one or more contact intensity sensors (e.g., one or more of sensors 457) for detecting intensity of contacts on touch-sensitive surface 551 and/or one or more tactile output generators 459 for generating tactile outputs for a user of device 400.

Although some of the examples which follow will be given with reference to inputs on touch screen display 212 (where the touch-sensitive surface and the display are combined), in some embodiments, the device detects inputs on a touch-sensitive surface that is separate from the display, as shown in FIG. 5B. In some embodiments, the touch-sensitive surface (e.g., 551 in FIG. 5B) has a primary axis (e.g., 552 in FIG. 5B) that corresponds to a primary axis (e.g., 553 in FIG. 5B) on the display (e.g., 550). In accordance with these embodiments, the device detects contacts (e.g., 560 and 562 in FIG. 5B) with the touch-sensitive surface 551 at locations that correspond to respective locations on the display (e.g., in FIG. 5B, 560 corresponds to 568 and 562 corresponds to 570). In this way, user inputs (e.g., contacts 560 and 562, and movements thereof) detected by the device on the touch-sensitive surface (e.g., 551 in FIG. 5B) are used by the device to manipulate the user interface on the display (e.g., 550 in FIG. 5B) of the multifunction device when the touch-sensitive surface is separate from the display. It should be understood that similar methods are, optionally, used for other user interfaces described herein.

Additionally, while the following examples are given primarily with reference to finger inputs (e.g., finger contacts, finger tap gestures, finger swipe gestures), it should be understood that, in some embodiments, one or more of the finger inputs are replaced with input from another input device (e.g., a mouse-based input or stylus input). For example, a swipe gesture is, optionally, replaced with a mouse click (e.g., instead of a contact) followed by movement of the cursor along the path of the swipe (e.g., instead of movement of the contact). As another example, a tap gesture is, optionally, replaced with a mouse click while the cursor is located over the location of the tap gesture (e.g., instead of detection of the contact followed by ceasing to detect the contact). Similarly, when multiple user inputs are simultaneously detected, it should be understood that multiple computer mice are, optionally, used simultaneously, or a mouse and finger contacts are, optionally, used simultaneously.

FIG. 6A illustrates exemplary personal electronic device 600. Device 600 includes body 602. In some embodiments, device 600 can include some or all of the features described with respect to devices 200 and 400 (e.g., FIGS. 2A-4B). In some embodiments, device 600 has touch-sensitive display screen 604, hereafter touch screen 604. Alternatively, or in addition to touch screen 604, device 600 has a display and a touch-sensitive surface. As with devices 200 and 400, in some embodiments, touch screen 604 (or the touch-sensitive surface) optionally includes one or more intensity sensors for detecting intensity of contacts (e.g., touches) being applied. The one or more intensity sensors of touch screen 604 (or the touch-sensitive surface) can provide output data that represents the intensity of touches. The user interface of device 600 can respond to touches based on their intensity,

meaning that touches of different intensities can invoke different user interface operations on device 600.

Exemplary techniques for detecting and processing touch intensity are found, for example, in related applications: International Patent Application Serial No. PCT/US2013/040061, titled "Device, Method, and Graphical User Interface for Displaying User Interface Objects Corresponding to an Application," filed May 8, 2013, and International Patent Application Serial No. PCT/US2013/069483, titled "Device, Method, and Graphical User Interface for Transitioning Between Touch Input to Display Output Relationships," filed Nov. 11, 2013, each of which is hereby incorporated by reference in their entirety.

In some embodiments, device 600 has one or more input mechanisms 606 and 608. Input mechanisms 606 and 608, if included, can be physical. Examples of physical input mechanisms include push buttons and rotatable mechanisms. In some embodiments, device 600 has one or more attachment mechanisms. Such attachment mechanisms, if included, can permit attachment of device 600 with, for example, hats, eyewear, earrings, necklaces, shirts, jackets, bracelets, watch straps, chains, trousers, belts, shoes, purses, backpacks, and so forth. These attachment mechanisms permit device 600 to be worn by a user.

FIG. 6B depicts exemplary personal electronic device 600. In some embodiments, device 600 can include some or all of the components described with respect to FIGS. 2A, 2B, and 4. Device 600 has bus 612 that operatively couples I/O section 614 with one or more computer processors 616 and memory 618. I/O section 614 can be connected to display 604, which can have touch-sensitive component 622 and, optionally, touch-intensity sensitive component 624. In addition, I/O section 614 can be connected with communication unit 630 for receiving application and operating system data, using Wi-Fi, Bluetooth, near field communication (NFC), cellular, and/or other wireless communication techniques. Device 600 can include input mechanisms 606 and/or 608. Input mechanism 606 is, optionally, a rotatable input device or a depressible and rotatable input device, for example. Input mechanism 608 is, optionally, a button, in some examples.

Input mechanism 608 is, optionally, a microphone, in some examples. Personal electronic device 600 optionally includes various sensors, such as GPS sensor 632, accelerometer 634, directional sensor 640 (e.g., compass), gyroscope 636, motion sensor 638, and/or a combination thereof, all of which can be operatively connected to I/O section 614.

Memory 618 of personal electronic device 600 can be a non-transitory computer-readable storage medium, for storing computer-executable instructions, which, when executed by one or more computer processors 616, for example, can cause the computer processors to perform the techniques described below, including process 900 (FIG. 9). The computer-executable instructions can also be stored and/or transported within any non-transitory computer-readable storage medium for use by or in connection with an instruction execution system, apparatus, or device, such as a computer-based system, processor-containing system, or other system that can fetch the instructions from the instruction execution system, apparatus, or device and execute the instructions. For purposes of this document, a "non-transitory computer-readable storage medium" can be any medium that can tangibly contain or store computer-executable instructions for use by or in connection with the instruction execution system, apparatus, or device. The non-transitory computer-readable storage medium can include, but is not limited to, magnetic, optical, and/or semiconductor storages. Examples

of such storage include magnetic disks, optical discs based on CD, DVD, or Blu-ray technologies, as well as persistent solid-state memory such as flash, solid-state drives, and the like. Personal electronic device 600 is not limited to the components and configuration of FIG. 6B, but can include other or additional components in multiple configurations.

As used here, the term “affordance” refers to a user-interactive graphical user interface object that is, optionally, displayed on the display screen of devices 200, 400, and/or 600 (FIGS. 2, 4, and 6). For example, an image (e.g., icon), a button, and text (e.g., hyperlink) each optionally constitute an affordance.

As used herein, the term “focus selector” refers to an input element that indicates a current part of a user interface with which a user is interacting. In some implementations that include a cursor or other location marker, the cursor acts as a “focus selector” so that when an input (e.g., a press input) is detected on a touch-sensitive surface (e.g., touchpad 455 in FIG. 4 or touch-sensitive surface 551 in FIG. 5B) while the cursor is over a particular user interface element (e.g., a button, window, slider or other user interface element), the particular user interface element is adjusted in accordance with the detected input. In some implementations that include a touch screen display (e.g., touch-sensitive display system 212 in FIG. 2A or touch screen 212 in FIG. 5A) that enables direct interaction with user interface elements on the touch screen display, a detected contact on the touch screen acts as a “focus selector” so that when an input (e.g., a press input by the contact) is detected on the touch screen display at a location of a particular user interface element (e.g., a button, window, slider, or other user interface element), the particular user interface element is adjusted in accordance with the detected input. In some implementations, focus is moved from one region of a user interface to another region of the user interface without corresponding movement of a cursor or movement of a contact on a touch screen display (e.g., by using a tab key or arrow keys to move focus from one button to another button); in these implementations, the focus selector moves in accordance with movement of focus between different regions of the user interface. Without regard to the specific form taken by the focus selector, the focus selector is generally the user interface element (or contact on a touch screen display) that is controlled by the user so as to communicate the user’s intended interaction with the user interface (e.g., by indicating, to the device, the element of the user interface with which the user is intending to interact). For example, the location of a focus selector (e.g., a cursor, a contact, or a selection box) over a respective button while a press input is detected on the touch-sensitive surface (e.g., a touchpad or touch screen) will indicate that the user is intending to activate the respective button (as opposed to other user interface elements shown on a display of the device).

As used in the specification and claims, the term “characteristic intensity” of a contact refers to a characteristic of the contact based on one or more intensities of the contact. In some embodiments, the characteristic intensity is based on multiple intensity samples. The characteristic intensity is, optionally, based on a predefined number of intensity samples, or a set of intensity samples collected during a predetermined time period (e.g., 0.05, 0.1, 0.2, 0.5, 1, 2, 5, 10 seconds) relative to a predefined event (e.g., after detecting the contact, prior to detecting liftoff of the contact, before or after detecting a start of movement of the contact, prior to detecting an end of the contact, before or after detecting an increase in intensity of the contact, and/or before or after detecting a decrease in intensity of the

contact). A characteristic intensity of a contact is, optionally based on one or more of: a maximum value of the intensities of the contact, a mean value of the intensities of the contact, an average value of the intensities of the contact, a top 10 percentile value of the intensities of the contact, a value at the half maximum of the intensities of the contact, a value at the 90 percent maximum of the intensities of the contact, or the like. In some embodiments, the duration of the contact is used in determining the characteristic intensity (e.g., when the characteristic intensity is an average of the intensity of the contact over time). In some embodiments, the characteristic intensity is compared to a set of one or more intensity thresholds to determine whether an operation has been performed by a user. For example, the set of one or more intensity thresholds optionally includes a first intensity threshold and a second intensity threshold. In this example, a contact with a characteristic intensity that does not exceed the first threshold results in a first operation, a contact with a characteristic intensity that exceeds the first intensity threshold and does not exceed the second intensity threshold results in a second operation, and a contact with a characteristic intensity that exceeds the second threshold results in a third operation. In some embodiments, a comparison between the characteristic intensity and one or more thresholds is used to determine whether or not to perform one or more operations (e.g., whether to perform a respective operation or forgo performing the respective operation) rather than being used to determine whether to perform a first operation or a second operation.

In some embodiments, a portion of a gesture is identified for purposes of determining a characteristic intensity. For example, a touch-sensitive surface optionally receives a continuous swipe contact transitioning from a start location and reaching an end location, at which point the intensity of the contact increases. In this example, the characteristic intensity of the contact at the end location is, optionally, based on only a portion of the continuous swipe contact, and not the entire swipe contact (e.g., only the portion of the swipe contact at the end location). In some embodiments, a smoothing algorithm is, optionally, applied to the intensities of the swipe contact prior to determining the characteristic intensity of the contact. For example, the smoothing algorithm optionally includes one or more of: an unweighted sliding-average smoothing algorithm, a triangular smoothing algorithm, a median filter smoothing algorithm, and/or an exponential smoothing algorithm. In some circumstances, these smoothing algorithms eliminate narrow spikes or dips in the intensities of the swipe contact for purposes of determining a characteristic intensity.

The intensity of a contact on the touch-sensitive surface is, optionally, characterized relative to one or more intensity thresholds, such as a contact-detection intensity threshold, a light press intensity threshold, a deep press intensity threshold, and/or one or more other intensity thresholds. In some embodiments, the light press intensity threshold corresponds to an intensity at which the device will perform operations typically associated with clicking a button of a physical mouse or a trackpad. In some embodiments, the deep press intensity threshold corresponds to an intensity at which the device will perform operations that are different from operations typically associated with clicking a button of a physical mouse or a trackpad. In some embodiments, when a contact is detected with a characteristic intensity below the light press intensity threshold (e.g., and above a nominal contact-detection intensity threshold below which the contact is no longer detected), the device will move a focus selector in accordance with movement of the contact on the touch-

sensitive surface without performing an operation associated with the light press intensity threshold or the deep press intensity threshold. Generally, unless otherwise stated, these intensity thresholds are consistent between different sets of user interface figures.

An increase of characteristic intensity of the contact from an intensity below the light press intensity threshold to an intensity between the light press intensity threshold and the deep press intensity threshold is sometimes referred to as a “light press” input. An increase of characteristic intensity of the contact from an intensity below the deep press intensity threshold to an intensity above the deep press intensity threshold is sometimes referred to as a “deep press” input. An increase of characteristic intensity of the contact from an intensity below the contact-detection intensity threshold to an intensity between the contact-detection intensity threshold and the light press intensity threshold is sometimes referred to as detecting the contact on the touch-surface. A decrease of characteristic intensity of the contact from an intensity above the contact-detection intensity threshold to an intensity below the contact-detection intensity threshold is sometimes referred to as detecting liftoff of the contact from the touch-surface. In some embodiments, the contact-detection intensity threshold is zero. In some embodiments, the contact-detection intensity threshold is greater than zero.

In some embodiments described herein, one or more operations are performed in response to detecting a gesture that includes a respective press input or in response to detecting the respective press input performed with a respective contact (or a plurality of contacts), where the respective press input is detected based at least in part on detecting an increase in intensity of the contact (or plurality of contacts) above a press-input intensity threshold. In some embodiments, the respective operation is performed in response to detecting the increase in intensity of the respective contact above the press-input intensity threshold (e.g., a “down stroke” of the respective press input). In some embodiments, the press input includes an increase in intensity of the respective contact above the press-input intensity threshold and a subsequent decrease in intensity of the contact below the press-input intensity threshold, and the respective operation is performed in response to detecting the subsequent decrease in intensity of the respective contact below the press-input threshold (e.g., an “up stroke” of the respective press input).

In some embodiments, the device employs intensity hysteresis to avoid accidental inputs sometimes termed “jitter,” where the device defines or selects a hysteresis intensity threshold with a predefined relationship to the press-input intensity threshold (e.g., the hysteresis intensity threshold is X intensity units lower than the press-input intensity threshold or the hysteresis intensity threshold is 75%, 90%, or some reasonable proportion of the press-input intensity threshold). Thus, in some embodiments, the press input includes an increase in intensity of the respective contact above the press-input intensity threshold and a subsequent decrease in intensity of the contact below the hysteresis intensity threshold that corresponds to the press-input intensity threshold, and the respective operation is performed in response to detecting the subsequent decrease in intensity of the respective contact below the hysteresis intensity threshold (e.g., an “up stroke” of the respective press input). Similarly, in some embodiments, the press input is detected only when the device detects an increase in intensity of the contact from an intensity at or below the hysteresis intensity threshold to an intensity at or above the press-input intensity threshold and, optionally, a subsequent decrease in intensity

of the contact to an intensity at or below the hysteresis intensity, and the respective operation is performed in response to detecting the press input (e.g., the increase in intensity of the contact or the decrease in intensity of the contact, depending on the circumstances).

For ease of explanation, the descriptions of operations performed in response to a press input associated with a press-input intensity threshold or in response to a gesture including the press input are, optionally, triggered in response to detecting either: an increase in intensity of a contact above the press-input intensity threshold, an increase in intensity of a contact from an intensity below the hysteresis intensity threshold to an intensity above the press-input intensity threshold, a decrease in intensity of the contact below the press-input intensity threshold, and/or a decrease in intensity of the contact below the hysteresis intensity threshold corresponding to the press-input intensity threshold. Additionally, in examples where an operation is described as being performed in response to detecting a decrease in intensity of a contact below the press-input intensity threshold, the operation is, optionally, performed in response to detecting a decrease in intensity of the contact below a hysteresis intensity threshold corresponding to, and lower than, the press-input intensity threshold.

3. Digital Assistant System

FIG. 7A illustrates a block diagram of digital assistant system 700 in accordance with various examples. In some examples, digital assistant system 700 can be implemented on a standalone computer system. In some examples, digital assistant system 700 can be distributed across multiple computers. In some examples, some of the modules and functions of the digital assistant can be divided into a server portion and a client portion, where the client portion resides on one or more user devices (e.g., devices 104, 122, 200, 400, or 600) and communicates with the server portion (e.g., server system 108) through one or more networks, e.g., as shown in FIG. 1. In some examples, digital assistant system 700 can be an implementation of server system 108 (and/or DA server 106) shown in FIG. 1. It should be noted that digital assistant system 700 is only one example of a digital assistant system, and that digital assistant system 700 optionally has more or fewer components than shown, optionally combines two or more components, or optionally has a different configuration or arrangement of the components. The various components shown in FIG. 7A are, optionally, implemented in hardware, software instructions for execution by one or more processors, firmware, including one or more signal processing and/or application specific integrated circuits, or a combination thereof.

Digital assistant system 700 can include memory 702, one or more processors 704, input/output (I/O) interface 706, and network communications interface 708. These components can communicate with one another over one or more communication buses or signal lines 710.

In some examples, memory 702 can include a non-transitory computer-readable medium, such as high-speed random access memory and/or a non-volatile computer-readable storage medium (e.g., one or more magnetic disk storage devices, flash memory devices, or other non-volatile solid-state memory devices).

In some examples, I/O interface 706 can couple input/output devices 716 of digital assistant system 700, such as displays, keyboards, touch screens, and microphones, to user interface module 722. I/O interface 706, in conjunction with user interface module 722, can receive user inputs (e.g., voice input, keyboard inputs, touch inputs, etc.) and processes them accordingly. In some examples, e.g., when the

digital assistant is implemented on a standalone user device, digital assistant system 700 can include any of the components and I/O communication interfaces described with respect to devices 200, 400, or 600 in FIGS. 2A, 4, 6A-B, respectively. In some examples, digital assistant system 700 can represent the server portion of a digital assistant implementation, and can interact with the user through a client-side portion residing on a user device (e.g., devices 104, 200, 400, or 600).

In some examples, the network communications interface 708 can include wired communication port(s) 712 and/or wireless transmission and reception circuitry 714. The wired communication port(s) can receive and send communication signals via one or more wired interfaces, e.g., Ethernet, Universal Serial Bus (USB), FIREWIRE, etc. The wireless circuitry 714 can receive and send RF signals and/or optical signals from/to communications networks and other communications devices. The wireless communications can use any of a plurality of communications standards, protocols, and technologies, such as GSM, EDGE, CDMA, TDMA, Bluetooth, Wi-Fi, VoIP, Wi-MAX, or any other suitable communication protocol. Network communications interface 708 can enable communication between digital assistant system 700 with networks, such as the Internet, an intranet, and/or a wireless network, such as a cellular telephone network, a wireless local area network (LAN), and/or a metropolitan area network (MAN), and other devices.

In some examples, memory 702, or the computer-readable storage media of memory 702, can store programs, modules, instructions, and data structures including all or a subset of: operating system 718, communications module 720, user interface module 722, one or more applications 724, and digital assistant module 726. In particular, memory 702, or the computer-readable storage media of memory 702, can store instructions for performing process 900 (FIG. 9), described below. One or more processors 704 can execute these programs, modules, and instructions, and reads/writes from/to the data structures.

Operating system 718 (e.g., Darwin, RTXC, LINUX, UNIX, iOS, OS X, WINDOWS, or an embedded operating system such as VxWorks) can include various software components and/or drivers for controlling and managing general system tasks (e.g., memory management, storage device control, power management, etc.) and facilitates communications between various hardware, firmware, and software components.

Communications module 720 can facilitate communications between digital assistant system 700 with other devices over network communications interface 708. For example, communications module 720 can communicate with RF circuitry 208 of electronic devices such as devices 200, 400, and 600 shown in FIG. 2A, 4, 6A-B, respectively. Communications module 720 can also include various components for handling data received by wireless circuitry 714 and/or wired communications port 712.

User interface module 722 can receive commands and/or inputs from a user via I/O interface 706 (e.g., from a keyboard, touch screen, pointing device, controller, and/or microphone), and generate user interface objects on a display. User interface module 722 can also prepare and deliver outputs (e.g., speech, sound, animation, text, icons, vibrations, haptic feedback, light, etc.) to the user via the I/O interface 706 (e.g., through displays, audio channels, speakers, touch-pads, etc.).

Applications 724 can include programs and/or modules that are configured to be executed by one or more processors

704. For example, if the digital assistant system is implemented on a standalone user device, applications 724 can include user applications, such as games, a calendar application, a navigation application, or an email application. If digital assistant system 700 is implemented on a server, applications 724 can include resource management applications, diagnostic applications, or scheduling applications, for example.

Memory 702 can also store digital assistant module 726 (or the server portion of a digital assistant). In some examples, digital assistant module 726 can include the following sub-modules, or a subset or superset thereof: input/output processing module 728, speech-to-text (STT) processing module 730, natural language processing module 732, dialogue flow processing module 734, task flow processing module 736, service processing module 738, and speech synthesis module 740. Each of these modules can have access to one or more of the following systems or data and models of the digital assistant module 726, or a subset or superset thereof: ontology 760, vocabulary index 744, user data 748, task flow models 754, service models 756, and ASR systems.

In some examples, using the processing modules, data, and models implemented in digital assistant module 726, the digital assistant can perform at least some of the following: converting speech input into text; identifying a user's intent expressed in a natural language input received from the user; actively eliciting and obtaining information needed to fully infer the user's intent (e.g., by disambiguating words, games, intentions, etc.); determining the task flow for fulfilling the inferred intent; and executing the task flow to fulfill the inferred intent.

In some examples, as shown in FIG. 7B, I/O processing module 728 can interact with the user through I/O devices 716 in FIG. 7A or with a user device (e.g., devices 104, 200, 400, or 600) through network communications interface 708 in FIG. 7A to obtain user input (e.g., a speech input) and to provide responses (e.g., as speech outputs) to the user input. I/O processing module 728 can optionally obtain contextual information associated with the user input from the user device, along with or shortly after the receipt of the user input. The contextual information can include user-specific data, vocabulary, and/or preferences relevant to the user input. In some examples, the contextual information also includes software and hardware states of the user device at the time the user request is received, and/or information related to the surrounding environment of the user at the time that the user request was received. In some examples, I/O processing module 728 can also send follow-up questions to, and receive answers from, the user regarding the user request. When a user request is received by I/O processing module 728 and the user request can include speech input, I/O processing module 728 can forward the speech input to STT processing module 730 (or speech recognizer) for speech-to-text conversions.

STT processing module 730 can include one or more ASR systems. The one or more ASR systems can process the speech input that is received through I/O processing module 728 to produce a recognition result. Each ASR system can include a front-end speech pre-processor. The front-end speech pre-processor can extract representative features from the speech input. For example, the front-end speech pre-processor can perform a Fourier transform on the speech input to extract spectral features that characterize the speech input as a sequence of representative multi-dimensional vectors. Further, each ASR system can include one or more speech recognition models (e.g., acoustic models and/or

language models) and can implement one or more speech recognition engines. Examples of speech recognition models can include Hidden Markov Models, Gaussian-Mixture Models, Deep Neural Network Models, n-gram language models, and other statistical models. Examples of speech recognition engines can include the dynamic time warping based engines and weighted finite-state transducers (WFST) based engines. The one or more speech recognition models and the one or more speech recognition engines can be used to process the extracted representative features of the front-end speech pre-processor to produce intermediate recognitions results (e.g., phonemes, phonemic strings, and sub-words), and ultimately, text recognition results (e.g., words, word strings, or sequence of tokens). In some examples, the speech input can be processed at least partially by a third-party service or on the user's device (e.g., device 104, 200, 400, or 600) to produce the recognition result. Once STT processing module 730 produces recognition results containing a text string (e.g., words, or sequence of words, or sequence of tokens), the recognition result can be passed to natural language processing module 732 for intent deduction.

More details on the speech-to-text processing are described in U.S. Utility application Ser. No. 13/236,942 for "Consolidating Speech Recognition Results," filed on Sep. 20, 2011, the entire disclosure of which is incorporated herein by reference.

In some examples, STT processing module 730 can include and/or access a vocabulary of recognizable words via phonetic alphabet conversion module 731. Each vocabulary word can be associated with one or more candidate pronunciations of the word represented in a speech recognition phonetic alphabet. In particular, the vocabulary of recognizable words can include a word that is associated with a plurality of candidate pronunciations. For example, the vocabulary optionally includes the word "tomato" that is associated with the candidate pronunciations of τᵒ'mεirou and τᵒ'matou. Further, vocabulary words can be associated with custom candidate pronunciations that are based on previous speech inputs from the user. Such custom candidate pronunciations can be stored in STT processing module 730 and can be associated with a particular user via the user's profile on the device. In some examples, the candidate pronunciations for words can be determined based on the spelling of the word and one or more linguistic and/or phonetic rules. In some examples, the candidate pronunciations can be manually generated, e.g., based on known canonical pronunciations.

In some examples, the candidate pronunciations can be ranked based on the commonness of the candidate pronunciation. For example, the candidate pronunciation τᵒ'mεirou can be ranked higher than τᵒ'matou, because the former is a more commonly used pronunciation (e.g., among all users, for users in a particular geographical region, or for any other appropriate subset of users). In some examples, candidate pronunciations can be ranked based on whether the candidate pronunciation is a custom candidate pronunciation associated with the user. For example, custom candidate pronunciations can be ranked higher than canonical candidate pronunciations. This can be useful for recognizing proper nouns having a unique pronunciation that deviates from canonical pronunciation. In some examples, candidate pronunciations can be associated with one or more speech characteristics, such as geographic origin, nationality, or ethnicity. For example, the candidate pronunciation τᵒ'mεirou can be associated with the United States,

whereas the candidate pronunciation τᵒ'matou can be associated with Great Britain. Further, the rank of the candidate pronunciation can be based on one or more characteristics (e.g., geographic origin, nationality, ethnicity, etc.) of the user stored in the user's profile on the device. For example, it can be determined from the user's profile that the user is associated with the United States. Based on the user being associated with the United States, the candidate pronunciation τᵒ'mεirou (associated with the United States) can be ranked higher than the candidate pronunciation τᵒ'matou (associated with Great Britain). In some examples, one of the ranked candidate pronunciations can be selected as a predicted pronunciation (e.g., the most likely pronunciation).

When a speech input is received, STT processing module 730 can be used to determine the phonemes corresponding to the speech input (e.g., using an acoustic model), and then attempt to determine words that match the phonemes (e.g., using a language model). For example, if STT processing module 730 can first identify the sequence of phonemes τᵒ'mεirou corresponding to a portion of the speech input, it can then determine, based on vocabulary index 744, that this sequence corresponds to the word "tomato."

In some examples, STT processing module 730 can use approximate matching techniques to determine words in an utterance. Thus, for example, the STT processing module 730 can determine that the sequence of phonemes τᵒ'mεirou corresponds to the word "tomato," even if that particular sequence of phonemes is not one of the candidate sequence of phonemes for that word.

Natural language processing module 732 ("natural language processor") of the digital assistant can take the sequence of words or tokens ("token sequence") generated by STT processing module 730, and attempt to associate the token sequence with one or more "actionable intents" recognized by the digital assistant. An "actionable intent" can represent a task that can be performed by the digital assistant, and can have an associated task flow implemented in task flow models 754. The associated task flow can be a series of programmed actions and steps that the digital assistant takes in order to perform the task. The scope of a digital assistant's capabilities can be dependent on the number and variety of task flows that have been implemented and stored in task flow models 754, or in other words, on the number and variety of "actionable intents" that the digital assistant recognizes. The effectiveness of the digital assistant, however, can also be dependent on the assistant's ability to infer the correct "actionable intent(s)" from the user request expressed in natural language.

In some examples, in addition to the sequence of words or tokens obtained from STT processing module 730, natural language processing module 732 can also receive contextual information associated with the user request, e.g., from I/O processing module 728. The natural language processing module 732 can optionally use the contextual information to clarify, supplement, and/or further define the information contained in the token sequence received from STT processing module 730. The contextual information can include, for example, user preferences, hardware, and/or software states of the user device, sensor information collected before, during, or shortly after the user request, prior interactions (e.g., dialogue) between the digital assistant and the user, and the like. As described herein, contextual information can be dynamic, and can change with time, location, content of the dialogue, and other factors.

In some examples, the natural language processing can be based on, e.g., ontology 760. Ontology 760 can be a hierarchical structure containing many nodes, each node representing either an “actionable intent” or a “property” relevant to one or more of the “actionable intents” or other “prop-

erties.” As noted above, an “actionable intent” can represent a task that the digital assistant is capable of performing, i.e., it is “actionable” or can be acted on. A “property” can represent a parameter associated with an actionable intent or a sub-aspect of another property. A linkage between an actionable intent node and a property node in ontology 760 can define how a parameter represented by the property node pertains to the task represented by the actionable intent node.

In some examples, ontology 760 can be made up of actionable intent nodes and property nodes. Within ontology 760, each actionable intent node can be linked to one or more property nodes either directly or through one or more intermediate property nodes. Similarly, each property node can be linked to one or more actionable intent nodes either directly or through one or more intermediate property nodes. For example, as shown in FIG. 7C, ontology 760 can include a “restaurant reservation” node (i.e., an actionable intent node). Property nodes “restaurant,” “date/time” (for the reservation), and “party size” can each be directly linked to the actionable intent node (i.e., the “restaurant reservation” node).

In addition, property nodes “cuisine,” “price range,” “phone number,” and “location” can be sub-nodes of the property node “restaurant,” and can each be linked to the “restaurant reservation” node (i.e., the actionable intent node) through the intermediate property node “restaurant.” For another example, as shown in FIG. 7C, ontology 760 can also include a “set reminder” node (i.e., another actionable intent node). Property nodes “date/time” (for setting the reminder) and “subject” (for the reminder) can each be linked to the “set reminder” node. Since the property “date/time” can be relevant to both the task of making a restaurant reservation and the task of setting a reminder, the property node “date/time” can be linked to both the “restaurant reservation” node and the “set reminder” node in ontology 760.

An actionable intent node, along with its linked concept nodes, can be described as a “domain.” In the present discussion, each domain can be associated with a respective actionable intent, and refers to the group of nodes (and the relationships there between) associated with the particular actionable intent. For example, ontology 760 shown in FIG. 7C can include an example of restaurant reservation domain 762 and an example of reminder domain 764 within ontology 760. The restaurant reservation domain includes the actionable intent node “restaurant reservation,” property nodes “restaurant,” “date/time,” and “party size,” and sub-property nodes “cuisine,” “price range,” “phone number,” and “location.” Reminder domain 764 can include the actionable intent node “set reminder,” and property nodes “subject” and “date/time.” In some examples, ontology 760 can be made up of many domains. Each domain can share one or more property nodes with one or more other domains. For example, the “date/time” property node can be associated with many different domains (e.g., a scheduling domain, a travel reservation domain, a movie ticket domain, etc.), in addition to restaurant reservation domain 762 and reminder domain 764.

While FIG. 7C illustrates two example domains within ontology 760, other domains can include, for example, “find a movie,” “initiate a phone call,” “find directions,” “schedule a meeting,” “send a message,” and “provide an answer

to a question,” “read a list,” “providing navigation instructions,” “provide instructions for a task” and so on. A “send a message” domain can be associated with a “send a message” actionable intent node, and optionally further includes property nodes such as “recipient(s),” “message type,” and “message body.” The property node “recipient” can be further defined, for example, by the sub-property nodes such as “recipient name” and “message address.”

In some examples, ontology 760 can include all the domains (and hence actionable intents) that the digital assistant is capable of understanding and acting upon. In some examples, ontology 760 can be modified, such as by adding or removing entire domains or nodes, or by modifying relationships between the nodes within the ontology 760.

In some examples, nodes associated with multiple related actionable intents can be clustered under a “super domain” in ontology 760. For example, a “travel” super-domain can include a cluster of property nodes and actionable intent nodes related to travel. The actionable intent nodes related to travel can include “airline reservation,” “hotel reservation,” “car rental,” “get directions,” “find points of interest,” and so on. The actionable intent nodes under the same super domain (e.g., the “travel” super domain) can have many property nodes in common. For example, the actionable intent nodes for “airline reservation,” “hotel reservation,” “car rental,” “get directions,” and “find points of interest” can share one or more of the property nodes “start location,” “destination,” “departure date/time,” “arrival date/time,” and “party size.”

In some examples, each node in ontology 760 can be associated with a set of words and/or phrases that are relevant to the property or actionable intent represented by the node. The respective set of words and/or phrases associated with each node can be the so-called “vocabulary” associated with the node. The respective set of words and/or phrases associated with each node can be stored in vocabulary index 744 in association with the property or actionable intent represented by the node. For example, returning to FIG. 7B, the vocabulary associated with the node for the property of “restaurant” can include words such as “food,” “drinks,” “cuisine,” “hungry,” “eat,” “pizza,” “fast food,” “meal,” and so on. For another example, the vocabulary associated with the node for the actionable intent of “initiate a phone call” can include words and phrases such as “call,” “phone,” “dial,” “ring,” “call this number,” “make a call to,” and so on. The vocabulary index 744 can optionally include words and phrases in different languages.

Natural language processing module 732 can receive the token sequence (e.g., a text string) from STT processing module 730, and determine what nodes are implicated by the words in the token sequence. In some examples, if a word or phrase in the token sequence is found to be associated with one or more nodes in ontology 760 (via vocabulary index 744), the word or phrase can “trigger” or “activate” those nodes. Based on the quantity and/or relative importance of the activated nodes, natural language processing module 732 can select one of the actionable intents as the task that the user intended the digital assistant to perform. In some examples, the domain that has the most “triggered” nodes can be selected. In some examples, the domain having the highest confidence value (e.g., based on the relative importance of its various triggered nodes) can be selected. In some examples, the domain can be selected based on a combination of the number and the importance of the triggered nodes. In some examples, additional factors are considered

in selecting the node as well, such as whether the digital assistant has previously correctly interpreted a similar request from a user.

User data 748 can include user-specific information, such as user-specific vocabulary, user preferences, user address, user's default and secondary languages, user's contact list, and other short-term or long-term information for each user. In some examples, natural language processing module 732 can use the user-specific information to supplement the information contained in the user input to further define the user intent. For example, for a user request "invite my friends to my birthday party," natural language processing module 732 can be able to access user data 748 to determine who the "friends" are and when and where the "birthday party" would be held, rather than requiring the user to provide such information explicitly in his/her request.

Other details of searching an ontology based on a token string is described in U.S. Utility application Ser. No. 12/341,743 for "Method and Apparatus for Searching Using An Active Ontology," filed Dec. 22, 2008, the entire disclosure of which is incorporated herein by reference.

In some examples, once natural language processing module 732 identifies an actionable intent (or domain) based on the user request, natural language processing module 732 can generate a structured query to represent the identified actionable intent. In some examples, the structured query can include parameters for one or more nodes within the domain for the actionable intent, and at least some of the parameters are populated with the specific information and requirements specified in the user request. For example, the user says "Make me a dinner reservation at a sushi place at 7." In this case, natural language processing module 732 can be able to correctly identify the actionable intent to be "restaurant reservation" based on the user input. According to the ontology, a structured query for a "restaurant reservation" domain optionally includes parameters such as {Cuisine}, {Time}, {Date}, {Party Size}, and the like. In some examples, based on the speech input and the text derived from the speech input using STT processing module 730, natural language processing module 732 can generate a partial structured query for the restaurant reservation domain, where the partial structured query includes the parameters {Cuisine="Sushi"} and {Time="7 pm"}. However, in this example, the user's utterance contains insufficient information to complete the structured query associated with the domain. Therefore, other necessary parameters such as {Party Size} and {Date} are, optionally, not specified in the structured query based on the information currently available. In some examples, natural language processing module 732 can populate some parameters of the structured query with received contextual information. For example, in some examples, if the user requested a sushi restaurant "near me," natural language processing module 732 can populate a {location} parameter in the structured query with GPS coordinates from the user device.

In some examples, natural language processing module 732 can pass the generated structured query (including any completed parameters) to task flow processing module 736 ("task flow processor"). Task flow processing module 736 can be configured to receive the structured query from natural language processing module 732, complete the structured query, if necessary, and perform the actions required to "complete" the user's ultimate request. In some examples, the various procedures necessary to complete these tasks can be provided in task flow models 754. In some examples, task flow models 754 can include procedures for obtaining

additional information from the user and task flows for performing actions associated with the actionable intent.

As described above, in order to complete a structured query, task flow processing module 736 optionally need to initiate additional dialogue with the user in order to obtain additional information, and/or disambiguate potentially ambiguous utterances. When such interactions are necessary, task flow processing module 736 can invoke dialogue flow processing module 734 to engage in a dialogue with the user. In some examples, dialogue flow processing module 734 can determine how (and/or when) to ask the user for the additional information and receives and processes the user responses. The questions can be provided to and answers can be received from the users through I/O processing module 728. In some examples, dialogue flow processing module 734 can present dialogue output to the user via audio and/or visual output, and receives input from the user via spoken or physical (e.g., clicking) responses. Continuing with the example above, when task flow processing module 736 invokes dialogue flow processing module 734 to determine the "party size" and "date" information for the structured query associated with the domain "restaurant reservation," dialogue flow processing module 734 can generate questions such as "For how many people?" and "On which day?" to pass to the user. Once answers are received from the user, dialogue flow processing module 734 can then populate the structured query with the missing information, or pass the information to task flow processing module 736 to complete the missing information from the structured query.

Once task flow processing module 736 has completed the structured query for an actionable intent, task flow processing module 736 can proceed to perform the ultimate task associated with the actionable intent. Accordingly, task flow processing module 736 can execute the steps and instructions in the task flow model according to the specific parameters contained in the structured query. For example, the task flow model for the actionable intent of "restaurant reservation" can include steps and instructions for contacting a restaurant and actually requesting a reservation for a particular party size at a particular time. For example, using a structured query such as: {restaurant reservation, restaurant=ABC Café, date=Mar. 12, 2012, time=7 pm, party size=5}, task flow processing module 736 can perform the steps of: (1) logging onto a server of the ABC Café or a restaurant reservation system such as OPENTABLE®, (2) entering the date, time, and party size information in a form on the website, (3) submitting the form, and (4) making a calendar entry for the reservation in the user's calendar.

In some examples, task flow processing module 736 can employ the assistance of service processing module 738 ("service processing module") to complete a task requested in the user input or to provide an informational answer requested in the user input. For example, service processing module 738 can act on behalf of task flow processing module 736 to make a phone call, set a calendar entry, invoke a map search, invoke or interact with other user applications installed on the user device, and invoke or interact with third-party services (e.g., a restaurant reservation portal, a social networking website, a banking portal, etc.). In some examples, the protocols and application programming interfaces (API) required by each service can be specified by a respective service model among service models 756. Service processing module 738 can access the appropriate service model for a service and generate requests for the service in accordance with the protocols and APIs required by the service according to the service model.

For example, if a restaurant has enabled an online reservation service, the restaurant can submit a service model specifying the necessary parameters for making a reservation and the APIs for communicating the values of the necessary parameter to the online reservation service. When requested by task flow processing module 736, service processing module 738 can establish a network connection with the online reservation service using the web address stored in the service model, and send the necessary parameters of the reservation (e.g., time, date, party size) to the online reservation interface in a format according to the API of the online reservation service.

In some examples, natural language processing module 732, dialogue flow processing module 734, and task flow processing module 736 can be used collectively and iteratively to infer and define the user's intent, obtain information to further clarify and refine the user intent, and finally generate a response (i.e., an output to the user, or the completion of a task) to fulfill the user's intent. The generated response can be a dialogue response to the speech input that at least partially fulfills the user's intent. Further, in some examples, the generated response can be output as a speech output. In these examples, the generated response can be sent to speech synthesis module 740 (e.g., speech synthesizer) where it can be processed to synthesize the dialogue response in speech form. In yet other examples, the generated response can be data content relevant to satisfying a user request in the speech input.

Speech synthesis module 740 can be configured to synthesize speech outputs for presentation to the user. Speech synthesis module 740 synthesizes speech outputs based on text provided by the digital assistant. For example, the generated dialogue response can be in the form of a text string. Speech synthesis module 740 can convert the text string to an audible speech output. Speech synthesis module 740 can use any appropriate speech synthesis technique in order to generate speech outputs from text, including, but not limited, to concatenative synthesis, unit selection synthesis, diphone synthesis, domain-specific synthesis, formant synthesis, articulatory synthesis, hidden Markov model (HMM) based synthesis, and sinewave synthesis. In some examples, speech synthesis module 740 can be configured to synthesize individual words based on phonemic strings corresponding to the words. For example, a phonemic string can be associated with a word in the generated dialogue response. The phonemic string can be stored in metadata associated with the word. Speech synthesis model 740 can be configured to directly process the phonemic string in the metadata to synthesize the word in speech form.

In some examples, instead of (or in addition to) using speech synthesis module 740, speech synthesis can be performed on a remote device (e.g., the server system 108), and the synthesized speech can be sent to the user device for output to the user. For example, this can occur in some implementations where outputs for a digital assistant are generated at a server system. And because server systems generally have more processing power or resources than a user device, it can be possible to obtain higher quality speech outputs than would be practical with client-side synthesis.

Additional details on digital assistants can be found in the U.S. Utility application Ser. No. 12/987,982, entitled "Intelligent Automated Assistant," filed Jan. 10, 2011, and U.S. Utility application Ser. No. 13/251,088, entitled "Generating and Processing Task Items That Represent Tasks to Perform," filed Sep. 30, 2011, the entire disclosures of which are incorporated herein by reference.

4. Exemplary Techniques for Controlling the Triggering of Multiple Virtual Assistant Sessions.

Attention is now directed towards embodiments of user interfaces ("UI") and associated processes that may be implemented on multifunction devices, such as devices 104, 122, 200, 400, 600, and 1000 (FIGS. 1, 2, 4, 6, and 10), to handle spoken triggers in usage scenarios involving multiple electronic devices that are proximate to one another. These techniques are described with reference to FIGS. 8A-8F. These figures are also used to illustrate the processes described below, including the processes in FIG. 9.

FIGS. 8A-8C describe an exemplary usage scenario that can result in undesirable, concurrent outputs from multiple electronic devices. FIG. 8A illustrates exemplary wearable electronic device 802 worn by user 800. Wearable device 802 is one of devices 104, 122, 200, 400, 600, or 1000 (FIG. 1, 2, 4, 6, or 10) in some embodiments. FIG. 8A also illustrates exemplary electronic device 804 being carried by user 800. Device 804 is one of devices 104, 122, 200, 400, 600, or 1000 (FIG. 1, 2, 4, 6, or 10) in some embodiments. In the illustrated example, device 804 is a phone.

Both wearable device 802 and phone device 804 have microphones for sampling audio input. In some embodiments, both devices 802 and 804 are configured to trigger a virtual assistant session upon detecting the utterance of a spoken trigger, such as the phrase "hey Siri," in the sampled audio input from their respective microphones.

As depicted in FIGS. 8B and 8C, when phone device 804 detects spoken input 806 while sampling audio input, it determines that spoken input 806 includes a relevant trigger phrase, and triggers a virtual assistant service, which includes displaying virtual assistant user interface 814 to prompt the user for additional input. At the same time, wearable device 802 also detects the trigger phrase in its sampling of audio input, as both devices 802 and 804 are within the range of picking up the user's utterance 806. Responsive to the input, wearable device 802 also triggers a virtual assistant and displays virtual assistant user interface 812, prompting the user for additional input.

These concurrent responses by devices 802 and 804 (and any potential others responses from additional nearby electronic devices) can produce a cumbersome user experience, particularly since the multiple devices produce audible and/or haptic outputs in accordance with the triggering of the virtual assistant, in some embodiments.

FIGS. 8D-8F describe an exemplary technique for overcoming the concurrent responses described with reference to FIGS. 8A-8C. As seen in FIG. 8D, wearable device 802 is configured to respond to certain movements, such as a movement of the device from a lowered position to a raised (e.g., viewing) position. In some embodiments, when device 802 detects movement meeting a predetermined condition, device 802 switches on touch screen 808 to display information, such as the current time. Additional details regarding techniques for determining whether a device movement meets a predetermined condition is described below with reference to FIG. 10.

Turning to FIG. 8E, in some embodiments, in accordance with the powering on of touch screen 808, wearable device 802 also performs (at least) two additional functions. First, device 802 begins to sample audio input using its microphone and to determine whether sampled audio input includes a spoken trigger for triggering a service, particularly a virtual assistant session. Second, as device 802 begins to sample audio input, the device also transmits instruction data 818 which can be received by compatible electronic devices that are within the communication range of device

802 using one or more mutually supported communication protocols, such as Bluetooth and/or Bluetooth Low Energy.

Instruction data **818** includes an instruction to other in-range electronic devices to stop, at least temporarily, sampling and/or responding to audio input. In the example of FIG. **8E**, phone device **804** is within communications range of wearable device **802** and thus receives instruction data **818**. Upon receiving instruction data **818**, phone device **804** refrains from triggering its virtual assistant service even if its audio detection circuitry (e.g., microphone **213**, audio circuitry **210**, peripherals interface **218**, so forth) detects the spoken trigger in sampled audio input.

As a result, turning to FIG. **8F**, even if user **800** provides spoken input **830**—which includes the trigger phrase “hey Siri”—within the microphone pick-up range of devices **802** and **804**, phone device **804** refrains from triggering its virtual assistant, leaving wearable device **802** as the (e.g., sole) device that responds to the user’s spoken input **830**. In this way, the redundant trigger of virtual assistant services between multiple devices is beneficially avoided.

Although the exemplary illustrations of FIGS. **8A-8F** depict wearable device **802** as the device that is responsive when competing triggers are heard (e.g., as opposed to phone device **804**), the above-described techniques are not so limited. In some embodiments, the user may select which device is to be responsive to competing triggers when multiple devices are present. For example, wearable device **802** and phone device **804** (and any other compatible devices owned by the user) can share a configuration setting that identifies one of the devices as being a default preferred device for responding to voice triggers. As another example, a wearable device **802** and phone device **804** (and any other compatible devices owned by the user) may be ranked relative to one another using a configuration setting, such that the highest-ranked device of the multiple in-range devices is the device that is responsive when a spoken trigger is provided in the presence of multiple devices.

In some embodiments, the multiple devices automatically determine which device should respond based on one or more conditions. The condition may be based on recency and/or frequency of use. For example, a virtual assistant can be triggered on the device that was most recently used, out of the devices that are within communication range of one another and that have sampled the user’s spoken trigger. Also, the condition may be based on distance. For example, audio speech processing can be applied to audio input sampled at the devices (e.g., with near-field vs. far-field determination algorithms or speech volume determination algorithms) to identify the device that is closest to the user, which should respond to the user’s spoken trigger. Also, the condition may be a usage condition. For example, if a device is on (e.g., phone device **804** is on) but another in-range device is not (e.g., wearable device **802** is off), then the device (e.g., phone device **804**) should respond to the spoken trigger

5. Exemplary Processes for Controlling the Triggering of Multiple Virtual Assistant Sessions.

FIGS. **9A-9C** depict a flow diagram illustrating method **900** for controlling the triggering of multiple virtual assistant sessions across multiple electronic devices. Method **900** is performed at one or more of devices **104**, **122**, **200**, **400**, **802**, **804** and **1000** (FIG. **1**, **2**, **4**, **6**, **8**, or **10**) in some embodiments. In some embodiments, method **900** is performed at a device having a touch screen. In some embodiments, method **900** is performed at a device with a separate display screen

and a touch-sensitive surface. Operations in method **900** are, optionally, combined and/or the order of some operations is, optionally, changed.

Turning to FIG. **9A**, at block **902**, the device samples audio input using a first microphone. In some embodiments, the sampling of audio input at block **902** is responsive to user input meeting a predetermined condition.

For example, the predetermined condition is that the display screen of the device is on. The device may determine whether the display is on by determining whether its back-light is lit. As another example, the predetermined condition is that the device is actively executing (e.g., in the foreground of the user interface) a predetermined service or application, such as a virtual assistant service. As yet another example, the predetermined condition is that a predetermined service or application has been recently dismissed from active execution, such as dismissal within a predetermined duration of eight seconds.

In some embodiments, the predetermined condition is a movement of the device, such as a lifting of the device into a viewing position (as seen in FIG. **8D**). Whether device movement constitutes a lifting movement is based on accelerometer readings over time, in some embodiments. Whether device movement constitutes a lifting movement is based on the smoothness of accelerometer readings over time, in some embodiments. Whether device movement constitutes a lifting movement is based on sensing a minimum period of dwell time (e.g., a period of relative non-movement or steadiness), in some embodiments.

In the exemplary lifting movement depicted in FIG. **8D**, user **800** raises device **802** from a lowered position to a raised position (e.g., a viewing position). This movement includes acceleration over time in one direction (e.g., in the vertical direction along the y-axis), and a rotational acceleration over time in another direction (e.g., a horizontal rotation about the x-axis), both of which can be determined by the acceleration sensors of the device. Optionally, the smoothness of such a lifting movement can be determined by comparing fluctuations in the acceleration sensors’ readings over time. Optionally, the lifting movement ends with the user glancing on the device’s touch screen in the raised position. The period of relative steadiness as user **800** focuses on the display of the device can be determined using acceleration sensor readings. The device uses at least some of these accelerometer readings in determining whether a predetermined condition for sampling audio input via microphone is met, in some embodiments.

Additional detail regarding techniques for determining raising gestures of an electronic device are described in, e.g., U.S. Provisional Patent Application Ser. No. 62/026,532, titled “Raise Gesture Detection in a Device,” filed Jul. 18, 2014, the content of which is hereby incorporated by reference. For brevity, the content of the application is not repeated here.

In some embodiments, the predetermined condition is activation of an input device such as a mechanical button, touch-sensitive button, rotatable input device, and so forth, of the device. In some embodiments, the predetermined condition is a touch on a touch-sensitive surface or touch screen (such as touch screen **808** shown in FIG. **8D**).

Turning to FIG. **9B**, at block **904**, in accordance with the sampling of audio input using the first microphone, the device sends instructions to a second electronic device with a second microphone. The second electronic device is also configured to respond to audio input received using a second microphone. The instructions at block **904** instruct the second electronic device to forgo responding to audio input

45

from the second microphone. In some examples, the instructions are represented by instruction data **818** (FIG. **8E**), and are referred to as “stop” instructions. The second electronic device is external to the electronic device that is performing process **900** (FIG. **9**). For example, the device performing process **900** (FIG. **9**) is wearable device **802** in FIG. **8** and the second electronic device is phone device **804**.

Turning to FIG. **9C**, at block **906**, the device determines whether the sampled audio input includes a spoken trigger. If the sampled audio input includes the spoken trigger, the device triggers a predetermined service. If the sampled audio input does not include the spoken trigger, the device does not trigger the predetermined service. In some examples, the predetermined service is a virtual assistant service that can process a user’s spoken input (e.g., in natural language) and that can operationalize the spoken input into computing tasks performed by the device. In some embodiments, the spoken trigger is a phrase such as “hey Siri.” Optionally, if the device triggers a virtual assistant session at block **906**, it provides a perceptible output such as a visual output (e.g., user interface screen **808** in FIG. **8C**), a haptic output (e.g., a vibration), and/or an audio output (e.g., a beeping sound).

In some embodiments, the second electronic device determines whether audio input sampled using the second microphone includes a spoken trigger. If the sampled audio input includes the spoken trigger, the second electronic device triggers a predetermined service. If the sampled audio input does not include the spoken trigger, the second electronic device does not trigger the predetermined service. For example, the predetermined service is a virtual assistant service that can process a user’s spoken input (e.g., in natural language) and that can operationalize the spoken input into computing tasks performed by the device. In some embodiments, the spoken trigger is a phrase such as “hey Siri.” Optionally, if the second device triggers a virtual assistant session responsive to a spoken trigger, the second device provides a perceptible output such as a visual output (e.g., user interface screen **810** in FIG. **8C**), a haptic output (e.g., a vibration), and/or an audio output (e.g., a beeping sound).

In some embodiments, the second electronic device processes audio input from the second microphone in response to user input meeting a predetermined condition. For example, the predetermined condition is that a predetermined processor or group of processors is powered on. Exemplary processes include a main processor and a dedicated audio processing processor. As another example, the predetermined condition is that the device is actively executing (e.g., in the foreground of the user interface) a predetermined service or application, such as a virtual assistant service. As another example, the predetermined condition is that a predetermined service or application has been recently dismissed from active execution, such as dismissal within a predetermined duration of eight seconds. As another example, the predetermined condition is that the display screen of the device is on. The device may determine whether the display is on by determining whether its backlight is lit. As another example, the predetermined condition is that the second electronic device is being charged.

In some embodiments, at block **908**, the device ceases to sample audio input, and sends instructions to the second electronic device, instructing the second electronic device to resume responding to audio input received using its second microphone. These instructions may be referred to as resume instructions. In some examples, the device ceases to sample audio input after it has sampled for a predetermined duration. In some examples, the device ceases to sample audio

46

input if a virtual assistant session is being dismissed from the foreground of the user interface of the device. In some examples, the device ceases to sample audio input after a virtual assistant has been dismissed for longer than a predetermined duration of time. In some examples, the device ceases to sample audio if its display screen is powered off.

In some embodiments, the stop instructions sent by the device at block **904** instruct the second electronic device to stop sampling of audio input using the second microphone. In some embodiments, the stop instructions sent by the device at block **904** instruct the second electronic device to suppress its responses to audio input received from the second microphone, even if underlying hardware and/or software processes of the second electronic device samples audio input. For example, the second electronic device is configured with a high-efficiency hardware audio processor that remains sampling audio input even as its software processes are instructed to temporarily refrain from responding to audio input.

In some embodiments, the stop instructions sent by the device at block **904** include an indication of the time duration for which the second electronic device is to forgo triggering a virtual assistant in response to audio input received using the second microphone. In some embodiments, the second electronic device is configured to automatically resume sampling audio input and/or processing sampled audio input after it has stopped responding for a predetermined duration.

In some embodiments, the second electronic device is configured to cease responding to audio input already sampled when it receives the stop instructions resulting from the operations of block **904**. For example, the second electronic device exits a virtual assistant session that is active. In some embodiments, the second electronic device is configured to provide an indication that it is ceasing to respond to audio input when it receives the stop instructions resulting from the operations of block **904**. For example, the second electronic device informs the user visually, audibly, and/or haptically that it is exiting an active virtual assistant session.

In some embodiments, the stop instructions and resume instructions sent at block **904** and block **908**, respectively, are sent using a stateless communication mechanism, meaning that the device does not expect to receive an acknowledgement from the second electronic device acknowledging receipt of the instructions. In some embodiments, the stop and resume instructions are sent via a broadcast mechanism, such as broadcast operations supported by WiFi, Bluetooth Low Energy, so forth. Put another way, the broadcasted instructions may be received by zero or more external devices including the second electronic device. In some embodiments, the stop and resume instructions are sent via a data packet that is directed to the second electronic device. Put another way, the device-specific stop and resume instructions are sent at block **904** and block **908**, respectively.

In some embodiments, the device maintains a counter, such as a numeric counter, that is used to determine whether the device sends stop instructions to the second electronic device. When the counter increase beyond a threshold value, the device sends the stop instructions. For example, the threshold value is zero, meaning that when the counter is increased to a positive non-zero value, the device sends stop instructions to the second electronic device.

The value of the counter depends on the usage conditions of the device. For example, the counter increases in value when: a backlight of the display of the device turns on; an

input device (e.g., a button, touch screen, touch-sensitive surface, or other input mechanism) is activated; the device detects movement meeting a predetermined condition; and a virtual assistant session is actively executing in the foreground of the user interface of the device. In some embodiments, each of these conditions increases the counter value by one.

In some embodiments, when the counter decreases to a value no longer exceeding the threshold value, the device sends resume instructions to the second electronic device. The counter decreases in value when: a backlight of the display of the device turns off; the display has been on for longer than a predetermined duration of time; a virtual assistant session is being dismissed from the foreground of the user interface of the device; and a predetermined time duration has elapsed since the dismissal of the virtual assistant session. In some embodiments, each of these conditions decreases the counter value by one.

In accordance with some embodiments, FIG. 10 shows a functional block diagram of an electronic device 1000 configured in accordance with the principles of the various described embodiments, including those described with reference to FIGS. 8A-8F and 9. The functional blocks of the device are, optionally, implemented by hardware, software, or a combination of hardware and software to carry out the principles of the various described embodiments. It is understood by persons of skill in the art that the functional blocks described in FIG. 10 are, optionally, combined or separated into sub-blocks to implement the principles of the various described embodiments. Therefore, the description herein optionally supports any possible combination or separation or further definition of the functional blocks described herein.

As shown in FIG. 10, an electronic device 1000 includes a display unit 1002 configured to display a graphical user interface, optional touch-sensitive surface unit 1004 to receive contacts, a microphone unit 1006 to detect audio input, communication unit 1008 to provide send and receive information using one or more data transmission mechanisms, and processing unit 1012 coupled to the above-described units. In some embodiments, processing unit 1012 includes display enabling unit 1014, audio sampling unit 1016, audio determining unit 1018, virtual assistant service unit 1020, instruction unit 1022, and usage condition counter unit 1024.

In some embodiments, processing unit 1012 is configured to: sample (e.g., with audio sampling unit 1016) audio input using the first microphone (e.g., with microphone unit 1006); in accordance with the sampling of audio input using the first microphone, send (e.g., with instruction unit 1022 and/or communication unit 1008) stop instructions to a second electronic device with a second microphone, the second electronic device external to electronic device 1000, where the second electronic device is configured to respond to audio input received using the second microphone, and where the stop instructions instruct the second electronic device to forgo responding to audio input received using the second microphone, where responding to audio input received using the second microphone comprises providing perceptible output (such as the visual display of screen 810 in FIG. 8C).

In some embodiments, processing unit 1012 is further configured to: cease the sampling of audio input (e.g., with audio sampling unit 1016); in accordance with the ceasing of the sampling of audio input, send (e.g., instruction unit 1022 and/or communication unit 1008) resume instructions to the second electronic device, wherein the resume instructions

instruct the second electronic device to resume responding to audio input received using the second microphone.

Note, in some embodiments, the second electronic device is configured to respond to audio input received using the second microphone by: sampling audio input using the second microphone, and initiating a virtual assistant session in accordance with a determination that the sampled audio input using the second microphone comprises a spoken trigger. The stop instructions (e.g., sent with instruction unit 1022) cause the second electronic device to forgo responding to audio input received using the second microphone by forgoing the sampling of audio input using the second microphone.

Note, in some embodiments, the second electronic device is configured to respond to audio input received using the second microphone by: sampling audio input using the second microphone, and initiating a virtual assistant session in accordance with a determination that the sampled audio input using the second microphone comprises a spoken trigger. The stop instructions (e.g., sent with instruction unit 1022) cause the second electronic device to forgo responding to audio input received using the second microphone by forgoing the initiating of the virtual assistant session even if the sampled audio input using the second microphone comprises a spoken trigger.

In some embodiments, the stop instructions comprise an indication of the time duration for which the second electronic device is to forgo responding to audio input received using the second microphone.

In some embodiments, the resume instructions cause the second electronic device to resume responding to audio input received using the second microphone.

In some embodiments, the stop instructions cause the second electronic device to: in accordance with receiving the stop instructions while the second electronic device is responding to audio input from the second microphone, cease responding to the audio input from the second microphone.

In some embodiments, the stop instructions cause the second electronic device to: in accordance with receiving the stop instructions while the second electronic device is responding to audio input received using the second microphone, provide an output indicating that the second electronic device is ceasing its response to the audio input from the second microphone.

In some embodiments, processing unit 1012 is further configured to: determine (e.g., with display enabling unit 1014) whether the display of device 1000 is on; in accordance with a determination that the screen is on, sample audio input using the first microphone; and in accordance with a determination that the screen is not on, forgo sampling of audio input using the first microphone (e.g., with audio sampling unit 1016).

In some embodiments, processing unit 1012 is further configured to: in accordance with the sampling (e.g., with audio sampling unit 1016) of the audio input using the first microphone: determine (e.g., with virtual assistant service unit 1020) whether a predetermined service is executing in the foreground of device 1000; in accordance with a determination that the service is executing in the foreground, sample (e.g., with audio sampling unit 1016) audio input using the first microphone; and in accordance with a determination that the screen is not executing in the foreground, forgo sampling of audio input using the first microphone (e.g., with audio sampling unit 1016).

In some embodiments, processing unit 1012 is further configured to: in accordance with the sampling (e.g., with

audio sampling unit **1016**) of the audio input using the first microphone at device **1000**: determine (e.g., with virtual assistant service unit **1020**) whether a predetermined service has been dismissed for longer than a predetermined duration of time; in accordance with a determination that the predetermined service has been dismissed for no longer than the predetermined duration of time, sample (e.g., with audio sampling unit **1016**) audio input using the first microphone; and in accordance with a determination that predetermined service has been dismissed for longer than the predetermined duration of time, forgo sampling of audio input using the first microphone (e.g., with audio sampling unit **1016**).

Note, in some embodiments, the second electronic device samples audio input using the second microphone when a predetermined at least one processor of the second electronic device is on. Note, in some embodiments, sample of the audio input using the second microphone at the second electronic device comprises: determine whether the second electronic device is charging; in accordance with a determination that the second electronic device is charging, sample audio input using the first microphone; and in accordance with a determination that second electronic device is not charging, forgo sampling of audio input using the first microphone.

In some embodiments, processing unit **1012** is further configured to: determine (e.g., with audio determining unit **1018**) whether the sampled audio input comprises a spoken trigger; in accordance with a determination that the sampled audio input comprises the spoken trigger, trigger (e.g., with virtual assistant service unit **1020**) a predetermined service; and in accordance with a determination that the sampled audio input does not comprise the spoken trigger, forgo triggering of the predetermined service (e.g., with virtual assistant service unit **1020**).

In some embodiments, processing unit **1012** is further configured to: send (e.g., with instruction unit **1022** and/or communication unit **1008**) the stop instructions or the resume instructions to the second electronic device using a stateless transmission mechanism.

In some embodiments, processing unit **1012** is further configured to: send (e.g., with instruction unit **1022** and/or communication unit **1008**) the stop instructions as part of a transmission addressed to the second electronic device on an electronic communication channel.

In some embodiments, processing unit **1012** is further configured to: in accordance with sending (e.g., with instruction unit **1022** and/or communication unit **1008**) the stop instructions to a second electronic device, broadcast (e.g., with instruction unit **1022** and/or communication unit **1008**) the stop instructions on an electronic communication channel.

In some embodiments, the spoken trigger comprises comprise a predetermined phrase.

In some embodiments, processing unit **1012** is further configured to: maintain a counter (e.g., with counter unit **1024**) based on device usage conditions, wherein the sending (e.g., with instruction unit **1022** and/or communication unit **1008**) of the stop instructions to the second electronic device comprises: in accordance with a determination that the counter exceeds a threshold value, send (e.g., with instruction unit **1022** and/or communication unit **1008**) the stop instructions, and in accordance with a determination that the counter does not exceed the threshold value, forgo the sending of the stop instructions (e.g., with instruction unit **1022** and/or communication unit **1008**).

In some embodiments, processing unit **1012** is further configured to send (e.g., with instruction unit **1022** and/or

communication unit **1008**) the resume instructions to the second electronic device by: in accordance with a determination that the counter does not exceed a threshold value, send (e.g., with instruction unit **1022** and/or communication unit **1008**) the resume instructions, and in accordance with a determination that the counter exceeds the threshold value, forgo the sending of the resume instructions (e.g., with instruction unit **1022** and/or communication unit **1008**).

In some embodiments, processing unit **1012** is further configured to increase the counter (e.g., with counter unit **1024**) in accordance with a determination (e.g., with display enabling unit **1014** and/or display unit **1002**) that a backlight of display unit **1002** of device **1000** is on.

In some embodiments, processing unit **1012** is further configured to increase the counter (e.g., with counter unit **1024**) in accordance with detecting activation of an input device (e.g., with touch-sensitive surface **1004**) of device **1000**.

In some embodiments, processing unit **1012** is further configured to increase the counter (e.g., with counter unit **1024**) in accordance with detecting (e.g., with movement sensor unit **1010**) movement of device **1000** meeting a predetermined condition.

In some embodiments, processing unit **1012** is further configured to increase the counter (e.g., with counter unit **1024**) in accordance with a determination that a predetermined service (e.g., with virtual assistant service unit **1020**) is actively executing (e.g., in the foreground) on device **1000**.

In some embodiments, processing unit **1012** is further configured to decrease the counter (e.g., with counter unit **1024**) in accordance with a determination (e.g., with display enabling unit **1014**) that a backlight of display unit **1002** is off.

In some embodiments, processing unit **1012** is further configured to decrease the counter (e.g., with counter unit **1024**) in accordance with a determination (e.g., with display enabling unit **1014**) that display unit **1002** has been on for longer than a predetermined time duration.

In some embodiments, processing unit **1012** is further configured to decrease the counter (e.g., with counter unit **1024**) in accordance with detecting a dismissal of a predetermined service (e.g., a virtual assistant service provided by virtual assistant unit **1020**) or application on device **1000**. In some embodiments, processing unit **1012** is further configured to decrease from the counter (e.g., with counter unit **1024**) in accordance with a determination that a predetermined time duration has elapsed since the dismissal.

The operations described above with respect to FIGS. **8A-8F** are, optionally, implemented by components depicted in FIG. **1**, **2**, or **10**. For example, audio receiving operation **902** is optionally implemented by audio circuitry **210**, and instructions transmissions at blocks **904** and **908** are optionally implemented by processor(s) **220**. It would be clear to a person of ordinary skill in the art how other processes can be implemented based on the components depicted in FIG. **1**, **2**, or **10**.

It is understood by persons of skill in the art that the functional blocks described in FIG. **10** are, optionally, combined or separated into sub-blocks to implement the principles of the various described embodiments. Therefore, the description herein optionally supports any possible combination or separation or further definition of the functional blocks described herein. For example, units **1002-1012** can have associated "controller" units that are operatively coupled with the respective unit and processing unit **1012** to enable operation. These controller units are not separately

51

illustrated in FIG. 10 but are understood to be within the grasp of one of ordinary skill in the art who is designing a device having units **1002-1012** such as device **1000**. As another example, audio sampling unit **1016** and/or audio determining unit **1018** may be hardware units outside of processing unit **1012** in some embodiments. The description herein thus optionally supports combination, separation, and/or further definition of the functional blocks described herein.

Although the disclosure and examples have been fully described with reference to the accompanying figures, it is to be noted that various changes and modifications will become apparent to those skilled in the art. Such changes and modifications are to be understood as being included within the scope of the disclosure and examples as defined by the appended claims.

What is claimed is:

1. A non-transitory computer readable storage medium storing one or more programs, the one or more programs comprising instructions, which when executed by a first electronic device with a display, a first microphone, cause the first electronic device to:

sample an audio input using the first microphone;

in accordance with the sampling of the audio input using the first microphone, send stop instructions to a second electronic device with a second microphone, the second electronic device external to the first electronic device, wherein the second electronic device is configured to respond to the audio input received using the second microphone, and

wherein the stop instructions instruct the second electronic device to forgo responding to the audio input received using the second microphone, wherein responding to the audio input received using the second microphone comprises providing perceptible output.

2. The non-transitory computer readable storage medium according to claim 1, wherein the non-transitory computer-readable storage medium further comprises instructions, which when executed by the first electronic device, cause the first electronic device to:

cease the sampling of the audio input;

in accordance with the ceasing of the sampling of the audio input, send resume instructions to the second electronic device, wherein the resume instructions instruct the second electronic device to resume responding to the audio input received using the second microphone.

3. The non-transitory computer readable storage medium according to claim 1,

wherein the second electronic device is configured to respond to the audio input received using the second microphone by:

sampling the audio input using the second microphone, and

initiating a virtual assistant session in accordance with a determination that the sampled audio input using the second microphone comprises a spoken trigger; and

wherein the stop instructions cause the second electronic device to forgo responding to the audio input received using the second microphone by forgoing the sampling of the audio input using the second microphone.

4. The non-transitory computer readable storage medium according to claim 1,

wherein the second electronic device is configured to respond to the audio input received using the second microphone by:

52

sampling the audio input using the second microphone, and

initiating a virtual assistant session in accordance with a determination that the sampled audio input using the second microphone comprises a spoken trigger; and

wherein the stop instructions instruct the second electronic device to forgo responding to the audio input received using the second microphone by forgoing the initiating of the virtual assistant session even if the sampled audio input using the second microphone comprises a spoken trigger.

5. The non-transitory computer readable storage medium according to claim 1, wherein the stop instructions comprise an indication of the time duration for which the second electronic device is to forgo responding to the audio input received using the second microphone.

6. The non-transitory computer readable storage medium according to claim 1, wherein the second electronic device is configured to:

after forgoing responding to the audio input received using the second microphone in accordance with receiving the stop instructions from the first electronic device:

resume responding to the audio input received using the second microphone.

7. The non-transitory computer readable storage medium according to claim 1, wherein the non-transitory computer-readable storage medium further comprises instructions, wherein the second electronic device is further configured to:

in accordance with receiving the stop instructions while the second electronic device is responding to the audio input from the second microphone, cease responding to the audio input from the second microphone.

8. The non-transitory computer readable storage medium according to claim 1, wherein the second electronic device is further configured to:

in accordance with receiving the stop instructions while the second electronic device is responding to the audio input received using the second microphone, provide an output indicating that the second electronic device is ceasing its response to the audio input from the second microphone.

9. The non-transitory computer readable storage medium according to claim 1, wherein the non-transitory computer-readable storage medium further comprises instructions, which when executed by the first electronic device, cause the first electronic device to:

in accordance with the sampling of the audio input using the first microphone at the first electronic device: determine whether the display of the first electronic device is on;

in accordance with a determination that the screen is on, sample the audio input using the first microphone; and

in accordance with a determination that the screen is not on, forgo sampling of the audio input using the first microphone.

10. The non-transitory computer readable storage medium according to claim 1, wherein the non-transitory computer-readable storage medium further comprises instructions, which when executed by the first electronic device, cause the first electronic device to:

in accordance with the sampling of the audio input using the first microphone at the first electronic device:

53

determine whether a predetermined service is executing in the foreground of the first electronic device; in accordance with a determination that the service is executing in the foreground, sample the audio input using the first microphone; and

in accordance with a determination that the service is not is executing in the foreground, forgo sampling of the audio input using the first microphone.

11. The non-transitory computer readable storage medium according to claim 1, wherein the non-transitory computer-readable storage medium further comprises instructions, which when executed by the first electronic device, cause the first electronic device to:

in accordance with the sampling of the audio input using the first microphone at the first electronic device:

determine whether a predetermined service has been dismissed for longer than a predetermined duration of time;

in accordance with a determination that the predetermined service has been dismissed for no longer than the predetermined duration of time, sample the audio input using the first microphone; and

in accordance with a determination that predetermined service has been dismissed for longer than the predetermined duration of time, forgo sampling of the audio input using the first microphone.

12. The non-transitory computer readable storage medium according to claim 1, wherein the non-transitory computer-readable storage medium further comprises instructions, which when executed by the first electronic device, cause the first electronic device to:

in accordance with the sampling of the audio input using the second microphone at the second electronic device:

sample the audio input using the second microphone when a predetermined at least one processor of the second electronic device is on.

13. The non-transitory computer readable storage medium according to claim 1, wherein the non-transitory computer-readable storage medium further comprises instructions, which when executed by the first electronic device, cause the first electronic device to:

in accordance with the sampling of the audio input using the second microphone at the second electronic device: determine whether the second electronic device is charging;

in accordance with a determination that the second electronic device is charging, sample the audio input using the first microphone; and

in accordance with a determination that second electronic device is not charging, forgo sampling of the audio input using the first microphone.

14. The non-transitory computer readable storage medium according to claim 1, wherein the non-transitory computer-readable storage medium further comprises instructions, which when executed by the first electronic device, cause the first electronic device to:

determine whether the sampled audio input comprises a spoken trigger;

in accordance with a determination that the sampled audio input comprises the spoken trigger, trigger a predetermined service; and

in accordance with a determination that the sampled audio input does not comprise the spoken trigger, forgo triggering of the predetermined service.

15. The non-transitory computer readable storage medium according to claim 2, wherein the non-transitory computer-

54

readable storage medium further comprises instructions, which when executed by the first electronic device, cause the first electronic device to:

at the first electronic device, send the stop instructions or the resume instructions to the second electronic device using a stateless transmission mechanism.

16. The non-transitory computer readable storage medium according to claim 1, wherein the non-transitory computer-readable storage medium further comprises instructions, which when executed by the first electronic device, cause the first electronic device to:

in accordance with sending the stop instructions to the second electronic device, send the stop instructions as part of a transmission addressed to the second electronic device on an electronic communication channel.

17. The non-transitory computer readable storage medium according to claim 1, wherein the non-transitory computer-readable storage medium further comprises instructions, which when executed by the first electronic device, cause the first electronic device to:

in accordance with sending the stop instructions to the second electronic device, broadcast the stop instructions on an electronic communication channel.

18. The non-transitory computer readable storage medium according to claim 3, wherein the spoken trigger comprises a predetermined phrase.

19. The non-transitory computer readable storage medium according to claim 2, wherein the non-transitory computer-readable storage medium further comprises instructions, which when executed by the first electronic device, cause the first electronic device to:

maintain a counter based on device usage conditions, wherein the sending of the stop instructions to the second electronic device comprises:

in accordance with a determination that the counter exceeds a threshold value, send the stop instructions, and

in accordance with a determination that the counter does not exceed the threshold value, forgo the sending of the stop instructions.

20. The non-transitory computer readable storage medium according to claim 19, wherein the sending of the resume instructions to the second electronic device comprises:

in accordance with a determination that the counter does not exceed a threshold value, sending the resume instructions, and

in accordance with a determination that the counter exceeds the threshold value, forgoing the sending of the resume instructions.

21. A method, comprising:

at a first electronic device with a display and a first microphone:

sampling an audio input using the first microphone;

in accordance with the sampling of the audio input using the first microphone, sending stop instructions to a second electronic device with a second microphone, the second electronic device external to the first electronic device,

wherein the second electronic device is configured to respond to the audio input received using the second microphone, and

wherein the stop instructions instruct the second electronic device to forgo responding to the audio input received using the second microphone, wherein responding to the audio input received using the second microphone comprises providing perceptible output.

22. An electronic device comprising:

a display;

one or more processors;

a memory;

a first microphone; and

5

one or more programs, wherein the one or more programs

are stored in memory and configured to be executed by

the one or more processors, the one or more programs

including instructions for:

sampling an audio input using the first microphone;

10

in accordance with the sampling of the audio input

using the first microphone, sending stop instructions

to a second electronic device with a second micro-

phone, the second electronic device external to the

first electronic device,

15

wherein the second electronic device is configured to

respond to the audio input received using the

second microphone, and

wherein the stop instructions instruct the second

electronic device to forgo responding to the audio

20

input received using the second microphone,

wherein responding to the audio input received

using the second microphone comprises providing

perceptible output.

* * * * *

25