

PLUG AND PLAY: ENGINE PROGRAMMERS FOR EXTRA POWER AND MILEAGE

TRAILER LIFE

FOLLOW THE ROAD TO ADVENTURE

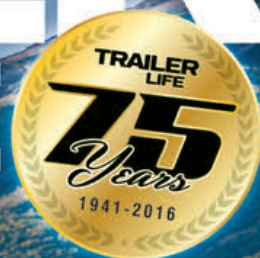

RETURN OF THE WARRIOR

The Iconic Toy-Hauler Brand Reloads

Tough Skin

Pouring on a Durable New Roof

Get the Best Deal

Tips for Buying a Used Tow Vehicle



Beaches and Backcountry

- Wilmington, North Carolina
- Canada's Northwest Territories



FIVE-SLIDE FIVER

◀ JAYCO'S LOFTY PINNACLE

ADVENTURE STARTS HERE.

Bully Dog GT Platinum

GT PLATINUM™ GAS & DIESEL

THE TRILOGY OF POWER

Take advantage of dyno-proven performance tuning, monitoring and diagnostics to gain performance as well as improved safety & fuel economy for your truck. Multiple tuning levels offer multiple levels of support, from trips across town to pulling a camper or trailer. GT Platinum's programming features deliver power and control, while monitoring capabilities ensure confidence in your vehicle. Performance, safety and fuel economy—all in one unit.



GAUGES



TUNING

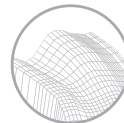

DIAGNOSTICS



> **SHOP ONLINE**
Free Shipping at bullydog.com

Bully Dog Technologies, Circle 104 on Reader Service Card



A full list of vehicle applications available at bullydog.com. All vehicle make/model names and vehicle manufacturer names and related marks are trademarks of their respective owners, which are in no way associated or affiliated with Derive Power, LLC ("Derive"). These trademarks of other manufacturers are used solely to identify the vehicles of those manufacturers with which Derive's products may be used. All other trademarks are the property of their respective owners. THIS PRODUCT IS NOT LEGAL FOR SALE OR USE IN THE STATE OF CALIFORNIA ON POLLUTION CONTROLLED VEHICLES.



26



31



52

FEATURES

20 Weekend Warrior and Ram 2500

The 28W toy hauler and Tradesman-model pickup team up to move a garageful of off-road toys

26 Jayco Pinnacle

The five-slide 38FLSA fifth-wheel lives up to its lofty name

31 Remote and Rugged NWT

An epic expanse of lakes, waterfalls and boreal forest, Canada's secluded Northwest Territories has more than its share of scenic wonders but fewer residents than most visitors' hometowns

Wilmington's 2-mile wooden Riverwalk has a scattering of tasty restaurants and eclectic shops in coastal North Carolina. Page 46

40 Peak Power

Aftermarket engine tuners and programmers can give tow vehicles an extra boost on steep grades and highway on-ramps without sacrificing fuel economy

46 On the Shore in Wilmington

Cloaked in Southern hospitality, North Carolina's historic port town on the Cape Fear River charms visitors with quaint-to-quirky shops and cafés, a historic battleship and a trio of classic beach towns

52 Tough Skin

With its unique liquid-applied, UV-resistant system, RV Armor offers the final solution for RV roof problems



DEPARTMENTS



➤ Venture RV's family-friendly SportTrek Touring Edition is available in five floorplans. Page 12

4 Driver's Seat

Quest for Power

6 Letters

Readers respond loud and clear

11 Around the Bend

News, events, places and trends

16 75 Years of Trailer Life

A tribute to the magazine's long history

18 RV Resolutions

Trailer Life is your referee

58 Hands On

UnderCover SwingCase Storage Box

60 10-Minute Tech

Now why didn't I think of that?

62 New Products

Goodies to improve the RV lifestyle

64 Performance Corner

Buying a Used Tow Vehicle

71 RV Clinic

Answers from the *Trailer Life* tech team

80 Free Travel Information

Help with trip planning

82 America's Outback

Bison in Nebraska

On the cover: The 28W Weekend Warrior and Ram 2500 Tradesman haul all the toys needed for a comfortable getaway. Photo by Scott Hirko

Quest for Power

Performance-seekers no longer have to spend hours turning a wrench or even getting their hands dirty



As a car buff, I always enjoy working on engines. Add in the RV-enthusiast component, and building horsepower to pull the trailer was always paramount. It was therapy or, more honestly, a way to feed my ego at being the first one up steep grades. The baseline was to crest Sherwin Summit, which starts the ascent north of Bishop on California's scenic Highway 395, without dropping below 55 MPH. Not only was this mountain road steep (6 percent), but achieving my target speed was a tall order in the early days. I did get there, but not before building a monster engine for a Ford F-100 truck, which was really entering hot-rod territory.

Only car buffs will understand what it's like to hunker down in engine compartments with components poking holes in your chest. I spent days swapping intake manifolds, adding headers and exhaust systems, and calibrating carburetors, just to improve throttle response and bring a smile to my face. Those of you who can relate to the process will know that any smile was preceded by sneers, moans and groans, and a few choice words.

While I reminisce about working on cars and trucks, the need to build high-performance tow vehicles is pretty much over. Nowadays, trucks and SUVs are powered by engines — right out of the box — that will keep most enthusiasts happy. Diesel engines have become the power of choice for those towing heavier rigs, and the horsepower and torque wars between pickup manufacturers remain vigorous. Getting up many grades at 55 MPH is no longer challenging for owners of late-model diesel-powered trucks.

Performance, though, is still part of the game for trailer owners who have hot-rodding in their DNA. But that game has changed with the advent of an OBD-II port under the dash. What used to take hours, and even days, of wrench turning can be achieved in minutes simply by plugging in a tuner that reprograms the computer. And the power gains are impressive, as described in the guide to tuners starting on page 40.

The beauty of a tuner goes beyond the simplicity of the installation and the fact that you no longer have to get your hands dirty — although that's still a rite of passage for true hot-rodders. Specific horsepower and torque gains can be dialed in based on the weight of the trailer, and many of these devices provide engine monitoring, which was something we used to do by hanging aftermarket gauges. My tools rest peacefully in their drawers much of the time, but some are still used to repair and improve the trailer. 🛠️

— Bob Livingston, publisher

Connect with us...

facebook.com/TrailerLifeMagazine twitter.com/TrailerLifeMag

SUMMER SOLSTICE

This year, June 21 is the Northern Hemisphere's longest day, when the sun reaches its northernmost point and the North Pole tilts toward it. Long days mean more time for outdoor fun in the summer sun while RVing.

Publisher Bob Livingston

Editor Valerie Law

Managing Editor Donya Carlson

Technical Editor Chris Hemer

Senior Art Director Rick Damien

Production Director Bob Dawson

Production Manager Brenda Hutchinson

Sales Administrator Katey Purgatorio

Consulting Editors Wes Caughlan, Ken Freund, Jeff Johnston

Contributors Kristopher Bunker, Rick Elder, Dennis Gaub, Bill Graves, Kevin Livingston, Paula Loehr, Bruce W. Smith, John L. Stein

Vice President National Sales Terry Thompson
847-229-6759

RV Marketplace/Classifieds Katey Purgatorio
847-229-6756, katey.purgatorio@goodsam.com

Advertising Sales/Southwest Sue Seidnitz
530-268-3005, sue.seidnitz@goodsam.com

Advertising Sales/Southeast Kim Whitaker
919-412-6325, kim.whitaker@goodsam.com

Advertising Sales/Northeast Lou Cicirelli
954-297-9234, lou.cicirelli@goodsam.com

Advertising Sales/Northwest Scott Oakes
847-229-6758, scott.oakes@goodsam.com

Advertising Sales/Detroit Scott Crompton, Crompton Holdings, 334-546-7243, scottcrompton@mac.com

Customer Service

Subscriptions (print and digital)
800-825-6861
trailerlife@cdsfulfillment.com

Editorial
info-ll@goodsam.com
www.trailerlife.com



President Mark Boggess

Senior Vice President/Group Publisher Bob Livingston

Vice President/Advertising Sales Terry Thompson

Vice President Ann Emerson



Trailer Life (ISSN 0041-0780) is published monthly by GS Media & Events (a division of Good Sam Enterprises, LLC), 2750 Park View Court, Suite 240, Oxnard, CA 93036. Periodicals postage paid at Oxnard, CA 93036, and additional mailing offices. The annual subscription rate is \$17.97 per year in the U.S. For Canadian and International subscriptions, add \$12 per year. U.S. funds only.

U.S. Postmaster Send address changes to *Trailer Life*, P.O. Box 5860, Harlan, IA 51593-1360.

Canadian Return Address GS Media & Events, 4960-2 Walker Road, Windsor, Ontario N9A 6J3. Publication Sales Agreement 40012332.

Printed in the United States

Trailer Life is a registered trademark of Affinity Group, Inc. Copyright 2016 by Affinity Group, Inc. All rights reserved.

Privacy Promise *Trailer Life* will never intentionally share subscribers' names, addresses or other personal information with other companies when requested not to do so. If you do want to opt out from receiving marketing offers in the mail from other reputable companies, or you opt out and subsequently desire to opt back in, contact *Trailer Life* by mail, phone or email:

Trailer Life Mail Preference Service
P.O. Box 5860, Harlan, IA 51593-1360
800-825-6861, trailerlife@cdsfulfillment.com

This policy applies to postal mail; *Trailer Life* will not send commercial emails to subscribers unless authorized to do so.

A DIVISION OF GOOD SAM ENTERPRISES, LLC

Chairman & CEO Marcus Lemonis

Executive VP Tom Wolfe

AMBITION

The Essence of Luxury

NOW SELLING FACTORY DIRECT!



- FULL-TIMER APPROVED
- RESIDENTIAL MATERIALS
- BUILT FOR 4-SEASON USE
- STARTING AT \$76K!

SCAN FOR
VIRTUAL TOUR
AUGUSTA-RV.COM/3D TOUR



FOLLOW US     



AUGUSTA RV | (844) 848-0200 | AUGUSTA-RV.COM

Augusta RV LLC, Circle 101 on Reader Service Card



Sin City Sweets

In the April issue's "Oasis in the Desert," Elizabeth Daniels mentioned M&M's World and Hershey's Chocolate World on the Las Vegas Strip. For chocolate lovers visiting the Las Vegas area, Ethel M Chocolate Factory in nearby Henderson is a must-see.

Ethel was the matriarch of the Mars family, and her recipes were used to start the now international Mars candy business. The walking tour of the factory winds up at, of all places, a gift shop, where they sell the most beautiful and delicious chocolates we have ever seen and eaten.

We had driven through a lot of desert to get to Henderson, and the plants in Ethel M Chocolate's Botanical Cactus Garden were spectacular in comparison with their undernourished cousins that we had seen for so many miles.

Ed Austin, Newport News, Virginia

Why Did They Do That?

As the owner of a Highland Ridge Roamer 291RLS, I enjoyed "Home on the Open Range," Kris Bunker's April review of the Roamer 288FLR. It's always interesting to read your candid opinions about the good and not-so-good ideas the manufacturers have in their RVs.

Like Kris, we were puzzled about the remote placement of the stereo and DVD in our trailer. It's 180 degrees away from the TV and is a non-Blu-ray Jensen. That was quite a disappointment in a 2013 trailer, particularly since 95 percent

Classic Trailers on a Roll

How about celebrating *Trailer Life's* 75th anniversary with coverage of vintage trailers and rallies? If you need a place to start looking, go to the Vintage Camper Trailers website, www.vintagecampertrailers.com. Not all of your readers are rolling with modern trailers, and vintage rigs are generally better made and built. How about equal time?

Tom Trischler, Orange, California



We're on the same page, Tom. Look for an article in the July issue on that very subject, written and photographed by Paul and Caroline Lacitola, publishers of Vintage Camper Trailers magazine and authors of a new coffee-table book with the same title. The July issue will commemorate Trailer Life's 75th anniversary with a special section chronicling the magazine's long history and the corresponding evolution of RVs. — Editors

of our DVDs are Blu-rays. We had to buy a separate Blu-ray player that I installed above the TV.

The other mistake the designers made was the placement of the thermostat, which is on the wall immediately next to the television. As soon as the TV heats up, the thermostat calls for air conditioning, so we have to set the temperature very high when watching the TV or the air conditioner constantly kicks on and off.

The manufacturers really should spend some time in their RVs.

**Joe Mahonchak
Asheville, North Carolina**

Hitching Up to a Honda Gold Wing

After reading the "North to Alaska" letters in April, I was prompted to

send a recap of our trip. We entered Canada north of Larimore, North Dakota, and headed northwest out of Brandon, Manitoba. After traveling up the Alaska Highway, we stayed in Anchorage, then headed on to Seward. We also went up to Fairbanks, then down through North Pole for a postcard stop. Along the way we saw wildflowers, wildlife and, of course, beautiful scenery. The bus tour of Denali was awesome.

I forgot to mention that the trip was on motorcycles with my sister. I pulled an Aspen Ambassador pop-up trailer (tongue weight: 24 pounds) with a Honda Gold Wing, and she was on her Harley Heritage Softail. We covered more than 10,000 miles in 27 days and camped in the pop-up all but five nights, mainly because of wildlife concerns.

On the route south, we ventured from Yukon to British Columbia on the Cassiar Highway and drove through the Northwest states on our way to Rocky Mountain National Park. If you have not been through this park, it is a must-see.

We are now planning a Route 66 trip — camping, of course.

Donald Mow, Osceola, Indiana

Originally named Open Range and now a division of Jayco, Highland Ridge builds fifth-wheels and travel trailers, including the four-season Roamer 288FLR reviewed in the April issue.



Out-of-Sight Idea

We appreciated Don Frank's "Out-of-Sight Shoe Rack" tip in April's 10-Minute Tech section. This was the first *Trailer Life* issue we received as a gift subscription with our new RV, and the directions for building the shoe rack were just what we needed. Thank you, Don, for such an awesome idea. The shoe rack took no time to make, it works like a charm, and the tip could not have come at a more appropriate time.

Stanley Collins, Chiefland, Florida

Bicycles, Front and Center

"Good-Bye, Bicycles" in the April Letters contained a tale of woe that resulted from mounting bicycles on a rack on the back of a trailer. A few years ago, we were in the market for something that would let us transport bicycles when we are towing our 22-foot trailer, but mounting a rack on the rear of a trailer voids the warranty for most, if not all, major bike racks.

From my research, it appears that the manufacturers basically prohibit this for two reasons. First, the bikes and rack are subject to extreme vibrations that can lead to them falling apart (especially on trailers without shock absorbers), and second, it can damage the trailer (this is especially the case with small trailers that have lightweight frames). Another consideration is that the driver can't see bikes mounted behind a trailer and may not know when things go wrong.

Our solution was a front-mounted receiver hitch for our Toyota 4Runner combined with a hitch-receiver bike rack. The bikes ride on the front whenever we are towing. When mounting them on the rack, I make a point of lowering the seats and handlebars so they are not in the driver's line of sight, and we don't cover the headlights and turn signals.

You can find front-mounted hitch receivers for many trucks and SUVs. Although some folks claim that mounting a bike rack on the front is against the law, we have driven from Pennsylvania to Florida and back

without incident, and we see many others doing the same.

**Mike Schnierle
Mechanicsburg, Pennsylvania**

State laws prohibit objects on vehicles that obstruct the driver's view or block the license plate, headlights or turn signals, and some jurisdictions don't allow anything to be mounted up front to protect pedestrians. If front-mounted bicycles are legal where you

live and travel, make sure the bikes and rack are mounted securely, the driver has a clear view of the road, and the front plate and lights aren't covered. — Editors

Switching Hitches

I'm writing concerning the letter from Ron Callahan in the April issue's RV Clinic. I've been using the Andersen Ultimate 5th Wheel Connection hitch for several months



LookUp
-Our-Skirts.com
Powered by **ICON**

Holding Tanks

A/C Shrouds

Skylights

ICON
Aftermarket *Specialty* Products
Available Nationwide
www.icondirect.com
1-888-362-4266

LETTERS

now and like it a lot better than the conventional hitch I used before. It comes with everything required.

The aluminum coupler block is easy for owners to install over the kingpin with hand tools and a torque wrench capable of 40 ft-lbs. The ball socket in the coupler block is Teflon-coated and requires no grease, at least until it wears off. It has a better ride because the connection is tighter with less

movement between the truck and trailer. I don't have any "chucking" or noise problems. It's easier to hitch up than a travel trailer with a "bumper hitch." The hitch tilts in all directions.

One disadvantage for me with a Ram 2500 with a 6-foot 4-inch bed is that I can't do a 90-degree angle. But it turns sharply enough that I'm keeping it because it has so many other advantages. I'm 65 years old and can install and remove the 40-

pound hitch myself with no help.

PullRite has recently come out with a similar hitch. These hitches are definitely different. In my opinion, they have some real advantages, and any disadvantages are minor.

Jim Harrison, Grove City, Ohio

Happy Campers

We just wanted to say how pleased we are with the great service we received from Dexter Axle after we made a claim regarding problems on our 2015 Fox Mountain fifth-wheel. The matter was handled quickly and efficiently, and we would happily do business with Dexter again and recommend the company to others, should the need arise.

**Virgil and Ruth Partridge
Nehalem, Oregon**

I would like to share our recent experience with Adventurer LP (ALP) and Duncan Industries, and recommend both companies to *Trailer Life* readers.

I own a 2013 Eagle Cap 1165 truck camper manufactured by ALP. It was originally equipped with a rear convertible couch. In 2014 and subsequent models, theater seats were offered as an option in lieu of the couch, and they were more desirable for our use.

Duncan Industries manufactures the theater seats for ALP, and we contacted the company about getting them for our camper. Duncan matched our decor pattern, which is not available in current models, and shipped the seats to the ALP factory in Yakima, Washington, with another scheduled shipment.

The staff at the ALP factory was extremely helpful. They installed the seats for a reasonable amount, charging just the hourly labor fee for the time expended. Thanks to both companies, we are happy campers.

Greg Helsel, Wilder, Idaho



TRANSFER FLOW FUEL TANKS

MORE FUEL. MORE FREEDOM.

Long distances, harsh elements, and fluctuating fuel prices are just some of the challenges you and your truck face. Be ready with a range-maximizing fuel tank system from Transfer Flow.

When your truck can tow a 22,000 lb. trailer across the country without breaking a sweat, don't compromise the performance or quality of your fuel system with a lightweight plastic container. Transfer Flow fuel tanks are made from high quality American-made aluminized steel and aluminum diamond plate.

To find the fuel tank that best fits your needs, call or visit our website at transferflow.com. Spend time less time at the pump, and more time on the road!



IN-BED AUXILIARY FUEL TANKS



TOOLBOX AND REFUELING TANK COMBOS



LARGER REPLACEMENT FUEL TANKS

tfi **TRANSFER FLOW, INC.**
The Leader in Aftermarket Fuel Tank Systems™

We Fuel Your Adventures.™



1-800-826-5776

www.TransferFlow.com



TALK TO US! Write to: *Trailer Life*,
2750 Park View Court,

Suite 240, Oxnard, California 93036 or
email info@trailerlife.com. Please include
your full name and location.



Flo doesn't personally cover your RV, but we do.

Progressive is America's #1 specialty RV insurance provider.
From motor homes to camper vans and travel trailers, we've got you covered.

PROGRESSIVE

1.800.PROGRESSIVE / PROGRESSIVE.COM

Progressive Insurance, Circle 131 on Reader Service Card

Progressive Casualty Ins. Co. & affiliates. Insurance prices and products are different when purchased directly from Progressive or through independent agents/brokers.
No. 1 in specialty RV insurance from 2013 Millward Brown national survey data.

SPF1000

More fabrics. More choices. More style.



Carefree's vinyl, solid color fabrics



- ▶ 13.5 oz. vinyl fabric
- ▶ No waiting! Fastest fabric or DIY Replacement
- ▶ Sealed edge, no stitching
- ▶ Replaces up to a 25' awning (24'-2" fabric size)

Carefree's standard and custom woven acrylic fabrics



- ▶ Minimal fading – color can't be washed out
- ▶ Easy to maintain – no mold, mildew or deterioration
- ▶ Hemmed and stitched edging
- ▶ Available with FLXguard or metal wraps

Carefree vinyl fabrics: Dune Stripes and Shale Fades

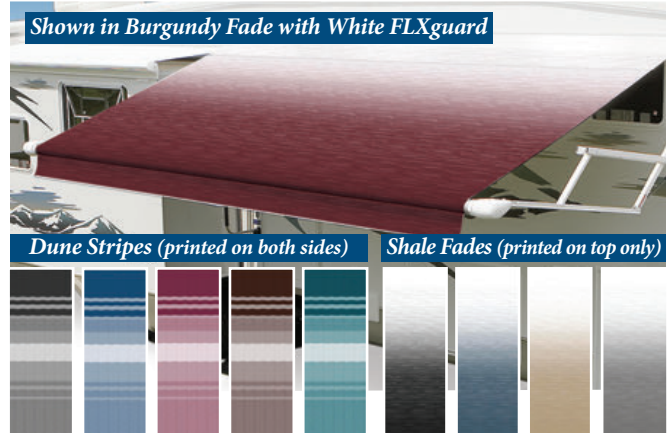

- ▶ 13.5 oz. vinyl fabric
- ▶ Greater durability than other awning brands
- ▶ Hemmed and stitched edging
- ▶ Available with Weatherguard, FLXguard or metal wrap

Carefree's premium vinyl fabrics

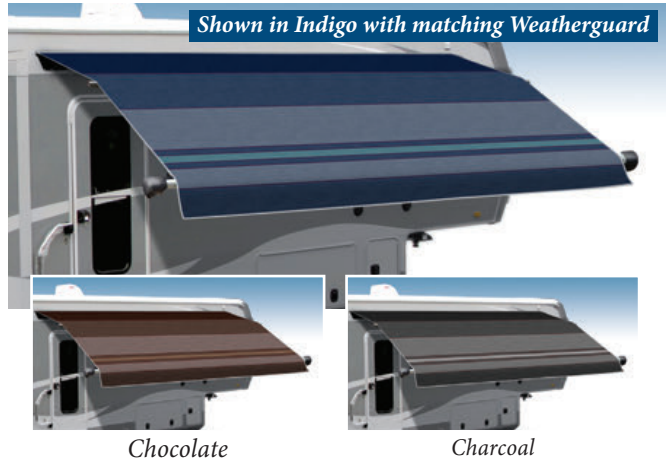

- ▶ Heavier, more robust 15 oz. vinyl fabric with printing on top and bottom
- ▶ Industry best 10 year warranty!
- ▶ Double-hemmed, double-stitched with Gore Tenara thread
- ▶ Available with vinyl Weatherguard, FLXguard or metal wrap

Tell your dealer to "Make it Carefree!"

Quality • Value



Performance • Style

Carefree of Colorado, Circle 105 on Reader Service Card



(From far left) Talk about a shotgun wedding: A couple married in 2001 at Bannack Days renews their vows at the 2015 event during the high-noon shootout. Jake the barber gives a customer a make-believe shave and a haircut.

Bannack's Glory Days

Every July, the site of Montana's first major gold discovery takes a step back in time to celebrate the Old West

article and photos by Dennis Gaub

If you're heading to Yellowstone or Glacier national park in July, consider spending a day or two at an annual celebration of Montana's pioneering past. This year marks the 40th anniversary of Bannack Days, a two-day event that gives visitors to Montana's first territorial capital a chance to envision the town in its gold-rush heyday.

Bannack sprang into existence in 1862. That's when a group of Colorado gold miners, the Pikes Peakers, as they were called, struck pay dirt on the banks of Grasshopper Creek. The first major gold discovery in Montana caused fortune-seekers to swarm into the high-mountain valley. Bannack's population swelled to 3,000 in the spring of 1863, reportedly peaking

at around 10,000, and it became a true town when a post office was built later that year.

Bannack's challenges grew with the arrival of Henry Plummer. A former California prison inmate who served time for manslaughter and escaped the state with the law on his tail, Plummer was elected Bannack's sheriff. People yearning for civility in the lawless locale awarded Plummer a badge, but most didn't know that it cloaked his real occupation: leader of an outlaw gang known as the Innocents that robbed and murdered miners entering and leaving Bannack with their gold bounty.

The Innocents' scourge quickly ended, thanks to formation of the

town's Vigilance Committee. Its members, the Vigilantes, tracked down and hung several members of the Plummer gang. The ringleader's turn for a trip to the gallows came on January 10, 1864.

That history of riches and rogues is celebrated the third weekend of July during Bannack Days. The 2016 festivities take place July 16 and 17, and include demonstrations of pioneer skills such as wool spinning and quilting. Visitors can learn how baskets and wagon wheels were made, shoot a black-powder rifle, hand-dip a candle, see a blacksmith in action, take a ride in a horse-drawn wagon and pan for gold. And, of course, watch out for gunfights, as a few staged ones are sure to erupt on Main Street.

Bannack Days

406-834-3413, www.bannack.org

Bannack State Park

Two campgrounds in the state park offer dry camping with picnic tables and fire rings. Wi-Fi is available. 855-922-6768 www.stateparks.mt.gov/bannack



Bannack's old mill, where gold was extracted from ore being sent to a smelter. Visitors can see the inside by guided tour only.



Low Cost Life Insurance for Good Sam Members

SAVE 70% ON PERMANENT WHOLE LIFE PREMIUMS

Compare \$100,000 policy on our best male monthly rates:

AGE	\$100,000
55	\$90.05
65	\$138.50
75	\$206.30

Guaranteed Level Premium
Minimum issue \$50,000

More information at www.ipm1.com/gs

or call for a fast quote!
877-572-4889



SportTrek: In It for the Long Haul

Venture RV introduced a new line of light-weight travel trailers, the SportTrek Touring Edition, in five floorplans. Unloaded vehicle weights range from 7,150 pounds on the 31-foot 9-inch STT280VRB with two slides to 8,515 pounds on the three-slide, 37-foot 8-inch STT343VIK.



The family-friendly trailers all have a 40-gallon freshwater tank, an 8-cubic-foot refrigerator and a 6-foot 10-inch ceiling height; sleeping can accommodate from four to 10. Features such as the six-process painted fiberglass front cap and two fireplaces are upgrades unique to the Touring Edition, according to the manufacturer. Most of the floorplans include a king bed with a Sleep Tight memory-foam mattress and reversible quilted comforter in a 6-foot-high slideout.

Inside, a three-burner range, a stainless-steel sink with a high-rise pullout faucet, wood-plank linoleum flooring, hand-glazed hardwood cabinet doors and residential carpeting make the whole family feel right at home. On the outside, four floorplans include the CampFire Café with a two-burner cooktop, a refrigerator and a sink (with hot water), plus a Bluetooth DVD/CD/AM/FM/MP3 entertainment center and a 40-inch LED HD theater TV with two speakers.

The SportTrek Touring Edition 336VRK boasts lay-flat theater seating and/or a trifold residential sofa. The 302VBH includes a double bed over another double bed in the back and a walk-around king bed in a slide up front that's separated from the living area by an entertainment center.

All Touring Edition models have tinted, frameless windows, slam-latch baggage doors with magnetic catches and four-point power stabilizer jacks with independent motors. MSRPs start at \$33,999.

Venture RV, 888-988-8440, www.venture-rv.com

Firestone
AIR BAG KITS

ELIMINATE SUSPENSION SAG
FREE SHIPPING | LOW PRICES

TS MICHIGAN TRUCKSPRING
SUSPENSION & BRAKE SPECIALIST +
1-800-358-4751 | www.TruckSpring.com

Southern California Beer and Chili Festival

Temecula, California's Pechanga Resort and Casino is once again hosting a festival to benefit Habitat for Humanity. The eighth annual Pechanga Microbrew Festival and Chili Cook-off takes place June 11 in the resort's Grand Ballroom. For the price of admission, enthusiasts can taste unlimited samples of more than 100 beers from craft and small-production breweries.



Ticket-holders also enjoy live music by two bands and limitless tastes of eight varieties of homemade chili, fired up by award-winning Pechanga chefs. Proceeds from the event's silent auction will go to Habitat for Humanity, which has built more than half a million houses worldwide, sheltering more than 2 million people.

General admission is \$50 for entry from 1 to 5 p.m. VIP tickets are \$65 and allow pass-holders entry at noon. Designated-driver tickets are available for \$30.

The adjacent Pechanga RV Resort has 168 campsites with picnic tables, a fenced pet area, a party pavilion and a neighboring golf course.

Pechanga Resort and Casino, 877- 711-2946, www.pechanga.com

Soar to New Heights in Denali

Touring Alaska is the ultimate experience for many RVers. Now the thrill level of visiting Denali National Park and Preserve has gone up a notch with a newly constructed zip-line course just outside the park's boundaries. Riders soar along cables through boreal forest and fly side-by-side on dual-racer zip-lines. The tour lasts three hours and takes adventure-seekers on eight zip-lines and six suspension bridges that cover half a mile, all while giving spectacular views of the stunning wilderness near the park's entrance.

The zip-line tour costs \$139 for adults and \$99 for children.



Denali Park Zipline, 907-683-2947, www.denalizipline.com

Denali National Park and Preserve

Three of the six national park campgrounds welcome RVs at primitive campsites with no hookups. A limited number of sites accommodate RVs up to 40 feet. 800-622-7275, www.nps.gov/dena/planyourvisit/campgrounds.htm

NEWSWIRE: INDUSTRY NEWS



Expansion Plans for Highland Ridge

Highland Ridge RV, a subsidiary of Jayco, plans to invest \$5.68 million to build a 92,000-square-foot facility on its current campus in Shipshewana, Indiana. The new building will allow the company to double production of its lightweight trailers sold in the United States and Canada.

Highland Ridge currently employs more than 330 full-time workers and plans to begin hiring more in August. The manufacturer claims it is committed to building high-quality towable RVs that have more room and less weight than competing products.

According to Randy Graber, president of Highland Ridge, "We knew that we wanted to stay in LaGrange County due to the highly skilled workforce that possesses a strong work ethic. We are excited about the growth we foresee for the company and our many current and future employees." The company plans to create up to 65 new jobs by 2019. www.highlandridgerv.com



Grand Design Opens New Plant

With a new 65,000-square-foot service/PDI facility up and running and plans for additional production capacity in the near future, Grand Design RV intends to expand its workforce through 2016 and beyond. Grand Design, based in Middlebury, Indiana, currently has more than 760 employees. The company manufactures fifth-wheels, travel trailers and toy haulers.

"Our employees are our most important asset and are critical for Grand Design's continued success," said Don Clark, CEO and co-owner of the company. "We rely on our people to help ensure that our dealer partners and retail customers have the best possible ownership experience.... As our company continues to grow at a record-setting pace, we have been very fortunate to attract the best of the best when it comes to our workforce, and I am so proud of our team and the accomplishments that they have made possible." www.granddesignrv.com

REMOTE CONTROL Trailer Positioning



"The Purple Line unit moves our trailer across the driveway, handling the incline nicely, and allows me to put it right where I want it. I don't get to use it much anymore as my 9 year old grandson says it's his job to hitch and unhitch the trailer... And he does it all by himself!"



All With One Effortless Touch!

- ✓ Eliminate Blind Spots
- ✓ Simplify Hitching
- ✓ Get Into Impossible Spaces
- ✓ Maneuver Around Driveway



SEE THE VIDEO AT:
www.purplelineusa.com

purpleline[®]
design...innovate...improve



◀ Revel in the view: The Sedona area's network of red-rock trails and breathtaking scenery is a hiker's delight. Here, a family gazes out from Schnebly Hill Road.

simply marveling at the multihued rock monoliths for which the area is known.

At Slide Rock State Park, the whole family can plunge into cool water from a natural sandstone waterslide. Less than 30 miles from Sedona is the historic copper-mining town of Jerome, once known as the wickedest town in the west. The region is also celebrated for its wine trail. Other points of interest are Cathedral Rock, Red Rock State Park and Oak Creek Canyon.

Sedona Chamber of Commerce

800-288-7336, www.visitsedona.com

RV Camping

Distant Drums RV Resort

877-577-5507, www.ddrvresort.com

Rancho Sedona RV Park

888-641-4261, www.ranchosedona.com

Sedona's Red-Rock Sensation

Regarded by Native Americans as a sacred place, Sedona, Arizona, offers something for everyone in the family. With shops, restaurants and galleries galore, the artsy town is surrounded by almost 2 million acres of national forest

land. Visitors and locals enjoy hiking, biking, fishing, hot-air balloon rides, horseback riding, bouncing around in Jeeps on dirt trails, and exploring petroglyphs and cliff dwellings at the ancient Palatki ruins, not to mention

IT IS NOT A MATTER OF OPINION... IT'S **SCIENCE**

The **STABLELOAD** Suspension Stabilizer from Torklift performed up to 60% better than the other aftermarket suspension options.

While dramatically improving safety and handling, StableLoad also has the ability to return to your comfortable factory ride in seconds with its quick off/on feature

Upper Overload

Lower Overload

Lower degree of inclination means a more stable ride

Take back control of your vehicle

Side-to-Side Sway

Suspension Type	Degrees of Inclination
Factory Suspension	150°
Airbags	60°
Shocks	50°
Swaybar	50°
Rubber Springs	45°
Rubber Bump Stop	35°
StableLoad Suspension Stabilizer	30°

StableLoad #1

Body Roll

Suspension Type	Degrees of Inclination
Factory Suspension	30°
Airbags	30°
Shocks	35°
Swaybar	25°
Rubber Springs	35°
Rubber Bump Stop	35°
StableLoad Suspension Stabilizer	20°

StableLoad #1

888-908-0322
torklift.com/trailerlife

TORKLIFT INTERNATIONAL
OVER 40 YEARS OF INNOVATION, QUALITY, SAFETY.



Airstream Acquires Nest Caravans

Airstream, a subsidiary of Thor Industries and manufacturer of the iconic "silver bullet" travel trailer, recently acquired the assets of Nest Caravans. A Bend, Oregon, start-up founded by designer Robert Johans, Nest builds compact travel trailers that appeal to customers who enjoy the outdoors.

The move is part of Airstream's growth strategy to expand its products to the molded-fiberglass segment of the industry to provide incremental growth and attract customers looking for a travel trailer that is light and modern and has automotive styling. Airstream says it will apply the same quality, durability and innovative engineering to Nest towables that it has to its own travel trailers.

Said Airstream's president, Bob Wheeler, "We've been imagining a small, well-thought-out fiberglass travel trailer for quite some time and are very confident about its potential. Nest is a product that conveys sophistication, simplicity and upscale modernity, so it made sense for us to partner and help bring this design to market."

According to Nest's Johans, "Our intent has been to introduce real innovation and quality to the light-weight travel-trailer-market segment. We are delighted to have Airstream embrace our vision."

Airstream has been in business for 85 years and is the longest-tenured travel trailer manufacturer in America.

Airstream
877-596-6111
www.airstream.com

Trailer Sway Control only DAMPENS trailer sway

Eliminate trailer sway completely!

Hensley® Towing Systems are
**Guaranteed to
Eliminate Trailer Sway.**
Call one of our Towing Specialists today
and ask which Hensley® is right for you.



Keep your family safe.

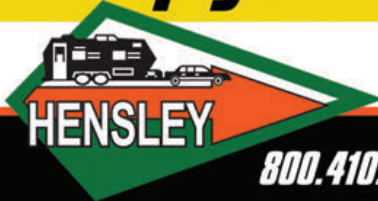

Call or visit us online **Free Video**

800.410.6580 • www.HensleyMfg.com

Continental Coach Luxury 5th Wheels *There is nothing else like it...*



See the difference at www.forksrv.com/continental

LUXURY - PERFORMANCE - TECHNOLOGY

FORKS RV INC. 11280 US 20 SHIP SHEWANA, IN 46565

PH: 574-825-7467



Hensley Manufacturing Inc., Circle 115 on Reader Service Card

Continental Coach by Forks RV, Circle 106 on Reader Service Card



Utah Deer Sams: Going above and beyond.

RAISING THE BAR

Good Sam's Chapter of the Year takes service seriously

Each year since 1975, the Good Sam Club has singled out one chapter that exemplifies the Good Samaritan spirit, and 2015 was no exception. Five judges based their scoring on last year's volunteer hours, charitable donations and other philanthropic pursuits. After the scores were tallied, the club presented its 2015 Chapter of the Year award to the Utah Deer Sams.

But they didn't stop there. Firing up their grills, members cooked hot dogs at the annual Halloween party to benefit Rise, a nonprofit organization that provides services for adults and children with developmental and other disabilities.

Throughout the year, the Utah Deer Sams also found time and funds to support their state's Good Sam Club organization. At the 2015 Utah Good Sam RV Rally at the Juab County Fairgrounds, the chapter organized the Crazy Golf tournament and the Theme Parade, judging the parade floats and making sure both activities ran smoothly.

Music producer Quincy Jones once said, "Imagine what a harmonious world it could be if every single person, both young and old, shared a little of what he or she is good at doing." For 2015's Chapter of the Year, those are words to live by.

Chapter of the Year Honorable Mentions

- ▶ Phoenix Phun Phinders: East Phoenix, Arizona
- ▶ Trail Blazing Sams: Tampa Bay, Florida

The Good Sam Club has more than 1,200 regional chapters of RVing families that get together for good times and good deeds. Joining or starting a chapter is a great way to meet people who share your interests and make a difference in your community. www.goodsamclub.com/chapters

FROM STITCHING SUPERHERO CAPES TO RAISING CASH, THE UTAH DEER SAMS USE THEIR SKILLS TO HELP LOCAL CHARITIES.

Based in Orem, Utah, the winning chapter provided more than 21,000 hours of volunteer service in 2015, and collected money and donated goods with a combined value of more than \$23,000. Putting their creative talents to work last year, members donated 136 homemade blankets, 49 hand-stuffed animals, 67 knit hats and 108 pillowcases to an assisted-living community and shelters for the homeless and victims of domestic violence and child abuse. Members also stitched 36 superhero capes to help make young patients feel special at the Utah Valley Regional Medical Center.

Remember the old saying "The train is leaving the station"? The Utah Deer Sams take this to heart. Each year the chapter volunteers at the Heber Valley Train Pull for Special Olympics where locals attempt to pull a 178-ton locomotive 30 feet in a fundraiser for the Law Enforcement Torch Run. Members set up, kept score and served as official timers at the 2015 event.



◀ Nicholas Barber (left) and his new Coleman.

Golden Giveaway

The first instant winner of a Coleman 262BH travel trailer in this year's Camping World and Good Sam Golden Giveaway is Nicholas Barber from Roscommon, Michigan. Barber received his scratch-off ticket after making a purchase at the Houghton Lake, Michigan, Camping World SuperCenter.

As part of the 50th anniversary

celebration for Camping World and Good Sam, four more 2016 Coleman trailers, valued at \$18,000 each, are yet to be given away to lucky scratch-card holders, along with \$5 million in free camping at Good Sam Parks and the grand prize of a 2016 Thor Windsport Class A motorhome worth \$140,000.

In addition to the Golden Giveaway sweepstakes, which continues through September 11, monthly events and July's big birthday celebration commemorate the 50-year milestone at Camping World all year long.

www.campingworld.com/goldengiveaway

GrillFest

Good Sam Club members can take advantage of sizzling savings with four-day-only specials at Camping World during GrillFest, sponsored by Coleman, May 19 through 22. On May 20 and 21, the first 50 customers at each location will receive a free grill lighter, and shoppers can enjoy free lunch from 11 a.m. to 1 p.m. Sale pricing on grills and grilling accessories continues through May 29.

www.campingworld.com/stores



DO YOU KNOW an RVing Good Sam Club member or couple who supports worthy causes or otherwise serves their community in a big way? If so, please take a few moments to nominate them for the 2016 RVer of the Year award. You can even nominate yourself and in the process promote your own charitable cause. www.goodsamclub.com/rveroftheyear

Faulty Kitchen Faucet

After waiting four months for the manufacturer to replace the kitchen faucet in his new fifth-wheel, a frustrated *Trailer Life* reader asked RV Resolutions to step in and try to speed things up:

► In May 2015, we purchased a 2015 Open Range 3X, manufactured by Highland Ridge. About three months later, we noticed a problem with the kitchen faucet. There is a button that is supposed to switch the flow from spray to stream, but it does not function properly, and the pressure has weakened because the mechanism is now stuck between the two options. The pressure increases when I push the button but decreases when I am not pushing it.

We believe this fifth-wheel was the one on display at our local RV show and was on the dealer's lot until we purchased it. That gave ample opportunity for many people to play with the faucet mechanism.

At the time we noticed the problem, I contacted the service department at Sonny's Camp-n-Travel in Duncan, South Carolina, where we purchased the fifth-wheel. I was asked to send a photo so the correct faucet could be ordered from Highland Ridge. I did so.

Since then, there has been no contact from the manufacturer. Perhaps you might intervene.

Edward C. Iwanski
Piedmont,
South Carolina

After hearing from Edward Iwanski, RV Resolutions sent a petition to Highland Ridge on his behalf, along with a copy of his original letter of explanation. We later received the following note from Iwanski:

► Sonny's Camp-n-Travel received the new kitchen faucet from Highland Ridge. I am convinced that, had we not contacted RV Resolutions, we still would not have our faucet. Thank you for your assistance.
E.C.I.



Tied-and-True Truck Camper

When a Colorado couple replaced their truck camper's new tie-downs in the interest of safety, they asked RV Resolutions to help obtain a partial refund for the installation fee:

► In September 2015, we purchased a used Lance truck camper from Rich and Sons RV Headquarters in Grand Island, Nebraska. The price included installation of the camper on our 2015 Chevrolet Silverado 2500 HD pickup. We assumed the installation would be stable and not cause any damage to the truck.

When we returned home, we stopped to talk to our mechanic. He recommended that we take the pickup and the camper to an RV dealer to have the tie-downs checked, because in his opinion the ones the dealership used were not adequate and could damage the side walls of the pickup.

We drove the camper to two different RV dealers, and the opinions of their service technicians were the same as our mechanic's. In fact, one technician went so far as to tell us we should park the vehicle until we could have the tie-downs replaced.

We have since upgraded the tie-downs to a system recommended by the technicians and have asked Rich and Sons to refund \$400 of the \$600 installation charge. Rich and Sons has offered \$250, stating that this is the cost of the tie-downs. We don't think \$250 is a fair amount.

George and Elissa Deaton
Red Feather Lakes, Colorado

THE COMPANY RESPONDS

RV Resolutions contacted Rich and Sons RV Headquarters to convey the Deatons' complaint and try to resolve the problem. The dealership's marketing manager sent the following response:

We mailed the Deatons a check for \$400, as they requested, and they cashed it soon after. I am enclosing a copy of the check for proof of the resolution.

If you need anything further, please let me know.

Sarah Chavez
Rich and Sons RV Headquarters
Grand Island, Nebraska 📧

NEED HELP? » RV Resolutions is a forum for the settlement of conflicts between consumers and RV dealers and manufacturers, accessory suppliers and service providers. After exhausting all other resources without success, please send a typed letter to *Trailer Life* RV Resolutions, 2750 Park View Court, Suite 240, Oxnard, California 93036. Include copies of appropriate bills and correspondence as well as a self-addressed, stamped envelope.



Opening May 2016



OUR RESORT HAS A NEW RESORT

Come discover fun and excitement, in the shade of the Palomar Mountains.

The new Pala Casino RV Resort offers comfort, fantastic amenities, and unbelievable views. And it's just a short shuttle ride away from the four-diamond luxury of Pala Casino Spa and Resort.

100 Full-Service Sites with Grass Lawns & Picnic Tables

- 77 - 20'x55' Back-In Sites
- 06 - 20'x60' Luxury Sites with Barbecue Grills
- 17 - 20'x70' Pull-Through Sites
- 20-30-50 Amp Power
- Electric, Water and Sewer Hook-Ups
- Free Wi-Fi
- Cable TV
- Restrooms and Showers
- Key Card (for access to pool, laundry and restrooms)
- Security Patrol, 24 Hours
- Propane Fuel Available
- Free Shuttle to Casino

Luxury Resort

- Heated Swimming Pool
- 2 Spas

Indoor Amenities

- Games, Billiard Table, Card Tables
- 3 Flat-Screen TVs
- Laundromat

Outdoor Amenities

- 5 Barbecue Grill Areas
- Table Tennis
- Horseshoe Pit
- Fenced Dog Park

For Additional Charge

- Clubhouse with 2 kitchens
- Laundry - Open 24 Hours
- 3 Pets per RV (\$5 per pet - 7-Day Restrictions Apply)
- Early Check-In/Late Check-Out (based on availability)



So Many Ways To Win™

For reservations: **1-844-4PALARV (1-844-472-5278)**

Pala RV Resort: 11042 Hwy 76, Pala, CA 92059

PalaCasino.com

Located in Northern San Diego County.

From San Diego County & Riverside County: Take I-15 to HWY 76, go east 5 miles.

From Orange County & Los Angeles County: Take I-5 South to HWY 76, go east 23 miles.

A Bigger, Better Getaway

The Weekend Warrior 28W and Ram 2500 Tradesman team up to move a garageful of off-road toys



Talk about a gateway drug. One hour on a little trail bike at 15 years old put the hook in me for a lifetime of dirty adventures. Starting with an unassuming 90cc scrambler, the passion soon turned into a 250, a motocross racer, and then, well, you know how it goes. And so today, the obsession has expanded to multiple bikes, piles of gear, friends and family — and the need to carry it all. The final straw this spring was the addition of a Polaris RZR XP Turbo side-by-side, on loan for a week.

Carrying four motorcycles, an off-road vehicle and a week's worth of gear, fuel and supplies is no easy task for an ordinary pickup and trailer, especially when the destination is miles removed from anywhere and the conditions can range from Dust Bowl-quality grit, rain or snow to wind, wind, wind. We needed a big space, a condominium's worth of storage and almighty torque to pull it all up a nearly mile-high mountain grade.

Fortunately, Weekend Warrior, the toy hauler credited with starting the fad for trailers that could pack motorized equipment, is back in production, and the 28W model — a 33-footer costing \$39,999 and offering a main storage

area measuring over 11 feet by 8 feet — is plenty big to fit the Polaris two-seater plus a couple of bikes. With food and cookware stashed in the cabi-

nets, the generous combined fridge/freezer stocked with volatile teen beverages that should have "Warning: Nitro!" and "Not Mom Approved!" emblazoned on the cans, and our riding-gear bags, well, riding in the master bedroom, the trailer promised the perfect solution. But weighing 7,950 pounds empty and closer to 12,000 pounds full of water, gasoline for the onboard fuel station and generator, and our toys and gear, the 28W would take some muscle to move.

This was satisfied by the Ram 2500 Tradesman, a nonsense 6.4-liter Hemi Crew Cab 4x4 rated at 12,650





The Weekend Warrior 28W is a model of space efficiency. Interior seating (left) includes one large and two smaller couches, twin easy chairs and dual removable tables. The well-appointed kitchen (center) includes a three-burner range and 1,000-watt microwave, while the roomy bathroom (right) has a walk-in shower.

pounds towing capacity and priced at \$43,435, as equipped. Although an 8-foot bed is ideal for motorcycles, we found that with creative loading techniques (one bike frontward and one bike backward, with both angled sideways), the 6-foot 4-inch standard bed in the Tradesman would fit two dirt bikes with the tailgate closed — barely. The Ram's coated bed is a great addition to any pickup. It not only offers a nonskid surface, but the inevitable scuffs that come from use just aren't visible.

Fully packed, we took our first tentative steps — or rather miles — along the Los Angeles freeway corridor. The Ram's pulling power is impressive, even with nearly 500 pounds riding in the bed and another 6 tons behind. The six-speed automatic transmission shifts smartly to keep the engine in its power band, while a tow/haul feature reduces gear hunting on grades. An adjustable electronic trailer-brake controller, integrated into the instrument panel, allows manually activating additional braking as needed. An electronic sway controller on the trailer, made by Tuson, helps deal with crosswinds, turns and road irregularities that can introduce yaw (sway) at highway speeds, while a weight-distributing

hitch keeps the combo on a level plane.

There is an old highway grade north of L.A. called the Grapevine for good reason: the road winds like a grapevine as it climbs to Tejon Pass. Most of that road has been replaced by the significantly straighter Interstate 5, which still ascends from 1,000 feet all the way up to 4,160 feet at the summit, and the relentlessly long incline and 100-degree temperatures during summer pose a challenge to tow vehicles. The Tradesman digs into the task, downshifting to third gear and climbing toward the Hemi's 4,000-RPM torque peak. While the instant MPG readout plummets during this most challenging part of our trip, the truck averages more than 9 MPG for the duration, in keeping with other tow vehicles doing similar workloads.

In two hours, we arrive at Gorman's Hungry Valley OHV park, a 19,000-acre state recreation area for off-pavement activities. Aside from a few latrines, there are no services here, so everything you need you have to bring in. We arrive at sunset and shift into 4x4, as we pull off the main road and onto the sandy campground-access trail, and finally park adjacent to our buddies. Fortunately for them, the trailer's wide profile blocks a stiff north wind.

With two latches unlocked and released, the 8-foot-wide tailgate swings down to reveal the suite of off-road toys. The exterior lighting switches on from an inside panel, with three LED arrays on the right side and three more above the rear door, throwing a bright swath of light as darkness descends and we unload two bikes and the Polaris. They roll sweetly down the inclined tailgate onto the California dirt. The last bit of exterior work is to manually lower four corner jacks to stabilize the trailer.

With the wind bringing a nighttime chill into camp, we quickly lift the spring-assisted trailer tailgate — it's a reasonable one-person job, but two makes it easier — secure the latches and then move inside to prepare for the night. Out comes the carpeting, which we had rolled up and stored in the bedroom. It's a big fitted piece with trimmed holes for the twin tables. The tables' stanchions screw into the floor, and the tabletops, which we had also stored in the bedroom, snap on in seconds, readying the room. One thing we left at home was the 28W's pair of free-standing easy chairs, choosing instead to fill the floor space with vehicles. While we gave up seating for two, this

Flexibility is the name of the game in seating and sleeping. Choose maximum seating capacity (right), flip down two backrests to create a lower-rear bed arrangement (center), or lower another queen bed (far right). Both beds can be raised electrically to enhance storage.



was easily resolved by using the three fold-down couches mounted on the toy hauler's walls.

Aside from fixing dinner, all that remained for the evening jobs was to prepare the beds. Among more than a dozen switches on the nicely self-explanatory main panel is a simple toggle for moving the bed up and down. Stacked together at the rear of the ceiling, twin convertible couches and the big upper bed descend via a motorized, chain-driven mechanism, automatically stopping in the correct position. Flipping various seatbacks down gives the Weekend Warrior an eight-person sleeping capacity, more than enough for us.

The transition from storage room to living and bedroom areas requires a few minutes at most and takes the work out of getting the trailer shipshape and leaving more time for fun. With the wind now howling outside, we scanned through the signal-seeking Furrion audio system and miraculously found an all-1980s music station. Didn't even know such a thing existed! However awkward much of the '80s were stylistically, some of the music is actually holding up really well. Go, Eddie Money! The sound system can pipe the tunes outside as well, so along with mood lighting (and hot and cold shower hook-ups), you can take your party outside or inside, depending on the environment. On this night, we stayed put inside.

High points for the Weekend Warrior include intuitive design for

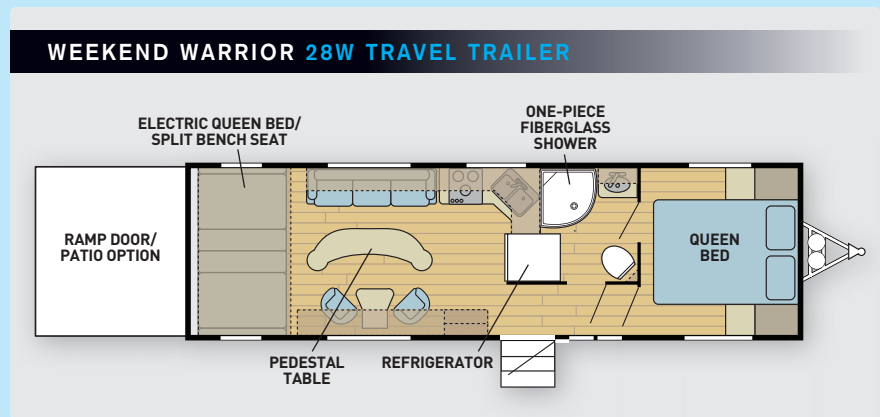

all switches and gauges, a robust heating and air-conditioning system, a 32-inch flat-screen TV with a DVD player, electric starting for the generator, a convenient onboard fuel station, a quick-working water heater, a powered awning and — not that dirt bikers would care — a large bathroom complete with a walk-in shower and designer sink and vanity. Capacities include 140 gallons of freshwater, 50 gallons each of black and gray water, twin 5-gallon LP-gas cylinders, 40 gallons of fuel-station gasoline, and 18 gallons of generator gasoline. Plenty for a week, with careful use.

And so began a comfortable week of dirt-biking and four-wheeling along Hungry Valley's 130 miles of trails. We fell into a routine easily enough: up early, snap on the three-burner gas stove to boil water for coffee, switch off the heater, fire up the generator to top up the batteries, and hop outside to

gas up the bikes and lube chains, while checking in with friends. Deploying the awning takes just moments to shade the morning sun.

Our shortest-range bike goes about 40 miles, maximum, on a tank of gas, and since that's a couple of hours of hard riding, we'd typically return before noontime to relax and refuel ourselves, the bikes and the Polaris. The Polaris offered a totally different take on off-road exploration than the bikes. It's wider, naturally, so it can't go on the single tracks that the bikes can. But it's fast as all get-out and handles the rolling sand washes with aplomb. On the other hand, its four fat tires kick up huge amounts of dust, making riding behind it a blinding experience. Finally, we let the motorcycles go ahead of the side-by-side, giving them the clear air.

Even years ago, my favorite time of the day on dirt-bike trips was after the last ride, when everyone has had their fill, the sun drops and that sweet late-afternoon light appears. There are always stories to tell: who dug them-

Once at your destination, the Weekend Warrior's tailgate first doubles as a loading ramp for your toys, then as a raised patio. At night, it swings up to serve as the trailer's rear wall.



10 

10 million
CYLINDERS IN USE
WORLDWIDE



A MARK OF PASSION

Exploring the world. Dreaming of new places. Waking up to the most epic sunrises. Discovering it all with your loved ones. That's your passion. Right?

Our passion is creating the world's best propane cylinders, so you can fully enjoy your passion. Viking Cylinders are the modern, lightweight alternative to traditional steel propane tanks. Our corrosion-free and translucent design means no rust rings, plus you see exactly how much propane is available. Viking Cylinders are the perfect choice for the RV owner. With over 10 million cylinders in use worldwide you can be sure it's the safest way to enjoy your passion.

WHAT LIGHTS YOUR FIRE? www.vikingcylinders.com/rv

Viking Cylinders is a registered trademark of Hexagon Ragasco AS.



 **VIKING**
cylinders
by HEXAGON RAGASCO



Located at the front of the trailer, the master bedroom (left) features a queen-size bed and numerous cabinets and drawers. Measuring 10 feet long, the two-seat Polaris RZR XP Turbo (right) nested perfectly inside the Weekend Warrior 28W, even leaving room for two dirt bikes.

selves into a sand wash, who climbed which hill and who learned or accomplished something for the first time. Fold out a lawn chair, grab something cold from the fridge, collapse into the shade and kick off the boots, and suddenly the experience transcends from all right to truly great. Of course, such trips with family and friends can take any form you like. I happen to like off-road adventure, but whether it's fishing or hiking, mountain biking or photographing wildflowers, day's end always seems to include shared experiences and friendship.

Over the years I've roughed it

plenty of times for the sake of such adventure, from a tube tent in Washington to no tent in the Mojave, sleeping half-frozen in the Utah snow and on the beach in Baja, and plenty more. While I'll admit suffering can be an adventure in itself, comfort does have its virtues. And on this trip, with all the storage for our dirt toys, all the pulling power, all the creature comforts and all the companionship that the Weekend Warrior and Ram 2500 Tradesman provided, I've decided this is a formula I can handle.

It's not cheating at all. It's just a bigger, better gateway. 🚚

Getting It Done

Products and practices for making off-roading safer, smarter and better



Tie It All Down: Far from the chains, ropes and knots of previous generations, specialized tie-downs now make loading so much simpler. We used traditional cam-buckle tie-downs on the motorcycles, but the big Polaris needed a better setup to control its mass in the trailer. Polaris sells convenient pairs of light-weight Tie-Down Straps, and we used two pairs to secure the RZR with a few swings of the handles. Highly useful for \$19.95 per pair.



See and Be Seen: Nothing startles you like climbing a hill or making a blind turn and coming face to face with another rider. I've had it happen and been with people on the receiving end of such collisions. Polaris smartly makes available a Whip Flag that attaches right to any of its off-road units, lending important visibility that benefits all parties. A good call for \$37.99. 888-704-5290, www.polaris.com



Know Your "20": When Trail A leads over the hills to Trail E, which intersects 3 miles and two gullies later with Trail P, it doesn't take long to get lost. The Garmin Zumo off-road GPS unit (\$599.99 to \$799.99), fitted to one of our bikes, proved helpful, as our exploration grew ever wider. The ability to input a home base and waypoints makes getting lost in the dirt a thing of the past. 800-800-1020, www.garmin.com/en-us



Be Fire-Safe: Public lands require spark arrestors on off-road vehicles, and some dirt bikes don't include them. Good thing supplier FMF Racing exists. FMF had the spark arrester-equipped silencers we needed. We added a TurbineCore 2 (\$159.99) to our Yamaha YZ125 and a Powercore 4 HEX (\$329.99) to our Yamaha YZ250F, making them fast, quiet, safe and legal. 310-631-4363, www.fmfacing.com

SPECIFICATIONS

2016 WEEKEND WARRIOR 28W TRAVEL TRAILER

Exterior Length	33' 5"
Exterior Width	8' 6"
Exterior Height	12'
Interior Width	8' 2"
Interior Height	8' 3"
Construction	Laminated walls and roof with aluminum framing, steel floor framing, fiberglass side walls, TPO roof
Freshwater Cap.	140 gal.
Gray-Water Cap.	50 gal.
Black-Water Cap.	50 gal.
LP-Gas Cap.	10 gal.
Water-Heater Cap.	6 gal.
Refrigerator	8 cu. ft.
Furnace	40,000 Btu
Air Conditioner	13,500 Btu
Converter	30 amp
Batteries	Manufacturer supplied
Tires	ST225/75R15
Weight [water and propane full, no supplies]	8,856 lbs.
Hitch Weight	1,020 lbs.
Axle Weight	7,836 lbs.
GVWR	10,000 lbs./12,000 lbs.
GAWR	12,000 lbs.
Cargo Carrying Cap.	1,144 lbs./3,144 lbs.
MSRP, base	\$39,999*
MSRP, as tested	\$51,159*
Basic Warranty	1 year

*Factory-direct pricing

Weekend Warrior

844-284-6678

www.weekendwarriortrailer.com

Circle 167 on Reader Service Card

2016 RAM 2500 TRADESMAN CREW CAB 4X4

Fuel Economy, Solo	15 mpg
Fuel Economy, Towing	9 mpg
Engine	V-8 Hemi MDS
Horsepower	410 @ 5,600 rpm
Torque	429 @ 4,000 rpm
Transmission	6-speed automatic
Axle Ratio	4.10:1
Fuel Cap.	31 gal.
Tires	LT245/70R17E
Suspension, Front	3-link
Suspension, Rear	5-link coil
Brakes	4-wheel disc with ABS
Tow Rating	12,650 lbs.
GVWR	10,000 lbs.
GCWR	22,800 lbs.
Weight as Tested	6,631 lbs.
Length	19' 9"
Wheelbase	148.9"
MSRP, base	\$38,315
MSRP, as tested	\$43,435
Basic Warranty	3 year/36,000 mile

Ram Trucks

866-726-4636, www.ramtrucks.com

GET ON THE ROAD TO BIGGER REWARDS!



OPEN A **GOOD SAM | CAMPING WORLD VISA®** TODAY*

EARN REC REWARDS POINTS ON **EVERY PURCHASE**

- ▶ Purchases at Camping World & on Good Sam Purchases
- ▶ Campgrounds
- ▶ Gas
- ▶ Groceries
- ▶ Everywhere Visa® is Accepted

REDEEM **REC REWARDS** POINTS FOR

- ▶ Good Sam Memberships
- ▶ Roadside Assistance
- ▶ Gift Cards for Camping World
- ▶ Gift Cards for Gas, Restaurants & Popular Retailers
- ▶ Cash Back as a Statement Credit
- ▶ And more

APPLY TODAY! **CALL: 1-844-271-2591** **CLICK: GoodSamCampingWorldVisa.com**
or Visit a Camping World SuperCenter near you! TDD/TTY 1-888-819-1918

*Offer subject to credit approval. This rewards program is provided by Comenity Capital Bank and its terms may discontinue or change at any time. For information about the rates, fees, other costs, and the reward program rules (including point accrual rate, bonus point awards, etc.) and benefits associated with the use of this credit card program please visit www.comenity.net/goodsamcampingworld for complete terms and conditions.

The Good Sam | Camping World Visa® and Visa Signature® cards are issued by Comenity Capital Bank, pursuant to license from Visa® U.S.A. Inc. VISA is a registered trademark of Visa International Service Association and used under license.

© 2016 CWI, Inc. & Good Sam Enterprises, LLC. CAMPING WORLD and the CAMPING WORLD Mountain Logo are registered trademarks of CWI, Inc. GOOD SAM and the GOOD SAM ICON are registered trademarks of Good Sam Enterprises, LLC. Unauthorized use of any trademarks is expressly prohibited. All rights reserved. GCR46888 - 0316

WALK-THROUGH: JAYCO PINNACLE 38FLSA

On Top of the World

Jayco's five-slide Pinnacle fifth-wheel lives up to its lofty name

There's something romantic about loading up the old pickup with the family and camping gear, finding an out-of-the-way fishing hole, pitching the tents and wetting a line. The whole crew enjoys getting away from it all and making do with what Mother Nature has to offer in terms of accommodations, entertainment and — if you keep what you catch — dinner.

That may be the sentiment for some happy campers, but many seasoned RVers have moved up to something more.

Jayco's 2016 Pinnacle 38FLSA fifth-wheel is that something more, and then some. With five slideouts, a Food Network-worthy galley and a bedroom straight out of a home-decor magazine, the Pinnacle makes you wonder if this can really be considered camping. To us, it felt more like vacationing in an upscale time-share with the option of transporting it almost anywhere.

The 38FLSA is big, and its profile juts nearly 13½ feet into the sky,

which limits its ability to travel on roads with low clearances and park at some of the more primitive campsites. But if you're in this fiver, who needs primitive?

The Pinnacle can be fitted with the MORryde LRE 4000 suspension (part of the \$4,498 Pinnacle Advantage Package) and pin box (part of the \$7,496 Luxury Fifth Wheel Package) to soften the ride. The vacuum-bonded, laminated side walls look great, and the front and rear fiberglass end caps are outfitted with LED lights. The Pinnacle Advantage Package also adds gelcoat to the side walls and end caps.

An electric six-point landing system from Lippert Components makes campsite setup easy, and the powered 50-amp cord reel is a nice convenience. The pass-through storage space should accommodate most gear, from luggage to outdoor chairs. Oversize aluminum entry steps include a fourth platform, which is great. For four-season living, the fifth-wheel has a 40,000-Btu



Overhead cabinets, built-in nightstands and the king-size bed's hardwood headboard tuck into the front-bedroom slide.

furnace, Astro-Foil in the roof and floors, and a heated and enclosed underbelly.

Stepping inside the Pinnacle is where the real fun begins, and it doesn't take long to forget you're in a fifth-wheel trailer. High ceilings, handmade furniture, attractive flooring and stunning solid-surface countertops transform the RV lifestyle into a residential experience.

The 38FLSA utilizes five slides in a front-living-room floorplan, making entertaining the neighbors or simply watching TV an impressive affair. In the entertainment area that's up front (where the bedroom would usually be), dual slides house a pair of couches. A third couch, this one with theater seating, is directly across from the 60-inch LED HDTV, electric fireplace and faux stone



For a solid foundation, Jayco builds custom frames for all of its RVs, including the Pinnacle.

PHOTOS COURTESY OF THE MANUFACTURER



GREAT COVERAGE

For Every Mile of your Journey

When the road opens up and you've got nothing but adventure on your mind, you'll have one less thing to worry about with us on your side.

GEICO[®] *for your RV*

geico.com | 877-434-2678 | Local Office





(Far left) A 60-inch LED TV, electric fireplace and stone-look hearth form the centerpiece of the forward living room, which features couches in opposing slide-outs. A third couch with dual theater seats faces the high-definition TV. (Left) Residential touches include a gooseneck faucet above twin stainless-steel sinks in the kitchen island.

hearth. The opposing sofas fold down to form one gigantic crash pad up front, which is great for families or overnight guests.

The galley features eye-catching Hi-Macs solid-surface countertops from LG in the island configuration and kitchen slideout. The island itself is home to a dual-basin stainless sink with a high-rise pull-out sprayer. An innovative cylinder pops out of the counter to provide power outlets for a toaster, mixers and other small ap-

pliances. The light fixture above the island is an acquired taste, but it emitted the right amount of lighting for food prep and post-meal chatting.

Housed in the slideout that also holds the range and under-cabinet microwave, the stainless residential refrigerator is a 23-cubic-footer with an in-door water and ice dispenser.

On the wall to the right of the fridge, a small computer desk makes good use of the space, though it was a bit awkward placing a dinette chair

in one of the trailer's main thoroughfares. The adjoining hall tree with flip-up storage is a great place to store shoes and smaller outdoor toys. On the opposite wall, the spacious corner pantry lies behind frosted, etched glass, further proof that Jayco is reaching for the top with the Pinnacle.

The dinette is of the freestanding, expandable variety and is placed in a sizable nook with tinted windows that let in more than enough natural light to offset the darker tones of the cherry

Quality is in our Nature...
...Let it be in yours.

Arctic Fox & Fox Mountain 5th Wheels

ABSOLUTE
NORTHWOOD
WWW.NORTHWOODMFG.COM

Northwood Mfg., Circle 126 on Reader Service Card

cabinets. The kitchen and dining area has what looks like wood-plank flooring, but closer examination reveals it to be vinyl, a common choice in many of today's fifth wheels. Stain-resistant residential carpeting covers the living room and bedroom floors.

At the back of the 38FLSA, the elegant master bedroom is a treat. Tall ceilings and the king-bed slideout really open things up. The full 80-inch luxury mattress is incredibly comfortable, and there's still plenty of room to walk around it while making the bed in the morning.

A good-size dresser across the room holds a 32-inch TV with a DVD player, as well as drawers for storage. The trailer's back wall is plumbed for a stackable washer-and-dryer unit, though our tester used that space for additional storage right next to the oversize cedar-lined closet with integrated shelving. Needless to say, storage was not an issue.

Because of the high ceilings, the

bathroom looks larger than it actually is, yet it is still more than ample. The 36-inch shower offers a residential experience, the porcelain toilet affords plenty of legroom, and the large linen closet is much appreciated.

Inside the 38FLSA, nearly every bit of space is smartly utilized for storage or high-line gadgetry. Of course, all those add-ons can up the price in a hurry. Our tester had a \$91,822 price tag, once all the option packages were added in, including a mandatory (which means standard equipment) \$2,999 Customer Value Package and a third air conditioner in the front living room.

If you want to get back to basics and reconnect with your inner wild, look elsewhere. If you're looking for something more, and you're in a financial position to get it, the Jayco Pinnacle is true to its name. 📞

Special thanks to Crestview RV in Buda, Texas.
512-282-3516, www.crestviewrv.com

QUICK INFO

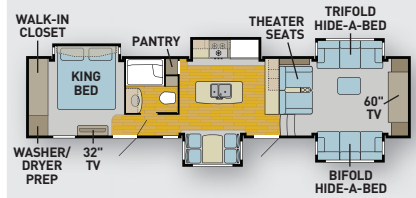

Exterior Length	42' 1"
Exterior Width	8' 6"
Interior Height	8' 11"
Exterior Height	13' 5"
Freshwater Cap.	85 gal.
Black-/Gray-Water Cap.	37 gal./107 gal.
LP-Gas Cap	15 gal.
UVW	13,505 lbs.
Hitch Weight	3,095 lbs.
GVWR	15,950 lbs.
MSRP, base	\$75,705
MSRP, as tested	\$91,822
Basic Warranty	2 years

Jayco

574-825-5861, www.jayco.com

Circle 166 on Reader Service Card

FLOORPLAN BY BILL TIPTON

GET SO MUCH MORE THAN SHADE AND SHELTER!

The 2016 line of Solera® Awnings offers a range of unique awning styles, sizes and options including awning lights, speakers and multiple fabric and hardware color options. The new XL 9-foot-8-inch projection Power, Hybrid and Destination awnings are perfect to extend shaded area for taller units and RVs with slide-outs under the awning. We've also got a range of premium Solera accessories you're going to love including the Awnbrella™ canopy support system, Solera Shield fabric guard and Solera Shades and Rooms.



12V Push-Button Control



Traditional Manual Spring Roll Up



Sets Up & Stores Automatically as you Crank



Carport-Sized Shade & Shelter



Solera Sliders



Solera Awnbrella



by Lippert Components

FASTEST GROWING AWNING BRAND IN AMERICA



Solera XL



Solera Family & Screen Rooms

Lippert Components, Circle 123 on Reader Service Card

PROTECTION

FROM THE COST OF MAJOR BREAKDOWNS



A Good Sam Extended Service Plan is better than a warranty, it's mechanical breakdown insurance and we not only cover RVs, we cover your auto too.

A Good Sam Extended Service Plan can help take the worry out of paying large repair bills with coverage on your engine assembly, transmission, drive axles, plus RV components like your fridge, awnings, seals, gaskets and so much more.

Go online now to see all that we cover and get your FREE QUOTE.

Come see how affordable it can be to repair your RV or vehicle.

GoodSamESP.com/TL0616

866-725-9412



TAKE THE WORRY OUT OF PAYING LARGE REPAIR BILLS

REMOTE AND RUGGED NWT

An epic expanse of lakes, waterfalls and boreal forest, Canada's secluded Northwest Territories has more than its share of scenic wonders but fewer residents than most visitors' hometowns

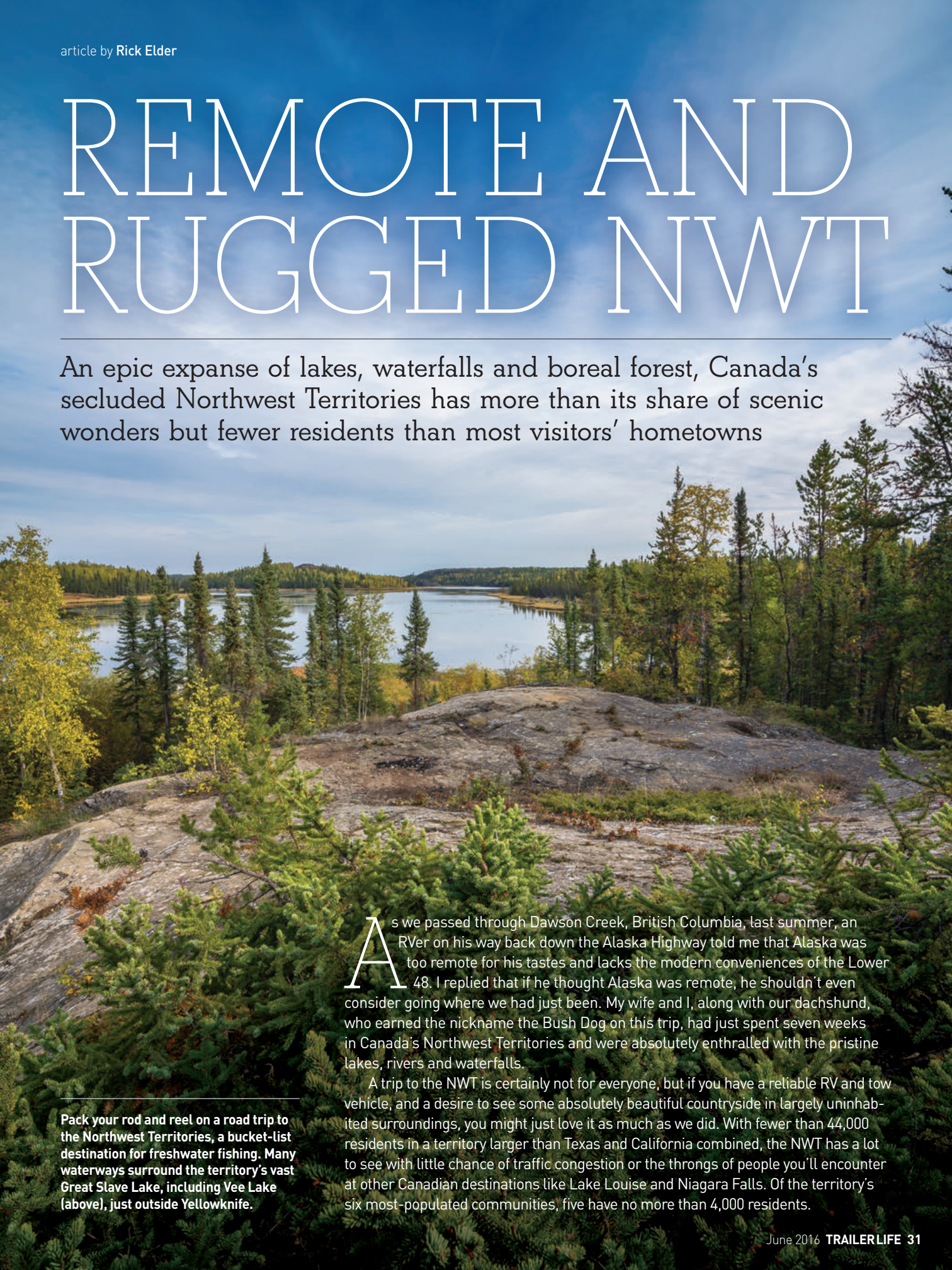

As we passed through Dawson Creek, British Columbia, last summer, an RVer on his way back down the Alaska Highway told me that Alaska was too remote for his tastes and lacks the modern conveniences of the Lower 48. I replied that if he thought Alaska was remote, he shouldn't even consider going where we had just been. My wife and I, along with our dachshund, who earned the nickname the Bush Dog on this trip, had just spent seven weeks in Canada's Northwest Territories and were absolutely enthralled with the pristine lakes, rivers and waterfalls.

A trip to the NWT is certainly not for everyone, but if you have a reliable RV and tow vehicle, and a desire to see some absolutely beautiful countryside in largely uninhabited surroundings, you might just love it as much as we did. With fewer than 44,000 residents in a territory larger than Texas and California combined, the NWT has a lot to see with little chance of traffic congestion or the throngs of people you'll encounter at other Canadian destinations like Lake Louise and Niagara Falls. Of the territory's six most-populated communities, five have no more than 4,000 residents.

Pack your rod and reel on a road trip to the Northwest Territories, a bucket-list destination for freshwater fishing. Many waterways surround the territory's vast Great Slave Lake, including Vee Lake (above), just outside Yellowknife.

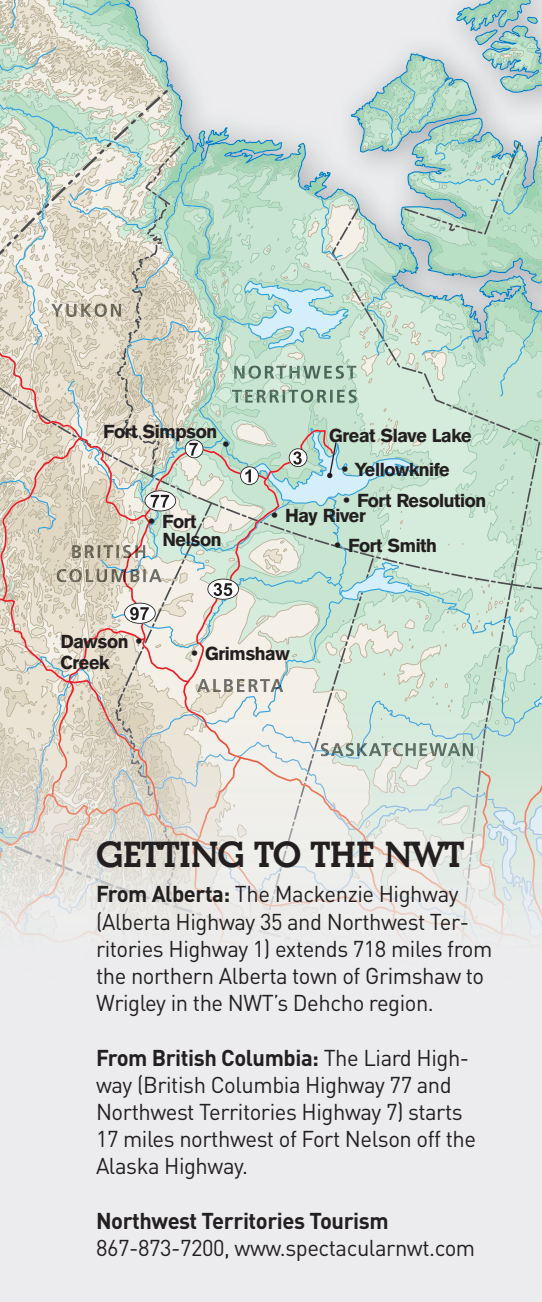

GETTING TO THE NWT

From Alberta: The Mackenzie Highway (Alberta Highway 35 and Northwest Territories Highway 1) extends 718 miles from the northern Alberta town of Grimshaw to Wrigley in the NWT's Dehcho region.

From British Columbia: The Liard Highway (British Columbia Highway 77 and Northwest Territories Highway 7) starts 17 miles northwest of Fort Nelson off the Alaska Highway.

Northwest Territories Tourism

867-873-7200, www.spectacularnwt.com



We towed our Flagstaff trailer from the Upper Peninsula of Michigan in mid-May and returned home in mid-August. Our northwesterly route took in some nice scenery and stops along the way, as we traveled the Trans-Canada Highway west toward Edmonton. Then we picked up Alberta Highway 43, which ultimately took us to Alberta Highway 35, also known as the Mackenzie Highway.

The Mackenzie Highway is the most traveled route into the territory and has its Mile Zero in Grimshaw, Alberta. From there, towns become

BUFFALO COUNTRY

One of the best places to see free-roaming bison is along Highway 5 near Fort Smith. Drive cautiously, especially between dusk and dawn.

fewer and farther between, and when an intrepid RVer reaches Indian Cabins, just before crossing into the NWT, we strongly suggest refueling, because the next pit stop is nearly 100 miles up the highway in Enterprise. For those driving the Alaska Highway, a junction with the Liard Highway,

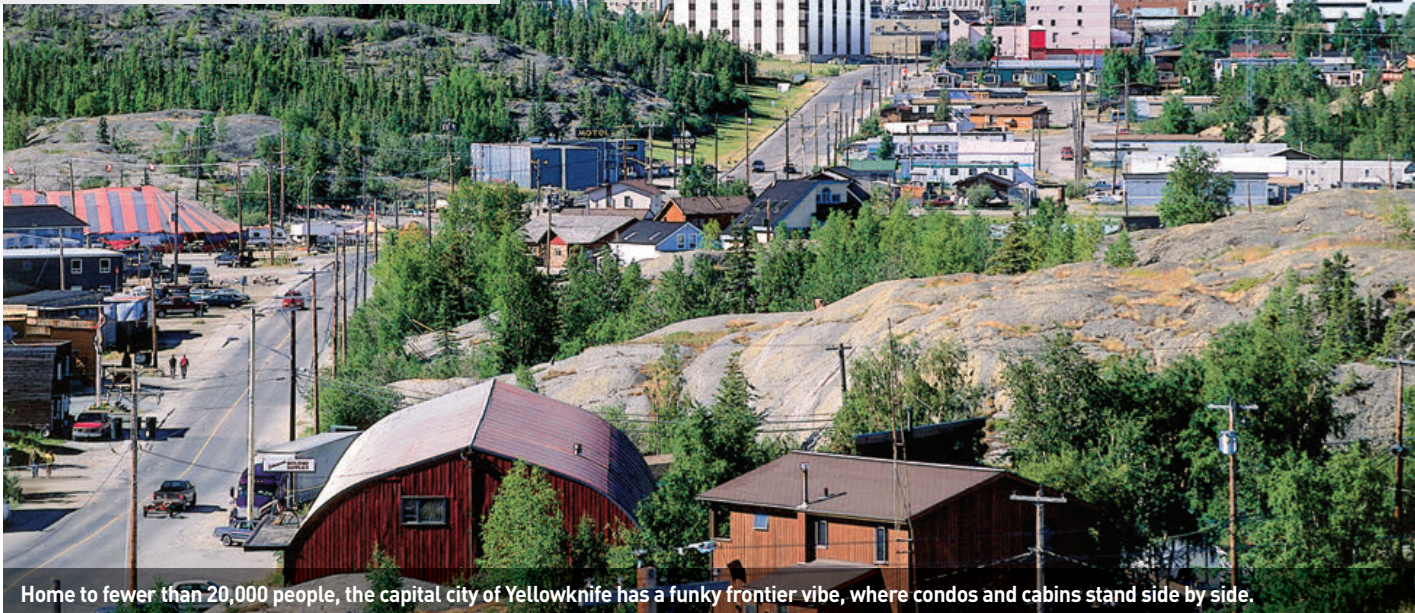

Home to fewer than 20,000 people, the capital city of Yellowknife has a funky frontier vibe, where condos and cabins stand side by side.

LUXURY CROSS-OVERS BY HEARTLAND



CROSS-OVER

[kraws-oh-ver, kros-] noun

1. Versatile recreational vehicles designed with garage areas transformable into multi-purpose spaces to suit your needs.



LEAVE NO TOY BEHIND

www.heartlandrvs.com

The Heart of Family Recreation

Heartland Recreational Vehicles, LLC, Circle 114 on Reader Service Card





(Clockwise from above) On its way to Great Slave Lake, the Cameron River tumbles 55 feet in a picture-perfect cascade. Equally picturesque lakes lure paddlers to discover the territory the way early explorers did. Campgrounds at 16 territorial parks entice RVers to extend their awnings.



north of Fort Nelson, British Columbia, leads into the territory.

The NWT is vast, and we didn't come close to seeing it all, but we did manage to visit three of the territory's five distinct areas, starting with the gateway South Slave region, which stretches from the southern border to Great Slave Lake and includes Wood Buffalo National Park and the towns of Hay River and Fort Smith. The North Slave region contains the East Arm of Great Slave Lake and the capital city of Yellowknife, and the Dehcho region covers the territory's southwest corner and is home to Nahanni National Park Reserve and the village of Fort Simpson.

After crossing into the NWT at the 60th parallel and picking up all sorts of valuable tourist information at the visitor center, we headed up the Mackenzie Highway to Twin Falls Gorge

WHAT TO KNOW BEFORE YOU GO

As the Scout motto says, "Be Prepared" when traveling into Canada's far-off Northwest Territories. It is a wild and remote place, and the things you've come to expect when RVing are often not to be found at any price. Here are a few tips for the first-time NWT traveler:

- Expect to pay more for some items because of the remoteness of the region.
- The costs for routine things like haircuts and oil changes can be surprisingly high.
- Stocking up on groceries is best done in the bigger towns of Yellowknife, Hay River and Fort Smith, where the selection is good and prices are reasonable.
- Fuel stations are not only few and far between, some stock only regular gasoline, and no premium or diesel.
- If you've been thinking about installing an auxiliary fuel tank, do it before you go.
- If you need a good hardware store, Yellowknife and Hay River are the best bets.
- The fire station in Yellowknife is a good place to fill your RV's water tank.
- Don't expect to find RV service centers in the NWT. The only place we saw with RVs for sale was the Chrysler dealership in Yellowknife.
- Good Sam Roadside Assistance is worth having in case your RV needs to be towed to a repair center hundreds of miles away.



Did You Know Over 50 Children Per Week Are Involved In Preventable Vehicle Backovers?

Back-up Cameras Can Save Lives.

Ultimate safety and peace-of-mind with Furrion's Vision 2™ observation system. Using the latest in wireless technology, the wide-angle lens camera digitally locks to the 4.3" LCD color display delivering smooth, clear and uninterrupted live video so you can travel safely.



Slated for federal protection as Thaidene Nene National Park in the coming years, the East Arm of Great Slave Lake is a watery wonderland with sandy coves, shallow bays and hundreds of in-flowing creeks.

Territorial Park to see Alexandra and Louise falls, a pair of large cascades that can be reached from the park's campground on a trail that follows the west side of the Hay River. The river plunges 114 feet at Louise Falls and then plummets another 105 feet over a wide ridge at the Niagara-like Alexandra Falls.

Our next stop was Fort Smith, headquarters of Wood Buffalo National Park. Canada's largest national park, Wood Buffalo extends across the NWT's southern border into northern Alberta and is the only place in Canada where endangered whooping cranes come to nest. American white pelicans pair off on the rocky islands of the Slave River near Fort Smith in their most northerly nesting colony. The hike to



PHOTO COURTESY NWT TOURISM/TERRY PARKER

view dozens and dozens of the large-billed waterbirds navigating the Class VI rapids is certainly worth the effort.

Beyond bird-watching, Fort Smith is a good place to stock up on groceries, gasoline and souvenirs. Bears and bison are likely to be spotted on late-evening drives along the Fort Smith Highway

(Northwest Territories Highway 5) going west of town.

A side trek on the mostly hard-packed-gravel Fort Resolution Highway (Northwest Territories Highway 6) took us along the Buffalo River, a popular fishing location with a small territorial park. In the hamlet of Fort Resolution,

**Setup is a snap with pre-assigned sensors for your tires.
Hit the road faster...it's a no-brainer!**

Tire Patrol
Tire Pressure Monitoring System

6 pack

4 pack

Available Spring '16
Pre-order Now!

Call 800.815.2159 | Shop tirepatrol.com

we again filled up with gas and stocked up on supplies before heading to Hay River Territorial Park.

A beautiful place on Great Slave Lake's Vale Island, at the mouth of the Hay River, the park has sandy beaches next to the 35-site campground. Our campsite was near the lakeshore and surrounded by a natural hedge of wild roses, some of which were 4 and 5 feet tall.

The adjacent town of Hay River has almost 3,700 residents, which surprisingly makes it the territory's second largest community. It is large enough to have all of the services a traveler might need including good Internet access at the Centennial Library and a two-screen movie theater.

With nearly 20,000 residents, the NWT's biggest city by far is Yellowknife, where we spent the next few weeks experiencing the culture of the capital. Yellowknife is cosmopolitan yet friendly, with good restaurants, a couple of shopping centers, an airport, and car and truck dealerships for GM, Ford and Chrysler vehicles. We were in Yellowknife on the July 1 Canada Day holiday, and the town staged a superb parade along Franklin Avenue.

The city is divided into two sections, Old Town and New Town. The New Town section is where most of the downtown businesses are located. The streets of Old Town definitely deserve a visit, with funky eateries such as Bullocks' Bistro, which serves excellent fish dinners, and the log-cabin Wildcat Café, just down the street from Bullocks'. Several fishing

RVING IN THE NWT

Commercial RV parks do not exist in the Northwest Territories. The only real option is to stay at the 16 territorial parks with campgrounds. Run by the government's Tourism and Parks Division, these are beautiful places with plenty of room for big rigs, but be prepared to power your RV with 30- or 15-amp service at the campgrounds that have electrical hookups or with your own battery power at the ones that do not. Pack containers for carrying water at campgrounds that don't have water hookups.

The territorial parks have a good online reservation system, and we recommend making reservations for every place you plan to camp. The main reason to reserve ahead of time is because even the smallest towns have events that can fill the campsites at neighboring territorial parks, and there are not a lot of other camping options.

During our trip, we stayed in campgrounds at nine territorial parks including Hay River. Nearly all of the 35 campsites at this lake-side park were pull-throughs with 30-amp service. The only water source was a hose near the gatehouse, but it was adequate for our needs, and there was a dump station on the way out of the park.

Northwest Territories Parks

867-445-1717, www.nwtparks.ca/campgrounds



YAMAHA
POWER PRODUCTS
POWERFUL | DURABLE | RELIABLE
YAMAHA RELIABILITY,
YAMAHA POWER



NEW! EF2000iSv2 GENERATORS

The Yamaha EF2000iSv2 is a lightweight, fuel-efficient and versatile portable generator featuring a new controller with advanced programming that can power a wider range of applications.

- **New Controller with advanced programming** - The addition of the new programming allows the EF2000iSv2 the ability to power a much wider range of applications than previous generation EF2000iS.
- **Super-quiet muffler with USFS-approved spark arrestor** - Only 51.5 dBA at 1/4 load and eliminates errant sparks.
- **Light Weight & Compact** - 44 pounds, 2.2 cu.ft. size is easy to store and transport.
- **Smart Throttle varies engine speed based on load** - Improves fuel economy and reduces noise.
- **Gasoline petcock** - Lets you shut off the gas to run the carb dry for storage and helps prevent stale gas problems.
- **Fuel Gauge** - Allows fuel level to be seen at a glance.
- **Twin Tech (Parallel generator operation)** - Deliver up to 30 amps. (Twin Tech cable sold separately)

*A second Yamaha EF2000iSv2 is recommended to use the full capabilities of this model.

Read Owner's Manual before operation. Specifications subject to change without notice.
© 2016 Yamaha Motor Corporation, U.S.A. All rights reserved.

Yamaha Outdoor Power Equipment, Circle 161 on Reader Service Card





PROTECT YOUR RV INVESTMENT



RUBBER ROOF CLEANER & RUBBER ROOF TREATMENT

REDUCES RUBBER ROOF MAINTENANCE BY 75%



PROTECT ALL

5 PRODUCTS IN 1 CLEANS, POLISHES, WAXES, SHINES, PROTECTS

OXIDATION REMOVER

ONE-STEP APPLICATION CLEANS, POLISHES & SEALS



BLACK STREAK CLEANER

REMOVES STREAKS, GREASE, BUGS, CLEANS FIBERGLASS, AWNINGS, TIRES, WHEELS & MORE

SLIDE-OUT DRY LUBE & RUBBER SEAL

LUBRICATES & PREVENTS RUST ON METAL SLIDES, EXTENDS SEAL LIFE



100% SATISFACTION GUARANTEED

WWW.PROTECTALL.COM



PHOTO COURTESY NWT TOURISM/TERRY PARKER

The untamed wilderness of the Northwest Territories extends to the sublime Mackenzie Mountains, a northern extension of the Rockies with deep valleys carved by the river of the same name.

charters are also based in Old Town for those who want to try their luck angling for lake trout, northern pike and arctic grayling.

While staying in Yellowknife, we drove up the Ingraham Trail (Northwest Territories Highway 4), a scenic route that runs north of the city for 43 miles, a third of which is paved, and the remaining miles are hard-packed gravel. Just off the route, a popular hiking trail leads to beautiful Cameron Falls.

We meandered home down the Yellowknife and Mackenzie highways, stopping in the village of Fort Simpson at the confluence of the Mackenzie and Liard rivers. From the Liard Highway, we drove to the Alaska Highway and a turn-off north of Dawson Creek, British Columbia, to see the Kiskatinaw Bridge, the last remaining wooden bridge from the original Alaska Highway that is still in use. It is not much off the main route, and was worth the drive for the view and the history of it.

For adventurous RVers looking to go where not too many have gone before, the Northwest Territories is an ideal destination. We loved it and plan to go back again in 2017. Maybe we'll see you there. 🚐

CHOOSE THE ORIGINAL

KING, manufacturer of the best-selling automatic portable satellite antenna in the world.



For DISH®

For DIRECTV®

SATELLITE TV ANTENNAS

KING satellite antennas, easy access to live TV • Fully Automatic, Simple Set-up
DISH®, DIRECTV® & Bell™ Compatible • Portable OR Roof Mountable



GREAT NEW ACCESSORIES FOR YOUR KING SATELLITE ANTENNA



PORTABLE SATELLITE ANTENNA CARRY BAG

Conveniently protects & stores your KING satellite antenna.*

Carry Bag, **CB1000**



TRIPOD MOUNT

Keep your KING antenna* off the ground and protected.

Tripod Mount, **TR1000**

*Carry bag & tripod for models VQ4100, VO4200 & VO4500 only.

KING, CONNECTING YOU TO THE THINGS YOU LOVE, WHEREVER YOU GO.

KING Simply better, by design.™
kingconnect.com

Get social with us
[@MYKINGPRODUCT](https://www.instagram.com/MYKINGPRODUCT)



King, Circle 122 on Reader Service Card

DISH® and Tailgater® are registered trademarks of DISH Network L.L.C. DIRECTV® is a registered trademark of DIRECTV L.L.C.

PEAK POWER



Aftermarket engine tuners and programmers can give tow vehicles an extra boost on steep grades and highway on-ramps without sacrificing fuel economy

When buying a vehicle for towing, high priority is placed on two performance aspects: power and mileage. The dichotomy is that making power uses fuel, and increasing mileage means cutting down on fuel use. So finding a good compromise in a tow vehicle is a tough balancing act for vehicle manufacturers. Ever-tightening air-pollution requirements add to those challenges.

Fortunately, today's tow vehicles have a multitude of computers that make such a feat manageable for drivetrain engineers who balance power with fuel economy while meeting other transmission, axle and engine concerns and constraints. The downside? All that balancing can leave a lot on the performance table.

On the upside, once a vehicle leaves the factory, its towing performance can be taken up a notch with some creative recalibration of the Engine Control Unit (ECU), Transmission Control Unit (TCU) and Power Control Module (PCM). All it takes is feeding those computers new information with what the automotive industry calls "tunes."

Reprogramming stock computer settings gives owners the ability to improve their tow vehicle's overall performance without getting a smudge on their fingers. It's as simple as plugging a handheld device into the vehicle's On-Board Diagnostics II (OBD-II) port below the dash and following the prompts that come up on the device's screen.

If you can use a smartphone, you can enhance your tow vehicle's performance in just a few minutes without knowing anything about writing computer code or even how an engine works. Someone else has already done all the heavy cerebral lifting for you.

Take It Up a Notch

From a pure power perspective, gains from changing tunes depend on the engine type. Diesels and turbocharged gas engines respond better to new tunes than naturally aspirated gas engines. Gas engines typically see about a 10 percent power boost over stock with reprogramming, while the typical

turbocharged engine will see horsepower and torque jump 20 percent or more.

This is especially true of diesels, because a diesel engine can function with a much wider range of air-fuel mapping and turbo-boost changes than a gas engine. For example, a programmer writing a diesel tune can change the engine-mapping code to keep the injectors open longer to supply more fuel (up to a point) and add some turbo boost so the engine makes considerably more power than it did straight from the factory.

Today's naturally aspirated gas engines, handcuffed by strict air-to-fuel ratios and timing, don't give much latitude in reprogramming, so it's a challenge for aftermarket tunes to make significant power gains. And when such gains are achieved, many tunes require running 91- or 93-octane premium fuel instead of regular unleaded.

Fuel-economy gains from loading a new tune depend on how the vehicle is driven and how the new code was set up to reduce the engine's fuel intake at certain points in the RPM curve and throttle position. Best-case scenario: Expect steady-state cruise mileage increases of 5 to 10 percent on the highway, whether towing or empty, over the factory setup.

Hum a New Tune

Tuning and programming devices vary widely in how they work and what they offer in terms of sophistication and levels of calibration. Some simply change transmission and throttle response, while others change fuel delivery and various parameters throughout the entire RPM range. Some tuners work in concert with aftermarket cold-air intake and exhaust systems. Others are tailored more toward fuel economy than power, or vice versa.

The more expensive programmers can have as many as 10 preloaded tunes, and some are designed to provide a way for the end user to upload or create custom tunes. Preloaded controllers with touch screens or buttons may allow the driver to choose the tune of choice on the fly, going from economy mode to multiple levels of power as driving

conditions and needs change.

Those new tunes can have a multitude of configurations, too. One may provide a torque bump in the lower RPM that is a big benefit in getting a heavy load like a travel trailer or fifth-wheel moving quickly, while another provides the maximum power near the top of the engine's RPM when climbing a long grade or passing slower vehicles.

Custom tunes are also available for those who have heavily modified their diesel tow vehicles, maximizing the investment in high-performance hard parts. So it pays to do your research to find out which tuners and programmers fit your needs best. To make that search a little easier, we've rounded up some of the latest tools for improving tow-vehicle power and performance.



aFe Power

The Scorcher series of vehicle programmers from Advanced Flow Engineering (aFe) has always delivered excellent horsepower and torque gains for tow vehicles. The 50-state-approved **Power Scorcher Module** alters the pressure-sensor signals to increase boost of turbocharged half-tons to an optimum level throughout the entire RPM range. It adds a claimed 22 horsepower and 38 lb-ft of torque to 2016 Ram EcoDiesels, and 40 horsepower and 53 lb-ft to Ford EcoBoosts. The 30-minute install results in improved throttle response across a broad power band, as well

as reduced turbo lag, according to the company. MSRP: From \$294
888-901-7693, www.afepower.com

Banks Power

Programming for power and better fuel economy is simple with the new generation of **AutoMind** devices from Banks Power, aka Gale Banks Engineering. The preloaded programmer comes ready to run right out of the box with calibrations developed for increased power and MPG while towing. Available



for a wide range of gas and diesel truck and motorhome applications, the 50-state-compliant AutoMind displays critical engine functions and provides service-technician diagnostic capabilities with the ability to scan and clear vehicle trouble codes. MSRP: \$368.68

Optimization of air intake, intercoolers and supercharging/turbocharging is at users' fingertips with the **iDash 4.3** touch-screen system from Banks. The forced-induction/density gauge adds patented functionality that measures



CHANGE YOUR TUNE

Diesels and turbocharged gas engines benefit most from reprogramming, but standard gas engines also see gains.



PEAK POWER

and displays intake-manifold air density, allowing fine-tuning of the complete intake system for maximum performance. The iDash includes a fast GPS-refresh rate, an A/V input for a backup camera, Bluetooth connectivity and an SD card slot. MSRP: From \$329



Sneak Peek: Available later this year, Banks' tentatively named **Derringer Diesel Tuner** (shown above with the Banks iDash) is said to add a safe 37 horsepower/56 lb-ft to Ram 3.0-liter EcoDiesel engines with the touch of a button. Better still, it offers multiple power levels that users can change on the fly to match driving conditions and towing needs. A plug-and-play tuner that communicates seamlessly with the vehicle's electronics and OBD-II system, the Derringer connects to the optional iDash and add-on screen control to provide a host of gauges and incredible functionality.

800-601-8072, www.bankspower.com

BD Diesel Performance

It's not a programmer as such, yet BD Diesel's **Throttle Sensitivity Booster** takes only the push of a button to feel like there's another 100 horsepower under the hood. The TSB's five performance settings access the engine's full power potential more quickly, greatly improving stock acceleration, according to the company. Factory con-



nections make it easy to install, and there's no tampering with emission controls. The TSB is available for a large number of gas and diesel applications. MSRP: \$264

800-887-5030

www.bddieselpower.com

Bully Dog

A performance tuner, monitor, set of gauges and diagnostic tool all in one, Bully Dog's **GT Platinum Gas Gauge Tuner** comes with 10 preloaded tunes, providing a very wide range of performance options. The device attaches to the windshield or dash for easy access and viewing, and tunes range from towing specific to fuel economy and everything in between. Real-time digital readouts show engine and transmission vitals with both audible and visual alerts. There's even a built-in Driving Coach that helps improve driving habits for better MPG. Available for Ford, Ram, Chrysler, GM, Nissan and Toyota vehicles, the 40417 GT Platinum Gas tuner is 49-state legal, and the 40410 is legal in all 50 states but does not support custom tunes. MSRP: \$471.90



With switch-on-the-fly capability for up to 10 preloaded tunes, the **GT Platinum Diesel Gauge Tuner** offers tunes ideal for towing a trailer, hauling a truck camper, climbing grades and driving off-road. It provides for a variety of custom vehicle setups and includes features from the gas-engine version, such as making speedometer and speed-limit adjustments for changes in tire size or gearing. The 49-state-legal GT Platinum Diesel is available for Ford, Ram and GM trucks that are not licensed in California. MSRP: \$493.90

MAKING SENSE OF POWER CLAIMS

THE TRUTH ABOUT HORSEPOWER AND TORQUE GAINS

One of the first things most tuner and programmer sales pitches tout is how much power they add over stock. The number is usually impressive, but it isn't necessarily a true reflection of how or where that power is delivered. It only shows the greatest difference between stock and the new tune at some point along the entire power curve. That's why the words "up to" are used in power-gain claims.

For example, manufacturers may claim a tune adds 40 horsepower and 60 lb-ft of torque to a stock gas engine, but that's at the very upper RPM, not at the RPM you normally drive when towing. Similarly, a diesel tune may claim up to 120 horsepower and 240 lb-ft of torque, which shows up around 2,800 RPM.

Most drivers won't notice much seat-of-the-pants driving difference when horsepower and torque gains are less than 10 percent, but they will definitely feel a 20 or 30 percent jump in power over stock.

The best way to compare power delivery is to put the products' dyno charts side by side to study the curves. Maybe one brand's "towing" tune provides more power and torque in the lower- to midrange RPM than a competitor's, but not as much in the "power" mode at the highest RPM. Then compare those to how you drive and in what types of conditions.

It's also good to note on dyno charts and in the fine print that many of the towing and performance tunes for gas engines require the use of more expensive premium fuel (usually 91 or 93 octane). If the engine is running on regular unleaded gas (usually 89 octane), those power gains will be significantly less.

**WE MAKE
GETTING THERE
PART OF THE
VACATION**

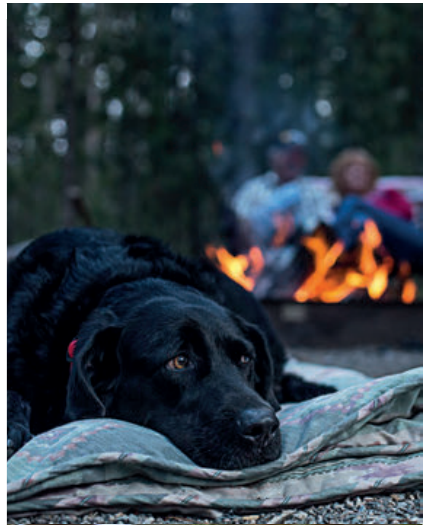

The hitch may be small, but don't underestimate its importance. The engineered metal can make the difference between a comfortable ride and a nail biter. That's why B&W developed a line of hitches based on a single goal: creating a smooth, worry-free ride.



PEAK POWER

Sneak Peek:

Featuring cloud-based tune delivery via built-in Wi-Fi, the forthcoming **BDX** programmer will be Bully Dog's most affordable device to date, according to the company.

877-285-5936, www.bullydog.com



DiabloSport

The 49-state-legal **inTune i2** programmer from DiabloSport makes the throttle more responsive, optimizes drivability and adds some bottom-end horsepower and potential fuel savings, according to the company. Available for Ford, GM and Chrysler applications, the inTune i2 comes preloaded with dyno-tested performance programs designed for specific gas trucks. MSRP: From \$399.99

561-908-0041, www.diablosport.com



Edge Products

The Edge **Evolution CTS2** for gas and diesel pickups is among the elite when it comes to vehicle tuning and data monitoring. Positioned on the truck's

dash or A-pillar, the new 5-inch LCD color monitor provides a high-res screen that the driver can touch to get the power level and change tunes on the fly. The tow tune adds power to pull faster, safer and cheaper, all while monitoring key parameters like exhaust-gas temperature (EGT) and boost. A California-legal model is available, along with the standard 49-state version. MSRP: From \$599.95

801-476-3343

www.edgeproducts.com



EFILive

RV dealerships, custom-tuning shops and tech-savvy individuals who want to create their own tunes can do so with EFILive's **FlashScan V2**, a full-fledged diagnostic, scan and tuning tool in one palm-sized device. Data-logging shows injector and



cylinder health, turbo boost, fuel pressure and other inner workings, and custom-built tunes can be built and saved on flash-drive cards. The FlashScan V2 offers flexible tuning options for Cummins engines, most 1998 to 2016 GM gas engines and 2001 to 2016 Duramax diesels. The legality of this tune creation/modification/diagnostic tool depends on who is doing the tuning and how it is used. MSRP: From \$899

661-775-5620, www.efilive.com

5 Star Tuning

Designed to enhance tow-vehicle performance and drivability, 5 Star's **X4 Flash** starts with the SCT X4 Power Flash controller, but the towing tunes are all configured by 5 Star's tuning experts. Robust yet safe for towing at maximum capacity, according to the company, these custom tunes include the RV Daily-Tow tune for use with 87-octane fuel. In addition to the X4 platform, 5 Star sells the SCT Livewire TS Plus, the



(continued on page 77)

THE BALANCE OF POWER

WHAT TO KNOW BEFORE YOU BUY A TUNER OR PROGRAMMER

Safeguards and Protection

Most of the bigger-name aftermarket tuners and programmers have coding provisions to protect the drivetrain. For example, when the new software increases engine torque, usually the pressure that controls the clutches inside the automatic transmission is also elevated to help take the extra load without slipping.

When EGT on turbo-diesels reaches a certain level, today's software typically has coding in place to help prevent catastrophic engine failure. And should the engine tuner or programmer have a stage that takes your vehicle beyond those safe levels, it's clearly stated, usually with the words "For Race Purposes Only."

Even with built-in safeguards, installing a pyrometer and EGT gauge for anyone adding a tune or reprogramming a diesel tow vehicle is a worthwhile investment. The cost for the gauge setup, if it's not already part of the programmer, is a drop in the bucket compared to paying for an engine rebuild.

Warranties and Legality

Some programmers are 50-state smog-legal and approved by the California Air Resources Board (CARB), some are 49-state approved and do not meet California's strict emission standards, and others are approved for off-road use only. If you have any concerns, particularly if you are a California resident, read the information on the websites and consult the manufacturer before purchasing an engine tuner or programmer.

As for the original engine and vehicle warranty, the Magnuson-Moss Warranty Act of 1975 allows the owner of a new vehicle to make modifications without voiding or affecting the warranty. In a nutshell, the law states that if something breaks and leads to a warranty claim, the manufacturer or dealership has to prove that the aftermarket part was the cause of the warranty issue, and the rest of the vehicle warranty coverage remains intact. Just keep in mind that a judgment in your favor could end up costing you a lot of time and hassle.

Modifications to anything that affects the vehicle's pollution-control systems are an exception to the law. But as long as a tuner or programmer meets federal emissions standards (and CARB standards in California), it's legal. Again, read the details before making a purchase.



Built by  THE RV FACTORY



FACTORY DIRECT

Starting at
\$78,300



Made in USA Wakarusa, IN | weekendwarriortoyhauler.com
info@theRVfactory.com | 844-284-6678

Prices and specifications subject to change without notice.

Manufactured by The RV Factory

Weekend Warrior Toy Haulers, Circle 137 on Reader Service Card

ON THE SHORE IN WILMINGTON

Cloaked in Southern hospitality, North Carolina's historic port town on the Cape Fear River charms visitors with quaint-to-quirky shops and cafés, a historic battleship and a trio of classic beach towns

Many RVers like us are value-conscious travelers who maximize their on-road bliss by seeking out the best of both worlds — places with more than one claim to fame. The greater Wilmington area at the southern edge of the North Carolina coast certainly qualifies as that kind of destination. Wilmington encompasses two watery wonderlands that complement one another perfectly: a spirited historic downtown district on the Cape Fear River, plus an easy-breezy trio of island beach towns — Carolina, Kure and Wrightsville — on the Atlantic Ocean.

MILITARY MASTERPIECE

For a fascinating step back in military time, start your Wilmington tour at the U.S.S. *North Carolina* Battleship Memorial. The celebrated battleship participated in every significant World War II naval offensive in the Pacific, earning 15 battle stars.

The *North Carolina* was built at the New York Naval Shipyard, launched

in June 1940 and commissioned for military use in April 1941. Weighing 44,800 tons fully loaded and exceeding 728 feet in length, the ship cruised more than 300,000 miles in its course of duty at a maximum speed of 28 knots. During wartime, it carried 2,195 enlisted men, including 83 Marines, and was commanded by 144 commissioned officers. The *North Carolina* was de-

commissioned in 1947 and relocated to Wilmington in 1961.

Viewed from the river, the vessel is an imposing sight, seeming to guard its present port. When observed from the memorial grounds, its enormous height, length and structural complexities are readily apparent, with towers, radar equipment, gun mounts and turrets all visible.

On a self-guided tour of the *North Carolina*'s nine decks, we saw where crew members served their country while living and working at sea. We learned their stories through spoken accounts, vintage photos and personal keepsakes. We could even simulate starting the engines, steering the vessel and firing her guns to mimic

The best way to experience the magic of downtown Wilmington? Take a stroll on the 2-mile Riverwalk alongside the Cape Fear River.



the crews' wartime duties.

After stepping off the battleship, we walked a few steps to the grassy edge of the grounds to board a reasonably priced water taxi that whisked us across the Cape Fear River. Water taxis are the most carefree and convenient way to travel into downtown Wilmington, where available parking spaces may be limited.

As you set out to tour Wilmington, if you visit the battleship memorial first, you can take advantage of free parking in the spacious, secure lot on the grounds. The water-taxi trip lasts about 15 minutes — just long enough to appreciate the panoramic Cape Fear River views — and drops riders off on the Riverwalk in the heart of the city.

TROLLEYS, CARRIAGES AND RIVERWALK

When getting around the port community, you can opt for a self-guided walking tour or roll along on a rental Segway's wheels. The trolley is an efficient way to take a whirlwind street tour of the downtown area. Most narrated trolley rides run less than one hour, and they cover all of Wilmington's hotspots.

Without a doubt, the Riverwalk is the best starting point for venturing into the city. The wooden walkway is edged with inviting cafés and chic shops on one side and the rippling Cape Fear River on the other. The 2-mile Riverwalk meanders from Chandler's Wharf to the Cotton Exchange and provides immediate pedestrian access to all of the downtown sights, sounds, retail shops, galleries and dining establishments.

To gain an offshore perspective of Wilmington, board a sightseeing cruise that embarks from the Riverwalk. The riverboats present all types of options from routine



The annual Carolina Cup Stand Up Paddle Board Race is the largest on the East Coast and draws hundreds of paddleboarders to the waters around Wilmington.

sightseeing to sunset sailings, musical performances and murder-mystery dinners. If a ride reminiscent of Wilmington's past is more your speed, hop aboard an elaborate horse-drawn carriage for a few whinnies and a click-clack excursion through the city.

HISTORIC RIVER DISTRICT

History buffs find plenty of compelling reasons to tour Wilmington's historic district, which encompasses 230 blocks and includes 82 properties on the National Register of Historic Places. The charming hustle and bustle of the district is enhanced by the amazing variety of architectural designs in the preserved buildings. Greek, gothic, Spanish baroque and neoclassical revival, Italianate, Georgian, Moorish and Victorian styles are all represented.

Established in 1739, Wilmington was once a thriving center for ship-

building and commerce. Its classic churches, colonial gardens, antebellum mansions and brick-paved streets offer present-day proof of the city's historic authenticity. Restored buildings such as the Old City Market and the Cotton Exchange (a former grain mill and cotton warehouse) now contain clusters of appealing shops and restaurants that cater to tourists.

Wilmington's museums and attractions feature everything from local artistry and scientific innovations to a railroad caboose and toothy crocodiles. On Saturdays, you can walk through the Riverfront Farmers Market to pick up blocks of cheese, baskets of berries, jars of honey or eggs fresh from the henhouse.

If you are into camellias, azaleas and all things green, a leisurely wander through Airlie Gardens is delightful. Under a canopy of moss-draped

(Right) The Graystone Inn Bed and Breakfast, circa 1905, is just one of Wilmington's well-preserved vintage buildings that represent an amazing variety of architectural designs. (Far right) Horse-drawn carriage tours provide an informative glimpse of Wilmington's historic downtown.





GETTING TO GREATER WILMINGTON

Midway between New York and Florida, Wilmington, North Carolina, is located at the southern terminus of U.S. Route 117 and is easily accessible from Interstate 40.

Wilmington and Beaches Convention and Visitors Bureau
877-406-2356, www.wilmingtonandbeaches.com

Southern live oaks, Airlie's glorious gardens encompass vibrant blossoms, gliding swans, sculptures and a house dedicated to butterflies, all occupying 67 lush acres.

ISLAND BEACH TOWNS

After getting sufficiently acquainted with Wilmington's rich history, we traveled east of downtown to Wrightsville Beach. It's a popular year-round destination for stand-up paddleboarders, kayakers, saltwater fishermen and surfers of all ages and skill levels. The island's scenic fitness loop (just under 3 miles) is a prime place for walking, jogging and cycling. Johnnie Mercer's Pier stretches more than 1,200 feet into the sea and is the only concrete structure of its kind in the state.

A variety of ocean-oriented businesses, from surf shops and beachwear boutiques to succulent seafood eateries, sets the laid-back tone for Wrightsville's colorful commercial strip. Scuba divers can spend hours or days splashing around just offshore exploring the 200 shipwrecks.

Minutes south of Wrightsville, Carolina Beach is best known for its lively oceanside boardwalk and vintage beach vibe: picture flip-flops and classic family fun. Exploring the boardwalk is a time-honored custom. The waterfront walkway is a hybrid structure with a paved concrete commercial area set back from the ocean and an elevated wood-plank boardwalk that runs parallel to it and overlooks the shimmering blue ocean.

We started our boardwalk quest by dunking an iconic Britt's doughnut in our morning coffee. Britt's Donuts (open seasonally) has been delighting Carolina Beach-goers since 1939. The shop's famous doughnuts — simple glazed circles



(Above, from left) Small-town Kure Beach is an outdoor-lover's paradise with sailing, surfing and swimming opportunities. A couple enjoys a leisurely bicycle ride on the Carolina Beach boardwalk.

of chewy dough that are free of extra goo or gimmicks — have inspired T-shirts, bumper stickers, a hardback book and a fan club. Beyond the loyal following in North Carolina, Britt's Donuts has earned wider acclaim, winning second place in a national doughnut-shop competition. After tasting one of their warm melt-in-your-mouth doughnuts with a secret signature glaze, you will likely become a Britt's fan, too.

Simple pleasures never seem to end on the Carolina Beach Boardwalk. In addition to doughnuts, you can sink your teeth into buttered corn on the cob, steamed crab legs, New Orleans-esque snowballs, handmade fudge and other goodies at the Fudgeboat. You can ride a dapper horse on the merry-go-round, sit through a rousing round of bingo or just watch stars twinkle. Later, catch a beachfront music festival, roast marshmallows around a blazing fire and see fireworks shoot through the sky,

For a glimpse of the area's all-natural side, be sure to visit Carolina Beach State Park, where fishing at the marina and boating are popular activities. On the park's nature trails, rare Venus flytrap plants, wild orchids, woodpeckers and yellow-throated warblers can be spotted. Look up for soaring ospreys, egrets and herons, and keep your eyes on the hiking trails to view marsh rabbits and white-tailed deer.

Kure Beach is the southernmost and smallest of the three beach towns on the outskirts of Wilmington. Angling enthusiasts like to visit quiet Kure Beach to cast their lines from the island's 711-foot-long fishing pier, one of the oldest such structures on the Atlantic coast. A steady stream of pedestrians and fishermen — both residents and tourists — keeps the scene hopping on the tall wooden pier.

From Kure Beach, a side trip to Fort Fisher State

The famed Battleship U.S.S. *North Carolina* earned 15 battle stars during its World War II Pacific tours.



GREAT TV ON THE ROAD... WHENEVER & WHEREVER YOU WANT!

FREE

HBO

FOR 3 MONTHS!*

with activation of DISH
Pay-As-You-Go
programming.



Wherever your RV takes you, DISH Pay-As-You-Go programming allows you to enjoy hundreds of channels and your favorite TV programs.

CLUB
MEMBERS
Save
30%



DISH ViP 211z Satellite Television
Receiver #73912
Club SALE \$74.97 Reg. \$109.99

With DISH Pay-As-You-Go programming**:

- Pay only for the months you use
- Only DISH lets you watch your favorite shows in HD
- No charge to start or stop monthly service
- **NEW LOWER PRICE!** Programming for as little as **\$36.99 per month!**

Hurry, offer expires May 29, 2016. Call Camping World at 1.888.875.1540 to activate your DISH programming!

*After 3 months you will be billed \$15/mo unless you call to cancel. HBO® and related channels and service marks are the property of Home Box Office, Inc. Offer ends June 6, 2016.

****Important Terms and Conditions:** All prices, fees, charges, packages, programming, features, functionality and offers subject to change without notice. **Installation/Equipment Requirements:** Monthly fees and limits on number and type of receivers will apply. All charges, including monthly programming, pay-per-view and equipment upgrades, must be paid in advance; failure to pay by due date will lead to service disconnection within 24 hours. **Miscellaneous:** Offers available for new and qualified former customers. Offers subject to terms of applicable Promotional and Residential Customer agreements. Taxes or reimbursement charges for state gross earnings taxes may apply. Additional restrictions may apply.



CAMPING WORLD®

SuperCenters Nationwide | 1.888.875.1540 | CampingWorld.com

DISH Network, Circle 108 on Reader Service Card

dish
AUTHORIZED RETAILER



(Above, from left) Luna, a rare albino alligator, can be seen at Fort Fisher's North Carolina Aquarium. An hour from Wilmington, Brunswick Beaches Camping Resort welcomes RVers.

Recreation Area offers yet another fresh perspective on greater Wilmington. The park protects 300 acres of unspoiled beaches where shorebirds and loggerhead turtles build their nests.

Exhibits at Fort Fisher's North Carolina Aquarium showcase all sorts of fascinating aquatic habitats from freshwater streams to brackish swamps and salty seas. Water-dwelling creatures such as alligators, sea turtles and sharks are also on display.

Fort Fisher State Historic Site preserves the archaeological remnants of a strategic bastion remembered as the Last Major Stronghold of the Confederacy and is a quirky site worth visiting if you want to expand your knowledge of Civil War history.

The next time you're searching for a best-of-both-worlds travel experience, add the watery wonders and historic gems in and around Wilmington, North Carolina, to your list. 📍

WHERE TO CAMP

Brunswick Beaches Camping Resort, 46 miles south of Wilmington in Sunset Beach, offers more than 80 campsites for all kinds of RV combinations. Pets are welcome at the top-rated resort. 855-579-2267 www.brunswickbeachescamping.com

Carolina Beach State Park, 10 miles south of Wilmington, has 83 tree-shaded campsites, each with a picnic table and a fire ring with a grill, but no hookups. The bathhouse has hot showers and flush toilets. 910-458-8206 www.ncparks.gov/carolina-beach-state-park

Wilmington KOA, 8 miles northeast of Wilmington, provides top-notch facilities and an assortment of level, shady, full-hookup campsites for RVs of all shapes and sizes. Pets are welcome. 888-562-5699/reservations 910-686-7705/information www.koa.com/campgrounds/wilmington

CAMPGROUND PHOTO BY JOE TESE

Order Now & Save!

The largest collection of new RV models in the marketplace — all in one handy volume



2016 RV BUYERS GUIDE

Completely Revised & Updated for 2016 • More Than 500 Listings

1-800-309-0311 • www.rvbog.com

Send me a total of ____ copies of the **2016 RV Buyers Guide** for only \$7.99 plus \$2 shipping and handling per copy. Total Payment due: \$ _____

Check or money order made out to RV Buyers Guide enclosed

Charge my: Visa Mastercard Discover American Express

Account # _____ Exp. Date _____

Signature _____

Name _____

Address _____

City _____ State _____ Zip _____

Available to US and Canadian residents only (U.S. funds only). Publication date is February 2016. Please allow 4-6 weeks for delivery.

2L07 2016 RVBG TL06



Clip out and mail to: 2016 RV Buyers Guide, P.O. Box 9291, Oxnard, CA 93031

The Murphys' next adventure awaits. Start yours too!

The Murphy kids are teenagers now, and ready to tackle the great outdoors head on – so the family upgraded to the Highlander fifth wheel toy hauler. Now it's easy to bring their new side-by-side along, no matter where their next adventure takes them.



\$5,000
— QUARTERLY —
Sweepstakes

Each quarter in 2016, we're giving away \$5,000 towards a new Highland Ridge RV.

Don't miss your chance to win! Register at HighlandRidgeRV.com/OwnYours and enter promo code **TLM5K**.



Only one registration per drawing is allowed. The winner must purchase a new Highland Ridge RV prior to December 31, 2016. For the complete set of rules and regulations, visit highlandridgerv.com/ownyours/rules.

Highland Ridge RV, Inc., Circle 118 on Reader Service Card

TOUGH SKIN

WITH ITS UNIQUE LIQUID-APPLIED, UV-RESISTANT SYSTEM, RV ARMOR OFFERS THE FINAL SOLUTION FOR RV ROOF PROBLEMS

Ask any RV owner, and they'll probably tell you that the thing that worries them most about their RV is its roof. It's easy to understand why. The roof stands up to the forces of Mother Nature, providing protection from rain, snow and hail, and it doesn't help matters that something as small as a cracked strip of caulking can lead to thousands of dollars in water damage. Interior stains, mold and mildew infiltration, and delamination of the side walls are all common issues caused by a roof that is failing in one way or another, and a hot, dry climate is no assurance of immunity to these problems. UV rays can cause rubber roofs to blister, peel and crack, and all roof types can suffer from chalking and fading over time. Protecting the roof with a high-quality RV cover is an obvious solution, but you can't do that 24 hours a day, 365 days a year. Or can you?

RV Armor says you can. Through a painstaking process of rigorous inspection, cleaning, repair and a liquid-applied membrane and roof system, RV Armor says it can effectively make your RV roof maintenance-free, yielding what the company claims will be the last roof your RV will ever need. In fact, they guarantee it with a lifetime warranty for materials and labor that is transferable and not prorated. Perhaps best of all, there's no need to drive to a shop to have the RV Armor system applied; a nationwide network of factory-trained technicians stands at the ready to visit wherever you may be and can even treat your roof while you continue to live in the RV.

Based in Florida, RV Armor is the brainchild of Lee Thaxton, a third-generation roofing contractor and full-time RVer. For years, he and his wife, Carol, had searched for a way to tie his commercial roofing expertise and product knowledge into the lifestyle they were passionate about, and RV Armor was born.

The process is most commonly applied to problematic rubber roofs but may also be used on one-piece fiberglass, TPO, vinyl, metal and even directly on wood decking. RV Armor technicians can also replace or repair wood damage, repair damaged



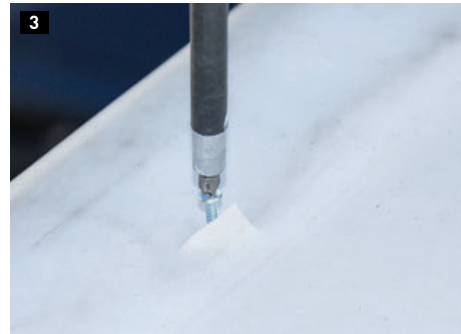

membrane, and replace vents and skylights. In short, RV Armor offers a one-stop, one-time solution to roof problems, and the system typically costs 30 to 50 percent less than a roof tear-off or replacement, according to the company.

The process usually takes two full days to complete but may take up to three. Once finished, the RV Armor roof is extremely durable, flexible and tough, plus it's resistant to fungus, salt, acids and most chemicals. The UV-resistant formula has a temperature range of minus-75 degrees to 350 degrees F, and the company says it

1) The owner of this RV kept it covered most of the time, so the roof was in good shape and relatively clean, which made preparation easier. The first step was a quick sweep to remove dust and accumulated dirt, followed by a wipe-down with denatured alcohol. **2, 3, 4)** On RVs with a radius roof, the edges are carefully inspected for areas where the underlayment is starting to delaminate, causing the rubber membrane to lift in some areas. While RV Armor can't completely solve this issue from an appearance standpoint (that would require removing and replacing the membrane altogether), the technicians can improve upon it and stop the issue from worsening. The first step in this direction is to make a small L-shaped incision in the membrane where the underlayment is rising. A self-tapping screw is then driven in place, and the area is covered with foil tape. **5)** With the roof secured, the next step is to inspect the sealant around the vents and skylights. If the sealant is in good shape, as was the case here, it is cleaned thoroughly with a terry towel and degreaser. Cracked or peeling sealant would be scraped off and resealed prior to applying the RV Armor system. **6)** The plumbing vent covers are removed, and the sealant around them is cleaned and inspected.

7, 8) On rubber roofs, the RV Armor process involves three different stages over two days (sometimes three). The first is a yellow epoxy primer that creates a barrier between the membrane and the base/final coats, preventing solvents in the product from forming gas pockets underneath the membrane. The primer is cut in with a brush along the edges, near the front and rear caps, and around the vents and skylights.

9, 10) Part of what makes it possible to apply RV Armor at a home, campground or storage lot is that each application is rolled on by hand with a common paint roller. Spraying the product on would create overspray that could potentially land on nearby vehicles, homes, etc. Once the yellow primer is applied, it is allowed to dry for approximately two hours.



TOUGH SKIN



11



12



13

won't crack, peel, chip or chalk. As a side benefit, the bright white coating [also available in gray or tan] can even net an improvement in thermal efficiency, keeping the RV cooler in hot summer months.

The owner of the 2013 RV shown in these photos wanted it to be the last one he ever owns — so even though the roof was in relatively good condition, he elected to have it treated to the RV Armor process before it began to degrade. We met the owner and RV Armor installation technician

11, 12, 13) Prior to application of the gray base coat, the roof is recaulked along the edges and as needed along the front and rear caps, and sealed around the antenna, vents and skylights with self-leveling sealant.

Luis Mendes at a storage lot near the owner's home in La Verne, California. Mendes was prompt, courteous and very detail-oriented, carefully explaining the process to the owner before and during the installation. In the end, we were impressed with the final result and could see no reason why the treated roof would

not live up to the company's claim of lifetime durability.

The RV lifestyle should be worry-free. If the roof of your RV is a concern, RV Armor could be the ideal solution. The company even offers financing. 🚐

RV Armor

855-782-7667, www.rv-armor.com

14) After the self-leveling sealant is applied, fabric mesh is gently pushed into it while it is still wet, helping to strengthen the area and prevent cracking once cured. 15, 16) Once the sealant is dry, the gray base coat is applied. This is actually the same material as the third and final white coat, but using two colors makes it easier for the technician to see which areas have been covered and which ones haven't during the final coat application. As with the previous step, the gray coating is first cut in

around vents and skylights, etc., before it is rolled on. It will then cure overnight. 17) The next morning, the RV Armor technician began by applying another layer of sealant over the fabric mesh in all areas, then placing masking tape along the edges. 18) Finally, the white coat is laid on nice and thick, and the masking tape removed, leaving a clean exterior edge. It will dry overnight and cure completely within four days. 19) The finished product looks great and is guaranteed for the life of the RV.



14

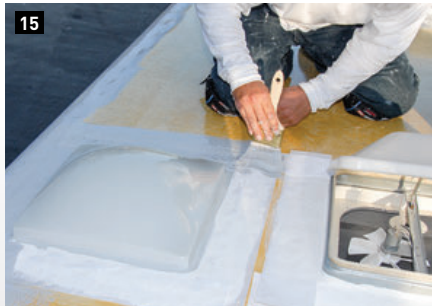

15



16



17



18



19



CAMPING WORLD

1966 **50 YEARS** 2016

RED HOT CLEARANCE

LOW APR FINANCING • NOW IS THE TIME TO UPGRADE • HUGE SELECTION OF TOWABLE RVS!



NEW BUNKHOUSE TRAVEL TRAILERS
STARTING AT
\$12,495* OR **\$107/MO.***

Stk. #1214457 - Based on 10% down @ 5.50% APR for 144 mos.



NEW REAR LIVING TRAVEL TRAILERS
STARTING AT

\$19,495* OR **\$167/MO.***

Stk. #1267827 - Based on 10% down @ 5.50% APR for 144 mos.



NEW REAR BATH TRAVEL TRAILERS
STARTING AT

\$23,495* OR **\$195/MO.***

Stk. #1270086 - Based on 10% down @ 4.99% APR for 144 mos.



NEW REAR LIVING FIFTH WHEELS
STARTING AT

\$35,995* OR **\$256/MO.***

Stk. #1221279 - Based on 10% down @ 4.99% APR for 180 mos.

BUY AN RV & BECOME A **Good Sam ELITE MEMBER!**



CAMPING WORLD RV SALES

866-9-RV-CENTER | CampingWorld.com/RV

*Government fees, state taxes, dealer fees and emissions testing charges as applicable will be added to comply with state vehicle codes. Freight and prep costs vary by state (Not applicable in CA, OH, TX, TN, GA, LA, WA, OR or UT). Inventory and floorplans vary by location, not all advertised manufacturers available at participating dealers. New units will be delivered from the nearest authorized dealer. Contact your area dealer for availability. VIN numbers posted at dealership. *All payments to qualified buyers with approved credit. Subject to lender terms. **RV must be purchased at a participating Camping World RV Sales Dealership to qualify. Offer is not retroactive on previous RV purchases. Benefits are subject to certain limitations and restrictions, and are subject to change. Discounts and benefits offered through your Good Sam Elite membership for 3 years from date of RV purchase. See dealer for full program details. Advertisized inventory available at time of production. New unit photography for illustration purposes only. May not be combined with any other offer and not applicable to prior sales. Offers valid at any Camping World RV Sales or FreedomRoads dealer only. See dealer for details. © 2016 FreedomRoads, LLC. CAMPING WORLD and the CAMPING WORLD Mountain Logo are registered trademarks of CWI, Inc. and used with permission. Unauthorized use of any of CWI, Inc.'s trademarks is expressly prohibited. All rights reserved. Offers expire 5/29/16. FR062240-0316

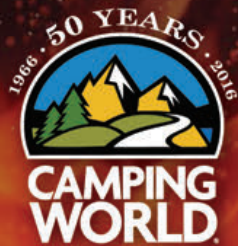

HOT SAVINGS

MAKE IT A Nostalgic Summer!



A. **NEW!** Retro Tablecloth #86814
Club SALE \$4.97 Reg. \$7.29

B. Vintage RV Table Weights.
Set of 4 #86907 Club SALE \$6.97 Reg. \$9.99

C. Vintage RV Salt & Pepper #86908
Club SALE \$6.97 Reg. \$9.99

D. Retro Collapsible Container #86854
Club SALE \$11.99 Reg. \$13.99

24"H x 19" dia.

E. **NEW!** Retro Picnic Caddy #87842
Club SALE \$9.97 Reg. \$14.99

F. **NEW!** Retro Garden Flag #86273
Club SALE \$7.97 Reg. \$11.49

G. 3-Piece Flag Pole #69696
Club SALE \$6.97 Reg. \$8.99



NEW!

CLUB SALE
\$99⁹⁷

Flame Genie #87333
Portable steel fire pit
burns wood pellets (sold
separately) that produces
virtually no smoke or
sparks. Storage bag
included. | Reg. \$139.99

13 1/2"H x 13 1/4" dia.



26" x 18" tabletop

Clay

Granite
White

CLUB SALE
\$18⁹⁷

Personal Table

EXCLUSIVE! Clay #74982
Granite White #48945
Height adjusts to 24",
26" or 28". | Reg. \$25.59

CLUB
MEMBERS
Save
25%

**GOLD
DEAL!**

CLUB MEMBERS
LOWEST PRICES
OF THE SEASON!

50
YEARS



Quik Fold Table:
17 1/4" L x 15 1/4" W x 19 1/4" H

CLUB
MEMBERS
Save
50%

CLUB SALE
\$15⁹⁷

Tag Along Table:
12" L x 14" W x 15 1/4" H

Folding Table Set, Portobello #88552
Both fold flat for compact storage. | Reg. \$30.98



CLUB
MEMBERS
Save
40%

250 lb. capacity

24" W seat

Folds compactly for storage

CLUB SALE
\$39⁹⁷

**WHILE
SUPPLIES
LAST!**

Papasan Chair #75017
Weather resistant fabric on a strong,
lightweight steel frame with non-skid leg protectors.
Stores in included zipper carry bag. | Reg. \$69.99 | ♻️ | ♡

12th ANNUAL at grillfest

SPONSORED BY



Prices expire May 29, 2016

CLUB SALE
\$89⁹⁷

CLUB MEMBERS
Save
\$25

BBQTek™ Portable Gas Grill #69360

Features a heavy-duty cast iron grate, porcelain steel lid and firebox, matchless push-and-turn ignition and foldable side tables. 37 3/8" W x 17 1/4" D x 15 1/4" H. | Reg. \$114.99 |



10,000 BTUs

200 sq. in. cooking area

Infinite heat control knob

Folds to 32 1/2" L x 22" W x 5" D

Slim Fold Cook Station #81922

Heat-resistant aluminum cook surface. Four folding side tables with hooks to hang grill tools. 52 1/4" L x 18" W x 32 1/2" open. Steel frame. Club SALE \$79.97 Reg. \$99.99 |

NEW!

Built-in temperature gauge

12,000 BTUs

Sears, Bakes, Roasts & Even Smokes Foods!

Napoleon TravelQ™ TQ285 Portable Gas Grill #86916
Two individually-controlled stainless steel tube burners let you grill using indirect heat. Porcelainized cast iron cooking grids feature Napoleon's iconic wave pattern. Uses disposable propane cylinders. Mfr. 10 year limited warranty. Reg. \$259.99 |

CLUB SALE
\$229⁹⁹



285 sq. in. grilling area



Use on stand or as a table top grill

20,000 BTUs

285 sq. in. cooking surface

Grill grate & griddle included

Tool hooks keep your grilling tools ready to go



CLUB SALE
\$179⁹⁷

Roadtrip™ Classic Grill #35188

- Two heavy-duty shelves
 - Collapsible wide base stand
 - Detachable lid
- Reg. \$249.99 |

12th ANNUAL

grillfest

MAY 19-22
SUPERCENTERS NATIONWIDE

Sponsored By



CLUB MEMBERS
SAVE up to 60%
ON 4-DAY ONLY DOORBUSTERS!

FRIDAY, May 20 & SATURDAY, May 21

FREE LIGHTER
TO THE FIRST 50 CUSTOMERS

PLUS,
FREE HOT DOG LUNCH!
11 am - 1 pm

A Swing and a Hit

Taking advantage of otherwise wasted space, UnderCover's unique cargo box mounts on the side of a truck bed

DIFFICULTY 1 2 3 4 5

TIME TO COMPLETE 40 MINUTES

TOOLS NEEDED SCREW GUN, BITS, MEASURING TAPE



SwingCases rotate on hinges to provide easy access to stored items while using the tailgate as a convenient bench. The boxes can be easily removed and carried to the job site.

Ask trailer owners if there is ever enough space for storage, and they will likely sheepishly admit to taking along too much stuff. If you're towing with a pickup truck, the bed offers a great amount of space, but without built-in toolboxes or other storage, the items kept in the bed are tossed around and vulnerable to those who prefer not to pay for things. A clever product to add to the storage options for pickups is the SwingCase, a unique box on a hinge that mounts on the side of the truck bed.

Made of heavy-duty molded plastic, the SwingCase is a swing-away cargo box that doesn't slide around the truck bed. Instead, it attaches to the back side of the bed, consuming a small amount of otherwise wasted space.

Mounting brackets that are specific to most newer trucks are provided with each SwingCase, making it easy to install and remove. The box can be mounted on older trucks, or models that are not on the fit list, using a universal bracket kit — which is what we

did, and it worked perfectly. We elected to mount two SwingCases, one on each side of the bed, and ordered the driver's side and passenger's side versions plus two universal bracket kits.

To begin the installation, the hinged mounting plate is affixed to the long, narrow locking bracket by way of the two studs and corresponding locking nuts. Once this is done, we attached the mounting plate to the SwingCase and mocked up the installation to establish proper clearance.

If a helper is not available, find something flat (like a piece of wood) that is thick enough to get the proper amount of spacing and keep the box steady. Mark the location for the hinge bracket that will mount to the stake-pocket post, immediately adjacent to

the tailgate. The objective is to position the bracket as close to the bed floor as possible, while allowing room for the box to swing back and forth freely.

The bracket with the latching mechanism is then attached to the side of the bed using the self-tapping bolts. From there, place the box back on the hinge, latch it into position, and the 20-minute install is complete.

Once the SwingCase is in place, regularly needed tools and other gear can be reached by grabbing the pull handle and swinging the box across the bed and open tailgate. A tool tray at the top of the box can be pulled out to access the storage space below, and there are even a pair of molded cutouts in the lid that can act as cup holders.

A locking mechanism secures



STRONG AND SECURE » Made of durable ABS plastic, the cleverly designed SwingCase will hold a good amount of small items. The hinged top has a keyed lock, and the brackets can be padlocked for extra security.

the contents and can be used with or without the key. Since the boxes can be easily lifted off the hinges, the brackets themselves can be padlocked for additional security; the padlocks just have to be removed before swinging the boxes out.

The two boxes were loaded with frequently used tools and supplies and subjected to blowing sand and rain over a period of time. The interior of the boxes remained clean and dry. We suspect that the high-impact ABS plastic will hold up for a long time. If the boxes outlast the truck, they can be transferred to another pickup.

The SwingCase is made in America by UnderCover, a company that specializes in truck-bed covers, so it comes as no surprise that the boxes fit comfortably under such covers. The SwingCase sells for around \$190, depending on the retailer. 📞

UnderCover

866-900-8800, www.undercoverinfo.com



1) The first step in the installation is to assemble the brackets for mounting on the side wall of the truck bed. **2)** Self-tapping bolts are driven into the side of the bed using a cordless drill. **3)** The end of the bracket with the latching mechanism is attached to the side wall using self-tapping bolts. **4)** With the SwingCase mounted on the hinge, the latch is pulled to release the box so it can swing out.

PHOTOS BY KEVIN LIVINGSTON

TAKING ORDERS APRIL 1ST FOR THE NEW 2017 ESCAPE

Check out our website for current pricing, options and standard features for the **NEWLY REDESIGNED EXTERIOR** of the 2017 Escape Travel Trailer.



 **Escape Trailer Industries**
Proudly built in British Columbia, Canada

escapetrailer.com | 855-703-1650 | Buy factory direct in Chilliwack, B.C.

Escape Trailer, Circle 109 on Reader Service Card

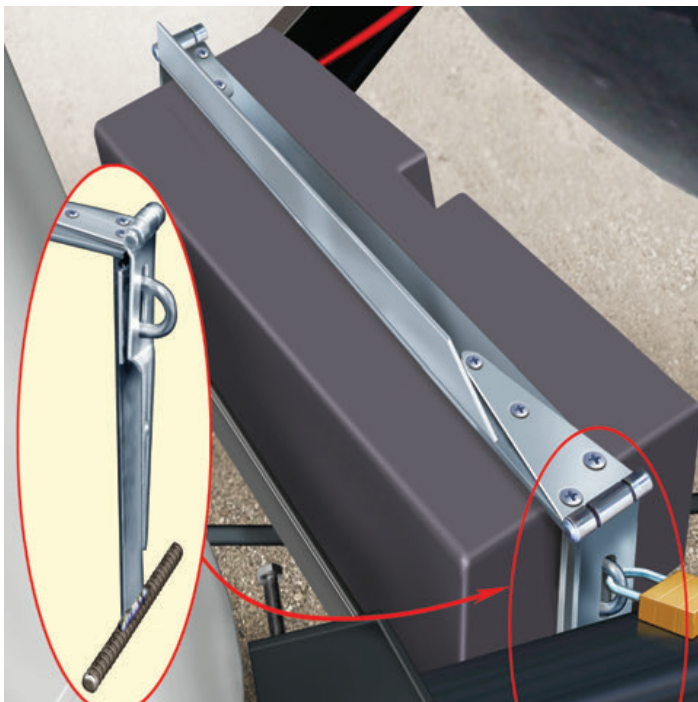

Secure Batteries

After having our new trailer's propane cylinders and batteries stolen at our "secure" storage facility, we decided it was prudent to "close the barn door after the fact." A trip to an RV supply store produced a Torklift Fortress GasLock, an efficient and simple locking device for the propane cylinders. Then, after a trip to Home Depot, I procured the materials I needed to secure the batteries: a 4-foot piece of 2-inch angle iron at $\frac{1}{8}$ -inch thick, a heavy-duty strap hinge and a 2-foot length of $\frac{1}{2}$ -inch rebar.

I cut a length of the angle iron for the top, then cut and split a section for the two sides. I cut two pieces of the rebar to $6\frac{1}{2}$ inches and welded them to the ends of each of the two sides in a "T" fashion. Then, I simply welded the hinge to one end of one side and the hasp to the other end of the top bracket, finishing off with the hasp loop welded to the top of the other side bracket. No drilling or cutting is needed on the battery support rails because the rebar sections simply hook under the battery support rails on the A-frame.

I also installed some thin self-adhesive weather stripping on the bottom of the top bracket and on the battery box side of both side brackets for a snug fit and to prevent rattle and wear. Now all that's needed is a nice big padlock.

Gary Ownby, Camino, California

To send your submission, write to 10-Minute Tech, 2750 Park View Court, Suite 240, Oxnard, California 93036 or email 10minutetech@trailerlife.com. Please include an illustration or photo, if applicable. *Trailer Life* will pay \$35 for original 10-Minute Tech ideas. All payments require an FEIN or SSN.



Get a Handle on the Fan Crank

My wife and I are too short to reach the fan crank handle on the overhead vents in our Jayco trailer without standing on a step stool. Our neighbor solved the dilemma with a simple tool he fashioned from a tree branch about $\frac{3}{8}$ inches in diameter. The legs of the "Y" are cut about 2 to 3 inches to fit the diameter of the handle/knob. The length of the "tool" can be made to whatever suits the user. The handle end is also squared off to operate the switch.

Frank Foti, Natick, Massachusetts

QUICK FIX

Foolproof Door Holder

I got tired of people closing our RV door when the door holder was hooked and breaking it. So far, I've had to replace the door holder three times at \$5 a pop. I bought a gas spring with the right length and power. It took a little measuring, plus I practiced extending and compressing it for the correct length. I then screwed it to the top of the door and side of the trailer above the door. It cost about \$35 and took me about half an hour to install.

Also, now the wind no longer closes or slams the door shut. And it's no longer broken off by people pulling on it.

Dave Smith, Owatonna, Minnesota 📧

Everything you need is within reach.

RIVERSIDE RESORT RV PARK LAUGHLIN, NEVADA

*We're pleased to offer you the following special
Trailer Life Weekly Rate.**



\$99 WEEKLY RATE

*Plus... Two Complimentary Choice Buffets and
Two Complimentary Breakfast Buffets!*

**To Make Your Riverside RV Park Reservations
CALL 1.800.227.3849**

ASK FOR THE TRAILER LIFE SPECIAL WEEKLY RATE.

*Excludes holidays and special event periods. Subject to availability. Two complimentary Choice Buffets and Breakfast Buffets per space, per week (excludes Sunday Champagne Brunch). Management reserves all rights. Offer valid May 1st through September 4th, 2016.



RiversideResort.com

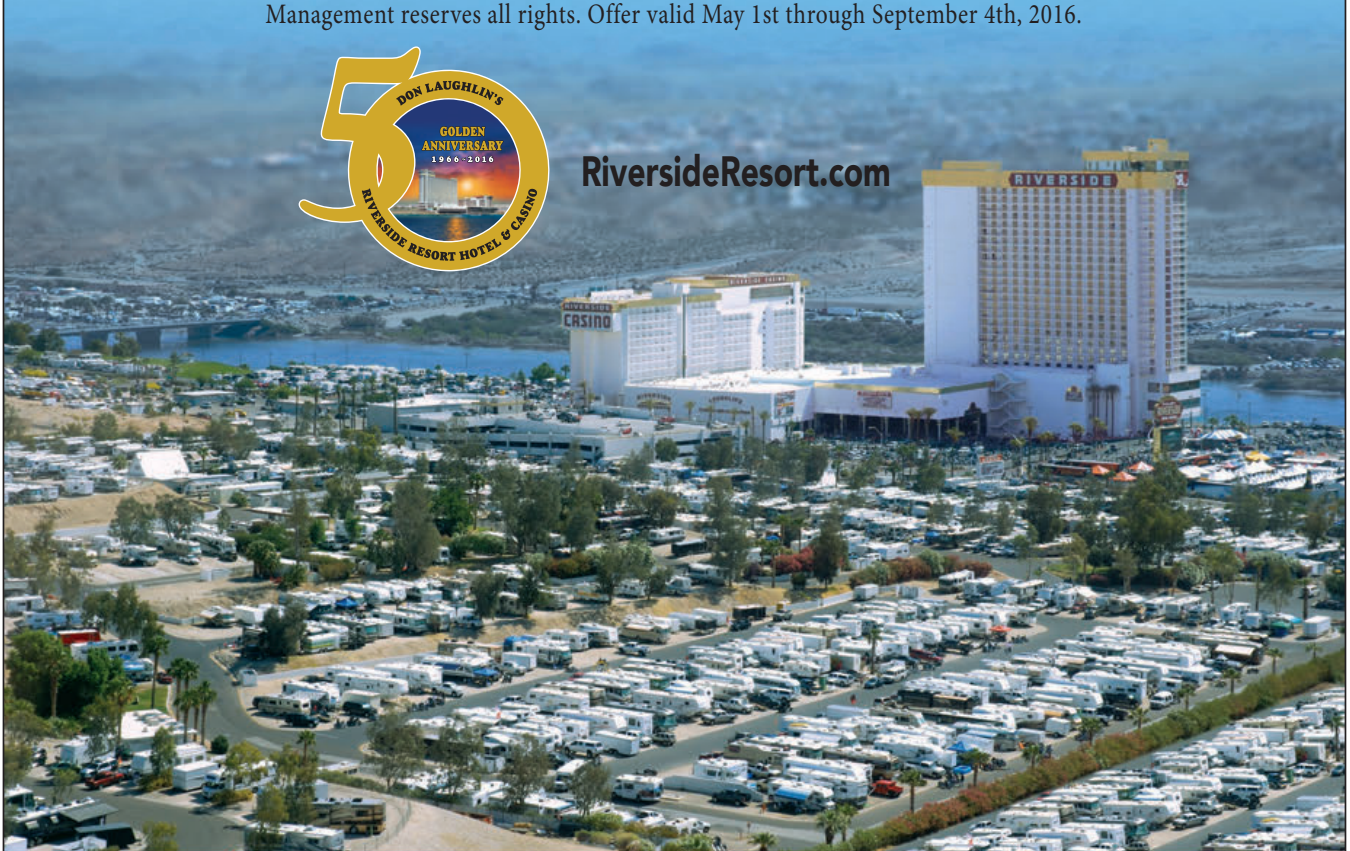



All-Seeing iBall

The iBall 5.8-GHz wireless camera takes the drama out of hitching up a trailer or fifth-wheel. To use, simply power up the iBall camera, which runs on a rechargeable lithium-ion battery, and position it on to the back of the tow vehicle. Thanks to the magnetic mount, no drilling is needed. Then plug the 3.5-inch LCD color display into the vehicle's 12-volt DC socket, and you're all set. With the help of the monitor and the camera's 120-degree view, you'll be able to quickly and easily line up the trailer coupler with a ball or a fifth-wheel king pin in the hitch saddle. The 5.8-GHz frequency avoids 2.4-GHz Bluetooth interference for clearer viewing. The weather-resistant iBall is backed by a one-year warranty.

MSRP: \$169.95

877-298-2055, www.iballhitchcam.com

Circle 162 on Reader Service Card



Overload Helpers

Need a better ride from your tow vehicle without spending a fortune? Torklift's StableLoad suspension stabilizers easily attach to the ends of upper and lower overload springs to dramatically improve handling characteristics by "pre-activating" the stabilizing effect designed within rear springs, keeping them actively under load the way the vehicle's engineers intended them to operate, according to the company. The kit also enhances the ride of vehicles equipped with air bags by lowering air pressure and activating the factory overloads. Each kit includes four stabilizers to completely outfit one vehicle, with no drilling required. The lifetime warranty includes coverage for the factory leaf springs.

MSRP: \$289

800-246-8132, www.torklift.com

Circle 163 on Reader Service Card



Faster Pedal Pusher

It's about a quarter the size of a deck of cards, yet the JMS PedalMax allows drivers to improve throttle response on 2005 and newer Ford vehicles, most 2008 to 2015 GM vehicles and many 2007 to 2014 Dodge Ram, Chrysler and Jeep vehicles, according to the company. The electronic upgrade works on gas and diesel engines to boost all-around throttle response and enhance low- and midrange torque. Simply unplug the factory connector from the accelerator pedal and plug in the supplied wiring harness. Using an optional control knob, the device can be adjusted on the fly for immediate changes in sensitivity and performance. At press time, the PedalMax was in CARB testing awaiting 50-state approval.

MSRP: \$289

601-766-9424, www.jmschip.com

Circle 164 on Reader Service Card



Lights! Music! Wireless!

RVers who enjoy sitting outside with streaming music or listening to broadcasts from smartphones or other Bluetooth-enabled devices will appreciate King's RV Media outdoor speaker and light. The waterproof fixture features 45 energy-efficient cool-white LEDs and is designed to replace the existing patio light with a simple two-wire 12-volt DC connection — no batteries to replace or recharge. The Premium version can be controlled wirelessly using a free app that offers a music equalizer, light controls and a bug light. Named Best New Item at the 2016 Northern Wholesale RV Show, the RV Media speaker/light comes in black or white. An AC-to-DC power-supply cord (\$29.99) is also available.

MSRP: \$199/Basic, \$249/Premium. 952-922-6889, www.kingconnect.com

Circle 165 on Reader Service Card





600+ Stores
Nationwide

WOW SUPER COUPON

PACIFIC HYDROSTAR 1650 PSI PRESSURE WASHER

SAVE \$73

LOT 68333
69488 shown

• 1.3 GPM

~~\$9999~~ **\$7699** comp at \$149.99

39511692

LIMIT 4 - Good at our stores or HarborFreight.com or by calling 800-423-2567. Cannot be used with other discount or coupon or prior purchases after 30 days from original purchase with original receipt. Offer good while supplies last. Non-transferable. Original coupon must be presented. Valid through 9/10/16. Limit one coupon per customer per day.

WOW SUPER COUPON

20% OFF

ANY SINGLE ITEM

LIMIT 1 coupon per customer per day. Save 20% on any 1 item purchased. *Cannot be used with other discount coupon or any of the following items or brands: Inside Track Club membership, extended service plan, gift card, open box item, 3 day parking lot sale item, compressors, floor jacks, saw mills, storage cabinets, chests or carts, trailers, trenchers, welders, Admiral, Badland, CoverPro, Daytona, Diablo, Franklin, Hercules, Holt, Jupiter, Predator, Slik-Tek, StormCat, Union, Vanguard, Viking. Not valid on prior purchases. Non-transferable. Original coupon must be presented. Valid through 9/10/16.

39515999

How Does Harbor Freight Sell GREAT QUALITY Tools at the LOWEST Prices?

We have invested millions of dollars in our own state-of-the-art quality test labs and millions more in our factories, so our tools will go toe-to-toe with the top professional brands. And we can sell them for a fraction of the price because we cut out the middle man and pass the savings on to you. It's just that simple! Come visit one of our 600+ Stores Nationwide.

WOW SUPER COUPON

FREE

WITH ANY PURCHASE

CENTECH 7 FUNCTION DIGITAL MULTIMETER

LOT 90899 shown
98025/69096

\$15 VALUE

LIMIT 1 - Cannot be used with other discount coupon or prior purchase. Coupon good at our stores, HarborFreight.com or by calling 800-423-2567. Offer good while supplies last. Shipping & Handling charges may apply if not picked up in-store. Non-transferable. Original coupon must be presented. Valid through 9/10/16. Limit one FREE GIFT coupon per customer per day.

39511207

WOW SUPER COUPON

SAVE 66%

72" x 80" MOVING BLANKET

HaulMaster

LOT 66537 shown
69505/62418

\$599 comp at \$17.97

39467427

LIMIT 4 - Good at our stores or HarborFreight.com or by calling 800-423-2567. Cannot be used with other discount or coupon or prior purchases after 30 days from original purchase with original receipt. Offer good while supplies last. Non-transferable. Original coupon must be presented. Valid through 9/10/16. Limit one coupon per customer per day.

WOW SUPER COUPON

WINNER

- Truckin' magazine

US+GENERAL

Customer Rating ★★★★★

26", 4 DRAWER TOOL CART

LOT 95659 shown
61634/61952

• 580 lb. capacity

\$11999 comp at \$349.99

SAVE \$230

39500006

LIMIT 4 - Good at our stores or HarborFreight.com or by calling 800-423-2567. Cannot be used with other discount or coupon or prior purchases after 30 days from original purchase with original receipt. Offer good while supplies last. Non-transferable. Original coupon must be presented. Valid through 9/10/16. Limit one coupon per customer per day.

WOW SUPER COUPON

PITTSBURGH AUTOMOTIVE

LOW-PROFILE CREEPER

LOT 69262
69094/61916
2745 shown

Customer Rating ★★★★★

• 300 lb. capacity

\$1999 comp at \$79.99

SAVE 75%

39500371

LIMIT 7 - Good at our stores or HarborFreight.com or by calling 800-423-2567. Cannot be used with other discount or coupon or prior purchases after 30 days from original purchase with original receipt. Offer good while supplies last. Non-transferable. Original coupon must be presented. Valid through 9/10/16. Limit one coupon per customer per day.

WOW SUPER COUPON

CENTRAL PNEUMATIC 3 GALLON, 100 PSI OILLESS PANCAKE AIR COMPRESSOR

LOT 95275 shown
60637/61615

SAVE 43%

\$4999 comp at \$89

39507013

LIMIT 5 - Good at our stores or HarborFreight.com or by calling 800-423-2567. Cannot be used with other discount or coupon or prior purchases after 30 days from original purchase with original receipt. Offer good while supplies last. Non-transferable. Original coupon must be presented. Valid through 9/10/16. Limit one coupon per customer per day.

WOW SUPER COUPON

SAVE \$29

1.5 HP ELECTRIC POLE SAW

PORTLAND

LOT 68862/62896 shown

• Extends from 6 ft. to 8 ft. 10"

\$6999 comp at \$99

39484004

LIMIT 7 - Good at our stores or HarborFreight.com or by calling 800-423-2567. Cannot be used with other discount or coupon or prior purchases after 30 days from original purchase with original receipt. Offer good while supplies last. Non-transferable. Original coupon must be presented. Valid through 9/10/16. Limit one coupon per customer per day.

WOW SUPER COUPON

PITTSBURGH AUTOMOTIVE

RAPID PUMP® 3 TON HEAVY DUTY STEEL FLOOR JACK

LOT 69227/62116
62584/62590
68048 shown

• Weighs 74 lbs.

SAVE \$75

\$7999 comp at \$155.95

39480816

LIMIT 5 - Good at our stores or HarborFreight.com or by calling 800-423-2567. Cannot be used with other discount or coupon or prior purchases after 30 days from original purchase with original receipt. Offer good while supplies last. Non-transferable. Original coupon must be presented. Valid through 9/10/16. Limit one coupon per customer per day.

WOW SUPER COUPON

SAVE \$79

10 FT. x 20 FT. PORTABLE CAR CANOPY

LOT 62858/63054/60728/69034 shown

\$11999 comp at \$199

~~\$15999~~

39491078

LIMIT 3 - Good at our stores or HarborFreight.com or by calling 800-423-2567. Cannot be used with other discount or coupon or prior purchases after 30 days from original purchase with original receipt. Offer good while supplies last. Non-transferable. Original coupon must be presented. Valid through 9/10/16. Limit one coupon per customer per day.

WOW SUPER COUPON

27 LED PORTABLE WORKLIGHT/FLASHLIGHT

LOT 67227 shown
69567/60566/62532

SAVE 58%

\$299 comp at \$7.15

Batteries included.

39503620

LIMIT 9 - Good at our stores or HarborFreight.com or by calling 800-423-2567. Cannot be used with other discount or coupon or prior purchases after 30 days from original purchase with original receipt. Offer good while supplies last. Non-transferable. Original coupon must be presented. Valid through 9/10/16. Limit one coupon per customer per day.

WOW SUPER COUPON

SAVE 40%

4-1/2" ANGLE GRINDER drillmaster

LOT 95578
69645/60625 shown

\$1199 comp at \$20.26

39493580

LIMIT 7 - Good at our stores or HarborFreight.com or by calling 800-423-2567. Cannot be used with other discount or coupon or prior purchases after 30 days from original purchase with original receipt. Offer good while supplies last. Non-transferable. Original coupon must be presented. Valid through 9/10/16. Limit one coupon per customer per day.

WOW SUPER COUPON

9 PIECE FULLY POLISHED COMBINATION WRENCH SETS

PITTSBURGH SAE METRIC

LOT 69043
69044
42304 shown
63171

YOUR CHOICE

\$599 \$899 comp at \$17.97

39466870

LIMIT 6 - Good at our stores or HarborFreight.com or by calling 800-423-2567. Cannot be used with other discount or coupon or prior purchases after 30 days from original purchase with original receipt. Offer good while supplies last. Non-transferable. Original coupon must be presented. Valid through 9/10/16. Limit one coupon per customer per day.

WOW SUPER COUPON

12" SLIDING COMPOUND DOUBLE-LEVEL MITER SAW WITH LASER GUIDE

CHICAGO ELECTRIC POWER TOOLS

Customer Rating ★★★★★

LOT 69684 shown
61776/61969/61970

SAVE \$264

\$13499 comp at \$399

39487529

LIMIT 4 - Good at our stores or HarborFreight.com or by calling 800-423-2567. Cannot be used with other discount or coupon or prior purchases after 30 days from original purchase with original receipt. Offer good while supplies last. Non-transferable. Original coupon must be presented. Valid through 9/10/16. Limit one coupon per customer per day.

WOW SUPER COUPON

900 PEAK/700 RUNNING WATTS 2 HP (63 CC) 2 CYCLE GAS RECREATIONAL GENERATOR

LOT 60338/69381 shown

SAVE \$78

\$8999 comp at \$168.97

~~\$12499~~

39500171

LIMIT 3 - Good at our stores or HarborFreight.com or by calling 800-423-2567. Cannot be used with other discount or coupon or prior purchases after 30 days from original purchase with original receipt. Offer good while supplies last. Non-transferable. Original coupon must be presented. Valid through 9/10/16. Limit one coupon per customer per day.

WOW SUPER COUPON

12,000 LB. ELECTRIC WINCH WITH REMOTE CONTROL AND AUTOMATIC BRAKE

LOT 61256/60813/61889
68142 shown

SAVE \$433

\$31999 comp at \$752.99

39508380

LIMIT 3 - Good at our stores or HarborFreight.com or by calling 800-423-2567. Cannot be used with other discount or coupon or prior purchases after 30 days from original purchase with original receipt. Offer good while supplies last. Non-transferable. Original coupon must be presented. Valid through 9/10/16. Limit one coupon per customer per day.

Buying a Used Tow Vehicle

A new heavy-duty tow vehicle can cost well north of 50 grand. When done right, buying a used vehicle can save many thousands of dollars. Great buys are out there, and it really is possible to get a clean, low-mileage van, SUV or pickup, if you know how to find them and are willing to expend the effort.

Buying any used vehicle entails some risk; whether you get a killer deal or a lemon that spends all of its time in the service bay depends on how you shop, inspect and negotiate. By following some buying guidelines, you can greatly reduce the risk and increase the odds that the tow vehicle you ultimately purchase is what you want, need and expect.

Know Your Needs

Before beginning the search, know exactly what you plan to tow or haul with the vehicle, including the RV type (travel trailer, fifth-wheel, folding trailer or truck camper) and the amount of weight to be towed. Armed with the gross vehicle weight rating (GVWR) of your trailer or the wet weight of your truck camper (total weight if available), look up the tow limits/payload capacities of the used vehicles you are considering. A good place to begin is *Trailer Life's* annual guide to tow ratings. The 1999 through 2016 guides are available online at www.trailerlife.com by clicking the Resources tab, then clicking on Towing Guides.

Pay attention to options such as body styles, engines, transmission types, gear ratios and towing packages required to obtain the maximum ratings, and always leave a sufficient weight margin for passengers, cargo, fuel and other items carried. The heavier the RV, the narrower the vehicle choices become and the more expensive.

Most buyers are also interested in factors such as trim levels, colors, extras and, of course, price. Make sure to discuss the choices with experienced RVers, check the online RV forums and read everything you can find about each vehicle, including reviews by experts and owners, and towing tests, if available. After you have that out of

the way, make a list of the features you want and your price range.

Once you narrow the search to one type of tow vehicle (for example, a heavy-duty pickup with dual rear wheels and a crew cab), you'll need to determine the engine size and type (diesel or gas). When you get up into the dually models, the engine choices become more limited, such as one gas model and one diesel, but many so-called half-ton and three-quarter-ton trucks (150 to 250 series and 1500 to 2500 series) offer several engine choices in gas, turbocharged gas and diesel.

(Below) When shopping for a used pickup, visit a dealership that specializes in light trucks to compare different models all in one place. (Bottom) Diesel engines can last a long time but are expensive to fix. Check them carefully and have an independent inspection done before buying.



Trailer Life's annual *Guide to Towing* is a helpful resource when comparing tow ratings for a variety of vehicles and model years. The 1999 to 2016 guides are available online at www.trailerlife.com.

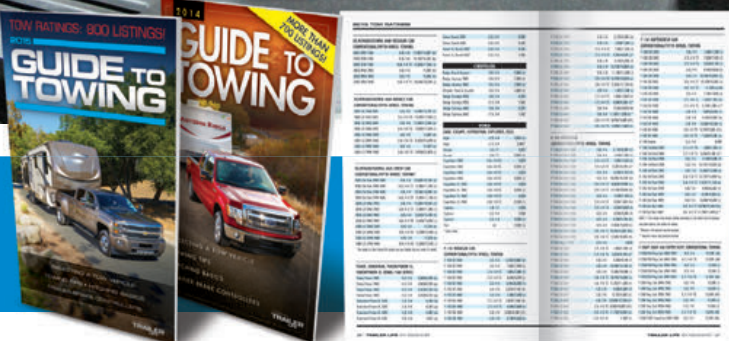



Look for mismatched paint, waves in sheet metal, uneven panel fit and gaps around panels as indicators of past damage.

With specific makes and models in mind, you have a basis to do some Internet research. To find common maintenance problems, use a search engine such as Google and type "problems with," followed by the specific year, make and model you are interested in. *Consumer Reports'* annual *Used Car Buying Guide*, available in print and online, is another source of information with year-by-year reliability ratings and price ranges for many used vehicles. Market-value price ranges can also be found on the Edmonds, Kelley Blue Book and NADA Guides websites. The TrueCar dealership website and eBay Motors auction site both show transaction prices from actual sales.

Narrow the Field

Today, there are more ways to shop for a used vehicle than ever. Besides the traditional newspaper classifieds and dealership ads, and weekly and monthly tabloids, countless websites post cars and trucks for sale, with more coming online all the time. Sites like Autotrader, Cars.com, CarsDirect and CarGurus list used vehicles from dealerships and private parties, and many provide online reviews, photos, pricing and access to vehicle-history reports. AutoTempest takes things a step further by combining vehicles for sale on Craigslist and eBay with dealer and private listings from some of the major automotive-sales sites.

One of the biggest considerations is whether to buy from a dealer

A Smooth Air-Ride 5th Wheel Hitch in an easy to remove package

HENSLEY

Introducing!

TRAILERSAVER

BD3 5th Wheel Hitch



- Eliminates 97% of road shock
- Solid Holland-Binkley style head
- 1 1/8" thick jaws that completely encircle the kingpin
- Assembles in two pieces for easy installation and removal
- Fits standard rails

Call 1-800-410-6580 for more information

HENSLEY

800.410.6580 • www.TrailerSaver.com

The Quality Alternative to High Cost Boats



Motor
Optional

Fish remote ponds, bays, lakes and wide rivers in the Sea Eagle® SE9 MotorMount Boat. Removable reinforced inflatable floor & seats make this boat lightweight & extremely portable. Transport in your car trunk, flatbed, RV compartment, by plane... the options are endless! Everything you need to get to your favorite fishing hole is included with the Fisherman's Dream Package: oars, foot pump, two inflatable seats, motormount and carry bag.

Best of all, it's just 499* complete!

(*NY & WA residents add sales tax.)



Fits in
a small
trunk.

SEA EAGLE.com

Join us on
SeaEagleBoats

For more information, visit our website

Or call 1-800-748-8066 M-F, 9-5 EST

Ask For Color Catalog Sea Eagle Boats, Inc.
19 N. Columbia St., Dept. TL066B, Port Jefferson, NY 11777

50,000 New & Used Towable RVs For Sale By Owners & Dealers

BUY



PERFORMANCE CORNER



(Above, from left) Check sideview mirrors for damage, noting that replacement mirrors can be expensive. Inspect brake-pedal pads for wear compared to claimed mileage; wear at the corner of the pedal pad indicates high mileage and/or city driving. Yellowed headlight plastic may indicate that the vehicle has been left out in the weather, rather than being garaged.

(including auction houses) or a private party. Each way has its pros and cons. Most dealers offer some kind of limited warranty on used vehicles or will help if anything goes seriously wrong shortly after purchase (make sure to get that in writing, if possible). You have some recourse with a dealer through various governing agencies and the Better Business Bureau. With auctions, you can usually return the vehicle only if the title paperwork isn't good. Private sales can be cheaper, but you could be stuck if the vehicle has a major problem.

If you are looking for an unusual

model, you have a better chance of finding it on eBay and national websites than through local sources, but be sure to check the seller's feedback ratings and read the comments, both positive and negative, before going any further. When shopping for vehicles from private parties, particularly on Craigslist, be aware that scammers can prey on unsuspecting buyers, so be cautious.

A quick way to get started is to go to dealerships that sell the type of used vehicles you are interested in to see them up close and test-drive them. The larger the selection,

(Below, from left) Look for signs of leaks on and under the engine, transmission and axles. Check the hitch rating to make sure it's enough for the trailer you plan to tow.



SEEMINGLY SMALL DIFFERENCES IN GEAR RATIOS CAN MAKE HUGE

SELL

Millions of RV Buyers!

Place a Free ad today



the better. Look at as many similar competing models as possible to narrow your search, and always inspect a used vehicle carefully before making a purchase.

When shopping online, you can narrow the search to used vehicles near you or widen it, if you are willing to travel to pick up the vehicle or have it shipped. If you decide to have the vehicle shipped, an online search for "vehicle shipping" will show the companies that can transport it. To bring buyers and vehicles together, Carmax offers free transfers of some of the tens of thousands of vehicles at the company's 150 used-car lots.

Ask Specific Questions

Asking the right questions during an initial phone call can often save a trip to see a vehicle that's not worth the time or effort. Prepare a list of questions appropriate to the type and model you're calling about. Start with some general questions, such as: How long have you had the vehicle? Do you use it for daily driving, commuting or just for towing? When and where did you buy it, new or used? What was the mileage? What is the current odometer mileage? Has the odometer ever been inoperative, broken or replaced? Has the vehicle ever been in an accident?

Continue asking for specifics: Are you financing the vehicle, or do you own it? Do you have the clear title? (You can't complete a sale without a lien release and title.) Can you tell me about prior owner(s), how they maintained and used the vehicle and what maintenance and repairs have been done? Do you have service records? What is the mechanical and electrical condition and cosmetic appearance of the vehicle now? Are there any minor or more serious problems? Do you have the Vehicle Identification Number (VIN) for this vehicle?

Prior to making a trip to see the vehicle, use an online service such as CarFax or AutoCheck to look up its history using the 17-digit VIN or the license-plate number. This can help confirm the odometer reading and previous ownership, and tell you if the vehicle was stolen, wrecked, salvaged or had safety recalls, but be aware that a clean report doesn't guarantee that the vehicle hasn't been damaged. You can also check www.recalls.gov/nhtsa.html for National Highway Traffic Safety Administration recalls.

Inspect the Vehicle

If a vehicle has been neglected, it's fairly easy for the seller to make it



**THE
LAST ROOF
YOUR RV WILL
EVER NEED.**



GUARANTEED.



**NEVER GET ON
YOUR ROOF AGAIN.**

Finally, there is a Convenient, Affordable, Permanent, Guaranteed RV Roof.

- ✔ The "Direct Bond" new RV roof system with a manufactured, custom fit.
- ✔ **Lightweight:** Seamless, and maintenance free.
- ✔ **Convenient:** Don't Move! We'll come to you and install your new roof. Two-day process with nationwide service.
- ✔ **Affordable:** Less expensive than a traditional roof replacement.
- ✔ Bonds directly over rubber, metal, fiberglass or wood decking.

FINANCING AVAILABLE

**www.RV-ARMOR.com
Call 855-RV-ARMOR (855-782-7667)**

**FIND OUT WHY MANY EXPERTS
CONSIDER RV ARMOR THE
ULTIMATE RV ROOFING SOLUTION**

RV ARMOR is a Federally Registered Trademark of RV Armor, Inc. All Rights Reserved.

**ES IN VEHICLE OPTIONS AND
DIFFERENCES IN TOW RATINGS.**

look good for a first impression with a thorough cleanup, buffing and detailing. However, don't let cosmetic appearance lull you into ignoring your due diligence. If you plan to check the vehicle yourself, bring some basic tools, including a flashlight and multimeter. Tell the seller you want the engine cold (preferably sitting overnight) when you arrive.

Walk around the vehicle and carefully note any signs of rust or

damage to metal, trim, glass or paint, wavy or distorted body panels, and uneven gaps around the doors, windows and other body panels. Inspect the frame; there should be no cracks, rewelds or other signs of damage. Tires should match and have good tread all the way across with no signs of uneven wear or damage. For all wheel types, look for dents or damage to the rims and tires. Peer into the brake calipers to

see how much of the pads are left and check on rotor condition.

Check the oil; a low level or dirty oil in a gas engine indicates neglect. Check the automatic transmission fluid level and color; it should be a nice, healthy pink color. Brown fluid indicates a transmission that has overheated and could fail in the near future. Inspect the condition of the engine, wiring and radiator. Check for leaks on and under the engine, transmission and axles. Look at the brake-fluid level and color. Fluid should be honey-colored; a very dark color indicates old fluid that may lead to master- and brake-cylinder or caliper failures.

Clip the multimeter leads across the battery terminals and check voltage. It should read no less than 12 volts DC at rest; 12.6 volts DC is ideal. Start the engine and listen for cranking speed. Does it sound strained or like the battery is weak? Voltage should read between about 13.6 and 14.6 volts at above idle. High or low voltage indicates charging system problems. Check the lights, turn signals, wipers, windows, locks and dashboard controls to confirm they all work.

If everything checks out, ask to take the vehicle to an independent mechanic for a complete diagnostic inspection.

Take a Test Drive

If possible, choose a nice day for the test drive with dry roads, high visibility and a route that has light traffic and good road conditions.

While on a straight, empty road, weave left and right to see how the steering feels and whether the vehicle pulls to one side or tracks poorly. Floor the accelerator when merging onto a highway to see how it responds, and look for tailpipe smoke on gas engines (most diesels will smoke on acceleration). Check all the gauges and note if any warning lights are on.

Listen for unusual engine or suspension noises, or rattling and undue vibration. Check the condition of the clutch (manual transmission) by accelerating hard in top gear



Parkit360°

Move any trailer with our compact, powerful, battery-powered trailer dolly.



Won't tip, tilt or pivot with *Stablelock* technology

Smart trailer brakes option

Simple forward & reverse thumb control rocker

Ability to freewheel



Model shown (Force) supports: Tag-Along and Pintle
Transformer supports: Gooseneck, 5th Wheel, Tag-Along and Pintle

www.parkit360.com
1-888-926-5517

while going up a hill. Listen for the engine revving up, which indicates slippage. Also note any chatter during initial engagement.

Test the brakes, which should engage smoothly and evenly and not grab violently or feel spongy. They should also not pulse or vibrate, which indicates faulty rotors or drums.

After the drive, check for leaks or fresh drips. Ask the seller about anything that concerns you, and again, ask to take the vehicle to a mechanic, if you have any doubts.

Close the Deal

When you're ready to make an offer, get the current market value using the pricing websites noted above and taking into account the vehicle's mileage and condition. Then set your buy price accordingly and be realistic when negotiating. For private sellers, this vehicle may be their baby, and a lowball offer may offend them. Most will consider discounts in the 10 percent ballpark. If you're at a dealership, realize that salespeople have a boss looking over their shoulder. Come in knowing what price range you are willing to offer, then adjust it after you inspect and test-drive a vehicle.

Generally, sellers expect at least a sizable deposit (typically around 10 percent of the total), if you agree on a price. The agreement should stipulate how long you have to deliver the balance and any other terms, including a warranty, in writing, with duplicates signed by both parties. Often, a better deal can be negotiated if full cash payment is offered and the deal is consummated immediately.

Before making a purchase, check the title and registration papers, and verify that the stamped numbers match the paperwork. Carefully inspect the title and hold it up to the light to check for watermarks. It's helpful to look at a known good set of numbers on a similar model vehicle so you know what the original numbers look like. Photograph them and keep the image on your smartphone for comparison.

Most titles have an area where lienholders are listed. If the lienholder has not signed off and provided a lien release, the vehicle can't be legally transferred to another owner. Ask for the seller's driver's license, compare it to the name and address on the title, and write down the details.

Make sure the vehicle registration is current. In some states, an expired registration can result in fees and penalties for the new owner, and

violations such as parking tickets may even become the buyer's responsibility.

California requires special emission-control equipment, and vehicles that are not California certified must have more than 7,500 miles on them to be brought into the state and registered. Wherever you live, check your state's regulations to avoid difficulties transferring the title, and know how many days you have to report a change of ownership. 🚗

Sway Master[®] Electronic Sway Control

Bringing Sway Control Into the 21st Century



- Eliminates sway electronically using solid state gyroscope and GPS
- Provides simultaneous braking when sway is detected bringing your trailer back to centerline.
- Easy Plug-n-Play installation

Don't Let This Happen To You!



Made in USA 



Patent Pending



When your safety depends on it™

www.hayesbc.com

Good Sam Finance Center

Questions & Answers



Now is the time to purchase a new or used RV or refinance your existing RV loan. Check out some of our frequently asked questions to see how the Good Sam Finance Center can get you out on the road!

Is refinancing at a good rate still possible?

Yes! Now may be a good time to refinance your current RV loan and lower your monthly payments. And remember, our loans have no pre-payment penalties if you decide to pay the loan off early.



How do I know I'm getting a good rate?

We offer a range of loan terms from five to 20 years, depending on the loan amount and age of the RV. Our short term loans with lower rates have become popular, helping customers pay off their loans more quickly.



Do you finance private party RV loans?

Yes! You can purchase a 2008 model year or newer rig from a private party seller in your town or from across the country. We'll pay off the seller, put the new registration in your name and handle all necessary paperwork.



Are your rates the same for new and used RV purchases?

Yes! Our rates are the same whether you purchase a new or used rig from a dealer or a private party seller across town or across the country.

I'm a Full-Timer. Can I get financing for my RV?

Yes! Good Sam Finance Center offers financing to purchase or refinance the perfect RV to call home.

APRs* AS LOW AS

3.79%**

on loan amounts of \$50k+

4.19%**

on loan amounts of \$25k to \$49,999

APR is fixed for the life of the loan. Other rates with different loan terms are available. Rates are accurate as of March 17, 2016. See our website for current rates and terms, as well as financing for Full-Timers and loan amounts below \$25,000

CALL

1-800-444-1476
mention priority code 552

VISIT

GoodSamRVLoans.com/552



Good Sam
RV Loans

* Estimated APR (Annual Percentage Rate). Subject to consumer loan program requirements and credit approval. Certain fees, closing costs, and restrictions may apply.

** Rates and terms may vary with market conditions and are subject to change without notice. APR applied to the loan is the APR in effect on the date the application is received and is valid until 30 days after the loan is approved. APRs may vary with loan term. For a refinance request, RV must be 2006 model year or newer. For a purchase request, RV must be 2008 model year or newer. Maximum loan to value is determined by the following: credit score and model year, with collateral value being established per NADA Used Wholesale Base Trade-in value. Maximum loan term may vary based on model year, loan amount, and lender guidelines. Example of a recreational use RV loan: A 7 year fixed-rate \$55,000 loan. Based on an APR of 3.79%, this loan has 84 monthly payments of \$746.48 each.

Good Sam Finance Center™ provided through Essex Credit, a division of Bank of the West.
© 2016 Bank of the West. NMLS ID #19116. Member FDIC. GRL47365 - 0316



EQUAL HOUSING LENDER

"SUMMERIZING" RVs

Q Every year we see articles about winterizing an RV, but we never hear about "summerizing" an RV. Snowbirds who park their RVs year-round in places like Florida and return to them in the winter months have told me that before you leave in May and return home, you should coat the rubber roof with a UV protectant and place trays of kitty litter inside to prevent black mold from forming.

Can you provide more information on this subject?

James Recco, Albion, New York

A Summerizing RVs isn't quite as complex as winterizing because you don't have to worry about freezing weather bursting pipes and water tanks. Kitty litter is one way of absorbing some of the moisture inside, but there are other types of drying agents that are far more effective. I also recommend allowing a little ventilation all the time by keeping a vent slightly open (with a screen to keep critters out and a roof-vent cover such as MaxxAir or Fan-Tastic Vent, available from Camping World (www.campingworld.com) and other RV dealers.



Dicor (www.dicor.com) makes many of the EPDM roofs used on RVs and also makes good products for maintaining them, including the cleaner and acrylic coating that is designed for protecting roofs from weather and sunlight.

All systems should be operated and tested. Batteries should be checked, and terminals cleaned and tested. Another important task is taking care of the freshwater system. After the RV has been in storage, the tank should be drained and refilled, while adding ¼ cup of bleach for each 15 gallons of water. Then a box of baking soda can be added to freshen up the water's smell and taste. Water should be run through all the plumbing, the pump should be activated, and the campground water pressure should be tested on the RV. — **Ken Freund**

TOWING WITH FRONT-WHEEL DRIVE

Q Is it ever advisable to tow a trailer with a front-wheel-drive vehicle?

Robert Smith, Indianapolis, Indiana

A Generally, it's preferable to tow with rear-wheel drive (RWD) or all-wheel drive (AWD), rather than front-wheel drive (FWD). That's because as you place weight on a hitch out behind the rear axle on a FWD vehicle, it has a lever effect that tends to lift weight off the front (drive) wheels. Also, as the vehicle accelerates, the resistance of the trailer unloads the front end and further reduces drive-wheel traction, increasing the likelihood of wheel spin, especially when climbing hills and accelerating hard.

It's worse on wet and slippery surfaces. Traction control may reduce wheel spin but can't change the physics of the situation. Having said that, there are some FWD models that have a usable tow rating, particularly some minivans and cars with forward weight biases. Check *Trailer Life's* annual tow-rating guide for listings of vehicles and their tow limits. — **K.F.**

BATTERY BYPASS

Q I have a 2014 Keystone Cougar High Country travel trailer that came with a battery-bypass switch. Can you please explain how this switch should be used? If my trailer is plugged into land power, should the bypass switch be set to on or off? If I am dry camping, what should

the switch be set to? I remove the battery in winter for storage, and I was told I should set the switch to off.

Nick Shirilla, Boardman, Ohio

A We're a bit confused by the term "battery-bypass switch," Nick. Could you mean "battery-disconnect switch?" The disconnect switch, as the name suggests, disconnects the battery from the RV's 12-volt DC circuit. This is mainly done when the RV is placed in storage to avoid discharging the battery, due to the parasitic draw from some 12-volt DC accessories.

Try this: With your trailer unplugged from shorepower, turn on some interior 12-volt DC accessories such as lights or the stereo. Activate the "bypass" switch, and see if the lights and devices shut off. If so, and I believe you'll find that's what happens, it's a disconnect switch.

Leave that switch on any time you're using the RV, including when it's plugged in to shorepower. That's what allows the 12-volt DC charging current to flow from the converter to the bat-

THE TECH TEAM



KEN FREUND: Ken is a former ASE Certified Master Technician, service manager and shop owner who has authored numerous books on automotive repair.



JEFF JOHNSTON: Jeff served as technical director of *Trailer Life* for 20 years and has been an RV enthusiast, mechanic and writer since he could hold a wrench.

tery. You'll especially want it turned on when dry camping because that's what connects the battery to the RV. With the battery removed for winter storage, the switch is a moot point because there's no 12-volt DC power connected to the system, so on or off doesn't matter in that case. — **Jeff Johnston**

BENT-AXLE BLUES REVISITED

Q In the "Bent-Axle Blues" Q&A in April's RV Clinic, Robert Hartnell asked if others had issues with bent axles. We had a Jayco 26BH, and the right-rear tire had a slow leak, so I took it to a friend who has a garage. He fixed the leak and pointed out that the tire was wearing crooked from one side to the other. He said it was most likely caused by a bent axle or bent spindle.

I took the trailer to Camping World in Harrisburg, Pennsylvania, and axle measurements were taken. The rear axle was bent. I weighed the trailer, and it was 1,100 pounds under gross weight.

I never hit curbs and avoid potholes.

Camping World contacted Jayco, and Jayco referred them to Dexter Axles, the maker of the trailer's axles. Camping World contacted Dexter and sent it the measurements. Dexter refused to replace the axle. We paid just over \$1,000 to have the axle replaced.

Although Hartnell didn't specify the manufacturer of his axles, I wonder if there may be a manufacturing defect. What do you think? Are others having issues with axles made by Dexter?

Rick Aurand, Harrisburg, Pennsylvania

A I don't get a lot of reports of faulty axles, and most of them can be attributed to impact damage after installation or overloading, rather than manufacturing defects. I know you say you never hit potholes or curbs, but I also know that Pennsylvania's roads have many potholes due to frequent frost cycles, and everywhere there are curbs just waiting for you to make a tight turn. From the driver's seat, it's

entirely possible not to feel an impact that may tweak an axle.

Here is a URL for handy instructions on how to simply and inexpensively check axle alignment yourself: www.centrevilletrailer.com/how-to/trailer-axle-alignment-trailer-tire-wear. — **K.F.**

FORD ROUGH IDLE

Q We have a 2004 Ford F-250 4WD with a V-10 engine. It has a Banks PowerPack system with headers, an engine and trans chip, and a special air filter. The truck has 75,000 miles, 75 percent of which are from towing. Lately, the truck has a rough idle when starting for the first time in the morning. The idle ranges from 1,000 RPM to about 500 RPM. This idle goes up and down until the truck reaches operating temperature. Then the truck runs fine for the rest of the day, and it does not matter what the morning temperature is.

Mark O'Connell, Rockledge, Florida

A A number of things can cause this surging at idle. Usually it is caused by something that upsets the air-fuel ratio. You didn't mention if the Check Engine light is on or if you've checked for stored trouble codes. Without that information, I have to generalize. Since the aftermarket products were on there for a while, and no problems occurred, it's likely that they are not a cause.

I've seen a lean condition caused by an air leak into the intake manifold cause this "hunting" up and down. Causes include a cracked vacuum hose or gasket leak around the intake manifold or throttle body. Sometimes a mass airflow sensor may be dirty (there are products made specifically to clean them) or a temperature sensor is going bad. As the engine warms up, the engine control unit (ECU) is able to offset the problem so the surging stops. — **K.F.**

HOLDING-TANK VENT SOLUTION

Q I have a 2013 Rockwood 8285WS fifth-wheel by Forest River with a separate 46-gallon kitchen-sink holding

h innovations housing

15th-Annual Charity Raffle

WIN

a New Winnebago Forza Motorhome

— or —

a Quarter of a Million Dollars in Cash!

All proceeds benefit Innovations Housing, a 501(c)(3) nonprofit organization that builds affordable homes for low-income families around the world.

Raffle monitored by Redwine & Tegerstrand, CPAs of Redding, CA. State of California, Department of Justice Raffle Registration Number R-173. Must be over 18 to enter. Void where prohibited. Winner need not be present to win.

Winner will take home a new 38-foot Winnebago Forza motorhome or \$250,000.00. Winner responsible for taxes, title and license.

To purchase tickets with a Visa, MasterCard, Discover or American Express call **+1 (800) 764-8096** toll free or **+1 (530) 243-5693**. or mail a check to Post Office Box 991846, Redding, CA 96099-1846, USA. For more information visit www.innovationshousing.org.

Tickets Only \$100.00 Each

No More Than 7,500 Tickets Will Be Sold

Drawing Will Be August 31st, 2016

Innovations Housing, Circle 121 on Reader Service Card

tank. In just a few days of use, this tank produces a sewer smell that escapes from its 1½-inch vent line. When the smell escalated to unacceptable, my wife suggested we get rid of the RV.

Allyn Brunet, Phoenix, Arizona

A We get a fair number of letters from readers who have holding-tank odor problems. Many RVs have a hidden vent under the sink that only allows air in but not out. This vent often fails and allows holding-tank odor to be expelled into the RV. Replacing the vent from an RV or plumbing-supply store solves the problem. Using a chemical deodorizer available at RV-supply stores might do the trick. — **K.F.**

REFRIGERATOR BOOST

Q I am having operational problems with the Dometic refrigerator in my 2014 Forest River Saber fifth-wheel that are similar to those Don Frank and Michael Gleason mentioned in "Refrigerator Fans Revisited" in the July 2015 RV Clinic. What was the portable shade that was discussed, and what can be done about operating noise?

John Taylor, via email

A The shade we mentioned was to be a homemade fabric model assembled by the user to block the sun, rather than an accessory from an RV shop.

RV refrigerators don't use compressors, so they run very quietly except for the LP-gas burner. If you hear a motor-type noise, it could be that someone installed an aftermarket air-circulation fan on the cooling coils and that fan could be out of balance or contacting something. In addition, some manufacturers install circulation fans if the refrigerator is located in a slideout room, due to the less-effective venting in a slide. Check the factory fans for the problems noted above.

It's also possible that the noise you hear is the converter. When in use, a cooling fan kicks in on the converter, and if it's close to the refrigerator, you may be hearing that noise. When you hear it, try having someone unplug your RV to see if the noise stops. — **Jeff Johnston**

FIFTH-WHEEL TRAILER SELECTION

Q My wife and I are looking for a new fifth-wheel in the 29- to 32-foot range, towable by our half-ton Chevy Crew Cab, which has been used to haul an 8,900-pound 1995 Fleetwood Prowler fifth-wheel for 19 years now with no problems. We're considering trailers with one or two slideouts, hitch weight of less than 1,500 pounds and gross

weight of less than 9,300 pounds.

We need your opinion on the best manufacturer of a fifth-wheel in this weight range and priced at around \$40,000.

Glenn Brown, Willis, Texas

A We can't tell you which fifth-wheel manufacturer is best for you, Glenn, because that's something you'll need to learn by a process of



Protect Your AC Unit and Satellite Dish!

The GiraffeG4 System will tell you the exact height of the Bridge, Trestle, Campground Tree and Gas Station Canopy you've encountered, so you don't hit it.

www.GiraffeG4.com
1-877-543-1087

Giraffe G4 Systems, Circle 112 on Reader Service Card

Hook it up Yourself with a WIRELESS CAMERA!



iBALL

Wireless Trailer Hitch Camera

- 100% Wireless & Portable
- Easy—Installs in Seconds!
- Magnetic & Submersible Camera
- Trailers (Boat, Camper, Horse, ATV, Livestock and More!)

Info/Buy Now: 1-877-298-2055 or visit our website at:

\$169⁹⁵ w/Free US/CDN Shipping
SAVE \$30 Today! Use Promo Code TL616

www.iballhitchcam.com

iBall Hitch Cam, Circle 127 on Reader Service Card



RVAWNINGSMART.com

**QUALITY RV AWNING
FABRICS & ACCESSORIES
AT UNBEATABLE PRICES!**

AWNING FABRICS

AWNING ACCESSORIES

SLIDE-OUT FABRICS



SUN-SHADES

AWNING MISTING

AWNING LED LIGHTS



(574) 966-5698

www.RVAwningsMart.com

RVawningsmart, Circle 103 on Reader Service Card

shopping around and keeping an eye on user forums and talking to RVing buddies. What constitutes the “best manufacturer,” beyond the basics of what components are used in the trailer and how it’s assembled, will also rely on other factors. These include, but are not limited to, convenient access to the dealership from your home, dealer- and service-department reputation, overall manufacturer reputation for warranty work, and so on. These all come into play with shopping around and RV ownership, and they all count toward finding the best RV for your investment. — J.J.

E-Z LUBE AXLE QUESTIONS

Q Our 2011 Passport has Dexter E-Z Lube axles, and I’m trying to get information on do-it-yourself greasing. I am being told that I should not do it. But if I decide to do it, what precautions should I follow to keep the grease from getting on the brake shoes?

Steve Rogers, Matthews, North Carolina

A E-Z Lube axle maintenance is a subject that keeps arising here, so we’ll cover it again. The best source of information is the axle owner’s manual, and you can also find the information online by searching for “Dexter E-Z Lube Axle Maintenance” on Google. The data is available from the factory and via assorted how-to videos.

Contrary to campfire talk, the E-Z Lube axle was not developed for the RV industry. E-Z Lube axles were originally designed for boat trailers because the axles are frequently immersed in water. Use on a boat trailer calls for more frequent bearing maintenance than is required on an RV, including forcing out any water that remains in the bearing area.

Dexter maintains that, for RV use on dry land, you do not need to add grease to E-Z Lube hubs as long as you follow the recommended annual inspection and bearing-repack maintenance schedule. However, you can add grease if you really want to — just pump a little bit in very slowly to allow the old grease to exit the port at the outside of the hub.

Owners get into greasy brake problems when they pump in the new grease

THE ORIGINAL
Equal-i-zer.
SWAY CONTROL HITCH

For more than
70 years, we have
built the safest,
best performing,
highest-quality
sway control hitch
on the market.



READER'S
CHOICE
GOLD
AWARD
WINNER
2012 - 2015



The best protection for your journey.™

EqualizerHitch.com • 800-478-5578



Progress Manufacturing, Circle 130 on Reader Service Card

READER SERVICE

too fast, which tends to push the grease past the seals and into the drum area. Unnecessarily adding grease too often can only exacerbate the problem.— J.J.

TRAILER PARKING BRAKES

Q Can the emergency breakaway switch be used as a substitute for tire chocks? If not, why not? I am talking about pulling the pin to lock the brakes once the trailer is level at the campsite.

Steven Metheny, Springfield, Oregon

A No, you absolutely *do not* want to use the trailer's electric brakes as "parking brakes" in lieu of wheel chocks! The electric brake mechanism does not work that way. Trailer brakes depend on the tire rotation engaging the brake magnet, which provides leverage on the brake-shoe actuators, to produce the force necessary to apply the brakes. When the tires are not turning, there's no braking force. In addition, the brake magnets are not meant for continuous duty and would overheat and/or draw down the batteries very quickly. Haul along a set of tire chocks, and you'll have all the parking-brake performance you need for very little money.— J.J.

NEW COMPARTMENT LOCKS

I discovered that many storage-compartment locks on RVs come with the same CH751 key. To make them more secure, these locks and keys can be replaced with Prime Products' keyed cam lock (part number 18-3315). They come four to a package, all keyed alike, and the cost is less than \$20 on Amazon.

L.C. Kirkley, Temple, Texas

Thank you, L.C. Installing aftermarket locks is a good way to improve compartment door security.— J.J. 📧

HAVE A QUESTION? » Email our experts at rvclinic@trailerlife.com or write to RV Clinic, 2750 Park View Court, Suite 240, Oxnard, California 93036. Include your full name and hometown. Selected letters will be answered in the magazine, but time does not permit individual replies. No phone calls, please.

ADVERTISERS' INDEX

RS#	ADVERTISER	PAGE#
101	Augusta RV LLC	5
102	B&W Trailer Hitches	43
104	Bully Dog Technologies	2
	Camping World	55-57
105	Carefree of Colorado	10
	Classifieds	78-79
106	Continental Coach	
	by Forks RV	15
108	DISH Network	49
107	Danko Manufacturing, Inc.	36
109	Escape Trailer	59
110	Furrion	35
111	Geico	27
112	Giraffe G4 Systems	73
	Good Sam Extended	
	Service Plan	30
	Good Sam RV Loans	70
	Good Sam Roadside	
	Assistance	81
	Good Sam Visa	25
	Harbor Freight Tools	63
113	Hayes Brake Controller	69
114	Heartland Recreational	
	Vehicles, LLC	33
115	Hensley Manufacturing Inc.	15
116	Hensley Manufacturing Inc.	65
118	Highland Ridge RV, Inc.	51
127	iBall Hitch Cam	73
120	Icon Technologies	7
121	Innovations Housing	72
119	Insight by Hopkins	84
122	King	39
123	Lippert Components	29
	Members Life Insurance	12
124	Michigan Truck Spring	12
126	Northwood Mfg.	28
128	Pala Casino Spa & Resort	19
129	Park It 360	68
130	Progress Manufacturing, Inc.	74
131	Progressive Insurance	9
132	Protect All Inc.	38
133	Purple Line LLC	13
135	RV Armor, Inc.	67
	RV Buyer's Guide	50
	RV Marketplace	76-77
125	RVT.com	66
103	RVawningsmart	74
134	Riverside Resort & Casino	61
136	Sea Eagle	65
138	Thetford Corporation	83

ADVERTISERS' INDEX

RS#	ADVERTISER	PAGE#
139	Torklift International	14
160	Transfer Flow Inc.	8
117	Viking Cylinders by	
	Hexagon Ragasco	23
137	Weekend Warrior	
	Toy Haulers	45
161	Yamaha Outdoor	
	Power Equipment	37

EDITORIAL PRODUCT INDEX

RS#	ADVERTISER	PAGE#
162	iBall Camera	62
164	JMS PedalMax	62
166	Jayco Pinnacle	26
165	King Connect	62
163	Torklift	62
167	Weekend Warrior	20

FREE TRAVEL INFORMATION

RS#	ADVERTISER	PAGE#
140	Alaska and The Yukon	80
141	Alaska Marine	
	Highway System	80
143	Arkansas State Parks	80
145	DeGray Resort State Park,	
	Arkansas	80
146	Florida Keys	80
147	Florida State Parks	80
154	Glacier National Park,	
	Montana	80
144	Hot Springs National Park,	
	Arkansas	80
150	Idaho RV Campgrounds	80
149	Idaho Travel Council	80
148	Lake Harris RV Resort,	
	Florida	80
152	Lake Of The Ozarks,	
	Missouri	80
142	North To Alaska	80
155	Ohio State Parks	80
151	Visit Missouri	80
153	Visit Montana	80
157	Wyoming Tourism	80
158	Yellowhead Highway,	
	Canada	80
156	Yellowstone Country,	
	Wyoming	80

While every effort is made to maintain accuracy and completeness, last-minute changes may occasionally result in omissions or errors.



BullRing®

America's Best Selling Truck Anchor Points For Ford, Chevy, GMC, Tundra and Ram trucks



BullRingUSA.com
(888) 879-2855

Available at  Search Bull Ring

Idaho Tote

"NO JACKKNIFING!"



The IDAHO TOTE is attached and not drawn as a regular trailer.
 Simply put:
"YOU DO NOTHING BUT DRIVE!"

- 3000 lb GVW
- Pressure sensing steering axle
- Steers traveling forward or backing up



IDAHO TOTE DOLLY, INC.
www.idahotote.com
 Call 208-276-3203 or 509-751-6297

A NEW CHOICE

Replace your RV Refrigerator Cooling Unit with an all NEW Replacement Cooling Unit
 Made in the USA



Ask us about our NEW Non-explosive HELIUM designed unit

 Dutch Aire

JC Refrigeration is a small and growing business at the heart of the RV industry. With over 21 years of manufacturing experience, we have a reputation you can depend on!
 Our goal is to bring a smile to your face as you enjoy wonderfully cold refrigeration on your travels for years to come.

Get it factory installed or we can ship to your door!

 Phone: (260) 768-4067
 Fax: (260) 768-4424
 Shipshewana, IN 46565
 www.jc-refrigeration.com
 *jcref@centurylink.net

TireTraker™

Tire Pressure Monitoring Systems



TT-500
 The Most Innovative TPMS On The Market Today With A "Lifetime Warranty"

- Pressure & Temperature Monitoring
- USB Rechargeable Monitor
- Monitors Up To 22 Tires (0-232psi)
- 0.5 oz. Sensors - Lightest on Market
- User Replaceable Sensor Batteries
- Visual & Audible Alarms
- Automatic Update Feature

4 Sensor Systems
 With Lifetime Warranty
\$289.00
 Additional Sensors ~ \$35.00 ea.

 **LIMITED LIFETIME WARRANTY**

866-200-9773
 info@tiretraker.com
 www.tiretraker.com

Steele

RUBBER PRODUCTS

OVER 100 RV EXTRUSIONS AVAILABLE



Call for your **FREE RV Catalog**
800-230-6109
www.steelerubber.com

KSH

Fuel Products
 www.kshmarine.com
 We Don't Dabble We Specialize!



- Toolbox/Tank combos in 45, 60, and 98 gallon Capacities.
- Auxiliary Fuel Tanks in 30, 50, 70, and 100 Gallon Capacities.
- Custom Fuel Tank Fabrication.
- Installation Kits for Chevy, Dodge & Ford.



KSH Fuel Products
 1675-103 Kiowa Ave.
 Lake Havasu City, AZ 86403

tel 928-680-6610
 fax 928-680-7379 email: kshmarine@rraz.net

(continued from page 44)

DiabloSport inTune i2 and the EFILive AutoCal with custom towing tunes. The X4 is currently 49-state legal and was going through CARB certification as this went to press. MSRP: From \$399.95
843-536-1244, www.5startuning.com



Hypertech

With Hypertech's 50-state-legal **Max Energy 2.0** programmer, three stages of power tuning are available, all tested with maximum trailer loads for each tow vehicle. Even the highest power level, stage 3, maintains safe EGT while towing the maximum weight specified by the vehicle's manufacturer, according to the company. Hypertech's low EGT, proper transmission shifting, programming for cold-air intakes and custom tuning don't require "defueling" (the practice of reducing fuel pressure/volume for a momentary decrease in power/torque during shifts, etc.), giving the tunes a power and fuel-economy edge. The Max Energy 2.0 comes in diesel and gas versions. MSRP: \$349
901-382-8888, www.hypertech.com



SCT Performance

SCT's 49-state-legal **X4 Power Flash** programmer takes driver control to the next level with a backlit touch screen and built-in Wi-Fi for easy updates. The handheld device provides high-speed data logging and monitoring, along with many features of sister (continued on page 79)

HONDA GENERATORS

When Quiet Counts,
Count on Honda



SHIPPED SAME DAY EU2000s

LOWEST PRICES ANYWHERE!!

VISA 800-832-7365 MasterCard

MOTOSPORTS OF UKIAH
1850 N. State St. Ukiah, Ca. 95482
www.motosportsofukiah.com

Calif. residents add 7.25%. For optimum performance and safety, we recommend you read the Owner's Manual before operating your Honda Power Equipment. Connection of generators to house power requires transfer device to avoid possible injury to power company personnel. Consult a qualified electrician.

Park it with Power Caster!

Maneuver your trailer easily in limited space, around corners, forward or reverse with the flip of a switch!



SAFE to use:
 Chain guard
 Ground wire

The Original Trailer Mover!
Manufactured since 1967.

Made in the U.S.A. Since 1967

POWER CASTER INC.
(800) 773-3833
(626) 287-6117
 www.powercaster.com
 5001 Encinita Ave., Temple City, CA 91780

NEVER WAX AGAIN

Wildwood

Easy 2-step process. Wipe on, let dry. Looks like new, lasts over 12 months.



Restore and protect. No rubbing or buffing.

GUARANTEED

SEE our video demo on our website!
www.poliglowproducts.com
800-922-5013

TRAILER LIFE.com



Dealers & Destinations

IDAHO

RVERS LOVE IDAHO!

- Great camping
- Less crowded, less expensive
- Amazing outdoor recreation
- Breathtaking scenery
- Friendly, helpful people



FREE! IDAHO RV Campground Directory





RVIdaho.org

TO ADVERTISE IN THE RV Marketplace or Dealers & Destinations

CONTACT:
Terry Thompson
206-310-6234
 terry.thompson@goodsam.com



ACCESSORIES



12-Volt Cooling for RVs

TurboKool Evaporative "Swamp" Coolers Powered by Battery and/or Solar. Cools your RV (up to 29°) without "plugging in"! Quiet and Affordable 1-800-326-4410 free brochure www.turbokool.com

LEAKY ROOF? Liquid Roof® goes on like paint -- cures to a sealed EPDM rubber membrane. UV & Ozone resistant -- good to 300°F. 5-year warranty 800-467-7135 www.AdvancedRubberCoatings.com

CAMPGROUND MEMBERSHIPS FOR SALE

CAMPGROUND MEMBERSHIP OUTLET-SINCE 1991
To buy 800-272-0401
To sell 800-952-0401
Any Membership-Nationwide. Best prices ever.

HELP WANTED

Earn While You Travel. Up to 65% Commission.
Complimentary RV Site While Working. Need self-motivated people with computer & sales experience. Adventure Awaits!!! 800-832-3292 • SoutheastPublications.com

HOMES FOR SALE



TOP RATED RESORT - S. Texas
Retama Village - Supersites \$50s.
RV Casitas \$120s RV Port Homes \$170s.
956-380-6500 www.bentsenpalm.com



#1 RATED RV RESORTS - S. Texas
Retama Village & Bentsen Palm Village
RV Lots \$20s, RV Casitas \$120s.
956-380-6500 www.bentsenpalm.com

RV Resort Home (Remodeled) with RV Lot
Full Hookups, Carports, 3 Sheds, Orlando, FL
Too many extras to list. Deeded Lots.
\$155,000 Invested-Sell \$133,900. Call Rich
for Info & Pics 407-257-8558

MAIL FORWARDING

AMERICAS MAILBOX Forwarding in SD/Low Rates
NO Wheel Tax/NO Sales/Income Tax/Save \$\$\$
NO Safety Insp/4-Season Campground & Hotel
We Scan Your Mail/Insurance/Ext Warranties
www.AmericasMailbox.com/TL *Call Us First!!*

OUR MAIL TRAVEL SERVICE • 800-723-0110
Merritt Island, FL No State Income Tax
NO ADDRESS-USE OURS FOR LOW VEHICLE REG
25 Yrs Exp • **FREE BROCHURE** • mailtravelservice.com

MOTORHOMES WANTED

Sell Your RV The Easy Way

- ◆ No hidden fees
- ◆ We tow from anywhere
- ◆ Competitive offer, running or not

877-422-7772

CASHFORCARS.COM

RECREATIONAL VEHICLES FOR SALE



BUY OR SELL RVS ONLINE! RVT.com ®
Reach Millions of RV Buyers with a FREE AD.
70,000+ RVs for Sale - By Owner and Dealer
Listings.
www.RVT.com or 1-877-705-0025

RV REGISTRY
www.rvregistry.com
Motorhomes, Trailers & Fifth Wheels
For Sale by Owners
No Sales Commissions
Buyers/Sellers 800-546-8457

SERVICES

Ask about Permanent Registration



Avoid Sales Tax
Call to speak with a licensed MT
Attorney about forming a LLC

Heggen Law Office, P.C.
www.HeggenLawOffice.com
888.777.5032



**PAY NO SALES TAX
ON ANY VEHICLE!**

Lowest rates in the 50 states
Secure online login - mobile access

877.913.5100 llctlc.com

ALL DAY
\$49
MONTANA
REGISTERED
AGENT LLC

\$700 for a 1 day MT LLC and permanent
trailer registration. Includes DMV fees.
www.49dollarmontanaregisteredagent.com
Call for more info 406-552-0004.

Let us help you BUY YOUR RV ... TAX FREE!
We guarantee **BEST** service and price
Receive **\$100 Gas Card & FREE Mail Fwding**
Call **888.430.3388 www.MontanaRV.net**

ACTION SERVICES, LLC
Consult a Licensed Montana Attorney
No Sales Tax in MT -- Low License Fees
Financing & Insurance -- For Professional Service
Call 800-481-0013 www.actionservices-mt.com

#1 IN SALES TAX SAVINGS
PAY NO SALES TAX! We have helped 1000's save
over the past 20 yrs. Call & talk to a CPA for
professional, friendly service! www.rvtax.com
Mountain States Consulting 800-565-4504

**TRAILER
LIFE.com**

The online
resource
for the RV
enthusiast

(continued from page 77)

TOURS



Guided RV Tours & Rallies

Lower 48 • Alaska • Canada • Mexico • Overseas
 Free RV Vacation Catalog **844-712-1077** or
www.adventurecaravans.com



RV CARAVANS and RALLIES

Pre-Planned, Safe and Organized RV Tours
 and Rallies for those who enjoy the journey.
 FREE RV Travel Guide - Call 800-952-8496

TRAVEL TRAILERS & FIFTH-WHEELS



NEW 2016 DRV ELITE SUITES 38RSSA: Loaded
 MSRP: \$176,841 Avg of 30% off MSRP
 Guar Best Price! More info at 877-643-7532. View
 Full Line of New/Used Units. www.rvsforless.net
 #1 USA Dealer 2011 - 2014



NEW 2016 Heartland Landmark
 Bath and 1/2. Loaded Only \$87,900. Guar Best
 Price! 877-643-7532 New units-Loaded. Cust order
 avail no chg. View New/Used Units www.rvsforless.net
 #1 USA Dealer 2012 - 2014



NATION'S LOW PRICED 5th WHEEL EXPERTS

Huge inventory of new/used high end 5ths
 DRV Mobile Suites, Lifestyle, Trilogy, HitchHiker
 View units at www.kansasrvcenter.com
 800-835-0676 or sales@nuwa.com for info

Classified Rates

Private Parties:

\$32 per line, four-line minimum.
 Add \$65 for color photo. All red
 text add \$25.

Commercial:

\$74 per line, four-line minimum, 40
 characters per line. For photo ads
 (limited to RVs and real estate), add
 \$95 B/W or \$115 color. For logo
 add \$95 B/W, \$115 color. No cat-
 egory limitations for logos. All red
 text add \$50.

Display Advertising:

1" ad B/W \$395. 2" ad B/W \$675. Ad
 \$75 for color. Frequency discounts
 apply.

Payment:

Check, VISA, MasterCard,
 Discover, American Express.
 w

Email: katey.purgatorio@goodsam.com

Phone: (847) 229-6756

Fax: (270) 495-6278

Mail: Trailer Life
 Attn: Classified Dept.
 3431 S. 257th Street
 Kent, WA 98032

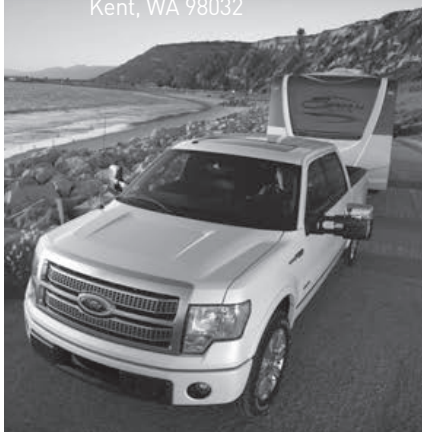

company Bully Dog's GT program-
 mers. SCT's preloaded, dyno-proven
 tunes optimize the vehicle's air-to-fuel
 ratio, engine timing and fuel curves for
 maximum performance while main-
 taining factory reliability and drivability.
 Tunes cover most gas and diesel Ford,
 GM and Chrysler vehicles from 1996
 to 2016, as well as some Nissan and
 Toyota trucks. MSRP: \$438.90



Sneak Peek: The GTX, an upgraded
 flash programmer and monitor from
 sister companies SCT and Bully Dog,
 debuts later this year with preloaded
 tunes and a grab-and-go magnetic
 mount for its 5-inch touch screen.

407-774-2447
www.sctflash.com

Superchips

Designed for ease of use,
 the new Superchips **Flashpaq F5** tuner pro-
 vides increases in horsepower
 and torque in numer-
 ous power levels for fuel
 economy, towing and
 performance. The increased
 horsepower potential is
 designed to minimize downshifting on the high-
 way, and that can definitely help at the
 pump. The tuner has a user interface
 that is clean and highly functional. The
 California edition delivers CARB-legal
 50-state tuning. MSRP: \$369.95



888-227-2447
www.superchips.com/f5

FREE TRAVEL INFORMATION

Trailer Life's Free Travel Information helps RVers with trip planning. The following attractions, states and provinces offer free information about their facilities. To request materials, tear out the postage-paid card opposite the Advertisers' Index, circle the numbers that correspond to your selections, fill out the card and drop it in the mail. For faster service, visit www.trailerlife.com/info and request your information online, and visit each listing's website for immediate information.

Alaska

Experience the breathtaking scenic beauty of Alaska and the Yukon. Get your FREE official Alaska and Yukon vacation guides today! www.alaskayukon.net/tra. Circle 140 on Reader Service Card.

See more of Alaska aboard our fleet of 11 state ferries. We travel a route so special it has been designated a National Scenic Byway and All-American Road. Learn more at www.ferryalaska.com/mh. Circle 141 on Reader Service Card.

North to Alaska — experience the Ultimate North American Road Trip, an epic adventure that takes you through Alberta, British Columbia and the Yukon on your way to Alaska. www.ultimatenorthamericanroadtrip.com/mth. Circle 142 on Reader Service Card.

Arkansas

Hook up your rig at Arkansas State Parks campsites and enjoy all the campground enhancements. Scenic lake, river and mountain settings. Outdoor recreation choices abound. Call 888-287-2757 or visit www.arkansasstateparks.com. Circle 143 on Reader Service Card.

Only Hot Springs National Park in Arkansas has so many unique things to do — from our famous thermal baths to an amazing botanical garden, fine dining and more! Visit www.hotsprings.org or call 888-SPA-CITY. Circle 144 on Reader Service Card.

Arkansas' DeGray Resort State Park offers lakeside campsites, golf, trails, tennis, swimming, boating, fishing, horseback riding and an island lodge with restaurant. Call 800-737-8355, or visit www.degray.com. Circle 145 on Reader Service Card.

Florida

With more than 120 miles of islands connected by bridges, the Florida Keys is a designated National Marine Sanctuary. Come and enjoy the spectacular natural wonders. Call 800-FLA-KEYS or visit www.fl-keys.com. Circle 146 on Reader Service Card.

Camp under the trees at Florida State Parks. Sites feature water, electricity and a central dump station. For more information, visit www.floridastateparks.org or call 850-245-2157. For reservations, go to www.reserveamerica.com. Circle 147 on Reader Service Card.

The premier Lake Harris RV Resort with a marina and motel on Lake Harris has 336 luxury sites, cable TV, a nine-hole executive golf course, a pool, 120 lighted wet slips and inside storage to 32 feet. Call 800-254-9993 or go to www.lakeharrisresort.com. Circle 148 on Reader Service Card.

Idaho

Idaho Travel Council. Stretch your imagination and budget with a vacation to Idaho, to keep you smiling after your vacation ends. Order a free travel guide at www.visitidaho.org or call 800-VISIT-ID. Circle 149 on Reader Service Card.

Idaho RV Campgrounds Association. RV Idaho! The scenery is breathtaking, outdoor recreation is legendary, and the folks are friendly. Stay awhile and play in Idaho. For a free RV/campground guide, call RV-IDAHO or visit www.rvidaho.org. Circle 150 on Reader Service Card.

Missouri

Free Missouri Vacation Planner. For fun places and great memories, enjoy a Missouri escape! Plan yours at 800-519-1500, extension 89, or call www.visitmo.com. While online, check out our valuable money-saving coupons. Circle 151 on Reader Service Card.

The beautiful 54,000-acre Lake of the Ozarks offers a breathtaking panorama plus 261 holes of golf, fishing, a premium outlet mall, music shows, show caves, waterparks and two state parks. Call 800-FUNLAKE or visit www.funlake.com. Circle 152 on Reader Service Card.

Montana

Epic views bookended by Glacier and Yellowstone national parks. Friendly locals share the unexpected and maybe their huckleberry pie. For your free Montana guidebook, call 800-VISIT-MT or go to www.visitmt.com. Circle 153 on Reader Service Card.

Visit Glacier National Park and satisfy your sixth sense — adventure, golf, hike, fly-fish, raft, cycle and more. Call 800-338-5072 or visit www.mt.glaciermt.com. Circle 154 on Reader Service Card.

Ohio

Ohio State Parks. Discover Ohio at any of our 57 state park campgrounds. Open year-round: hiking, golf, swimming, picnicking, boating and nature programs. Call 866-OHIOPARKS for reservations or visit www.ohiostateparks.org. Circle 155 on Reader Service Card.

Wyoming

Buffalo Bill's Cody/Yellowstone Country, Wyoming: Rodeos, history, culture, outdoor adventure, recreation, tours, wildlife and Yellowstone National Park. Enjoy fine dining, museums, shopping, music and more. Call 800-393-2639 or visit www.yellowstonecountry.org. Circle 156 on Reader Service Card.

Experience an adventure full of the spirit that is forever West. The Grand Tetons, Yellowstone, Devils Tower and more. Wyoming. Forever West. Call 800-225-5996, or visit www.wyomingtourism.org. Circle 157 on Reader Service Card.

Canada

Yellowhead Highway: Crossing the Trans-Canada Yellowhead Highway is a journey into Canadian history, including prairie mysteries and mountain legends. Request your free travel guide and map to explore the Yellowhead Highway in greater detail. Yellowhead it! Visit www.yellowheadit.com or call 877-GO-YELLO. Circle 158 on Reader Service Card.



Good Sam
Roadside Assistance

THE BIG Deal

Protect your whole family with **24/7 roadside assistance** and **unlimited distance towing** to the nearest service station!

CHOOSE THE PLAN THAT'S RIGHT FOR YOU & GET 3 MONTHS FREE!

<p>\$112⁹⁵ ONLY \$79⁹⁵ For 15 months 12 months</p>  <p>AUTO + RV STANDARD</p> <ul style="list-style-type: none"> Covers your owned RV, autos, motorcycles and boat trailers Spouse and dependent children included—no extra fees Coverage in the U.S., Canada, Mexico, Puerto Rico & the U.S. Virgin Islands 	<p>\$139⁹⁵ ONLY \$114⁹⁵ For 15 months 12 months</p>  <p>AUTO + RV PLATINUM</p> <ul style="list-style-type: none"> All the coverage of the Standard plan Additional coverage for sports trailers and utility trailers Access to certified RV technicians through the RV Tech Assistance Helpline Hotel and car rental discounts 	<p>\$79⁹⁵ ONLY \$69⁹⁵ For 15 months 12 months</p>  <p>AUTO PLATINUM</p> <ul style="list-style-type: none"> Covers all your owned autos and motorcycles Spouse and dependent children included—no extra fees Better coverage, towing & service than competitive plans!
---	--	--

Sign up NOW and save! LIMITED-TIME OFFER expires May 31, 2016!

Call: 888-246-2964 Click: GoodSamRoadside.com

* Introductory offer for Good Sam Members who are first-time buyers only.

Motor club benefits and services provided by Americas Road & Travel Club, Inc. for Members residing in Alaska, Alabama, Utah and Virginia; and by Affinity Road & Travel Club, LLC for Members residing in all other States. Note: All program benefits and services are subject to limitations set forth in the current Member Benefit Brochures and will be sent to you upon approval of your membership. GRA46511-0316

Where the Buffalo Roam

Millions of North America's largest land mammals once wandered the grasslands, but their population declined to less than 1,000. Now they're making a comeback



Many of us think of buffalo as being a creature of the Wild West, and Hollywood has a lot to do with that. But buffalo roamed all over North America 200 years ago, wherever there was grass, from along the Gulf Coast to the northern reaches of Canada and Alaska. Back then, the buffalo population was 30 to 50 million. That number dropped to

fewer than 1,000 by 1900, after the senseless slaughter of America's largest land animal as the country moved west.

Today, there are more than 500,000, and most of them are on ranches and private preserves. About 30,000 are on public land such as Yellowstone National Park, which has the largest population of wild plains buffalo — about 4,000.

What we call buffalo, of course, are really bison, which are native to North America. They got misnamed by early settlers, who had no local residents to consult except American Indians. An Indian word for buffalo is *tatanka*. So we have to assume that the settlers flipped a coin, presumably a buffalo nickel, and it came up heads. True or not, popular usage perpetuates the term "buffalo," so we will use it here.

A private herd roams Santa Catalina Island, 22 miles off the coast of Southern California. Fourteen of them were brought there in 1924 for a movie that never got made. At one point, as many as 600 buffalo roamed the 8-mile-long island. The Catalina Island Conservancy that monitors the herd decided that 150 is about all the island can support, so they moved some to the mainland and have the remaining ones on birth control.

Ted Turner, media and sports mogul and now the owner of more land in this country than anyone, owns about 11 percent of the world's buffalo population, or about 51,000. They are spread across 2 million acres, mostly in Montana, but also in Nebraska, New Mexico, Kansas and South Dakota. While Turner deserves credit for returning the iconic animal to its natural habitat, he also made ranchers aware that buffalo can be a "cash cow." He and a partner operate 44 Ted's Montana Grill locations, where they advertise "the



(Top) Covering a quarter of the state, the Sandhills of Nebraska are once again home to hundreds of buffalo, including these ones that are shedding their winter coats. (Above) Some are raised commercially in place of cattle, and several ranches here conduct tours.

most extensive menu of bison in the world." Most of the restaurants are in Colorado and east of the Mississippi, though Montana has one. There are none in Nebraska.

On a recent visit to Nebraska, in the country's most prolific beef-producing region, I discovered that ranchers are engaged in a supreme historic irony. On land once swept clean of buffalo to make way for cattle, ranchers are now sweeping away cattle to make way for buffalo.

One of them is Dave Hutchinson. I visited Dave at his Perfect 10 Buffalo Ranch near Rose, Nebraska. On 5,000 acres of rolling Sandhills, Dave and his family raise a couple hundred buffalo along with cattle, goats, quarter horses and donkeys. Though the sandy soil of the Sandhills has never been suitable for raising crops, it does support a thriving mix of sand-tolerant grasses. And for Dave, grass is what ranching here is about.

"We've never fed corn to our animals," Dave told me. "Grass is healthier for them — for buffalo especially, as they are native here."

Dave has horse-drawn wagons that he and his son-in-law use when they give visitors a tour of the ranch. But Dave asked me to ride with him and his dog in a 4x4 when he headed out with some photographers to get a close look at his buffalo. They are beautiful animals — some of them weighing more than 2,000 pounds.

It was close; thank God they're back.

Welcome to America's Outback. 🐾

KEEP IN TOUCH

To connect with Bill, email roadscribe@aol.com

Super Summer Special!

\$25 REBATE*

ON SELECT TOILETS!



See in-store
Coupon or go to:
thetford.com/rebate

THETFORD
Going Places

*Manufacturer mail-in rebate. Offer valid April 18 - July 10, 2016. www.thetford.com

Thetford Corporation, Circle 138 on Reader Service Card

CAN YOUR BRAKE CONTROL DO THIS?



47297 InSIGHT™ FLEX-MOUNT Brake Control



**LIFETIME
WARRANTY**

- ✓ Easily installs with absolutely **NO TOOLS REQUIRED**
- ✓ Makes **KNEE BANGING** a thing of the **PAST**
- ✓ Brings **TOTAL CONTROL** within easy reach
- ✓ Creates the **PERFECT INSTALL** for any vehicle
- ✓ Brings the display back to your **LINE of SIGHT**

InSIGHT does ALL OF THE ABOVE!!

Visit www.BrakingInSight.com To See What Else It Can Do!