



Door Closers Catalogue



Table of contents

04	Rack - and - Pinion door closers	66	Concealed door closers
06	TS Kompakt	68	ITS 96
08	TS 68		
10	TS 71	72	Floor Springs
12	TS 72		
14	TS 73V	74	BTS 84
18	TS 83	76	BTS 75V
22	TS Profil	80	BTS 80
24	Cam Action door closers		
26	TS 90		
30	TS 91/92		
34	TS 93 System		
50	TS 97		
52	TS 98 XEA		
60	G - Ubivis XEA		





Rack-and-Pinion Door Closers



TS Kompakt Door Closer

The perfect solution for standard doors



Technical data and Features		
Adjustable closing force		EN 2/3/4
Standard doors ≤ 1100 mm		●
External doors, opening outwards		–
Fire and smoke check doors ≤ 1100 mm		–
Non-handed		●
Arm	Standard Slide channel	● –
Closing speed adjustable at 2 separate valves	180° - 15°	●
	15° - 0°	●
Backcheck		–
Delayed action		–
Dimensions in mm	Length	205.0
	Overall depth	46.0
	Height	40.0
Hold-open		Option
Weight in kg		1.2

Key advantages

For Users

- Two valves for optimum closing speed

For Sellers

- Ideal solution for standard doors
- Just one model for all door sizes to simplify stocking

For Installers:

- Non-handed unit
- Quick and easy to install
- Fixes perfectly to all door types without the need for a mounting backplate
- One model for all mounting positions

Functions and options

- 1 Adjustable closing speed in the range 180° – 15°
- 2 Adjustable closing speed in the range 15° – 0°
- 3 Hold-open range with hold-open arm model (optional extra)

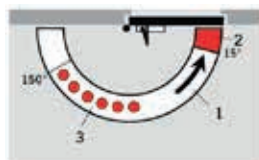

TS Kompakt is a door closer which can be universally used on all common door types and sizes.

It is quick and easy to install – and does not require a mounting backplate.

Certified to ISO 9001

Standard equipment

Color	xx
Silver	01
Brown	03
White	11
(RAL 9016)	
Black	19
(RAL 9005)	

Order number:

■ □ -Closer with arm, complete
- Accessory

**Door Closer
TS Kompakt**

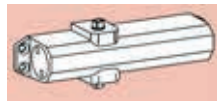

Size EN 2/3/4

Standard arm



■ □ 670101xx

Hold-open arm



■ □ 670102xx

Applications and Fixing

Closing force settings

Door width	Size setting
≤ 850	Size 2
≤ 950	Size 3
≤ 1100	Size 4

The TS Kompakt size setting is selected for the door width by moving the closer body and/or turning the arm power shoe.

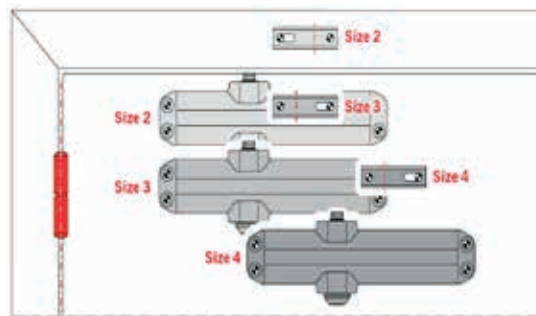

Rack and pinion door closer with selectable closing force, size EN 2, 3 and 4 and adjustable closing speed in two independent ranges.

Non-handed.

Available with:

- standard arm
- hold-open arm

Colors:

- Silver
- Brown
- Black (similar to RAL9005)
- White (similar to RAL9016)

**Door - leaf fixing,
Pull side**

	EN2	EN 3	EN4
A	170.0	170.0	250.0
B	59.0	43.0	43.0
C	96.5	96.5	76.5
D	198.5	198.5	278.5
E	89.0	89.0	169.0

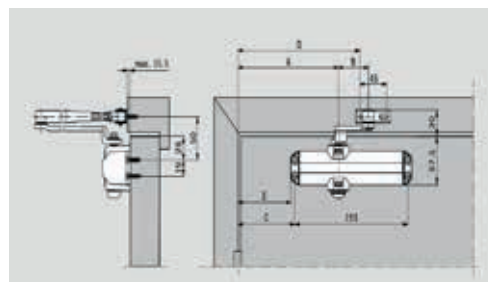

**Frame fixing,
Push side**

	EN2	EN 3	EN4
A	170.0	170.0	250.0
B	9.0	43.0	43.0
C	96.5	96.5	176.5
D	198.5	198.5	278.5
E	89.0	89.0	69.0

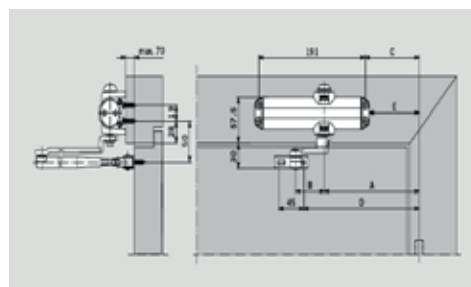

TS 68 Door Closer

The ideal low-cost solution for standard doors



Technical data and Features		
Selectable closing force (variable via from arm power shoe and templating)		EN 2/3/4
Door width ≤ 1100 mm		●
External doors, opening outwards		–
Non-handed		●
Arm	Standard Slide channel	● –
Closing speed adjustable at 2 separate valves	180° - 15°	●
	15° - 0°	●
Backcheck		–
Delayed action		–
Dimensions in mm	Length	220
	Overall depth	45
	Height	53.5
Hold-open		Option
Weight in kg		1.4

Key advantages

For Users

- The door closer works with constant parameters independent of changes in ambient temperature
- Two valves for optimum closing speed and latching action

For Sellers:

- Low-cost solution for standard doors
- One model for all mounting positions

For Installers:

- Convenient and easy to adapt for both left and right handed doors
- Quick and easy to install
- Fixes perfectly to all door types without the need for a mounting backplate

Functions and options

- 1 Adjustable closing speed in the range 180° – 15°
- 2 Adjustable closing speed in the range 15° – 0°
- 3 Hold-open range with hold-open arm model (optional extra)

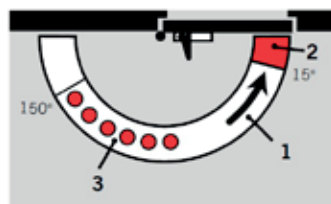

TS 68 is a door closer which can be universally used on all common door types.

It is particularly quick and easy to install – and does not require additional mounting backplates.

Certified to ISO 9001

Standard equipment and accessories

Color	xx
Silver	01
Dark brown	03
White	11
Black	19

Order number:

■ □ - Closer with arm, complete
- Accessory

Door Closer TS 68

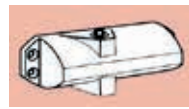

Size EN 2/3/4

Standard arm



■ □ 664001xx

Hold-open arm



■ □ 664002xx

Parallel arm bracket



660005xx
#

Applications and Fixing

Closing force settings

Door width	Size setting
≤ 850	Size 2
≤ 950	Size 3
≤ 1100	Size 4

The TS 68's size setting is selected for the door width by moving the closer body and/or turning the arm power shoe.

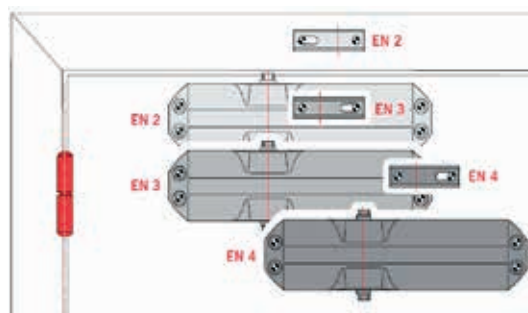

Rack and pinion door closer with selectable closing force, size EN 2, 3 and 4 and adjustable closing speed in two independent ranges.

Non-handed.

Available with:

- standard arm
- hold-open arm

Colors:

- Silver
- Dark brown
- White (RAL 9016)
- Black

Door - leaf fixing, Pull side

	EN2	EN 3	EN4
A	170	170	250
B	59	43	43
C	96	96	176
D	198.5	198.5	278.5
E	87	87	167

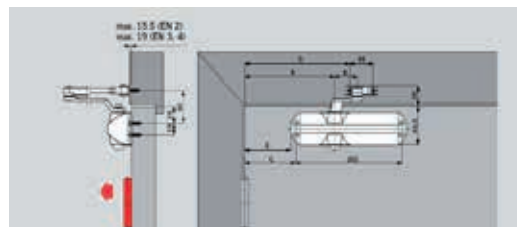

Frame fixing, Push side

	EN2	EN 3	EN4
A	170	170	250
B	59	43	43
C	96	96	176
D	198.5	198.5	278.5
E	87	87	167

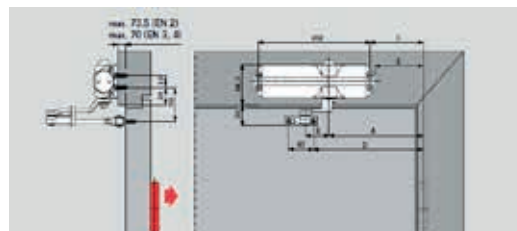

Parallel arm fixing, Push side

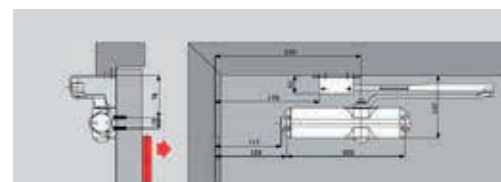

TS 71 Door Closer

Competitive model for standard doors



Technical data and Features		
Closing force (adjustable by turning round the hinge plate)		EN 3/4
Standard doors ≤ 1100 mm		●
External doors, opening outwards		–
Fire doors		●
Non-handed		●
Arm	Standard	●
	Slide channel	–
Closing speed adjustable at	180° - 15°	●
2 separate valves	15° - 0°	●
Latching action adjustable (by arm)		●
Backcheck		–
Delayed action		–
Dimensions in mm	Length	232
	Overall depth	45
	Height	68
Hold-open		Option
Weight in kg		1.2
Door closer tested to EN 1154		●
CE mark for construction products		●

Functions and options

- 1 Closing speed adjustable in the range 180° – 15°
- 2 Closing speed adjustable in the range 15° – 0°
- 3 Latching action
- 4 Hold-open range for model with hold-open arm (optional extra)



Key advantages

For Users:

- Constant closing action virtually unaffected by temperature fluctuations
- Optimum closing speed adjustment with two regulating valves
- Reliable closing with adjustable latching action

For Sellers:

- Competitive model for standard doors
- Compact construction with combined with classic design

For Installers:

- Non-handed design
- Easy and quick to fix

The ease and speed with which it can be fixed, the fact that its spring strength can be so easily adapted to the door size make it the ideal choice for your doors.

Certified to ISO 9001

Standard equipment

Color	xx
Silver	01
Dark brown	03
White (RAL 9010)	10
White (RAL 90165)	19

Closer body TS 71

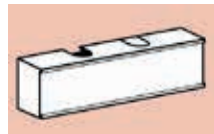

Standard arm

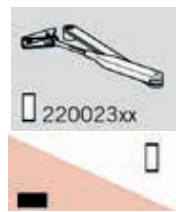

Hold-open arm

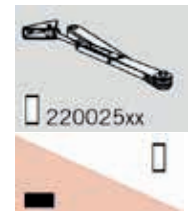

Mounting backplate

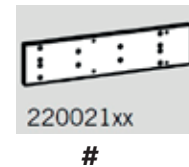

Parallel - arm bracket



Order number:

■ - Closer separate

□ - Arm assembly separate

Size EN 2/3/4
222121xx

= Accessory

Applications and Fixing

Closing force settings

Door width	Size setting
≤ 950	Size 3
≤ 1100	Size 4

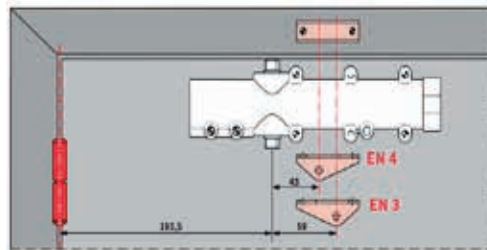

With the TS 71, the spring strength (size setting) of the closer is adjusted to the door width concerned by merely turning round the hinge plate.

Rack-and-pinion door closer with adjustable closing force, size EN 3 or 4, closing speed adjustable in two independent ranges, with adjustable latching action.

Non-handed.

Door - leaf fixing, Pull side

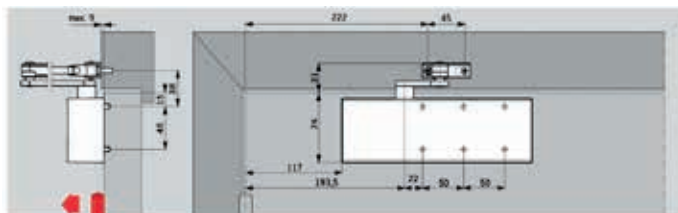

Transom fixing, (overhead frame installation), Push side

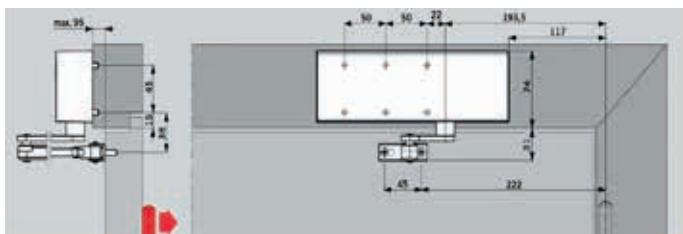

Parallel-arm fixing, push side

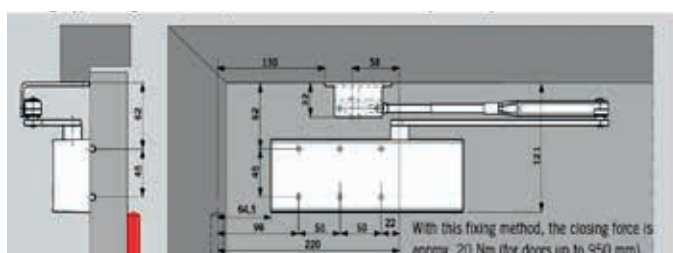

Available with:

- standard arm
- hold-open arm

Accessories:

- mounting backplate
- fixing bracket for parallel-arm assembly

Colors:

- Silver
- Dark brown
- White (similar to RAL9010)
- White (similar to RAL9016)

TS 72 Door Closer

Competitive model for standard doors



Technical data and Features		TS 72	TS72 VBC
Closing force (adjustable by turning round the hinge plate)		EN 2-4	EN 2-4
Standard doors ≤ 1100 mm		●	●
External doors, opening outwards		—	—
Fire doors		●	●
Non-handed		●	●
Arm	Standard	●	●
	Slide channel	—	—
Closing speed adjustable at 2 separate valves	180° - 15°	●	●
	15° - 0°	●	●
Latching action adjustable (by arm)		●	●
Backcheck		—	●
Delayed action		—	—
Dimensions in mm	Length	232	232
	Overall depth	45	45
	Height	68	68
Hold-open		Option	Option
Weight in kg		1.2	1.2
Door closer tested to EN 1154		●	●
CE mark for construction products		●	●

Key advantages

For Users:

- Optimum closing speed adjustment with two regulating valves
- Constant closing action virtually unaffected by temperature fluctuations
- Reliable closing with adjustable latching action

For Sellers:

- One model for all standard doors

For Installers:

- Non-handed design
- Closing force, closing speed and latching action adjustable in a few movements

Functions and options

- 1 Closing speed adjustable in the range 180°–15°
- 2 Closing speed adjustable in the range 15° – 0°
- 3 Latching action (variable at arm)
- 4 Adjustable closing force

The closing speed of TS 72 is variable in two independent ranges by separate valves. In addition, the latching action can be adjusted at the closer arm.

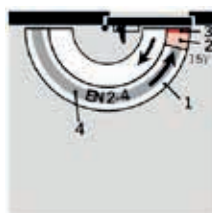

TS 72 is the perfect multi-purpose door closer for all standard doors. Without a backplate, it is quick and easy to fix.

The closing force can be individually adapted to the door size by means of an adjusting screw ensuring optimum performance in every situation.

Certified to ISO 9001

Standard equipment and accessories

Color	xx
Silver	01
White (RAL 9016)	19
Special color	09

Order number:

- - Closer separate
- - Arm assembly separate
- # - Accessory

Closer body
TS 72
TS 72VBC

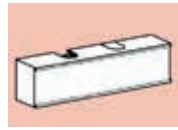

Size EN 2/3/4
 222121xx

Standard arm



Hold-open arm



Mounting backplate

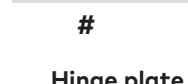
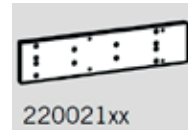

Parallel - arm bracket



Hinge plate



Applications and Fixing

Closing force settings

Door width	Size setting
≤ 850	Size 2
≤ 950	Size 3
≤ 1100	Size 4

The closing force setting for the door width concerned is variable at the adjustment screw located at the end face of the TS 72 closer body.

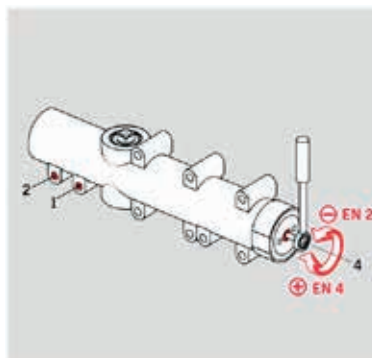

Door - leaf fixing, Pull side

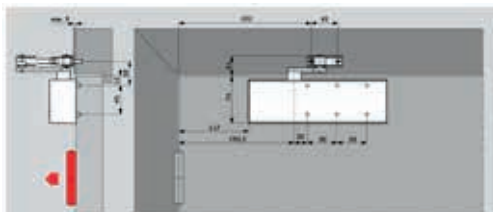

Transom fixing, (overhead frame installation), Push side

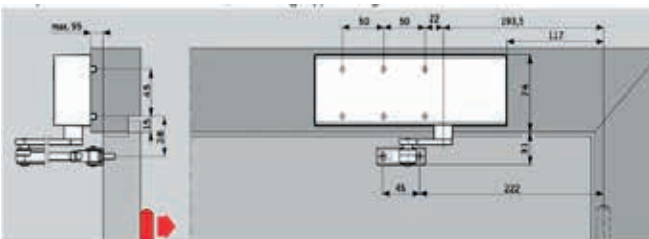

Parallel-arm fixing, push side

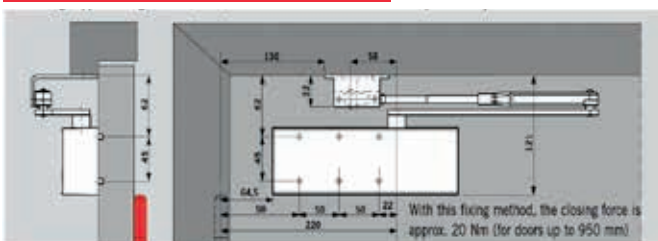

Rack-and-pinion door closer with adjustable closing force, size EN 2 – 4, closing speed adjustable in two independent ranges, with adjustable latching action.

Non-handed.

Tested and approved to EN 1154.

Available with:

- standard arm
- hold-open arm

Accessories:

- mounting backplate
- fixing bracket for parallel-arm assembly
- upstand hinge plate

Colors:

- Silver
- Dark brown
- White (similar to RAL9010)
- White (similar to RAL9016)
- Special color

TS 73V Door Closer

Easy to fix, easy to adjust



Technical data and Features		TS 73V
Closing force (adjustable)		EN 2-4
Standard doors ≤ 1100 mm		●
External doors, opening outwards		—
Fire and smoke control doors ≤ 1100 mm		●
Non-handed		●
Arm	Standard	●
	Platform	—
	Slide channel	●
Closing force adjustable by means of setting screw		●
Closing speed adjustable at 2 separate valves	180° - 15° 15° - 0°	● ●
Latching action adjustable by arm		●
Backcheck	self-regulating	●
	adjustable at valve	●
Delayed action		—
Dimensions in mm	Length Overall depth Height	225 40 60
Hold-open		Option
Weight in kg		1.3
Door closer tested to EN 1154		●
CE mark for construction products		●

Key advantages

For Users:

- High mechanical efficiency, low sensitivity to temperature change, wide opening angle, pressure relief valve to protect hydraulics from abuse
- Optimum wall and door protection thanks to "thinking" backcheck

For Sellers:

- The TS73 V covers the application and closing force requirements of most standard interior doors
- Wide range of fixing brackets and accessories for non-standard doors and frame details

For Installers:

- Quick and easy to fix
- Closing speed, latching speed and spring strength all simply adjusted with common hand tools

TS 73V is known for its simple and easy installation, and guaranteed quality.

It is specially designed for internal doors, including fire doors, with various designs and styles.

Certified to ISO 9001



Standard equipment and accessories

Closer body
TS 73 V

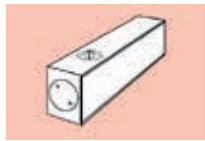

Size EN 2 - 4
■ 370101xx

Standard
arm



□ 220023xx

■ □

Platform
arm



□ 830001xx

■ □

Hold-open arm
with on/off switch



□ 220030xx

■ □

Mounting
backplate



370001xx

△

Hinge
plate



830014xx

△

Angle
bracket

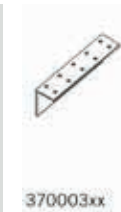

370003xx

△

Drop
plate



380002xx

△

Parallel
arm bracket



280066xx

- Body only
- Arm only
- △ Optional accessory

Color	xx
Silver	01
White (RAL 9016)	11
Special color	09

Spindel extension
16 mm



83003705

△

Functions and Options

With "thinking" backcheck

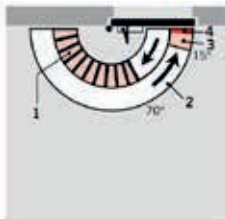

- 1 Self-regulating backcheck
- 2 Infinitely variable closing speed in the range 180° – 15°
- 3 Infinitely variable closing speed in the range 15° – 0°
- 4 Adjustable latch range (by arm)

With hold-open arm

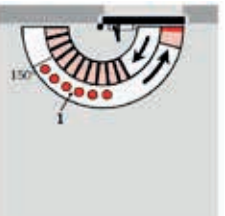

- 1 Hold-open range

Applications and Fixing

Door - leaf fixing, pull side

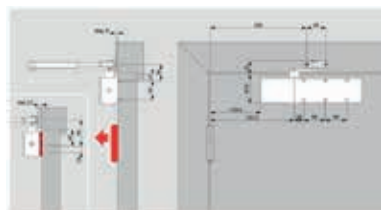

Transom fixing, push side



Door leaf fixing with hold-open arm



Rack and pinion door closer with adjustable power size EN 2 – 4, according to EN 1154, carries the CE mark, integral self-regulating backcheck.

Closing speed adjustable in two independent ranges and adjustable latch action.

Non-handed.

Available with:

- standard arm
- hold-open arm
- with on/off switch
- platform arm

Colors:

- Silver
- White (similar to RAL 9016)
- Special color



TS 83 Door Closer

Engineered for excellence



Technical data and Features		TS 83	
Closing force (adjustable)		EN 3-6	EN 7
Standard doors	≤ 1400 mm ≤ 1600 mm	● –	– ●
External doors, opening outwards	≤ 1400 mm ≤ 1600 mm	● –	– ●
Fire and smoke check doors	≤ 1400 mm ≤ 1600 mm	● –	– ●
Non-handed		●	●
Arm	Standard Flatform Slide channel	● ● –	● ● –
Closing force adjustable by means of setting screw		●	–
Closing speed adjustable at 2 separate valves	180° - 15° 15° - 0°	● ●	– –
Closing speed variable by means of valve adjustment		–	●
Latching action adjustable by arm		●	●
Backcheck	self-regulating adjustable at valve	● ●	● ●
Delayed action variable at valve		Option	–
Dimensions in mm	Length Overall depth Height	245 46 60	293 47.5 60
Hold-open		Option	Option
Weight in kg		1.7	3.3
Door closer tested to EN 1154		●	●
CE mark for construction products		●	

Key advantages

For Users:

- Optimum wall and door protection thanks to "thinking" backcheck
- Closing speed virtually unaffected by temperature fluctuations

For Sellers:

- Practical and effective solutions to meet special applications thanks to comprehensive choice of accessories
- Wide range of standard functions supplemented by optional extras for installers

For Installers:









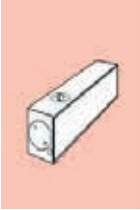

- Compact closer design and sturdy flat-form arm assembly
- Easy to fix

TS 83 door closer provides a high level of user convenience for easy entry coupled with a wide range of functions.

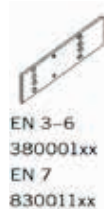
Certified to ISO 9001



Standard equipment and accessories

Closer body TS 83V	Standard arm	Standard arm, anti corrosive type	Platform arm	Hold-open arm with on/off switch	Mounting backplate	Arm bracket adapter	Angle bracket	Drop plate	Parallel arm bracket	Spindel extension 16 mm
	 □ 220023xx		 □ 830001xx	 220030xx	 EN 3-6 380001xx EN 7 830011xx	 830014xx	 EN 3-6 380003xx	 EN 3-6 380002xx	 280066xx	 83003705
Size EN 3-6 BC/ÖD ■ 380101xx	■ □		■ □	■ □	△	△	△	△	△	△
Size EN 3-6 BC/ÖD + DC/ SV ■ 380201xx	■ □		■ □	■ □	△	△	△	△	△	△
Size EN 3-6 BC/ÖD (AC)		■ □ 38030301			△	△	△	△	△	△
Size EN 3-6 BC/ÖD ■ 830501xx	■ □		■ □	■ □	△	△	△	△	△	△

Color	xx	■ Body only
Silver	01	□ Arm only
White	11	△ Optional accessory
(RAL 9016)		■ Closer with arm, complete
Special color	09	

Functions and Options

With "thinking" backcheck

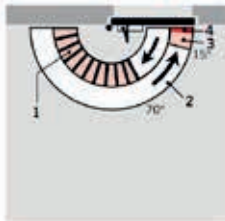

- 1 Self-regulating backcheck
- 2 Infinitely variable closing speed in the range 180° – 15°
- 3 Infinitely variable closing speed in the range 15° – 0°
- 4 Adjustable latch range (by arm)

With hold-open arm

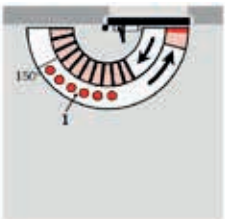

- 1 Hold-open range

With additional delayed action



- 1 Adjustable delayed action
- 2 Fully controlled closing with adjustable speed

Applications and Fixing

Door - leaf fixing, pull side

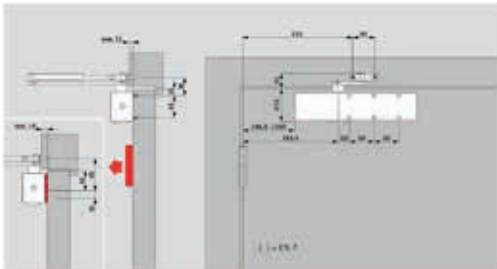

Door leaf fixing with hold-open arm

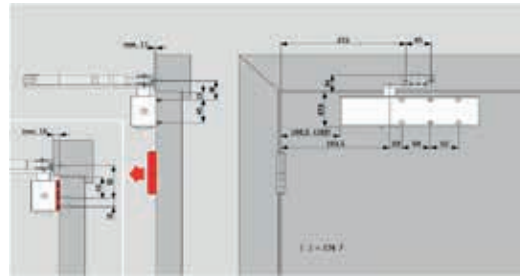

Transom fixing, push side

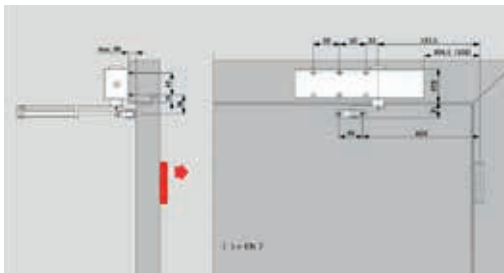

TS 83, EN 3 – 6

Rack and pinion door closer; with adjustable power size EN 3 – 6, according to EN 1154, carries the CE mark, integral self-regulating backcheck; closing speed adjustable in two independent ranges and adjustable latch action.

Non-handed.

Available with:

- additional, adjustable delayed action
- anti-corrosion protected (AC)
- standard arm
- flatform arm
- hold-open arm with switch

Colors:

- Silver
- White (sim. to RAL 9016)
- Special color (sim. to RAL)

TS 83, EN 7

Rack and pinion door closer; with power size EN 7, according to EN 1154, carries the CE mark, integral self-regulating backcheck; adjustable closing speed and adjustable latch range.

Non-handed.

Available with:

- standard arm
- flatform arm
- hold-open arm with switch

Colors:

- Silver
- White (sim. to RAL 9016)
- Special color (sim. to RAL)

TS Profil Door Closer

The ideal solution for standard doors



Technical data and Features		
Adjustable closing force		EN 2/3/4
Standard doors ≤ 1100 mm		●
External doors, opening outwards		●
Fire and smoke checks ≤ 1100 mm		-/●/●
Non-handed		●
Arm	Standard	●
	Slide channel	—
Closing speed adjustable at 2 separate valves	180° - 15°	●
	15° - 0°	●
Backcheck		●
Delayed action		—
Dimensions in mm	Length	207
	Overall depth	38.5
	Height	55.0
Hold-open		—
Weight in kg		1.4
Door closer tested to EN 1154		●
CE mark for construction products		●

Key advantages

For Users

- Protection against abuse usage
- Optimum wall and door protection thanks to backcheck function

For Sellers:

- Ideal solution for standard doors
- One model for all door sizes

For Installers:

- Non-handed unit
- Quick and easy to install
- Fixes perfectly to all door types without the need for a mounting backplate

Functions and options

- 1 Adjustable closing speed in the range 180° – 15°
- 2 Adjustable closing speed in the range 15° – 0°
- 3 Backcheck

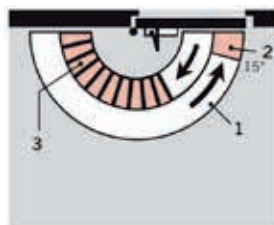

TS Profil is a door closer which can be universally used on all common door types and door sizes.

It is quick and easy to install – and does not require a mounting backplate.

Certified to ISO 9001

Standard equipment

Color	xx
Silver	01
White (RAL 9016)	11
Black (RAL 9005)	19

Door Closer TS Profil



Size EN 2/3/4

Standard arm



■ □271122xx

Order number:

■ □ - Closer with arm, complete
- Accessory

Applications and Fixing

Closing force settings

Door width	Size setting
≤ 850	Size 2
≤ 950	Size 3
≤ 1100	Size 4

The force setting is altered by selecting position of close on the door without changing existng fixing holes.

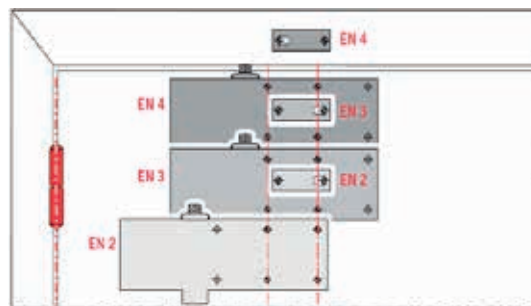

Rack and pinion door closer according to EN 1154, carries the CE mark, with selectable closing force, size EN 2, 3 and 4, adjustable closing speed in two independent ranges and backcheck.

Non-handed.

Available with:

■ standard arm

Accessories:

■ mounting backplate

Colors:

- Silver
- Black (similar to RAL9005)
- White (similar to RAL9011)

Door - leaf fixing, Pull side

	EN2	EN 3	EN4
A	138	188	188
B	113,5	63,5	49,5
C	63	113	113

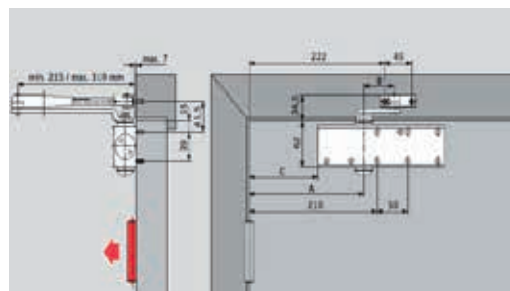

Frame fixing, Push side

	EN2	EN 3	EN4
A	170.0	170.0	250.0
B	59.0	43.0	43.0
C	96.5	96.5	176.5

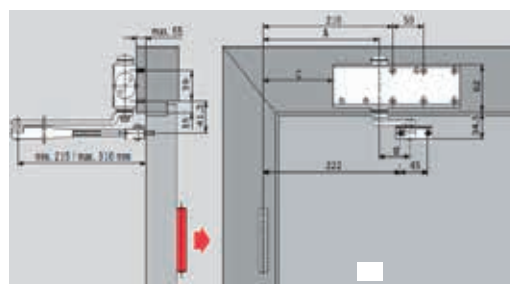

Mounting plate

For fitting the door closer to fire doors and to doors where direct fitting is not possible.





Cam Action Door Closers



TS 90 Impulse Door Closer

User-friendly and reliable door closer

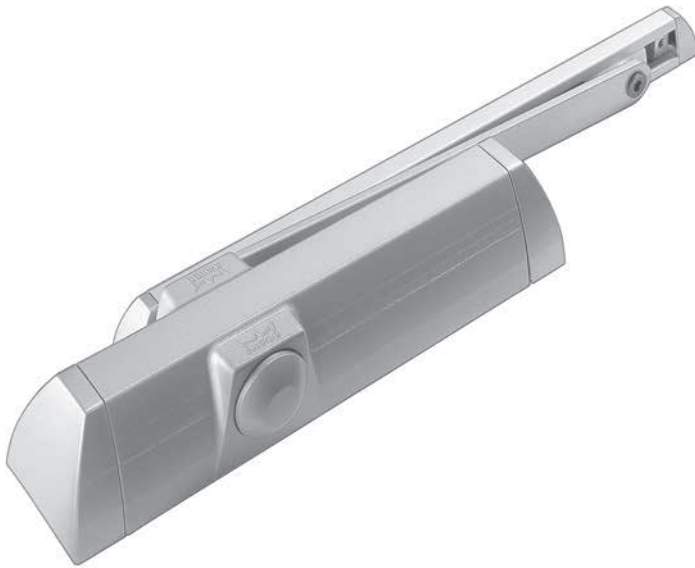

Technical data and Features

Adjustable closing force	EN 3/4		
Standard doors ≤ 1100 mm	●		
External doors, opening outwards	●		
Fire and smoke check doors	●		
Non-handed	●		
Slide channel	●		
Two independent valves for closing speed adjustment	●		
Cushioned limit stay (mechanical)	Option		
Delayed action	–		
Dimensions in mm	Length	246	
	Overall depth	46	
	Height	57	
Hold-open	Option		
Weight in kg	1.7		
Door closer tested to EN 1154	●		
CE mark for construction products	●		

Key advantages

For Users

- Convenient, low-resistance opening with fully controlled closing
- Two regulating valves for precise adjustment of closing speed
- Available with hold-open and cushioned limit stay options

For Sellers:

- Cost-efficient slide channel door closer for interior doors
- Complete package for easy stocking

For Installers:

- Easy to fix without mounting backplate
- Non-handed
- Four installation arrangements with one model

The heart-shaped cam and the linear drive mechanism of TS 90 impulse ensure that the resistance encountered decreases almost instantly with the door opening action. So even children, the elderly and people with disabilities have no problems to open the door.

Certified to ISO 9001

Standard equipment

**Door Closer
TS 90 Impulse**

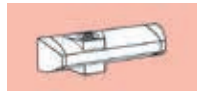

Angle bracket



Cushioned limit stay



Mechanical hold-open device



Slide channel



■ □ 102004xx

100030xx

10002000

10002100

△

△

△

Order N°.: Color

■ □ = Closer body with
slide channel, complete

Silver xx
White 01
(RAL 9016) 11

△ = Accessory

Applications and Fixing

Pull side fixing

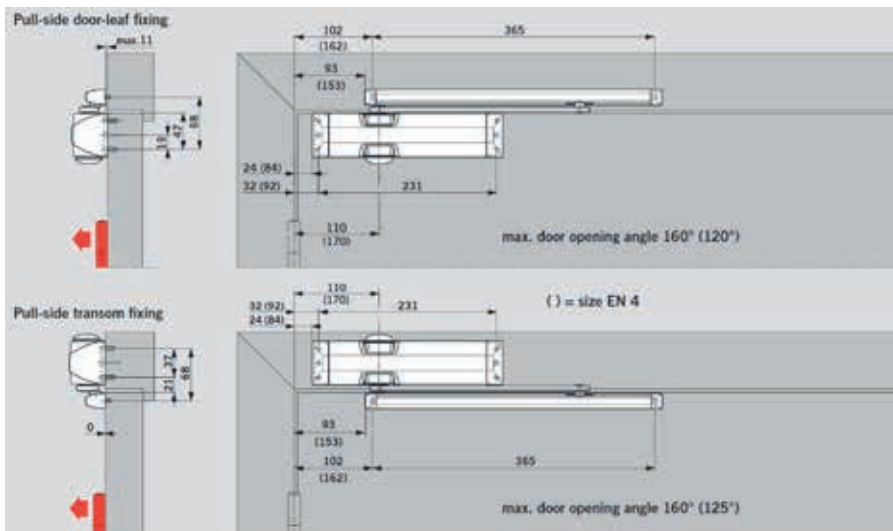

Push side fixing

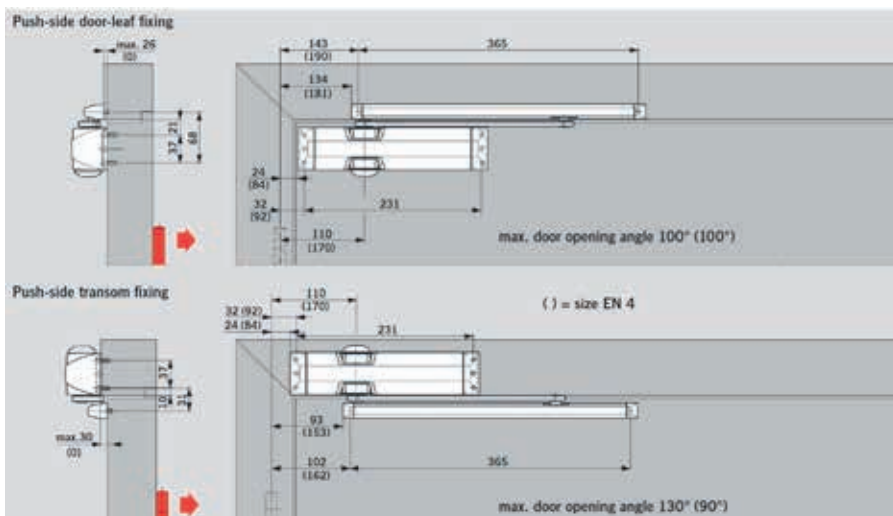

Standard and optional functions

Closing speed

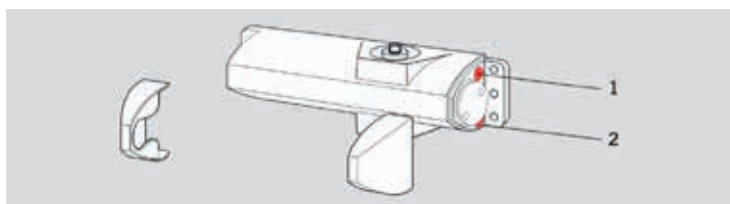

The closing speed of TS 90 impulse is adjustable in two independent ranges at the valves indicated.

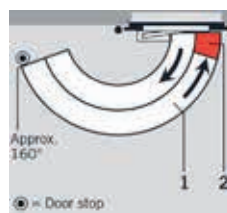

- 1** Infinitely variable closing speed in the range 160° – 15°
- 2** Infinitely variable closing speed in the range 15° – 0°

Closing force settings EN3/EN4

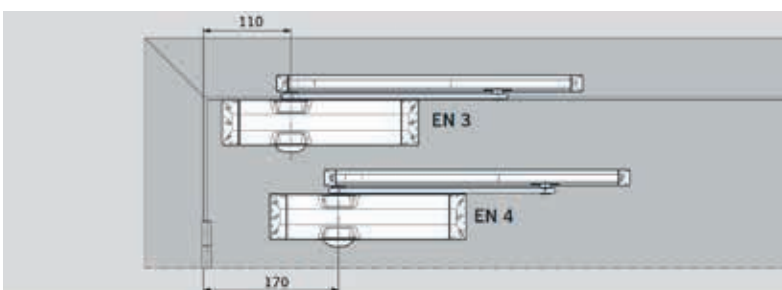

Door width	size setting
≤ 950 mm	EN 3
≤ 1100 mm	EN 4

TS 90 impulse size setting is selected for the door width by the closer

Mechanical hold-open device

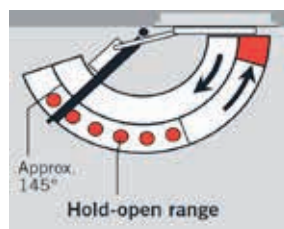
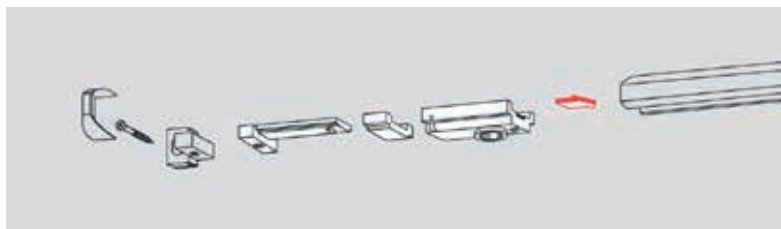

The hold-open device enables doors to be precisely held without any fall-back up to an opening angle of approx. 145°. The hold-open device is suitable for both LH and RH doors and is designed for retrofitting to the slide channel.

Cushioned limit stay

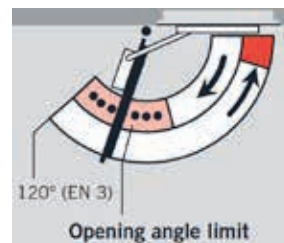
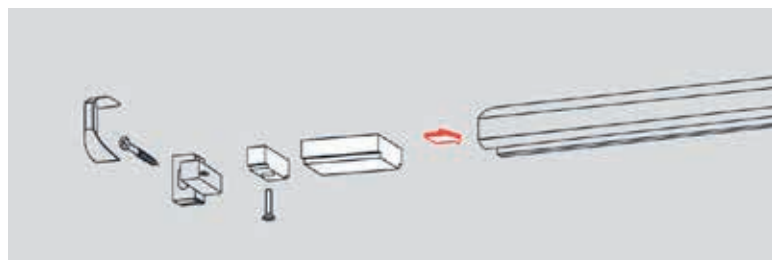

Cushioned limit stay for retrofitting by insertion in the slide channel. Adjustable between 80° and max. 120°.

Use of the cushioned limit stay helps to prevent a normally opened door from colliding with adjacent walls.

The cushioned limit stay is not an overload protection device and in many cases is no substitute for a door stop.

Only for the use of TS 90 Impulse size EN 3



TS 91 & TS 92 Door Closers

The universal closers for standard doors



Technical data and features	TS 92 B/G ¹⁾	TS 91 B
Closing force, adjustable	EN 1-4 ●	EN 3 ●
Standard doors	≤ 950 mm ●	≤ 1100 mm ●
External doors, opening outwards*	—	—
Fire and smoke check doors	●	●
Non-handed design	●	●
Arm	Slide channel ●	●
Closing speed and latching action independently adjustable at two separate valve	180°–15° ● 15°–0° ●	● ●
Cushioned limit stay, mechanical	Option	Option
Backcheck	—	—
Delayed action	—	—
Hold-open	Option	Option
Weight in kg	2.0	1.9
Dimensions in mm		
Lenght	281	267
Overall depth	47	47
Height	65	65
Door closer tested to EN 1154	●	●
CE mark for construction products	●	●

Key advantages

For Users

- Exceptional ease of use and fully controlled closing action
- Optimum adaptability of the closing speed with reliable latching thanks to two regulating valves

For Sellers:

- Inexpensive cam-action technology for standard interior doors
- Low storage costs and reduced inventory requirement

For Installers:



- Non-handed
- Easy to fix and quickly adjustable

TS 92 and TS 91 door closers are the perfect complement to the dormakaba TS 93 cam-action door closer system.

Their outstanding level of assured quality make TS 91/TS 92 particularly attractive from an economic standpoint as well.

Certified to ISO 9001

Standard and optional functions

	TS 92 B	TS 92 G	TS 91 B	Mounting backplate 30 mm for G-N	Mounting backplate 40 mm for G-N	Angle bracket for G-N	Cushioned limit stay set for G-N	Hold-open unit for G-N
	Size EN 1-4 ■ 420201xx	Size EN 1-4 ■ 420301xx	Size EN 3 ■ 410201xx	644000xx	644100xx	644300xx	35800093	18570000
G-N	□ 640100xx	■	□	△	△	△	△	△
Mounting backplate for TS 91								
 410002xx					△			
Glass door saddle plate for TS 92								
 420001xx	△	△						

Color

Silver	01
White (RAL 9016)	11
Special color	09
Stainless steel	04
Polished brass	09

xx

Order N°.:

- = Closer body
- = Slide channel assembly separate
- △ = Accessory

TS 92 also available in matching "Design" finishes

TS 92 B/G

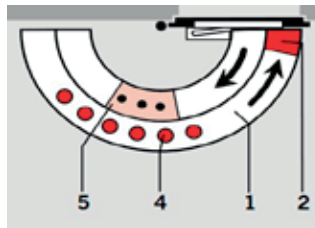
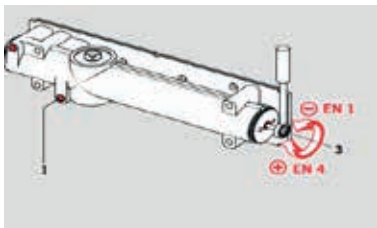

- 1 Variable closing speed in the range 180°-15°
- 2 Variable latching speed in the range 15°-0°
- 3 Infinitely variable closing force
- 4 Hold-open (option)
- 5 Cushioned limit stay (option)

The **closing speed** of the TS 92 is individually adjustable over two independent ranges at two separate valves. The **closing force setting (spring strength)** for the relevant door width is adjusted with the TS 92 at an infinitely variable lateral adjustment screw.

TS 91 B

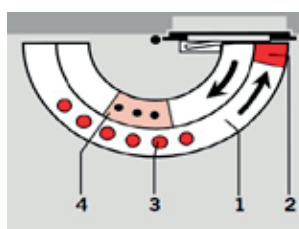
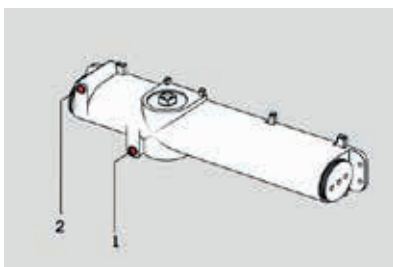

- 1 Infinitely variable closing speed in the range 180°-15°
- 2 Infinitely variable latching speed in the range 15°-0°
- 3 Hold-open (option)
- 4 Cushioned limit stay (option)

The **closing speed** of the TS 91 is individually adjustable over two independent ranges at two separate valves. The **closing force (spring strength)** in the TS 91 is permanently set to size EN 3.

Applications and Fixing

TS 92 B Door Leaf Fixing, Pull side

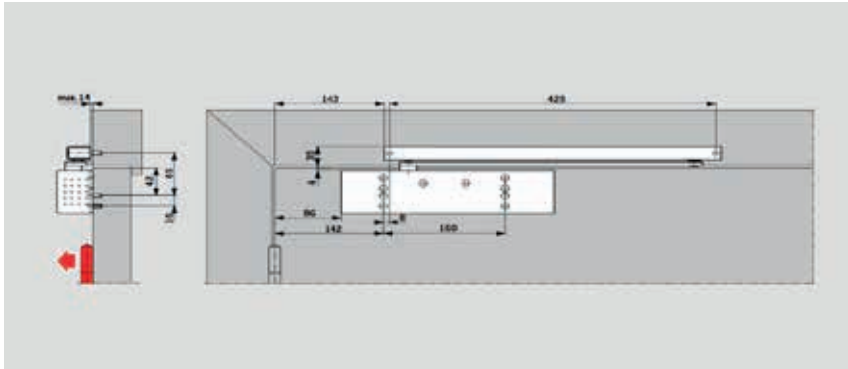

TS 92 B Transom fixing, push side

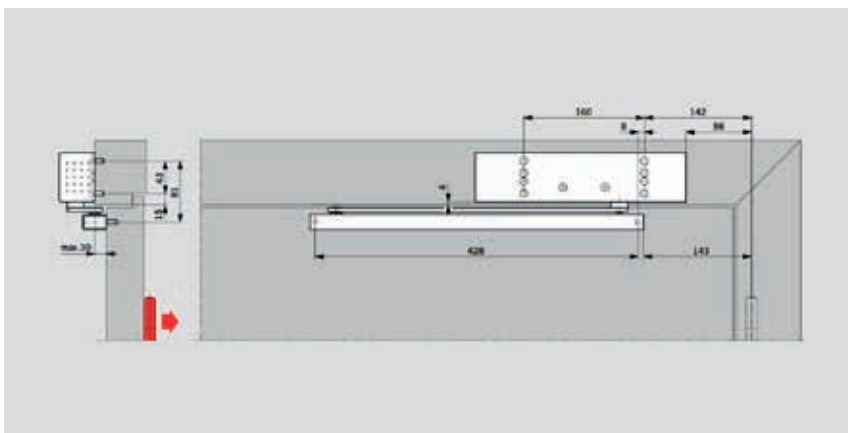

TS 92 G Door leaf fixing, push side

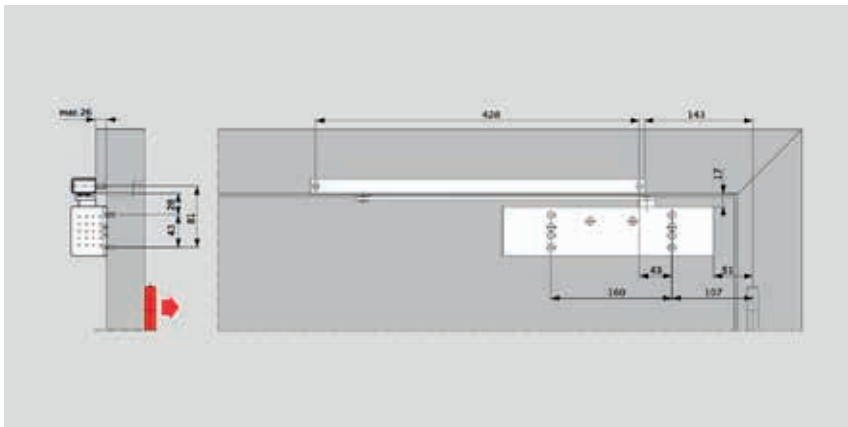

TS 92 G Transom fixing, pull side

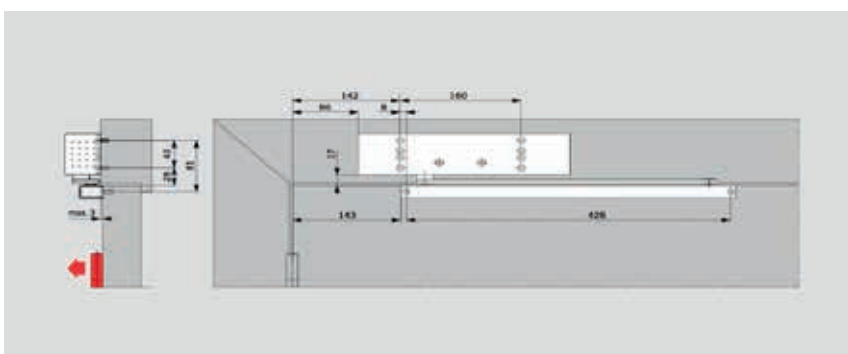

TS 91 B Door leaf fixing, pull side

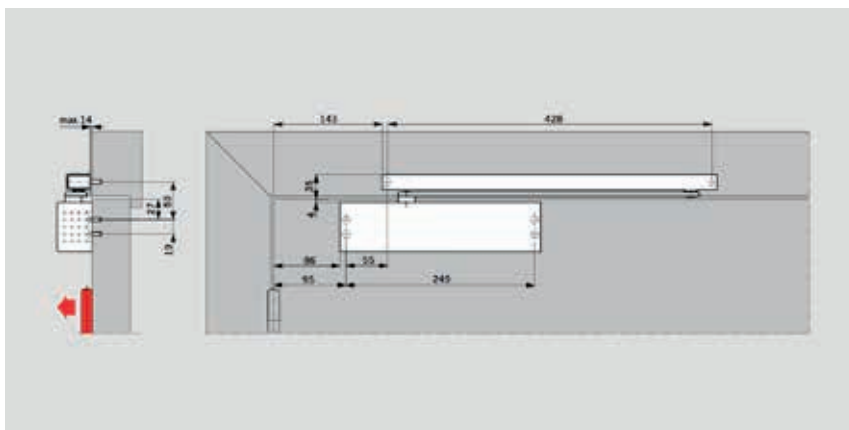

TS 91 B Transom fixing, push side

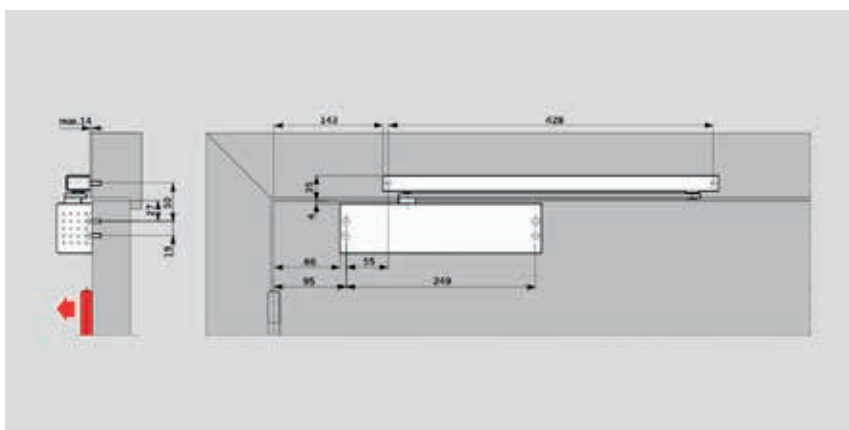

TS 92 B/G

Cam-action door closer, CERTIFIRE approved (CF 119), in Contur design with linear drive and rapidly decreasing opening resistance/torque, adjustable closing speed in two independent ranges and mounting backplate with universal fixing hole pattern; closing force infinitely variable between size EN 1 and EN 4.

Non-handed.
Approved to EN 1154.

Model

- TS 92 B
- TS 92 G

Accessories:

- Hold-open unit
- Cushioned limit stay
- Mounting backplate (30 mm) for G-N
- Mounting backplate (40 mm) for G-NN
- Angle bracket for G-N
- Saddle plate for toughened glass doors

Colors:

- Silver
- White (sim. to RAL 9016)
- Stainless steel
- Polished brass
- Special color (sim. to RAL)

TS 91 B

Cam-action door closer, CERTIFIRE approved (CF 119), in Contur design with linear drive and rapidly decreasing opening resistance/torque, adjustable closing speed in two independent ranges and mounting backplate with universal fixing hole pattern; closing force EN 3.

Non-handed.
Approved to EN 1154.

Accessories:

- Hold-open unit
- Cushioned limit stay
- Mounting backplate (30 mm) for G-N
- Mounting backplate (40 mm) for G-N
- Mounting backplate for TS 91

Colors:

- Silver
- White (sim. to RAL 9016)
- Special color (sim. to RAL)

TS 93 System Door Closer

Versatile and elegant



TS 93 N

TS 93 EMF

TS 93 EMR



The TS 93 cam action door closer system provides a high-quality architectural solution for all project application requirements.

The proven **dormakaba** technology featuring the heart-shaped cam ensures exceptional ease of opening.

Rapidly decreasing opening force

The TS 93 system's unique cam technology sets it apart from conventional door closer systems.

The resistance encountered when opening the door is instantly reduced, offering an easy opening action much appreciated by, in particular, children and older people.







Technical data and Features		TS 93 B/G ¹	
		EN 2/5	EN 5/7
Closing force, adjustable			
Standard doors ²	≤ 1250 mm	●	–
	≤ 1600 mm	–	●
External doors, opening outwards ²	≤ 1250 mm	●	–
	≤ 1600 mm	–	●
Fire and smoke check doors ²	≤ 1250 mm	●	–
	≤ 1600 mm	–	●
Non-handed		●	●
Arm	Standard	–	–
	Slide channel	●	●
Closing force variable by means of adjustment screw		●	●
Closing speed adjustable by valve		●	●
Latching speed adjustable	at arm	–	–
	at valve	●	●
Backcheck (BC/ÖD) adjustable	at valve	–	–
		●	●
Delayed action (DC/SV) adjustable at valve		●	●
Dimensions in mm	Length	275	285
	Overall depth	53	62
	Height	60	71
Hold-open		Option	Option
Weight in kg		3.5	5.2
Door closer tested to EN 1154		●	●
Door closer tested to EN 1155		●	●
Door closer tested to EN 1158		●	●
CE mark for construction products		●	●

¹B = Standard model for pull-side door leaf fixing/push-side transom fixing

G = Special model for push-side door leaf fixing/pull-side transom fixing.

²For applications involving particularly heavy or wide doors, and doors which have to close against wind resistance, the next highest door closer size should be selected, or the closing force adjusted to a higher setting.

Key advantages

For Users

- Easy opening action and fully controlled closing
- Smoke detector with convenient service and maintenance indicator
- Adjustable hydraulic functions for easy adaptation to each specific door situation

For Sellers

- Clear product allocation ensures use of the right models for the right applications
- Identical door closer model for single and double doors
- Available in a wide range of colours and finishes

For Installers

- TS 93 System is suitable for all fixing positions
- Mounting bracket with universal fixing hole pattern for optimal fixing
- Simple, fast installation

TS 93 door closer comprises a modular system which enables just a few door closer models to be combined with a number of different slide channels to meet virtually every conceivable functional requirement.

Doors of varying designs can be equipped for a wide range of different applications.

Functions and options

Standard mounting backplate with universal fixing hole system

This mounting backplate with its universal hole system, including hole pattern to supplementary sheet 1 of DIN EN 1154 A, ensures ideal fixing whatever the conditions and irrespective of the door type.

The fixing hole patterns are the same for both sizes of the TS 93. Additional mounting plates/brackets are no longer required. Alignment dowels on the mounting backplate facilitate location of the closer body.

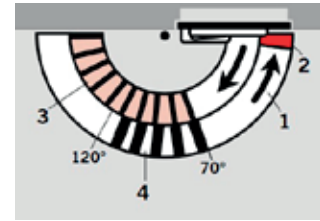
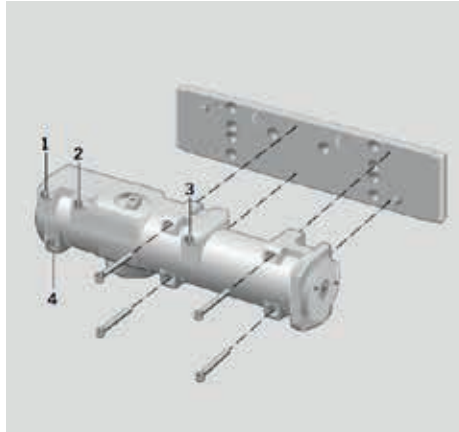

- 1 Fully controlled closing action with adjustable speed
- 2 Adjustable latch speed
- 3 Adjustable backcheck
- 4 Adjustable delayed action

Backcheck

The backcheck feature ensures the safe deceleration and restraint of a door which has been flung open or caught by a gust of wind.

This effectively reduces the danger of the door and adjacent wall being damaged.

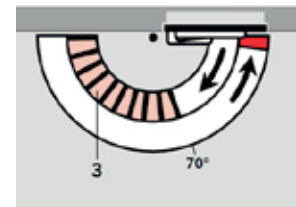

- 3 Adjustable backcheck

Delayed action

The delayed action feature retards the closing cycle between 120° and 70° (approximate values for pull-side door leaf fixing). The extra time allowed for passage through the doorway can be essential for people with luggage or bulky items: mothers with prams, personnel with tea trolleys, post trolleys, hospital beds, etc.; and also for disabled people.

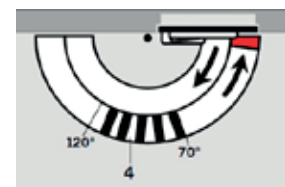

- 4 Adjustable delayed action

Applications and Fixing

Pull-side door leaf fixing

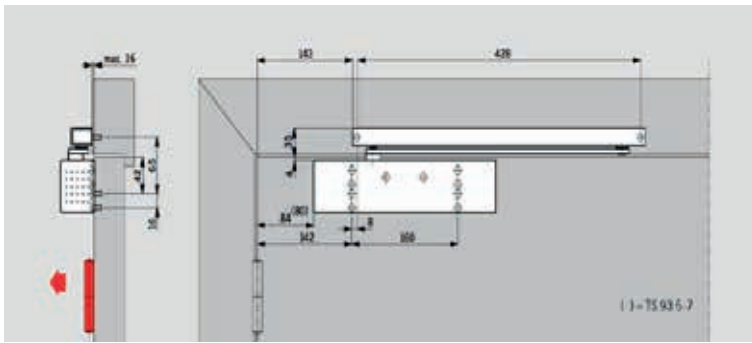

Door leaf fixing (standard arrangement) of the TS 93 B on the pull side.

Push-side transom fixing

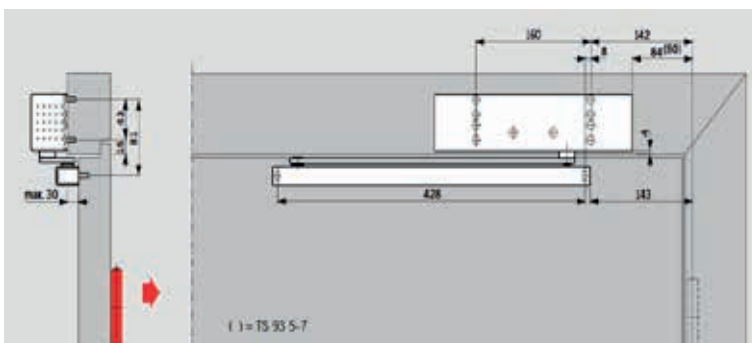

Transom fixing (overhead frame fixing) of the TS 93 B on the push side.

Push-side door leaf fixing

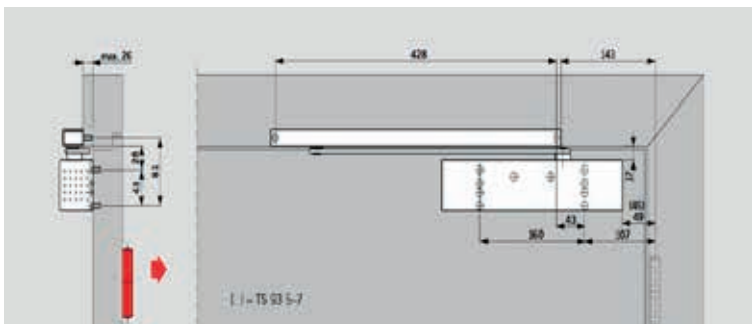

Door leaf fixing (standard installation) of the TS 93 G on the push side.

Pull-side transom fixing

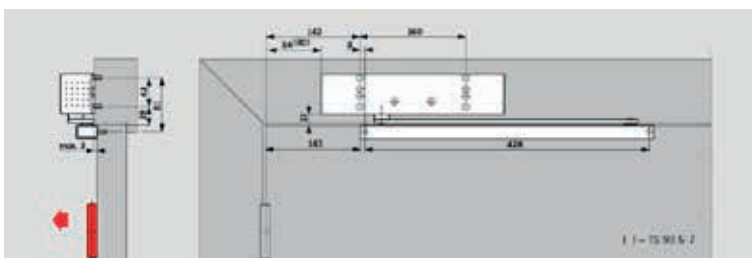

Transom fixing (overhead frame fixing) of the TS 93 G on the pull side.



G-EMF slide channel with electro-mechanical hold-open

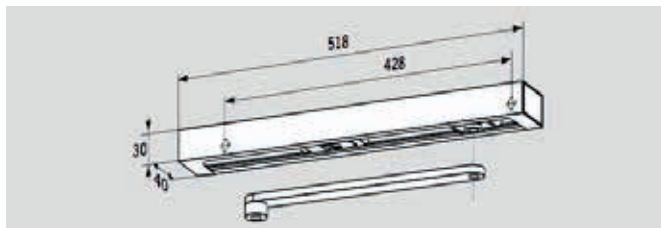

The **G-EMF** slide channel assembly enables the door to be held open securely at a preselected position without fall-back. The hold-open point can be adjusted within an opening angle of approx. 80° and 140°.

Note

The active leaf can be opened up to the maximum selected hold-open point (door stop to be positioned accordingly).

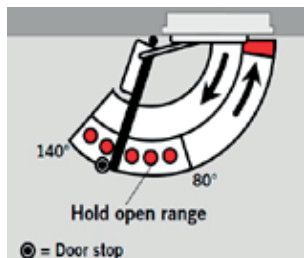

F Approval certification

The TS 93 EMF has been successfully type-tested to EN 1155, Electrically Powered Hold-Open Devices. Certificates are available on request.

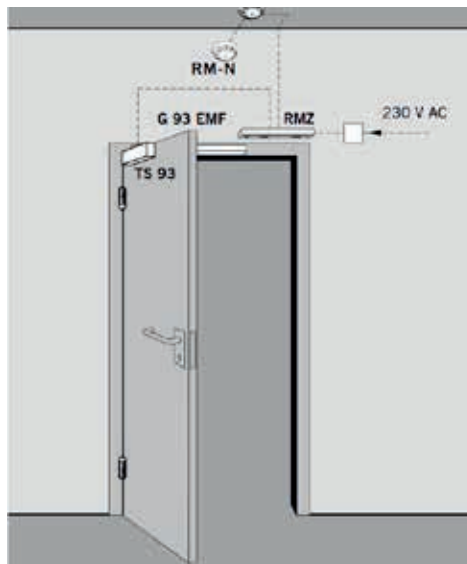

Technical data

Operating voltage	24 V DC, ± 15%
Power input	1.4 W
Rated for continuous duty	100% ED
Release force	adjustable

G-EMR slide channel electro-mechanical hold-open and integral smoke detector

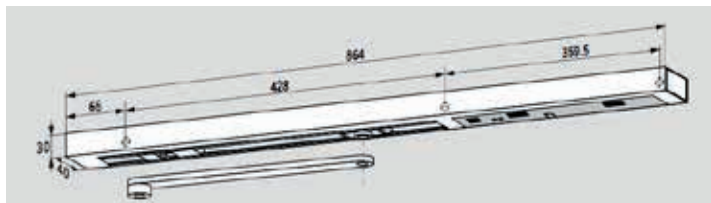

The **G-EMR** slide channel assembly enables fire and smoke doors to be held open securely at precisely the angle required, and monitored and controlled completely independently of other systems. The hold-open point can be adjusted to opening angles between approx. 80° and 140°.

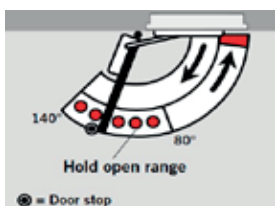

F Approval certification

The TS 93 EMR has been successfully type-tested to EN 1155, Electrically Powered Hold-Open Devices. Certificates are available on request.

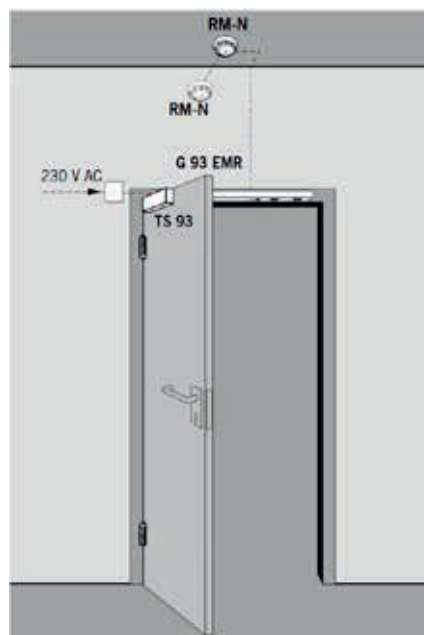

Technical data

Power supply	230 V AC ± 10%
Operating voltage (internal)	24 V DC
Max. output rating	9.8 W
Power input EMF	1.4 W
Rated for continuous duty	100% ED
Release force	adjustable

G-SR door coordinator slide channel Pull side fixing

The G-SR slide channel with integral door coordinator featuring a push rod clamping system for **double doors**, ensures that the active leaf always closes after the inactive leaf.

As this system operates independently of the door closer hydraulics, it offers maximum safety and reliability (doors prevented from "creeping closed").

An overload release protects both the door coordinator and the door set from damage. The G-SR door coordinator is non-handed and suitable for combination with TS 93 B door closers.

F Approval certification

The TS 93 G-SR has been successfully type-tested to EN 1158, Door Coordinator Devices. Certificates are available on request.

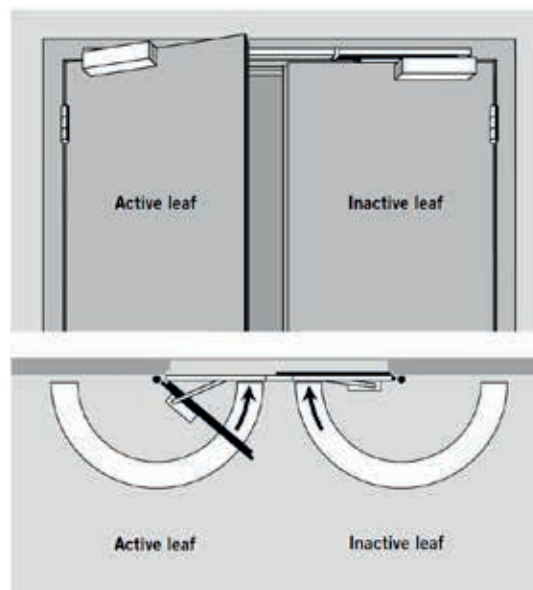

G-SR-EMF with electro-mechanical hold-open G-SR-EMR with integral smoke detector

These door coordinators not only ensure the correct closing sequence of double doors, but also allow the door leaves to be individually held open.

In the event of an alarm or power failure, the hold-open is released and the door is closed by the door closer.

The release action is triggered by a signal from the smoke detector integrated in the G-SR-EMR door coordinator.

The G-SR-EMR DCW® door coordinator model is also available without a power pack for integration in building management and control systems via a DCW® bus and the TMS door management system.

The pull-off force for the hold-open mechanism can be adjusted without tools and is rated to ensure that the door can also be easily released manually. G-SR-EMF and G-SR-EMR door coordinators are non-handed and suitable for combination with TS 93 B door closers.

In the case of doors in which the hold-open point required exceeds 130°, we recommend that EM hold-open magnets be applied instead of the electro-mechanical hold-open unit.

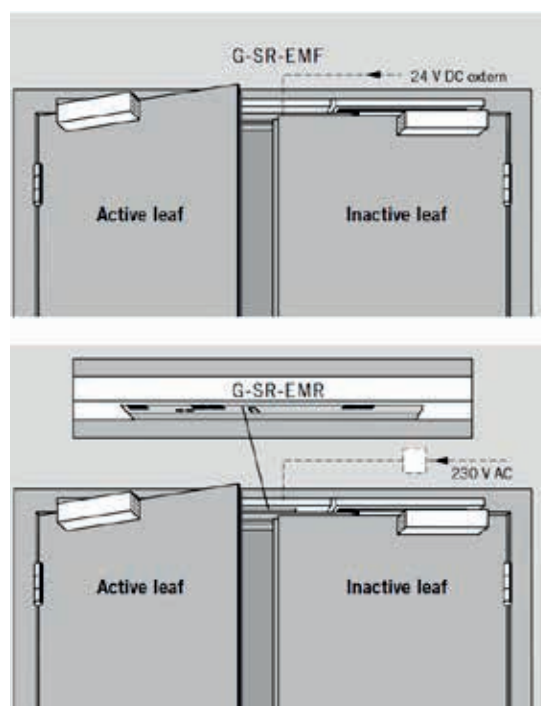



G-SR-EMF 1

This door coordinator contains just one hold-open mechanism, located in the inactive leaf slide channel, for holding open both door leaves. The single-point hold-open position is adjustable between approx. 80° and 130°.

Note

The active leaf can be opened up to the maximum selected hold-open point (door stop to be positioned accordingly). The active leaf can be held open by the door coordinator at any angle up to max. 150°.

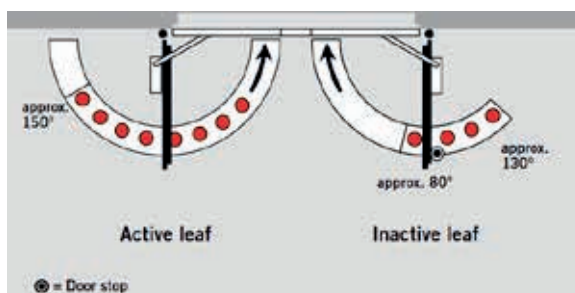
**G-SR-EMR 1**

This door coordinator includes an integral smoke detector. A floating (volt-free) alarm contact and connections for further detectors and external manual release devices are also provided.

G-SR-EMF 2

With this door coordinator, the active leaf can be held open independently of the inactive leaf. The hold-open points for each leaf lie between approx. 80° and 130°.

Note

The active leaf can be opened up to the maximum selected hold-open point (door stop to be positioned accordingly).

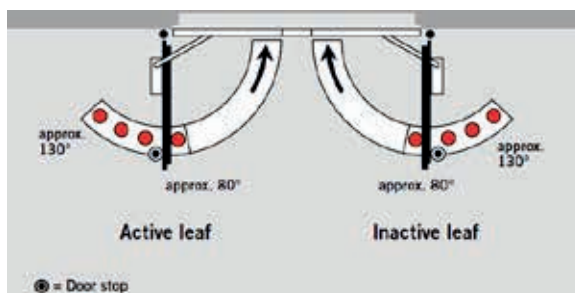
**G-SR-EMR 2**

This door coordinator includes an integral smoke detector. A floating (volt-free) alarm contact and connections for further detectors and external manual release devices are also provided.

G-SR-EMF 1G

This door coordinator enables the active leaf to be held open independently in special door sets involving, for example, fixed side screens, narrow inactive leaves („penny farthing” doors), etc. The hold-open point lies between approx. 80° and 130°.

Note

The active leaf can be opened up to the maximum selected hold-open point (door stop to be positioned accordingly).

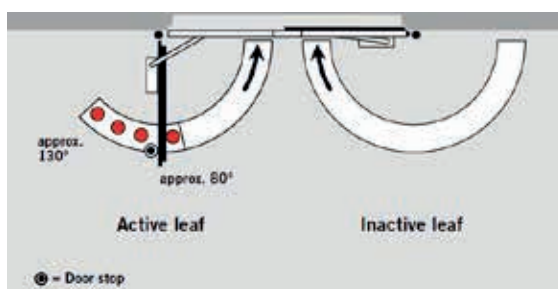
**G-SR-EMR 1G**

This door coordinator includes an integral smoke detector. A floating (volt-free) alarm contact and connections for further detectors and external manual release devices are also provided.

F Approval certification

The TS 93 G-SR-EMF 1, EMF 2 and EMF 1G have been successfully type-tested to EN 1155, Electrically Powered Hold-Open Devices. Certificates are available on request.





Technical data

Power supply	EMR	230 V AC ± 10%
Max. output rating	EMR	9.8 W
Operating voltage	EMF	24 V DC, ± 15%
Power input	EMF 1	1.4 W
	EMF 2	2.8 W
Rated for continuous duty		100% ED
Release force		adjustable



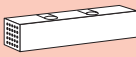
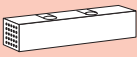

F Approval certification

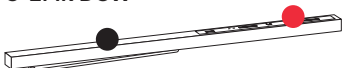



The TS 93 G-SR-EMR 1, EMR 2 and EMR 1G have been successfully type-tested to EN 1155, Electrically Powered Hold-Open Devices. Certificates are available on request.

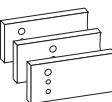
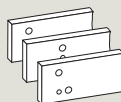

Range of equipment and optional accessories **single doors**

		TS 93 B	TS 93 G	30 mm mounting backplate for G-N	40 mm mounting backplate for G-N
		 2-5 ■ 430200xx 5-7 ■ 435200xx	 2-5 ■ 430300xx 5-7 ■ 435300xx	 644000xx	 644100xx
G-N		□ 640100xx	□ ■ □ ■	△	△
G-EMF		□ 640800xx	□ ■ □ ■		
G-EMR DCW®		□ 640703xx	□ ■ □ ■		

Range of equipment and optional accessories **double doors**

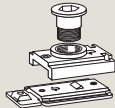
		TS 93 B	TS 93 G	Mounting backplate for G-SR	Mounting backplate for G-SR/BG
		 2-5 ■ 430200xx 5-7 ■ 435200xx	 2-5 ■ 430300xx	 644800xx	 644900xx
G-SR	Active leaf  Inactive leaf	□ VK 641010xx □ V 641020xx □ VL 641030xx	□ 2 x ■	△	

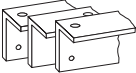
<p>40 mm mounting backplate for G-EMF</p>	<p>40 mm mounting backplate for G-EMR</p>	<p>Angle bracket for G-N</p>	<p>Angle bracket for G-EMF</p>	<p>Cushioned limit stay set for G-N</p>	<p>Add-on old-open unit for G-N</p>
					
<p>644200xx</p>	<p>644600xx</p>	<p>644300xx</p>	<p>644400xx</p>	<p>35800093</p>	<p>18570000</p>
<p>△</p>	<p>△</p>	<p>△</p>	<p>△</p>	<p>△</p>	<p>△</p>

<p>Angle bracket for G-SR/BG</p>	<p>Pivot block</p>	<p>Cushioned limit stay</p>
		
<p>644700xx</p>	<p>645000xx</p>	<p>18020000</p>
	<p>△</p>	<p>△</p>

Specification text single doors

TS 93 N EN 2-5 / EN 5-7

Cam action door closer conforming to EN 1154, carries the CE mark, Contur design, with rapidly decreasing opening torque/force. Door leaf fixing on the pull side, transom fixing on the push side. Closing speed, latching speed, hydraulically controlled backcheck and delayed action conveniently adjustable at valves accessible from the front.

Mounting bracket with universal fixing hole system. Non-handed. Height-adjustable slide channel.

Optional

■ With retrofittable cushioned limit stay for integration in the standard slide channel.

■ With retrofittable mechanical hold-open unit (RF), hold-open point adjustable between 75° and 150°.

Use of mechanical hold-open units is not permitted on fire and smoke check doors.

Colors:

■ silver
white, sim. to RAL ■ 9010
■ 9016

■ stainless steel
■ polished brass
■ special colour (sim. to RAL)

Make

TS 93 N, EN 2-5
TS 93 N, EN 5-7
TS 93 RF, EN 2-5
TS 93 RF, EN 5-7

TS 93G N EN 2-5 / EN 5-7

Cam action door closer conforming to EN 1154, carries the CE mark, Contur design, with rapidly decreasing opening torque/force. Door leaf fixing on the push side, transom fixing on the pull side. Closing speed, latching speed, hydraulically controlled backcheck and delayed action conveniently adjustable at valves accessible from the front.

Mounting bracket with universal fixing hole system. Non-handed. Height-adjustable slide channel.

Optional

■ With retrofittable cushioned limit stay for integration in the standard slide channel.

■ With retrofittable mechanical hold-open unit (RF), hold-open point adjustable between 75° and 150°.

Use of mechanical hold-open units is not permitted on fire and smoke check doors.

Colors:

■ silver
white, sim. to RAL ■ 9010
■ 9016

■ stainless steel
■ polished brass
■ special colour (sim. to RAL)

Make

TS 93G N, EN 2-5
TS 93G N, EN 5-7
TS 93G RF, EN 2-5
TS 93G RF, EN 5-7

TS 93 EMF EN 2-5

Cam action door closer conforming to EN 1154, carries the CE mark, Contur design, with rapidly decreasing opening torque/force. Pull-side fixing. Closing speed, latching speed, hydraulically controlled backcheck and delayed action conveniently adjustable at valves accessible from the front.

Mounting bracket with universal fixing hole system. Non-handed. Slide channel assembly with integral electro-mechanical hold-open, 24 V DC, conforming to EN 1155. Hold-open point (80° – 140°) and pull-off force infinitely variable. One-piece cover. Overall height 30 mm.

Approved by the German Institute for Building Technology, Berlin, for use in hold-open systems. Acceptance inspection of the system is mandatory.

Colors:

■ silver
white, sim. to RAL ■ 9010
■ 9016

■ stainless steel
■ polished brass
■ special colour (sim. to RAL)

Make

TS 93 EMF,
EN 2-5

TS 93G EMF EN 2-5

Cam action door closer conforming to EN 1154, carries the CE mark, Contur design, with rapidly decreasing opening torque/force. Push-side fixing. Closing speed, latching speed, hydraulically controlled backcheck and delayed action conveniently adjustable at valves accessible from the front.

Mounting bracket with universal fixing hole system. Non-handed. Slide channel assembly with integral electro-mechanical hold-open, 24 V DC, conforming to EN 1155. Hold-open point (80° – 140°) and pull-off force infinitely variable. One-piece cover. Overall height 30 mm.

Approved by the German Institute for Building Technology, Berlin, for use in hold-open systems. Acceptance inspection of the system is mandatory.

Colors:

■ silver
white, sim. to RAL ■ 9010
■ 9016

■ stainless steel
■ polished brass
■ special colour (sim. to RAL)

Make

TS 93G EMF,
EN 2-5

Specification text double doors

TS 93 GSR EN 2-5

Cam action door closer conforming to EN 1154, carries the CE mark, Contur design, with rapidly decreasing opening torque/force. Pull-side fixing. Closing speed, latching speed, hydraulically controlled backcheck and delayed action conveniently adjustable at valves accessible from the front. Mounting bracket with universal fixing hole system.

Non-handed.

Slide channel assembly with integrated mechanical door co-ordinator, conforming to EN 1158. This system operates independently of the door closer hydraulics using a push rod clamping system with an overload release and one-piece cover. Overall height 30 mm. Non-handed.

Approved by the German Institute for Building Technology, Berlin, for use on fire and smoke check doors.

Colors:

- silver
- white, sim. to RAL 9016
- stainless steel
- special colour (sim. to RAL)

Make
TS 93 GSR

TS 93 GSR-EMF EN 2-5

Cam action door closer conforming to EN 1154, carries the CE mark, Contur design, with rapidly decreasing opening torque/force. Pull-side fixing. Closing speed, latching speed, hydraulically controlled backcheck and delayed action conveniently adjustable at valves accessible from the front. Mounting bracket with universal fixing hole system. Non-handed.

Hold-open point (80° – 130°) and pull-off force infinitely variable. This system operates independently of the door closer hydraulics using a push rod clamping system with an overload release and one-piece cover. Overall height 30 mm. Non-handed.

Approved by the German Institute for Building Technology, Berlin, for use in hold-open systems. Acceptance inspection of the system is mandatory.

Model

- TS 93 GSR-EMF 1
With electro-mechanical hold-open for the inactive leaf
- TS 93 GSR-EMF 2
With electro-mechanical hold-open for the active and inactive leaf
- TS 93 GSR-EMF 1G
With electro-mechanical hold-open for the active leaf

Colors:

- silver
- white, sim. to RAL 9016
- stainless steel
- special colour (sim. to RAL)

Make
TS 93 GSR-EMF 1
TS 93 GSR-EMF 2
TS 93 GSR-EMF 1G

TS 93 GSR-EMR EN 2-5

Cam action door closer conforming to EN 1154, carries the CE mark, Contur design, with rapidly decreasing opening torque/force. Pull-side fixing. Closing speed, latching speed, hydraulically controlled backcheck and delayed action conveniently adjustable at valves accessible from the front. Mounting bracket with universal fixing hole system. Non-handed. Smoke detector with standby and maintenance indicators, fully integrated in the door co-ordinator body. A floating (volt-free) alarm contact and connections for further detectors and external manual release devices are provided.

Power supply 230 V AC, operating voltage 24 V DC. Slide channel assembly with integrated mechanical door co-ordinator, conforming to EN 1158. With electro-mechanical hold-open, 24 V DC, conforming to EN 1155. Hold-open point (80° – 130°) and pull-off force infinitely variable. This system operates independently of the door closer hydraulics using a push rod clamping system with an overload release and one-piece cover. Overall height 30 mm. Non-handed. Approved by the German Institute for Building Technology, Berlin, for use as a hold-open unit. Acceptance inspection of the system is mandatory.

Model

- TS 93 GSR-EMR 1
With electro-mechanical hold-open for the inactive leaf
- TS 93 GSR-EMR 2
With electro-mechanical hold-open for the active and inactive leaf
- TS 93 GSR-EMR 1G
With electro-mechanical hold-open for the active leaf
- TS 93 GSR-EMR 2 DCW®
Smoke detector without power pack for connection to DCW® bus. With electro-mechanical hold-open for the active and inactive leaf.

Colors:

- silver
- white, sim. to RAL 9016
- stainless steel
- special colour (sim. to RAL)

Make
TS 93 GSR-EMR 1
TS 93 GSR-EMR 2
TS 93 GSR-EMR 1G
TS 93 GSR-EMR 2 DCW®

TS 93 EMR EN 2-5

Cam action door closer conforming to EN 1154, carries the CE mark, Contur design, with rapidly decreasing opening torque/force. Pull-side fixing. Closing speed, latching speed, hydraulically controlled backcheck and delayed action conveniently adjustable at valves accessible from the front. Mounting bracket with universal fixing hole system. Non-handed.

Slide channel assembly with integral smoke detector featuring standby and maintenance indicators and electro-mechanical hold-open,

24 V DC, conforming to EN 1155. Hold-open point (80° – 140°) and pull-off force infinitely variable. A floating (volt-free) alarm contact and connections for further detectors and external manual release devices are provided. One-piece cover. Overall height 30 mm.

Approved by the German Institute for Building Technology, Berlin, for use as a hold-open unit. Acceptance inspection of the system is mandatory.

Model

■ TS 93 EMR with integrated power pack. Power supply 230 V AC, operating voltage 24 V DC

■ TS 93 EMR DCW[®] Smoke detector without power pack for connection to DCW[®] bus.

■ Optional integral alarm module adding an audible signal to the visual indicator.

Colors:

■ silver
white, sim. to RAL ■ 9010
■ 9016

■ stainless steel
■ polished brass
■ special colour (sim. to RAL)

Make

TS 93 EMR, EN 2-5

TS 93 EMR DCW[®], EN 2-5

TS 93G EMR EN 2-5

Cam action door closer conforming to EN 1154, carries the CE mark, Contur design, with rapidly decreasing opening torque/force. Push-side fixing. Closing speed, latching speed, hydraulically controlled backcheck and delayed action conveniently adjustable at valves accessible from the front. Mounting bracket with universal fixing hole system. Non-handed.

Slide channel assembly with integral smoke detector featuring standby and maintenance indicators, power pack and electro-mechanical

hold-open, 24 V DC, conforming to EN 1155. Hold-open point (80° – 140°) and pull-off force infinitely variable. A floating (volt-free) alarm contact and connections for further detectors and external manual release devices are provided. One-piece cover. Overall height 30 mm.

Approved by the German Institute for Building Technology, Berlin, for use as a hold-open unit. Acceptance inspection of the system is mandatory.

Model

■ TS 93G EMR with integrated power pack. Power supply 230 V AC, operating voltage 24 V DC

■ TS 93G EMR DCW[®] Smoke detector without power pack for connection to DCW[®] bus.

■ Optional integral alarm module adding an audible signal to the visual indicator.

Colors:

■ silver
white, sim. to RAL ■ 9010
■ 9016

■ stainless steel
■ polished brass
■ special colour (sim. to RAL)

Make

TS 93G EMR, EN 2-5

TS 93G EMR DCW[®], EN 2-5

RMZ

Smoke detector, Contur design, with standby and maintenance indicators, integral power pack and optical smoke sensor for transom/lintel fixing. For activation of dormakaba hold-open devices. A floating (volt-free) alarm contact and connections for further detectors and external manual release devices are provided.

Can be switched to manual reset. One-piece cover. Overall height 30 mm. Approved by the German Institute for Building Technology, Berlin, for use in a hold-open system. Acceptance inspection of the system is mandatory.

Model

■ RMZ with integrated power pack. Power supply 230 V AC, operating voltage 24 V DC

■ RMZ DCW[®] Smoke detector without power pack for connection to DCW[®] bus.

■ Optional integral alarm module adding an audible signal to the visual indicator.

Colors:

■ silver
white, sim. to RAL ■ 9010
■ 9016

■ stainless steel
■ polished brass
■ special colour (sim. to RAL)

Make

RMZ

RMZ DCW[®]

RM-N

Optical smoke detector, 24V DC, for ceiling fixing. For use as second and third triggering detector on all dormakaba hold-open systems. With floating (no-volt) changeover contact. General building

approval granted by DIBt, Berlin and the VdS, Cologne; compliant to EN 54, Part 7. Acceptance inspection mandatory in Germany.

Color:

■ white, sim. to RAL 9003

Make

RM-N

TS 93 GSR/BG EN 2-5

Cam action door closer conforming to EN 1154, carries the CE mark, Contur design, with rapidly decreasing opening torque/force. Push-side fixing. Closing speed, latching speed, hydraulically controlled backcheck and delayed action conveniently adjustable at valves accessible from the front. Mounting bracket with universal fixing hole system. Non-handed.

Slide channel assembly with integrated mechanical door co-ordinator, conforming to EN 1158. This system operates independently of the door closer hydraulics using a push rod clamping system with an overload release and one-piece cover. Overall height 30 mm. Non-handed.

General building approval issued by the German Institute for Building Technology, Berlin, for use on fire and smoke check doors.

Colors:

- silver
- white, sim. to RAL 9016
- stainless steel
- special colour (sim. to RAL)

Make

TS 93 GSR/BG

TS 93 GSR-EMF 2/BG EN 2-5

Cam action door closer conforming to EN 1154, carries the CE mark, Contur design, with rapidly decreasing opening torque/force. Push-side fixing. Closing speed, latching speed, hydraulically controlled backcheck and delayed action conveniently adjustable at valves accessible from the front. Mounting bracket with universal fixing hole system. Non-handed.

With electro-mechanical hold-open for the active and inactive leaf, 24 V DC, conforming to EN 1155.

Hold-open point (80° – 120°) and pull-off force infinitely variable. This system operates independently of the door closer hydraulics using a push rod clamping system with an overload release and one-piece cover. Overall height 30 mm. Non-handed.

Colors:

- silver
- white, sim. to RAL 9016
- stainless steel
- special colour (sim. to RAL)

Make

TS 93 GSR-EMF 2/BG

Approved by the German Institute for Building Technology, Berlin, for use in hold-open systems. Acceptance inspection of the system is mandatory.

TS 93 GSR-EMR 2/BG EN 2-5

Cam action door closer conforming to EN 1154, carries the CE mark, Contur design, with rapidly decreasing opening torque/force. Push-side fixing. Closing speed, latching speed, hydraulically controlled backcheck and delayed action conveniently adjustable at valves accessible from the front. Mounting bracket with universal fixing hole system. Non-handed.

Slide channel assembly with integrated mechanical door co-ordinator, conforming to EN 1158. With electro-mechanical hold-open for the active and inactive leaf, 24 V DC, conforming to EN 1155. Hold-open point (80° – 120°) and pull-off force infinitely variable. This system operates independently of the door closer hydraulics using a push rod clamping system with an overload release and one-piece cover. Overall height 30 mm. Non-handed.

Model

■ TS 93 GSR-EMR 2/BG
With integrated electro-mechanical hold-open for the active and inactive leaf.

■ TS 93 GSR-EMR 2 DCW®/BG
Smoke detector without power pack for connection to a DCW® bus. With integrated electro-mechanical hold-open for the active and inactive leaf.

Colors:

- silver
- white, sim. to RAL 9016
- stainless steel
- special colour (sim. to RAL)

Make

TS 93 GSR-EMR 2/BG

TS 93 GSR-EMR 2

DCW®/BG

Smoke detector with standby and maintenance indicators, fully integrated in the door co-ordinator body. A floating (volt-free) alarm contact and connections for further detectors and external manual release devices are provided. Power supply 230 V AC, operating voltage 24 V DC.

Approved by the German Institute for Building Technology, Berlin, for use as a hold-open unit. Acceptance inspection of the system is mandatory.

TS 97 Door Closer

A perfect combination of form and function



Technical data and Features		
Adjustable closing force		EN 2 - 4
Standard doors ≤ 1100 mm ¹		●
External doors, opening outwards ¹		–
Fire and smoke check doors ¹		●
Non-handed		●
Arm	Slide channel	●
Closing speed adjustment by valve		●
Latching action adjustment by valve		●
Dead stop unit (mechanical)		●
Backcheck		–
Delayed action		–
Dimensions in mm	Length Overall depth Height	340 37 49
Hold-open		Option
Weight in kg		2.5
Door closer tested to EN 1154		●
CE mark for construction products		●

1) In the case of particularly heavy doors and doors that have to close against wind pressure, we recommend TS 93 door closer..

Key advantages

For Users

- High ease of use and fully controlled, reliable closing with adjustable latching action
- Dead stop unit as standard to protect the wall and door

For Sellers:

- High-quality architectural solution for superior interior designs
- Single-piece faceplate without slots or fixing points
- Single pack for easy handling

For Installers:

- Universally applicable on both LH and RH doors
- Quick and easy to fix with mounting bracket

TS 97 door closer features the proven heart-shaped cam for maximum user convenience based on minimum opening effort.

With its compact dimensions, the TS 97 ideally complements the overall appearance of any door.

Certified to ISO 9001

Applications and Fixing

Door - leaf fixing, Pull side

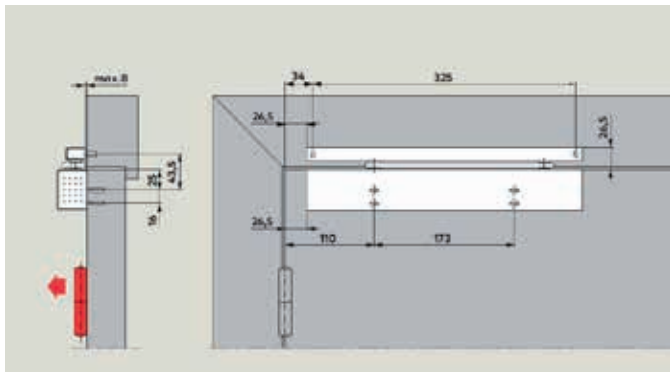

Transom fixing, Push side

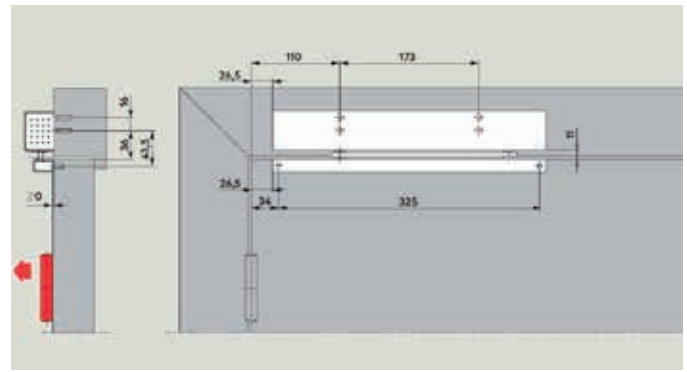

Standard and optional functions

The functions of the TS 97 can be individually adjusted to each door situation and matched to varying requirements. The closer speed of the TS 97 can be infinitely adjusted by means of a valve, and there is a second valve for adjusting the latching action. The closing force is adjustable between EN 2 and 4 by means of a screw.

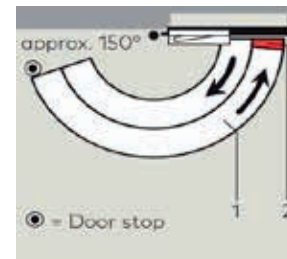
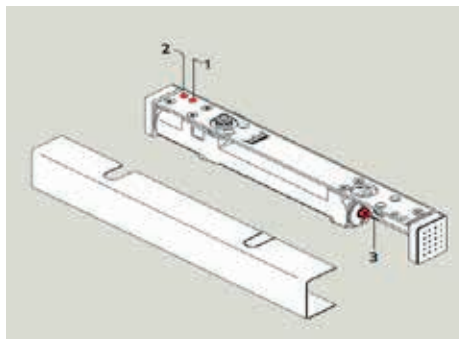

- 1 Infinitely adjustable closing speed in the range 150° – 0°
- 2 Infinitely adjustable latching action in the range 7° – 0°
- 3 Adjustable closing force

The integral cushioned limit stay of the TS 97 features progressive damping and helps to prevent a normally opened door from colliding with the adjacent wall. It can be adjusted to an opening angle between 80° and max. 120°.

The cushioned limit stay is not an overload protection device and in many cases is no substitute for a door stop.

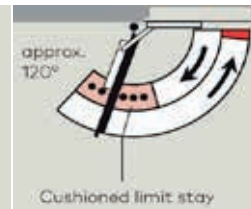
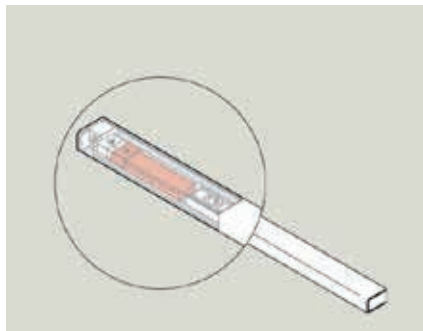

The mechanical hold-open device enables doors to be held without fallback at an opening angle up to approx. 120°. The hold-open device is suitable for both LH and RH doors and is designed for retrofitting into the slide channel.

Not suitable for fire and smoke check doors.

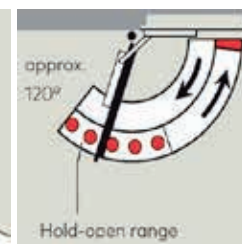
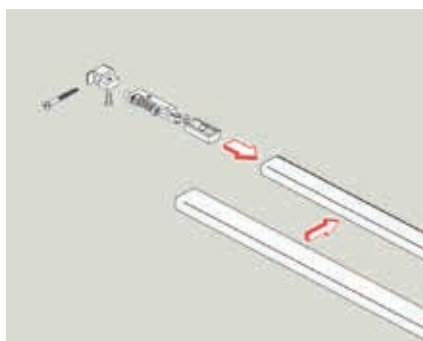

TS 98 XEA Door Closer

The highest standards in quality, comfort and design



Technical data and Features

Adjustable closing force		EN 1 - 6
Standard doors	≤ 1400 mm	●
External doors, opening outwards ¹	≤ 1400 mm	●
Fire and smoke control doors ¹	≤ 1400 mm	●
Same design for DIN-L and DIN-R		●
Same design for pull and push side		●
Arm assembly type	Standard Slide channel	- ●
Closing force can be adjusted from the front with the adjusting screw		●
Visual closing force indicator		●
Closing speed adjustable by valve		●
SoftFlow: second closing range, 15°–0° and adjustable via valve		●
Latching speed adjustable via valve		●
Backcheck (BC/OD), adjustable via valve		●
Delayed closing (DC/SV) adjustable via valve		●
Hold-open		Option
Weight in kg		4.5
Dimensions in mm	Length Depth Height	327 59 60
Door closer tested according to EN 1154 Certificate number 0432-CPR-00026-90		●
Hold-open devices tested according to EN 1155		●
Door coordinator tested according to EN 1158		●
Smoke detection (integrated or external) tested according to EN 14637		●
CE mark for construction products		●
Barrier-free according to DIN 18040 for door widths (mm) up to a max of		1250
Environmental Product Declaration as per ISO 14025 and EN 15804; Programme holder and publisher: Institut Bauen und Umwelt e.V. (IBU) Declaration number: EPD-ARG-20160183-IBG1-EN		●
Temperature range up to -40°C		●

¹⁾ For exceptionally tall and heavy doors and doors that constantly close against strong wind pressure, we recommend selecting the next-biggest door closer size or setting a stronger closing force.

Key advantages

For Users

- High level of convenience of use and fully controlled closing
- Simple adjustment of use thanks to hydraulic functions
- Almost silent closing

For Sellers:

- Suitable offer for almost all applications
- Meets a wide range of user requirements
- One closer body for all 4 installation types

For Installers:

- All functions are always set from the front
- The closing force can be regulated using a battery-powered screw driver
- Closing from 180° door opening (pull side application)
- Optical closing force display

TS 98 XEA slide channel door closer features an attractive, high-grade XEA design and is also flexible and easy to install.

01



02



03



04



01
TS 98 XEA
 Door leaf installation, pull side

02
TS 98 XEA EMF with RMZ XEA
 with electromechanical hold-open unit
 and smoke detector in XEA design,
 pullside installation

03
TS 98 XEA EMR
 with electromechanical hold-open unit
 and integrated smoke detector, pull
 side installation

04
TS 98 XEA GSR EMF
 Door coordinator with electromechanical
 hold-open unit, pull side installation

XEA – Excellent form in many colors

Combine color variants and surfaces as desired – in line with the entire installation

The new creative leeway in the XEA design means customer confection. A multitude of color combinations for decor plates, cover, slide channels, and main arms are available for selection.

A selected range of material impressions and surface quality meets the requirements of demanding interior architects in many ways.

- Excellent visual integration of the door closer
- Flexible adaptation to the door design
- Easy ordering process



01
Silver similar to RAL 9006 (P 600)

03
Stainless steel design (P 700)

05
Gold (P 750)

02
White similar to RAL 9016 (P 100)

04
White similar to RAL 9010 (P 210)

06
Black similar to RAL 9005 (P 190)

7



8



9



10



07
 TS 98 XEA White similar to RAL 9016 (P 100)
 G-N XEA stainless steel design (P 700)

08
 TS 98 XEA Gold (P 750)
 G-N XEA Gold (P 750)

09
 TS 98 XEA Stainless steel design (P 700)
 G-N XEA Silver similar to RAL 9006 (P 600)

10
 TS 98 XEA Black similar to RAL 9005 (P 190)
 G-N XEA White similar to RAL 9016 (P 100)

EN 1 to EN 6, pull or push side? One door closer for all applications! For high-quality architectural solutions in the project

The centerpiece of the TS 98 XEA slide channel door closer system is the heart-shaped cam. Together with the innovative, hydraulic functions, the TS 98 XEA system's unique Cam Action Technology makes it very comfortable to pass through the door.

The door closer system in XEA design impresses due to

- one door closer for all installation types
- three different closing ranges
- standard delayed closing
- standard backcheck
- conveniently adjust all settings from the front
- door width up to 1,400 mm
- usable at up to -40°C



A door closer for all installation types

The TS 98 XEA can be installed on the pull or push side, on the transom or the door leaf and on the left-hand or right-hand side.



Closes at 180°

If the door closer is mounted on the pull side, 180° closing is possible with both door leaf and transom installation.



Rapidly decreasing opening torque

The resistance that needs to be overcome when opening the door instantly decreases. Children and the elderly in particular will appreciate so much comfort.



Torque curve TS 98 XEA (Closing force adjustment EN 6)

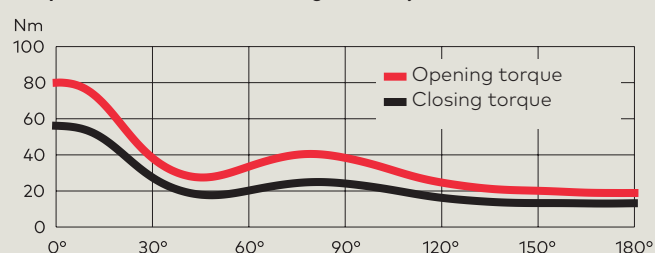



SoftFlow – Silent closing

A combination of two adjustable closing ranges (15°–0° and 7°–0°) allows for the door to close silently.



Delayed closing – DC/SV

The delayed closing reduces the closing speed until the door closing angle reaches 70°. As a result, there is always enough time to pass through the door.



Backcheck – BC/OD

Thanks to the backcheck function, the momentum of a flung-open door or a door caught by the wind is mostly cushioned. This protects the wall and door from damage. However, we still recommend using a door stop.

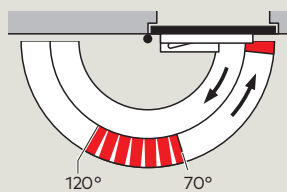

Adjustable delayed closing

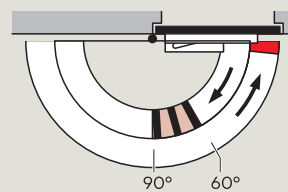

Adjustable backcheck

Flexible technology

Can be universally used for one and two-leaf door applications

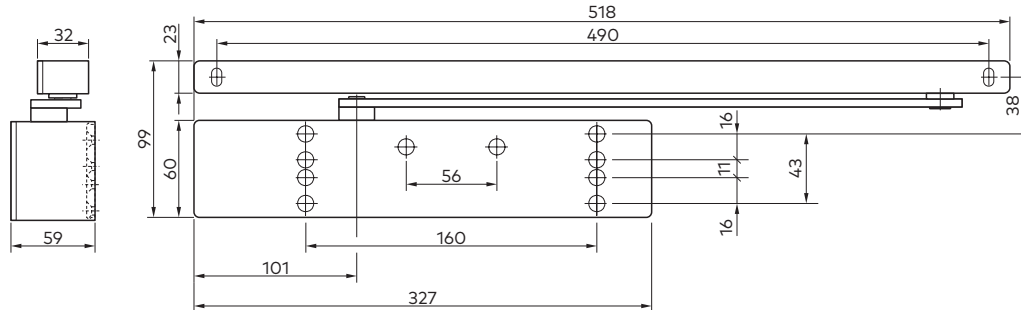

Whether it is one-leaf or two-leaf, DIN left or right – the TS 98 XEA is dormakaba's single door closer for all installation types. As a result, the number of product variants and complexity in installation is reduced while simultaneously increasing flexibility at the construction site.

The mounting plate with a universal hole pattern system offers the optimum or required fastening for many different door constructions.

Adjustments are easily made from the front.

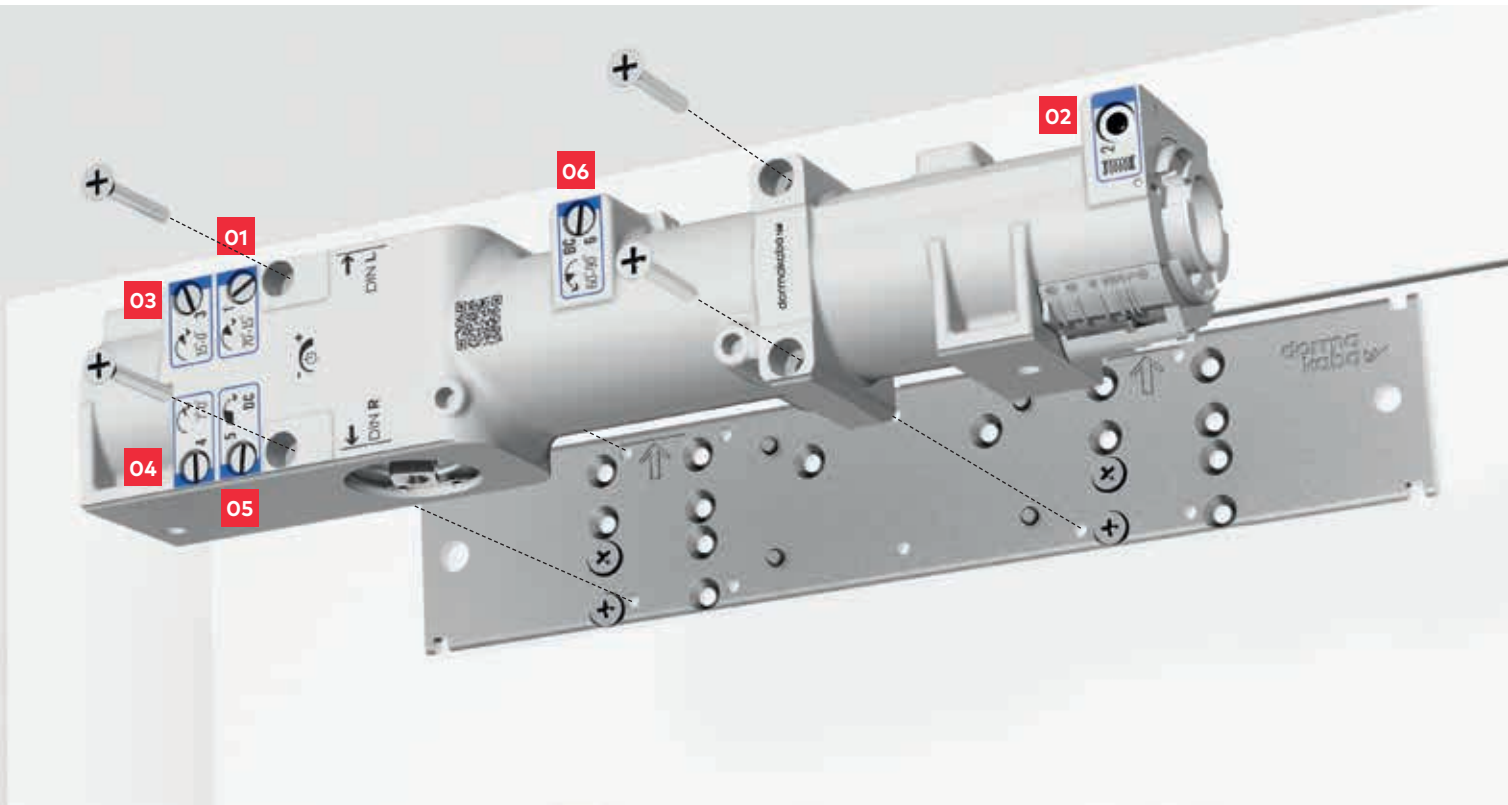

All functions are adjustable from the front



- 1** Adjustable closing speed between 70° and 15°.



- 2** Closing force adjustment EN1-6
A visual display (closing force indicator) shows the selected closing force. Easy to adjust from the front using a cordless screwdriver.

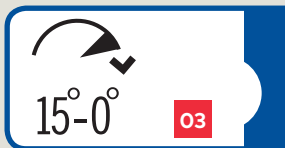

- 3** SoftFlow: adjustable closing range from 15° to 0° – allows for the door to close silently.

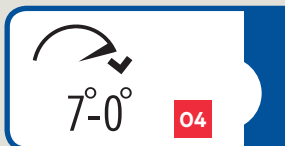

- 4** Adjustable latching speed in the 7°-0° closing range



- 5** Delayed closing – DC/SV Closing speed reduced to 70°. Allows for sufficient time to go through the door with luggage, baby carriages, hospital beds, etc.



- 6** Backcheck – Thanks to the backcheck function, the momentum of a flung-open door or a door caught by the wind is mostly cushioned. This protects the wall and door from damage. However, we still recommend using a door stop.



Indicator according to size information in EN 1154 regarding door width.

G - Ubivis XEA

Shut out fire without connecting to the main power



With the new battery-powered G-Ubivis XEA slide channel hold-open system with integrated smoke detector, fire protection gains new freedoms without compromising safety.

Technical data	G-Ubivis XEA
Class of protection	IP30
Class of protection	III
Door type	Single-leaf
Door width	up to 1.250 mm
Installation height	34 mm
Hold-open point	about 80°–140°
Door opening angle	max. 140°
Release force	adjustable
Colors	silver P 600 similar to RAL 9006; white P 100 similar to RAL 9016; pure white P 210 similar to RAL 9010; black P 190 similar to RAL 9005; stainless steel P 700; gold P 750 and other customised colours.
Power supply	Stand-alone thanks to battery

Key advantages:

- More flexibility on construction sites
- No 230 V wiring
- No dependence on other work being completed first
- No additional trades required when installing so you save time and money
- No alterations to the building fabric
- Patented technology in time-tested quality
- Attractive XEA design

You no longer need to alter the building fabric or install complicated electrical wiring to connect systems to the mains thanks to G-Ubivis XEA.

Easy to install: saves on labour, time and costs

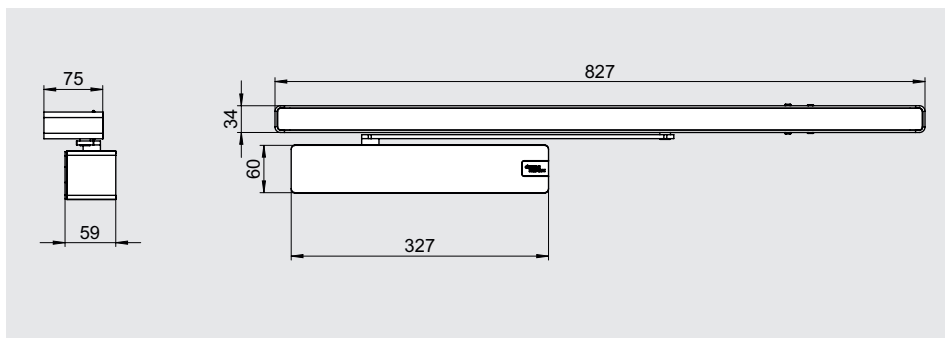

dormakaba's first battery-powered hold-open system does not require a 230 V power connection and can thus be conveniently fitted on single-leaf doors using the extended G-N drilling template. Laborious matching is now a thing of the past. The battery has a service life of about 16 months and should be replaced during yearly maintenance.

Before installing and using G-Ubivis XEA it is mandatory to check the local laws and regulations in regards to battery powered hold-open devices since battery powered hold-open devices are not covered by a harmonized standard.



Specification texts

1-leaf doors

TS 98 XEA EN 1-6

Slide channel door closer according to EN 1154, with **CE mark**, in XEA design, including rapidly decreasing opening torque for easy door opening according to DIN SPEC 1104.

Installation types Normal installation on the pull and push side, transom installation on the pull and push side.

Closing speed, 2. 15°–0° doorway, latching speed (SoftFlow), hydraulically controlled opening dampening and delayed closing can be comfortably adjusted from the front via a valve.

EN 1–6 closing force can be configured from the front using a cordless screw-driver, includes visual closing force indicator.

Installation console with universal hole pattern system. Suitable for DIN-L and DIN-R. Height-adjustable slide channel.

Colors:

- Silver colored similar to RAL 9006 (P 600)
- White similar to RAL 9016 (P 100)
- White similar to RAL 9010 (P 210)
- Black similar to RAL 9005 (P 190)
- Stainless steel design (P 700) ■ Gold (P 750)
- Other colors

TS 98 XEA EMF

Slide channel door closer according to EN 1154, with **CE mark**, in XEA design, including rapidly decreasing opening torque for easy door opening according to DIN SPEC 1104.

Installation types: Normal installation on the pull and push side.

Closing speed, 2. 15°–0° closing range, latching speed (SoftFlow), hydraulically controlled opening dampening and delayed closing can be comfortably adjusted from the front via a valve.

EN 1–6 closing force can be configured from the front using a cordless screwdriver, includes visual closing force indicator.

Installation console with universal hole pattern system. Suitable for DIN-L and DIN-R. Slide channel with integrated, electromechanical hold-open unit, 24 V DC, tested according to EN 1155.

Hold-open position (80°–140°) and release force can be adjusted.

One-piece cover, 30 mm installation height.

General building approval by DIBt, Berlin for use in hold-open systems. Acceptance test required.

Colors:

- Silver colored similar to RAL 9006 (P 600)
- White similar to RAL 9016 (P 100)
- White similar to RAL 9010 (P 210)
- Black similar to RAL 9005 (P 190)
- Stainless steel design
- Gold (P 750)
- Other colors

TS 98 XEA EMR

Slide channel door closer according to EN 1154, with **CE mark**, in XEA design, including rapidly decreasing opening torque for easy door opening according to DIN SPEC 1104.

Installation types: Normal installation on the pull and push side.

Closing speed, 2. 15°–0° closing range, latching speed (SoftFlow), hydraulically controlled opening dampening and delayed closing can be comfortably adjusted from the front via a valve.

EN 1–6 closing force can be configured from the front using a cordless screwdriver, includes visual closing force indicator.

Installation console with universal hole pattern system. Suitable for DIN-L and DIN-R. Slide channel with integrated smoke detector with operation and maintenance indicator and electromechanical hold-open unit, 24 V DC, tested according to EN 1155 and EN 14637.

Hold-open position (80°–120° / 80°–140°) and release force can be variably adjusted. Connectors available for additional detectors, an external manual trigger, and potential-free alarm contact.

One-piece cover, 30 mm installation height.

Colors:

- Silver colored similar to RAL 9006 (P 600)
- White similar to RAL 9016 (P 100)
- White similar to RAL 9010 (P 210)
- Black similar to RAL 9005 (P 190)
- Stainless steel design
- Gold (P 750)
- Other colors

Specification texts

Smoke detector

RMZ XEA

Smoke detector in XEA design, with operation and maintenance indicator, integrated power supply, and visual smoke detector for transom installation. For controlling dormakaba hold-open devices.

Connectors available for additional detectors, an external manual trigger, and potential-free alarm contact. Changeable to manual reset. One-piece cover, 30 mm installation height. General building approval by DIBt, Berlin as a hold-open system. Acceptance test required. Tested according to EN 14637.

Colors:

- Silver colored similar to RAL 9006 (P 600)
- White similar to RAL 9016 (P 100)
- White similar to RAL 9010 (P 210)
- Stainless steel design
- Gold (P 750)
- Other colors

RM-N

Optical smoke detector, 24 V DC, for ceiling installation. Usable as a second and third detector in all dormakaba hold-open systems.

With potential-free changeover contact. General building approval by DIBt, Berlin and by VdS, Cologne, tested according to EN 54, part 7. Acceptance test required.

Color:

- White similar to RAL 9003

Specification texts

2-leaf doors

TS 98 XEA GSR

Slide channel door closer according to EN 1154, with **CE mark**, in XEA design, including rapidly decreasing opening torque for easy door opening according to DIN SPEC 1104.

Installation type: Normal installation, pull side. Closing speed, 2. 15°–0° closing range, latching speed (SoftFlow), hydraulically controlled opening dampening and closing delay can be comfortably adjusted from the front via a valve.

EN 1–6 closing force can be configured from the front using a cordless screwdriver, includes visual closing force indicator.

Installation console with universal hole pattern system. Suitable for DIN-L and DIN-R.

Slide channel with integrated, mechanical closing sequence control, tested according to EN 1158.

Closing sequence is controlled via a thrust-rod clamping system, which is independent of the door closer hydraulic system, with overload protection and continuous cover, installation height 30 mm. Suitable for DIN-L and DIN-R.

General building approval by DIBt, Berlin, in conjunction with fire and smoke control doors.

Colors:

- Silver colored similar to RAL 9006 (P 600)
- White similar to RAL 9016 (P 100)
- White similar to RAL 9010 (P 210)
- Black similar to RAL 9005 (P 190)
- Stainless steel design
- Gold (P 750)
- Other colors

TS 98 XEA GSR EMF

Slide channel door closer according to EN 1154, with **CE mark**, in XEA design, including rapidly decreasing opening torque for easy door opening according to DIN SPEC 1104.

Installation types: Door leaf installation, pull side. Closing speed, 2. 15°–0° closing range, latching speed (Soft Flow), hydraulically controlled opening dampening and closing delay can be comfortably adjusted from the front via a valve.

EN 1–6 closing force can be configured from the front using a cordless screwdriver, includes visual closing force indicator.

Installation console with universal hole pattern system. Suitable for DIN-L and DIN-R. Slide channel with integrated, mechanical closing sequence control, tested according to EN 1158.

Electromechanical hold-open unit, 24 V DC, tested according to EN 1155.

Hold-open position (80°–130°) and release force can be adjusted.

Closing sequence is controlled via a thrust-rod clamping system, which is independent of the door closer hydraulic system, with overload protection and continuous cover, installation height 30 mm. Suitable for DIN-L and DIN-R.

General building approval by DIBt, Berlin for use in hold-open systems. Acceptance test required.

Colors:

- Silver colored similar to RAL 9006 (P 600)
- White similar to RAL 9016 (P 100)
- White similar to RAL 9010 (P 210)
- Black similar to RAL 9005 (P 190)
- Stainless steel design
- Gold (P 750)
- Other colors

TS 98 XEA GSR EMR

Slide channel door closer according to EN 1154, with **CE mark** mark, in XEA design, including rapidly decreasing opening torque for easy door opening according to DIN SPEC 1104.

Installation types: Door leaf installation, pull side. Closing speed, 2. 15°–0° closing range, latching speed (SoftFlow), hydraulically controlled opening dampening and delayed closing can be comfortably adjusted from the front via a valve.

EN 1–6 closing force can be configured from the front using a cordless screwdriver, includes visual closing force indicator.

Installation console with universal hole pattern system. Suitable for DIN-L and DIN-R. Smoke detector with operation and maintenance display integrated flush in the closing sequence control's housing.

Connectors available for additional detectors, an external manual trigger, and potential-free alarm contact. Connection voltage 230 V AC, operating voltage 24 V DC. Slide channel with integrated, mechanical closing sequence control, tested according to EN 1158.

Electromechanical hold-open unit, 24 V DC, tested according to EN 1155 and EN 14637. Hold-open position (80°–130°) and release force can be adjusted.

Closing sequence is controlled via a thrust-rod clamping system, which is independent of the door closer hydraulic system, with overload protection and continuous cover, installation height 30 mm. Suitable for DIN-L and DIN-R.

General building approval by DIBt, Berlin as a hold-open system. Acceptance test required.

Color:

- Silver colored similar to RAL 9006 (P 600)
- White similar to RAL 9016 (P 100)
- White similar to RAL 9010 (P 210)
- Black similar to RAL 9005 (P 190)
- Stainless steel design
- Gold (P 750)
- Other colors

Specification texts

2-leaf doors

TS 98 XEA GSR BG

Slide channel door closer according to EN 1154, with **CE mark**, in XEA design, including rapidly decreasing opening torque for easy door opening according to DIN SPEC 1104.

Installation types: Normal installation, push side. Closing speed, 2. 15°–0° doorway, latching speed (SoftFlow), hydraulically controlled opening dampening and delayed closing can be comfortably adjusted from the front via a valve.

EN 1–6 closing force can be configured from the front using a cordless screwdriver, includes visual closing force indicator.

Installation console with universal hole pattern system. Suitable for DIN-L and DIN-R. Slide channel with integrated, mechanical closing sequence control, tested according to EN 1158.

Closing sequence is controlled via a thrust-rod clamping system, which is independent of the door closer hydraulic system, with overload protection and continuous cover, installation height 30 mm. Suitable for DIN-L and DIN-R.

General building approval by DIBt, Berlin, in conjunction with fire and smoke control doors.

Colors:

- Silver colored similar to RAL 9006 (P 600)
- White similar to RAL 9016 (P 100)
- White similar to RAL 9010 (P 210)
- Black similar to RAL 9005 (P 190)
- Stainless steel design
- Gold (P 750)
- Other colors

TS 98 XEA GSR EMF 2 BG

Slide channel door closer according to EN 1154, with **CE mark**, in XEA design, including rapidly decreasing opening torque for easy door opening according to DIN SPEC 1104.

Installation types: Normal installation, push side. Closing speed, 2. 15°–0° doorway, latching speed (SoftFlow), hydraulically controlled opening dampening and delayed closing can be comfortably adjusted from the front via a valve.

EN 1–6 closing force can be configured from the front using a cordless screwdriver, includes visual closing force indicator.

Installation console with universal hole pattern system. Suitable for DIN-L and DIN-R. Slide channel with integrated, mechanical closing sequence control, tested according to EN 1158. Electromechanical hold-open unit in active and inactive leaf, 24 V DC, tested according to EN 1155. Hold-open position (80°–120°) and release force can be adjusted. Closing sequence is controlled via a thrust-rod clamping system, which is independent of the door closer hydraulic system, with overload protection and continuous cover, installation height 30 mm. Suitable for DIN-L and DIN-R.

General building approval by DIBt, Berlin for use in hold-open systems. Acceptance test required.

Colors:

- Silver colored similar to RAL 9006 (P 600)
- White similar to RAL 9016 (P 100)
- White similar to RAL 9010 (P 210)
- Black similar to RAL 9005 (P 190)
- Stainless steel design
- Gold (P 750)
- Other colors

TS 98 XEA GSR EMR 2 BG

Slide channel door closer according to EN 1154, with **CE mark**, in XEA design, including rapidly decreasing opening torque for easy door opening according to DIN SPEC 1104.

Installation types: Normal installation, push side. Closing speed, 2. 15°–0° doorway, latching speed (SoftFlow), hydraulically controlled opening dampening and delayed closing can be comfortably adjusted from the front via a valve.

EN 1–6 closing force can be configured from the front using a cordless screwdriver, includes visual closing force indicator.

Installation console with universal hole pattern system. Suitable for DIN-L and DIN-R. Smoke detector with operation and maintenance display integrated flush in the closing sequence control's housing. Connectors available for additional detectors, an external manual trigger, and potential-free alarm contact. Connection voltage 230 V AC, operating voltage 24 V DC. Slide channel with integrated, mechanical closing sequence control, tested according to EN 1158. Electromechanical hold-open device in active and inactive leaf, 24 V DC, tested according to EN 1155 and EN 14637. Hold-open position (80°–120°) and release force can be adjusted.

Closing sequence is controlled via a thrust-rod clamping system, which is independent of the door closer hydraulic system, with overload protection and continuous cover, installation height 30 mm. Suitable for DIN-L and DIN-R.

General building approval by DIBt, Berlin as a hold-open system. Acceptance test required.

Colors:

- Silver colored similar to RAL 9006 (P 600)
- White similar to RAL 9016 (P 100)
- White similar to RAL 9010 (P 210)
- Black similar to RAL 9005 (P 190)
- Stainless steel design
- Gold (P 750)
- Other colors



Concealed Door Closers



ITS 96 Door Closer

The integrated solution for prestige doors



Technical data and features		ITS 96	
		EN 2-4	EN 3-6
Closing force Adjustable	Spring strength	EN 2-4	EN 3-6
Standard doors	≤ 1100mm ≤ 1400 mm	● —	● ●
External doors, opening outwards*		—	—
Fire and smoke check doors	≤ 1100mm ≤ 1400 mm	● —	● ●
Door leaf thickness	up to 40 mm up to 50 mm	● ●	— ●
Max. door leaf weight in kg		130	180
Non-handed design (closer)		●	●
Arm	Slide channel	●	●
Closing force variable by means of adjustable screw		●	●
Closing speed adjustable by means of valve		●	●
Cushioned limit stay, mechanical		●	●
Delayed action		—	—
Max. door opening angle (depends on door design)		approx. 120°	
Hold-open		Option	Option
Input voltage		—	—
Power consumption		—	—
Weight in kg		1.3	2.5
Dimensions in mm	Lenght	277	291
	Overall depth	32	39.5
	Height	42	51
Door closer tested to EN 1154		●	●
CE mark for construction products		●	●

Key advantages

For Users

- Optimum protection against vandalism thanks to the concealed installation
- Enhanced user convenience and fully controlled, reliable closing with adjustable latch action
- Free-swing function from a door angle >0°, resulting in virtually resistance-free opening of the doors in applications requiring passive fire protection

For Sellers

- Unblemished appearance of prestige doors thanks to concealed installation
- Compliance with statutory requirements for barrier-free building
- Universally suitable for single or double doors

For Installers

- Non-handed system
- Easy adjustment of the closing strength, closing speed and latch action after hanging of the doors

Thanks to its extraordinarily compact construction, ITS 96 door closer can be used in nearly all doors with a door leaf width of 40 mm or higher, while guaranteeing safety with its proven quality.

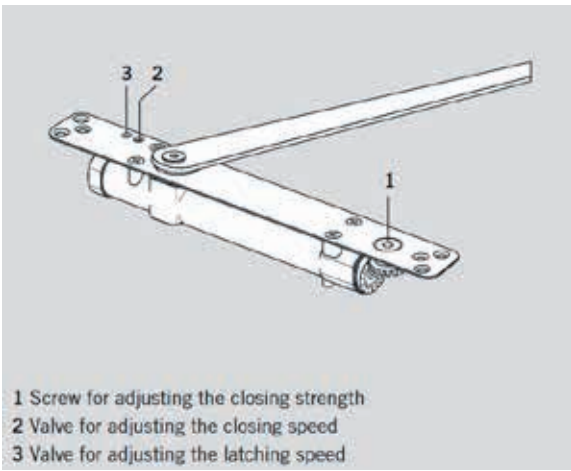

Adjustment of settings

The functions of the ITS 96 can be individually adapted to the local conditions of each application. The closing strength can be easily varied in accordance with the door width via the adjustment screw accessible from the top. The closing speed and the latch action can likewise be modified at any time using adjustment screws at the top, even after the door has been hung.

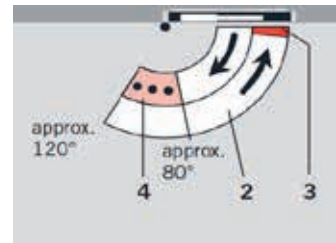

- 2 Fully controlled closing with adjustable speed
- 3 Adjustable latch action
- 4 Cushioned limit stay









Floor Springs



BTS 84 Floor Spring

Double action floor spring



Technical data and Features				
Spring strength		EN 2	EN 3	EN 4
Standard	≤ 850 mm	●	—	—
and external doors ¹⁾²⁾	≤ 950 mm	—	●	—
	≤ 1100 mm	—	—	●
Closing speed variable by valve adjustment		●	●	●
Backcheck		—	—	—
Delayed action		—	—	—
Hold-open point 90°		Option	Option	Option
Dimensions in mm	Length	306		
	Overall depth	108		
	Height	40		
Weight in kg		5.0		
Door closer tested to EN 1154		●	●	●
CE mark for construction products (products with factory-fitted hold-open do not carry a CE mark)		—	●	●

1) For applications involving particularly high or heavy doors, and doors which have to close against wind or draught conditions, the next larger closer size or the DORMA BTS 80 should be selected.

2) Max. opening 130°.

Door stop necessary for doors which can open further than 130°.

Key advantages

For Users

- Thermo constant smooth operation
- High mechanical efficiency for easy door opening
- Optional single point hold-open
- Proven, robust unit for door weights up to 100 kg

For Sellers

- Available with stronger and weaker springs for special requirements
- Concealed unit for invisible installation

For Installers

- Easy installation thanks to shallow design
- Easy to adapt to individual requirements with dual valve control 130° to 0° and 130° to 20°
- Minimum floor recess dimension

BTS 84 is developed to meet the special requirements of door closers for double action doors.

With the choice of two closing ranges and corresponding closer model, BTS 84 floor spring is able to meet practically any requirement.

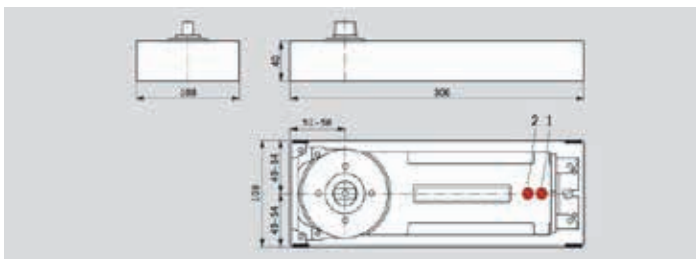

- 1 Valve for closing speed adjustment
130° – 0°
- 2 Valve for increasing closing speed
130° – 20°

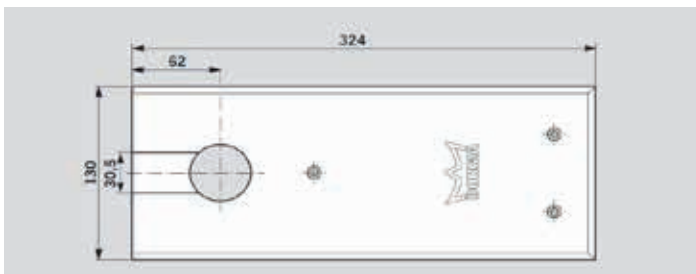

Universal cover plate
Available in stainless steel or satin brass

Standard and optional functions

Closing ranges

The floor spring has two controlled closing ranges:
Valve 1: 130° – 0° sweep
Valve 2: Increases the closing speed between 130° and 20°

Hold-open

With the hold-open (optional extra), the door can be held at an angle of 90°.

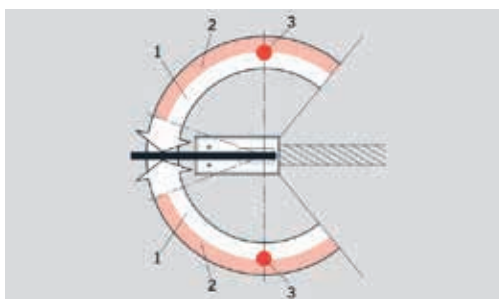

- 1 First adjusting closing range (130° – 0°)
- 2 Second adjusting closing range (130° – approx. 20°)
- 3 Hold open at 90° (optional extra)



BTS 75V Floor Spring

Faster aligned fit



Technical data and Features		
Spring strength		EN 1-4
Spring strength adjustment		●
Standard and external doors	≤ 950 mm ≤ 1100 mm ≤ 1400 mm	– ● –
Fire and smoke check doors		●
Max. leaf weight (kg)		120
Non-handed, suitable for single and double action doors		●
Closing force variable by means of adjustment screw		–
Closing speed adjustable by value	175° – 0° 175° – 15° 15° – 0°	– ● ●
Backcheck, mechanical		●
Delayed action adjustable by valve (selectable alternative to the hold-open feature)		–
Hold-open	Adjustable Fixed 90° Fixed 105°	– ● ●
Coverplate secure to	cement box floor spring	– ●
Weight in kg		3.0
Dimensions in mm	Length Overall depth Height	285 82 50
Floor spring tested to EN 1154		●
CE mark for construction products (products with factory-fitted hold-open do not carry a CE mark)		●

Key advantages

For Users

- Constant, temperature-independent closing cycle
- Highly efficient mechanism gives maximum user convenience

For Sellers

- Reduced stock requirements because of separate, interchangeable spindles
- Slim product range offering all key functions
- All essential functions provided

For Installers

- Fast, precise alignment
- Simple to mount without additional spirit level
- Easy installation saves time and, consequently, money

BTS 75 V is a highly adaptable floor spring suitable for all standard single and double action doors and for exterior doors with widths up to 1,100 mm.

Application and Installation

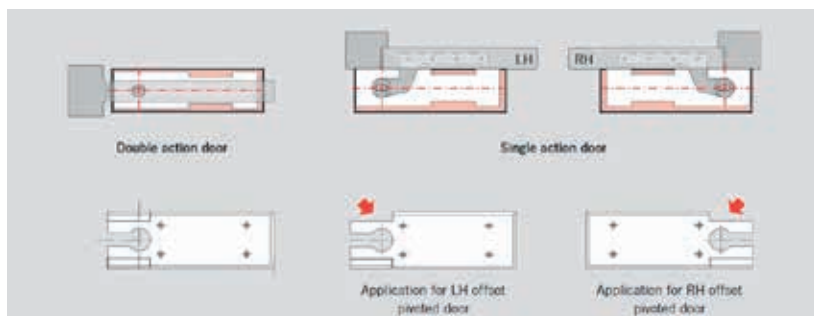

Accessories

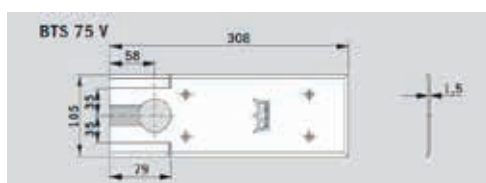

Universal cover plate

Adaptable to right or left hand single action applications by simply snapping off the appropriate pre-blanked corner sections. For double action doors, the corner sections remain in place.

The universal cover plate is available in stainless steel or satin brass (material thickness 1.5 mm).

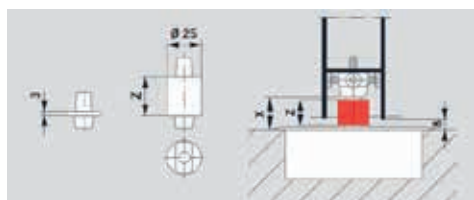

Calculating the necessary length of spindle extension:
 Extension = X – Floor clearance (normally 8 mm)
 Collar height Z of the extended spindle inserts = Spindle extension length + 3 mm (collar height of the standard spindle insert)

Spindles

A range of interchangeable spindles is available to provide greater floor clearance if required (e.g. doors with thresholds, carpeted floors etc).

Special spindles available on application: e.g. with flat face profile and 3° offset or square section; spindles for non-dormakaba-specific accessories are also available.

dormakaba 2300 sealing compound

For filling cavities between the floor spring body and the cement box to protect against moisture penetration

Information about other accessories such as **door straps and top centers** can be found in the "Accessories for dormakaba BTS Floor Springs" leaflet

Standard and Optional Functions

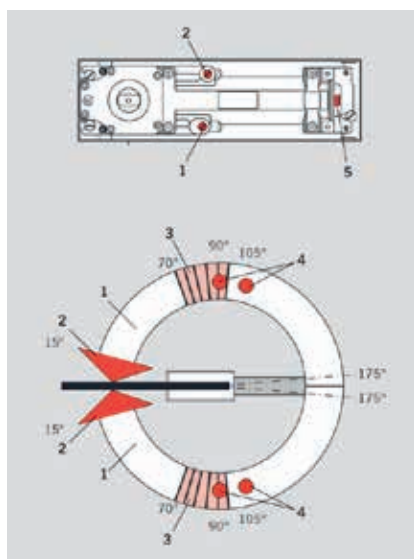

- 1 Adjustable closing speed in the range 175° – 15°.
- 2 Adjustable closing speed in the range 15° – 0°.
- 3 Mechanical backcheck (from approx. 70°).
- 4 Fixed hold-open at 90° or 105° (option).
- 5 Adjustable spring strength (EN 1–4).

Closing speed

With two independently adjustable closing ranges (175° – 15° and 15° – 0°) the dormakaba BTS 75 V is ideally adaptable to different structural conditions.

Backcheck

The integrated mechanical backcheck function protects the wall and door from damage caused by excessively vigorous opening.

Fixed hold-open (option)

With the fixed hold-open function the door can be held open at an angle of 90° or 105°, depending on model. **Not suitable for use on Fire doors.**





BTS 80 Floor Spring

Universal application, individual functions and assured quality



Technical data and Features				
Spring strength		EN 1-4	EN 4	EN 6
Spring strength adjustment		-		
Standard and external doors	≤ 950 mm	●	-	-
	≤ 1100 mm	-	●	-
	≤ 1400 mm	-	-	●
Fire and smoke check doors		-		
Max. leaf weight (kg)		300		
Non-handed, suitable for single and double action doors		●		
Closing force variable by means of adjustment screw		-		
Closing speed adjustable by valve	175° - 0°	●		
	175° - 15°	-		
	15° - 0°	-		
Backcheck, mechanical		●		
Delayed action adjustable by valve (selectable alternative to the hold-open feature)		●		
Hold-open	Adjustable	●		
	Fixed 90°	-		
	Fixed 105°	-		
Coverplate secure to	cement box	-		
	floor spring	●		
Weight in kg		7.1		
Dimensions in mm	Length	341		
	Overall depth	78		
	Height	60		
Floor spring tested to EN 1154		●		
CE mark for construction products (products with factory-fitted hold-open do not carry a CE mark)		-		

Key advantages

For Users

- Proven, robust design capable of withstanding leaf weights of up to 300 kg
- Constant, temperature-independent closing cycle
- Highly efficient mechanism gives maximum user convenience

For Sellers

- Reduced stock requirements because of separate, interchangeable spindles
- Slim product range offering all key functions

For Installers

- Suitable for installation with LH or RH single and double action doors
- Interchangeable spindles enable easy adaptation to structural conditions-even when retrofitted

BTS 80 can control exceptionally heavy single- and double-acting doors. It is easily installed into almost any design to meet most materials, size, and weight requirements.

Application and Installation

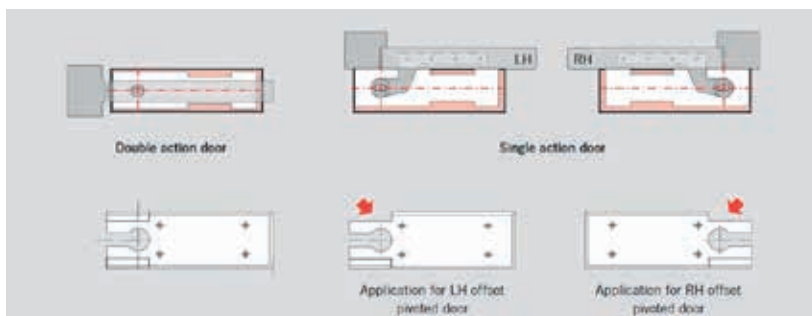

Accessories

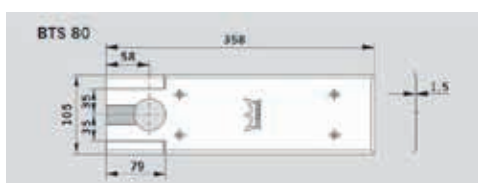

Universal cover plate

Adaptable to right or left hand single action applications by simply snapping off the appropriate pre-blanked corner sections. For double action doors, the corner sections remain in place.

The universal cover plate is available in stainless steel or satin brass (material thickness 1.5 mm).

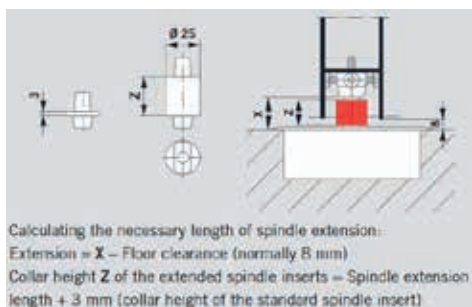

Spindles

A range of interchangeable spindles is available to provide greater floor clearance if required (e.g. doors with thresholds, carpeted floors etc).

Special spindles available on application: e.g. with flat face profile and 3° offset or square section; spindles for non-dormakaba-specific accessories are also available.

dormakaba 2300 sealing compound

For filling cavities between the floor spring body and the cement box to protect against moisture penetration

Information about other accessories such as **door straps and top centres** can be found in the "Accessories for dormakaba BTS Floor Springs" leaflet

Standard and Optional Functions

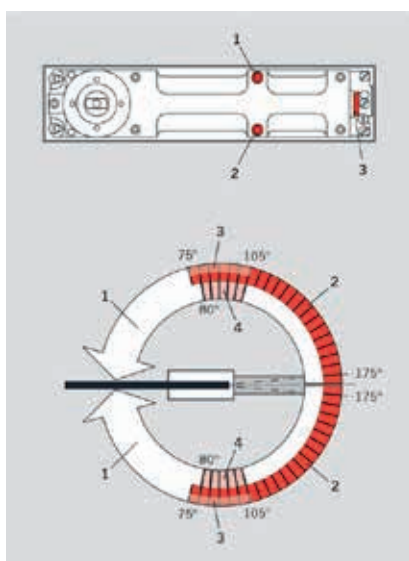

- 1 Adjustable closing speed
- 2 Hold-open range or delayed action range
- 3 Adjustment range – point at which hold-open begins, or end of delayed action range (approx. 75° to 105°).
- 4 Mechanical backcheck (from approx. 80°)

Hydraulic hold-open

The integrated hold-open function allows the door to be held open at any angle between 75° and 175°. The angle at which the holdopen function begins can be adjusted in the range of 75° to 105°.

Backcheck

The integrated mechanical backcheck function protects the wall and door from damage caused by excessively vigorous opening.

Delayed action

The delayed action function slows the door closing speed, thereby allowing disabled persons, mothers with pushchairs, staff with trolleys or hospital gurneys etc. to pass through the door without problem.



Whether for private homes or contemporary office buildings, door closer systems from dormakaba are intelligent, integrated access solutions that combine consistency, convenience, design and premium quality. The wide-ranging product portfolio satisfies a broad spectrum of functional requirements and thus offers solutions for almost any individual door situation.

Our brand promise

In one word we stand for Trust.

With over 150 years' experience and millions of products and solutions installed worldwide – from pushbutton locks and door closers to highly complex, networked access solutions with smartphone access – dormakaba is your reliable partner for secure and flexible access to buildings and rooms.

dormakaba

Sustainability Report 2007/8

Investor relations



Media Release

Wednesday, 23 October 2007 - 4:00 PM

Media Release

Investor Relations

70200 CHF

+150 CHF (+0.21%)

Our products and solutions

Our products and solutions

With our products, solutions and services, we offer our clients access to buildings and rooms of all from a single source.

dormakaba

Products

Product overview of the dormakaba Group

Door Hardware	Entrance Systems	Electronic Access & Data
Services	Mechanical Key Systems	Lodging Systems

Media Center

For more information, technical data, product brochures and photos, visit www.dormakaba.com and choose your **local dormakaba website**.

Subject to change without notice