

Guidelines for Installing Guided Wave Radar in Chambers



1.0 Introduction

This document provides guidelines for choosing and installing Rosemount™ guided wave radar (GWR) devices in chambers. Chambers — also known as bypass chambers, bridles, side-pipes, bypass pipes, and cages — are used to obtain a level or interface measurement from the outside of a process vessel.

Chambers are used in many applications and with different types of tanks and vessels and have several things in common with stilling wells. For recommendations and best practices related to stilling wells and non-contacting radars, please refer to the Guidelines for Choosing and Installing Radar in Stilling Wells and Bypass Chambers [Technical Note](#).

Figure 1-1. Example of a chamber (left) and a stilling well (right)

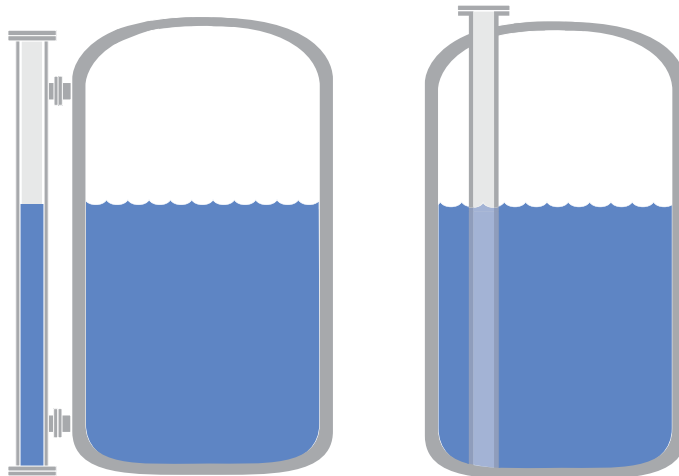

2.0 Advantages of using chambers

The reasons why it is beneficial to use a chamber will differ depending on the application. The following are some typical examples.

2.1 Chambers create calmer and cleaner liquid surfaces

A chamber housing a radar probe can increase the reliability and robustness of the level measurement. Because the liquid in a chamber has passed through a port, there will not be the same amount of agitation, turbulence, or foam in a chamber. Additionally, a metal chamber acts as a shield and amplifier to the radar signal, giving more reliable reflections in low dielectric liquids and allowing you to avoid metal objects that are located directly in the tank or vessel. This prevents these elements from affecting the reliability and accuracy of the measurement.

2.2 Chambers provide access to specific areas of interest

Chambers are mounted on the outside of a vessel using ports to allow liquid to move freely between the chamber and the vessel. Some applications may only require the chamber to be mounted on a small section of the vessel or column. For example, if you had an oil tank and were expecting only some water in the tank, you would perhaps use a chamber only on the lower portion of the tank or vessel or maybe you are measuring tray level in a distillation column.

2.3 Chambers allow instrumentation to be isolated from a vessel

Chambers often include valves on the connection ports to allow instrumentation isolation for verification or removal for servicing. Chambers are not without limitations, however. Generally, chambers should be used with cleaner fluids that are less likely to leave deposits and with fluids that are not viscous or adhesive. Apart from the additional cost of installation, there are some probe sizing and selection criteria that must also be considered. This document outlines those considerations.

3.0 Installation guidelines for guided wave radar

3.1 GWR in chambers: what probe to use?

The large diameter coaxial probe should always be considered first whenever the application and dimensions of the chamber allow for it. Large diameter coaxial probes offer the strongest return signal and have no upper dead zone and a very small lower dead zone, making them a suitable option for installation in chambers with limited space above and below the process connections. This type of probe has the best interface resolution, with a capability of detecting interface layers down to 1 in. (25 mm) and outstanding performance with low dielectric fluids. It is also completely unaffected by external disturbances such as protruding welds and side taps.

Rigid probes are a suitable option for chamber installations. When used in a metal, small diameter pipe, single rigid probes offer a stronger return signal than when used in open applications. This makes them suitable for low dielectric and interface applications. Flexible probes may be used in longer bypass chambers, but care must be taken to ensure that the probe is suspended in a true vertical position and does not touch the pipe wall. If flexible probes are to be used, the bypass chambers should be 4 in. (100 mm) or larger in diameter to allow room for some flexing. Also, as fluid moves into the pipe, it may push the probe towards the pipe wall. If the probe touches the wall, false reflections will create false level measurements. Coaxial probes are unaffected by these issues and rigid probes are less susceptible to them. Flexible probes simply need more room. Very narrow chambers allow little room for movement or flexing of the probe.

3.2 Centering discs

To prevent the probe from contacting the chamber wall, centering discs are available for rigid and flexible probes. Centering discs are not needed when using a large coaxial probe or a standard coaxial probe. For rigid single probes it is usually sufficient to fit one centering disc at the probe end, while flexible single probes may require several centering discs installed at points down the probe to keep it centered and prevent it from touching the chamber wall. It is recommended to use a maximum of five centering discs for each probe. The space between each disc must be at least 3 ft. (1 m).

When using a metallic centering disc at the probe end, the lower transition zone is 8 in. (20 cm), including a weight if applicable. When using a PTFE centering disc at the probe end, the lower transition zone is not affected. The lower transition zone is also not affected by PEEK Snap-on centering discs installed along the probe.

3.3 Pressure and temperature

Standard (S) GWR seals can be used in applications with operating temperatures of up to 302 °F (150 °C) and 580 psi (40 bar). For higher pressures and temperatures, as well as low temperatures, high pressure (HP), cryogenic (C), and high temperature and high pressure (HTHP) seals are available. See [Figure 1-2](#) for details. The large coaxial probe is available with standard (S), high pressure (HP) and cryogenic (C) seals.

Figure 1-2. Process Temperature and Pressure - Max Rating

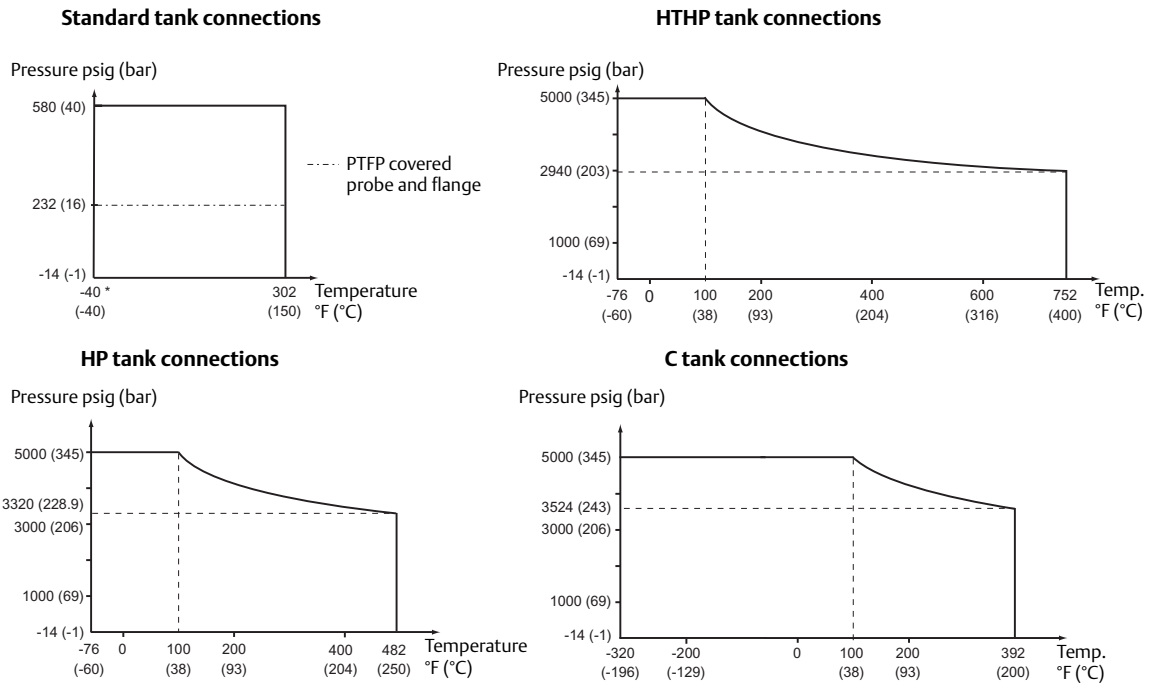

* -49 °F (-45 °C) depending on O-ring selection

3.4 Flushing connections and vents

For submerged single probe applications, it is desirable to vent the chamber near the top. This will ensure there is no trapped air or gas, which can affect the reading for the level of the liquid. A large coaxial probe set to level and interface mode is insensitive to an air gap, so venting is not required unless it is desirable to read the level all the way up to the flange. Venting is also needed if the level in the chamber will be manipulated to verify the output of the GWR or to drain the chamber. The following options will accomplish this task:

- A separate flushing ring may be inserted between the GWR flange and the chambers that use ASME or DIN flanges.
- Proprietary flanges are available with an integrated vent option. They are used with 1 ½ NPT threaded probes.

3.5 Chamber requirements

Probes of different styles and materials are available for use with Rosemount GWR. [Table 1-1](#) shows the various options and appropriate pipe sizes and lengths. GWR may be used in chambers made of metal, plastic, and other non-metallic materials. All chambers provide isolation from the process conditions. Metallic chambers help to increase signal strength and shield the probe from EMI disturbances. If EMI is present and a non-metallic pipe must be used, a Rosemount 5300 Guided Wave Radar Level Transmitter with a large diameter coaxial probe should be used although a standard coaxial can also be considered for clean applications.

Table 1-1. Probe Styles and Installation Considerations

	Large coaxial	Single rigid	Single flex	Coaxial
Maximum recommended length of chamber	19 ft. (6 m)	10 ft. (3m)	33 ft. (10 m)	19 ft. (6 m)
Centering disc	N/A	Yes	Yes	N/A
Recommended chamber diameter	3 in. (80 mm) or 4 in. (100 mm)	3 in. (80 mm) or 4 in. (100 mm)	4 in. (100 mm)	3 in. (80 mm) or 4 in. (100 mm)
Minimum dielectric Rosemount 5300	1.2 (STD) 1.4 (HP)	1.25 (STD) 1.4 (HP) 1.4 (HTHP)	1.4 (STD) 1.6 (HP) 1.6 (HTHP)	1.2 (STD) 1.4 (HP) 2.0 (HTHP)
Minimum chamber diameter	2 in. (50 mm)	2 in. (50 mm)	Consult factory	2 in. (50 mm)

Table 1-2. Rosemount 5300: Blind Zones Vary with Probe Type

Probe type	Upper Blind Zone		Lower Blind Zone	
	High dielectric	Low dielectric	High dielectric	Low dielectric
Large coaxial	0 in. (0 cm)	0 in. (0 cm)	2 in. (5 cm)	4 in. (10 cm)
Single rigid	4 in. (10 cm)	3.5 in. (9 cm)	0.4 in. (1 cm)	4.7 in. (12 cm)
Single flex	4 in. (10 cm)	3.5 in. (9 cm)	0.4 in. (1 cm)	4.7 in. (12 cm)
Coaxial	2 in. (5 cm)	3.5 in. (9 cm)	2 in. (5 cm)	5.1 in. (13 cm)

Table 1-3. Centering Disc Dimensions

Disc size	Actual disc diameter
2 in.	1.8 in. (45 mm)
3 in.	2.7 in. (68 mm)
4 in.	3.6 in. (92 mm)
6 in.	5.55 in. (141 mm)
8 in.	7.40 in. (188 mm)

Table 1-4. Centering Disc Size Recommendation for Different Pipe Schedules

Pipe size	Pipe schedule					
	5s, 5	10s, 10	40s, 40	80s, 80	120s, 120	160s, 160
2 in.	2 in.	2 in.	2 in.	2 in.	N/A ⁽¹⁾	N/A ⁽²⁾
3 in.	3 in.	3 in.	3 in.	3 in.	N/A ⁽¹⁾	2 in.
4 in.	4 in.	4 in.	4 in.	4 in.	4 in.	3 in.
5 in.	4 in.	4 in.	4 in.	4 in.	4 in.	4 in.
6 in.	6 in.	6 in.	6 in.	6 in.	4 in.	4 in.
7 in.	N/A ⁽¹⁾	N/A ⁽¹⁾	5 in.	6 in.	N/A ⁽¹⁾	N/A ⁽¹⁾
8 in.	8 in.	8 in.	8 in.	8 in.	6 in.	6 in.

- Schedule is not available for pipe size.
- No centering disc is available.

Table 1-5. Installation Parameters and Chamber Size Summary

Installation parameter	Chamber diameter		
	2 in.	3 in.	4 in.
Large coaxial probe	✓	✓	✓
Rigid probe	✓	✓	✓
Flexible probe	Not recommended	Application dependent	✓
Coaxial probe	✓ ⁽¹⁾	✓ ⁽¹⁾	✓ ⁽¹⁾
Side connections, large (2 in.)	Not recommended	Application dependent	✓
Side connections, small (1 in.)	✓	✓	✓
Overall length (<2 m)	✓	✓	✓
Overall length (>2 m)	Application dependent (use centering disc/heavy weight)	Application dependent (use centering disc/heavy weight)	✓
Low DC fluid (down to 1.4)	✓	✓	✓
High DC fluid	✓	✓	✓
Rapid fill rates	Application dependent	✓	✓
Boiling, turbulence	Application dependent	✓	✓
Gas lift	Application dependent	✓	✓
Viscous, clogging fluids	Application dependent, heat trace	Heat trace	Heat trace

- Application dependent based on coating properties of the liquid.

Figure 1-3. Weight Dimensions

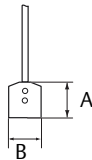
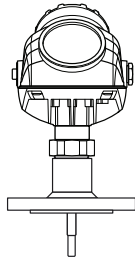

Short weight:

A. 2 in. (50 mm); 4 mm SST probes
B. 1.5 in. (37.5 mm); 4 mm SST probes

Long weight:

A. 5.5 in. (140 mm); 4 mm SST probes
B. 1.5 in. (37.5 mm); 4 mm SST probes

4.0 Replacing displacers with guided wave radar

4.1 Key points

- Mounting flanges vary by displacer supplier
- Probe must extend the length of the displacer chamber
- Large coaxial probe or single rigid probe are the preferred probe choices
- GWR measurements are reliable even when there is vibration or liquid density changes

4.2 Rosemount guided wave radar vs displacer

Displacers are used for level, interface, and density applications, where the buoyancy of the displacer in the fluid is the primary measurement principle. Fluid density is a key factor in determining the size of displacer required and the stability of the application, with deviation from the initial density impacting measurement accuracy. Displacers have moving parts that require frequent cleaning and replacement creating higher maintenance costs. Displacers are affected by mechanical vibration creating the potential for false readings. GWR technology has no moving parts, which means a reduction in maintenance costs as well as improved measurement accuracy and reliability. GWR is not affected by changes in density and provides reliable measurement even when there is mechanical vibration and high turbulence. Replacing displacers with GWR is simplified because existing chambers can often be used. There are many displacer flanges and styles. Both standard ASME and DIN flanges are used, as well as proprietary chamber flanges with a non-standard diameter and gasket surface. It is important to correctly match the Rosemount 5300 flange choice and probe length to the chamber.

4.3 Steps to determining replacement with the 5300 Series

1. Determine which measurement is needed: level, interface or density

GWR is an easy, direct replacement for displacers. For interface level measurements, the upper fluid must have a lower dielectric value than the lower fluid. See the interface guidelines below for more details. GWR is not a suitable solution for density measurements, and a differential pressure transmitter should be considered instead.

2. Check displacer chamber mounting style with the diagrams shown in Figure 1-4 and Figure 1-5

Figure 1-4. Can be retrofitted with GWR

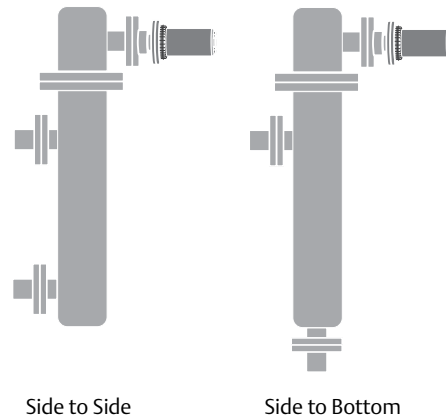
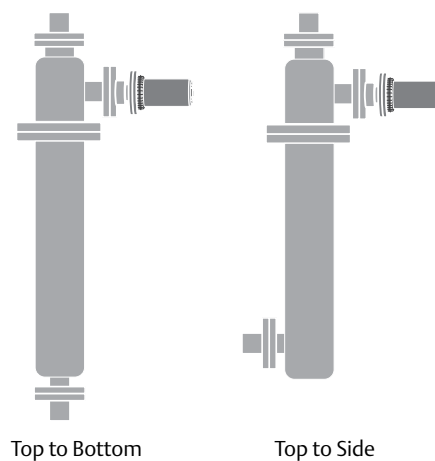

Figure 1-5. Cannot be retrofitted with GWR



3. Determine manufacturer and type of displacer chamber flange (proprietary, ASME or DIN)

The outside diameter (OD) of the flange on top of the chamber can help determine if a proprietary flange is used:

Major torque tube chambers

249B and 259B OD: 9.0 in. (229 mm)

249C OD: 5.8 in. (148 mm)

249K: 10 in. (254 mm)

249N: 10 in. (254 mm)

Masoneilan™ OD: 7.5 in. (190 mm)

All others

Per ASME or DIN specifications

4. Determine from Figure 1-6 if it is a torque tube or spring loaded displacer chamber

Figure 1-6. Spring loaded displacer chamber (left) and torque tube (right)

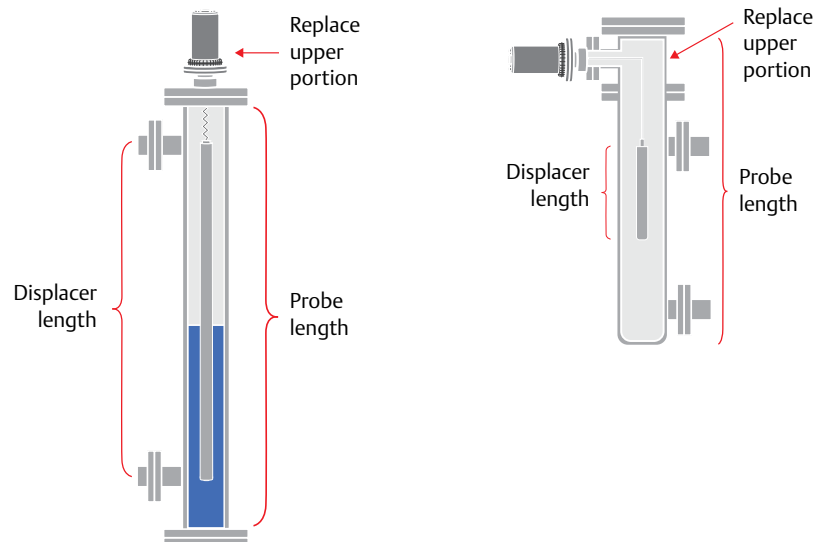

5. Determine probe length

The probe length is measured from the flange face to the bottom of the chamber (internally) as shown in Figure 1-6 or listed in Table 1-6. While the probe needs to extend the full height of the chamber, it should not touch the bottom of the chamber. There should be a small gap (between ½ to 1 in. [12 to 25 mm]) between the end of the probe and the bottom of the chamber.

Table 1-6. Chamber Manufacturers with Probe Length Corrections

Chamber manufacturer	Probe length ⁽¹⁾
Major torque-tube manufacturer (249B, 249C, 249K, 249N, 259B)	Displacer + 9 in. (229 mm)
Masoneilan (torque tube operated), proprietary flange	Displacer + 8 in. (203 mm)
Other torque tube ⁽²⁾	Displacer + 8 in. (203 mm)
Magnetrol® (spring operated) ⁽³⁾	Displacer + between 7.8 in. (195 mm) to 15 in. (383 mm)
Others — spring operated ⁽²⁾	Displacer + 19.7 in. (500 mm)

1. If flushing ring is used, add 1 in. (25 mm).
2. For other manufacturers, there are small variations. This is an approximate value, actual length should be verified.
3. Lengths vary depending in model, SG and rating, and should be verified.

4.4 Setting range values - three options

Chambers are mounted on the vessel to correspond with the desired measurement and area of control. This is often a small portion of the overall height. With displacers, the output span corresponds to the displacer length. The lower (LRV) and upper range values (URV) represent the bottom and top of the displacer. In the side-to-side chambers, this corresponds to center-of-the-pipe connections to the vessel.

Option 1 - Setting LRV to 0 in. (0 mm) at the lower tap

Set the tank height to the distance to the zero level point. In this example, it is the lower side-pipe which is located 19 in. (483 mm) below the reference point. Output range values will equal the pipe connection heights relative to the zero level point. LRV should be set at 0 in. (0 mm) and the URV should be set at 14 in. (356 mm). The probe should be set to the correct probe length.

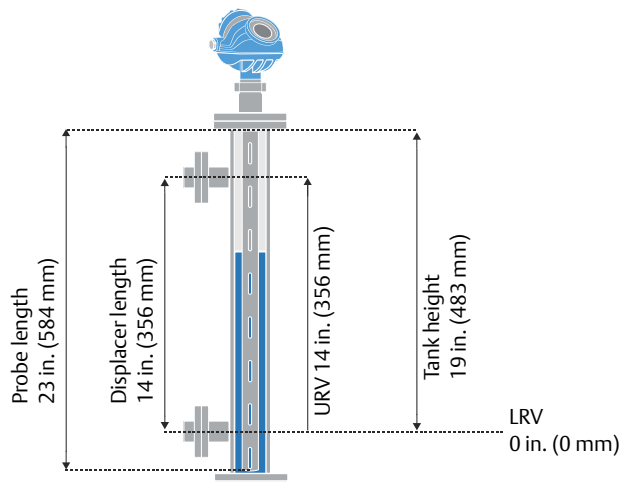

Option 2 - Matching displacer output

The tank height (reference gauge height) and the probe length should be set to the same value. The LRV is the distance from the bottom of the probe to the lower tap. The URV is the LRV plus the distance to the upper tap. In this example, tank height (reference gauge height) equals the probe length of 23 in. (584 mm), the LRV is 4 in. (102 mm), and the URV is 18 in. (457 mm).

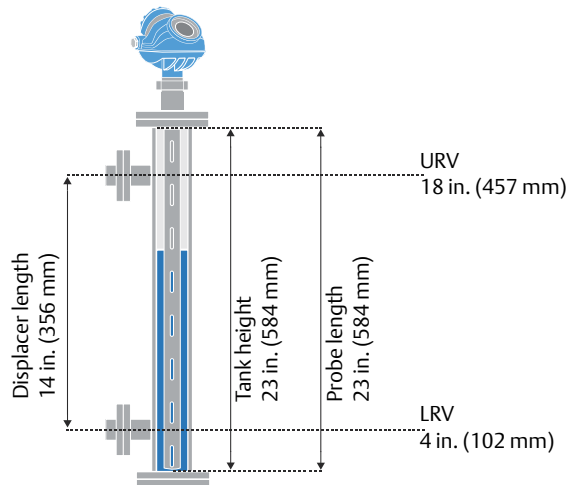

Option 3 - Matching actual tank level

For the level measurement to correspond to the actual level, the correct gauge height needs to be entered. The LRV is the distance from the bottom of the tank, or the common reference line, to the lower tank connection tap. For the URV, simply add the tank connection distance. The actual probe length needs to be entered.

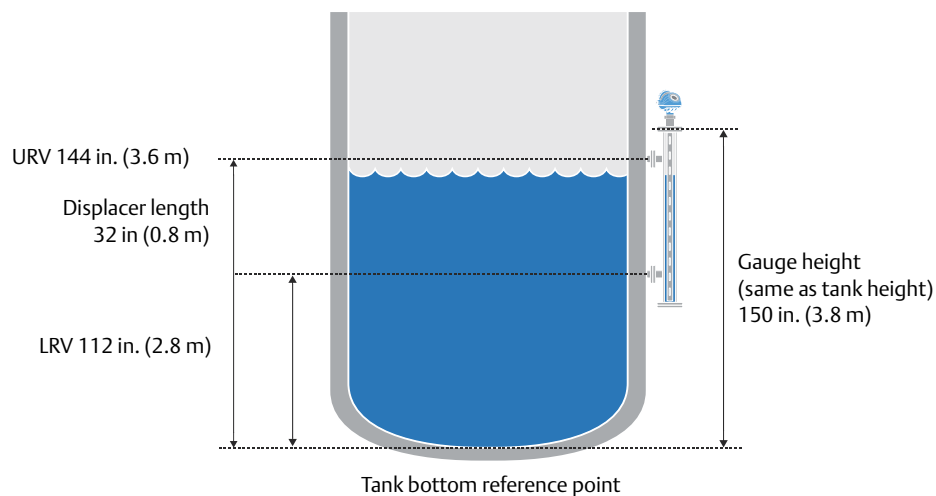

Example: Replacing a 32 in. (813 mm) displacer with a 41 in. (1041 mm) probe. The gauge height is the distance from the top flange to the tank bottom reference point. The probe length will be the actual probe length. The LRV setting will correspond to height of the lower tank connection relative to the tank bottom.

5.0 Interface applications in chambers

A large diameter coaxial probe is recommended for most chamber installations. It offers the strongest signal and is the best option for interface measurements because it will not require chamber venting. Due to the large diameter, it is less prone to build-up. An exception is for chambers where the inner diameter is <2 in., or if the liquid is highly viscous or very dirty. In these instances, single lead probes are recommended. Since the chamber walls help to amplify the signal, single probes can also be used for interface measurement and measurements of materials with a low dielectric. Centering discs are recommended whenever single lead probes are used in chambers.

5.1 Interface in chambers

The following information should be considered when measuring an interface in a chamber. The recommended practice is to measure either the level or interface. A chamber provides a fixed view of the level in a vessel. The effective measurement range of a chamber is the area between the process connections. Thus, when the level drops below or rises above those connections, it will not be visible in the chamber.

Figure 1-7. Chamber Interface Measurement Consideration

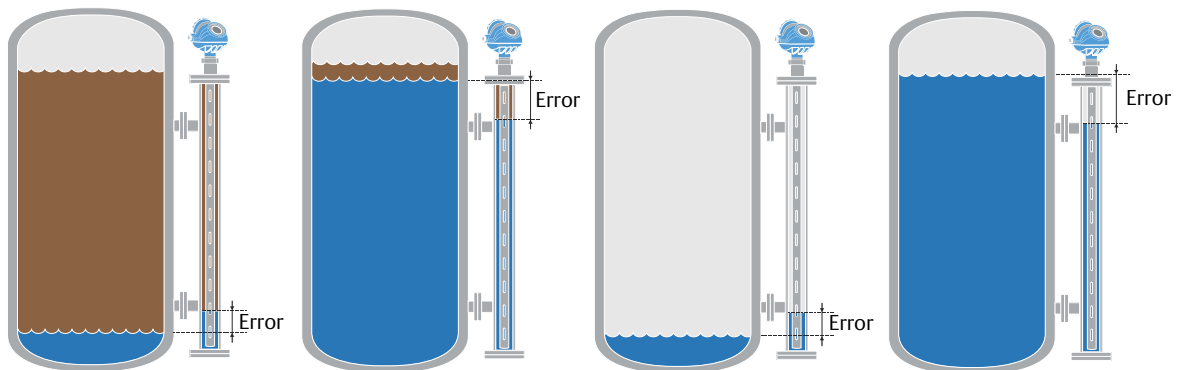

5.2 Match product in tank and chamber

Below are examples of situations that might occur in the field.

Figure 1-8. Difference in Product Specific Gravity (SG)

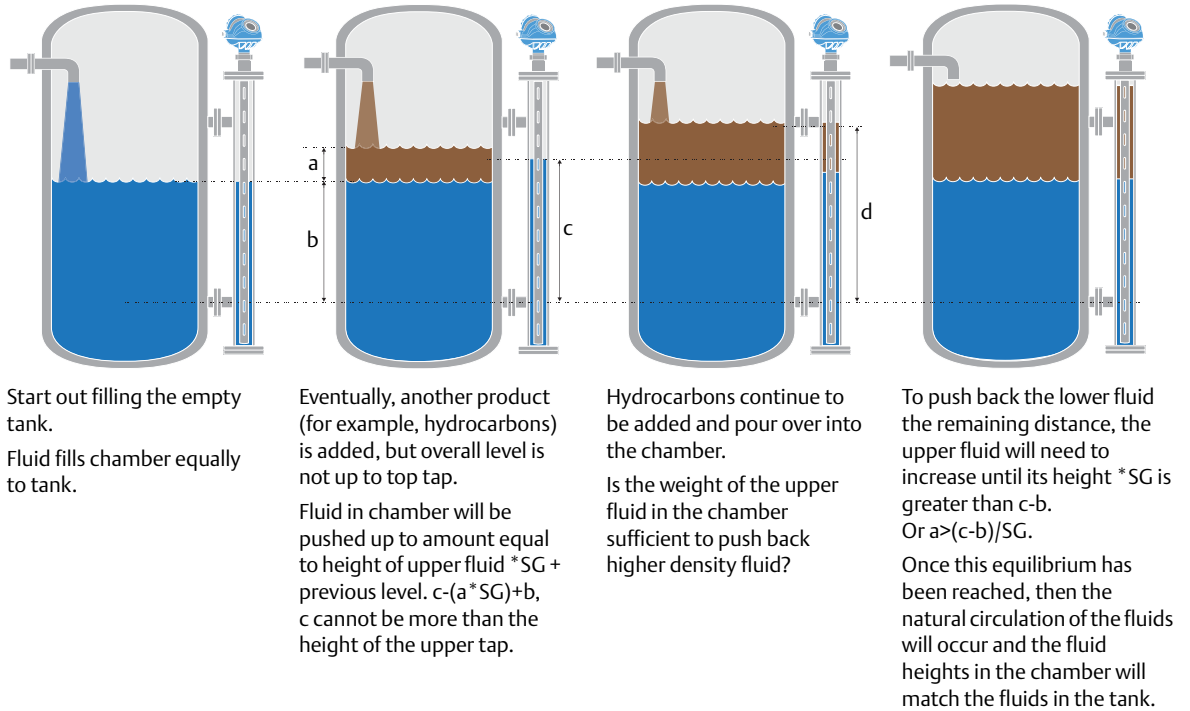
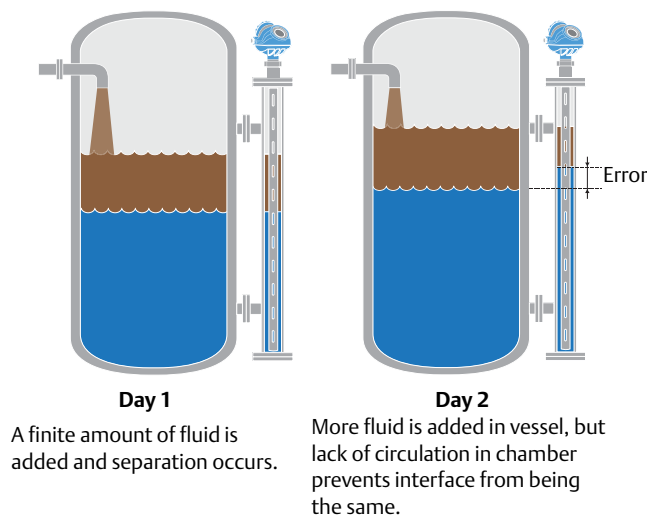

Figure 1-9. Lack of Circulation in Chamber



5.3 Submerged interface

A submerged interface application is one where the upper portion of the probe is in oil or a similar fluid and the interface between the upper fluid and lower fluid is the desired measurement. Often this measurement is performed with the probe mounted in a chamber. A Rosemount 5302 GWR with a large coaxial probe is the most appropriate solution for submerged interface applications. Even if an air pocket forms in the top of the chamber, a Rosemount 5302 with a large coaxial probe will ensure accurate measurement of both interface and level. Furthermore, in the event of power loss the transmitter will resume both level and interface measurement once power is restored.

Figure 1-10. Air Pocket Formation in a Submerged Interface Application

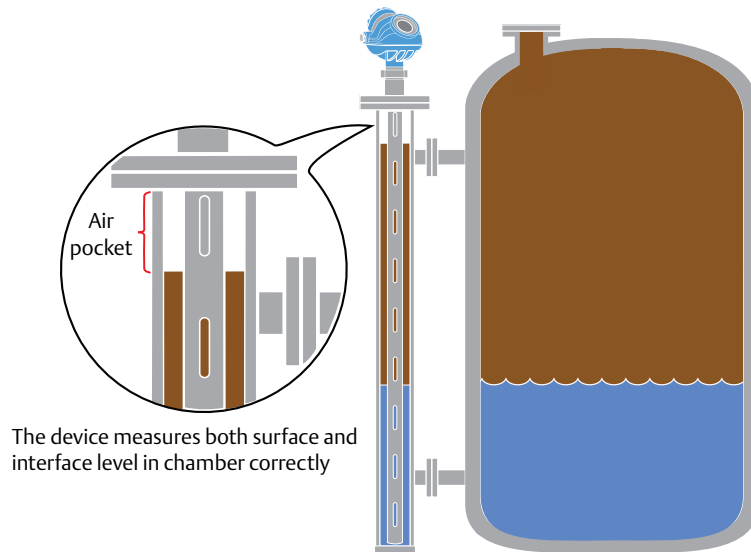

Under special circumstances, such as very viscous fluids or small chambers where the large diameter coaxial probe will not fit, a Rosemount 5301 GWR with a single rigid probe can be used to measure submerged interface. Air is often trapped in the chamber and if there is an air pocket, this creates an offset in the measurement reading due to the difference in the speed of travel of the microwaves in the air space compared to the upper fluid. For example, if the device is configured with oil as the upper fluid, with a dielectric constant of 2, the offset error will be 30 percent of the size of the air pocket (that is, a 15.7 in. (40 cm) air pocket creates a 4.7 in. (12 cm) offset error to the reading).

5.4 Level and interface measurement

Measurement of level and interface in a chamber should be avoided because the lack of fluid flow will not provide representative measurements. However, chambers are often used for interface measurements between oil and water. If this is the only way to perform a measurement, multiple connections to the chamber will help to enhance fluid flow. The additional crossover connections should be located near the most critical measurement areas.

Figure 1-11. Chamber with Multiple Connections

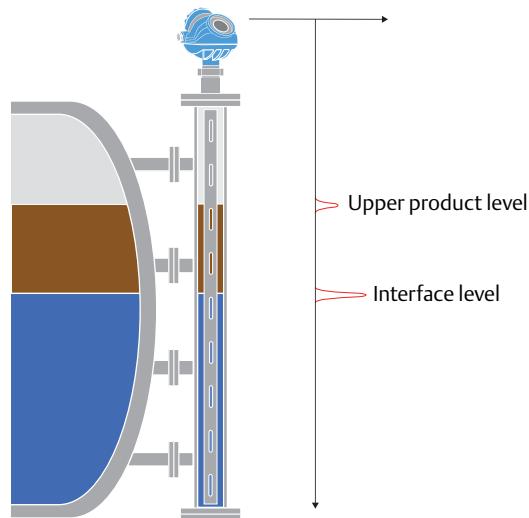

In these types of applications, for the interface measurement to be accurately measured, there must be good flow-through of both the top and bottom fluids. Care must be taken to avoid a layer of fluid being trapped in the chamber. The device must be configured to measure level and interface, with the process variable set to interface. The GWR will measure the distance to the top surface as well as the lower product. The air gap will be measured and included in the calculation of the interface level.

Level and interface measurement key points:

- Lower dielectric fluid must be on the top
- The two liquids must have a dielectric difference of at least 6
- The upper layer dielectric must be known (in-field determination is possible)
- The upper fluid layer thickness must be at least 1 in. (2.5 cm) for the 5300 Series with a large coaxial probe
- Target applications: low upper layer dielectric (<3), high lower layer dielectric (>20)
- Dielectrics of oil and gasoline range from 1.8 to 4. Water and water-based acids have high dielectrics (>50).

Global Headquarters

Emerson Automation Solutions

6021 Innovation Blvd.

Shakopee, MN 55379, USA

+1 800 999 9307 or +1 952 906 8888

+1 952 949 7001

RFQ.RMD-RCC@Emerson.com

North America Regional Office

Emerson Automation Solutions

8200 Market Blvd.

Chanhassen, MN 55317, USA

+1 800 999 9307 or +1 952 906 8888

+1 952 949 7001

RMT-NA.RCCRFQ@Emerson.com

Latin America Regional Office

Emerson Automation Solutions

1300 Concord Terrace, Suite 400

Sunrise, FL 33323, USA

+1 954 846 5030

+1 954 846 5121

RFQ.RMD-RCC@Emerson.com

Europe Regional Office

Emerson Automation Solutions Europe GmbH

Neuhofstrasse 19a P.O. Box 1046

CH 6340 Baar

Switzerland

+41 (0) 41 768 6111

+41 (0) 41 768 6300

RFQ.RMD-RCC@Emerson.com

Asia Pacific Regional Office

Emerson Automation Solutions

1 Pandan Crescent

Singapore 128461

+65 6777 8211

+65 6777 0947

Enquiries@AP.Emerson.com

Middle East and Africa Regional Office

Emerson Automation Solutions

Emerson FZE P.O. Box 17033

Jebel Ali Free Zone - South 2

Dubai, United Arab Emirates

+971 4 8118100

+971 4 8865465

RFQ.RMTMEA@Emerson.com



[Linkedin.com/company/Emerson-Automation-Solutions](https://www.linkedin.com/company/Emerson-Automation-Solutions)



[Twitter.com/Rosemount_News](https://twitter.com/Rosemount_News)



[Facebook.com/Rosemount](https://www.facebook.com/Rosemount)



[Youtube.com/user/RosemountMeasurement](https://www.youtube.com/user/RosemountMeasurement)

Emerson Terms and Conditions of Sale are available upon request.
The Emerson logo is a trademark and service mark of Emerson Electric Co. Rosemount is a mark of one of the Emerson family of companies. All other marks are the property of their respective owners.
© 2019 Emerson. All rights reserved.